

JULY, 1928

25 CENTS

RADIO

(REG. U. S. PATENT OFF.)

IN THIS ISSUE

FIRST
SHOWING
OF NEXT SEASON'S
RADIO
MODELS

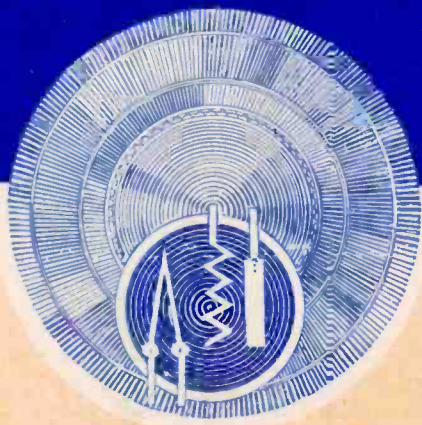

MAGNAVOX DYNAMIC POWER SPEAKERS FOR EVERY SET

Seventeen years ago the first radio loud speaker was created. It was a Magnavox. It was a dynamic. Today the Magnavox Dynamic is in 400,000 homes, in the sets of America's fine radio manufacturers, in the stores of the country's best dealers.

Magnavox Dynamic "translates" the audio delivery of the power tube into a faithful reproduction over the full range of frequencies. It gives ample volume with studio realism.

Write your name on margin of page below for speaker bulletins giving full information.

THE MAGNAVOX COMPANY

Oakland, California

Eastern Sales: 1315 So. Michigan Avenue, Chicago

Magnavox Dynamic Speakers are protected by 13 U. S. and foreign patents. Infringements will be prosecuted.



ARISTOCRAT MODEL

Beautiful butt burl walnut cabinet finished in two tones. It houses Dynamic 6, 7 or 80 unit. List prices:

With—
Dynamic 6, DC. \$70
Dynamic 7, DC. \$75
Dynamic 80, AC. \$85



BEVERLY MODEL

Gracefully proportioned cabinet finished in light mahogany.

For AC Operation, \$70
A-Battery Operation \$55

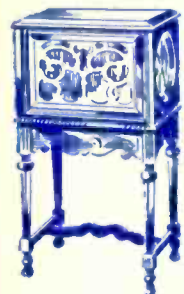

CORDOVA MODEL

With dynamic 700 unit. 110 volt, 60 cycle AC. Combining rectifier and power amplifier. Takes place of last audio stage in set. Handsome walnut cabinet.
List \$175. Unit \$125

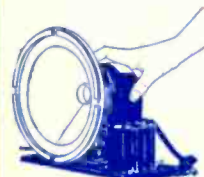

DYNAMIC 80

110 volts AC. Has power transformer and dry rectifier. The most popular unit of the new line. Designed to operate with AC. sets.
Unit, list \$50.

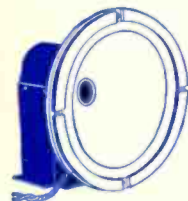

DYNAMIC 6
6 volts DC. Field current consumption, .65 amperes. Operates from A battery.
Unit List Price, \$35

DYNAMIC 7
110 to 220 volts DC. Field current consumption, 45 to 90 milliamperes.
Unit, list \$40

FADA Radio

Excels in the Radio Essentials

Tone Quality / Distance / Selectivity / Reliability

FADA-10

(Illustrated)

THIS new Fada set, pictured below, ready to operate as illustrated from house current lines, in a two-tone ornamental metal cabinet, is a real winner—make no mistake about that.

An A. C. Fada—Single Dial—Illuminated Station Finder, showing wave lengths—Volume control—from full on, smoothly down to a whisper—Vernier for Super-fine operation—

Single casing encompasses entire mechanism—Completely shielded—Improved circuit that minimizes A. C. hum—Exceptional long life, five A. C. tubes—Seven tubes total—Adapted for either short or long antenna—180 Volts on power tube—Operates efficiently on any rated 90 to 130 Volt A. C. line—Available in 25 or 60 cycle models—Unusually attractive cabinet.

F. A. D. ANDREA, Inc.

Jackson Avenue, Orchard and Queens Streets

LONG ISLAND CITY, N. Y.

CHICAGO

KANSAS CITY

SAN FRANCISCO

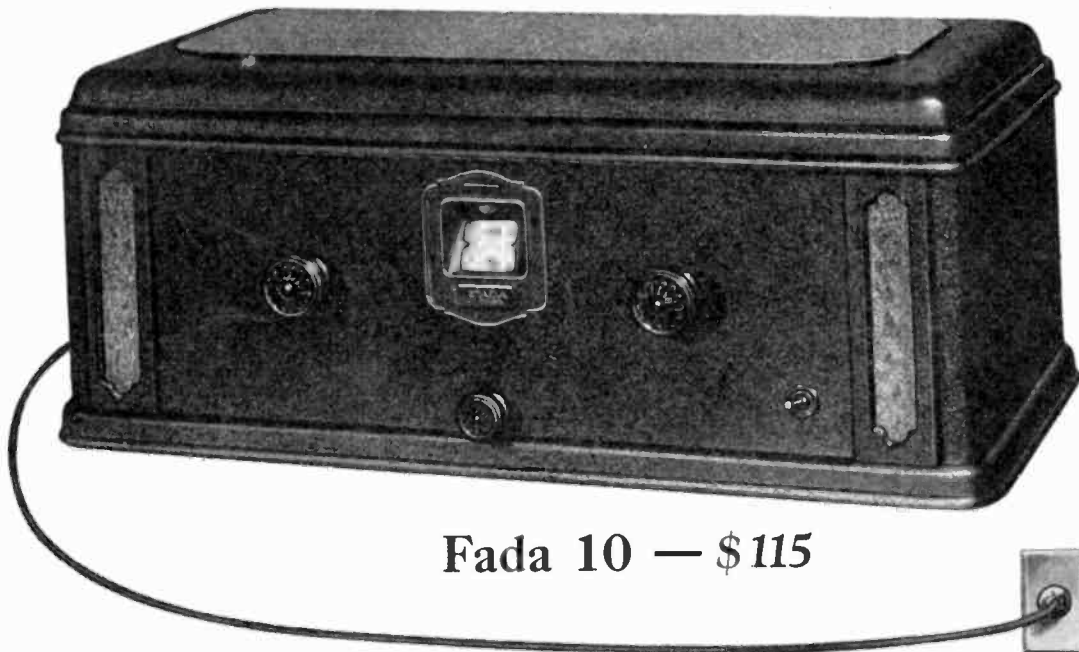

Fada 10 — \$115

\$110 East of the Rockies

Tell them you saw it in RADIO

RADIO

Established 1917

Published Monthly by the Pacific Radio Publishing Co.

ARTHUR H. HALLORAN, Editor
H. W. DICKOW, Business Manager

GERALD M. BEST, Technical Editor
A. I. RIVETT, Draughtsman

Entered as second-class matter at Post Office at San Francisco, Calif.

Copyright 1928 by the Pacific Radio Publishing Co.

Address all communications to

PACIFIC RADIO PUBLISHING COMPANY
Pacific Building, San Francisco, California

Vol. X JULY, 1928 No. 7

CONTENTS

RADIOTORIAL COMMENT.....	17
RADIO EQUIPMENT OF THE "SOUTHERN CROSS".....	18
<i>By Jack Kaufman</i>	
THE A.C. 115 KILOCYCLE SUPERHETERODYNE.....	21
<i>By G. M. Best</i>	
THE SPIDER'S WEB.....	22
<i>By A. E. Kennelly as told to C. William Rados</i>	
A SMALL PUBLIC ADDRESS SYSTEM.....	23
<i>By Francis Churchill</i>	
VOLUME CONTROL METHODS.....	25
<i>By Nelson P. Case</i>	
FIGURING GREAT CIRCLE DISTANCES.....	26
<i>By Arthur Hobart</i>	
A QUESTIONNAIRE FOR RADIO ENGINEERS.....	27
<i>By G. M. Best</i>	
NEW FACTORY-BUILT RECEIVERS AT R. M. A. SHOW.....	29
SOME OF THE NEW LOUDSPEAKERS.....	31
D.C. AND A.C. POWER UNITS AND AUDIO AMPLIFIERS.....	32
SUMMARY OF ALL EXHIBITS AT R. M. A. SHOW.....	33
NEW INSTRUMENTS FOR RADIO MEASUREMENTS.....	36
R.F. AMPLIFYING EQUIPMENT.....	37
NEW AUDIO TRANSFORMERS.....	38
MISCELLANEOUS RADIO ACCESSORIES.....	39
RADIO KIT REVIEWS.....	40
QUERIES AND REPLIES.....	41
WITH THE AMATEUR OPERATORS.....	42
THE COMMERCIAL BRASSPOUNDER.....	43
<i>By P. S. Lucas</i>	
A NEW ANGLE.....	43
<i>By W. L. Jepson</i>	
FRIJOLES, TR'S AND PIGTAILS.....	44
<i>By E. J. Stenman</i>	

FORECAST FOR AUGUST ISSUE

Features of the August issue include an account of some new aids for aerial navigation by S. R. Winters (which was crowded out of the July issue by Jack Kaufman's story), a straight-from-the-shoulder article on radio grounds by Heckert Parker, and "A Selective Screen-Grid Receiver" by Francis Churchill. G. M. Best tells how to make a short-wave adapter for any a.c. receiver. L. T. Carlson describes the construction of a power phone transmitter. James Montagnes illustrates radio control of forest fires in Canada. Maynard J. Columbe gives simple directions for adapting the 115-k.c. superheterodyne to short waves. In addition to the usual departments it is hoped to start a new department on radio pictures, edited by John P. Arnold.

Looking Ahead We See~

from this issue of "RADIO" that the industry is more stabilized, more standardized and in a better position to offer greater values for less money than at any other time in its history.

This July issue of "RADIO" is the first consumer radio publication to carry the whole story of new radio devices exhibited at the Chicago R. M. A. show. Much of the editorial data contained herein was sent to us by air mail on the opening day of the show—June 11th. It reached us two days later. And in another five days copies of this issue of "RADIO" were being made ready for mailing to all parts of the world. That's speed. It proves that "RADIO" can get the scoops to you quicker than its competitors.

The next six issues of "RADIO" will carry more elaborate and detailed descriptions of the many new things in radio for the coming year. A wealth of engineering data is being prepared for us by the engineering staffs of the large radio factories. Many new receivers will be reviewed in the columns of "RADIO," plainly labelled as manufacturer's write-ups. Our own staff authors have a number of real surprises in store for you. The parts manufacturers have so many new ideas to offer that it will take a year to get all of this data to you. Everything of importance will be given publicity in "RADIO."

"RADIO" will be a magazine for every radio enthusiast. IT WILL COVER THE FIELD. In each issue will be found much of interest to the manufacturer, dealer, jobber, professional set-builder and the consumer. Amateur and commercial operators will find valuable articles in every issue.

You can get this magazine for the next six months by sending us a dollar bill today. That's fifty cents less than six copies cost when purchased from a news dealer. Clip the coupon now. Attach a dollar bill, check, money order or stamps and mail NOW.

One
Dollar
and
the
Coupon



"RADIO,"
433 Pacific Building,
San Francisco, Calif.

Here is \$1.00. Send me the next six issues of
"RADIO," starting with the August issue.

Name.....

Street and No.....

City and State.....



One of the 50,000 professional set-builders

who are working to give the American public better radio—longer-lasting radio—more satisfactory radio.

You don't hear much of this army of set-builders. They do not occupy expensive retail stores. They cannot advertise in the big magazines. But they are doing a real job every day of the year. They are building nationally-known circuits to meet the varying conditions of reception in every locality.

One of these Custom Set-Builders is just the man you want to meet and know. He is within easy reach of you. He understands local conditions. His reputation depends on the performance of every set he builds. You will be surprised to learn what a real constructor can do in giving you permanent radio-satisfaction. If you don't know one, just clip, sign and mail the coupon below. We will send you the names of several in your locality.

. . 1928 Infradyne . .

Most Professional Set-Builders recommend the Infradyne when their customers want a set that combines marvelous performance with utmost convenience. Five tubes for local reception; ten when you want to range from coast to coast. The Infradyne is the receiver for the man who won't accept a substitute.

REMLER

Division of

GRAY & DANIELSON MANUFACTURING COMPANY

260 First Street, San Francisco

Chicago

Eastern Warehouse, Elkhart, Indiana

New York

REMLER DIVISION, GRAY & DANIELSON MANUFACTURING CO. 260 First Street, San Francisco, Calif.

Please send me the names of Professional Set-Builders in my locality.

Name..... Street..... City.....

Aluminum Contributes to Radio

—Lightness, Beauty, Finer Results

MANUFACTURERS of the finest sets are using Aluminum in constantly increasing quantities. Their tests have demonstrated that Aluminum is the *one* metal that most efficiently meets the widely differing conditions encountered in radio design.

Its lightness; its permanent beauty; the fact that it does not rust or corrode; its high electrical conductivity; its efficient shielding quality; its "workability"—all are advantages that combine to make Aluminum the ideal metal for radio.

IN many of the most advanced receiving sets Aluminum Shields are used to achieve better tone quality, greater selectivity, closer tuning—in short, finer reception.

Aluminum shielding reduces interference. It eliminates electrostatic and electro-magnetic interaction between various stages of radio-frequency amplification. It eliminates modulation of radio frequency stages by feed-back from audio-fre-

quency amplifier. It makes possible more compact design.

Aluminum performs these functions efficiently and adds less to the weight of the set than any substitute metal. Moreover, it is easily worked into special shield shapes—cans, boxes or casings. Thus it presents few limitations of size and shape.

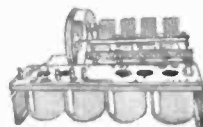

It allows the engineer great freedom to design his shielding to meet, ideally, the various requirements of his set.

ALUMINUM is widely used for variable condenser blades. Aluminum Company of America produces special sheet Aluminum for this purpose that is accurate and uniform beyond anything hitherto attained. Gauge tolerance in thickness is $\pm .001$ inch and the *total* variation within one sheet is limited to .0005 inch.



Aluminum Company of America also makes finished condenser blades from this highly accurate and uniform sheet.

THE leading manufacturers of foil and paper fixed condensers now use Aluminum foil because of its high electrical conductivity and its great covering area (a pound of Aluminum foil .0003 inch thick covers 34,000 square inches). Terminals can readily be soldered to Aluminum foil condensers by a process recently developed by Aluminum Company of America.



ALUMAC Die Castings of Alcoa Aluminum combine lightness, strength, accuracy and high conductivity. They have equal strength with *less than half the weight* of other casting materials. They are used with complete success for loud speaker frames and bases, condensers and condenser frames, drum dials, chasses—and even for cabinets.

There is a fund of information on the use of Aluminum in radio, and on radio in general, in the new edition of "Aluminum for Radio." Your copy of this interesting book will be mailed on request.



ALUMINUM COMPANY OF AMERICA

ALUMINUM IN EVERY  COMMERCIAL FORM
2463 Oliver Building **Pittsburgh, Pa.**

ALUMINUM

The mark of Quality in Radio

Tell them you saw it in RADIO

METALLIZED

Durham Resistors for Every Power Purpose!

NOW, after three years of experiment and research, International Resistance Co. offers a complete line of resistances for all types of receivers, power amplifiers and accessory radio devices at new low costs which represent important savings.

Durham Resistors are supplied in ranges from 500 Ohms to 10 Megohms, while Durham Powerohms range from 1 to 50 Watts and are supplied with every practical type of tip as illustrated. All are constructed upon the well-known Durham Metallized principle which has been approved in every type of service by the most important set and amplifier manufacturers in the country.

As for years past with Durham Resistors, these modern Powerohms are guaranteed for accuracy and absolute dependability.

Samples and full data with accurate operating curves together with prices, supplied upon request.



ABOVE — $\frac{2}{3}$ Actual Size
BELOW — $\frac{1}{2}$ Actual Size

- 1 Durham Resistors—500 Ohms to 10 Megohms; standard brass end tip, mould or pigtail type.
- 2 Durham Grid Suppressors—250 Ohms to 3000 Ohms in steps of 100; standard brass end tip.
- 3 Durham Powerohm—1 Watt; 250 to 1,000,000 Ohms; standard brass end tip or pigtail type.
- 4 Durham Powerohm—2½ Watts; 500 to 250,000 Ohms; standard brass end tip type.
- 5 Durham Powerohm—2¼ Watts; 500 to 250,000 Ohms; knife-end type.
- 6 Durham Powerohm—2½ Watts; 500 to 250,000 Ohms; soldered end tapped type.
- 7 Durham Powerohm—2½ Watts; 500 to 250,000 Ohms; screw-end type.
- 8 Durham Powerohm—5 Watts; 250 to 250,000 Ohms; soldered end tapped or screw-end type.
- 9 Durham Powerohm—10 Watts; 250 to 250,000 Ohms; soldered end tapped and screw-end type.
- 10 Durham Powerohm—25 Watts; 250 to 250,000 Ohms; soldered and tapped.
- 11 Durham Powerohm—50 Watts; 250 to 250,000 Ohms; soldered and tapped.
- 12 Durham Mounting supplied in various lengths to carry any required number of Powerohms where quick change of resistance is necessary.

INTERNATIONAL RESISTANCE COMPANY
2½ South 20th Street, Philadelphia, Pa.

DURHAM

METALLIZED

RESISTORS & POWEROHMS

METALLIZED

Tell them you saw it in RADIO

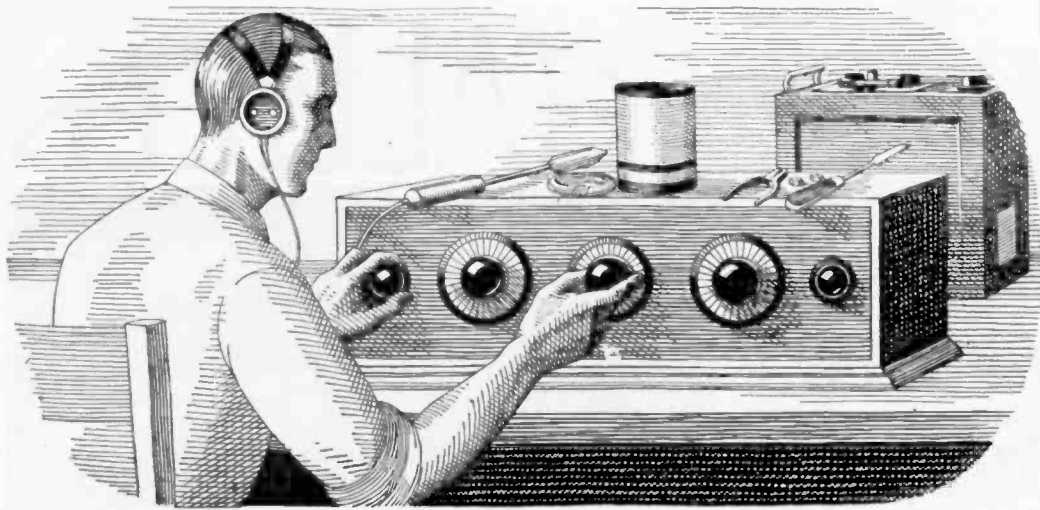

If all the Radio Sets I've "fooled" with in my time were piled on top of each other, they'd reach about halfway to Mars. The trouble with me was that I thought I knew so much about Radio that I really didn't know the first thing. I thought Radio was a plaything—that was all I could see in it for me.

I Thought Radio Was a Plaything

But Now My Eyes Are Opened, And I'm Making Over \$100 a Week!

\$50 a week! Man alive, just one year ago a salary that big would have been the height of my ambition.

Twelve months ago I was scrimping along on starvation wages, just barely making both ends meet. It was the same old story—a little job, a salary just as small as the job while I myself had been dragging along in the rut so long I couldn't see over the sides.

If you'd told me a year ago that in twelve months' time I would be making \$100 and more every week in the Radio business—whew! I know I'd have thought you were crazy. But that's the sort of money I'm pulling down right now—and in the future I expect even more. Why only today—

But I'm getting ahead of my story. I was hard up a year ago because I was kidding myself, that's all—not because I had to be. I could have been holding then the same sort of job I'm holding now, if I'd only been wise to myself. If you've fooled around with Radio, but never thought of it as a serious business, maybe you're in just the same boat I was. If so, you'll want to read how my eyes were opened for me.

When broadcasting first became the rage, several years ago, I first began my dabbling with the new art of Radio. I was "nuts" about the subject, like many thousands of other fellows all over the country. And no wonder! There's a fascination—something that grabs hold of a fellow—about twirling a little knob and suddenly listening to a voice speaking a thousand miles away. Twirling it a little more and listening to the mysterious dots and dashes of steamers far a sea. Even today I get a thrill from this strange force. In those days, many times I stayed up almost the whole night trying for DX. Many times I missed supper because I couldn't be dragged away from the latest circuit I was trying out.

I never seemed to get very far with it, though. I used to read the Radio magazines and occasionally a Radio book, but I never understood the subject very clearly, and lots of things I didn't see through at all.

So, up to a year ago, I was just a dabbler—I thought Radio was a plaything. I never realized what an enormous, fast growing industry Radio had come to be—employing thousands and thousands of trained men.

I usually stayed home in the evenings after work, because I didn't make enough money to go out very much. And generally during the evening I'd tinker a little with Radio—a set of my own or some friend's. I even made a little spare change this way, which helped a lot, but I didn't know enough to go very far with such work.

And as for the idea that a splendid Radio job might be mine, if I made a little effort to prepare for it—such an idea never entered my mind. When a friend suggested it to me one year ago, I laughed at him.

"You're kidding me," I said.

"I'm not," he replied. "Take a look at this ad."

He pointed to a page ad in a magazine, an advertisement I'd seen many times but just passed up without thinking, never dreaming it applied to me. This time I read the ad carefully. It told of many big opportunities for trained men to succeed in the great new Radio field. With the advertisement was a coupon offering a big free book full of information. I sent the coupon in, and in a few days received a handsome 64-page book, printed in two colors, telling all about the opportunities in the Radio field and how a man can prepare quickly and easily at home to take advantage of these opportunities. Well, it was a revelation to me. I read the book carefully, and when I finished it I made my decision.

What's happened in the twelve months since that day, as I've already told you, seems almost like a dream to me now. For ten of those twelve months, I've had a Radio business of my own. At first, of course, I started it as a little proposition on the side, under the guidance of the National Radio Institute, the outfit that gave me my Radio training. It wasn't long before I was getting so much to do in the Radio line that I quit my measly little clerical job, and devoted my full time to my Radio business.

Since that time I've gone right on up, always under the watchful guidance of my friends at the National Radio Institute. They would have given me just as much help, too, if I had wanted to follow some other line of Radio besides building my own retail business—such as broadcasting, manufacturing, experimenting, sea operating, or any one of the score of lines they prepare you for.

And to think that until that day I sent for their eye-opening book, I'd been wailing "I never had a chance!"

Now I'm making, as I told you before, over \$100 a week. And I know the future holds even more, for Radio is one of the most progressive, fastest-growing businesses in the world today. And it's work that I like—work a man can get interested in.

Here's a real tip. You may not be as bad off as I was. But think it over—are you satisfied? Are you making enough money, at work that you like? Would you sign a contract to stay where you are now for the next ten years—making the same money? If not, you'd better be doing something about it instead of drifting.

This new Radio game is a live-wire field of golden rewards. The work, in any of the 20 different lines of Radio, is fascinating, absorbing, well paid. The National Radio Institute—oldest and largest Radio home-study school in the world—will train you inexpensively in your own home to know Radio from A to Z and to increase your earnings in the Radio field.

Take another tip—no matter what your plans are, no matter how much or how little you know about Radio—clip the coupon below and look their free book over. It is filled with interesting facts, figures, and photos, and the information it will give you is worth a few minutes of anybody's time. You will place yourself under no obligation—the book is free, and is gladly sent to any one who wants to know about Radio. Just address J. E. Smith, President, National Radio Institute, Dept. 7-R, Washington, D. C.

J. E. SMITH, President,
National Radio Institute,
Dept. 7R, Washington, D. C.
Dear Mr. Smith:

Please send me your 64-page free book, printed in two colors, giving all information about the opportunities in Radio and how I can learn quickly and easily at home to take advantage of them. I understand this request places me under no obligation, and that no salesman will call on me.

Name.....
Address.....
Town..... State.....
Occupation.....

Tell them that you saw it in RADIO

Radio Employers

Do You Need Trained Experienced Men?

Will You Need Any in the Future?

For additions to, or replacements in your organization, call on us. Our Employment Department has trained, experienced men available that can be supplied on short notice to almost any point in the United States and Canada. There is absolutely no charge to the employer or the employee for this service.

Men qualified by training and experience for Radio manufacturers, jobbers, dealers, ships, broadcasting stations, laboratories—service men, salesmen, mechanics, assemblers, set testers, licensed men for operating; Radio men for every conceivable opening are on our list.

Whether you need men now or anticipate requiring one or more in the future, send the coupon below. George O. Sutton, Manager, Employment Department, will promptly send you a list of men he has available qualified for your opening and, if you wish, will send you regularly our employment bulletin, listing men he has available and their qualifications.

We are the pioneer and world's largest home-study Radio school. Our students and graduates are to be found in almost every large Radio organization. Our course of training is complete, practical; teaches the "how and why." Your organization is only as efficient, as large as the men who work for you. Get thoroughly trained men from us.



SEND THIS COUPON, MR. RADIO EMPLOYER. Let us help you find good men for your present or future openings.

The coupon on the opposite page is for the man who is in the Radio business and wants to learn more about Radio and how to make more money also for the man who is interested in getting in it.

GEORGE O. SUTTON,
Manager, Employment Dept.,
Dept. 7-R,
National Radio Institute,
Washington, D. C.

We have an opening for (describe position).....

We anticipate needing (describe positions).....

Send me a list of the men you have available.

Name

Address

Occupation

Put (me) (us) on your list to receive regularly a copy of your free Employment Bulletin.

Tell them you saw it in RADIO

LEUTZ

UNIVERSAL TRANSOCEANIC

9 TUBES

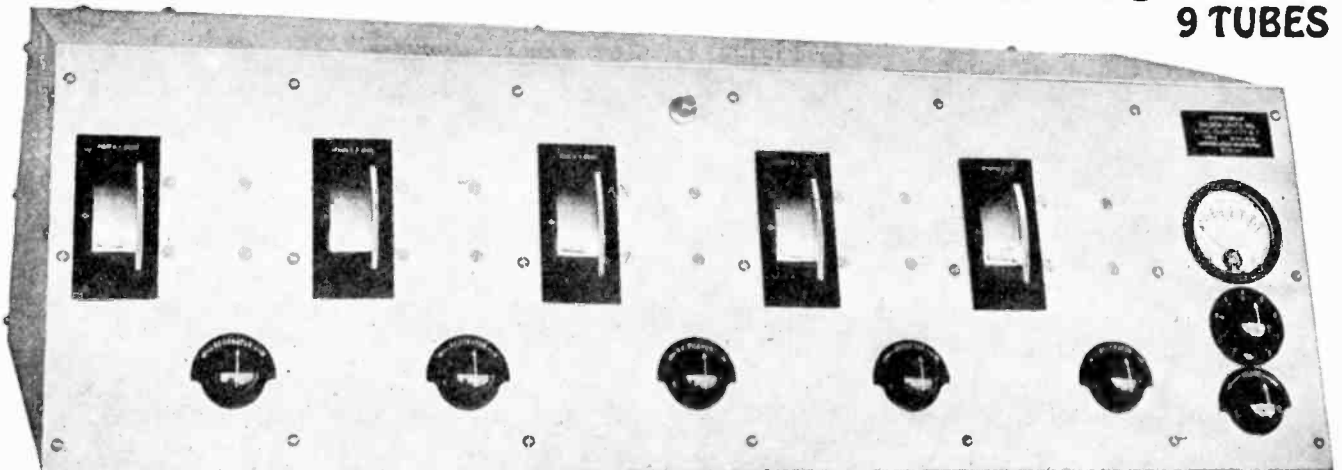

TRUE SELECTIVE POWERFUL

NEW IMPROVEMENTS

THE UNIVERSAL TRANSOCEANIC has now been completely redesigned to use the new 222 Screened Grid Tubes in the four stages of radio frequency amplification. The total radio frequency amplification is now approximately 810,000 compared with only 10,000 obtained with the 201A tubes. This allows increased receiving range, greater volume on distant signals and without any loss in selectivity. The detector circuit has been altered to use the new 200 type detector.

The audio amplifier has been further improved, a total of four stages being employed, two of these stages in a push-pull system. The push-pull power

amplifier will take either two 210 or two 250 power tubes, the most powerful audio amplifier one could desire. The undistorted output available for the loud speaker is approximately five times greater than a receiver using only one 210 or 250 power tube.

The 400/500 Volt DC Current Supply has been changed to the full wave type using two 281 rectifier tubes for increased output. Provision has been made to use a Dynamic speaker if desired. The addition of the Leutz "A" Current Supply having a capacity of 3 amperes at 6 volts makes it available for all electric operation.

Present owners of Transoceanics can have the above improvements added to their receivers at a nominal cost, sending the receiver to our factory.

WRITE FOR LATEST LITERATURE TODAY

C. R. LEUTZ, Inc., 195 Park Avenue, Astoria, New York

QUALITY AT LOW COST

The Radio Book You Want!

"MODERN RADIO RECEPTION"

A Complete Ready Reference Educator

250 ILLUSTRATIONS **\$3.00** MODERN RADIO RECEPTION 384 PAGES
 384 Pages—250 Illustrations Fully Bound—6 x 9 inches
 Three Dollars Complete

PRACTICAL HELPS IN HANDY FORM

Diagrams, charts, graphs, illustrations, tables, easily read text make difficult problems easy.

"Modern Radio Reception" is a good book, explaining all important subjects on radio reception and radio receivers, written in a clear manner easily understood by anyone. It is not too technical and the mathematical examples are confined to simple problems.

Considerable information is given on the operation and care of radio receivers and accessories. The most powerful receiver for broadcast reception in the world, the Transoceanic Silver Ghost, is described in detail. Short Wave Reception is also covered, as this is one of the coming things in world-wide broadcast reception.

As this handy book covers the entire field of broadcast reception in such a clear and complete manner it will prove

to be a practical daily help to both the student and professional worker as well as the broadcast listener.

Professional and Student Radio Engineers find "Modern Radio Reception" a Time and Money Saver. The book that every Broadcast Listener should own.

Here is an up-to-date, quick ready reference and text book on radio reception. It is the only up-to-date book exclusively on radio reception. Such late improvements as A.C. Tubes, Shielded Grid Tubes, "A" Eliminators, Push Pull Power Amplifiers, 400-volt "B" Eliminators, etc., are covered in detail.

All the different important subjects relating to radio reception are covered in an interesting and clear manner. By reading this book you can probably save the price of the book many times, the suggestions will save you money and enable you to secure the best results in your radio receiving work.

A RADIO EDUCATOR

This single volume contains all the practical up-to-date radio receiving information that the professional radio worker, broadcast listener, student or amateur needs. "Modern Radio Reception" is fully bound, size 6 x 9 inches, 384 pages, over 250 illustrations including many graphs and circuit diagrams. It is nicely bound, a book that will look well on your library table, furnishing the means of a thorough knowledge of radio reception by spare time reading and study.

Some of the Subjects Covered

Antennae
 Counterpoise
 Ground
 Condenser Plate Shapes
 Acoustic Chart
 Transmission Units
 Dynamic Loud Speakers
 Cone Loud Speakers
 Dynamotors
 Inductances
 Condensers
 Shielding
 Resistors
 D.C. Battery Eliminators
 Wavemeters

Meters
 Oscillators
 Audibility Meter
 Capacity Bridges
 Mechanical Oscillators
 Ohmmeter
 Beat Oscillator
 Amplifier Test Set
 Push Pull Amplifiers
 Vacuum Tube Bridge
 String Oscillograph
 Piezo Electric Oscillator
 Synchronous Motor
 Vacuum Tube Reactivation
 Decade Bridge

Tungar Chargers
 Coupling Methods
 "A" Eliminators
 "B-C" Eliminators
 Power Amplifiers
 Western Electric Super-Heterodyne
 Grebe Synchrophase
 Norden Hauck Super-10
 Frequency Changers
 Vacuum Tubes
 Ballast Tubes
 A.C. Tubes
 Radio Standards and Definitions
 Radio Symbols
 Short Wave Reception

List Short Wave Stations
 Universal Transoceanic
 Super-Heterodynes
 Consoles
 Universal Silver Ghost
 Super-8
 Universal Plio-6
 Wave Antenna
 Radio Servicing
 Tube Characteristics
 World Time Chart
 Overloading Tubes
 Audio Amplifiers
 Shielded Grid Tubes
 Radio Amplifiers

FREE EXAMINATION

Effective immediately, free examination will be allowed. We accept payment for our book only after the book is worth the money. Postpaid to any address in the United States.

USE THE COUPON ATTACHED TO GET THIS FREE OFFER.

C. R. LEUTZ, Inc., 195 Park Place, Long Island City, New York.
 Gentlemen:

- Please send C.O.D. one copy 1928 Edition of Modern Radio Reception.
 I enclose \$3.00. Please send postpaid one copy Modern Radio Reception.

Note: In either case I am allowed seven days Free Examination. If found unsatisfactory, full price of \$3.00 is to be refunded upon return of book.

Occupation Name
 Employed by Address
 City State

Tell them you saw it in RADIO

4 PURPOSE LIGHT-SOCKET AERIAL and POWER OUTLET

TOBE

COMBINES 4 RADIO CONVENIENCES

in one small unit at a negligible cost

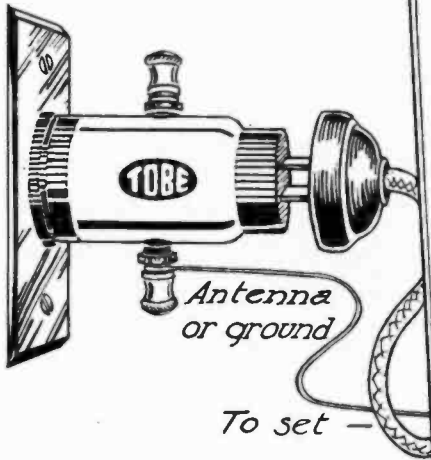

1. A perfect indoor antenna, eliminating static pick-up and giving clear, pure tone reception, or—
2. A convenient and efficient ground without troublesome water pipe connections or long wires, and—
3. A power socket outlet which may be used for operating set, B eliminator, power pack, charger or any electrical apparatus, and
4. Takes the place of a lightning arrester, protecting the set from all high potential atmospheric discharges.

The most convenient of all recent radio developments. With it your set is as self-contained and as easy to operate as a reading lamp.

TWO-YEAR GUARANTEE

Each "4 Purpose Aerial" is sold with a TOBE iron-clad two year replacement guarantee.

TEN-DAY FREE TRIAL

Special arrangements with your dealer enable you to test the "4 Purpose Aerial" in your home for ten days free trial. If you are not absolutely satisfied after using with your own set and under your own receiving conditions, your money will be returned to you without question.

Secure your "4 Purpose Aerial" now!

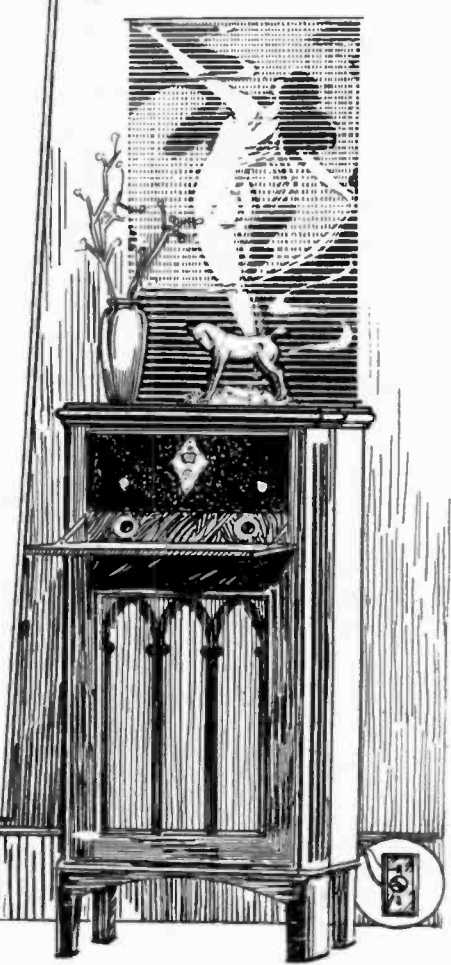

2.00

10 DAYS FREE TRIAL
2 year replacement guarantee

TOBE DEUTSCHMANN CO.
CAMBRIDGE, MASS.

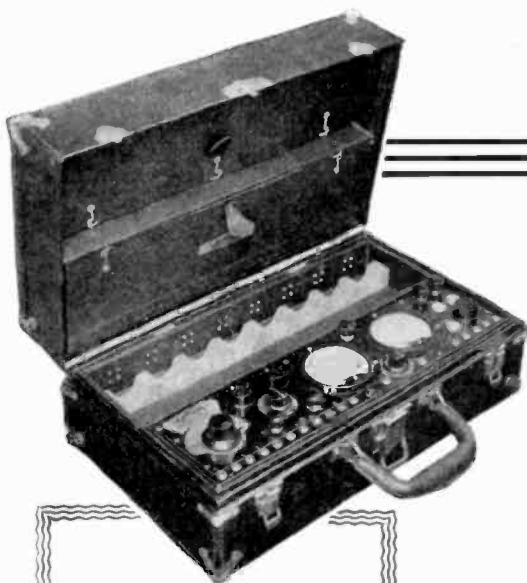

"Supreme" Model 100A
Radio Service Instrument and
Travelling Case

Instrument lifts out of case. Fully equipped with instrument, all tools, and supplies necessary for a service man to step out on a job. This case contains compartments for everything and has a tube shelf designed for instant accessibility but absolute protection to tubes. Under this swinging shelf are felt-lined compartments for small tubes, oscillator coils, etc. Has lock and key. Strong leatherette covered case, size 10½x18x7 inches. Price complete, \$98.50 net. Equipped with large A.C. meter O-3, O-18, O-150 volt triple scale with leads, in leather case. \$11.00 extra.

Installment plan. \$28.50 cash and 8 monthly payments of \$10.00 each.

A.C. **SUPREME** D.C.
SERVICE INSTRUMENTS

Trade Mark Reg. U. S. Pat. Off.

**FOR DEALERS, SERVICE MEN AND
PROFESSIONAL SET BUILDERS**

HERE ARE A FEW REASONS WHY THEY ARE TELEGRAPHING ORDERS FOR SUPREMES

1. The tube broadcaster sends out a modulated wave to test radios at any time, any place.
2. It is the only oscillator with which you can synchronize condensers in single dial control radios with both meter reading and audible sound.
3. It tells the oscillation quality of all tubes and whether they are normal, abnormal or subnormal.
4. It rejuvenates up to twelve tubes at one time in a scientific manner. In or out of the radio.
5. It locates open transformers from the socket and has a feature that it will play the radio with bad transformers for estimating, to locate further trouble.
6. It will demonstrate condenser and choke coil outputs on radios not wired for that purpose and also inductive output.
7. It will test fixed condensers and has a calibrated .0005 variable condenser.
8. It has contained various fixed condensers up to 2. mfd, a 500,000 ohm variable resistance and a 30 ohm variable resistance for your use at any time and for quick demonstration purposes.
9. And it will make every milliammeter and voltmeter test imaginable.
10. It is equipped with a high resistance double scale precision voltmeter, O-10, O-250 volt for all eliminator and other readings requiring a meter using only .001 ampere at full scale. The millimeter is O-100 and both meters are large 3¾" diameter with jeweled D'Arsonval movement, fully guaranteed. The A.C. Meter has three scales, O-3, O-18, O-150, which is portable and has leads to plug into the Supreme pin jacks.
11. The book which goes with the Supreme is entitled "How to Service Radios and Money-Making in Radio Service," and is some book.
12. All adapters, double plug cords, test cords, etc., for A.C. and D.C. work are standard equipment.

Our Engineering Department is at the service of Supreme owners at all times to help them in their service work and is worth the price of the instrument. However, in the Supreme you get an assembly that you could not duplicate yourself at the price and you get three years development. Send for one today, and watch your service business take a decided boost.

TEN DAYS FREE TRIAL

If we accept your order, you will be furnished with a Supreme on open account. You may use the Supreme and if it is not what you want it may be returned within ten days. All terms of purchase must be strictly adhered to.

If you have not had dealings with this concern heretofore, send the customary trade references with your order, otherwise shipment will be delayed until they are received. We warn here—If the seal of a Supreme is broken and the instrument returned, we will fully prosecute and collect damages in full.

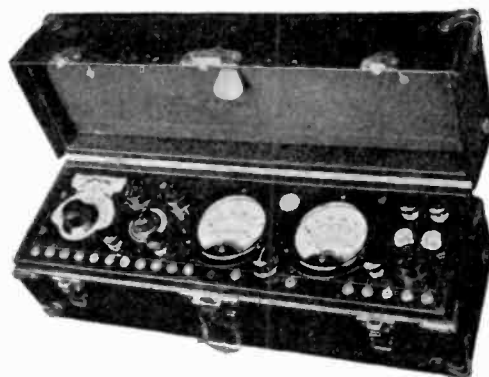

SUPREME MODEL 80A
Radio Service Instrument, Store Case
Cover has slip hinges for removal

Fully equipped with instrument, special test cords, adaptors, coils, and everything needed to test radios and demonstrate in the store or on counter. Cover has compartment to hold all accessories. Has lock and key. Strong leatherette covered carrying case, size 7"x18"x5½".

PRICE COMPLETE \$89.50 NET!

Equipped with large A.C. meter O-3, O-18, O-150 volt triple scale with leads, in leather case \$11.00 extra.
Installment plan. \$28.50 cash and 7 monthly payments of \$10.00 each.

SEND

*the coupon
NOW!*

SUPREME
INSTRUMENTS
CORP.,
Greenwood, Miss.

Date.....

Please ship.....

Supreme Model.....

with.....A.C. meter
and your book, "How to Service
Radios and Money-Making in Radio
Service," to the undersigned who
understands and agrees that title re-
mains in you until paid for. Attached
are customary trade references.

Name.....

Address.....

Town.....State.....

Supreme Instruments Co.
Greenwood, Mississippi

Worth while profits for you in this year 'round seller---

When you sell a Samson Pam Amplifier you can usually sell

Type PAM 16 is for all ordinary types of loud speakers.

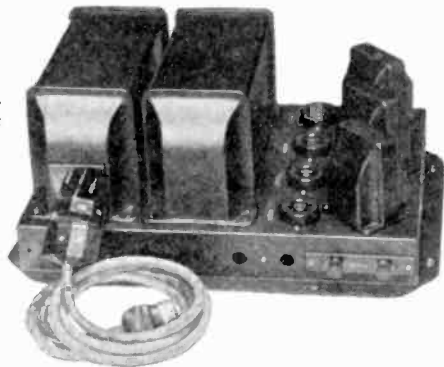

tubes, phonograph pick up and turn table, microphone, radio set, loud speakers or head sets and wiring for installation

Type PAM 17 is for and supplies field current to dynamic type speakers.

A SELF-contained, rugged, all electric, two-stage audio amplifier, with the famous Symphonic and Symphonic Push-Pull Transformers, uses the new AC tubes and operates from 110 volt 50-60 cycle AC current. Compensation is made for line voltage variation. Designed to meet Underwriters' and AIEE Standards, and made for either dynamic or ordinary type loud speakers as specified.

Wide variety of uses make the Samson Pam Amplifier a universal all year ready seller for:

Electrification of Phonographs
 Quality Power Amplifier for Home Entertainment
 Announcement Amplifier
 Public and Private Institutions
 Incidental Music in Theatres, Lodges, etc.
 Beauty Parlors, Shops, etc.

Distribution of Radio Programs to Apartments, Hotel and Hospital Rooms, etc.
 Sound Detecting Systems
 Dance Music in Tea Rooms, Dancing Schools, Dance Halls, Restaurants, Cabarets, etc.
 Roadside Stands, Filling Stations, etc.
 Athletic Contests, Races, Fairs, etc.

If you did not receive our broadside containing a special offer for one sample Pam amplifier, write for details

SAMSON ABC ELIMINATOR, TYPE ABC71

supplies raw AC filament current from 105, 110, 115, 120 volt, 50-60-cycle power source to five 226, two 227 and two 171 type tubes. Also supplies 3 voltages as follows: 30 to 75 volts variable and 90, 135, 180 fixed. C voltages supplied are $-4\frac{1}{2}$, -9 , and -40 . This is practically a constant voltage eliminator, and it has a total capacity of 70 mils.

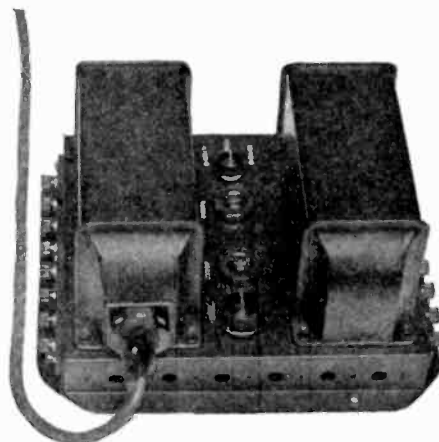

General Offices
 CANTON, MASS.

Samson Electric Co.
MEMBER
R.M.A.

Factories: Canton and
 Watertown, Mass.

This Is a Private Label Year!

Open View-Table Model. Note ready accessibility of tubes, power supply, etc. Made for either type tubes, standard R. C. A. 5 No. 227, and 1 No. 171, or Heater Type 5 No. 401 and 1 No. 403.

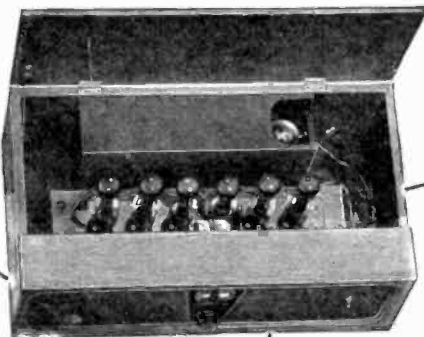

Rear View. All metal chassis, very strong and rigid, stays put in shipment. Beautifully finished in rich brown Duco. Panel sizes—7"x18", or 7"x21".

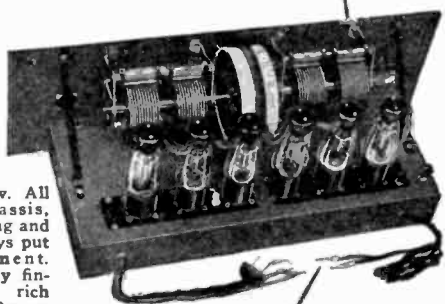

Table Model. Solid walnut cabinet—rich in its simplicity. Front panel natural wood, mounted on heavy steel back panel. Size 22"x8½"x12½" deep.



Console Model. A beautiful solid walnut cabinet finely finished. Equipped with "Peerless" Speaker. Size 26"x40"x16" deep.

Are You Ready With Yours?

Good Radio Merchandisers are doing it this season. There's a reason—more real profits. Private brand radio is the remedy for top-heavy inventories, insufficient mark-up, fixed selling price. It permits you to meet fluctuating market conditions and all kinds of competition. It preserves your trade identity—the most valuable possession you have.

Premier has everything—Looks—Quality—Performance—Comparable with the best every way—All metal chassis—Rigid—Strong—Stays Put—Unconditionally guaranteed—Chassis—Table and Console Models—Made for either type A-C Tubes. 5 No. 227 and 1 No. 171, or 5 No. 401 and 1 No. 403—Licensed under U. S. Navy Patents and Hogan Patent No. 1,041,002.

To those interested in a Private Brand Chassis or Complete Set and wanting a responsible supplier, we respectfully extend an invitation to write us.

PREMIER ELECTRIC COMPANY

Established in 1905 and Manufacturers Ever Since

Dept. 175, 3800 Ravenswood Ave.

Chicago, Illinois

Tell them you saw it in RADIO

BOOTH No. 158
Stevens Hotel, Chicago
June 11-15

The New Abox

A. C. CONVERTER
Makes your set Electric
No change in tubes
or wiring

All the features that made Abox the outstanding success of last year are retained in this new model. The improvements are the result of untiring research and the experience gained from many thousands of these devices in actual service.

For convenience a receptacle for the "B" unit and a control switch is now standard equipment. A new design and attractive finish adds to its trim appearance.

Interior changes in construction give assurance of even longer life and better service.

The reliability and efficiency of the standard D. C. tubes need not be sacrificed to enjoy the convenience of true electric operation. Abox converts 110-volt 50—60-cycle current to hum-free direct current thus giving true A. C. operation. No storage battery is used.

The Abox may also be used to supply current for the 6-volt dynamic speaker.

\$35.00

Licensed by the
Andrews-Hammond
Corporation, under
Patent No. 1,637,795
and applications

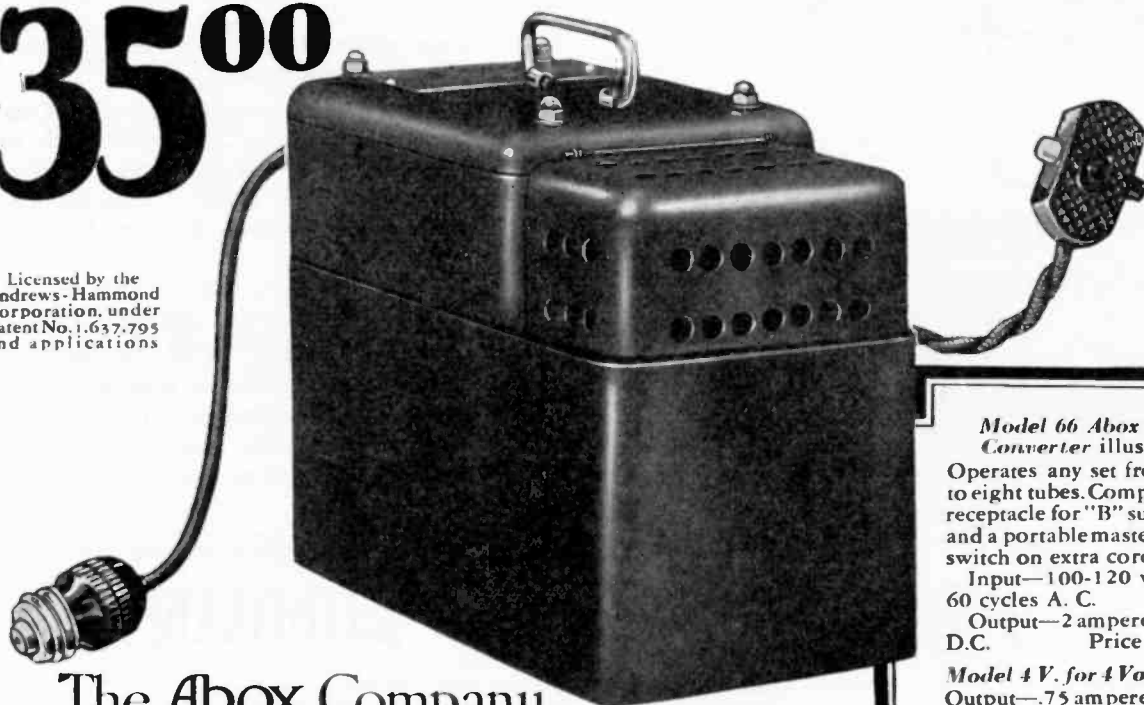

The Abox Company

215 N. Michigan • Chicago, Ill.

**Model 66 Abox A. C.
Converter illustrated**

Operates any set from three to eight tubes. Complete with receptacle for "B" supply unit and a portable master control switch on extra cord.

Input—100-120 volts, 50-60 cycles A. C.

Output—2 amperes, 6 volts D. C. Price \$35.00

Model 4 V. for 4 Volt Tubes

Output—.75 amperes, 4 volts D. C. Price \$27.50

Prices higher on West Coast

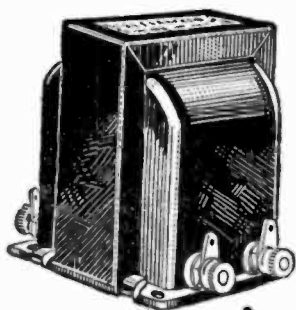

In Most of The Better Radio Receivers

Watch dogs of tone quality safeguarding the musical reproduction of broadcast programs, Thordarson Audio Transformers do their part in making real musical instruments of hundreds of thousands of receiving sets annually.

Among leading set manufacturers, Thordarson transformers have long been recognized for their fidelity of reproduction. Today their use is so universal that it is difficult to find a dealer who does not sell at least one make of receiver so equipped.

Try this simple experiment. Ask your dealer for a demonstration of his receivers. Pick out the instrument with the most natural reproduction, and then look inside the cabinet. You will find, in the majority of cases, Thordarson amplifying and power supply transformers.

You will realize that it is wise to specify Thordarson amplification when buying your receiver, for the manufacturer who is far-seeing enough to equip his sets with Thordarson transformers, may be depended upon to have the balance of his instrument in keeping with this high standard.

new!



THORDARSON
R-300
AUDIO TRANSFORMER

A superior audio transformer that will satisfy the most critical musical ear. The high impedance windings of the R-300 are wound on a core of D-X Metal, a recent development of the Thordarson laboratory. This new core material has an exceedingly high A.C. permeability, and an inductance that is 50% greater than that of the highest grade silicon steel. In performance, this transformer responds exceptionally well to the lower frequencies and provides the same degree amplification to the diapason of the grand organ as to the note of the flute. Ratio 3:1. Dimensions, $2\frac{1}{2}$ " x $2\frac{1}{2}$ " x 3" high. Weight, 2 lbs. Price, \$8.00.

THORDARSON

RADIO TRANSFORMERS

*Supreme
in
musical performance*

THORDARSON ELECTRIC MANUFACTURING CO.
Transformer Specialists Since 1895
WORLD'S OLDEST AND LARGEST EXCLUSIVE TRANSFORMER MAKERS
Ituron and Kingsbury Streets — Chicago, Ill. U.S.A.

Tell them that you saw it in RADIO

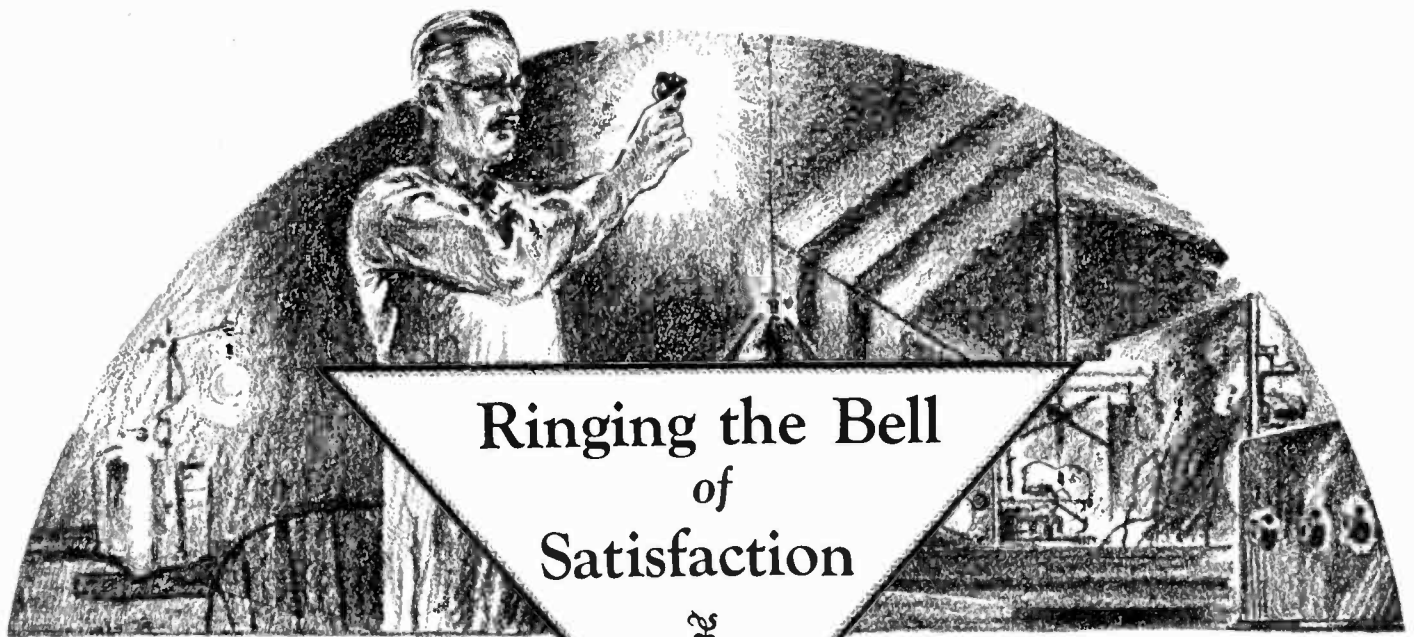

Ringing the Bell of Satisfaction





**TRUVOLT
ALL-WIRE
Resistances**

Reg. U. S. Pat. Off.
Pats.
Pending

In Truvolt Variable Resistances, the contact arm slides lengthwise over the turns of resistance wire; hence there is practically no wear on the resistance element. Their easy potentiometer control eliminates difficult calculation, and permits easy adjustment to tubes and line voltages.

An exclusive feature of Truvolt Fixed Resistances is that the values can be changed and set at any point desired by the use of sliding clip taps. From 85c to \$3.00.

Truvolt Variable, Fixed and Tapped Resistances are kept cool by their unique air-cooled design. Hence they do not break down and are always accurate. 22 Stock Sizes, \$3.50 each.

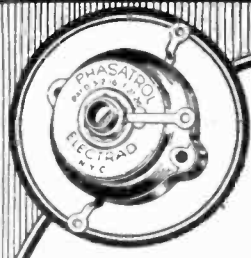

Licensed by
Rider Radio
Corporation.
Patented
5-2-'16,
7-27-'26,
Pats. Pend.

PHASATROL

Reg. U. S. Pat. Off.

A True Balancing Device for Radio Frequency Amplifiers

In constructing a receiver using R.F. amplification, it is important to insert a Phasatrol for each stage of R.F. amplification to suppress and control R.F. oscillations.

After installation of Phasatrol, it is possible to adjust its variable resistance to a permanent value for an amplifying tube so that no further chance of oscillations breaking out is experienced.

This device is excellent for use in purchased sets to cure them of the R.F. oscillation habit. Very easy to install even by a novice. Price, \$2.75 each.



Exclusively
licensed by
Technidyne
Corporation
Under U. S.
Patent No.
1593658,
1034103,
1034104.

ROYALTY VARIABLE HIGH RESISTANCES

A standard resistance widely recommended for its accuracy and dependability wherever variable high resistances are required in the circuit.

Made with the best insulating materials and free from injurious inductance and capacity effects. Same resistance always secured at same point. Entire range of resistance covered in one turn of knob.

There is a type for every radio purpose—11 in all, designated Type A to Type L. Potentiometer Types, \$2.00. All other types, \$1.50.

THE difference between ordinary resistances and Electrad Resistances may mean the difference between a poor unit and one of super-fine performance.

That is why experienced set and eliminator builders insist on Electrad Resistances wherever variable, fixed or tapped resistances are required for control in their circuits.

Every Electrad Resistance is constructed of finest materials to assure utmost quality and dependability. Each is tested for mechanical and electrical accuracy in each stage of manufacture. Each represents the most efficient design developed by radio science.

Resistances in radio must be right. When constructing or experimenting, be sure to use only Electrad Resistances to assure proper control and smoother operation of your receiver or power unit.

Electrad specializes in a full line of resistances and controls for all radio purposes. These are on sale by your favorite dealer.

*Tear out and mail coupon
for complete FREE circu-
lars and full information.*

ELECTRAD Inc.

Pacific Coast Office:
**905 Mission Street
SAN FRANCISCO,
CALIFORNIA**

ELECTRAD, INC.,
Dept. 16-J, 175 Varick St., New York.

Please send me descriptive circulars on the following products and put me on your mailing list for similar literature.

..... General Circular

..... Tonatrol Volume Controls

..... Phasatrols

..... Royalty Variable Resistors

..... "Electrad Control Manual" (Enclose 10c for mailing)

..... "What B Eliminator Shall I Build?" (Enclose 10c for mailing)

..... "Truvolt Divider Manual" (Enclose 10c for mailing)

I am particularly interested in.....

Name.....
Address.....

RADIO

VOLUME X

JULY, 1928

No. 7

Radiatorial Comment

The past few months have witnessed a wild scramble for the privilege of using the short waves between 5 and 200 meters, which were once considered worthless. They were given as a plaything to the amateurs when these enterprising young men were crowded out of the 200 to 550 band of wavelengths by the broadcasters. With characteristic ingenuity and energy the amateurs soon astounded the world with remarkable records of long-distance transmission even when using very little power. Their erstwhile toy suddenly became valuable and once again the amateurs are faced with attempts to wrest from them that which they have developed.

In the band of wavelengths between 5 and 200 meters, or more technically, between 60,000 and 1500 kilocycles, there are 5,850 channels each 10 kilocycles in width, as compared to the 96 channels now available for broadcast telephony.

At the International Radiotelegraph Convention in November certain of these frequencies were allotted for amateur use, some of them being exclusive and some to be shared with other services. The exclusive allocations include the 300 kilocycles or thirty 10 k.c. channels between 41 and 42.8 meters, and the 400 kilocycles or forty 10 k.c. channels between 20.8 and 21.4 meters. There are also 2000 kilocycles between 10 and 10.7 meters and 4000 kilocycles between 5 and 5.35 meters which are reserved for amateur and experimental use, but which yet have many difficulties in practical use. The amateurs also share with various fixed and mobile services the 285 kilocycles between 150 and 175 meters and the 500 kilocycles between 75 and 85 meters.

This means that about one-eighth of the frequencies in this band is now open to amateur transmission, of which 700 kilocycles of usable frequencies are exclusive, 785 kilocycles are shared, and 6000 kilocycles are yet to be applied to practical use. All the other frequencies, including 850 kilocycles for broadcasting, are reserved for various governmental and commercial services.

While the amateurs are not entirely satisfied with these limitations, they are working contentedly and with little or no interference to other services. But in the absence of specific permission to use the short waves, certain commercial interests, especially a number of newspapers, have acquired amateur licenses and are transacting commercial traffic thereunder. This is contrary to the law which provides that an amateur shall have no pecuniary interest in his work and which specifically prohibits him from broadcasting news, this being classified as a limited commercial service.

Not only are these stations violating the law which governs amateur transmission privileges, but they also have had the temerity to complain of amateur interference with their news broadcasts and to request that amateurs refrain from

using the amateur channels upon which these broadcasts are made under the disguise of amateur call letters. Naturally the amateurs resent and have protested against this invasion of their privileges.

A happy solution to this difficulty has been effected by the Federal Radio Commission in the granting of twenty short-wave channels to the American Publishers Committee, by whom the various newspapers will be given allocations. Thus the newspapers are given what they now need and the amateurs may continue to use their present channels without commercial interference therein.

But this episode is but a mere incident in the battle that is being waged by conflicting interests who desire to secure short-wave channels. Although all frequencies between 1500 and 28,000 kilocycles were reserved by the International Radiotelegraph Convention, relatively few definite assignments have yet been granted by the Federal Radio Commission. The Radio Corporation of America and the Mackey Company have each been granted fifteen channels, the American Telephone and Telegraph Company nine, the Robert Dollar Company eight, and the Tropical Radio Telegraph Company seven. A large number have also been reserved for Army and Navy use as well as for airplane communication.

So far as is now known no specific allocations have been made for the radio transmission of pictures, the regular broadcast and commercial channels sufficing for the little that is now being done. This new art, especially the transmission of moving pictures by radio, may eventually require more space than will be available unless the Commission is most sparing in its allocations to other services. A 100-kilocycle band is necessary as a single channel for the eventual transmission of a moving picture having the fineness or definition in a small image no better than that given by a newspaper half-tone. Even a small picture having ninety-six lines to the inch requires an 80-kilocycle band for its transmission. In view of these facts the Commission would seem to be justified in granting permission to use a number of wide channels especially for experiments in picture transmission.

If further evidence were needed as to the value of this short-wave prize, for which there are so many claimants, ample proof is provided by the remarkable radio communication maintained by the "Southern Cross" during its flight toward Australia. Never was it out of radio touch with the world while crossing the vast expanse of the Pacific. With but 50 watts power on 33 meters its signals were always picked up by ship or shore stations so that anxious waiters were constantly informed as to its conditions and its progress. This would have been an impossible feat on long waves. The prize is valuable, may its allocation be equitable!

Radio's Part in the "Southern Cross" Flight

By JACK KAUFMAN

ONCE again short wave radio history has been written in a flight across the Pacific Ocean, and the value of short wave radio transmission to long distance aviation conclusively proven. The flight of the *Southern Cross*, from San Francisco Bay, California, to Brisbane, Australia, via Honolulu and the Fiji Islands, during which complete reports by short wave radio telegraphy were sent and received continuously, was of tremendous interest to the entire aviation industry, as well as to the public generally. The newspapers gave unusual publicity to the feat, stressing the value of the short wave transmission from the plane, which kept the listeners on shore and at sea in constant touch with the plane's progress, so that there was no doubt as to the condition of the fliers at any time during their three periods of flight.

Those who were fortunate enough to be listening to the transmission from KHAB, the *Southern Cross*, were able to follow its course from hour to hour with scarcely a break, and the public, through the published newspaper radio log, was equally well informed. But there has been little accurate information as to what comprised the radio equipment, so that a description should prove of interest not only to every radio amateur, but also to those concerned with aviation or other commercial applications of short wave transmission.

The radio equipment was designed by Ralph Heintz, of the firm of Heintz & Kaufman, Inc., San Francisco, who have been active in the field of short wave transmission and reception for a number of years, and was built and installed by that company. Following the successful demonstration of the capabilities of the short wave transmitter used on the ill-

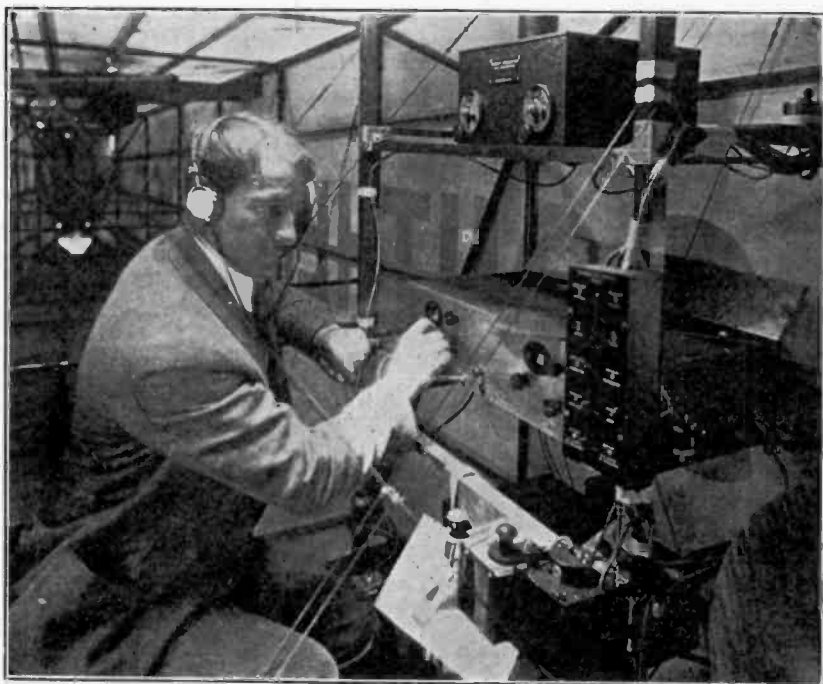

Interior View of "Southern Cross," Showing Radio Installation

fated *Dallas Spirit*, a description of which appeared in October, 1927, RADIO, Captain Kingsford-Smith of the *Southern Cross* had a duplicate outfit installed in his plane, late in the fall of 1927. Two endurance flights made during the winter, in an attempt to establish a new endurance record, gave ample opportunity to test the transmitter. As described in detail by J. G. Eisenberg in May, 1928, RADIO, a detailed log covering some ninety-seven hours of flight was kept, proving that the transmission from the plane, on a wave length of 33.4 meters, was relatively free from skip distance and fading effects, and would be thoroughly reliable for a trans-Pacific flight.

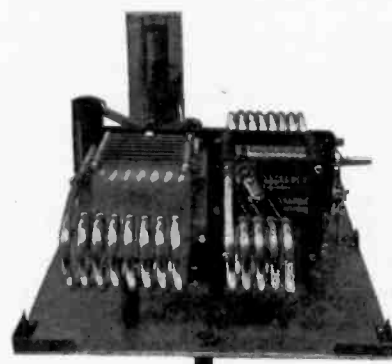

Fig. 2. Constructional Details of Short Wave Transmitter

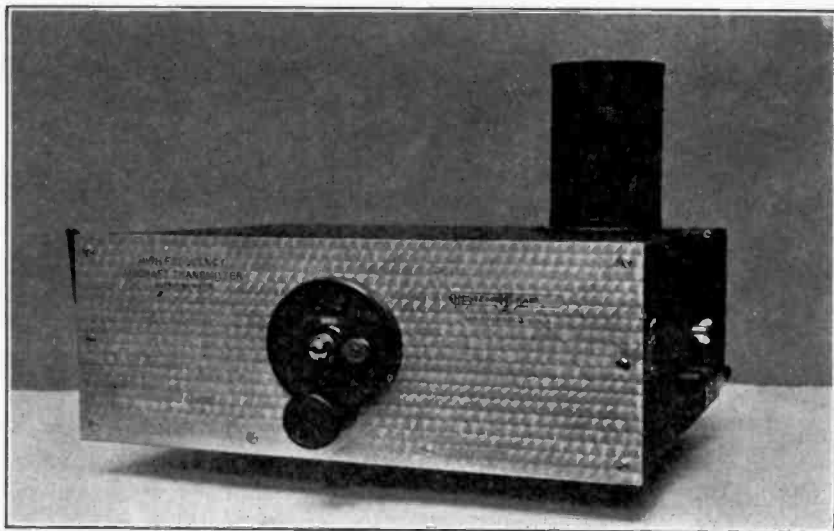

Fig. 1. Short Wave Transmitter on "Southern Cross"

With perfect confidence, therefore, in the reliability of the radio equipment, the *Southern Cross* left Oakland on May 31, reaching Honolulu on June 1, and after a rest of thirty-six hours, covered the 3138 miles from Honolulu to Suva, in the Fiji Islands, without mishap. During this time, totalling exactly sixty-two hours, the radio transmitters worked continuously, for when not sending a message, the key was left closed so that the carrier wave could be heard by those on shore, as an indication that the plane was continuing on its course safely, except when working on 600 meters, when the short wave set was cut out altogether. At no time was the plane out of hearing of a shore station, and while its signals were not heard consistently on the Pacific Coast during the last six hours of its second hop from Hawaii to Fiji, they were heard by any number of stations at Hawaii, Samoa, Fanning Island,

and various other points where short wave receivers were installed.

The radio equipment consisted of three transmitters and three receivers; a short wave transmitter operating on 33.4 meters, a commercial wave transmitter adjusted to 600 meters, and an emergency spark transmitter for use in case the plane was forced down. The receiving

generator is shown disassembled in Fig. 4, and is also shown in place on the side of the plane in Fig. 5.

The generator is a special Aladdin-Duplex built by the Harris Electric Co. of San Francisco, and provides two a.c. voltages, both 240 cycles, one of 10 volts for the filament and the other 65 volts for the plate transformer, which in turn

bly signal which might have been impossible to follow. The antenna consisted of a wire approximately 26 feet long, weighted at the free end, and suspended from a take-up reel on which was mounted the radiation ammeter. This reel is shown in Fig. 6. When operating on 600 meters, wire from another reel is run out until resonance at 600 meters is obtained.

The 600-meter transmitter was identical in general construction with the 33-meter outfit, and was used during the flights for communication with ships, and such shore stations as had no short wave receivers. The range of this transmitter was much less than that of the short wave outfit, and served more as an auxiliary to the latter. Both transmitters were contained in aluminum cases, mounted one above the other on the side of the navigator's chamber, projecting only about 8 in. from the wall.

The emergency transmitter was designed for use in case the plane was forced to light in the water, and hence was made completely waterproof. It consists of a 1-in. spark coil transmitter, very broadly tuned to 600 meters, and supplied with power from a 9-volt hot-shot dry cell battery. The entire transmitter was self-contained in a water-tight box, with the key underneath a rubber-covered hole in the box, so that to key the transmitter, the rubber was pressed, thereby operating the key underneath, but preventing water from entering the transmitter.

The antenna for the emergency transmitter consisted of a 200-ft. section of stranded wire, suspended in the air by a hydrogen-filled balloon, such as is used in the meteorological service. A deflated balloon fastened to a small tank of hydrogen under pressure was carried on the flight, so that it could instantly be filled by turning on a valve and releasing the balloon. Sufficient power could be obtained from the batteries to operate the set for eight hours, and tests made

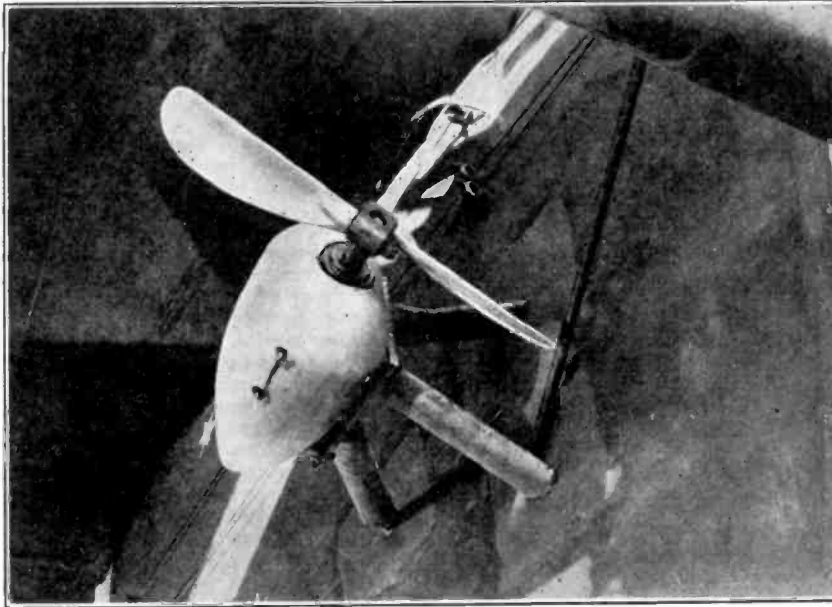

Fig. 5. Wind-driven Generator in Housing, on Fuselage of "Southern Cross"

set consisted of a two stage audio frequency amplifier and three receiving units, all mounted in one aluminum case, so that any of the three receivers could be used by throwing a switch, with the

steps up the voltage to 900 before being applied to the plate of the tube. Duplicate generators were mounted on each side of the fuselage, on the under part of the wing, and were automatically connected or disconnected in case one of them failed during transmission. The generators, driven by 18-in. impellers, were so designed that no matter what the speed of the impeller, the generator voltages would always remain constant. No small part of the credit for the successful transmission from the plane is due to these generators, as the use of generators having poor voltage regulation would have resulted in a wob-

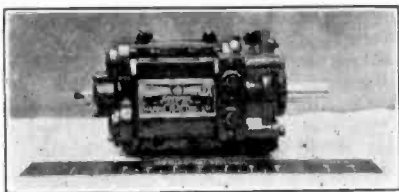

Fig. 4. Generator Assembly, Showing Relative Size

headphones plugged in the output of the audio amplifier common to all three receivers. A short wave receiver covering all the amateur bands, an intermediate wave receiver for 600-meter ship or shore work, and a radio beam receiver for receiving U. S. Army radio beacons operating on 1034 meters, comprised the three receiving units. The total weight of this receiving outfit, together with the three transmitters, was exactly 100 pounds, a surprisingly small weight considering the amount of apparatus represented.

The main transmitter was the 33.4-meter set, a picture of which is shown in Fig. 1, while the actual construction is shown in Fig. 2. The transmitter is of the tuned-grid tuned-plate type, the circuit of which is given in Fig. 3, and employs one 50-watt type UV-211 tube, with plate and filament supply from a two-unit wind driven generator. This

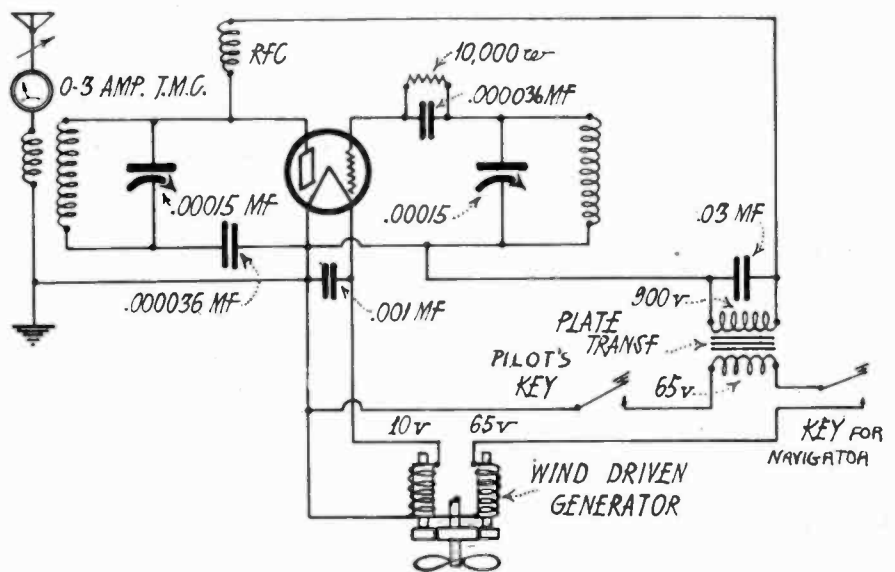

Fig. 3. Circuit Diagram of "Southern Cross" Transmitter

with it before the flight showed that it had a range of over 200 miles at night, thus enabling the fliers to broadcast their position to any ships in their vicinity.

Reports from various parts of the world have been pouring into San Francisco since the flight, telling of the reception of signals from the plane. Without taking into account the recording of extreme distance reception, the reliability of the short waves for aircraft transmission, giving continuous communication with shore stations during a flight of over 7000 miles, is a direct refutation of recent statements by several writers that the short waves are worthless for aircraft use. During the flight to Hon-

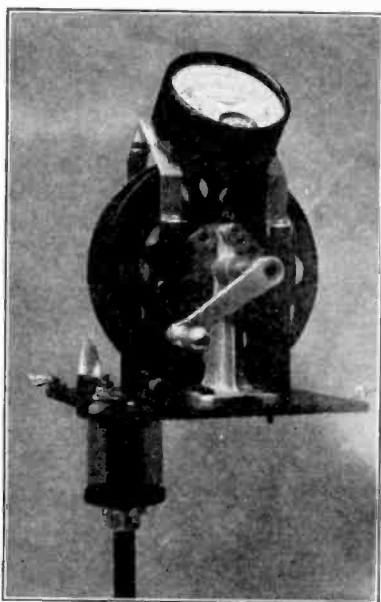

Fig. 6. Antenna Reel, with Radiation Meter

olulu, a number of commercial messages were exchanged between the plane and a shore station in San Francisco, thus establishing the first commercial message service of its type. Signals from the plane were picked up in South Africa by FO-A3V, at Bloemfontein, indicating the remarkable range of the short wave transmitter.

It may be of interest to know that Commander Richard Byrd has equipped his plane, the Floyd Bennett, with transmitting and receiving equipment similar to that used on the *Southern Cross*, and expects to use this equipment in maintaining contact with his base of supplies during the projected flights over the South Pole this year.

One of the most remarkable features of the flight was an incident which occurred when the plane was flown from the Victoria Park landing in the town of Suva, Fiji Islands, to Naselai Beach, about 20 miles from Suva, where the takeoff to Brisbane was made the day following. Two stations in San Francisco which had maintained constant

watch on the plane's wave since leaving the United States were listening in on June 6th in the early evening, at the time the plane was scheduled to hop off for Australia, and picked up the carrier wave from the plane for a period of about 10 minutes, while the plane was making the short flight to the beach. No pre-arranged schedule had been contemplated, and the operator on the plane did not send any messages, but simply tied down his key for a few minutes, and signed off with his call letters just before the plane landed on the beach.

During the first few hours of the flight from San Francisco, and from the Barking Sands take-off at Hawaii, the U. S. Army radio beacon signals were heard, but they were lost thereafter, and not again picked up, indicating that to make this service reliable for long distance flights, either the power of the beacon transmitter must be increased, or it should be adapted to short wave transmission so as to increase the range. This beacon was described fully in the August, 1927, issue of *RADIO*, and was first used for the flight of Lieutenants Maitland and Hegenberger in the Army's Fokker plane, practically a duplicate of the *Southern Cross*.

SOME SHORT WAVE PHONE STATIONS

Call Letters	Location	Wavelengths
AGC	Nauen, Germany.....	17.2, 26.0 39.8, 40.2
AGJ	Nauen, Germany.....	56.7
ANE	Bandoeng, Java.....	17.4
ANH	Malabar, Java.....	17.4, 27.0, 32.0
A-2FC	Sydney, N.S.W., Australia.....	32.0
A-2ME	Sydney, N.S.W., Australia.....	28.5
A-3LO	Melbourne, Australia.....	29.8, 32, 36
F-8GC	Radio LL, Paris.....	60.
G-2NM	G. Marcuse, Caterham, England.....	32.5
G-5SW	Chelmsford, England.....	24.
I-1AX	Rome, via Savoia 80.....	45.
JB	Johannesburg, South Africa.....	32.
KDKA	Westinghouse E. & M. Co., East Pittsburgh, Pa.....	39, 68.
PCJJ	Philips Lamp Works, Hilversum, Holland.....	30.2
U-2XAA	Houlton, Maine.....	22.99
U-2XAD	G. E. Co., Schenectady, N. Y.	21.96
U-2XAF	G. E. Co., Schenectady, N. Y.	32.7
U-2XBA	Newark, N. J.....	65.18
U-2XE	A. H. Grebe, Richmond Hill, N. Y.....	58.5
U-2XG	W. E. Co., Rocky Pt., N. J.....	16.02
U-6XAI	Inglewood, Calif.....	66.04
U-6XAR	San Francisco, California.....	33.00
U-9XU	Council Bluffs, Iowa.....	61.06
WGY	G. E. Co., Schenectady, N.Y.....	35.
WIZ	R. C. A., New Brunswick, N. J.	43.35
WLW	Crosley Radio Corporation, Cincinnati, Ohio.....	52.02
WOWO	Fort Wayne, Indiana.....	22.8
WRNY	Coteyville, N. J.....	30.91

WIRELESS TELEGRAPHY IN THE 1927 MISSISSIPPI RIVER FLOOD

By JOE H. MCKINNEY

Little did the Mississippi River Commission realize the important role wireless telegraphy would play in a future disaster when they approved the installation of wireless transmitting and receiving equipment aboard their survey boats and dredges at the Dredging Depot, Memphis, Tennessee, in 1923. For four years their small chain of stations carried on efficient communication between the field parties and the Memphis office, expediting the movement of floating equipment and writing new history in river navigation.

In April, 1927, the Commission left St. Louis, Missouri, for New Orleans, Louisiana, on their annual inspection trip. Their steamer, the *U. S. Inspector*, was equipped with a new vacuum tube transmitter, and was manned by one radio operator.

The river was rising fast, but there was little thought of an impending flood. The *Inspector* proceeded south until forced to tie to the bank behind a small island just above New Madrid, Missouri, because of high winds. These strong head winds lasted for several days, causing high waves to wash against the levees already weakened by the rising water. The Commission's only contact with the outside world was by radio. They ordered a constant watch to be kept at the land station in Memphis while the operator aboard the *Inspector* remained on duty an average of 18 hours a day. Relief crews were ordered to the weakening points along the levee in order to top the levees with sand bags. As the wind subsided the *Inspector* proceeded on to Memphis and hence to New Orleans, Louisiana, being at all times in constant touch with flood relief headquarters, having added an extra operator at Memphis in order that a continuous radio watch might be maintained.

As levee after levee gave way, flooding millions of acres and making thousands homeless, radio equipped boats were rushed to the stricken areas. These boats plied the Mississippi and her tributaries, picking up refugees and their effects, feeding them and landing them at the Red Cross Relief Camps in dry territory and along the levees. Where a town was completely isolated from the outside world insofar as communication was concerned, a wireless equipped boat would be rushed to the assistance of the relief workers and inhabitants.

Radio operators were hard to find. The few on duty remained at the key from sixteen to twenty hours a day. All requisitions for relief supplies, communications from flood sufferers to outside friends, Red Cross official business and, in fact, all touch with the outside world from some districts was maintained by radio. Static was exceptionally bad, making it necessary to establish radio relay stations every 150 miles or so from Memphis to Baton Rouge, Louisiana. Answering requests for operators, the Navy sent about thirty men, the Marine Corps twenty. These men had portable transmitters which they installed in towns impossible to reach by boat.

Had it not been for the communication system many more lives would have been lost, relief work handicapped and relatives of flood victims slow in obtaining information. Approval for dynamiting the levee below New Orleans was relayed by radio. In the opinion of the writer, the value of radio proved itself as never before in history except at the sinking of the *Titanic*.

During the peak of the flood, lasting approximately one month, more than four thousand radiograms averaging forty words each were handled by the Mississippi River Commission's radio net alone, employing only fifteen commercial operators.

The A. C. 115 Kilocycle Superheterodyne

By G. M. BEST

THE recent announcement of several types of shielded grid tubes for operation from a.c. current supply is of great interest to owners of shielded grid receivers, as it will enable the elimination of the storage battery supply required by previous models of the tube, and thus convert the receiver into full a.c. operation. After obtaining a supply of the new a.c. shielded grid tubes, a 115-k.c. superheterodyne was converted from d.c. to a.c. filament supply, and the results have been so satisfactory that the information is being passed on to those who have already built this set, or are contemplating its construction.

A revised circuit diagram, showing all the connections for a 9-tube receiver, is given in Fig. 1, from which it can be seen that the principal change is in the filament and *C* biasing circuits, there being no changes in the coils, condensers, or the high frequency connections.

The shielded grid tubes which were used were Arcturus, which have a 15 volt heater element and with the cathode connected to one side of the heater, thus requiring only a 4-prong tube socket. These tubes required a separate filament source from that used for lighting the filaments of the rest of the tubes in the set, as no transformer having a 15-volt secondary, as well as 2½ and 5 volts, was available. A G. E. 50-watt bell ringing transformer having secondary voltages of 8, 16 and 24 is adequate for the purpose, as the 16-volt winding is just right for four shielded grid tubes. A special 15-volt filament transformer can be obtained for the Arcturus tube, from most radio supply houses. The heater current of the shielded grid tube, at 15 volts, is .35 amperes, so that the four tubes draw about 1.4 amperes from the transformer.

As can be seen from the diagram, the heater element has one side grounded to the cathode, so that the negative *B* supply, through the *C* biasing resistors, is connected to the cathode side of the heater, which is also grounded. The mixer, oscillator, detector and first audio tubes are of the '27 type, with 2½-volt heater supply and the cathode brought out as a separate connection, so that five-prong tube sockets must be used for these four tubes. There is ample room for these sockets in the shield bases, so that the only constructional change is to remove the four-prong sockets, and substitute the new type. The power tube, which may be of the type '12-A or '71-A, has its filament lighted from a.c. by means of a 5-volt winding on the power transformer which supplies current for the type 227 tubes, and does not require a new socket.

All heater wiring should be run in twisted pairs, and kept away from grid or plate wires. It is preferable to run these wires along the back of the shield base, and terminate the three a.c. pairs at a separate cable terminal, or a group of terminals other than those used for the *B* voltage supply leads, as the use of the same cable for the a.c. as well as the *B* voltages would introduce bad a.c. hum which could not be eliminated.

A 45-volt positive bias is applied to the four '27 tubes, through a 60-ohm variable resistance, which can be obtained in the form of a small resistance strip which may be connected to the two heater terminals of one of the five-prong sockets. The slider is easily adjusted with a screw driver, and once it is set, it can be left permanently adjusted. The a.c. shielded grid tubes have the control grid terminal on the top of the bulb the same as for the d.c. mod-

els, and the shield grid is connected to the "G" terminal of the tube socket as is customary with this tube.

The volume control system is the same as for the d.c. model, with a 500,000-ohm variable resistor in the 45-volt *B* supply to the four shield grids, and the plate of the mixer tube. The oscillator tube has a 4½-volt *C* bias, and the four-shield grid tubes receive 1½ volts negative *C*, while the first and second audio tubes receive 4½ and 9 volts negative, respectively. This *C* bias is obtained by means of the voltage drop through a set of resistances placed between the negative *B* supply lead, and the common ground connection to the cathodes of all the a.c. tubes. The power tube has a separate *C* bias resistance, as a '71-A tube might be used in place of the '12-A tube shown in the diagram. The values of the resistances are given in the diagram, and while the plate current total for each individual set may be slightly more or less than that obtained with the experimental model, the resistance values will be near enough for all practical purposes. If the resistances and their associated 1 mfd. bypass condensers seem to be too great an expense, a 9-volt *C* battery, with taps at 1½ and 4½ volts can be used equally as well, and will last a year or more.

The apparatus which will no longer be needed, in converting a d.c. model to a.c., will be the rheostat-switch located in the center of the panel, the filament voltmeter, and the 200-ohm potentiometer. The latter may be used in place of the 60-ohm potentiometer recommended for the positive bias to the type '27 tubes, and in place of the rheostat-switch, a snap switch for turning on and off the 110-volt a.c. line may be installed. An a.c. voltmeter to indicate

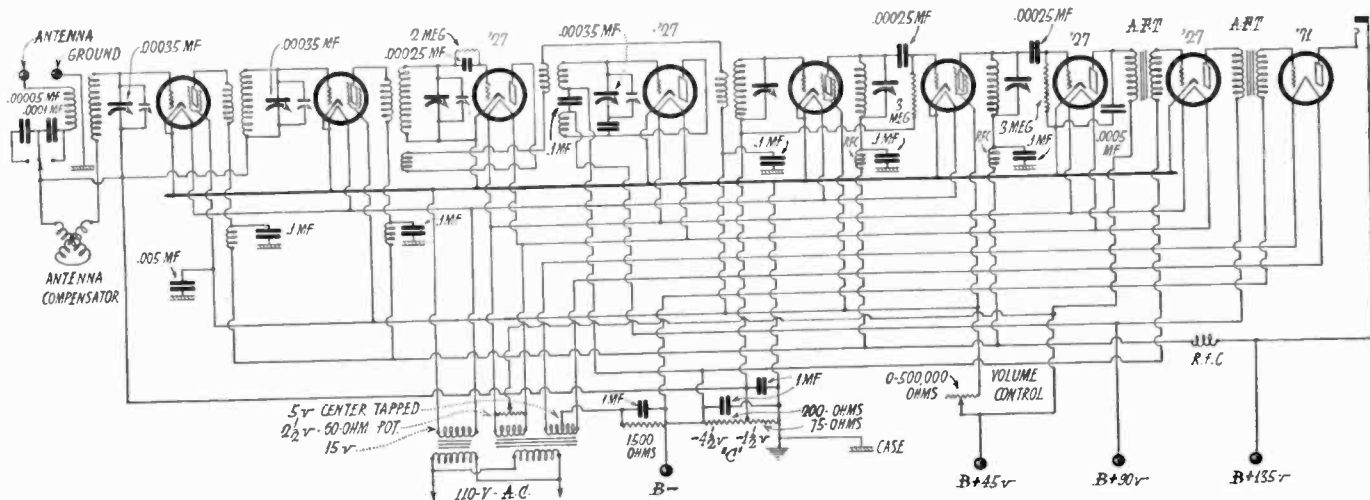

Fig. 1. Diagram of 115-K.C. Superheterodyne, Wired for A.C. Operation

the a.c. line voltage and enable the proper regulation of the voltage in case it varies considerably would be a handy adjunct, which could be installed in place of the d.c. voltmeter, but it is not necessary to the operation of the set.

In turning on the set, the shielded grid tube heaters will heat the cathodes of the tubes to full temperature in a few seconds, but the type '27 tubes will require nearly a minute before they will function, so that the set will remain dead during that time. If, after the set is in operation, there is an objectionable amount of a.c. hum, it may be due to several causes. Adjust the positive bias to the type '27 tubes, and make sure that the ground connection is in place. If the hum still persists, it may be due to oscillation of the r.f. amplifier because the volume control is advanced too far. At the extreme setting of the volume control, where the r.f. amplifier has a tendency to oscillate, a certain amount of a.c. hum will occur, and this is not of the deep, 60-cycle type, but rather is a nasal buzzing sound. This noise will not prove objectionable on stations at a reasonable distance from the set, so that for average reception, it will not be noticed.

The audio transformers used in the set are especially good at the very low audio frequencies, and hence they will pass any a.c. ripple which is present in the output of the detector or first audio tubes. By using a heater type tube in the first audio stage, this hum is cut to a minimum, and even when used with an electro-dynamic speaker mounted on a wall type baffle, the hum was not objectionable, although noticeable when no station was being received.

If a.c. shielded grid tubes other than the Arcturus are used, the cathode of each shielded grid tube will be a separate terminal, and five prong sockets will be required for all four-shielded grid tubes. The only change necessary in Fig. 1, in that event, would be to connect the cathodes in parallel with those of the type 227 tubes, and to provide a.c. voltage for the heaters of the shielded grid tubes from a separate filament winding, unless the voltage required happened to be the same as for the 227 tubes, in which case the heaters could be placed in parallel with the 227 tube heaters, and operated from 2½-volt a.c. supply.

Motor-boating can ordinarily be stopped by connecting a 2 mfd. condenser across the $-B$ and $+$ detector B terminals of both the plate supply unit and the receiver and by inserting a 50,000-ohm resistance between the two terminals.

The Spider's Web

By A. E. KENNELLY

(As Told to C. William Rados)

THE general aspects of radio are of tremendous importance to the world today," said Prof. Kennelly as we sat in his book-lined office recently. A. E. Kennelly was formerly president of the Institute of Radio Engineers and also president of the American Institute of Electrical Engineers.

"Due to radio, *genus homo* has become a creature somewhat similar to the spider. His tentacles extend over an area. The spider's web extends his influence over an area far greater than the spider alone can attend to. When anything disturbs the tranquillity of his web, the spider can exert his influence over that object. The radio operator who sits at the base of an antenna weaves a web out over water and air. Wherever the radio influence is felt, there the operator has extended his culture, ideas and civilization.

"Think of the value of mass broadcasting in keeping the language the same over large areas. As the listener sits there he is only a part of a group of thousands and possibly hundreds of thousands. Those listeners are isolated only physically. They receive the same ideas and language through the air.

"A disaster comparable to a war, would be the drifting apart of the two great branches of the English-speaking race in language. There is a drift towards separation of the spoken language from the written that is noticed here and in Great Britain. Unfortunately, while the printed language remains the same on both sides of the Atlantic, there has been a gradual trend towards two different spoken branches.

"When the New York-London telephone first opened, the operators had some difficulty in understanding each other. Although they used technical terms which differed on the two shores, they had to ask, 'Are you speaking English?' The drift had already gone so far as to include different technical terms for the same object or action. As broadcasting and other uses of radio, both code and voice, help unify a country's language, so will radio assist in keeping the two branches of the spoken English the same.

"Thirty years ago French was in a fair way to become the official international language. In fact, when I attended the last international radio conference at Washington the official language was French. The tendency today is toward one international radio language. Radio is hastening that. It takes radio about a fifteenth of a second to 'go' from New York to the antipodes,

half the way around the world.

"In this one-fifteenth of a second world, radio is an influence tending toward the use of one international language. Around the Mediterranean Sea, French is the language used for official international purposes. On the Atlantic Ocean the international languages are French, English and Spanish. On the Pacific the language is English. Gradual filling of the air with radio tends to make for one world language. Other languages will doubtless survive, but radio is boundaryless, and one common trunk air language will be necessary for general understanding.

"The world is three-quarters water, one-quarter land. Whoever controls the waters and air of the globe by radio, ships, and planes, controls the world. Not in the 'Uber Alles' sense, he hastened to explain. "I mean 'control' in the sense that civilization and ideas are spread."

"Civilized countries must control the waterways of the world. To mankind with a multitude of land problems the other three-quarters of the surface of the globe is sometimes forgotten. Yet at the Washington conference much time was spent on marine radio.

"Many Asiatics do not love us. To many of them the European is an ignorant man. With this understanding the future might see grave East-West problems. However, radio is a force for mutual understanding, for promoting international peace and amity.

"Last March I attended a meeting in New York held jointly with a meeting of British engineers at London. Three thousand miles across the sea, those men talked to us in New York. They spoke about their views on current problems. They told us how they felt about various matters. Radio will permit more joint meetings. It will help us understand each other.

"Before the telephone was invented, business men used much profane and strong language in their business talk. In the dealings of that period it was customary to swear great oaths and use strong language. The business man who refrained was not one of 'the boys.' Then these business men started using the telephone. Operators were instructed to cut off captains of industry as soon as they started using fiery language. The business men soon found themselves talking to silent machines. The final result was they developed methods of talking which carried on business conversations without the use of improper language."

A Small Public Address System

Directions for Assembling a Four Stage Audio Amplifier from Standard Parts

By FRANCIS CHURCHILL

THE need for a small public address amplifier to be used in an auditorium can be met at a reasonable cost by assembly from standard parts in accordance with the experimental model here described. It is designed for local pick-up with a microphone or phonograph or to amplify the output of a radio receiver. Exclusive of tubes, microphone and loud speaker, the cost is less than \$200.

It employs four stages of amplification, consisting of three equalized transformer-coupled stages and a push-pull output stage for C X 310 or 350 power tubes. The first two stages use A tubes and the third stage a 112 tube. It will operate two electrodynamic speakers without overloading. An external 6-volt battery supplies filament current for the first three stages, all other current and voltage requirements being met by the power supply unit which is incorporated in the set.

In the accompanying picture of the complete unit the amplifier system appears on the upper shelf and the power supply unit on the lower shelf. But less a.c. hum would be introduced by assembling them as separate units and keeping them several feet apart.

On the lower portion of the panel are mounted the 110-volt a.c. terminal plate, a switch for turning the output on or off, and four output jacks for the loud speakers. On the center of the panel is a 0-50 milliammeter for measuring plate currents and a 0-15 a.c. voltmeter for measuring filament voltage to the push-pull stage. The milliammeter terminates in a phone plug which can be plugged into

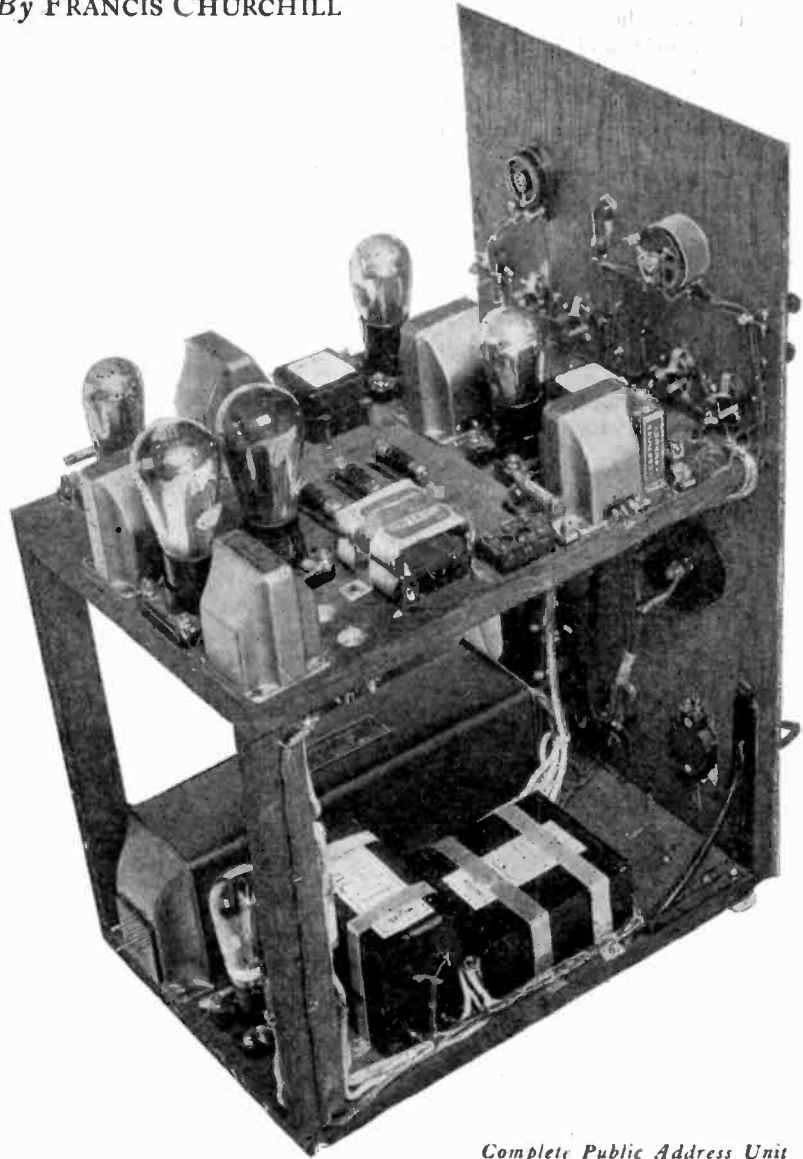

Complete Public Address Unit

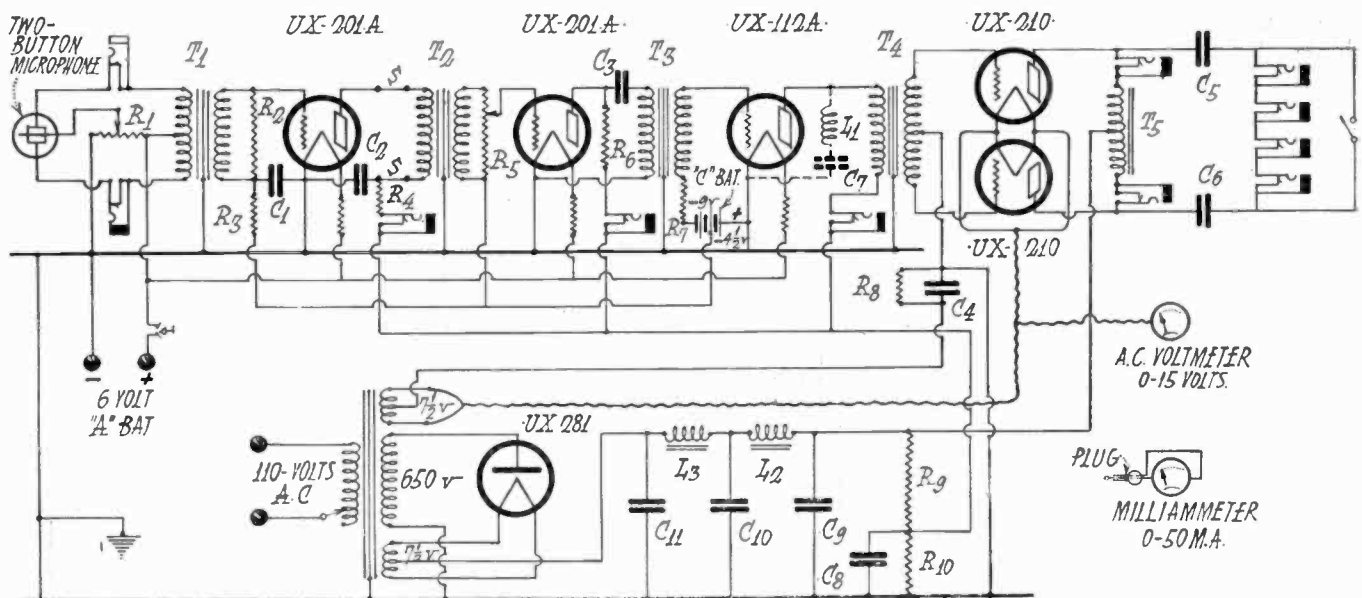
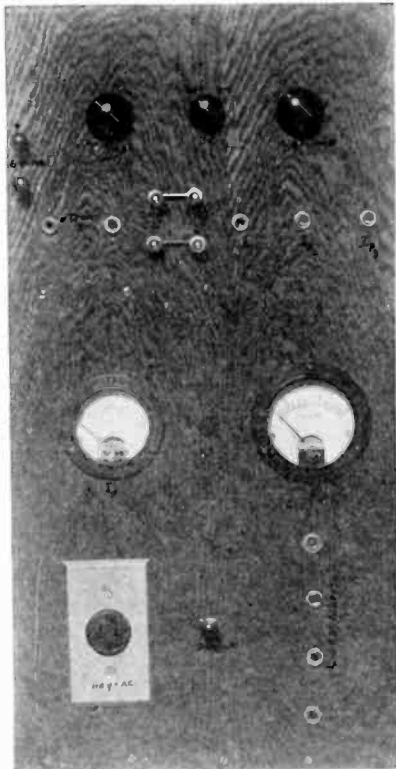

Fig. 1. Circuit Diagram of Public Address System

any one of the three jacks above the voltmeter for checking plate current, or it can be plugged into either side of the microphone. The panel also provides for control of microphone current and of volume.

The transformers should be widely separated and all grid and plate leads should be as short as possible. The layout shown in the picture of the amplifier unit is a good one to follow in order to



Panel for Public Address System

avoid the howling that sometimes results when such high amplification is employed in an audio amplifier.

This great amplification is necessary when using a standard two-button microphone, which has a low output level. Not more than 14 to 18 milliamperes should be used through each side or button, this being checked with the milliammeter by means of the two jacks shown on the panel and wired as shown in Fig. 1. The battery supply is obtained through a 200-ohm potentiometer R_1 shunted across the 6-volt storage battery.

Since the impedance of most two button microphones consists of a resistance of about 200 ohms, the microphone transformer for stepping this low impedance of 200 ohms up to some high value, 100,000 ohms, is necessary. It is possible to get a voltage gain of over 20 by means of a good transformer here. The one used was designed for a 200-ohm to 100,000-ohm impedance and when so terminated, has a very excellent frequency characteristic. The impedance of the grid to filament of the tube is very high, so a 100,000-ohm resistance R_2 in the form of a metallized leak is shunted across the secondary. The 4½-volt C

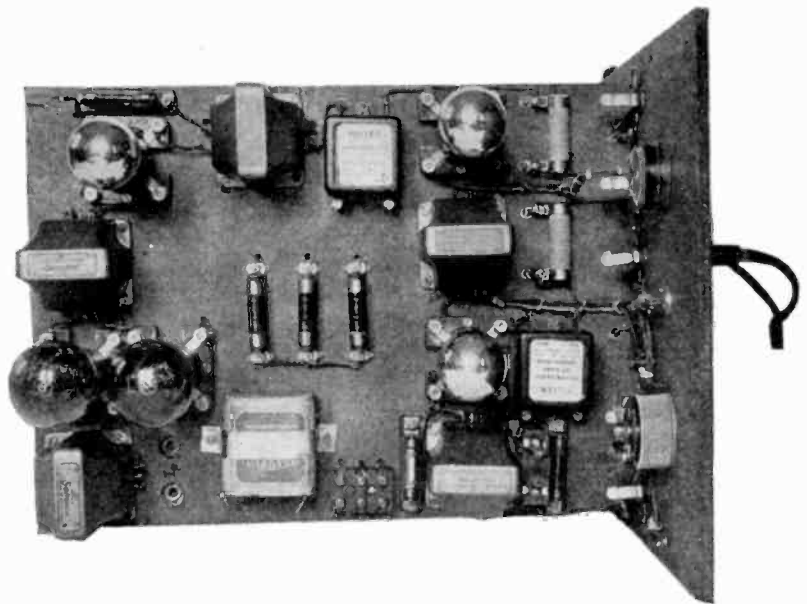

Audio Amplifier Section of System

battery is connected to this transformer through a special resistance filter in order to eliminate any tendency towards oscillation from the common C battery. The audio frequency path is through the condenser C_1 to filament, while the 4½-volt negative lead is through the 250,000-ohm resistance R_3 .

The output of the first tube goes through four binding posts on the front panel. This enables the operator to use the last three stages of amplification by connecting the right hand binding posts to a phonograph electrical pick-up unit, or to the output of the detector tube of a radio receiver. Thus the amplifier system can be used for several purposes.

The plate voltage for the first tube is fed through another resistance filter C_2R_4 consisting of a 2-mfd. condenser and a 25,000-ohm resistance. The audio path is through C_2 and the d.c. path through R_4 . The resistance R_4 also reduces the voltage from 150 down to about 80 or 90 volts, which is correct for a 4½-volt C bias.

The next transformer T_2 is a 1 to 3 ratio high quality transformer having the volume control R_5 shunted across the secondary. This volume control should be a 0-500,000-ohm potentiometer, preferably with a logarithmic variation of resistance. It should be tapering in

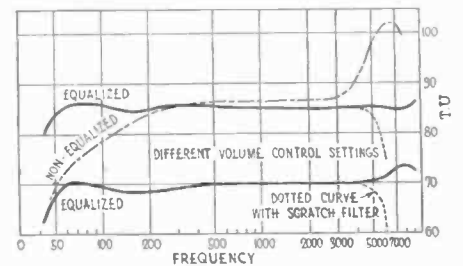

Fig. 2. Frequency Characteristics of System

value so that a small turn of the control knob at the high end will cause a large change of resistance and a small change at the lower end. The use of this method of volume control causes a slight change

(Continued on Page 75)

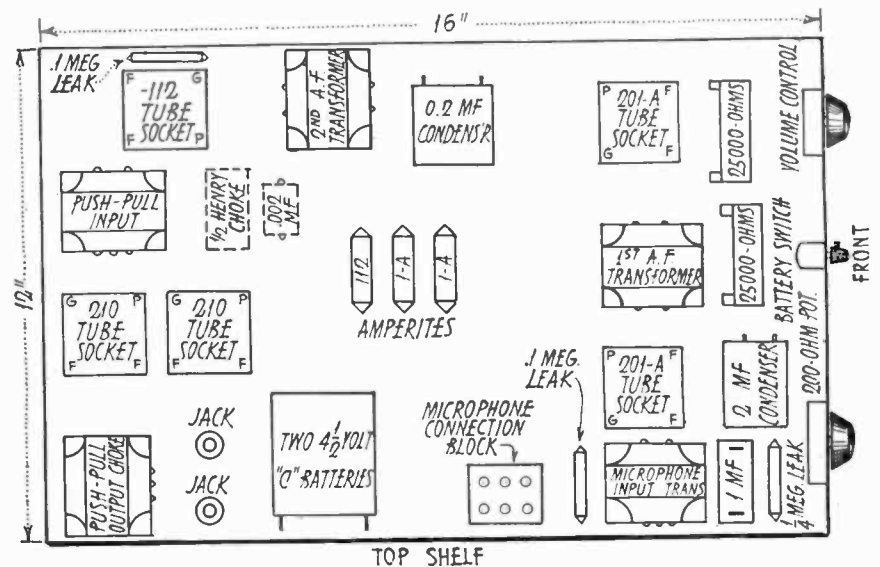

Fig. 3. Suggested Layout for Audio Amplifier

Volume Control Methods

A Discussion and Comparison of the Various Means Used to Control the Sound Volume from a Receiver

By NELSON P. CASE, E. E.

INASMUCH as the method of volume control often makes the difference between an excellent receiver and a mediocre one, it seems that this subject should receive more attention than it has in the past. This article will attempt to give an impartial analysis of all the commonly used methods, in an effort to determine the best method or methods for different types of sets. Obviously there are a number of places in the set where the volume can be controlled. We will take these up, more or less in order, starting with the loud speaker itself.

If the speaker is mounted in a cabinet with doors over the grill, the volume can be controlled to some extent by opening or shutting the doors. This is objectionable, as the presence of the doors in the path of the sound waves results in reflections, interference effects, etc., which alter the tone.

Another method is to shunt the loud speaker with a variable resistance, thus by-passing more or less of the current around the speaker. This would be satisfactory if it were not for the fact that there is every probability that one or more tubes in the set will be overloaded on strong local signals, which results in a badly distorted current being sent to the speaker. This distortion will be present in the output of the speaker, no matter how low the volume is turned. The conclusion is apparent that the loud speaker is not the proper place for a volume control.

Coming now to the audio-frequency amplifier, we find that only one method of controlling volume is available here. This consists of varying a high resistance shunt across a transformer winding, generally across the secondary of the first transformer. The advantages of this method are: smooth, noiseless control, no losses introduced into radio frequency circuits, and improvement in the tone where transformers of dubious characteristics are used.

The latter action is brought about in the following way: poor transformers have very pronounced resonant peaks, which are usually located somewhere between 800 and 2000 cycles. Where the loud speaker response is already very good, the action of the shunt resistance is to add to the damping, thus broadening the resonant peak and reducing its amplitude. See Fig. 1. The lower the shunt resistance, the greater is this effect; since the resistance will be lowest when receiving a local station, the action is to

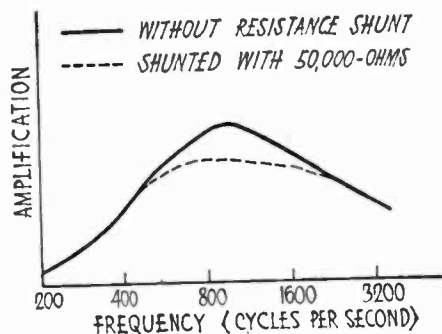

Fig. 1. Effect of Shunt Resistance

improve the tone on locals more than on distant stations; this is desirable because quality is not usually one of the prime features of distant programs, anyway, due to the presence of static and other noises which are unavoidably picked up with the signal. If the resistance is placed across the secondary of the first transformer, it will produce the maximum improvement in tone quality.

To see why this should be so, we must examine the conditions of the circuit a little more closely. The normal load on the transformers consists almost entirely of the plate impedance of the preceding tube, which is effectively shunted across the primary of the transformer. In general, the plate impedance of the detector tube is much higher than that of any succeeding tube, so the effective load on the first transformer is less than that on any of the others. Hence it is desirable to introduce our extra load on this transformer.

If the transformers are of the modern high quality type, the damping action is not necessary, and in this case the connections are often changed so that the high resistance is hooked up as a potentiometer or voltage divider. Even in this case, however, it is still desirable to place the volume control in the first stage, in order to prevent overload on the first audio amplifier tube. The only objection to this system of volume control is that it does not prevent the detector from becoming overloaded on strong local signals, if plenty of radio-frequency amplification is being used. Since most present-day receivers do employ a great deal of radio-frequency amplification, however, it seems that this objection is sufficiently strong to justify the statement that the volume control should come on the radio-frequency side of the detector, in order to avoid overload on any tube which handles audio-frequency currents.

The radio-frequency amplifier offers

a number of possible positions for a volume control, since changes in tube conditions, such as grid, plate, and filament voltages, in the radio-frequency amplifier cannot produce distortion of the audio-frequency output. This statement is rather surprising at first sight, in view of the number of times the contrary has appeared in print, but a rather simple mathematical analysis will show that it is true. Hence we are free to choose our method of volume control on the basis of other factors, resting assured that whatever method we choose will give as good tone quality as any other method. (This assumes that the amplifier is sufficiently stable so that the volume control does not have to be turned away down to prevent oscillation; a condition which must be satisfied anyway, for the receiver to be satisfactory.)

The method which has been previously discussed in connection with the audio-frequency amplifier has occasionally been employed in the radio-frequency end, but the condition which is an advantage in the former case, viz., its effect in increasing the damping, is undesirable here, because it tends to make the set broad in tuning.

The same objection holds for that method whereby the grid returns of the radio frequency amplifier tubes are brought back to the slider of a potentiometer connected across the filaments. When the grid is made positive, the volume is reduced all right, but the input resistance of the tube drops to a relatively low value. This low input resistance affects the damping of the tuned circuit in just the same way that the external resistance previously mentioned does, producing broad tuning. This method has the further disadvantage of causing the tubes to draw excessive plate current when the grids are positive, resulting in shortened life for the B batteries, as well as for the tubes themselves.

If the receiver is of such a design that it cannot be made to oscillate, perhaps as satisfactory a method of volume control as any is that which makes use of a variable high resistance in the plate circuits of the radio frequency tubes, thus varying the plate voltage applied to the tubes. This resistance is ordinarily shunted by a fairly large condenser, the purpose of which is to by-pass the radio-frequency currents around the resistance, and it is the presence of this condenser which

makes this method unsatisfactory for receivers that can be made to oscillate.

When a tube goes into oscillation, there is usually a sudden change in plate current; this surge makes the resistance-condenser circuit tend to charge and discharge at a rate determined by the time constant of the circuit. With the values of resistance and capacity generally used, this time constant is such that the system charges and discharges at an audible frequency, resulting in a terrific howl just as the set goes into oscillation. This explanation is not intended to be strictly accurate from a technical standpoint, but it is sufficiently so to give a general explanation of the phenomenon referred to.

It is the opinion of the writer that, for the ordinary types of receivers, the filament rheostat on the radio frequency tubes is about the best method for controlling the volume. If the set is properly designed for this method, no drawbacks accompany its use. The points of design which should be kept in mind are:

(1) the rheostat should be in series with a fixed resistance of such value that the tubes will burn at their rated voltage when the volume control rheostat is turned full on; this is to keep the user from inadvertently turning the filament voltage up to too high a value;

(2) the rheostat should be of such a resistance that the filament voltage will not be below 60 per cent of the rated voltage when the volume control is set at a minimum; at this value the emission has nearly ceased, hence there is no need of carrying the voltage lower; a higher resistance rheostat would only crowd all the control into a smaller portion of the arc through which the rheostat arm swings;

(3) the rheostat should be placed in the positive side of the filament, the grid being returned to the negative side through a C battery of appropriate value. This arrangement insures that the volume control will not change the grid potential; this point is of minor importance, as the only effect of a changed grid potential with this method is to make the control a little less smooth and even.

The filament rheostat method of control is not recommended for those receivers which use a.c. tubes, however, as these tubes have such heavy filaments that it takes quite an appreciable time to change their temperature after the filament voltage is changed. This causes an annoying delayed action on the volume control. The plate resistance method is good for these tubes, as a.c. sets should not be worked close to the oscillation point anyway, on account of the excessive hum which results from such operation.

Several single control receivers employ no tuned circuit in the input to the first tube, using instead a resistance or radio

(Continued on Page 76)

FIGURING GREAT CIRCLE DISTANCES

By ARTHUR HOBART

The shortest distance between two points on the earth's surface is the great circle passing through them. This distance may be computed by means of a simple formula which can be used by anyone who is able to look up the sines and cosines of angles in a table of trigonometrical functions. These functions are found for three angles, one corresponding to the difference in longitude between the two points and the other two corresponding to the latitudes of the points.

The difference in longitude is found by subtracting the lesser from the greater longitude if both are east or both are west longitude, or by adding them if one is east and the other is west. If the latter sum is greater than 180 degrees it should be subtracted from 360 degrees to find the true difference in longitude D .

Depending upon whether D is greater or less than 90 degrees and upon whether both the latitudes are either north or south or whether one is north and the other south, four cases are possible, each requiring a slightly different formula.

Let the latitude of the point nearest either pole be designated as angle a and the latitude of the point nearest the equator be called b . Look up the sines and cosines of a , b , and D , multiplying and adding them according to the proper formula given herewith. The result is the cosine of the angle along the arc c of the great circle between the two points. Since one minute of this arc c equals one nautical mile or 1.15 statute miles, multiply the number of degrees in the arc by 60 and add the number of minutes to determine the number of nautical miles, and multiply this by 1.15 to get the number of statute miles.

The formula and the solution of a typical problem for each of the four possible cases follows:

Case (1)—when both latitudes are north or both are south and D is less than 90 degrees.

$$\cos c = \sin a \sin b + \cos a \cos b \cos D.$$

Find the distance between a point $37^{\circ} 48' N$, $122^{\circ} 23' W$ and a point $14^{\circ} 2' N$, $171^{\circ} 20' W$. Then $a=37^{\circ} 48'$, $b=14^{\circ} 2'$, and $D=48^{\circ} 57'$.

$$\begin{array}{l} \sin 48^{\circ} 57' = .75414. \quad \cos 48^{\circ} 57' = .65672 \dots (D) \\ \sin 37^{\circ} 48' = .61291. \quad \cos 37^{\circ} 48' = .79016 \dots (a) \\ \sin 14^{\circ} 2' = .24249. \quad \cos 14^{\circ} 2' = .97015 \dots (b) \\ \sin a \sin b = .61291 \times .24249 \dots = .14862 \\ \cos a \cos b \cos D = .79016 \times .97015 \\ \times .65672 \dots = .50342 \end{array}$$

The angle whose cos is .65204 is $49^{\circ} 18'$. Then $(49 \times 60) + 18 = 2958$ nautical miles or 3406 statute miles.

Case (2)—when both latitudes are north or both are south and D is more than 90 degrees.

$$\cos c = \sin a \sin b - \cos a \cos b \sin D.$$

(This differs from Case (1) in that sin D is used instead of cos D and that the second term is subtracted from instead of added to the first term.)

Find the distance between a point $52^{\circ} 30' N$, $14^{\circ} 50' E$ and a point $18^{\circ} 30' N$, $149^{\circ} 20' E$. Here $a=52^{\circ} 30'$, $b=18^{\circ} 30'$, and $D=134^{\circ} 30'$. As the sine or cosine of an angle which is greater than 90 degrees is same as the sine or cosine of the angle which is equal to that angle, minus 90 degrees, $134^{\circ} 30' - 90^{\circ} = 44^{\circ} 30'$ is used when consulting the tables in this and similar cases.

$$\begin{array}{l} \sin 44^{\circ} 30' = .7009 \quad \cos 44^{\circ} 30' = .7133 \dots (D) \\ \sin 52^{\circ} 30' = .7934 \quad \cos 52^{\circ} 30' = .6088 \dots (a) \\ \sin 18^{\circ} 30' = .3173 \quad \cos 18^{\circ} 30' = .9483 \dots (b) \\ \sin a \sin b = .7934 \times .3173 = \dots 25174 \\ - \cos a \cos b \sin D = .6088 \times .9483 \times \\ \dots 7009 = \dots 40463 \end{array}$$

The angle whose cos is $-.15289$ is $81^{\circ} 12'$ which must be subtracted from 180 degrees because of the minus sign, leaving $98^{\circ} 48'$. Then $(98 \times 60) + 48 = 5928$ nautical miles or 6826 statute miles.

Case (3)—when one latitude is north and the other south and D is less than 90 degrees.

$$\cos c = \cos a \cos b \cos D - \sin a \sin b.$$

Find the distance between a point $37^{\circ} 48' N$, $139^{\circ} 43' W$ and a point $14^{\circ} 2' S$, $171^{\circ} 20' E$. Here $a=37^{\circ} 48'$, $b=14^{\circ} 2'$ and $D=360 - (139^{\circ} 43' + 171^{\circ} 20') = 48^{\circ} 57'$. The angles and functions are the same as in Case (1) but because of the north and south latitudes the sines are subtracted from instead of being added to the cosines.

$$\begin{array}{l} \cos a \cos b \cos D = .50342 \\ - \sin a \sin b = \dots 14862 \end{array}$$

The angle whose cos is .35480 is $69^{\circ} 13'$. Then $(69 \times 60) + 13 = 4153$ nautical or 4782 statute miles.

If the product of the cosines is less than the product of the sines the resulting angle should be subtracted from 180 degrees to get the required distance. This occurs when angles b and D become large.

Case (4)—when one latitude is north and the other south and D is more than 90 degrees.

$$\cos c = -\sin a \sin b - \cos a \cos b \sin D.$$

Find the distance between a point $52^{\circ} 30' N$, $14^{\circ} 50' E$ and a point $18^{\circ} 30' S$, $149^{\circ} 20' W$. Here $a=52^{\circ} 30'$, $b=18^{\circ} 30'$ and $D=(14^{\circ} 50' + 149^{\circ} 20') - 90^{\circ} = 74^{\circ} 10'$.

$$\begin{array}{l} \sin 74^{\circ} 10' = .9620. \quad \cos 74^{\circ} 10' = .272 \dots (D) \\ \sin 52^{\circ} 30' = .7934. \quad \cos 52^{\circ} 30' = .6088 \dots (a) \\ \sin 18^{\circ} 30' = .3173. \quad \cos 18^{\circ} 30' = .9483 \dots (b) \\ - \sin a \sin b = \dots 7934 \times .3173 = \dots 25174 \\ - \cos a \cos b \sin D = \dots \\ \dots 6088 \times .9483 \times .962 = \dots 55540 \end{array}$$

The angle whose cos is $-.80714$ is $-36^{\circ} 11'$, which must be subtracted from 180 degrees because of its minus sign, leaving $143^{\circ} 49'$. Then $(143 \times 60) + 49 = 8629$ nautical or 9936 statute miles.

The laborious multiplications in these operations can be avoided by adding logarithmic sines and cosines instead of multiplying the natural functions. This has been done by A. H. Babcock in March *QST* from whose article this one is adapted. But as many readers are not skilled in using logarithms, the long-hand method is used here. Approximate results can quickly be obtained with a slide rule.

A Questionnaire for Radio Engineers

By G. M. BEST

The asking of questions for brain exercise seems to be a popular pastime, judging from the current fiction magazines, and now we have the Radio Questionnaire, which appeared in a recent issue of the *Radio Manufacturers' Monthly*, in an article by W. W. Harper.

The article dealt with the qualifications which were most desired in engineering assistants, laboratorians, and others employed in the engineering departments of radio manufacturing plants. Included was a questionnaire which was suggested as a test to be used by a manufacturer in determining the capabilities of applicants for positions in the laboratory. The answers were not given in the article, so they are worked out here for the guidance of students, and to exercise the brains of those who already consider themselves competent radio technicians.

It was stated that a radio engineer must not only be well versed from a purely technical standpoint, but he must be able to apply his knowledge so that a good product can be made at a minimum cost. Hence he must be grounded in electrical engineering as well as have practical knowledge of radio and its problems. The man who has a preponderance of knowledge along practical radio lines and little of the theoretical side of electricity may be unsuited for laboratory work.

Most radio manufacturers prefer a man having an accurate understanding of Ohm's law and other fundamentals of electricity, so the questionnaire has been divided into two parts, the first part dealing mostly with Ohm's law and the elementary principles of electricity, while the second part is devoted to specialized radio problems. Something is wrong with a man's training if he can answer all or most of the second group and none of the first group. Those readers who find themselves in this category can take heed, and by studying the points on which they are somewhat hazy, they can thereby improve their general usefulness in handling radio problems.

At the risk of our reputation, we have prepared a set of answers to the questions in as brief a form as is possible. For a more detailed discussion of any of the questions in Group One, the reader is referred to any standard text on electricity and magnetism.

Group One

1. Express Ohm's law in three different ways.

$E=IR$ $I=E/R$ $R=E/I$, where E is the voltage, I is the current in amperes, and R is the resistance in ohms.

2. Determine the values of R and R_1 in the network shown in Fig. 1.

The voltage drop across R_1 in series with the 3-volt lamp is 5 volts, and applying Ohm's law, the resistance of this lamp is 24 ohms; since R_1 has a 2-volt drop, the same formula gives a value of 16 ohms. The 5-volt lamp has a resistance of 20 ohms, and the combined resistance of R_1 in series with

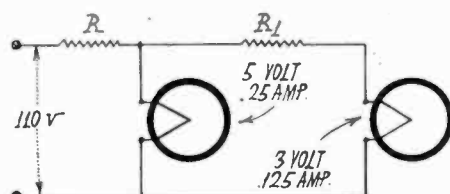

Fig. 1

the 3-volt lamp and the 20-ohm resistance of the 5-volt lamp is 13.3 ohms, since the resistance in multiple is equal to their product divided by their sum. Since the current drawn by the two lamps totals .375 amperes, the total resistance shunted across the 110-volt source is 293.3 ohms, and subtracting the value of 13.3 ohms leaves 280 ohms as the value of R .

3. Give the equation for e in the network of Fig. 2, in which all the values indicated by capital letters are known.

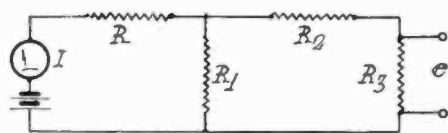

Fig. 2

$$e = \frac{I R_1 R_3}{R_1 + R_2 + R_3}$$

The derivation of this formula involves an interpretation of Pollard's Theorem. This seems to be a "catch" question. Engineers who fail to solve it without consulting a reference should not be discouraged.

4. Determine the required values of the resistors R_1 , R_2 and R_3 in the network of Fig. 3 in order that the maximum current drain on the battery is limited to .01 amp., and with the other conditions as shown.

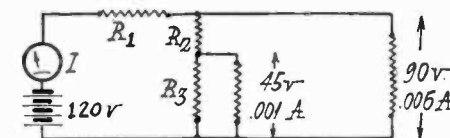

Fig. 3

Compute the total resistance across the 120-volt source, since the current flow, .01 amp., is known. Result, 12,000 ohms. From data given in the diagram, the voltage drop across R_1 in series with the combination of R_2 and the resistance in shunt with it, is 90 volts, leaving a balance of 30 volts drop across R_1 . By Ohm's law, R_1 equals 3000 ohms.

Since the total current consumed is .01 amps., and one of the 90-volt branches consumes .006 amps., the current flowing through the R_2 , R_3 combination must be .004 amps. The resistance in shunt with R_3 consumes .001 amps., so that R_3 has .003 amps. flowing through it. The voltage drop across R_3 is

given as 45 volts, so that R_3 is thus 15,000 ohms. Subtracting the drop across R_3 from the total drop across R_2 in series with R_3 and its associated resistance leaves a voltage drop of 45 volts, so that with .004 amp. flowing through it, R_2 is 11,250 ohms.

To check these figures, work out the value of the resistance in shunt with R_3 , which is 45,000 ohms, and this combined with R_3 is 11,250 ohms. This resistance, in series with R_2 , will be 22,500 ohms, and the remaining resistance in parallel with it is 15,000 ohms, since the voltage drop is 90, and the current .006 amps. The combination of these two resistances is 9000 ohms, which in series with R_1 , which is 3000 ohms, makes a total of 12,000 ohms, the value required.

5. Define the following terms and indicate their relation to other circuit values: (a) resistance, (b) conductance, (c) reactance, (d) impedance, (e) admittance, (f) susceptance, (g) reluctance, (h) permittivity.

(a) Resistance is the ratio of the voltage across the circuit to the current flowing through it. Its unit is the ohm, which is defined as that resistance which will permit one ampere of current to flow, at a pressure of one volt.

(b) Conductance is the reciprocal of resistance, or the ratio of current to voltage. Resistance denotes how difficult it is to force a unit current through a given conductor, while conductance denotes how easy it is to produce the same current in the same conductor. Its unit is one mho.

(c) Reactance is the effect produced by an inductance or capacitance in a circuit, expressed in terms of frequency as well as the inductance and capacity values. To find the reactance of an inductance, multiply the inductance in henries by 6.28 times the frequency of the a.c. in cycles per second. To find the reactance of a condenser, multiply its capacity in mfd. by 6.28 times the frequency of the a.c. and divide 1,000,000 by the product. It is expressed in ohms, and an inductive reactance is positive, while a capacitive reactance is negative.

(d) The impedance of a circuit is the ratio of the a.c. voltage across it to the current flowing in the circuit. Its unit is the ohm. Impedance is a vector quantity, and is equal to the square root of the sum of the effective resistance squared and the reactance squared.

(e) The admittance of a circuit is the reciprocal of the impedance. Its unit is the mho, the same as for conductance.

(f) The susceptance of a circuit is the reciprocal of its reactance, with the unit expressed in mhos.

(g) Reluctance is obstruction to magnetic flow. In a simple magnetic circuit, it is the ratio of the magnetomotive force to the magnetic flux.

(h) Permittivity is the specific permittance of a substance, permittance being the power of storing or holding an electric charge. It is analogous to electric conductivity and magnetic permeability.

6. Explain Kirchhoff's laws and how they differ from Ohm's law.

Kirchhoff's laws are as follows: At any point in a circuit there is as much current flowing to the point as there is away from it. In any closed electric circuit the algebraic sum of the electromotive forces and potential drops is equal to zero. If there is no electromotive force in the circuit, the sum of the potential drops in one direction is equal to the sum of those in the opposite direction. Kirchhoff's laws apply to voltage, current or

resistance conditions in a complex network, whereas Ohm's law applies to the relation between these quantities in a single simple circuit or its network equivalent.

7. Explain the difference between peak, average and root-mean-square values of alternating currents.

The peak value of a sine wave is the value reached at the maximum point attained during an alternation. If the maximum voltage is E , then the peak value is equal to $E \sin 2\pi ft$, where f is the frequency in cycles per sec., and t is the time in seconds. The average value is equal to the maximum value divided by $\pi/2$, or $.6366 E$. The root-mean-square value, also called the mean effective value, is that continuous value which gives the same total current squared times resistance loss. It is equal to the square root of the mean square of the variable values. In simple terms, it is equal to the amplitude divided by $\sqrt{2}$, or $.7071 E$.

8. What do commercial measuring instruments indicate: peak, average, or R. M. S. values?

Instruments of the hot-wire and electro-dynamometer types indicate R. M. S. values.

9. What does a direct current meter read on rectified alternating current: peak, average, or R. M. S. value?

A d.c. meter reading unfiltered rectified a.c. would read the average value.

10. What is meant by the form factor of an alternating current wave?

The ratio between the effective and average values of a sine wave is called the form factor.

11. What is the value of the form factor for a pure sine wave?

For a pure sine wave, the form factor is 1.11.

12. Correct the following sentence by striking out the undesired words: "Impedances must be added algebraically geometrically and not geometrically algebraically."

Impedances must be added geometrically and not algebraically.

Group Two

1. The circuit of the General Radio Decade Bridge is shown in Fig. 4. Explain what other equipment you would need and how you would proceed to measure the inductance of a small air core coil of approximately 300 microhenries; to measure a paper condenser of unknown value; probably between .1 and 2 mfd.?

A calibrated variable inductance is connected to the terminals marked *STD* and the unknown inductance is connected to the terminals marked *X*. Standard variable inductances are available in several sizes, and the one whose range will cover points consider-

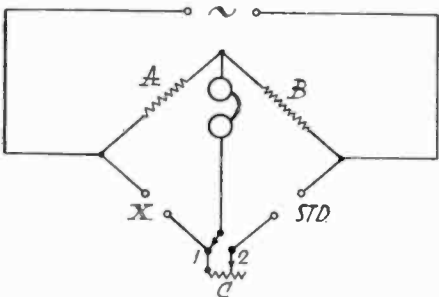

Fig. 4

ably above and below 300 microhenries should be used. As the inductance to be measured probably has more effective resistance than the standard, which is usually very low resistance, the resistance C is inserted in the same arm with the standard by throwing the switch to 1.

The oscillator is turned on, and the standard inductance is varied until the tone of the oscillator is at a minimum. Then the resistance C is varied until the tone can no longer

be heard, or is very faint, after which a slight readjustment of the standard inductance is made in case the balance has been upset. The value indicated on the scale of the standard can then be obtained from the curve accompanying the standard, in case the ratio arms A and B are of equal resistance. If they are unequal, as would be the case if they were set at a ratio of 100 to 1000, then the unknown resistance is equal to A times the inductance of the standard, divided by B . If it is impossible to obtain a null point with resistance C in series with the standard, the switch is set to point 2, and the resistance is thus placed in series with the unknown, which has less resistance than the standard.

For measuring a paper condenser of .1 to 2 mfd., it is necessary to have a group of standard condensers so that any capacity within a reasonable range can be obtained. The standard condenser group is connected to the terminals marked *STD*, and the adjustment of the bridge for the null point is made the same as for the inductance method. By the use of ratio arms of 100 and 1000 ohms, a proportion can be arranged so that a condenser of from .01 to .2 mfd. can be used as a standard for measuring capacities ten times greater. The capacity is equal to the resistance of arm B times the capacity value of the standard, divided by the resistance of A . In measuring paper condensers, whose internal resistance is often high, the resistance C will probably be needed to obtain anything like a null point, especially if the standard condensers are of highest grade mica dielectric.

2. In what units do we measure (a) the intensity of a radio wave, (b) amplification, (c) attenuation?

(a) In microvolts per meter. (b) In terms of voltage increase, or in transmission units. (c) Usually the transmission unit.

3. What is meant by a transmission unit?

The transmission unit is an electrical unit for measuring the efficiency of an electrical circuit. It is defined as ten times the common logarithm of the power ratio. $TU=10 \log (P_1/P_2)$, where P_1/P_2 is the power ratio.

4. Name the element or elements of a radio broadcasting system, (transmitter and receiver) which affect the fidelity of reproduction or tone quality.

In the transmitter, the microphone, speech amplifier, and the type of modulation employed. In the case of the latter, where the Heising system is used, the inductance of the plate choke common to the oscillator and modulator tubes has a marked effect on the low frequencies, if the inductance is not high enough.

In the receiver, the characteristic of the tuned circuits, with reference to their ability to pass a wide enough band of frequencies so as not to cut off some of the audio frequencies with which the r.f. carrier is modulated; the stability of the detector tube, and the characteristic of the audio frequency amplifier.

5. Given a high impedance resonant circuit, how would you go about determining the peak voltage across either the coil or the condenser with a given induced voltage?

If the circuit is of the parallel resonant type, the voltage across the coil or condenser is the same, but if it is of the series resonant type, the factor of internal resistance of the coil and condenser may slightly change the effective voltage across either coil or condenser. A vacuum tube voltmeter of the C bias type is the most convenient voltage indicator to use. The voltmeter input is shunted across that part of the circuit whose voltage is to be measured, and the plate current noted in the customary manner. The voltmeter is then disconnected from the tuned circuit, and sufficient positive C bias by means of dry cells is applied to the grid, so as to produce the same amount of plate

current as was caused by the a.c. voltage. The d.c. voltage thus applied is the peak a.c. voltage.

6. Which type of vacuum tube voltmeter draws the less current, the grid rectification or anode rectification type? Which has the lowest input impedance? Which would you use for voltage amplification measurements?

The grid rectification type draws less current than the anode rectifier. The grid rectification method presents the lowest input impedance. Preferably the anode rectification type, which, for the sake of clearness, is defined as one which uses a three-element vacuum tube with negative C bias on the grid.

7. Discuss the various methods of measuring high frequency resistance.

They are divided generally into four methods: substitution, calorimeter, resistance-variation, and reactance-variation. The substitution method consists in substituting a known resistance standard in place of the apparatus whose resistance is unknown, after a certain definite current indication is obtained. When a value of standard resistance is obtained which indicates the same current flow as that permitted by the unknown, the value of the standard is equal to the value of the unknown resistance. This method is not highly accurate, except for measuring small changes in the resistance of a circuit.

The calorimeter method consists in placing the apparatus whose resistance is desired in some form of calorimeter, which measures the rise in temperature of the apparatus. With the current flowing through the circuit measured by an accurate high-frequency meter, the unknown resistance is calculated from the observed current and the power consumed in raising the temperature in the calorimeter.

The resistance-variation method consists in setting up a simple circuit such as an inductance and capacity, with source of induced voltage, and an ammeter to read the h.f. current flowing in the circuit. The resistance is measured with the unknown apparatus in the circuit, and is then measured with a resistance standard in the circuit, so that the unknown resistance value can then be obtained by subtraction.

The reactance-variation system is also called the decrement-variation method, and is analogous to the resistance-variation method, two observations being taken. In a simple resonant circuit, the current is measured at resonance, the reactance is then varied, and a new current reading taken. The total resistance of the circuit is then calculated from these two observations.

8. What methods are available for determining the inductance of an iron core choke under certain definite operating conditions?

It is assumed that "definite operating conditions" refers to the inductance of the choke while direct current is being passed through the windings. An inductance bridge such as is shown in Fig. 4 can be used, if the direct current through a suitable high resistance is impressed across the points of the bridge to which the headphones are connected, and the standard is a condenser group instead of a standard inductance. As most iron core chokes have a value of inductance much higher than is available in variable standards, the reactance balance method is preferable. A special bridge can also be set up, having ratio arms on opposite sides, as was described in RADIO in the September 1924 issue, the d.c. current supply and the a.f. source being in series.

9. What factors control the output impedance of a three-element tube and how is the output impedance related to other factors involved in a radio frequency amplifier?

The plate-filament spacing, and the plate area; the plate voltage used, as well as the grid voltage, and the grid mesh and di-

(Continued on Page 78)

New Factory Built Receivers at R. M. A. Show

The Grebe A.C. Synchrophase Six has three stages of tuned r.f. with '26 tubes, binocular coils, straight line frequency condenser, and tube isolation circuit; a '27 tube detector, and two stages of audio with a '71A tube in the last stage. A complete ABC

sockets so as to avoid a.c. hum. There are two tuning controls and one volume control with horizontal tangent wheel verniers and a horizontal illuminated dial. A smooth, gradual control of volume is attained with a sharply-tapered variable resistance shunted

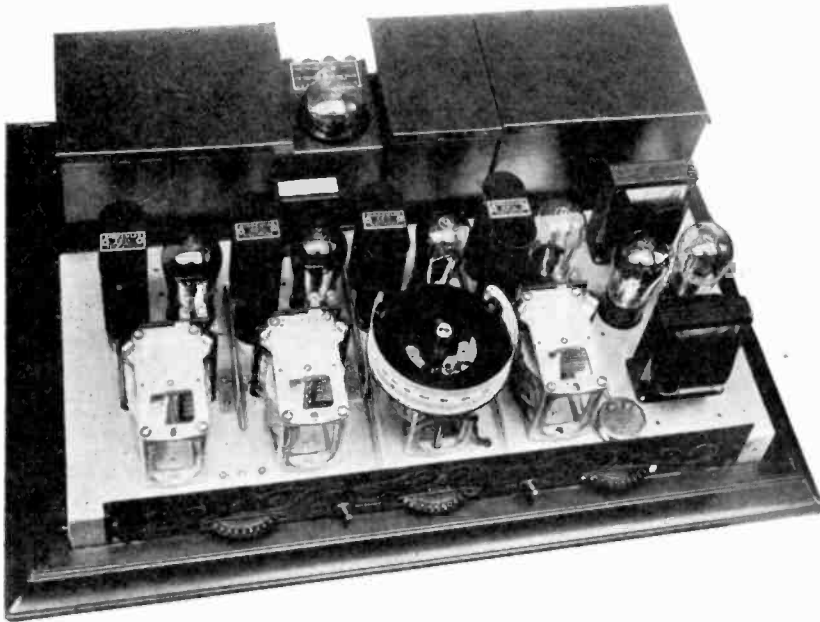

Chassis of Grebe A.C. Synchrophase Six

power plant with '80 rectifier tube is a part of the chassis.

One feature of this new set is a "local distance" switch which shunts a resistance across the primary of one of the r.f. transformers for controlling selectivity and sensitivity. Special precautions are taken to insure firm contact with the tube prongs in the

sockets so as to avoid a.c. hum. There are two tuning controls and one volume control with horizontal tangent wheel verniers and a horizontal illuminated dial. A smooth, gradual control of volume is attained with a sharply-tapered variable resistance shunted

across the primary of the r.f. input transformer. The chassis is of heavy aluminum with four reinforcing ribs. A mahogany veneer cabinet with bronze control board fits over the mounting-frame which forms the base. It is available either as a cabinet or with table mounting.



The Fada 31

New items in the Fada line include six a.c. receivers and two loudspeakers. Four of the receivers have the same type of six-tube chassis with rectifier, and use an outside antenna. Two of them have eight tubes and rectifier and use either a loop or antenna.

The six-tube chassis uses five '27 tubes, one '71 tube, and an '80 rectifier, giving three stages of r.f., detector, and two stages of audio. It has a single tuning control, with illuminated dial. Extra fine tuning may be done with a vernier control of the antenna

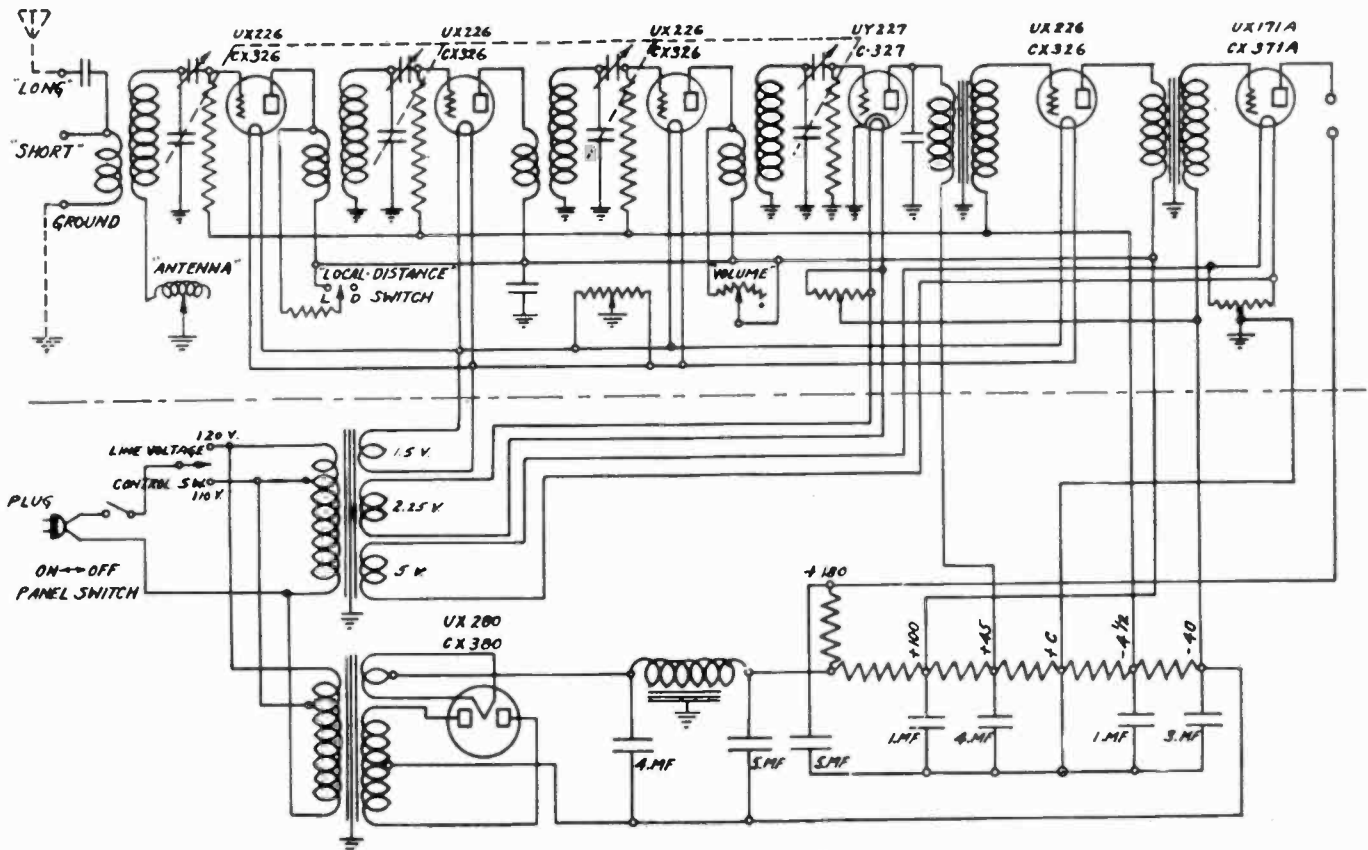

Circuit Diagram of Grebe A.C. Synchrophase Six

condenser. Change in volume is accomplished by varying the equalizing r.f. stage. A small switch controls the 110-volt a.c. supply. The chassis frame is of heavy steel.

The "10" model with this chassis is in a two-tone metal cabinet, 21 x 9 x 12 in. The "11" is in a burl walnut cabinet 11½ x 25¼ x 13¼ in. The "30" model is a walnut console, also containing a Fada 4B cone speaker, and the "31" model is a high-boy console with space for a built-in speaker.

The eight-tube models have four r.f. stages and two '71 tubes in a push-pull last audio.



The Fada 70

A jack provides connection for a plug from any phonograph pick-up which thus utilizes the two stages of audio and the loudspeaker for record reproduction. The loop is automatically disconnected when folded within the cabinet, and the antenna is then automatically connected. They have the same controls as the six-tube models. The "50" model is housed in a walnut cabinet 11¾ x 27 x 17 in. The "70" is a Sheraton console with a built-in dynamic speaker.

One of the new loudspeaker models, the Fada-4, is a 7 in. cone housed in a mantle-clock metal case 13½ x 11½ x 9½ in., the cone being driven by a rod from a balanced armature. The other, the Fada-14, is an electrodynamic speaker in a cabinet which also houses the power supply.

The R C A Radiola 18 combines in one cabinet a six-tube radio set using a.c. filament supply and a UX-280 rectifier with filter for plate voltages. It employs an improved form



Radiola 18

of r.f. amplifier tuning using three UX-226 tubes, a UY-227 detector, and a UX-226 and 171-A as audio amplifiers. The set is turned on or off by a single power switch. Tuning is accomplished with one knob which moves an illuminated indicator dial past a window in

the panel. The intensity of volume is controlled by a switch at the left.

The Majestic seven-A.C. receiver employs a standard chassis, which is available in four table and console models. It has a tuned antenna input to three stages of tuned r.f. (R.F.L. balanced circuit), detector, and two stages of audio with push-pull connection of two '71 tubes in the last stage. It



Model 71 Majestic

has single-dial control with secondary controls of selectivity and of volume.

Model 61 is in a walnut cabinet with a Majestic electric power unit. Model 62 consists of a one-piece cabinet and table. Model 71 is essentially the cabinet type mounted on a Majestic dynamic power speaker. In Model 72 the dynamic speaker is mounted over the receiver and both are concealed by doors of matched burl walnut.

The new Kellogg line of a.c. receivers is housed in four models, one table cabinet and three consoles. They use tuned and balanced r.f. amplification and two stages of transformer coupled audio with a built-in output



Model 516 Kellogg Receiver

transformer. Kellogg a.c. tubes are employed together with a power unit especially designed for the set. Both radio and audio circuits are completely shielded. Of the three knobs on the illuminated control panel, one is a zone switch divided in kilocycles, one is a single station selector, and one a volume control by means of variation in C bias. The table model is encased in a brown metal cabinet and has two r.f. stages. The Model 516 console is 42½ in. high, 31 in. wide and

18¼ in. deep, has four r.f. stages and built-in speaker. The 514 and 517 models are slightly larger and more elaborately finished but otherwise is similar to the 516.

The Balkite a.c. receiver is a seven-tube neutrodyne using three stages of tuned r.f. a tuned detector and two stages of audio with two '12A tubes in the last stage. It is equipped with power plant supplying a.c. for filaments and d.c. for plate voltages. A jack is provided for phonograph connection. The single

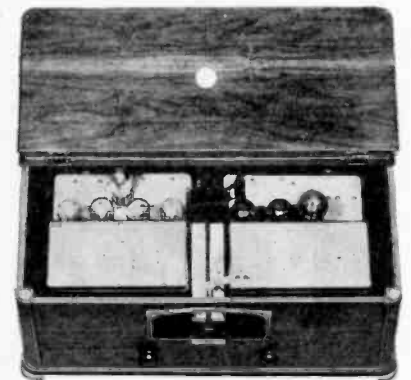

Balkite A-5

tuning dial is of the large drum direct drive type. The two other controls are for volume and an off-and-on switch. The escutcheon is recessed for easy tuning. The chassis is completely enclosed by shielding so that the only exposed parts are the connections for aerial,



Balkite A-7

ground, and speaker, the tube sockets, and the drum dial. It is made in two Berkey & Gay furniture models, a table cabinet and a high boy with dynamic speaker and one model in a steel case.

The Freed-Eisemann NR-80 is a seven-tube neutrodyne with integral tube rectifier

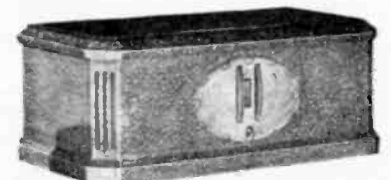

Freed-Eisemann NR-80

and filter for plate supply. It is made in two types, one for a.c. filament tubes and one for

(Continued on Page 50)

Some of the New Loud Speakers

New items from the Magnavox Company consist of a number of cabinet model electro-dynamic speakers, and three speaker units without cabinets. The Dynamic-6 is an improved electro-dynamic cone unit, with magnetic field supplied by 6 volts d.c., at .65 ampere. It is furnished complete with output transformer and filter, and is ready to mount on a suitable baffle board. The Dynamic-7 is similar in appearance to the Type 6, but has a field requiring from 110 to 220 volts d.c., at from 45 to 90 milliamperes, so that it is suitable for use as the choke coil in a



Magnavox Dynamic 80 Speaker Unit.

B power supply filter circuit. The Dynamic-80 consists of a speaker unit mounted on a metal baseplate, on which is also placed a step-down transformer and contact rectifier, so as to supply about 25 watts of rectified a.c. to the field of the speaker. This type of unit is most suitable for use with a.c. receivers, and requires no separate source of d.c.



Improved Belvedere Model Magnavox Electro-Dynamic Speaker.

Among the cabinet models are the Beverly, a table speaker of particularly fine appearance; the Belvedere, which is designed to be set on the floor alongside a console type receiver, and has an open back so as to avoid cabinet resonant effects; the Aristocrat, a console type cabinet speaker; and the Cordova, which contains a stage of power amplification using a type 210 tube. All the cabinet models except the Cordova come in three types, using either Type 6, 7 or 80 units.

News items from the Jensen Radio Mfg. Co., makers of the Jensen electro-dynamic loudspeaker, include a type D-44 cabinet speaker which operates directly from the electric light socket. The unit obtains its field excitation from rectified alternating current, supplied by a Westinghouse transformer and

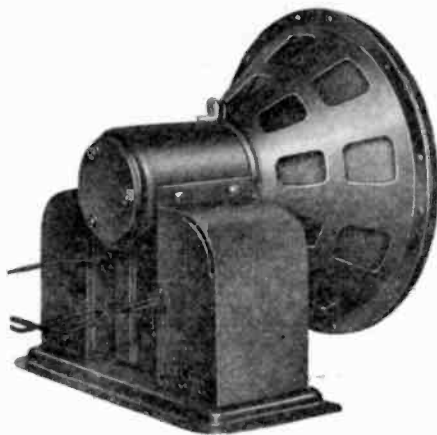

Unit for Jensen D-44 Cabinet Speaker

Rectox contact rectifier, especially designed for Jensen use. The entire unit is mounted on a metal base, the rectifier equipment being completely enclosed. It is contained in a handsome cabinet for table mounting, or it may also be had in console form. The unit is furnished separately, for use in electric phonograph, or console type radio receivers.

Improved units, with cabinet types as well, include one for operation from 6 volts d.c., at 4 amperes, and another requiring 90 volts d.c., at 40 milliamperes. All models have a frequency range of from 20 to 5500 cycles, with uniform response throughout that frequency band.

The RCA 105 loudspeaker is of the electro-dynamic type in a walnut floor model cabinet which contains a B and C eliminator with two UX-281 tubes which supplies voltage not only for a radio set, but also for a power amplifier with UX-250 power tube in



RCA 105 Loudspeaker

RADIO FOR JULY, 1928

the cabinet. The entire equipment is operated from 110 volt a.c. The speaker unit uses a corrugated moisture-proof paper cone.

Newcomb-Hawley dynamic cone speakers, which are manufactured under license from the Magnavox Company, are available in two models of chassis, each of which are supplied either as a separate unit, or mounted in various styles of cabinets, tables, and consoles. The Model NH-6 has a field winding designed for operation from a 6-volt battery. Model NH-9 is equipped with rectifier and filter to supply the field winding

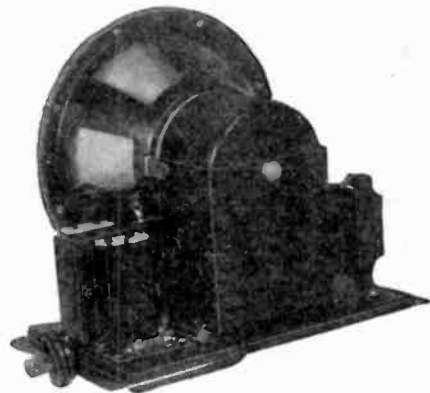

Model NH-3 Dynamic Cone Chassis.

with 90 volts d.c. from a 110-volt a.c. source. Both are equipped with input transformers.

No. 100 provides a unique mounting for a NH-9 chassis, as it also houses a motor-driven phonograph turntable and has space for any a.c. electric radio set. A selector

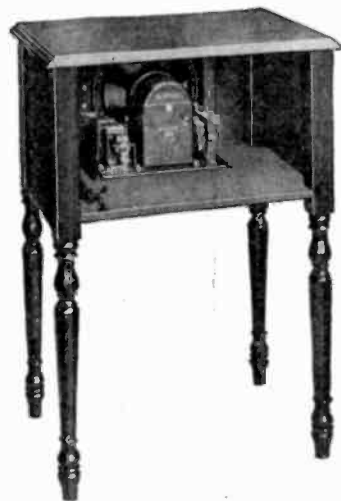

Rear View of Newcomb-Hawley Table Model.

switch provides connection for either radio or phonograph reproduction. No phonograph pick-up is included.

Model 80 is a new addition to their line of magnetic cone reproducers, the chassis being sold separately, as a cabinet or as a table.

Martin-Copeland electro-dynamic speakers are made in three types, each of which is mounted in an artistic brown mahogany table cabinet. Type D-6 requires one-half ampere at 6 volts d.c. from a battery. Type D-90 requires 90 to 110 volts d.c. for its field, and Type D-110 is equipped with a rectifier and filter so that 110 volts a.c. may be used.

(Continued on Page 56)

D. C. and A. C. Power Units, Audio Amplifiers

The General Radio Type 445 plate supply and grid bias unit uses a UX-280 rectifier tube and provides any desired combination of voltages from 0 to 180 volts, by means of four adjustable wire-wound resistance units.



General Radio Plate Supply Unit

An adjustable grid bias voltage from 0 to 50 is also available. It is equipped with an automatic cut-out switch to break the 110-volt a.c. circuit when the cover is removed for adjusting voltages or connecting wires to binding posts. Its dimensions are 15 x 7 x 7 in. and its weight 16 lbs.

The General Radio Type 441 push-pull amplifier is a completely wired second stage of audio consisting of two high quality push-pull transformers with the necessary resistances and sockets mounted on a brass base-board. It is intended for use with any type of power or semi-power tube. Where a first stage amplifier of 20 to 30 provides a signal input of 6 volts, two '26 tubes are recommended. When a signal voltage of 15 to 20 is available at the amplifier input, the '71 type of tube is recommended. This form of

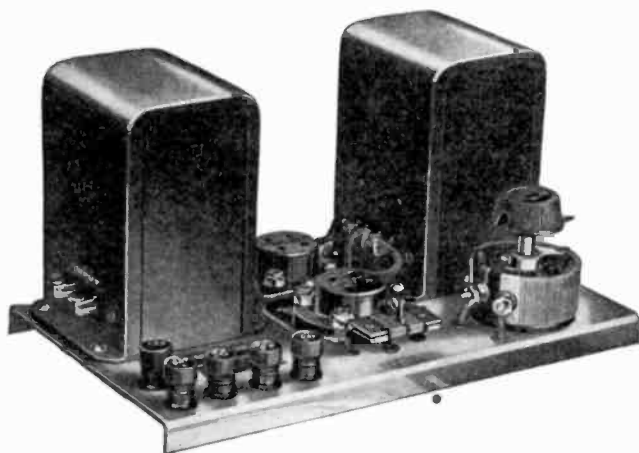

General Radio Push-Pull Amplifier

connection tends to cancel out distortion due to tube overloading and a.c. hum, giving a maximum undistorted power output.

The Powerizer is essentially a transformer for supplying alternating current of the proper voltage for the filaments and heaters of a.c. tubes. Thus the "A" model is designed to supply current to seven '26 tubes, two '27's and two '71 tubes. The "P 171" model supplies *B* and *C* voltages by means of an '81 rectifier tube, in addition to the *A* current. The "PXY-1" model not only supplies *A*, *B* and *C* current to the set, but also to a '10 tube in the device itself, making it a combined power plant and power amplifier. A special type of this model is made for use with the Radiola 25 or 28 sets. The "PD-5" is for



"PXY-1" Model Powerizer

d.c. sets using '99 tubes. It supplies *B* voltage and 0.5 amperes *A* current at 3 volts.

In this line also are two power amplifiers without current supply for the set. The Powerizer "PX-2" is a two-stage unit with a '26 tube in the first stage and a '10 tube in

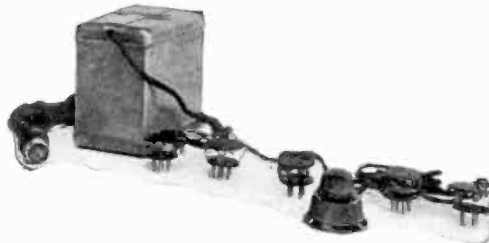

"A" Model Powerizer

the second, together with an '81 rectifier. The "PX-3" has three stages, using '27 tubes in the first and second and a '50 in the third stage. Both use special alloy core transformers.

The Samson PAM 16-17 is a two-stage power amplifier operated from a 110, 115 or 120 volt a.c. source and having an undistorted power output of 7 watts. It uses a '27

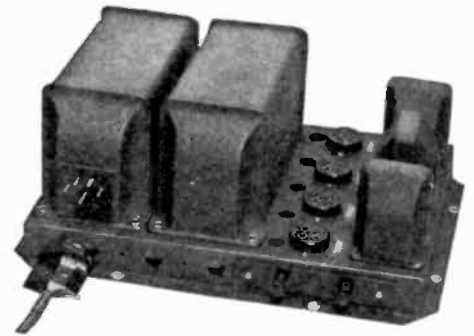

Samson PAM 16-17 Amplifier

tube in the first stage, and two '10 tubes in the second push-pull stage, with a '81 tube as rectifier. It is intended to give great volume from a radio set or phonograph pick-up.

The Samson ABC-71 is a power unit designed to supply constant voltage to sets using a.c. tubes. The supply is adjustable for 110, 115 or 120 volt a.c. It uses a '80 tube as rec-

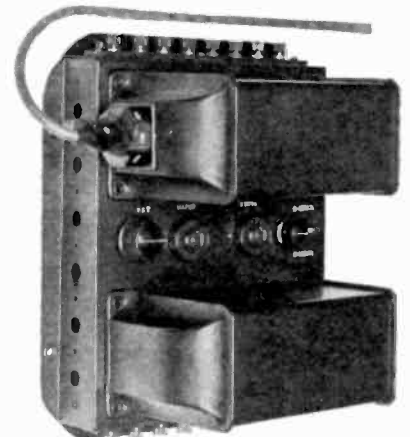

Samson ABC-71 Power Unit

tifier and '74 as voltage regulator, and through various binding-posts supplies 1½, 2½ and 5 volts a.c. for *A* current; 45 to 90

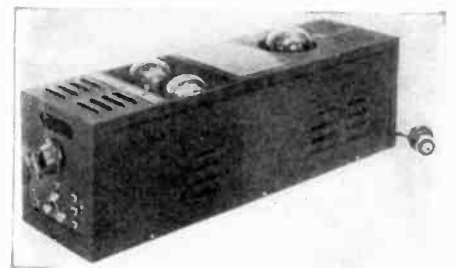

"PX-2" Model Powerizer

volts variable; 90, 135, and 180 volts *B*; and -4½, -9 and -43 volts *C*. It is built to meet the A. I. E. E. and National Board of Fire Underwriters' requirements.

A new RCA *B* eliminator, Model AP-1080, employs no tubes, liquids or mechanical parts to be replaced, the rectifier being of the contact type and enclosed and sealed in a

(Continued on Page 58)

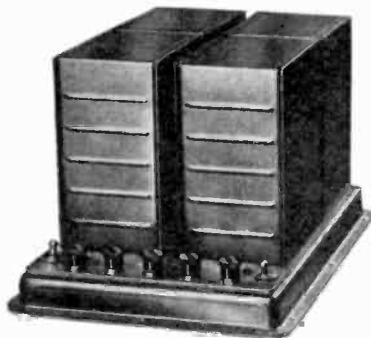

R. C. A. "B" Eliminator

RADIO FOR JULY, 1928

Summary of R. M. A. Show Exhibits

ABOX Co., Chicago, Ill., *A* power plants, for supplying *A* current from the lighting mains for d.c. sets, and a group of electrolytic condensers and filter equipment.

A-C DAYTON Co., Dayton, Ohio, four table model receivers, three with six a.c. tubes and one with six d.c. tubes; all using tuned r.f. circuit.

ACME ELECTRIC & MFG. Co., Cleveland, Ohio, complete line of *A*, *B* and *C* eliminators, in separate and combined units, using disc rectifier for *A* and '80 tube for *B C*; also tone filter, push-pull transformer for '50 tube, and "Flash" five-tube receiving set.

ACME WIRE Co., New Haven, Conn., an improved type of Parvult paper condenser, in all sizes and voltages required. Also a new line of Celatsite wire for a.c. filament wiring, and a new 12 conductor cable for a.c. receivers.

AERO PRODUCTS Co., Chicago, Ill., complete kits of parts for short wave receivers and a new kit for building a short wave transmitter, for radiophone as well as telegraph service.

AEROVOX WIRELESS CORP., Brooklyn, N. Y., a group of non-inductive paper condensers in all capacity or voltage ratings, fixed mica condensers, filter condenser blocks, wire wound resistors, grid leaks, and a new large capacity *A* condenser for *A* eliminator service.

ALL-AMERICAN MOHAWK CORP., Chicago, twelve new models with '80 rectifier tube and a.c. tubes. These include two table cabinets with phonograph jack, one having six tubes and three r.f. stages and one being eight tubes for four r.f. and push-pull audio. These are also incorporated in various consoles with or without magnetic or dynamic speakers; also with phonographs.

ALLEN BRADLEY Co., Milwaukee, Wis., a complete line of fixed, variable and tapped resistance units, including the famous Bradleystat.

ALUMINUM CO. OF AMERICA, Philadelphia, Pa., a complete line of aluminum box shields, panels, and cabinets, cut to size for all popular kits and circuits.

AMERICAN MECHANICAL LABORATORIES, INC., Brooklyn, N. Y., makers of Clarostats. New items include a dual clarostat with screw-driver adjustment so as to save space, and a line of socket antenna plugs, voltage regulators for a.c. sets, and many types of power rheostats and variable resistors.

AMERICAN-BOSCH MAGNETO CORP., Springfield, Mass., eight-tube a.c. receivers in table cabinet or in console with cone speaker, and nine-tube console with dynamic speaker and push-pull audio. All use R. F. L. circuit.

AMRAD CORP., Medford, Hillside, Mass., four a.c. operated console mod-

els with seven tubes and '80 rectifier, three stages tuned r.f. and push-pull second audio using either '10 or '50 tubes; built-in dynamic speaker; one model includes phonograph.

AMSCO PRODUCTS Co., New York City, a group of fixed and variable resistors, for all types of radio service, especially in *B* power devices. A group of single and gang variable condensers, the gang condensers being guaranteed to within 1/2 of 1 per cent as to matching.

F. A. D. ANDREA, INC., New York City, six new a.c. models, four of which are six-tube receivers, and two are deluxe models with eight tubes. The six-tube consoles have built-in electro-magnetic cone speakers, and the eight-tube console has an electro-dynamic unit. A new type of circuit is used in these receivers, differing from all previous models. Two loud speakers, one of which is an electro-dynamic cone, with table cabinet mounting, are also announced.

APEX ELECTRIC MFG. Co., several table and console model a.c. receivers, using the neutrodyne circuit, also a model for d.c. operation.

ARCO ELECTRIC CORP., a group of *A* and *B* power units, including battery chargers, *A* power unit parts such as chokes, transformers and automatic control relays.

ARCTURUS RADIO Co., Newark, N. J., a new line of a.c. tubes, including a shielded grid tube, high mu, special detector and power amplifier, all of the four prong variety so as to be adaptable to sets already wired for d.c. service.

ARGUS RADIO Co., New York City, four six-tube a.c. sets using three stages of tuned r.f. with one shield grid tube; single dial control with selector switch and volume control, in table cabinet or one of three consoles with built-in dynamic speaker.

ATWATER KENT Co., Ardmore, Pa., a complete line of six and seven-tube a.c. receivers and a group of loud speakers. Model 40 is completely enclosed in a metal cabinet and employs improvements in circuit and apparatus which will be featured this season.

BALKITE (Fansteel Products, Inc.), North Chicago, Ill., a new line of table and console a.c. receivers with built-in power supply. Two table models and two hi-boy consoles.

BELDEN MFG. Co., Chicago, Ill., a new line of wire equipment for a.c. receivers, as well as flexible cords for loud speakers, extensions and battery wiring.

BENJAMIN ELECTRIC MFG. Co., Chicago, "red-top" sockets (4 and 5-prong), r.f. transformers, sub-panel brackets, battery switch.

BEST MFG. Co., Irvington, N. J., an improved loud speaker unit of the electro-magnetic type, known as the B. B. L. motor. It has a large armature and magnet, so as to handle the high power required by present day speakers.

BIRNBACH RADIO Co., New York City, a line of radio parts and accessories, including r.f. transformers of the regenerative type, extension cords, and battery cable connectors.

L. S. BRACH MFG. CORP., Newark, N. J., *A B C* eliminators, as well as separate power plants for *A* or *B* service. Their line of lightning arresters, automatic filament control resistors, and other radio accessories has also been enlarged.

BREMER-TULLY MFG. Co., Chicago, six a.c. Counterphase receivers and two speakers, a magnetic and a dynamic. There are two six-tube, two seven-tube, and two 8-tube models, table cabinet or console with speaker.

BROOKLYN METAL STAMPING CORP., Brooklyn, N. Y., a new device for connection to a radio receiver, by which the voice can be reproduced by the loud speaker by talking into a microphone.

BUCKINGHAM RADIO CORP., Chicago, Ill., a group of five six-tube tuned r.f. sets for either a.c. or d.c. operation, in table and console models.

D. K. BULLENS MFG. Co. Pottstown, Pa., three grades of permanent magnets for loud speaker manufacturers, including chromium, tungsten and cobalt alloys.

BURGESS BATTERY Co., Madison, Wis., the new Super *B* battery, which has unusually long life, an addition to their full line of *A* and *B* batteries of the dry cell type.

BUSH & LANE PIANO Co., Holland, Mich., seven a.c. seven-tube receivers, and two speakers, magnetic cone and dynamic. Four of the receivers have a tuned r.f. circuit, one in a table cabinet, two in consoles with cone speaker, and one in a console with dynamic speaker. Three have a neutrodyne circuit in console with cone or dynamic speaker.

CARTER RADIO Co., Chicago, Ill., a complete line of radio parts and accessories, including all types of rheostats and potentiometers, fixed resistors, condensers, and a variety of outlet plates for radio wiring of homes and buildings.

CASE RADIO CORP., Marion, Ind., seven a.c. receivers and one d.c. model, in table and console models, some with air column loud speakers, and several with built-in electro-dynamic units. The most expensive model has a phonograph attachment, and uses a loop antenna.

CELERON Co., Bridgeport, Pa., complete line of celeron panels, tubing, rods

Summary of R. M. A. Show Exhibits

and sheets, especially for manufacturers and jobbers.

C-E MFG. Co., Providence, R. I. several new a.c. tubes, including a shielded grid a.c. tube having a low voltage filament, and designed to fit in a five-prong socket.

CENTRAL RADIO LABORATORIES, Milwaukee, Wis., new types of power rheostats for both light and very heavy duty, wire wound resistors of all sizes, and a complete line of potentiometers and variable resistances for volume control service.

CHICAGO-JEFFERSON FUSE & ELECTRIC Co., Chicago, Ill., a new line of power transformers for filament lighting service in a.c. sets, also of Concertone audio transformers.

CHILLICOTHE FURNITURE Co., Chillicothe, Mo., radio cabinets and radio furniture of all types, for standard makes of receivers, as well as practically all radio kits now on the market.

CONTINENTAL FIBRE Co., Newark, Del., a line of extra thin wall Bakelite-Dilecto tubing for r.f. coils, panels, tube sockets and fittings for all radio parts.

COLUMBIA PHONOGRAPH Co., New York City, a new line of combination radio receivers and electric phonographs. The radio receiver is the Kolster, and is available in two console models, with built-in loud speaker.

CORNISH WIRE Co., New York City, radio wire products, as well as adapter harness equipment for converting d.c. receivers to a.c. operation.

CROSLY RADIO CORPORATION, Cincinnati, Ohio, new Jewelbox, Showbox and Gembox models for a.c. operation; also a new Dynacone dynamic speaker, an improved Bandbox and Bandbox, Jr. for battery-operation. The a.c. Gembox has two stages of radio frequency amplification and a non-radiating regenerative circuit. Illuminated single dial control. Housed in metal container with gold highlights. The coils are shielded. A combination neutrodyne and non-radiating regenerative circuit is claimed to be the equivalent of an additional stage of radio frequency amplification. The Dynacone speaker is built on the electro dynamic principle; frequency range from 50 to 7000 cycles; the Dynacone is made in two types one for sets having no output transformer and one for sets with an output transformer. The showbox and jewelbox receivers have push-pull audio amplification and are equipped with power units capable of delivering sufficient current to energize the field of the Dynacone speaker. Two Crosley Musicone cone speakers are also available. These speakers are of the magnetic type.

CROWE NAMEPLATE & MFG. Co., Chicago, panel metal escutcheons, nameplates, dials and scales.

E. T. CUNNINGHAM, INC., New York City, a complete line of nearly 40 types of radio tubes, for d.c. and a.c. service.

DAY-FAN ELECTRIC Co., Dayton, O., an eight-tube a.c. receiver with tuned r.f. circuit in either table cabinet or console with speaker, and an eight-tube similiar model for battery operation.

DEJUR PRODUCTS Co., New York City, a line of radio parts, including vitreous enameled resistors, variable condensers, r.f. transformers, sockets and rheostats. An a.c. voltage regulator is another new item and is equipped with an a.c. voltmeter to insure accurate adjustment.

DIAMOND ELECTRIC SPECIALTIES CORP., Newark, N. J., dry batteries and radio tubes.

DONGAN ELECTRIC MFG. Co., Detroit, Mich., new audio transformers, including power push-pull input and output, and a power transformer for filament lighting of a.c. tubes; power transformers for all services; filter chokes for *A* and *B* eliminators; and by-pass condensers.

DUBILIER CONDENSER CORP., New York City, special filter devices for attachment to all types of electric power equipment which causes radio interference. In addition, an enlarged list of fixed paper and mica condensers as well as metallized grid leaks, and improved light socket antenna plugs.

H. H. EBY MFG. Co., Philadelphia, Pa., vacuum tube sockets for all types of a.c. and d.c. tubes, complete group of binding posts for all purposes.

ELECTRAD, INC., New York City, Tonatrol units, Truvolt resistance units of all types and sizes, fixed mica condensers, by-pass and filter condensers, grid leaks, rheostats, potentiometers, and other radio accessories.

ELECTRICAL RESEARCH LABS., Chicago, Ill., makers of Erla products, a voltage regulator for a.c. sets, designed to be connected between the power line and the input to the receiver. Three new models of a.c. receivers, in console cabinets, with built-in dynamic cone speakers. The dynamic units will also be available as separate items. A phonograph pickup is another new item.

ELKON WORKS, INC., Weehawken, N. J., a new dry element *B* eliminator, dry *A* eliminators, a dynamic loud speaker, and a tapering battery charger, which has an automatic adjustment of charging rate to suit the condition of the battery.

FANSTEEL PRODUCTS Co., North Chicago, Ill., a new line of radio receivers, and a complete line of *A* and *B* power units. (See Balkite).

FARRAND MFG. Co., Long Island City, N. Y., five electro-magnetic cone speakers in various table styles, and three electro-dynamic models, including a console model of unusually handsome appearance. The electro-dynamic units are available separately, for a.c. or d.c. operation.

FEDERAL RADIO CORPORATION., Buffalo, N. Y., six types of a.c. receivers, of six and seven tubes, with four of the models also available for d.c. operation. All sets are single control with illuminated scale, and have push-pull amplification in the power stage. The console cabinets are available in carved walnut or mahogany, and are equipped with built-in-air column speakers, or can be had with electro-dynamic cone units.

FERRANTI, INC., New York City, audio transformers, including new types of push-pull input and output transformers, the latter being designed both for high impedance speakers, and those of the electro-dynamic type which have low input impedance.

FORMICA INSULATION Co., Cincinnati, O., a complete line of Bakelite products, including drilled and engraved panels for all popular kits and circuits.

FREED-EISMANN RADIO CORP., Long Island City, N. Y., a new line of a.c. receivers employing the tuned r.f. circuit, in handsome wood and metal cabinets both in table and console styles, also loud speakers of electro-magnetic and electro-dynamic types.

FRESHMAN Co., INC., New York City, eight models of seven-tube a.c. receivers, using the Equaphase circuit, in table and desk consoles. One model includes an electric phonograph attachment.

FRENCH BATTERY Co., dry *A*, *B* and *C* batteries for every service, including new heavy duty batteries for *B* service.

FROST, HERBERT H. INC., Chicago and Elkhart, a complete line of new parts include new heavy duty filter condensers, *B* blocks, new moulded mica condensers, by-pass condensers, fixed wire resistances, variable resistances, air-cooled rheostats, a.c. snap switches, cable plugs and a complete power amplifier universal resistance kit. The kit consists of three fixed resistors of 2000 ohms each of the new Frost "A" series, wound on flexible Bakelite strips and four 2000 ohm heavy duty wire wound potentiometers as well as one 1500 ohm series "A" fixed resistor. These fixed resistors are equipped with sliding contacts to give variable 135 to 180-volt taps. The resistor for the *C* bias will

Summary of R. M. A. Show Exhibits

give proper bias for the type and number of tubes used. Convenient wall outlets, hook-up wire, medium duty filters, panel brackets, center tapped resistances, Gem Hum Balancers and UX base sockets for subpanel mounting are included in the Frost line for the new season.

GENERAL INSTRUMENT Co., New York City, a complete line of radio parts, including improved models of variable condensers.

GENERAL RADIO Co., Cambridge, Mass., audio frequency oscillators of the beat frequency type, as well as the conventional types, impedance bridges, artificial lines and networks for telephone line measurements, input and output transformers for the 350 power tube, and power transformers of all types are but a few of the many new items introduced this season.

GENERAL TRANSFORMER CORP., Chicago, Ill., a complete line of power packs for manufacturers, including separate items of transformers, chokes and tuned audio transformers.

GREENE-BROWN MFG. Co., Chicago, Ill., *A* and *B* eliminator units, the *A* unit employing a dry plate rectifier, with 2½ amp. output, and the *B* unit supplying 85 milliamperes at 180 volts, using a gas-filled rectifier tube.

GRIGSBY-GRUNOW Co., Chicago, Ill., Majestic seven-tube a.c. receivers with R. F. L. circuit in table, spinet, console and hi-boy models.

HAMMARLUND MFG. Co., New York City, plug-in coils for a short wave receiver, covering the 20, 40 and 80 meter bands; space wound on a celluloid form, with a variable primary coil. Kits of parts for building tuned r.f. sets employing Hammarlund circuits, and a complete line of variable condensers, r.f. chokes, r.f. transformers and other parts for the professional set builder and the experimenter.

HIGH FREQUENCY LABORATORIES, Chicago, Ill., a new line of custom-built sets, including superheterodynes, using shielded grid tubes, and complete *ABC* socket power devices, as well as tuned r.f. and audio transformer equipment for the set builder.

HOYT ELECTRICAL INST. Co., electrical meters for all purposes, especially test sets for the a.c. tubes and sets.

HOWARD RADIO Co., Chicago, Ill., seven models of receivers using six, seven, or eight a.c. tubes and employing a tuned r.f. circuit; with or without loud speakers. The eight-tube models have push-pull audios with '71 tubes in last audio stage.

HYATT ELECTRIC CORP., portable radio receivers, as well as a group of accessories for all types of sets.

INTERNATIONAL RESISTANCE Co., Durham, Ind., grid leaks from 250 ohms to 20 megohms; power ohms from ¼ to 50 watts, 1000 to 50,000 ohms; made with variety of lugs and terminals for every manufacturing need.

JENSEN RADIO MFG. Co., Oakland, Calif., four cabinet type electro-dynamic speakers, and three units for separate installation. The cabinet styles are both table and console, finished in walnut. The units are furnished either for a.c. or d.c. operation.

JEWELL ELECTRIC INST. Co., Chicago, Ill., a.c. and d.c. set tester, new types of a.c. meters, both portable and for panel mounting.

HOWARD B. JONES, INC., Chicago, Ill., three multi-plugs for connecting radio receivers with associated batteries or rectifier equipment.

KARAS ELECTRIC Co., Chicago, Ill., radio parts and accessories, the latest item being a set of a.c. transformers for filament lighting service. Included in the list of new parts are subpanel brackets, condenser control systems, and the new type 28 audio frequency transformer.

KELLOGG SWITCHBOARD & SUPPLY Co., Chicago, Ill., four new receivers, all a.c. operated, one being a table model and the rest consoles. Tuned r.f. amplification, using Kellogg a.c. tubes and with two stages of transformer coupled audio with output transformer, used in all four models. The sets are completely shielded, and have illuminated control panels.

KENRAD CORPORATION, Owensboro, Ky., a line of 16 radio tubes, known as Archatrons.

KING MFG. Co., Buffalo, N. Y., four receivers, two of 5 and 6-tubes for d.c. operation, using the neutrodyne circuit, and 6 and 7-tube a.c. models, one with push-pull amplification in the power stage.

KINGSTON PRODUCTS CORP., Kokomo, Ind., a complete line of *B* eliminators using Raytheon *BH* rectifiers and designed specially for use with 25, 30, 40 or 60-cycle supply; furnished 125 m.a. at 120 volts for '71 tube; also an Elkon *A* unit supplying 2½ amp. at six volts.

KODEL RADIO CORP., Cincinnati, O., a.c. power plants for operation of d.c. receivers from a.c. power lines, as well as trickle chargers, and high rate battery chargers, all using the Kuprox dry element charging unit.

KOLSTER RADIO CORP., Newark, N. J., seven types of a.c. receivers, of six and seven tubes, the console models having built-in electro-dynamic speakers. Besides two table models, there are two loud speakers, one a table type cone, and the other an electro-dynamic model in a console cabinet.

MAGNAVOX Co., Oakland, Calif., electro-dynamic loud speakers, in table, console and unit form, including a.c. units for operation from the electric light socket. The units are also available for d.c. sets, and all cabinet and console models can be had equipped with the d.c. units.

MARTI ELECTRIC RADIO Co., INC., three models of a.c. receivers, including a table model. Sets are eight tubes, with three stages of tuned r.f., detector and three stages of resistance coupled audio, with 210 power tube.

MCMILLAN RADIO CORPORATION, Chicago, Ill., four eight-tube a.c. receivers with four stages of shielded radio frequency, detector and three stages of audio frequency, (push-pull); built on steel framework; full wave rectification system. The Winchester is a table model 10x25x16, single dial control. The New York Combination is a table cabinet with mounting table, housing cone speaker, 39x27x16. The Westminster is a high boy console in American walnut, housing same receiver as the Westchester. The Warwick is a console model in combination walnut and satinwood.

MICARTA FABRICATORS Co., Pittsburg, Pa., a line of panels and other products for the professional set builder, as well as the radio factories.

MINERVA RADIO CORP., Chicago, Ill., seven types of seven-tube tuned r.f. receivers, all for a.c. operation, with one table model. The console models have built-in loud speakers, three of which are of the electro-dynamic type.

MOLDED WOOD PRODUCTS, INC., Chicago, Ill., two loud speakers with exponential horn, and a cone assembly for separate installation in console cabinets.

LESLIE F. MUTER Co., Chicago, Ill., a.c. power units, by-pass and filter condensers of all sizes and a variety of radio parts such as rheostats, switches, grid leaks, and new types of audio frequency transformers, including double impedance units.

NATIONAL CARBON Co., radio receivers, including a special d.c. model using high-mu tubes so as to economize on *B* battery power, and a.c. models of both table and console types. A new cone type loud speaker is also announced, as well as a complete line of *A*, *B* and *C* batteries.

NATIONAL Co., INC., Malden, Mass., tuning units for regenerative tuned r.f. sets, a new drum dial of the vernier type, in addition to short wave condensers and coils, push-pull amplifier equipment, and *B* power units.

NEWCORBE-HAWLEY, INC., St. Charles, Ill., electro-dynamic speakers, as well as improved air column reproducers and magnetic-cone reproducers.

(Continued on Page 64)

New Instruments for Radio Measurements

The Weston Model 537 A.C.-D.C. radio set tester is provided with an a.c. voltmeter, a d.c. volt-milliammeter, and an ingenious system of switches and binding posts for automatic connection to the circuits of any radio receiver, whether a.c. or d.c. The a.c. voltmeter has three ranges, 150/8/4 volts, the



Weston Model 537 A.C.-D.C. Radio Set Tester

lower ranges measuring the filament voltage of a.c. tubes and the highest range the line voltage. The d.c. volt-milliammeter has four voltage ranges, 600/300/60/8 volts with a resistance of 1000 ohms per volt, and two current ranges, 150 and 30 m.a. The set is furnished with a complete instruction book and necessary socket adapters so that any current or voltage in the set can be measured without need of power other than that supplied to the radio receiver.

The Jewell No. 199 radio set analyzer has been designed to give a rapid indication of the circuit conditions in any radio set, whether a.c. or d.c. It is arranged to read all the various values of current and voltage in connection with each tube and its socket by plugging an adapter into the tube socket



Jewell Pattern No. 199 Radio Set Analyzer

and pressing special push button switches on the tester panel. The a.c. voltmeter has ranges of 0-4-8-16-160 volts. The d.c. instrument has ranges of 0-7½-75-300-600 volts with 1000 ohms per volt and 0-15-150 m.a. Special leads are provided for making continuity tests. It gives a cathode voltage test for a.c. tubes for which it has a five-prong plug. Each instrument is provided with a complete instruction book and a pad of test charts.

The Hoyt universal service set tester is a compact, accurate instrument for making rapid tests of wiring, power supply and tubes, in all kinds of radio sets, without disturbing connections or accessories. Tubes may be tested with this instrument under actual working conditions and a.c. line voltage of "electric sets" checked as well. It is equipped with a d.c. precision moving coil volt-milliammeter and a three-range a.c. volt-



Hoyt Universal Service Set Tester.

meter. The d.c. voltmeter has a resistance of 1000 ohms per volt and has five d.c. scales—10, 100 and 500 volts, 25 and 100 m.a. Three scales are available on the a.c. voltmeter—3, 9, and 150 volts. It contains a tube socket and has a flexible four-wire lead terminating in a plug which, with the furnished adapters, fits all tube sockets. Plainly marked

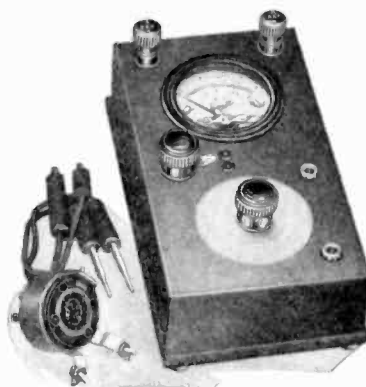

Hoyt A.C. Attachment.

push-buttons and switches provide easy operation during each test.

The Hoyt a.c. attachment for d.c. tube testers consists of a heavy-duty rheostat and a 0-3, 3-9 voltmeter responsive to either a.c. or d.c. It is equipped with a special adaptor for '27 tubes and a pair of leads with terminals to fit tubes having top connection. A similar instrument is also made with a 0-3, 4-15 volt range. Full directions for attachment and use accompany each instrument.

The Hoyt Universal a.c. and d.c. tube tester provides a means for testing all types of tubes, including those with top heater connections. Power for its operation may be obtained either from the receiving set socket by means of socket plug base and cable, from batteries, or from transformers.

The Sterling Junior A.C. Tube Checker is designed primarily to test short circuits between the elements of any vacuum tube and also to check the emission of '26, '27, '99, and '20 tubes. When the device is connected to a 110-volt socket its arrow indicates the existence of a short between the filament and

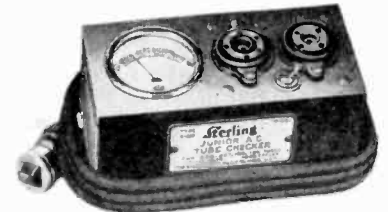

Sterling Junior A.C. Tube Checker.

grid, plate and grid, or plate and filament of the tube inserted in the socket. The relative emission is also indicated by throwing the switch.

The Hoyt pocket voltmeter for a.c. sets has three scales—0-3, 0-8, 0-150—the dial being marked in red at the important points, 1½, 3, 5, 7½, and 110 volts. On special order the second scale is supplied for 4-15 volt

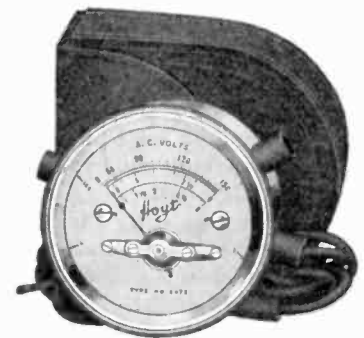

Hoyt A.C. Pocket Voltmeter.

readings. The resistance on all scales is more than 20 ohms per volt. It reads without appreciable error on d.c. above 90 volts. It is supplied in a nickel case 2¼ inches diameter with a pair of special leads and a leather carrying case.

NEW RADIO CATALOGS

Catalog No. 16 from the Jewell Electrical Instrument Company, Chicago, is one of the most helpful guides published for users of measuring instruments. In its 112 pages are illustrated and described all the portable and switchboard instruments made by this company, including voltmeters, ammeters, ohmmeters, galvanometers, wattmeters, power factor meters, frequency indicators and relays. Most of these are of interest to industrial and power company engineers, but many of them, including various radio test sets, are especially designed for radio men. The constructional features of various types of movements are also shown.

"The Gateway to Better Radio" is a 32-page booklet from American Mechanical Laboratories, the manufacturers of the Clarostat, a micrometric variable resistance whose construction and various radio applications are clearly shown. Interesting suggestions are given for getting the most out of your radio, how to make it reach farther, how to control volume and improve tone quality, and how to build battery eliminators.

Radio Frequency Amplifying Equipment

The Sterling Pre-Amplifier is a complete tuned r.f. stage using a shield-grid tube to be connected ahead of any set using d.c. tubes. It adds greater distance, selectivity, and better tone without the necessity of rebuilding



Sterling Pre-Amplifier

an existing set. It is equipped with switch and power cable having marked leads. It is especially adapted for use with short aerials, thereby reducing static.

The Braxton-King impedance unit is designed for use with shield-grid tubes in a 350 k.c. amplifier. It consists of a plate coil with its tuning condenser, a filament resistor,

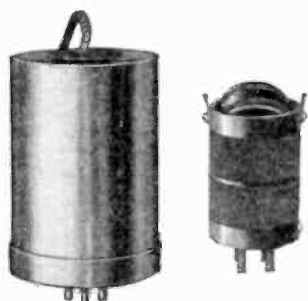

Braxton-King Impedance Unit and Oscillator Coil.

blocking condenser, and grid condenser, completely shielded and fitted for plug-in to a standard socket. The oscillator coil for use with a matched set of three or four of these impedance units consists of a balanced plate and grid winding with a variable pick-up coil and is tuned by a .00035 mfd. variable condenser in series with a .0005 mfd. fixed condenser.

Carter accessories for '22 type of shield-grid tubes include a metal shield which completely covers the tube and base, a brass

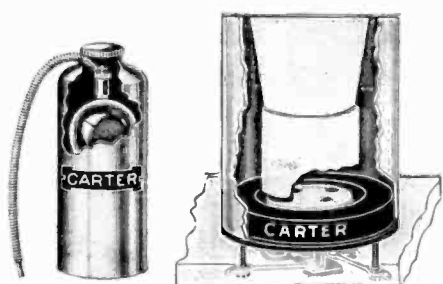

Carter Tube Shield, Connector, and Adapter

connector and shielded wire for the grid terminal of the tube, and an adapter ring to hold the tube shield in place on the socket. The connector is slotted to make a firm spring contact. While these devices are designed for joint use, each may be bought and used separately.

Carter also has a small and conveniently mounted 25-ohm resistor which is tapped at 10 ohms, so as to provide 3.3 volts filament current from a 6-volt battery, and to give C bias to the tube. A similar 15-ohm type, tapped at 5 ohms, is designed for use in connection with a rheostat. These are less than 2 in. long and 1/4 in. wide.

The new S.-M. "130 Series" plug-in coils and forms are Bakelite moulded, of small dimensions (1 7/8 in. high, above prongs;



Silver-Marshall No. 130 Plug-in Coils

1 15/16 in. top diameter) suitable for plugging into any 5-prong a.c. tube socket. As compact and efficient as it is economical, the S.-M. 130 unwound coil form is ideal for short-wave experimenting. The S.-M. 131-T, U, V and W coils, space-wound with enamelled copper wire, provide wavelength range from 17.5 to 204.5 meters.

The National single dial tuning unit is made in two types. No. 222 is for use with screen grid tubes and has a high impedance transformer with slot-wound primary. Type b is similar except that it is designed for use with '1A, '26 or '27 type tubes. The unit includes an escutcheon plate drum dial with velvet vernier control and lamp for illumina-

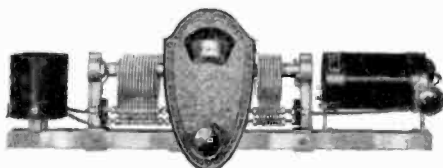

National Single Dial Tuning Unit.

tion, two Equitone condensers, and small size, space-wound Browning-Drake type of r.f. transformers. Each of these parts is also available separately. The unit is assembled on rigid aluminum girders which preserve the alignment and make it easy to install and use. The antenna circuit has a built-in induction trimmer which obviates the use of a trimmer condenser and simplifies the wiring when building a receiver.

The Flewelling short-wave adapter is a single stage tuned r.f. amplifier equipped with an adapter to be plugged into a socket of an existing receiver, which is thereby converted into a short-wave receiver without any change in wiring.

The S-M 638 Stage Shield is made of .014 sheet copper, with removable top and bottom. Its small size (5-9/16 inches high by 4 1/2 inches wide by 2 5/8 inches deep) recommends

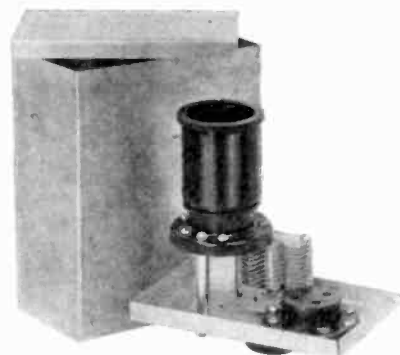

Silver-Marshall Shield for R.F. Stage

it particularly for use with the new S-M five-prong plug-in coils. The bottom is pierced for tube socket, coil socket, and midget condenser assembly.

New Silver-Marshall condensers include a .00035 mfd. two-gang and a "three-gang" bath-tub type equipped with compensators,

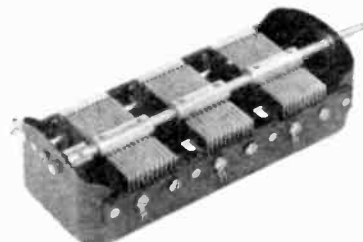

New S-M Three-Gang Condenser.

and also a single variable condenser to match. There is also a .00014 mfd. model of similar design for short-wave reception.

The Lincoln tuned intermediate frequency transformer is of the air core type. By means of a calibrated condenser knob it may be tuned from 350 to 450 kilocycles for use in a special Lincoln 8-tube superhetrodyne cir-



Lincoln Tuned I. F. Transformer

cuit using four screen grid tubes. It is completely shielded in a copper case of the same size and appearance as the Lincoln audio transformers.

New Audio Transformers

The new Remler first-stage audio transformer applies the old-time telephone repeater system to secure greater gain and an approximately straight line amplification curve for all frequencies received from a broadcast transmitter. In this system the transformer primary is resonated at about 60 cycles with a fixed condenser in series. The resonance curve is broadened by means of a shunted high resistance which is also effective in by-passing the d.c. component of the audio frequency voltages so that only the a.c. component passes through the primary. The turns ratio is raised to an effective $4\frac{1}{2}:1$ by means of an auto-transformer, of which one part is the primary and the entire winding is the secondary.

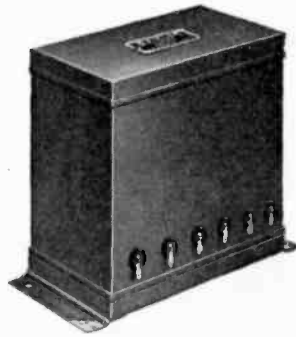

New Remler Output Transformer

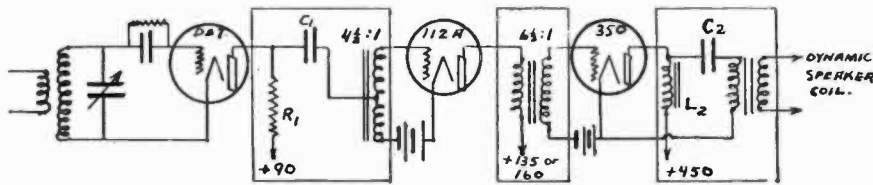

Fig. 1. Circuit Diagram of New Remler Audio Amplifier System

Figure 1 shows the circuit diagram for these connections as well as the balance of the audio amplifier system with 112A tube in the first stage. A special $6\frac{1}{2}:1$ transformer and 350 tube in the second stage, and a step-down output transformer preceding a dynamic speaker.

The 112A tube is recommended because of its low plate impedance with respect to its amplification constant. A resistance of 100,000 ohms for R_1 gives the proper low-frequency characteristic to offset the drop in the second transformer. This resistance causes a voltage drop in the detector circuit which thus requires 90 volt B supply instead of the usual $22\frac{1}{2}$ or 45 volts.

with a.c. filament tubes, which otherwise may produce an a.c. hum in a dynamic speaker. The use of the higher resonating frequency is also advantageous when a '71 power tube is used to give the same apparent volume as a '10 tube without overloading or blasting on the low notes.

The Remler audio amplifier system is made complete with an output transformer having a low impedance secondary to match the low impedance of a dynamic speaker's moving coil. D.C. is kept out of the output transformer by means of a choke coil and condenser.

S.-M. 225 and 226 are first and second stage audio transformers which are claimed to give straight line amplification from 30 to 5,000 cycles, and a voltage amplification 50 to 100 per cent greater than that provided

heretofore. This transformer is manufactured in accordance with the Clough invention, whereby the d.c. component of the plate current is carried by a large resistance which is shunted between the B battery and plate terminal of the transformer primary, and the a.c. component flows through the transformer primary. The drop in plate potential due to this resistance is overcome by using 180 to 200 volts on the plates of the detector and first audio tubes, using a greater resistance in the detector circuit to give the requisite lower voltage.

By thus keeping the d.c. component out of the transformer primary, any hysteretic distortion due to oversaturation of the core is minimized and the core can be operated at a higher point in its permeability curve. Only the a.c. signal flows through the primary and operates on the iron core. Thereby a greater effective inductance is obtained for a given expenditure of copper and iron.

In order to accentuate the amplification of the very low frequencies, a fixed condenser of proper value is placed in series with part of the transformer primary, causing a resonance hump in the curve. By the auto-transformer connection shown in Fig. 1, the same winding that previously provided a 3:1 turn ratio now

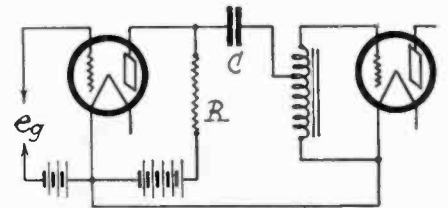
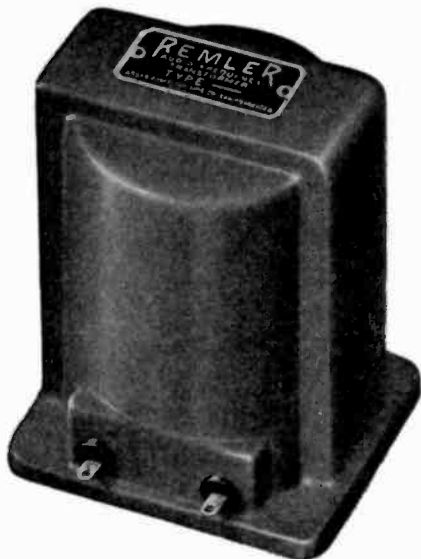

Fig. 1. Connection for Clough System

provides an effective 4:1 ratio. This correspondingly reduces the distributed capacity in the secondary and thus gives better amplification of the high frequencies.

Actual curves of comparative tests of a number of high grade transformers are

(Continued on Page 73)



New Remler Audio Transformer

The combination of the two audio transformers and 112A tube is sufficient to give a grid swing of 70 volts for a 350-power tube when the detector tube has an output of $1/3$ volt, which is about the maximum for distortionless reproduction. The entire system with two tubes is claimed to give a gain of from 55 to 57 TU for all frequencies between 50 and 5000 cycles.

The transformers with resonated primaries are made in two types, one resonated to about 60 cycles for use with d.c. filament tubes and one to about 100 cycles for use



The New Silver-Marshall 225-226 and The Lincoln 105, all using the Clough System

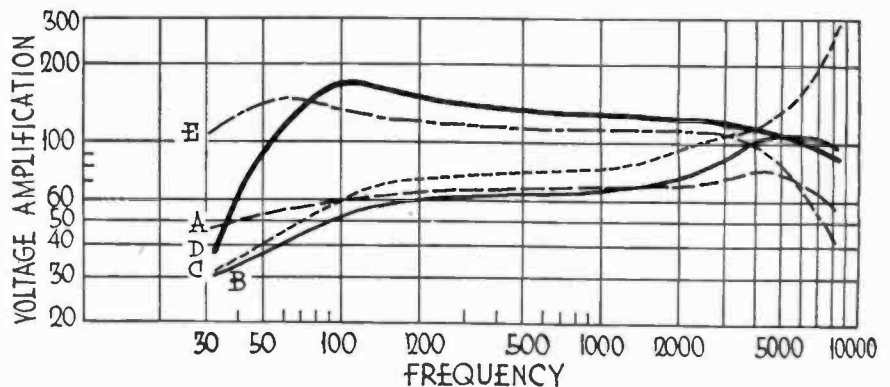
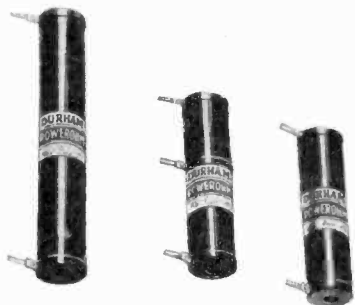

Fig. 2. Curves of Audio Frequency Amplification

Miscellaneous Parts and Accessories

RESISTORS

Durham Powerohms are fixed resistors ranging in power capacity from $\frac{1}{8}$ to 50 watts and in resistance from 20 to 500 meg-



Durham Powerohms

ohms. Sizes vary from 1 to 24 in. in length, depending upon their resistance and heat-dissipating ability.

The Super-Davohm is a wire-wound high resistance unit which can be furnished in any value from 500 to 5,000,000 ohms. It has practically negligible inductance and a minimum of distributed capacity. Its ohmage

500 OHMS TO 5,000,000 OHMS



rating is claimed to be accurate within 1 per cent plus or minus. It has a safe carrying capacity of 1 watt and a temperature coefficient of .0001. It is especially adapted for use as a plate or grid resistor in radio sets, a multiplier for voltmeters, or as a high voltage regulator.

A number of novel Clarostats for micro-metric control of resistance are now available in addition to the standard model. These include a table type equipped with cords and connector and having a resistance range of 0 to 500,000 ohms and a capacity of 7 watts, and a volume control of similar range

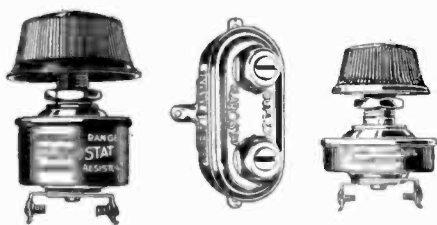

Volume Control Duplex Grid-Leak.

and capacity. There is also a grid-leak type with a range of $\frac{1}{10}$ to 10 megohms for use in short-wave reception or with a resistance or impedance coupled amplifier. It is also recommended for a.c. detector tubes. One model, the Duplex, combines two units in one, with screwdriver adjustment of resistance for semipermanent use. The power Clarostat with a 40-watt capacity is available in three ranges, 0-10, 25-500, and 200-100,000 ohms. It is intended for voltage tap, line voltage, C biasing and other heavy duty control.

Polymet center-tapped resistances in all standard sizes from 10 to 100 ohms are designed to insure proper grid balance for a.c. tubes. They are equipped with a combination soldering and mounting lug at either end and



Polymet Center-Tapped Resistance

a center mounting hole whose distance can be made to suit requirements. The same form of flat resistance element is also available without center tap in all sizes from one to 2000 ohms for low current carrying capacity use. Flexible resistance elements wound on non-inductive tubing, covered with an insulating sleeve and equipped with a tinned soldering lug are made in sizes from 1 to 5000 ohms.

Har-Field universal voltage dividers for B eliminators are made in two types, one for a 180-volt rectifier and the other for the 425-volt type. They consist of a fixed resistor for 90-volt supply with a 45-volt tap and an ad-

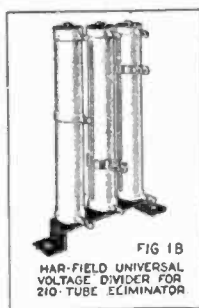

FIG 1B
HAR-FIELD UNIVERSAL
VOLTAGE DIVIDER FOR
210-TUBE ELIMINATOR

Har-Field Universal Voltage Divider

justable resistor for the maximum terminal. They may be adjusted for a specific eliminator and load requirement either by simple calculation or by trial, both of which methods are described in the directions and circuit diagrams which accompany the units. They are designed for use with voltage regulator tubes.

The Electrad Truvolt Divider is a wire-wound resistor having five adjustable contacts for supplying any desired B and C voltages from a rectifier and filter system. The adjustable contacts can be calibrated



Electrad Truvolt Divider

and by means of tables and graphs which are furnished with the unit the divider can be adjusted to give specified voltages at a given current drain without using a high resistance voltmeter. It has a bakelite base and knobs and can be mounted in any position.

Carter wire-wound tapered rheostats and potentiometers are designed for circuits where the useful range of adjustment is crowded into a small portion of the knob's rotation. The strip upon which the resistance wire is wound is tapered so as to be narrower at one

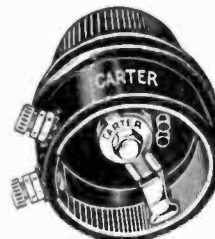

end than the other, and has a greater spacing between turns at the narrow end. Both rheostats and potentiometers are made in 400, 750, 1000, 3000, 5000, 6000 and 10,000 ohm sizes and have a maximum dissipation of 5 watts.

"Amperite" No. 226 and No. 227 are automatic resistance controls for the filaments of '26 and '27 types of a.c. tubes. They are designed to keep the tubes operating within the proper limits when used on the required



transformer taps. They are found to prolong tube life and eliminate distortion. They are to be connected in series with the tube filament and the A line from the transformer.

FIXED CONDENSERS

New Parvolt condensers include complete groupings of filter condensers in metal housings with lead-in terminals designed for use with the more important a.c. and d.c. power



Grouping of Parvolt Filter Condensers for Power Units.

supply units. These are of standard mfd. capacities and in ratings of 200, 400, 600, 800, 1000, and 1500 volts. Parvolt by-pass condensers also are available in standard capacities and voltage ratings.

Dubilier interference devices are designed to suppress line transmission of interference to radio reception from make-break sparking contact apparatus which produces an inductive kick-back. Models No. 1 and 2 are heavy capacity condensers either of which may be grounded and shunted across the apparatus which is causing the trouble.

(Continued on Page 70)

Radio Kit Reviews

"Silver Ghost" Universal Transoceanic

This is a nine-tube receiver using four stages of tuned r.f. amplification with shield grid tubes, gassy detector tube, two resistance coupled audio with high-mu tubes and one push-pull audio with two '10 or '50 tubes. It also has a BC eliminator using two '81 rectifiers capable of supplying 180 m.a. at 450 volts. Provision is made for an external A eliminator.

Interaction in the r.f. stages is prevented by liberal shielding and spacing between stages and by the use of small transformers with concentrated fields. Individual control is provided for each r.f. stage and the detector, but these can also be connected together for two-dial tuning with auxiliary vernier adjustments. One dial then controls the



Silver-Marshall Screen-Grid Eight

antenna series condenser, which, with the three-point selector switch of its coil, is claimed to give 10 k.c. selectivity. Plate voltage to the r.f. and detector tubes and grid bias for the r.f. tubes are regulated from the front panel. The broadcast band transformers are interchangeable with those for long waves up to 3600 meters and short waves down to 35 meters.

The undistorted audio output is 7000 milliwatts with two '40 tubes in the resistance coupled stage and two '10 tubes in the push-pull stages. With '50 tubes this approaches 20,000 milliwatts which can be properly handled only by a dynamic speaker. If such is used its field serves as the filter choke coil in the BC eliminator.

A two-scale volt meter with nine-point switch is provided for reading all A, B, and C voltages and a milliammeter to measure the total plate current of all except the power tubes. A single switch turns on or off the entire equipment, as indicated by a pilot light.

Great care has been taken in the details of design. All parts are of rugged construction and the kit is packed to avoid breakage in transit. Amazing records of satisfactory long distance reception are cited from the

(Continued on Page 74)

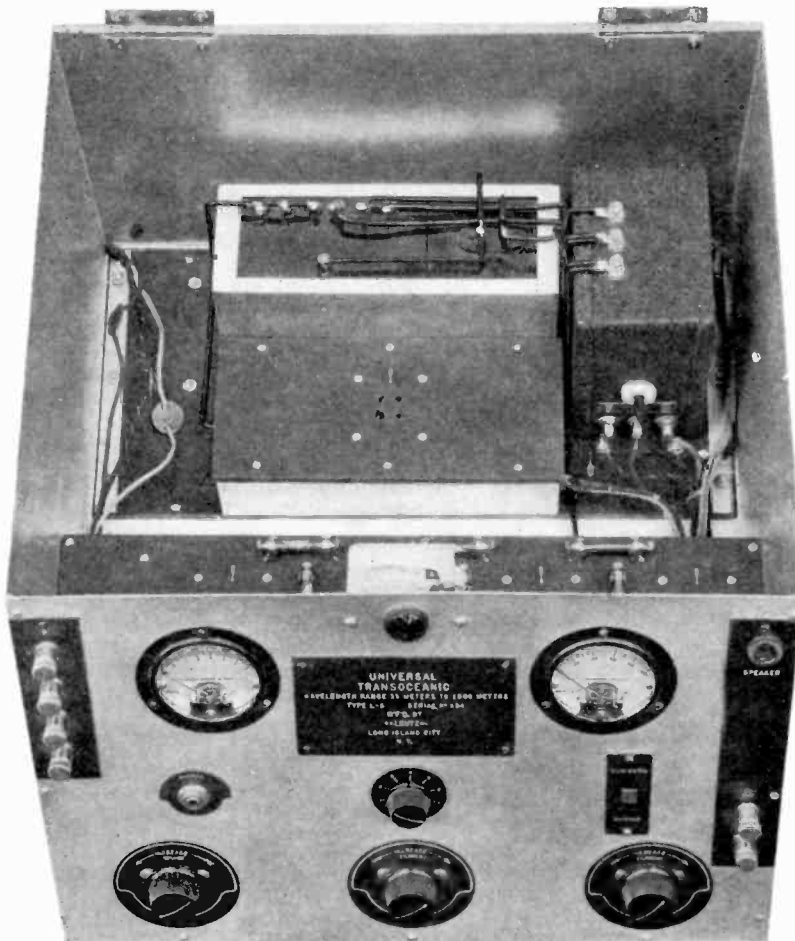

Completed "Silver Ghost" Transoceanic

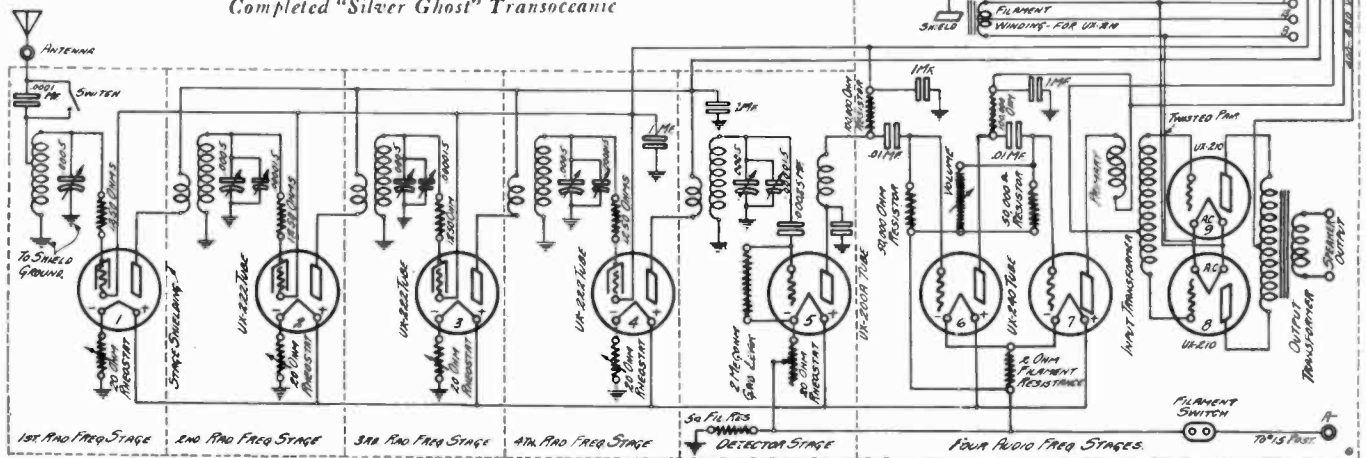

Circuit Diagram of New "Silver Ghost" Receiver

RADIO FOR JULY, 1928



QUERIES and REPLIES



Questions of general interest are published in this department. Questions should be brief, typewritten, or in ink, written on one side of the paper, and should state whether the answer is to be published or personally acknowledged. Where personal answer is desired, a fee of 25c per question, including diagrams, should be sent. If questions require special work, or diagrams, particularly those of factory-built receivers, an extra charge will be made, and correspondents will be notified of the amount of this charge before answer is made.

I wish to improve the selectivity of my Best 45 k.c. superheterodyne, and would like the circuit diagram for a r.f. amplifier of one or two stages, to be placed ahead of the first detector, and which will retain the loop antenna feature. Should straight line frequency condensers be used in preference to the older straight line wavelength condensers originally installed in the set?—F. W. K., Cleveland, Ohio.

oscillate badly. The loop antenna requires a separate .0005 mfd. tuning condenser, which cannot easily be ganged to the condensers tuning the two r.f. transformers. This is because the tuning curve of the loop antenna, and that of each r.f. transformer are different, and a large trimmer condenser, which would be inconvenient to operate, would be needed. The set would have three dials, one for the loop antenna, one controlling a two-gang con-

A type CX-381 half-wave rectifier tube is much better than the 316-B, which is now obsolete. The filament voltage for the new tube is the same, and no changes need be made in the circuit to accommodate it.

Please publish the circuit of the Kennedy Model 15 set, and what is the address of the Kennedy Company?—C. W. Y., Alhambra, Calif.

This receiver is no longer made, and as far as we know, the company is out of business. Circuit diagrams of obsolete receivers are often very difficult to obtain, and we have been unable to locate an authentic diagram of the Model 15 set.

What is the circuit of the Northern Electric 9-tube superheterodyne, and can it be operated from a.c.?—H. R. C., Cleveland, O.

The circuit is shown in Fig. 2. It consists of the usual superheterodyne arrangement of oscillator, mixer, three i.f. stages, detector and first audio, with type R-215-A peanut tubes in a series-parallel combination to work from a 6 volt storage battery. The second audio stage is push-pull, with tubes having 6 volt filaments, and the entire set is designed to operate from storage *A* and not directly off the lighting socket. Of course, standard types of *A* and *B* eliminators can be used to supply the d.c., so that the set can be run without batteries, except for the *C* batteries used in the first detector and power stage.

In connection with the Best 115 k.c. superheterodyne, are chokes and by-pass condensers of advantage, in the shield grid leads? Would larger by-pass condensers than the present .1 mfd. size improve results? Would a choke of 125 mh. be of value in the plate of the second detector?

(Continued on Page 67)

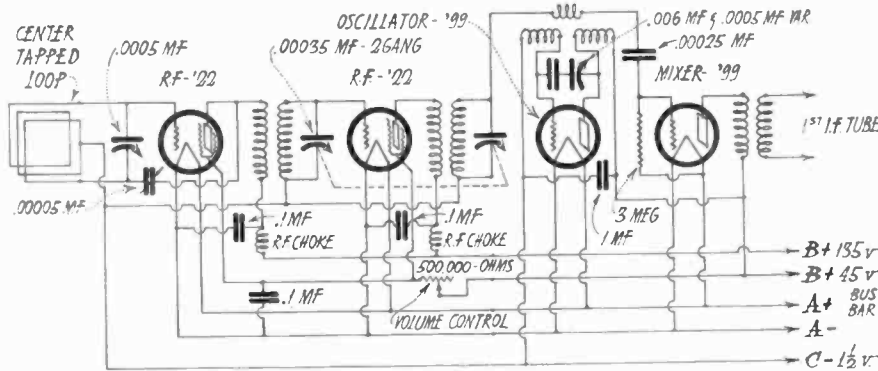

Fig. 1. Circuit of R.F. Amplifier for 45-Kilocycle Superheterodyne

In Fig. 1 is incorporated a diagram of a two-stage tuned r.f. amplifier, using a loop antenna for input, and feeding into the first detector circuit of the 45-k.c. superheterodyne. This amplifier has shielded grid tubes, and the r.f. transformers may either be those used in the new Best 115-k.c. superheterodyne, or any other shielded grid r.f. circuit now on the market. It is important that each stage be individually shielded, for otherwise, the selectivity will be poor, and there will be a tendency on the part of the amplifier to

denser tuning the two r.f. stages, and one for the oscillator condenser.

I have a half-wave "B" eliminator built after plans published in RADIO about two years ago. The output voltage seems to be lower and lower each time I measure it and I think the tube is wearing out. Is there any better tube than the 316-B, and what changes in the circuit must be made if a new tube is advisable?—E. L. A., Terre Haute, Ind.

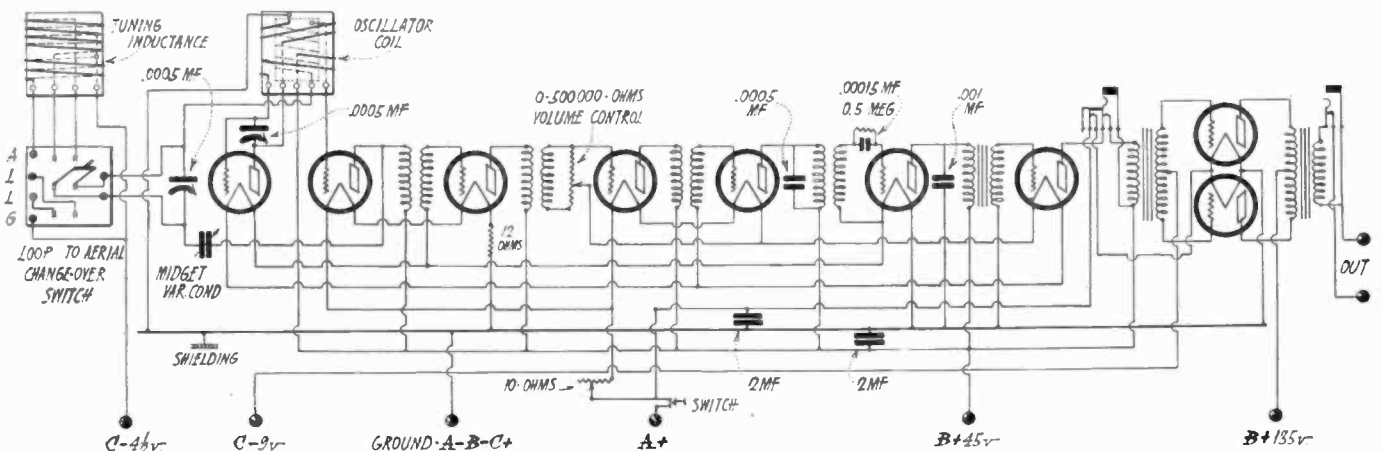

Fig. 2. Circuit of Northern Electric 9-Tube Superheterodyne

With the Amateur Operators

A PRACTICAL C W KEYING SYSTEM

By FRANK C. JONES

Many amateurs are confronted with the problem of eliminating the key click and maintaining a steady note when using a C W transmitter having pure d.c. plate supply. Ordinarily a bad click occurs unless the plate voltage is applied to the oscillator gradually and any change of load causes a chirp unless the oscillator is crystal-controlled. Even a slight change of plate voltage changes the capacity between the plate and the filament and between the grid and the filament, thus causing a chirp when the transmitting key is depressed.

This defect can be partially remedied by placing a large condenser across the transmitting inductance so as to counteract the change in tube capacity. Values of from .0001 mfd. for 20 meters up to .0005 mfd. for the highest amateur band are recommended. The LC circuit should then be designed for very low resistance since the closed circuit r.f. current will be high when a small inductance and a large capacity are used. This means short heavy leads between the condenser and the tuning inductance. The latter should be of copper tubing.

Key clicks can be minimized by finding a proper keying location, such as a combination of plate and grid keying.

But the real solution for the problem of preventing chirps and clicks is a constant voltage supply so that the oscillator frequency is not varied. This may be secured by maintaining a constant load, which also gives a longer life to the transmitting tube.

Fig. 1 shows a method for accomplishing this with a Hartley or other circuit using a grid leak. R is a 0-100,000-ohm variable potentiometer. R_5 is a variable resistor capable of dissipating 25 watts, as it takes most of the load when the key is up, the remainder of the load being absorbed by one or two A tubes, which have a positive bias when the key is up.

This positive bias is obtained through a 13½ volt C battery with the positive side towards the grid through R_2 . This makes the plate impedance extremely low and so

large current values are obtained. R_1 and R should be adjusted until the current through jack 2 measures the same as that through jack 1 when the transmitting key is up and down respectively. The current as measured in jack 3 should be constant at all times. The resistor R_1 should generally be in the neighborhood of 25,000 ohms when using a 210 oscillator. The corresponding value of R_2 will be around 75,000 ohms.

A 1 or 2 henry choke L_1 in series with the key and a key shunt C_1 , R_4 reduce the key click to a negligible value.

L_1 can be made by winding 1500 or 2000 turns of No. 22 wire on an iron core having a cross-section of about 1 square inch, or the 110-volt winding of a good-sized toy step down transformer may be used. The condenser should be of a high voltage type of about 1 mfd., and the resistance about 400 ohms. This combination slows down the application of the plate voltage, and grid leak current return also, a few thousandths of a second; enough to stop the key click.

When the key is open there is a large posi-

tive bias on the grids of the A tubes, causing normal load current to flow through the absorbing resistance R_1 and tubes. The grid leak return and negative plate lead are practically open, that is through a 100,000-ohm resistance and a negative bucking battery. This is more than sufficient to stop oscillations for most tubes.

When the key is down, the oscillator is normal, but there is a closed grid circuit network on the absorbing tubes which puts a high negative potential on the grids. With the values of R_1 , R_2 , E_1 and E_2 shown, the effective negative potential is about 65 volts. For higher negative potentials, a greater ratio than 3 to 1 for R_2 to R_1 should be used, and a larger value of E_1 . This applies to the case of higher plate potential for the oscillator.

NU-6 BXD

Station 6 BXD, illustrated herewith, is owned and operated by Walter F. Scott, 223 Terrace Avenue, Altadena, California. Since it started operations in 1923 it has passed through all the stages from an A tube to a 50 Watter Hartley with 1000 volts on the plate supplied by two 281 tubes. It has a 40-ft. antenna and counterpoise. The station has worked every continent except Europe, including 25 countries and 47 states. The receiver is a throttled condenser type with a UX-226 a.c. amplifier tube used as a detector.

The "Radio Guide" from Amalgamated Wireless (Australasia) Ltd. of Sydney, Australia, is an illustrated description of all the widespread activities of this corporation. These include the beam service to Great Britain, the coastal and island radio service given by 29 stations, marine wireless, police wireless, short-wave broadcasting and research, the Marconi school, and their manufacturing facilities. Catalog descriptions are also given of various broadcast receivers and accessories as well as of circuits for home construction. Price one shilling and six pence.

"How to Take Care of Your Radio Tubes" is the subject of a twenty-four-page, 3¼x 6¼ in. booklet from the Sonatron Tube Company. In addition to an explanation of what a vacuum tube is and how it operates, together with hints on the correct control of tubes, it describes the thirty-seven tubes in the Sonatron line.

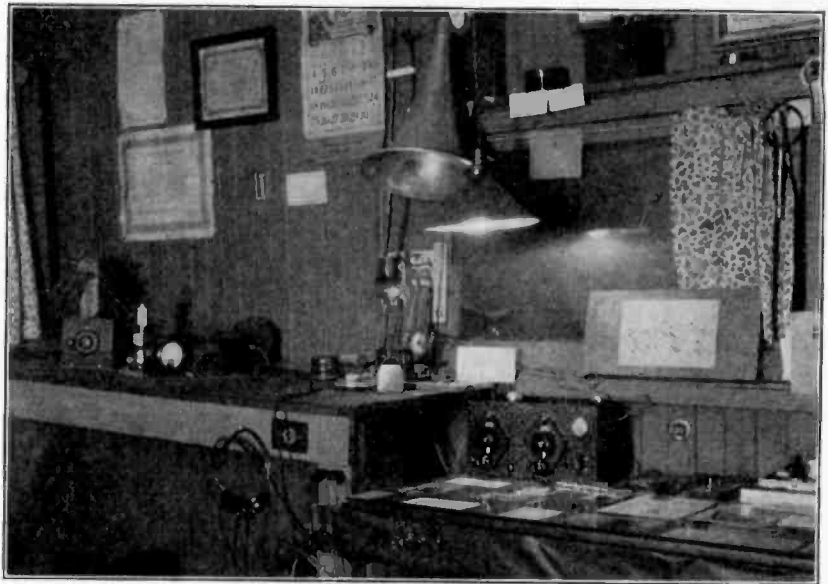

NU-6BXD, Altadena, Calif.

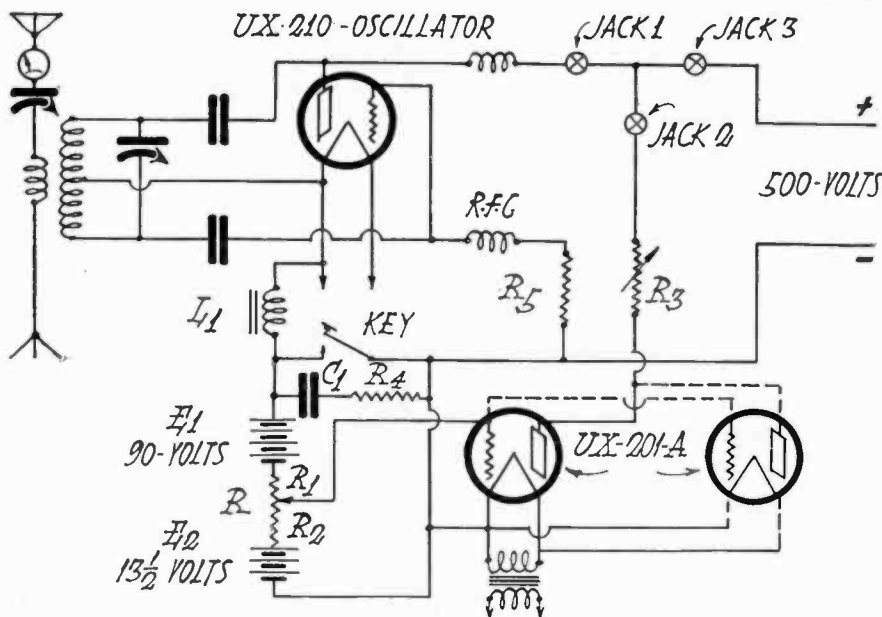
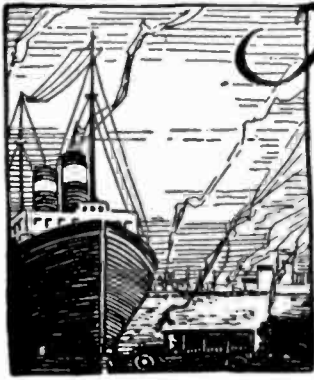

Fig. 1. Hartley Circuit Arranged to Minimize Chirps and Key Clicks



The COMMERCIAL BRASSPOUNDER

A Department
for the Operator
at Sea and Ashore



Edited by P. S. LUCAS
R. O. KOCH, Assistant

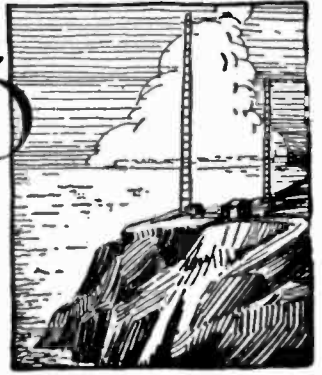

STEVE BRODIE DID

A lot of money has been made in years past by men who have either had the vision to see or have been willing to gamble on some undeveloped industry. A lot of money is being made today by men who took a chance on the horseless carriage twenty years ago, or "wireless" ten years ago, or the aviation industry within the last two years; and a pile of money will be made ten years from now by those who have confidence in some of the budding industries of today, plus a certain amount of the gambling spirit which says, "Take a chance." (NOTE: We're not trying to sell any stock in a QTE station in Iowa, so don't quit on us, yet.)

Those men who owe their success to this spirit have usually gambled one of two things: their money or their time and talent. Many of our greatest engineers have been men who saw possibilities in a certain line, got down to work and crammed their brains full of information on the subject, and when the time for the "grand opening" came, were ready to step into their rightful places as authorities along their chosen lines. These men are considered "up" in the world of engineering—all because they got their start before the field was crowded; because they gambled their time and effort on an undeveloped industry.

Today, more than ever before, are we offered opportunities for such a gamble, especially in or pertaining to our chosen field of activity: radio. Let us mention a few that are plain enough even for ye humble Department Editor to notice: television, telephotography, wired wireless, motion picture and sound synchronism, aerial beacons, etc., etc., none of which has reached the stage of standardization, but all of which will some day be giant industrial enterprises. Take your choice and take a chance. Your time will come.

LETTERS TO THE EDITOR

Dear OM,—I don't know whether very many operators have tried the UX-200A as a detector, but I am very sure they will have fine results with it if they try the tube. After reading Forest Ritz's excellent article on RF amplification on 600-2400 meters I decided that my receiver wasn't what it ought to be. Lacking the necessary "diner" I tried this tube and was greatly pleased with the results. It is not quite equal to the additional stage of RF as the RCA says, but is great stuff for a detector.

The grid return should go to the negative terminal of the A battery for smoothest regeneration.

Hoping this to be of some use, I remain,

Yours sincerely,

HARRY F. WASHBURN.

ORIENTAL NOTES NEW SKEDS

By MICKEY DORAN

It looks as if the following is to be Mickey Doran's swan song as a North Pacific and Orient correspondent. He has quit us cold, and now hangs his sky-piece on a nail out at Marshall, Calif., where he attends to the incoming oscillations at KPH. Ever since this department started in April, 1926, Mickey has been our mainstay in the Orient. We have come to rely upon him so thoroughly for his regular reports and schedule changes that we are expecting to be lost without him. However, Mickey deserves the promotion that has been given him, and congratulations are in order. He has steadfastly followed the principle that if you want to be a good operator you must do a lot more than is expected of you. So here's to you, Mickey. We hope you'll get as much kick out of your new job as you did out of rambling around the Pacific.

P. S. T.

- 2:00 a. m. NPN Guam 2300 Mtrs.
Sends Manila Observatory Weather Report; may start any time up to 2:20 a. m.
- 2:00 a. m. or later NPG S. F. 36 Mtrs.
Press. Sent as test messages to NPU and NPN; long files, may total several thousand words but is very poor news as a general rule. All "back page" stuff.
- 4:00 a. m. or later NPN Guam 35 Mtrs.
Press. Same stuff as above; NPN sends to naval vessels as test messages.
- 4:00 a. m. 'JJC Tokyo 53 Mtrs.
Japanese time signals. (Regular all of February and March.)
- 6:00 a. m. WUAJ Manila 43 Mtrs.
Repeats NPO time sigs. (Not regular every night.)

MISCELLANEOUS

BXY Hongkong time sigs have been discontinued. VPS Hong Kong radio-compass station has been discontinued.

Weather reports formerly sent by VPS are now sent by Hong Kong Observatory, call GOW, on 800 Mtrs. ICW at 0400 and 1200 GMT and repeated at 0500 and 1300 GMT.

ADDITIONS TO PACIFIC COAST SKEDS

By J. H. PAYNE

In looking over the collection of skeds that I have from RADIO, I do not see the following, and am passing them on for what they may be worth to some of the fellows. These skeds may have been in an issue that I missed but here goes.

VAD, Pachina Beach, B. C., is a radio compass station on 800 meters whose bearings are used in conjunction with Tatoosh when going into the straits. No QSJ.

NPD, Tatoosh, sends WX to QST at 9 a. m., 1, 5, and 8 p. m. on 800 meters local and for vicinity of Seattle and straits; also Northern Pacific Ocean.

NPE, North Head, Wash., sends WX and Hydro to QST on 2883 approx. at 9:30 a. m., 1:30, 5:30 and 9:30 p. m., for Seattle and vicinity, Straits of Juan de Fuca and Northern Pacific Ocean.

KFS now sends a fair file of PX starting at 10:05 p. m. on 3300 meters approx.

KPH is now sending his WX and PX simultaneously with 6XI; 6XI on 44.6 meters and KPH on 2200 as usual.

A NEW ANGLE

By W. L. JEPSON

Judging by the correspondence from the BRASSPOUNDER readers of your department, there is at this time a universal effort to "figure" the operator situation with a view to improved conditions.

Such an "improved condition" might be said to be represented by a substantial increase in all operators' salaries. That phase of it in which the operator is held is largely one of the individual case and unaffected by the proportions of his wages; for example, the average set of officers will accept a man at his own valuation as indicated by his comportment on shipboard, such dignity as may be sensible, the seriousness with which he undertakes his duties and the extent to which he performs those more or less optional.

Approaching the matter of the value of the job on various ships, we must consider what is expected of the operator by the master and steamship people, and whether their estimation of the value of the services expected of the operator (not necessarily those rendered by him) is a fair one.

Considering the case of the usual one-man freighter or tanker, the duties actually expected of the operator are few. The situation varies with the command and the vessel. The following instance suffices to illustrate.

There was some controversy over a certain berth and I had momentarily abandoned any modesty I might have had and was informing the "old man" that I was a "good operator" and could get much dope, and so on, but this speel left the old boy unmoved. He responded that his requirements were met in any man who could handle the set and get off his nightly paid TR report with an occasional time tic. I saw at once that it would be necessary for me to display an aptitude for cribbage or an ability to perform on a mouth organ (these possibly being to his liking) inasmuch as obviously any fairly intelligent chap with a license could hold down the job to his complete satisfaction.

However, in my mind I am certain that the wireless is immensely valuable on shipboard in simple cases of dispatching, not to mention its incalculable value in emergency or distress, and such being the case there is a very

evident need for a man exclusively for the responsibility and the care of the wireless. Certainly, too, the berth warrants a salary more nearly on a par with that of the first cook or steward.

As we all are well aware, there are operators of varying proficiency or efficiency. This is painfully apparent to anyone brave enough to negotiate the TR-ridden atmosphere with any traffic around seven of an evening. Further opportunities are afforded oftentimes for observing this phenomenon when about to relieve some tub going on a long cruise. Batteries, brightwork, wiring, tuners, arc chambers, gaskets and others without end insidiously reflect the habits of the former man-in-charge.

Furthermore most operators take pride in their ability to cope with traffic and general QSO situations in a masterly and clean manner. Some go in for considerable relay work which beyond question is of assistance to certain traffic stations in clearing their hook, not to mention the odd messages they gather in through these helpful operators which, otherwise, would be routed via some rival company. It is a source of satisfaction to have at their fingers' ends all manner of schedules and data on the transmissions and peculiarities of traffic and broadcast stations in different parts of the world.

Now all this is very nice and praiseworthy, but the fact remains that it is not, strictly speaking, called for by those in whose employ are the operators. In other words, it amounts to indulging in a hobby. From my experience I'd say it is the only way to do in order to feel contented on the job and derive any satisfaction from the performance of the wireless work.

However, good work and conscientious effort can't fail to help somewhere. I have mentioned its relation to the operator. It is now readily seen that the service company is the party to profit most from this over-zeal on the part of the man at sea. The incongruity of the thing quickly reveals itself. The wireless company's reward usually is a delightful willingness to place the operator whenever the S. S. company demands a man. Those lucky chaps habitually chosen are those whom the service company has found to be depended upon to keep schedules with the company's coastal stations at all hours, harvest traffic, and leave the very least for their inspectors to do in the way of repairs and upkeep. In my opinion this is as it should be, with this one change: that the operators should be in the actual constant employ and pay of the telegraphing companies. Under such circumstances the operator would have greater incentive for special effort as in cases of proven ability the company would have particular assignments carrying with them increased salaries and the consequent greater responsibility to the company.

There is a very excellent series of talks on the possibilities of the radio equipment in the marine field, appearing in these columns by Mr. Dustin. I therefore won't attempt to cover the ground, but will merely say that I believe that a progressive type of radio service company desires to put such ideas of increased uses for the ship's wireless over with the steamship companies and they would find this process simplified and accelerated under some such plan as suggested of non-promiscuous operator employment and assignment.

It has occurred to me, as it has no doubt to others, that possibly the operators and the S. S. companies would be better off under the old plan of ownership and entire control of the radio equipment by said S. S. companies. It might at first seem possible for the operator to assume complete charge of all installation, service and research work. This, of course, would mean a bigger job with compensation.

There are unfortunately enough two major obstacles to such a course. In the first place,

it is very doubtful whether the S. S. companies left to themselves would encourage any plans for increased service from the wireless, calling as it would, for greater investment. "We get position reports from our ships and they are able to send out the SOS in case of necessity, so why go to greater expense when we are satisfied?" This attitude, of course, is the customary one being coped with by appliance, equipment and machinery concerns anywhere today. It is natural and to be expected. It is clearly indicated, then, that sales and research organizations exclusively radio are what "the doctor ordered" for the marine radio field.

In the second place, while there are operators with advanced capabilities and ideas, they would nevertheless be handicapped in most cases by inadequate engineering education and training, not to mention the difficulty remarked in the foregoing paragraph.

I realize that when the present system of employing operators, and the one advocated are compared point for point, there is not shown any pronounced advantages for the radioman in the one over the other. But in the one there are greater possibilities for development for both parties concerned—the operators and the service company. It is a matter of indifference to the S. S. companies, I assume, rightly or wrongly, not being familiar with the highlights of the contracts drawn up for the said S. S. people's approval.

I confess I don't see much to hope for in the idea of a union such as is possible for operators to have. The reason for this depressing sentiment is seen in considering the widely diversified fields in which radio operators hold down jobs, and how complete, usually, is their non-contact with the other fellow. The primary cause for this condition, amusingly enough, is the individual's feeling of smug self-satisfaction in the fancied security of his new birth. How ill-founded is this feeling when it is considered that, should he for any reason at all lose his connection, he must then look for a job as a radio operator wherever there is a vacancy he can fill—in the marine field, at sea or ashore, point-to-point jobs for oil concerns, airplane outfits, fisheries, stores, mines, or what have you?

Some sort of an operators' association of a more or less passive nature is suggested. It at least might have the virtue of a fairly complete and comprehensive membership.

In further support of my advocacy of the direct and actual employment of the operator by the radio service companies, I will say that the customary limited connection with the radio service company has been more satisfying than a connection with an outfit where the radio field is limited to the one or two similar jobs.

FRIJOLE, TRs & PIGTAILS

(Being an episode from the life of an American brasspounder who took a chance on a foreign ship.)

By E. J. STENMAN

Curiosity, that dangerous state of mind which is supposed to have once put the ninth count onto the proverbial cat, got me into this scrape, and has satisfied itself along this line for many years to come. (Let's hope!) But it was after a rather uneventful voyage that it happened; and one is not responsible for what happens after uneventful voyages.

Leaving the good ship that had been my home for the few months past, I dragged my weary carcass to the well known static-room of one of the service companies, applying for some kind of a scow that would float and furnish the three squares a day with a few shekels thrown in for a peace offering. At first our friend, the District Supe, gave me the well known line, "Nothing in sight," but after pondering over the matter for a few minutes, (to create the proper respect, I

presume) he told me that he had a very good ship which was to sail in an hour, and that he must have an experienced brasspounder for her.

"Really," he said, with a very straight face, "She is a dandy little ship . . . fine captain and officers . . . good grub, etc. Of course, she is under a foreign flag for some private reasons known to the company, but the operator is always an American."

After hearing this speech through I decided to take a run over and give the old

(Continued on Page 48)

Electro-Bug, Jr., \$12.50

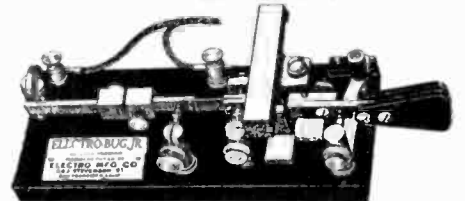

A full size, highest class instrument. Special introductory terms—half with order, half in 30 days. Five-day trial, money refunded if not satisfactory. SPECIAL WIRELESS MODEL \$17.00. $\frac{3}{4}$ " silver contacts, extra heavy cord, will work any hook up. Same terms and guarantee of satisfaction as Junior. ELECTRO MFG. CO., 443 Stevenson St., San Francisco, Calif

How to be a commercial Radio Operator

A practical book that should enable anyone of average intelligence to pass the Government's theoretical examination given to applicants for a Commercial Radio Operator's License.

JUST OUT
Nilson and Hornung's
**PRACTICAL
RADIO
TELEGRAPHY**

380 pages. 5 x 8, 223 illustrations, \$3.00 net, postpaid.

The book covers in detail the theory and practical operation of every type of modern, 1928, commercial arc, spark, and vacuum tube transmitter. It furnishes complete data on commercial vacuum tube receivers. It covers everything from elementary electricity to the practical operation of radio compasses.

Some outstanding points

1. Very little mathematics;
2. Assumes no prior knowledge of electricity;
3. Covers everything in commercial radio in detail;
4. Complete list of self-examination questions;
5. Simple, yet rigidly accurate;
6. Complete wiring diagrams given.

See the book before you purchase. Fill in and mail just this coupon.

McGraw-Hill FREE EXAMINATION COUPON

McGraw-Hill Book Co., Inc.,
370 Seventh Ave., New York, N. Y.
You may send me Nilson and Hornung's
PRACTICAL RADIO TELEGRAPHY,
\$3.00 net, postpaid. I will either return the
book, postage prepaid, in 10 days, or remit
for it at that time.

Name.....
St. & No.....
City.....
State.....
Name of Employer.....
Official Position.....
(Books sent on approval in the U. S. and
Canada only) Radio 7-1-28

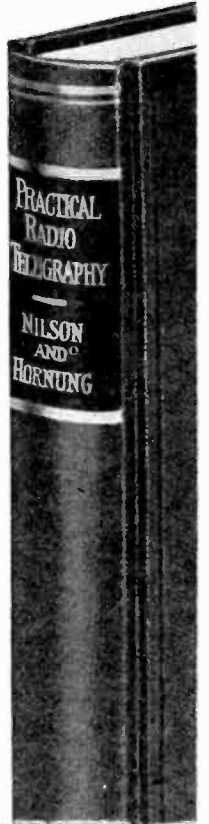

Your Own Audition Test

When you buy a speaker you judge it—not by what it is—but what it does!



Jensen Dynamic Units
TYPE D-4 A. C.
(110 Volt Operation) \$55.00

THERE are many good speakers on the market today. To choose merely a good speaker is easy. To choose the really outstanding performer of the year is much more difficult.

But if you put various speakers to the test of actual comparison, you will come to one certain conclusion. Your own audition test will prove that the Jensen Dynamic Speaker gives a fidelity of reproduction, a tone-clarity, which is far ahead of all competition.



Jensen Cabinet Model
TYPE D-44 (6 Volt Operation) . . . \$55.00
TYPE D-45 (90 Volt Operation) . . \$58.00
TYPE D-44 A.C. (110 Volt Operation) \$70.00

OF COURSE THERE IS A REASON

We start with the Dynamic Principle, we add perfection of design, we follow with perfection of craftsmanship, and we finish with a series of tests far more exacting than any Audition Test you would make. Every speaker that wins a final "O.K." in our laboratory is sure to win an enthusiastic "O. K." from you.

Now—as Radio's Greatest Season opens—is the time to equip with the finest radio speaker. Only in the Jensen can you find the tone-fidelity which completely satisfies.



Jensen Dynamic Units
TYPE D-4 (6 Volt Operation) \$40.00
TYPE D-5 (90 Volt Operation) \$43.00



Console Model
\$85.00

JENSEN RADIO MANUFACTURING COMPANY
212 Ninth Street, Oakland, Calif. 338 North Kedzie Avenue, Chicago, Ill.

JENSEN

DYNAMIC SPEAKER

"The Finest in Radio"

A special two-color folder describes the complete line of Jensen Dynamic Speakers. Write for a copy.



What Others Say

Salt Lake City, Utah.
Oct. 13, 1927.

My Bremer-Tully Receiver has given entire satisfaction and I am of the opinion that I have just a little better outfit than the other fellow.

It has been my experience to bring in stations within a radius of 2,000 miles. This is considered very good in this locality.

C. P.

Ft. Worth, Tex.
Dec. 27, 1927.

I know nothing about radio other than to state that the Bremer-Tully which I purchased in 1925 is still the best I ever saw. I am using the same tubes that came with it, and getting results.

Livingston, Mont.
Dec. 23, 1927.

Out here in Montana far away from broadcasting stations, we have to have a good radio to bring them in. Although I have heard many I never heard one that I could say I wanted until my friend brought me down to hear his Bremer-Tully. I now have one like it and have been able to get the best kind of reception every night and everybody says it is the best set they have ever heard.

J. V.

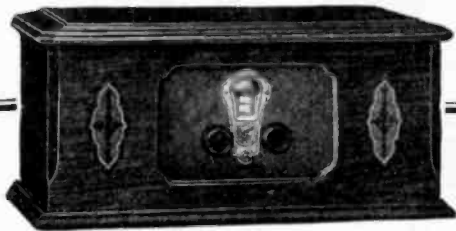

The 6-40 is furnished in two cabinet styles—Model "R" illustrated at the top of the page and Model "S" illustrated above. Both are of equal size.

Bremer-Tully

RADIO

SINCE the earliest days of commercial broadcasting every Bremer-Tully radio product has been a continued outstanding success.

Six years of progress—and a reputation second to none—Bremer-Tully start their seventh season with the finest receiver in its class, the new 6-40.

It is the culmination of these years of experience, the result of many months' intensive effort and development.

Simple, compact, self-contained, the 6-40 embodies all those features and refinements that are responsible for the traditionally fine Bremer-Tully quality—and at the amazingly low price of \$136.00.

A radio set that surpasses everything at anywhere near its price in musical reproduction—a set that excels in general performance as well.

See it, hear it, compare it—you will be convinced that here is the greatest radio value ever offered.

The coupon will bring descriptive literature and name of our dealer in your community.

Bremer-Tully Mfg. Company

520-532 SO. CANAL ST., CHICAGO

Name.....

Address.....

City..... State.....

Quality PLUS

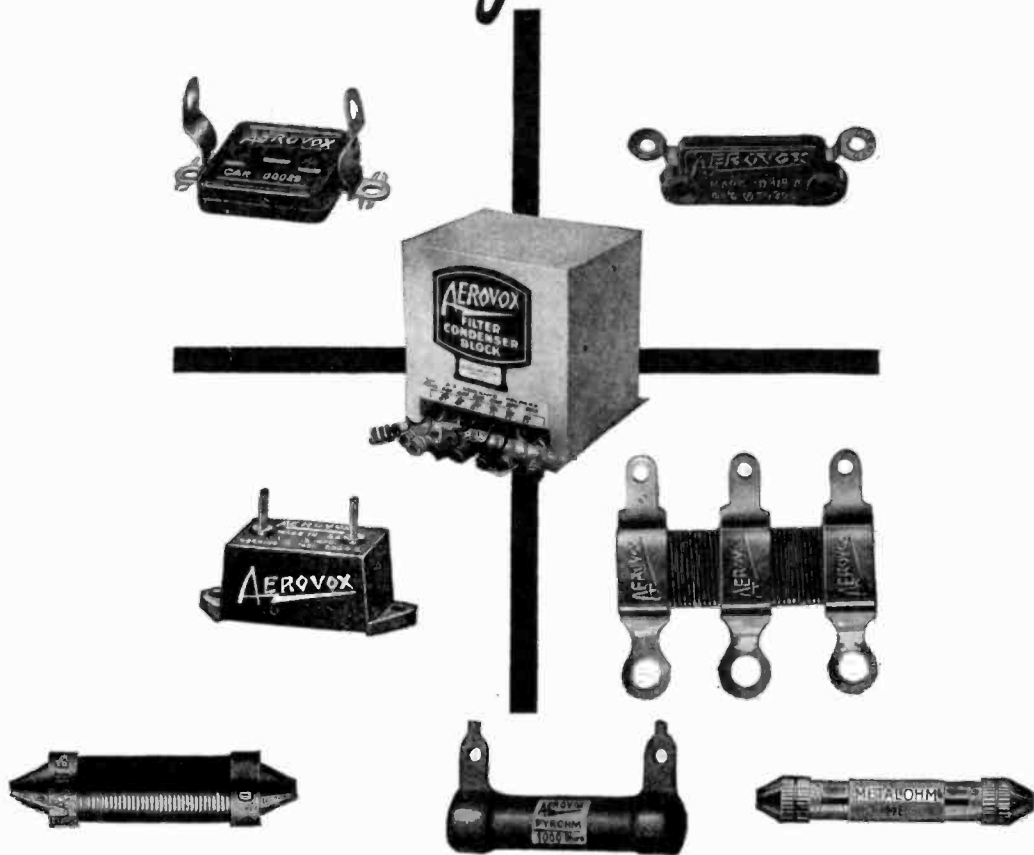

EXCUSES and alibis will not satisfy the customer whose equipment has been ruined because of the use of unreliable parts.

Whether the units required be resistors, mica condensers, socket power condensers or filter condenser blocks, you will find a suitable one in the Quality Products line of Condensers and Resistors made by Aerovox.

Build customer Good Will with Aerovox Products.

The Aerovox Research Worker is a free monthly publication that will keep you abreast of the latest developments in Radio. A postcard will put your name on the mailing list. Write today.

AEROVOX

"Built Better"
68-A Washington St., Brooklyn, N. Y

Cunningham
RADIO TUBES



The Name Means Everything

Strict vigilance guards the acknowledged high standards of these tubes with the result of an ever-increasing efficiency of performance.

A set of new Cunningham Tubes gives new life to your radio.

Manufactured and sold under rights, patents and inventions owned and/or controlled by Radio Corporation of America.

E. T. CUNNINGHAM, Inc.

New York
Chicago
San Francisco

**Since 1915
STANDARD QUALITY**

COMMERCIAL BRASSPOUNDER
(Continued from Page 44)

tub the O.O., so grabbed a sea-goin' hack for the docks. I looked her over from fo'c's'le to stern, sizing her up in detail. Finally I felt the old curiosity getting the best of me and knew that I might as well let it have its way, so back I went and signed the papers.

Thanks to good luck the weather was fine, going South. Four days out one of the blades of our propeller gave up the ghost, but the little sewing machine engine kept up her plunkety plunk with renewed vigor. The officers (we shall call them such for lack of better titles) were not sure whether part of the propeller had actually left us or was just dragging along behind, so, of course, we had to stop the ol' scow to let the chief engineer and mate go over the side with the little work boat. After peeking and poking around the stern post for awhile they were finally convinced that one of the blades had really deserted us. Well, full speed ahead and let the devil take the hindmost. We made our port in due time, discharged the cargo and loaded up with copper bullion for the return trip.

Everything went along smooth as silk on the homeward voyage. As long as we were able to sight some light or landmark ashore we knew just about where we were. When we were out of sight of land for twelve hours at a stretch out would come all three time-corroded sextants, and the sun would be peppered from all angles. Then the three snipers would rush into the pilot house where they would use up a few tablets of scratch paper, chew up a couple of volumes of Bowditch, and submit three different positions. Then, with a shrug of six shoulders, they would start gazing shoreward for sight of land. (I'll bet old C. Columbus never looked for land more anxiously.)

Getting my 8 p.m. TR was a delicate matter for the O.M. He must have considered it more important than the ship, as it would always take him anywhere from 15 to 45 minutes to dope it out. Then he would proudly tell me in halting, half Spanish, half English, the exact number of miles we were from the Golden Gate. I would then proceed to check it with that of the previous night, usually finding it "slightly" off (not more than one or two hundred miles), so would tell the grand OM, politely, that the ship was making very good time; about sixteen knots or more.

"No possible," he would groan, and start the grinding all over again. A few more pages would fly from the scratch tablet, and we would have another TR, putting us somewhere near our exact position (maybe). On one occasion the TR gave us a 24-hour run of approximately 465 miles, which was pretty good for a nine-knot ship, so I again called the OM's attention to it. Much scratch paper, more perspiration, and finally another TR, this time giving us a run of 340 miles. Well, I hated to bother the old gent again, but could not send in a TR like that, so once more I invaded the domains of the mighty. After figuring it up and down, sideways and a few other ways, he dramatically announced that there would be no TR that night. Mañana; and that's that.

I finally decided to mind my own business with regards to these high class TRs, and promptly set the home office in a whirl of excitement. This time it was 42 miles in 24 hours, and immediately brought a *rush* msg from the officials demanding to know what the trouble was. The old gent in command replied briefly that we were making nine knots per hour. They could take it or leave it.

Getting around to the more important points of interest let me say a few words about our celestial cucinero and his con-

coctions. The supply of frijoles never gave out, of course; but they were good ones, and accompanied by a lot of other good dishes. One dish in particular seemed to be ever present, and although I have never been able to find out what all was in it, I'm here to tell you it contained everything available, including several different kinds of meat and some fish, numerous vegetables and whatever else was around handy. Several times my eye was caught by a peculiar looking piece of meat, but I hesitated to take a chance (oh, yes, there are limits) until I knew what it was. Finally, I discovered that it was the hindermost extremity of a pig. Well, I've tried oxtail joints at various times, but that's where I stop. Pigtails might be O.K. Quién sabe?

And still we sailed northward, even though them as has the say refused us another propeller blade when we stopped at 'Frisco. Two days out of Seattle I roused myself from the horizontal exercises in which I had been indulging, and discovered that we were lost. Due to the exceedingly heavy swells and westerly gales we had been compelled to haul off shore during the night and our valiant imitators of Columbus had no idea where we were or why. They had shot all the stars in the heavens, and when the sun had come out they had shot that, but still they were baffled. I asked one of the "moites" as to our position and was graciously informed that neither he nor anyone else knew. I suggested the use of radio compass bearings but he said that he did not put much faith in them. After awhile, however, the captain told me to get some on general principles, so I got to work. Bien, luck was with me, the ops at the QTE stations were right on the job, and I received three bearings, giving us a good cross bearing which tickled the whole bunch almost to death.

At last we reached the "Sound," safe and sound, and as I write this I am hoping that we keep afloat until we reach Seattle.

Solve All B Eliminator Problems!

Can you adapt a B eliminator to various receivers?

Can you calculate resistances for various output voltages?

An 86-page "Laboratory Treatise on B Eliminator Design and Construction" has been written by John F. Rider, a national authority on radio practice and design . . . 86 pages just full of data and 71 wiring diagrams you can easily understand. Every possible question pertaining to B eliminators is answered . . . every phase of B eliminator design and construction is considered. Price \$1.00.

This book will save you money!

RADIO TREATISE CO.

270 Madison Ave., Dept. "R"
NEW YORK CITY

--- MAIL THIS COUPON ---

Here is my \$1.00 for the "B Eliminator Treatise" to be mailed postpaid to

Name.....

Address.....

City..... State.....

FROST-RADIO LEADS AGAIN!

With a COMPLETE LINE of Parts for 1928-29 for the use of the Amateur and Professional Set Builder



NEW MOULDED MICA CONDENSERS

Their small size cuts down dielectric losses and gives greater ease of mounting. Equipped with well designed terminal lugs and integrally moulded Bakelite flanges for subpanel mounting. Made in seven capacities from .0001 to .006. Price, 45c to 90c.

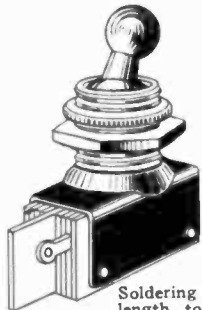

NEW A.C. SNAP SWITCH

Its positive contacts easily carries 3 amps. at 250 volts. Inspected and passed by Underwriters' Laboratories. Entire switch is inclosed in nicely finished metallic housing. Soldering lugs are of sufficient length to make soldering easy, and are thoroughly insulated from each other. Single hole mounting. The finest small A.C. switch made. Price, 75c.

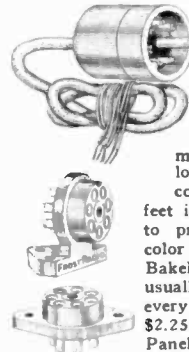

NEW CABLE PLUG

A moulded Bakelite Cable Plug that possesses unique advantages. Terminals, being moulded in Bakelite, cannot come loose. Cable itself is best quality colored rubber covered wire five feet in length. Springs are designed to provide permanent tension, and color markings are moulded into Bakelite, doing away with paper chart usually employed. A quality plug in every way. Plug, complete with cable, \$2.25. Baseboard socket, 75c. Sub-Panel Socket, 75c.

NEW BY-PASS CONDENSERS



Conservatively rated, accurately manufactured and designed to give many years of trouble-free service. Linen and flax paper stock and finest grade foil are used in their construction. Vacuum impregnated and enclosed in hermetically sealed metal cases. Five capacities from .1 to 2 MFD. all tested to 400 volts D.C. and rated at 200 volts working voltage. Prices, 80c to \$2.00.

POWER AMPLIFIER Universal Resistance Kit

Consists of 3 fixed resistors of 2,000 ohms each of the Frost A series, wound on flexible Bakelite strips 1 inch wide and 5 1/2 inches long, and four 2,000 ohm heavy duty wire wound Frost Potentiometers, and one 1,500 ohm series A Fixed Resistor. Fixed resistors are equipped with sliding connections to give the variable 135 and 180 volt taps and the fixed resistor for the C bias is variable to give the proper bias for the number and type of tubes used. Complete, \$9.00.

NEW HEAVY-DUTY

FILTER CONDENSERS

Designed for use in B eliminators, power amplifiers and other power devices for general experimental work, for transmitting circuits and with other spark discharge apparatus. Conservative voltage ratings, and built of the finest materials. We guarantee them to give complete satisfaction when used according to instructions. Capacities: .5 to 2 MFD. \$2.00 to \$7.00.



OTHER NEW ITEMS ARE:

- Frost Variable High Resistance Units with A.C. Snap Switch
- Frost Gem Hum Balancer
- Frost Center Tapped Resistances
- Frost UX Base Socket for Sub-Base Mounting
- Frost Panel Brackets
- Frost Hook-Up Wire
- Frost Medium Duty Filters
- Frost Convenience Wall Outlets

NEW FROST-RADIO UNIVERSAL "B" BLOCKS

The finest "B" Blocks made, with conservative voltage ratings and superior construction. Encased in hermetically sealed metal cases, and fitted with tinned soldering lugs. Consists of 3 sections of 2 Mfd. each 1 section of 1,000 working volts; other two sections of 600 working volts; 1 section of 4 Mfd., 400 working volts and 1 section of 1 Mfd., 400 working volts. Price, \$18.00.



THESE OLD FRIENDS ARE KNOWN TO THOUSANDS



FROST-RADIO VARIABLE HIGH RESISTANCES



FROST-RADIO GEM RHEOSTATS "A Good Little Rheostat"

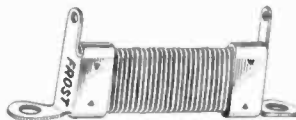

FROST-RADIO FIXED RESISTANCES

Ample current carrying capacity and wound on die cut threaded flexible Bakelite. Fitted with terminals enabling them to be mounted either under sub-base or on terminals of sockets, etc. .4 to 50 ohms, 15c. 100 to 1000 ohms, 25c.



FROST-RADIO AIR COOLED BAKELITE RHEOSTATS

One of the most famous rheostats ever built. Winding strip is die-cut threaded Bakelite, flexible. German silver contact arm and nickel plated metal parts. Plain type, \$1.00. With switch, \$1.35.



FROST-RADIO UX BASE BAKELITE SOCKET

Contact springs grip tube prongs for almost entire length. Holds all UX and CX base tubes in a "bulldog" grip. Genuine moulded Bakelite. Plainly marked terminals. Complete, \$.40.

ACT NOW! FILL OUT and Mail This Coupon

HERBERT H. FROST, INC.
ELKHART, IND.
CHICAGO
New York City San Francisco

THIS COUPON and 10c Brings Our Valuable 16 Page Data Book Just off the press. Valuable, complete Data Book that every set builder should have. If you are a professional set builder, we want you to have your copy FREE. Otherwise inclose 10c with coupon to cover postage and mailing. Mail the coupon NOW.

HERBERT H. FROST, Inc.,
160 N. LaSalle Street, Chicago
Send me your new 16 page Data Book, containing complete wiring diagrams, data and much other valuable information.
Are you a professional set builder?.....
If not, please inclose 10c stamps or coin.
Name
Address
City State.....

The One Outstanding Log Book of today



Price
50
Cents

THIS is the only log book of its kind. Only two pages are required for logging stations. Every station in the United States and Canada is listed in this call book. All the information is there and correct right up-to-date. "It's the handiest log ever compiled." That's what every reader says that has gotten one.

SERVICE FREE. You can at any time return your old log to us and get a new one corrected to date. (Send only 10 cents to cover postage and handling.) This service is perpetual. You can get a new log book as often as changes occur in station listings. This log and call book is kept corrected day by day and week by week. You can always get one right up-to-date.

— — — — — **GET YOURS TODAY—MAIL THE COUPON—** — — — — —

BROADCAST WEEKLY PUBLISHING CO.,
416 Pacific Bldg., San Francisco, Calif.

Gentlemen: Herewith is 50c. Send me one of your new Log and Call Books. It's understood that I can at any time return it with 10 cents and get a new one corrected to date.

Name..... Address.....
City..... State.....

FACTORY BUILT RECEIVERS

(Continued from Page 30)

d.c. tubes. It has three stages of tuned r.f., detector, and two stages of audio, with an output transformer. Matched coil inductances are used with individual copper compartments for each coil. It may be obtained in either a walnut cabinet $20\frac{1}{2} \times 8\frac{1}{8} \times 11$ in., or in a metal cabinet in hammered silver effect with bronze escutcheon plate framing a volume control and single tuning control, with internally illuminated dial.

The Splitdorf line of six-tube a.c. receivers are announced in ten models, five of which use one '50-tube in the last audio stage with one dynamic reproducer and five of which

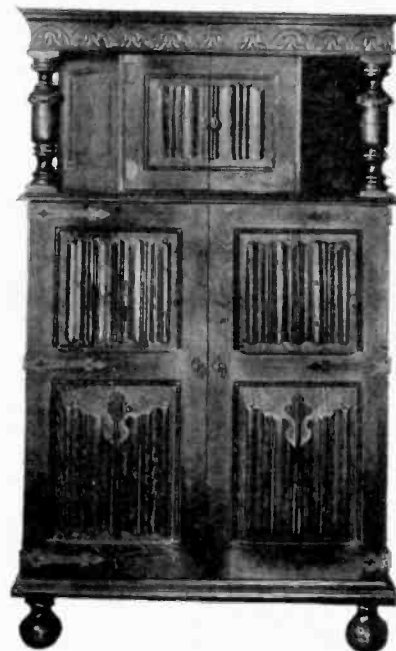

Devon Model of Splitdorf A.C. Receiver

use two '50 tubes in push-pull and double dynamic speaker. The models include a table cabinet and various elaborate consoles and have a jack for a phonograph pick-up plug.

Stewart-Warner have four new models of tuned r.f. receivers, three for a.c. tubes and one for d.c. tubes. These are available in handsome metallized cabinets with or without a 6-in. magnetic cone speaker in a similar

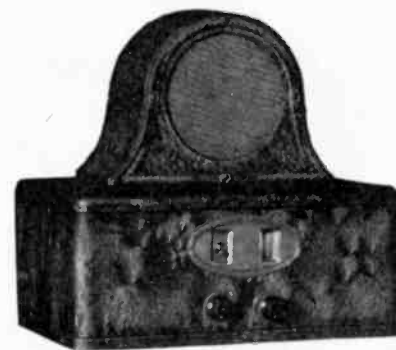

Stewart-Warner A.C. Receiver with Cone Speaker

case. The receivers have one tuning control with illuminated drum dial, one volume control and an on-and-off switch.

(Continued on Page 52)

ANOTHER SPECIAL OFFER!

UNI-RECTRON POWER AMPLIFIERS

Model AP-935

As the Uni-Rectron stands it is a super power amplifier, which can be used in connection with any radio set and loud speaker. Binding posts are provided for input to the Uni-Rectron and output to the speaker. Requires no batteries for its operation. It obtains its power from the 110 volt, 60 cycle alternating current lighting circuit of your house.



List Price \$88.50 Each
(without tubes)

Special at \$19.75 Each

Every one new and packed in original factory carton

The UX-210 super power amplifying tube and the UX-216B or 281 rectifying tube are used with this amplifier, which cannot overload. From the faintest whisper to the loudest crash of sound—R. C. A. Uni-Rectron amplifies each note at its true value. High and low notes are all treated alike. The volume and quality delivered will be a revelation.

AMERICAN SALES CO., 19-21 WARREN ST., NEW YORK CITY



Air-Cooled Rheostat
\$1.35

Built to the
Highest Standard



Radio Convenience
Outlets
\$1.00 up

Add Good
Appearance to Set
Satisfaction



Insulated Phone
Tip Jacks
25c per pr.

Of Its Type
the Best

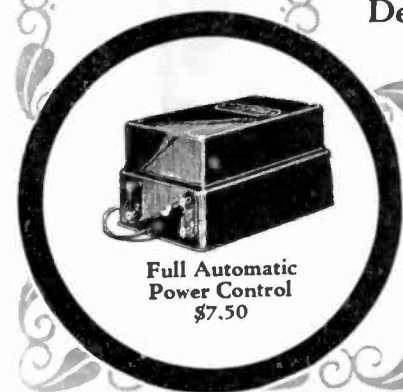

Full Automatic
Power Control
\$7.50

YAXLEY

APPROVED RADIO PRODUCTS



Junior Rheostat
75c up to 400 ohms

Correct in
Design

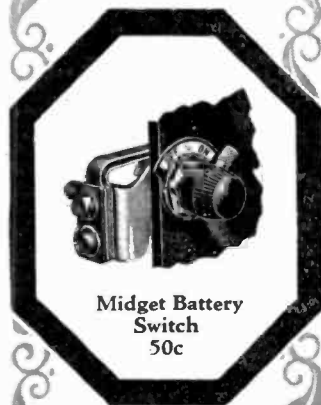

Midget Battery
Switch
50c

Made by Workers
of the Greatest
Skill



Pilot Light
Bracket
50c

Material of
the Highest
Quality

IMPROVEMENT in radio and the ultimate enjoyment of the radio program has moved impressively along three distinct lines.

On the one hand the development of broadcasting methods has been startling; on the other refinement in the design of receiver circuits has given the radio user a range of operation undreamed of a few years ago. But along with these two great developments the manufacture of parts and accessories has kept pace. And in this direction the Yaxley Mfg. Co. has won distinct recognition.

Yaxley Approved Radio Products, ever since their inception, have been the choice of the designers of many of the most prominent and successful circuits. Today, as never before, the value of a receiver is measured by its dependability. Whether it be of the greatest simplicity or extreme complexity the choice of parts is of vital concern.

A thoughtful selection of Yaxley parts will give you the greatest measure of protection and the most positive assurance of dependability in set performance.

Yaxley products are available at most radio dealers and jobbers. In the meantime, let us send you our latest illustrated descriptive bulletin. Send us your name and address today.

Yaxley Mfg. Co.

Dept. A, 9 South Clinton St., Chicago, Illinois

YAXLEY

APPROVED RADIO PRODUCTS

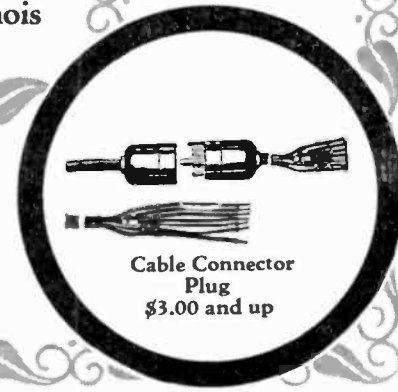

Cable Connector
Plug
\$3.00 and up

Tell them you saw it in RADIO



**AMERTRAN
DE LUXE**

First Stage turn ratio 3 } \$10.00
Second Stage turn ratio 4 } Each

**Standard of Excellence in
Audio Amplification**

AmerTran De Luxe Transformers are but two of more than 30 quality Radio Products bearing the name AmerTran, including power transformers, choke coils, push-pull systems and allied products. Each AmerTran device is designed for a specific use. Full and authoritative information will be given on any audio or power problem.

AMERICAN TRANSFORMER COMPANY
Transformer Manufacturers for 28 Years
132 Emmet St., Newark, N. J.

LEEDS

The Home of RADIO
**45 VESEY STREET
NEW YORK**



Cardwell condensers, double spaced for transmitting, .00025 cap. **3.45**



WARD LEONARD RESISTANCE
\$.75 list—6½ inch long—300-1000-1200-3000-6000-8000-11000 ohms; can be used for 2-50 watt tubes or less.....\$1.45

Neon Glow Lamps, made by General Electric Co., type G.10, standard base. 101 uses, as illustrated in Q S T May issue page 17\$0.55

THORDARSON POWER TRANSFORMER

\$13 list—T-125, cap. 100 watt, secondary each side of neutral 350 and 550 volts\$9.85

\$18 list—T-126, cap. 450 watt, secondary each side of neutral 1000 and 1500 volts\$13.95

\$30 list—T-127, cap. 900 watt, secondary each side of neutral 1000 and 1500 volts\$22.50

Many other good items

FACTORY BUILT RECEIVERS

(Continued from Page 50)

Workrite new 7 and 9-tube models using a.c. tubes are equipped with illuminated drum dial for single control of tuning and with an additional control for volume. The 7-tube No. 18 cabinet and No. 28 console



Workrite Nine-Tube Console

have three stages of tuned r.f., detector, two of audio, and one rectifier tube. The console is equipped with a Type B speaker. The 9-tube models have four shielded stages of tuned r.f. detector, push-pull audio, and rectifier tube. They are available in either a table cabinet or in a console with Type B speaker.

The Grebe CR-19 short-wave receiver uses a screen grid tube as an r.f. amplifier, '01A tubes as detector and first stage audio, and '12 tube as second stage audio. Its regeneration control is continuously variable from zero to



Grebe CR-19 Short Wave Receiver

the point of oscillation. It is designed for the reception of short-wave broadcasting, CW and ICW telegraphy, and other special purposes requiring either a wide or a narrow frequency band. Every important unit is heavily shielded.

The new Steinite line of a.c. receivers include four models, a table cabinet, and three consoles, two of the latter being arranged to receive the cabinet into a drawer. The consoles are equipped with a long air-column speaker with a matched unit to take the output of a '71 tube. The cabinet has three r.f. stages with '26 tubes, '27 detector, one audio with '26 tube and one audio with '71A tube, together with an '80 rectifier tube.



Steinite A. C. Table Cabinet

Tuning with a gang condenser is accomplished by means of a single control of an illuminated drum dial. The escutcheon plate also carries an "on-and-off" switch and a combined oscillation and gang control. The power transformer is adjustable to line voltages of from 85 to 135 volts by means of pin jacks connected to taps on the primary. There are also pin-jack connections for a phonograph pick-up unit.

The Apex Model 36 is a six-tube Neutrodyne using a.c. tubes and supplied complete in a metal cabinet with plate supply rectifier and filter. It has three r.f. stages with '26 tubes, detector stage with '27 tube, first audio with '26 tube and second audio with '71 tube, together with '80 tube for rectifier. It has illuminated drum dial with single tuning control. Its 17½ by 7 by 12-in. case will fit any standard table cabinet or console.

The Walbert 77 is an electric receiver with seven a.c. tubes and four stages of inductively tuned r.f. amplification with single control. It has a self-contained power plant for plate and filament supply.

The sixteen new Kolster models include sets designed for 60-cycle and 25-cycle a.c. operation, for d.c. supply, for battery current, magnetic speakers, dynamic speakers, and a B eliminator. The receivers are in four, five, six, and seven-tube models. Each uses a tuned r.f. circuit with antenna variometer. Each has single tuning control with an illuminated drum dial. A single volume control varies the filament current. A.c. hum is reduced to a minimum by a special filter system. Various table and console models are available.

The new Sleeper A.C. Monotrol is a six-tube set using three '26 tubes as r.f. amplifiers, '27 tube as detector, '26 as first audio and '71 as last audio. Its power unit has an '81 tube as rectifier and has a voltage control to care

(Continued on Page 54)



Kolster Seven-Tube Table Model with Magnetic Speaker

Tell them you saw it in RADIO

CROSLLEY



New
Dynamic
Speaker

DYNACONE
\$25



The first AC set of any type ever offered at so low a price. Highly selective; coils shielded; illuminated dial; genuine Neutrodyne; powerful, efficient, proven!... \$65

The crowning achievement in a history of successes!

6 tube
AC Electric
GEMBOX
\$65

Features of the 1928-29 Crosley Radio Receivers

Genuine Neutrodyne radio amplification with all the increased efficiency this superior circuit introduces.

Complete shielding which adds so greatly to the amazing selectivity of Crosley receivers.

Full voltage delivered to the plates of the tube. Tone and volume assurance.

A sensitivity that delights the "old" radio fans and thrills the new ones by the ease with which weak, distant stations are brought in.

Positive volume control reduces volume without detuning set.

Adaptability to any type of console. Simple construction permits quick and easy installations.

Modern illuminated dial eliminates the annoyance of shadows, searching for lights in the dusk, etc.

Beautiful gold and brown finish of receivers and matching Musicone and Dynacone delight the eye.

Here, in a new line of radios for the season of 1928-29, Crosley presents VALUE such as Radio has never seen . . . an engineering triumph in *quality* . . . a production miracle in *price*.

Crosley presents fine radio—perfect performance and utmost enjoyment of broadcasting at seemingly impossible prices. These prices are possible only through years of experience, a skilled organization and the resources of a financially sound and economically operated company.

These values are yours today because of the powerful advantage gained through study, work and development acquired in the Herculean task of building and selling nearly 2 million pieces of radio apparatus.

Satisfied by laboratory and actual home installation comparisons that Crosley radio has NO equal, Crosley NOW makes it possible for every prospective radio owner to know how well Crosley radio will perform in his or her home before they buy. Try, test and prove the amazing Crosley receiving sets before you buy!

5 Days FREE Trial In Your Own Home

This is the NEW way . . . the CROSLLEY way to buy radio. First advertised nationally by Crosley last April.

Study the sets shown at the right. Then go to the nearest Crosley dealer. Ask for a FREE trial. Learn in the quiet and privacy of your own home what wonderful sets the 1928-29 Crosley's are. Enjoy their performance! Delight in their beauty! Congratulate yourself on their prices!

Over 18,000 Crosley dealers serve the United States, but if you cannot locate one near you send us this coupon and we will arrange a home demonstration for you at once.



The 8 Tube AC Electric JEWELBOX
Genuine Neutrodyne; full 180 volts on output tube plates; 2 171 output tubes, push pull. . . . \$95



The 8 Tube AC Electric SHOWBOX
A new completely shielded genuine Neutrodyne, illuminated dial; full 180 volts on the plates of 2 171 output tubes, push-pull. . . . \$80



The 6 Tube Improved Battery Type BANDBOX
Proven star of Crosley radio; Neutrodyne; shielded; illuminated dial; Acuminators. . . . \$55



The 5 Tube Dry Cell Operated BANDBOX Jr.
Modern radio reception for places where electric current is not available or storage battery recharging is inconvenient. . . . \$35

DYNACONE \$25 **MUSICONE** \$15
New dynamic DYNACONE reproduces every note with remarkable fidelity, naturalness and realism.

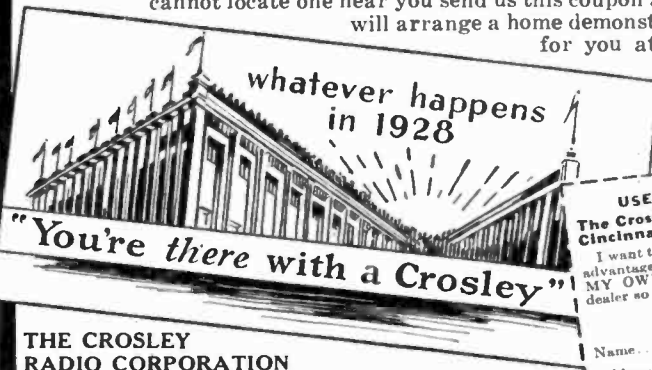

THE CROSLLEY RADIO CORPORATION
Cincinnati, Ohio. Powel Crosley, Jr., Pres.
Montana, Wyoming, Colorado, New Mexico and West, prices slightly higher.

USE THIS COUPON FOR FREE TRIAL
The Crosley Radio Corporation,
Cincinnati, O. Dept. 19.

I want to know more about Crosley Radio. I want to take advantage of your offer to let me try one 5 DAYS FREE IN MY OWN HOME. I cannot locate the nearest Crosley dealer so please arrange a demonstration for me.
Send literature ()
Send Set ()

Name

Address

Tell them you saw it in RADIO

Chosen by

**TWO THIRDS OF THE
RCA Licensed Manufacturers
For Electric Set Essentials
QUALITY ALWAYS WINS!**



These companies based their choice of power supply essentials on scientific research. Polymet products were selected for consistent performance—a performance made possible only through standardized quality.

After all, it's the result that counts.



Let us submit samples and let your laboratory tests prove the quality.

POLYMET MANUFACTURING CORP.
589 Broadway, New York City

POLYMET PRODUCTS

COMMERCIAL RADIO INSTITUTE

(Founded 1920)

Resident School Only. All Branches Taught. Laboratory. Workshop. School Thoroughly Equipped. Graduate Certificates.

Day and Evening Classes

Fall Classes Sept. 24th. Literature.
10 East Centre Street
BALTIMORE, MD.

MAJESTIC

Means Greater Radio Values
at less cost to you

GRIGSBY-GRUNOW Co.

4540 Armitage Avenue
CHICAGO, ILL.

PHOTOELECTRIC CELLS — GLOW LAMPS TELEVISION APPARATUS

WRITE FOR BULLETIN E-3

PHOTON INSTRUMENT CORP., 574 Southern Blvd., New York City

(Continued from Page 52)

for line fluctuations. A ballast resistance protects the detector tube against over-voltage at the start. A special connection is provided for a dynamic speaker and for phonograph pick-up unit. A local-distance switch reduces power of local stations. This equipment, mounted on an aluminum chassis, is offered in a table set and two consoles with built-in Temple Air-Chrome speakers. The escutcheon plate, in addition to single tuning control, volume control, and throw switch also contains an electric clock.

The Eveready a.c. set is a seven-tube antenna type receiver with three stages of neutralized tuned r.f. using '26 tubes, detector with '27 tube, one audio stage with '26 tube and one push-pull audio with two '71 tubes, the audio stages being transformer coupled and having an output transformer. The r.f. stages are bridge-balanced by the R. F. L. circuit and are doubly shielded. The

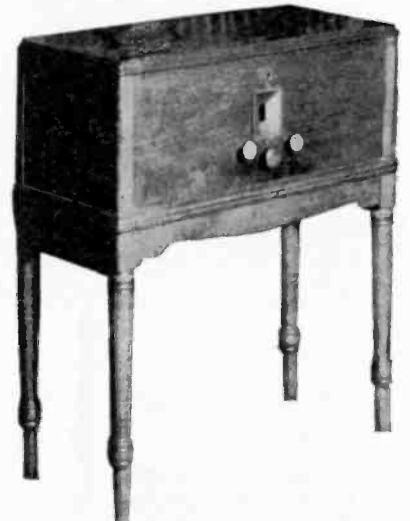

Eveready A.C. Set in Maple Cabinet Set on Supporting Stand

tuning is by single control of a gang condenser with illuminated drum dial. Auxiliary tuning is accomplished by an antenna trimmer or variometer tuned by one of the gang condensers. Volume is controlled by a potentiometer shunted across the detector input. The detector plate circuit includes a filter system to minimize feed-back through the B supply and to simplify the wiring. The detector plate voltage is tapped from the 90 volt lead and reduced to 45 volts by a 50,000-ohm resistor which is part of the filter system. Eight by-pass condensers are used to improve stability and tone quality.

The last audio stage and output transformer are contained in the separate power plant unit whose power transformer has a three-tapped primary to compensate for difference in line voltage. Connection between the power unit and receiver is made by a multiple plug and socket. The power unit uses an '80 rectifier tube, has ample condenser capacity, and employs C biasing resistors.

The chassis is of steel and is housed either in a maple cabinet with natural finish or in an aluminum case finished in dark green with silver lines. The cabinet may be either set on a table or upon a special knock-down stand.

The Eveready d.c. set is a six-tube single dial antenna type of receiver especially designed to conserve B battery current. Hi-mu tubes, '40 type, are used in the three stages of neutralized tuned r.f. detector, and first audio. A '12 tube is recommended for the last audio stage because of its low plate current consumption, although a '71 tube may be used. The r.f. stages use a special R. F. L. bridge circuit, doubly shielded.

Thordarson's New Units Meet With Instant Success

FOR the 1928-1929 season the Thordarson Electric Manufacturing Company of Chicago, Illinois, has introduced several new transformers and power supply devices to meet the pressing demand for such items. It has been Thordarson's policy in the past to be the first on the market with worth-while new items to operate in conjunction with new tubes and circuits as they are announced by the designers. With the overnight popularity of the dynamic speaker Thordarson introduced the proper transformers to most effectively deliver perfect tone quality in connection with these speakers. For years the Thordarson R-200 audio transformer has been the standard among dozens of leading set manufacturers, professional set builders and home constructors. Every Thordarson item has made good. Zenith, Howard, Magnavox, Willard, Sparton and other manu-

facturers of note have been consistent users of the Thordarson product. In the highest priced sets you will find Thordarson audio transformers. Hardly an amateur operator in the country is without something made by Thordarson.

Ever alert to the exacting requirements of those who demand nothing short of perfect reproduction, the Thordarson engineers have developed the new R-300 audio transformer. In this new R-300 transformer the high impedance windings are wound on a core of D-X metal, a recent development of the Thordarson laboratories. This new material for core building has a very high A.C. permeability and an inductance that is 50% greater than that of the highest grade silicon steel. The entire frequency band is reproduced faithfully with this new transformer and the same degree of amplification is obtained throughout. Its ratio is 3 to 1.

The new 250,350 power tubes and the new dynamic speakers capable of reproducing frequencies of extreme ranges, will function at the peak of efficiency when the new Thordarson R-300 transformers are used. Other new items in the Thordarson line for the coming season include a Voltage Changer, Amateur Plate Supply Unit, Filament Supply Transformer and the Push-Pull Output Transformer. These units are shown in the pictures on this page.

Production has been increased to take care of the large demand for the Thordarson "Z" Coupler and the metal base boards for mounting "B" eliminator and power amplifier parts. The Thordarson metal base board is equipped with insulating bushings for passing the connecting wires through the plate for sub-panel mounting, thereby giving the unit a professional factory-built appearance when completed. All parts are grounded to the metal base thereby avoiding any danger to the power supply apparatus.

The Thordarson "Z-Coupler" is a special audio impedance coupler for use with screen grid tubes. One stage of this form of coupling is equivalent to two or more stages of ordinary coupling. Signals barely audible, ordinarily, can be heard at normal room volume when this coupler is used. The Z-Coupler replaces the second audio transformer. The screen grid tube is used in the first audio stage. Remarkable tone quality is had when this coupler is used. Both high and low notes come through with the same volume increase. At 60 cycles the amplification is over 95% of maximum.

The standard line of Thordarson R-171 and R-210 power supply transformers and chokes are giving unusual satisfaction to the many thousands of people who are building sets for sale and to those who are satisfied with nothing short of the last word in sound reproduction.



Z-Coupler



Amateur Plate Supply



Voltage Changer

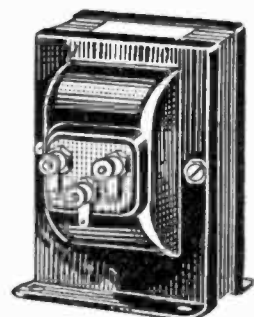

Push-Pull Output Transformer

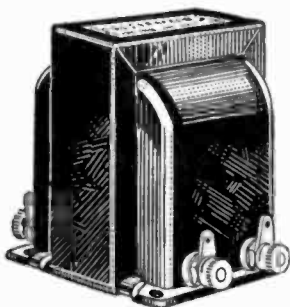

New R-300
Audio Transformer

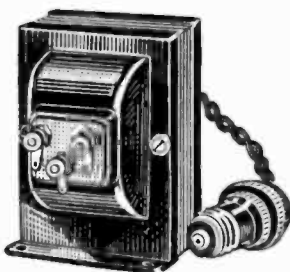

T-3081
Filament Supply
Transformer

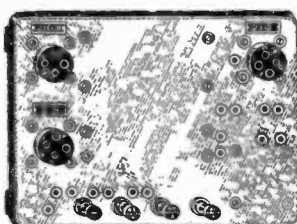

R-211
Metal Base Board

Tell them you saw it in RADIO

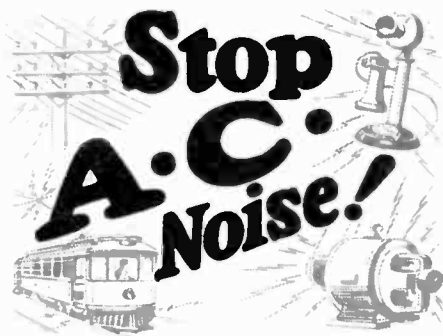

STOP A.C. NOISE!
DON'T let the "static" that comes in over the house lighting system from motors, street cars, telephones and electrical appliances mar your radio programs with blare, squeal, fry and scratch!

Plug in a Falck Claroceptor between wall socket and set and have clearer A.C. reception. A wonderful new improvement by a pioneer radio equipment manufacturer. Grounds and thus blocks our line interference noise and radio frequency disturbances. Also improves selectivity and distance. Requires no changes in set. Measures just $3\frac{1}{2} \times 5\frac{1}{2} \times 2\frac{1}{2}$ inches. Tested, proved. Praised by thousands. Get one right away—at radio parts dealers.



\$7.50 complete with cord and plug

Falck CLAROCEPTOR

Mfd. by ADVANCE ELECTRIC CO.

1260 West Second St., Los Angeles

Distributed by DETSCH & COMPANY

San Francisco :: Los Angeles :: Seattle
Denver :: Spokane :: Salt Lake City

**QST nu9 FO
JUST OUT**



*June
Number*

U. S. and Canada
\$1.00 Each
(Foreign \$1.10)

ONE YEAR
(4 Issues)

For \$3.25
(Foreign \$3.50)

Amateur and Commercial
Stations from 83
Countries

**RADIO AMATEUR
CALL BOOK, Inc.**
508 S. Dearborn Street
CHICAGO, U. S. A.

LOUDSPEAKERS

(Continued from Page 31)

New items from Temple, Inc., include two table models, one of which incorporates the Air Chrome principle with a large surface diaphragm so arranged that the larger or



Temple Model 15 Air Column Speaker.

front half is tuned to the lower frequencies of the musical scale, and the smaller or back half to the higher frequencies. The unit is enclosed in a walnut cabinet, the sides of which have a grained leather effect. The



Temple Model 20 Air Chrome Speaker.

other model is an air column speaker, having an effective length of 54 in. This column fits into a space only $11\frac{1}{2}$ in. wide, and offers an unusually effective response to the useful audio frequencies.

Trimm speakers are made in five models: 7-in., 14-in., and 17-in. cone, 18-in. and 23-in.

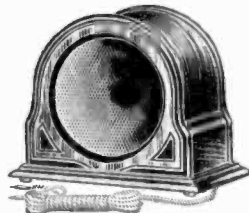

Trimm 7-in. Cone Speaker

horn, and a balanced armature unit for use in a cone. The picture shows the Entertainer clock type of cone speaker, Model 58.

The "Ferranti 1928 Year Book" presents a detailed description of audio frequency transformer and choke coil construction and characteristics and gives circuit diagrams and pictures of their use in four tube d.c. and a.c. receivers, push-pull power amplifiers, and *A B C* eliminators. Of special interest is the material on output transformers for dynamic speakers. A nominal charge of fifteen cents is made for the 60-page booklet.

Farrand dynamic speakers are designed to operate with any make of set using a power tube. They are made in three handsome models, each of which is available for three different types of current supply. One type uses 6-volt d.c. for field excitation, one takes



Farrand Dynamic Console Grande.

50 to 125 volts d.c. and a minimum of 40 m.a., and a third has a self-contained rectifying unit for 110-volt a.c. supply. All types are equipped with a 25-1 step-down input transformer. Each type is also supplied in chassis form. The Gothic model is a table speaker, the Tiffany is an upright console of two-tone walnut, and the console grande is embellished with carvings. Seven attractive models of Farrand balanced armature magnetic cone speakers are also available.

The Peerless dynamic speaker equipped with rectifier element for light socket operation is offered either as a chassis, as a mahogany cabinet or as a complete built-in speaker table. There is also a new model of a cone speaker installed in a table.



Racon Speakers

Racon magnetic speakers are made in a variety of styles, including cones and exponential horns of the long air-column type.

Quam cone speakers are made in two types, a 9-in. for manufacturers and a 13-in. for consumers.



Quam 13-in. Cone Speaker.



Simplified - A - Supply

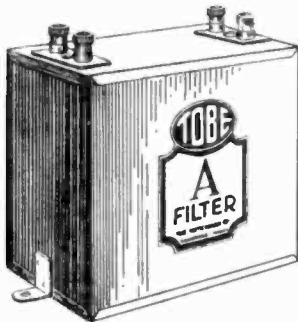

This New Tobe Device combined with any good two ampere charger, does away with the need of the messy A Battery completely.

Dynamic Speaker Energizer

Any trickler charger capable of delivering $\frac{4}{10}$ of an ampere with this TOBE-A-CONDENSER connected as shown, will furnish the proper power to energize your Dynamic Cone Speaker.

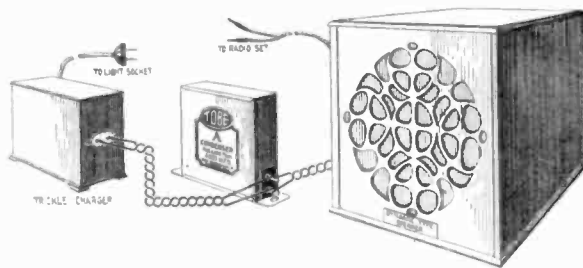

FOR SALE BY ALL THE BETTER DEALERS

Tobe Deutschmann Co.

ENGINEERS, MANUFACTURERS AND IMPORTERS OF TECHNICAL APPARATUS
CAMBRIDGE, MASS.



Tell them you saw it in RADIO



Look This New Service Instrument Over

After you have seen the new Jewell Pattern No. 199 A. C. and D. C. Radio Set Analyzer, you will agree that it has desirable features not found in similar instruments now available—features that improve and increase its value in the servicing of radio sets and equipment.

It is entirely new—designed to meet the present, up-to-date service demands, with additional features that anticipate future requirements.

Some of the features which mark it as distinctly advanced in design are: A new 5-prong plug arrangement, simple push button switches for making tests, provision for an accurate tube test, a new cathode voltage test,—all of which are distinct Jewell accomplishments and worthy contributions to the advancement of radio.

The two instruments, one an A. C. and the other a D. C., have the following ranges: 0-4-8-16-160 A. C. Volts and 0-7.5-75-300-600 D. C. Volts and 0-15-150 Milliampères. All ranges are brought out to binding posts and special leads are provided for continuity tests. All D. C. voltage ranges have a resistance of 1000 ohms per volt.

The instrument case measures $9\frac{1}{2} \times 11\frac{1}{2} \times 3\frac{3}{4}$ inches and is covered with genuine Morocco leather. The complete set weighs $7\frac{1}{2}$ pounds and is equipped with a handy carrying handle.

A new descriptive circular No. 2002 gives complete details of its special features. Write for a copy.

Jewell Electrical Instrument Co.

1650 Walnut Street / / Chicago

"28 Years Making Good Instruments"



Pattern No. 199

POWER UNITS AND AMPLIFIERS

(Continued from Page 32)

steel container. Under average load it draws 22 watts, supplying a maximum of 135 volts. It is capable of supplying sufficient plate current for eight tubes.

Kuprox *A B C* combination power pack consists of two units, both using contact rectifying elements and filters and each of which



Kuprox "A B C" Combination Power Pack.

is available separately. The *A* section will supply 1 ampere at 6 volts. The *B C* section may be had in any one of four models which supply plate and grid tubes to meet the requirements of various sets and tubes.

The S. M. *A B C* power supply, model 670, delivers a.c. filament current and d.c. plate voltage to an a.c. receiver from a 110-volt a.c. source. It delivers 4 amp. at 1.5 volts, 3.5 amp. at 2.25 volts, or .5 amp. at 5 volts.



Silver-Marshall "A B C" Supply

By means of an '80 rectifier tube with filter system it delivers a total of 60 m.a. to fixed taps for 22, 90, 135 and 180 volts and for a variable 3-voltage tap for 22-90 volts. Another model without filament transformer delivers the same *B* supply. Both models are available in either kit or wired form.

The Acme line of rectifier-filter systems includes an *A*-power unit, a *B*-power unit, and a combination of the two to supply all the current needed by a set having seven 6-volt tubes or less. The *A* unit uses a contact rec-



Acme Dry "A B C" Unit.

tifier and high capacity condenser. The *B* unit uses an '80 tube rectifier, filter, and 12,000-ohm voltage divider to supply $22\frac{1}{2}$,

(Continued on Page 62)

AER-O-LAC

The Only Correct Dope for CLOTH AND CONE SPEAKERS

Any Size Containers from $\frac{1}{2}$ Pints to 50 Gal. Drums



Any Colors Bronze Gold Silver Aluminum Clear Ready for Use

WATERPROOF

Can be used for coating Radio cases and Consoles, Preventing Electrical Losses

BEAUTIFUL GLOSS FINISH

This Lacquer is the standard for all first-class Speakers

Distributors

D. X. Electrical Prod. Corp.
25 Church St., New York

Manufacturers

HENRY V. WALKER CO.
17 John St. New York City

The Braid Slides back



CORWICO BRAIDITE HOOK-UP WIRE

Simply push back the insulation on Braidite, make your connection, solder it, and the insulation slides right back into place, leaving no exposed sections of bare wire. Braidite holds its shape permanently after bending, and you cannot scorch or burn it with a soldering iron. Braidite is the easiest and fastest working hook-up wire made, yet it costs less than ordinary hook-up wires.

If your dealer cannot supply you write us direct.

25 Ft. Stranded Braidite.....35c
25 Ft. Solid Braidite.....30c
Made in red, green, yellow, blue, and black.

CORNISH WIRE CO.
30 Church St., New York



Electrify your battery set with the Corwico A-C Adapter Harness. No rewiring. Ask your dealer.

BIG PROFITS *To Be Made*

BY DEALERS WHO TURN
BATTERY SETS INTO
POWER AMPLIFIED
A.C. ELECTRICS

Through Powerizer's amazing invention—and effective advertising—buyers everywhere will be looking for the dealer who makes every battery set a Power Amplified De Luxe Electric. Wire for details on becoming a Powerizer sales and service station and for Bulletin PR-1 which tells how to make every radio or phonograph a power amplified A.C. All Electric.

RADIO RECEPTOR CO.
106 Seventh Avenue
NEW YORK

*Licensed by Radio Corporation of America and
Associated Companies*

Now—your own dealer will make your battery set an A. C. De luxe Power Amplified Electric

with the
famous

POWERIZER

REG

\$ 12⁰⁰

IF YOU HAVE A "B" ELIMINATOR
—just hook up Powerizer A and install
new A. C. Tubes. Easily attached or wired
into your set by dealer at nominal charge.
POWERIZER A \$12

IF YOU HAVEN'T A "B" ELIMINATOR
—just hook up Powerizer Junior and you
are all ready for complete A. C. operation.
Attach it yourself or have Powerizer
dealer wire it into set at small charge.
\$35

GET TONE QUALITY OF \$500 to \$800
RECEIVER

Ask dealer for demonstration of the Powerizer . . . The unit that gives power amplification—the richest tone quality in radio. Bring in those deep tones with amazing realism—greater volume—greater distance. A Powerizer for every purse and purpose.

A New and Finer Appreciation of RADIO

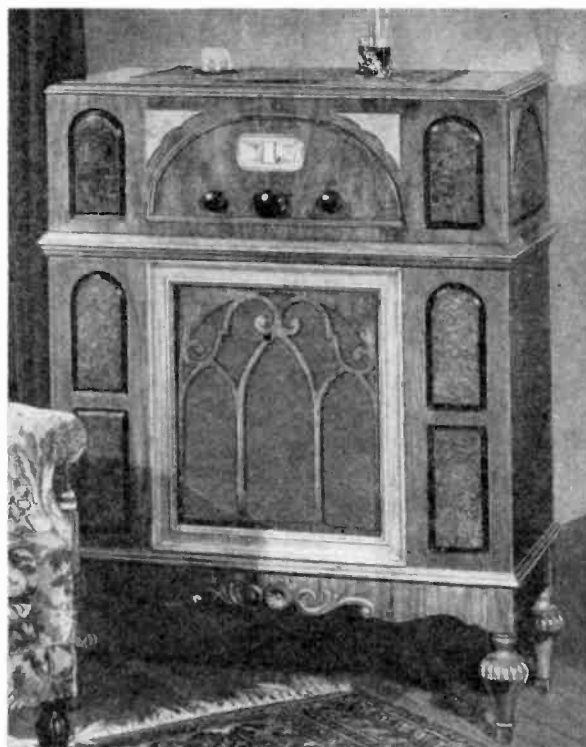

The Model 32 Console

TO BROWNING-DRAKE engineers, the new Model 30 and Model 32 receivers are the embodiment of characteristics long sought for perfect radio satisfaction.

Complete recognition of the art demands admission for telegraphy, radio telephony, television and a long list of other branches. For the present the greater number of us are interested in the translation of living entertainment to lifelike reproduction.

For years an audio amplifier system incorporating pure resistance coupling has given Browning-Drake receivers first claim in the realm of tone quality. Distance reception has always been the recognized companion of the Browning-Drake name. The careful thought and design applied to the first Regenaformer has held Browning-Drake receivers far in the lead through a turbulent sea of broadcast interference.

The new Model 30 and Model 32 receivers are based on the firm foundation of success and sound technical design. This year's contribution includes increased selectivity through the use of four tuned circuits, real power amplification, mechanical improvement and cabinet work of the highest order. A new balanced tension speaker of the Whitmore type is built into these all-electric receivers, adding to the perfect reproduction of the amplifier system alone.

[*DEALERS: Browning-Drake exclusive dealer franchises are now being granted. Write direct to the factory before your territory is closed.*]

BROWNING-DRAKE



Two Good Friends Present--- *Another!*

THE new Model B Browning-Drake loud speaker combines a beautifully designed cabinet with the new balanced tension speaker developed by W. B. Whitmore, and manufactured by Browning-Drake under the Air-Chrome patents pending. The cabinet, in addition to providing an attractive appearance, adds to the reproduction because of its acoustical characteristics.

This loud speaker is noteworthy among the models produced by Browning-Drake because of its unusually even response to the entire audible scale. Low notes are produced with fidelity and definition which mark the speaker as a great advance over contemporary designs. Actual comparison with the average cone or exponential speaker definitely proves the superiority of the Model B.

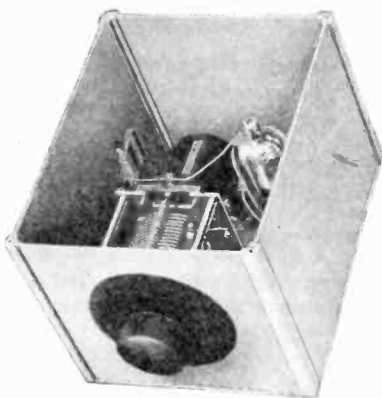
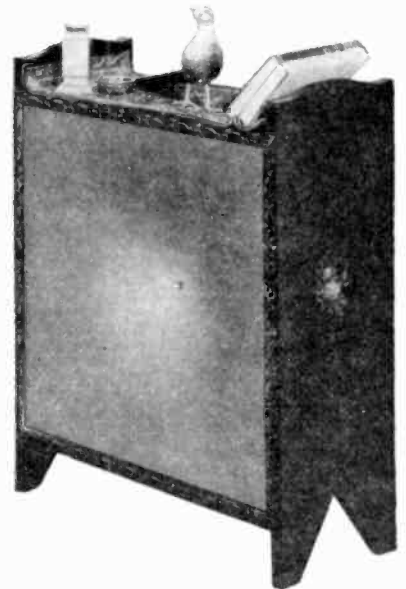

The new Model B loud speaker is 26" high at the ends and is 18" wide. The depth is 9". The top is, therefore, sufficiently large to accommodate many of the smaller receivers, if desired. It can be had in a walnut brown or ebony finish with hand decorated touches which give it pleasing individuality. The list price is \$35.00. Other speakers ranging in price from \$25.00 to \$75.00 will be demonstrated by our dealers this season.

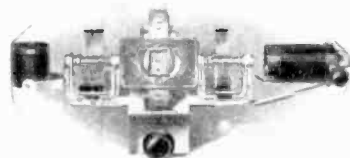

The Browning-Drake shield grid Booster is a development parallel to that of the shield grid tube. Most of the receivers constructed or purchased prior to the introduction of this tube cannot be readily adapted to use it. The Booster offers all of the advantages of the shield grid tube without changes in the receiver proper, and is therefore ideal for use with all older machines. Selectivity and volume are appreciably increased and distance reception is greatly improved when the Booster is used. Connections are extremely simple and no complication in tuning is introduced.

The Booster is included in an attractive aluminum shield cabinet 7"x7"x10". It can be had for use with the standard D.C. shield grid tube or with the new 15 volt and 2½ volt shield grid alternating current tubes. The list price without tube is \$25.00. The Booster is also available in Kit form at \$17.00.

The single control Browning-Drake Kit and the assemblies using it are well known to Browning-Drake fans throughout the world. The universal characteristics of the Kit make it possible to use dry cell, the standard 5 volt D.C., or shield grid tubes in either A.C. or D.C. types in the radio frequency amplifier. If the experimenter plans to use only the shield grid tube in the R.F. amplifier, a special shield grid type Kit may be had. The selectivity and great sensitivity available with Browning-Drake receivers constructed with the Official Kit are equal to those characteristics in the finest and most expensive factory-built receivers. Plans for construction are complete and the most inexperienced builder can be assured of excellent results. The list price of the single control Official Kit is \$26.00 in either the regular or special shield grid types.

BROWNING-DRAKE CORPORATION
CAMBRIDGE MASS.

BROWNING-DRAKE



Tell them you saw it in RADIO

—for—
BETTER RADIO

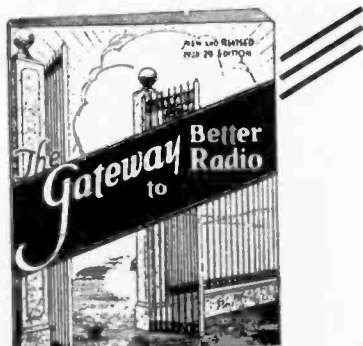

A manual of 36 pages and cover—with 88 illustrations and over 20,000 words of practical, concise, readily understood text—prepared by Austin C. Lescarbourea in collaboration with our engineering staff. "The Gateway to Better Radio" tells what's what for bettering your radio receiver, amplifier or power unit! what's what in A-C tubes, short-wave reception, improved tone quality, added sensitivity, and so on! and what's what in interpreting radio circuits and innovations for best results. *Usable, Unselfish, Unbiased.* Just the plain radio truth, such as you can put to work. **ALL FOR 25 CENTS**, to defray mechanical costs of publishing!

Order your copy of this manual now—before it is out of print—from your local radio dealer, or direct from us by remitting 25c in stamps or coin

American Mechanical Laboratories, Inc.
Specialists in Variable Resistors
285-7 N. Sixth St. Brooklyn, N. Y.

CLAROSTAT

Reg. U. S. Pat. Off.



Used in

Every High Grade Circuit or Receiver Today!

X-L NEW BAKELITE INSULATED PUSH POSTS

The perfect binding post at last! Convenient, simple, permanent connections. You don't have to remember to tighten them. Push down the X-L, insert wire, remove pressure. Connection is tight and will stay tight. No vibrations can loosen. Release instantly. Engraved in all standard markings. Price each, 15 cents.



FREE Big new up-to-date book of wiring diagrams of all leading circuits. Write today for copy.

XL Radio Laboratories

Dept. J, 1224 Belmont Ave., Chicago, Ill.

WANTED

Radio equipment of standard and obsolete types. We buy tremendous quantities. What have you?

References

Anglo & London Paris National Bank

Radio Equipment Co.

942 Market Street, San Francisco

POWER UNITS AND AMPLIFIERS

(Continued from Page 58)

45, 67, 90, 135 and 180-volt taps; one type also supplies 4½ and 45-volt C bias. The A B C unit supplies all these voltages and comes in a metal case 9½ by 12 by 9½ in., weighing 42 lbs.

A Lincoln ABC power unit for a.c. sets is available in a steel shielding case 13 in. long, 3¾ in. wide and 5½ in. high. Besides supplying 22½, 90, 135 and 180-volts d.c. from a



Lincoln "B" Power Unit

'80 rectifier and filter, it furnishes 1.5, 2.25 and 5 volts a.c. for filament heating from a transformer. The same d.c. voltages are supplied from a separate B unit of the same size for use with d.c. filament tubes.

The Abox A.C. converter supplies 6 volt d.c. for 110 volt a.c. through a step-down transformer, liquid rectifier, and complete

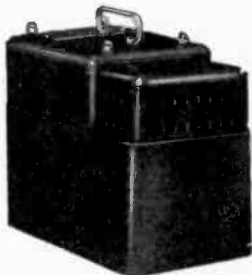

Abox A.C. Converter

filter system. It is equipped with a receptacle for the B unit and has a master control

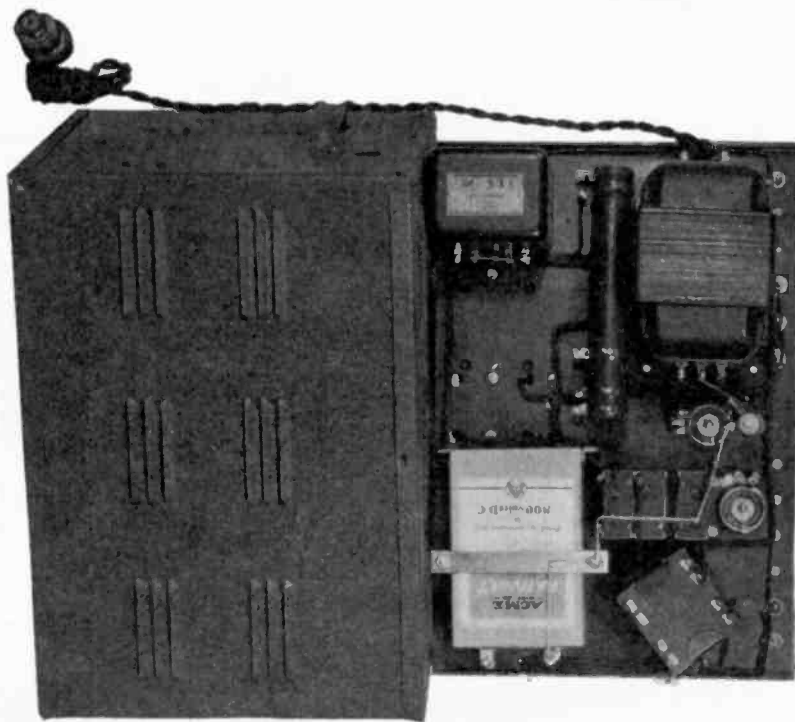

Silver-Marshall No. 685 Public Address Unipac

switch. Its output is adjustable for sets using from 3 to 8 tubes.

The new S-M 685 Public Address Unipac is a 3-stage amplifier for permanent or portable use, and may be operated with microphone, radio receiver, or phonograph record pick-up. Developing nearly 5 watts of undistorted power, this unit is capable of operating 10 to 12 loudspeakers for adequate coverage of theatres, churches, fairs, and outdoor gatherings. It incorporates one UY-227 first stage, one UX-226 second stage, and one 250 power output stage, with two UX-281 rectifiers. It is offered completely wired in steel cabinet or in kit form.

Esco dynamotors and motor generators are now designed especially to operate a.c. receivers, speakers and phonographs in locations where only d.c. power is available. These are equipped with filters so as to give results which are claimed to give results as good or better than secured from 60-cycle

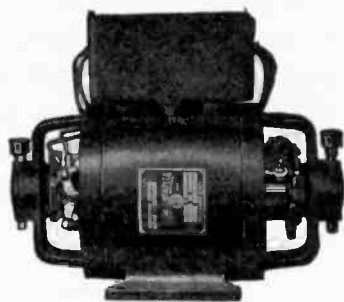

Esco Dynamotor with Filter for Radio Receivers

lighting sockets. Dynamotors are recommended except where adjustment of the secondary voltage is desired, when a motor-generator should be used. These machines are quiet running and require a minimum of attention. A small rotary converter without filter is also available for the operation of a.c. electric phonographs, without radio attachment, from a d.c. source.

What Goes Into the Detector Tube Is Delivered to the Speaker

When You Use the

New **REMLER** AUDIO-TRANSFORMERS

Ten years of Remler Radio Reliability are behind this modern system of audio-transformers. So much ahead of the old-time transformers that every tone-enthusiast will substitute these new Remler Units for his present, inefficient equipment.

The Remler Transformer Team

for Dynamic Speakers

(920)
(921)
(923)



Types 900, 901, 920, 921, 922

ALL the wide range of frequencies which the dynamic speaker can reproduce—from the lowest rumbling notes of the organ, to the trill of the flute—will be faithfully transmitted to it by Nos. 920, 921 and 923. They are especially designed to produce maximum undistorted power output from the CX350 (UX250) Power Tube without overload of the detector or first audio tubes. Their unique construction results in isolation of the audio frequency currents from the plate supply unit and in a high gain stable amplifier entirely free from the annoying phenomenon known as "motor boating."

No. 920 Resonated Primary. A $4\frac{1}{2}$ to 1 ratio first stage transformer with primary resonated to give a slightly rising frequency characteristic at the lower end of the scale to compensate for the falling frequency characteristic of the higher-ratio second-stage transformer No. 921. List Price..... **\$12.00**

No. 921 High-Gain. A $6\frac{1}{2}$ to 1 ratio second-stage transformer designed for use with Transformer No. 920 to produce an amplifier having a flat frequency characteristic over the entire band of transmitted frequencies. List Price..... **\$12.00**

No. 923 No Saturation. An output impedance-compensating transformer primarily designed for use following the CX350 (UX250) Power Tube. Consists of choke, blocking condenser and transformer whose primary is tapped for best results from either the CX350 (UX250) tube, or the CX371A (UX171A) or CX310 (UX210) tube. Secondary tapped for either magnetic-drive cone speaker or dynamic speaker. Isolates audio current from plate supply unit, assuring stable operation. Power tube plate current isolated from transformer windings, eliminating direct-current saturation and providing faithful reproduction of full frequency band. Current-carrying capacity 100 milliamperes. List Price..... **\$20.00**

No. 900 A $3\frac{1}{2}$ to 1 ratio first-stage transformer having a resonated primary and giving special emphasis to the lower frequencies to compensate for the falling characteristic of the No. 901 Transformer. Transformers Nos. 900 and 901 have frequency characteristic falling sharply just above 60 cycles, making them ideal for use in receivers employing A.C. tubes in radio frequency, detector and first audio positions. Designed for use with the No. 901 Transformer in an amplifier employing a CX112A (UX112A), CX371A (UX171A) or CX310 (UX210) Power Tube. List Price..... **\$8.00**

No. 901 A $3\frac{1}{2}$ to 1 ratio second-stage transformer for use with Transformer No. 900 to produce an amplifier having an overall characteristic flat over the desired band of transmitted frequencies. List Price..... **\$8.00**

No. 922 An output transformer intended to follow a CX112A (UX112A), CX371A (UX171A) or CX310 (UX210) Power Tube. Primary tapped to permit best operation with power tube used. Safe current-carrying capacity 40 milliamperes. List Price..... **\$10.00**

*Remler Audio Transformers ready
for shipment about September 1.*

SOLD THROUGH JOBBERS

Write for four-page, two-color Bulletin No. 15,
completely describing the new Audio-Transformer.

REMLER

Division of

GRAY & DANIELSON MANUFACTURING COMPANY
260 First Street

Chicago

SAN FRANCISCO

New York

Eastern Warehouse, Elkhart, Ind.

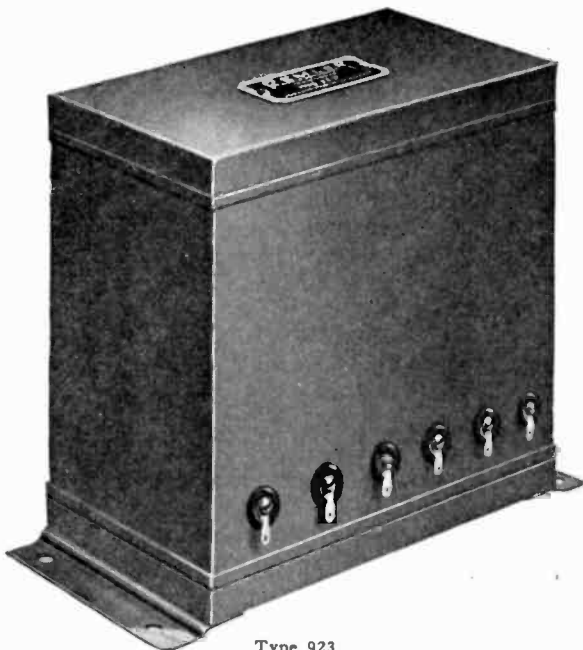

Type 923

Tell them you saw it in RADIO

There's a



Tube forever Radio



*The
Largest Exclusive Radio Tube
Manufacturers in the World.*

5 Reasons

Why you should
use CeCo Tubes.

Because

the exclusive process
of evacuation results
in a more sensitive,
clearer and longer
life tube.

Because

they make any radio
set perform better.

Because

14 inspection tests
assure absolute uni-
formity.

Because

the leading radio ex-
perts use and endorse
them.

Because

you can secure "spe-
cial purpose" tubes
from CeCo not ob-
tainable elsewhere.

At all dealers

CeCo MFG. CO. Inc.
PROVIDENCE, R. I.

Summary of R. M. A. Show Exhibits

(Continued from Page 35)

The electro-dynamic speakers are available in three units, for a.c. or d.c. operation and are installed in four console cabinets, ranging in size from a telephone stand to large folding door types. The air column reproducers are available in four console types, and the magnetic cone reproducers are in table models only.

O'NEIL MFG. CORP., West New York, N. Y., loud speakers of the magnetic cone type in various attractive models, also dynamic type with or without rectifier.

OPERADIO MFG. Co., St. Charles, Ill., three types of exponential, electro-magnetic loud speakers, and two styles of electro-dynamic speakers, including a unit for installation in console cabinets.

PACENT ELECTRIC Co., New York City, Phonovox phonograph pickup unit, equipped with a supporting arm, or for separate attachment to present tone arm. Among the features are ability to use fibre needles, and an arrangement whereby detector tube in radio receiver need not be removed when changing from radio to phonograph. A line of radio parts and accessories completes their new items.

PERRYMAN ELECTRIC Co., New York City, a.c. and d.c. tubes, for all purposes.

PRECISION PRODUCTS Co., Arbor-
phone radio receivers and loud speakers.

PHILADELPHIA STORAGE BATTERY Co., Philadelphia, Pa., five a.c. models of six-tube neutrodyne receivers and two speakers, a magnetic cone and a dynamic. All receiver models have the same type of chassis with single control drum dial tuning, trimmer, and volume control. Each has a built-in power unit with '80 rectifier tube. The table models are in colored metal cabinets with golden floral decorations, gray, green, red and brown. There are three consoles, a low-boy, a high-boy, and high-boy with phonograph. The consoles have a self-contained loop or may be connected to an aerial. The speakers are in clock and console models, the latter being designed to support a cabinet receiver.

PIONEER RADIO CORP., Plano, Ill., three types of tube a.c. receivers, called the Peerless A.C. Seven. Available in either metal or wooden cabinets, or the shielded chassis may be obtained separately.

POLYMET MFG. CORP., New York City, moulded Bakelite fixed mica condensers, as well as wire wound resistances, by-pass and filter condensers, grid leaks, potentiometers, and rheostats.

POTTER MFG. Co., No. Chicago, fixed paper condensers from .0001 to 50 mfd.

for by-pass and filter also 10 mfd. electrolytic filter condenser for 250 volts.

Q. R. S. Co., Chicago, Ill., radio tubes for all purposes, especially heavy current rectifiers for series filament current supply to either type 99 or A tubes.

RACON ELECT. Co., exponential horns of the long air column type, as well as horns for large halls and service where great volume and range of sound is required.

RADIO RECEPTOR Co., New York City, Powerizers, for furnishing B current to any radio receiver, as well as supply a.c. for the filaments of a large number of factory built receivers, by means of an adapter harness. The new Powerizers include a power stage employing a type 210 power tube, and use a type 280 rectifier.

RADIO CORPORATION OF AMERICA, New York City, R. C. A. Radiolas, radiotrons, loud speakers, B eliminator.

RAYTHEON MFG. Co., Cambridge, Mass., rectifying tubes, BH full wave 125 m.a., BA full wave 350 m.a. at 250 volts; A cartridge 2½ amp. at 6 volts: neon Rino lamp, photo-electric cell, hard vacuum or gas-filled.

R. B. M. MFG. Co., Logansport, Ind., a voltage regulator device for attachment to a.c. sets so as to regulate the input voltage to the set. Consists of a transformer with eight taps, controlled by a switch, with indicating buzzer which operates when the correct voltage is reached.

REICHMANN Co., Chicago, Ill., makers of the Thorola receiver, a new line of a.c. and d.c. sets, as well as new electro-dynamic units and cabinet models, together with electro magnetic cone speakers.

REMLER DIVISION OF GRAY & DANIELSON MFG. Co., San Francisco, Calif., several types of new audio frequency transformers, and a special output transformer for use between the 250 power tube and electro-dynamic speakers. A complete line of parts for shielded grid circuits, single and gang variable condensers, drum dials and other accessories.

ROLA COMPANY, Oakland, Calif., table and console models of magnetic-armature and electro-dynamic speakers with step-down transformer and Marathion rectifier for d.c. field supply.

SAMSON ELECTRIC Co., Canton, Mass., full line of standard and Symphonic audio transformers, including push-pull and output types; one, two and three-stage power amplifiers for phonograph or radio sets, A, B and C elim-

(Continued on Page 66)

A NEW 26 INCH SPEAKER!

**LOW NOTES
LOW NOTES
LOW NOTES**

Just Read This

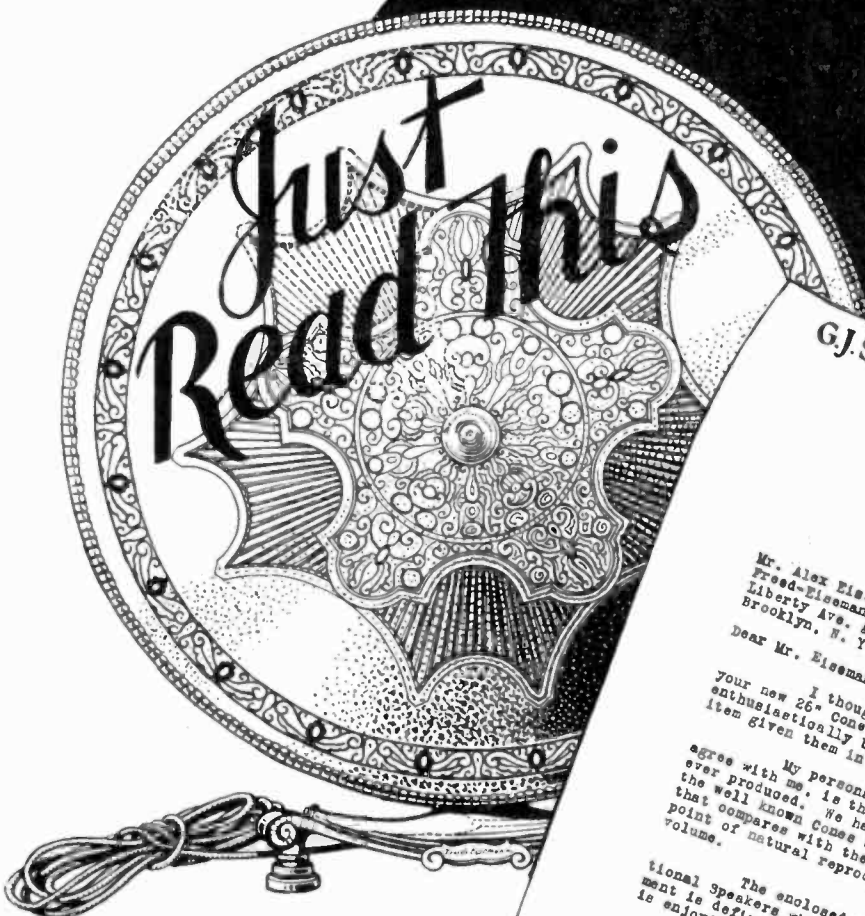

Model 330

Price \$35.
(Pacific Coast prices \$2. add'l)

G.J. Seedman Automotive & Radio Co. Inc.
JOBBER AND
Wholesale Distributors
BEDFORD AVE. at MADISON ST.
BROOKLYN NEW YORK

Mr. Alex Eisemann,
Freed-Eisemann Radio Corp.,
Liberty Ave. & Junius St.,
Brooklyn, N. Y.

March 16th, 1928.
PLEASE ADDRESS ONLY
ATTENTION OF

G. J. Seedman.

Dear Mr. Eisemann:

I thought you would like to know that your new 26" Cone Speaker has been received more enthusiastically by our sales force than any new item given them in a long time.

My personal opinion, and all of the men agree with me, is that it is the finest Cone Speaker ever produced. We have made tests against all of the well known Cones and we have yet to find one that compares with the new Model 26 from the standpoint of natural reproduction and ability to take volume.

The enclosed order for three hundred additional speakers which we require for immediate shipment is definite evidence of the fine acceptance it is enjoying at the hands of dealers.

I hope you are arranging to give the new Speaker wide publicity for you cannot exaggerate its quality, and anyone who buys the Speaker will feel indebted to you for the tip.

With best wishes for continued success and kindest regards, I am

Very truly yours,
G.J. Seedman
President,
G.J. SEEDMAN COMPANY, INC.

GJS/MDT

**FREED
EISEMANN**

FREED-EISEMANN RADIO CORP. BROOKLYN-NEW YORK

Tell them you saw it in RADIO



Approved Parts

(Transformers, Chokes and Condensers)

for the

New U X No. 250 Power Amplifier Tubes

For the popular new U X No. 250 P. A. Tube Dongan laboratories have perfected a complete line of power unit parts. You can assure yourself of the maximum in performance with the proper Dongan parts, designed specially for use with this tube.



Illustrating No. 1177 output Transformers. Chokes and Condensers are also mounted in matched cases similar to the one shown here.

No. 7568—A power supply Transformer.

No. 1177—A straight power amplifier output Transformer.

No. 1176—An output Transformer, for push-pull amplification, designed for all types of dynamic speakers.

Condensers and chokes for the complete Filter Circuits.

Set Manufacturers and Custom Set Builders

You are invited to consult the Dongan engineering department for any desired information for your particular requirements. Production on all types assures satisfactory deliveries.

DONGAN ELECTRIC MFG. CO.

2981-3001 Franklin St., Detroit, Mich.

TRANSFORMERS of MERIT for FIFTEEN YEARS

"RADIO" and "CITIZENS" RADIO CALL BOOK

One year subscription to both for \$2.50—the price of "RADIO" alone—if you subscribe now.

"RADIO," San Francisco

FREE RADIO BOOK !

40 pages chock-full of vital information for radio set builders. 14 new Aero circuits—receivers, transmitters, radiophones, short wave—fully described. Complete construction data, schematics, photos, etc. Exactly the book you've wanted. Write for FREE copy TODAY. Address AERO PRODUCTS, Inc., Dept. 103, 1772 Wilson Ave., Chicago, Ill.

SUMMARY OF R. M. A. SHOW EXHIBITS

(Continued from Page 64)

inators; chokes, r.f. and eliminator, condensers fixed and variable, filters, couplers.

SANDAR CORP., Long Island City, N. Y., a division of the Farrand Mfg. Co., four electro-magnetic and three electro-dynamic models, in table and console cabinets, and with the units available separately if desired.

SANGAMO ELECT. Co., Springfield, Ill., a new line of audio frequency transformers in addition to their well known group of fixed mica condensers.

SENTINEL MFG. Co., Chicago, a six-tube a.c. receiver with three tuned r.f. stages, two transformer coupled audio, rectifier tube and a.c. power unit.

SHAMROCK DYNAMIC ELECTRIC, Newark, New Jersey, a new table model equipped for a.c. tubes with built-in power unit, single dial control, various types of cabinets, Chinese green lacquer, ebony, gold, ivory, mandarin red or antique walnut.

SILVER MARSHALL, INC., Chicago, a new six-tube kit designed by Sargent-Rayment, employing S. M. specially wound coils for three shield grid tubes, a single dial control receiver with individual trimmer condenser for each tuning stage; new S. M. audio amplifying system (3 transformers), main tuning with National single dial 10 k.c.; selectivity in congested areas. Receiver is mounted in and on solid heavy aluminum framework with aluminum mounting base, shield cases, and housing. Style name SM-710, Sargent Rayment Six. In addition to this kit Silver-Marshall displayed a complete line of radio parts which are described in detail elsewhere in this issue.

SLAGLE RADIO Co., Fort Wayne, Ind., two new consoles, both of large size and utilizing the Technidyne circuit. All electric operated receivers with dynamic power speakers in the console models and provision for phonograph pick-up connection as well as for loop operation.

SLEEPER RADIO & MFG. CORP., Long Island City, three models of a.c. electric receivers equipped with electric clock, one 6-tube d.c. electric set.

SONATRON TUBE Co., Newark, N. J., 33 types of tubes for all purposes, including a new model a.c. shielded grid tube.

SPARKS-WITHINGTON Co., Jackson, Mich., five Sparton "Equasonne" receivers and one cone speaker. Three use seven a.c. tubes and two use eight, one is a table model and the others are consoles, with or without speakers. These are especially designed to give good reproduction for all stations between 200 and 550 meters.

SPLITDORF RADIO CORP., Newark, N. J., nine types of a.c. receivers, three of which have 9 tubes, while the re-

mainder are 7-tube models. They are made in two table models and seven console types, the latter having electro-dynamic loud speakers. The sets are all single dial control, illuminated scale, with duplex control so that regeneration can be employed to obtain great sensitivity when extreme distance reception is wanted. The sets are available with type 250 tube power amplifiers as well as the smaller sizes of power tubes.

STEINITE RADIO Co., Chicago, Ill., table and console model a.c. sets, including a compact table model with single dial control, illuminated drum dial, and completely shielded apparatus. The console models have built-in loud speakers, and the latter are also available separately, as a table or console speaker.

STERLING MFG. Co., Cleveland, O., a series of meters and test sets for testing all types of receivers and tubes; also a group of dry and bulb type A and B power units.

STEVENS MFG. CORP., New York City, four new models of cone type electro-magnetic speakers, including two cabinet styles with the cone concealed, and two with exposed cone, all for table mounting.

STEWART-WARNER SPEEDOMETER CORP., Chicago, Ill., a new a.c. standard chassis, and five console cabinets and one table cabinet into which this chassis is fitted. The table model has a loud speaker built into the top of the cabinet. All of the console cabinets except one are for a.c. or d.c. models, and there is a d.c. chassis to supply the demand for that type of set. Both models are single dial control, with illuminated drum dial, calibrated in wavelengths, and the table model is housed in a metal cabinet.

STROMBERG CARLSON TELEPHONE MFG. Co., Rochester, N. Y., a new AC receiver, known as the No. 635 Treasure Chest, employs 7 AC tubes; chassis and base of sheet steel to enclose all wiring. New audio amplification system giving uniform amplification throughout the entire broadcast band. Wires enclosed in casing filled with sealing compound to prevent moisture and mechanical damage. Phonograph pick-up jack. Volume control, single knob varying two resistor units. Range 200 to 550 meters. Cabinet in American walnut.

SYLVANIA PRODUCTS Co., Emporium, Pa., radio tubes, for a.c. and d.c. service.

TELEVOCAL CORP., Newark, N. J., radio tubes.

TEMPLE, INC., Chicago, air column and Airchrome speakers.

THORDARSON ELECT. MFG. Co., Chicago, Ill., power transformers, including filament lighting transformers for a.c. sets, audio frequency coupling units for the shielded grid tubes, and a complete line of other audio frequency coupling devices, and output transformers.

TIMMONS RADIO PRODUCTS CORP., Philadelphia, Pa., loud speakers of cabi-

Tell them you saw it in RADIO

net and unit type, eliminators and power amplifiers.

TOBE DEUTSCHMAN Co., Cambridge, Mass., a new high capacity condenser for A eliminator service, new styles of vacuum type grid leaks, resistors, and a complete line of paper condensers for bypass and filter service.

TOWER MFG. CORP., Boston, Mass., four types of electro-magnetic loud speakers, all of the cone type, with decorative exterior effects in metal.

TRANSFORMER CORP. OF AMERICA, a.c. transformers for manufacturers and professional set builders, as well as chokes, audio frequency transformers, power packs and other parts for the manufacturer.

TRAVELER MFG. CORP., Chicago, Ill., portable radio set.

TYRMAN ELECTRIC CORP., Chicago, Ill., type 50 five-tube portable receiver, with a shielded grid tube; also audio frequency transformers, drum dials, sockets and other parts for the set builder.

ULTRATONE MFG. Co., Chicago, air column magnetic speakers.

UNITED RADIO CORP., Rochester, N. Y., Peerless loud speakers, three types of electro-magnetic cones, and two electro-dynamic units, the latter having two sizes of cones, one 7 in., and one 9 in. Speakers are available in table and console models.

UTAH RADIO PRODUCTS Co., Chicago, Ill., six new speakers of the cone and dynamic types; also speaker units for console mounting.

VICTOREEN RADIO CORP., for an a.c. superheterodyne, including intermediate frequency transformers and associated equipment, as well as parts for d.c.

WALBERT MFG. Co., Chicago, a complete self-contained eight-tube a.c. receiver with power unit. Operation is controlled by single dial without supplementary controls. It has four tuned stages of radio frequency with inductance tuning.

WEBSTER ELECTRIC Co., Racine, Wis., an electric phonograph pickup in two models, one with supporting arm, and the other designed to fit in place of old reproducer on any phonograph, volume control and terminal connector block accompany each unit.

WESTON ELECT. INST. CORP., Newark, N. J., test meters and sets for a.c. or d.c. receivers; a.c. meters for flush panel mounting, as well as the table types, including a three range a.c. voltmeter having ranges of 4, 8 and 150 volts, enabling the complete checking of an a.c. receiver from the input line voltage to the filaments of the various tubes.

YAXLEY MFG. Co., Chicago, Ill., resistors, switches, jacks, rheostats and other parts for the radio set builder; also convenience outlet flush-plates for house wiring of radio installation.

ZENITH RADIO CORP., Chicago, Fifteen new models, table and console types. Model 33 is a six-tube set with single dial control; transparent dial illuminated from underneath; walnut cabinet; uses AC tubes; self-contained power plant. Dial control of this receiver set in circular recess in cabinet. Model 31, same as Model 33 but for battery operation. Model 34, low-boy 6-tube receiver with built-in cone speaker. Completely electric. Model 32, same as 34 but for battery operation. Model 35, a more elaborate hi-boy with standard 6-tube AC receiver and built-in cone speaker. Model 39, a massive console with 8 a.c. tubes loop operated; power speaker.

QUERIES AND REPLIES

(Continued from Page 41)

Will the oscillator work on 45 volts plate? Would there be any advantage in shielding the plate lead from each shield grid tube to its associated r.f. transformer?—W. H. F., East Ely, Nev.

It was found that so little difference could be noted, in the operation of the 115 k.c. superheterodyne, with or without the r.f. chokes in the shield grid leads, that they were omitted for the sake of economy. Actually, there is a total of .105 mfd. connected between the 45-volt lead to the shield grid tubes, and ground, so that additional capacity would be unnecessary. Larger bypass condensers in the present arrangement might help if the B voltage supply had high internal resistance, but when using a high grade B eliminator, or a set of B batteries in good condition, the larger condensers are superfluous. An r.f. choke can be placed between the primary of the first audio transformer and the plate of the detector tube, with the .0005 mfd. bypass condenser connected between the plate and the negative filament. It would help in case there was regeneration in the detector tube circuit, due to parallel leads, but if directions for building the set are carefully followed, this should not be necessary. There would be a slight advantage in shielding the plate leads.

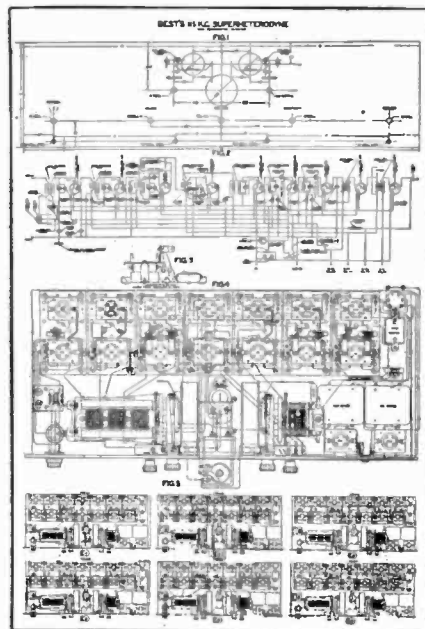

Look at these prints

A complete new system for assembling and wiring the 115 KC Gerald M. Best Super Heterodyne. Color charts, showing the entire wiring operation, step by step. Complete continuity instructions for the whole assembly and a handy, complete instruction book so far ahead of the times that it will surprise you. These new instructions are printed on a very large chart, suitable for framing. Your money most cheerfully refunded if you don't think the prints are worth ten times their price.

25c

covers cost of both the prints and instruction book. Sent postpaid anywhere.

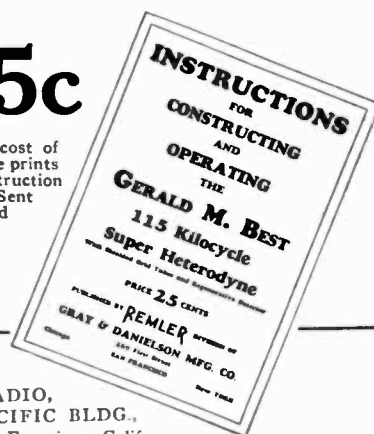

RADIO, PACIFIC BLDG., San Francisco, Calif.

Here is 25 cents. Mail me the new color chart for wiring the 115 KC Best super and also the INSTRUCTION BOOK.

Name.....

Street and No.....

City and State.....

		Power Tube Data						
Tube		Plate Volts	Grid Volts	D-C Plate Current (Milli-amperes)	Voltage Amplification Factor	Plate Resistance	Load Resistance	Max. Output (Watts)
CX-350	UX-250	450	80	55	3.8	1800	4000	4.6
		400	67.5	52.5	3.8	1850	3700	3.5
		350	58.5	44	3.8	2050	4100	2.45
CX-310	UX-210	400	35	16	7.5	5400	11000	1.34
CX-371A	UX-171A	180	40.5	19	3.1	1900	3800	0.8
CX-112A	UX-112A	180	13.5	8.5	8.4	4850	9700	0.273
CX-220	UX-120	135	22.5	7	3.3	6600	13200	0.105

Tell them you saw it in RADIO

SM

A STATION EVERY TEN KILOCYCLES

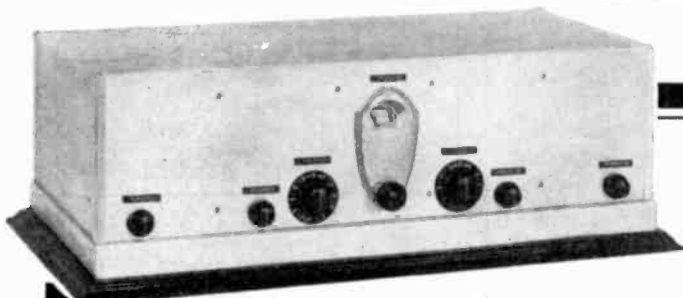

A STATION tuned in for every ten kilocycles—an average of one hundred stations heard in one evening—that is the performance record of the Sargent-Rayment Six, operated in the heart of Chicago interference on a warm summer evening.

Silver-Marshall, Inc., is proud to announce the completion of arrangements with the designers,

Messrs. Sargent and Rayment, whereby their latest radio development can be offered in complete kit form as the S-M 710 Sargent-Rayment Six kit. This remarkable receiver will be distributed by the Radio Constructors Corp. of Oakland, Calif., in the territory west of the Rockies, and elsewhere by regular Silver Marshall distributors.

It is unnecessary to introduce Messrs. Sargent and Rayment, whose past work on a unique receiver system, invented by them has made their names well known to every experienced radio fan. Their new receiver, developed in conjunction with the Silver-Marshall engineering laboratories, needs no other recommendation than the names of its designers, and the full and complete endorsement of Silver-Marshall, Inc., which it carries.

By the seasoned fan, anxious for the finest in radio, the true excellence of the 710 Sargent-Rayment Six will be fully appreciated, for it is the precision product of two seasons of laboratory research work. It is truly a finer radio set than has ever been offered to the discriminating fan before, for in it no compromises have been made with quantity production methods, and none with the taste of those who buy furniture and not radio performance.

The designers set out to make six tubes do full one hundred percent work. Their success proves that the ideal radio set of 10 kilocycle selectivity, ample volume, and 2000 to 3000 mile distance range does not require more than six tubes—if all six are worked at full rating. This contention, acknowledged theoretically and mathematically correct, remained for Sargent, Rayment and S-M to actually prove for the first time in practice. How well they have done it is told in the opening sentence of this advertisement.

The 710 Sargent-Rayment Six is a precision laboratory radio receiver. It has been designed thruout as such. It is like a battleship stripped for action, shorn of every piece of surplus gear. The thick aluminum shielding and chassis, finished in satin silver and trimmed by black instrument name plates with white engraving gives to the appearance a beauty and dignity in keeping with the set's fine performance. Electrically the receiver consists of four sharply tuned circuits in a three stage screen grid R. F. amplifier, all tuned by a single illuminated drum, and provided with individual verniers. One knob turns the set on and off, and adjusts battery voltage. A second controls volume from zero to maximum. There are no other controls. Following the R. F. amplifier are the detector and the A. F. amplifiers, using the new Clough audio transformers which provide unequalled tone quality and high volume. Each circuit is individually shielded, bypassed and isolated from all others. The set goes together simply and positively, with clear direct wiring. It is a joy to build, so workmanlike is its design and layout.

To the fan who appreciates and values really fine performance, in a truly precision receiver of great individuality and distinction, Silver-Marshall unhesitatingly recommends the 710 Sargent-Rayment Six. The kit for this receiver is approved by the designers and exclusively manufactured by Silver-Marshall, Inc., is priced at \$120.00 complete with cabinet.

Exclusive Distributors West of the Rockies
RADIO CONSTRUCTOR'S CORPORATION
357 12th Street, Oakland, Calif.

SILVER-MARSHALL, INC.
852 West Jackson Blvd.
CHICAGO, U. S. A.

A complete booklet written by Messrs. Sargent and Rayment, aided by the S-M engineering staff, is in preparation. It describes the design, construction, operation and maintenance of the Sargent-Rayment Six. It contains an ample number of large, clear plates, diagrams, and working drawings illustrating every angle of the set, as well as amplification and selectivity charts. It is a treatise of such a generally informative nature as to be a liberal education in precision receiver design.

It will be mailed on receipt of 50c in stamps as soon as off the press.

SILVER-MARSHALL, INC., 852 Jackson Blvd., Chicago
Please send me booklet on the Sargent-Rayment Six, as soon as available, for which I inclose 50c.

Name _____
Address _____
City _____ State _____

Special Announcement!

TO THE RADIO TRADE

In order to assure the best possible service to the radio trade west of the Rockies, Silver-Marshall have made Radio Constructors Corporation their exclusive distributor to the trade on the SM-710 Sargent-Rayment Six Receiver. A large Pacific Coast Stock will be maintained throughout the season, assuring immediate deliveries. The set will be furnished to the trade either knock-down, in kit form, or built up, wired, tested, ready to operate.

Our plans call for distribution via the jobber. Jobbers are requested to communicate with us at once for details. Names of all jobbers will be carried in our advertising throughout the season. Local advertising will be done by us in co-operation with the local trade.

This is the greatest opportunity ever offered to the Western Radio Trade to identify itself with a national tie-up. Write us at once.

Outstanding Features

1. Ten Kilocycle Selectivity, even on locals.
2. All Distance Records Smashed. Sets a new standard.
3. One Dial Control. Easy to operate.
4. Will absolutely out-demonstrate any other set, regardless of number of tubes or type of circuit.
5. Every model absolutely guaranteed.

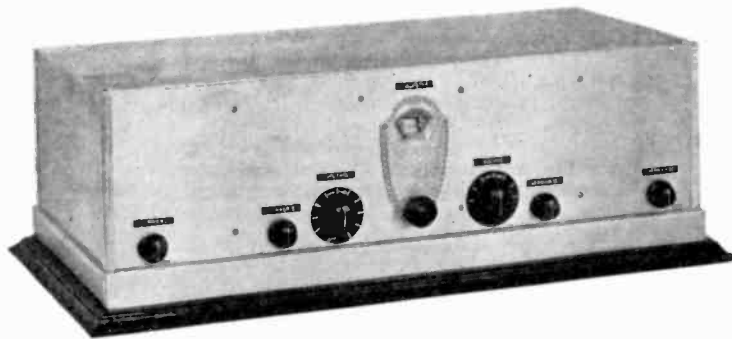

Exterior View of Sargent-Rayment Six

PRICE
\$120.00

This includes everything necessary to build the complete set. Note that, due to its unique construction, no "cabinet" is required. The set when put together forms itself into a handsomely decorated, silvery finished container.

Full instructions for assembling, wiring, and operating accompany each kit.

WRITE FOR FREE DESCRIPTIVE BOOKLET

The limited amount of space in this ad does not permit us to go into details about the new features of this circuit. We have therefore prepared a special 16 page descriptive booklet,—"RADIO PAR EXCELLENCE—1929"—which tells about the Sargent-Rayment Six from start to finish. This booklet, written in plain, understandable language, explains the design of the receiver and shows conclusively just why we are able to make such wide claims for distance, selectivity and tone on the Sargent-Rayment Six. We would appreciate the opportunity to mail you a copy. Just send in your name and address.

A Statement by the Designers

"It has long been a recognized fact that too many tubes were being used in radio sets to accomplish a given result. In the past, lack of proper tubes has made this necessary, but with the coming of the shield grid tube the last obstacle in the way of a perfectly designed radio set has been removed.

"It has many times been shown mathematically and theoretically that six tubes, operating at 100% efficiency would do more than any radio set ever has in the past, no matter how many tubes it used. In the Sargent-Rayment Six, we have proved in practice that this is so. Coils of the highest efficiency, careful shielding, and correct design throughout have resulted in a receiver giving radio results little short of amazing. Ten kilocycle selectivity on local stations becomes an accomplished fact. Distant stations are brought in with unusual clarity and volume, and the concentrated power of the set pulls weak stations right up through the noise level, making their announcements fully audible.

"This set closely approaches the ideal for which radio designers have striven for years, and we take pleasure in offering it to the discriminating radio owner,—the one who likes radio entertainment that is not necessarily confined to local reception."

(Signed) E. M. SARGENT, L. C. RAYMENT

SPECIAL DEALER OFFER

Expires August 1st

This radio season is opening early and we want our dealer outlets to get lined up at once. In order to make sure that dealers on the Sargent-Rayment Six get off to a good start we have arranged a SPECIAL CONCESSION for those dealers who communicate with us at once. Everyone who contemplates selling the Sargent-Rayment Six (and those who do not will be missing the best bet of the season) should fill out the coupon below and send it to us by return mail. These coupons positively will not be honored after August 1, 1928. Meanwhile, they are worth REAL MONEY.

COUPON—Pin to Your Letterhead and Mail at Once

RADIO CONSTRUCTORS CORP.,
357 Twelfth St.,
Oakland, Calif.

I am a dealer in radio parts or a professional set builder as shown by the attached letterhead (if no letterhead, give name of jobber from whom you buy), and am interested in your special offer to dealers on the Sargent-Rayment Six. Without any obligation on my part, please send me at once full details on this offer.

Name.....

Address.....

City and State.....

Exclusive Distributors West of the Rockies

RADIO CONSTRUCTORS CORPORATION
357 Twelfth St., Oakland, California

Power--Quality New Altone---

POWER SPEAKER

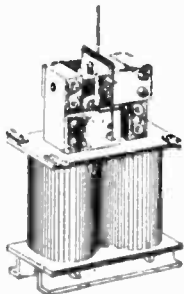

Employs famous DYNATONE ELECTROMAGNETIC Power Unit. Kit includes Baffle Box with special cloth diaphragm. The only speaker not affected by climatic changes. Unit price, \$12.50. Enjoy the best in radio reproduction.

Buy without hesitation on our absolute money back guarantee. Your money back if not satisfied. Works on any set. Will take the output of 250 push pull without distortion or rattling. You will love the rich bass note and tonal brilliancy.

Complete kit.....	\$18.50
Dynatone electromagnetic unit.....	12.50
Piano units.....	6.00
3 ft. cone speaker kit.....	7.50
Altone Balloon cloth speaker.....	11.50

MAIL ORDERS FILLED PROMPTLY

EXPERIMENTERS RADIO LABS

25 R Church Street, New York

SEND FOR FREE CATALOG

From Chicago's Oldest
Radio Jobbers. The
Most Valuable Radio Catalog.
Write for your copy today—IT'S FREE!
TELEPHONE MAINTENANCE CO.
123-5 S. Wells St., Dept. 86, Chicago, Ill.

"Ionized Helium"



List
Price
\$4.50

THE SECRET OF THE STANDARD REPLACEMENT TUBE for "B" ELIMINATORS

The use of Ionized Helium gives to the Raytheon "BH" Tube a superior ruggedness, a far longer life and a sustained voltage. Be sure you get a Raytheon "BH" for your eliminator when the tube needs replacing, which is generally every nine to twelve months.

Raytheon LONG LIFE RECTIFYING TUBE

MISCELLANEOUS PARTS AND ACCESSORIES

(Continued from Page 39)

Model No. 3 embodies a complete filter network for correcting extreme cases where the load may be as much as five amperes. These devices by-pass the inductive kick-back



No. 3 Dubilier Interference Device

caused by any make-break sparking contacts that may exist in motors, transformers, heaters, etc. They are intended for use on a.c. or d.c. 110-220 volt circuits. They do not suppress interference which is radiated into space.

The Polymet small moulded bakelite condenser has all the electrical and constructional features of the large sizes combined



Polymet Small Moulded Bakelite Condenser

in a light, compact unit for easy mounting in any position. It is made in all standard sizes.

The Tobe Tipon vacuum mica condenser is of standard grid-leak size, fitting the ordinary clips for subpanel mounting. It con-



Tobe Tipon Condenser

tains a mica condenser, accurately calibrated to the desired capacity, sealed into a glass tube in a high vacuum.

The Tobe-A-Filter consists of a 7600 mfd. dry condenser cased with two choke coils of

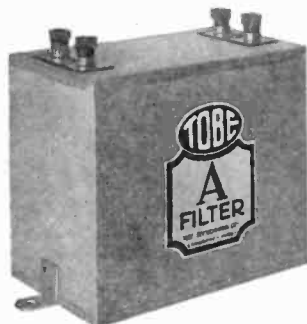

Tobe-A-Filter

proper size to supply humless A current when connected to a two-ampere charger.

The Rayfoto picture recorder kit consists of a three-tube unit which is plugged into the loudspeaker output terminals of a broadcast receiver in order to receive still pictures as broadcast by the Cooley system. The unit consists of the received electrical impulses into light which is radiated as a corona dis-

charge from a needle point and is recorded on sensitive paper mounted on a revolving cylinder driven by a spring or electric motor. The kit includes a precision printer unit, selective synchronizing relay, a phonograph record of a picture transmission for demonstration purposes in the lack of broadcasting, and a complete instruction book. It fits into any standard cabinet with 7x21 in. panel.

The new S-M single and double escutcheon plates with windows provide an attractive mounting for custom-built sets. The general appearance of the single plate is shown herewith, and of the double plate in the picture

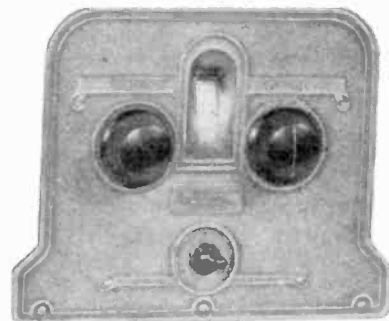

Silver-Marshall Single Escutcheon Plate and Drum Dial

of the S-M screen grid eight. Each plate is 6 5/16 inches high, the single being 8 inches wide, and the double 8 7/8 inches wide. These pictures also show the dials of the S-M 806 illuminated drum which is controlled by a drum operating a friction drive. Both right-hand and left-hand models are provided for 180-degree rotation, 0-100.

The Fritts Phono-Console, illustrated herewith, is one of a number of new designs in radio furniture. This model has a sliding drawer equipped with an electrically-oper-



Fritts Phono-Console

ated phonograph turn-table. The lower shelf on the stretcher is designed for a cabinet speaker. The upper apparatus compartment with drop-door is of ample size to hold any standard make of radio receiver. It stands 41 1/2 in. high, 29 in. wide and 17 in. deep. It is made of dark walnut with burl overlay.

The A-C 171 Pierce-Aero chassis is designed to fit into a desired cabinet or chassis. It provides three stages of tuned r.f., detec-



A-C 171 Aero Chassis

tor and one stage of audio with a.c. tubes and one push-pull power stage with two '71 tubes. It has a complete a.c. power plant with filament transformer and '80 rectifier tube. The panel is 7x18 in. and is fitted with a bronze escutcheon and illuminated single drum dial.

The Acme VR-1 is a line voltage regulator designed to give an almost constant 110-volt output from an input which may vary from 90 to 150 volts. It is rated for a 60-watt output and has a variation of less than 2 per



Acme VR-1 Line Voltage Regulator

cent regardless of its load up to rating. It is to be inserted between the power socket and the radio set and is equipped with a plug and cable, switch and cable, and receptacle for set plug. It contains no tubes or liquids and its dimensions are 4½ by 7½ by 6¼ in.

The Acme B-8 is a double choke coil of 125 m.a. capacity and having an inductance of 18 henries in each section. It is designed for use in power amplifier B supply units and low power transmitters.

The Acme BH-1 is a power transformer with 110-volt 60-cycle primary designed for use with high voltage rectifiers and filters for plate supply to power tubes. It has a secondary winding for 510 volts and tertiary connection for 255 volts, all windings being center-tapped. The secondary current-carrying capacity is 125 m.a., and the tertiary 4.5 amperes. The transformer is enclosed in a metal case approximately 8 inches over all.

The Sonatron Type X401 detector and amplifier tube is of the a.c. heater type drawing 1.05 amperes heater current at 3 volts and using a maximum of 180 volts plate current.



Sonatron X401

It has a standard four-prong base and cap top connections for heater current. Its plate impedance is 8000 ohms and its amplification factor is 10.

The CECo hi mu tube has an amplification factor of 16 and is designed for use in a resistance coupled amplifier. The filament draws 1.05 amp. at 1.5 volts.

The CECo shielded grid tube is of the separate heater type drawing 1.5 amp. at 2.25 volts. It has a 5-prong socket, with a control grid terminal at the top. It has a high mutual conductance and other characteristics comparable to the d.c. shielded grid tube.

The Dongan filament transformer is designed to supply 4.2 amp. at 1½ volts, 1.75 amp. at 2½ volts, and ½ amp. at 5 volts for



Dongan Filament Transformer

the filaments of a.c. tubes. It is mounted in a lacquered case equipped with lamp, cord and plug outlet, and tap for control switch.

The Bodine electric turn-table is designed for use in radio phonograph combinations. It is equipped with a single phase induction

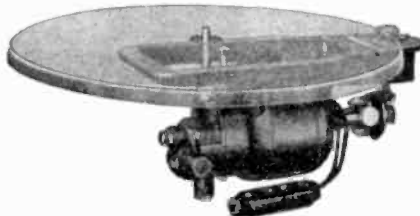

Bodine Electric Turn-Table

motor which has no commutator or brushes and so causes no interference from sparking.

The Tobe socket aerial not only utilizes the light circuit wiring as an aerial, but also allows the use of any electrical attachment



Tobe Aerial Socket

or appliance while serving as an antenna. It is safe and is neat in appearance.

The Clarostat light socket antenna plug is a mica condenser which permits the passage of r.f. current but does not pass 60 cycle

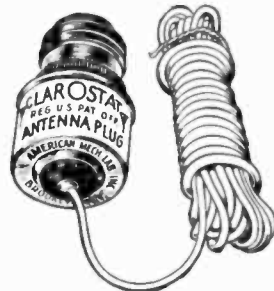

Clarostat Light-Socket Antenna Plug

current. Hence it utilizes house-wiring as an aerial, being connected to the radio set with a flexible cord.

Tell them you saw it in RADIO

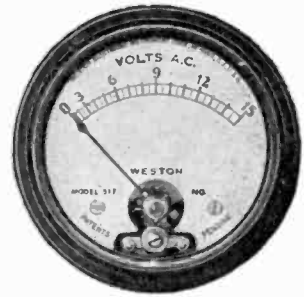

The Greatest Money Value in Matched Instruments

Electrical units of measurement are not subject to change. But electrical quantities can, and do, vary widely when measured with unreliable instruments.

Why gamble with inferior products when Weston instruments insure life-time accuracy at a very moderate cost?

Moreover, the use of bargain instruments sooner or later results in ruined equipment and big repair bills.

Think before you buy, and then buy dependability. Write for Circular "J" on Weston Radio Instruments.

Weston Electrical Instrument Corp.
600 Frelinghuysen Ave., Newark, N. J.

Pacific Coast Representatives

GRAYBAR ELECTRIC COMPANY, Inc.
84 Marion Street
Seattle, Wash.

J. H. SOUTHWARD
San Francisco, Calif.

A. A. BARBERA
Los Angeles, Calif.
REPAIR SERVICE LABORATORY
682 Mission Street
San Francisco, Calif.

WESTON RADIO INSTRUMENTS

Loudspeaker Perfection At Last

12.50

Dynatone Electro Magnetic Unit

Approved by Radio Listeners' Guide

Power unit reproduces full range of both high and low frequencies without rattling or 'storting. Unit approved and endorsed editorially by Radio News, N. Y. Sun, Radio World and leading engineers.

Price per unit \$12.50

3 ft. cone kit 8.50

4" cone unit 7.50

Alitone balloon cloth speaker kit 11.50

Mail orders filled promptly.

EXPERIMENTERS RADIO LABS.
Dept. R 25 Church St. New York



Herman Schnitzel
der Perlessor...
Coniversity
Cincinnati
Oh ho ho

Herman Schnitzel, famed Pacific Coast radio announcer, has published a little booklet containing 26 short radio subjects, written in his comical dialect. These stories have made a hit among thousands of broadcast listeners who have enjoyed Schnitzel's lectures. You, too, will get many a hearty laugh if you read his "works." Send for Schnitzel's book, "Unt Comes It Now." Limited supply on hand.

50 Cents Post Paid
"RADIO," Pacific Bldg., San Francisco, Calif.

DEPENDABLE! EVERLASTING!

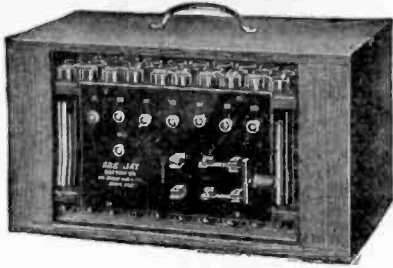

100 Volt Edison Element,
Non-Destructive Rechargeable
"B" Battery with Charger \$12
140 Volt with Chemical Charger \$17
180 Volt with Dry Trickle Charger \$24

Complete knockdown batteries, all sizes at reduced prices. Detector and intermediate voltages plainly marked. Greater volume and clearer than any other eliminator.

Use this coupon
to receive our interesting booklet.

SEE JAY BATTERY COMPANY
913 Brook Ave., New York, N. Y.

Please mail me at once your FREE illustrated booklet describing your batteries and power units, without any obligation to me.

Name
Street & No.
Town..... State.....

Be Your Own Broadcaster

Fool Your Friends!

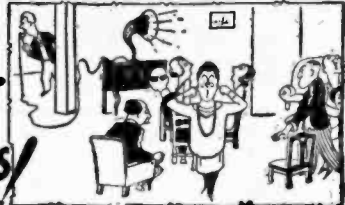

The Sky Is the Limit

A New Idea for a Radio Party!
The mystic Home Broadcaster is attached to any radio set in a jiffy. No skill required. Stretch long extension cord into another room or closet, press the switch button on the microphone which automatically cuts off radio reception and you begin to broadcast.

Then the Fun Begins!

Sing—Joke—Play—The sky is the limit! Release the button and radio reception comes through once more. Slip a Home Broadcaster in your pocket when you go to the next radio party and see what happens. It is not necessary to remove the Broadcaster from the Set. It can be left permanently connected to the Set as it will not interfere with radio reception. The Broadcaster is therefore always ready for instant use.

Send No Money!

Pay postman \$4.95 plus postage for the Home Broadcaster outfit consisting of Microphone, Special extension cord and adaptor plug. State whether you want the Type U. X., using 4-prong detector tubes or Type A. C., using 5-prong detector tubes. If you are not entirely satisfied your money will be returned.

ELBA PRODUCTS MFG. CO.

726 Atlantic Avenue, B'klyn, N. Y., Dept. 115

free

A Continental Control Switch will be given free with a one year subscription to RADIO (\$2.50) if you act immediately. Only a few on hand.

"RADIO"

Pacific Building San Francisco

Nema Annual Meeting

During its annual meeting in Chicago the week of June 4, the Radio Division of the National Electrical Manufacturers' Association went on record as favoring the increased use of higher power by broadcasting stations. They also recommended to the Secretary of Commerce that the radio inspectors, working under the Secretary of Commerce, be supplied with adequate apparatus for the accurate measurement of the carrier frequencies of broadcasting stations.

During the last session of Congress, many voices were raised against the use of high power by broadcasting stations, the loudest of which was that of Representative Edwin L. Davis of Tennessee, who boldly announced that 10,000 watts was the largest power which should be permitted any broadcasting station. The scientific basis for his stand was not indicated. The attitude of the transmitter section, National Electrical Manufacturers' Association, expressed at their annual June meeting is in direct opposition to that of Representative Davis and those others who sympathized with him.

"The radio manufacturer and the radio listener have a strong parity of interest," said Louis B. F. Raycroft, vice president of NEMA, "It is to the interest of the radio manufacturer to see that the radio listener is not only supplied with the best possible radio receiver, but that he is also supplied with the best possible broadcasting stations. He cannot generally receive satisfactory broadcasting signals at all hours of the day and night, winter and summer, in most locations, unless the broadcast stations which furnishes him his programs is of sufficient power to provide him with a strong signal under all conditions. We shall have to revise our ideas of the power of broadcasting stations if the listener is to have generally the signals to which we believe he is entitled.

"We all know the radio art is changing rapidly and it is as surely changing in respect to the power required from our broadcasting stations to suit modern ideas and conditions as it has changed in respect to receiving apparatus in the past seven years. Some voices have been raised against the use of higher power, but those are the voices of those who will not see the situation as it is. As the general level of power is increased, just so will the general satisfaction of the listener improve."

The NEMA recommendation to the Secretary of Commerce and to the Federal Radio Commission on the questions of higher power follows:

"Whereas the question has been discussed publicly as to what if any power limits should be placed on broadcasting stations, and whereas the gradual increase of the power of many well-known broadcasting stations has resulted in better broadcast service to radio listeners generally and whereas, the increase of power is in the public interest, convenience and necessity: therefore, the radio transmitter section of the National Electrical Manufacturers' Association hereby expresses its opinion that the increase of power broadcasting stations is highly beneficial and feel that this betterment of the radio broadcasting art should not be hampered by undesirable restrictions."

In proposing that the Department of Commerce be allowed adequate technical apparatus for the proper checking of broadcasting stations, disapproval of the action of the director of the Budget at the last session of Congress is seen. Only a fraction of the financial budget requested by the radio section of the Department of Commerce was allowed.

The radio service, Department of Commerce, charged as it is with the detail work of administering the radio act requested sufficient funds for additional personnel and apparatus to properly carry out the provisions of the Radio Act. The full recommendations of the NEMA radio transmitter section committee follow:

"WHEREAS, in many cases, measurements made of the carrier frequencies of broadcasting stations are not based upon comparisons with recognized and respected standards of frequency, and whereas many of the broadcasting stations do not regard the present equipment of the radio supervisors of the Department of Commerce as suitable for the purpose of accurately measuring the carrier frequencies; THEREFORE, the radio transmitter section of the National Electrical Manufacturers' Association expresses hereby its sympathy with and support of the efforts of the Department of Commerce to obtain suitable equipment for checking the frequency of broadcasting stations. Further, that NEMA urges that the Radio Supervisors be supplied with such equipment at the earliest possible date."

In order to show in a graphic way the exact comparisons by radio zones of broadcasting facilities proportionate to the population, area, power and number of licenses, the accompanying chart has been prepared by Ralph H. Langley of the Crosley Radio Cor-

(Continued on Page 77)

Power	35.30	19.34	7.80	27.31	10.24
Stations	19.68	16.40	14.55	30.67	18.68

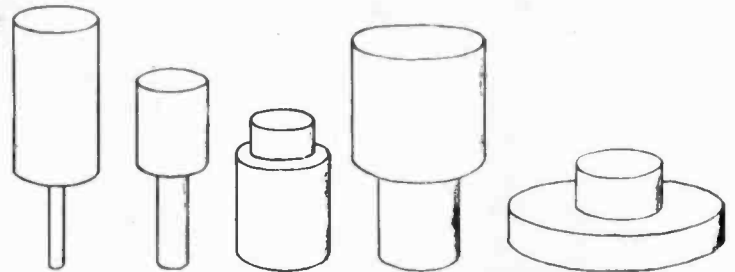

--Radio Division, NEMA

Zone	1	2	3	4	5
Population	22.73	22.69	23.14	22.83	8.59
Area	3.63	6.93	21.33	18.42	49.68

Comparison of Broadcast Facilities by Zones

Tell them you saw it in RADIO

AUDIO TRANSFORMERS

(Continued from Page 38)

shown in Fig. 2, Curve "E", showing the amplification obtained with S-M 225 and 226 transformers and one standard audio tube, or the amplification between the detector output and the power tube grid circuit. Curves A, B and C show the results with three other makes of high grade transformers and Curve D the performance of two low-priced transformers employing the Clough system.

The Clough idea for audio frequency transformers is used by the Lincoln Radio Corporation in the types which are uniformly housed in copper cases $3\frac{1}{2}$ in. high, $2\frac{11}{16}$ in. wide and $3\frac{3}{16}$ in. over two mounting feet. No. 105 is a first audio with $4\frac{1}{2}$:1 effective ratio and with practically a flat curve from 200 to 8000 cycles and rising characteristicly between 65 and 200 cycles. No. 106 is a second stage with effective ratio of $3\frac{1}{2}$:1 and a frequency characteristic like that of No. 105. No. 107 in an output transformer for power tubes. No. 106 has been found to give, in conjunction with a screen grid tube, an amplification of forty-two times for frequencies between 32 and 8000 cycles.

The Transformer Corporation of America transformers include medium and large size designs of 2:1, 3:1, and push-pull models as well as 1:1 output transformers. They have

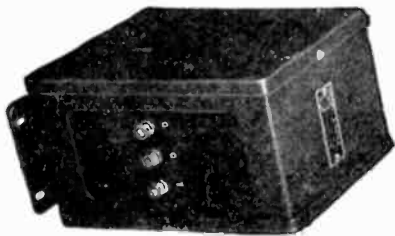

T.C.A. Audio Transformer

clean-cut laminations of silicon steel and their coils are vacuum-impregnated. They are capable of reproducing the very low notes. The T. C. A. Amplipack No. 631 sup-



T.C.A. Amplipack

plies 5.3 amp. at 1.5 volts, 1.75 amp. at 2.25 volts, 5 amperes at 7.5 volts, and 100 m.a. at 500 volts for a 210 push-pull amplifier and for an a.c. electric set. This company also manufactures a complete line of small step-down and step-up power transformers for professional set builders. They specialize on the manufacture of chokes for use in battery eliminators as well as in r.f. circuits.

NEW SHIELDED SUPER-10

5 Screen Grid R. F. Amplifiers
4 Stage Power A. F. Amplifier

A new and Superior Receiver, representing highest type of efficiency obtainable, in point of extreme range, selectivity, and quality of reproduction.

Illustrated literature gratis

Complete Constructional Blue Prints,
\$2.00, postpaid

NORDEN-HAUCK, INC.

Builders of Highest Class Radio Apparatus in the World

Marine Bldg., Philadelphia, Pa.

Cable Address "NORHAUCK"



The *Perfected* **PLUG-IN COIL**
It's the Hammarlund!

Set of Three Coils with Plug-in. Base, \$10 comp. Plug-in Coils, \$2.50 ea. Base only, \$3 ea.

Now the famous Hammarlund low-loss, space-wound coils may be had in plug-in form. A set of three coils covers the low-wave band from 20 to 80 meters. Special coils supplied for higher wave lengths. The variable primary coil has phosphor-bronze flexible connections and is integral with the Bakelite base. Friction holds it at any desired coupling.

Write for special folder

HAMMARLUND MFG. CO.
424-438 W. 33rd St., New York

For Better Radio
Hammarlund
PRECISION
PRODUCTS

THIS MONTH ONLY—

To those who subscribe to "RADIO" for one year at \$2.50 we will send, postpaid, free of all cost, a CONTINENTAL control switch for automatically turning on and

off your battery charger. These switches retail for \$3.00. Only a few on hand. Better subscribe now. "RADIO," Pacific Building, San Francisco, Calif.

LINCOLN ANNOUNCES

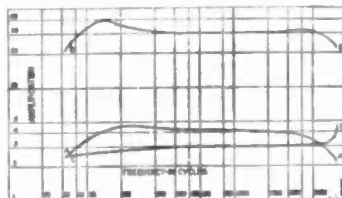

Curve "A" is Lincoln 105 first stage transformer. Curve "B" is Lincoln 106 second stage transformer. Curve "C" is a \$10.00 high-grade audio transformer of standard make. All curves are under actual amplifier operating conditions. Note absolute Lincoln superiority.

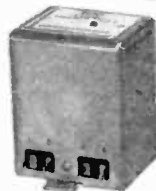

All Lincoln transformers can be identified by the satin-copper case $3\frac{1}{2}$ " high, $2\frac{3}{4}$ " wide, and $3\frac{3}{16}$ " over mounting feet.

REVOLUTIONARY A. F. TRANSFORMERS!

LINCOLN offers new radio transformers of phenomenally high amplification and precision manufacture, designed by Kendall Clough. Look at the actual operating curves for these new Lincoln products! Where have you ever seen such high amplification and excellent frequency characteristics as these new transformers offer! The new 105 first stage audio transformer has an average effective ratio of 4.4:1—nearly 50% more than other more expensive transformers. The 106 second stage audio transformer is 3.7:1 or nearly 25% more than other types. And the tone—it simply must be heard to be appreciated, so far superior is it to that of ordinary \$8.00 and \$12.00 transformers. No matter what set you have, or what you're going to build, Lincoln's are the best audios, for they'll give you finer tone and 50% more amplification on weak signals.

POWER UNITS—B and ABC

TWO new Lincoln power supplies, one a "B" eliminator only, and the other a complete "ABC" power supply for A. C. tube sets, are contained in attractive brown crystalline steel shielding cases, long and narrow so that they may be placed in a radio set cabinet by the receiver itself. Each case is $13\frac{1}{2}$ " long over two mounting feet, $3\frac{3}{8}$ " wide, and $5\frac{1}{2}$ " high, or $6\frac{1}{2}$ " over the single 280 type tube used. Model 110 B power unit delivers from 180 to 200 volts at 50 to 60 m. a. from the "high voltage" binding post, and $22\frac{1}{2}$, 90, and 135 volts from other posts. From a special post, a variable voltage of $22\frac{1}{2}$ to 90 volts is available. This powerful eliminator will operate any set of one to ten tubes, and is especially designed for high quality Lincoln audio amplifiers, its filtration being remarkably fine. The model 110-ABC unit furnishes just the same B voltages, plus 1.5, 2.25 and 5 volts for up to five 226 tubes, three 227 tubes, and four 112A tubes. C voltage is obtained by suitable bias resistors in any A. C. set. Type 110B is priced at \$36.00, and type 110-ABC at \$39.00 retail list, fully guaranteed. Both will operate from any 105 to 120 volt, 60 cycle alternating current lamp socket.

Lincoln will soon have ready a new receiver kit of wonderful tone, excellent selectivity and sensitivity—a set that brings DX right into the Lincoln offices in a steel building night after night. Send 2c for all data on new Lincoln products.

LINCOLNRADIO CORPORATION
329 SOUTH WOOD ST. — CHICAGO - ILLINOIS.

Tell them you saw it in RADIO

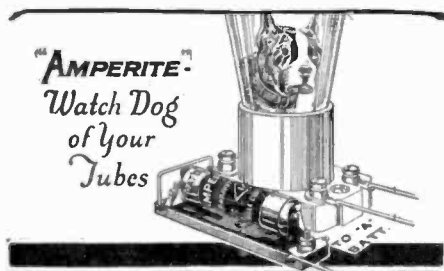

Simplifies-

1. Tube control—No knobs
2. Wiring—Short leads
3. Panel design—No drilling
4. Tuning—No hand rheostats

Only AMPERITE can automatically keep the temperature or voltage of the filament constant despite variations in "A" battery voltage. Particularly essential with eliminators. Proved for 6 years to be indispensable in every radio circuit. Do not confuse with fixed filament resistors. Accept only AMPERITE. Price \$1.10 with mounting (in U.S.A.). At all dealers.

Write for Free "Amperite Book" of season's best circuits and latest construction data. Address Dept. K-5-A.

Radiall Co., 50 Franklin St., New York

AMPERITE

REG. U.S. PAT. OFF.

The "SELF-ADJUSTING" Rheostat

Quality Radio Products
INCLUDE

Potter Condensers

Balkite BRANT KARAS Willard
Audiola
UNITED KODEL WORK RITE Slagle AMRAD
RADIO CORP. GLOBE
ZEPHITH VESTA Universal
ANDERSON DELMAR CONSOLIDATED BATTERY CO.
UTAH F. ELECTRIC CO. MOHAWK
LIBERTY TRANSFORMER CO.
KING Radioline GOULD Modern
BALDOR Howard
PIONEER NUNN LONDON COMPANY Peerless
Sleeper BOSWORTH ELECTRIC MFG. CO. Penstock
INTERSTATE COLIN B. KENNEDY INCORPORATED NASSAU
Paul O'Leary
MaLaren
THE ELECTRIC HEAT CONTROL CO. W. J. MILLER
BATTERY HOUSE LIMITED
The Wise McClung Co. L. M. BRADLEY
Fred E. McQuinn Co. L. M. BRADLEY
Ecophone FEDERAL BUSH ELANE
Electric Products Corporation CENTRAL RADIO
W. J. MILLER
E. L. MAURET

Potter Manufacturing Co.
No. Chicago, Ill.

Pacific Coast Offices
905 MISSION STREET
San Francisco California

Gerald Best's

SUPER BLUE PRINTS

The complete working plans in full size for building the new incomparable Gerald Best 115 Kilocycle superheterodyne with full instructions for building.

\$1.00

Per set. Postpaid anywhere in the U. S. Send remittance by cash, check or money order. Stamps also accepted. "RADIO," Pacific Bldg., San Francisco, California.

RADIO KIT REVIEWS

(Continued from Page 40)

recorded results obtained from those who have constructed this receiver.

The new S-M "Screen-Grid Eight" is a custom receiver kit, has five screen-grid r.f. tubes, detector, and two-stage audio am-

The new S-M No. 740 "Coast to Coast" screen-grid a.c. receiver kit has one stage of 222-type screen-grid radio-frequency with 227-type detector; one 222-type screen-grid audio amplifier and 171-type second-stage power tube, providing enormous amplification and permitting complete light socket operation. Two drum dials and unusually large coils permit hair-line tuning and selec-

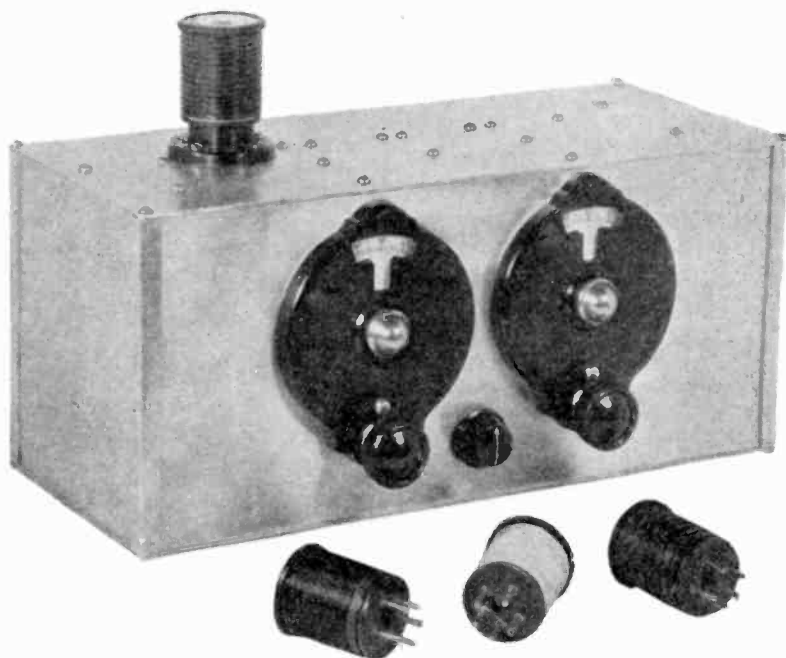

S-M 730 Short-Wave Receiver and Plug-In Coils

plifier. The steel cabinet, finished in rich coloring, is included in the kit. Every necessary part is supplied wherewith to custom build one of the finest receivers that can be had.

The new S-M 730 "Round the World" short-wave receiver, with one 222-type screen-grid tube in the r.f. stage, employs the new S-M 131 plug-in coils. It is most ingeniously assembled upon aluminum plates which, when erected, comprise the cabinet, size 14 inches long, six inches deep, and 6 inches high. Four separate coils provide a wave-length range from 17.5 to 204.5 meters. Both a complete kit No. 730 and an essential kit No. 732 are provided. Or by dropping the two-stage audio amplifier a two-tube Short-Wave Adapter (S-M Kit No. 731) of remarkable efficiency is available.

tivity. The tone quality is of the highest order, by virtue of the new S-M 255 and 256 audio transformers. In conjunction with the S-M 670-ABC power supply and S-M No. 700 cabinet and chassis, a complete a.c.-operated receiver is provided.

Case Neutrodynes are made in two types, each using standard a.c. filament tubes. The six-tube type has three stages of neutralized tuned r.f. amplification and the seven-tube has four stages. Each is fitted for a '71 tube in the last audio stage. The six-tube set is supplied with a cabinet and the seven-tube with either a spinet console with cone speaker or deluxe console with air column speaker. The entire tuning system is mounted on a rigid aluminum casting. The condensers are shielded and "floated" on the same shaft. The power plant, with its '80 tube, is a separate unit.

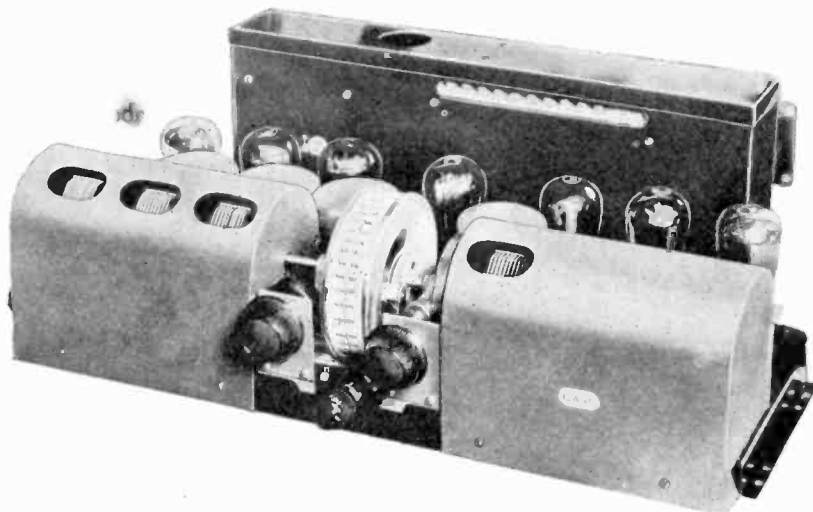

Chassis for Seven-Tube Case Neutrodyne

Tell them you saw it in RADIO

PUBLIC ADDRESS SYSTEM

(Continued from Page 24)

in the overall frequency characteristic as is apparent from the curves of Fig. 2. This is caused by the input capacity of the A tube, 50 mmf. or more, moving up or down along different points to the potentiometer. This capacity combines with the transformer leakage reactance to cause a resonant peak at some high frequency. The arrangement shown tends to smooth out the rising characteristic of the transformers shown.

The plate of the second tube works into the next transformer T_3 through a special circuit to raise the low frequencies. This circuit consists of a 25,000-ohm shunt resistance R_6 for feeding in the plate d.c. supply, and a series condenser C_3 used to resonate the primary of the transformer T_3 to about 50 cycles. Resonating the primary with this condenser causes a larger voltage to be set up across the secondary of T_3 at the resonant frequency. By this means it is possible to put an actual bump in the gain frequency curve which will be higher than at say 1000 cycles. By using a 0.2 mfd. condenser here a bump is put in which tends to make up for the small drop in the other three input transformers, leveling out the frequency characteristic on the low end.

The secondary of the transformer T_3 has another equalizer in the form of R_7 which puts a droop in the high frequency characteristic. Its action is explained by the following: there is a capacity between the two windings, primary and secondary, which is charged by the induced voltage set up in the secondary. The charging current flows to ground through the resistance R_7 causing an emf opposite to that of the secondary induced voltage in its effect on the grid of the tube. At low frequencies the charging current is very small, due to the small capacity, so its effect is negligible, but at high frequencies the current is high so the bucking emf is high. This reduces the hump in the high frequency characteristic of the transformer and if the resistance is large enough, it may actually drop the high frequencies down lower than at say 1000 cycles. This is what has been done by means of R_7 in order to make up for the rising characteristics of transformers T_2 , T_3 and T_4 . There are tricks to all trades, including the equalizing of audio frequency amplifiers.

As can be seen from the curves of Fig. 2, the amplifier is very good up to over 7000 cycles per second, which may be desirable for some purposes but is not when a phonograph is used. In fact, it is doubtful whether it is desirable to go above 5000 cycles in any case, so a "scratch filter" $L_3 C_7$ is shown dotted across the output of the third tube. Personally, I use this filter at all times as it reduces some of the microphone hiss or

phonograph needle scratch. With a $\frac{1}{2}$ henry choke and a .002 mfd. condenser, it resonates between 5000 and 6000 cycles, cutting this off and in effect all above the resonant frequency. The choke can be 1600 turns of No. 36 wire wound on a small iron core $\frac{1}{2}$ in. cross section. An adjustable air gap in the core should be provided, and for $\frac{1}{2}$ henry value, the gap should be about $\frac{1}{64}$ in.

The transformer T_4 is a push-pull input type, having a very good frequency characteristic. Its slight ill effects are compensated by the equalizers previously mentioned. The transformer center-tap connects through a resistance to the center of the filaments of the power tubes. The plate current of the two power tubes flows through this resistance R_8 , giving a negative bias to the grids of the power tubes. The 2 mfd. bypass condenser C_4 is connected across R_8 in order to prevent this stage from howling if the two tubes are not exactly matched. In practice, for maximum undistorted output, a value of resistance of from 1000 to 1200 ohms for R_8 is correct for 310-power tubes. For the type CX 350-power tubes, a 750-ohm resistance should be used. This resistance should be capable of dissipating 10 watts in heat in order to safely carry the required current.

The output of the push-pull tubes is connected through a double choke as shown and through two 4 mfd. condensers to the loud speaker jacks. For most loud speakers, more power in sound can be obtained by means of a series connection when a pair of 310-power tubes are used. A better impedance match will result when two or three, or even four loud speakers are connected in series as the load, than when only one is used. If only one speaker is to be used in the final installation, a push-pull step-down output transformer should be used in place of the double choke and two 4 mfd. condensers.

A short-circuiting switch S_2 across the output of the speakers is used in turning the amplifier on or off in order to avoid loud cracks or bats that occur when any changes are made in microphone current, or such adjustments.

Little needs to be said about the power supply. The power transformer having the plate supply winding and two filament windings, is in the same case with the two chokes L_2 and L_3 . One type 381 rectifier tube is used and it supplies the load quite easily without overheating. The condensers C_5 , C_6 , C_9 , C_{10} , and C_{11} should be rated for 1000 volts d.c. working voltage, and of approximately the values shown. The condenser C_8 and also the other condensers can be of a lower rating, say 500 volts. The values of the resistances R_9 were worked out for the combination of tubes used. These resistances should be able to dissipate about 25 watts or so in order

Improves
tone fidelity, clarity, sensitivity - by automatically keeping tube filament voltage constant, despite "A" battery variations.

AMPERITE

REG. U.S. PAT. OFF.

The "SELF-ADJUSTING" Rheostat eliminates hand rheostats. Simplifies wiring, tuning, panel design. Particularly essential with Battery Eliminators. Accepted only Amperite. 81.10 mounted (U.S.A.)

FREE - "Amperite Book" of latest circuits and construction data. Write Dept. A-7.

RADIALL CO.
50 Franklin St., New York





No. 390

R. R. Panel Meters

IMPROVE YOUR SET
Use them to maintain accurate voltages and currents so maximum reception efficiency is assured.

Cat. No.	Type	Price
Panel Voltmeters		
326	For reading DC voltages, 0-6 volts	\$1.65
335	For reading DC voltages, 0-8 volts	1.65
310	For reading DC voltages, 0-10 volts	1.65
316	For reading DC voltages, 0-16 volts	1.65
337	For reading DC voltages, 0-50 volts	1.65
339	For reading DC voltages, 0-100 volts	1.75
342	For reading DC voltages, 0-150 volts	1.75
Panel AC Voltmeters		
351	For reading 0-15 volts AC	\$2.25
352	For reading 0-10 volts AC	2.25
353	For reading 0-6 volts AC	2.25
Panel Milliammeters		
311	For reading 0-10 milliamperes DC	\$1.95
325	For reading 0-25 milliamperes DC	1.85
350	For reading 0-50 milliamperes DC	1.65
390	For reading 0-100 milliamperes DC	1.65
399	For reading 0-300 milliamperes DC	1.65
394	For reading 0-400 milliamperes DC	1.65
DC Pin Jack Voltmeters		
306	For No. 25 and No. 28 Radiolas, 0-6 volts DC	\$2.50
308	For No. 20 Radiola, 0-6 volts DC	2.50
"B" Eliminator Meters		
346	For testing B battery eliminators, grid bias voltage across resistors, batteries, etc.; 0-300 DC scale	\$4.50
347	For same as No. 346, except scale is 0-500	5.50

B. C. L. Radio Service Co., Inc.
218 Fulton Street New York City
BRUNO "Book of Hook-ups," 25 cents
Mail Orders Promptly Filled
Send for Free Catalog

THERE IS A

FERRANTI

*Audio Frequency Transformer
for every requirement*

Get the very best in audio amplification. Know how to use it. The 1928 Ferranti Year Book contains 60 pages of useful information, including circuits and instructions for building receivers, power amplifiers, etc. Sent anywhere for 15c in coin. Stamps not accepted.

FERRANTI, INC.
130 West 42nd St., New York, N. Y.

Tell them you saw it in RADIO

Practical Radio Telegraphy

A new book, worthy of a place in any radio man's library. Written by Arthur R. Nilson, Director West Side Y.M.C.A. Radio Institute, New York and J. L. Hornung, Chief Instructor, West Side Y.M.C.A. Radio Institute, New York. A book expressly for radio students preparing to become radio operators. A fine general handbook for those having to use and care for modern radio transmitting and receiving equipment. Every commercial operator should have this very latest down-to-the-minute book. Wonderful help to those who contemplate taking commercial operator's examinations.

380 PAGES

Bound in cloth. 223 illustrations. Will be sent postpaid upon receipt of price to any part of the U. S. or Canada. Edition limited. Prompt action necessary.

\$3.00

PUBLISHERS OF "RADIO"

433 Pacific Building San Francisco

WHAT'S WRONG WITH YOUR SUPER?

Jeems Super Trouble Shooter, most complete, accurate, sure-fire method of locating trouble in any superheterodyne. Chart comprises 16 symptoms, 130 possible causes; result of ten years' trouble finding on supers. By mail 50 cents.

"A DOLLAR A MINUTE"

One rat builder writes:

Los Angeles, Calif.

"Made \$5.00 in five minutes servicing a super no one had been able to fix. Your Jeems chart showed me the trouble in a minute."

J. B. R.

It's easy to locate trouble with a Jeems Super Trouble-Shooting Chart. Quick, handy, accurate.

ROBERTS RADIO SERVICE

Caxton Building
Chicago, Ill.

to provide a good margin of safety. A set of six 5000-ohm resistances makes a good combination.

In wiring up such a set or system, the filament and plate battery leads should be cabled. All high voltage leads as well as the output leads from the 310 tubes to the loudspeaker jacks should be of heavy rubber-covered wire. No. 14 ground wire is quite satisfactory. The $7\frac{1}{2}$ -volt a.c. filament leads to the push-pull tubes should be twisted and kept away from all other leads in order to prevent a.c. induction. With the transformer layout as illustrated, the wiring is quite simple and direct, most of the leads being less than 2 in. in length. The microphone lead from the connecting block to the current measuring jacks, and from the jacks to the input transformer, should be shielded. This can be done most readily by running a pair of No. 18 DCC "bell wires" inside of a copper meshing. This copper meshing or tubing should be grounded to -A battery, as should all transformer and condenser cases also.

The output leads from the 310 tubes should be twisted together, and kept several inches away from the preceding amplifiers. For the same reason the plate current jacks should be mounted in the shelf beside the output transformer or choke.

When the system has been completed, a very careful check of the wiring should be made. When the power is turned on, the plate current for each 310 tube should be between 20 and 30 milliamperes. The 112 should draw about 8 to 10, the A tubes each about $2\frac{1}{2}$ to 4, and each button of the microphone should not be unbalanced more than 50 per cent. Generally a little tapping or gentle shaking of the "mike" will restore the balance to reasonable values. Incident-

ally, be sure that the current is turned off from the "mike" before touching it if you want it to last for a long time. These two-button microphones cost from \$75 to \$150, so it behooves one to be extremely careful in handling it. The "mike" should be suspended on 8 small springs and a flexible three-conductor cord run to the amplifier connecting block. If this microphone lead is over 25 ft. long, it should be shielded, using the latter as the third or common return. In most "mikes" the common return is to the heavy metal casing with the two button connections, one to the "bridge" and the other to the center button on the opposite side. A glance at a "mike" will clear up this matter.

The loudspeakers should not be located near the amplifier or microphone, because of feedback. Unless directional horn type loudspeakers are used, it will be necessary to have the microphone 50 to 150 ft. from the loudspeakers, or what is preferable, in a separate room. This is necessary in order to prevent sound from the loudspeakers coming back into the "mike" and setting up a howling or singing tone. Needless to say that in any installation, the volume control should be set below the beginning of the howling or singing point.

Usually a good ground connection should be made to the -A battery lead in order to reduce hum and to stabilize the amplifier. Because of the very high gain of the complete amplifier, it may be desirable to shunt the volume control at the transformer secondary with a 100,000 or 250,000 ohm metalized leak. This depends a good deal on the sensitivity of the microphone which is used. Perhaps it should be emphasized here again that an ordinary telephone transmitter cannot be used because of its poor frequency characteristic.

LIST OF PARTS FOR PUBLIC ADDRESS SYSTEM

- T₁—Microphone input transformer 200:100,000 ohms.
- T₂ and T₃—3:1 ratio audio transformers.
- T₄—Push-pull input transformer.
- T₅—Push-pull output choke.
- L₁— $\frac{1}{2}$ henry choke.
- L₂ and L₃—30 henry chokes (in power transformer case).
- C₁—1 mfd. (500 volt type).
- C₂—2 mfd. (500 volt type).
- C₃—0.2 mfd. (500 volt type).
- C₄—2 mfd. (500 volt type).
- C₅—4 mfd. (1000 volt type).
- C₆—4 mfd. (1000 volt type).
- C₇—0.02 mfd. (mica).
- C₈—6 mfd. (500 volt type).
- C₉—2 mfd. (1000 volt type).
- C₁₀—2 mfd. (1000 volt type).
- C₁₁—2 mfd. (1000 volt type).
- R₁—0-200 ohm potentiometer.
- R₂—0.1 megohm.
- R₃—25 megohm.
- R₄—25000 ohms (heavy duty).
- R₅—0-500,000 ohm volume control potentiometer.
- R₆—25000 ohms (heavy duty).
- R₇—0.1 megohms.
- R₈—1000 ohms (heavy duty).
- R₉—20,000 ohms (heavy duty).
- R₁₀—10000 ohms (heavy duty).
- S-S—Straps between binding posts.

VOLUME CONTROL

(Continued from Page 26)

frequency choke. If the resistance is connected between antenna and ground, volume control may be obtained very nicely by connecting the grid of the first tube to a slider on this resistance, thus using more or less of the voltage drop along this resistance as the input voltage to the tube. For smooth control, the resistance should not be greater than about 2000 ohms. An ordinary 2000 ohm potentiometer can be used here very satisfactorily.

Summarizing, then, we see that filament, plate, and grid voltages should be left at their rated values in the detector and audio frequency amplifier circuits to avoid distortion. The control should be ahead of the detector, so that distortion will not be introduced through overloading a tube handling audio-frequency currents. The control should not affect the damping of the radio-frequency tuned circuits.

Tell them you saw it in RADIO

NEMA ANNUAL MEETING

(Continued from Page 72)

poration, and chairman of the NEMA committee on section activities.

On this chart, there are ten cylinders. The bottom cylinders show the area and the population of the five zones created by the Radio Act of 1927. The diameter of the cylinders is proportional to the area of the zones, while the height of these cylinders is proportional to the population.

Note that the first four zones are closely alike in population but that the fifth zone is much lower than any of the other four. The areas of the zones differ greatly. For instance, the fifth zone is *thirteen* times the area of the first zone. The upper cylinders show the number and total power of the broadcasting stations assigned to each zone. The diameter is the number of stations and the height is the total power.

The results of balloting for officers gave to Louis B. F. Raycroft of the Electric Storage Battery Company the vice-presidency and leadership of the radio group for another year. This is Mr. Raycroft's third term in office. In the division dealing with trade and merchandising problems, George A. Scoville was re-elected chairman of the Merchandising Council, and H. Curtis Abbott was chosen vice chairman. Mr. Scoville is with the Stromberg-Carlson Company, and Mr. Abbott is general sales manager of the Crosley Radio Corporation.

In the important technical committee sections, L. W. Chubb of the Westinghouse Company was chosen chairman of the radio receiver section; George Lewis, Arcturus Radio Company, head of the vacuum tube section; H. L. Olesen, Fansteel Products Company, head of the power supply section, and Julius Weinberger, Radio Corporation of America, head of the radio transmitter section.

The merchandising and technical sections of the NEMA meet twice annually to settle upon standard radio technical and commercial practices. The technical section has published the only commercial radio manufacturing and engineering standards now in existence in the United States. The member radio manufacturers of NEMA make more than 80 per cent of all the radio receivers sold in the United States annually.

At the June Chicago meeting of NEMA, the important radio market analysis "The Radio Market" was issued, the first accurate study of radio market statistics ever made. It is already in use by most of the radio manufacturers and distributors and advertising men in the industry and has been hailed as one of the most important contributions to the merchandising and advertising of radio products ever made.

The Raytheon BA rectifier tube is of ionized helium type and is designed to supply A, B and C voltages for a complete radio set. It has an output rating of 350 m.a. at 210 volts and has regulating characteristics which tend to compensate for variations in load current. It is designed for a maximum input voltage of 350 R. M. S. per anode. It has standard tube-base anode connections to the usual filament prongs. Cathode connection is to the usual plate prong.

The Muter a.c. power unit utilizes an '80 rectifier tube to supply 40 m.a. at 220 volts from a 110-volt a.c. source. It also supplies 1.5, 2.5 and 5 volts for filament current from a step-down transformer. It is equipped with five positive B leads for 45, 67, 90, 135 and 180 volts. Similar units supplying 30 m.a. at 180 volts or 40 m.a. at 220 volts are also made for use with either Raytheon or '80 tube rectifiers, but without transformer for filament supply.

STATION KFYS

United Fruit Steamer, "La Perla."

By Its Operators

The shack on the *La Perla* is laid out about amidships on the boat deck, with a large battery room on the port side, operating room in the middle and operators' quarters on the starboard with doors opening out to either side of the boat deck.

The transmitting equipment consists of an R. C. A. ET 3626 750 watter with QSYs covering everything between 600 and 2500 meters. It is panel mounted and the set itself is in the battery room. A ½ kw wireless specialty QS-500 spark completes the transmitters. These outfits are probably the best sets of their size manufactured. They, also, are panel mounted and very compact, taking up only a space of approximately 2 by 6 ft. We average 9 amps radiation on 600 with this baby outfit, which has every other ½ kw outfit I've ever seen beaten to a frazzle, as the majority of them are lucky if they put out 6 amps.

The receiver is also W. S. apparatus, consisting of receiver and two stage amplifier unit. It resembles the old SE type Navy Standard with a few improvements.

The emergency equipment consists of 100 Edison cells stacked neatly away in a rack in the corner of the battery room; the charging panel being mounted between the tube transmitter and the spark. This panel is as high as the shack walls and divided into two portions, the upper half having switches controlling the emergency lighting circuits while the bottom half's switches control the ship's juice to the shack and regulating rheostats for charge and discharge of battery unit, 220 volts d.c. being used for charging.

The whole layout is handy, as almost everything can be controlled from a seated position. The table is at the forward end of the operating room and stretches from wall to wall. On the extreme right is the starter control of the tube set which consists of start and stop buttons, rheostat for adjustment of filament voltage, and filament voltmeter. Next is the receiver with a spacing of about six inches between it and the amplifier unit, a small hand key for use on the spark outfit being placed between the two units. Following the amplifier unit come the rest of the keys; a straight one for the tube, and a cootie and bug with connections for use on either spark or tube. The file is in the extreme right-hand corner of the table with the horn, and a small desk is attached to the table on the right which accommodates the mill. Table lamps are in use over the receiver and mill. A desk for the filing of passenger traffic and a settee complete the furniture. The entire shack is laid out in white enamel with mahogany trimming and furniture.

Two ops hold down the job, maintaining a continuous watch, and most of the traffic is handled on schedule with our own stations, working Castilla, Honduras (UA), and Cartago, C. R. (UR), daytimes, on 1800 and 2400 meters; and Miami, Fla. (WAX), and New Orleans (WNU), on 750 meters at night. We are practically QSO with these during the entire voyage from KPH to Puerto Limon, Costa Rica. We also have hourly schedules with T.R.T. ships on 750 meters, but these are not so good along the northern part of the run, as considerable QRM is experienced around that wave. However, this doesn't mean a lot with the bunch of QSYs that practically all T.R.T. ships can cover. With local business KPH can usually be carried about 1000 to 1200 miles south on long waves daytimes, so the files are usually kept pretty clean. Guess that's about all, so shall close with an invitation to any of the gang to come down and look us over.

Protects A-C Tubes— Improves reception!

Excessive voltage burns out A-C tubes, filters and step-down transformers. They are built to operate on 110 volts. In many cities the normal line voltage is from 112 to 118 volts. In most cities, too, the voltage varies with the time of the day. These "surges" burn out tubes, and harm sets.

Wirt A-C Voltage Regulator No. 211

prevents these troubles. It will protect your set and tubes. It eliminates A-C "hum." At the same time, it enhances the tonal quality of your set and gives truer reproduction of music and the speaking voice.

Costs only \$2.25. If your dealer cannot supply you, send direct. Get yours today!

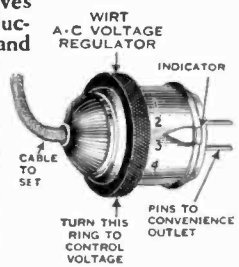

WIRT COMPANY
5221 Greene St., Philadelphia, Pa.
Makers of "Dim-a-lite" and "Dim-a-lamp"

Amazing RADIO RECORDER Developed!

POPULAR demand has produced a recorder that now *proves* the location of stations received. Covers the entire field of 864 stations. Users write us that U. S., Canada, Mexico and West Indies are at their command; with adequate equipment for reference.

The only known method of proper selection. Price: \$2.35 complete, with 100 colored indicators. Sent postpaid.

Moneyback if not entirely satisfied
RADIO RECORDING Co.
Dept. 9-R
1554 W. Sixth St., Los Angeles, Calif.

THREE-FOOT CONE STILL UNSURPASSED

3 Ft. "E. R. L." CONE KIT

All frequencies at any volume. All tones from high to low. Kit contains famous DIRECT-DRIVE UNIT, Fontex, Apexes, Extension-rod, and booklet of instructions.

PRICE PER KIT.....\$8.50

Reproduces lower frequencies better than any other speaker. Fully Guaranteed throughout. Send for Free Radio Log and Circular.

Mail Orders Filled Promptly

Experimenters Radio Labs.
25-R CHURCH ST., NEW YORK

Tell them you saw it in RADIO

GET A SET OF SPINTITE WRENCHES FREE

The Publishers of "RADIO" have 500 sets of brand new STEVENS SPINTITE RADIO WRENCHES in stock which will be given free to those who subscribe to "RADIO" for one year at \$2.50. The retail price of these wrenches is \$1.25 per set of three. A set of these 3 wrenches, in standard packages, will be given free to the first 500 people who send us a one year subscription to this magazine. We will pay the postage.

The wrenches are standard sizes and will be of great help to the builder of radio sets, mechanics and others. They are the "ROUND STYLE" wrenches and, although intended primarily for round head nuts, they are equally practicable for square or hexagonal nuts. A set of universal wrenches for your workshop without cost if you subscribe now. Get your subscription into the mails today.

RADIO

Pacific Building
SAN FRANCISCO, CALIF.

Resumption of Service by GERALD M. BEST

THE demand for properly matched Intermediate Frequency Transformers has caused the resumption of this one service by Radio's Calibration Laboratory. The matching is personally done by Gerald M. Best, technical editor of Radio. Prompt and accurate matching is assured. As D. B. McGown is no longer associated with this laboratory, no other testing or repair work is done.

Mail orders are solicited when transformers are carefully packed in box suitable for re-shipment.

Price \$3.00 per set

Calibration Laboratory

Pacific Radio Publishing Co.

433 Pacific Building
SAN FRANCISCO, CALIFORNIA

QUESTIONNAIRE FOR RADIO ENGINEERS

(Continued from Page 28)

ameter of the grid wires. The distance between grid and plate also has an effect, but not as much as the plate to filament. If the plate load impedance is equal to the plate impedance, the maximum transfer of energy will take place, and as the load impedance becomes less, the energy transfer becomes proportionately smaller. In r.f. amplifiers, the load impedance is usually much smaller so as to permit the proper degree of selectivity being attained, since with a very high plate impedance and high load impedance, the selectivity would probably be poor.

10. Upon what does the voltage amplification factor of a three-element tube depend, and where does this factor appear in the equation for the amplification in an audio frequency amplifier?

Depends on the number and spacing of the grid wires, their position with respect to the filament and plate, and is known as the amplification constant, represented by the Greek letter Mu (μ). This factor appears in the formula for the mutual conductance of a tube where $G_m = \mu / R_p$, R_p being the plate resistance. When defining the voltage amplification of a tube, it is usually expressed as Mu times the input voltage, and when a transformer is also to be figured in the result, its turns ratio is multiplied by the amplification factor of the tube, to get the total amplification per stage.

11. What factors internal and external to the vacuum tube affect its input impedance?

The inter-electrode capacity and the load in the plate circuit are the chief factors.

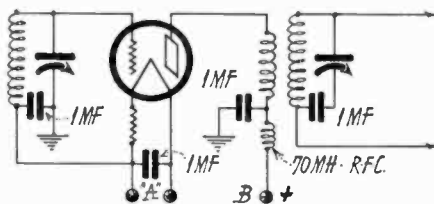

Fig. 5

12. In Fig. 5, is shown one stage of a "broadband" amplifier. Discuss the circuit with respect to the technical features, keeping in mind the problem of cost reduction.

The 1 mfd. bypass condensers shown in the diagram are all unnecessarily high in capacity. Economical design consistent with satisfactory operation would call for the elimination of all these condensers, and the substitution of a condenser of not more than .1 mfd., between the plate side of the r.f. choke and ground. It is quite probable that a condenser of .006 mfd. would do at this point. The condenser in series with the tuning condenser is superfluous. Admitting that the filament circuit is not grounded, as shown in the diagram, it would be better to ground the filament, and save the cost of the condenser. The r.f. choke in the plate circuit is larger than need be, and in most factory built sets is omitted, unless it is part of an impedance coupled scheme.

An "electric set," according to the R. M. A. standard nomenclature, is a radio receiver operating from the electric light line, without using batteries. If it employs tubes which obtain filament or heater current from an a.c. line without the use of rectifying devices, but with built-in tube rectifier for plate and grid voltages, it is an "a.c. tube electric set." If it uses current supplied by a d.c. line it is a "d.c. tube electric set." If it is designed to be operated from batteries it is a "battery-operated set." If the latter is connected from a power unit operating from the electric light line and supplying filament and plate potentials to the tubes, it is a "socket-powered set."

"RADIO" and "CITIZENS" RADIO CALL BOOK

One year subscription to both for \$2.50—the price of "RADIO" alone—if you subscribe now.

"RADIO," San Francisco

"RADIOBUSTER"

112 Page Book of Radio Fiction
by Mathison

\$1.00 POSTPAID

"RADIO," San Francisco

Master the Code

Wireless or Morse—at home with the TELEPLEX Automatic Code Instructor. No better method for self-instruction exists. Quick—Easy—Thorough. Endorsed by U. S. Navy. The only instrument that reproduces actual sending—messages, radiograms, etc. Any speed. Complete Course (6 tapes) FREE. Thirty times as many words as any other instrument. Avail yourself of the TELEPLEX for a quick mastery of the code. Write for booklet R. TELEPLEX CO., 76 Cortlandt Street, New York.

Visual Communication

A new department starting in the next issue of "RADIO." Edited by an authority on radio picture transmission.

WATCH FOR IT

NEW BOOKLET

On Audio Amplification, A. C. and D. C. Power Amplifiers, and Specially Developed Receivers—How to Get Better Tone, Volume and Power.

Newest circuits. 30 pages with diagrams and photographs.

Send 10c to cover mailing cost

FERRANTI, Inc.

130 West 42nd St., New York, N. Y.

POWER UNIT

Save 75% of cost of Electro-Magnetic Power Unit. All parts factory-made—easily put together—A modern driving unit in knockdown form—complete only \$6.75. Send for circular or send us your order—GUARANTEED.

TUNBAR RADIO CO.

26 Cortlandt St., New York

Send for Free Catalog Airplane Cloth Speaker

It contains many bargains in all types of Cone Speakers, Units, complete parts to build all types of cone speakers. Also the latest parts of the New AIR-PLANE Cone Speaker. Accessories. ACCUSTI-CONE, 1 No. 7th St., Phila., Pa.

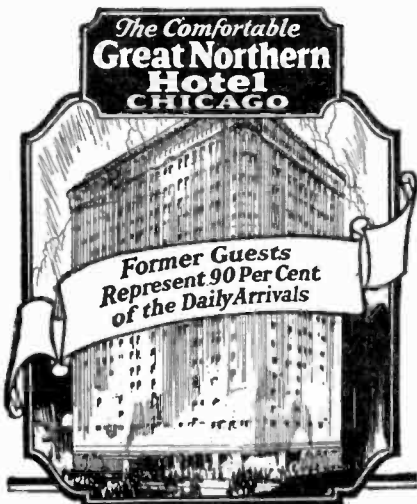

TRAVELERS select the Great Northern for its wonderful location in Chicago's "loop". They return because the large comfortable rooms, homelike environment, attentive service, excellent food and moderate charges make it an ideal hotel.

400 Newly Furnished Rooms
\$2.50 a day and up

Sample Rooms
\$4.00, \$5.00, \$6.00
\$7.00 and \$8.00

WALTER CRAIGHEAD
Manager

Dearborn St. from Jackson to Quincy
New Garage One-Half Block

RADIO ADS

A CLASSIFIED ADVERTISING SECTION READ BY BETTER BUYERS

The rate per word is eight cents net. Remittance must accompany all advertisements. Include name and address when counting words.

Ads for the August Issue Must Reach Us by July Fifth

NAVY BARGAINS: 50,000 volt Leadin insulators, new \$4.50 each, cost \$30.00. 18-inch aerial insulators, new, \$1.25 each; new Leyden jars, .002 Mfd., 12,500 volts, Pyrex Glass, \$1.50 each; Motor-generators and generators, 500 cycles, 900 cycles and D.C. Attractive prices, all sizes up to 5 K.W. New Navy Ship Transmitting sets, tube and spark. Lot used 3 phase A.C. motors from 30 to 450 H.P. Write. Tell what you want, can get anything. Commercial or Navy radio. D. B. McGOWN, 1247 Forty-seventh Ave., San Francisco, Calif.

SUPERHETERODYNE (1927 model Best) neatly built to specifications; black crystalline aluminum panel; "Radio" Laboratory matched parts; new tubes; without audio stages. \$95, or in attractive walnut finish console \$120. With audio, filter, add \$20. Priced less than wholesale for quick sale. Particulars: Harold Reavis, 1373 Laveta Terrace, Los Angeles, Calif.

SELL: Magnavox Dynamic, Kolster Six, Citizen's Super Nine, Radiola's Eighteen and Twenty, Radiola hundred A Loudspeaker, Radiola 26 Portable Superheterodyne, Ithaca Trap Gun, Century Camera. BRACKENRIDGE, HARRISON, OHIO.

SET BUILDER SELLING OUT offers All Electric Super, Western Electric Intermediates, all electric screen grid 4. Many parts, sets, kits, meters. Sell at half regular prices. H. A. Newby, San Rafael, Calif.

GENUINE WESTERN ELECTRIC VT1 TUBES \$1.00; DeForest 201A tubes, \$1.00; General Electric G-10 standard base Neon lamps, as described in May QST, "Amateur Television." Sent C.O.D. Wm. Wagner, 819 DeKalb Ave., Brooklyn, N. Y. C.

MEN—BIG PAY. SOUTH AMERICAN work. Companies pay fare, expenses. South American Service Bureau, 14,600 Alma, Detroit, Mich.

MAKE MONEY WITH PATENTS! We offer patents with money-making possibilities; circular free. Floyd Clymer, Denver, Colo. (3T)

YOUR RADIO TROUBLES are over with Hoff's Radio Trouble Finder, Log and Station Book, also Dictionary, illustrated. Write for circular. John McQuade, 129 North Port St., Baltimore, Md. Desk 2. (7T)

WANTED—Two Complete Files of "RADIO" for 1927. Must be in perfect condition. Write, stating price. Box 400, "RADIO," Pacific Bldg., San Francisco.



Always the Best!

Citizens' Radio Call Book

Spring Edition

Radio's Greatest Publication

Latest circuits, world's largest station list, helpful hints for the fan, and a wealth of radio data for the listener, set builder, jobber, dealer and experimenter.

On Sale Everywhere

50c

Published by

CITIZENS' RADIO SERVICE BUREAU

508 South Dearborn Street
CHICAGO, ILL.

ANOTHER SPECIAL OFFER!

NEW *Automatic* KATHANODE
GOULD Radio "A" Power Unipower

The New and Improved Gould Kathanode Unipower type AC-6k (6 volt) Automatic "A" Power Unit with built-in relay. Throws the charger on and off and controls a "B" battery Eliminator if one is to be used.

Fundamentally different from any other automatic charging "A" power device on the market.

Its Kathanode construction insures longer life and is an exclusive patented feature being used



List Price, \$39.50

Extra Special **\$15.50**

by the U. S. Government in their submarine Batteries which are furnished by Gould. Its high capacity makes it especially adaptable to heavily worked or power tube sets.

Equipped with a noiseless Balkite Charging Unit, which has four graduated charging rates and in addition one booster rate (1½ amps.), which always keeps the battery fully charged.

Operates on 110-120 volt 60 cycle A.C.

AMERICAN SALES CO., 19-21 WARREN ST., NEW YORK CITY

Tell them you saw it in RADIO

I Will Train You at Home to Fill a Big-Pay Radio Job

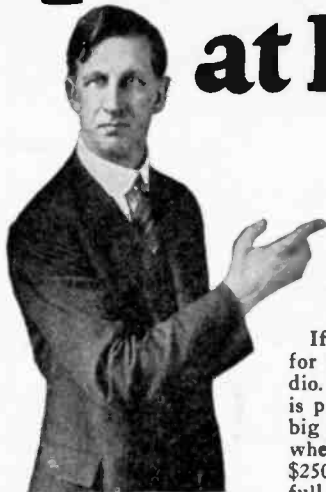

If you are earning a penny less than \$50 a week, send for my book of information on the opportunities in Radio. Its FREE. Clip the coupon NOW. A flood of gold is pouring into this new business, creating hundreds of big pay jobs. Why go along at \$25, \$30 or \$45 a week when the good jobs in Radio pay \$50, \$75 and up to \$250 a week. My book "Rich Rewards in Radio" gives full information on these big jobs and explains how you can quickly become a Radio Expert through my easy, practical home-study training.

Salaries of \$50 to \$250 a week not unusual

Get into this live-wire profession of quick success. Radio needs trained men. The amazing growth of the Radio business has astounded the world. In a few short years three hundred thousand jobs have been created. And the biggest growth of Radio is still to come. That's why salaries of 50 to \$250 a week are not unusual. Radio simply hasn't got nearly the number of thoroughly trained men it needs. Study Radio and after only a short time land yourself a REAL job with a REAL future.

You Can Learn Quickly and Easily in Spare Time

Hundreds of N.R.I. trained men are today making big money—holding down big jobs—in the Radio field. Men just like you—their only advantage is training. You, too, can become a Radio Expert just as they did by our new practical methods. Our tested, clear training makes it easy for you to learn. You can stay home, hold your job, and learn quickly in your spare time. Lack of education or experience is no drawback. You can read and write. That's enough.

Many Earn \$15, \$20, \$30 Weekly on the Side While Learning

My Radio course is the famous course "that pays for itself." I teach you to begin making money almost the day you enroll.

My new practical method makes this possible. I give you SIX BIG OUTFITS of Radio parts with my course. You are taught to build practically every type of receiving set known. M. E. Sullivan, 412 73rd Street, Brooklyn, N. Y., writes: "I made \$720 while studying." Earle Cummings, 18 Webster Street, Haverhill, Mass., "I made \$375 in one month." G. W. Page, 1807 21st Ave., Nashville, Tenn., "I picked up \$935 in my spare time while studying."

Your Money Back if Not Satisfied

I'll give you just the training you need to get into the Radio business. My course fits you for all lines—manufacturing, selling, servicing sets, in business for yourself, operating on board ship or in a broadcasting station—and many others. I back up my training with a signed agreement to refund every penny of your money if, after completion, you are not satisfied with the course I give you.

ACT NOW—64-page Book is FREE

Send for this big book of Radio information. It won't cost you a penny. It has put hundreds of fellows on the road to bigger pay and success. Get it. Investigate. See what Radio has to offer you, and how my Employment Department helps you get into Radio after you graduate. Clip or tear out the coupon and mail it RIGHT NOW.

J. E. SMITH, President,
Dept. 6-R,
National Radio Institute
Washington, D. C.



**You can build
100 circuits with
the six big outfits
of Radio parts
I give you**

**3 of the 100 you
can build**

**Find out quick
about this
practical way
to big pay**

Mail This FREE COUPON Today

J. E. SMITH, President,
Dept. 6-R, National Radio Institute,
Washington, D. C.
Dear Mr. Smith: Kindly send me your big book "Rich Rewards in Radio," giving information on the big-money opportunities in Radio and your practical method of teaching with six big outfits. I understand this book is free, and that this places me under no obligation whatever.

Name..... Age.....
Address.....
City..... State.....
Occupation.....

Here's the PROOF



Made \$185 in Three Weeks Spare Time
"I have met with continued success. For instance, recently I realized a profit of \$185 in three weeks, \$1.50 an hour. I have been making good money almost from the time I enrolled. The N. R. I. has put me on the solid road to success."—Peter J. Dunn, 901 N. Monroe St., Baltimore, Md.

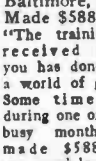

Made \$588 in One Month
"The training I received from you has done me a world of good. Some time ago during one of our busy months I made \$588. I am servicing all makes of Radio receiving sets. My boss is highly pleased with my work since I have been able to handle our entire output of sets here alone."—Herbert Reese, 2215 So. E St., Elwood, Indiana.



Earns Price of Course in One Week Spare Time
"I have been so busy with Radio work that I have not had time to study. The other week, in spare time, I earned enough to pay for my course. I have more work than I can do. Recently I made enough money in one month spare time to pay for a \$375 beautiful console all-electric Radio. When I enrolled I did not know the difference between a rheostat and a coil. Now I am making all kinds of money."—Earle Cummings, 18 Webster St., Haverhill, Mass.

Employment Service to all Graduates
Originators of Radio Home Study Training

GENERAL RADIO

TYPE 441 PUSH-PULL AMPLIFIER

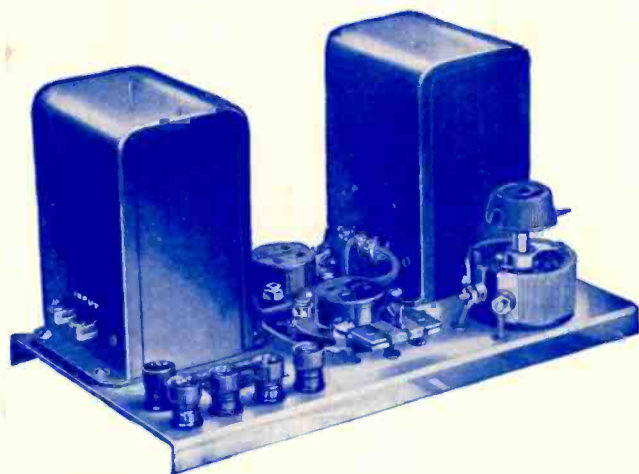

IN a search for an amplifier which would give the maximum in quality and volume, the push-pull method has proved particularly satisfactory. This type of amplifier in the last stage provides the speaker with ample power to faithfully reproduce the full frequency range that is now being broadcast without tube overloading.

A push-pull amplifier draws no alternating current from the plate supply, a fact of great importance if socket power is used, as the impedance of the power unit does not affect the amplifier. This results in improved reproduction of sustained notes, particularly of low frequency.

Other advantages of the push-pull system are, a reduction in hum when alternating current is used for filament supply and for equal power output, a reduction in the plate voltage required.

The Amplifier is supplied completely wired.

Type 441 Amplifier

For use with UX 226, CX 326, UX 171, CX 371, UX 210 or CX 310 tubes.

Input Inductance	30 henries
Input turns ratio.....	1:2.25
Output impedance ratio.....	12:1
(Whole primary to secondary)	
Price completely wired.....	\$20.00

Licensed by the Radio Corporation of America, for radio, amateur, experimental and broadcast reception only and under the terms of the R. C. A. license the unit may be sold only with tubes.

GENERAL RADIO Co.

If we can be of any assistance to you in supplying technical information we welcome your correspondence. Have you a copy of our latest bulletin No. 929 in your files?
If not a post-card will bring one.

30 State St., Cambridge, Mass.

274 Brannan St., San Francisco, Calif.

In the Finest Sets — *Faradon*

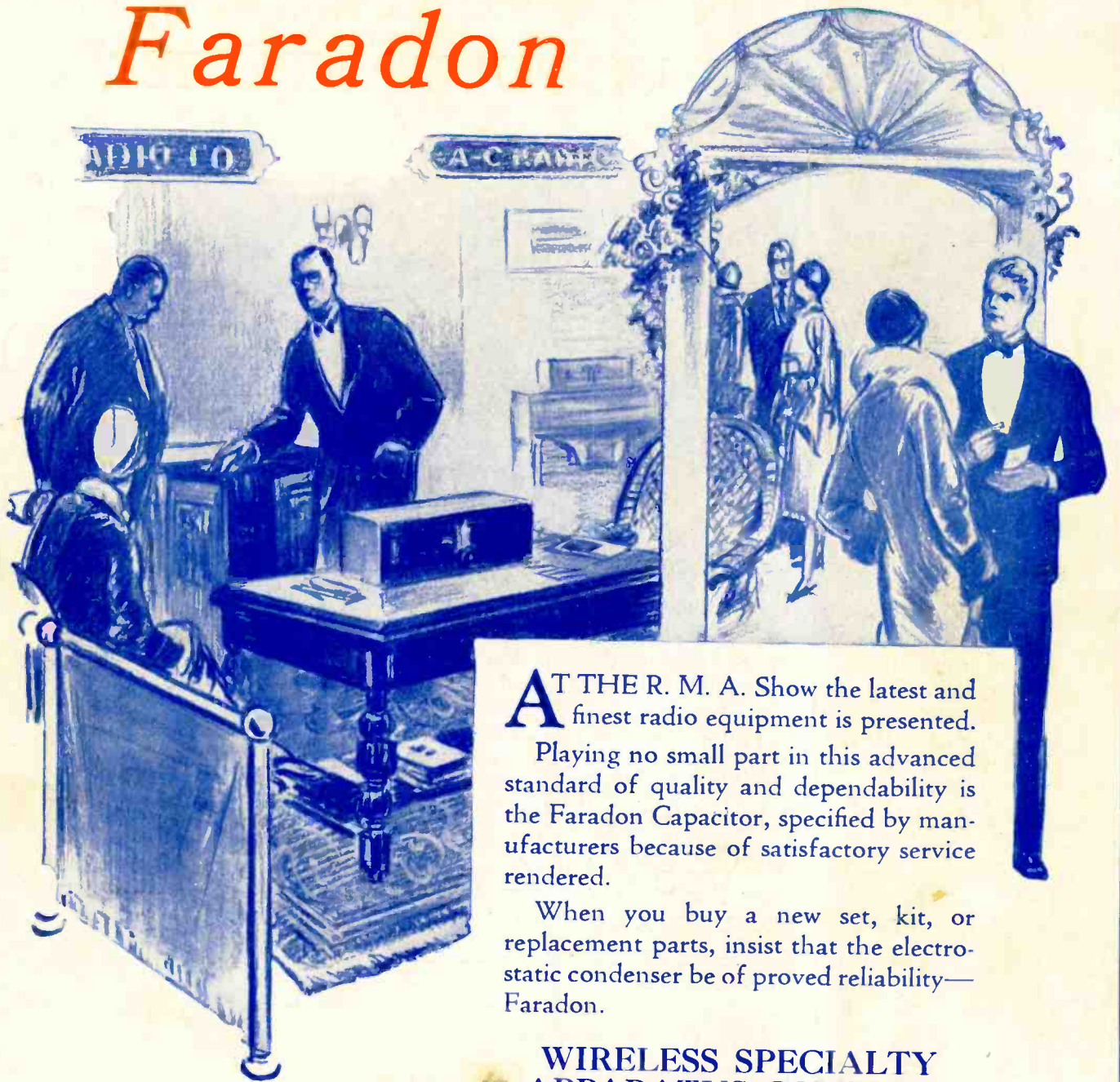

AT THE R. M. A. Show the latest and finest radio equipment is presented.

Playing no small part in this advanced standard of quality and dependability is the Faradon Capacitor, specified by manufacturers because of satisfactory service rendered.

When you buy a new set, kit, or replacement parts, insist that the electrostatic condenser be of proved reliability—Faradon.

**WIRELESS SPECIALTY
APPARATUS COMPANY**

Jamaica Plain, Boston, Mass., U. S. A.
Established 1907

Faradon

Electrostatic Condensers for All Purposes

1937

Press of
THE JAMES H. BARRY COMPANY
SAN FRANCISCO, U. S. A.