

NOVEMBER, 1927

25 CENTS

RADIO

(REG. U. S. PATENT OFF.)

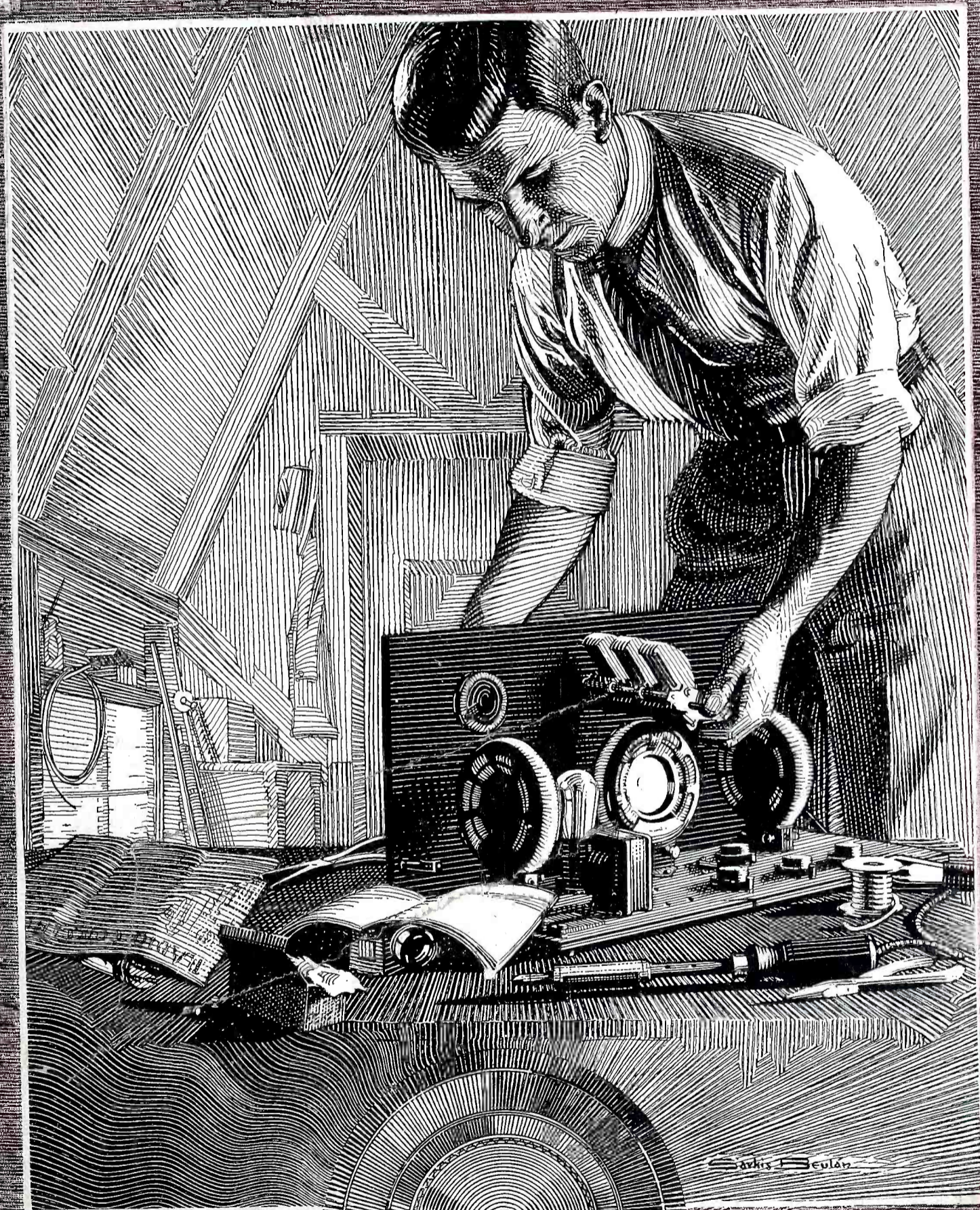

**IN THIS
ISSUE**

A. C. Operation of Magnaformer and Infradyne
A Tiny Superhet . . . A Heavy Duty Amplifier

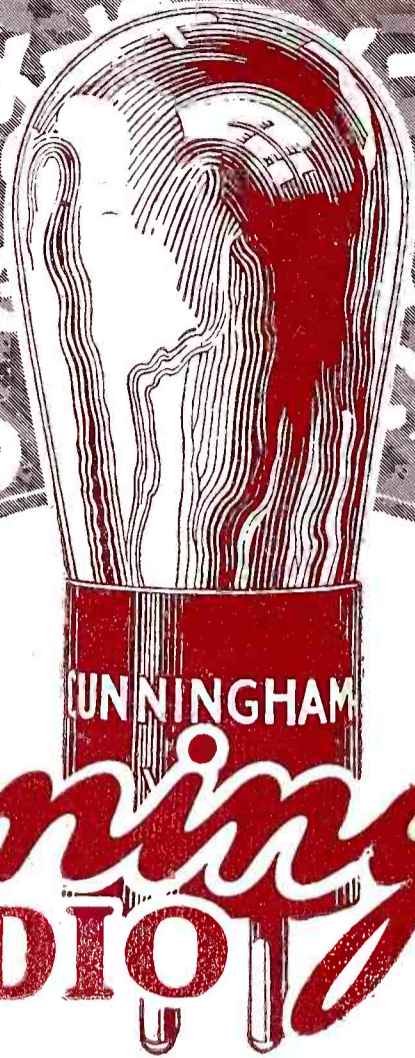

Cunningham RADIO TUBES

The Right Tube in the Right Socket

There are now twenty distinct types of Cunningham Radio Tubes each expressing the correct balance in design and specification to perform a definite function most efficiently in your radio. Your dealer will tell you the correct type your radio is designed to use. Equip throughout with Cunningham Radio Tubes. By so doing you insure maximum performance in your radio.

Twenty different types — all in the
Orange and Blue carton.

E. T. CUNNINGHAM, Inc.

NEW YORK CHICAGO SAN FRANCISCO

Since 1915 — Standard for all Sets

Silent Magic



Here is the Eveready Layerbilt "B" Battery No. 486, Eveready's longest-lasting provider of Battery Power.

TURN your radio dial, and presto! you turn your home into a theater, a concert hall, a lecture room, a cabaret, a church, or whatever you will. Turn the dial and your attentive ear does the rest. That is all there is to this magic of radio.

Or almost all. If a radio set is to work at its very best, attracting no attention to itself, creating for you the illusion that can be so convincing, you must pay a little attention to the kind of power you give it. There is but one direction, a simple one — use Battery Power. Only such power is

EVEREADY
Radio Batteries
—they last longer

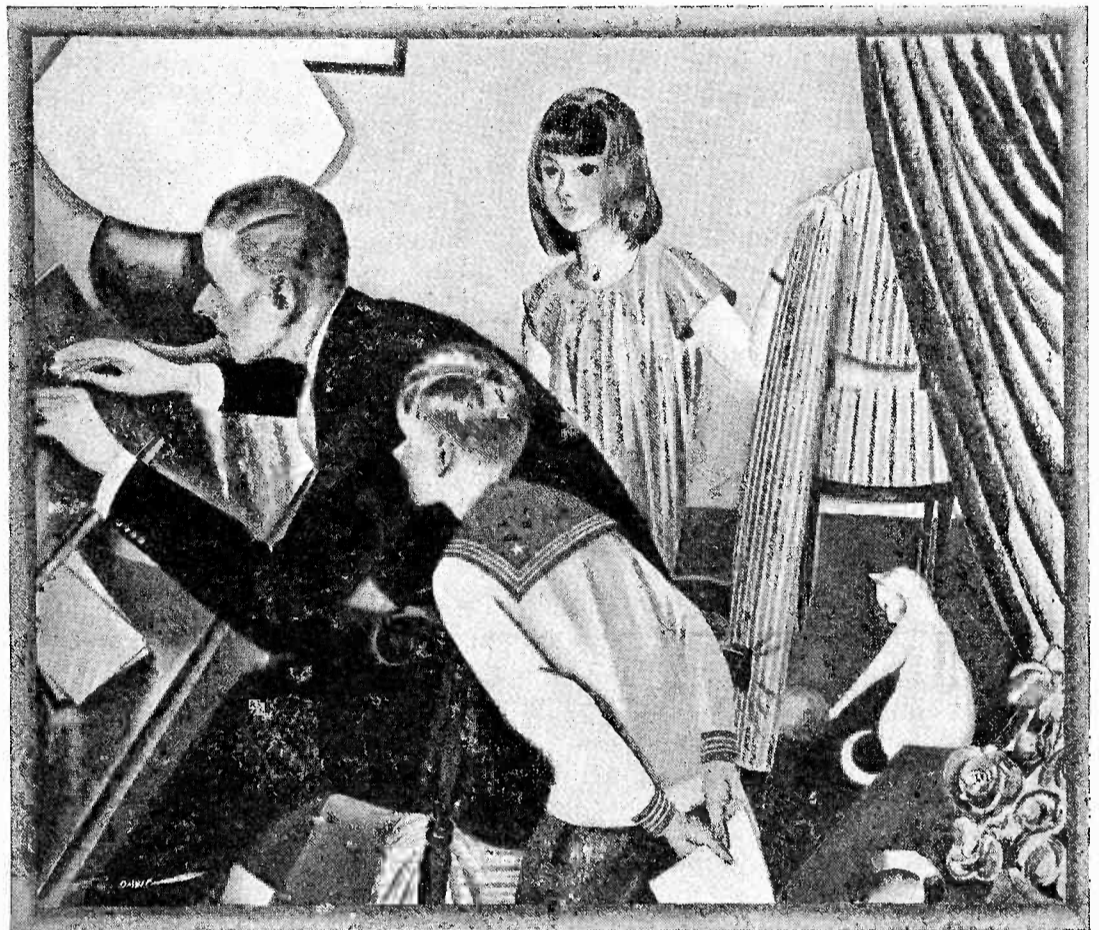

Radio is better with *Battery Power*

steady, uniform, silent. It is called by scientists pure Direct Current. Any other kind of current in your radio set may put a hum into the purest note of a flute, a scratch into the song of the greatest singer, a rattle into the voice of any orator.

Don't tamper with tone. Beware of interfering with illusion. Power that reveals its presence by its noise is like a magician's assistant who gives the trick away. Use batteries—use the Eveready Layerbilt "B" Battery

No. 486, the remarkable battery whose exclusive, patented construction makes it last longest. It offers you the gift of convenience, a gift that you will appreciate almost as much as you will cherish the perfection of reception that only Battery Power makes possible.

NATIONAL CARBON CO., INC.
New York  San Francisco
Unit of Union Carbide and Carbon Corporation

Tuesday night is Eveready Hour
Night—Pacific Coast Stations—
9 P. M., Pacific Standard Time

KPO-KGO—San Francisco
KFOA-KOMO—Seattle
KFI—Los Angeles
KGW—Portland

The air is full of things you shouldn't miss

Tell them that you saw it in RADIO

RADIO

With Which Is Incorporated "Radio Journal"
Established 1917

Published Monthly by the Pacific Radio Publishing Co.

ARTHUR H. HALLORAN,
Editor
GERALD M. BEST,
Technical Editor

H. W. DICKOW,
Business Manager
A. I. RIVETT,
Draughtsman

Branch Offices:

New York City, 20 East 42nd St.
Chicago, 307 N. Michigan Ave.
Boston, 86 St. Botolph St.
Kansas City, Mo., Davies & Dil-
lon, 707 Land Bank Bldg.

Rates:

Issued Monthly, 25c a copy.
Subscription price, \$2.50 per year
in the U. S., \$3.00 per year else-
where.

Correct Addresses:

Instructions for change of address
should be sent to the publisher
two weeks before the date they
are to go into effect. Each old
and new address must always be
given.

Advertising:

Advertising Forms Close on the
First of the Month Preceding
Date of Issue.

Member Radio Magazine Publishers' Association
Entered as second-class matter at Post Office at San Francisco, Calif.
Copyright 1927 by the Pacific Radio Publishing Co.

Address all communications to

Pacific Radio Publishing Company

Pacific Building, San Francisco, California

VOLUME IX

NOVEMBER, 1927

NUMBER 11

Forecast of Contents for December Issue

The main features of the big December issue of RADIO are several articles which give the details for building new and improved models of standard kit sets. These are fully illustrated from photographs and line drawings. The construction of any one of these will provide pleasant pastime for winter evenings and afford the owner many hours of good long distance reception.

Alan Donaldson has designed a resonant circuit for an r. f. amplifier, which in connection with a Phasatrol, gives amplification without oscillation on the higher wavelengths. He describes its application to a six-tube set.

Francis Churchill has devised a capacity-coupled r. f. receiver having two controls and seven tubes for use with a loop aerial. Full directions are given for its construction.

G. F. Lampkin discusses the old subject of wave traps in a new manner. His treatment is so complete, and yet withal so simple, that it leaves no excuse for any reader's suffering from broadcast station interference.

The practical use of reactance and susceptance curves is explained and illustrated by Gilbert W. Cattell. He employs a minimum of theory and a maximum of practice in his article.

Thos. A. Marshall tells how short-wave reception may be improved by care in aerial design and construction.

James Millen describes a new development in rectification of large currents at low voltages by means of the cartridge rectifier. The construction of this type is fully illustrated.

Samuel G. McMeen's article on the construction of a Thomson galvanometer, which was unavoidably omitted from this issue, is scheduled for December publication.

For the amateur operator Francis Churchill describes an interesting short-wave receiver for use on 20 and 40 meters and above. It may also be used for short-wave broadcast reception as it is a good r. f. amplifier and regenerative detector.

A. Binneweg Jr. gives the results of his successful experiments in transmitting on $\frac{3}{4}$ and 5 meters.

J. E. Smith presents some interesting notes on radio prospecting, illustrated by many diagrams.

Everett W. Thatcher concludes his article on "Fishing for Radio Waves" by presenting and interpreting the results of his experiments.

Harry R. Lubcke describes the equipment which he is using for automatic radio control through the medium of a standard receiver.

Next in B. F. McNamee's series of radio service articles is a complete exposition of the subject of tube testing.

The Christmas spirit is carried by Earle Ennis' bit of fiction—"The Kid was Steady." It is dedicated to Mickey Doran—to all the Mickey Dorans wherever found—the men of key and tuner, who sit through the long watches, with the lives of sleeping men and women in their hands, and never fail in their trust,—the unsung stickers who cling like burrs to their traditions.

CONTENTS

	PAGE
RADIOTORIAL COMMENT	17
<i>By Arthur H. Halloran</i>	
"FISHING" FOR RADIO WAVES	18
<i>By Everett W. Thatcher</i>	
THE CONSTANT GAIN RECEIVER	21
<i>By Francis Churchill</i>	
A HEAVY DUTY AMPLIFIER	23
<i>By G. M. Best</i>	
THE RADIO SERVICE SHOP	26
<i>By B. F. McNamee</i>	
THE GREY PHANTOM	27
<i>By Earle Ennis</i>	
A NEW SHIELDED GRID TUBE	28
<i>By W. James</i>	
ADAPTING THE MAGNAFORMER 9-8 FOR A. C. TUBES	29
<i>By D. B. McGown</i>	
HOW TO CHECK RESISTOR VALUES	30
<i>By Harry R. Lubcke</i>	
RECTIFIERS	31
<i>By G. F. Lampkin</i>	
A POWER AMPLIFIER FOR THE INFRADYNE	33
<i>By E. M. Sargent</i>	
LABORATORY NOTES ON THE TYRMAN TEN	34
A TINY SUPERHET	35
<i>By G. M. Best</i>	
SIMPLE CONSTRUCTION OF A 3-FT. CONE SPEAKER	39
<i>By W. H. Sinclair</i>	
LIMITATIONS OF DISTORTIONLESS AMPLIFICATION	40
<i>By Don Lippincott</i>	
QUERIES AND REPLIES	41
A SIX TUBE SHORT-WAVE RECEIVER	42
<i>By Frank Churchill</i>	
A CONSTANT FREQUENCY SHORT-WAVE TRANSMITTER	43
<i>By A. Binneweg, Jr.</i>	
THE COMMERCIAL BRASSPOUNDER	44
MARINE RADIO NOTES	45
<i>By L. O. Doran</i>	
FROM THE RADIO MANUFACTURERS	46

**30 Days
FREE
TRIAL
5 year
Guarantee**

MARWOOD

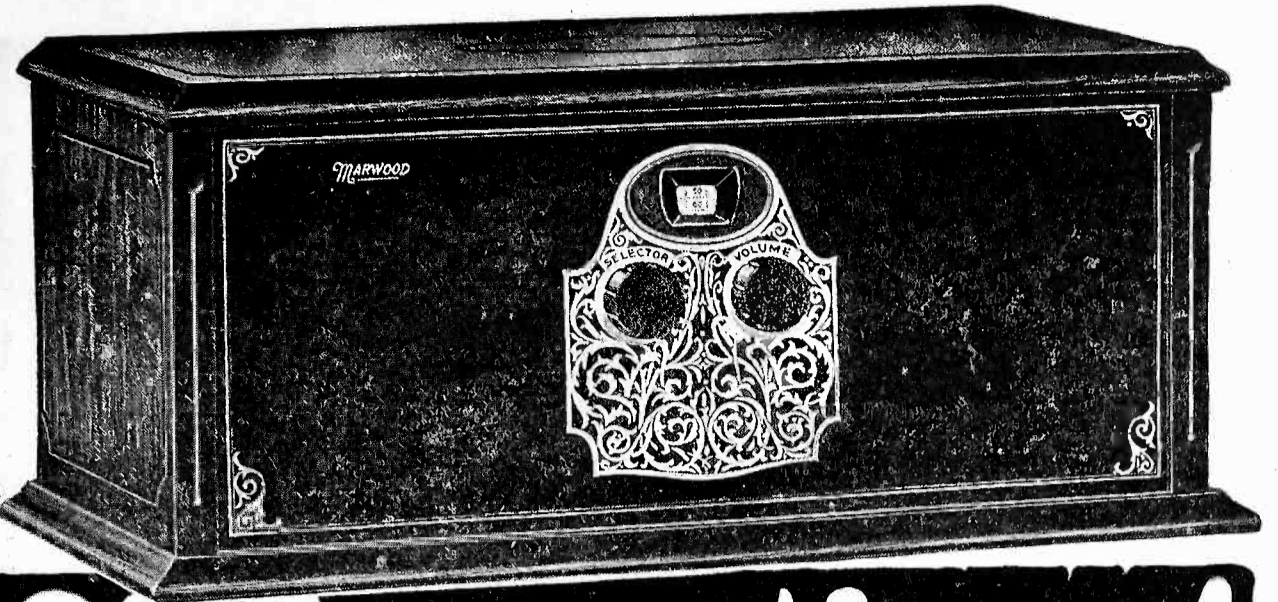

The 1928 Sensations! 8 Tube-1 Control

All Electric or Battery Operation

AGAIN Marwood is a year ahead—with the Radio sensation of 1928—at a low price that smashes Radio profiteering. Here's the sensation they're all talking about—the marvelous 8 Tube Single Control Marwood for BATTERY or ALL ELECTRIC operation. Direct from the factory for only \$69.00 retail price—a price far below that of smaller, less powerful Radios. Big discount to Agents from this price. You can't beat this wonderful new Marwood and you can't touch this low price. Why pay more for less quality? To prove that Marwood can't be beat we let you use it on 30 Days Free Trial in your own home. Test it in every way. Compare it with any Radio for tone, quality, volume, distance, selectivity, beauty. If you don't say that it is a wonder, return it to us. We take the risk.

New Exclusive Features

Do you want coast to coast with volume enough to fill a theatre? Do you want amazing distance that only super-power Radios like the Marwood 8 can get? Do you want ultra-selectivity to cut out interference? Then you must test this Marwood on 30 Days Free Trial. An amazing surprise awaits you. A flip of your finger makes it ultra-selective—or broad—just as you want it. Every Marwood is perfectly BALANCED—a real laboratory job. Its simple one drum control gets ALL the stations on the wave band with ease. A beautiful, guaranteed, super-efficient Radio in handsome walnut cabinets and consoles. A radio really worth double our low price.

Buy From Factory - Save 1/2

Why pay profits to several middlemen? A Marwood in any retail store would cost practically three times our low direct-from-the-factory price. Our policy is highest quality plus small profit and enormous sales. You get the benefit. Marwood is a pioneer, responsible Radio, with a good reputation to guard. We insist on the best—and we charge the least. If you want next year's improvements NOW—you must get a Marwood—the Radio that's a year ahead.

AGENTS

Make Big Spare-Time Money

Get your own Radio at wholesale price. It's easy to get orders for the Marwood from your friends and neighbors. Folks buy quick when they compare Marwood quality and low prices. We want local agents and dealers in each territory to handle the enormous business created by our national advertising. Make \$100 a week or more in spare time demonstrating at home. No experience or capital needed. We show you how. This is the biggest season in Radio history. Everybody wants a Radio. Get in now. Rush coupon for 30 Days Free Trial, beautiful Catalog, Agents' Confidential Prices and Agents' New Plan.

MARWOOD RADIO CORP.

5315 Ravenswood Avenue
Dept. B-1 Chicago, Ill.

Tell them that you saw it in RADIO

Only
\$69 RETAIL PRICE
Big Discount
to Agents
From This
Price

Get Our Discounts Before You Buy A Radio

Don't buy any Radio 'till you get our big discounts and catalog. Save half and get a Radio that IS a Radio. Try any Marwood on 30 Days Free Trial at our risk. Tune in coast to coast on loud speaker with enormous volume, clear as a bell. Let your wife and children operate it. Compare it with any Radio regardless of price. If you don't get the surprise of your life, return it. We take the risk. Don't let Marwood low prices lead you to believe Marwood is not the highest quality. We have smashed Radio prices. You save half.

6 Tubes—1 Control

This is the Marwood 6 Tube, 1 Control for BATTERY or ALL ELECTRIC operation. Gets coast to coast on loud speaker with great volume. Only \$47 retail. Big discounts to Agents. Comes in handsome walnut cabinets and consoles. This low price cannot be equalled by any other high grade 6 tube Radio. Has the volume of any 7 tube set. If you want a 6 tube Radio you can't beat a Marwood and you can't touch our low price.

**ALL
ELECTRIC
8 Tube
1 Control
\$98** RETAIL PRICE

Big Discount to Agents From this Price

Has Complete A-B Power Unit

A REAL ALL ELECTRIC Radio with one of the best A-B power units on the market—no batteries needed—at the world's lowest price. This Marwood can't be excelled at ANY price. If you have electricity in your home, just plug into the light socket and forget batteries. No more battery trouble and expense. Costs less than 2c a day to operate. Always have 100% volume. ALL ELECTRIC Radios are high priced because they are new. We cut profit to the bone and offer a \$250.00 outfit for \$98.00 retail price. Big discount to Agents. Don't buy any Radio 'till you get details of this sensational new ALL ELECTRIC Marwood.

\$47
Retail Price
Big Discount to
Agents from this
Price.

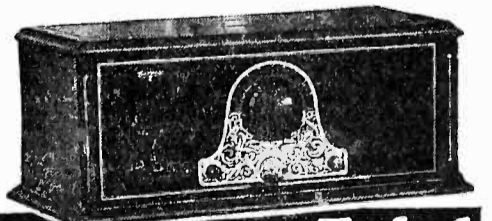

Rush for Free Trial

Marwood Radio Corporation
5315 Ravenswood Ave., Dept. B-1, Chicago, Ill.
Send Agents' Confidential Prices, 30 Days Free Trial, New Catalog and Agents' New Money Making Plan. No obligations on my part.

Name.....
St. or R.F.D.....
City.....State.....



Panels for Magnaformer and Other Kits

FORMICA is supplying handsomely decorated and drilled front and sub panels for the Magnaformer Circuit; also Tyrman front and sub panels, H. F. L. new hook-up, Karas new hook-up, World's Record Ten, Camfield Nine and Camfield Seven.

Other kits for which Formica panels are available are Madison-Moore, Melo-Heald, Victoreen, St. James and Infradyne.

These panels enable the home constructor to build a set equal in appearance and efficiency to the best manufactured receivers.

Sold by leading dealers and jobbers everywhere

The FORMICA INSULATION COMPANY
4616 Spring Grove Avenue Cincinnati, Ohio

Any parts-dealer or jobber can get Formica panels for you

FORMICA
Made from Anhydrous Bakelite Resins
SHEETS TUBES RODS

Formica has a Complete Service on Insulating Parts for the Radio Manufacturer.

Follow It!

ANOTHER story on the Magnaformer 9-8 circuit by Gerald Best in the December issue of "RADIO." You should subscribe now to insure yourself against missing a single issue of "RADIO." Get it for the next 6 months for only one dollar. That's a considerable saving. Use the coupon—attach a dollar bill, money order, check or stamps to it and get it on the way now—before you turn this page.

COUPON

"RADIO"
Pacific Building
San Francisco, Calif.

Here is \$1.00 for which you will send me the next 6 issues of "RADIO" starting with the December issue.

Name.....

Address.....

City & State.....

AEROVOX CONDENSERS are exclusively specified for the
Magnaformer
9-8 Circuit

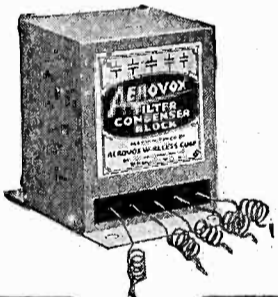

Eternal Life

We cannot guarantee eternal life, but we do guarantee the AEROVOX FILTER CONDENSER when properly used to outlast all the other equipment used in conjunction with it.

WHY???

Because—

each section of a block is individually sealed and impregnated against moisture absorption.

the safety factor used in manufacture, testing and rating will permit indefinite continuous operation at the rated working voltage without injury.

For all eliminators:

AEROVOX
"Built Better"
70 Washington St., Brooklyn, N. Y.

BENJAMIN
TRADE MARK

Cle-Ra-Tone Sockets and Brackets

are specified for the

Magnaformer 9-8 Circuit

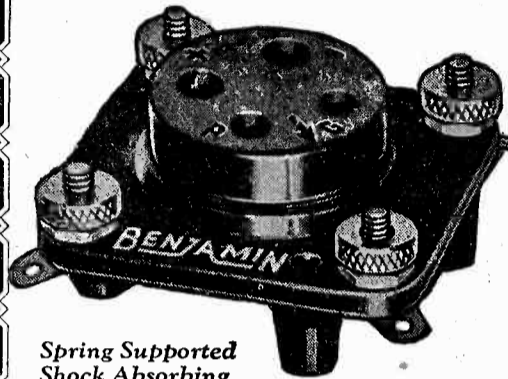

Spring Supported Shock Absorbing

USED the world over by set builders who know and want the best.

Stop tube noises. Anti-microphonic. The greatest contribution to the non-noisy operation of the set.

Tube "floats" on finely tempered springs. One-piece terminal to tube connection. Knurled nuts for binding post connections or handy lugs for soldering.

The choice for practically every prominent circuit for several years. Among the most recent hook-ups for which it has been specified are:

- Magnaformer 9-8
- Camfield Super-Selective 9
- Lynch Suppressor Circuit
- H.F.L. Nine-in-Line
- World's Record Super 10
- Strobodine 8
- Melo Heald Fourteen
- St. James Super
- Two-Dial Equamatic

Benjamin Shelf Bracket

An aid to simplification in set construction. Support sub-panel, with room underneath for accessories and wiring. Plain and adjustable.

At all Radio Jobbers and Dealers

Made by

Benjamin Electric Mfg. Co.

120-128 S. Sangamon St., Chicago

247 W. 17th St.
New York

448 Bryant St.
San Francisco

Manufactured in Canada by the Benjamin Electric Mfg. Co. of Canada, Ltd., Toronto, Ontario

Tell them that you saw it in RADIO

FERRANTI

**FERRANTI A. F. 4
TRANSFORMERS**

*exclusively specified
for the Magnaformer
9-8 Circuit*



T *TRUE Musical Reception*

... whether you build or buy your set!

That is your ideal, your goal in radio—true musical reception! Ferranti audio frequency transformers will give it to you, for they amplify every note faithfully, giving it the exact *tone* of the original. Even the elusive deep bass and quavering treble notes are caught and rendered exactly as they are—a transformer can do no more. Plenty of volume, too, and yet the amplified sound is always rich, mellow.

Whether you build your set from component parts or buy your set complete, make sure that Ferranti transformers are included in it. The part that they play in quality reception is so large, so important, that it is wise to use them if you want results.

**Audio Frequency Transformer
TYPE AF-3 \$12.00**

A new and better standard for 1928 in audio frequency amplification. Confidently recommended to all who wish the best in rich tone quality over the entire broadcast range.

Ratio 3½ to 1 Dimensions 2¼" x 3" x 3¾"
Weight . . . 1 lb 14 oz.

**Audio Frequency Transformer
TYPE AF-4 \$8.50**

A Transformer giving exceptionally uniform amplification at a moderate price. All types tested to 1000 volts between windings and between windings and ground.

Ratio 3½ to 1 Dimensions 2¼" x 3" x 3¾"
Weight . . . 1 lb. 8 oz.

**Output Transformer
TYPE OP-1, \$10.00**

The finishing touch of the modern radio set. Will purify and improve the tone of your speaker. Prevents possible accidents from shock and burnouts by eliminating D. C. and high plate voltage at speaker.

Ratio 1 to 1 Dimensions 2¾" x 3" x 3¾"
Weight . . . 2 lbs. 10 oz.

FERRANTI Ltd.
Hollinwood, England

FERRANTI Incorporated
130 West 42nd Street, New York, N. Y.

FERRANTI ELECTRIC Ltd.
Toronto, Ontario, Canada

Tell them that you saw it in RADIO

Want More Money?

You Can Increase Your Earning Power
by Learning More About Radio

If you're making a penny less than \$50 a week, you're not getting what you ought to get out of Radio.

Thoroughly-trained men — men whose knowledge of Radio is completely rounded out on every point — earn all the way up to \$250 a week.

Radio is a new industry with plenty of fine positions unfilled. There are countless opportunities in Radio for a man to earn a splendid salary. But these are not opportunities as far as you are concerned, unless you're fully qualified for them.

The only way to qualify is through knowledge — training — practical, complete training, that fits you to get and to hold a better position in the Radio field.

See If This Free Book Can Do You Any Good

I publish a 64-page book, printed in two colors and filled with facts and photos relative to Radio and its opportunities.

I don't say this book will help you, but it **does help** such a large percentage of those who read it that I can afford to send it to all who ask for it — free. You may get only a single idea out of this book that will be of any value to you. Or every line of it may give you a message.

**A message to men now
in the Radio business.
And another to men who
would like to be in.**

I have helped all sorts of men to advance themselves in Radio.

Lots of them, men who knew absolutely nothing about Radio when they first wrote me. Some who didn't know the difference between an ampere and a battle-axe.

Others, graduate electrical engineers who wanted special work in Radio. Licensed sea operators who were way behind on the "BCL stuff." "Hams" by the score.

Last but not least, the service and repairman or salesman who wanted to advance or go into the Radio Business on his own. And the man already in on his own, who wanted to look forward to a more solid and permanent Radio future.

My Free Book—see coupon below—tells about my helpful methods, and cites the experiences of a hundred men—giving photos and addresses.

At any rate, fill in the coupon below and look it over. It costs you nothing but a two-cent stamp, and you place yourself under no obligation. I won't even send a salesman to call on you.

And there's always a chance that that two-cent stamp may make quite a difference in your future.

What My Radio Training Is

Under my practical system, a man can study at home in his spare minutes, and get a thorough, clear, practical and expert knowledge of Radio in from 4 to 12 months. The time required depends on his previous knowledge, his ability, and the time he can spare for study. He keeps right on with the job he has — no necessity for his leaving home or living on expense.

Then as soon as he's ready for a better position I'll help him to get it and to make a success of his work.

This proposition is open to anybody who is not satisfied with his job, his prospects, or his Radio knowledge. Regardless of how much you know already (or if you don't know the first thing about Radio technically) I'll fit my methods to suit your needs.

If you want to enter into any correspondence about your own situation, anything you write will come directly, to me and will be held strictly confidential.

Tear the coupon off now before you turn the page, and mail it today.

J. E. Smith, President

NATIONAL RADIO INSTITUTE
Washington, D. C.

Oldest and Largest
Radio Home-Study
School In the World

Originators of
Radio Home-Study
Training

J. E. SMITH, President,
National Radio Institute,
Dept. GB-55, Washington, D. C.

Please send me your free book about the bigger opportunities awaiting the thoroughly trained Radio man. At present I (am) (am not) in the Radio business.

Name.....

Address.....

Town..... State.....

Tell them that you saw it in RADIO



Total Price Only
\$14⁹⁵ *On Easy Payments*

Radio Cabinet and Bench

\$1.00
down

Only \$1.00 with coupon below brings this handsome, massive, pure Period design console radio cabinet, with bench to match, to your home on 30 days

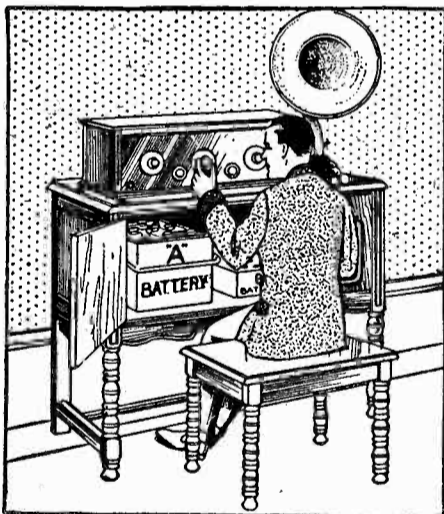

FREE Catalog
of home furnishings sent with or without order. See coupon.

Free Trial!

Just the thing you need to give your radio the appearance of a costly set and to beautify the room with a touch of elegance. Ample space inside of cabinet for all batteries, chargers and eliminators. Keep all unsightly accessories out of sight in this splendid piece of furniture. Made of well seasoned, selected hardwood in **Handsome Walnut Finish**. Two large, French style swinging doors at front with ornamental brass knobs. Front panels of doors in carved panel effects and legs of both cabinet and bench are neatly turned. Edge of top neatly bevelled. Cabinet has lower cross brace to insure rigidity. Top is 33 $\frac{3}{4}$ x 18 inches, height inside 11 $\frac{1}{2}$ inches. Full height 33 inches. Bench is 18 inches high.

\$1⁵⁰ a Month

After 30 days trial if not satisfied, send Cabinet and bench back at our expense and we'll refund your \$1.00 plus all transportation charges you paid. Or keep them and pay only \$1.50 a month till you've paid our smashed cut price for this sale - only **\$14.95**. Our credit price beats cash prices anywhere. Order by No. B182A. Shpg. wgt. about 70 lbs.

Send Coupon NOW!

Straus & Schram Dept. R3488 **Chicago**

Straus & Schram, Dept. #3488 Chicago
 Enclosed find \$1. Ship Walnut Finish Radio Cabinet and Bench. I am to have 30 days free trial. If I keep the cabinet and bench I will pay you \$1.50 monthly. If not satisfied, I am to return them at your expense and you are to refund my money and any freight or express charges I paid.
 Radio Cabinet and Bench No. B182A, \$14.95
 Name.....
 Street, R.F.D. or Box No.....
 Shipping Point.....
 Post Office..... State.....
 Married or Single..... Nationality or Color.....
 If you want only our free catalog of home furnishings, mark X here

Tell them that you saw it in RADIO



Now Demanded

by Experts!

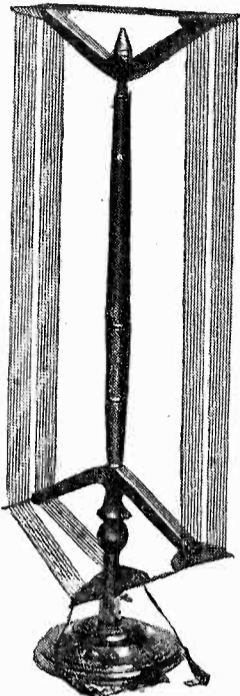

Radio Engineers and Technical Editors accept Quali-Tone Loops as the ultimate in effecting highest efficiency in radio reception.

Convince yourself of Quali-Tone's superiority by comparing it with any other loop made.

Allow your set to do full justice to itself by using a Quali-Tone Loop.

Holds Two World Records for DX Reception

UNEXCELLED FOR DISTANCE-SELECTIVITY-TONE

The electrical characteristics of Quali-Tone Loops meet the demand of present day successful loop antenna receivers—resulting in Quali-Tone Loops being highly endorsed and specified as standard equipment with the better circuits.

The De Luxe \$12.50
The Quali-Tone 10.00

Jobbers Dealers

The Quali-Tone Loop is not an experiment. For two years it has been the fastest selling loop on the market—due entirely to its exceptional merit and the improved results it guarantees. Order today or write for circulars.

DURO METAL PRODUCTS CO.
2653 N. Kildare Avenue, Chicago

Magnaformer Receivers Serviced and Balanced

To get the most out of the powerful Magnaformer receiver let us accurately balance and peak the transformers and match the entire set for you. Ship the parts to us or let us purchase them for you. The Magnaformer will give remarkable results. Take precautions to have everything matched for 100% results. We will do the matching for you for only \$2.50 if the transformers are sent to us.

D. B. McGOWN
435 Pacific Building
San Francisco California

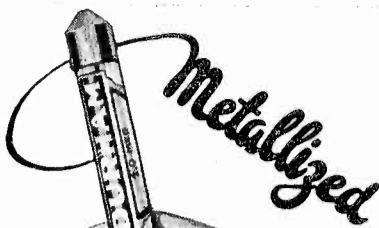

Durham Leadership

The Original Metallized Resistor—Adopted by leading Set Manufacturers—Endorsed by Foremost Engineers—Are Sold by Reputable Dealers!

DURHAM Resistors and Powerohms have won their position of leadership because they have never failed to deserve the recognition of radio leaders who appreciate flawless accuracy and utmost dependability.

Ever since their first appearance, years ago, manufacturers, engineers, professional builders and radio fans have adopted Durhams in steady progression. Today Durhams are in use wherever fine results are a foremost consideration.

If you are not using Durhams now, an experiment with replacements may prove why they are the accepted leaders in their field.



Durham standard resistors are made in ranges from 500 ohms to 10 megohms. Durham Powerohms for "B" Eliminators and Amplifier circuits are made in 2.5 watt and 5 watt sizes in ranges from 500 to 100,000 ohms.

DURHAM
METALLIZED
RESISTORS & POWEROHMS

International Resistance Company
Dept. M, 2½ So. 20th St., Phila.

YAXLEY

APPROVED RADIO PRODUCTS

Automatic Power Control

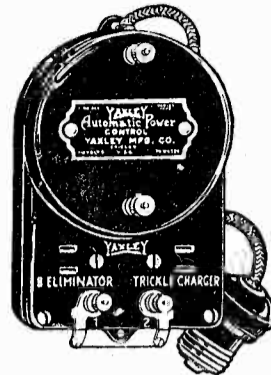

Here is a great radio convenience that makes a power operated receiver of your set. It controls the switching of both B eliminator and trickle charger in combination or switches either eliminator or charger separately when either is installed alone.

No. 444—Series Type. With the exclusively Yaxley feature that keeps the voltage drop less than two-tenths (2-10) volts when used with sets having a current draw equivalent to four 199 type tubes up to eleven 201 type tubes \$5.00

Yaxley Approved Radio Products

are specified in most of the leading circuits. Among others of recent design are:

Magnaformer
Constant Gain Receiver
Camfield Super Selective 10
Melo-Heald
Infradyne Socket Power

At your dealers. If he cannot supply you send his name with your order to

Direct Representatives

HENGER-SELTZER CO.

711 E. 14th St. Los Angeles
377 Brannan St. San Francisco

DON H. BURCHAM

1553 E. Everett St. Portland

Keep a Record of Your Magnaformer Log

The publishers of "RADIO" have a complete station Log Book ready for you. It gives all station listings—spaces for logging all stations received—kilocycle and wave bands, locations of stations and 32 pages of valuable data. It's yours for only 25 cents, postpaid. Stamps accepted.

RADIO, Pacific Bldg., San Francisco

Magnaformer 9-8

Complete kits in stock
No substitutions

\$139.99

LC-28 Kits \$90.50
LC-27 Kits 85.20

Dealers and Professional Set Builders write for discounts

Sets wired to order at nominal charges
Transportation charges prepaid on retail sales when full remittance is received with order.

RADIO SERVICE CO.

P. O. Box 144 Knoxville, Iowa

Tell them that you saw it in RADIO

SIXTEEN REMLER REASONS WHY!

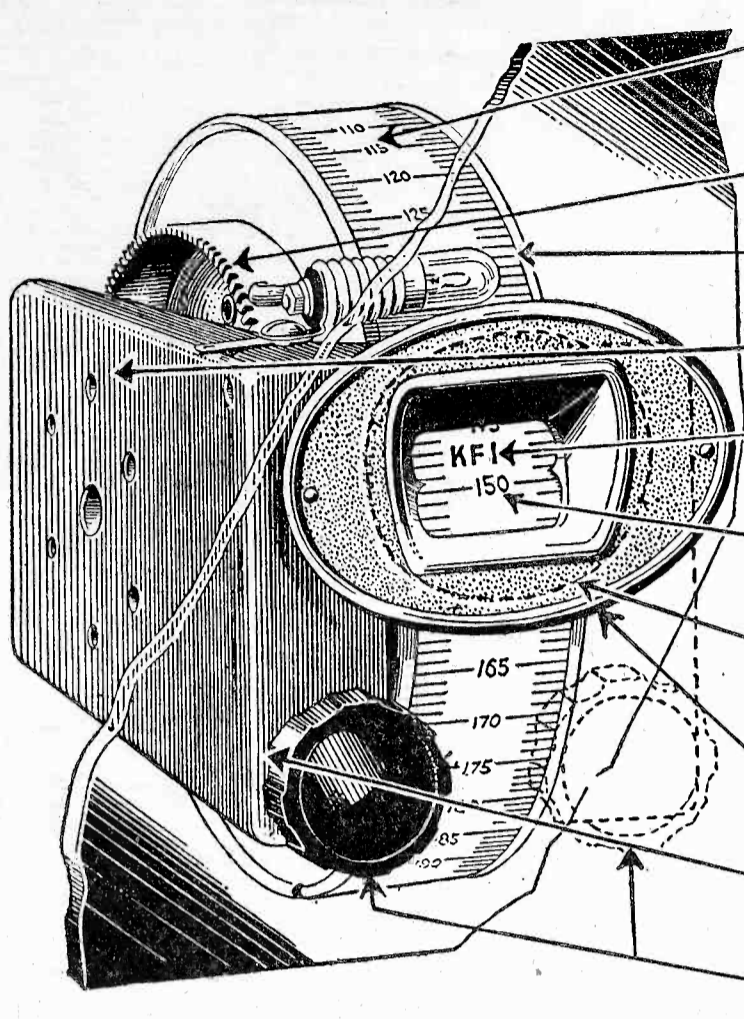

- 1 Readily changeable, white cardboard indicator strips. Supplied for clock-wise or counter-clock-wise reading.
- 2 Large, easily read figures.
- 3 Space provided for call letters.
- 4 Attractive bronze escutcheon plate.
- 5 Station Settings spread over 15 inches of space.
- 6 Heavy brass bracket supports condenser; rigid construction.
- 7 No back lash. Fine-tooth gear driven by spiral-cut pinion.
- 8 Vernier control; Special shaft cannot bind in bushing.
- 9 Round hole for escutcheon plate; no special tools necessary.
- 10 Right or left hand control.

REMLER *Drum* DIAL

Exclusively specified in the
Magnaformer 9.8 Circuit
—and many others—

- 1 360° rotation of shaft and reduction drive give vernier control.
- 2 Proper placing of insulating material minimizes resistance to radio frequency currents.
- 3 Complete insulation of plates from dial and dial shaft and provision for grounding dial and shaft give absolute freedom from body capacity effects.
- 4 Plates carefully aligned by hand and soldered rigidly in position at three points.
- 5 Balanced Twin-Rotor construction gives utmost smoothness of operation.
- 6 Shape of plates permits attainment of very low minimum capacity and wide tuning range.

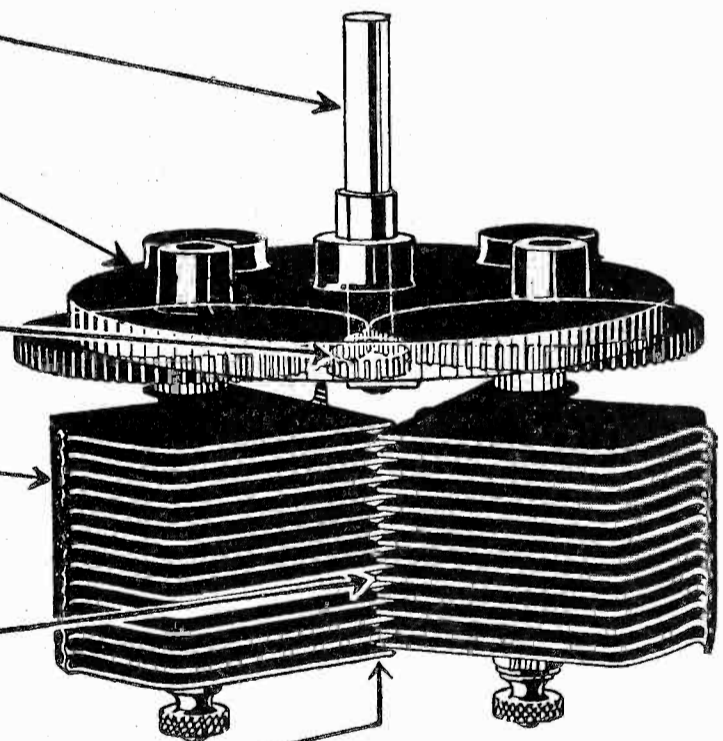

REMLER *Twin-Rotor* CONDENSER

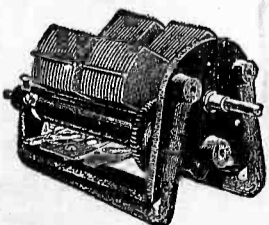

REMLER Gang CONDENSERS—both 2-in-line and 3-in-line—incorporate all the advantages of the Twin-Rotor Condenser. No common rotor. Balancing condensers provided.

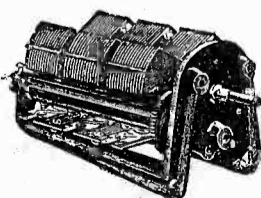

REMLER
DIVISION OF
GRAY & DANIELSON MANUFACTURING CO.
260 FIRST ST., SAN FRANCISCO
CHICAGO NEW YORK
EASTERN WAREHOUSE, ELKHART, INDIANA

NINE YEARS *of* RADIO EXPERIENCE

Tell them that you saw it in RADIO



Both
for
\$2.50
RADIO
and

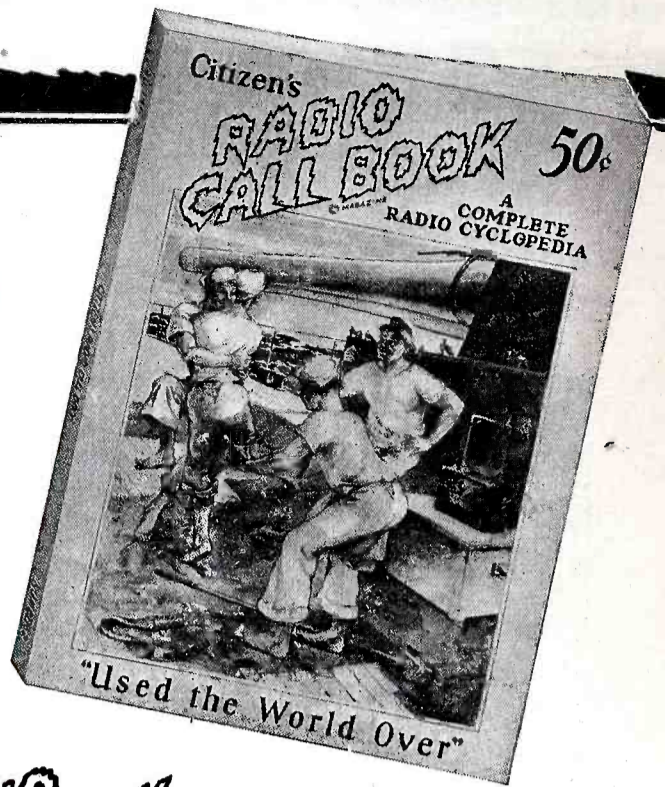

**The BIGGEST Offer
 EVER MADE**

ARRANGEMENTS have been completed between the publishers of "RADIO" and the publishers of "Citizens Radio Call Book" whereby you can now get both of these magazines for exactly the price of one.

EVERY phase of radio is covered in these two leading radio publications—reading material on everything known in radio—"Citizens Radio Call Book" contains a wealth of live radio information, with the most complete up-to-date list of all broadcasting stations, showing schedules, wave lengths, etc., 150 pictures of radio celebrities, and helpful hints for operation and maintenance of receivers. Complete construction articles on all popular circuits and on receivers of unusual merit.

"CITIZENS RADIO CALL BOOK" is entering its seventh successful year.

"RADIO" is one of the oldest radio magazines published and is noted for its well edited, practical and authentic articles devoted to the interests of the radio fan, radio constructor, experimenter and amateur. "RADIO" has been published for eleven years.

**Citizen's
 RADIO
 CALL BOOK**

**16 copies a year
 less than 16¢ a copy -
 Effective Immediately**

THE new November copy of the "Citizens Radio Call Book" and the December issue of "RADIO" will be mailed to you November 21st, provided you fill out and send in the coupon with \$2.50 before this date. Don't fail to send your subscription early so that it can start with the next issue.

"RADIO" is published monthly and will be sent to you for twelve months. "Citizens Radio Call Book" is published four times a year—September, November, January and March. All four issues are included in this joint money-saving subscription offer.

IF you are a present subscriber to "RADIO" or "Citizens Radio Call Book" you can still take advantage of this cut rate price. We will extend your subscription for one year.

IF you bought both of these magazines from a news dealer, you would pay \$5.00 a year. Save \$2.50—exactly half—by subscribing now to BOTH magazines for the price of one. The regular yearly subscription price on "RADIO" is \$2.50 and "Citizens Radio Call Book" \$2.00. You even save \$2.00 on the regular subscription price.

WE advise you to fill in the coupon now and send immediately.

"RADIO"
 PACIFIC BUILDING
 SAN FRANCISCO, CAL.

Here is my \$2.50 for the combination subscription to "RADIO" and "Citizens Radio Call Book" for one full year as advertised in your November issue.

Name.....

Address.....

**SAVE
 \$2.50 by using
 this coupon**

BUILD A SHIP MODEL LOUD SPEAKER

\$12.50

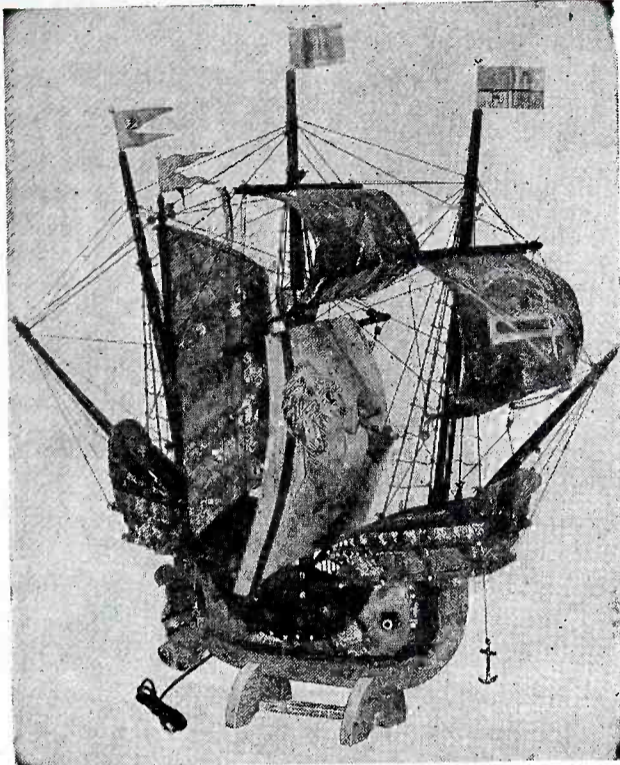

\$12.50

A combination of a beautiful ship model and a loud speaker that is easily worth \$100. You can build it yourself in a few spare hours with no other tool than a small tack hammer.

Size: 26 inches high; 12 inches wide; 27 inches long (overall). The La Pinta, a reproduction of one of the famous Fifteenth Century ships.

The famous Melody Ship which has met with instant approval everywhere it has been shown and played can now be purchased in knock down form at the startlingly low price of \$12.50. This remarkable speaker combines

PERFECT TONE -- PLENTY OF VOLUME -- NO DISTORTION

No doubt you have often admired ship models and yearned to possess one but could not do so because the price was too high. Now it is possible to own a beautiful ship model and loudspeaker combined at a small cost. Let the **WORLD'S LARGEST BUILDERS OF SHIP MODELS AND SHIP MODEL LOUD SPEAKERS** supply you with all the necessary parts, cut to fit and ready to assemble from which you can build a beautiful model of the historic Mayflower, the Santa Maria or the La Pinta in a few hours. To all outward appearances the completed model is a beautiful ship model but upon closer observation a loudspeaker can be seen cleverly incorporated into the mainsail.

The loud speaker unit is of the Electro Magnet type. Power amplification is not needed to force the low tones through. They come through with perfect ease and do not interfere with the high notes, giving faithful reproduction at all frequencies. The mainmast, upon which the unit is securely fastened is seated two inches deep in a three and a half pound solid wood hull, making it impossible for counter vibrations to affect the perfect reproduction of the Melody Sail. The driving pin is attached to our super-vibrating, especially prepared, Melody Sail. The installation of the Melody Sail does not change the appearance of the model in any way. Melody ships come in three beautiful models, the Mayflower, the Santa Maria and the La Pinta, with parts cut to fit and ready to assemble. No tool needed but a small hammer.

You need not know anything about ship building or carpenter work in order to build one of these ships. No special knowledge of ship model building is necessary either. We will supply all the parts from the hull down to the smallest piece of rigging, all cut to fit and ready to

MINIATURE SHIP MODELS, Inc.
3818-20-22-24 Baring St., Philadelphia, Pa.

Canadian Branch: 1485 Bleury St., Montreal, Canada
Canadian Prices Slightly Higher. Send all Canadian Orders to Canadian Office.

assemble You cannot go wrong. Diagrams and plans of parts that are included with each kit tell exactly what to do with each part.

These plans show you step by step just how the model is constructed. Everything is made so simple that even a small child can build a beautiful model.

All you need is a small hammer to tap the parts into place. Here is a part of the instructions copied word for word from the diagram and instruction sheet that goes with the kits. "Take part No. 57 place it in front end of part No. 56 and tap lightly with a hammer. Next take part No. 58 and place it up against No. 57 and tap it with a hammer to bring it into place."

Easy! Nothing simpler. The instructions are like that from beginning to end. Do this and that and before you realize it a beautiful ship model has grown before your eyes.

Write for our free beautifully illustrated catalog which contains photographs of all our models together with complete details and price of each. We will send this catalog without obligation to you. Fill in the coupon below and we will act upon it immediately.

If, after assembling the model according to our instructions you do not think it worth many times the purchase price, return it to us in good condition and we will gladly refund your money.

MINIATURE SHIP MODELS, Inc., DEPT. ½
3818-20-22-24 Baring St., Phila., Pa.

Please send me complete parts, cut to fit and ready to assemble for the Melody Ship.....for which I agree to pay postman \$12.50, plus postage.

PLEASE PRINT NAME AND ADDRESS PLAINLY.

Name.....
Street or R. F. D.....
City.....
State.....

Tell them that you saw it in RADIO

Now-Build The TYRMAN TEN

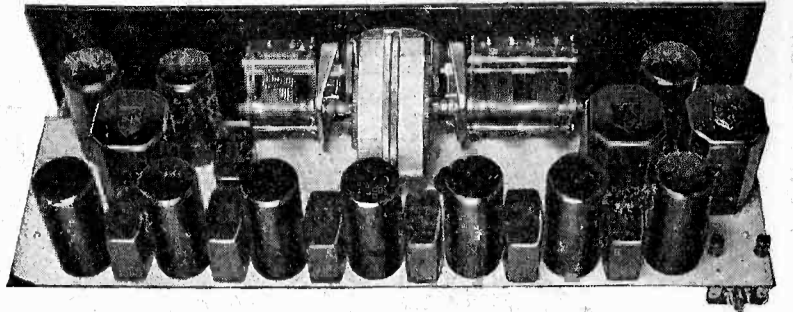

Radio's Most Powerful Coast-to-Coast Receiver

One of America's Foremost Radio Laboratories Says this of the "TYRMAN TEN"

ONE SPOT

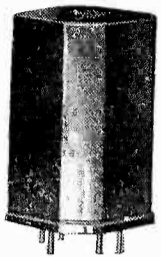

Audio Transformer



Shielded Socket

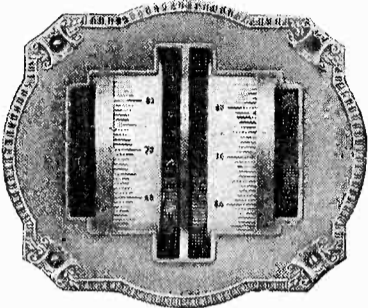

Double Vernier Drum

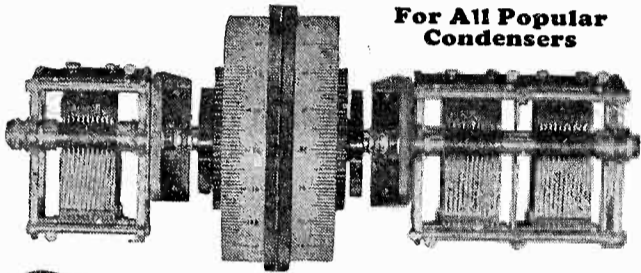

For All Popular Condensers

"Selective without critical operation. (We can separate WTAM, a powerful station here, from Shreveport, La. KWKH, 5.3 meters away on one side, and WCCO, 5.4 meters away on the other side, clean and absolutely.)"

"Is as certain a distance getter as any set we ever built. (We got KFI within 30 minutes after building our

first Tyrman, on next to the hottest morning of this summer.)"

"It has the most beautiful tone of any set we ever built. Practically free from any 'under' noises."

"It is the most beautifully engineered inside, and the best looking outside of any receiver we ever built."

"It has absolutely no harmonics, is a real ONE SPOT. Is easy to build. Seems to absorb a large part of the so-called static—we have used it during weather when even a loop set could not be operated because of static, and it was more above the noise level than any circuit we ever built, either loop or antenna operated."

MAIL THIS COUPON TODAY

2 ounces of interesting Radio Literature FREE to Set Builders.

TYRMAN ELECTRIC CORP.
141-143 W. Austin Avenue
Chicago, Illinois

Kindly send me your 2 ounces of interesting Radio Literature. This, of course, is FREE.

Name.....

Address.....

TYRMAN **LABORATORY TESTED** **PRODUCTS**

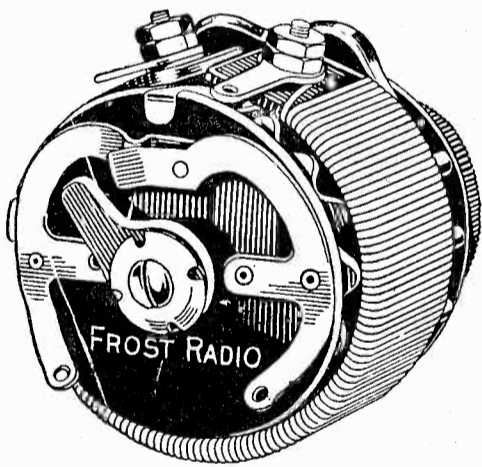

FROST-RADIO

Magnaformer Exclusively Specifies FROST-RADIO

In the powerful and popular Magnaformer Circuit Frost-Radio De Luxe Parts are EXCLUSIVELY SPECIFIED. They help to make the Magnaformer the wonderfully successful receiver that it is.

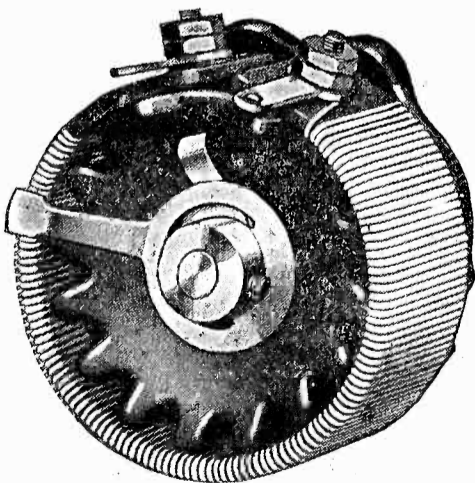

Not only are Frost Parts used in the Magnaformer, "The Commander-in-Chief of the Air," but these well known parts are to be found in such other well known sets as Camfield Super-Selective 9, Bodine A-C 6, Melo-Heald 14, Infradyne, etc. The reason for their selection was FROST QUALITY.

FROST-RADIO Used In the Popular MAGNAFORMER

- 1 No. 1810 De Luxe 10-ohm Rheostat
- 1 No. S-1810 De Luxe 10-ohm Rheostat with switch
- 1 No. 1830 De Luxe 30-ohm Rheostat
- 1 No. 1824 De Luxe 400-ohm Potentiometer
- 4 No. 253 Cord Tip Jacks

The new Frost De Luxe Parts are made to a standard higher than ever before achieved in radio. They have a finish that makes any set look better, and a quality that makes it work better. Be sure to insist on Frost-Radio. Order these parts from your dealer by name. He can supply you promptly from stock.

HERBERT H. FROST, INC.

New York

Main Office and Factory:
ELKHART, IND.

Chicago



Tell them that you saw it in RADIO

When the ball goes 'round the end for 40 yds.

"You're there with a Crosley!"

The Crosley Radio Corporation:
Please tell us just what "Acuminators" are. Folks aren't technically educated but they do like to know why the Bandbox is such a superior receiver.
Yours truly,
Doubleday Hill Elec. Co.,
Pittsburgh, Pa.

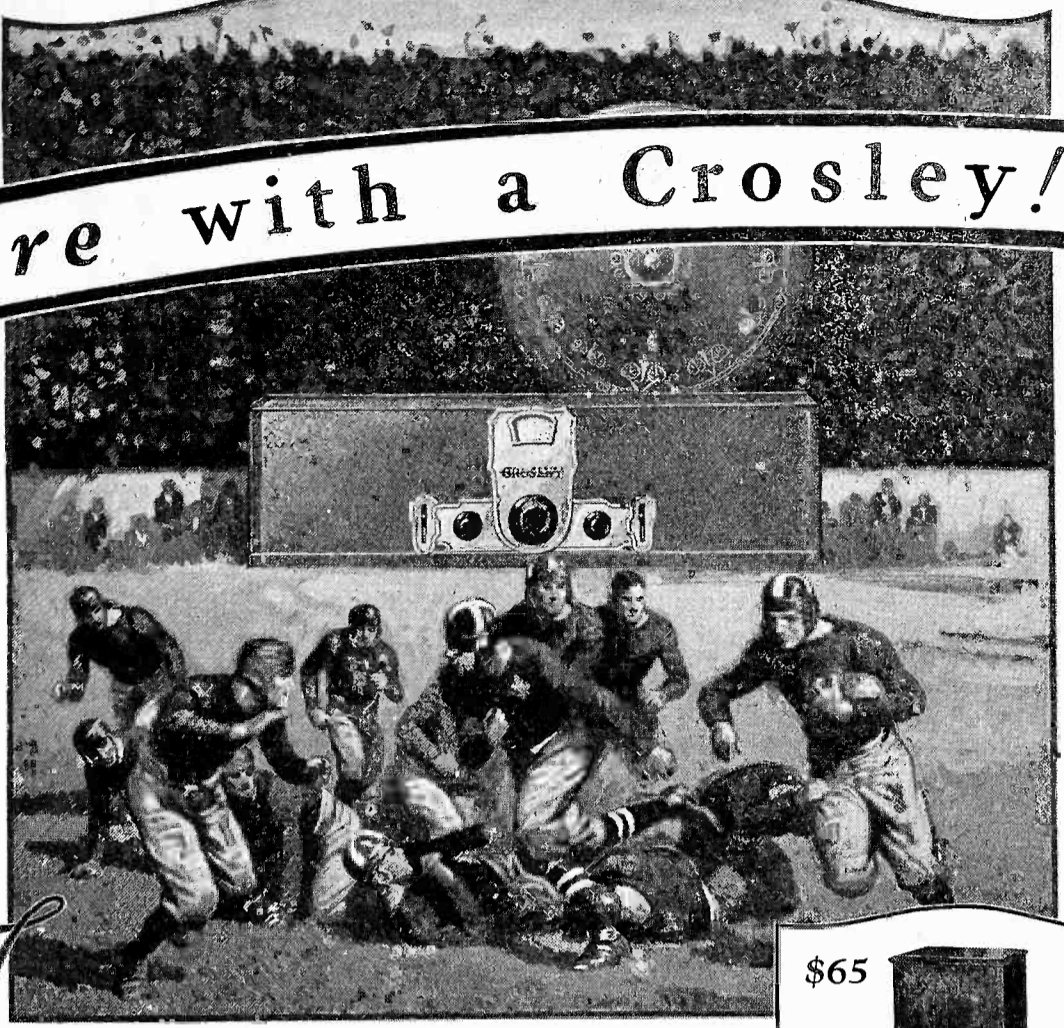

Several different names have been used for the fine tuning adjustments on radio sets. It is well impossible to build a set in the factory so that the three or more tuned circuits will always be adjusted exactly to far away or weak signals. So the Acuminators were developed as secondary adjusters. For nearby or powerful stations they are never needed. The name "Acuminator" was coined from the word "acumen."



With all ordinary local broadcasting which is reasonably strong, the adjustment of the circuits with the master selector is plenty close enough. Full volume is easily obtained. But for the very weak and distant signals and in order to get the highest possible degree of amplification, to bring them up to maximum volume, it is necessary that the circuits be tuned very exactly. The Acuminators provide for this. They are very fine tuning adjustments on the first and second tuned circuits and permit the user to tune these two circuits exactly to the same signal to which the third circuit has been adjusted by the master selector. The first two circuits, will, of course, be very nearly right but with the Acuminators they can be made exactly right.

The effect of the Acuminators is a good deal like using a telescope. They bring the weak, distant signals closer like far away scenes are brought into the foreground. The Acuminators are an additional refinement provided on Crosley receivers in order that the user may get the maximum possible results.

THIS new Crosley Bandbox
6 TUBE RECEIVER *de luxe*
is the national radio hit at \$55.

The "All American" radio of 1928! With license to participate in the enormous radio resources of The Radio Corporation of America, The General Electric Co., The Westinghouse Co., The American Telephone and Telegraph Co., and The Hazeltine and The Latour Corporations, the Crosley Bandbox of 1928 is an "eleven" of super-efficient features and amazing co-ordinated performance. In it are incorporated:

- 1—The best idea of balancing.
- 2—The best ideas of shielding.
- 3—The best ideas of sharp tuning.
- 4—The best idea of controlling volume.
- 5—The best idea of station selection.
- 6—The best idea of finish and color.
- 7—The best idea of power tube use.
- 8—The best idea of console installation.
- 9—The best idea of power supply connections by enclosing all leads in a cable.
- 10—The best idea of AC tube operation.
- 11—The best idea of converting AC current to necessary radio DC.

Operation of the Bandbox receiver from house current is possible with the AC model at \$65, which uses the new amazing R.C.A. AC tubes. Power converter costs \$60 more.

These new Bandbox receivers are now on display at over 16,000 Authorized Crosley dealers. Their faultless reception of the many wonderful events constantly on the air is proving such a startling demonstration that a national enthusiasm sweeps the country in the natural exclamation—"You're 'there' with a Crosley!" Write Dept. 19 for descriptive literature.



Selected by Powel Crosley Jr. as ideal, acoustically and mechanically for the installation of the Crosley "Bandbox." Genuine Musicone built in. Crosley dealers secure them from their jobbers through
H. T. ROBERTS CO.
1340 S. Michigan Ave.,
Chicago, Ill.
Sales Agents for Approved Console Factories
Showers Brothers Company
The Wolf Mfg. Industries

IMPROVED MUSICONES
Musicones improve the reception of any radio set. They are perfect affinities in beauty and reproductive effectiveness for Crosley Radios. A tilt-table model with brown mahogany finish stands 36 inches high, \$27.50—16-inch Super-Musicone as pictured above with "Bandbox," \$12.75—12-inch Ultra-Musicone, \$9.75.

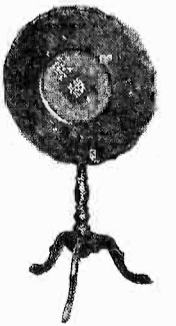

CROSLEY RADIO

THE CROSLEY RADIO CORPORATION
Powel Crosley, Jr., Pres. Cincinnati, Ohio
Prices slightly higher west of the Rocky Mts.



Crosley is licensed only for
Radio Amateur, Experimental and
Broadcast Reception

Tell them that you saw it in RADIO

Unequaled All Records

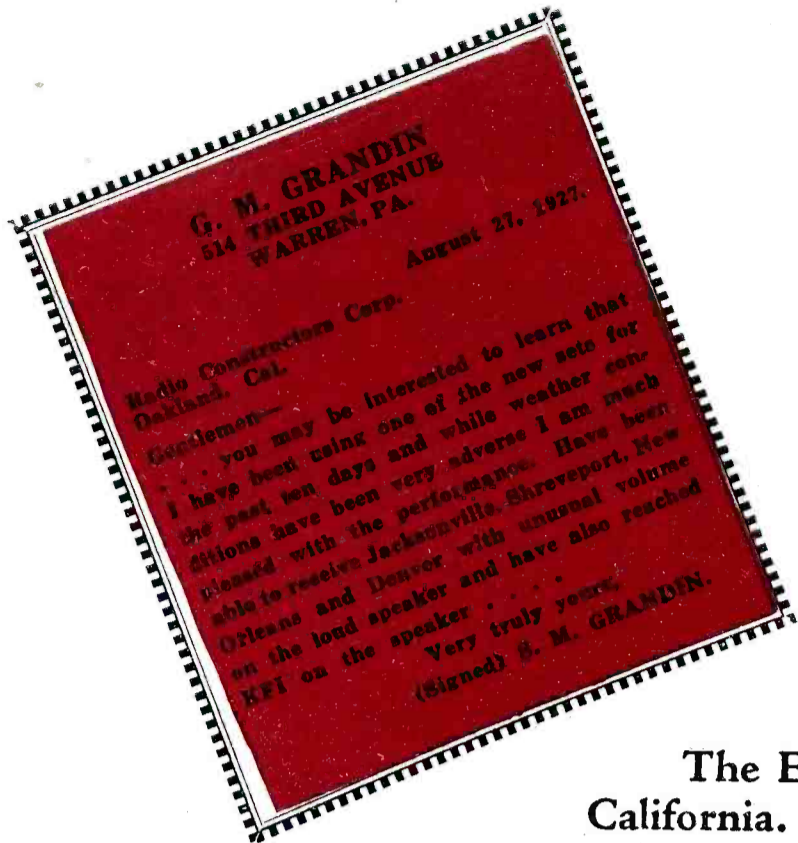

The East Hears California. KFI from Pennsylvania.

Try and duplicate Mr. Grandin's performance for Coast-to-Coast reception in August on other sets. Look at his testimonial—above. He remarks about the unusual volume received from the DX stations. That's the beauty of operating an Infradyne. When you get the DX stations they come in with a powerful wallop.

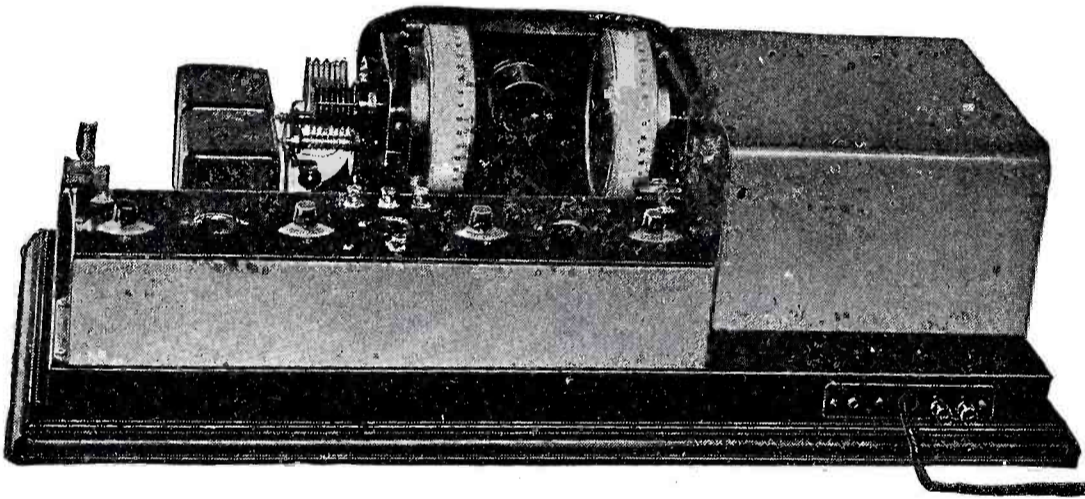

Completely Assembled for You

The illustration above gives you the picture of the assembled Infradyne on its heavy steel chassis. The wiring is below the chassis. The set is a beauty in appearance. Lacquered copper contrasted with the dull black finish of

the chassis and audio unit. Our Infradynes are shipped complete with two SM audio transformers, Jewell voltmeter and battery cable. A fifteen minute job to put the set into operation.

90% of the Wiring in Place

We connect the battery wires to the various units. All switches, transformers, voltmeters and control panel connections are securely soldered in place. Here you save hours and hours of labor. All of the delicate assembly work is completed before the receiver is shipped. Drum dials are in place. The drum dial illuminating lights are secured to the dials and the wires are in place.

Exceeding the fondest expectations of owners, the new 1928 Model DX Infradyne smashes right through the heavy summer static and noise level—brings in stations from Coast to Coast with loudspeaker volume and breaks all Infradyne records of a year ago for exceptional performance. Here is conclusive proof from the East and West that the Infradyne is destined to lead the 1927-1928 field. Two testimonials are shown on these pages. One is from the East. One from the West. Owners of the 1928 Infradyne are its best boosters. The word is spreading fast and production is now weeks behind schedule. Nevertheless, we have anticipated the present Infradyne boom and a considerable number of Infradynes were assembled for prompt delivery a few weeks ago. The lucky few who send us a check today or telegraph an order for the Infradyne will get delivery on the same day the order is received. Jobbers and dealers will all tell you of the present Infradyne shortage. You may have to wait weeks before you can get delivery. But if you send your order to the Radio Constructors Corporation you will get an idea of what real mail order service means. Send us your order by wire—telegraph 50% of the money and pay the balance C. O. D. Let us show you how promptly we can make delivery. This is a wonderful "DX" season. Get in on the sport. Only the Infradyne will stand the severe tests of distance smashing performance.

Special Offer On Last Year's Infradyne

For \$122.50 you can convert last year's Infradyne into a 1928 Model DX receiver. Ship us the audio transformers, Infradyne amplifier and voltmeter from your old set and we will completely build a 1928 Infradyne

for you upon receipt of these parts and \$122.50. The set will perform just as well as the complete new model because no change has been made in the Infradyne amplifier, audio system or voltmeter. Securely

pack the parts in a wooden box and ship to us by express or parcel post. We will rebuild the set for you within eight hours. If your parts reach us in the morning your new set goes out at night.

Performance Smashed

When you buy an Infradyne from the Radio Constructors Corporation it is completely assembled for you and 90% of the wiring is in place. The set is hooked-up in our laboratory, tested at least six times on the air for DX reception, thoroughly inspected and securely crated in a strong box for safe shipment to any part of the world. The assembled receiver costs only seven dollars more than the individual parts. It actually costs us more than \$7.00 to do this work for you but it gives you complete and positive protection, assures you of receiving a 100% satisfactory assembly and a real wiring job. After you get the Infradyne from us you attach a few wires and you are ready for the greatest radio thrill imaginable.

Price **\$179⁵⁰**

Send your order and remit by Telegraph at our expense. Your set will reach you 4 days later.

Radio Constructors Corporation
357 Twelfth Street -- **Oakland, California**

Order Direct from this Advertisement. The Coupon is Your Order Blank. C.O.D. orders accepted when half cash accompanies order. Deliveries in 8 hours. See it displayed by —

REMLOC RADIO CO.
206 PACIFIC BUILDING, SAN FRANCISCO, CAL.
PIONEER RADIO CO.
1200 FRANKLIN STREET, OAKLAND, CAL.



and California Gets Louisiana Like a Local Station.

From the Santa Cruz Mountains in California an Infradyne owner gets Shreveport, Louisiana with sufficient volume to fill the house. Do not overlook the fact that these are summer records—made under the most adverse atmospheric condition. Reception now is wonderful. Get your share of the DX with an Infradyne.

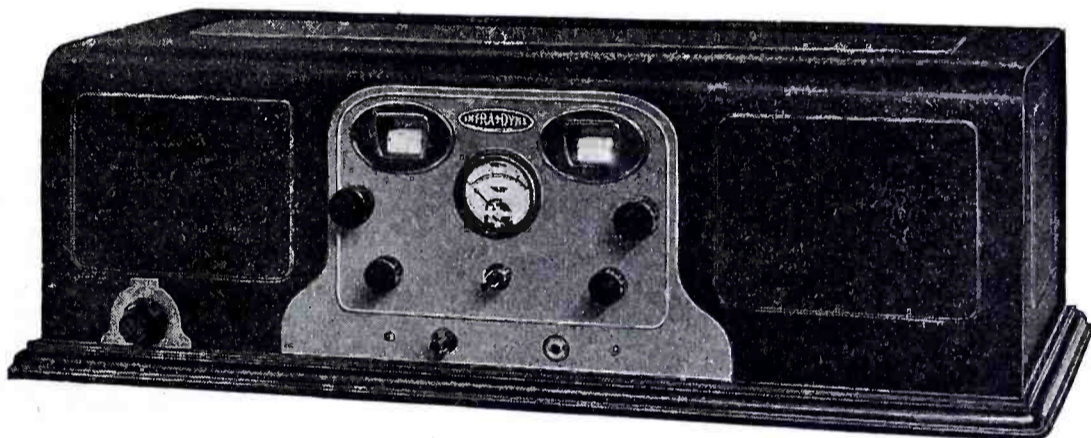

Copper Shielded Cabinet of Rare Beauty

The 1928 Infradyne is housed in a pure copper case, illustrated above. The case is finished in a neutral shade of crackle crystalline. No rough edges. Embossing on top and sides. This cabinet reshields the entire receiver, even though the radio frequency amplifier and the Infradyne amplifier are individually shielded in pure copper cases. A hardwood base goes with each cabinet. The cabinet is included in the price of the set—\$179.50 covers everything.

Each Set Tested 6 Times Before Shipment is Made. All Circuits Balanced.

RADIO CONSTRUCTORS CORP. Dept. R11
357 12th St., Oakland, California

Within eight hours after receipt of this order you are to ship me one complete 1928 Model DX INFRADYNE as advertised in "RADIO." My check for \$179.50 is enclosed.

Name.....
Street and No.....
City and State.....

NEW!
The
Two Tube
 OFFICIAL
BROWNING-DRAKE
 KIT SET

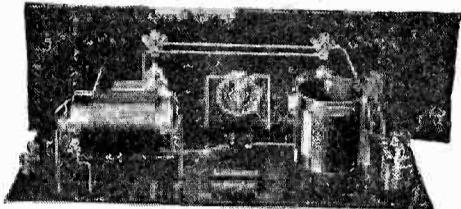

THIS new assembly, the two tube Official Browning-Drake has been designed to be used with any good audio transformer system now on the market, such as Amer-Tran, Thordarson, etc. The combination gives remarkable tone quality and great volume. This two tube assembly uses only the detector and R. F. tubes. Special type T foundation unit makes construction easy. The Official Browning-Drake Kit is used. Other Browning-Drake Corporation products incorporated in the assembly are the cartridge resistance and the neutralizer.

If your dealer does not carry all of the specified parts, send us his name and your requirements will be met immediately.

**The
 Official
 Browning-
 Drake
 Kit**



HEAR
 the
BROWNING-DRAKE

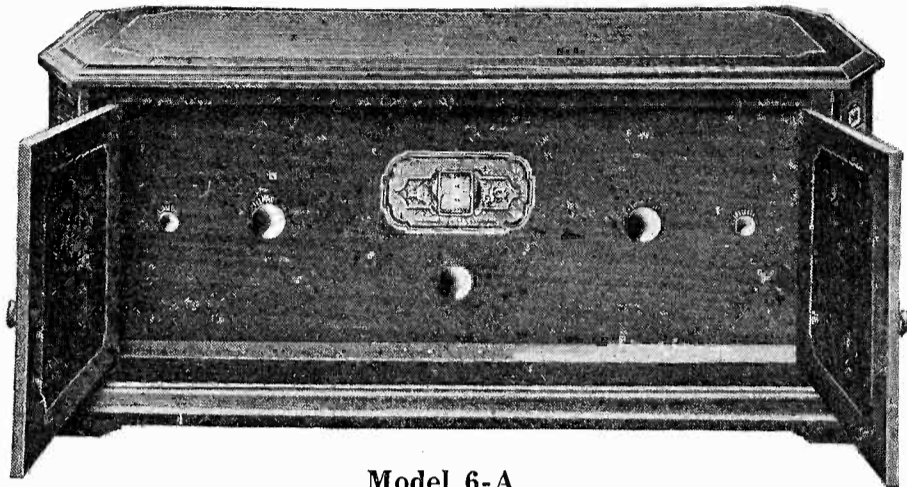

Model 6-A

COMPARE Browning-Drake tone quality with that of any other popular receiver now on the market. Hear how perfectly Browning-Drake reproduces every note throughout the entire tone range. Your own ears will at once appreciate the superiority of Browning-Drake reproduction. Listen! How REAL the low notes of the bass viol, cello and bass tuba sound! Listen again to the high notes of the violin, piccolo and flute. Every sound sent into the microphone is reproduced with such fidelity by the Browning-Drake, that the broadcasting artists are literally transported into your home. Your dealer will gladly demonstrate the new Browning-Drakes. If your dealer does not handle the Browning-Drake Receivers, send us his name and we will forward descriptive folder immediately to you.

The new Model 6-A Browning-Drake (above), has been received with much enthusiasm everywhere. It has six tubes and uses the conventional Browning-Drake circuit incorporating the famous Browning-Drake slot-wound radio frequency transformer in its latest and improved form. Four audio tubes give a natural tone and ample volume. Exceptional selectivity makes it easy to tune out interfering stations. All important parts are completely shielded. Single dial illuminated drum control simplifies tuning. Small auxiliary condenser brings signals of distant stations to maximum intensity. Beautiful two tone Duco walnut cabinet harmonizes with all home furnishings. Length, 27 inches; depth, 15 inches; height, 11 inches. Price without tubes and batteries \$105.

[DEALERS:—There is profit and satisfaction in handling popular products. Write or wire TODAY about the Browning-Drake line of factory-built receivers and the Browning-Drake line of parts.]

Model 7-A

Seven tubes; single dial; illuminated drum control. Four audio tubes give fine tone and great volume when desired. Excellent selectivity. Cabinet can be had in either two tone Duco mahogany or walnut. Length, 30 inches; depth, 15 inches; height, 11 inches. Beautiful console is available for this model. List without tubes and batteries \$145; with console \$185.

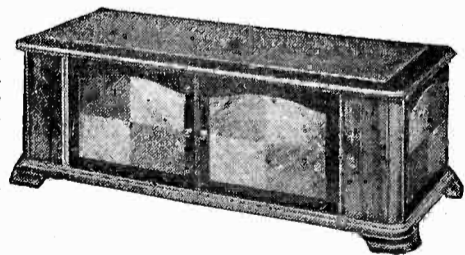

BROWNING
 TRADE MARK
DRAKE
 CABINETS PARTS RECEIVERS KITS

RADIO

WITH WHICH IS INCORPORATED "RADIO JOURNAL"

VOLUME IX

NOVEMBER, 1927

No. 11

Radiatorial Comment

The International Radio Conference at Washington, in its potential influence on world affairs, is rated second in importance only to the League of Nations. The reason for this extreme importance resides in its power to determine future policies with regard to all kinds of radio communication, upon which commerce is so dependent. Whatever facilitates communication between nations develops commerce and promotes mutual understanding. Whatever retards communication restrains trade and breeds misunderstanding. Hence the findings are awaited with great interest.

The announced purpose of the conference is to bring up to date the rules and regulations which were adopted in 1912 at a similar meeting in London. During the fifteen years that have elapsed radio has grown from a puny infant, whose lisps could scarcely be heard a hundred miles, to a great giant whose stentorian voice is heard around the globe. Yet this giant is still supposed to wear the swaddling clothes of the infant.

Supposed is used advisedly. Many of the early restrictions are now so generally ignored that they have become dead letters, at least as far as American practice is concerned. The stereotyped procedure which is specified by the international law causes much unnecessary interference to the transaction of business. But instead of particularizing these practical infractions of the present law, consideration should be given its broader and better aspects.

At the London Convention was originated the system of call letters now used by various nations, these being assigned by a central bureau at Berne, Switzerland. Thus the United States can use letter combinations beginning with *N* and *W* and those with *K* from *KDA* to *KZZ*.

This convention also specified the use of 300 and 600 meters for marine communication, although the 300 meter wave cannot now be used by American vessels and the 600 meter is restricted to distress calls. This change was intended to lessen interference to broadcast reception. But until disapproved for international use, foreign ships may continue to transmit on 300 and 600 meters while in American waters.

The London Convention also adopted the continental code and the *Q* signals as the recognized means of commercial communication. But most of the fifty-seven other varieties of regulations, excepting those relating to rates and accounting, are as dead, on American vessels, as the proverbial door nail.

When the London Conventions were adopted almost the only regular radio communication was that between ships at sea and between ships and shore. Broadcasting by radio

telephone was unknown, amateurs were few and far between, point to point communication was handled almost exclusively by wire or cable, and short waves, radio vision, and aircraft communication were almost undreamed. Consequently the rules applied primarily to ship work. Other services were required only to minimize their interference to marine traffic, to give priority thereto, and to answer distress calls.

Consequently the Washington Conference faces many new problems. First is the equitable allocation of frequencies to the new services to which radio is applied,—commercial, press, government, amateur, experimental, broadcasting, vision, and beacon, as well as to the original marine and distress. These may be roughly classified as fixed or mobile stations. Their allocations will probably be governed, in great measure, by the principle of priority of use.

Discussion will be based largely upon the Book of Proposals which was prepared by the International Bureau at Berne. These proposals cover matters where treaties are necessary and also matters of operation and management. The latter involves a distinction between governmental and private ownership of stations. As the United States has always encouraged private initiative its representatives are not likely to adopt those rules concerned only with governmental ownership.

The great danger to be averted in the Conference's recommendations is any straight-jacket legislation that will retard radio's extension to non-marine services. It is to be hoped also that the delegates will listen favorably to the men familiar with the requirements of marine traffic. Much of the interference which now clutters the ship lanes can be obviated by authorizing the abbreviated codes and methods used by the American brass-pounder.

The amateurs are hopeful of retaining at least their much-loved 20, 40 and 80 meter bands, as proposed in the American agenda. Other countries have urged that amateur transmission be restricted, and even, in the Swiss proposals, that it be forbidden. However it is probable that wiser counsel will prevail and the amateur encouraged in his praise-worthy efforts. Each amateur is an ambassador without portfolio. More power to him!

Although there is little likelihood of any change that will directly affect the American broadcast listener, he will be indirectly helped by many of the Conference's recommendations after they have been confirmed by treaties between the nations. For upon these recommendations is based much of our future peace and commercial prosperity. Before the Conference adjourns it will have written a new code of international law. May good sense and vision be with them!

“Fishing” For Radio Waves

Some Radio Fading Experiments on Long and Short Waves

By *Everett W. Thatcher*

THE use of the purely relative terms, “long” and “short” in the title of this article requires that some definite meaning be assigned to them. In this discussion, the waves lying in the broadcast spectrum are referred to as the long waves, while those which lie below 100 meters are included under the general classification of “short” waves. This somewhat arbitrary division separates the time honored channels of radio communication from the new field which has recently come into general use.

The reason for the migration to the short waves is because greater distance can be covered with the same power, the apparatus is simplified, the cost of installation and operation is reduced, and relief is offered from the interference resulting from the crowding of the older bands.

High frequencies do not behave like those of lower frequency. An entirely new set of phenomena are encountered. One of these is the problem of fading, which has faced engineers since the early days of long distance radio communication. It is closely allied with the problem of propagation; for at some point between the radiation of the waves into space, and their ultimate detection at the receiving station, the factors which produce fading are operative. It may be possible then, by a study of radio

fading to throw some light on the problem of wave propagation, and vice versa.

We must, first of all, have clearly in mind the nature of the electromagnetic wave. As the name implies, there are two distinct parts, neither of which can exist independently of the other. Either may, however be investigated separately. The electric field, sometimes referred to as the “static” field, and the magnetic field are both necessary to make up an electromagnetic field.

In considering the characteristics of these fields when moving, it is an aid to the clearness of the picture to assume the existence of a medium of transmission, the ether, particles of which in motion produce the wave effect. The individual particles in any elastic medium which is subject to wave transmis-

sion may move in any one of an infinite number of different ways. These may be resolved into components of motion in three co-ordinate directions. The components of a light wave are shown to exist *at right angles* to the direction of propagation of the wave, while sound is composed entirely of vibrations *in* the direction of propagation. The former is called transverse vibration, and the latter, longitudinal vibration.

The electromagnetic field produced by a rapidly alternating e.m.f. set up in an antenna involves a flow of current which changes direction with the frequency of oscillation. Let us now slow the picture down, and consider what happens during one complete oscillation, after which we may imagine the same thing occurring at any frequency we desire.

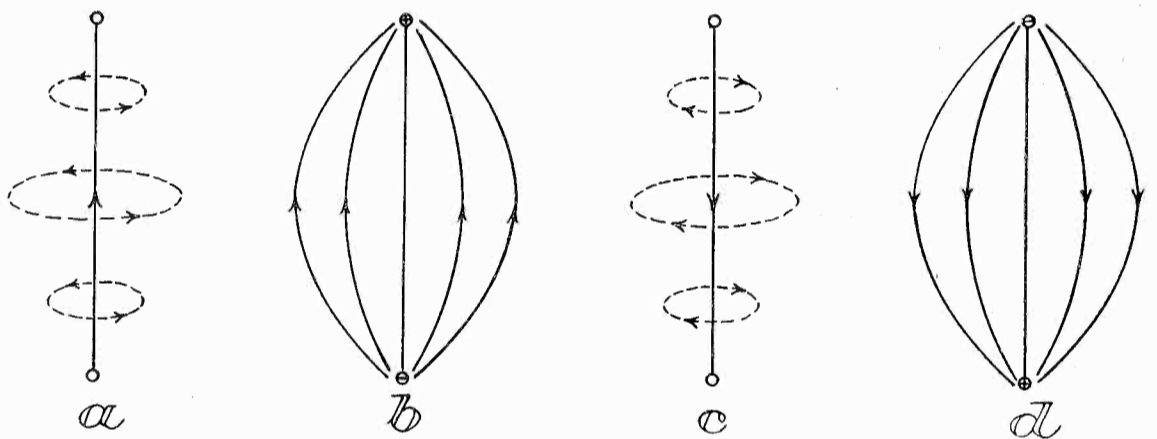
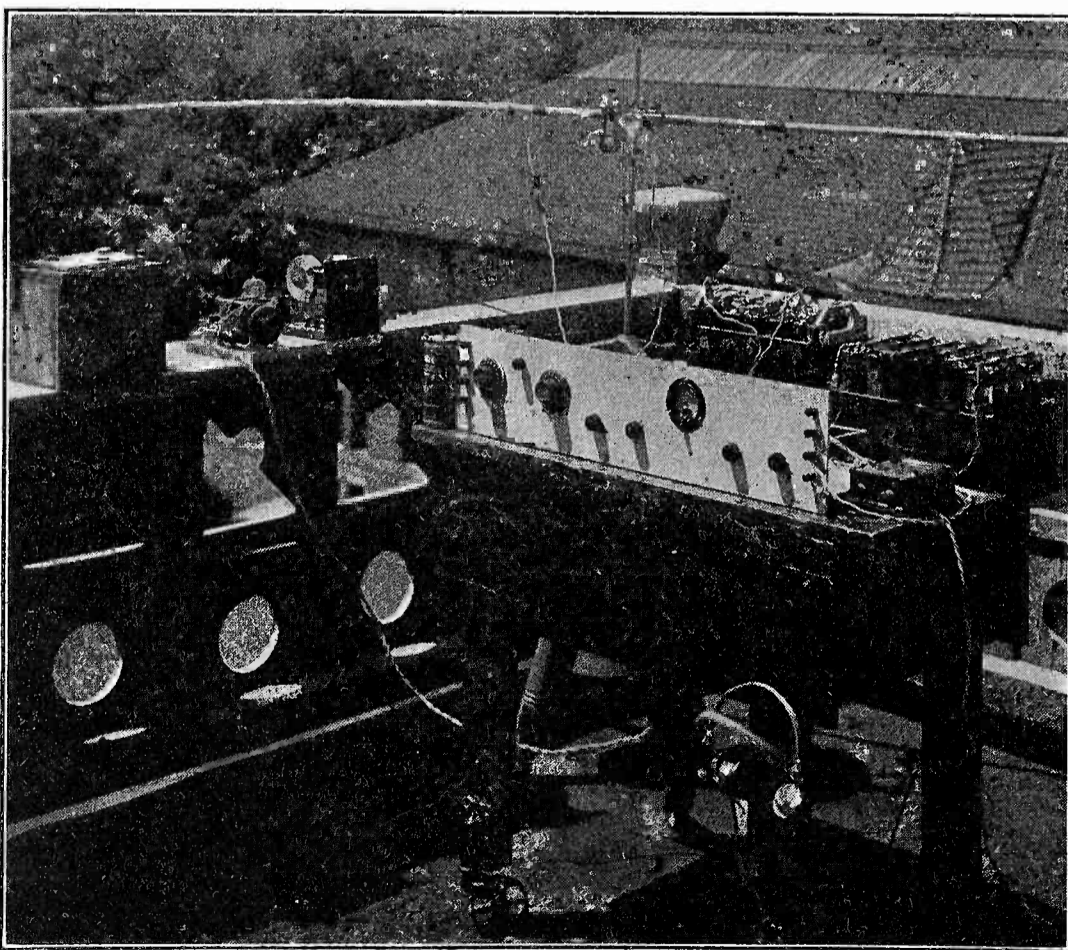

Fig. 1. Four Maximum Phases During One Cycle.

As the current starts to flow, a state of electric strain is produced, due to the difference in potential between the two ends of the antenna. This builds up until, by whatever means is employed, the maximum is reached, and the flow starts in the other direction. Another phenomenon has been occurring simultaneously with this, the setting up of a magnetic field which always accompanies the passage of an electric current along a conductor. By applying the familiar “right hand screw” rule, we can find the direction taken by the magnetic lines of force for each direction of the current. These are indicated by the dotted lines surrounding the antenna in Fig. 1. The electric lines of force, perpendicular to the magnetic lines, are shown by the continuous lines and the directions of each by the small arrowheads.

The figures show the four “maximum” phases which occur during one complete oscillation or cycle. First, in Fig. 1a, the maximum current, and hence maximum magnetic field exists. In Fig. 1b the e.m.f. has been built up to its greatest value, and a strong electrostatic field



The “Sky Laboratory,” Showing Receiver, Local Oscillator for Unmodulated C.W., and Fish-pole Analyzer Antenna.

surrounds the antenna; the current and magnetic field are momentarily zero. Fig. 1c shows the current flowing back, and the magnetic field again a maximum, this time in the opposite direction. And Fig. 1d has reversed the conditions of Fig. 1b.

If a stone, or succession of stones, be dropped into still water, the effect of the disturbance will be the production of ripples or waves which move out from the source in ever expanding circles on the surface. In much an analogous way any disturbance in an electrostatic or electromagnetic field is propagated through space at a definite speed in the form of a wave. After several such oscillations as the one described above, the fields could be pictured as in Fig. 2.

had been shown to increase with the height, might be instrumental in bringing back to the earth electric waves which strayed into the upper strata. Ten years later, Eccles proposed a reflection theory based upon the intense ionization of the Kennelly-Heaviside layer. This, however, met with difficulties in experimental verification.

Perhaps the earliest attempt at an experimental study of the phenomena of long distance electromagnetic wave propagation was made by Austin from 1910 to 1913. His records of the variations in intensity of the long wave, transatlantic stations were made with the aid of a resistance audibility meter, and resulted in the expression of the Austin-Cohen formula for the intensity of the

brought about the immediate necessity for changes in the accepted theories of electric wave propagation. An account of some early experiments was published by Reinartz in 1924, who outlined at the same time a theory of reflection from the conducting layers in the atmosphere. A. H. Taylor of the Naval Research Laboratory presented at the National A. R. R. L. Convention in Chicago in August, 1925, a most complete consideration of the subject, basing his statements and assumptions on the results obtained at the Naval Research Laboratory and the short wave equipped ships in co-operation with the American Radio Relay League. Mention should also be made of the papers of Appleton, and Nichols and Schelling which appeared the same year, and those of Taylor and Hulbert, and Baker and Rice, of 1926.

The question of the plane of polarization of the electromagnetic waves has also been given little attention until very recently. The assumptions, made by Marconi and apparently confirmed by other experimenters, that the horizontal component of the electric wave is comparatively useless, and that the vertical, earth-connected antennas make the best radiators, have stood the test of time as far as long-wave radio was concerned.

To a certain extent they hold for short waves also in that the ground wave horizontal component is quickly quenched, but several new and unlooked for facts appear. Much work, primarily of a statistical nature, in this field has been done by G. W. Pickard, whose recent papers have attracted wide attention.

It is logical to suspect that there might be some definite relation between the refraction of an electric wave and the rotation of its plane of polarization. We are familiar with this exact instance in the case of light. When the electromagnetic wave of which it is composed undergoes total reflection, a change of phase is introduced in the components which results in a rotation of the plane of polarization depending upon the angle of incidence and the qualities of

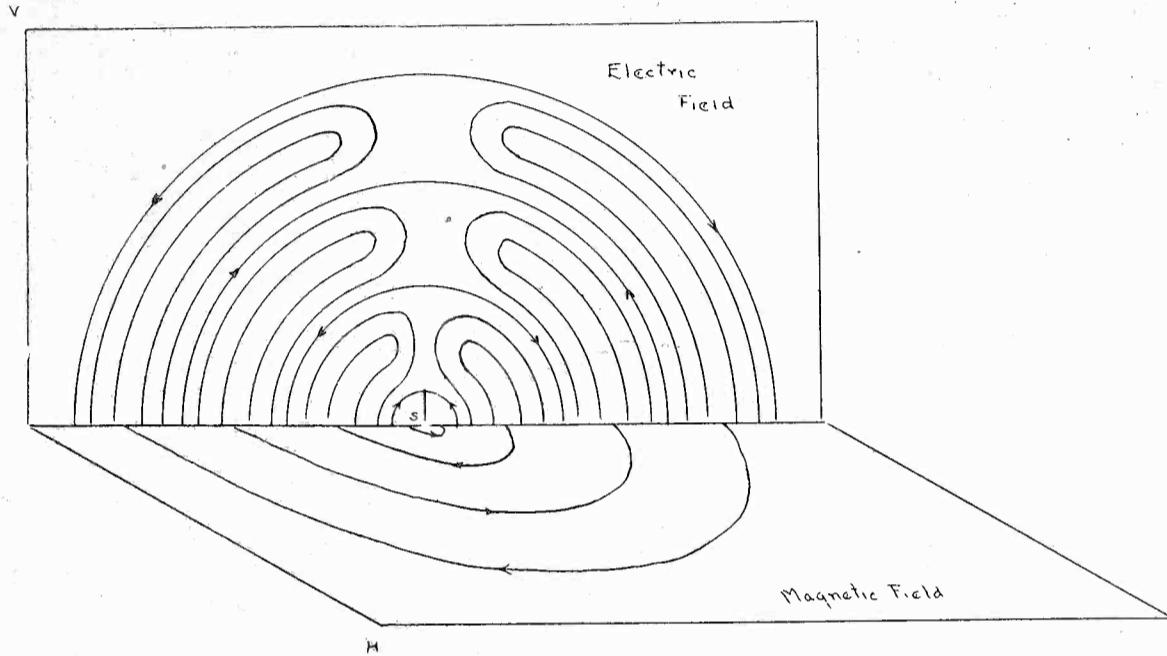

Fig. 2. Cross Section of Electro-Magnetic Field.

The two fields will alternate synchronously, but there will be a phase difference of $\frac{1}{4}\lambda$ or $\pi/2$ between them. The reason for this is evident from a consideration of the maxima and minima in the antenna.

At any appreciable distance from the source the wave has assumed essentially the form shown in Fig. 3. The radius of curvature of the field is so great, that the lines can be considered straight, provided however, that no distortion of the field has occurred.

Our problem resolves itself now into a study of what happens to such a wave as it is propagated through space. By virtue of what influence is it possible for wireless waves to reach points a quarter or half way around the earth? Electro-magnetic waves are known, under ordinary circumstances, to travel in apparently straight lines. Thus, were it not for some guiding force, causing the waves to bend around the spherical surface of the globe, this very curvature would limit the range of a transmitting station to a few miles.

Kennelly, in 1902, and later in the same year, Heaviside, suggested that the ionization of the atmosphere, which

received signal as the distance from the transmitter varied.

Finally, in 1924, Larmor published a theory of refraction due to the free electrons in the upper atmosphere. This, with the background of Austin's experimental work and the mathematical research of others, seemed to account satisfactorily for the observed phenomena on the wave bands then in use.

At about this same time the experimental attack on the short waves was begun, and as has been intimated,

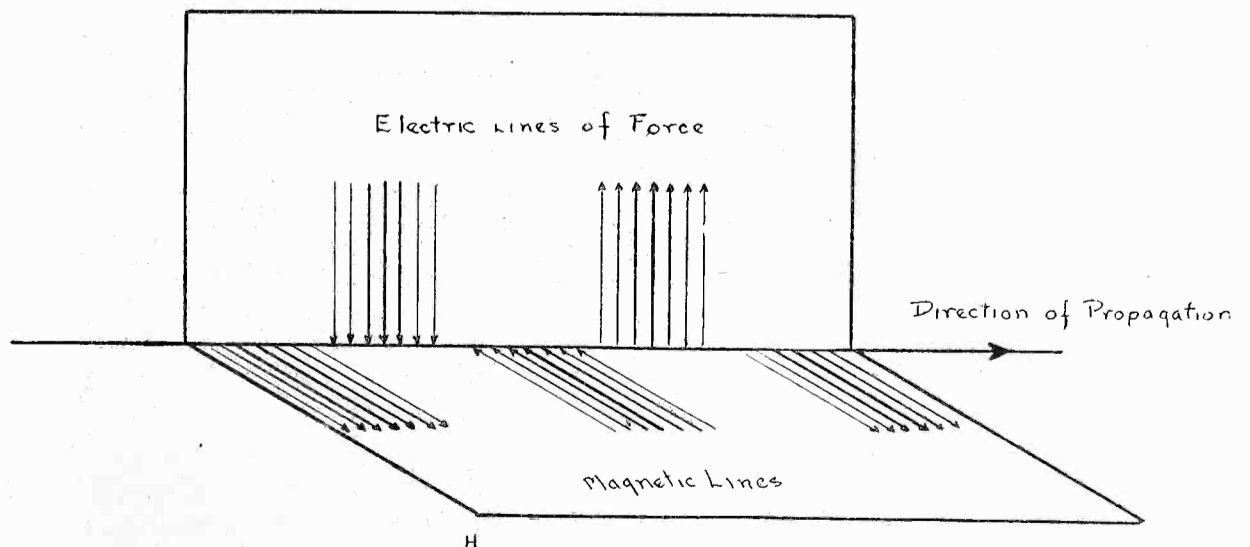

Fig. 3. Electro-Magnetic Field at Distance From Source.

the refracting medium. (cf Houston, *Treatise on Light*, Chap. XXII.)

We are lead forcibly then to the conclusion that such a relation does exist. Whether it is the only agency active is another question, answerable probably in the negative. But an attempt has been made to correlate these two phenomena experimentally by obtaining records of the variations in the intensity of radio signals under varying conditions of propagation.

The Experimental Equipment

IN the construction of apparatus to receive and record the variations in the intensity of radio signals, several factors must be borne in mind.

1. The current produced must be of sufficient strength to deflect a galvanometer.

2. The frequency of the received signal must remain constant.

3. The final product of the receiver must be free from external or internal disturbing influences which might, in themselves, produce irregularities in the record.

It has appeared after some experimentation with simpler types of apparatus that some form of a receiver employing amplification at radio frequency was necessary, and the superheterodyne without audio amplification was selected as best suited to the purpose in view. Three stages of intermediate frequency amplification were used to amplify a 45,000 cycle "beat" between the incoming signal and the local oscillator. In place of a vacuum tube for the second detector, a crystal was employed in the galvanometer circuit.

A coupling coil, interchangeable with the loop circuit, provided for reception on various types of antennas. The

rotor of this unit could be energized by an antenna-ground, an antenna-counterpoise, or a split wire analyzer, which is in reality a modification or special form of an antenna-counterpoise. By simply removing the coil and connecting to the terminals of a loop antenna, measurements on the magnetic component of the wave could be made.

It is possible, by using the proper number of turns in the antenna and oscillator inductances, to make the same condensers serve for both the broadcast range and the short wave bands down to 40 meters. For ease in tuning, however, and for lower wave lengths, it is advisable to use smaller condensers and smaller coils.

No part of the circuit itself may be grounded when using any type of directional antenna, as the qualities which we most want are thereby destroyed. Distributed capacity with parts of the circuit and grounded objects tends to produce the same result. A small shield was therefore placed directly back of the tuning condensers, carefully insulated from the instruments and connections, and connected to earth. The effect is the same as if the hand were held constantly on the dial. This arrangement was found to be satisfactory.

It is apparent from a study of the mechanics of electromagnetic wave propagation that the measurement of the electric field strength or electron displacement can be accomplished by the use of a single straight wire. The oscillations induced in the wire will be a maximum when it is placed in the line of maximum displacement, and a minimum or zero will occur at right angles to this position. At all other points, a component of the maximum, propor-

tional to the cosine of the angle between its line and the line of the receiving antenna, will be received.

An antenna constructed in this way is known as an analyzer. The type used in the present work consisted of a pair of bamboo fish poles, fastened end to end—each of which carried a length of enameled copper wire, 4 meters long. Thus a total length of 8 meters was attained. The wire was split at the center, and the primary of the antenna coupling coil was inserted at this point.

The recording apparatus was designed by Professor Carl E. Howe of Oberlin College. It is shown in detail in Figs.

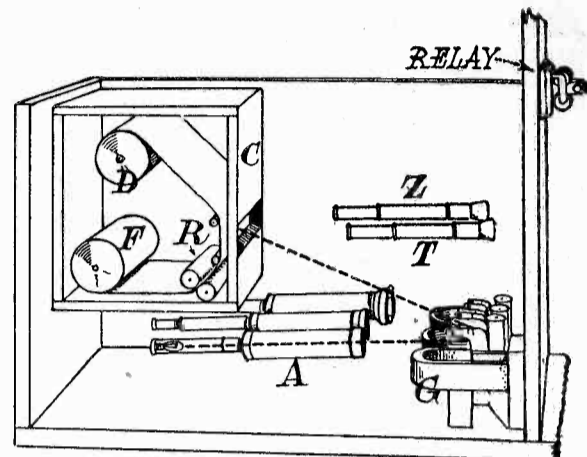

Fig. 5. Skeleton View of Recorder.

4 and 5. The equipment provides for the simultaneous operation of three receivers. The three galvanometers which register the variations in signal current are located on the baseboard directly back of the panel. By means of a galvanometer mirror, light from the telescopes at A of Fig. 5 is reflected back, and brought to a focus at the camera C. Here a long narrow slit allows only a point of light to penetrate and register on the moving film. Within the camera box, a spool at D carries a supply of sensitized paper. From here, it is carried back of two guide bars which hold the paper close to the opening, to a pair of rubber rollers connected by a shaft coupling to the driving mechanism. A set of gears, turned by an electric motor, moves the film downward at a rate of about 1.5 centimeters per minute. The speed of the film, and hence, its power of resolution of small variations can be varied by changing the motor gear ratio. At F a second spool connected flexibly to the moving rollers, receives the exposed paper, from which it is taken for development.

A continuous light is maintained in telescope Z, which registers the zero line on the record. The timer, T, provides a vertical line every minute. A small spring contact on the second hand of the clock operates a relay, which in turn, flashes on the light at T.

The source of light for each recording system is a miniature lamp, the filament of which is a small straight wire. The length of this is placed perpendicular to the camera slit, and the tele-

(Continued on page 48)

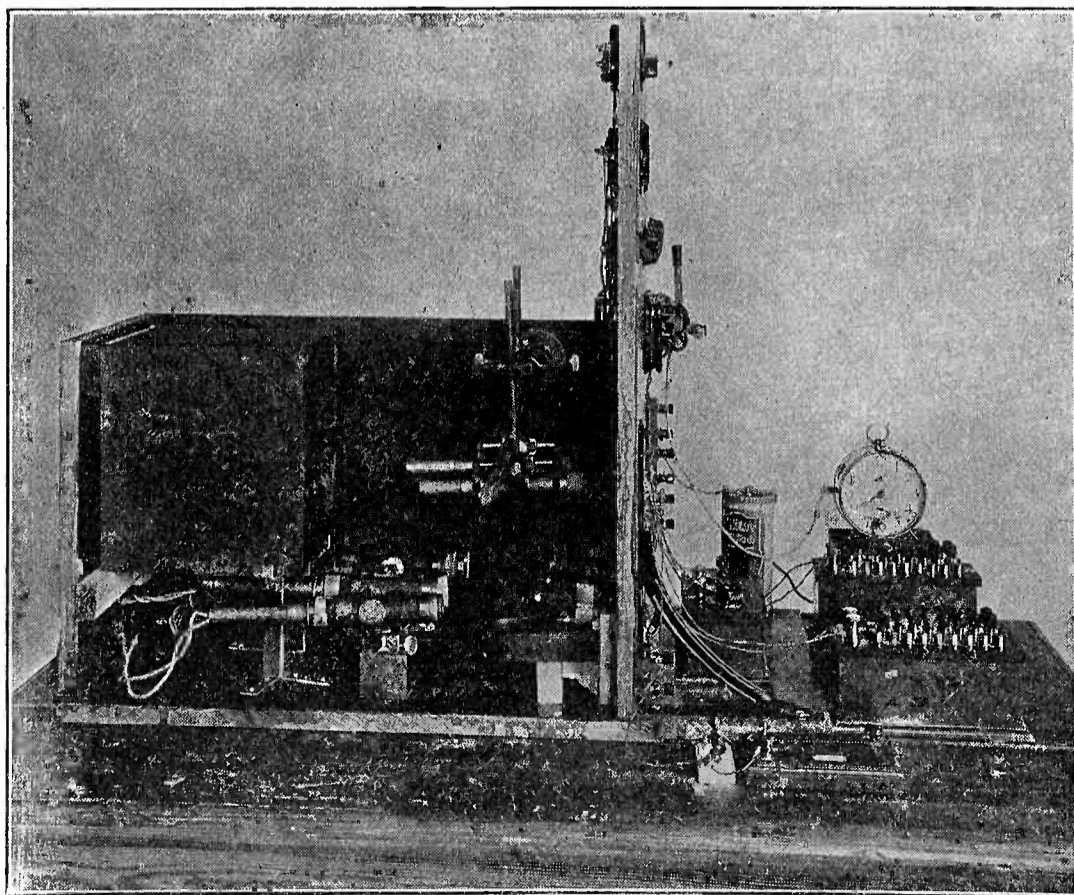

Fig. 4. Recording Apparatus.

The Constant Gain Receiver

Wherein Oscillation is Prevented by Phase Control Condensers and Regeneration is Increased with Wavelength

By Francis Churchill

THIS receiver is a modified five tube set in which constant gain or amplification is obtained over the whole broadcast band of from 200 to 550 meters. Most of the present day receivers using tuned radio frequency amplification are quite sensitive on the shorter wavelengths and broad and insensitive on the upper side of the band. This is due mainly to the effect of more regeneration on the lower wavelengths

controlled by means of phase controlling condensers in the plate circuit of each tube instead of the usual neutralizing condenser scheme. These phase controlling condensers, C_5 and C_6 in Fig. 1 cause the voltages fed back through the grid-plate capacities of the tubes, to be out of phase with the impressed grid voltages. A purely capacitive or resistive load in the plate circuit will not provide a condition where oscillation is possible.

range for obtaining constant gain over the broadcast band.

The condensers, C_1 and C_8 and the inductance L_8 form a circuit for introducing regeneration as the wavelength goes up in tuning the set. C_1 is simply a very small capacity, such as a neutralizing type condenser, and C_8 and L_8 form a resonant circuit tuned to about 185 meters, which is about the lowest range of this receiver in tuning. This circuit,

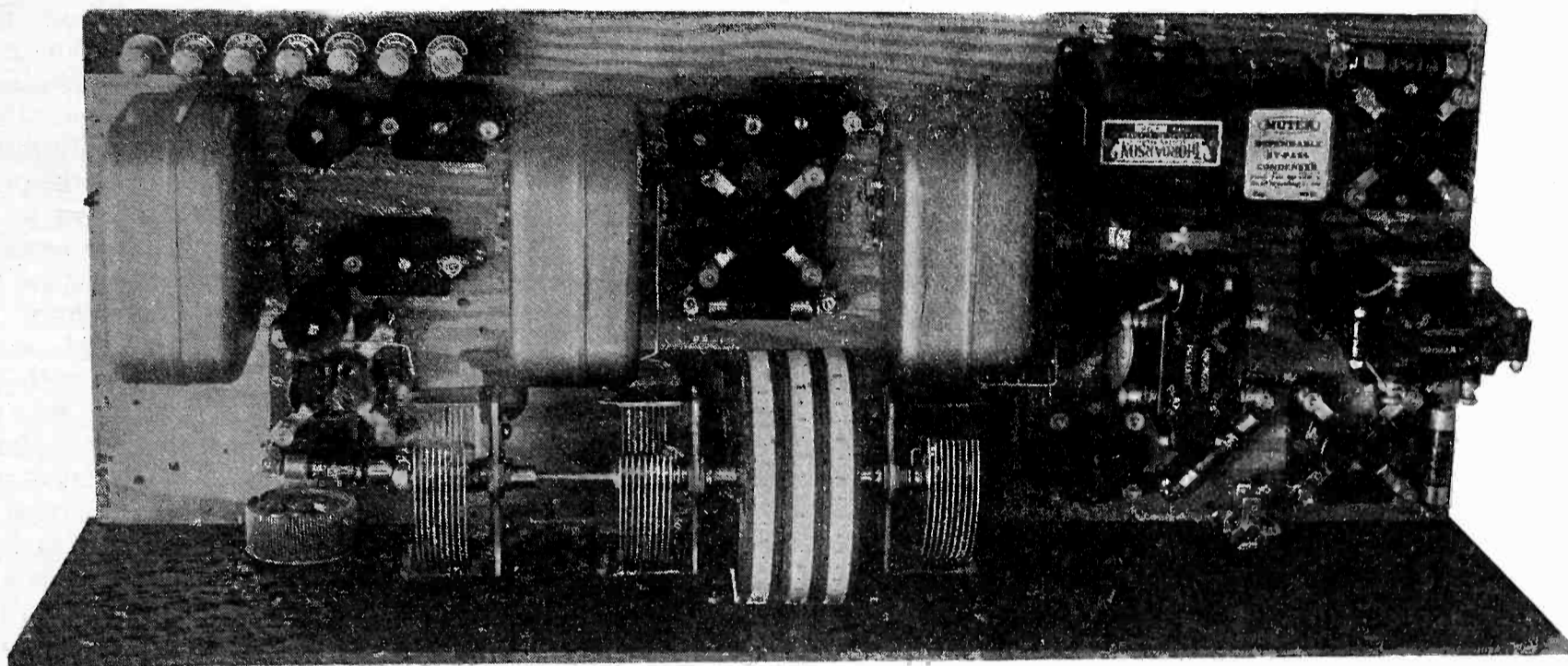

Rear View of Constant Gain Receiver.

and practically none higher up which means greatly decreased efficiency on the higher wavelengths.

A slight amount of regeneration in the r.f. amplifier is desirable as it tends to diminish the effect of circuit resistance, which means higher voltages across the grid circuit of the tube and more gain per stage. Too much regeneration causes distortion, due to extreme selectivity, and trouble may also result from oscillations.

In this receiver the oscillations are

However, by making C_5 and C_6 semi-variable, the phase conditions can be controlled so that each stage is just under the point of oscillation. By setting these condensers for this condition, maximum gain is obtained, but unfortunately this does not give the same condition over the whole broadcast band. As far as this latter effect is concerned the phase controlling condensers are no more efficient than the ordinary neutralizing condenser scheme but the use of this scheme does allow an ar-

being resonant at a short wavelength, offers nearly infinite impedance for any feedback from the plate circuit of the second tube to the grid of the first. However, as the tuning is advanced, the wavelength increased, the impedance of this circuit C_8 and L_8 is decreased and so allows more feed back. By proportioning the resistance, capacity and inductance of this circuit properly the feedback can be made to increase for a given set of r.f. transformers, in a

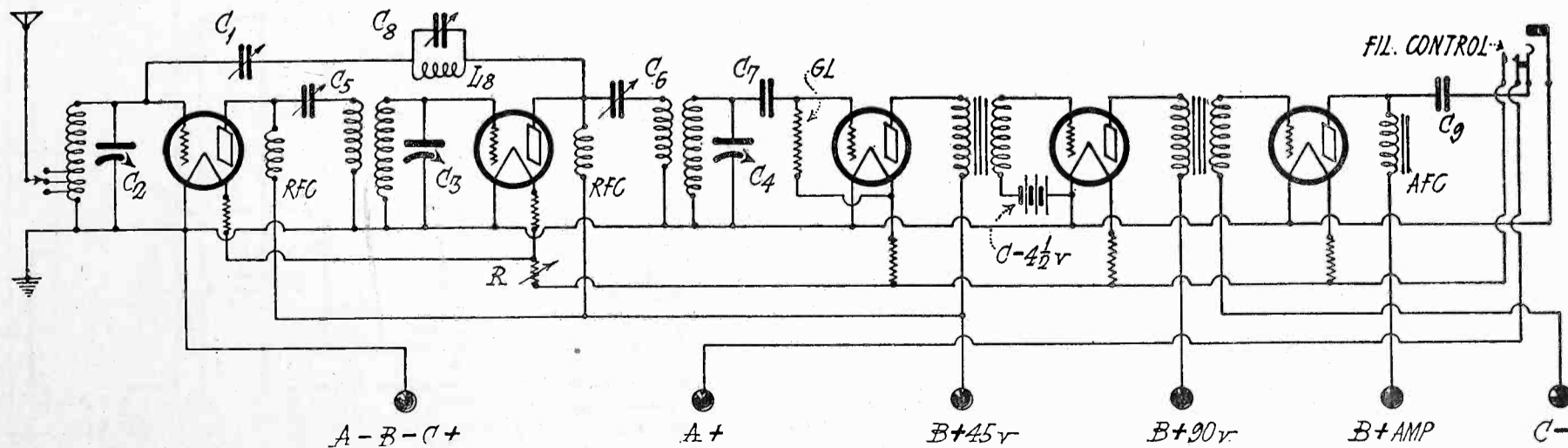

Fig. 1. Circuit Diagram of Constant Gain Receiver.

direct proportion to the natural decrease of regeneration.

This means that the r.f. amplifiers can be operated just under the point of oscillation over the whole broadcast band automatically and constant gain will be obtained. L_8 is a small coil wound with 70 turns of No. 32 dsc. wire on a $\frac{1}{2}$ in. diameter. This size wire and coil makes the resonant peak rather broad so that it "shades" off at the right rate over the broadcast band. A Precision r.f. choke coil form was used, winding about 20 turns in each slot. Later a choke wound on an old spool was substituted and worked just as satisfactorily.

C_8 and L_8 were designed for use with the new shielded Quadraformers which are an efficient type of shielded r.f. transformer. Since these coils are shielded, the receiver is quite selective as each r.f. transformer does not act as a small loop aerial for picking up energy from nearby broadcasting stations. They also make it possible to control oscillations readily, since the electro-magnetic coupling between r.f. stages is reduced to a minimum. The Alden localized control triple condenser is used because it can be operated with one hand and yet it allows each stage to be tuned for maximum efficiency.

The audio frequency amplifier consists of two stages of transformer coupled amplification, using high quality transformers. An output choke and condenser are used since it is good policy to keep the direct current out of the loudspeaker. This arrangement allows the use of either the 112 or 171 type power tube.

The picture of the receiver shows the general layout of the apparatus with the exception of the feedback control condenser C_1 . The capacity of a bus wire to the stator plates of the first stage

- LIST OF PARTS OF CONSTANT GAIN RECEIVER**
- 1—Set Quadraformer coils
 - 4—Airgap sockets
 - 1—Benjamin cushion socket
 - 2—Ferranti AF-3 Transformers
 - 1—Thordarson 30 henry choke
 - 2—1 mfd. Muter by-pass condensers
 - 1—Alden triple-localized control condenser
 - 3—Muter semi-variable condensers .00003 to .0005 mfd.
 - 1—Muter semi-variable condenser .000003 to .00005 mfd.
 - 3—Precision coil r.f. chokes
 - 4—1A Amperites
 - 1—112 Amperite
 - 1—.00025 Sangamo grid condenser
 - 1—3 megohm Electrad grid leak
 - 1—Frost rheostat, 6 ohm type
 - 1—Frost single jack with filament circuit contacts
 - 7—X-L push type binding posts, —A, +A, —C, +45 Volts, +90 Volts, + Amp, Aerial.
 - 1—7x24x3/16" panel
 - 1—9x23 1/2x 1/2" pine baseboard

condenser was used at first but it was found that a variable "neutralizing" type condenser was much more satisfactory and so the arrangement shown in the baseboard sketch was used. The author prefers the familiar "golf" type of wiring, that is from hole to hole using No. 18 bell wire for most of the wiring. By mounting the baseboard about $\frac{1}{8}$ in. above the lower edge of the panel, plenty of room is available for the wiring underneath. A small amount of bus wiring was done on the grid leads, connecting the variable condensers to the Quadraformers.

The apparatus should be placed as shown in the picture. The equipment was fastened down to the wooden baseboard with woodscrews, as soon as the desired relative positions were found and holes drilled through the baseboard with a $\frac{1}{8}$ in. drill for wiring. The exact positions of the various condensers, coils, sockets, etc., is not extremely important since shielded r.f. transformers are used. By placing all of the apparatus on the baseboard, including the variable tuning condenser, the best arrangement to suit the individual taste can be had by shuffling the parts around slightly.

The triple condenser is also used as a support for the panel, as it is fastened securely to both the panel and the baseboard. Incidentally if a hard-rubber panel is used, the set should be placed in a cabinet as soon as completed to keep the panel from warping. A bakelite or formica panel will not give this trouble but is more difficult to drill and cut. The rectangular hole for the tuning condenser drums and panel plate can be either drilled out, using a small drill, drilling holes close together, or cut out with a scroll saw.

After the wiring is completed, a complete check should be made and then the batteries and so forth connected. It should be noted that the primaries of the Quadraformers are reversed and that the whole primary is connected into the circuit. The posts marked "plate" should connect to ground or filament and the posts marked *B No. 2* should connect through the phase condensers to the plates of the r.f. tubes. The Ferranti audio frequency transformers have a condenser shunted across the primaries within the transformer cases so no external by-pass condenser is necessary in the plate circuit of the detector tube.

In making the preliminary adjustments, condenser C_1 should be set for minimum capacity that is with the adjusting screw nearly all the way out. C_8 should also be set at a low value. The receiver should then be tuned to some broadcast station near the lowest end of the broadcast band and C_5 and C_6 adjusted until the receiver is just under the oscillating or "squealing" point when the volume control rheostat is turn on full. It is best to use distant broadcast stations in these tests and adjustments.

When the receiver is tuned to some station near the upper end of the broad-

(Continued on page 50)

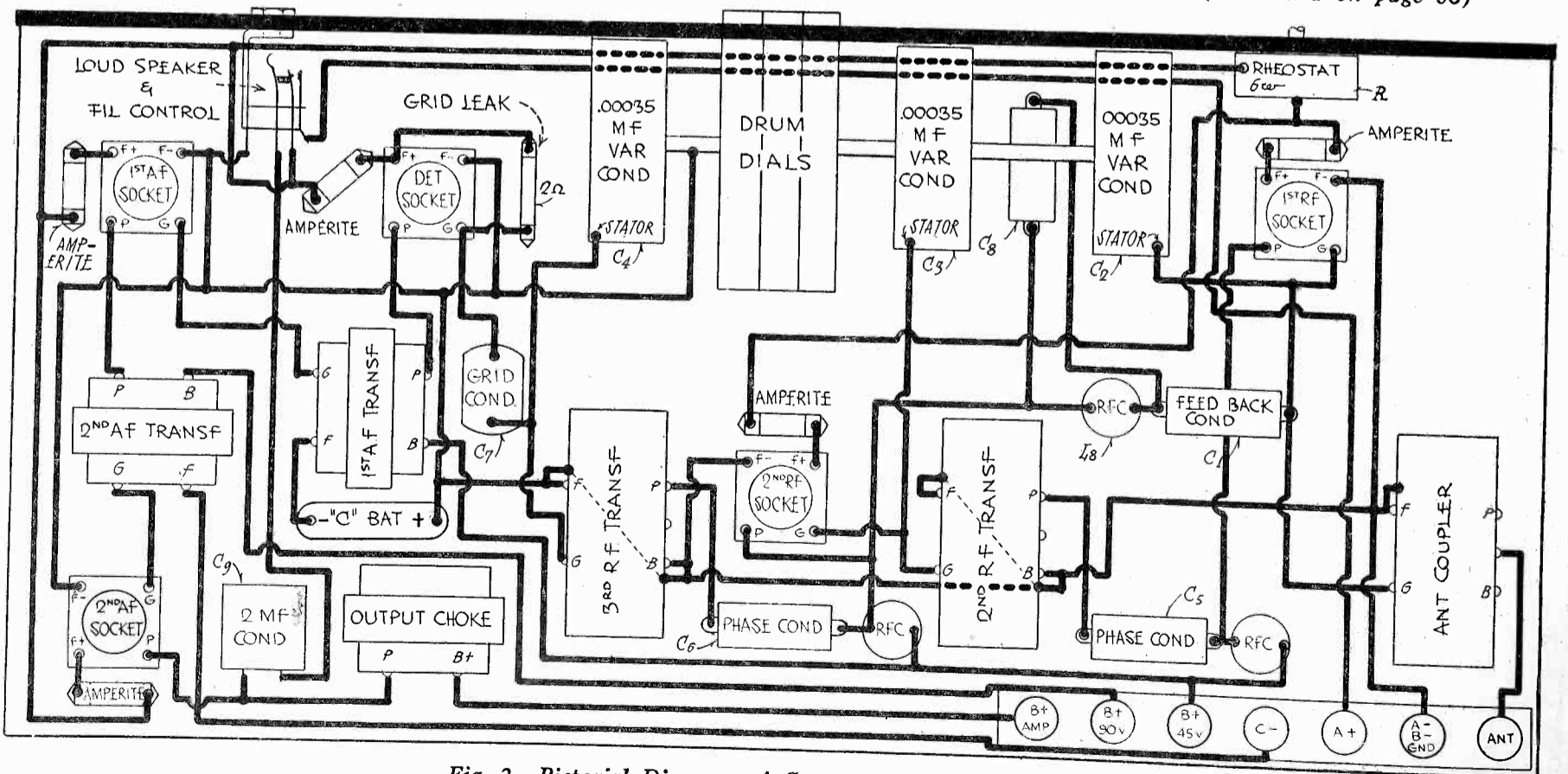

Fig. 2. Pictorial Diagram of Constant Gain Receiver.

A Heavy Duty Amplifier

A High Quality Audio Amplifier Giving Great Volume Over Wide Areas or Suitable for Use With A Phone Transmitter

By G. M. Best

THE power amplifier described in August RADIO had as its last stage a type CX-310 tube, which has an output as an amplifier of from 1½ to 2 watts, despite its rating as a 5 watt tube, the latter being customary only when it is used as an oscillator. Such an amplifier is capable of supplying ample room volume for one or two loud speakers, but it will not give sufficient volume to fill a large hall, especially where there is dancing and accompanying room noise.

So many queries have been received as to the right type of amplifier for supplying four or more cone type speakers to meet the latter requirement that a brief description is herewith given. While it is obvious that the amplifier would represent the height of extravagance for the home installation, there are many dealers and professional set builders who are interested in the design of such an amplifier. It also makes a fine preliminary amplifier and modulator for a radiophone transmitter, the only modification being a rectifier or power supply of greater output, so as to take care of the oscillator circuit.

The amplifier consists of a high- μ preliminary stage, resistance coupled to a power stage using a 50-watt tube, which when used as an amplifier will give about 7 or 8 watts power output. Plate voltage for both amplifier tubes is obtained from the a.c. mains, being stepped up to 1000 volts through a transformer, and rectified by another 50-watt tube used as a rectifier, although a Kenetron rectifier tube could be used equally as well. The filaments

of both rectifier and power tubes are lighted from raw a.c., while the filament of the high- μ tube is lighted from a 6 volt storage battery, since its filament is not of the type adapted to a.c. operation. The circuit used is almost identical with that of the smaller power amplifier described in August RADIO, except that apparatus capable of withstanding 1000 volts d.c. is used, and certain

minor changes are made in the circuit to accommodate such a high voltage.

The schematic wiring diagram is shown in Fig. 1; no pictorial diagram has been shown, because anyone not familiar with schematic diagrams should not attempt to build the amplifier.

The amplifier input is through a high quality audio transformer, the primary of which is connected either to the detector or first audio amplifier tube in the radio receiver. Grid bias of 4½ to 6 volts for the high- μ tube is obtained through the voltage drop across a 100 ohm fixed resistance placed in the negative B voltage supply, the resistance being shunted with a 1 mfd. fixed condenser as an a.c. bypass.

The plate voltage for the high- μ tube is obtained from the main power supply, the 950 volts being stepped down through a 600,000 ohm resistor consisting of six 100,000 ohm lavite resistances in series. This allows an effective voltage of 220 at the plate of the high- μ tube, and at the same time provides a coupling resistor for the resistance coupled circuit. While the plate voltage is somewhat higher than normal for the CX-340 tube, it will do the tube no harm. The plate of the high- μ

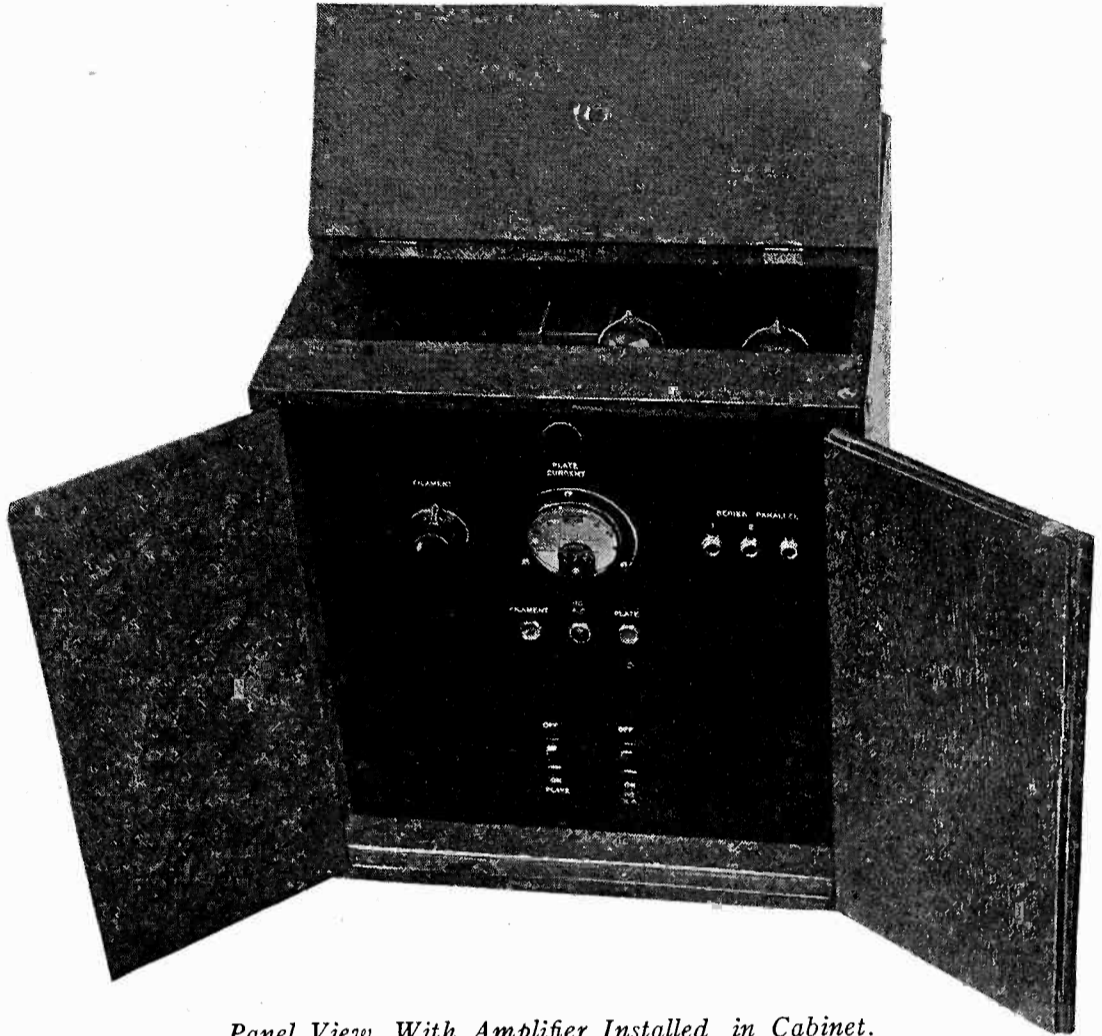

Panel View, With Amplifier Installed in Cabinet.

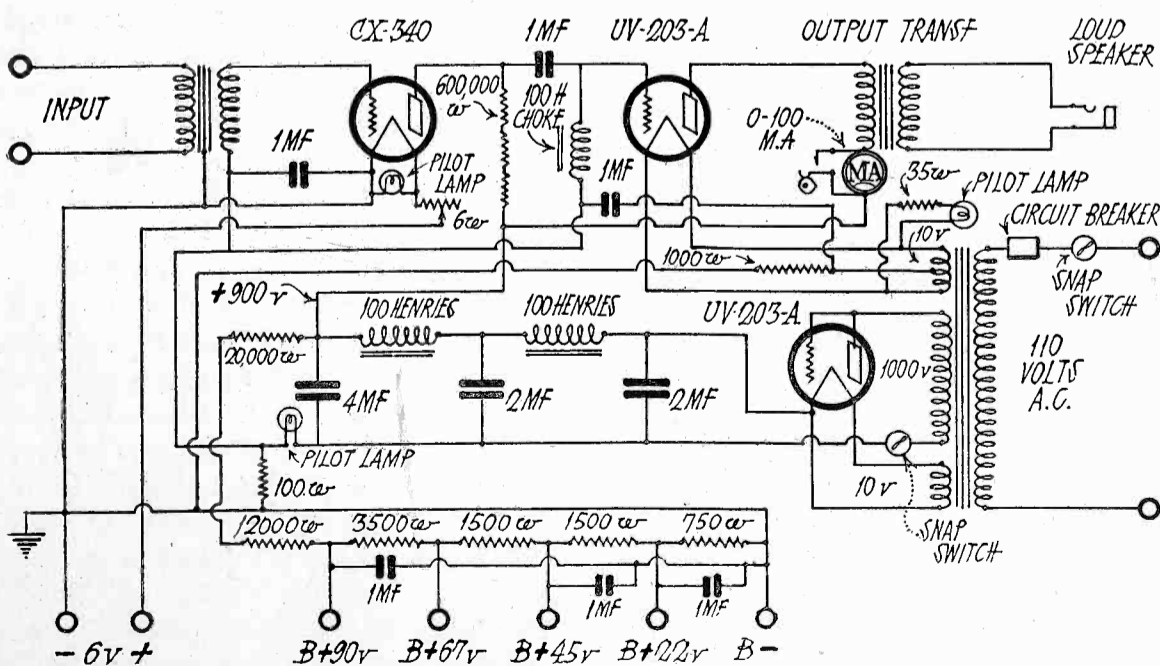

Fig. 1. Wiring Diagram of Power Amplifier.

tube is coupled to the grid circuit of the power tube through a 1 mfd. 1000 volt condenser, with a grid choke of 100 henrys inductance between the grid and filament circuit of the power tube.

The output of the power stage is coupled to the loud speaker through an output transformer, although impedance coupling can also be used. The particular transformer used in the experimental model was designed to operate at voltages up to 500 d.c., but a number of them were tested at continuous d.c. voltages up to 1500 without breakdown between the primary and secondary, so that it is considered safe to assume that the transformer is satisfactory for passing 50 milliamperes of plate current at 950 volts.

The tone quality of the two stage amplifier is remarkably fine, and by the use of the combination of transformer and impedance coupling, with the particular pieces of apparatus chosen, the resultant frequency characteristic curve from 25 to 6000 cycles is beyond reproach. There is only a slight falling off in the amplification at 25 cycles, compared with that at 1000 cycles, and the dip in the curve at 6000 cycles is negligible.

The rectifier system is supplied by a power transformer with 1000 volt plate winding and two 10 volt filament windings, each of 8 amperes capacity, one having a center tap for the amplifier tube. This transformer can be home

PARTS REQUIRED FOR AMPLIFIER

- 1—Amertran transformer, see text
- 2—Amertran type 854, 100 henry chokes
- 2—Aerovox type 1002 inverted 2 mfd. 1000 volt condensers
- 1—Aerovox type 1002 inverted 4 mfd. 1000 volt condenser
- 1—Aerovox type 1002 inverted 1 mfd. 1000 volt condenser
- 1—General Radio type 369 Coupling Impedance
- 1—Silver Marshall type 221 Output Transformer
- 2—50 watt tube sockets
- 1—X base or Navy type socket
- 8—XL push posts
- 6—Aerovox 100,000 ohm lavite resistances
- 1—General Radio type 410 6 ohm rheostat
- 3—Yaxley Pilot Lamps—Green, Amber, Red
- 2—G. E. No. 1688 flush switches
- 1—Weston Model 301 milliammeter, 0-100 ma.
- 1—Yaxley filament switch, for shorting meter
- 1—Frost closed circuit jack
- 2—Frost open circuit jacks
- 1—Precise No. 1600 Protector
- 5—Aerovox type 1200 1 mfd. bypass condensers
- 1—Ferranti Type AF-3 Audio Transformer
- 1—Ward-Leonard Type 507-49 tapped resistor, 19,250 ohms
- 1—Ward-Leonard type 507-31 resistor, 20,000 ohms
- 1—Ward-Leonard 1000 ohm fixed resistor
- 1—Ward-Leonard 100 ohm fixed resistor
- 1—G. E. Cat. No. 92965 fuse block
- 1—Bakelite panel, 14x15x3/16 in.
- 2 Bakelite panels, 11 $\frac{3}{4}$ x13 $\frac{1}{2}$ x3/16 in.
- 1—Carter type H-30 resistance
- 1—Saturn toggle switch

made, or can be obtained on special order from the American Transformer Company, who made the transformer used in the experimental model.

In case the transformer is to be made up by the builder of the amplifier, the following data will be of assistance. The recommended core size, for a rectangular core, would be 4x5 in. outside, of

silicon steel pieces 1 in. wide, and piled 3 in. high. This would make a core cross sectional area of 3 sq. in. and a primary of 275 turns of No. 18 d.c.c. wire, wound on one leg of the core. Over the primary would be wound the two filament lighting secondaries, each of 26 turns of No. 14 d.c.c., with a tap at the 13th turn on one secondary. On the other leg of the core, wind 2600 turns of No. 30 d.c.c. or enameled wire, for the high voltage secondary. Particular care should be used in taping the core and coils with empire cloth. If the home made transformer is used, it would be a good idea to shield it with a metal partition, at least above it, and on the side towards the filter circuit.

The output of the plate winding is connected to the rectifier tube, which may be a 50 watter with grid and plate connected together, or a Kenetron rectifier having a filament and plate only.

The filter system consists of two 100 henry chokes in series, with a total of 8 mfd. in combination; the condensers must be capable of withstanding a continuous d.c. voltage of 1000 volts, since the effective voltage at the output of the filter, while the load is on, is 950 volts, and may rise at times to higher values due to surges. If condensers having a 1000 volt flash test, but lower working voltage, are used, they will surely break down in a short time, so that their lower cost will soon be offset by continued replacements. The condensers represent one of the major items of expense in building the amplifier, so that it is better to buy condensers suited to the job and have no cause for replacement.

Where the amplifier is to be used as a *B* voltage supply for the receiver, a group of tapped resistances is shunted across the output, and the various voltages which the receiver requires can be obtained from the taps starting with the negative end. This resistance requires from 15 to 18 milliamperes of current even when the receiving set is not connected, so that when it is not needed for *B* supply, the small toggle switch shown in the positive lead can be opened and the resistance disconnected from the rectifier. The switch is mounted on the top shelf between the two 50 watt tubes.

The plate current of the power tube is indicated on a 0-100 scale milliammeter, which can be short circuited when the current readings are not needed, by means of a small switch located on the panel above it. Three pilot lamps are mounted on the panel, to indicate conditions while the amplifier is operating. The left hand lamp is connected across the filament of the high-mu tube, to warn the operator that the battery is turned on; the center lamp is across the filament of the power tube, to indicate that the 110 a.c. is on, and

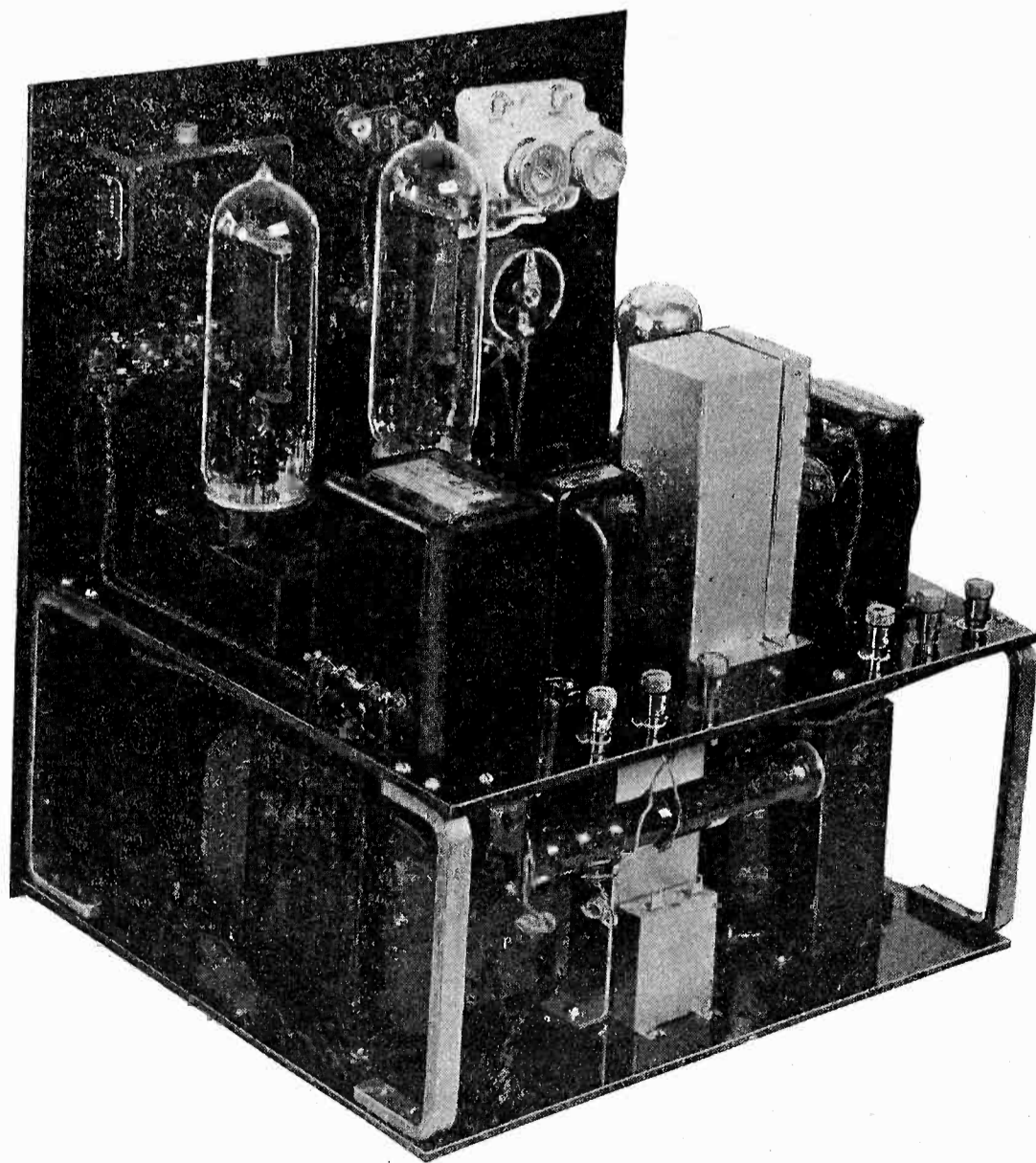

Rear View of Amplifier.

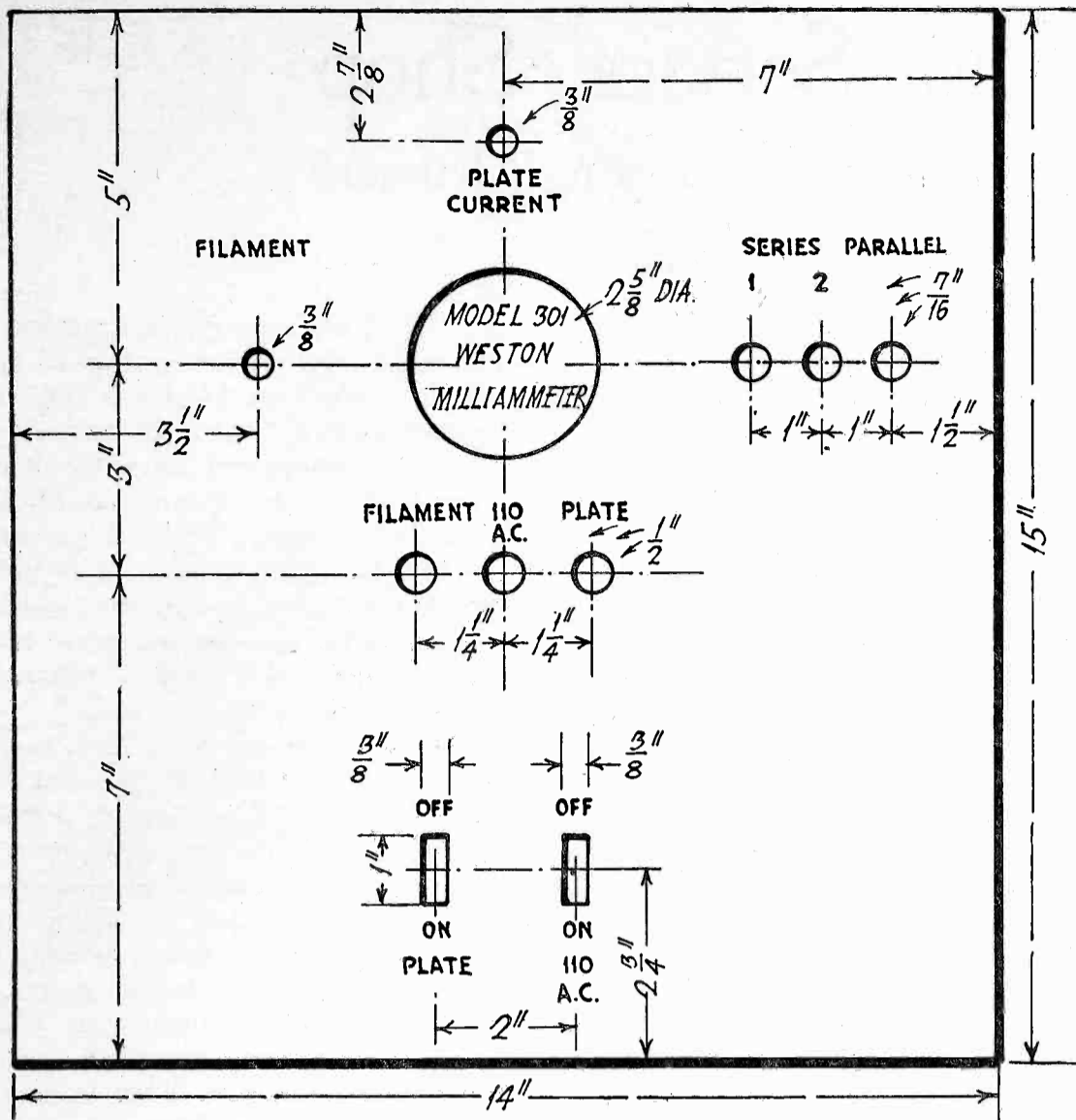

Fig. 2. Panel Dimensions, Showing Location of Toggle Switches.

the right hand lamp is in series with the negative *B* supply, to indicate the fact that the high voltage is connected to the amplifier. The first two lamps are standard 6 volt, .12 ampere miniature lamps, but the latter is a small flashlight bulb for 3 volt service.

Looking at the picture of the front panel, two toggle switches are seen at the bottom of the panel. The right hand one turns on the 110 a.c., and the left hand switch is used to connect the negative high voltage supply to the amplifier. These switches are of the flush wall type, ordinarily used with a metal plate, but in this case slots are cut in the bakelite, and the switches mounted on the back of the panel with machine screws set in holes drilled and tapped part way through the panel. At the left of the plate milliammeter is the filament rheostat for the high- μ tube, and at the right are the output jacks.

Looking at the panel from the rear, in the picture showing the rectifier equipment located underneath the top shelf, a small circuit breaker is shown at the left. This is a breaker such as is installed on washing machines, and is normally set at 6 amperes. By loosening up on the tension spring it can be made to operate at 2 amperes, so that in case the power tube plate current rises to 90 milliamperes or more, the breaker will operate and save the fireworks. Two fuses are also connected between the breaker and the main a.c. supply, as additional protection.

In building the amplifier, a front

panel 14x15x3/16 in. bakelite was used, with two subpanels 11 3/4 x 13 1/2 x 3/16 in. each. The subpanels were fastened to the front panel by means of brass angle brackets, which were made from 1/4 x 1/2 in. brass rod bent in the form shown in the pictures. The front panel drilling data are given in Fig. 2. On the bottom shelf were mounted the power transformer, filter condensers and chokes, and the 1000 ohm fixed resistance used to provide *C* bias for the power tube. The condensers were mounted between the transformer and the chokes, so as to partially shield the chokes from the transformer; it was thought at the time of building the amplifier that a metal shield would have to be placed around the power transformer to keep it from

introducing noise into the amplifier, but this was not found necessary.

On the top shelf are mounted the input and output transformers, fixed condensers, tube sockets, lavite resistors and *B* supply resistors, which are mounted underneath along the edge of the subpanel, so that they will clear the apparatus on the bottom shelf. Practically all the wiring can be completed on the two subpanels, before the top panel is placed over the other, so that there are no difficult connections to make.

The wiring from the power transformer to the filaments of the rectifier and power tubes was made in twisted pair, and passes through slots cut in the edge of the top panel where it joins the front panel, thus permitting removal of the former in case the apparatus on the bottom shelf needed attention. All wiring was done with heavily insulated No. 16 and 18 flexible or solid wire, as the voltage in the power tube circuit is too high for spaghetti to be employed with safety unless extreme care not to nick the insulation is used.

Binding posts for the *B* voltage supply to the receiver are mounted along the edge of the top panel, as well as the *A* battery posts for the filament supply of the high- μ tube. The 110 a.c. input is to the fuse block located on the back of the panel.

The operation of the amplifier is not difficult, and only requires a little courage to turn on the switches after the wiring has been completed and checked carefully for accuracy. See that all

(Continued on page 52)

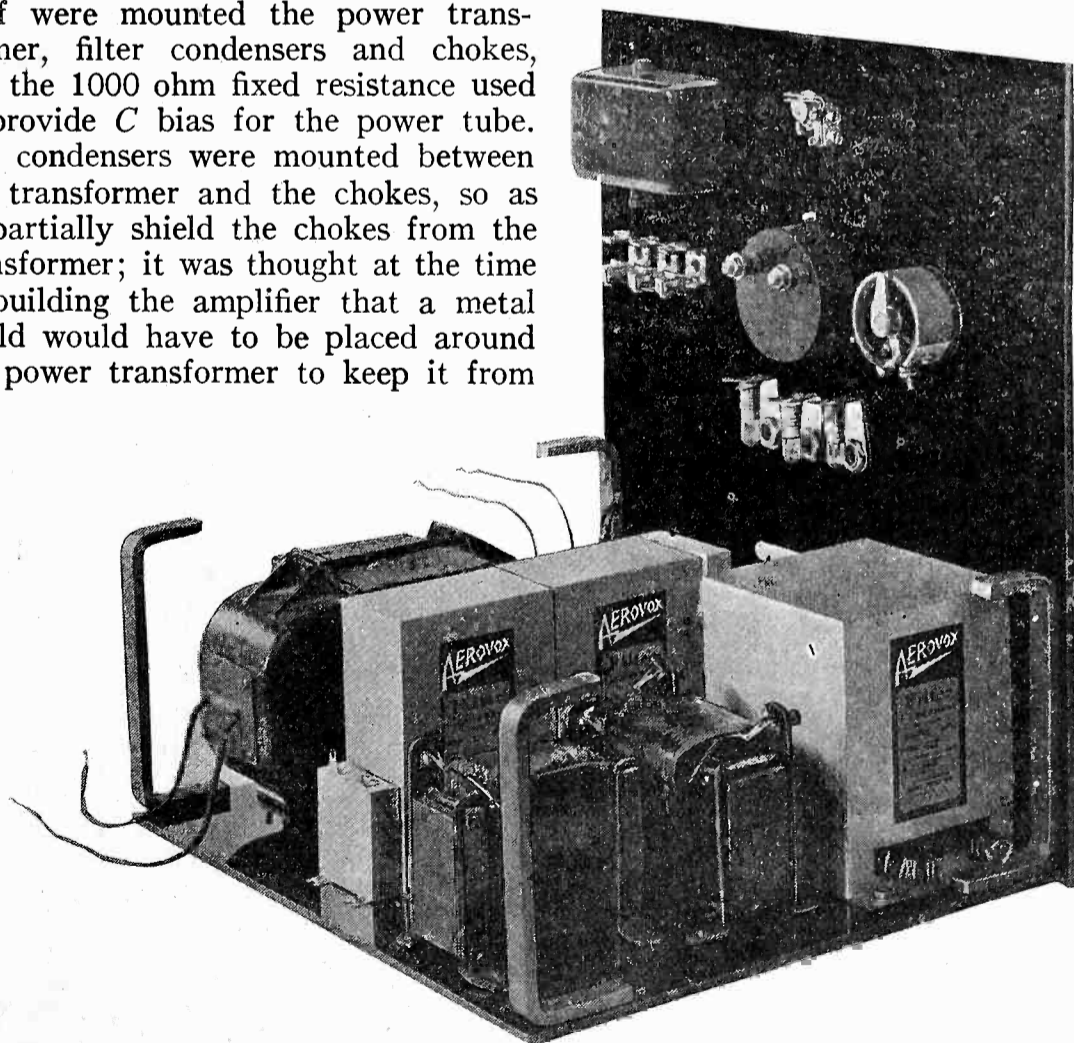

Bottom Shelf Assembly, Before Start of Wiring.

The Radio Service Shop

Its Location, Equipment and Testing Methods

By B. F. McNamee

The location of a shop should be at a good distance from any electrical apparatus, such as car lines or X-ray machines, which may cause disturbance in radio receivers. It is likewise important to avoid a location which has much "background" noise which might necessitate the use of excessive loudspeaker volume in testing.

The equipment depends upon the amount of work to be done and whether the service is to be general or concerned only with some particular article or line. The minimum requirements for general service work include a test table, work bench with usual tools, oscillator, wavemeter, tube tester, tube rejuvenator, batteries and charger, meters, standard receiver with comparison switch, standard speaker with comparison switch, and miscellaneous supplies such as wire, screws, collodion, lacquer, tape, etc. The tools should include a drill and a grinder. Other equipment may be added as needed.

A Portable Electric Drill to take drills up to 1/4 in. is a time and labor saver in the service shop, frequently of more use than a drill press, since it can be used on completed sets which could not conveniently be held in the drill press.

Machine Screw Sizes most required in radio work are the various lengths of 6-32, which will nearly fill all requirements. Next in order are 4-36, 8-32 and 10-32. Nuts, lockwashers and soldering lugs should also be on hand.

The following table shows the drill sizes for drilling tap and clearance holes for the above machine screws.

Size of screw	Drill for tap hole	Drill for clearance hole
4-36	No. 42	No. 33
6-32	No. 35	No. 28
8-32	No. 28	No. 19
10-32	No. 24	No. 10

Hook-up wire for the usual receiving set voltages may well be telephone switchboard wire. Instead of stripping the insulation at the ends, it can be pushed back, saving time and avoiding the nicking of the wire, which often causes a break later. This wire is tinned. For higher voltages, as in power amplifiers and B eliminators, No. 18 fixture wire is suitable.

Engraving filler may be obtained in small sticks from the Dixon Graphite Co. White engraving which has turned yellow can be removed with a sharp-pointed awl, and the stick of filler rubbed back and forth over the surface, crossing the engraving lines as much as possible. Then wipe off the excess filler with clean cheesecloth.

Collodion is useful for holding loose turns of wire on coils. It is painted on with a small brush, and dries very quickly. The drugstore carries the best variety, free from water. Keep covered, as it evaporates quickly. When too thick, it may be thinned with ether. On multilayer coils, apply on the outside only. Before painting a whole coil with collodion, be sure that the insulation on the wire is dry, otherwise the collodion will seal the moisture in.

Testing Methods

The entire receiver which is to be repaired should be given a complete test under actual receiving conditions. It is not sufficient to know that it works, but it is necessary to know how well it works. This involves comparison with another set whose sensitivity, selectivity, and fidelity of reproduction are known to be of a high standard. Every shop should have such a standard for relative comparison. Those who prefer absolute tests of performance are referred to the I. R. E. Proceedings, p. 387, May 1927, or to the Nema Handbook of Radio Standards.

The receiver comparison switch is a double throw switch having ten blades. It can be made from 2 four-pole D.T. switches and one D.P.D.T. switch, so mounted that their handles are moved by a single bar. Or these switches may be taken apart, the bases and handles discarded, and the parts used on a single new bakelite base and handle. Such a knife switch is freer from trouble than any other type. It is of course possible to construct switches of the jack type

or of the drum type for this purpose, the advantages being the saving in space.

The centers, or blades of the comparison switch are connected to the aerial, batteries and loud speaker, as shown in Fig. 1. The standard set is connected to one side and the set under test on the other side. The B battery taps not required on any particular set are left idle. The ground need not go through the switch. Use a separate C battery on each set.

The same station is tuned in on both sets, and results can be compared with practically no loss of time by throwing the switch. In this way the same aerial, ground, batteries, and loud speaker are used on both sets, and the rapid change from one set to the other does away with false comparisons due to fading, etc.

Batteries should always be disconnected while making any changes in the connections of a set. This lessens the danger of making short-circuits with tools or wires. There is a tendency to neglect this, due to loss of time involved, but with the comparison switch it is done with a single movement.

If a B eliminator not having complete voltage regulation on all taps is used on the comparison switch, the comparison between two sets is apt to be unfair, since the two sets may draw unequal currents from corresponding taps, with a consequent variation in voltage. For this reason B batteries are usually used, the storage type being preferred.

Comparison of sensitivity may be accomplished by tuning two sets to the same distant station. For more complete information about their relative sensitiveness, two or more stations of widely separated frequencies should be tried, since the qualities of broadcast receivers are usually quite different at different dial positions.

Comparison of selectivity can be made by tuning both receivers to some distant station while a strong local station, fairly near in frequency, is operating. The more selective set will have less of the local station in the background. If there is no interference in either set, a distant station still closer in frequency to the local station is tried. It must be remembered that in the case of some sets the comparison holds only for dial settings in the vicinity of the one at which the test was made.

A modulated oscillator may be used instead of a local station, if certain precautions are taken. It must be placed at sufficient distance from the receiving

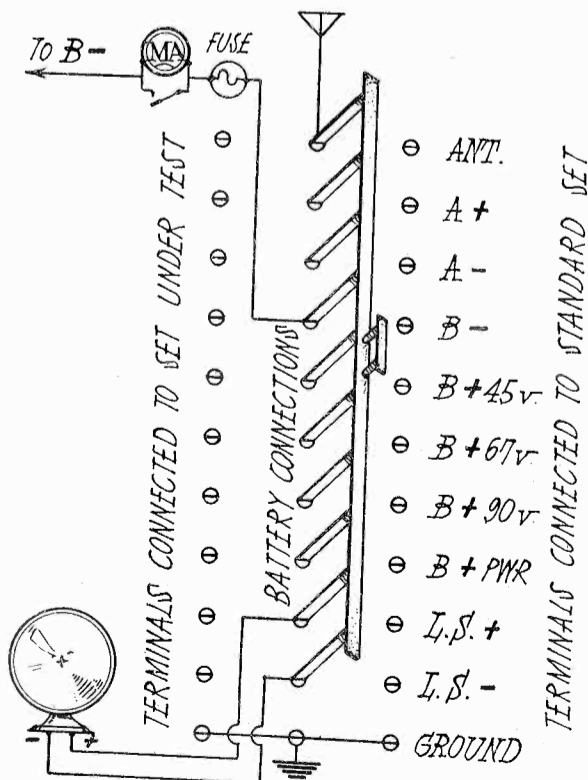

Receiver Comparison Switch

(Continued on page 54)

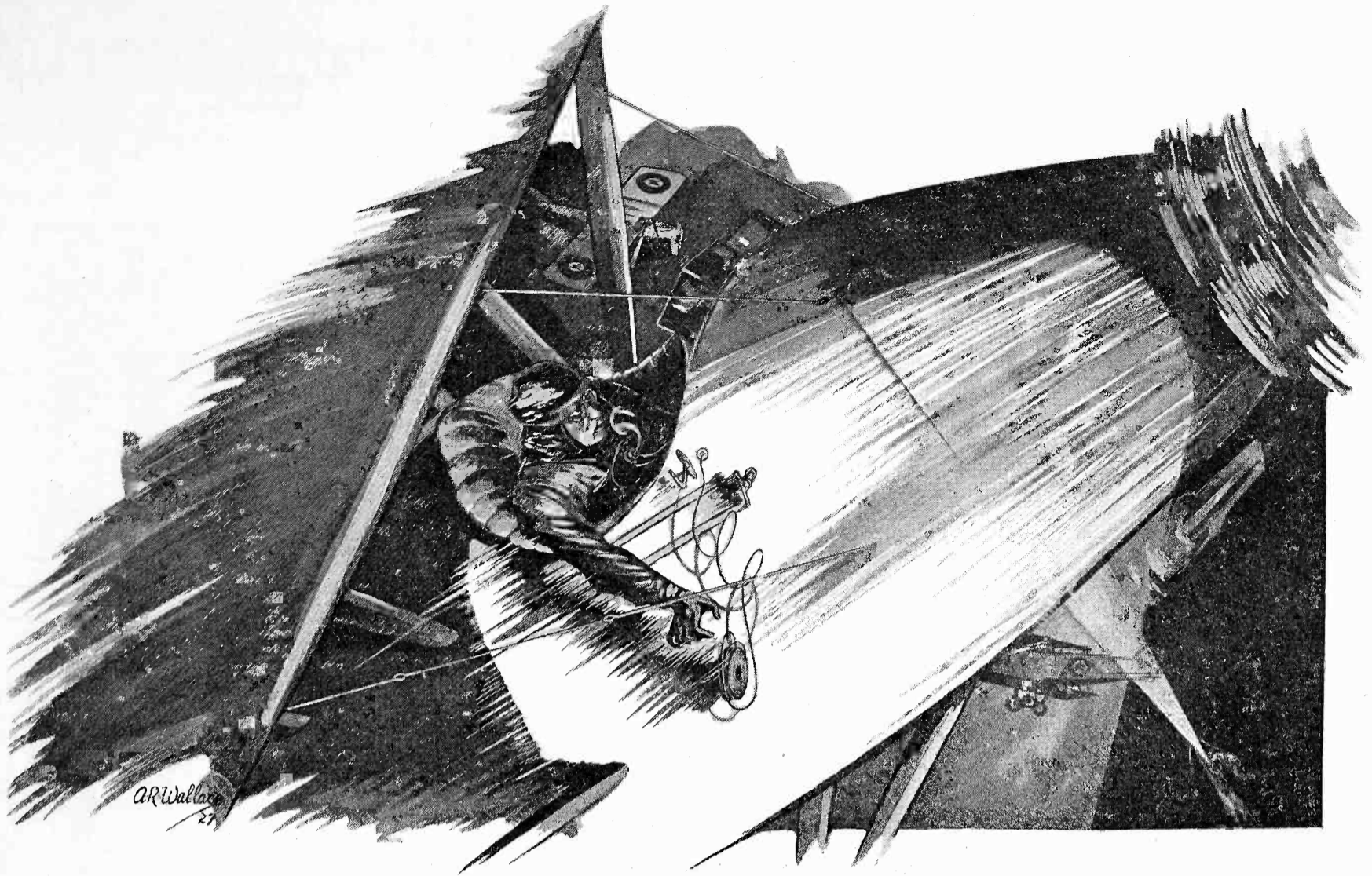

The Grey Phantom

By Earle Ennis

DAN CROWLEY, revenue chief, and Lamson, head of the prohibition forces, faced each other across the table in Crowley's office. Dan chewed a cigar and grinned cheerfully at the other's scowling face.

"Five hundred cases, eh?" he said. "Where'd they come ashore?"

"Somewhere between Bolinas and Eureka." Lamson spoke shortly. "We can't watch the whole coast, you know—not with the staff I've got."

Dan Crowley chuckled.

"So you want me to do it with one cutter, is that it?"

Lamson shrugged.

"It's a blamed sight easier to pick a boat loitering offshore than it is to find a truck on seven thousand miles of highway."

Dan removed his cigar and his smile disappeared.

"Oh, is that so?" he remarked sarcastically. "Well, say! Ever try to locate a runner in a fog? Ever see this coast when there isn't any fog? Go on—I've tried it. Those boys can slide past you a knot away and you'll never know they're there. They cut off the engine and use sails so we can't pick 'em with a sonophone. With a truck on the highway you've got a Chinaman's chance."

It was an old argument—one that always developed when the two got together.

"See the runner?" Crowley asked presently.

Lamson shook his head.

"It was all stacked on shore when we got there. They came up the coast in launches and picked Salt Cove for a landing. We grabbed two men, a horse and a sand dredge—and the hooch. The others got away. There were six in the party—and four launches. It's Canadian stuff. There's more out there in the fog—somewhere. That part's up to you."

Dan Crowley sighed and knocked his ashes into a tray.

"I guess it is," he sighed. He touched a button and an ensign entered.

"Radio Captain Hackett, in code, that five hundred cases of Canadian came ashore at Salt Cove last night, from an off-shore runner. That's all. Let me have his reply as soon as it comes."

Lamson rose when the ensign left the room.

"I'll run the two babies we caught through the wringer and see what they've got," he said, "but I don't figure on landing much. They probably tell the truth when they say they don't know anything. This Canadian ring is a foxy crowd. Nobody knows who is working for who. That keeps anybody from spilling it all. Good system."

Crowley nodded thoughtfully.

"Yes, and the only birds who can tell, are up in Canada where we can't reach 'em. What a life!"

The revenue patrol boat *Stowbridge* was cruising off Monterey Bay when the invisible finger of the radio reached out from the Custom House in San Francisco and laid down a message from Dan Crowley to Captain James Hackett, the cutter's commander.

"Onwort odus dencos vixen!" it read. It was signed "1221."

The operator of the *Stowbridge* grinned when he handed the message to his commander. Such messages usually spelt action and the crew was pining for something to do. Captain Hackett was conscious of the grin. He laid out the paper on his desk, and from a pocket cipher carefully decoded it.

"Hum," he said leaning back. "They put one over on us again."

"The *Grey Phantom*, sir?" asked the operator.

Captain Hackett nodded.

"Looks like it. Off Salt Cove this time—five hundred cases of the Dominion's best. They had a gun fight. Two, in the brig. The prohis think she's still there."

"Hot diggity!" exclaimed the operator.

He hucked his trousers with an unconscious motion and rubbed his hands. He had been a marine in the war, and the prospect of a fight always warmed his insides. He cast a loving look toward the cutter's guns, muffled under a protecting canvas. The old commander

(Continued on page 56)

A New Shielded Grid Tube

By W. James

A new era in r.f. amplification is opened by the appearance of a vacuum tube with a shielded grid. Heretofore it was necessary to externally neutralize the capacity that exists between the grid and the plate if oscillation is to be prevented. Even then perfect balance cannot be obtained because the neutralizing condenser has not the same phase angle in the inter-electrode capacity. Furthermore this neutralization is effective only over a comparatively narrow band of frequencies and requires re-adjustment if the receiver is to be maintained at its most sensitive stable working point.

By interposing a fine mesh secondary grid or shield between the usual grid and plate the inter-electrode capacity effect is overcome within the tube, making external neutralization unnecessary. For the British market this has been accomplished in the Type S625 Marconi shielded valve. Similar tubes are in experimental development in American laboratories and will undoubtedly be available in a short time as a four element tube.

The Marconi valve, as illustrated herewith, is seen to have five connecting prongs, two at one end and three at the

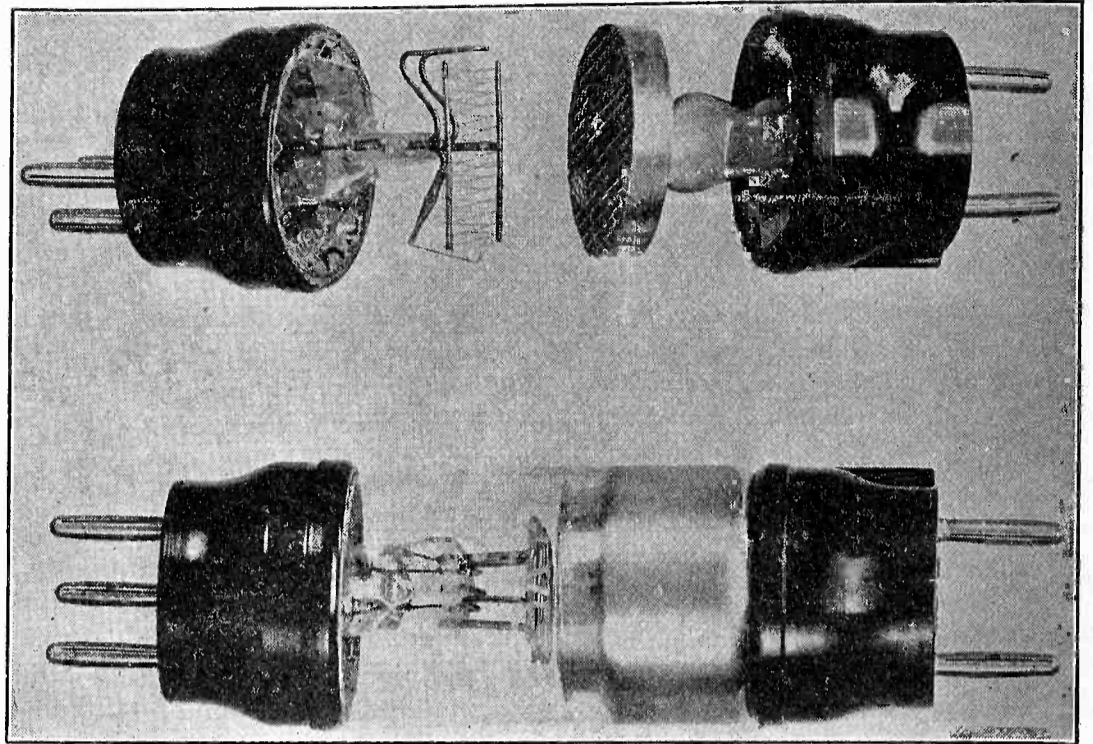

Marconi Shielded Valve.

other, the tube preferably being mounted horizontally. The control grid and filament are supported by and connected to a cap at one end of the glass tube and the plate and screening grid by a second cap at the opposite end, so that the "live" leads are as far apart as possible. The grid and plate circuits are separated by copper screening boxes so

arranged that the partition dividing them is in the plane of the screening grid, being cut away only just sufficiently to allow the glass bulb to pass through. The partition is earthed and the screening grid connected to a suitable point in the B battery, so that a complete electrostatic screen is formed. Approximately 120 volts may then be applied to the plate through a suitable high frequency transformer or tuned plate coupling.

Normal filament current is 0.25 amp. at 6 volts. With 120 volts on the plate, 80 volts on the screening grid, and 9 volts on the control grid, the amplification factor is 110 and the plate impedance is 175,000 ohms. The amplification factor and impedance vary within wide limits with changes of grid and plate voltage.

As the internal resistance is high, it is desirable to use "litz" wire for the short wavelength (up to 600 meters) coils to obtain maximum impedance when tuned and to reduce losses to a minimum. However, when ordinary coils are used the results obtained are in advance of those given by neutralized circuits and ordinary valves. The best type of coil is the single layer solenoid of 2 to 3 in. diameter for the broadcast band and a pile wound coil of similar size for longer wavelengths. Owing to the copper screens it is advisable to use some kind of "fieldless" winding to reduce eddy current and reaction effects. Two simple circuit arrangements are shown herewith, one for purity and one for range.

Thus the new screened valve brings within reach an amplification of 30-50 per stage with absolute stability and

(Continued on page 50)

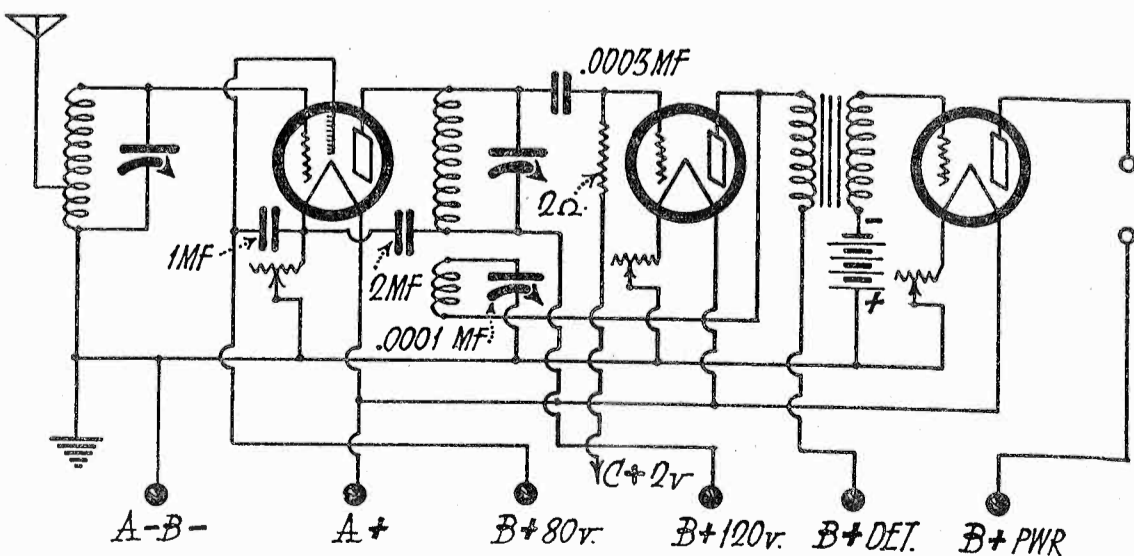
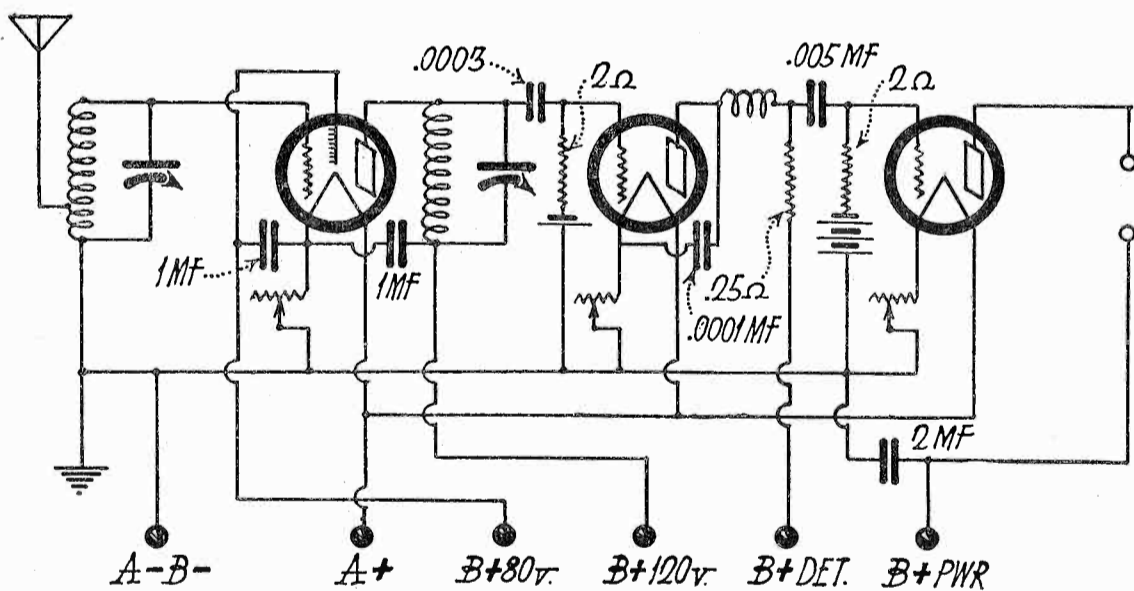

Circuit Diagrams for Using Shielded Grid Tube as R.F. Amplifier.

Adapting the Magnaformer 9-8 for A.C. Tubes

By D. B. Mc Gown

THE filaments of the new a.c. tubes are heated from a step-down transformer which supplies low voltage alternating current to the tubes connected in parallel. In the Magnaformer 9-8 receiver this requires the substitution of three of the nine four-prong sockets with five-prong sockets to hold the heater-element type of tube. Several changes must also be made in the circuit.

of r.f. amplification and the first audio amplifier tube are all type CX-326 tubes, with their 2 volt filaments operated from a separate winding on the power transformer. Each filament is shunted with a 60 ohm center tapped resistance which is so designed that it fits underneath the filament terminals of the tube socket, so that it is self supporting. As each tube draws slightly

one of these holes, was moved to the top of the sub-panel, where it was held in place with a small brass bracket. The detector tube is also of the C-327 heater type, and its heater is placed in parallel with the oscillator and mixer tube heaters, making a total of three C-327 and five CX-326 a.c. tubes. The power tube is a CX-371, and has its filament lighted from a.c. by means of a 5 volt winding

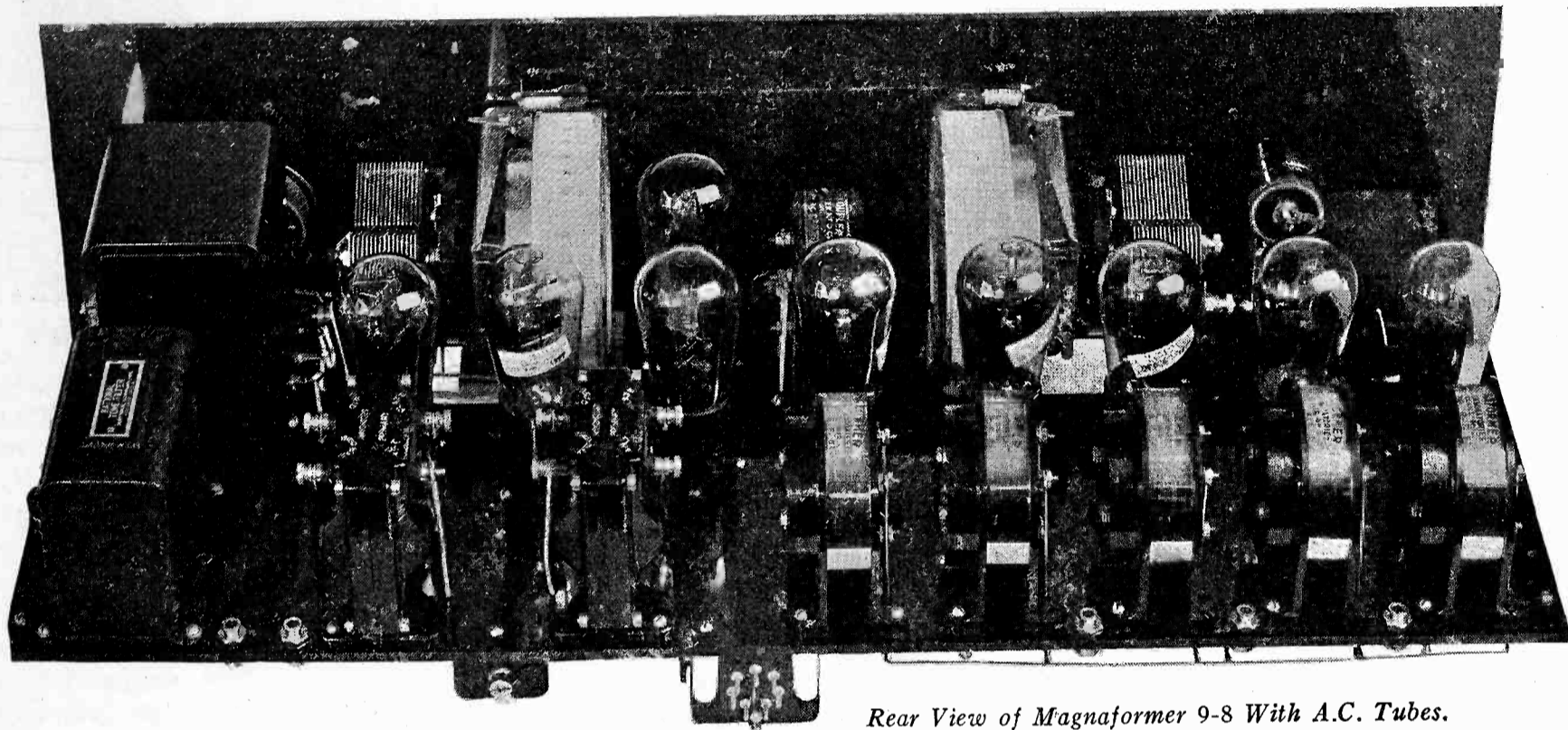

Rear View of Magnaformer 9-8 With A.C. Tubes.

The most practical method of connecting the a.c. tubes is shown in Fig. 1, which gives all wiring connections necessary. The oscillator and mixer tubes use C-327 a.c. heater tubes, with their heater elements in parallel, and connected to a 2½ volt winding of the special power transformer, which has a total of three windings for the various a.c. filament currents. The four stages

over 1 ampere, a ½ ohm rheostat must be used for every three tubes, so that the first three r.f. tubes are operated from one rheostat, and the remaining two CX-326 tubes from the other ½ ohm rheostat. As there are two rheostat holes drilled in the sub-panel, the two ½ ohm rheostats were mounted in these positions, and the midget feedback condenser, which was formerly placed in

on the power transformer.

The cathodes of the three heater type tubes, as well as the center taps of the filament resistances, are all made common and grounded, so that they form the negative B battery connection to all tubes. The power tube being operated from 5 volts, is shunted by a separate 60 ohm resistance, but the mid-point is connected to the same center tap and ground as the others.

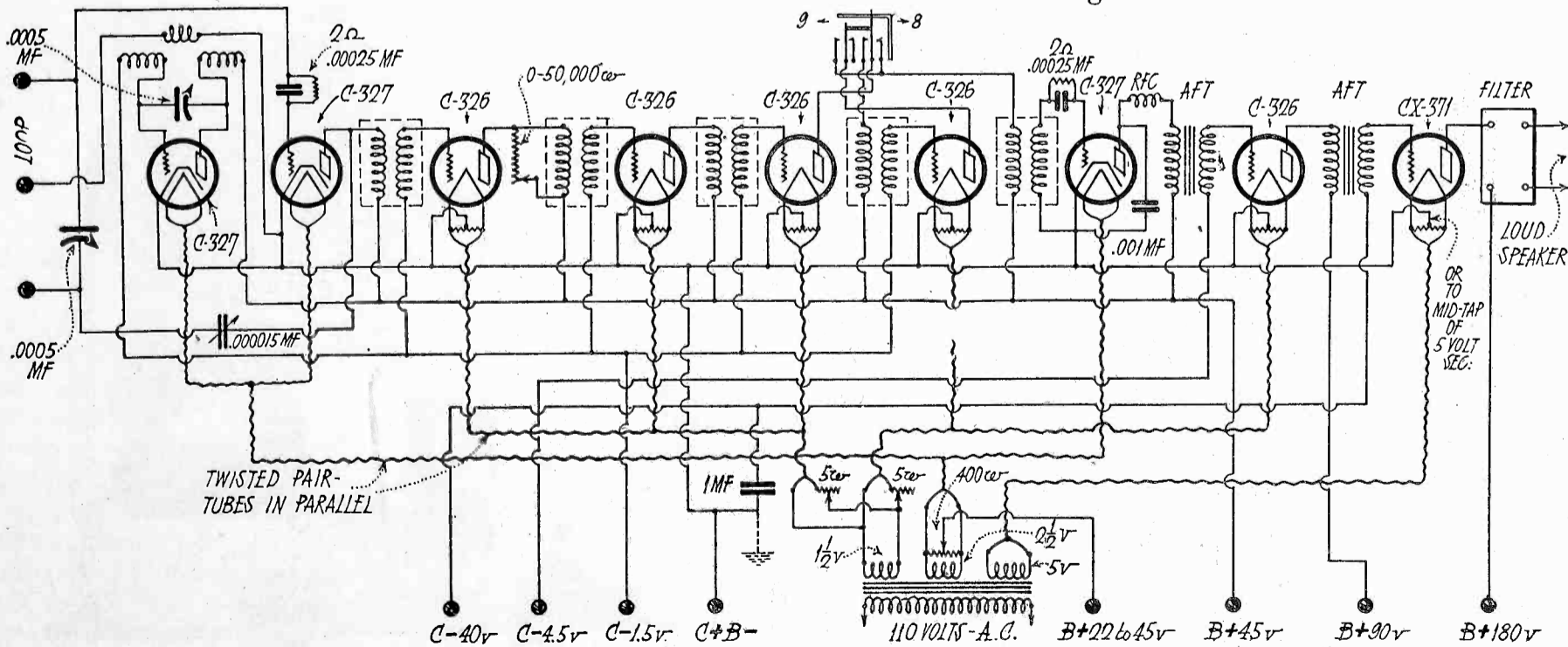

Fig. 1. Wiring Diagram of Magnaformer 9-8, With A.C. Tubes.

The oscillator, mixer and r.f. amplifier tubes are operated from 45 volts *B*, instead of 90 volts, and have a 1½ volt negative grid bias. The r.f. amplifier gain is controlled by a 50,000 ohm variable resistance shunted across the primary of the second r.f. transformer, as the filaments of the a.c. tubes cannot be varied to control the volume, and the potentiometer system of gain control is not practical.

The heater filament supply leads are shunted with a potentiometer, and a tap taken from the *B* supply at the 22½ or 45 volt point is connected to its slider, so that the heater is made 22½ to 45 volts positive with respect to the cathode. This permits the adjustment of the slider so that there will be no a.c. hum. As the secondary voltage is very low, a potentiometer of 6 ohms may be used. Since a 400 ohm potentiometer was originally used with the battery operated Magnaformer 9-8 set, it may be used at this point without difficulty, and is mounted on the panel at the right hand end.

For the convenience of those who wish to convert their set to a.c. tube operation, a list of the new parts required is given below:

- 3—A.C. tube sockets—5 prong
- 6—General Radio Type 439 Center Tap Resistances (60 ohm)
- 1—General Radio Type 440-A, Low Voltage Transformer
- 2—General Radio ½ Ohm Type 410 Rheostats

The primary of the power transformer may be connected in parallel with the input to the *B* power plant, so that the entire set may be turned on or off with one switch. As the heater type tubes are slow in starting or stopping, it will be necessary to wait a short time after the current is turned on, before signals are heard. Bad a.c. hum is a sign of unbalance either in the heater tube circuits, due to faulty adjustment of the

HOW TO CHECK RESISTOR VALUES

By HARRY R. LUBCKE

The slight variations from the rated values of resistors which are inevitable in manufacture may easily be checked with a voltmeter and battery. This is useful in securing the maximum results from a set when exact value of grid-leaks, for instance, are specified. Low resistance from 500 to 10,000 ohms can be measured with an ordinary voltmeter while high resistances from 10,000 ohms to 8 megohms require a high resistance voltmeter with high voltage battery or *B* eliminator.

Only two readings are required for a determination; one with the voltmeter across the source of voltage, and the other with the resistor under test in series with the voltmeter. This is shown in Fig. 1. The first reading, called D_1 is secured by making the connection shown dotted and marked 1 opposite the resistor; the second, D_2 , by removing this lead and connecting it at 2.

The second reading will be less than the first because of a voltage drop that occurs in the resistor. For any one determination the original voltage of the battery (or socket-power device) *B* should be such that a convenient and readable difference in D_1 and D_2 is obtained. For example, the battery volt-

potentiometer, or to an unbalanced shunt resistance across one of the CX-326 tubes. Do not use the latter tubes in either the oscillator or mixer tube sockets, as a slight unbalance may modulate the output of the oscillator, and cause an a.c. hum which will be impossible to eliminate. Be sure to run all a.c. filament leads in twisted pair, as is shown in the picture of the under part of the subpanel. Rubber covered No. 18 wire is excellent for this purpose, and if it comes in single lengths, it may be twisted easily.

age used for measuring the resistance of a Tobe Loewe Leak rated at 1 megohm was 210 v., making $D_1=210$ and $D_2=33$.

Having these two readings it is only necessary to substitute them in the following formula and the result is obtained. $X=R(D_1-D_2) \div D_2$ where *X* is the resistance of the unknown resistor,

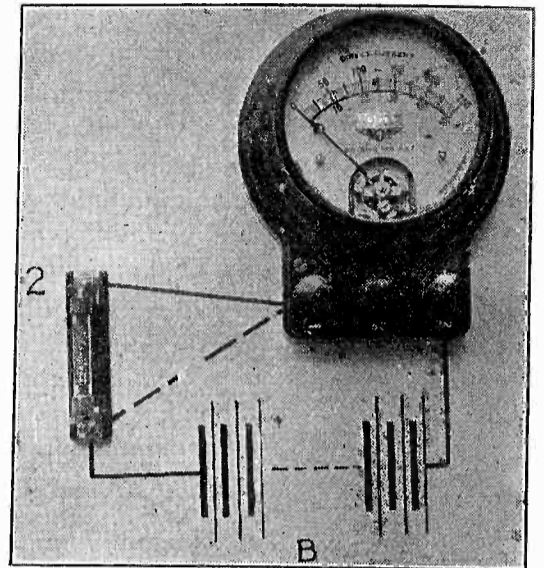
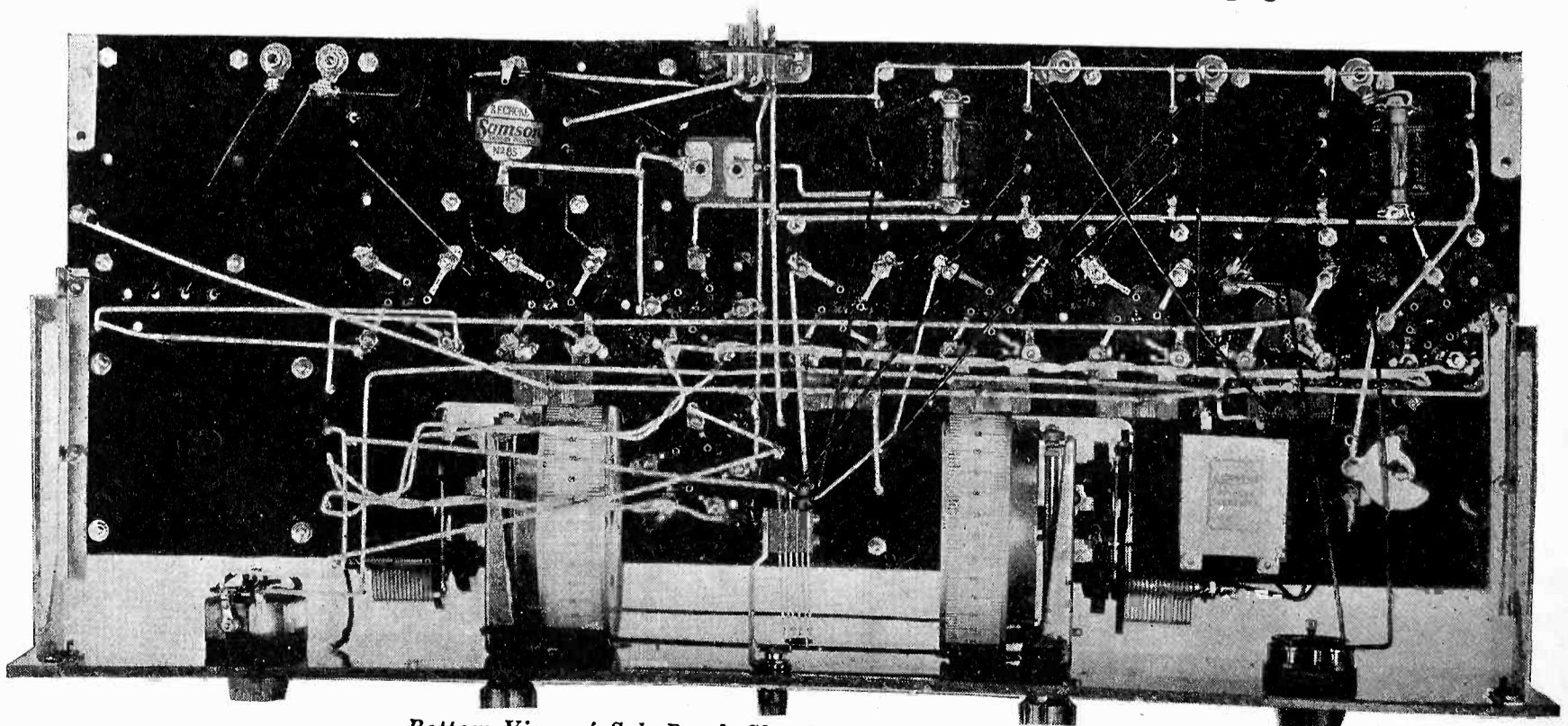

Fig. 1. Connections for Resistor Measurement.

R is the resistance of the voltmeter, D_1 is the first reading, and D_2 is the second reading.

Since the resistance of the Weston Model 301 voltmeters of low range are 62 ohms per volt, *R* for a 0-10 v. range would be 62×10 or 620 ohms. Similarly, for the Jewell 116 meter the resistance is 40,000 ohms for the 50 v. range and 200,000 ohms for the 250 v. range, while for the Weston 489 it is 50,000 ohms and 250,000 ohms for the 50 and 250 v. ranges respectively.

For the example considered we have, since the meter resistance, *R*, was 200,000: $X = 200,000 (210-33) \div 33 = 1,070,000$ ohms. Dividing by 1,000,000 to get megohms we have 1.07 megs., which is very close to its rated value as these things go.



Bottom View of Sub Panel, Showing A.C. Filament Wiring.

Rectifiers

A Simple Explanation of the Theory Involved in Determining the Efficiencies of Various Types

By G. F. Lampkin

IF YOU have ever had to carry your *A* battery to the service station, perhaps after it went dead at a critical moment; or have had to fit the set up with 135 more volts of heavy-duty *B* battery; or have tried to copy the raw a.c. signals from the other fellows transmitter, then you can appreciate how radio has immensely widened the field for use of a.c. to d.c. conversion units. As by far the greatest part of domestic electrical supply is alternating current, it is but natural to use this as a power source, and do away with the inconvenience and expense of others. So that there are considerably more than fifty-seven varieties of conversion units that are available today in the form of chargers, trickle chargers, *A*, *B* and *C* eliminators, transmitter supplies, and so on. These units are all alike in one respect, in that a rectifier is a most essential part of their makeup; and the rectifiers are further alike, in that they all operate on the principle of unsymmetrical conduction of current.

The alternating current is not unsymmetrical—the pictorial representation by a sine wave, as in Fig. 1, shows this.

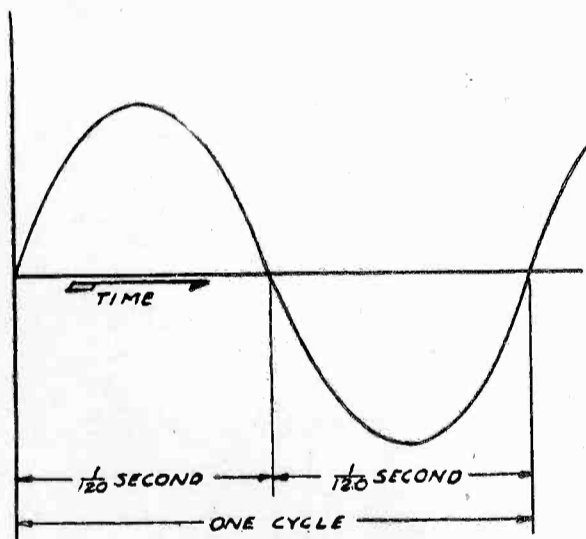

Fig. 1. Representation of Sine Wave.

The vertical distance from the zero line to a point on the curve corresponds to the value of current flowing at that instant. If the distance is measured up from the line, the current is arbitrarily said to be flowing in a positive direction; and, conversely, in a negative direction when the distance is measured down. In the case of domestic alternating supply, the cycle of actual flow of current in one direction, stoppage, and flow in the reverse direction, happens 60 times a second.

When an a.c. ammeter is put in the circuit to measure the flow of current, its deflection does not reverse when the

flow of current reverses. It is so made that it gives a positive reading for either direction of current flow. But the moving part of the meter is too heavy to follow the instantaneous values of a current that varies from zero to maximum and back to zero in 1-120th of a second. What the pointer does is to take up an intermediate deflection between the zero and maximum values of the current. This deflection corresponds to the effective value of the current, and is 70.7 per cent of the maximum.

There are other ways of looking at the effective value of an alternating current. Suppose there are two electric heaters—resistors—which are exactly alike, and alternating current is passed through one and direct current through the other. When the two resistors are giving off equal amounts of heat, the value of the direct current in one is equal to the effective value of the alternating current in the other. Thus the derivation of the term, “from equivalent effect in heating.”

If we put a direct-current meter in the circuit where an alternating current is flowing, its reading will be zero. For the deflection on a direct-current meter is not independent of the direction of current flow, but reverses as the current reverses. The alternating current is symmetrical about the zero line, so that the tendency for the meter to show a deflection above zero on the positive half wave is counterbalanced by the equal tendency below zero on the negative half. And as the pointer is comparatively inert for the 60-cycle variations, its deflection remains zero. In other words, it indicates the average value of current flow.

Another way of determining the average value of the wave is to work with

areas. If we divide the area of any figure by the length of its base, we obtain its average height. The area in the case of a current wave is that included between the curve and the zero line. Areas above the line are considered positive, and below the line, negative. Thus the total area in one cycle of an alternating current is zero, so that the average height, corresponding to the average value of current, is zero.

Now suppose that an unsymmetrical conductor—a rectifier—is included in series with the circuit, as in Fig. 2a. As indicated by the name, the device will conduct current better in one direction than the other. The result is that more or less of one-half of the current wave is cut off. The areas above and below the line are no longer equal, so that the average value of the current is not zero, and the d.c. meter shows a current. Such a setup could be used for charging a storage battery.

Incidentally, it may be seen why a d.c. meter should always be used to measure the charging current of a battery. An a.c. meter would read both charging and discharging current, if any of the latter were present in the form of an alternating current. But of course the ideal rectification method would be to use a device which would conduct no current whatsoever in the negative direction, and so cut the lower loops of current completely off. In the positive direction, the device should conduct current perfectly. In other words, the ideal rectifier would offer infinite resistance to the flow of current in the negative direction, and zero resistance to flow in the positive direction.

The efficiency of a rectifier, as such, has been expressed in several ways. One such defines the rectification efficiency

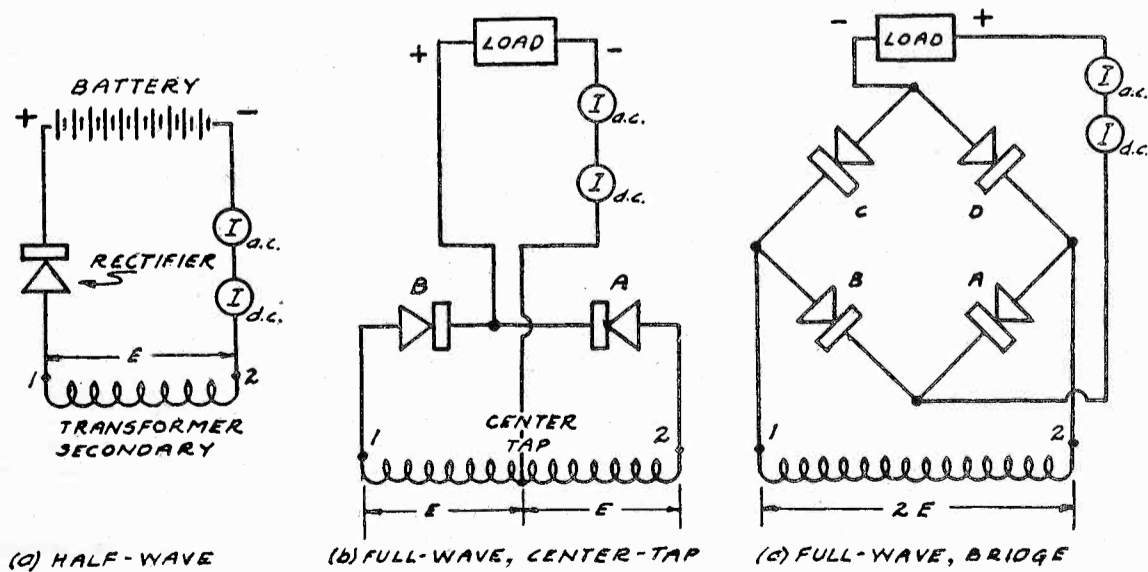

Fig. 2. Rectifier Connections.

simply as the ratio of the average value of the current to the effective value. That is, the ratio of the reading of a d.c. to that of an a.c. ammeter; both meters being placed in the circuit to measure the output current of the rectifier.

This means that if the output were alternating current, the efficiency would be zero, for the d.c. reading would be zero. If the lower loop of the sine wave of current were completely cut off, the d.c. reading would be 31.8 per cent of the maximum value of the remaining loop; the a.c. reading would be 50 per cent of the maximum, so that the ratio would be $\frac{31.8}{50.0}$, or 63.6 per cent. This

would be the maximum possible rectification efficiency of a half-wave rectifier.

Obviously better results could be had if both halves of the alternating current were used. To do this two rectifier elements can be hooked up in a full-wave rectifier as in Fig. 2b. On the positive half cycle for element *A*, the current flows through it, out to the load, and back through the transformer center tap. The next half cycle, negative for element *A*, is positive for element *B*, and the current path is through the latter, the load, and back to center tap. Thus the two elements, with their respective halves of the transformer winding, work alternately to utilize the full wave of current.

Sometimes it is a disadvantage to use a center-tapped transformer, for the output voltage is only half that available from the secondary. To make use of the full transformer voltage, and both halves of the wave, four rectifier elements can be hooked up into the bridge circuit of Fig. 2c. It can be seen that elements *B* and *D* operate when terminal 1 is positive, and elements *A* and *C* when 2 is positive. The bridge rectifier takes four elements, but as the output voltage is doubled, the number of elements for a given output voltage is the same for either a bridge or a center-tap rectifier.

The respective d.c. and a.c. readings on the output of a full-wave rectifier would be 63.6 and 70.7 per cent of the maximum. This would figure a value of 90 per cent as the ideal rectification efficiency for such a rectifier, when using the above definition.

The "rectifying power" is an expression that assumes that the chief function of the rectifier is to block the passage of reverse current, and if this is done completely the device is rated at 100 per cent. The expression states that the rectifying power is equal to the difference of the forward and reverse currents, divided by the forward current. Thus if the reverse current is zero, the ratio becomes 1 to 1, or 100 per cent.

The "rectification ratio" is sometimes

taken as the ratio of the forward to the reverse current. All these expressions will give values, which, in actual practice, will depend on the load resistance.

A fairly accurate conception of how closely a rectifier approaches the ideal can be had from a current-voltage characteristic of the device. The characteristic is obtained by connecting the rectifier with an ammeter and voltmeter to a direct-current supply; the voltage is varied, and the current read at each point; then the procedure is repeated with the connections to the rectifier reversed. The results, when plotted on cross-section paper, will take the form shown in Fig. 3, which shows a characteristic for a thermionic rectifier—a UX-213B. A characteristic for a single disc of one of the dry copper-oxide rectifiers, and another for a tantalum-lead-sulfuric acid rectifier, are given. If a device were a symmetrical conductor, that is, a pure resistance, the current-voltage characteristic would be simply a straight line through the zero point. If it were an ideal rectifier, the characteristic on the forward half would be a straight line up the current axis, for at any value of current the drop would be zero; on the negative

half, the characteristic would be a straight line to the left on the voltage axis, for the reverse current would always be zero at any value of reverse voltage.

The thermionic rectifier fails to pass reverse current when the voltage is run up above 300. In its case, the operating voltage is limited by the voltage at which the insulation at the stem of the tube breaks down. The operating voltage on the other types of rectifiers is limited by the reverse current. In the battery-charging sketch of Fig. 2a, when terminal 1 of the transformer is positive, and 2 negative, the rectifier passes current and the battery charges, as noted before. On the next half cycle, when terminal 1 is negative and 2 positive, the battery voltage and the transformer voltage add up, so that the reverse voltage across the rectifier is practically twice the maximum voltage of the transformer.

Similarly, in the full-wave, center-tap rectifier, when the element *A* is conducting—terminal 2 positive—the full transformer voltage from 1 to 2, or twice *E*, is impressed as a reverse voltage on element *B*. In the bridge circuit, when element *A* is conducting, the transformer

(Continued on page 76)

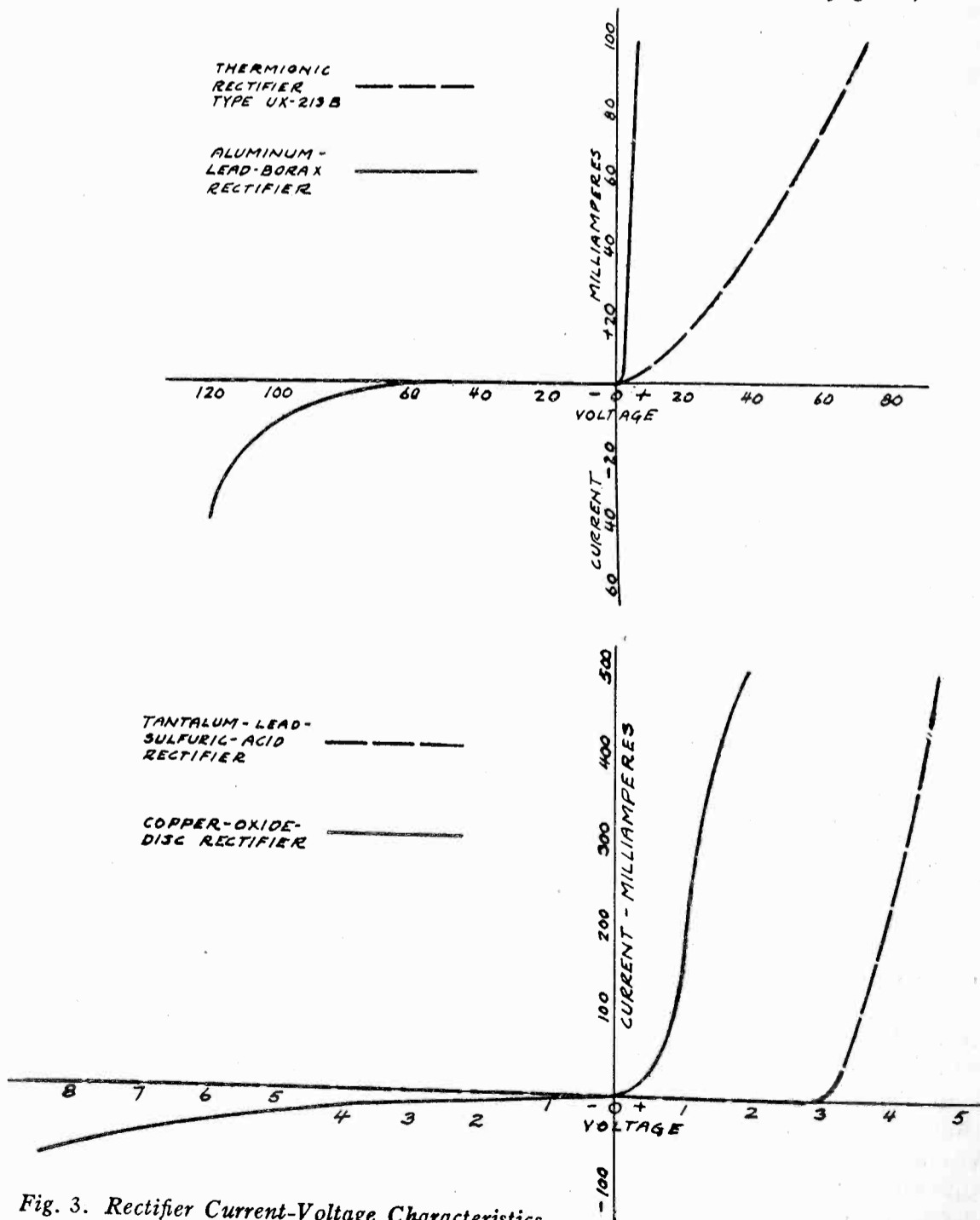

Fig. 3. Rectifier Current-Voltage Characteristics.

A Power Amplifier for the Infradyne

A Socket Power Unit Providing Plate and Grid Voltages for the Set Together With a Power Stage of Audio Amplification

By E. M. Sargent

A SATISFACTORY method of plate voltage supply from socket power instead of batteries has been developed for the infradyne receiver after many unsuccessful efforts to use some of the B eliminators ordinarily available. The relatively heavy plate current drain by ten tubes causes the voltage delivered by some eliminators to drop below that required for the operation of the infradyne, and where the voltage is sufficient for ten tubes it may be too great for the five tubes when the 5-10 switch is thrown.

These difficulties have been overcome

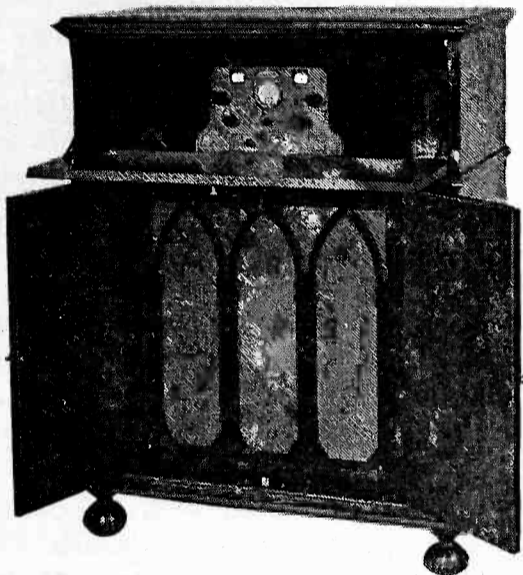

Infradyne in Excello Console With Built-in Speaker and Power Unit

- PARTS USED IN INFRADYNE POWER AMPLIFIER**
- 1—Baseboard, pine, 12 by 28½ by 1 in.
 - 1—Baffle Board for mounting loudspeaker, pine, 28 by 24 by ¾ in.
 - 1—Set Binding Posts, X-L, 22½ V., 67 V., 90 V., C—, C plus, 400 V., Plate, A— and A plus
 - 1—Thordarson R200 Audio Transformer for power stage
 - 1—Thordarson R76 Output Transformer
 - 1—Thordarson R210 Power Compact
 - 1—Tobe R210 B Block
 - 1—Tobe 1 mfd. Bypass Condenser
 - 1—Tobe 2 mfd. Bypass Condenser
 - 1—Excello or Ehlert Console as illustrated
 - 1—Yaxley Automatic Power Control Unit
 - 1—½ ampere to 2 amp. trickle charger. Thordarson 2 amp. or Rectox ½ amp. (Depending on service required from set.)
 - 1—6 volt Storage Battery, 100 ampere hour capacity
 - 3—Remler Sockets
 - 1—Bakelite strip, 1 in. by 12 in. for mounting binding posts
 - 1—CX-310 Power Tube
 - 1—CX-374 Glow Tube
 - 1—CX-316B or 381 Rectifier Tube
 - 1—No. 2313 Carter Resistance Kit
 - 1—Ward Leonard S-5000 ohm Resistance
 - 1—Loudspeaker (Electrodynamic speaker illustrated)
 - 1—Jewell or Weston high resistance Voltmeter, 0 to 250 volts

by using a 400 volt rectifier and filter with a suitable resistance unit for cutting down to the required voltages, and by using a glow tube to control voltage variations. With this equipment available it is also possible to use a 310 power tube in the last stage of audio with 7½ volt a.c. filament supply, which is also used for the filament of the 316-B rec-

tifier. Filament current for the other tubes may then be secured from a storage battery with trickle and booster charger, as indicated in the accompanying diagrams, or from an A battery eliminator. This gives a set operated from the 110 volt a.c. supply mains.

Plate voltages of 22½, 67 and 90 volts are secured through a Carter No. 2313 resistance unit equipped with sliders which can be initially set in the

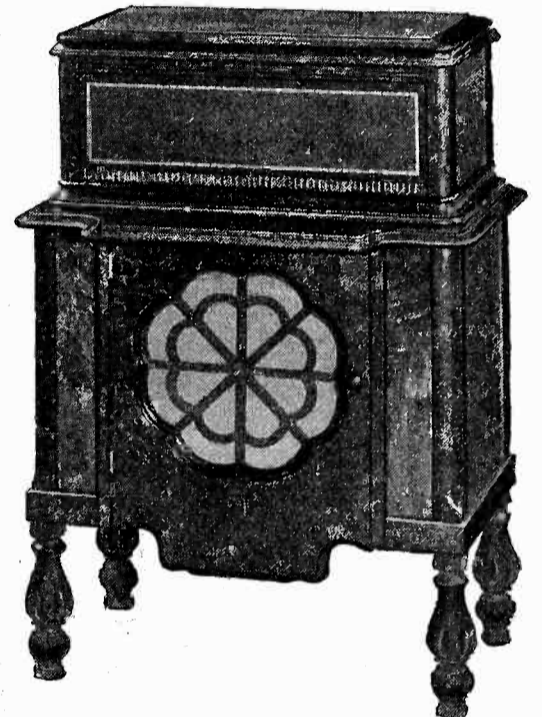

Infradyne in Ehlert Console With Built-in Power Unit.

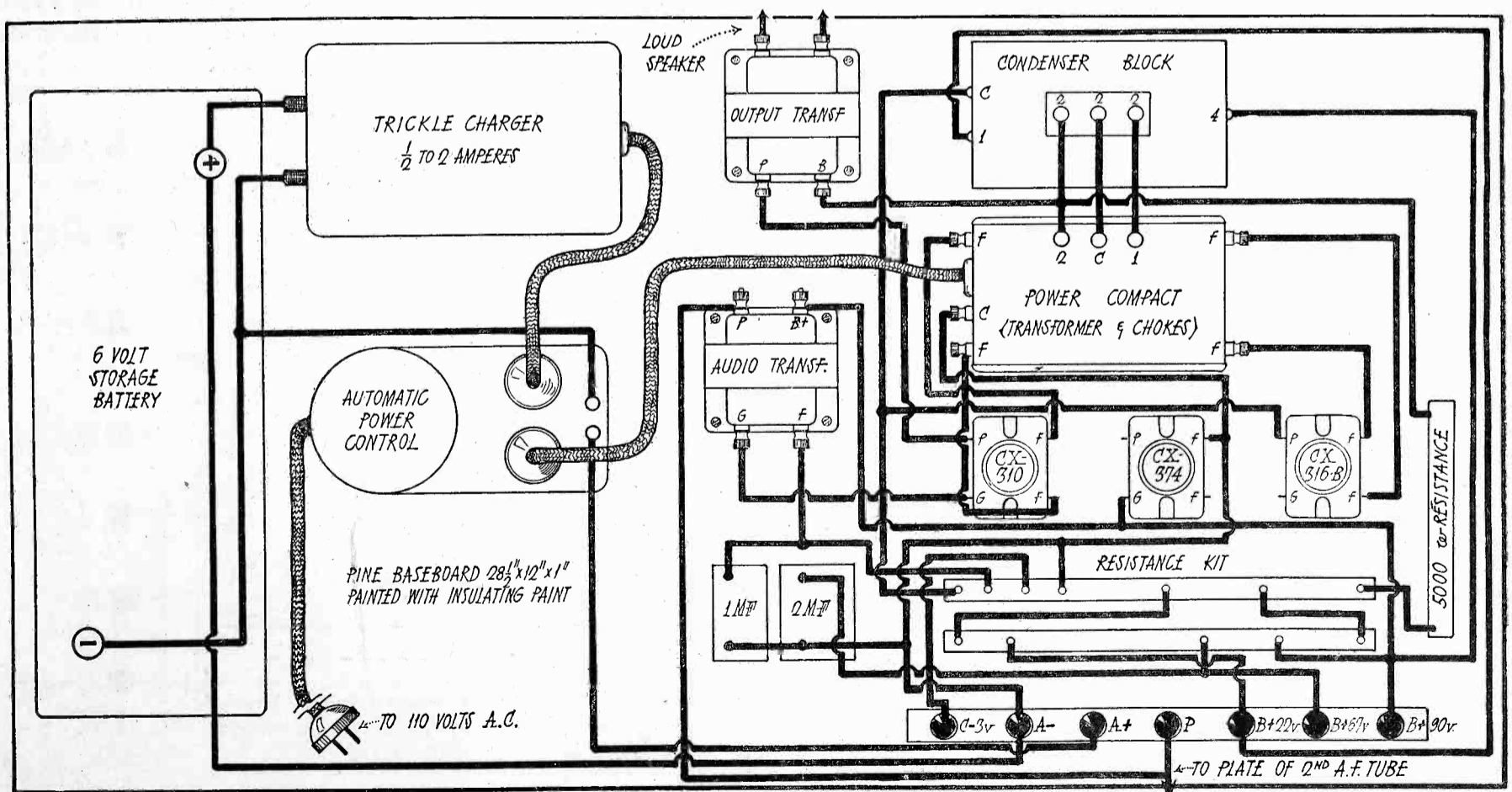

Pictorial Wiring Diagram of Power Supply Unit.

proper positions. This unit also gives the requisite C voltages. By using the settings marked on the diagram in inches, the required voltages may be closely approximated without measuring them with a high resistance voltmeter.

charger is recommended where the set is used more than two hours a day.

The pictures show the power supply unit housed in a large Excello console and in a smaller Ehlert console with a walnut case for housing the receiver.

ly high voltage if the power unit is turned on when the filament current is not in the tubes in the set. This precaution has prevented many a burn-out as it insures a load for the power supply unit.

This system is applicable to either the old or new models of the infradyne and the usual battery cable may be used without change by running a plate lead from the first audio transformer in the receiver to the P post of the power supply unit.

Where obtainable the UX-281 or CX-381 rectifier may well be substituted for the 316-B, as the former has a maximum possible output of 110 milliamperes as compared with the latter's 65 milliamperes.

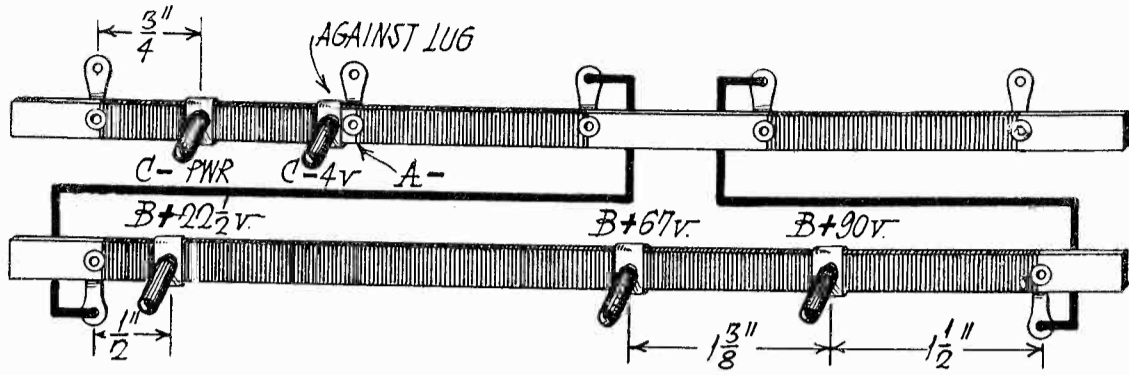

Resistance Unit Settings.

The constructional details are self-evident from the pictures and diagrams together with the list of parts used in the construction of the unit shown. The use of a 2 ampere booster charger in connection with a 1/2 ampere trickle

The former has ample space for an electrodynamic speaker with baffleboard or for other types of loudspeakers.

The automatic power control unit or relay switch is not only a convenience but also a protection against dangerous-

LABORATORY NOTES ON THE TYRMAN TEN

Experiments with the Tyrman Ten, described in October RADIO, have shown that the push-pull transformers in the last audio stage are well adapted for use with UX-210 power tubes. Tremendous volume without distortion is this obtainable. Two UX-171 tubes in parallel deliver about the same energy as one UX-210. By using two of the latter tubes the energy is practically doubled.

This is accomplished without any change in the set excepting to supply the 210 filaments with ac. from the input transformer. A Thordarson 210 power pack and B eliminator proved satisfactory for the purpose.

The appearance of the receiver has excited much favorable comment because of its beauty which rivals that of much more expensive factory-built models. It is considered an outstanding example of what can be accomplished in home-built receivers.

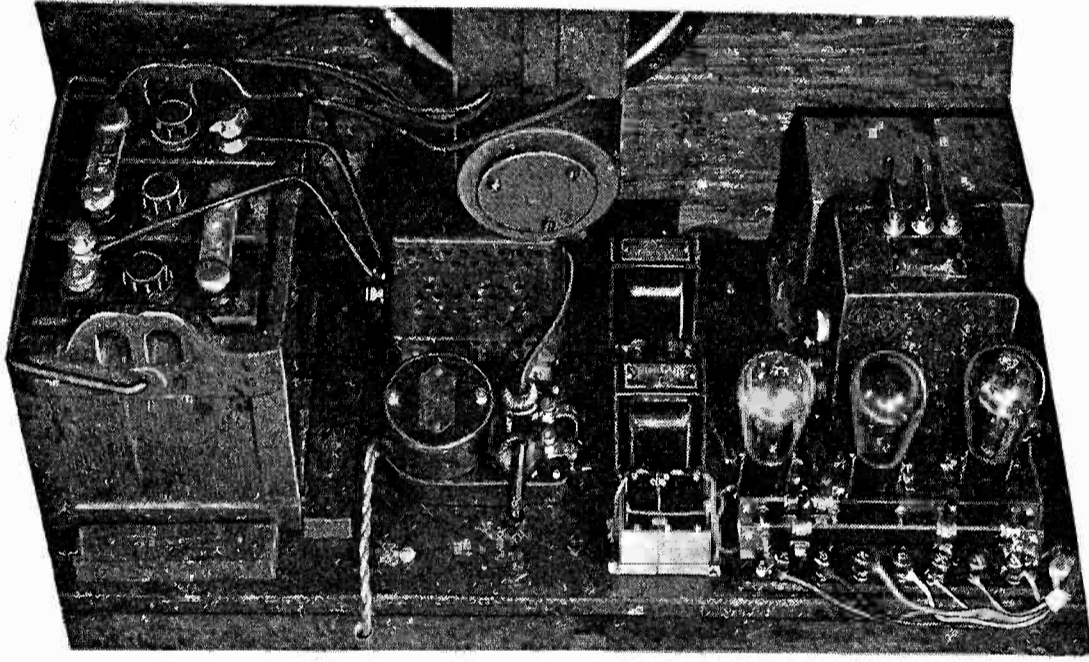

Rear View of Power Unit and Baffleboard Mounting.

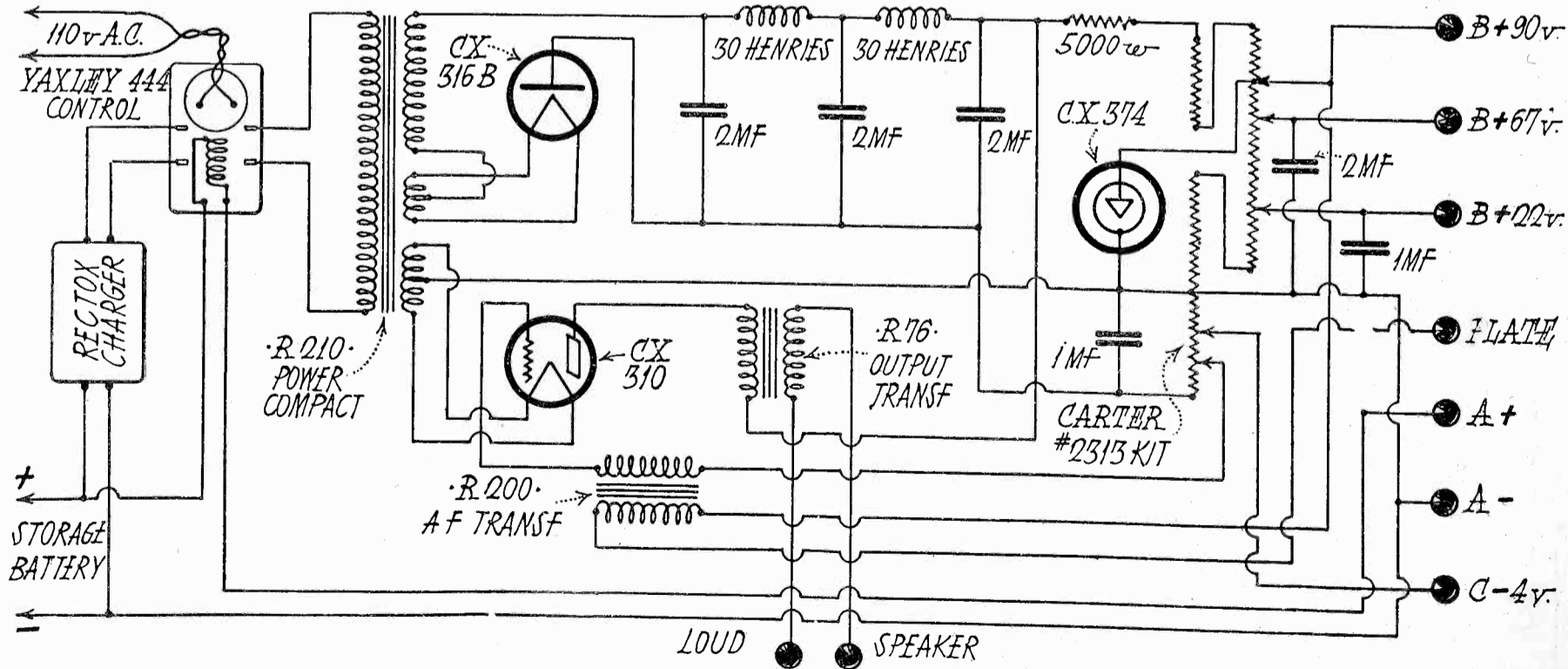

Schematic Wiring Diagram of Power Supply Unit.

A Tiny Superhet

By G. M. Best

A PORTABLE receiver, to fulfill the title in every sense of the word, must be light in weight, small in dimensions, and economical of batteries. This is hardly possible where the receiver must be capable of supplying volume for loud speaker service, as the B batteries necessary for such a receiver would be quite heavy, and the set correspondingly cumbersome.

Where headphones alone are to be used, the problem is simpler, and the set shown in the pictures is the result of a desire for a receiver having a range of at least 500 miles at night, with a loop antenna, with an absolute minimum of weight and space, together with the smallest size battery equipment possible. In addition, the set should have a wavelength range from 200 to 1100 meters or more, in order to receive foreign broadcasts and commercial ship or shore stations.

The receiver is a six tube superheterodyne, the circuit diagram of which is shown in Fig. 1. It consists of a regenerative first detector, oscillator, two stages of shielded, iron core transformer coupled intermediate amplification at 40 kilocycles, second detector and one stage of transformer coupled audio amplification. The size of the set is 5 in. high, by 8 in. long by 5 in. deep, and the weight is approximately 4 pounds, 11 ounces, with tubes in their sockets. It will fit in the corner of a suitcase without difficulty, and takes up little more room than a camera. The loop folds up so that it occupies only a small amount of space, and the four dry cells and two tiny 22½ volt B batteries can be scattered though the rest of the baggage in any convenient corner. No battery box was used for the reason that it would take up too much room, since it is always easier to find nooks and crannies for the individual batteries than to concentrate them in one box.

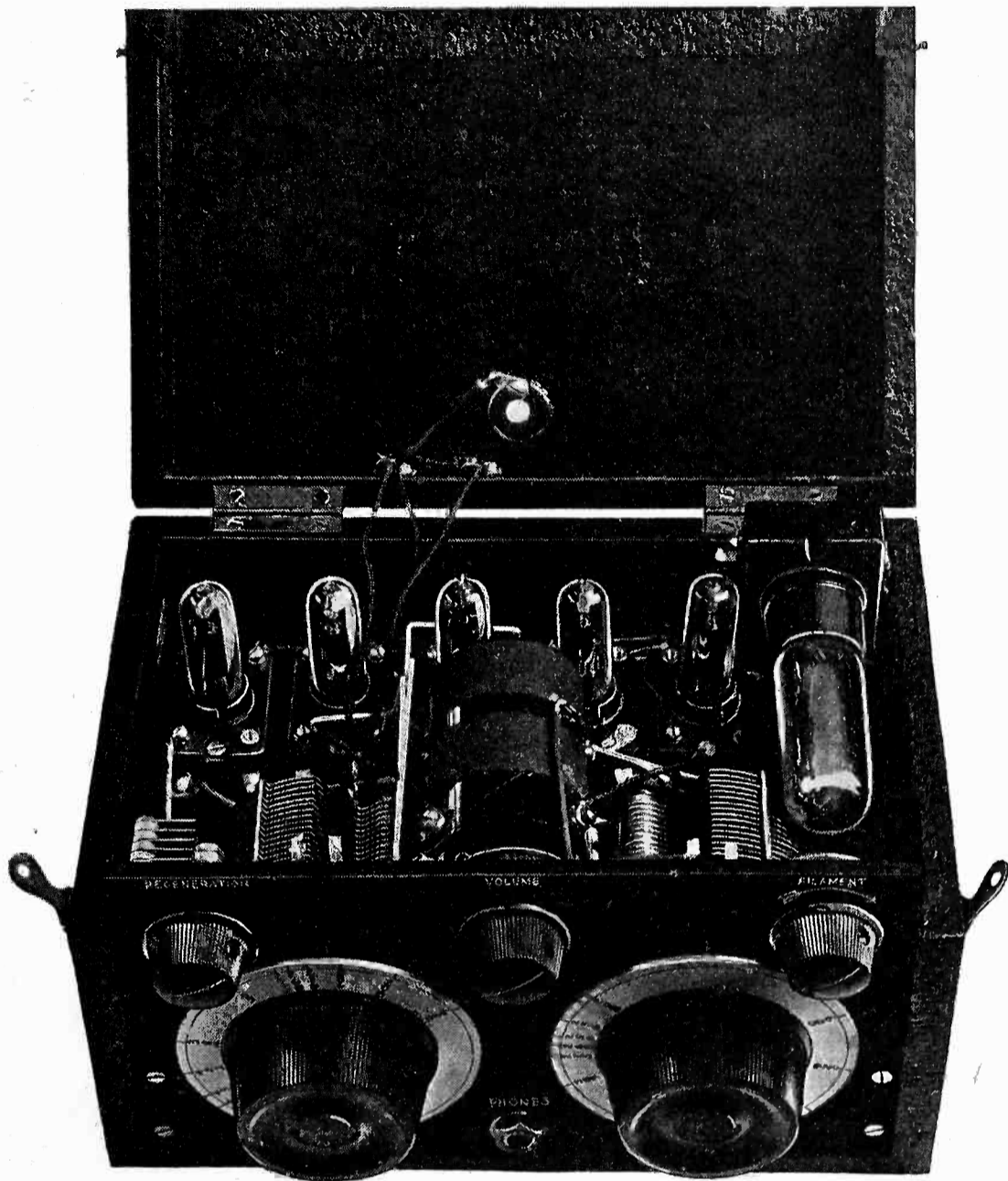

Top View, Showing Method of Connecting Loop Leads.

As can be seen from the pictures and the circuit diagram, five of the tubes are of the so-called "peanut" variety, made in Canada by the Northern Electric Co., and coded R-215-A. Like certain other bottled goods, these tubes find their way across the border in considerable quantities; if you can't find any locally, get the next one of your friends who visits

Canada to buy some for you. Even with the duty, their cost is not prohibitive, although somewhat higher than the dry cell tubes sold in the U. S. They were used in this set because by so doing, the size could be reduced to about two-thirds that required for the 99 tubes, and the total filament current drain reduced by an appreciable amount. If the 99 tubes

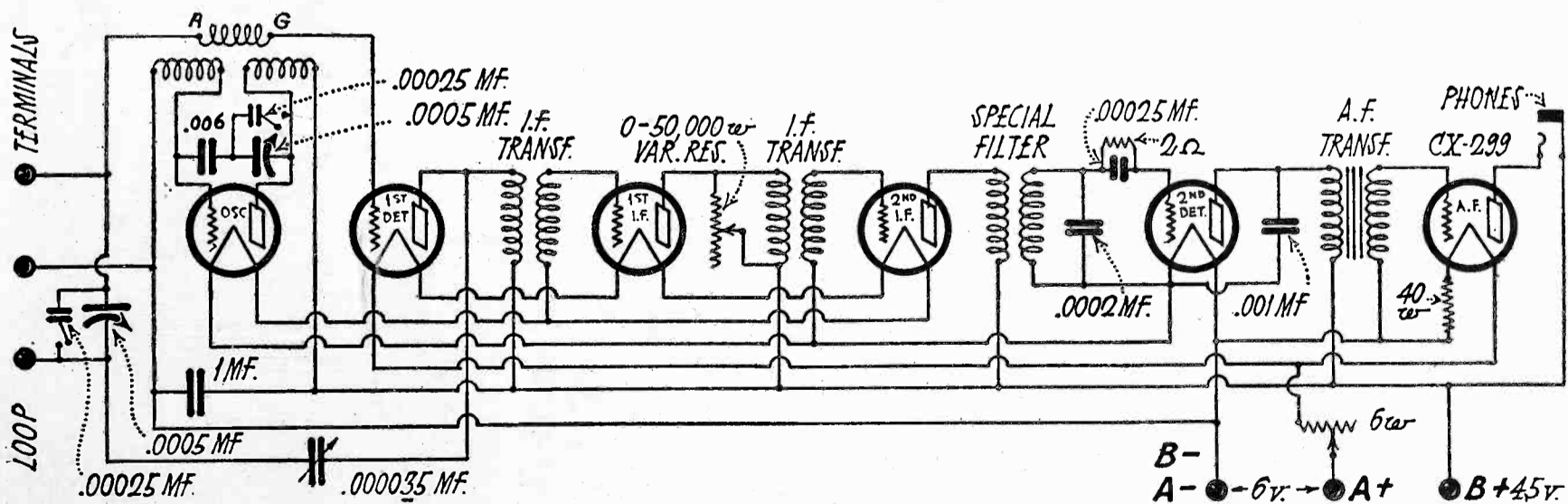

Fig. 1. Diagram of Tiny Superheterodyne.

were used throughout, the length and depth of the set will be increased somewhat, and data for enlarging the design to accommodate the 99 tubes will be given later in this article. The five "peanut" tubes were used in all sockets except the first audio, which is a type 99.

This was done so that the set could be operated from four dry cells, or a 6-volt storage battery. Five R-215-A tubes in series draw .25 amperes at 5.5 volts, leaving a margin of $\frac{1}{2}$ volt for drop through the rheostat, or falling of voltage as the battery runs down. The type 99 tube is shunted across the 6 volt supply, in series with a 40 ohm resistance to limit the filament voltage to 3.3 or less, and thus the total current consumption is .31 amperes at 6 volts. The B battery is 45 volts for all tubes, and the C voltage for each tube is obtained by means of the voltage drop across some one or more of the other tubes in the circuit, except in the case of the 99 tube, which gets its C bias from the drop through the filament resistance placed in series with it.

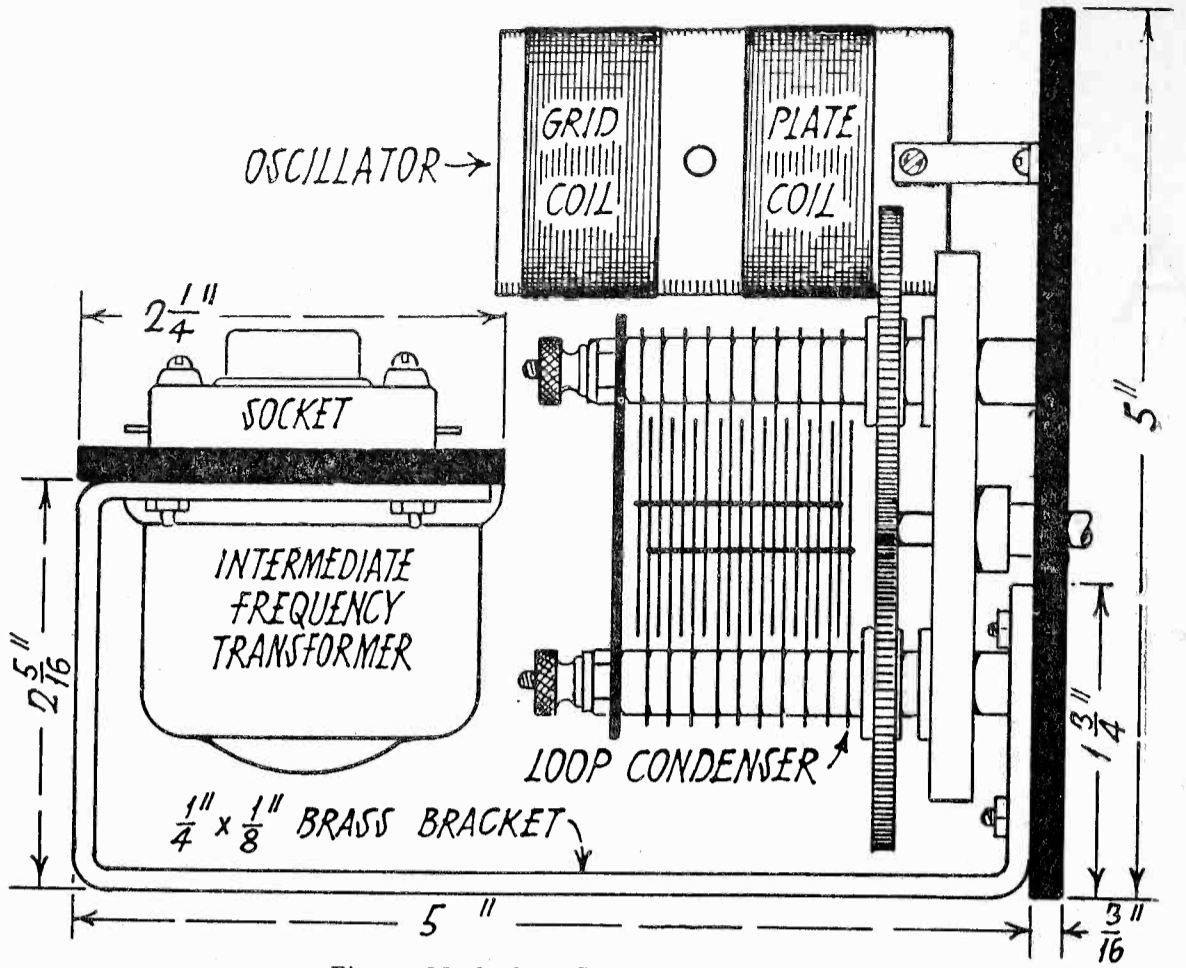
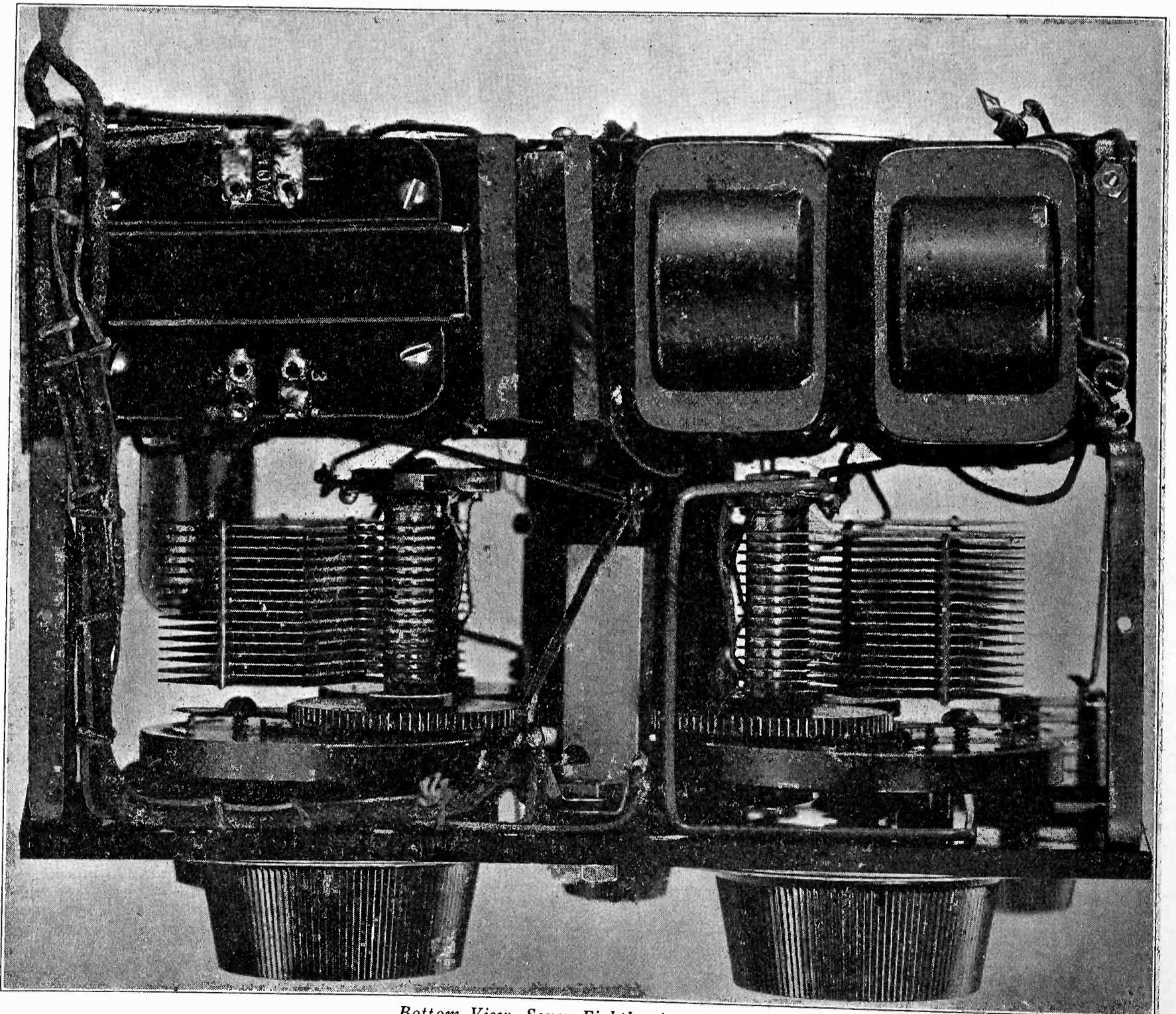
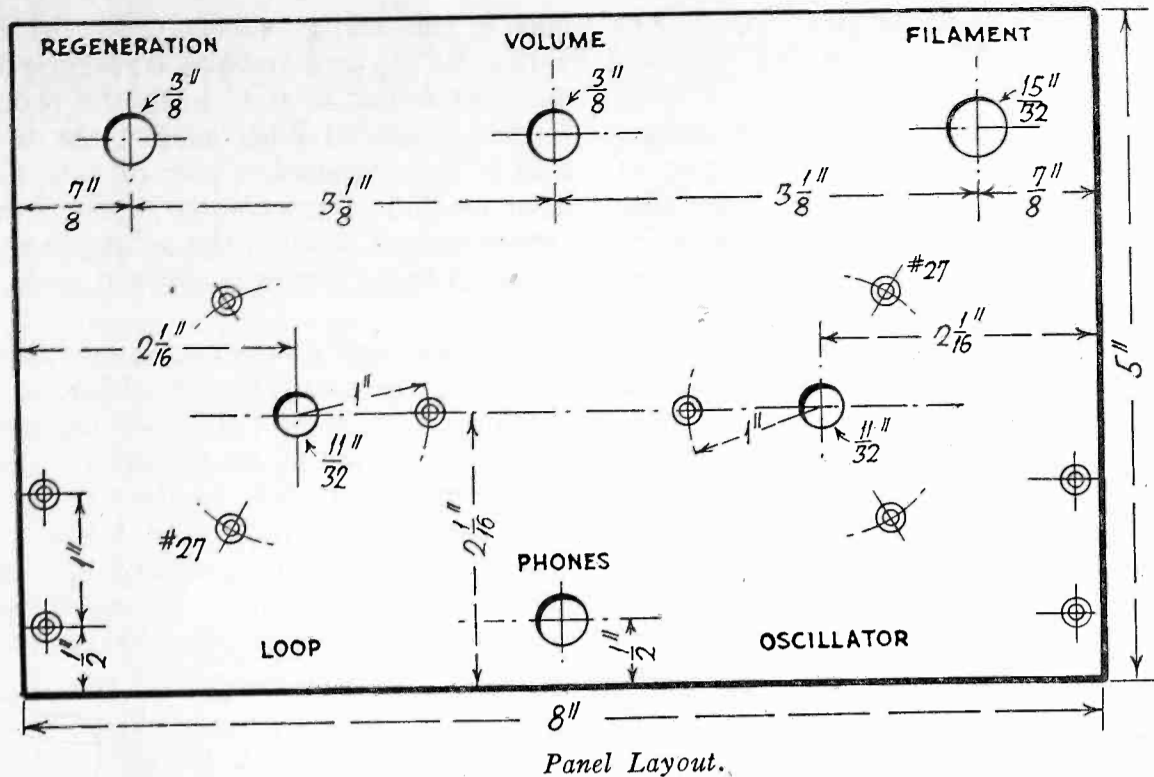

Fig. 2. Method of Sub-Panel Assembly.



Bottom View, Seven-Eighths Actual Size.



Practically all of the parts used in the set are standard, with the exception of the oscillator coil and filter, which are homemade, and the intermediate frequency transformers, which are rewind. On the panel are mounted the two variable condensers, which are placed 90 degrees out of their customary position, with the bottom edge of each condenser vertical with respect to the top of the panel. It is important that the particular model of condenser shown in the pictures be used, as the writer knows of no other condenser on the market which will fit into the tiny space available. In addition to the two condensers, there is an output jack for the headphones, a filament rheostat which serves as a switch, a volume control resistance, and a regeneration condenser, all on the front

of the panel. On the rear of the panel are mounted the oscillator coil and two tiny size .00025 mfd. fixed condensers.

The oscillator coil is made from a piece of $1\frac{5}{8}$ in. bakelite tubing, $2\frac{1}{2}$ in. long, supported at one end by two brass feet made from two pieces of $1\frac{1}{4} \times \frac{1}{4} \times \frac{1}{32}$ in. brass strip, drilled at both ends with a No. 36 drill, and bent into an "L" shape. The back of the oscillator coil is then 3 in. from the rear of the front panel. The panel has holes drilled in the back with a No. 42 machine drill, and tapped with a 4-36 bottom tap, the holes being drilled only part way through the panel, so as not to show from the front. The oscillator coil has two windings of equal dimensions, each winding consisting of 52 turns of No. 30 silk or cotton covered wire. Inside the

main coil is the grid pickup coil, which is supported by a piece of No. 14 bare wire passing through both sides of the main coil at its center. The grid coil consists of 25 turns of No. 36 double silk wire, wound on 1 in. tubing, 1 in. long.

With a hack saw, cut off the projecting binding posts on the back of the two variable condensers and use the soldering lugs as terminals, as this cuts down on the space required by the condensers. On the center of the bakelite terminal strip of the oscillator condenser, fasten the .006 mfd. fixed condenser which is connected in series with it for protective purposes.

The 1 mfd. bypass condenser is held in place on the back of the panel, between the two variable condensers, in the same manner as the oscillator coil, with $4/36$ machine screws. This condenser should be not over $\frac{5}{8}$ in. thick, 2 in. long and $1\frac{13}{16}$ in. wide, this being the customary size of a 1 mfd. bypass condenser designed for service at not over 200 volts d.c. The two tiny fixed condensers are held to the back of the panel with strips of thin brass, with holes at each end for $4/36$ machine screws.

The subpanel supports the tube sockets, transformers and miscellaneous apparatus, and is $2\frac{1}{4} \times 8 \times 3\frac{1}{16}$ bakelite. To hold this subpanel in place, two brackets made of $\frac{1}{4} \times \frac{1}{8}$ in. brass strip are prepared. The dimensions are shown in Fig. 2, which shows the end of the set. Two holes are drilled with a No. 36 machine drill, for the two panel support screws, and two more for the sub-panel support screws, the subpanel resting on

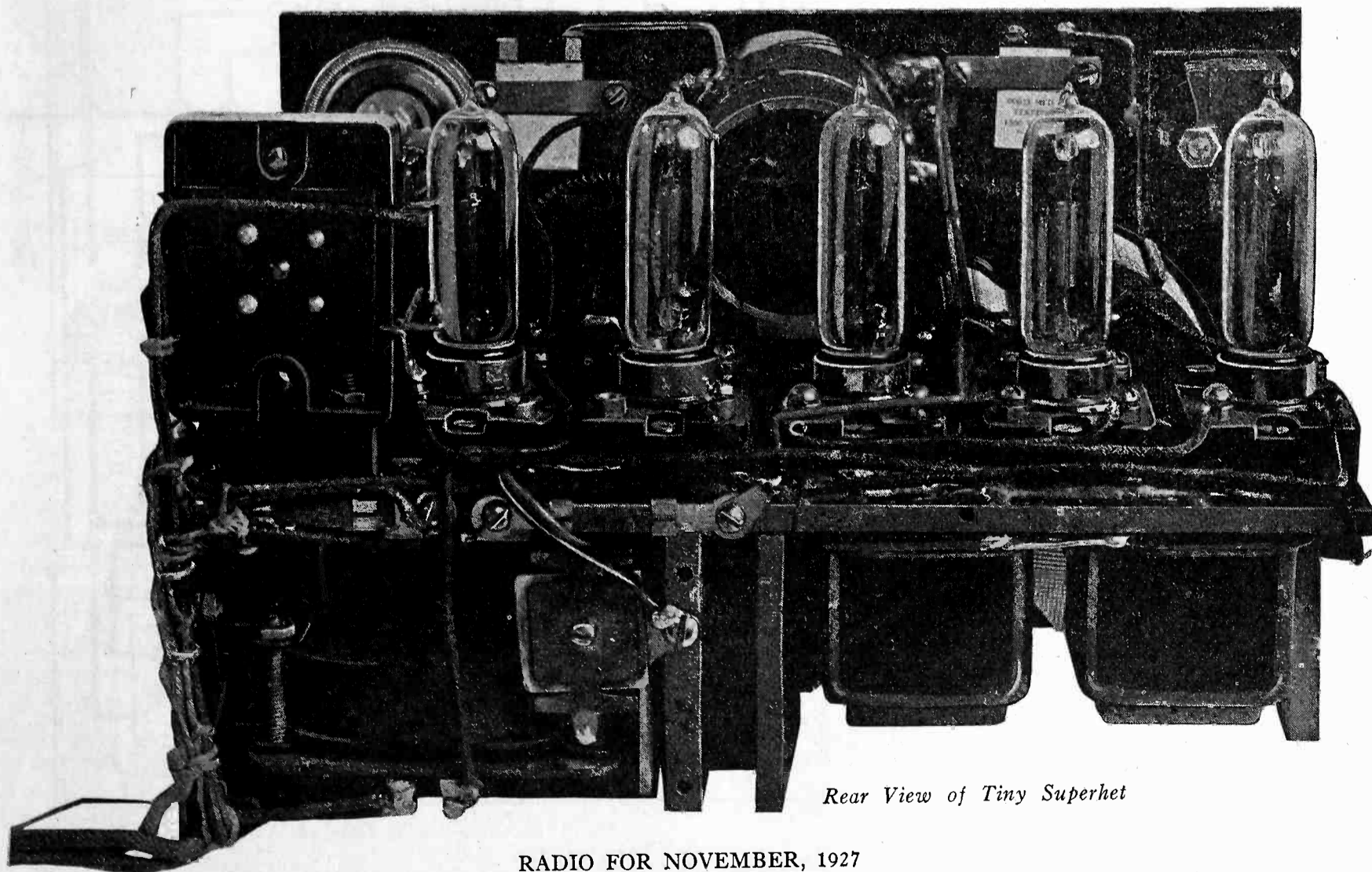

top of the brackets as shown in the diagram. To make the entire set as rigid as possible, an additional strip of brass is soldered to one side of the bypass condenser mounted on the panel, and the opposite end is fastened to the sub-panel by means of a 6-32 machine screw.

On the top of the subpanel, five Northern Electric peanut tube sockets are fastened with 4-36 machine screws, and one Remler No. 50 socket is mounted on end, for the 99 tube. Underneath the subpanel, the two intermediate frequency transformers, filter and audio transformer are mounted, with the grid condenser and leak in the space between the audio transformer and the bottom of the subpanel. The audio transformer used by the writer is a Western Electric input transformer taken from an old 7-A amplifier which was popular a few years ago. It was used because of its small size, but a Thor-darson 2-1 transformer can be used equally as well, or any other transformer having dimensions of not over 2½ in. high, 2¼ in. long or 1¾ in. wide. In assembling the subpanel apparatus, the transformers should be mounted first, and the sockets last, due to the filter and intermediate transformer mounting screws coming through the subpanel, to the top.

The intermediate transformers used were General Radio type 271, peaked at 30 kilocycles normally, but rewound for a higher intermediate frequency so as to

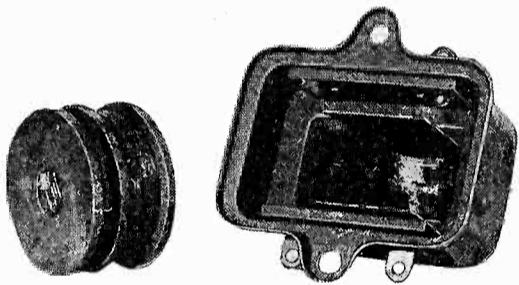

Fig. 3. Intermediate Transformer After Spool Is Removed From Case.

further separate the two settings of the oscillator dial and improve the selectivity. The transformer is easily rebuilt, and the following data is given so that the rewinding can be done without the use of elaborate measuring apparatus. Remove the eyelets holding the metal plate to the bottom of the transformer, and take out the plate, exposing the interior, which is filled with wax. Place the transformer upside down on the lid of a coffee can or other suitable container, and heat it over the stove or electric toaster until the wax is boiling vigorously, after which it is poured off and the coil exposed. Carefully unsolder the four leads from the coil spool, and with a pair of pliers gently remove the spool from the case. You will then have the condition shown in Fig. 3, with the main part of the shell type core remaining in the case, and the center of the core inside of the spool.

Now remove 600 turns of wire from the primary, and 1700 turns from the

secondary, to raise the peak from 30 to 40 kilocycles. Next remove all four terminal lugs from the transformer case, and grind or file down the projecting edges of the case so that it occupies as little room as possible on the under side of the subpanel. The object of doing this can be seen in the picture of the subpanel assembly. Cut four pieces of thin strip brass, ¼ in. wide, and bend one end into an "L" shape, drilling a hole at each end. Now drill a hole through the transformer case in the center of the bakelite terminal strip, on each side of the transformer, and fasten the long end of the "L" shaped strip to the inside of the case, so that the bent over portion of the strip is just even with the bottom edge of the case. The

hole in this end of each strip is drilled with a No. 42 drill and tapped for a 4-36 machine screw, so that when the transformer is placed flush against the bottom of the subpanel, a pair of 4-36 flat head machine screws about ¼ in. long can be passed through the subpanel and will hold the transformer tightly against it.

This is a somewhat difficult operation to describe in detail, but its object is to save nearly an inch of room on the sub-panel, which would be required if the transformers were left in their original condition. In addition, the leads are brought through holes drilled in the subpanel, so that they are separated from each other by a considerable dis-

(Continued on page 73)

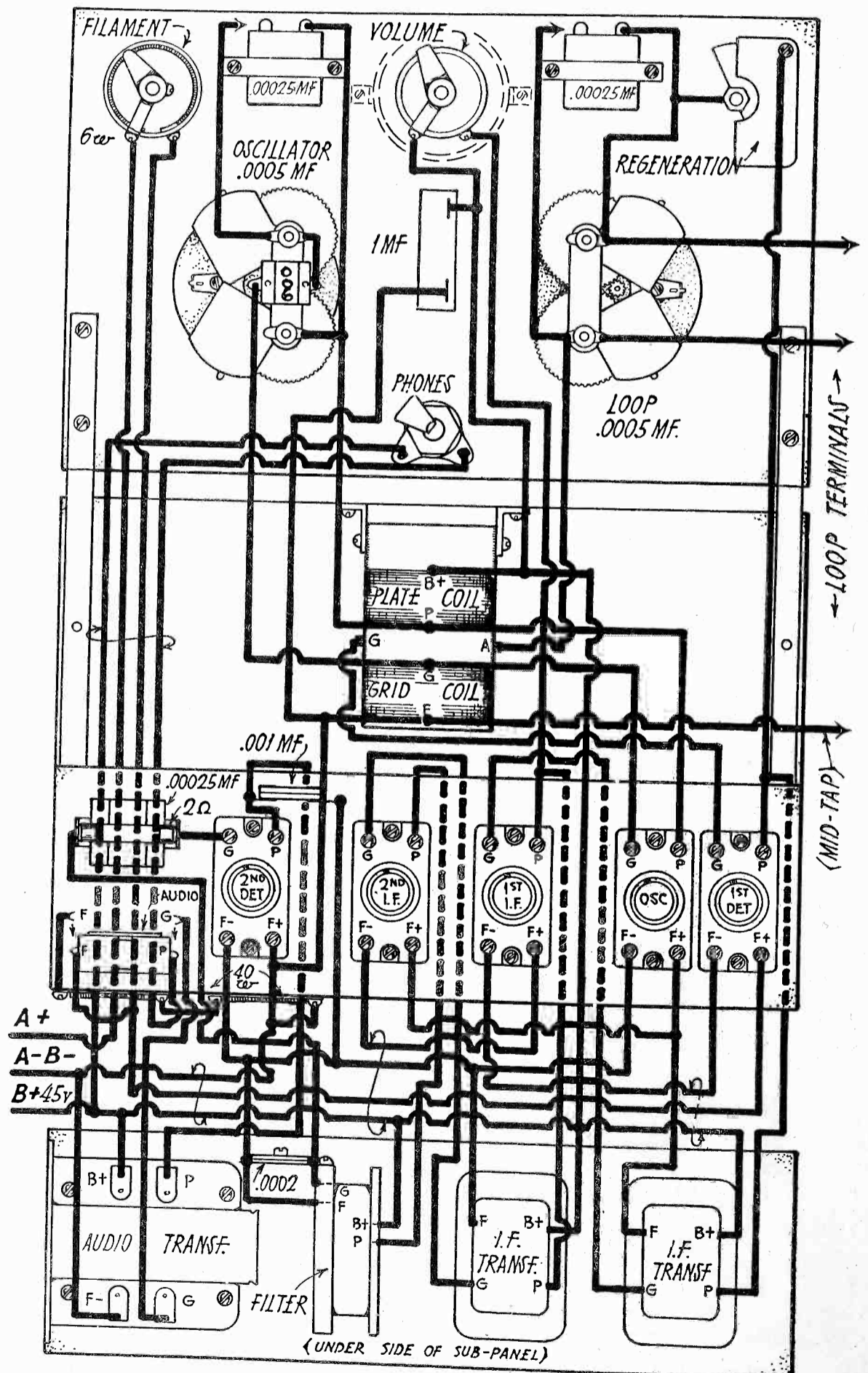

Fig. 5. Pictorial Wiring Diagram.

Simple Construction of a 3-ft. Cone Speaker

By W. H. Sinclair

THE present availability of 38-in. square sheets of Alhambra Fonotex at radio stores, either as separate sheets or as part of a kit, facilitates the construction of a 3 ft. cone speaker. The great improvement in tone range, volume, and quality which such a cone is capable of giving, well justifies the assembly. This is especially so in the speaker here described, as the job has been greatly simplified and the cone is assembled flat, thus obviating much otherwise awkward manipulation.

An excellent basis for such work is the kit for the G. R. Penn double cone speaker. The directions are such that with a little ingenuity any other parts can be utilized likewise. The first thing is to flatten the Fonotex sheets for the front and back cones. This can be done by rolling them in the opposite way from which the sheets were rolled for shipment.

A sheet for the back cone is then cut to the shape shown in Fig. 1, this being

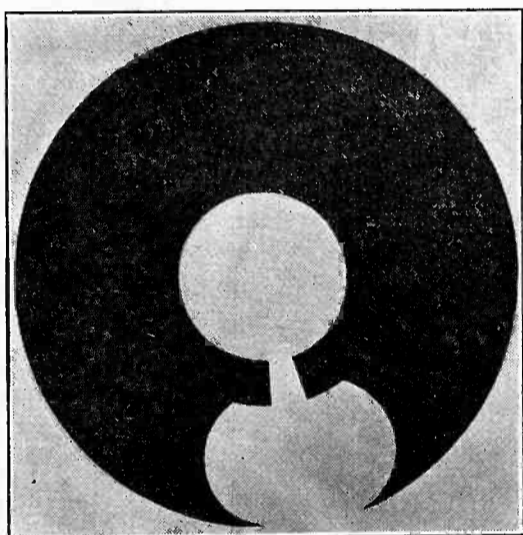

Fig. 1. Flat Shape of Back Cone.

readily done by cutting along the lines as printed on the kit sheet or as drawn on a separate sheet. An old safety razor blade is a good cutting tool, spreading the sheet flat on the floor or large table.

In like manner a wedge-shaped piece is cut from the square sheet for the front cone, as may be seen in Fig. 2. The cut-out sheet for the back cone is then placed on top of the square sheet for the back cone so that the tip ends of the two crescents and the ends of the annular center ring just meet the edges of the wedge. The two sheets are held in position by books or other weights as shown in Fig. 2.

The next process is to join the outside edges of the two cones by means of a film of Ambroid cement. This must not be a lap joint. In other words there must be no cement between the two edges. This is done by applying a very thin stream of the cement exactly around

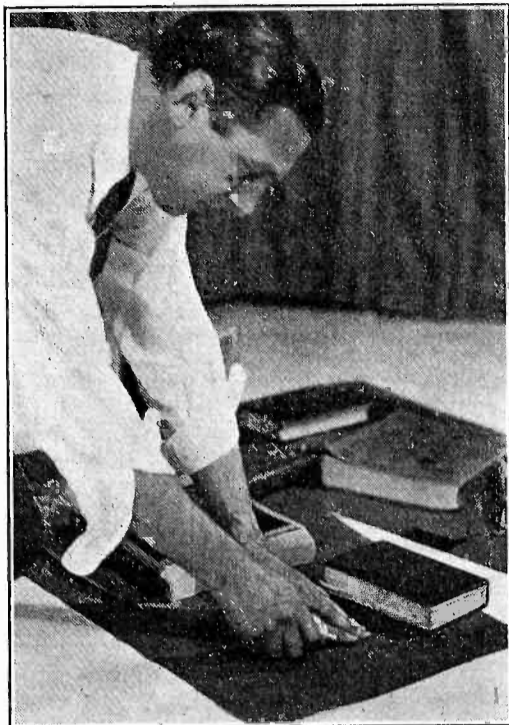

Fig. 2. Cementing Back Cone Onto Front Cone.

the extreme edge of the entire circumference of the back cone, allowing the cement to flow over onto the front cone, but not to seep between the edges of the two cones. This can easily be done by placing the index finger of the left hand at the point on the back cone where the cement is being applied with the right hand. Do not try to cement more than one inch at a time, giving the Ambroid a chance to congeal and set.

Then repeat this cementing process with a wider film of cement, extending $\frac{1}{8}$ in. in on the back cone and flowing over the edge of the back cone onto the edge of the front cone. This can be done rapidly without waiting for the cement to dry as there is now no danger of its seeping in between the edges.

The entire under surface of the back ring is then quickly covered with a thin coating of cement, using a small piece of cardboard to spread it, and the back ring is placed in position on the back

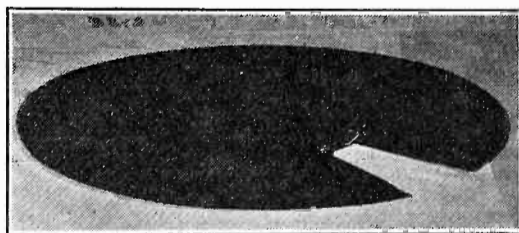

Fig. 3. Appearance After Back Ring Is in Place

cone as indicated in Fig. 3, placing weights on it to hold it in position till the cement hardens. This must be done quickly before the cement dries. The circular front cone can now be cut out of the square sheet.

So far, it will be noted, all the work has been done while the two cones, now cemented together at the edges, are flat

on the floor. Before bulging out the sheets to form the cones, it is necessary to attach the two sides of the bolt which holds the two edges of the back ring together. One half the bolt, the hump part, goes on one side, and the other half, the link part, on the other. Fig. 4 shows the appearance of the job after this is done.

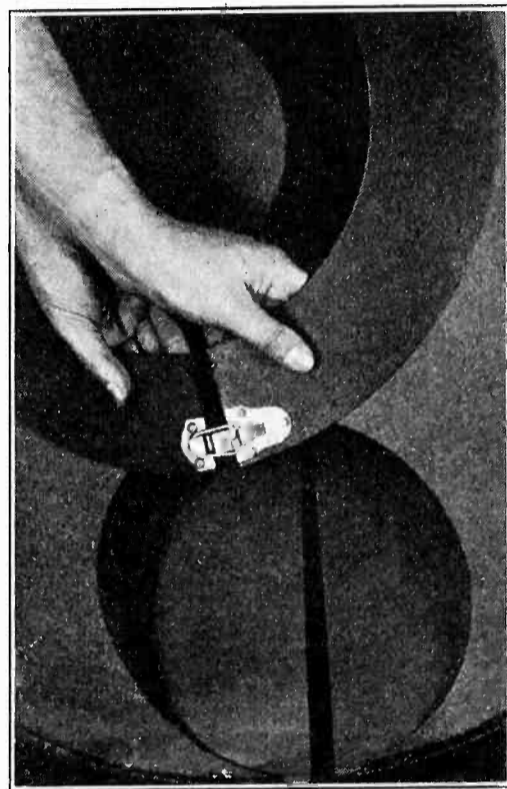

Fig. 4. Closing the Back Ring.

The link of the bolt is placed over the hump, the bolt is closed by sliding the tongue into the groove, and the cones form themselves. Any possible flat spots can be rounded out by placing the hand inside the cone. The back ring's cross strip is then fastened in place with a bolt, washer and nut.

The seam of the front cone is closed with adhesive tape, as shown in Fig. 5, holding the seam flat on the table with the left hand after its two edges have



Fig. 5. Closing the Front Seam.

been brought together. The adhesive tape should be ready in the form of 8 or 10 strips, $\frac{1}{4}$ in. wide and 1 in. long. Starting at the circumference of the cone, apply these small strips crosswise of the seam with the right hand, placing them about 2 in. apart and covering them with an 18 in. strip of adhesive.



The Complete Cone.

In many types of cone speakers the unit can now be mounted. But in the Penn speaker it is first necessary to mount a small cone which is cut out of a corner of the original sheet for the back cone, forming it into shape and cementing its edges together, before cutting off its tip. It is cemented in position in the apex of the large cone. There are two apexes, a larger disc that fits inside the cone and a smaller one for the outside. They are connected together with a chuck and bolt.

The method of mounting the unit depends upon the type thereof. In any case full directions accompany the unit. Similar directions are always available for adjusting it. The speaker is completed by cementing braid around the edges.

A new listing of broadcast channels from No. 1 to No. 96 has been proposed by Nema instead of the present kilocycle or wave length assignments. By this plan the 500 kilocycle or 545.1 meter channel would be No. 1 and the 1500 kilocycle or 199.9 meter channel would be No. 96, other channels at 10 k. c. separation being assigned intermediate numbers. This plan would obviate much needless confusion among broadcast listeners and greatly simplify published schedules. The system has been submitted to the Institute of Radio Engineers and other organizations for approval and, if adopted, will be presented to the Federal Radio Commission. The idea has received many favorable comments and would help to remove some of the mystery and complexity of radio from the mind of the novice.

LIMITATIONS OF DISTORTION-LESS AMPLIFICATION

By Donald K. Lippincott

ALTHOUGH the ideal audio amplifier, theoretically, should give equal response to all the frequencies to which the human ear is responsive, from 16 to 20,000 cycles per second, there are several practical reasons for limiting the frequency response to from 100 to 5000 cycles. These include not only the standard 5000 cycle upper cut-off of the transmitter, due to the 10,000 cycle channel upon which each station may broadcast without heterodyning a station on the adjacent channel, but also the limitations of the average receiver as a distortionless amplifier. The purpose of this article is to explain the underlying causes of this distortion.

The first of these is the overloading of the output tube by high notes of great intensity. Thus a 171 type of tube with an average loudspeaker will not distort speech of ordinary intensity. But when an orator, revivalist or emotional actress really gets worked up, the tube becomes overloaded and "blasts." The tone sounds like a dull file on a rusty saw. Using a 210 type of tube, this distortion may not happen with speech, but it may happen with a symphony orchestra.

Distortion of this kind is first noticed on high notes, and is due to the introduction by the tube of notes even higher than those causing the distortion. We are all familiar with the "papery" sound of the cone type speaker when used without a proper power tube input. This sound has nothing to do with the material of the cone. If it had, the addition of the power tube would not cure it. It is merely that the cone responds enthusiastically to the high notes introduced by the overloaded tube whereas a horn would not let them through.

The lower we place the cut-off of our reproducing system, the more volume we can get without the painful "blast" which signifies overloading. The problem then becomes, where shall we put the upper cut-off so that we may not impair the quality of speech or music, and still may have reasonable volume without blasting? Several factors enter into this compromise.

The highest speech frequencies are some which go to make up the "fricative consonants"—*th*, *f*, *s* and *z*. The highest of these are about 6400 cycles per second. If we cut off above this point, our loud speaker can say "Smith's booze is in the booth" and give full value to every letter. If we drop the cut-off to 5,000, the final *s* in "Smith's" will almost disappear, and when we drop it much farther the speaker will enunciate some thing approximating "Smiz booze is in the booze." The probability is that we would still under-

stand perfectly what was meant, even in as extreme a case as this. There would be a slight loss in intelligibility, but this loss would not be proportional to the gain in output it made possible.

If we can afford a 5000 cycles cut off for speech, how about music? The high note of the piano is about 4100 cycles. "Yankee Doodle" played in the high octave sounds like a piccolo. The point is this—We distinguish one instrument from another by the harmonics in the tone it generates. By the time we reach the upper octave our ears are losing sensitivity so fast that we can hardly distinguish whether these harmonics are present or not. We can tell the difference if they are, but only by direct comparison. If we haven't heard them within a few minutes or even seconds, we do not notice their absence.

The case for the 100 cycles cut-off on the low side is equally logical, but in view of present tendencies and prejudices—one might almost say superstitions—is likely to be less readily accepted.

The lowest note on the piano is about 27 cycles. About half of the organs have a "32 foot C" giving a note of about 32 cycles, and some are equipped with "64 foot C's" giving a 16 cycle tone. These great pipes are used occasionally. Their emotional effect is great, they radiate enormous power and set whole buildings to vibrating when they speak. They are the instruments it is customary to cite when we argue for amplifiers to pass the very low notes. But it is doubtful if we ever hear them and more than doubtful if they are ever broadcast. The "64 foot C" makes it appeal to the sense of touch, not hearing.

As we pass below 1000 cycles the sensitivity of the ear falls off, first gradually, then very rapidly. It takes 25 hundred times the energy to produce a definite sensation at 100 cycles as it does at 1000 cycles, and as we descend the scale to 50 cycles the necessary energy rises to a quarter of a million times the 1000 cycles value. The result is that as we get farther away from a source of music, the low notes are the first to disappear, and we never notice their going. The circus band sounds as natural two blocks away as when it is marching past.

It is absurd to argue that we do not hear the 27 cycle low note on the piano, when it is struck, but here the case is different. The bass strings are heavily "loaded"—wrapped with wire—to drop their pitch to the desired point. When struck they emit energy not only at their normal pitch frequency, but on all the harmonics of this frequency. These harmonics combine to produce a "beat note" or "heterodyne," and the beat between any pair of successive har-

(Continued on page 79)



QUERIES and REPLIES



Questions of general interest are published in this department. Questions should be brief, typewritten, or in ink, written on one side of the paper, and should state whether the answer is to be published or personally acknowledged. Where personal answer is desired, a fee of 25c per question, including diagrams, should be sent. If questions require special work, or diagrams, particularly those of factory-built receivers, an extra charge will be made, and correspondents will be notified of the amount of this charge before answer is made.

Wish to build a wavemeter equipped with a vacuum tube voltmeter, and would like to know the best arrangement of condenser, coil and tube, for short wave bands from 10 to 80 meters.—G. J. T., Olean, N. Y.

The circuit of a wavemeter using a type 99 tube as vacuum tube voltmeter is shown in

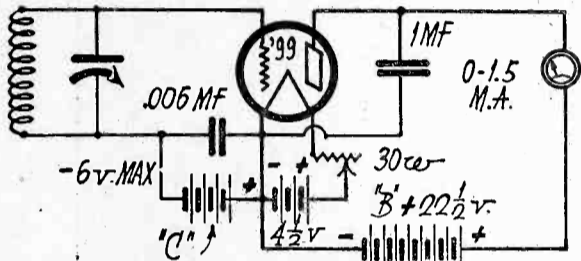

Fig. 1. Wavemeter Equipped With Vacuum Tube Voltmeter.

Fig. 1. A milliammeter having a range of 0-1½ milliamperes is used as the resonance indicator. The C battery voltage will have to be varied until the plate current as indicated by the milliammeter is zero, with no current being rectified. Of course the wavemeter must be calibrated with the vacuum tube in its socket, for the grid-filament capacity of the tube is sufficient to affect the wavelength setting of the tuned circuit.

Will anything be gained by substituting a type CX-381 rectifier tube for the CX-316-B half wave rectifier in my power amplifier-rectifier circuit?—T. P. M., Augusta, Me.

The CX-381 will deliver about twice as much rectified current as the CX-316-B, without overloading, and hence is to be preferred in a new installation, but if your present tube is working satisfactorily, and is not worn out, it would be a foolish waste of money to discard the old tube and buy the new style. When the old one is worn out, buy a CX-381 to replace it.

In regard to the article by Arthur H. Lynch in July RADIO, what tubes should be used in the r.f. amplifier to be placed ahead of the resistance coupled audio stages? Where is the minus "B" battery connected? What is the "C" battery voltage? What should be the size of the r.f. choke in the plate circuit of the detector tube? What is the value of R-13 and the condenser shunted across it?—W. A. K., Pasadena, Calif.

Type A tubes are customarily used in r.f. amplifiers, except where special design is made of the r.f. transformers, for type 99 or other type tubes. The negative B is connected to the negative A binding post. The C battery is 9 volts for a type 112 tube with 135 volts plate, or 22½ volts for a type 371 tube with the same plate voltage. For 180 volts plate, the C battery voltages are 12 and 40 respectively, for the 112 and 371 tubes. The r.f. choke should be 85 millihenries. R-13 is a 2

megohm grid leak, and the grid condenser is usually .00025 mfd.

In April RADIO you show the circuit of the Loftin-White receiver, and in the plate circuit of each tube is a .001 mfd. variable condenser. What make or type of condenser would be most suitable for this part of the circuit?—C. M. B., Morrisonville, N. Y.

The condenser should preferably be of the variable mica type, so as to occupy a small amount of space. The XL Model G-10 is an excellent condenser for this circuit.

Have just completed an Infradyne, and apparently my "B" eliminator will not give sufficient current to supply the receiver with the full amount required. What is the current drain of the Infradyne, and will it work from the average "B" eliminator output?—R. G. M., Roseburg, Ore.

With a type CX-371 power tube, and 180 volts B, the plate current of the new Infradyne will be from 40 to 45 milliamperes. Hence the B eliminator should be of a type rated at 50 milliamperes or more, at 180 volts, in order to take care of the set properly. If a type 112 power tube, even with 180 volts plate, was used, the plate current would be 30 milliamperes or less, so that an eliminator with less current output could be used.

Can you furnish me with a copy of February 1923 RADIO, in which an article on how to build a 5 ampere Tungar charger was published? If not, could the diagram and directions be reprinted so that I can build one?—G. L. D., Warren, O.

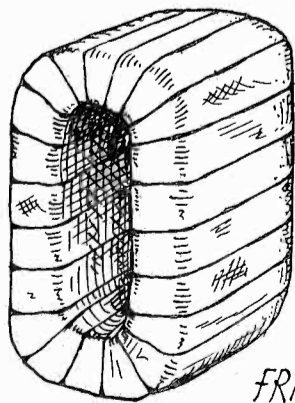
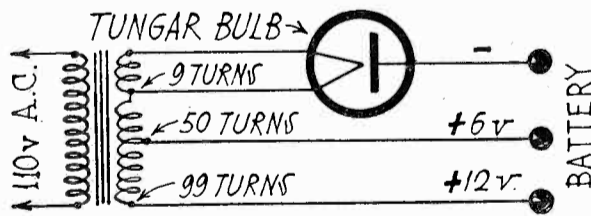

FINISHED COIL, BOUND WITH FRICTION TAPE

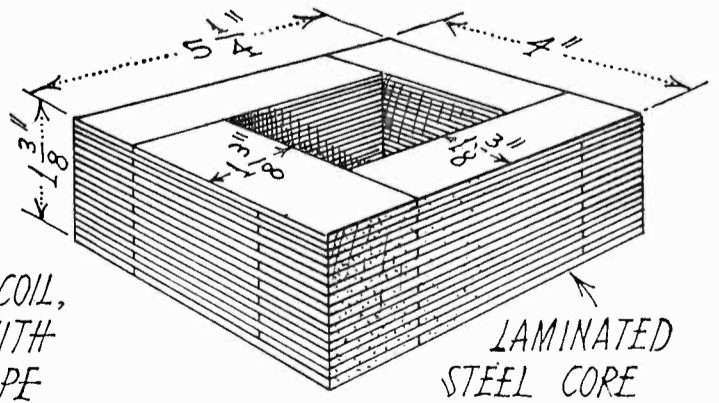

LAMINATED STEEL CORE

Fig. B. (a) Core and Coil for 5 Ampere Tungar Charger. (b) Circuit Diagram of Tungar Charger.

With the Amateur Operators

A 6 TUBE SHORT WAVE RECEIVER

By Francis Churchill

This receiver was designed to cover efficiently all of the amateur bands excepting the $\frac{3}{4}$ meter band. For some time the super-regenerative type of short wave receiver was used here, especially on 5 meters, and it was found to be extremely sensitive and easy to tune, but had the disadvantage of bringing in all of the magneto interference within several hundred feet. Magneto interference originates in several makes of automobiles but is worse in the ignition system of a something or other called a Ford. This type of interference is awful on the 5 meter band and is also pretty bad on 20 meters where a large amount of dx transmission is done nowadays.

In order to get a better signal to interference ratio it was found necessary to use an autodyne type of super-heterodyne. This seems to solve the question or trouble quite nicely and increases the signal, or rather more correctly, decreases the interference, a good many hundreds of times on the 5 meter band. The same applies to a somewhat lesser degree in the 20 meter band. Besides decreasing the interference, the signal is increased a great deal also so that the receiver works admirably in the other amateur bands, being more sensitive than the usual short wave receiver.

This receiver functions in a manner similar to a standard receiver except that the incoming signals are autodyned to 30,000 cycles instead of to 1000 cycles and then amplified. A two stage amplifier, oscillating slightly, amplifies the 30,000 cycle signal component and then a second detector makes the signal audible. The intermediate frequency amplifier oscillates weakly, we will say on 31,000 cycles, so that these two components combine in the second detector to give a 1000 cycle note. It seems rather peculiar that autodyning or heterodyning the incoming signal to 30,000 cycles or thereabouts, instead of to 1000 cycles, should reduce the power and ignition interference so much, but it does and that's the important item.

The intermediate frequency transformers peak at about 30 or 35 kilocycles when the 201A type of tubes are used. Oscillations are controlled by a potentiometer to which are connected the grid returns from the first two transformers. If the amplifier tends to oscillate too hard and blot out the signals, it would be better to run the grid return of the second transformer to the potentiometer and that of the first transformer to the positive side of the filament. The above applies to the case where more efficient intermediate frequency transformers are used in the receiver.

It will be noted in Fig. 1 that two stages of audio frequency amplification are used but

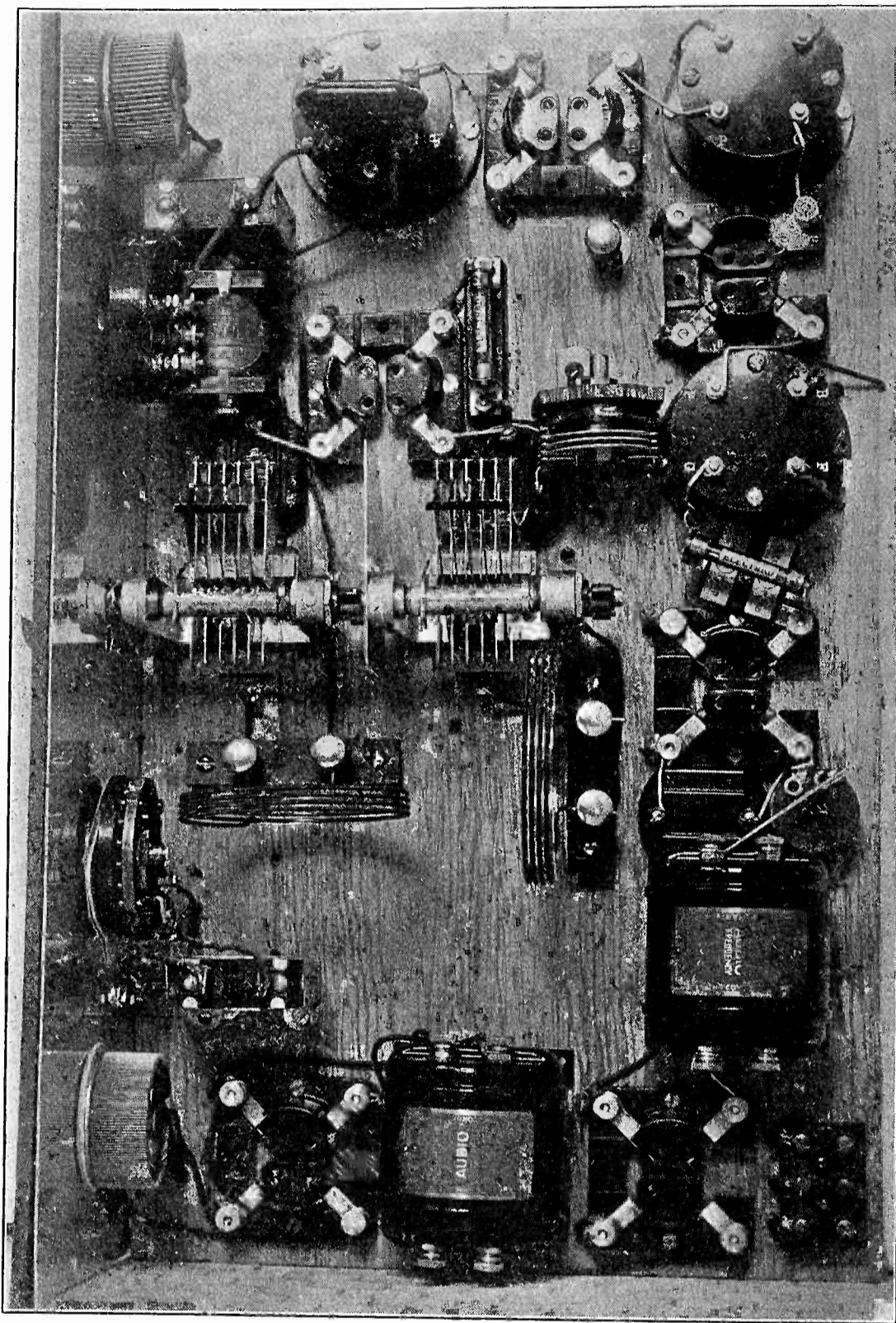

6 Tube Short Wave Receiver.

that no B battery is used on the second tube. Strong signals were so extremely loud on one stage of audio, that it was necessary to use a special circuit to limit the signal strength of

all signals to some comfortable volume for ease in copying.

This special circuit consists of a second audio transformer, and a tube working very near

(Continued on page 71)

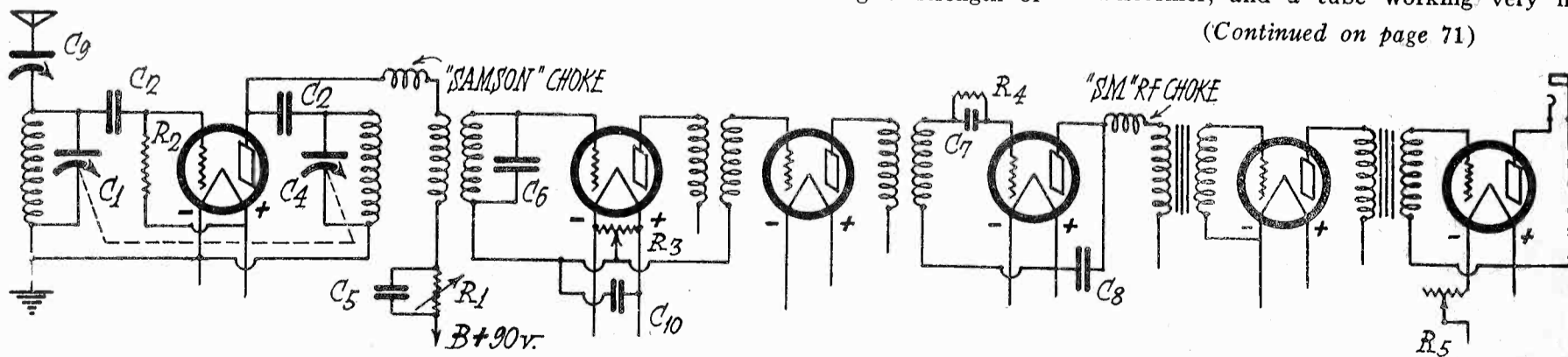

Fig. 1. Circuit Diagram of Six Tube Short Wave Receiver.

R_1 —0-50,000 ohm heavy duty resistor
 R_2 —5 megohm grid leak
 R_3 —400 ohm potentiometer
 R_4 —5 megohm grid leak
 R_5 —30 ohm rheostat

C_1 and C_4 —.0001 mfd. variables on common shaft
 C_2 —.0001 mfd. grid condenser
 C_3 —.0005 mfd. by-pass condenser
 C_5 —1 mfd.

C_6 —.0005 mfd.
 C_7 —.00025 mfd. grid condenser
 C_8 —.002 mfd. by-pass
 C_9 —Midget variable, 25-35 mmf. max.
 C_{10} —1 mfd. by-pass

A FLEXIBLE CONSTANT FREQUENCY SHORT-WAVE TRANSMITTER

Constructional Details of the 100-Watt Short-Wave Transmitter of the Borden-Field Arctic Expedition, KGEG.

By A. BINNEWEG JR.

John Borden's *Northern Light*, on its extended cruise into the Arctic, carried 600-meter equipment of standard design and a flexible, short-wave 100-watt outfit designed by the writer and assembled at 6BX. The latter employed a tuned-grid, tuned-plate oscillator to give a steady signal and to allow the use of different frequencies for reliable communication at different hours.

As the transmitter was suspended from the ceiling, due to limited table space, the meters were mounted upside-down and the panels were substantially braced.

The antenna was coupled to the plate circuit, thus allowing the grid circuit, with its greater capacity, to control the oscillator frequency. This also allowed the use of a single plug-in coil to cover a given range, all coils being wound of the same material and being interchangeable in either the grid or plate circuits.

The circuit diagram is shown in Fig. 1. It may be readily adapted to use two 7 $\frac{1}{2}$ watt instead of two 50 watt tubes by slight changes shown in the diagram, using smaller sockets, lower plate voltage, and lower capacities in the grid and plate-stopping condensers. The correct capacity is .0006 mfd. for the 100 watt set and .0004 mfd. for the 15 watt set.

The tuning condensers were made by removing half of the stator and rotor plates of a 43-plate condenser, giving a maximum of about .00025 mfd. This double spacing prevents arcing. The plug-in attachments and binding posts were mounted in the condensers before re-assembly, as shown in the pictures.

The coils of the proper number of turns were cut from a long coil made by winding 20 ft. of 3/16 in. copper tubing on a 2 in. wooden cylinder, bored at one end with a hole to hold the start of the winding. The ends of the coils were bent so as to fit the connectors on the condensers, being soldered thereto. To avoid corrosion the coils were silver-plated. For 40 meter transmission the plate coil should have 9 turns and the antenna coil 5 turns.

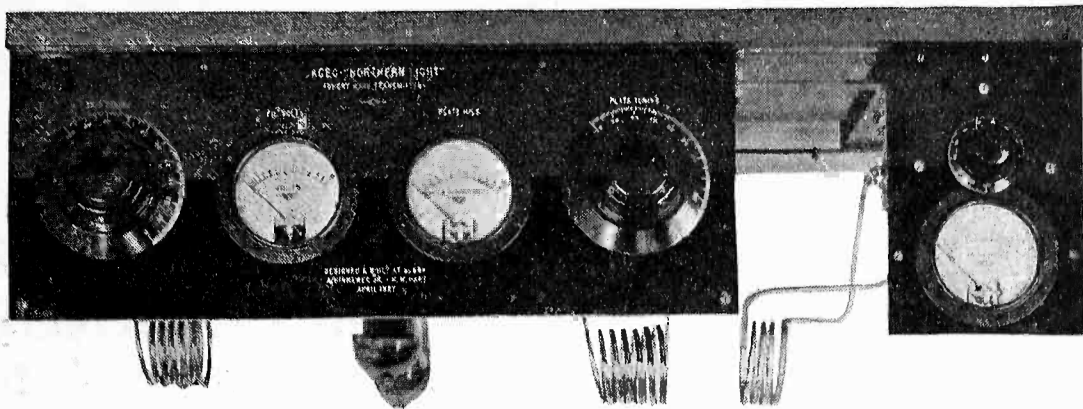

Front Panel of KGEG Short Wave Transmitter.

LIST OF PARTS FOR 100-WATT TRANSMITTER

- 3—43 plate, .001 mfd. variable condensers, G. I. Co.
- 1—Leach Keying Relay, Model 18 type S-3
- 1—.5 mfd. Tobe Fixed Condenser
- 1—250 ohm Resistor, for relay
- 2—.0012 Sangamo fixed condensers, grid
- 1—R. C. A. Tapped Plate Condenser, high voltage
- 1 ft.— $\frac{1}{2}$ in. diam. bakelite tubing
- 10 ft.—No. 12 enameled wire, for wiring
- 2—50 watt sockets and tubes
- 1—5000 ohm grid resistor, heavy duty
- 1—Filament A.C. 0-15 voltmeter
- 1—0-300 milliamperes D.C. meter
- 1—0.3 antenna high frequency ammeter
- 20 ft.— $\frac{3}{16}$ in. copper tubing, for 40 meter band
- 8—Plug-in attachments, "Ajax," 2 for each extra coil
- 6—Binding posts, large bakelite
- 60 ft.—No. 28 wire, for chokes
- Panels, baseboard, etc.

Coupling is accomplished by sliding the panel and baseboard carrying the antenna ammeter and series condenser along a groove in the main baseboard.

The grid and plate chokes were made by winding 200 turns of No. 28 wire, single layer, on $\frac{1}{2}$ in. bakelite tubing. They were supported by the No. 12 enameled wire used in wiring the transmitter, this wire passing through small holes at the ends of the windings. A 20-turn choke in series with the grid, center-tapped to the grid condenser, was used to prevent oscillation at frequencies other than that to which the set is tuned.

Plate supply at 1000-1500 volts is secured from a chemical rectifier and filter. Constructional features are evident in the pictures and diagrams.

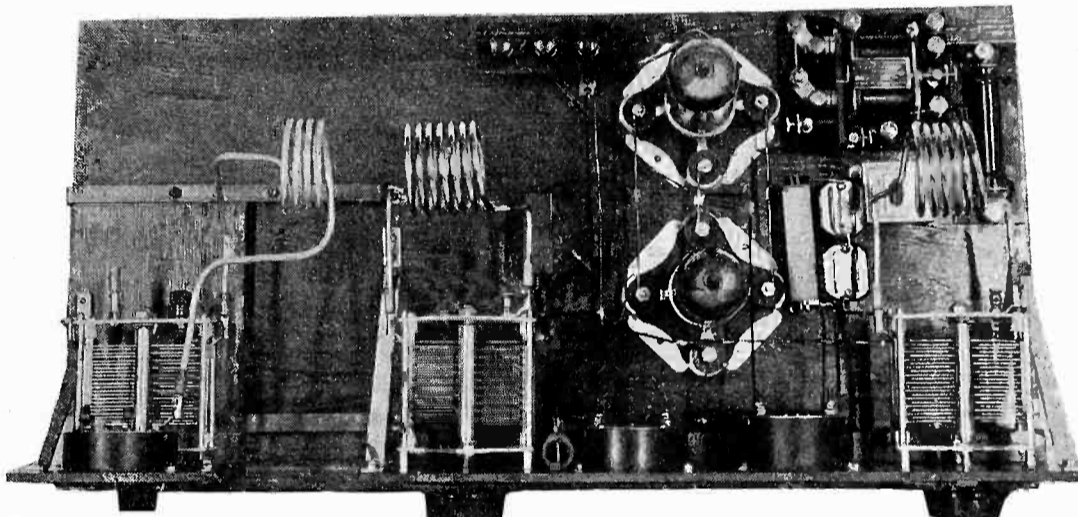

Plan View of KGEG Transmitter.

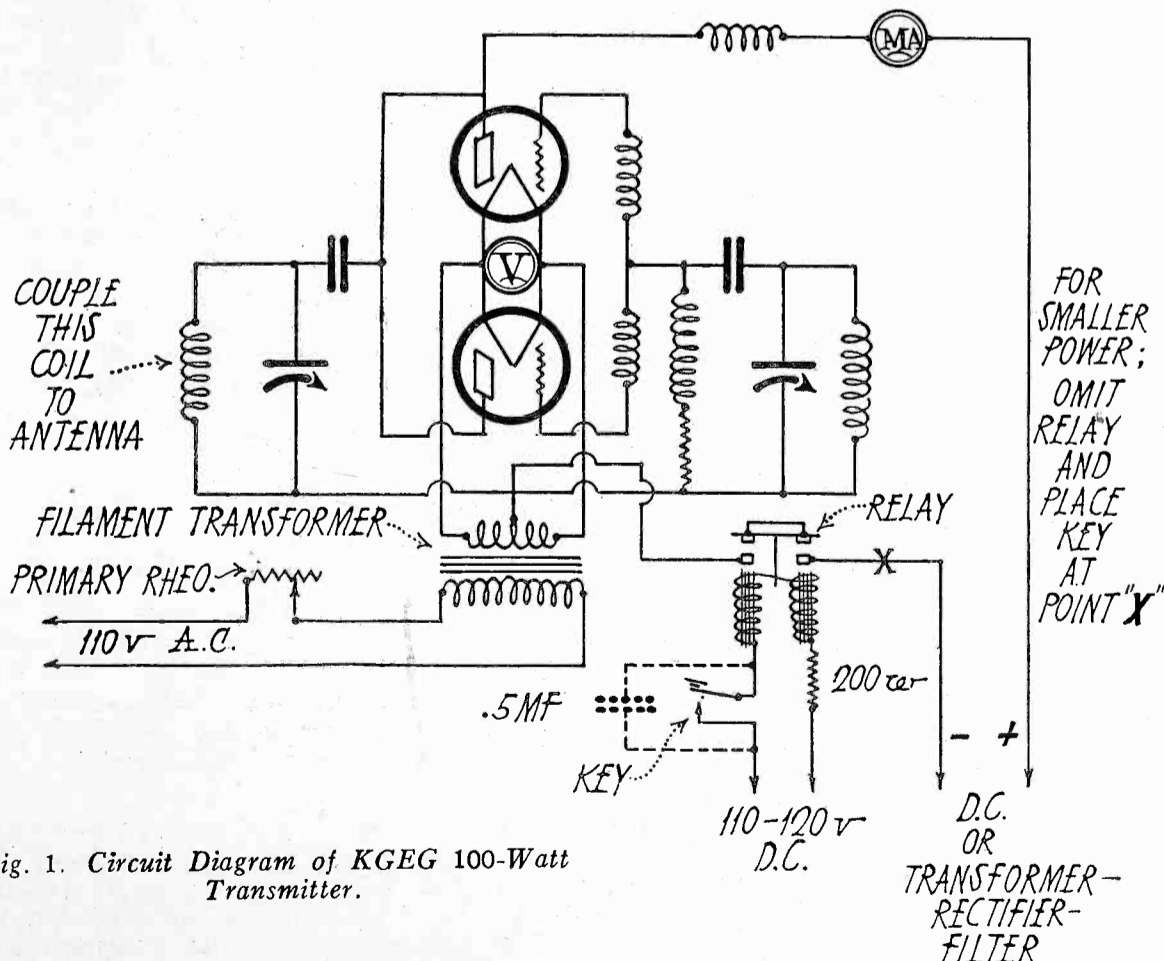

Fig. 1. Circuit Diagram of KGEG 100-Watt Transmitter.

NEWS OF THE AMATEUR OPERATORS

The banquet of the Los Angeles Radio Club on September 13 was featured by a number of interesting talks. Carl Zindt, operator on Zane Grey's *Fisherman*, KNT, described his successful schedule of communication with 6DDO, 6CUA and 6CVJ. KNT will again leave for the South Seas about January 1 and return about April 1. J. E. Strachan, OZ-3A1, of Rangiora, N. Z., emphasized the part that amateur radio is playing in making personal contact between individuals in different nations, instead of through solely official channels. Wallace S. Wiggins, 6CHZ, told of the KFLF-6CHZ circuit's success. Elden Smith, 6BUR, is operating on KFLF. A complete story of the cruise with an account of KFLF and his schedules will appear soon. The banquet-meeting was concluded with a "liar's contest" and a raffle; the latter to help in the expenses for the section's booth at the recent Radio Show Beautiful, at which they received over 1800 messages for transmission to all parts of the world. Don C. Wallace presided.

More than 150 amateurs attended the recent Northwest convention of the American Radio Relay League at Spokane, Wash. Among the speakers at the various sessions were Howard F. Mason who told of the difficulties he had met as radio operator with the Wilkins expedition to the Arctic from January to June of the year. T. W. MacLean

(Continued on page 70)

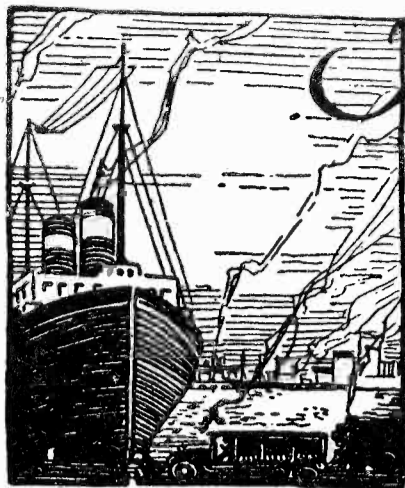

The COMMERCIAL BRASSPOUNDER

A Department for the Operator at Sea and Ashore



R. O. KOCH, *Great Lakes Correspondent*

Edited by P. S. LUCAS

C. WILLIAM RADOS, *Boston Correspondent*

ARE YOU ACQUAINTED WITH YOUR COMPANY?

It has just occurred to us that the majority of wireless operators we know do not ordinarily pay much attention to the company for which they work. Most of them are assigned to the ship by and make all their reports to the radio service company—and in a way they are responsible to the latter, which is in turn responsible to the steamship company. Therefore, as far as the operator is concerned, the steamship company doesn't even exist. Even though it is the source of his pay, it is immaterial to him whether the company is making money or going on the rocks, what its policy is, how it conducts its business, etc.

Now, so far as earning a hundred and five dollars a month is concerned, a working knowledge of the company's affairs is unnecessary; superfluous. The hundred and five (or what have you?) will be there whether or no, but—hasn't the prevalence of that same carefree, disinterested attitude something to do with the fact that the wireless operator is not appreciated by the steamship company?

Put yourself in the company's place. You have to equip your ships with radio because the law requires it. Probably you would anyway, figuring that it would save you money. The radio company rents you an operator—a man who goes to sea for a year or so as a tourist, does nothing and gets paid for it—will last a trip or so then switch to another line—doesn't know anything but how to send and receive messages, and sometimes you doubt that.

Are you, a company official, going to bother about keeping your eyes on the ranks of the brasspounders in hopes of running into ability that will fill a higher place in your organization? Are you going to be interested in the development of the radio industry as it affects your company, and the quality of your own apparatus, or will you limit your interest to the department's operating costs?

On the other hand, if all your operators seem to take an interest in the company, lose no opportunity to inform you of improvements that might be made in your equipment and operating system, let their interest lead them into fields of cargoes, rates, insurance or any of the multitudinous details which make the life of a transportation man so interesting, you would soon get a different viewpoint of the average wireless operator. And the changed viewpoint will probably result in what we, as a group, have long been crying for: respect plus decent consideration which is summed up in increased wages, better equipment, more satisfactory relationship with company and crew. And what's more—we'd be worth it!

Now we don't want to give the impression that the wireless operator should offer his services as the skipper's stenographer. Never! We're dead agin' it—for pounding brass is a job in itself if done conscientiously. But just get acquainted, take an interest, and make an attempt to prove that "Sparks" is on the job.

Lots of us have listened to the dying signals of a sinking ship, and all of us have read stories, true ones, of the heroic passing of game radio operators, but this is the first time our ranks have been scratched by aviation's "grim reaper." The following is the story, first hand, of the tragic death of Will Erwin and his navigator-operator, "Ike" Eichwaldt, who left Oakland on August 19th, QRD Honolulu. But let Commander Dewey tell it as he heard it.

EXIT KGGA

By Lieut. Com. Fred L. Dewey, U. S. N. R.

In spirit I made a trip with Capt. "Bill" Erwin and "Ike" Eichwaldt, leaving Oakland at 2:15 p. m., August 19. Optimism was prevalent throughout the trip from the time of crossing out through the Golden Gate, passing the lightship, until the dread moment of the unfinished appeal for assistance.

Such trivialities as the "missing toothpicks," "a drink of water," "sandwiches were good," "passing rum runner" and the difficulty in "keeping Bill in," all indicated most strongly that if there was a lowered morale it was not in evidence. Fog banks there were, making it necessary for these boys to fly closer to the water than was safe.

Sitting at my radio, there came through the loud speaker a signal that sounded like nothing more than the roaring of an airplane's propeller at a distance. It must be understood that during the time Ike was not actually transmitting, he kept his signal on the air, making it possible for every listener to keep him tuned in, and I listened with bated breath for the signal to be broken up into code. Then came the report that the air was bumpy and had holes in it. Might it not have been one of these very holes in the air that a short two hours later sent them into one—two tail spins?

From 7:58 p. m., when Ike told us that the darkness was now on them and that they would not likely see anything until dawn, until 9:02, when the SOS came through the air, nothing was heard from these emissaries of mercy. I can contemplate just what nerve, what bravery, these boys must have possessed, being practically certain two other planes had failed to reach their goal, when they took off to meet a similar fate with but this difference: nobody knows and probably never will know what happened to the Golden Eagle and the Miss Doran. We do have a terrible picture of what probably did happen to Wild Bill and Ike, and just when it happened.

From 7:58 until 9:02 a decided change in the note from Ike's radio was apparent, which leads me to the conclusion that they were encountering trouble of some kind or other. This change was only noted in the rising and falling of the note itself, as the alternator was run by a small propeller and the speed of the ship as well as the intensity of the wind varied the frequency of its output. The antenna was trailing the ship and any erratic movement of the ship would reveal itself in a change of note. And from the fact that

nothing was heard from Wild Bill and Ike from 7:58 to 9:02 the thought occurs to me that perhaps they were both busily engaged in keeping the ship aloft, and that these troubles began shortly after their broadcast at 7:58 p. m. At 6:48 Bill changed his course. He was flying the great circle and naturally every few hundred miles he must bear a point or two closer to his ultimate goal. This change in course was the only one reported by the ship.

Earlier in the morning they reported passing the steamship *Moana*, and later they reported seeing, off in the distance and to the left, a destroyer, but the distance did not permit their reading of the number. This was the last indicated contact with human beings the boys had. Another significant thing was that up until 9:02 p. m., when the SOS was broadcast, every word had been sent twice; at this later time, however, time must have been short, for Ike transmitted this message single and much more rapidly than before. The frequency of the alternator suddenly went up, also, from 240 cycles to approximately 500 or 600, indicating that the ship at this time was probably in its first tail spin.

Shortly after 9 p. m. came "SOS—we are in a tailspin, send assistance—hold that—we came out of it—Gee! but we were scared. Bill thought it was all off that time—all the lights went out on the instrument board and Bill couldn't see the things." Then at 9:02 a QRX and then "We are in another—," trailing off into nothingness. What a remarkable nerve Ike must have had to continue sending without a quiver up until the exact moment when he must have struck the water at perhaps 300 miles an hour. On the long list of radio operators who have willingly given their lives in doing their duty, the name of "Ike" Eichwaldt has taken its place with the bravest.

We would like to see that next International Convention decide to combine the Alphabetical List of Call Letters with the International List of Radiotelegraph Stations, and likewise combine the respective supplements. These two lists really belong together, as neither is complete without the other. It would also help things a great deal if ships were listed alphabetically by their last names.

Op: "The voltage took an awful fall when the load was applied."

Wife: "Was anyone hurt, John?"

Life's little joke number 8,972,374, according to Ollie Penny and Edw. A. Carroll, KLF, is a guy trying to raise "VQI" on 600 CW. Yes—but what's their idea of bringin' that up? We remember trying it ourselves.

The same Penny says his life's ambition is to go ashore some night, get properly "organized" on Bacardi or something as good, and have one of us take WSC and the other take WIM and mutilate the ether chewing the rag together on 600 for an hour or so.

MARINE RADIO NOTES

By L. O. DORAN

(Continued from October RADIO)

TR Reports

TR reports sent to U. S. Pacific Coast stations are published in all the coast city newspapers. It is not necessary to send the TR to more than one station.

TRs to KZRC Manila are published in Manila newspapers.

TRs to VPS Hong Kong are posted on the Post Office bulletin board.

Vessels entering the Columbia River should send TRs to KEK when crossing the bar, when leaving Astoria and when passing St. Helens. Outward bound, KEK should be notified when the bar is crossed.

Yokohama. The Harbor Office station JFSA, 600 meters, ICW or spark, should be notified of arrival time a day in advance if possible.

Shanghai. The Pilot Boat, PTG, 600 meters spark, should be given arrival time and draft a day in advance if possible. PTG stands intermittent watch from 7:30 AM to 11.00 PM Shanghai time, and generally calls CQ when open for business.

* * *

British Silent Period

All British ships and stations in the Orient maintain a silent period twice each hour from the 15th to 18th and from the 45th to 48th minutes. They will not answer calls during these periods.

* * *

Alternative Working Waves

Many coast stations work on long waves and do not listen on 600 while doing so. Much useless calling can be avoided by listening on the alternative wave, provided the station is not already going on 600. Some of the traffic waves are:

NPE 2667	JCS 2400
KPE 2100	VPS 2800
NPQ 2650	VPW 1800

* * *

Philippine Stations

All Bureau of Posts stations carry on point-to-point work on long waves and listen for 600 meter calls for only 10 minutes of each hour that the station is open. The listening periods for the stations at the more important ports follow.

All of these stations are very lax in observing the 600 meter listening periods during the greater portion of each day but they will occasionally "wake up" and call CQ.

KPI Cebu, 45th to 55th minute of each hour from 7 AM to 8 PM, Manila time. Answers either 600 or 2800 spark.

KPM Iloilo, first to 10th minute, 7 AM to 8 PM. Answers on 600 or 2400 spark.

KIW Zamboanga, first to 10th minute, 7 AM to 8 PM. Answers on 1200 spark only.

Traffic can be routed through KZRC, Manila to any point in the Philippine Islands but there is often as much as two days' delay in the delivery of messages to Islands other than Luzon.

* * *

International Watch Periods

For ships with less than three operators

ZONE	PACIFIC ZONES	Operators	
		One	Two
		Hours	GMT.
C.	Long. 80 E., to 160 E. China Sea, Western Pacific	00-02	00-06
		04-06	08-10
		08-10	12-14
		12-14	16-22
D.	160 E., to 140 West. Central Pacific	00-02	00-02
		04-06	04-06
		08-10	08-10
		20-22	12-18
E.	140 W., to 70 W. Eastern Pacific	00-02	00-02
		04-06	04-06
		16-18	08-14
		20-22	16-22

General Calls

NOB Any U.S. Warship.
 NQO Any U.S. Naval Shore Station.
 BXZ Any British Warship.
 WKW Any U.S. Merchant Vessel.
 WTM Any U.S. Commercial Shore Station.
 KSBV Any U.S. Shipping Board Vessel.
 KFZZ Any Independent Wireless Tel., company vessel.
 WWSA Any Radio Corp. of America Vessel.
 KSOC Any Standard Oil Company Vessel.
 KFVV Any Alaska Packers Association Vessel.

* * *

Radiophone Broadcasting Stations

Most of the U.S. Pacific Coast broadcast stations can be heard with good volume far to the westward of the 180th Meridian. Many inland stations can also be heard. In winter, some of the higher powered stations can be heard beyond Japan.

The Japanese and some of the Australian stations can be heard with good volume westward of the 180th Meridian.

The following list gives the Oriental stations now in commission and the Australian stations usually heard best.

CALL	LOCATION	WAVE LENGTH	POWER
JOAK	Tokyo, Japan	375	1500
JOCK	Nagoya, Japan	360	1500
JOBK	Osaka, Japan	385	1500
JQAK	Darien, Manchuria	390	500
KRC	Shanghai, China	345	100
KZRQ	Manila, P. I.	410	500
KZIB	Manila, P. I.	275	10
3-LO	Melbourne, Australia	370	5000
4-QG	Brisbane, Australia	385	5000
2-BL	Sydney, Australia	353	5000
I-YA	Auckland, New Zealand	333	
2-YA	Wellington, New Zealand	420	
3-YA	Christchurch, N. Z.	306	
4-YA	Dunedin, N. Z.	435	

* * *

Rates

Given in Centimes as per International practice. Five centimes equals one U. S. cent. Land-line rates to some points are shown. Other rates can be obtained from the stations on request.

Station	Coast charge per word	Coast minimum charge	Land-line charge per word to point given		Pay other line charges to
KFS	50	0	San Francisco	15	Federal Tel. Co.
KPH	50	0	San Francisco	15	R. C. of A.
KOK	50	0	L. A., San Pedro	15	Federal
KSE	50	0	L. A., San Pedro	15	R. C. A.
KPE	25†	0	Seattle	0	City of Seattle
KEK	50	0	Portland	15	Federal
VAE	25†	0	Victoria, Vancouver	10	Govt. Radio Service, Victoria, B. C.
Japanese Stations					
XOQ	60	0	Any part of Japan	10	Japanese Govt.
XOF	50	0	Tientsin	50	Chinese Govt.
XSG	50	0	Chefoo	50	Chinese Govt.
FFZ	50	0	Shanghai	0	Chinese Govt.
VPS	60	600	Shanghai	0	French Govt.
KZRC	50	0	Hong Kong	0	British Govt.
All Philippine Bureau Posts Stations					
	30	0	Local Delivery	0	Bureau Posts, Manila
All Indo China Stations					
VPW	50	500	Any part Indo China	5	French Govt.
	60	0	Singapore	14¼	British Govt.

(†25 centime rate on ship's business messages only. 50 centimes on private messages.)

Notes on Rates

GOVT SB messages through NPQ St. Paul, carry a 7 cent land-line rate to Pacific Coast states.

GOVT SB messages through NPE North Head, carry 5 cent land line rate to Oregon, 7 cents to California.

The 5 cent coast rate through VAE and

KPE applies only to ships' business messages prefixed "SB".

GOVT WB messages can be transmitted free through any U. S. Naval station and also through stations of the Federal Telegraph Company, as FREE. The Federal people have a contract with the Weather Bureau for handling these messages and they can be entered on abstract sheets as carrying no charges.

KZRC Manila has a 6 cent rate for Inter-Island vessels only. He may give this rate on GOVT SB messages but charge the full 10 cent rate as the Radio Service Companies have not been advised of the 6 cent rate being official.

(To Be Continued)

A GOOD SE 1220 HOOKUP

By Wm. A. Breniman

If anything goes wrong with the secondary circuit of an SE 1220 receiver the attached circuit diagram for connecting it to an SE

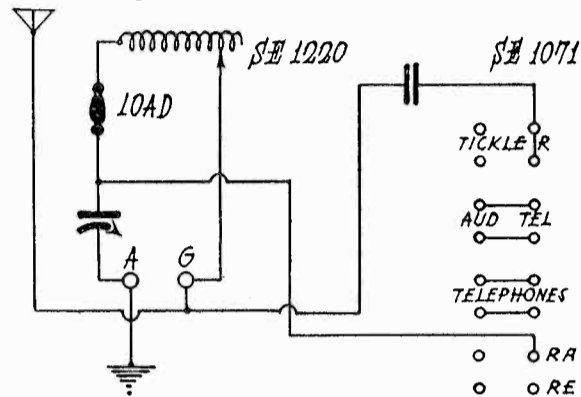

SE 1220 Hookup.

1071 audion control box may come in handy. With loading coils it can also be used as a wonderfully efficient long wave receiver using only one loading inductance.

THE LATEST STYLE OF SIGNING ON AND OFF SHIPS

Los Angeles, Calif.
 June 22, 1927.
 SS. Whoset Maru.

TO WHOM IT MAY CONCERN:

This is to certify that on this day, the twenty-second day of June, nineteen twenty-

seven, I, John Dugadget have relieved Bill Gillhickey as Radio Operator aboard the steamship Whoset Maru and can commit as follows:

I have found the apparatus aboard the SS. Whoset Maru to be in first class condition, both externally and from all appearances in-

(Continued on page 72)

FROM THE RADIO MANUFACTURERS

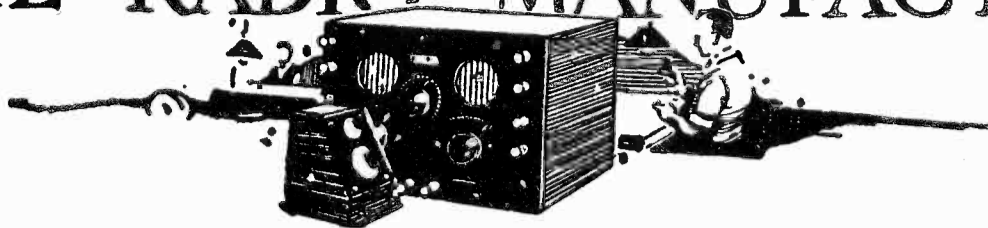

The Heterograph is a new device for automatically transmitting code, either for instruction or for uses when a manually-operated key is inconvenient. It employs a punched tape which is driven by an electric motor whose commutator

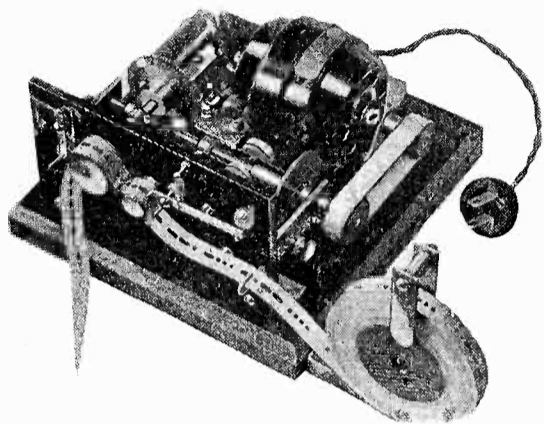

also supplies the note, thus obviating the need for a buzzer. When used for instruction from one to twenty or more pairs of headphones are connected to the instrument. The speed may be regulated from 2 to 60 words a minute. The tapes are made in three grades, one for the beginners, having long dashes and spacing, one with intermediate length, and one with short length of dashes and spaces.

The Jensen Speaker uses an electro-dynamic unit and an 8 in. cone inclosed in a mahogany cabinet which acts as a baffleboard. Its field coil draws .4 ampere from a 6 volt battery and has 7 lb. of No.



19 wire. Its movable coil is wound with No. 32 wire and has a resistance of 5 ohms. A filter or output transformer is not required with this speaker as a 25 to 1 step-down transformer is built into it. It is claimed to have a frequency range from 80 to 8,000 cycles with unusually uniform amplification for each audio frequency. It is capable of giving great volume without distortion.

The Temple Comparator is a multi-point switch designed to allow rapid and easy comparison of a number of loudspeakers or to connect any one of five loudspeakers to a receiver. It consists of bakelite turret moulded in the form of a truncated cone. Around its base are five pin jacks, each of which is con-

nected to the common lead to five speakers. Above each of these pin jacks is a jack with whose terminal a switch arm can make contact. The switch arm is mounted on a central shaft which extends through the top of the cone to the com-



mon speaker lead. When the switch arm is turned from one jack to the next it drops into position with a snap and makes positive electrical contact. Its passage from one to another of the speakers is almost instantaneous so that the same tones may be heard from each of the speakers, thus allowing a critical comparison.

The Muter Tuned Double Impedance is an audio-frequency coupling unit to be used instead of a transformer or resistance coupler. It consists of two coils which are tuned to a very low frequency by means of a fixed condenser. This allows greater amplification of the low notes and gives a greater depth of tone

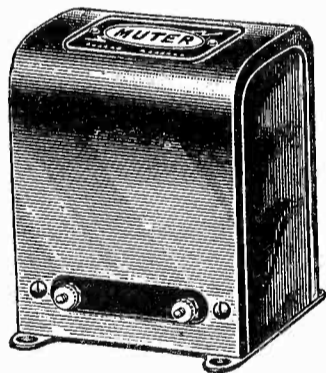

from any loudspeaker. Any possibility of "motor-boating" is eliminated by applying a steady average potential to the grid of the tube in accordance with the principles developed by Hiler. The complete magnetic shielding of the unit prevents any disturbance of the audio circuit by high frequency currents.



The Valley Automatic Charger uses a

Raytheon cartridge as the rectifier element. It is equipped with a relay switch so that the charger is disconnected when the switch on the receiving set is turned, this operation also throwing on or off a "B" battery eliminator, if used. By means of a plug under the lid it is capable of delivering either 1½ or 2½ amperes at 6 volts.

The new Sangamo a. f. transformer uses a core made of an alloy having a permeability many times greater than silicon steel. It has a high primary inductance designed to emphasize amplification of low notes and a low leakage reactance designed to give uniform amplification of the high notes. It has a 3-1 ratio and is intended for use with a power tube. Its primary resistance is 1960 ohms, secondary resistance 7100 ohms and it will safely handle 6 milliamperes plate current. It weighs 2 lbs. 2 oz., including its iron case shielding. Soldering lugs are provided near the bottom as terminals.

The new H. F. L. Audio Transformers comprise a low ratio transformer, C. 26, for use in the first stage, a 3-1 ratio transformer, C. 16, for use in the second stage with a power tube, and an output transformer, C. 25, to protect the loudspeaker against high voltage and to match average input and output impedances. These transformers have silicon

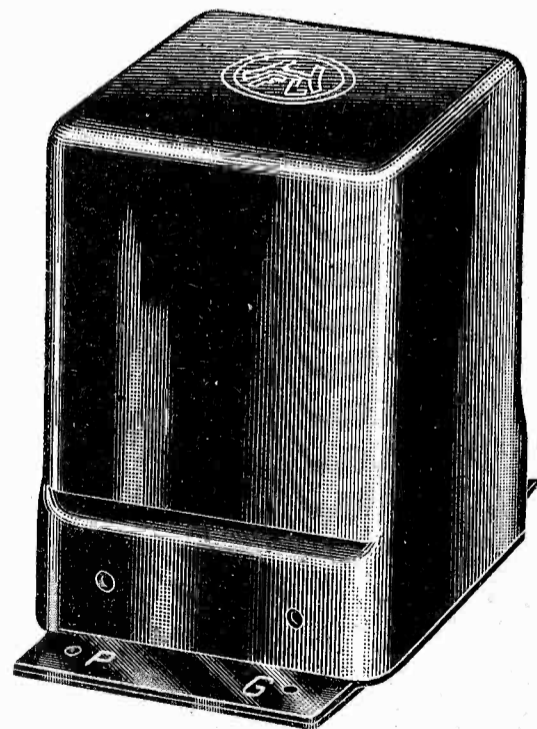

steel cores designed to avoid saturation. The coils are designed to withstand heavy electrical surges and are treated to exclude moisture. They are shielded to avoid interstage coupling and their terminals provide for short leads. They are claimed to give uniform voltage amplification from 50 to 5000 cycles, thus giving great fidelity of reproduction.

After you Buy these Parts



The 1928 Infradyne

Now you can build the new Infradyne with positive assurance of marvelous reception and trouble-free operation. Now, four complete, assembled, and tested units—all made by Remler—plus transformers and voltmeter can be assembled into a beautiful, compact receiver in a few hours. Why limp along with the crowd when the 1928 Infradyne is the outstanding radio value of the season? Even if you spend five times as much, you cannot excell the Infradyne in all-round excellence of performance.

The following materials will be required for the construction of the complete 1928 Infradyne Receiver:
LIST PRICE \$180.00

- 1 Remler No. 710 Radio Frequency Amplifier and Antenna Compensator.
- 1 Remler No. 700 Infradyne Amplifier.
- 1 Remler No. 750 Foundation Kit.
- 1 Remler No. 760 Cabinet and Base.
- 2 Audio Transformers (Silver-Marshall Type 220).
- 1 Output Transformer (Silver-Marshall Type 221 or 222).
- 1 Voltmeter (Weston Model 506 or Jewell Pattern 135).

The following accessories will be needed:

- 1 6-Volt Storage Battery (80 ampere-hour capacity or larger).
- 3 45-Volt "B" Batteries (Eveready No. 770 or Layerbilt or Burgess No. 10308).
- 1 "C" Battery (See Tube Mfrs. Specifications).
- 5 CX 301A (UX 201A) Tubes.
- 1 CX 112 (UX 112) or CX 371 (UX 171) Tube.
- 4 CX 299 (UX 199) Tubes.
- Suitable Loud Speaker, preferably of the cone type.

Write for special folders describing 1928 Infradyne and complete line of Remler parts. Free for the asking

REMLER

DIVISION OF

GRAY & DANIELSON MANUFACTURING CO.

260 FIRST STREET, SAN FRANCISCO

EASTERN WAREHOUSE, ELKHART, INDIANA

CHICAGO

NEW YORK

Tell them that you saw it in RADIO



Only those manufacturers whose power units have been fully tested and approved by the Raytheon research laboratories are entitled to use Raytheon rectifiers or this symbol in connection with their products.

When You Offer Your Opinion on Light Socket Power Units

—be sure you recommend a Raytheon equipped power unit which will maintain a constant flow of smooth, silent power night after night and month after month.

The performance of any power unit depends upon the rectifying tube. There are nearly a million Raytheon gaseous rectifying tubes, which have no liquids or fragile filaments, now doing service.

When you recommend Raytheon your opinion is backed by the engineering departments of over 40 leading manufacturers who have designed their power units for the Raytheon long life rectifying tube and have the approval of Raytheon Research Laboratories.

TYPE BH

An improved rectifier for universal use in all B-power units for outputs up to 300 volts. Also A-B-C power to receivers using 199 tubes in series.

Rating: 125 m. a. at 300 V.

List Price, \$4.50

TYPE BA

This remarkable tube is designed for power units which completely eliminate all batteries, chargers and outside power accessories. A-B-C Units employing Type BA are now on the market.

Rating: 350 m. a. at 250 V.

List Price, \$7.50

TYPE A

A simple, compact, unbreakable metal cartridge of revolutionary principle and design. Type A is the efficient rectifier for battery chargers and A-power units.

Rating: 2½ amps.

List Price, \$4.50

TYPE R

The voltage regulator tube designed to maintain constant voltage output from B-power units regardless of fluctuating line and load conditions.

Rating: 90 V. 60 m. a.

List Price, \$4.00

RAYTHEON MANUFACTURING CO., Kendall Square Bldg., Cambridge, Mass.

Raytheon

THE HEART OF RELIABLE RADIO POWER

Tell them that you saw it in RADIO

FISHING FOR RADIO WAVES

(Continued from page 20)

scopes adjusted for zero current. When no current is passing through the galvanometer coils, the images of all of the small lights should coincide with the zero indicator. The filament current was supplied from a six volt storage battery, and controlled by a 10 ohm rheostat connected in series with a 0-1 ammeter in each circuit.

The most satisfactory brilliance for the lights was determined by experiment, so that it was merely necessary to set the rheostat until the desired current was passed. In event that the signal is varying extremely rapidly, a slight increase is advisable, and if little variation occurs, turning down the filaments will produce a better record.

From each receiver a double line is brought in to the recorder, and connected across the galvanometer ter-

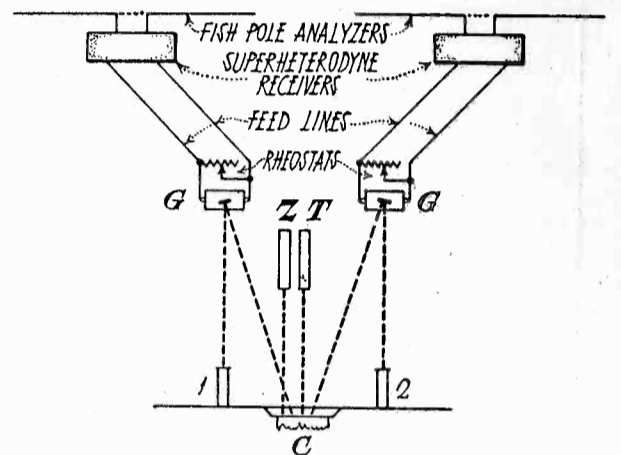

Fig. 6. Connections From Analyzer and Optical Diagram Showing Paths of Light Rays in Recorder.

minals, as shown in Fig. 6. To enable the operator of the recorder to hear, when desired, the received signal in the recorder room, monitor phones may be connected through a low ratio audio frequency transformer, one winding of which is in series with the "feed" line.

For controlling the magnitude of the deflection, variable resistances are placed in parallel with the galvanometers. Each change of this resistance was carefully noted in a record book, with the exact time the change was made. Notes are also kept of changes in each receiver during the recording process.

From these data the photographic records may be interpreted. A few representative types will be considered in the succeeding article.

(To Be Continued)

Transmitting amateurs who have chemical rectifiers will find that a much purer DC note can be obtained if they increase the number of jars in the rectifier. It seems nearly impossible to use too many jars. One jar should be used for each fifty volts, if anything resembling pure DC is desired; although one jar for each thirty or forty volts would be better. If 1000 volts DC is required, a 2200-volt center-tapped transformer should be used with a chemical rectifier of at least 56 jars connected across it.

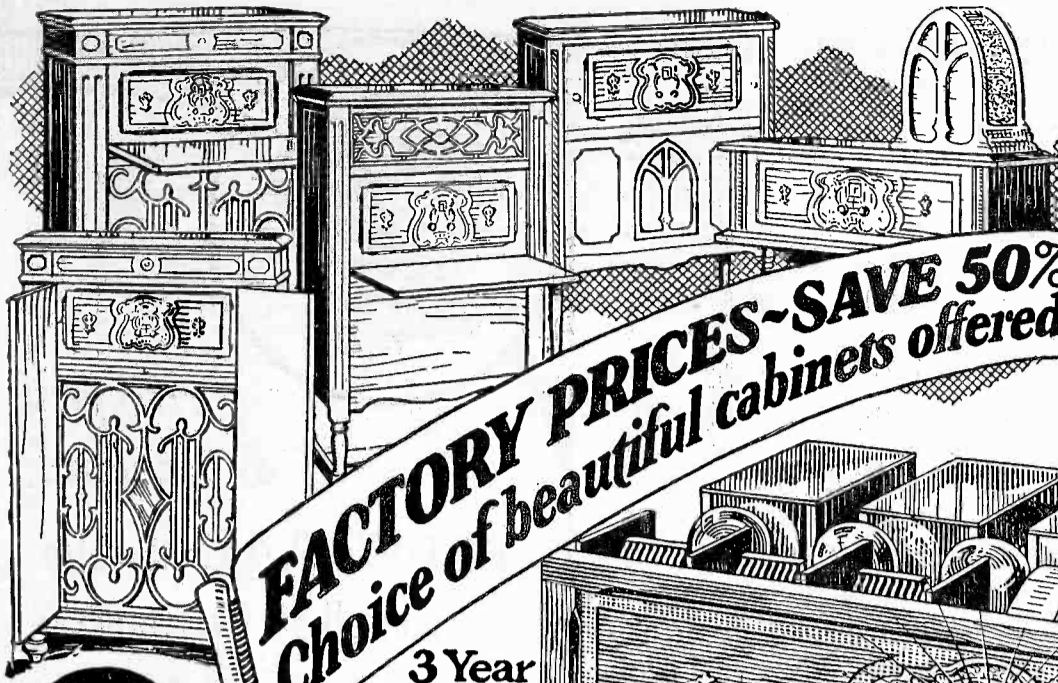

FACTORY PRICES - SAVE 50%
Choice of beautiful cabinets offered

3 Year Guarantee

TRY IT 30 DAYS FREE
BEFORE YOU BUY

ALL METAL SHIELDED CHASSIS

8 tube - one dial
MIRACO
TRADE MARK REGISTERED

Only **\$69⁷⁵**
Retail List Completely Assembled

MAGNIFICENT TONE - SUPER SELECTIVE - POWERFUL DISTANCE GETTER

All Electric or Battery Set!

Big Discounts to User-Agents

MIRACO Users Say:

Reports from users everywhere leave little for us to add. These are only a few of the many in our files and which we receive daily. Send coupon for plenty of additional proof and testimony of nearby users.

CLEARER THAN A \$450.00 SET
Before I bought your set I tried out and heard quite a number of different makes sets and I believe I can truthfully say that I never yet have heard a set with such wonderful tone and clearness as the Miraco. I never thought that a set could be as clear and reproduce tones and voices as the Miraco. Saturday I listened to a \$450.00 set and it can't even come near your set for clearness and volume. I have logged some very distant stations on the Unitone and although people won't hardly believe me, the first week I had KFI Los Angeles on two nights in succession on a 30-ft. temporary inside aerial. —FRANK A. OLDENBURG, Milwaukee, Wis.

SHARPLY SEPARATES STATIONS
The Unitone brings in stations very clearly and with a selectivity that is amazing when you take in consideration the mass of stations on the air at the same time. I have heard three and four stations that were on almost same wavelengths at the same time and was able to tune out one after the other without the least interference. —W. L. BROBACK, San Francisco, Calif.

EXPERIENCED FAN PRAISES SET
Miraco is the most wonderful radio I have ever seen. I have had experience with many popular makes of radios, also have built a number of them myself but in tone quality it is far superior to all. For sensitiveness I can say it is more like a super-heterodyne. —R. D. WHITE, Proctor, W. Va.

HAS POWER TO SPARE
"Well Pleased" with Miraco would be putting it mildly. Haven't heard anything to equal it regardless of price. With temporary aerial tuned in WEAF then WIOD Florida felt sure this must be WJZ the pet station of this locality. Stations all coming in clear with wonderful tone and tremendous volume. Seldom have more than half of volume turned on. A local agent insisted he could prove his set superior but to his surprise and astonishment my family and neighbors and the agent himself admitted his \$165 set had to step out of the way for Miraco. —H. W. HOEFFL, Perkiomenville, Pa.

America's big, old, reliable Radio Corporation* (8th successful year) **guarantees** in its big, powerful, latest 6, 7 and 8 tube Miraco sets "the finest, most enjoyable performance obtainable in **high grade** radios." Unless 30 days' use in your home fully satisfies you a Miraco is unbeatable at any price for beautiful, clear cathedral tone, razor-edge selectivity, powerful distance reception, easy operation, etc.—**don't buy it! Your verdict final.** Save or make lots of money on sets and equipment—write for testimony of nearby users and **Amazing Special Factory Offer.**

Miraco's work equally fine on "AC" electric house current or with batteries. Take your choice. Many thousands of Miraco users—who bought after thorough comparisons—enjoy programs Coast

to Coast, Canada to Mexico, loud and clear—with the magnificent cathedral tone quality of costliest sets. Don't confuse Miraco's with cheap, "squawky" radios. Miraco's have finest parts, latest approved shielding, metal chassis, etc.—as used in many \$200 sets.

Deal Direct with Big Factory

Your Miraco reaches you completely assembled, rigidly tested, fully guaranteed. Easy to connect and operate. **30 days' trial free.** 3 year guarantee if you buy. You take no risk, you insure satisfaction, you enjoy **rock-bottom money-saving prices** by dealing direct with one of radio's oldest, most successful builders of fine sets. 8th successful year in the radio manufacturing business.

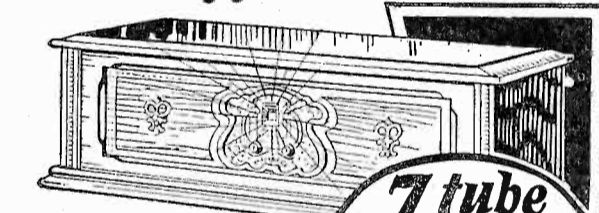

MIRACO "Powerplus" sets—both in 8 and 7 tube models—have magnificently beautiful, clear cathedral tone quality. Turn one dial for stations everywhere. Ultra-selective. Miraco multi-stage distance amplification gives "power-plus" on far-off stations. Latest all-metal shielded chassis. Illuminated dial. Fully guaranteed. *Try one free for 30 days!* Choice of beautiful cabinets.

7 tube one dial
METAL SHIELDED CHASSIS
\$49⁷⁵
RETAIL LIST



Dealers Write!

Free!

mail coupon right now!

BEAUTIFULLY ILLUSTRATED CATALOG AND AMAZING SPECIAL OFFER

SEND NO MONEY—30 DAYS' TRIAL, Special Wholesale Price Offer to User-Agents, Bank References, testimony of nearby Miraco users—all the proof you want—sent with catalog.

Electrify Any Radio with MIDWEST NO-BATTERY "A-C" Light Socket Power Units

BIG DISCOUNT TO User-Agent

"A", "B" and "C" power, direct from light socket, without batteries! Write for Midwest prices and discounts. Midwest Units are highest grade—lastingly dependable, quiet in operation, fully guaranteed.



Another Big Bargain! Famous powerful big Miraco Super 6, 1928 model—ultra selective! Thousands find it outperforms sets of much higher price. **30 Days' Trial Free. Fully Guaranteed.**

MIDWEST RADIO CORPORATION
Pioneer Builders of Sets
414-E Miraco Building, Cincinnati, Ohio.

Without obligation, send free catalog, **AMAZING SPECIAL OFFER**, testimony of nearby Miraco users. User Agent Dealer

NAME _____
ADDRESS _____

THIS COUPON IS NOT AN ORDER

Tell them that you saw it in RADIO

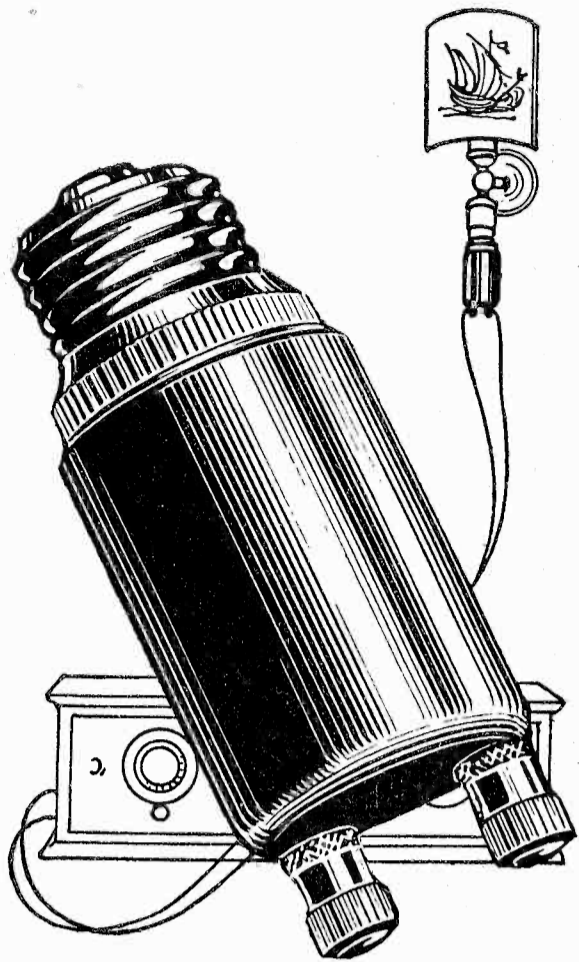

A Perfect Aerial in 5 Minutes

Just connect it to the set and plug in—that's all the work you need to do on an aerial that brings in programs with remarkable volume and clarity. It uses absolutely no current, reduces both static and interference, and completely eliminates the lightning hazard. Sold by all good dealers on a 5 day, money-back basis for \$1.50.

Dubilier LIGHT SOCKET AERIAL



Building A Power Unit?

Then select the condenser blocks built for long hours of heavy-duty service. Dubilier Blocks are the choice of leading manufacturers and of experimenters who build with care.

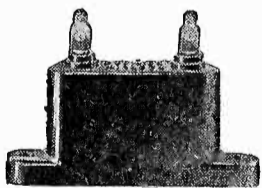

Micadon—the Standard of Radio

This famous fixed condenser is now incorporated in a moulded Bakelite case designed to meet modern receiver designs. Terminals adapted to soldered and screwed connections. All capacities. Price 45c to \$1.50.

DUBILIER CONDENSER CORP.
4377 BRONX BLVD. NEW YORK CITY

Dubilier

Condensers

CONSTANT GAIN RECEIVER

(Continued from page 22)

cast band it will be noted that the receiver is not anywhere near the oscillating point, that is, C_5 and C_6 can be increased considerably. Next tune to the lowest wavelength station available, one that comes in between 0 and 10 on the dials, providing the drum scales are not reversed, make the set just oscillate by increasing C_5 or C_6 , or both, and then very slowly increase C_8 until the set stops oscillating. This adjustment will set the circuit C_8L_8 correctly so that it should not have to be touched again. After C_8 is properly adjusted C_1 should be increased sufficiently so that the receiver will just break over into oscillation at any particularly wavelength over the whole tuning condensers when either C_5 or C_6 is turned up too far.

Playing with these adjustments for a few minutes will enable one to become familiar with the effects that each condenser C_1 , C_5 , C_6 , and C_8 have on the rest of the r.f. amplifier. None of the adjustments are very critical and setting the oscillation control condensers C_5 and C_6 is many times easier than adjusting the neutralizing condensers on most r.f. receivers.

The r.f. tube volume control was decided upon in order to prevent overloading the grid condenser-leak detector when listening to nearby stations. This rheostat volume control is in series with a pair of Amperite filament resistances so that it can not be turned up high enough to run the filaments at more than 5 volts. The filaments are automatically turned on when the loudspeaker plug is inserted into the jack.

SHIELDED GRID TUBE

(Continued from page 28)

maximum efficiency over a very wide range of wavelengths, and is an important step towards reliable long distance reception. A single stage presents no constructional difficulties, and once the general principles are mastered a second and even a third may be added, when the sensitivity is on a par with that of the best superheterodyne circuits.

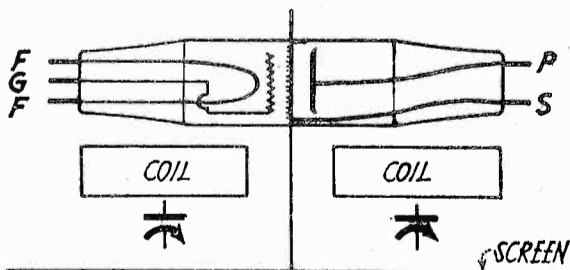

Since a considerable high frequency input to the detector tube is obtainable, anode bend rectification may be used, a resistance coupling the audio frequency tube being suitable.

Where a greater range is required, reaction may be used and the detector tube should be of low impedance (6000 ohms normal) followed by a low ratio transformer and a power tube.



Exclusively
Licensed by
Technidyne
Corporation
under U. S.
Patent No.
1593658,
July 27, 1926

*Accepted
as Standard!*

ELECTRAD Royalty Variable High Resistances

Reception from your radio depends upon the quality and efficiency of even its smallest parts. That's why fans everywhere insist on Electrad Royalty wherever variable high resistances are required.

Electrad Royalty Resistances are acknowledged superior because (1) same resistance always secured at same point, (2) contact made positive by metallic arm on wire wound strip, (3) resistance element not exposed to mechanical wear.

A range for every purpose designated A to L. Type E \$2.00. All other types \$1.50.

Write for free hook-up circular.

Dept. 53C, 175 Varick St., New York

ELECTRAD

SELL YOUR OLD SETS

Use the Classified Ads in
"RADIO" for quick results.
The rate is only 1c per word.
Mail your ad now.

Giant Like STAMINA



SPRAGUE MIDGETS are built to carry maximum loads. A new process of triple impregnation and a special waterproof asphalt wrapper insures constant capacities.

The new .1 M. F. D. is truly a condenser revelation. Order it from your dealer or send one dollar for sample complete with mounting bushings.

SPRAGUE SPECIALTIES CO.
Dept. R
Quincy, Massachusetts



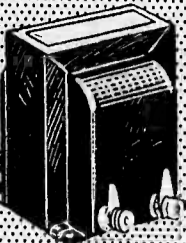

P-200
AMPLIFYING
TRANSFORMER
\$ 8.00

6-1 Ratio \$4.50
3-1 Ratio \$4.00
2-1 Ratio \$5.00
Super Amplifying Transformer

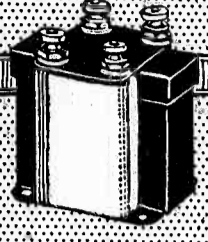

6-1 Ratio \$4.50
3-1 Ratio \$4.00
2-1 Ratio \$5.00
Sub-Panel Mounting Type

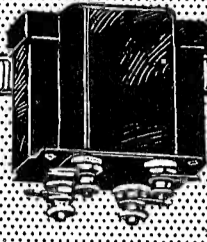
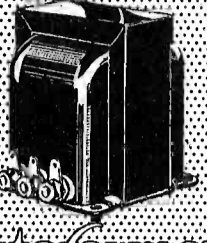
Autoformer
\$ 5.00



T-2445
Transformer for
RCA Tubes \$10.00

THORDARSON RADIO TRANSFORMERS

Supreme
in
Musical
Performance

FOR SALE AT
GOOD DEALERS
Everywhere



T-2098
Full Wave Rectifier
Transformer
\$ 20.00



R-175
Battery Charger
\$ 12.50



P-2229 Raytheon
Heavy Duty
Rectifier Supply
\$ 20.00



T-2291
Q.P.S. Heavy Duty
Rectifier Supply
\$ 24.00

POWER PUSH-PULL
TRANSFORMER
AND
CHOKE



T-2408
Input
Trans \$8.00

T-2420
Output Choke
\$ 8.00



T-2099
Double Choke Unit
\$ 14.00

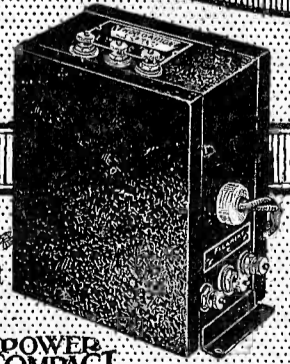

POWER
COMPACT
R-171 - \$15

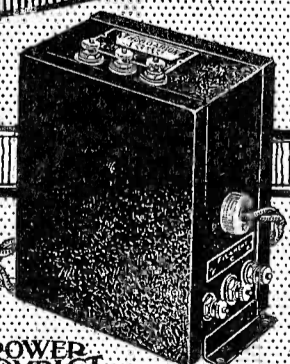

POWER
COMPACT
R-210 - \$20

R-196
CHOKE COIL
\$ 5.00

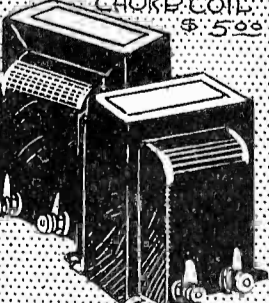

R-76
Speaker Coupling
Transformer \$ 6.00

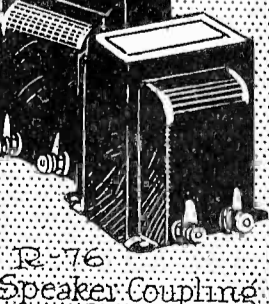

Tell them that you saw it in RADIO

AMERTRAN

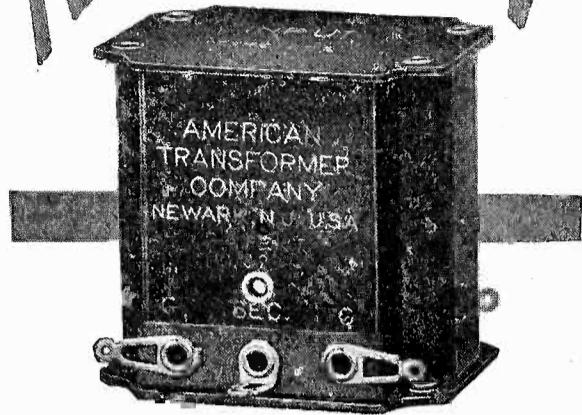

Now AmerTran Push-Pull Transformers

A stage of AmerTran Push-Pull with power tubes, following a first stage AmerTran DeLuxe, provides even greater energy output to the speaker with less distortion than can be obtained with a single power tube. With push-pull amplification, tube distortion and harmonics are suppressed and the slight hum, caused by raw A C on the filaments of the power tubes, is eliminated.

The AmerTran Push-Pull Input and Output transformers use high permeability alloy cores with multiple windings so arranged and balanced as to give high inductive coupling and low capacity coupling. The Input transformer, which works out of the plate of one amplifying tube into the grids of two power tubes, has approximately the same primary impedance as the second stage AmerTran DeLuxe. It is suitable for use ahead of any pair of standard power tubes.

The plate impedance of two tubes connected push-pull is double the impedance of a single tube. Since various types of power tubes have different values of plate impedance, this company provides output transformers of different types to correspond with the power tubes and the speakers which are in most general use. The impedance ratios are calculated for the greatest transfer of energy at frequencies from 60 to 100 cycles, because at these low frequencies more energy is required to drive the loud speaker mechanism.

AmerTran Push-Pull Transformers are now available in these types:

Push-Pull Input Type 151—\$15 each
 Push-Pull Output Type 152 (Impedance ratio 4:1), for two UX-210's or similar power tubes—\$15 each
 Push-Pull Output Type 271 (Impedance ratio 2:1), for two UX-171 tubes connected push-pull—\$15 ea.

AMERICAN TRANSFORMER CO.
 178 Emmet Street Newark, N. J.

We also make Audio and Power Transformers, Chokes and Resistors
 Pacific Coast Office, Chronicle Building,
 San Francisco

**Transformer Builders for
 Over Twenty-Six Years**

HEAVY DUTY AMPLIFIER

(Continued from page 25)

switches are turned off, except that the filament of the high-mu tube is lighted, as well as the filaments of the receiving set, in case it is receiving its B supply from the amplifier. Turn on the 110 a.c. switch and note that the filaments of both rectifier and power amplifier tubes light. The pilot light will serve as an indication of this condition.

After allowing the filaments of the tubes to warm for a few seconds, turn on the plate voltage switch, and the plate current should read from 50 to 60 milliamperes, for Western Electric 211-D or R.C.A. UV-203-A tubes, as well as the new UX-874, which worked very satisfactorily in this type of amplifier. The heating of the filaments of the 50 watt tubes for a few seconds before applying the plate voltage is most important with the Western Electric tubes, and is not so essential with the other makes.

If the milliammeter needle goes off the scale as soon as the plate voltage is turned on, either the tube is defective, or there is no C voltage on the grid of the power tube. If there is no plate current at all, and the rectifier tube plate becomes red hot, one of the condensers in the filter is short circuited.

In connecting the loud speakers, a set of three jacks, so that two 36 inch cone speakers could be connected either in series or parallel, was provided, but more jacks can be placed on the panel for extra speakers if required. The plate impedance of a 50 watt tube used in this circuit is about 3000 ohms, so that if the combined impedance of the loud speaker group is very much greater or less than that amount, a considerable reflection loss will take place and the power tube will appear to overload easily. Overloading is evident when the plate current fluctuates more than 1 or 2 milliamperes. Violent fluctuations of 10 milliamperes or more should not be tolerated, as distortion is surely taking place.

In conclusion, it may be noted that if the power tube is to be used with voltages in excess of 950, with correspondingly increased C voltage, the output of the high-mu tube in terms of impressed voltage on the grid of the power tube will be insufficient to overload the latter, and a tube of characteristics such as the CX-310 tube must be used next to the 50 watt tube. A good amplifier is so designed that the power tube always overloads first; if some one of the preliminary amplifier stages overloads before the power stage, then the full output cannot be realized without serious distortion.

The NEW
 3 foot Cone
 LOUD

“ENSCO”
 WALL TYPE
 SPEAKER

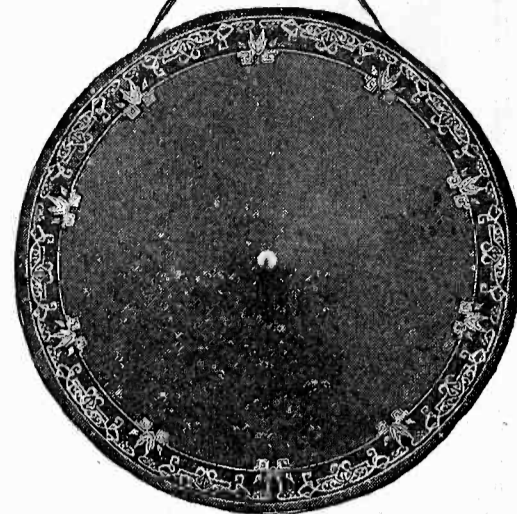

STANDARD “ENSCO” KIT - \$10.00
 With Hardwood Wall Frame - \$11.00

Anyone can assemble the “World’s Finest Loud Speaker” in less than an hour, from the complete “EnSCO” Kit. Ask any engineer why the single cone is far superior to the double cone. At your dealer’s or direct from any of the offices listed below. Send check, money order or C. O. D. (Shipping charges paid) In Canada \$11.50 and \$12.50. Absolute money back guarantee.

ENGINEERS’ SERVICE COMPANY
 25 Church Street, New York 73 Cornhill, Boston
 28 E. Jackson Blvd., Chicago 331 Bay St., Toronto, Can.
 Pacific Coast Reps., Phelan & Gardner, Oakland, Cal.
 Pacific Coast Reps., BELDEN S. GARDNER
 144 Second Street, San Francisco

A NEW Socket

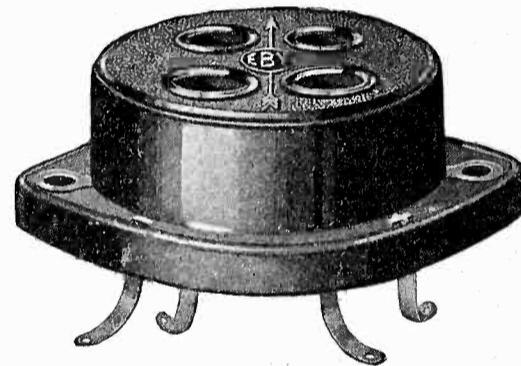

With An Old Name

The name Eby stands for the utmost in quality and performance in the radio industry.

The new Eby socket is a worthy member of a famous family. It has won unqualified approval because of—

1. Contact—3 point wiping spring contact the full length of the prongs—most perfect known. Prongs cannot spread.
2. Appearance—beautifully moulded of phenolic material—top same size as tube base. Small, beautiful and completely self-contained.
3. Easy Mounting—Above or below metal, bakelite or wood. List 40c.

The H. H. EBY MFG. CO., Inc.
 4710 Stenton Ave., Philadelphia, Pa.

MAKERS OF EBY BINDING POSTS

NEW RADIO LOG-25c

All the New Listings
 right up to date

“RADIO”

Pacific Building - San Francisco

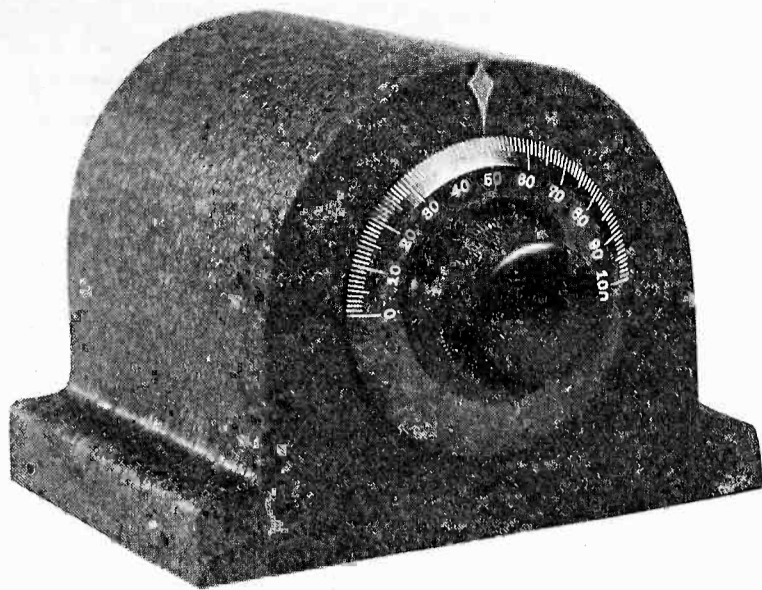

Sargent's Station Isolator

Doubles Selectivity - Doubles Distance

Adaptable to Any Tuned R. F. or Neutrodyne Circuit

Sargent and Rayment offer another clever device to the radio enthusiasts in the form of a new Station Isolator. You can attach it to any receiver using a tuned radio frequency or neutrodyne circuit and double the selectivity of the set in addition to vastly increasing your "DX" range. When used in connection with tuned r. f. or neutrodyne receivers it acts as an added stage of radio frequency amplification. A vacuum tube is required when the STATION ISOLATOR is used in conjunction with these circuits. In addition to the vacuum tube model there is also available another model for use on all Atwater Kent Receivers. The Station Isolator for Atwater Kent

circuits employs no vacuum tube. A tremendous increase in selectivity is at once attained when this simple device is connected to the Atwater Kent receiver by means of only two wires. The Atwater Kent Isolator and the Isolator for Neutrodyne and Tuned Radio Frequency Receivers are identical in appearance. The picture shows the device. A simple, neat and attractive metal container, finished in crackle crystalline to match the Atwater Kent job. Hook the Station Isolator to your receiver — improve your selectivity 100 per cent — double your distance range — give your set the kick of a super and bring in the distant stations right through the locals.

\$17.50

One model — one price. Order direct from the manufacturers. Send check or money order for \$17.50 and the Station Isolator will be shipped on same day order reaches us.

Astounding Results When Used With Atwater Kent Sets

The Sargent-Rayment Station Isolator can be used in connection with any Atwater Kent Model. The exterior appearance of the Isolator for Atwater Kent sets is highly pleasing. The dial matches the ap-

pearance of the dials on the Kent sets. Can be connected in a few minutes. The Station Isolator with an Atwater Kent Model gives astounding results. Dealers are invited to write at once for territory.

Order Direct by Mail Use the Coupon for 8 Hour Service

RADIO CONSTRUCTORS CORPORATION
357 12th Street, Oakland, California

I am enclosing remittance of \$17.50 for which you will immediately send me one of the new Sargent-Rayment Station Isolators as advertised in "RADIO" for November. It is understood and agreed that this Isolator be shipped to me on the same day my order reaches you.

The Station Isolator is to be used on a.....

Be sure to state here type of receiver you desire to use in connection with this Station Isolator. Also give model number of receiver.

Name

Street and No.

City and State.....

Shipments made by Parcel Post unless otherwise stated. We pay the mailing charges.

Tell them that you saw it in RADIO

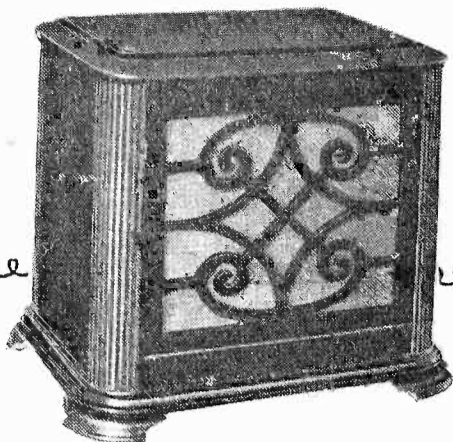

Jensen Dynamic Speaker

TREMENDOUS volume without a trace of distortion—volume as you hear it only on the most expensive phonograph—is now within the reach of all through the remarkable invention of Peter L. Jensen, pioneer in sound producing devices.

The new Jensen Dynamic Speaker employs the movable coil principle, used extensively in reproducers selling for several hundred dollars. The frequency range of this new speaker is from zero to 8000 cycles. The highest and lowest audible notes are reproduced with absolute fidelity. The Jensen Dynamic Speaker uses a specially designed cone, a field coil drawing but 0.4 amperes and a 25-1 ratio step down transformer, all included in the assembly. No output transformer or filter is required even when the speaker operates on 400 volts in conjunction with a power amplifier. This new speaker will give you an entirely new conception of reproduction at its best—reproduction that cannot be surpassed in any instrument at any price.

PRICES

\$65⁰⁰

for the beautiful cabinet model as illustrated. Grilled front and rear. Hand polished Mahogany.

\$47⁵⁰

for the speaker without cabinet but including step-down transformer.

Jobber and Dealer representation now being made. Manufacturers' orders solicited.

Licensed under Magnavox Patents

JENSEN RADIO MFG. COMPANY

212 Ninth Street, Oakland, Calif.

RADIO SERVICE SHOP

(Continued from page 26)

sets that its field strength is not stronger in their vicinity than in the vicinity of the aerial. Otherwise the energy of the interfering signal induced directly in the detector grid coil or arriving there through battery leads, etc., may be far greater than the amount similarly introduced by even a strong local station. It is usually advisable to use a small aerial on the oscillator.

Comparison of fidelity of reproduction is most practically done by tuning in the same broadcast program on both sets, and judging by ear. The following points should be noted:

a. A high quality broadcast station should be used.

b. The set which gives the better quality on local broadcasting may not do so on a more distant station.

c. When a local station is tuned in it is very easy to overload the detector, and thus introduce distortion. This can be avoided by using the volume control, except in those sets where this control acts on the a.f. amplifier, which cuts down the volume *after* instead of before the detector tube, and is therefore bad practice.

d. On some sets an inferior loud speaker may give more faithful reproduction than a better one, since it may to some extent increase the volume of the audio frequencies poorly amplified by the set. When possible the set should be tested with the speaker belonging to it (against the standard speaker on the standard set) as well as with the standard speaker.

Protection against short circuits is important in the comparison switch, since it is frequently connected to defective sets. The filament of a 199 type tube, which has been paralyzed and will not rejuvenate, makes a good fuse when connected in the wire between the negative *B* battery and the switch. Some prefer a 110-volt Mazda lamp, although the resistances of the sizes which are small enough to afford protection are fairly high even when cold. A 10-watt, 110-volt tungsten filament lamp measures roughly 1000 ohms when incandescent and 100 ohms at ordinary temperatures. The small Mazda lamp which is used for illuminating dials on radio sets becomes incandescent at 100 milliamperes and makes a satisfactory *B* battery fuse. Its resistance when cold is quite low, probably about 6 ohms.

A milliammeter (0 to 50) may also be connected in the —*B* wire, in series with the fuse, and mounted on the panel with the switch. It should be provided with a short-circuiting switch, which is left closed to protect the meter except when a reading is desired. A meter for measuring *A* and *B* voltage may also be added.

Tell them that you saw it in RADIO

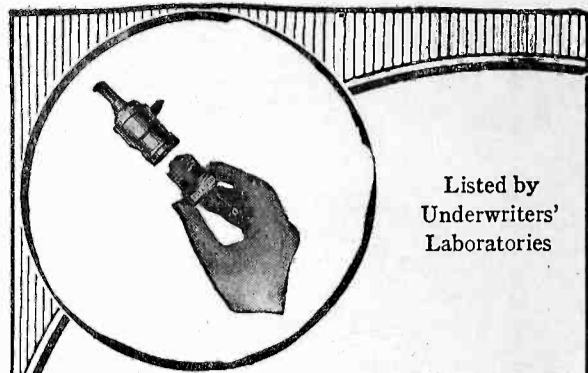

Listed by Underwriters' Laboratories

Safe!

ELECTRAD

Lamp Socket Antenna

\$1.00

You have many aerials in your home now—so why buy one? This antenna makes every outlet an efficient aerial.

No current used, gets distance, neat in appearance and attached in a few seconds. Tested at 2500 volts A. C.

Write for free circular

At your dealer's or write

Dept. 57A, 175 Varick St., New York

ELECTRAD

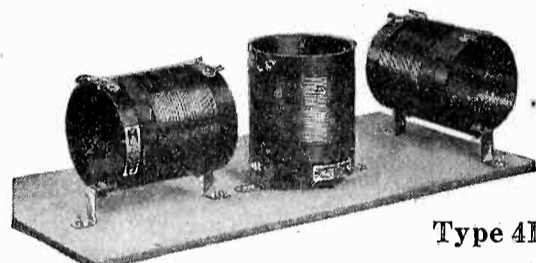

Type 4D

The New Diamond Cut PRECISION COILS

are now the "Standard of Comparison"

They are accurate to within 1% of the rated inductance and most of them are better. Only with diamonds can this extreme accuracy be obtained. The diamond cut bakelite assures accurate spacing of the turns and uniform diameter of the tubing. Our new catalogue gives more details. Send for it.

No. 420

Coils shown are our Type 4D and R. F. Choke No. 420. Type 4D—\$5 No. 420—\$1

PRECISION COIL CO., Inc.
209 Center Street, New York City

RADIO ACCESSORIES at WHOLESALE

Radio Sets, "B" Eliminators, Chargers, Tubes, Kits, Parts—everything new in Radio at lowest wholesale prices. Thousands of nationally advertised bargains. All listed and illustrated in my Big New Catalog and FREE Call Book. 182 Pages of valuable Radio information—trouble finding, set building—Radio knowledge of all kinds. Write today. HARRY SCHWARTZBERG PRES.

AMERICAN AUTO & RADIO MFG. CO.
Dept. 14, American Radio Bldg.
Kansas City, Missouri



FREE BIG BARGAIN CATALOG

A B O X

"A" BATTERY ELIMINATOR



Licensed by The
Andrews-Hammond Corporation, under Patent No. 1,637,795 and applications

A B O X is a True "A" Battery Eliminator

THE ABOX consists of a transformer to step-down alternating house lighting current to a low voltage which is passed through a rectifying valve that allows current to flow in one direction only, creating a pulsating direct current. This is filtered through a circuit consisting of a choke and two of the well known ABOX condensers, which remove the pulsations and smooth the current into pure, hum-free 6 volt direct current—ideal for radio "A" power supply and of sufficient quantity to operate *any* set using up to eight tubes.

ABOX contains no battery in any form. Converting house lighting current into radio "A" power with an ABOX is entirely a new and advanced development.

Attaching an ABOX is as simple as connecting a loud speaker. Anyone can do it in a few minutes—and once attached it requires no attention or service. It will operate *your* set with a degree of efficiency and economy you have never before experienced.

See ABOX at your local radio store.

[[Send for interesting booklet,
"ABOX and The Light Socket"]]

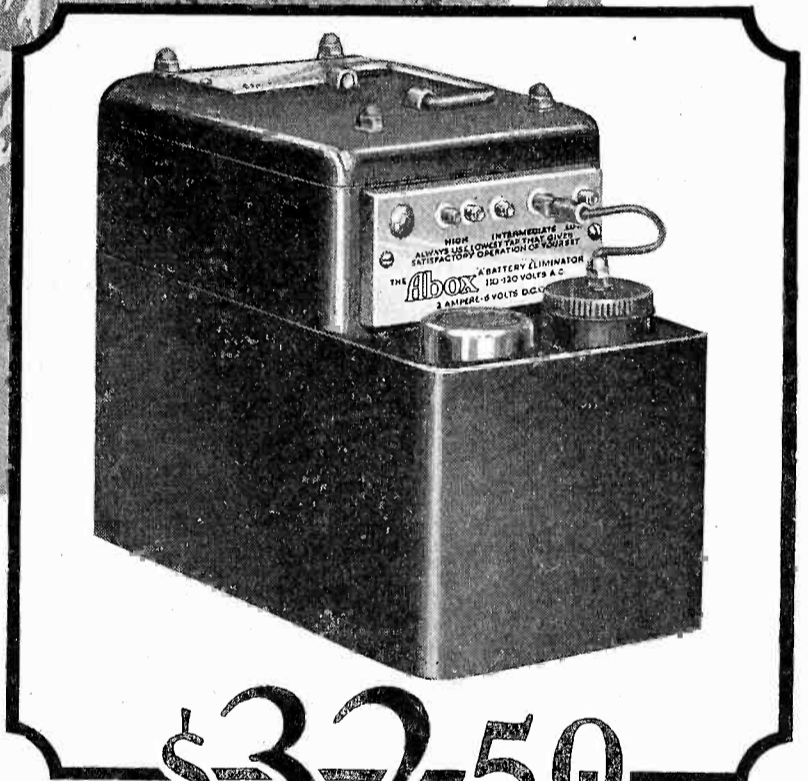

\$32.50

Slightly higher west of the Rockies

Input—110 volts, 50-60 cycles A. C. Output—6 volt direct current, 2 amperes. Shipping weight, 25 lbs.

Unlimited shelf life.

4-volt model for Radiola sets or any receiver using small tubes \$27.50

The ABOX Filter is an entirely different unit from the Eliminator, being the filter circuit alone in a small, compact unit. If you have a suitable charger, it can easily be converted into an "A" Eliminator by substituting the ABOX Filter for the storage battery. Shipping weight, 11 lbs. Price, \$19.50. *Slightly higher west of the Rockies.*

Send for Special Circular

The ABOX Company

215 North Michigan Avenue

Chicago, Illinois

MAGNAVOX

(electro dynamic)

Magnetic Cone Speaker



M-7 Unit

Distortion-free on power tube volume

This speaker goes far beyond previous magnetic cone reproducers. By reason of the new type pole piece construction, patented by Magnavox, new beauty of tone and new range of equalized volume are possible.

The M-7 passes low frequencies down to about 100 cycles with substantial volume. It also reproduces unusually high frequencies without distortion provided tubes are not being overloaded. It is extremely sensitive and responds easily and with little energy to weak signals and low notes. Takes volume from biggest sets and power tube.

The unit is only 8 5/8 inches in diameter, —it fits into any radio or phonograph cabinet and is simple to install, only 4 screws to turn. Unit list price \$15.00.

Warwick Cabinet Model

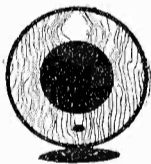

Has standard M-7 unit mounted on beautiful burl walnut circle on enameled metal base. List \$27.50.

Dynamic Power Cone Speaker

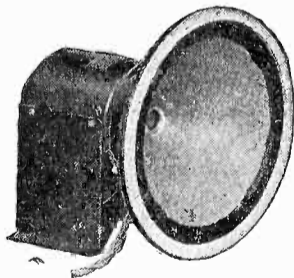

R-4 Unit

Built under electro dynamic patents made famous by Magnavox. Operates from A battery. Gives full power volume but at a fraction of the cost of other power speakers. You should hear this speaker and

realize the great advance in musical reproduction. R-4, 6 volt unit only \$50. In mahogany cabinet \$75.

R-5, 110 volt D. C. unit only for electric phonograph and A. C. circuits, \$55.

Send for Speaker Bulletins They give full information on Magnavox magnetic and dynamic type speakers. We will give you name of nearest dealer.

THE MAGNAVOX CO.
OAKLAND, CALIF.

Chicago Sales Office — 1315 So. Michigan Avenue

THE GREY PHANTOM

(Continued from page 27)

chuckled and cuffed him affectionately on the side of the head.

"Go 'long and keep that mouth of yours shut like a clam," he said. "I don't want this spread about." He frowned. "There's a leak somewhere Joe, and we're not sure it isn't here."

The operator flushed with sudden anger.

"Nobody but a rat . . ."

"I know son," said the old commander. "Yet there are rats and they gnaw away just the same. It'll help to keep these things quiet . . ."

"Yes sir," snapped the operator. "Only I'd like to get my paws on him."

Captain Hackett held out his own sun-browned, sinewy wrists.

"Well, there's others," he said succinctly.

The operator went out walking on the balls of his feet. The *Stowbridge* abruptly changed course and began to belch black smoke from her funnels, as the engines throbbed into sudden life. They were heading north on the trail of the *Grey Phantom*—and adventure!

The *Grey Phantom*, in a day when piracy took the form of illegal liquor running instead of rapine, was the most famous of that fleet of shadow craft that appeared at infrequent intervals out of the ocean mists, deposited a priceless cargo of "wet goods" on some secluded shore and disappeared, wraith-like into the night. Many newspaper fictions were woven about her movements and many weary nights were spent by cutter commanders in an effort to apprehend her. Yet not once was she seen or was a clue given to her true identity by those who knew.

Some said she was a tramp freighter. Others whispered that she was a well known coaster. Government agents combed the docks, working as stevedores, as clerks, as timekeepers, seeking the casually dropped word that would lead the way. And it never came. As silently as a ghost, the shadow craft came and went with seeming indifference to the elaborate plans laid to catch her—the Pacific's most illicit and intriguing mystery.

Captain Hackett had chased the *Grey Phantom* before. Once he followed oil spume on the water for two hundred miles, to overtake a startled but innocent Swedish hog-boat, wallowing on its way to Puget Sound. On another occasion, he had left the twelve-mile limit far behind to race a smoke smudge on the sky-rim until a Japanese tanker grew up against the water. In each case it had seemed that he was on the right trail.

And now again . . .

"By the Lord Harry," he promised himself profanely, and with much expletive, "by the Lord Harry—this time . . ."

Don't Bore Holes!

ELECTRAD CERTIFIED LEAD-IN

No need of marring window sash or walls if you use this Lead-In. Goes under locked doors or windows. Stops current losses and lead-in short circuits. Read these specifications. Real insulation (full 10 in. long) three-ply covered with waterproof webbing. One piece copper strip, tinned to prevent corrosion. Fahnestock clips, all connections riveted and soldered.

Insist on the genuine Electrad Lead-In. 40c at your dealers.

Write for descriptive circular
Dept. 56A, 175 Varick St., New York

ELECTRAD

Intermediate Transformers MATCHED

Let Gerald Best and D. B. McGown match and "peak" the intermediate transformers for your super. Proper fixed condensers will be attached. This entire service for \$2.50. Condensers extra. Laboratory of "RADIO," San Francisco

REMOTE CONTROL

Mechanical Model . . . \$18
Electrical Model . . . 60
(Add 10% west of Rocky Mts.)
Write for illustrated descriptive circular

Imagine the pleasure of tuning your radio without having to get up once all evening! Turn set "on" or "off," tune, regulate volume— from your easy chair! Easily attached to any single removable dial receiver in a few minutes.

ALGONQUIN ELECTRIC COMPANY, Inc.
245 Fifth Avenue, New York City

The NEW *Algonquin*

Trade Mark Reg. U. S. Pat. Off.
Remote Control Radio Tuning Unit

BIG NEW CATALOG FOR RADIO BUILDERS

FREE My big 1928 Radio Catalog, Call Book and Trouble Finder. 132 pages about Radio. Chock full of newest circuits—kits, transmitter parts, short wave outfits, eliminators and speakers. Thousands of bargains at lowest wholesale prices. A regular Radio Encyclopedia—Free. Write today.

American Auto & Radio Mfg. Co.
HARRY SCHWARTZBERG, PRES.
Dept. American Radio Bldg., Kansas City, Mo.

LATEST RADIO CIRCUITS

It was late that night—just at sun-down to be accurate—that the lookout on the *Stowbridge* contacted the *Eagle*. Old Bob Sorenson was in the bow, his flat blue eyes staring far ahead into the creeping shadows of the night. Suddenly he chanted to the bridge.

“Airplane on the starboard, sir!”

“Aye,” came the answer.

The first officer, who was at the wheel, leaned out of the pilot-house, following the lookout’s upstretched hand. There, silhouetted against the crimson sky, a yellow dragon-fly floated for an instant, its gauzy wings semi-transparent in the waning light — a monoplane, most graceful of all craft of the air. The drone of the engine came down distinctly It was gone into the clouds, with a flirt of its up-cocked tail.

The cutter was some fifty miles off shore . . a long distance out for a land plane. Yet land plane it was, as the under gear showed. The first officer shifted his quid speculatively.

“Blamed queer,” he muttered.

Later he spoke to Captain Hackett about the matter. The patrol commander came to attention instantly.

“Ever seen it before?” he asked quickly.

The pilot spat over the rail with deliberation.

“Seems t’me I did . . . yes . . the night we was lookin’ for that there *Grey Phantom*, sir. Las’ October, if I remember rightly. The same felley, he come a switherin’ past without so much as a God-bless-or-damn-ye. I thumbed me nose to him, handsome as he was.”

Captain Hackett stared at the speaker.

“Sure of that?”

“Well, yes sir. I remember the date—the tenth, sir, seein’s ’twas me weddin’ ann’vers’ry, which I allus remembers . . .”

The commander dismissed him with an injunction to keep what he had seen to himself. Then, locked in his cabin, with a black cigar, he sat for a long time in deep thought, turning over a number of things in his mind. Finally he dug out a bunch of reports, some log records, and other data, and began figuring on a chart. By midnight matters had clarified and he sent a radio to headquarters.

The *Stowbridge* went north and made a perfunctory search for the *Grey Phantom*, saw nothing, and so reported. Off Bolinas Bay Captain Hackett got that for which he was waiting—an order to report to Dan Crowley at San Francisco. He went, the cutter travelling under forced draft. The quickness of the reply from headquarters convinced him that they were at the end of their resources and anxious for a suggestion. That was what he desired.

Follow the Specifications!

In seeking the RELIABILITY of fixed resistance with the convenience of VARIABLE resistance, radio authorities invariably specify CLAROSTAT. Manufacturers of better grade radio power units invariably use CLAROSTAT. Radio laboratory workers invariably employ

CLAROSTAT

Why? Over five years of persistent, concentrated, specialized efforts have gone into developing the present CLAROSTATS. An entire plant is devoted to making just CLAROSTATS. An engineering staff thinks only in terms of CLAROSTATS. Specialization, then, has produced the desired result.

Now you may be offered devices “just as good as the CLAROSTAT.” You may be imposed upon with imitations at bargain prices. But if you seek results, follow the specifications! Use only the standard of variable resistance, which you will find in the familiar green box and bearing the name Clarostat stamped on the nickel-plated shell of the Universal type (20-watt) and the Power type (40-watt).

Ask your radio dealer for literature on the application of Clarostat for improving your present set or building a better one—or write us direct.

AMERICAN MECHANICAL LABORATORIES, INC.

Specialists in Variable Resistors

285 NORTH SIXTH ST. BROOKLYN, N. Y.

MEMBER
RMA

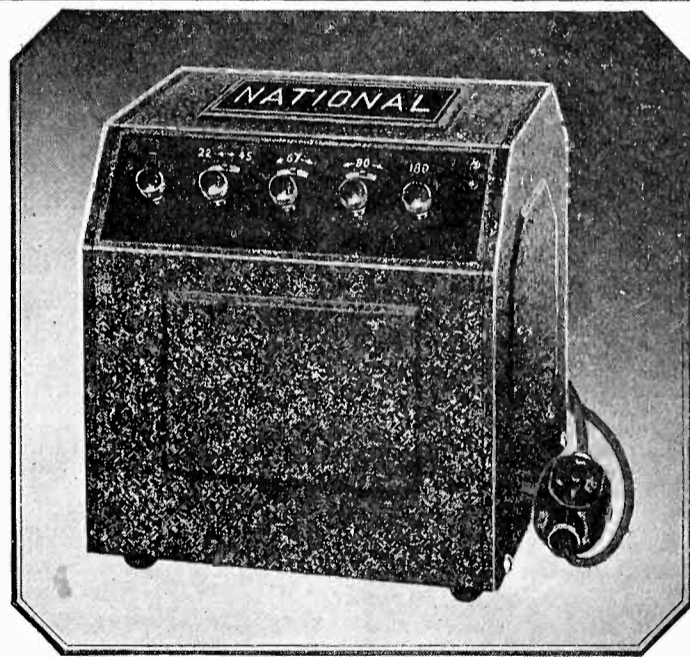
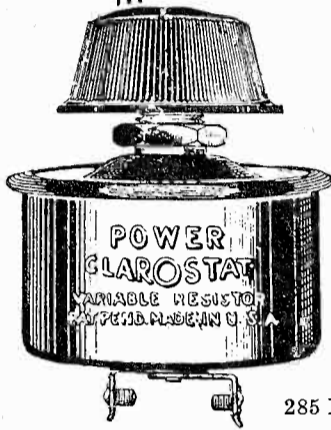

AN ENTIRELY NEW AND UNIQUE HEAVY-DUTY BETTER-B

Supplies

Detector voltages, 22 to 45, adjustable;
R. F. voltages from 50 to 75;
A. F. voltages from 90 to 135;
Power tube voltage 180 fixed.

An Exclusive Feature

Tubes and by-pass condensers are protected against excessive and harmful voltages.

Designed for lasting service with liberal factors of safety.

A Strictly Heavy-Duty Power Unit

Output rating is 70 mills at 180 volts. Uses R. C. A. UX-280 or Cunningham CX-380 Rectron.

Licensed under patents of Radio Corporation of America and Associated Companies.

For 110-120 Volts, 50-60 cycles A. C. List price with cord, switch and plug, \$40. Rectifier tube, \$5.

Write National Co., Inc., W. A. Ready, Pres., Malden, Mass., for new Bulletin P-11.

NATIONAL - B

Type 7180

A “B” That’s Built for Service

Tell them that you saw it in RADIO

New Aero Circuits Worth Investigating

The Improved Aero-Dyne 6 and the Aero 7 and Aero 4 are destined to be immensely popular this season!



AERO UNIVERSAL TUNED RADIO FREQUENCY KIT

Especially designed for the Improved Aero-Dyne 6. Kit consists of 4 twice-matched units. Adaptable to 201-A, 199, 112, and the new 240 and A. C. Tubes. Tuning range below 200 to above 550 meters.

This kit will make any circuit better in selectivity, tone and range. Will eliminate losses and give the greatest receiving efficiency.

Code No. U-16 (for .0005 Cond.).....\$15.00
Code No. U-163 (for .00035 Cond.).....\$15.00



AERO SEVEN TUNED RADIO FREQUENCY KIT

Especially designed for the Aero 7. Kit consists of 3 twice-matched units. Coils are wound on Bakelite skeleton forms, assuring a 95% air dielectric. Tuning range from below 200 to above 550 meters. Adaptable to 201-A, 199, 112, and the new 240 and A. C. Tubes.

Code No. U-12 (for .0005 Cond.).....\$12.00
Code No. U-123 (for .00035 Cond.).....\$12.00

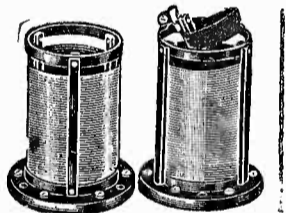

AERO FOUR KIT

An exceptionally efficient kit for use in the Aero 4 and other similar circuits. Consists of one Aero Universal Radio Frequency Transformer and one Aero Universal 3-Circuit Tuner. Uses 201-A, 112, 199 and new A. C. Tubes.

Code No. U-95 (for .0005 Cond.).....\$8.00
Code No. U-953 (for .00035 Cond.).....\$8.00

NOTE: All AERO Universal Kits for use in tuned radio frequency circuits have packed in each coil with a *fixed primary* a twice matched calibration slip showing reading of each fixed primary coil at 250 meters and at 500 meters; all having an accurate and similar calibration.

A NEW SERVICE

We have arranged to furnish the home set builder with complete Foundation Units for the above named Circuits and for the Chicago Daily News 4-Tube Receiver, drilled and engraved on Westinghouse Micarta. Detailed blue prints and wiring diagram for each circuit included in foundation units free. Write for information and prices.

You should be able to get any of the above Aero Coils and parts from your dealer. If he should be out of stock order direct from the factory.

AERO PRODUCTS, INC.
Dept. 103
1772 Wilson Ave. Chicago, Ill.

Captain Hackett's suspicion was verified when he met with Dan Crowley early the following morning. Dan shoved a box of cigars across the table, lighted one himself, and cocked his feet on the table. The captain opened the conversation himself.

"This *Grey Phantom* thing is getting my goat," he announced. "For that matter I guess it is getting everybody's goat. It is there and it isn't there, if you get what I mean."

Dan Crowley snorted.

"Oh, I get it all right," he said. "We go out and look around and there isn't a boat in sight. And while we are looking the liquor is landed under our noses. And it is done every day in the week. The only time Uncle Sam grabs the load is after it is laid down on the shore and then the prohis pick it up. Our department might just as well be selling rag dolls at a church fair. Our patrol system is worth ten cents on the dollar, if you get what I mean."

Captain Hackett stiffened but Dan held up his hand.

"I know the boys are doing their work and doing it well," he continued quickly, "only—we are not getting results. In this whole arrangement, the only weak link seems to be in our department. For instance we get a tip that a certain shipment is coming down from Vancouver. We set a trap. The prohis get action. We get—nothing. Our cutters go out, mosey around and come in without seeing anything. What is the answer?"

"There might be a leak in the office," suggested Captain Hackett, "or it might be there is a communication leak."

"Don't see how there can be," said Dan Crowley. "You get your orders in code and reply the same way. There are only two copies. I've got one in my pocket and you ought to have your copy in yours."

Captain Hackett nodded and tapped his breast.

"All right then—that seems reasonably secure. Yet how does it work out? Two weeks ago I shot you a message that the *Phantom* was off Bolinas. It went in code. You acknowledged in code. You went north under forced draught. You made the spot in twelve hours. What happened? You were just four hours too late. Now get this: within two hours after you got my message, the *Phantom* made a quick trip inshore, dumped a whale of a cargo in small boats and was gone. That argues only one thing, viz., she knew exactly where you were!"

Captain Hackett nodded.

"Exactly," he said. "And that brings me to my idea. I think I know how he works that little trick. There are only two things necessary for the skipper of that craft to defeat the best of our plans. One is to know your orders to

It has become
standard practice
to use

PARVOLT

WOUND CONDENSERS

in circuits that break down ordinary by-pass condensers.

You will find that the same characteristics of accuracy, high direct-current resistance, and the ability to give continuous duty, at full rated voltage, make them desirable in circuits where even a poor condenser might "get by."



The Acme Wire Co.

New Haven, Connecticut

6131-6

SELL YOUR EXCESS PARTS
Through a Classified Ad in
"RADIO" See Page 79

Free Wholesale Radio Catalog **Send today**

1928 for it

1928 Catalog
Dealers, set builders—make this your biggest radio season. Shure's great wholesale catalog insures the best in quality at lowest prices. This wonderful book is jammed full of the newest offerings of Nationally known radio parts, kits, sets, accessories, table and console cabinets, etc. Also contains short wave section showing the finest electrical apparatus for short wave receiving and transmitting. Your request brings our book of a thousand bargains, price list and discount sheet. Write for a copy today.

2000 Items **Big Values**

Shure Radio Company
339 V. West Madison St. Chicago, Ill.

me. The other, to know where I am. Now, assuming that he cannot get the code by which we communicate, he can at least do the next best thing, which is pretty nearly as good."

"What's that?" demanded Dan.

"Tap your information from Vancouver. If he gets that, if he is able to know what is tipped off to you, he can know by pure guesswork about what your information to me will be. That leaves him only one hard task and that is to locate the *Stowbridge*. And that is a cinch."

"A cinch?" Dan Crowley laughed shortly. "Well, let's hear it! I've worked on the thing and I can't figure it out."

"I think I've got it," said Captain Hackett. "Let's assume a hypothesis, just for the sake of argument. Let's assume that the ring has a fast airplane holed up somewhere along the coast. A good plane can run from Los Angeles to San Francisco in three and a half hours—a distance of approximately 500 miles. Suppose this plane was in touch with San Francisco, with someone who has the entree to your office."

"All right—what then?" asked Dan.

"Why," said Captain Hackett, waving his cigar. "It's perfectly simple. Down comes a tip from the north. The ring's agent here taps the dope and shoots it to the plane. Then he waits to see if you shoot me a radio. You do. He knows I'm on my way. Right! He notifies the plane. The flier hops off, locates me, hits his home station and . . ."

"Wait a minute!" Dan Crowley sat up in sudden excitement. "By Jove—I see it now. Suppose that plane carried a radio set. It could work direct with the *Grey Phantom*, couldn't it? That would explain how it is that they can slide in ahead of you, dump their load and get away before your boat gets on the job."

"Sufferin' catfish!" exclaimed Captain Hackett, "I believe you've hit it."

"I hit it? Ha—that's good. You hit it. I haven't had an idea for a month. But I believe you've got the system. I just added the radio idea . . . and the more I think about it the more I'm sure that's the way the thing is done. If that is so . . . say, listen here."

"By golly, Dan—if we can put that over . . ."

Dan bit the end off of a fresh cigar.

"You get out, now," he ordered, "and let me think awhile. Then I'm going to do some telephoning and I'll let you know if it can be done. If it can—we'll give 'em both barrels."

"We will that," said Captain Hackett. "We'll declare war on this little birdie . . . we'll knock 'em off the poop deck, we will."

Dan Crowley grinned.

"Maybe," he said, and let it go at that.

Superb tone quality — great volume

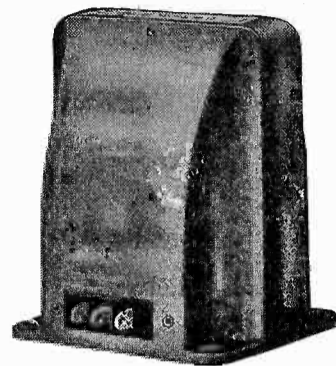
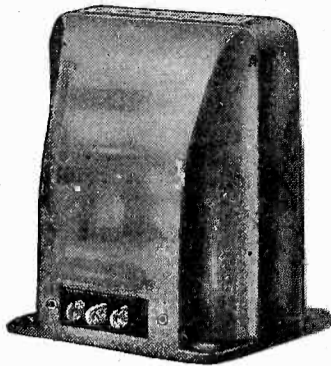

RICH bass notes—tonal brilliancy—uniform amplification over entire audible range are now possible by the use of Samson Push Pull Units. One stage of these units gives as much undistorted volume with but 180 volts on plates of two type 171 tubes as an ordinary amplifying circuit would supply from a type 210

tube with 400 volts on its plate. Dance hall volume can be obtained with two 210 tubes or still greater volume and better quality from two Push Pull stages using new Symphonic Interstage Transformer in first stage. Samson power units will supply dependable A, B and C current for the above.

Unfiltered AC may be used on filaments of both stages. Symphonic Push Pull Input Transformer and Output Impedance \$19.50.

New Symphonic Interstage Push Pull Transformer, Type Y \$14.00. Know how to get supreme coil efficiency from our new "Inductance Units Bulletin" which will be mailed on receipt of 10c to cover postage.

Learn how to apply RF and AF Chokes to 17 popular circuits or your own from our illustrated Make-'Em-Better Sheet. Send 5c for postage.

"Audio Amplification" contains highly practical original information for bettering quality of reproduction. Sent on receipt of 25c.

SAMSON ELECTRIC COMPANY

Manufacturers Since 1882

Sales Offices in
Thirty Leading Cities



Main Offices at
Canton, Mass.
Factories:
Canton and Watertown

HEAR the wonderful
New Acme Speaker at
your dealer's

ACME
for amplification



KARAS EQUAMATIC MANUAL

Price 10c.

Build the Karas Equamatic 5-Tube Radio Sensation—the most selective receiver ever designed. Mail 10c today for 16-page Manual of wiring diagrams and complete instructions for building this remarkable receiver.

Address:
KARAS ELECTRIC COMPANY
4031-J No. Rockwell St. Chicago, Ill.

FREE NEW CATALOG

Dealers and Set Builders—Write today for our new 1928 Catalog. It's FREE. Shows latest and best nationally advertised radio equipment. Complete Kits as specified in articles in leading radio magazines now ready for shipment. No delays in filling orders. Best Prices.

MILLER - WELLES CO.
18-H W. Kinzie St. Chicago

Self-Adjusting!

For best performance your tubes require a variable filament control to supply the definite current they need, despite "A" battery variations. AMPERITE is the only self-adjusting and automatic filament tube control that does this. Takes the "guess," inconvenience and unsightliness out of panel rheostats. Simplifies wiring, panel design, and tuning. Prolongs tube life. Order by name. Accept nothing else. Price \$1.10 mounted (in U. S. A.) For sale by all dealers. Write for FREE "AMPERITE BOOK" of season's best circuits and latest construction data. Address Dept.

RADIALL COMPANY
50 Franklin St., New York

AMPERITE
The "SELF-ADJUSTING" Rheostat

CLASSIFIED ADS
Bring Results. See Page 79. Mail
your ad now for December issue.

There is a Vitrohm Radio Resistor for EVERY power unit

More than 90 standard Vitrohm Resistors and Rheostats cover the resistance need of every socket power circuit now on the market.

Resistance is the heart of power circuits. Make sure of quiet, permanent, and unflinching service by insisting on Vitrohms for radio.

Vitrohm Resistors and Rheostats are guaranteed unconditionally for continuous-duty in any circuit where they operate within their watts dissipation rating—Vitrohm Resistors have the highest continuous-duty rating without resistance change of any resistor.

New Vitrohms

The list below of new resistors and rheostats is partial. A full description of new Vitrohms for Radio is available without charge. Send for it.

RAYTHEON 350 M. A. UNITS

Vitrohm Resistor 507-70 \$8.75
Vitrohm Rheostat 507-59 5.50

QRS 400 M. A. CIRCUITS

Vitrohm Resistor 507-62 \$8.75
Vitrohm Rheostat 507-59 5.50

SILVER-MARSHALL UNITS

Vitrohm Resistor S-M 653 \$2.50
Vitrohm Resistor S-M 655 2.50
Vitrohm Resistor S-M 657 5.00

THORDARSON POWER PACKS

Vitrohm Resistor for R-171 \$2.15
Vitrohm Resistor for R-210 2.65
Vitrohm Resistor for R-210 4.90
with UX874 Regulator Tube

The Adjustat

A new Vitrohm Rheostat, dissipating 20 watts, having 15 steps of resistance. The Adjustat is priced at \$3.00.

11 types are available in the following resistances and current capacities:

507-79, 1 ohm, 4 amp.—507-71, 2 ohms, 3 amp.—507-72, 6 ohms, 1.5 amp.—507-73, 20 ohms, 1.0 amp.—507-74, 30 ohms, 0.75 amp.—507-80, 50 ohms, 650 m.a.—507-81, 600 ohms, 180 m.a.—507-75, 1000 ohms, 125 m.a.—507-76, 2250 ohms, 90 m.a.—507-77, 10,000 ohms, 40 m.a.—507-78, 25,000 ohms, 10 m. a.



WARD LEONARD
ELECTRIC COMPANY
MOUNT VERNON, N. Y.

WHILE the wheels of official action were getting under way in San Francisco, with a whirling of cams and pistons, and a snapping of red tape, another conference was taking place on a slight eminence south of Monterey Bay—a conference between the Eagle and a man who rode a motorcycle. The meeting was held in a secluded barn on a barren portion of the coast—a barn that stood back from the road some distance and was shielded from it by a grove of trees.

From the barn extending toward the ocean, was a long flat field that anyone at all familiar with aviation would have recognized instantly as an airplane runway. Yet so cleverly was it camouflaged between fences, that it appeared from a distance, merely as an unusually well cultivated strip of ground. There was nothing in the ground or the barn itself which in any way gave indication of the canary-yellow airplane which crouched just inside the locked double doors of the weather-beaten structure.

The conference in the barn between the Eagle and the messenger was brief and to the point.

"The old man says to give this special attention," said the messenger, "because he's got a lot tied up in it."

The Eagle shrugged, and licked the paper of the cigarette he was rolling.

"He always has," he said.

"Well take it or leave it—that's the works," said the other. "You'll get a flash as usual."

The Eagle nodded, the sunlight through the cracks in the barn, illuminating his thin, sharp features and giving them an almost saturnine expression.

"What's the date?" he asked presently.

"About the fifteenth, depending, of course on the fog."

"Okay. I'll be on the job."

The messenger kicked in the engine of his motorcycle.

"Well, s'long," he said, and was gone in a cloud of dust.

The Eagle watched him go, with another shrug. There was a casual indifference about him which is the mark of the true flier the world over. He stood regarding his plane affectionately. After a bit he ground out his cigarette, locked the barn door, and went upstairs.

The upper portion of the barn had been fitted up into a unique "dugout." There were books, a picture or two of a woman, and a banjo. In one corner was a small radio transmitter and short wave receiver. The antenna swung taut from the barn's roof to the top of a nearby pine tree. On the wall were pilot maps and navigation charts. A small cast iron stove occupied the center of the room. Plainly the Eagle was comfortable in his off moments, even to elec-

(Continued on page 62)



The Newest A B C Power Supply Unit

—used with R C A 226 and 227 A C tubes
—and the Raytheon BH tube

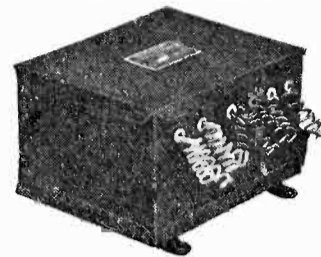

No. 5552

List

\$20.00

This latest development of the Dongan laboratories combines in one small, compact case the essential transformers and chokes designed for use with R C A 226 and 227 A C Filament Tubes (also UX 171 power amplifier tube) and the Raytheon BH Rectifier Tube. Complete power supply is secured, eliminating the need of batteries and charger. R C A 226 and 227 A C tubes also take the place of standard 201 A tubes.

For complete information write to Dongan laboratories. If your dealer cannot supply you send check or money order direct.

Dongan Electric Manufacturing Company

2981-3001 Franklin St.

Detroit

TRANSFORMERS of MERIT for FIFTEEN YEARS

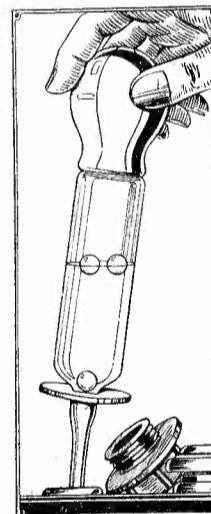

Things Don't Just Happen

That nothing to equal the patented Chaslyn Balls for accuracy, unbreakability and simplicity of reading has been discovered is why the big manufacturers of Batteries use them as Charge Indicators in Glass-Cased Batteries and Power Units.

Easiest to Read
Nothing to Break

Swim all three—
charged fully

Sinks the white—
charge still right

Sinks the green—charge is lean
Sinks the red—charge is dead

Ask your dealer. If he can't supply, send 75c to us.

Chaslyn Corrosion Cure for Battery Terminals protects contacts. A large tube is 30c.

THE CHASLYN COMPANY
4629 Ravenswood Ave. Chicago, Ill.

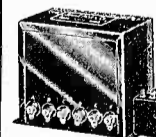

FAST CONDENSERS FOR ABC PACKS

Fast Hi-Test, extra capacity condensers are built to withstand every requirement of usage. Millions now in use and since 1919, one of the oldest established and reliable manufacturers.

An exclusive feature—by-pass condensers enclosed in one-piece die-press steel housing, makes them positively impervious to climatic conditions or abuse. Before being encased condensers receive special laboratory treatment, moisture content is effectually removed and the housing seals them permanently—Fast condensers thus give better service.

Illustration shows condenser pack used in Q. R. S. or Raytheon A-B-C unit. Fast condensers fit all units, whether specified or not. Write for free condenser booklet. Dealers and jobbers, send for prices.

JOHN E. FAST & CO.
3982 Barry Avenue, Dept. C, Chicago, U. S. A.



ALL-AMERICAN

TRADE MARK

REPRODUCER

—the most popular cone type speaker yet developed . . . with filter system built in

Here is a radio speaker that enhances the appearance of any radio set and gives unending satisfaction.

Assures true, full tones throughout the entire musical range; provides absolute protection against burn-out from high voltages with its *built-in* filtering system.

Has handsome all-metal case of beautiful design, finished in permanent walnut-brown enamel. A special unit adjustment screw means improved reception regardless of atmospheric conditions.

Ask Your Dealer for
Demonstration

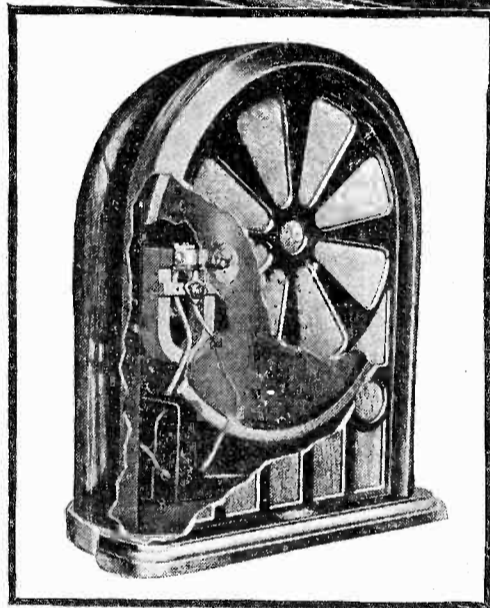
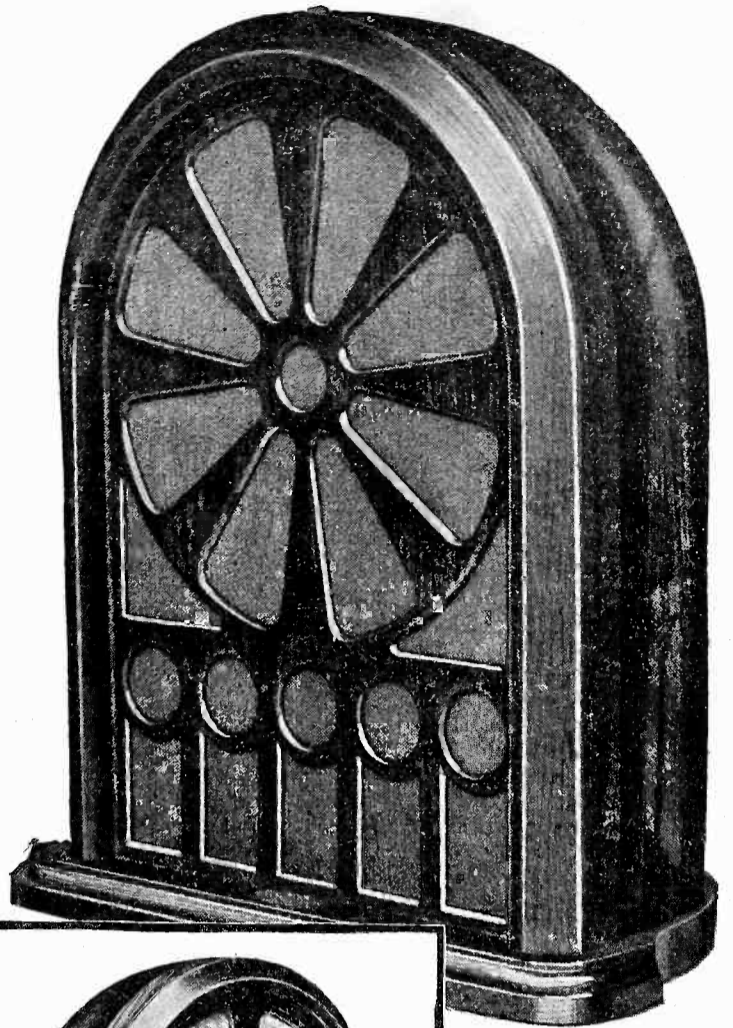

Type A-5 Reproducer. List \$25.
(Slightly higher West of Rockies)

Cut-away view showing sturdy cone, unit and filter housing.

“B” SOCKET B POWER

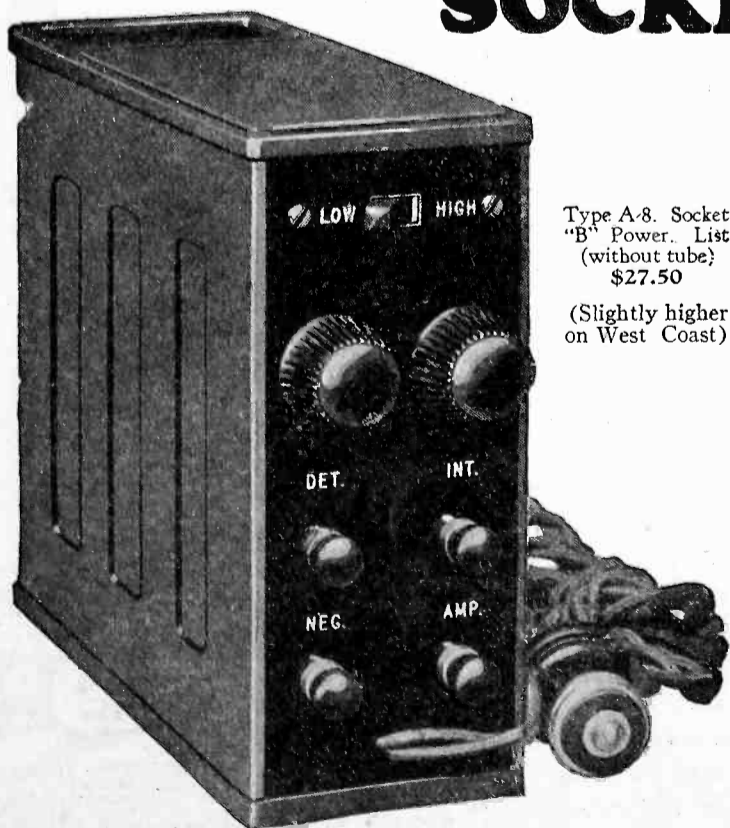

Type A-8. Socket “B” Power. List (without tube) \$27.50

(Slightly higher on West Coast)

This compact, powerful radio “B” power unit combines All-American dependability and manufacturing skill with superior RAYTHEON tube rectification. Delivers 180 volts — is as small as ONE upright “B” battery. Another All-American winner. Let your neighborhood dealer show you why this All-American Socket “B” power unit is designed for continued satisfactory service.

ALL-AMERICAN RADIO CORPORATION
4201 BELMONT AVENUE
CHICAGO :: ILLINOIS

Tell them that you saw it in RADIO

(Continued from page 60)

tric lights and an automatic coffee percolator.

While Dan Crowley went about on certain mysterious errands that took him to the Presidio, to the Twelfth Naval district headquarters, and resulted in the sending of numerous telegrams, the Eagle lay holed up in his cache in the old barn, apparently inert and indifferent to the passing of time. But on the morning of the fifteenth, he woke into sudden activity. Rising at dawn, he tested his short wave set, adjusted the receiver and snapped on a loud speaker.

As the hours passed, he smoked innumerable cigarettes, and drank several cups of coffee. Noon. Two o'clock . . . two-thirty, three, five, six o'clock . . . the loud speaker suddenly chirped a clear bird-like note . . . The Eagle was at the table instantly. It was his call—the one for which he had been waiting. He flipped over the transmitting switch and his 50-watt "bottles" moaned with unleashed power as he answered the call. Back came a message from San Francisco.

"41.10.136."

There was no signature. The message was repeated twice. The Eagle took a pair of dividers and plotted out certain spots on his shore chart, finally circling a spot just off Eureka—41 degrees 10 minutes north, 136 degrees west.

"Okay—got U," he replied on his key. "Any smoke?"

"Nil," chattered the invisible sender. "Bozo north Bimbo south unknown."

The Eagle swore softly. The information conveyed to him in answer to his question to where the revenue cutters were, had brought the response that the sender did not know, except that the *Stowbridge* was somewhere south and the *McNamara* was north of San Francisco. Usually he was given more data. He frowned and opened the key.

"How come?"

"Pipe line broken," came the reply from a hillside tenement in the North Beach area of San Francisco. Something had gone wrong with the usual leak out of Dan Crowley's office apparently, and he would have to find the cutters himself, confound the luck.

"Right," he snapped, and shut the key.

He rolled a cigarette and thought the situation over. If the *Grey Phantom* was due off Eureka that night he would have to work rapidly to locate the cutter, and radio its position to the *Phantom*. The shore squad was probably already on the job, for the syndicate's system was well organized. He and the yellow canary would have to get busy.

He filled a thermos with hot coffee and wrapped up a couple of sandwiches. Then he dropped down the ladder to the lower floor and went over his plane, test-

(Continued on page 64)



ACME Celatsite Battery Cable

A rayon-covered cable of 5, 6, 7, 8 or 9 vari-colored Flexible Celatsite wires for connecting batteries or eliminator to set. Plainly tabbed; easy to connect. Gives set an orderly appearance.

Stranded Enameled Antenna

Best outdoor antenna you can buy. Seven strands of enameled copper wire.

Presents maximum surface for reception, resists corrosion; this greatly improves the signal. Outside diameters equal to sizes 14 and 16. (We also offer solid and stranded bare, and stranded tinned antenna.)

Loop Antenna Wire

Sixty strands of No. 38 bare copper wire for flexibility, 5 strands of No. 36 phosphor bronze to prevent stretching.

Green or brown silk covering; best loop wire possible to make.

Flexible Celatsite for sub-panel wiring

A cable of fine, tinned copper wires with non-inflammable Celatsite insulation. Ideal for sub-panel or point-to-point wiring. Strips easily, solders readily. Nine beautiful colors; sold only in 25 ft. coils, in cartons colored to match contents.

Acme Celatsite Wire

Tinned copper bus bar hook-up wire with non-inflammable Celatsite insulation, in 9 beautiful colors. Strips easily, solders readily, won't crack at bends. Sizes 14, 16, 18, 19; 30 inch lengths.

Spaghetti Tubing

Oil, moisture, acid proof; highly dielectric — used by leading engineers. Nine colors, for wire sizes 12 to 18; 30 inch lengths. (We also make tinned bus bar, round and square, in 2 and 2½ ft. lengths.)

Send for folder
THE ACME WIRE CO., Dept. R
New Haven, Conn.

ACME WIRE
MAKES BETTER RADIO



Licensed by
Rider Radio
Corporation
Pats. Pending
Patented 5-2-'16
Patented 7-27-'26

R. F.
Oscillations
Gone Forever!

PHASATROL

Reg. U. S. Pat. Off.

A True Balancing Device for All
Radio Frequency Amplifiers

Price \$2.75

You can solve the problem of proper control of oscillations, either in the set you own, or the set you intend building, by simply installing PHASATROL. This new Electrad device simplifies tuning and lets distance come in clear. Easily installed in any R. F. set—tuned, untuned or reflex.

Write for free hook-up circular for any set or circuit

At good dealers

Dept. 52C, 175 Varick St., New York

ELECTRAD

Now!
Televoal Tubes
For A. C. Sets

Electrify your set with the New Televoal A. C. 226 and A. C. 227 Tubes. Using these tubes, you can operate on A. C. current without A Batteries. Also use Televoal T. C. 112 A and T. C. 171 A Power Tubes. Now made with oxide-coated filament, current consumption is reduced ½ — from ½ to ¼ amperes.

Televoal Tubes are made in all standard types.



Televoal Corp., Televoal Bldg.
Dept. C-2 588 12th St.
West New York, N.J.

TELEVOCAL QUALITY TUBES



5 TUBE RADIO ONLY \$19.98

It's a wonder for power and selectivity. Famous ARL circuit. Coast to coast reception! Finely built of selected, tested parts. Thousands now in use. FREE Log and Call Book and New 132-p. Catalog with thousands of nationally advertised bargains. Latest in radio at big savings. Write for Free copy.

AMERICAN AUTO & RADIO MFG. CO.
HARRY SCHWARTZBERG, PRES.
Dept. 141 American Radio Bldg., Kansas City, Mo.

AMERICAN RADIO BARGAINS

Tell them that you saw it in RADIO

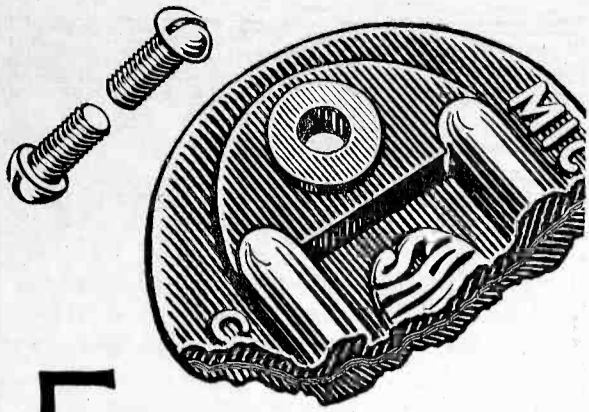

EASY to use

Accurate rating, permanent capacity value, high D. C. resistance — low self inductance are characteristics of Sangamo Mica Condensers.

In addition, they are easy to use!

One may solder directly to the terminals, or pass bus-bar through them, use lugs, or mount the condenser with machine screws — all with the knowledge that the condenser will not be injured and that connections are permanent!

6336-5

Sangamo Electric Company
Springfield, Illinois

SANGAMO MICA CONDENSERS

SARGENT'S INFRADYNE MANUAL

Describing Last Season's MODEL

Is now ready for
Immediate Delivery

Order your copy now
by sending 25c in coin or
stamps to

"RADIO"

433 Pacific Bldg., San Francisco

You can quickly learn
**MORSE OR CONTINENTAL
CODE** at home with the NEW

TELEPLEX

The TELEPLEX is the only instrument that REPRODUCES actual sending of expert operators. It sends messages, radiograms, etc., at any speed from 5 to 80 words per minute. Always ready. Easy and fascinating. Saves months of tiresome practice. Sends FIVE TIMES as many words with one tape as any other instrument, and SIX are furnished. Nothing else to buy. Fully guaranteed. Used by U. S. Navy. Write NOW for particulars of this amazing instrument.

Dealers Wanted

TELEPLEX CO.

76 Cortlandt St.

New York City

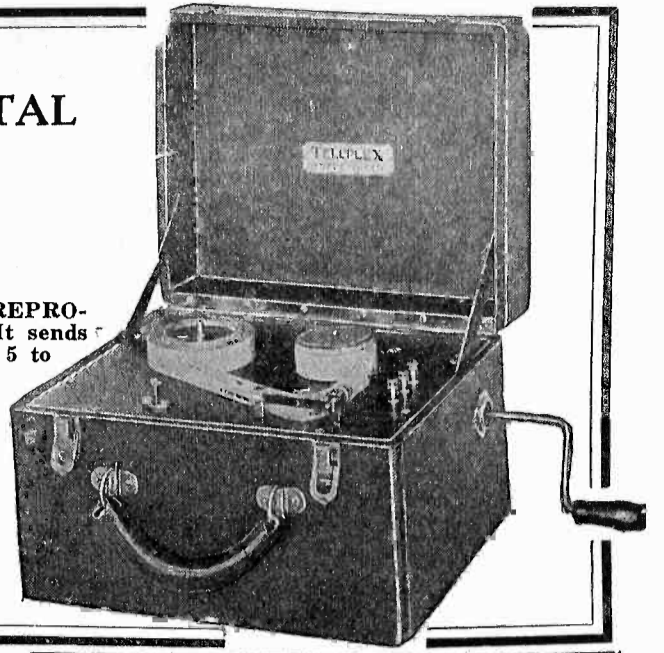

Nathaniel BALDWIN LOUD SPEAKERS

A Famous Speaker



Benj. Franklin once said:
"My performance devotes
itself entirely to thy service
& will serve thee faithfully
and if it has the good fortune
to please its master, tis
gratification enough for the
labor of—"Poor Richard"

The New "Baldwin 99"

is without comparison. To-day, as 15 years ago, Baldwin performance is the standard by which others are judged. The workmanship of this speaker is comparable to the sensitive mechanism of a fine watch. Can be used on any set.

At all good \$28.50
dealers

Ask your dealer to
demonstrate it.

BALDWIN UNITS
Loudspeaker units, Phono
adapters, and head sets
are standard the
world over.

J. W. & W. L. WOOLF
Distributors & Exporters
227-229 Fulton St., N.Y.



Write for booklet.

To keep posted on
INFRADYNE
suggestions and
improvements

Why not subscribe now to
"RADIO" for 12 months at
the price of \$2.50.

**6 TUBE
RADIO**
ONE DIAL Latest advanced circuit. All steel chassis totally shielded. Balanced parts of best quality. Marvelous power and selectivity. Gets the long range stations as clear as a bell. One dial single control. An unsurpassed value—just one of our many mighty bargains.
Only \$32.50
FREE Log and Call Book, and Big New Catalog—just off the press. Full of Radio Bargains. Send for your free copy now!
American Auto & Radio Mfg. Co.
HARRY SCHWARTZBERG, Pres.
Dept. 142 American Radio Bldg., Kansas City, Mo.

Tell them that you saw it in RADIO

NEW A. C. TUBES & Filament Transformers

Immediate Delivery

THE new A. C. tubes by Cunningham or R. C. A. solve your battery problem forever. We can make delivery now on the new Cunningham CX-326 tubes at \$3.00 each. Cunningham C-327 sell for \$6.00. General Radio Filament transformers for these new tubes, \$10.00. Tube Sockets, General Radio, for new A. C. Tubes 60c each.

You can use the 112 or 171 power tube in the last stage, lighting the filament from A. C. A resistance with center tap is necessary. We sell these resistances for 60c each. We rewire sets for A. C. tube operation. Ship your set to us by express or bring it to our laboratory if you live in San Francisco. Estimates cheerfully furnished. The labor cost for converting your present set for A. C. tube operation is only \$10.00. This does not include tubes, sockets or transformers. A perfect wiring job is guaranteed.

Send check, money order or draft to—

D. B. McGOWN

435 Pacific Building, San Francisco

The next **6**
issues of
"RADIO"
for **1** dollar
if you subscribe Now

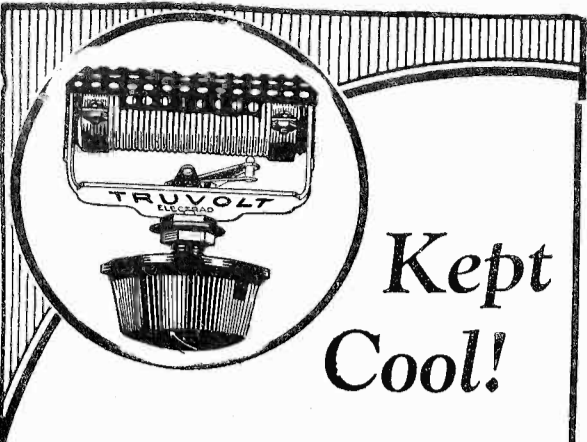

**Kept
Cool!**

*Like the best
Airplane Motors*

TRUVOLT

*An All-Wire
Variable Voltage
Control*

HERE is the finest voltage control you can possibly buy for your power devices! Its special mechanical construction gives greater radiation area and keeps it cool like an air-cooled engine. This prevents deterioration and assures permanent accuracy with long life.

Resistance made entirely of nichrome wire with very low temperature coefficient and exposed directly to air—heat not held in by enamel coverings as in other resistances. Permits potentiometer control and gives positive metallic contact at all times with 30 exact readings of resistance.

Type	Ohms Resistance	Milliamperes Current
T - 5	0 to 500	224
T - 10	0 to 1,000	158
T - 30	0 to 2,000	112
T - 50	0 to 5,000	71
T-100	0 to 10,000	50
T-200	0 to 20,000	35
T-250	0 to 25,000	32
T-500	0 to 50,000	22.5

Eight stock types with resistances up to 50,000 ohms. All rated at 25 watts.

Price \$3.50 each

Also full line of fixed wire resistances.
Write for free hook-up circular
Dept. 16A, 175 Varick St., New York

ELECTRAD

(Continued from page 62)

ing instruments, parachute, oil feed, gasoline pump and the other apparatus. He made a brief test of a powerful little radio-telephone which was built into the side of the cockpit, flipping the wind driven generator with his finger to see that it turned freely. This done he climbed into his fur-lined coat, opened the doors and rolled the powerful little plane out into the sunlight.

The Eagle had worked out an ingenious method of anchoring the plane when he made his hopoff. By a system of snaps and a running bowline, he fastened the rear structure to the corners of the barn. Then he set his throttle and turned the propeller over. The whirlwind engine kicked into instant life with a roar, whipping up a great cloud of dust. The Eagle climbed into the cockpit, tested his controls and the throttle, jerked the bow-line, and released the little yellow plane for flight.

It taxied slowly down the runway, gathered speed with sudden terrific velocity, hunched, lifted its tail, and was off the ground in a perfect getaway. The sun was far down the horizon and the Eagle pointed the canary off across the white strip of beach sand straight out to sea. Skimming along the surface of the water he was soon lost to sight. For perhaps ten minutes he held this course until the shoreline was just a thin pencilled line of gray and then he began to climb upward to an altitude of eight thousand feet, at which point he headed northward.

By the time the night began closing down like a great lid, clapped over the world, the Eagle had spotted a smoke plume far to the northward. A freighter was directly beneath him, plunging stodgily along. Far to the left a liner crawled down toward Tahiti, and beyond that a tanker from the Orient with a bone in its teeth.

Ahead the smudge

Another hour of fast running. The lights of the vessel were distinctly visible through the darkness now. He swooped down for a closer look. Picking a cutter in the dark was a difficult task. Above him the little wind-generator of his radio set spun steadily. He threw over the transmitting switch and the 50-watt lamp glowed for an instant against the night. Satisfied he snapped it off, and hooked the microphone on his chest. He was all set now.

Far off in the night, somewhere, an operator on the *Grey Phantom*, tuned to his exact wavelength was listening, waiting for his signals. The Eagle circled the lights far down below, at a hundred and twenty miles an hour or better, banking around so as to come down lower and swim just over the craft. As he did so a searchlight suddenly sprang out of the vessel's deck, shot off into space, swam around in a rapid arc,

(Continued on page 66)

Tell them that you saw it in RADIO

What did you learn from the RADIO SHOWS?

Your visit to the major radio shows this fall will convince you of the marked trend towards the use of voltmeter control of radio sets. This is the final safeguard of set performance for both the manufacturer and the owner.

Eventually every set owner will come to the same conclusion if he desires the best performance with continuous radio satisfaction.

Regardless of type or hook-up, all sets are designed for operation at a definite predetermined filament voltage. Only at that voltage will a set give the best results.

Not only is a voltmeter necessary, but anything short of the best injects uncertainty into your radio operation.

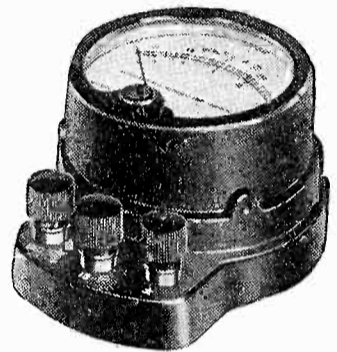

**Model 528 A. C. Portable
Instruments made as Double-
range Voltmeters and Single-
range Ammeters.**

When you buy a Weston meter your reception problems are solved. Engineers will tell you that Weston instruments have no equal and, in the light of the service they render, are the least expensive in the long run.

Portable types of testing instruments are always desirable because of their adaptability to all testing conditions. With the new trend towards A. C. operation Weston has developed a companion A. C. line to the Model 489 D. C. instruments. These new instruments known as Model 528 are designed for testing the voltages of A. C. operated sets. Write for Circular J and learn of their unmatched characteristics before making your final selection of A. C. portable instruments.

WESTON ELECTRICAL
INSTRUMENT CORPORATION
156 Weston Avenue Newark, N. J.

PACIFIC COAST REPRESENTATIVES:
Graybar Electric Company, Inc.
84 Marion St., Seattle, Wash.
J. H. Southard, San Francisco, Cal.
A. A. Barbera, Los Angeles, Cal.
Repair Service Laboratory
682 Mission St., San Francisco, Cal.





VARIO DENSER

Quick, easy tuning—more volume, clearness, stability with an X-L VARIO DENSER in your circuit.

Endorsed by experts, specified in all latest and best hook-ups.

MODEL "N"—Micrometer adjustment easily made, assures exact oscillation control in all tuned radio frequency circuits. Neutrodyne, Roberts two tube, Browning-Drake, Silver's Knock-out. Capacity range 1.8 to 20 micro-microfarads. Price \$1.00

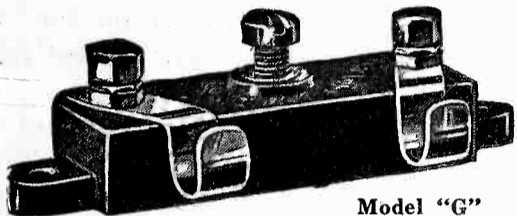

Model "G"

MODEL "G"—Obtains the proper grid capacity on Cockaday circuits, filter and intermediate frequency tuning in superheterodyne and positive grid bias in all sets.

Capacity range:

Model G-1 .00002 to .0001 M. F. D.

Model G-5 .0001 to .0005 M. F. D.

Model G-10 .0003 to .001 M. F. D.

Price, each with grid clips.....\$1.50

X-L PUSH POST—Push it down with your thumb, insert wire, remove pressure and wire is firmly held. Vibrations will not loosen. Releases instantly. A push post that excels in appearance, action, service and convenience.

Price each 15c

X-L PUSH POST PANEL—Seven push posts mounted on black insulating panel with permanent white markings. Soldering lugs, raising bushings and screws for mounting, etc., in box complete.

Price \$1.50



X-L Push Post



X-L Push Post Panel

FREE—New, up-to-date book of wiring diagrams showing use of X-L units in the new LOFTIN-WHITE constant coupled radio frequency circuit, and in other popular hook-ups. **WRITE TODAY!**

XL Radio Laboratories

2428 Lincoln Ave.

Chicago, Ill.

New LOG BOOK Now Ready

A clever log book giving spaces for logging dial setting for any U. S. or Canadian station. Also a complete list of all stations by call letters. A separate list of stations by states. Another list of stations by meters, starting at low wavelengths in numerical order. A directory of stations. Calls, waves, kilocycles and meters in alphabetical order. Printed on bond. Handy size. The best 25 cent investment you can make. Limited edition. Order your copy NOW.

25c PER COPY
POSTPAID

PACIFIC RADIO PUB. CO.
Pacific Building San Francisco

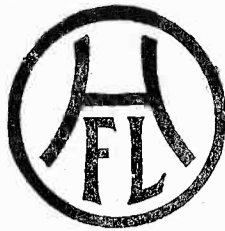

Transformers

Two Additions to Last Year's Radio Sensation. The Amazing Achievement in Audio Amplifications

Designed for set builders who demand efficiency, sensitivity, precision and high quality

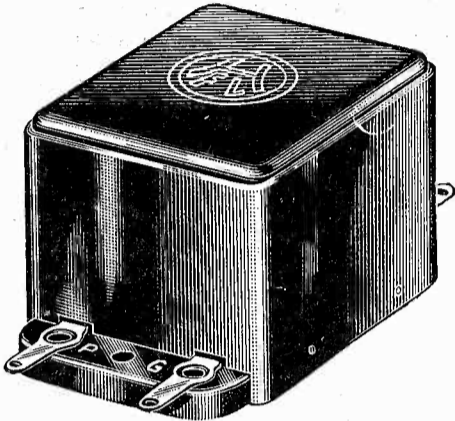

H. F. L. Units Give Wonderful Clear Reception

Engineers acclaim H. F. L. C-16 a marvellously efficient Audio Transformer. It carries signals at highest volume and lowest amplitude without blasting or developing harmonies. Operates with all power tubes as well as standard tubes.

H. F. L. C-25 Output Transformer handles the voltage output of power amplifying tubes, at the same time matches the impedance of the average speaker to tubes. Protects loud speaker unit without reducing plate voltage.

Mechanical features of these two transformers are: A coil designed and treated to exclude moisture and withstand heavy electrical surges without breaking down—complete magnetic shielding to avoid interstage coupling—terminals brought out so as to insure short leads.

PRICES

No. H-210 Transformers	\$8.00
No. H-215 Transformer	8.00
No. C-25 Output Transformer.....	8.00
No. L-425 R. F. Choke.....	5.50
No. L-430 R. F. Transformer.....	5.50
No. C-16 Transformer	8.00

Set Builders—Dealers

If your jobber cannot supply you with H. F. L. Transformers, wire us for name of nearest jobber.

HIGH FREQUENCY LABORATORIES

133-H NORTH WELLS STREET

CHICAGO, ILL.

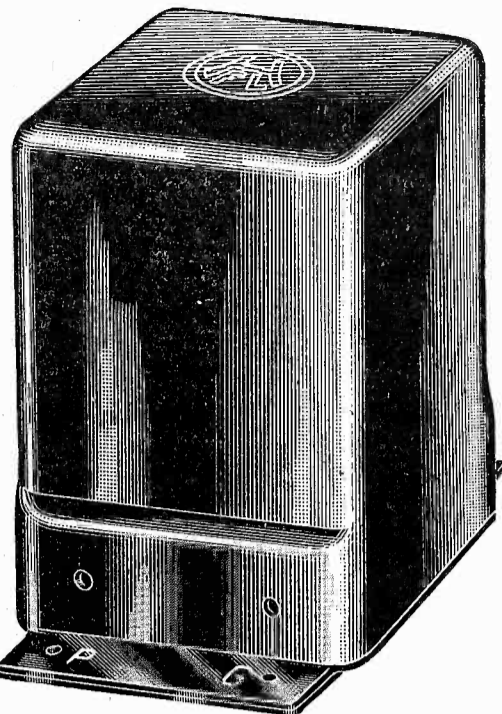

H. F. L. C-16 Audio Transformers and C25 output Transformer—New companions of a Great Unit, will work in any circuit and improve any radio set.

H. F. L. Facts

H. F. L. Units have been used, approved and most highly endorsed by *Radio News*, *Citizens' Call Book*, *Radio Review*, *Radio Age*, *Radio Engineering*, *Radio Mechanics*, *Chicago Evening Post*, the *Daily News* and others. Thousands of engineers and fans, who have turned to H. F. L. Units for better reception, hail them as the finest transformers known to Radio—unexcelled for Power, Selectivity and Purity of Tone.

Perfectly matched, skilfully designed, carefully made, rigidly tested—in a word, H. F. L. transformers are technically correct to the minutest detail.

All H. F. L. transformers are designed for baseboard mounting or invisible sub-panel wiring—each unit is enclosed and sealed in a genuine bakelite moulding.

H. F. L. Units are easily connected into the assembly, simplify set construction, and make a beautifully finished job.

Endorsed by America's Leading Engineers—Guaranteed by the Manufacturers

BIG DEALERS DISCOUNTS
thousands of.
NATIONALLY ADVERTISED
RADIO SETS-PARTS-KITS

Lowest Wholesale Prices
Just Out
Write For FREE BOOK

Midland Wholesale Co.
5116 Ravenswood Ave.
Dept. R Chicago, Ill.

RADIO AGENTS
Make Big Money

EASY to sell American Radios and Supplies. Nationally advertised, high quality merchandise at wholesale. Big profit on every sale. No capital to invest. No stock to carry. Order direct from my huge warehouse as you sell.
Get My Liberal Offer and also Big New 132-page Catalog and Guide—"How to Sell Radios"—Free. Full of Bargains—all latest in Radio. Write today.

AMERICAN AUTO & RADIO MFG. CO.
HARRY SCHWARTZBERG, PRES.
Dept. 146 American Radio Bldg., Kansas City, Mo.

BIG BARGAIN CATALOG

METERS

WE REPAIR THEM REGARDLESS OF MAKE

VOLTMETERS
AMMETERS
WATTMETERS

Send Them To Our Laboratory

HEINTZ AND KAUFMAN
SCIENTIFIC INC. APPARATUS

219-221-223 NATOMA STREET
SAN FRANCISCO

Tell them that you saw it in RADIO

WARNING!

There is still a great deal of misleading advertising appearing in the public press on radio. Unscrupulous advertisers take advantage of the fact that the vast majority of the public is unversed in the technical side of radio.

Following the popularity of Battery Eliminators, manufacturers and dealers saw the advantage of selling sets complete with power units; then there are the new A C tube sets equipped for use with a B-Power Unit and a Transformer for the "A" side.

Many advertisements of the above popular "All-Electric Radio Sets" carry such statements as:

"No Batteries, No Eliminators, Your Light Socket Supplies all Power"

Such statements are absolute falsehoods and are unfair to honest advertisers. No electric radio set has ever been built or marketed which does not require a so-called "B Battery Eliminator," better termed a "B Current Supply" or "Power Unit." The current as it comes from the light socket is totally unsuited to operate any radio set without the use of power units.

Buy your new electric receiving set and power unit, therefore, from manufacturers and dealers who tell the truth.

This advertisement printed in the interest of fair trade by
GRIGSBY-GRUNOW-HINDS CO., Chicago
Manufacturers of Majestic Electric Power Units.

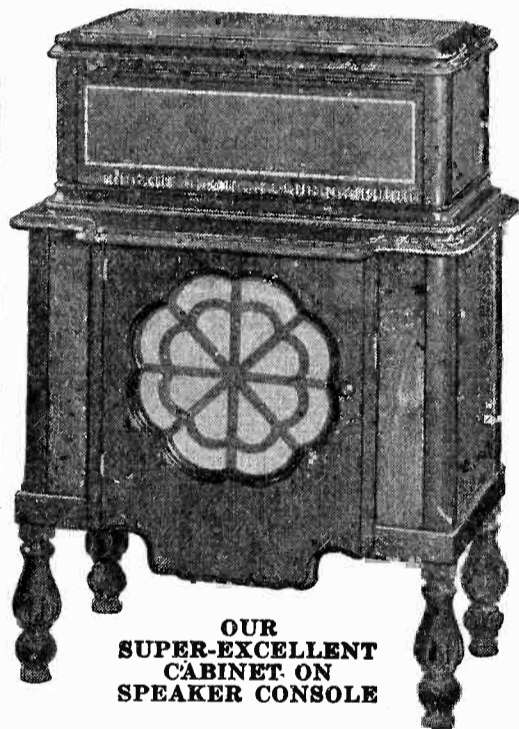

OUR
SUPER-EXCELLENT
CABINET ON
SPEAKER CONSOLE

Radio Cabinets

This cut shows our Super-Excellent Table Cabinet on our Super-Excellent Speaker Console. This is only one of our 10 latest conceptions of Radio Furniture. We have an unusual display of Furniture designed and built exclusively as Radio Furniture.

Send for catalog and descriptions and you will find that we are listing and carrying, ready for immediate shipment a very beautiful line. From all forecasts it is apparent that Radio Furniture will be the dominating factor in radio sales this coming season. Sets in our Cabinets will make sales. Special Cabinets Built to order in quantities.

Ehlert Radio Furniture Company
2468 Lincoln Avenue, Chicago, Ill.

Show Rooms and Large Stock Carried in Chicago.

Manufacturers of: RADIO CABINETS, RADIO DESKS, RADIO CONSOLES, RADIO TABLES.

NOW! USE THIS SHIELDED GRID TUBE

TYPE SP 122

Radio's Greatest Last-Minute Development

Never before have so many outstanding features been incorporated into one tube. Radio Engineers throughout the country marvel at this newest and greatest discovery. Technical Editors proclaim it radio's greatest improvement. (See article in this issue.)

Note These 6 Points of Superiority

- 1—Amplification is 50 times greater than ordinary tubes.
- 2—Oscillation is entirely eliminated.
- 3—It is self neutralized.
- 4—A Battery drain is only .125 amperes.
- 5—Operates on three volts.
- 6—Brings in DX stations like locals.

Guaranteed

The Shieldplate Tube Corporation guarantee these tubes to be just as represented, or your money cheerfully refunded.

INSIST ON THE
ORIGINAL

If your dealer cannot supply you, order direct from the factory. Include money order with your request, or we will ship C. O. D.

Price \$7.50

BUY DIRECT FROM FACTORY—All orders filled in rotation. Don't Delay.

Mail your orders direct to

208 So. La Salle St.

SHIELDPLATE TUBE CORP.

Chicago, Illinois

(Continued from page 64)

caught a wing-tip of his yellow canary, shifted and smeared him in brilliant white.

Startled, the Eagle swung his controls upward and went into a rapid loop, to get away from that all-revealing shaft of light. But the beam held him like a gleaming cable tied to his tail. He banked sharply, twisted and turned, spun end over end, and then sped into vertical climb. As he did so, a giant khaki-colored plane suddenly swooped down out of the upper levels of the air, crossed the white beam, with tiny yellow flashes stabbing the night ahead of it. An unseen finger jerked at his plane and set it to rocking

"My God!" The exclamation was wrung through the Eagle's gritted teeth. "Machine guns . . ."

He heard the staccato chatter of the weapon as he flopped over and dived under the other. But the khaki plane, although it did not maneuver so rapidly, was too quick for the yellow canary, and dropped like a plummet. As it did so, two other khaki planes flashed into sight, leaving the Eagle in the center of the nest. spurts of flame shot the night from the three deadly strangers.

The Eagle was a war ace and he had had many machine-gun battles in mid-air. He put his knowledge into effect now. Banking into a quick turn while the searchlight held him like a brilliant finger of justice, he shot straight upward at terrific speed. As he did so, he knocked loose his radio antenna reel and a fifteen foot span of wire trailed out behind him.

"Hello . . ." he was speaking into the transmitter now, the 50-watt "bottle" glowing like a dull coal of fire. "Hello Joe . . . there's a bunch of army planes trying to machine gun me . . . I've got to run for it. Beat it Bimbo's wise and there's hell popping . . . I'm about twenty miles south of you now . . . get out quick . . ." He repeated the message, holding the nose of the yellow bird in a sky-point.

He had a moment of darkness as the searchlight wavered and lost him. Just as he was about to congratulate himself on the escape from that merciless finger, it found him again, and directly below him he caught the three army planes closing in . . . He straightened out and headed due west. As he did so, a new searchlight of terrific brilliance swept up against a fog bank, flicked a couple of quick letters he could not read against its responsive surface, swung over and crossed the revenue cutter's beam like the slithering of one sword against another, and picked him out with deadly certainty.

"Another cutter — the McNamara probably," said the Eagle to himself. He glanced down. The army planes were

(Continued on page 68)

RADIO'S LABORATORY

Special Facilities For Matching I. F. Transformers

SETS CHECKED: Complete laboratory test and check of all parts, including any type or make of set	5.00
This includes a complete check-up of all parts, matching of radio frequency coils, elimination of "bugs," etc. Sets must be shipped complete with tubes and circuit diagram, unless of standard type or make, when diagrams may be omitted. (Extra charge if diagram is not supplied.)	
Intermediate Frequency Transformers. Transformers matched, to optimum frequency and filter tuned to resonance	2.50
Condenser to tune filter extra. Transformers rewound and calibrated to a specified frequency for \$2.00 per transformer. STATE TYPE TUBE TO BE USED.	
Radio Frequency Coils. Matched to resonance with a gang or bank condenser, per set of 3 coils	2.50
(Coils and condensers both must be submitted.)	
WAVEMETERS and Oscillators. Covering all wavelength (frequency) bands from 10 meters up, with 1 coil only. At least 5 points furnished	2.50
Additional coils, per coil	1.00
Curves drawn, per curve	1.00

WRITE FOR QUOTATIONS ON SPECIAL TESTING AND ENGINEERING SERVICE

PARTS

Any part made by any radio factory can be supplied by us. Before parts are shipped to our customers we make a careful inspection. When you buy parts from the laboratory of "RADIO" you know in advance that you can't go wrong.

HOW TO ORDER

When ordering parts from the laboratory be sure to specify Manufacturer's name, type number and style. C.O.D. orders accepted if half cash accompanies order. Prompt deliveries assured.

Testing and Calibration Laboratory

Pacific Radio Publishing Company

Established 1917



PACIFIC BUILDING

SAN FRANCISCO-CAL.

KITS

The many new kits of the season can be supplied by the laboratory of "RADIO." Let us send you a real matched and tested kit for any circuit. The usual retail prices prevail. No extra charge for matching.

Sovereign

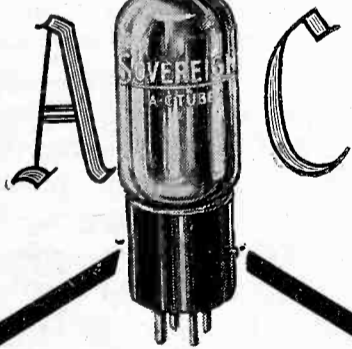

Tubes and Kits

Don't be a "back number." Throw away all "A" Batteries, "A" Eliminators and Chargers. Slip Sovereign A-C Tubes into your circuit, plug into the light socket for "A" power, and enjoy clear, clean, crackless, truthful reproduction. Sovereign A-C Tubes give astounding satisfaction—unequaled performance—transmit no hum—no disturbance—require no new sockets.

Sovereign A-C Tubes.....Price \$5.00
Sovereign A-C Power Tube for last
Audio Stage.....Price \$6.00
Sovereign A-C Kit 110 or 220 Volts,
60 Cycles.....Price \$8.75
Sovereign A-C Kit 110 or 220 Volts,
25 Cycles.....Price \$9.75

If your dealer cannot supply you, we will send C.O.D. Specify line voltage and number of cycles.

Get free booklet on A-C Tubes and Circuits.
SOVEREIGN ELECTRIC & MFG. CO.
121 N. Sangamon Street Chicago, Ill.

KARAS HARMONIKS

are again specified

THE famous Karas Harmonik Audio Transformers have been specified again in the circuits designed by Francis Churchill, and described in other pages of this issue. These great all-stage ratio audio transformers are the most powerful made. They amplify with tremendous volume and with extreme fidelity of tone. Wherever you use them you will find them the best audio transformers on the market for the price. The world's greatest transformer value—now \$5.00. Write us for complete data on their performance in ANY circuit.



NOW
\$5.00



Write for Complete Blue Prints on the
2-Dial Equamatic and Knickerbocker 4

KARAS ELECTRIC CO.
4031-K No. Rockwell St. Chicago

Tell them that you saw it in RADIO

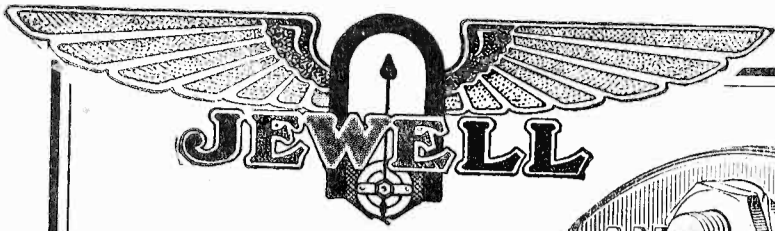

Jewell
Lightning
Arrester

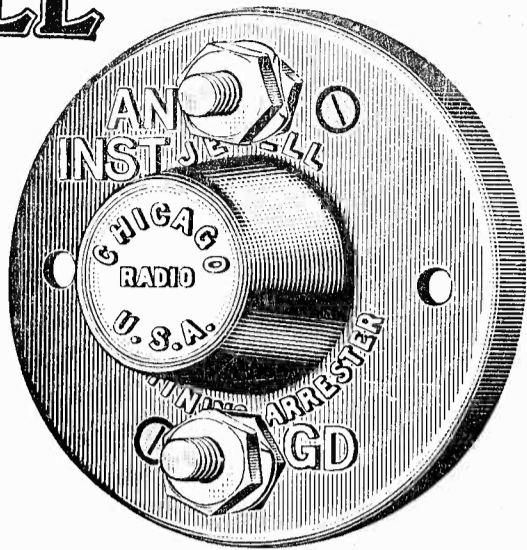

Listed
by
Underwriters

Protect Your Set

If you are buying a new radio set and are using an outside antenna, it is most essential that your set be protected against injury or destruction from lightning.

This can best be accomplished by the use of a Jewell Lightning Arrester, properly connected in the antenna circuit.

The Jewell Lightning Arrester consists of an accurately calibrated air gap, enclosed and sealed in a waterproof, glazed porcelain case. It is suitable for either inside or outdoor installation and is listed for such use by Underwriters' Laboratories.

Write for descriptive circular No. 1019, or ask your dealer to show you one of these arresters.

Jewell Electrical Instrument Company

1650 WALNUT STREET, CHICAGO

"27 Years Making Good Instruments"

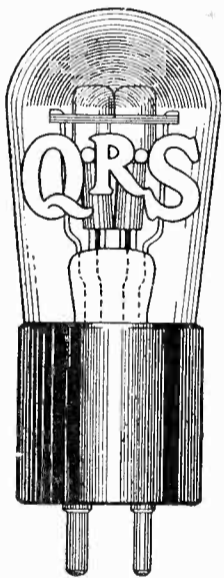

For Your "B" Battery Eliminator,
Ask Your Dealer for Guaranteed

Q · R · S
Trade Mark
Registered

**GASEOUS
Rectifier Tubes
ARE BETTER**

60 Milliamperes

\$4.50

85 Milliamperes

\$4.50

400 Milliamperes

With Ionizer 300 Volts

for A, B and C Eliminators
with Charts and Diagrams

\$7.00

Manufactured by The **Q · R · S** Company CHICAGO
MUSIC

Established 1900. References: Dun, Bradstreet or any bank anywhere

Just a Few Left

Blue Prints of Best's 1927 Shielded Superheterodyne

ONE DOLLAR PER SET

"RADIO" San Francisco

(Continued from page 66)

gaining on him, despite the fact that he was crowding his gallant bird to its limit.

Suddenly off toward the west there came a terrific concussion preceded by a flash of light. The next instant a star shell exploded directly above him, illuminating the ocean far below, and causing him to stand out clearly against the sky. Another and another

"God in Heaven—a destroyer . . . !"

The machine-gun crackle was growing closer now. Again came that plucking at his machine, causing it to rock and teeter as though in an air patch. He tried to steady it, and something cracked. The Eagle whirled in his seat, his face white, in time to see his right wing crumple, swirl around Something ripped the fabric off, leaving the understructure exposed for a second. In that moment, the plane sagged, slithered around, wobbled crazily, and turned over.

Held by his safety straps, the Eagle tried to right it, but it kept turning over. The world became a spinning flare of light and swinging darkness. The Eagle made one desperate effort to get clear of it all, to step off with his parachute. The plane was above him, and he was head downward. He fumbled with the straps . . . smoke was pouring into his face. He knew the gasoline tank would go in a moment, and he wanted to get away from that terrible death . . .

There was a quick second when he saw the ocean sweeping up to him, in the merciless glare of the searchlight. The next . . . a streaming, sizzling, crippled plane plunged into the water—a yellow, streaming comet that exploded as it struck. The Eagle remembered guarding his face against that awful sheet of flame, praying for the rushing water and then . . . blackness.

TWENTY miles north, the *Grey Phantom* sprang into sudden activity. Bells jangled, and engines began to throb. The *Phantom* was a fast boat and it made record time seaward. Over and around it as it went the air sizzled with navy code. Presently a navy destroyer changed course a bit, as a lieutenant, his ear to a sonophone, gave the bridge certain readings. For an hour the *Phantom* sped toward Hawaii, and then just as it seemed safe to reduce speed, a searchlight beam plucked at it out of the night and a roaring shell whistled across the fugitive's bows. The *Grey Phantom* was running without lights, and a lightless ship gets no quarter under the code of the sea.

The captain reached for the ship's telegraph. His first mate was at his elbow.

"Gonna run for it?" he asked.

The captain shook his head.

(Continued on page 70)

Old
INFRADYNES
Converted Into
1928 Models

Bring last year's Infradyne up to date by having us install the new Remler radio frequency amplifier, steel chassis, control panel and wiring system. Write us for estimate on this work, telling us what changes you wish to make. Complete re-build job of last year's Infradyne to make it an exact duplicate of the 1928 model—\$122.50.

Radio Constructors Corp.
357 12th Street Oakland, Calif.

Silver A Beauty POWER

For Your Present Set or the
Set you eventually buy



Our 4-volt "A" Eliminator
Fits Into All Radiola Consoles

\$39⁵⁰
6-volt—2 amp.
\$43⁵⁰
6-volt—3 amp.
\$39⁵⁰
4-volt—1/2 amp.
\$2 Higher
West of Rockies

Finally—the Perfect "A" Eliminator

Perfect, because its principle is simple and correct!

THE 110 volts Alternating Current is scientifically reduced with the famous "Silver Beauty" transformer coil to deliver the proper voltage to an especially developed dry, noiseless rectifier, which transforms the electricity to direct current. This current of exact voltage, is then transmitted through a patented special filter which clarifies the current, eliminating

all foreign noises caused by rectifier or generator. The result! A smooth, noiseless, constant "A" current supply, that makes radio reception the pleasure it is intended to be. Silver Beauty is the outstanding "A" eliminator today. Nothing equals it. Endorsed by prominent radio engineers—adopted by leading distributors and dealers—approved by thousands of users. These are sufficient reasons for making Silver Beauty your final choice.

**Silver A Beauty
POWER**

- Replaces "A" storage battery and charger.
- Has full wave "dry" rectification.
- Maintains required voltage in uniform, constant flow.
- Operates automatically by moving a switch.
- Economical—uses minimum amount of current [about 1-10 cost of using electric iron].
- Has rheostat control for additional refinement in voltage and reception.
- Gives maximum power to radio tubes and lengthens their life.
- No acids to test or spill.

*Satisfactory Results
Guaranteed*

Silver Beauty

"B-C" UNIT
Does away with "B"
and "C" batteries

Embodies every up-to-date refinement and principle, insuring smooth, unfailing reception. As beautiful as it is efficient.

Silver Beauty CHARGERS

Employing an entirely new method of rectification. Two models—with or without bulbs.

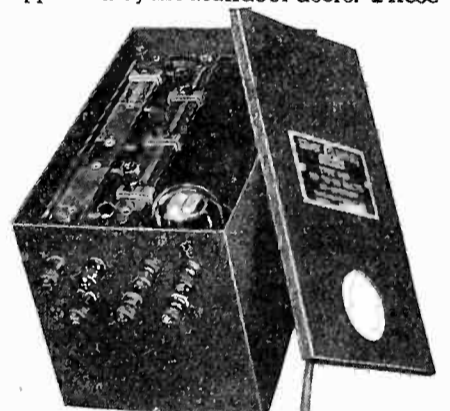

No. 450—180 Volts 40 Milliamperes \$45
No. 460—135 Volts 35 Milliamperes \$35
Individual adjustment adapted to all sets

See Your Dealer or Jobber

Triple-A-Specialty Company

Manufacturers of the famous Silver Beauty Chargers
312-316 SOUTH HAMILTON AVE.
Chicago, Illinois



KITS For all known circuits. Get our Special Prices. 36-inch cone kits and cone units in stock. Also kits made up specially for all "RADIO" circuits.

Send for FREE RADIO CATALOG
B. C. L. RADIO SERVICE CO., INC.
218 Fulton Street New York City

**Set Builders!
Dealers!** Catalogue

Van-Ashe
The Set Builders!

FREE
—big catalogue

Standard parts and equipment at money-saving prices, with discounts that show you a real profit. Electrical Phonograph—pick-ups—latest kits! Complete stock of Tyrman 10 parts. New AC tubes and transformers—parts for any circuit—power audio equipment—short-wave supplies—they are all in our big new 1928 catalog. Write for it today, with discount sheet. 12-hour shipment guaranteed.

Dan-Ashe Radio Co.

212 North 10th St. ST. LOUIS, MO

KNICKERBOCKER 4
THE WONDER SET
2-Dial Karas Equamatic 5-Tube Receiver

These two famous receivers as well as scores of other well known sets owe no small part of their marvelous performance to the use of Karas parts: Karas Condensers, Transformers, Filters, Coils and Dials

KARAS ELECTRIC CO., 4031-K N. Rockwell St., Chicago

2-DIAL KARAS EQUAMATIC USE
KARAS
PARTS
KNICKERBOCKER "4"

At \$6⁰⁰ this famous
Cabinet
has no equal!

The Blue Ridge
7"x18"x10" Mahogany
or Walnut Finish

Send us your order or write for catalog and full information. 12 hour service, factory to you.

Southern Toy Co. Inc.
MANUFACTURERS HICKORY N.C.

RADIO AT WHOLESALE

Write for my Big 1928 Radio Catalog—just off the press. Thousands of marvelous bargains in nationally advertised goods. All the LATEST IN RADIOS and equipment. Lowest wholesale prices. Agents Wanted.

FREE DEALERS NEW 1928 CATALOG

It's a regular encyclopedia on Radio. All about trouble finding. **FREE Log and Call Book** and Catalog. Get your copy today. Send postcard now!

American Auto & Radio Mfg. Co.
HARRY SCHWARTZBERG, PRES.
Dept. 143 American Radio Bldg., Kansas City, Mo. 3

Subscribe Now To
"RADIO"
\$1.00 for six months

Tell them that you saw it in RADIO

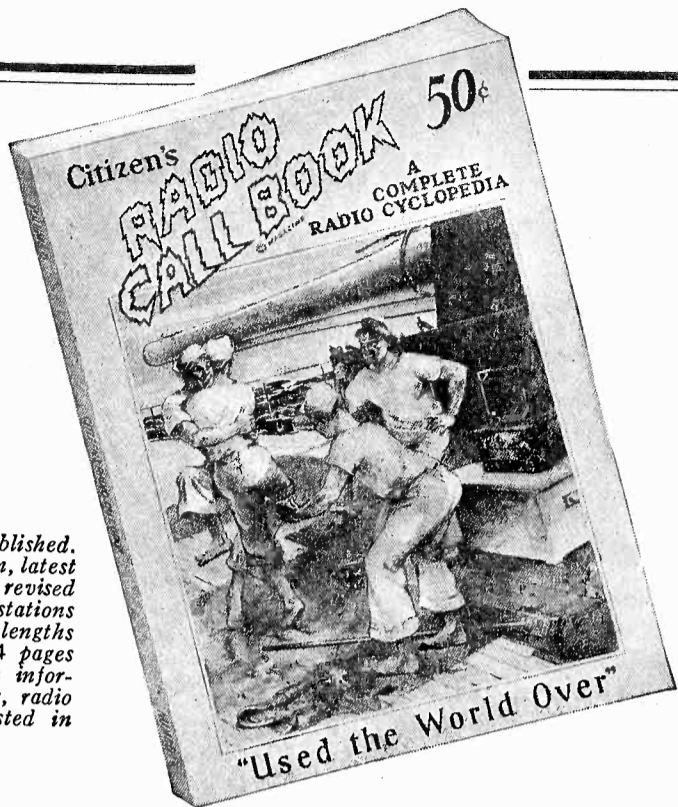

The biggest edition --

The biggest edition ever published. Brimful of newest information, latest circuits and hook-ups, new revised list of world's broadcasting stations with schedules and new wave lengths in meters and kilocycles. 264 pages of news, ideas, and valuable information for fans, set builders, radio dealers and everyone interested in radio's advancement.

Citizens Radio Call Book

NEW SEPTEMBER 1927 EDITION

On Sale Now At Newsstands and Radio Stores

Wonderful Rotogravure Section

One of the big features of the new Call Book is the 16-page rotogravure section. It is replete with photographs and views. Your favorite radio artists, pictures of studio life, prominent announcers and other features are shown in actual photographic views.

Complete Details on Newest Circuits

Every Receiver Designed and Thoroughly Tested in Our Laboratories. Complete constructional details on the newest modern radio circuits are given, including the Aero-7, Camfield Super-Selective-9, Remler 45 KC., Nine-in-Line, Meloheald 14, Magna-former 9-8, Eight-in-Line, Tyrman Super 10, Infradyne, World's Record Super 10, Equamatic, Browning-Drake, St. James Upright-8 and others.

A Complete Radio Cyclopedia

Be sure that you get the CITIZENS RADIO CALL BOOK, the original and most widely circulated publication of its kind. Accept no substitutes. Published four times yearly, September, November, January and March. On sale now at newsstands and radio stores the world over, or subscribe now and be sure of receiving each issue as published. Use the handy coupon below and mail in now.

Mail
This →
Coupon
Today!

CITIZENS RADIO SERVICE BUREAU, Inc., Publishers
508 So. Dearborn St., Chicago, Ill., Dept. R, U. S. A.

Date.....192.....

Please enter my subscription for the CITIZENS RADIO CALL BOOK for [] one year, \$1.75; [] two years, \$3.25; [] three years, \$4.50. Enclosed please find.....in payment for same, mailed postpaid four times yearly, January, March, September and November. Canada and Foreign \$2.00 yearly.

Name.....

Address.....

City.....

State.....

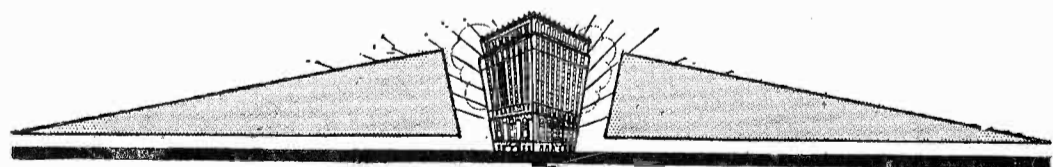

The
Ritz-Carlton

PHILADELPHIA
at Broad and Walnut Sts.

CONTINENTAL ATMOSPHERE.
ROOMS, CUISINE & SERVICE
OF EXTREME EXCELLENCE.

DAVID B. PROVAN

MANAGING DIRECTOR



Tell them that you saw it in RADIO

(Continued from page 68)

"Not from them babies," he said "As good as this old tub is she never saw the day she could outrun a destroyer"

"A destroyer . . . Gosh cap . . ."

The captain nodded grimly.

"Yep Pete—I reckon it's McNeill's for us," he said and slapped the telegraph over to "stop."

It was three days later that Dan Crowley with Captain Hackett took stock of their raid. The Eagle was in a hospital under federal guard, badly burned—a wreck of a man, through with flying forever. The *Grey Phantom*, true name *Celaris*, was at anchor in San Francisco bay with a U. S. deputy marshal in charge. Jimmy Dodd, true name Bill McCarthy, skipper of the *Celaris*, was in jail with his crew. And on the records of the revenue department was a seizure of four hundred thousand cases of prime Canadian liquor, valued at nearly a million dollars.

"Well," said Dan Crowley, "exit the *Grey Phantom*."

"Yep—she's done," said Captain Hackett, "and here's one hombre that is not sorry."

The door opened to admit Lamson of the prohibition department.

Dan Crowley noted the fact out of the corner of his eye. He winked at Captain Hackett.

"Yes, and we'd have rounded 'em up sooner," he said, "if the revenue service had had any co-operation from the prohis."

"What's that?" said Lamson. "Say, listen here . . ."

And the old argument was on again!

NEWS OF THE AMATEUR OPERATORS

(Continued from page 43)

explained methods of mitigating interference to radio reception. Senator C. C. Dill spoke about the necessity of preventing any private ownership of radio frequency channels and the possibility of this object's being accomplished as regulation of interstate commerce. Howard Mason was elected president, L. H. Harman, vice-president and Otto Johnson, secretary-treasurer. The 1928 meeting will be held at Seattle.

CALLS HEARD

By nu8DED, William and Russell Sackers,
53 East 7th Street, Holland, Mich.

Ef-8arm, ef-8yor, ef-8ct, ef-8qrt, ef-8yap, eb-4ww, eb-4ax, ei-1ay, ei-1cr, ei-1co, ep-1ae, ep-3fz, ep-8ma, ek-4uah, ac-brj, fq-pm, fo-a3b, fo-a3z, na-wwdo, nm-1j, nm-1aa, nm-1n, nm-cyy, nm-9a, nn-1nic, nn-a3y, nz-ez5, nd-hik, nr-2fg, sa-cb8, sc-3ag, sc-2bl, sc-2as, sv-ayre, su-lcd, sb-lao, sc-2ak, oa-2yi, oa-3hl, oa-2sh, oa-3ag, oa-7cw, oa-4ak, oz-2bl, oz-1an, oz-3ar, oz-4ac, oz-4am, ao-7, cx6, lgl, lw, nq-8kp, abl.

A normal radio field intensity, according to the preliminary Nema standards, gives a normal output for a receiver which is modulated 30 per cent at 400 cycles. The reciprocal of this value is used as a quantitative unit of measurement of the receiver's sensitivity.

SHORT WAVE RECEIVER

(Continued from page 42)

the saturation point of its characteristic curve. A weak signal then will come through in the normal way but a loud signal will cause the tube to operate on the saturated or horizontal portion of its curve so that one signal has about the same intensity as the next in the telephone receivers. The tube is made to operate on that portion of the curve by bringing the grid return back to the positive side of the filament, using an additional filament rheostat to operate the tube below normal filament voltage, and connecting the telephone receivers between the plate and the positive side of the filament. As to which side of the filament the grid return is made depends on the individual taste, as the filament rheostat can be set so that either connection will work satisfactorily.

The circuit used in the first detector, which is also the oscillator, is a tuned grid tuned plate system with the grid and plate condensers coupled together for single control. The strength of oscillations in this tube are controlled by the 0-50,000 ohm heavy duty resistance R_1 . This setting is not critical and can be left alone over the usual amateur bands.

This tuned grid-tuned plate system was finally decided upon after considerable experimenting because it gave excellent efficiency on all of the bands from 20 meters up, and because it became readily adaptable to the special circuit shown in Fig. 2 for the 5 meter band.

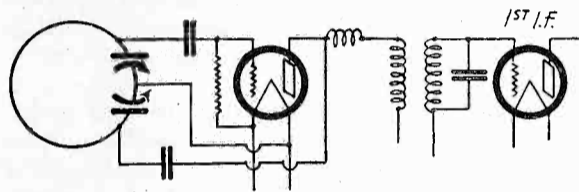

Fig. 2. Special Circuit for 5-Meter Band Six Tube Short Wave Receiver.

The arrangement is as follows, on 20 meters two coils of 4 turns each are plugged into the push binding posts. On 5 meters a single coil of 1 turn is plugged into the two push posts which connect to the grid and plate sides of the variable condensers. The circuit then becomes that shown in Fig. 2 and will work down to less than 4 meters without the slightest difficulty.

If wavelengths below 4 meters are desired, place a midget variable condenser in the middle of the single turn coil shown in Fig. 2 and a special r.f. choke in the plate circuit. This special choke may be 20 turns, basketweave, on a $\frac{1}{2}$ in. diameter. The Samson r.f. choke shown in the picture was the only one tried which would function properly over all of the amateur bands. It will work even better when about $\frac{1}{3}$ of the wire on it is removed, as it doesn't affect the 30,000 cycle component as much then.

For 20 meters two 4 turn coils were cut out of the Hammarlund low wave coil form, for the 40 meter band two 7 turn coils, and for the 80 meter band two 16 turn coils were cut. These coils are space wound on a thin shell of some substance, celluloid I believe, with 10 turns per inch, so that the six coils can be cut from a 6 in. section of this coil. Using the 100 mmf. double-spaced Hammarlund condensers coupled together on a single shaft the coils listed above will cover all wavelengths from 17 or 18 meters up to over 100 meters without any bands being skipped.

It will be noted in the picture that a shielding plate is fastened between the two condensers to electro-statically shield the plate side of one condenser from the grid side of the other. Hammarlund condensers have removable shafts so that it is but a minute's work to couple two of them together with a piece of $\frac{1}{4}$ in. brass rod.

(Continued on page 72)

POWERIZER

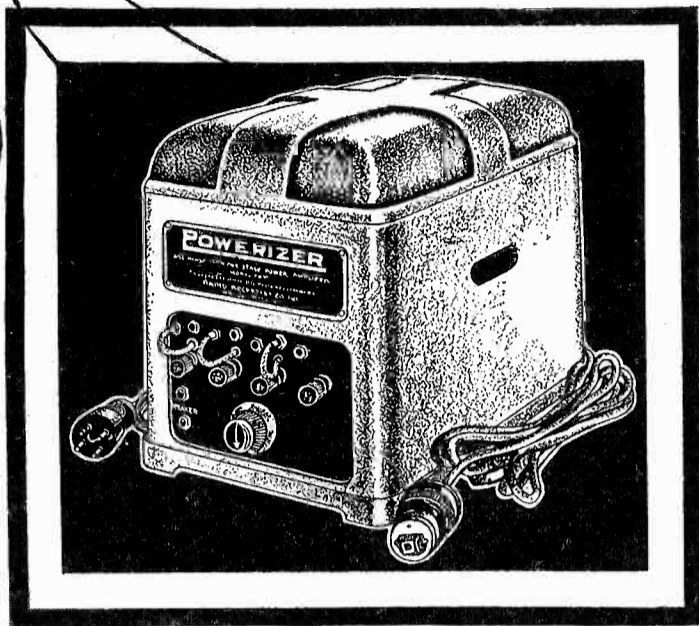
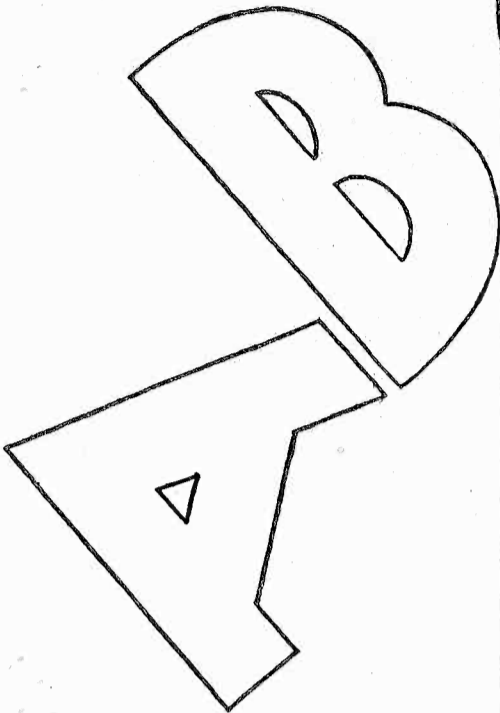

"Universal", for RFL and Neutrodyne Sets, \$60
Model for Atwater-Kent, without tubes . . . \$60
Radiola "20" model, without tubes . . . \$59

MAKES YOUR SET AN A. C. ELECTRIC

*with the newest
A. C. Radiotrons which
require no batteries!*

Cymbals crash . . . the great bass booms . . . the baritone sax sighs and moans . . . dance music with jungle deep intonations . . . music such as you've never heard from your radio before . . . With the Powerizer, all those elusive low notes are captured—and reproduced with a rich mellowness.

Equip your set with a Powerizer and the finest tone quality in Radio is yours—for there is installed in your set the same system of A. C. Radiotron electrification that is used in the finest \$500 and \$300 A. C. Receivers.

Write for literature explaining details "How to make your set a modern A. C. Electric".

RADIO RECEPTOR CO., INC.
106 Seventh Avenue - New York

LICENSED BY RADIO CORPORATION OF AMERICA and Associated Companies

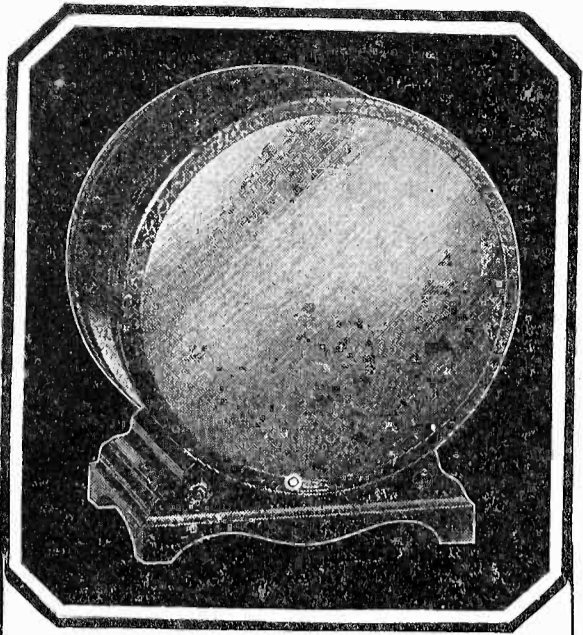

You Will Marvel at the
Tone Reproduction of the

TEMPLE AIR - COLUMN SPEAKER

People are positively astonished when they hear the TEMPLE AIR COLUMN SPEAKER for the first time. The marvelous clarity and purity of tone is amazing.

The TEMPLE AIR COLUMN SPEAKER brings new joy in radio. Thruout the entire musical scale this super-speaker is sensitive beyond comparison—unequaled for tone quality. Dance music—organ recitals—opera—hear them now in a way you never dreamed was possible!

Not a Cone

This new type speaker is selling like wildfire all over the country. New enthusiasts by the thousands are buying TEMPLE. Eddie and Fannie Cavanaugh, the Gaelic Twins of KYW, Chicago, say: "We have tried many speakers but none have the wonderful tone quality and volume of the TEMPLE."

Hear a TEMPLE AIR COLUMN SPEAKER demonstrated on the TEMPLE COMPARATOR at your nearest dealer. Make this test: Close your eyes as you hear different speakers. You'll pick the TEMPLE every time because of its unflinching purity and richness of tone reproduction.

CONSOLE CABINET MODEL No. 65—
priced at \$65.00; west of Rockies, \$75.00

DRUM TYPE MODEL No. 13—13 inch
—priced at \$29.00; west of Rockies, \$32.00

DRUM TYPE MODEL No. 18—18 inch
—priced at \$48.50; west of Rockies, \$55.00

If your dealer cannot supply you write for complete information and name of our nearest Temple dealer

TEMPLE, Inc.
213 S. Peoria St., Chicago, Ill.
LEADERS IN SPEAKER DESIGN

(Continued from page 71)

The picture shows the layout of the set pretty well. The first intermediate frequency transformer is on the left and the rest of the equipment follows around in a sort of a circle with the last audio on the right hand side. The wiring, especially of the filaments and B battery leads, is run in golf fashion, from hole to hole in the baseboard. It will be noted that the panel is shielded, so that the set can be completely shielded by surrounding the rest of the set with an aluminum can.

The baseboard was made 18 in. long and 11 in. wide, the latter dimension being such that aluminum sheet 12 in. wide can be used conveniently in making the metal shielding can. Shielding is desirable in order to eliminate long wave interference which is quite bad in some localities and which the intermediate frequency amplifier is quite efficient at picking up.

PARTS USED BY THE AUTHOR

- 1 18x7 in. panel.
- 1 18x11x½ in. dry wooden baseboard.
- 6 Airgap sockets.
- 2 Hammarlund .0001 double spaced condensers.
- 5 X-L push binding posts.
- 1 Sangamo .0001 mfd. grid condenser.
- 2 Sangamo .0005 mfd. condensers.
- 2 Electrad 5 megohm leaks.
- 1 Electrad grid condenser.
- 3 Remler superheterodyne transformers.
- 1 Midget variable condenser.
- 2 Karas audio transformers.
- 2 Frost rheostats, one 2 ohm and one 30 ohms.
- 1 Samson R.F. choke.
- 2 1 mfd. Electrad by-pass condensers.
- 1 Yaxley 400 ohm potentiometer.
- 1 0-50,000 ohm heavy duty Centralab resistance.

In adjusting this receiver, the potentiometer should be turned around until the intermediate frequency amplifier slides into oscillation. The variable resistance R_1 is then turned up until the first detector oscillates, this being readily checked at first by listening in that plate circuit with a pair of phones for the click or hiss of oscillation.

A wavemeter should be on hand for checking the wavelength of the receiver on all bands. The usual amateur wavemeter is quite satisfactory for this purpose. For the five meter band a wavemeter made up of a single turn 5 in. in diameter of stiff brass or copper ribbon shunted by a midget condenser of 35 to 50 mmf. is quite handy. Very little hand capacity effect is noted with such a wavemeter since only one turn of inductance is used and the condenser is part of the turn.

This type of wavemeter can be readily calibrated using the receiver described, and an oscillator which is plentiful in harmonics. This type of calibration has been described many times and consists of setting the oscillator exactly on the second or third harmonic of a broadcast station of known wavelength, and then working down from one harmonic to the next using the short wave receiver. Down on the very short waves, it is generally necessary to re-set the oscillator down around 20 or 30 meters in order to pick out the harmonics in the neighborhood of 5 meters and less. This system of calibration is certainly more accurate than the use of Lecher wires where large errors are likely to occur unless a great many precautions are taken.

LATEST STYLE OF SIGNING ON

(Continued from page 45)

ternally. I have further found that said instruments were functioning in such a manner as to expedite instantaneous communication and therefore relieve the present operator, Mr. Bill Gillhickey of any further responsibility in connection with it.

In the light of what has been said in the above paragraphs, we, the undersigned, do hereby affix our seals.

BILL GILLHICKEY,
JOHN A. BENDER.

What Kind of Voice Has Your Loud Speaker?



Does it
Snearl?
Does it
Whine?

or Does it register
clear, natural Human Tones?
The New Muter Clarifier
(Output Transformer)

on your set will astonish and delight you by immediate, almost unbelievable improvement in reception. In nine cases out of ten that weak, distorted voice issuing from the speaker unit is suffering paralysis from high "B" Voltage. The Clarifier protects Speaker coils from this shattering current, assuring longer life as well as strong, full tone, clarity and volume.

If your speaker is one of the great majority that fail to respond properly to the output of the set—you need a Muter Clarifier. It's the only thing that will remedy the cause. Easily attached in a few seconds without disturbing set. Try it out to your own satisfaction on our liberal guarantee—you won't recognize your set!

See Your Dealer—or Send Direct

Dealers can easily secure Muter Products for you from leading Jobbers. If, however, you have any difficulty in obtaining from your dealer, mail coupon direct to us. Prompt shipment complete, with phone cards attached, will be made upon receipt of price or C.O.D. if preferred. Give your speaker a chance to produce its utmost. Mail coupon today.

Leslie F. Muter Company

76th and Greenwood

Dept. 819-P

CHICAGO, ILL.



**Dependable
Products**

The Complete Quality
Popular Priced Line
Send for comprehensive catalog



Use This Coupon!

LESLIE
F. MUTER CO.

76th and Greenwood Ave.

Dept. 819-P

Chicago, Ill.

- Send Muter Clarifier at once, postage prepaid. \$5.00 is enclosed.
- Send C.O.D.
- Send complete Muter Catalog.

Name.....

Address.....

City.....

State.....



Tell them that you saw it in RADIO

"In the Heart of
Cleveland"

AUDITORIUM HOTEL



EAST 6TH AND ST. CLAIR AVE.

TO THE PUBLIC:

Are you wondering why we have built "Another" Hotel in Cleveland. One must have a good reason for spending nearly two million dollars. We have a reason worth far more than that.

Every hotel operator gives "His best efforts for your comfort." We have centered our efforts around one ideal desire, "To make you happy."

There must be something back of that desire. You can easily prove it by coming here just once.

Sincerely yours,
James L. Smith
Manager

LATEST LOG BOOK 25c

ALL THE NEW LISTINGS
HANDY POCKET SIZE

"RADIO," Pacific Bldg., S. F., Cal.

RAJAH SOLDERLESS SNAP TERMINALS

Instantaneous in Operation—Positive Contact. For Panel, Ground and Battery Connections.

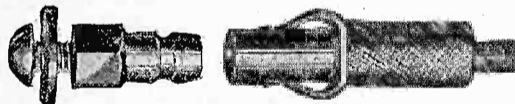

Patented—Sept. 23rd, 1924.

The Base Stud is tapped and furnished with 8-32 screw and washer. This fits all "B" Batteries with screw posts.

Used on

TUNGAR - RECTIGON - PHILCO - EXIDE
Terminal, complete,....15c Extra Base Studs....5c

Furnished with

BAKELITE FERRULES

In Three Colors

BLACK — RED — GREEN

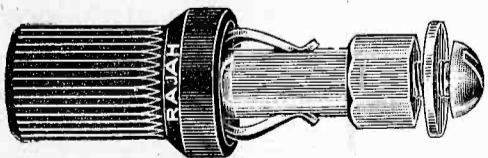

LIST PRICE - 25 Cents Each

Distributors

MARTIN WOODARD CO.

438 Phelan Building, San Francisco, Cal.
28 E. Sprague Avenue, Spokane, Wash.
Terminal Building, Seattle, Wash.
229 Pine Street, Portland, Oregon

THE RAJAH CO.
BLOOMFIELD NEW JERSEY

TINY SUPERHET

(Continued from page 38)

tance, whereas if the transformers were crowded against each other with their terminals in normal position, the grid and plate leads of the two i.f. stages would be very close together, and the amplifier might oscillate. Extend all four leads of the transformer spool with small pieces of flexible wire, and replace the spool in the case, being sure to insert the insulating paper between the spool and the core. Now melt the wax which was removed from the transformers, and pour it in the case, thus sealing the transformer again and making it impervious to moisture. Drill four small holes through the subpanel at points where they will clear the tube sockets, and pass the leads through these holes, after which the transformers can be secured in place.

The filter is next placed on the subpanel, and is constructed as follows: Out of a block of wood, or slabs of bakelite, build a spool after the data given

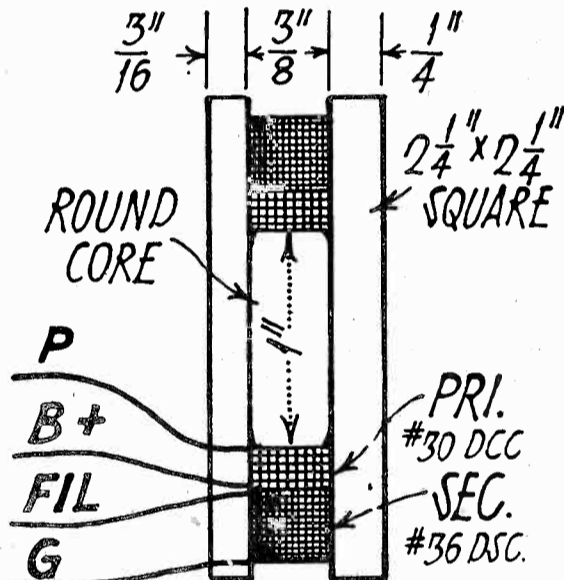
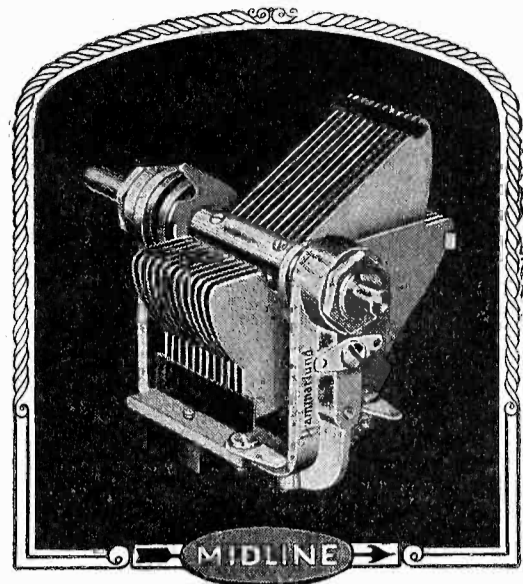

Fig. 4. Filter Transformer Details.

in Fig. 4, which shows the exact size required. On the spool wind 250 turns of No. 28 or 30 double cotton covered wire, for the primary, and after covering the primary with a layer of paper, for insulation, wind on 1250 turns of No. 36 double silk wire, for the secondary. Bring out all four terminals on one side of the transformer by drilling small holes through the bakelite or wooden flange. The secondary is tuned with a .002 mfd. fixed condenser, and in experimenting with the design, five transformers made from these specifications all peaked within 1 kilocycle of each other, around 40 kilocycles.

To hold the transformer to the subpanel, drill two holes through the latter with a No. 36 drill, place the transformer under the panel so that the 1/4 in. flange comes directly underneath the holes, and mark the transformer with a center punch so that two holes can be drilled in the flange with a No. 42 drill and tapped with a 4-36 tap. Two flat head 4-36 brass machine screws about 1/2 in. long will suffice to hold the trans-



World-wide Leadership
of the

HAMMARLUND "Midline" Condenser

is now shared by these new Hammarlund Precision Products:

Radio Frequency CHOKE COIL;
Illuminated DRUM DIAL;
Improved "HAMMARLUND, JR.";
Equalizing CONDENSER;
Improved AUTO-COUPLE COIL.

HAMMARLUND MANUFACTURING CO.
424-438 W. 33rd St. New York

Pacific Coast Representatives
HENDER-SELTZER CO.

711 E. 14th St., Los Angeles—377 Brannan
St., San Francisco

For Better Radio
Hammarlund
PRECISION
PRODUCTS

The AIRGAP SOCKET

Specified and highly recommended
by Francis Churchill in short wave
and constant gain receivers

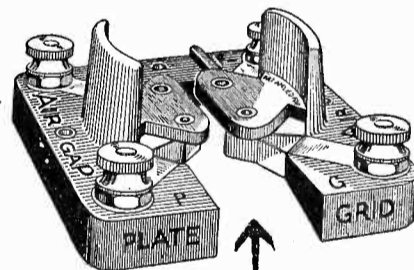

See that Gap

For Maximum Results

Install AIRGAPS. They prevent closed circuit, absorption of current, intercoupling of circuits, feedback and undesirable capacity. THEY MAKE ANY CIRCUIT more stable and sharpen tuning, resulting in purer and clearer tones with more volume particularly on distant stations.

At All Dealers or Direct
60c Each

AIRGAP PRODUCTS CO.
54 Clinton Street Newark, N. J.

"It gets that last mile"

Tell them that you saw it in RADIO

TOBE

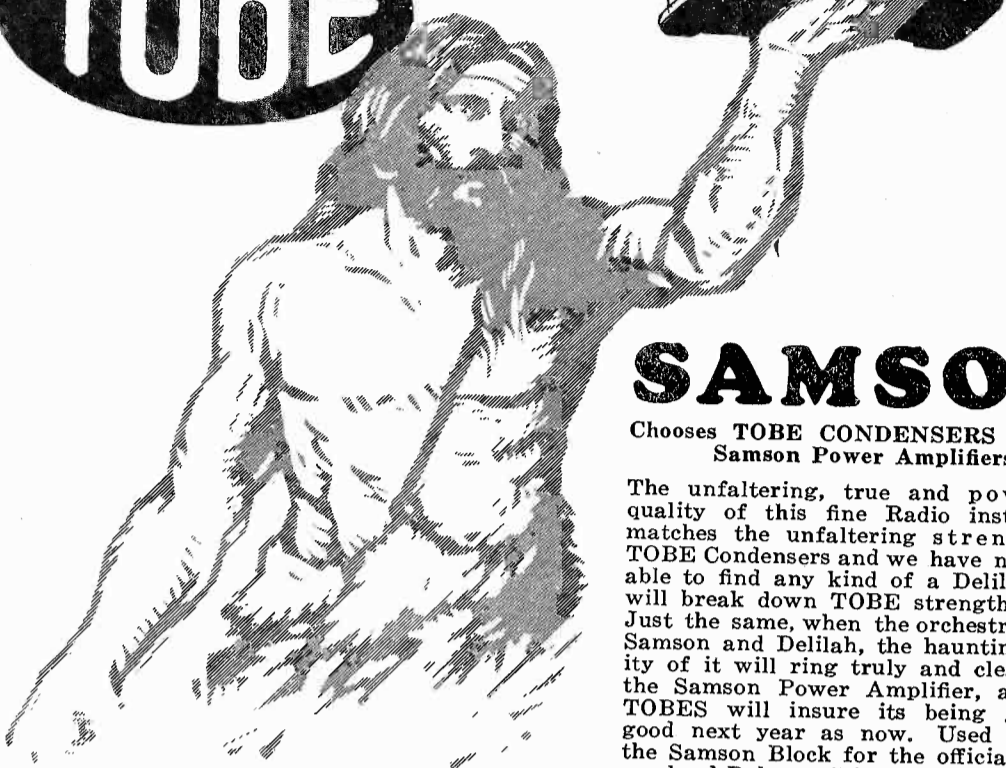

SAMSON

Chooses TOBE CONDENSERS for the Samson Power Amplifiers

The unflinching, true and powerful quality of this fine Radio instrument matches the unflinching strength of TOBE Condensers and we have not been able to find any kind of a Delilah that will break down TOBE strength. Just the same, when the orchestra plays Samson and Delilah, the haunting reality of it will ring truly and clearly on the Samson Power Amplifier, and the TOBES will insure its being just as good next year as now. Used also in the Samson Block for the official Hammarlund-Roberts Hi-Q.

- TOBE-SAMSON B BLOCK No. 713—using one 171 Power Tube
- TOBE-SAMSON B BLOCK No. 718—using two 171 Power Tubes in Push Pull
- TOBE-SAMSON B BLOCK No. 210—using two 210 Power Tubes in Push Pull
- TOBE-HAMMARLUND-ROBERTS OFFICIAL B BLOCK for Hi-Q Set

Write for TOBE Power Pamphlet with descriptions of Power Circuits and prices of TOBE B BLOCKS.

Tobe Deutschmann Company
Cambridge Mass.

former securely to the subpanel. It will be noted that the filter is crowded against the metal case of the second intermediate transformer and the core of the audio transformer, but it does not affect the operation of the transformer except to lower the gain about 10 per cent and lower the peak frequency approximately 1 kilocycle. No oscillation troubles are had with such crowded conditions, strange as it may seem.

The audio transformer is mounted to a piece of thin sheet brass, which is cut out to fit around the edge of the end bracket supporting the subpanel, so that the transformer is laid on its side when installed. As there is a small amount of space underneath the subpanel, near the front edge, the grid condenser and leak were mounted there. Between the detector and audio tube sockets, a .001 mfd. tiny fixed condenser was mounted, for the high frequency bypass in the

LIST OF PARTS

- 2—Remler No. 639 Straight Line Wavelength Condensers
- 2—Remler No. 636 Dials
- 2—General Radio No. 271 Transformers
- 1—Thordarson 2:1 Audio Transformer
- 1—Carter Midget Rheostat, 6 ohms
- 1—Carter HiOhm Variable Resistance, 50,000 ohms
- 1—Silver Marshall No. 340 Midget Condenser
- 1—Electrad Open Circuit Jack
- 1—Aerovox Type 1200 Bypass Condenser, 1 mfd.
- 1—Oscillator Coil—See text
- 1—Filter—See text
- 1—Remler No. 50 Socket
- 5—Northern Electric Peanut Tube Sockets
- 1—Tinytobe .001 mfd. Fixed Condenser
- 1—Tinytobe .006 mfd. Fixed Condenser
- 2—Sprague Midget Condensers, .00025 mfd.
- 1—Aerovox Type 1475 Grid Condenser, .00025 mfd., with clips
- 1—Aerovox Type 1450 Fixed Mica Condenser, .0002 mfd.
- 1—Lynch 2 megohm Grid Leak
- 2—Carter Type RU-20 Fixed Resistances
- 1—Bodine Type B-14 High Inductance Special Loop
- 1—Panel 5x8x3/16 in.
- 1—Subpanel 2 1/4x8x3/16 in.
- 2—Brass Brackets—See text
- Misc. screws, wire and brass strip

plate of the second detector. On the back edge of the subpanel, two 20 ohm tiny size fixed resistances are mounted, for the 99 tube filament circuit. This completes the apparatus assembly procedure with the exception of the tube sockets, which are mounted last. Looking at the pictures of the rear of the set, the tube on the right is the first detector, next is the oscillator, first i.f. amplifier tube, second i.f. amplifier, second detector and audio amplifier.

The actual wiring layout is shown in the pictorial diagram, Fig. 5, which, while distorted to show the wiring more clearly, will show where each connection is made.

The subpanel assembly is naturally made separate from the front panel job, and as much of the wiring as is possible should be completed before the two units are placed together. In this way all parts of the set are accessible and the builder does not have to tie himself up in a knot to solder some of the connections. For the filament, negative grid and positive B leads, flexible wire



New!

BRAIDITE Hook-Up Wire

"The Braid Snaps Back"



To make a soldered connection, it is not necessary with Braidite, to strip back the insulation. The braid is simply pushed back while the soldering is done and then replaced thus forming the neatest possible connection.

Braidite is made from either solid or stranded tinned copper wire covered first with a cotton wrap and then with a cotton braid. It is then impregnated with a damp proof compound making it impervious to moisture and adding to its insulating qualities. Made in red, green, yellow, brown and black.

- 25 Ft. Solid Copper Core..... 30c.
- 25 Ft. Stranded Copper Core..... 35c.

"Corwico" Radio Wires are sold by all leading dealers. Write for free booklet on radio wires and their uses.

"Corwico" Radio Wires

- Antenna Wire (Solid, Stranded and Braided)
- Complete Aerial Kits
- Magnet Wire
- Battery Cable
- Bus Bar Wire
- Hook-up Wire
- Lead-in Wire
- Annunciator Wire
- Loop Aerial Wire
- Litz Wire
- Flexible Wire

CORNISH WIRE COMPANY
30 CHURCH STREET NEW YORK CITY

was used, and No. 18 Celatsite for the high frequency leads, including grid and plate leads in the intermediate amplifier. The battery supply leads, which are the negative and positive *A*, and positive 45 volt *B*, are cabled in with the other wiring as far as a point at the bottom rear of the left hand bracket, looking at the set from the rear, at which point the wires run loosely to the terminal jacks of the cabinet. These three wires are made long enough so that the set can be removed from the cabinet and examined or repaired without unsoldering the wires from the terminal jacks.

The cabinet is made of redwood, and is covered with leatherette so as to resemble a camera finish. It has a hinged lid, and in the center of the lid is mounted a carrying handle. At each end is a snap clasp to hold the lid in place, and at the rear of the cabinet lid is a brass fitting for the loop antenna. This fitting was turned out of a piece of $\frac{3}{4}$ in. brass rod, drilled with a $\frac{1}{4}$ in. drill, and equipped with a flange. It is cemented in place with Ambroid glue or Dupont's household cement, and has a soldering lug screwed to the flange, for connection to the loop.

The loop antenna was designed for use with a .00035 mfd. variable condenser, and when used with a .0005 mfd. Remler, which has an extremely low minimum capacity, the loop will tune from 180 to 720 meters. This crowds the settings at the lower wavelengths, but makes the set very flexible as to wavelength bands, and can be used on the 600 or 706 meter ship waves without changing the loop or condenser dimensions.

The oscillator has been designed to cover the same band as the loop, and the .00025 mfd. fixed condensers are only used for waves from 720 to 1100 meters.

The loop has three binding posts for the terminals, when it comes from the factory, and these were removed. The two outside terminals of the loop were brought down through the brass shaft at the bottom, the shaft being drilled out with a 3/16 in. drill, so that two flexible wires project from the bottom of the loop, and are connected to terminals located on the cabinet lid. The brass shaft of the loop is made the center tap, and connection is made to the set through the brass bushing in the lid of the cabinet. If so large a loop is not wanted, a smaller one can easily be made, although the range of the set will be correspondingly decreased. The loop could also be mounted on a separate stand if the method shown in the pictures is not practical. The set is fastened in the cabinet by means of two machine screws which pass through the bottom of the cabinet and through tapped holes in the bottom of the brass

(Continued on page 78)

ALUMINUM

IN RADIO—A SIGN OF QUALITY

IN the fine sets of many of the leading manufacturers you will find that Aluminum is the prevailing metal for shielding, variable condensers and chasses.

The reason for the widespread preference for Aluminum is expressed in three characteristics which are possessed in combination only by Aluminum:

High Electrical Conductivity, Workability, Lightness

Added to these characteristics, Aluminum is impervious to common corrosion.

The exhaustive experiments of leading manufacturers that have proved the superiority of Aluminum are a guide to the layman in building or in buying.

Information on the subject of Aluminum in Radio will be sent on request. Write for the booklet, "Aluminum for Radio." It is sent without cost.

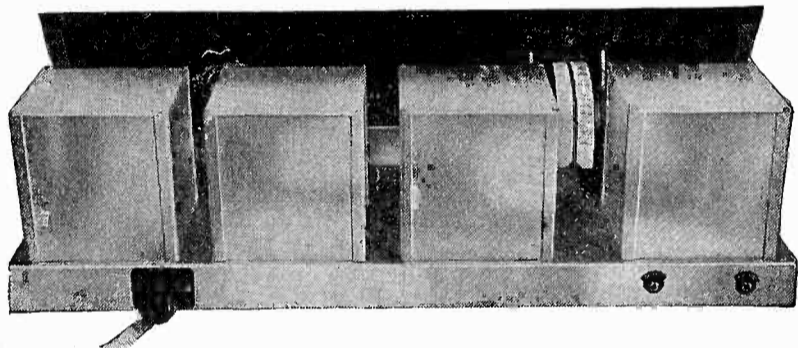

The Aluminum Co. of America manufacture the L.C. 28 Chassis-Sub Panel and the "Junior" Aluminum Box Shields specified for Cockaday's L.C.28



ALUMINUM COMPANY OF AMERICA

2463 Oliver Building, Pittsburgh, Pa.

Offices in 18 Principal American Cities

ALUMINUM IN EVERY COMMERCIAL FORM

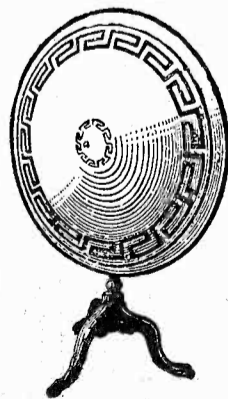

The New **POWERTONE 36" GIANT** Cone Speaker Kit (Double Edge)

A speaker of beauty, tone quality and has the characteristics of the higher priced speakers. Can be assembled in less than an hour.

The **POWERTONE** kit consists of:

- | | |
|-------------------------|--------------------|
| 1 POWERTONE UNIT | 1 Apex |
| 1 Designed Front Sheet | 1 Tube Cement |
| Fonotex Paper | 1 Set Screws, Nuts |
| 1 Back Sheet Paper | 1 Stand |
| 2 Metal Rings | Full Instructions |
| 1 Metal Bracket | |

\$12.00

Incl. Stand **FREE**

Powertone Cone Unit \$5.50

Dealers and Jobbers Write for Proposition

POWERTONE ELECTRIC CO.

218 FULTON ST., N. Y. C.

Tell them that you saw it in RADIO

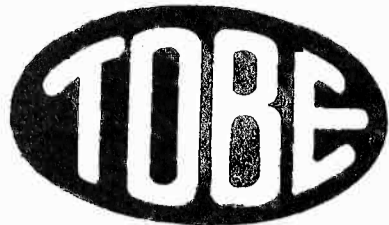

Trade Mark Reg. U. S. Pat. Office

And NOW...

The Infradyne

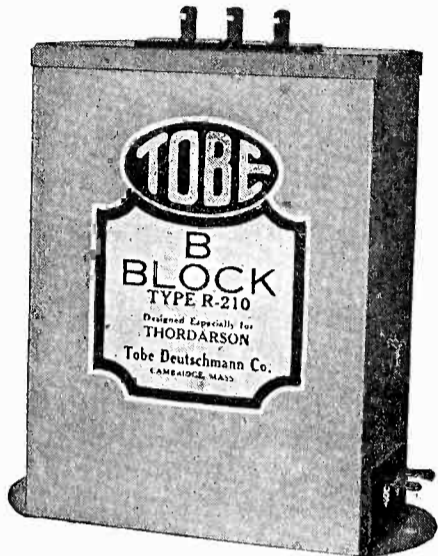

TOBE R-210

Surer than any other test of the true merit of a product is the place it holds in the esteem of men who know.

McMurdo Silver has chosen TOBE condensers above all others for use with the Silver-Marshall Unipac. He says they are "superior to all condensers tested." It is needless to point out that Silver and his engineers made exhaustive tests of ALL condensers before TOBE was finally selected.

The popularity of TOBE condensers and resistors is widespread. EVERY radio engineer and writer of any prominence has unstintingly endorsed TOBE products.

TOBE R-210 B Block enjoys the sole approval of the originators of the Infradyne for use with the Infradyne power unit.

8

TOBE condensers and resistors are always recommended by the following engineers and technical writers.

They have been approved for all the circuits mentioned.

- | | |
|--------------------|------------------------------------|
| Jas. Millen | Raytheon A-B-C 350 M. A. Rectifier |
| Keith Henney | QRS A-B-C 400 M. A. Rectifier |
| Volney Hurd | Silver-Marshall Unipac |
| Zeh Bouck | Thordarson 171 and 210 Compacts |
| Austin Lescarboura | AmerTran Power Pack |
| Joseph Calcaterra | Browning-Drake |
| Milton Sleeper | R. B. Lab. Receiver |
| Hollis De Neeffe | L. C.—27 |
| Wilmer S. Trinkle | Worlds Record Super |
| Stuart Rogers | Nine in Line Super |
| Larry Cockaday | Samson Super |
| McMurdo Silver | Infradyne |
| Lloyd C. Greene | Hammarlund-Roberts Hi-Q |
| Perry Graffam | Lincoln Super |
| Kendall Clough | |
| Glen Browning | |
| Gerald M. Best | |
| E. M. Sargent | |
| John C. Brennan | |

Tobe Deutschmann Co.

Cambridge

Mass.

RECTIFIERS

(Continued from page 32)

voltage $2E$ is placed across element B , and also D .

The reverse voltage, then, on a single-wave rectifier element working into a battery or filter is twice the maximum transformer voltage. The reverse voltage on an element of a full-wave rectifier of either the center-tap or bridge type, is the maximum transformer voltage from outside to outside terminal. If this reverse voltage is too great for a single element, as shown by the current-voltage characteristic, a sufficient number of elements may be placed in series.

The voltage drop in the rectifier when it is passing current in the forward direction, is shown by the characteristic.

For any given value of current it is the horizontal distance from that value, on the current axis, to the curve. If the drop increases greatly as the current is increased, a very unsatisfactory condition is had, especially in B eliminators. A two-tube receiving set would require comparatively little plate current, and if the internal drop in the eliminator were small at this current value, the output voltage would be very high. Now suppose an eight-tube set were supplied from the eliminator, and if the internal drop went up greatly, the plate voltage on the tubes would be low. The condition would be one in which the voltage from the B eliminator would vary tremendously, depending on how much current was being used.

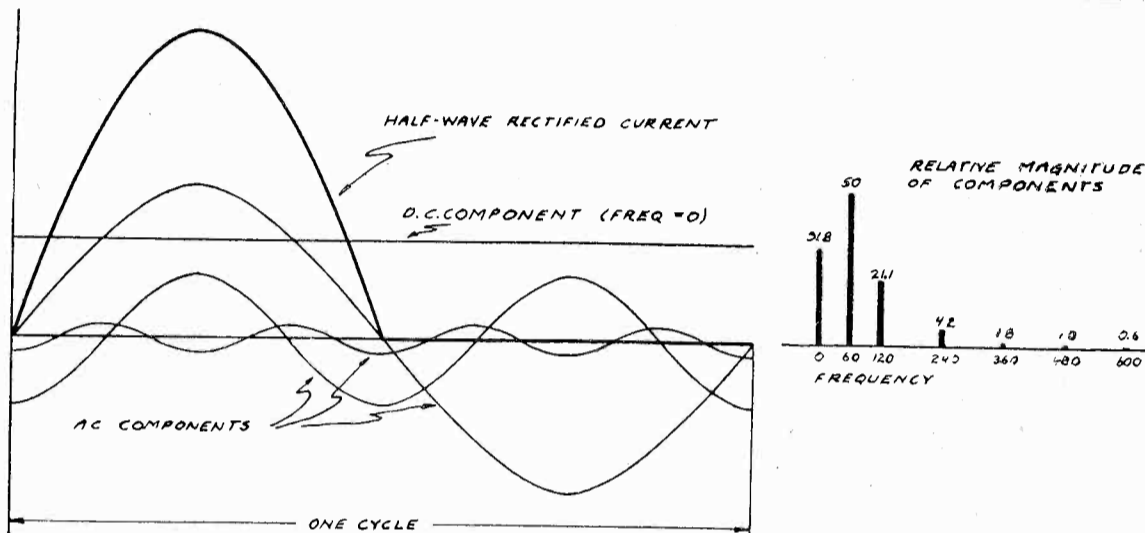

Fig. 4. Analysis of Half-Wave Rectified Current.

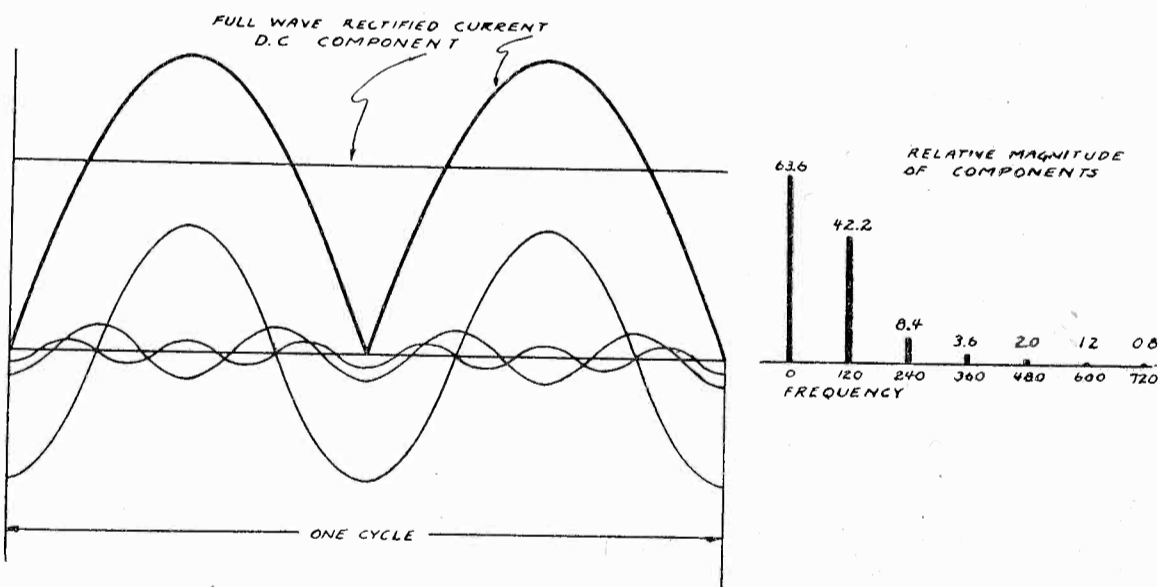

Fig. 5. Analysis of Full-Wave Rectified Current.

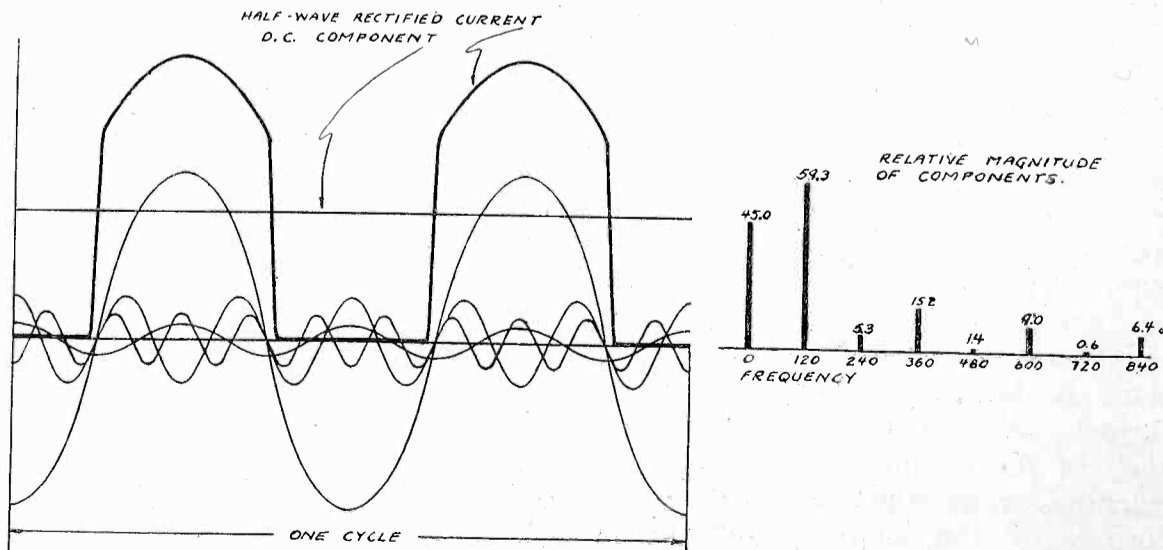

Fig. 6. Analysis of Distorted Half-Wave Rectified Current.

Tell them that you saw it in RADIO

On the current-voltage characteristic the area between the curve and the zero axes, over the range of current and voltage through which the rectifier is operated, represents the power loss per cycle in the rectifier; for it is voltage times current, or power. The operating current of the rectifier is limited by the heating of the element, which is in turn dependent on this power loss. The d.c. current-voltage characteristic thus forms a pretty good basis on which to compare rectifiers, insofar as their electrical characteristics are concerned.

When a half-wave rectifier cuts off the lower loop of current, the output is no longer the simple sine wave. The wave shape is that of the upper loop for half the cycle, then zero for the remaining half. Actually the wave is made up of a steady direct current, which would be indicated on a d.c. meter, and a flock of small sine waves of different amplitudes, or heights and frequencies. The frequencies do not vary promiscuously over the range, but each is an integral multiple of the original 60-cycle frequency. These sine waves are called harmonics of the original wave. They are drawn, with the d.c. component, in Fig. 4, for the case of the half-wave rectified current. If the vertical distances at any point are added up, with due regard to positive and negative values, they will be found to be equal to the curve of rectified current. The relative magnitudes of the direct current and the harmonics of different frequencies are indicated at the side of the wave shape.

The analysis for a full-wave rectified current is shown in Fig. 5. The components are not fictitious, but really exist in the circuit, and the rectified wave is a result of their combination. The function of a filter is to obliterate the alternating components and leave only the pure direct current. Obviously, the less the number and magnitude of the harmonics, the better will be the output from a rectifier-filter combination.

The a.c. voltage from the domestic supply is practically a pure sine wave. If the current-voltage characteristic of a rectifier during the conducting half-cycle is a straight line, starting from the zero point, then the half loop of current will also be a sine wave, for it will vary proportionally with the voltage. If the characteristic departs from a straight line, for a given change of voltage the current will change a disproportionately greater, or lesser, amount, so that its wave shape is distorted from the sine. The passage of reverse current will add to this distortion.

To illustrate the effect, we may take a case where the current-voltage characteristic is such that the rectifier does not pass current in the forward direction until the voltage has reached an appreciable value. The current will flow

(Continued on page 78)

Why CeCo Tubes Last Longer



CeCo Tubes are evacuated by an exclusive process developed by our engineers and the exceedingly high vacuum thus obtained is one important reason for the longer life of CeCo Tubes.

Thorough inspection of materials and parts, critical testing to highest standards assures uniform quality, steady performance, longer life.

There's a CeCo Tube for every radio need.

Ask your Radio Dealer for Complete CeCo Data Sheet

C. E. MFG. CO., Inc. PROVIDENCE, R. I., U. S. A.

CeCo

RADIO TUBES

Exclusive Method of Evacuating CeCo Tubes



Ward Leonard Vitrohm Resistors

Rated to carry 60 watts continuous duty

1100 ohms with taps of 400, 400 and 300 ohms
2600 ohms 7000 ohms

Your choice of any of these three sizes at

EXTRA SPECIAL PRICE OF 85 CENTS EACH

All of these Ward Leonard Heavy Duty, Vitrohm (vitreous enamel) Resistors are brand new, Size 4x1 in. They are absolutely permanent and accurate in value and are for use in your Eliminator, Transmitter and all kinds of electrical control work.

AMERICAN SALES CO., 21 WARREN STREET, NEW YORK CITY

SEND FOR FREE CATALOG

From Chicago's Oldest Radio Jobbers
The Most Valuable Radio Catalog

GREATER

BETTER

WRITE FOR YOUR COPY TODAY
SEE WHAT YOU SAVE

VALUES

New Kits Featured Include:

Aero—Bodine
Camfield—Citizens
H-F-L—Infradyne
Karas—Melo
Heald—Scott's
Silver Marshall
St. James—Tyrman
Etc.

Everything new and desired—all under one roof. You don't need to look elsewhere. Complete stock carried.

Est. 1918



Prompt Efficient Dependable Service



123-C South Wells Street

TELEPHONE MAINTENANCE CO.

Chicago, Illinois

CHICAGO'S OLDEST RADIO HOUSE

WHOLESALE ONLY

Tell them that you saw it in RADIO

RECTIFIERS

(Continued from page 77)

only when the voltage is higher than this value, and will be zero at other times. The case is not extreme, but is often approached in practice. The resulting wave of current will be like that of the heavy curve of Fig. 6. The analysis of the shape makes it apparent that the harmonics are greater in both number and magnitude than those of the current having the sine-wave loops. All the waves are drawn to have the same maximum value of current.

As long as the total power consumed by an a.c. to d.c. conversion unit runs less than 100 watts or so, the efficiency of the rectifier as a power device is not overly important. Even when the power consumption goes higher, there are usually other factors that enter more strongly in the comparison of rectifiers than does energy efficiency. The latter, then, can be pretty much neglected when dealing with rectifiers.

A TINY SUPERHET

(Continued from page 75)

brackets which support the subpanel.

After finishing the set, it is a very simple matter to test it and get it in operation. First connect the filament battery, and with an ammeter in the positive lead, adjust the filament current to .25 amperes by means of the 6 ohm rheostat, and observe the brilliancy of the filaments of the R-215-A tubes. If a voltmeter is handy, measure the voltage across the filament of the 99 tube and see that it does not exceed 3.3. Connect the negative *B* to the negative *A*, and before permanently connecting the positive *B*, temporarily insert a fixed resistance of 300 ohms or more, so as to prevent burning out the tubes in case of a short circuit. A 40 watt mazda lamp will do if other suitable resistors are not available. It is a good idea to have the resistance in the circuit at all times, connecting it permanently to the positive *B* battery at the battery itself. A Carter H-500 resistance will do very well for this purpose and occupies no more space than a stick of chewing gum.

The oscillator grid-pickup coil will probably have to be adjusted for best selectivity, and usually finds a normal position with the rotor about 45 de-

grees from minimum. The regeneration condenser at the left hand end of the panel should produce a great increase in volume, particularly on distant stations, as the capacity is cut in, and when advanced far enough, the first detector will oscillate and a loud squeal or hissing sound will be heard. When not in use this condenser should be left set at zero. Volume control is had by means of the 50,000 ohm variable resistor which is mounted in the center of the panel, directly in back of the oscillator coil. As the coil is practically on top of the resistance, the latter must be of very small size, the Carter being the most suitable.

If type 99 tubes are used throughout, the circuit shown in Fig. 1, Page 11 of May 1927 RADIO should be used, and the panel must be increased in size 5x13 in., while the subpanel will measure 2 $\frac{1}{4}$ x13 in. The sockets must be mounted on edge as is done with the 99 tube socket in the set using R-215-A tubes, or the panel must be increased in height to 7 in. With 99 tubes, the filaments are wired in parallel, and operated from a 4 $\frac{1}{2}$ volt dry cell bank.



No. 25 Console
List Price, \$70.00

Reg. U. S. Pat. Off.

Radio Speakers

Manf. by Borkman Radio Corp., Salt Lake City, Utah

The Year's Greatest Loud Speaker Values

Among the many new developments exhibited at the radio shows this fall, none created wider enthusiasm than these Velvet Speakers. Everyone agreed that here was truthful reproduction of broadcast sound, together with unobtrusive beauty of design.

The Velvet Console Speaker, with its nine foot air column horn, produces a tone of unbelievable richness. It is equipped with a double-stylus, balanced diaphragm Borkman Velvet Unit.

The Jewel Case model, already an established favorite, continues to gain in popularity every day. It has a 65 in. air column horn, which pours forth a surprising volume of perfectly pitched tone.

Progressive dealers in all parts of the country now have these and other Velvet Speakers in stock. If you are unable to locate the dealer in your community, write to our General Sales Office for information. Address—Borkman Radio Corp., 230 East Ohio Street, Chicago.



No. 21 Jewel Case
List Price, \$40.00

LIMITATIONS OF DISTORTION- LESS AMPLIFICATION

(Continued from page 40)

monics is the same as the fundamental frequency. The 27 cycle piano string emits energy at 108, 135, 162 and many higher frequencies. The difference between 108 and 135 is 27. The ear detects this 27 just as the detector of a superheterodyne picks out the beat frequency. The beat between 135 and 162 adds to this effect, and so on up. The result is that we experience a powerful

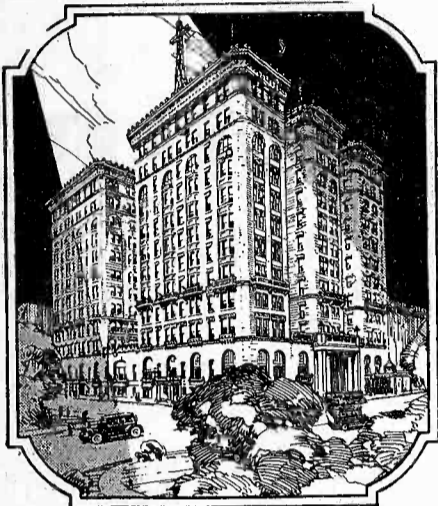

Live

Where uptown and
downtown meet

That's what everyone would like to do—combine country quiet with Broadway activities.

And that's exactly what this hotel offers you.

The serenity of Central Park; where two of New York's most desirable thoroughfares meet. Central Park West and 72nd Street, —and yet just 10 minutes from leading shops and theatres.

Appointments, service, cuisine unexcelled, in keeping with its international reputation.

Booklet sent free on request
on New York and Hotel Majestic

Opeland Danseub

Proprietor

Majestic Hotel and RESTAURANTS

Two W. 72nd St., New York

Entire Block Fronting Central Park

General Headquarters:

New York Automobile Club

The Majestic Hotel, Central Park West
at 72nd Street, New York City.
Without obligating me, please send me free
Booklet on New York and Hotel Majestic.

Name.....

Address.....

Radio 11-27

27 cycle sensation, even though there may be no actual 27 cycle wave for us to "hear," it having all been filtered out by amplifiers and loud speaker.

If you have any doubts about this, arrange to hear a good piano solo on an "orthophonic," Rachmaninoff "Prelude" for instance. Wonderful isn't it? The bass goes 'way down near the grass roots, and thence up your spine, with appropriate shivers. But if that record is playing on the larger model instrument, the lowest note you get at anything like full value is 115 cycles, and on the smaller models is higher than that.

Most cone speakers have a cut-off well above 100 cycles. A small free edge cone needs a baffle board 32 in. in diameter to pass a 100 cycle note. Will you give one with a 64 in. baffle board house room in order to hear 50 cycles? Then how about a 16 ft. baffle and a 32 cycle cut-off? It is easier to cut a hole in the wall of the room and mount the cone there. We probably shall see that done as time goes on, at that.

But even if the speaker does cut off these low frequencies, why not over-amplify them to compensate for the inefficiency of the speaker and allow the ear to get at least a partial sensation from them?

The answer is again in the limited power the tube can handle without overloading. As has been shown, these low notes carry enormous energy, but it has little effect on the ear and even less on the loud speaker. It is quite conceivable that the amplifier might be overloaded at 60 cycles and the note barely perceptible with close attention. If we superpose on this a note in the treble, with the amplifier already overloaded, we get the usual nerve shattering result, even though the high note itself is of very moderate strength.

The point of all this is not that the notes outside of the 100-5000 bands are not audible. They are. Or that they do not add to the richness and brilliancy of the music—they do. The lack of these notes is, in a very real sense, distortion. But unless you are using an output tube much larger than is customary, together with a most extraordinary speaker, you will get better and more natural results by confining the pass of your amplifier within given definite limits.

The function of the low cut-off being to prevent the low tones reaching the last tube, it should be embodied in the amplifier. The high cut-off, on the other hand, is to eliminate unpleasant tones introduced by the last tube. This should therefore, take place between the last tube and the reproducer.

RADIOADS

8 8 8

A Classified Advertising Section
Read by Better Buyers.

8 8 8

The rate per word is eight cents net.
Remittance must accompany all advertisements.
Include name and address when counting words.

8 8 8

Ads for the December Issue Must
Reach Us by November Fifth

SALESMAN—Calling on the radio trade to sell **ORTHOCONES** Speakers—nationally famed for their wonderful tonal qualities. Low price, liberal discounts to dealers. Big commissions. An unusual money-making opportunity for you. Sample furnished. References required. Write immediately to Orthocone Speaker Co., 2728 St. George Court, Chicago, Ill.

LATEST three tube circuit and construction data, 25c. Good quality, performance. Radioman, 4528 Adams Street, Chicago.

LOG-CHART YOUR RADIO—By the newest, and simplest way. Absolutely no writing of call letters, wavelength or dial numbers—A MERE DOT locates that station as received on your radio. Stations from all parts of the world. Includes outline map of the United States. Priced at 25c. Dearie Radio Laboratory, 505 Madison Square Bldg., Chicago; or 229 Whittemore, Pontiac, Michigan.

DO YOU GET TIRED of buying "B" batteries? A lifetime Edison will solve your troubles. Good, live, large size element connected with pure nickel wire, electrically welded, 7c pair. All parts for sale. Sample cell and dope sheet, 10c. Paul Mills, Woodburn, Oregon.

BACK ISSUES of "RADIO," perfect condition. Early or late issues. 65c postpaid (no checks). Speedy service. R. M. Harris, Grimes, Calif.

AMERTRAN POWER KIT—These parts have been used but are perfect. PF52 Transformer, 3-854 Chokes, 4-4MFD 1000 Volt Sangamo Condensers, DeLuxe second stage Audio, 316B Tube, 400 Resistor. For quick sale \$30 for lot. Madison-Moore One Spot Transformers, set \$20. J. W. Howlett, Santa Paula, Cal.

RADIO AGENTS—Make Big Money—Easy! Selling Marvelous New Sets and accessories. Buy from factory at lowest prices. Get New Catalog with thousands of nationally advertised bargains. FREE Call Book. Write today. American Auto and Radio Co., Dept. 148, American Radio Bldg., Kansas City, Mo. (3T)

MOTOR GENERATORS—Generators and motor-generators of various sizes, suitable for radio service on hand. New and second hand. Dynamos, 500 cycle alternators, separately excited and self-excited in all sizes from ¼ K.W. to 5 K.W. Prices reasonable. Special machines built up to order. Several machines with gas-engine drive; fine for portable service. Write for prices and full particulars. D. B. McGown, 435 Pacific Bldg., San Francisco, Cal.

PRESS AND PUBLIC concede it to be the best ever produced. "Radio Theory and Operating" by Mary Texanna Loomis, member Institute of Radio Engineers, lecturer on theory of radio, Loomis Radio College. Thorough text and reference book; 886 pages, 700 illustrations, handsome, flexible binding. Price \$3.50, postage paid. Used by Radio Schools, Technical Colleges, Universities, Government Schools, Department of Commerce and Engineers. At bookdealers, or sent on receipt of check or money order to Loomis Publishing Company, Dept. X, 405 9th St., Washington, D. C.

BACK ISSUES of "RADIO," perfect condition, early or late copies. 75c stamps or coin, postpaid. Speedy service. R. M. Harris, Grimes, Calif.

Tell them that you saw it in RADIO

Having had a musical education, I had definitely high ideals about tone quality in a reproducer. To say that the G.R.P. 3-ft. Cone Speaker meets my ideal is the highest compliment that I can pay it. That my clumsy, inexperienced hands could assemble it perfectly is a tribute to its simplicity of construction.

Never have heard its equal; never expect to hear its superior.

No one seeing my G.R.P. 3-ft. Cone Speaker will believe that I built it myself. And they cannot believe that a speaker having such wonderful tone quality costs so little.

Expressions such as these are to be heard everywhere. G.R.P. 3-ft. Cone Speakers arouse enthusiasm because they create a new standard of tone quality. Bring complete, enjoyable reproduction within everyone's reach.

Such wonderful tone quality as comes from the G.R.P. 3-ft. Cone Speaker is a challenge to perfection. I cannot imagine anything better, more natural or complete in range from low to high.

With your new Back Ring and Back Cone Design you have created a speaker which the most inexperienced person can build with confidence that the result will be delightful.

Your G.R.P. 3-ft. Cone Speaker is as near perfection as I imagine a radio reproducer can be. You have contributed a wonderful instrument to radio and your simple method of assembly makes it a pleasure to build.

My ideas of how good a speaker can be and of how enjoyable radio reception can be made have been entirely changed by the G.R.P. 3-ft. Cone Speaker.

And as for Tone Quality, after having heard nearly all the new speakers, I am more enthusiastic than ever about G.R.P.

Your G.R.P. 3-ft. Cone Speaker needs to be heard to be appreciated. Comparison with high priced speakers, supposed to be the best, serves but to emphasize the quality of yours... The most astonishing thing about it is that such wonderful tone quality can be enjoyed for such a small outlay of money. I wouldn't have believed it if I didn't know it to be so.

Now I know how fine reproduction can be. G.R.P. 3-ft Cone Speaker has shown me.

G.R.P. BACK RING

(PAT. PENDING)



and exclusive

G.R.P. BACK CONE

Design

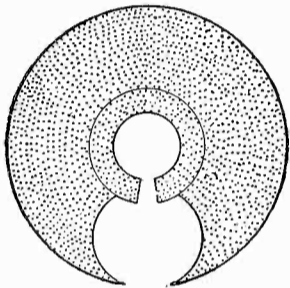

simplify cone speaker building wonderfully; no cones to form—they shape themselves; the complete speaker is assembled FLAT!

Simple, complete, illustrated
Directions for Assembling



and clearly, accurately marked
sheets of genuine FONOTEX

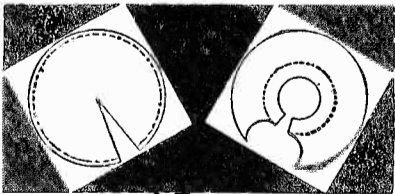

for Front and Back Cones enable ANY-ONE to assemble a perfect G.R.P. 3-ft. Cone Speaker, even if you never have made anything before. G.R.P. Simplified Method of Assembling is your assurance of success and satisfaction.

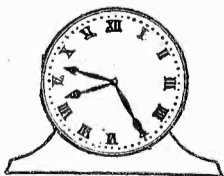

One Hour
from KIT
to Reception



G·R·P
3 FOOT
CONE SPEAKER
Build It Yourself

Easiest to Build
of any 3-ft. Double Cone Speaker

The finest radio reproducer that you can own is now the easiest to assemble.

G.R.P. Back Ring and G.R.P. Back Cone Design have completely revolutionized home construction of 3-ft. DOUBLE Cone Speakers. G.R.P. simplified method of assembling makes experts of novices—enable anyone without experience to assemble a perfect 3-ft. DOUBLE Cone Speaker quickly.

Never Before So Wonderful A Speaker

Radio experts, musicians and laymen who have heard the G.R.P. 3-ft. DOUBLE Cone Speaker were amazed at its wonderfully rich, sweet and accurate reproduction. Never, they said, had they heard anything that sounded so natural that it was not radio but a true duplicate of the original itself.

If that is what YOU want in radio reproduction you can have it with a G.R.P. 3-ft. DOUBLE Cone Speaker. Improves repro-

duction from any set because it gives you the best that is in the receiver.

Build Yours Now!

If you've hesitated about assembling your 3-ft. cone speaker remember that the G.R.P. simplified method of assembling makes an expert of you.

You CAN do the job perfectly. Anyone can. Assembling a G.R.P. 3-ft. DOUBLE Cone Speaker is simplicity itself. And this really fine loud speaker cost no more than a low-priced speaker.

Ask Your Dealer

Reliable radio dealers everywhere have or

can get genuine G.R.P. 3-ft. Cone Speaker Kits. If your dealer hasn't them and will not get them for you, we will ship direct, f.o.b. N. Y. C., on receipt of price. You need not be content with less than G.R.P. Quality and G.R.P. ease of assembly.

Write for "How to Build Seven Practical 3-ft. Cone Speakers," by C. Denton. Regular price 50c; for limited time sent for only 10c, coin or stamps.

No. 3 G.R.P. Kit for
3-ft. DOUBLE Cone

Absolutely complete in every particular including G.R.P. Unit. **\$13.50**
Nothing else to buy

Slightly more in Far West and Canada

No. 4 G.R.P. Kit for
3-ft. SINGLE Cone

Most complete, lowest priced wall type Single Cone Kit; finest tone quality... **\$10.50**

PENN RADIO SALES COMPANY, Exclusive Selling Agents for

G. R. P. PRODUCTS CO., Inc.

104 Fifth Avenue

Suite 2700

New York City

Pacific Coast Distributors: Herbert H. Horn Co., Los Angeles, Calif.

The Wedel Co., Seattle, Wash.

Offenbach Electric Co., San Francisco, Calif.

Push! — Pull!

AMPLIFICATION for Quality and Volume

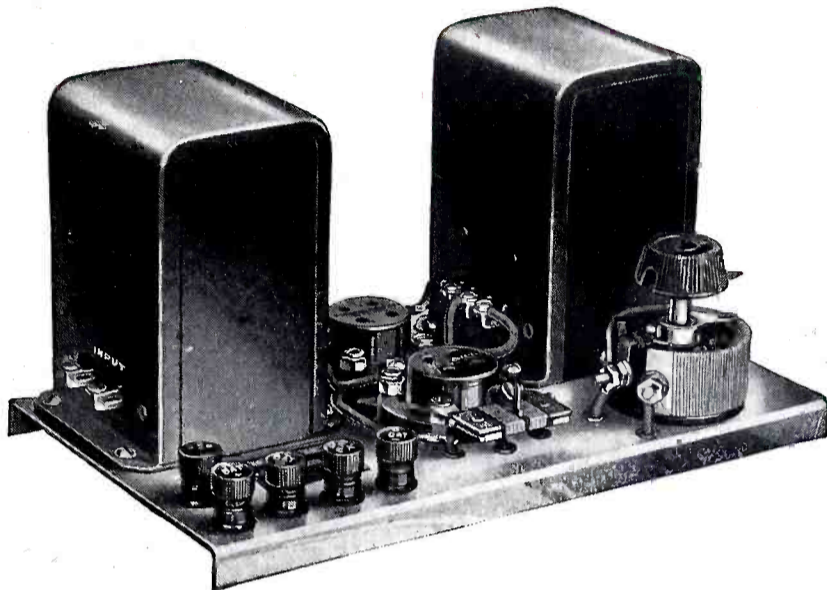

In a search for an amplifier combination which would give the maximum in quality and volume, the push-pull method has proved particularly satisfactory.

While push-pull transformer coupling does not increase the amplification per stage, the maximum undistorted power output is greatly increased. The reason for this is that distortion due to tube overloading cancels out, permitting a greater output from each tube than would be possible if the tubes were used as in other methods of coupling. A further advantage of push-pull amplification when using an A. C. filament supply is that hum voltages also cancel out, rendering the amplifier very quiet.

The type 441 unit with two type 171 power tubes having a plate voltage of 180 will give more volume and better quality than a single transformer coupled stage using the type 210 power tube with 400 volts on the plate.

The General Radio Type 441 unit is completely wired and mounted (as illustrated) on a brass base-board with conveniently located binding posts so that the unit may be built into a receiver or connected with an existing set as a separate unit.

The type 441 may be used with either the UX-226, UX-326, or UX-171, CX-371 tubes.

Type 441 Push-pull Amplifier.....\$20.00

The type 441 unit is licensed by the Radio Corporation of America for radio amateur, experimental, and broadcasting reception only, and under the terms of the R. C. A. license the unit may be sold only with tubes.

Type UX-226 or CX-326 Amplifier Tube.....\$3.00

Type UX-171 or CX-371 Amplifier Tube.....4.50

GENERAL RADIO COMPANY, Cambridge, Mass.

GENERAL RADIO

Parts and Accessories

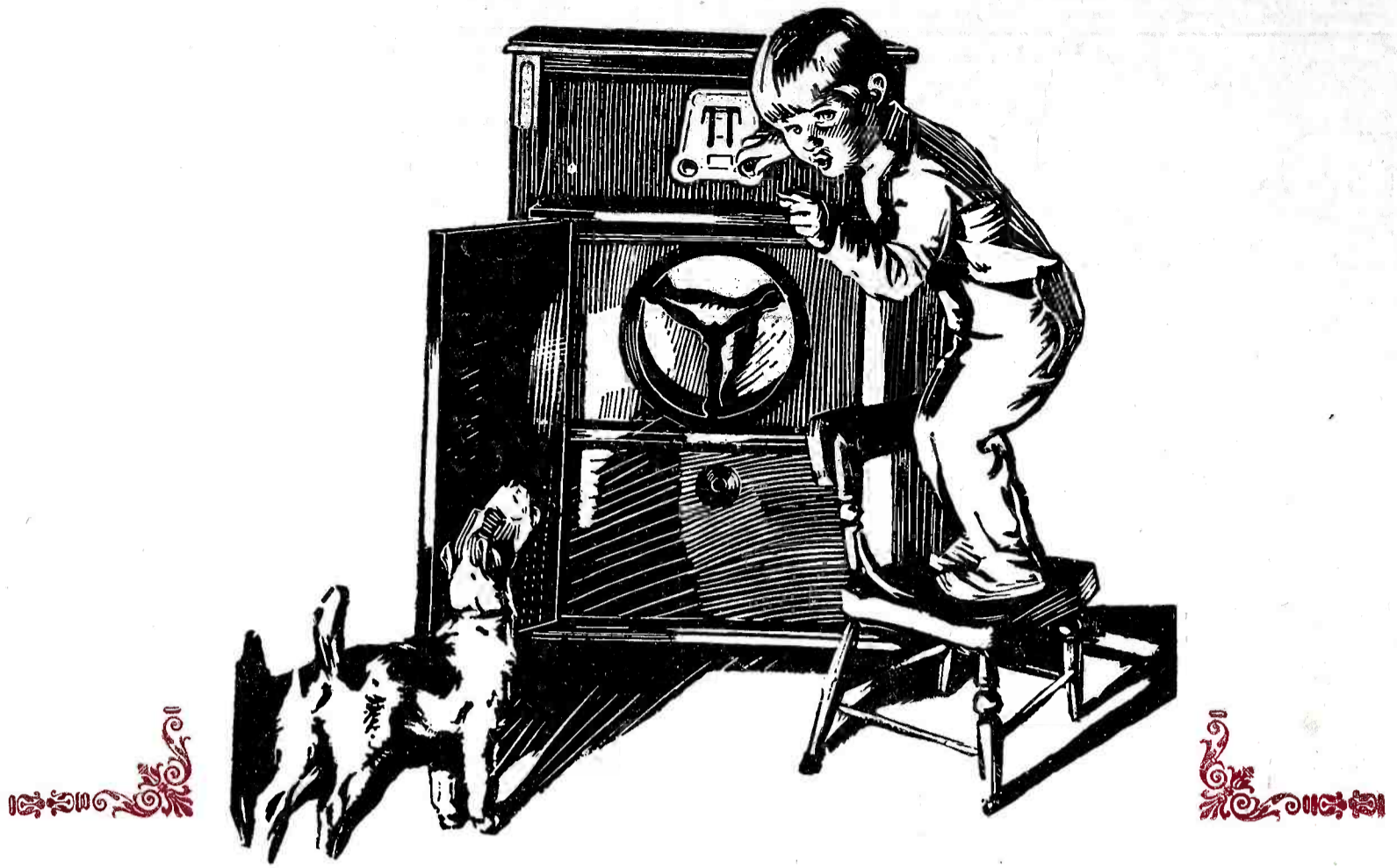

THE *New* FRESHMAN
ELECTRIC
RADIO

acids } **NO** } water
 trouble } } excuses
 batteries } } makeshifts

Always Ready... Always Right

The cabinet panelled entirely of genuine mahogany, contains a large cone speaker mounted on a Baffle Board, which is placed in a remarkably resonant tone chamber, rendering exceptionally fine tone quality and "true-to-life" reproduction.

FRESHMAN
EQUAPHASE

Plug in Your Light Socket and Listen
\$185.00
 COMPLETE READY TO OPERATE

A Freshman development—licensed under patents; R C A—General Electric Co.,—Westinghouse Electric & Mfg. Co. and American Tel. & Tel. Co.

CHAS. FRESHMAN CO., Inc., Freshman Building, New York
 800 NORTH SPRING ST., LOS ANGELES