

SEPTEMBER, 1927

25 CENTS

RADIO

(REG. U. S. PATENT OFF.)

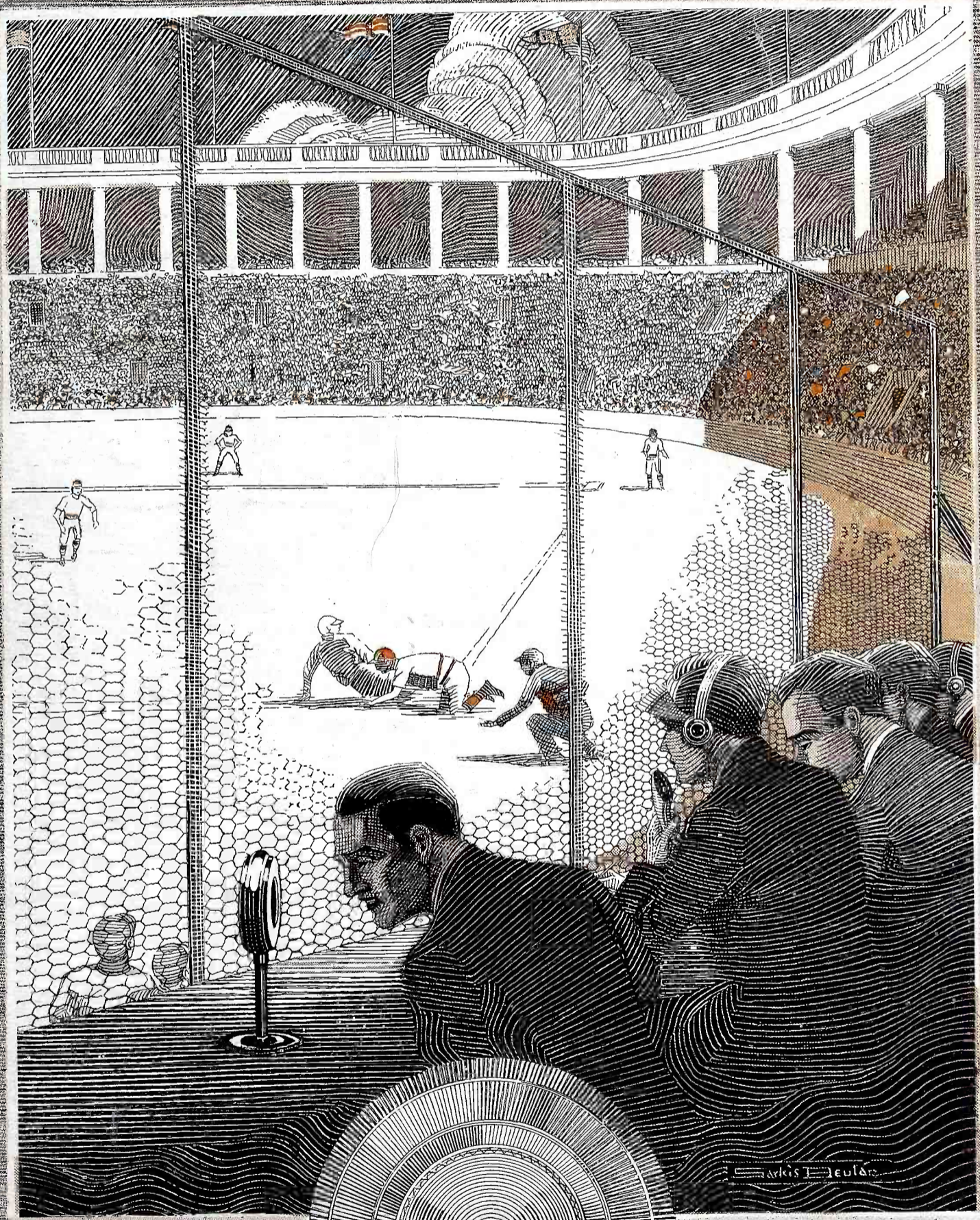

**IN THIS
ISSUE**

**The Magnaformer 9-8 Circuit R. F.
Amplifier Tuner—Radio Television**

Cunningham RADIO TUBES

Since 1915
Standard for all sets

are built in one of
the greatest radio
research laborato-
ries the world has
ever known.—

Every process and material used in their manufacture has been developed in or passed the exacting tests of this world-renowned research organization. That is the secret of the in-built quality of Cunningham Radio Tubes.

A hidden yet ever-present integrity, twelve years of constant striving for a better and still better product, and always the ideal of "Quality First"—these combine to create value, an assurance of trouble-free radio reception.

There is a special purpose Cunningham Radio Tube for every radio and power supply use. Consult your radio dealer. He will tell you the best combination of Cunningham Radio Tubes to use for your particular set.

E. T. CUNNINGHAM, INC.

New York

Chicago

San Francisco

CUNNINGHAM
RADIO
TUBES

FAIS

Tower

Presents

New Startling

1927-28 SPEAKER VALUES

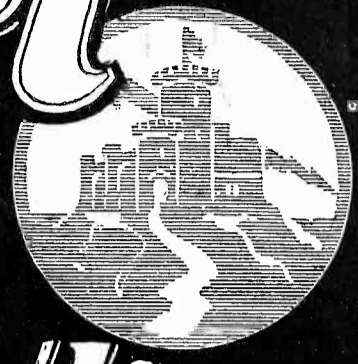

COMPLETELY revolutionizing present day standards, TOWER offers these five new, brilliantly conceived and executed cones. Select no speaker until you see them!



MODEL "28" \$1750

Suggestive of the days of chivalry with elaborate heraldic grill and armature type unit. Superb volume and tone quality.

No matter what design meets your fancy—sailing ship or medieval castle, popular drum or octagonal cone — there's a TOWER Speaker of highest quality to delight both the eye and ear.

See your dealer or write us for illustrated circular.



Adventurer \$950

A genuine sailing ship model cast in bas-relief with bright natural colorings. Armature unit. WEST OF DES MOINES, IA., \$10.50

TOWER MFG. CORP.
124 Brookline Ave., Boston

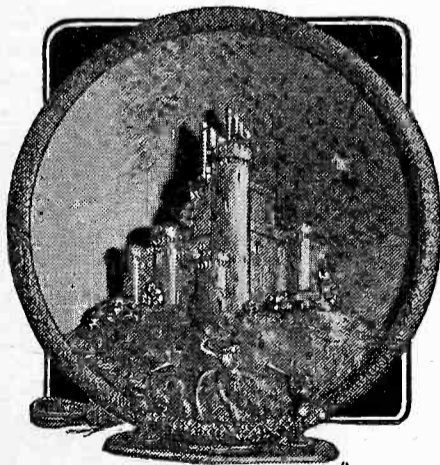

Castle Cone \$950

A creative work of art finished in two-toned bronze. Employs powerful new type armature unit for power tube amplification. WEST OF DES MOINES, IA., \$10.50

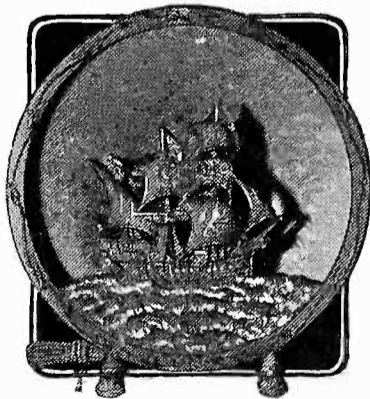

Pirate Ship \$795

The most amazing cone on the market! A fine old PIRATE SHIP with exceptional reproducing qualities. The utmost in eye and ear value. WEST OF DES MOINES, IA., \$8.75

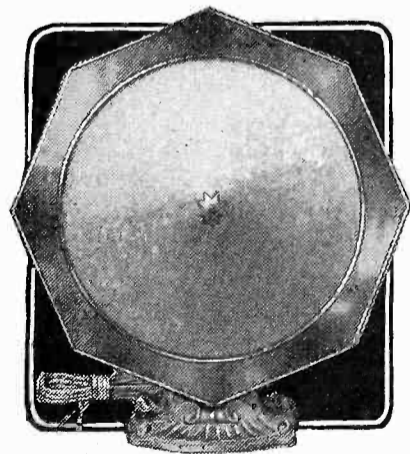

Meistersinger \$15-

America's most beautiful cone! Both a wall and table model with new armature type unit for power tubes. Mahogany finished frame. Art Metal Base.

Over Two Million Tower Products now in use!

Tell them that you saw it in RADIO

RADIO

With Which Is Incorporated "Radio Journal"

Established 1917

Published Monthly by the Pacific Radio Publishing Co.

ARTHUR H. HALLORAN,

Editor

GERALD M. BEST,

Technical Editor

H. W. DICKOW,

Business Manager

A. I. RIVETT,

Draughtsman

Branch Offices:

New York City, 20 East 42nd St.
Chicago, 307 N. Michigan Ave.
Boston, 86 St. Botolph St.
Kansas City, Mo., Davies & Dil-
lon, 707 Land Bank Bldg.

Rates:

Issued Monthly, 25c a copy.
Subscription price, \$2.50 per year
in the U. S., \$3.00 per year else-
where.

Correct Addresses:

Instructions for change of address
should be sent to the publisher
two weeks before the date they
are to go into effect. Each old
and new address must always be
given.

Advertising:

Advertising Forms Close on the
First of the Month Preceding
Date of Issue.

Member Radio Magazine Publishers' Association
Entered as second-class matter at Post Office at San Francisco, Calif.
Copyright 1927 by the Pacific Radio Publishing Co.

Address all communications to

Pacific Radio Publishing Company

Pacific Building, San Francisco, California

VOLUME IX

SEPTEMBER, 1927

NUMBER 9

Forecast of Contributions for October Issue

G. M. Best describes how to build an ABC socket power device to operate the Magna-former receiver whose construction is described in September RADIO.

—:—

C. J. Penther tells how to make your own phonograph pick-up unit from a Baldwin phone unit.

—:—

Edward T. Jones details the construction and use of a portable testing set that gives a visible record of tests of sealed Radiola catacombs and of other factory built sets. This should be a boon to the service man.

—:—

Prof. W. C. Osterbrock has devised an ingenious chart for determining great circle distances. This should prove invaluable to amateur and commercial operators as well as to all who are interested in knowing the correct distance between any two points on the earth's surface.

—:—

Hugo E. Anderson discusses 40 and 20 meter antenna systems.

—:—

Charles F. Felstead gives a popular exposition of the radio ground question, presenting many facts that will interest the novice.

—:—

Samuel G. McMeen, in continuing his series on Experimental Shop Practice, gives directions for coloring and finishing metals, together with some useful kinks on metal working.

—:—

In "Servicing The Installed Set" B. F. McNamee presents the first of a series of a dozen or more articles dealing with systematized trouble shooting. These constitute a veritable manual of instructions.

—:—

Francis Churchill describes the construction and operation of a new constant gain receiver which he has devised. This is a modified five-tube set that gives constant amplification throughout the entire broadcast band. He also gives the results of his successful experience with a 5 meter receiver as used at 6AJF.

—:—

5-meter reception is further treated by A. Binneweg, Jr., 6BX, in his account of wavemeter calibration for this wavelength.

—:—

The amateur transmitter should furthermore be interested in C. K. Stedman's description of an improved capacity microphone.

—:—

In addition to the usual material published by P. S. Lucas in the Commercial Brasspounder Department, Micky Doran starts the first of a useful series of Marine Radio Notes covering the North Pacific and Oriental waters.

—:—

G. V. Willetts in his story on "Direct Communication" gives a humorous insight into the life of a commercial operator. Simpleton Fitts, whose identity is disclosed elsewhere in these columns, pokes a little fun at radio amplification, or rather radio exaggeration.

—:—

The fiction feature is a radio detective story by Paul Oard.

CONTENTS

	PAGE
RADIOTORIAL COMMENT: STABILIZATION OF THE RADIO INDUSTRY BY PATENT CONTROL.....	13
RADIO TELEVISION	14
<i>By Arthur Hobart</i>	
THE MAGNAFORMER 9-8	16
<i>By G. M. Best</i>	
HANDY HINTS	18
ANENT STORAGE "A" BATTERIES.....	20
<i>By Charles F. Felstead</i>	
THE MYSTERIOUS MR. HANKINS.....	21
<i>By Volney G. Mathison</i>	
REMOTE CONTROL BY RADIO.....	23
<i>By G. F. Lampkin</i>	
A SELECTIVE R. F. AMPLIFIER TUNER.....	25
<i>By G. M. Best</i>	
THE IMPROVED IMPEDANCE EQUALIZED RECEIVER.....	26
<i>By Francis Churchill</i>	
EXPERIMENTAL SHOP PRACTICE	27
<i>By Samuel G. McMeen</i>	
RADIO GUIDANCE FOR AIR PLANES.....	28
A PRACTICAL WAVEMETER FOR THE B. C. L.....	29
<i>By B. F. McNamee</i>	
EVOLUTION OF MARINE RADIO.....	30
QUERIES AND REPLIES	31
BOOK REVIEWS	32
THE COMMERCIAL BRASSPOUNDER	33
<i>By P. S. Lucas</i>	
CLICKLESS HIGH POWER D. C. TRANSMITTER.....	35
<i>By Don C. Wallace</i>	
PRACTICAL HINTS FOR RADIO AMATEUR TELEPHONY.....	36
<i>By G. M. Best</i>	
SOME OF THE NEW FACTORY BUILT RECEIVERS.....	38
THE AERO-SEVEN BROADCAST RECEIVER.....	39
<i>By Zeh Bouck</i>	
THE SEA-GOING OPERATOR	63
<i>By M. R. Upton</i>	

8BIT

**30
DAYS
FREE
TRIAL**

7 Tube Set Single Dial Radio



**Metrodyne
Radio Sets**
Are Equipped
For
**BATTERY or
ELECTRIC**
operation

The **Metrodyne**
ONLY ONE DIAL TO TUNE

RETAIL PRICE
\$75⁰⁰
Completely Assembled
Big Discounts to
Agents and Dealers

Wonderful offer direct from the factory! The world's greatest radio! A perfect working, single dial control, 7 tube receiver! And just to prove our claims, we will ship it to your home for 30 days' free trial. Test it under all conditions. Test it for distance, volume and tonal quality—and if you are not convinced that it is the best single dial set you ever heard, return it to the factory. We don't want your money unless you are completely satisfied.

Three Year Guarantee

**BIG PROFITS
TO AGENTS AND DEALERS**
Our Agents and Dealers make big money selling Metrodyne Sets. You can work all or part time. Demonstrate the superiority of Metrodynes right in your home. Metrodyne Radios have no competition. Lowest wholesale prices. Demonstrating set on 30 days' free trial. Greatest money-making opportunity. Send coupon, a letter or a postal for our agent's proposition.

Metrodyne Super-Seven Radio

A single dial control, 7 tube, tuned radio frequency set. **Tested and approved by Popular Science Institute of Standards, Popular Radio Laboratory, Radio News Laboratory and by America's leading Radio Engineers.** Designed and built by radio experts. Only the highest quality low loss parts are used. Magnificent, two-tone walnut cabinet with beautiful, gilt metal trimmings. Very newest 1928 model, embodying all the latest refinements.

Easiest set to operate. Only one small knob tunes in all stations. The dial is electrically lighted so that you can log stations in the dark. The volume control regulates the reception from a faint whisper to thunderous volume, **1,000 to 3,000 miles on loud speaker!** The Metrodyne Super-Seven is a beautiful and efficient receiver, and we are so sure that you will be delighted with it, that we make this liberal **30 days' free trial offer.** You to be the judge.



30 Days' Free Trial—3 Year Guarantee

Metrodyne Super-Six

Another triumph in radio. Here's the new 1928 model Metrodyne 6 tube, two dial, long distance tuned radio frequency receiving set. Approved by leading radio engineers of America. Highest grade low loss parts, completely assembled in a beautiful walnut cabinet. Easy to operate. Dials easily logged. Tune in your favorite station on same dial readings every time — no guessing.

Mr. Howard, of Chicago, said: "While five Chicago broadcasting stations were on the air I tuned in seventeen out-of-town stations, including New York and San Francisco, on my loud speaker horn, very loud and clear, as though they were all in Chicago."

We are one of the pioneers of radio. The success of Metrodyne sets is due to our liberal 30 days' free trial offer, which gives you the opportunity of trying before buying. Thousands of Metrodynes have been bought on our liberal free trial basis.

METRO ELECTRIC COMPANY

2161-71 N. California Ave. • Dept. 11 • Chicago, Illinois

**6
Tube Set**
\$48⁵⁰
RETAIL PRICE
Completely
Assembled

**MAIL THIS
COUPON**
or send a postal or letter. Get our
proposition before buying a radio.
Deal direct with manufacturer—
SAVE MONEY—WRITE NOW!

MAIL COUPON BELOW

Let us send you proof of Metrodyne quality—our
30 days' free trial offer and 3 year guarantee

Mrs. Wm. Leffingwell, Westfield, N. J., writes: "The Metrodyne Radio I bought of you is a wow! This is as good as any \$225 machine I have ever seen."

N. M. Greene, Maywood, Ill., writes: "My time is up and the Metrodyne works fine. I got Havana, Cuba, Oakland, Calif., Denver, Colo., Toronto, Canada, all on the loud speaker."

J. W. Woods, Leadville, Colo., writes: "Received the 7-tube Metrodyne in fine condition. Had it up and working same day received. Was soon listening to Los Angeles, San Diego, Oakland and other California points; also St. Louis, Kansas City and other east and south stations—all coming in fine. Am more than pleased. Sure enjoying it."

We will send you hundreds of similar letters from owners who acclaim the Metrodyne as the greatest radio set in the world. A postal, letter or the coupon brings complete information, testimonials, wholesale prices, and our liberal **30 days' free trial offer.**

METRO ELECTRIC COMPANY
2161-71 N. California Ave., Dept. 11
Chicago, Illinois

Gentlemen:

Send me full particulars about Metrodyne 6 tube and 7 tube sets and your **30 days' free trial offer.**

Name.....

Address.....

If you are interested in AGENT'S proposition, place an "X" in the square

Tell them that you saw it in RADIO

REMLER

RADIO PARTS

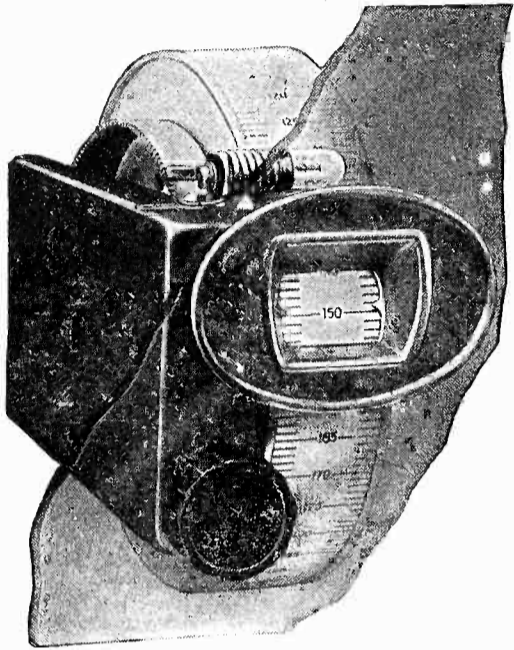

Remler Drum Dial

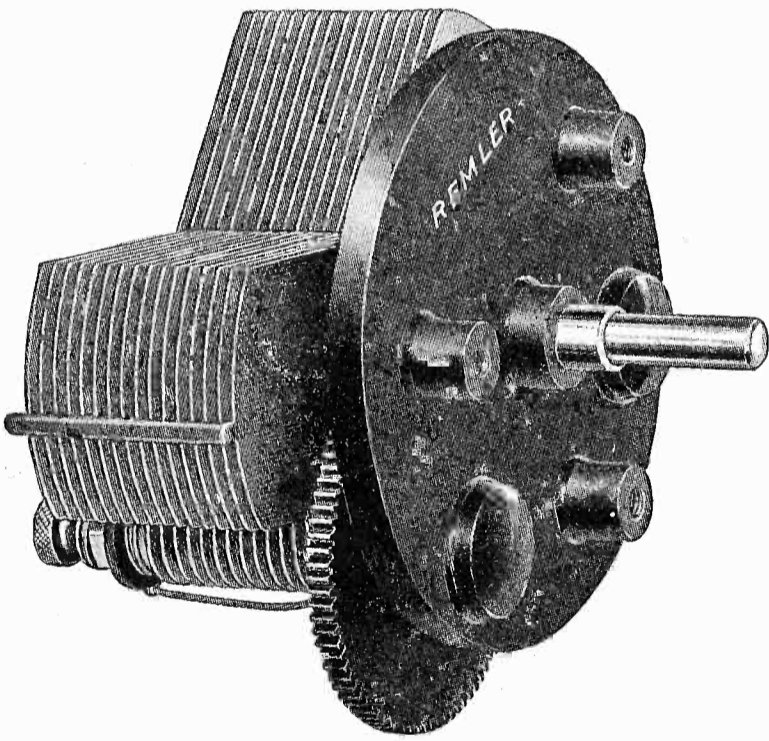

Remler
Twin-Rotor Condenser

Exclusively Specified for the Magnaformer 9-8 Circuit

Once more the quality and accuracy of Remler Radio Apparatus wins important endorsement. Again parts that are built for maximum service are used to give maximum results.

Your Magnaformer deserves the improved reception which only Remler Parts can give.

Twin-Rotor Condenser

This variable condenser is definitely established as the standard of comparison in 1927 radio.

Rotation of the dial through a full 360° gives greater separation of stations at all wave lengths than is possible with the usual 180° dial. A special adjustment which permits variation of the condenser capacity at zero dial setting allows a still further spreading of the stations in the Straight Line Frequency type. This minimum capacity adjustment allows compensation for small differences in coil construction and makes possible accurate matching of the dials controlling several tuned circuits.

Both sets of plates rotate. They are driven by Bakelite gears operated by a cam and lever in the Straight Line Frequency type and by a brass pinion in the Straight Line Wave-Length type. This construction results in complete insulation of the dial shaft from the plates, allowing the dial to be grounded and completely eliminating body capacity effects.

Price \$5.00

Drum Dial

The Remler Drum Dial gives a full 15 inches of dial space, divided into 200 divisions—2 for each broadcast channel.

Calibration strips are rigidly mounted, yet easily removable and renewable. Call letters are readily written in.

Spiral gear drive gives quiet operation and no back-lash.

Socket and 6-volt lamp furnished for illumination. Easily mounted, round drilled hole required for panel plate.

The Remler Drum Dial will drive all standard makes of condensers either single or in gangs of one, two or three condensers.

Mounting template is included in each carton. Right or left-hand mounting. Supplied for either clock-wise or counter clock-wise rotation of dial.

Price \$4.50

REMLER

Division of

GRAY & DANIELSON MANUFACTURING CO.

260 First Street
SAN FRANCISCO

Eastern Warehouse
ELKHART, INDIANA

CHICAGO

NEW YORK

Tell them that you saw it in RADIO

FERRANTI A. F. 4 TRANSFORMERS

Exclusively specified

FOR THE

Magnaformer 9-8 CIRCUIT



*The Quality
Audio Frequency
Transformer
Used in
High Grade
Radio Sets by
Slagle Radio Company
Indiana Manufacturing
and Electric Co.
Case Sets*



A. F. 4 Price \$8.50
Ratio: $3\frac{1}{2}$ to 1
Dimensions $2\frac{1}{4}$ "x3"x $3\frac{1}{4}$ "
Weight 1 lb. 8 oz.

A. F. 3 Price \$12
Ratio: $3\frac{1}{2}$ to 1
Dimensions $2\frac{1}{4}$ "x3"x $3\frac{3}{4}$ "
Weight 1 lb. 14 oz.

Output Price \$10
Ratio: 1 to 1
Dimensions $2\frac{3}{4}$ "x3"x $3\frac{3}{4}$ "
Weight 2 lbs. 10 oz.

Ferranti known design
electric characteristics and construction assure the
highest degree of radio reception

FERRANTI, Inc.

130 West 42nd Street, New York, N. Y.

Ferranti, Ltd.
HOLLINWOOD, ENGLAND

Ferranti Electric, Ltd.
TORONTO, ONTARIO, CANADA

Tell them that you saw it in RADIO

INDISPENSABLE! in Every Radio Circuit

"AMPERITE"
Watch Dog
of your
Tubes

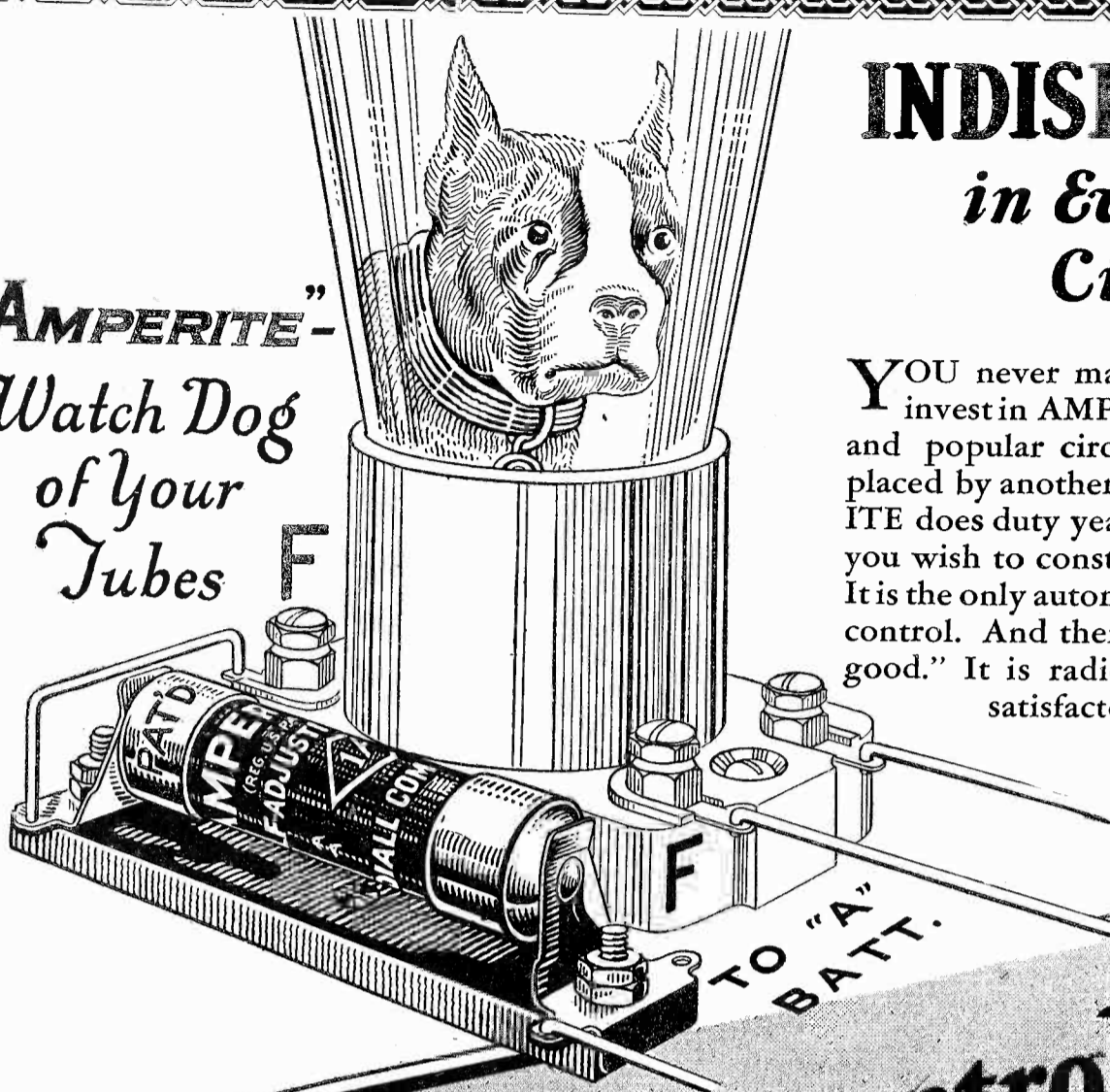

YOU never make a mistake when you invest in AMPERITES. The most clever and popular circuit of today may be replaced by another tomorrow. But AMPERITE does duty year after year in any circuit you wish to construct. It never wears out. It is the only automatic self-variable filament control. And there is nothing else "just as good." It is radio's most permanent and satisfactory investment.

solves the tube control problem

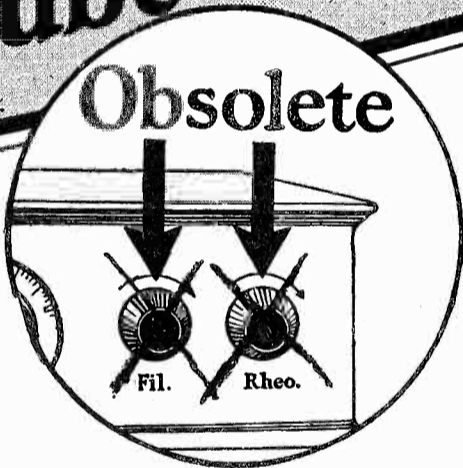

**Season's Best
Hook-ups FREE**

AMPERITE simplifies wiring and operation. Insures just the proper filament current for each and every tube. Does away with all hand rheostats on the panel. Precludes tube damage from under or excessive "A" current—resulting in both increased tube life and at all times maximum tube performance.

If you want AMPERITE performance you must insist upon AMPERITE. Nothing else will do. More essential than ever if you use a battery eliminator or trickle charger. Types for every tube. Sold everywhere. Price complete with mounting \$1.10 (in U. S. A.).

Write today for new "AMPERITE Book" just off press. A veritable jewel for last minute information on the season's most popular hook-ups and construction data. Address Dept. R9.

**Specified
in the**

Hi-Q
Strobodine
Magnaformer
Browning-Drake
Equamatic
Lincoln Quality
Camfield Super
Infradyne
Ultra 5
Citizens Super 9
Bodine Twin 8
Lodge N Circuit
L C-27
DX Special
Super-Sensitive 5
Planofier 7
Find-All-5 and 6

**and all other
GOOD Circuits**

Radiall Company
50 FRANKLIN ST. NEW YORK

AMPERITE

REG. U.S. PAT. OFF.

The "SELF-ADJUSTING" Rheostat

Tell them that you saw it in RADIO

BENJAMIN

TRADE MARK

Cle-Ra-Tone Sockets and Brackets

are specified for the
Magnaformer
9-8 Circuit

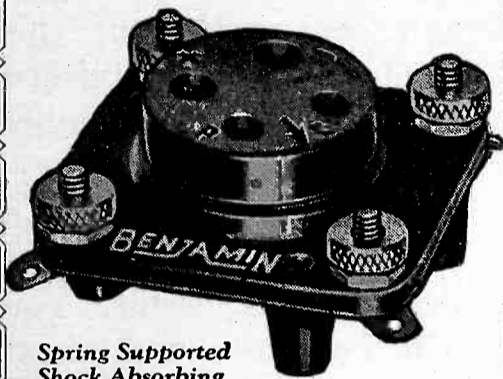

Spring Supported
Shock Absorbing

USED the world over by set builders who know and want the best.

Stop tube noises. Anti-microphonic. The greatest contribution to the non-noisy operation of the set.

Tube "floats" on finely tempered springs. One-piece terminal to tube connection. Knurled nuts for binding post connections or handy lugs for soldering.

The choice for practically every prominent circuit for several years. Among the most recent hook-ups for which it has been specified are:

Magnaformer 9-8
Camfield Super-Selective 9
Lynch Suppressor Circuit
H.F.L. Nine-in-Line
World's Record Super 10
Stroboddyne 8
Melo Heald Fourteen
St. James Super
Two-Dial Equamatic

Benjamin Shelf Bracket

An aid to simplification in set construction. Support sub-panel, with room underneath for accessories and wiring. Plain and adjustable.

At all Radio Jobbers and Dealers

Made by
Benjamin Electric Mfg. Co.
120-128 S. Sangamon St., Chicago

247 W. 17th St.
New York

448 Bryant St.
San Francisco

Manufactured in Canada by the Benjamin Electric
Mfg. Co. of Canada, Ltd., Toronto, Ontario

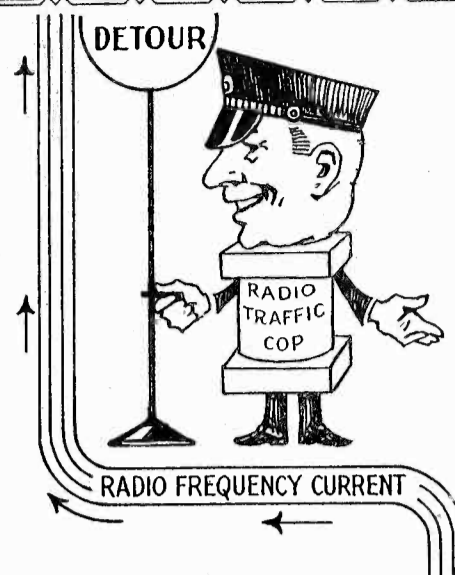
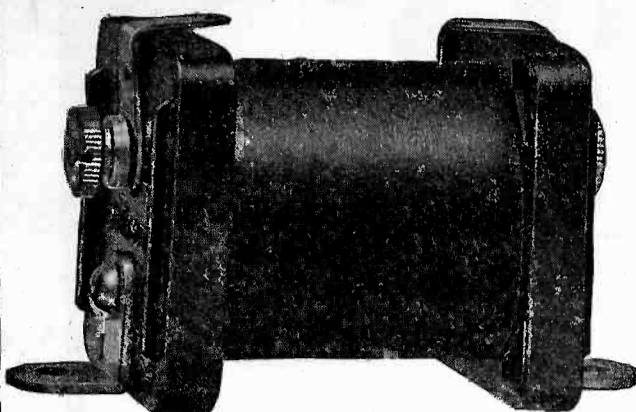

"STOP and DETOUR" orders the Samson R. F. Choke

All R. F. currents are thus kept out of B battery or audio circuits, and prevented from marring the perfect reproduction possible with Samson Chokes and other Samson Parts.

It is easy to put Samson Parts on duty in your set and begin enjoying wonderfully fine radio music today.

Write for the Samson "Make 'em Better Sheet" which will be sent free. This sheet shows how to apply chokes to 17 popular circuits.

SAMSON ELECTRIC COMPANY

Manufacturers Since 1882

Sales Offices in
Thirty Leading Cities



Main Offices at
Canton, Mass.
Factories:
Canton and Watertown

Specified for the **Magnaformer** 9-8 Circuit

Magnaformer

9-8 Circuit

Complete Parts in Stock

IMMEDIATE DELIVERY

Send For Our Catalogue

WHOLESALE RADIO SERVICE COMPANY

6 Church Street

New York City

Tell them that you saw it in RADIO

Permanent Accuracy!

AEROVOX Fixed Mica Condensers stay accurate because they are moulded in genuine Bakelite and are sealed and protected against possible injury, moisture or chemical action.

A special process in the manufacture of the condenser element enables us to manufacture and guarantee them to be within 10% of their marked rating.

AEROVOX

70 Washington St., Brooklyn, N. Y.

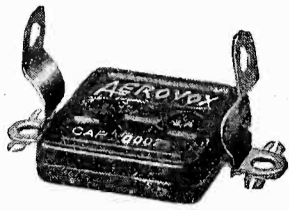

Specified by
G. M. Best for the
Magnaformer
9-8 Circuit

Follow the Series every

GET the complete story of the Magnaformer 9-8 Circuit every month in "RADIO." Further details regarding the operation and construction of this receiver will be published in our October, November and December issues. Gerald M. Best has devised a number of clever adaptations to this circuit. You will find these in the next issue of "RADIO." These new wrinkles will in no way alter the present design or size of the receiver. For example—the addition of a stage of tuned radio frequency will necessitate the purchase of only a few more parts. Go right ahead with the construction of the receiver as described in this issue and cash-in on Gerald Best's ideas in the months to come. We will show you, later, how to "electrify" the receiver—how to keep it right up-to-date and how to get the most out of it.

The next **6**
issues of **"RADIO"**
for **1** dollar
if you subscribe Now

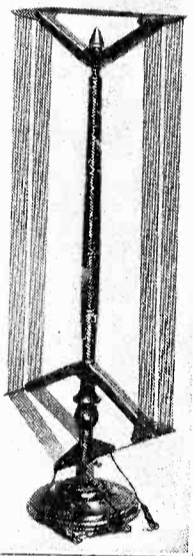

Quali-Tone "DeLuxe"

Is Exclusively
Specified for the

Magnaformer

9-8 Circuit
Patented

\$12.50

Recommended
By Leading Radio
Authorities

And specified for exclusive use with the World's Record Super Receivers, the 9-in-Line, Melo Heald, Victoreen, St. James, Popular Mechanics Economy Nine, and many other receivers.

Because

The Quali-Tone is the only loop that can claim two world records—brought in stations 8000 miles distant, and most consistent reception of far distant stations. In the Quali-Tone De Luxe, construction is of the highest quality throughout. Woodwork is of selected, solid walnut, hand rubbed, natural finish. Only the finest grade of stranded wire, well insulated and covered with brown silk braiding is used. Wire spacers are made of best grade insulating material, reducing losses to a minimum. Every Quali-Tone Loop has the special patented Quali-Tone adjustment which keeps the wires taut always. Three leads are furnished, the center tap being removable.

Compare the Quali-Tone construction, design and performance, and you will find that it excels in every particular. It incorporates every loop improvement and is flawless throughout. The De Luxe model turns within a radius of 5½ in.—the Quali-Tone within a radius of 7½ in. All Quali-Tone Loops are designed for use with .0005 condensers. Try the De Luxe for the finest reception.

The Quali-Tone De Luxe..... **\$12.50**

The Quali-Tone..... **10.00**

Jobbers — Dealers

The Quali-Tone Loop is not an experiment. For two years it has been the fastest selling loop on the market—due entirely to its exceptional merit and the improved results it guarantees. Order today or write for circulars.

Duro Metal Products Co.
2653 N. Kildare Avenue Chicago

YAXLEY

APPROVED RADIO PRODUCTS

Cable Connector Plug and
Jack Switches are specified
for the

Magnaformer

9-8 Circuit

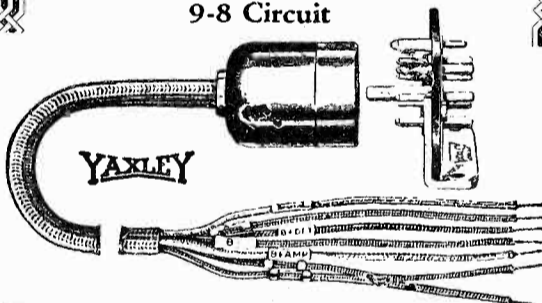

Correct design, superior construction and great utility have won a place for Yaxley Approved Radio Products in this new receiver. The Cable Connector Plug is a great convenience in keeping up the general appearance of the set by centering all battery wires in one neat compact cable. As easy to use as an electrical plug.

No. 660—Cable Connector Plug

Complete.....\$3.00

No. 60 Jack Switch 1.25

Switching Rheostat—This is the Air-Cooled Rheostat with an added feature—a filament switch. An ideal combination for any set.

Switching Rheostat (2 to 100 ohms)
.....\$1.75

At All Dealers

YAXLEY MANUFACTURING CO.
Dept. A, 9 So. Clinton St., Chicago, Ill.

Complete Parts IN STOCK

IMMEDIATE DELIVERY

Send For Our Catalogue

Wholesale Radio Service Company

6 Church Street

New York City

Tell them that you saw it in RADIO

Magnaformer month in 'Radio'

THE Information Department of "RADIO" stands ready to assist you in building any of the receivers described in this magazine. Write us for advice — when you need it. Let us answer your questions and solve your problems. More than 15,000 questions are answered yearly by Gerald M. Best. Let our laboratory assist you also.

Insure yourself against missing the next six issues of "RADIO" by subscribing now at the low price of \$1.00 for six months. That's fifty cents less than it costs to purchase individual copies from a news-dealer. Have the magazine sent to your home for six months, starting with the October issue, out on September 25th. This offer will be withdrawn shortly. You profit by sending us your dollar bill, check or money order right now.

**Don't Delay—Send
the Coupon Today**

"RADIO"
Pacific Building,
San Francisco, California.

Here's my dollar. Put me on the subscription list of "RADIO" for the next six issues, starting with the October number, out on September 25th.

Name.....
Address.....
City.....
State.....

NATIONAL TONE FILTER

Is Exclusively
Specified for the

Magnaformer 9-8 CIRCUIT

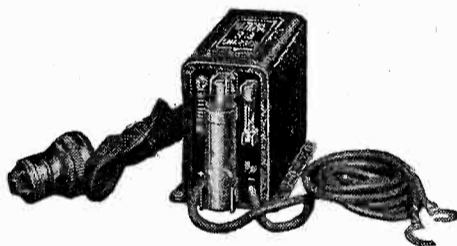
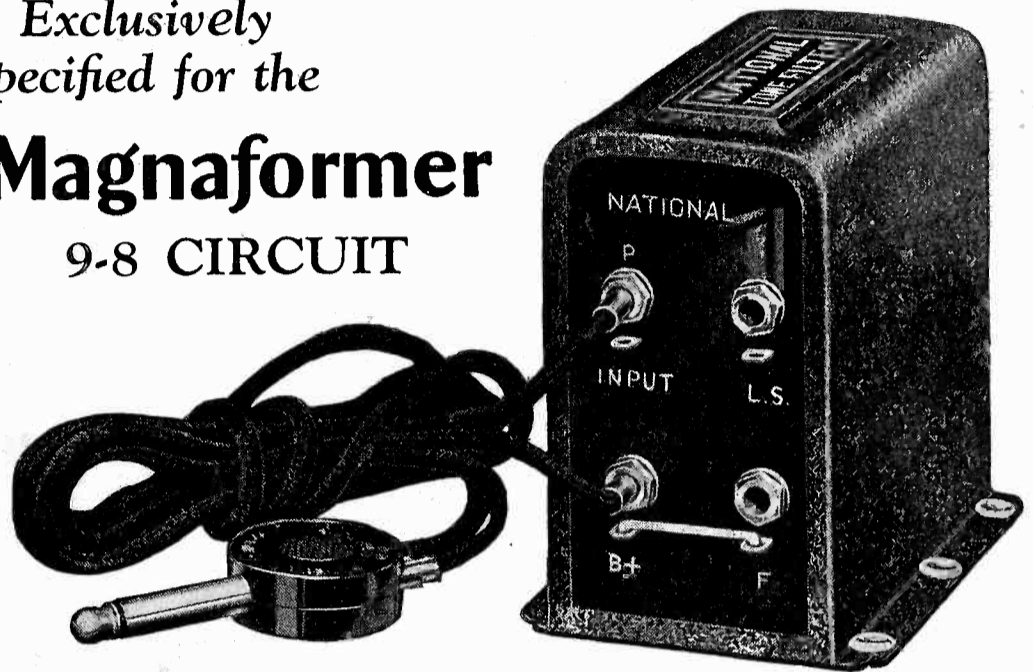

This new NATIONAL Charger uses one Raytheon "A," charges your radio batteries at a 2½ ampere rate, is light, compact, dependable and uses very little electric current.

Price, complete with cord and plug, rubber-covered leads and terminals.....\$11.50



The NATIONAL Duo Range Charger uses two Raytheon "A's" and gives a choice of half-wave charging at 2½ amperes or full-wave at 5 amperes. Now equipped with indicator lamp and fuses and special resistance.

Price, complete with two Raytheon "A's," cord and plug, rubber-covered battery leads and clips\$19.00

More stress is being laid in Radio this year on fidelity and quality of tone than anything else. Everyone realizes now that higher voltages are required than used to be employed. Everyone is using a power tube, also, because they give better results. But power tubes take more "B" current than other types and if this current at a high voltage is passed direct into the loud speaker it may burn out the delicate windings. It will also, in many cases put a steady pull on the speaker magnets which makes the performance much less satisfactory.

The NATIONAL Tone Filter overcomes these difficulties. It can be attached by anyone to any existing set in less time than it takes to tell about it. It is so connected as to keep all flows of direct current out of the loud speaker, thereby protecting and improving the tone quality. R. C. A. and other power tube manufacturers recommend a device of this kind for use with the 171 and 210 types of power tubes.

Price, National Tone Filter, complete with 5 foot phone cord for instant attachment to any existing set\$7.00
Price, without cord 6.50

National Co., Inc.
Malden

W. A. Ready, Pres.
Mass.

Write us for pamphlet

BE SURE TO GET THE GENUINE
NATIONAL
RADIO PRODUCTS

Tell them that you saw it in RADIO

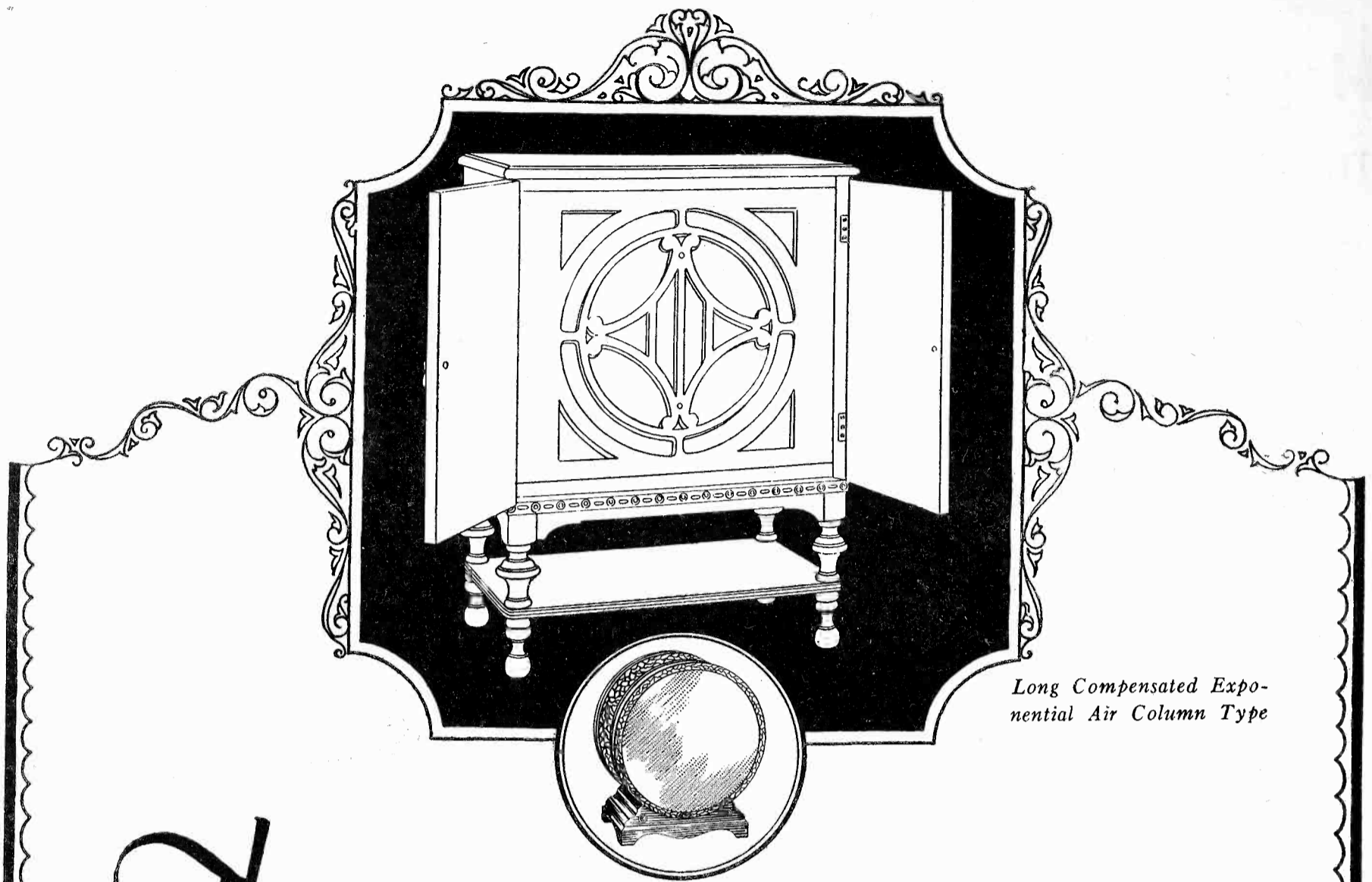

Long Compensated Exponential Air Column Type

The **TEMPLE SPEAKER** *improves the tone quality of ANY radio set*

Like a Strad violin, a Steinway piano or other fine musical instruments, the outstanding quality is tone. And that is equally true of radio speakers. No matter how much you have paid for your set, if it fails to radiate purity of tone, then it has failed in its purpose.

Wherever the Temple is heard its audience is more than enthusiastic — it marvels — for no one believed that such reproduction of tone was possible.

No longer need you worry about radio reception. Today, in the TEMPLE SPEAKER, you are guaranteed results never before known. Because it is designed on an acoustical principle that is scientifically correct, you can now

enjoy a richness, mellowness and purity of tone that will surpass your fondest expectations.

Listen to the Temple once. That's the way to buy speakers. Any dealer will be glad to give you a home demonstration.

Regardless of the cost or make of your particular set, the TEMPLE SPEAKER will enhance its tone quality, will increase your pleasure in radio a thousand-fold over what you have been used to. Irrespective of the nature of the program—be it opera, an orchestra, ball game, etc., TEMPLE will bring it to you clearly, unflinching in its fullness.

Rigid sales policy backed by extensive advertising campaign.

13 inch priced at.....\$29.00	18 inch priced at..... 48.50
West of the Rockies..... 32.00	West of the Rockies..... 55.00
Console Model priced at.....\$65.00	West of the Rockies.....\$75.00

TEMPLE, INC., 213 S. Peoria Street, Chicago

Sales Offices in all Principal Cities

LEADERS IN SPEAKER DESIGN

Magnaformer

Magna—The dictionary definition of "magna" (Latin) is "great"; the definition of "former" is "creator". Thus, we have the "Great Creator, truly a name emblematic of the astonishing accomplishments of the Magnaformer.

Price
\$8.50

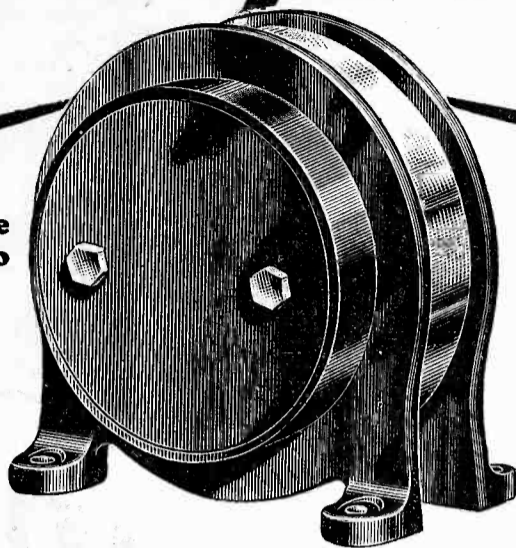

Two Years Ahead in Design

At the Radio Trade Show in Chicago, the announcement of the Magnaformer was one of the few startlingly new ideas in radio development. We know from actual observation that the Magnaformer is two years ahead in design, for it incorporates advanced and evolutionary ideas throughout. It is distinctly different, with its self-shielding, matched units, double amplification for each R. F. stage and excellent laboratory construction. It is a fresh idea—the very heart of the new and better receiver in which its remarkable qualities are given full range. Coming, as it does, when the air has been cleared by the new rulings of the federal radio commission, it makes it possible to secure exceptional results, accomplishments heretofore unknown to radio fans.

THE new Magnaformer 9-8 Receiver has won the instant approval of radio experts. It has created a new standard of all-around radio efficiency. It is the season's feature circuit in Radio, Citizens Radio Call Book, Popular Radio, and other well-known magazines. This widespread acceptance and enthusiasm is due to the inherent excellence of the circuit—its hair-splitting selectivity, perfected, superb tone, great volume and extremely long range. During the first test of the Magnaformer Receiver this Spring, 43 D-X stations were logged from Chicago, including three on the Pacific Coast. The engineers present during the test were astounded. Subsequent performances have shown that the Magnaformer does the amazing thing consistently. Winter reception will see many additional record performances, according to the experts. The enthusiastic reception accorded in Chicago is now being given the Magnaformer the country over. Its performance is sensational. It is the talked-about circuit in radio professional and amateur circles. One of the real thrills and joys in truly exceptional radio performances is in store for the man who "builds his own," and it is impossible to duplicate the work of the Magnaformer in any other way.

The secret of the Magnaformer circuit's efficiency lies in the new Magnaformer intermediate long-wave transformers with which it is equipped. These transformers are a distinct innovation in radio. They are refreshingly new in design, in workmanship and in performance. This new and superior construction meets the present-day demand for greater radio efficiency, a demand far more critical than ever before, due to radio's rapid advancement in factory-built receivers. The circuit throughout is new and modern. It has the latest lighted drum dials, controlled by knobs instead of the fingers; unique Ferranti transformers give equal amplification of all audio frequencies; output tone filter insures retention of tone quality.

Thus, in the Magnaformer you have a precision-built instrument that ranks foremost in laboratory circles and which is available to set builders in the perfection of a truly remarkable radio receiver, a receiver that is designed from the best available parts possible to produce, all matched perfectly into a compact, high-quality receiving set of the first order.

Truly, it has well earned its name, Magnaformer, the "Great Creator."

Magnaformers are different, outstanding and unusual in four vital respects

FIRST—Magnaformers are precisely and unalterably tuned in the laboratory to exactly the same wave length in such a manner that they always positively pass the full and complete signal-wave with all of its harmonic carrying side-bands intact; result—surprisingly beautiful tone quality.

SECOND—The combined elements of technical engineering design of Magnaformer Intermediates are such that the incoming signal receives double the usual amplification in each R. F. stage; result—a very powerful output perfectly controlled from a whisper to volume enough to fill a large hall—every sound clear and distinct.

THIRD—Magnaformers are thoroughly and scientifically shielded—so that the tubes to which they are connected will not oscillate, no matter how closely together or in what position they are placed in the receiver—a very important factor of its superior design; result—no fuss, no fuming, no squeals, squawks, blurps nor hisses. Just beautiful, natural reception, clear, full-toned, quiet, powerful.

FOURTH—Mechanically, Magnaformers are as nearly perfect as engineering skill can make them. The three foregoing electrical factors are depend-

ent on perfection of Mechanical Design to insure their unvarying performance. The primary and secondary coils of each Magnaformer are wound on pure Bakelite and are permanently fixed so that their inductances cannot possibly change. The secondary inductances are exactly tuned in the laboratory by small variable condensers which are fixed and locked after the tuning is done. These small condensers are locked in entirely separate Bakelite compartments and are ENTIRELY outside the electrostatic fields of the coils. No jar or jolt can disturb or change the inductances or capacities of Magnaformers after they leave the laboratory. The coils also are locked in entirely separate Bakelite compartments. Both coils and condensers are specially treated before being locked in their separate compartments. They cannot possibly be affected by moisture, atmospheric or climatic changes; result—a permanency of vital tuning factors that insures a uniform and unalterable reception for the Receiver, year in and year out—a rare achievement.

Permanent, Unalterable, Fixed Construction

The size, the shape, the built-in quality features—these three elements incorporated in the Mag-

naformer intermediate transformer, makes it surprisingly efficient and practical.

It is the best-balanced, most critically adjusted and fixed unit that can be had. It is the correct size for ease in handling and mounting side by side. It is the one unit in a radio set upon which the performance of everything else is dependent. Therefore, it is constructed with precision, exactness and fixed, adjusted and sealed in manufacturing to insure perfect operation continuously. It will never need adjustment, taking apart or tinkering. It is as fixed and final when it reaches you as anything can be.

It is fool-proof and trouble-free—features that will be appreciated by both the amateur and experienced set builder.

An Appreciation to the Set Builder

We take off our hats to the set builder, the man who has really made radio what it is today. Without set builders—the makers of custom-built receivers, the science of radio would still be in the infant stages. The inspirations, the innovations, the continuous streams of new ideas, advancement and accomplishment in radio—these are all due to the set builder. It was the set builder who was the first to recognize radio's possibilities. It is to his untiring zeal that radio is what it is today.

The set builder deserves the respect of every professional radio engineer and manufacturer in the industry.

Here's to the Knight of the soldering iron! Long may he carry on!

Enjoy This Thrill!

How many times have you wished that you could have a radio set that would bring in almost any station you desired, loudly and clearly, regardless of distance, and without squeals and howls? A set you could operate with perfect ease? A set that reproduces naturally, sweetly, delightfully, just as if you were listening to the program in the studio?

Now the opportunity to actually hear the supreme achievement in radio is afforded to you through the Magnaformer. It will be a new and pleasing experience for you and will furnish you with a new and novel radio thrill.

10c brings you full-size visualized circuit blue-prints, novel wiring diagram, complete wiring instructions and detailed story of development and accomplishments of Magnaformer. Be the first to get it.

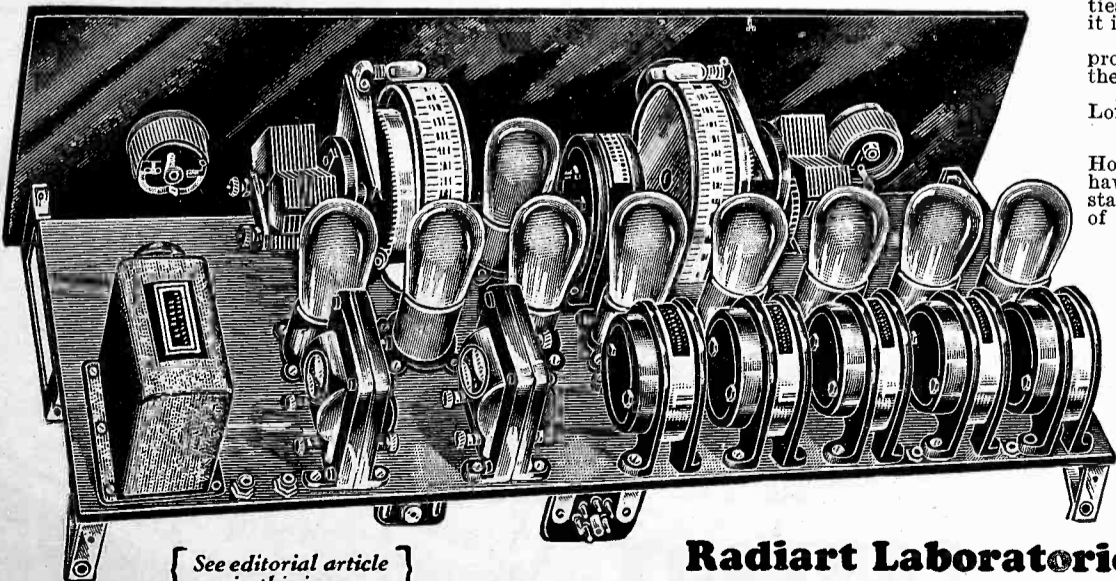

[See editorial article
in this issue]

Radiart Laboratories Co. 19 S. LaSalle St., Dept. 86
CHICAGO, ILLINOIS

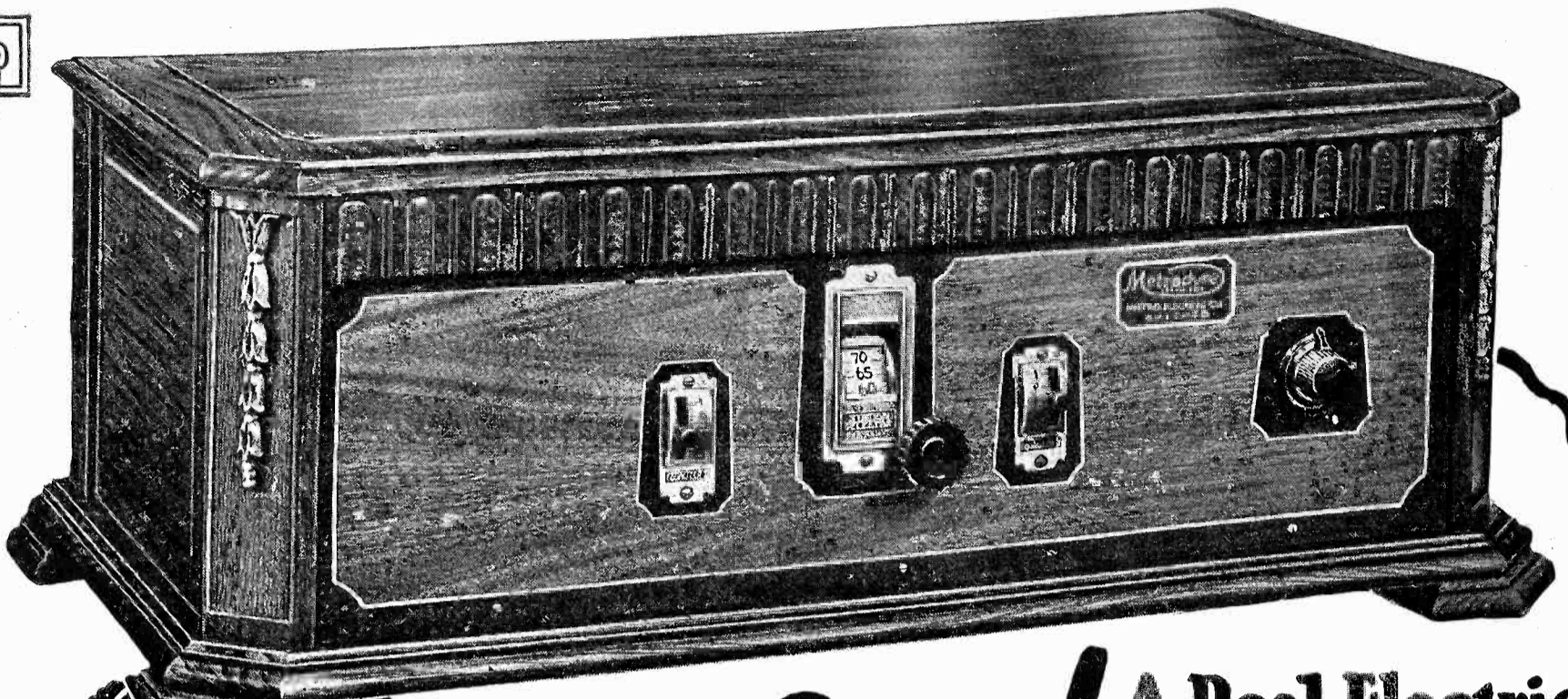

**30
Days
Free
Trial**

Now! **A Real Electric
Radio Set**

Three Year Guarantee
Shipped direct from our factory at
rock bottom prices—cost less than
most battery sets

No Batteries, Chargers or Eliminators
No Acids; No Liquids—Plug In—Press Button—“Tune In”

Metrodyne
ALL ELECTRIC RADIO

**AGENTS! DEALERS!
BIG PROFITS!**

Make big money taking orders for Metrodyne. All or part time. Metrodyne All Electric Radios are in a class by themselves. Unequalled for quality, performance and price. Demonstrate at home and take orders. Lowest wholesale prices. Your demonstrating set on 30 days' free trial. Mail coupon below for details.

7 Tubes—Single Dial Set

100% Electric Radio

At last! The radio you've dreamed about! If you have electricity in your home you can now really enjoy coast to coast radio reception without the care, bother and muss of batteries, chargers, eliminators, etc. The Metrodyne All Electric is a real, genuine batteryless radio set. Simply insert the plug in the socket, press the switch button and “tune in.” You could not possibly buy a better radio set than the Metrodyne All Electric, no matter what price you paid.

**BEAUTY—EFFICIENCY
DEPENDABILITY**

The Metrodyne All Electric Radio is a 7 tube, single dial set. Only the highest quality low loss parts are used throughout. Solid walnut cabinet, beautiful two-tone effect, with handsome gilt metal trimmings. Size of cabinet, 28 inches long, 13 inches deep, 10 inches high. Has electrically lighted dial so that you can log stations in the dark. Only one dial to tune in all stations. Excellent tone qualities—wonderful volume—very selective.

Costs Less Than Most Battery Sets

Do not confuse the Metrodyne electric radio with ordinary light socket sets, because the Metrodyne is truly an all electric radio—consumes less than 2c worth of power a day. Comes to you direct from the factory. Its low cost brings it down to the price of an ordinary battery set. We are so confident that you will be delighted with this wonderful, easy-to-operate batteryless radio that we offer to ship it to your home for thirty days' free trial—you to be the judge.

Mail This Coupon

We are one of the pioneers of radio. The success of Metrodyne sets is due to our liberal 30 days' free trial offer, which gives you the opportunity of trying before buying. Thousands of Metrodynes have been bought on our liberal free trial basis—**WRITE TODAY!**

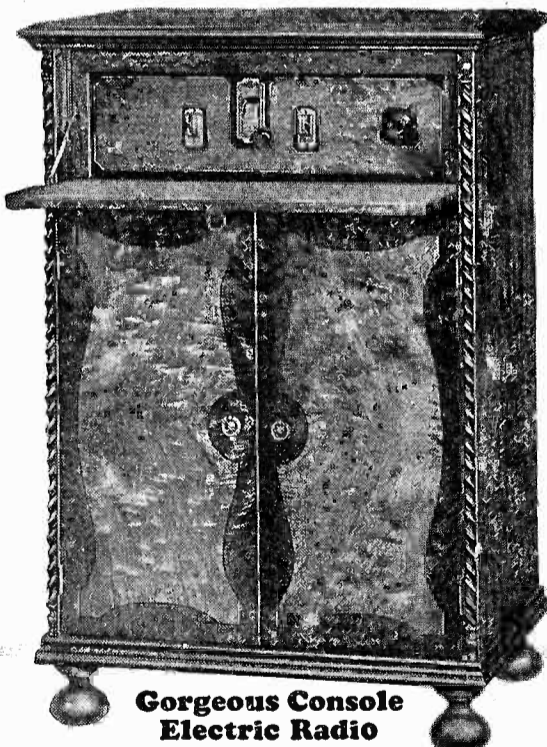

**Gorgeous Console
Electric Radio**

Here is the Metrodyne All Electric Console Radio—a gorgeous, genuine walnut cabinet, in a beautiful two-tone finish. Has a built-in genuine Metro-Cone large size speaker. Brings in programs with great volume, reproducing the entire range from the lowest to the highest notes with remarkable clearness and distinction. All metal parts are finished in old gold. Wonderful electric radio, in a cabinet that will beautify the appearance of any home.

METRO ELECTRIC COMPANY
2165 N. California Ave. Dept. 641 Chicago, Illinois

METRO ELECTRIC COMPANY
2165 N. California Ave., Dept. 641
Chicago, Illinois

Gentlemen:
Send me full particulars about Metrodyne All Electric Radio and your **thirty days' free trial offer.**

Name _____
Address _____
If you are interested in AGENT'S proposition place an "X" in the square

**MAIL
COUPON
NOW!**

RADIO

WITH WHICH IS INCORPORATED "RADIO JOURNAL"

VOLUME IX

SEPTEMBER, 1927

No. 9

Radiatorial Comment

The year 1927 will go down in history as the beginning of stability in the radio industry. Previously there was no legal control of broadcasting and but little control of patent rights. The Federal Radio Commission has now been given definite control of broadcasting and the Radio Corporation of America has assumed control of the patent situation by licensing a dozen or more firms to manufacture receivers under its patents. Thus the process of stabilization has started.

Stabilization of the Radio Industry

Six years ago the Pacific Radio Trade Association, the first radio trade organization in the country, announced that its prime objects were "to popularize, to standardize, and to stabilize radio." Since that time many agencies have been working and contributing to the same objects so that today radio is certainly popular, it is rapidly becoming standardized, and it has stabilization within reach.

But the industry has been in an unstable condition for such a long time and there are still so many forces to unbalance it, that an appreciable time will probably elapse before complete equilibrium is gained. Nor is stability an unmixed blessing. Instability requires forward motion, while equilibrium often becomes a state of rest. So, with stability, there is danger of slowing-up the rapid progress that has characterized the radio industry in the past.

The acceptance of an R. C. A. license is a practical admission of the validity of its patent claims. These claims cover almost all of the principles that are vital to the operation of the most popular types of receivers. It is difficult to make a tuned radio frequency set, a neutrodyne or a regenerative set which does not infringe upon some one or more of them. They cover the use of a grid-leak or of a C battery and other features that add to the efficiency or convenience of operation.

Of course there are various means for getting around some of them, just as there are good radio patents which are not controlled by the R. C. A. Many of them have been generally disregarded in the past and none of them have finally been adjudicated. Yet it is most significant that some of the leading manufacturers have secured a license to use them.

The granting of these licenses and probable concentration of much of the future radio business into the hands of the owners and licensees of these patents is of direct interest to the public. Just what will be the final effect depends largely upon the manner in which they are administered. This plan has not yet been divulged.

The Effects of Patent Control

Two somewhat parallel cases of patent control were afforded by the Marsh patents on electrical heating and the Selden automobile patents. Both long dominated their respective industries. Yet one is believed to have been beneficial and the other detrimental.

The Marsh patents were administered with foresight and moderation. Licenses were granted on a reasonable basis, strict supervision was exercised over the quality of the output of the different licensees, and the industry acquired a stability that would not otherwise have been gained for years. The buyer paid slightly higher prices, but got what he paid for. The Marsh patents have expired, but the electric heating industry is stronger and the public has received better service than would have been likely under unlimited competition.

On the other hand, the Selden patents were apparently administered under the policy of charging all that the traffic would bear. The disappearance of many once-famed names of automobiles is ascribed to the burdens which were imposed upon licensees. Until these patents were broken by Ford, after years of bitter litigation, they did much to stifle initiative and retard development.

Either of these results might occur in the case of radio, or the patent control may have an entirely different effect. For the radio industry seldom follows precedent. Should it become necessary to pay royalties to several owners of patents, each royalty averaging five per cent of the price of the set, including the battery-eliminator and loud speaker if built in, the selling price might become prohibitive.

The immediate effect of such prohibitive prices would be to stimulate the construction of home-built sets. The builder would have the double incentive of the joy of creation and the saving of money. To fix responsibility and to penalize millions of amateur infringers would be even more difficult than enforcing the Volstead Act. Furthermore, the Radio Corporation, in recognition of the great contributions which the amateurs have made to the art which it has capitalized, has not openly discouraged their activity.

Some sensible means for clearing the radio patent maze is confidently anticipated from the recommendations of the Nema Patent Committee. If they can work out a feasible plan for pooling patent interests, a reasonable basis of return to the inventor, and a minimum of restrictions on initiative, a prosperous industry may weather the calm of stabilization.

Clearing the Patent Maze

Or to use another figure of speech, while the industry is in no danger of drowning, it has been bobbing about in deep water. Whether the stability that is now within its reach is a life preserver or an anchor remains to be demonstrated.

Radio Television

A Simple Explanation and Description of The Bell Laboratories Successful Experiments

By Arthur Hobart

ONE of the most interesting and promising of the several methods which are being developed for the radio transmission of action pictures of moving objects is that employed by the American Tel. & Tel. Company in connection with its recent demonstration of similar wire transmission. Both wire and radio transmission of moving pictures, or television, are outgrowths of the Bell system's commercial practice in the wire transmission of still pictures. The methods are yet in the experimental stage and the elaborateness of the equipment precludes any present probability of its general use. But as an example of what can be accomplished by organized scientific research and as a foretaste of what the future holds, they are of intense interest.

The actual radio transmission was accomplished from 3XN, the Bell Laboratories' experimental station at Whippany, N. J., to New York City, a distance of about fifty miles. It was done with a standard Western Electric 5 kilowatt broadcast transmitter which was

modified so as to transmit sidebands extending 20 kilocycles on either side of the 1575 k. c. (192.2 meters) carrier wave.

Thus, as compared with radio telephony, which requires a 10 k. c. channel, radio television takes a 40 k. c. channel. The receiver, likewise, must be especially designed to give uniform amplification throughout this 40 k. c. band and to have a sharp cut-off at 1555 and 1595 k. c.

The carrier wave is modulated by, or has superimposed upon it, an electrical current whose intensity varies in accordance with the brilliancy of the light or the darkness of the shade reflected from the object whose picture is to be transmitted.

This conversion of variation in light to variation in current is accomplished by means of a photo-electric cell. This is a vacuum tube with a potassium cathode. The potassium gives off electrons when it is illuminated, the number of electrons depending upon the intensity of the illumination. When the

cathode and the anode are connected through an external circuit, an electric current flows through it. The intensity of this current is dependent upon the number of electrons flowing and thus upon the intensity of the illumination.

The object or picture to be transmitted is normally in shadow. By rapidly sweeping a narrow beam of light over it, each element successively reflects a certain amount of light which correspondingly affects the photoelectric cell. This beam is guided by a "scanning disc" and sweeps over the entire scene in less than a fifteenth of a second. The scanning disc contains a series of spirally arranged holes and is rapidly revolved so that darts of light from it successively illuminate narrow horizontal strips of the scene.

As each detail is illuminated the photoelectric cell instantly initiates a current proportional to the light reflected to it. As the beam of light swings across the scene, working its way from top to bottom, the current from the cell varies correspondingly. So quickly does the beam scan the scene that the current

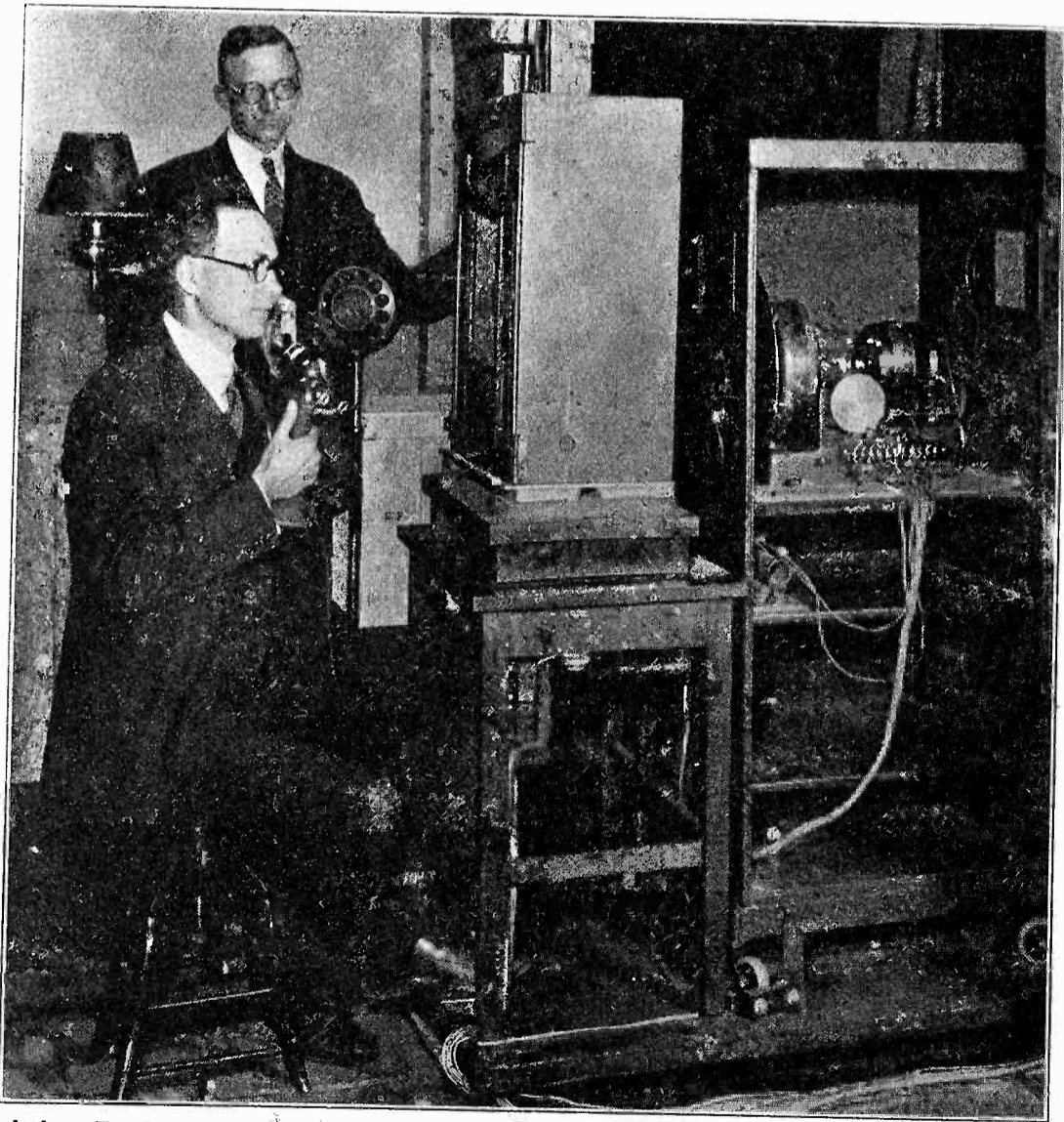

Transmitting Equipment at 3XN. Light Beam From Hole at Right Passes Through Motor-Driven Screen in Center to Throw Scanning Ray on Face of Speaker. Light Reflected Therefrom Causes Varying Electron Emission in Photoelectric Cells.

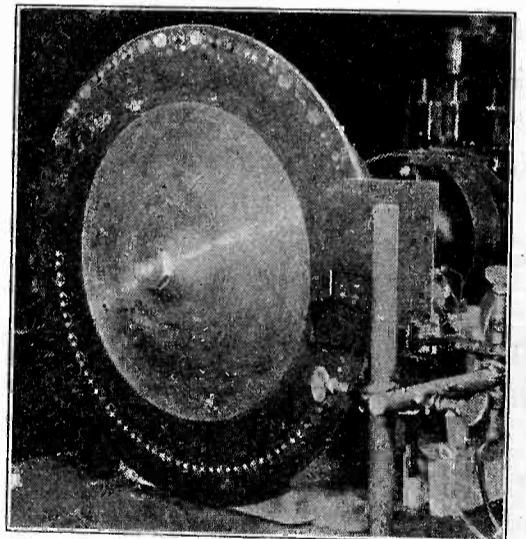

Synchronized Disc for Viewing Radio Transmitted Moving Picture. Image is Viewed Through Rectangular Shield at Right.

variations may change from a maximum to a minimum and back to a maximum in a twenty-thousandth of a second.

The weak current from the photoelectric cell is first amplified by vacuum tube amplifiers and is then impressed upon a vacuum tube modulator whose output is impressed upon the carrier wave from a vacuum tube oscillator and thus radiated from the antenna.

At the receiving end the radiations are amplified, and impressed across the electrodes of a neon tube, whose brilliancy of glow is proportional to the applied voltage. These variations in light intensity pass through the holes of a

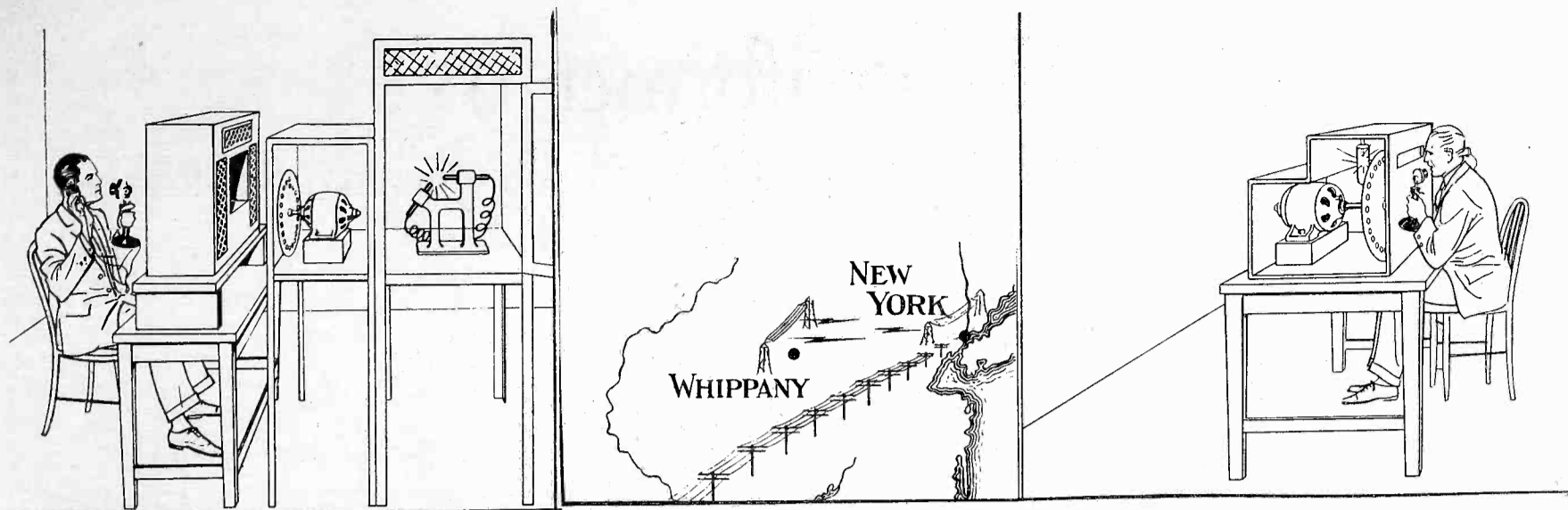

Radio Television Equipment. At Left is Cabinet Containing Three Photoelectric Cells. Next is Arc Light and Motor-Driven Scanning Screen. In Center Are Radio Channels. At Right is Neon Tube and Synchronous Screen.

revolving disc onto a screen. As the disc at the receiver is identical with that at the transmitter and is revolved at exactly the same speed, the screen shows light variations corresponding to those on the original object and so reproduces a picture of it.

Thus the current at the receiving station produces at each instant a spot of light whose brightness corresponds to that of the scene detail reflected to the photoelectric cell at the moment it initiated that particular amount of current. At each instant the position of this spot of light also corresponds to that of the scene detail. The entire scene, in successive details is thus reproduced for an observer.

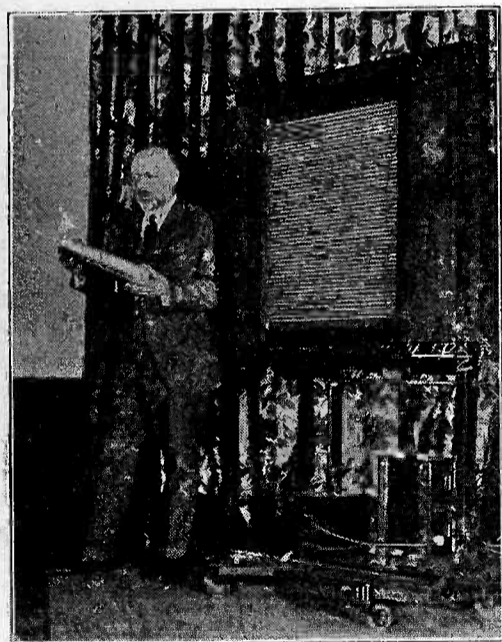

Dr. Herbert E. Ives Holding Photoelectric Cell and Standing Beside Neon Tube Grid.

The complete process of reproducing these light details in proper order takes less than an eighteenth of a second. It is then automatically repeated and the observer instantaneously sees each detail eighteen times a second, which is equivalent to seeing a moving picture of the scene as a whole.

Many of the difficult problems involved in the practical accomplishment are not apparent in this simplified explanation of the process. For instance, the synchronization of the speed of the disc at the receiving end with that at

the transmitting end required a separate 1 kw. transmitter at 180 kilocycles to control the speed of the motor which operates the disc. Such synchronism is accomplished by using two synchronous a. c. motors at each end. The main motor operates at a frequency which rotates the disc at the right speed to form complete images, say 18 cycles per second. A second and smaller motor at each end operating at 2000 cycles per second keeps the two main motors in exact step, its speed being directly controlled by radio.

The general method described produces a small picture about 2 by 2½ in. In order to give a larger picture on a plane 2 ft. square, a very long neon tube is folded back and forth to form a great grid. Inside of this long neon tube are 2500 pairs of electrodes, each corresponding to a single small area of the picture plane. As the current corresponding to each area reaches the receiving station it is distributed through contacts controlled by the synchronized motors to the appropriate electrode and

so causes a flash of light similar in location and intensity.

The entire grid-like tube is observed either directly or through a translucent screen. Eighteen times a second each of its 2500 areas shines forth with a brilliancy similar to that of a portion of the distant scene. Due to the persistence of vision the observer sees not a series of discrete light flashes, but the picture as a whole.

Three large photoelectric cells are used to receive the light reflected from the object. These are placed so as to secure the equivalent of illumination from various directions. Illumination by the rapidly moving beam and its observation by several photoelectric eyes is like the arrangement of lights around the subject in a photographic studio.

In addition to the channels required for the radio transmission of the picture and the speed control of the discs a third channel was required for the radio telephone transmission of speech and music.

This entire development was under the leadership of Dr. Herbert E. Ives. But it involved the co-operation of many experts, perhaps two hundred in number, who perfected the various details.

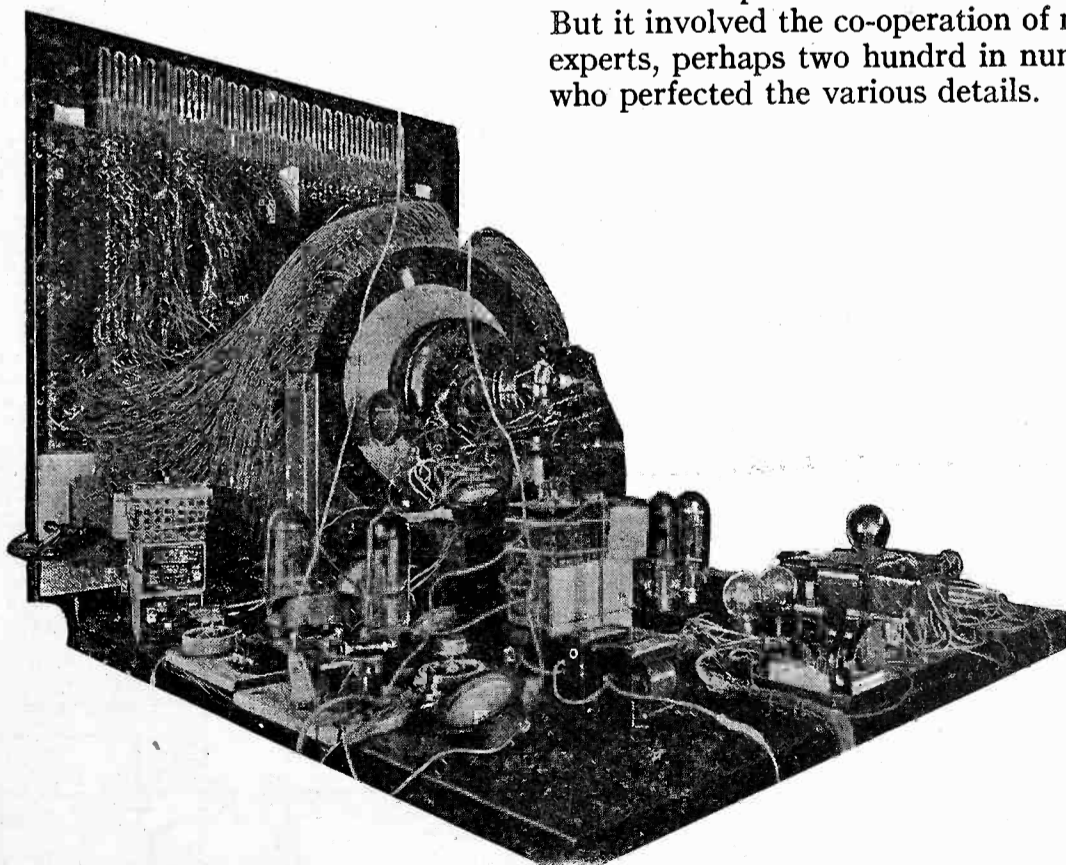

Rear View of Neon Tube Grid Showing Current Distributor.

The Magnaformer 9-8

Detailed Directions For Assembling the Latest Loop-Operated Kit Receiver Using Nine or Eight 5-Volt Tubes

By G. M. Best

THE new Magnaformer 9-8 has been especially designed to give such simplicity of assembly that any novice builder having normal patience can easily build a set which has good selectivity, great volume and fine tone quality. It meets every requirement of the modern trend in receivers, including drum dials and concealed wiring. It also meets the demand for a set using large tubes to be operated by storage battery or A socket power.

The parts are of the latest and most approved design. The Magnaformers, or radio frequency transformers, give great voltage amplification without distortion and the audio system assures well-nigh perfect reproduction of all tone values. Furthermore the completed receiver contains no complicated adjustments that might tend to make its operation difficult.

It is designed to operate with a standard two or three tap loop antenna. Connections are shown in the circuit diagram for the three tap loop, but a loop without center tap may be used without difficulty. Due to its four stages of r. f. amplification, there is adequate sensitivity even with a small loop antenna. Where four stages are found to give too much sensitivity, a switch is provided to cut out the last r. f. stage.

There are two tuning controls on the front panel, each operating a .0005 mfd. variable condenser, with a drum dial. Sensitivity is controlled by a 400 ohm potentiometer at the left hand end of the panel, and an additional adjustment of the r. f. tube filaments is had with the 10 ohm rheostat-switch at the right end of the panel, the latter being used as a main switch to turn the set on or off.

Seven of the nine tubes are type 201-A, one is a type 112 in the first audio stage, and one is a type 371 in the last audio stage. The Magnaformer circuit presents no innovations, all emphasis being placed upon the efficiency of the amplification accomplished with these shielded, air core transformers, each of which is permanently tuned by means of a condenser contained within the shield. These transformers are designed to give extreme selectivity and yet have a sufficiently flat amplification curve at the peak so as not to cut off the side bands of the modulated frequency which is being amplified. The output of the amplifier is connected directly to the detector without additional external condensers or other tuning apparatus.

The output of the detector, which rejects the carrier and retains only the audio frequency component with which the carrier was modulated, is fed into a two stage transformer coupled amplifier, using high quality transformers. A r. f. choke is placed in the plate circuit of the detector, so as to prevent r. f. currents from passing through the audio transformer primary. These currents

find an easy path through the .001 mfd. fixed condenser, back to the filament, while the audio frequencies pass through the choke without hindrance, and into the audio amplifier. The output of the power tube is connected to the loud speaker windings, but permits the audio frequencies to pass without loss.

The filament circuit is wired for six volt storage battery or A eliminator supply throughout, suitable rheostats and Amperites being provided so that the best operating condition for each tube may be obtained.

The only C batteries required are connected to the audio amplifier circuit. The type 112 first stage tube has 4½ volts C, when using from 90 to 135 volts plate, and the 371 power tube will require 22½ volts C for 135 volts plate, or 45 volts C for 180 volts plate, the latter being preferable because it enables obtaining much greater power output than is possible with only 135 volts plate. The necessary bias for the other tubes is obtained through the voltage drop in the filament rheostat or by means of a 400 ohm potentiometer.

A center tapped loop antenna is used, as this type is more selective than a

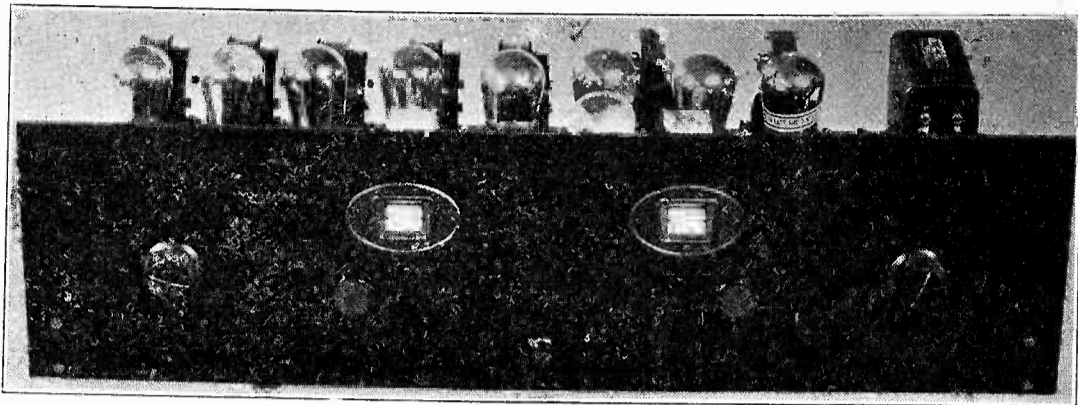

Panel View of Magnaformer 9-8

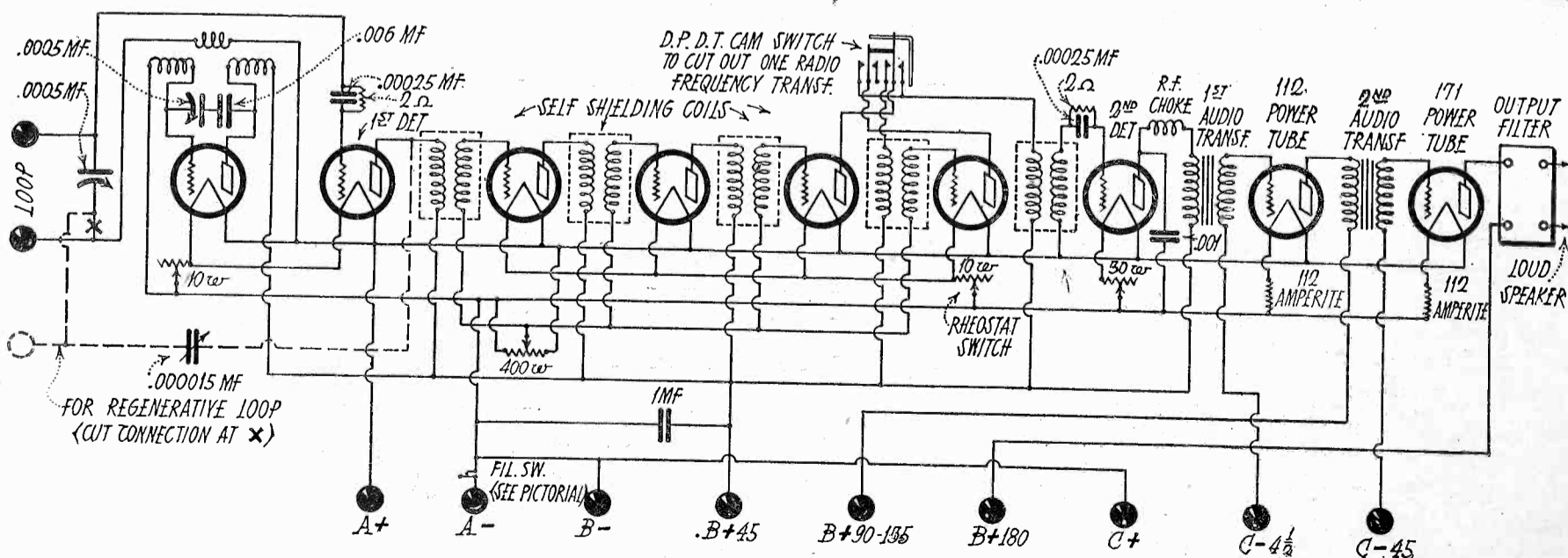
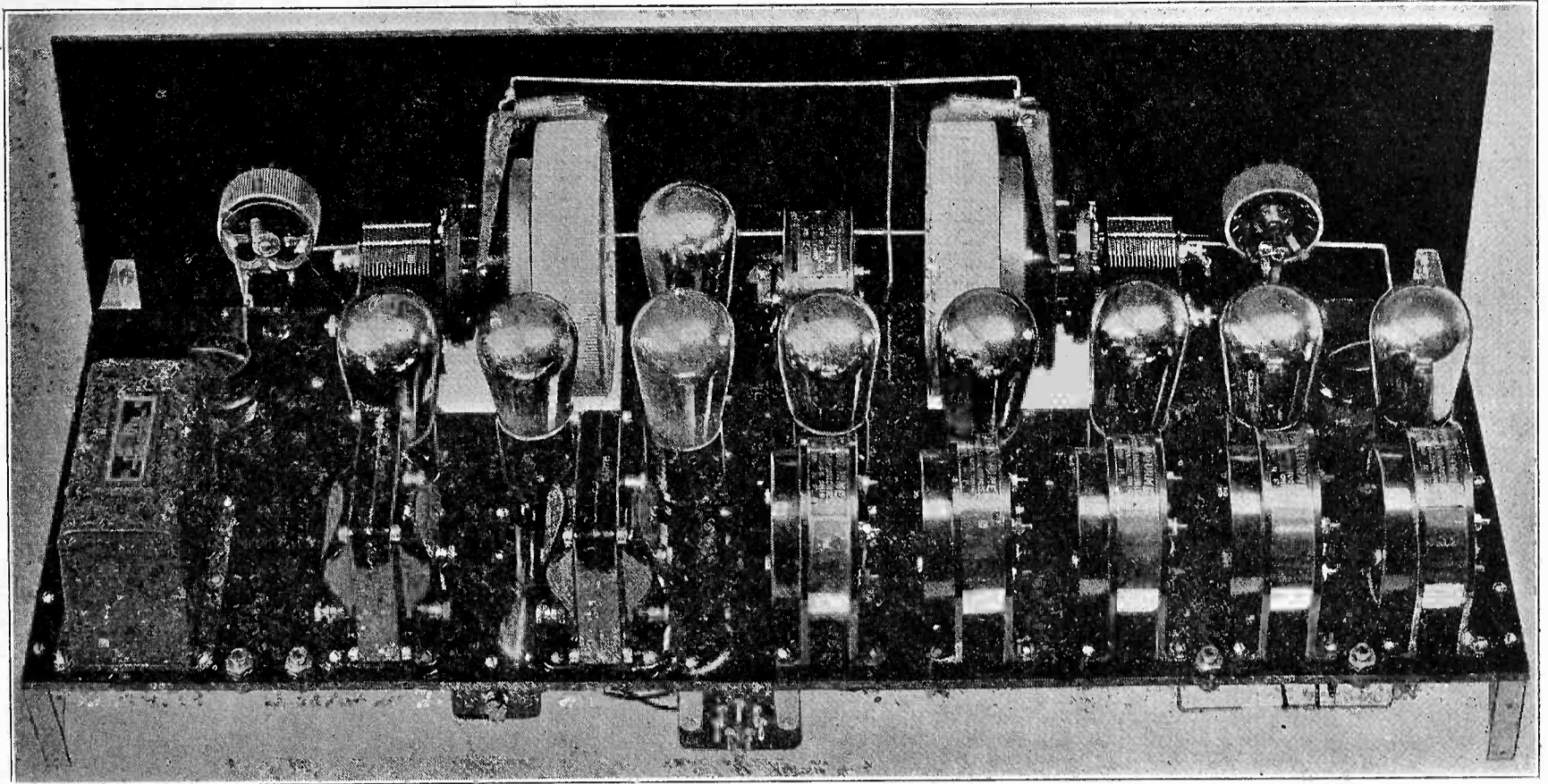

Fig. 1. Circuit Diagram of Magnaformer 9-8



Rear View of Magnaformer 9-8

two terminal loop, and permits regeneration where extreme distance is wanted. The position of the regeneration condenser is shown in dotted lines on the circuit diagram, as it is not included in the list of parts, nor shown in the pictures. It may be of the variable mica type, such as the XL Model G-1, or a small variable condenser such as the General Radio .00045 mfd. If it is the former type, it may be mounted on the subpanel, and adjusted for best operation on one of the stations in the lower end of the broadcast wavelength band. If it is variable, it can be mounted on the panel above the volume control, where it can be adjusted easily.

The parts list gives all the details about the parts required to build the receiver, and includes the identical apparatus used for the set shown in the

pictures. However, the more advanced set builders will be able to select other makes of apparatus which will serve the purpose equally well.

The panel can be obtained already drilled for the parts used, and hence no panel drilling template is given. The drum dials, with associated condensers, are spaced at equal distances on each side of the panel center, and the subpanel is cut out in two places so as to clear them. The subpanel is also obtainable ready drilled for immediate use, and with the slots for the drum dials already cut.

For use in wiring the receiver, as well as the assembly, two circuit diagrams have been prepared: one in schematic form, Fig. 1, and a pictorial diagram, Fig. 2. The latter has been drawn as near to scale as is possible, consistent

with clearness, and will serve as a guide in the placement of parts on the subpanel. Wiring which is underneath the subpanel is shown in solid lines, and that above the panel in dotted lines, since most of the wiring is underneath the panel.

As can be seen in the picture of the underpart of the subpanel, the r. f. choke, bypass condenser, Amperites, mica condensers and subpanel supports are the only parts not mounted on top of the subpanel, but practically all the wiring is run underneath the shelf so as to present a good appearance, as well as give an efficient wiring layout. Flexible spaghetti covered wire is used for all connections which pass through holes in the subpanel, while solid busbar wire is used for the filament circuit and other connections easily made. The sockets

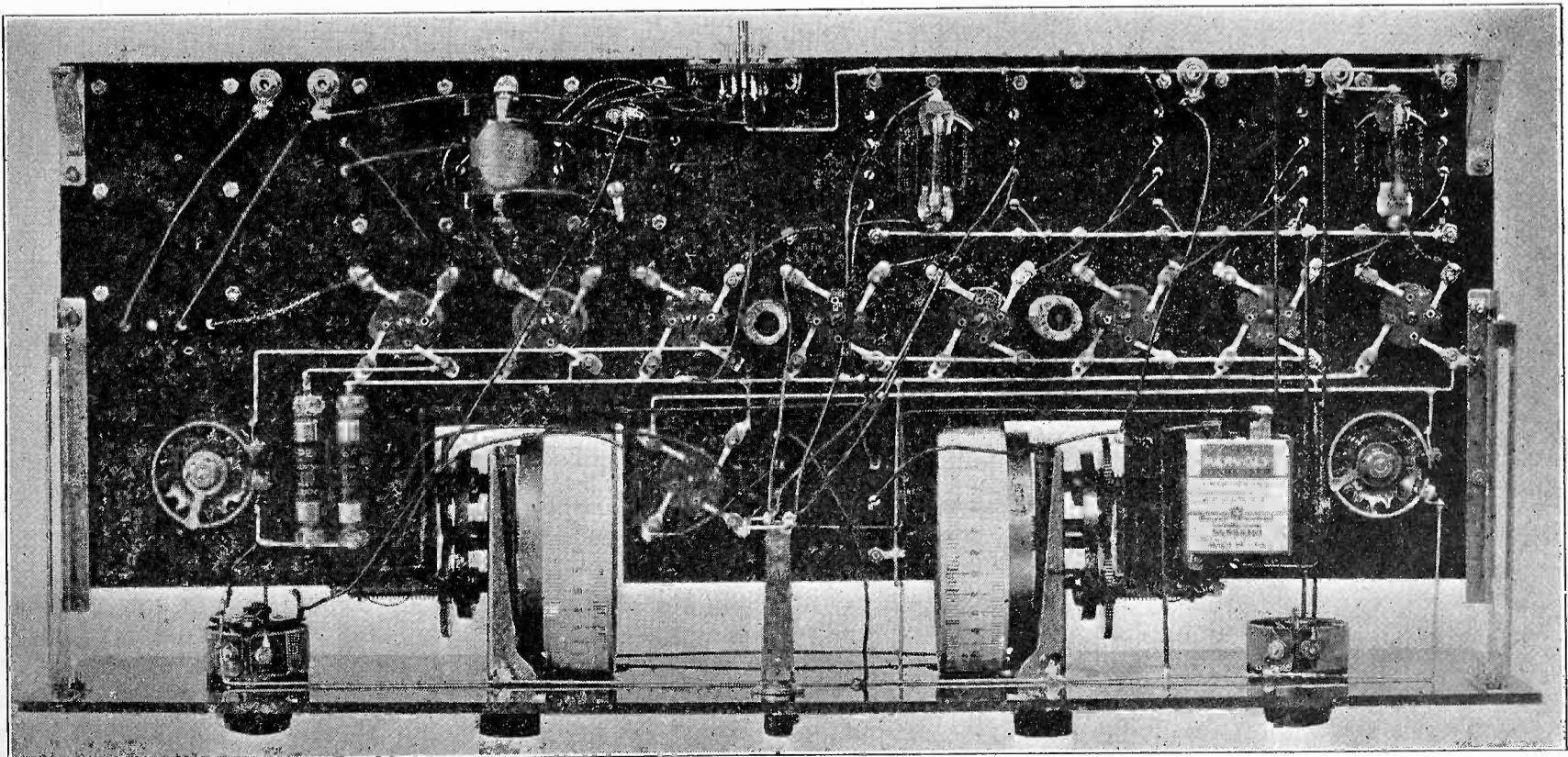

Under Side of Sub-Panel

are of the type designed for assembly direct to the subpanel, the panel providing the necessary support for the socket springs.

In assembling the set, it would be best to mount the panel apparatus first; then the subpanel equipment, and wire the latter as completely as possible before fastening the subpanel to the mounting brackets attached to the front panel. As the battery leads are all connected to the set by means of the cable connector, all filament wiring, with the exception of the panel rheostats, can be completed before the two main parts of the set are put together, and most of the wiring, particularly in the audio amplifier, can be completed and tested.

The loop antenna connections are made to a set of tip jacks located on the back edge of the subpanel; the picture shows but two, since the center tap of the loop was connected to the positive *A* battery. But the third jack should be installed adjacent to the other two so as to simplify the loop connections. The connections to the loud speaker are through a similar pair of tip jacks, located between the second audio transformer and the output filter. The wiring of the jack switch for cutting out the last r. f. amplifier tube may seem complicated at first sight, but the pictorial diagram shows clearly where each wire goes, and the position of the wiring to the switch terminals, so that after a little studying of the diagram the job should be a simple one.

Upon completing the wiring, connect the battery cable to the connector plug on the subpanel, and connect the six volt *A* battery to the terminals at the end of the cable. Turn on the main rheostat-switch, and the dial lamps should light. Insert a type *A* tube in each socket in turn, and note whether the individual rheostats function properly, by swinging them through their full range. Should the tube filament fail to light, while the dial lamps work normally, there is an open circuit in the main filament busbar.

Now disconnect the positive *A* battery wire, and touch the various positive *B* battery wires to the positive *A* battery. If the tube filament lights in any of the sockets, when the above test is made, there is a short circuit in the *B* supply, somewhere in either the wiring or the apparatus itself, and this should be located before the *B* batteries are connected.

Assuming that the wiring tests O. K., it is still a good idea to insert a 25 watt Mazda lamp temporarily in the negative *B* battery lead, shunting this lamp with a 1 mfd. bypass condenser to prevent oscillation. Then if a short circuit develops the lamp will light, but will not pass sufficient current to burn out any of the tube filaments. As there might be a short circuit in the oscillator con-

LIST OF PARTS FOR MAGNAFORMER 9-8

- 1 Formica Front Panel, 7x26x $\frac{1}{8}$ in.
- 1 Formica Sub-Panel, 9x25x $\frac{1}{8}$ in.
- 5 Magnaformer Transformers, Unit R. F. No. 61.
- 1 Unicoupler, Unit C. U. No. 71.
- 1 Remler No. 110 Drum Type Dial with Control.
- 1 Remler No. 110-R Drum Type Dial with Control.
- 2 Remler .0005 mfd. Variable Condensers.
- 9 Benjamin Sockets No. 9044.
- 2 Benjamin Sub-Panel Brackets 2 in. high, No. 8629.
- 2 Ferranti Audio Transformer, A. F. No. 4 or A. F. No. 3.
- 1 National Tone Filter.
- 1 Samson Radio Frequency Choke Coil No. 125.
- 2 Aerovox .00025 Grid Condensers, with Mountings, Type 1475.
- 1 Aerovox .001 Fixed Condenser, Type 1450.
- 1 Aerovox 1 mfd. By-Pass Condenser, Type 200 Short.
- 2 Durham 2 Megohm Grid Leaks.
- 1 Frost DeLuxe 400 Ohm Potentiometer.
- 1 Frost DeLuxe 10 Ohm Combination Rheostat and Battery Switch.
- 1 Frost DeLuxe 10 Ohm Rheostat.
- 1 Frost DeLuxe 30 Ohm Rheostat.
- 5 Frost Tip Jacks.
- 2 No. 112 Radiall Amperites, with Holders.
- 1 Yaxley Cable Connector Plug No. 660.
- 1 Yaxley Radio Jack Switch, No. 60.
- 2 Feet Acme Bus Bar Wire, No. 14 round tinned.
- 5 Feet Acme Flexible Spaghetti Covered Wire.
- 1 Quali-Tone Loop—Duro Metal Products Co.
- 1 $\frac{5}{8}$ x $\frac{3}{4}$ x2 in. Wood Block for Sub-Panel Support.
- 2 2 in. Right Angle Supports for Supporting Rear of Sub-Panel.
- Wire, Screws, Lugs, Nuts, Bolts, Solder.

denser, due to damage to the condenser, or rough handling during assembly, a .006 mfd. fixed mica condenser is placed in series with the tuning condenser, so that if the air condenser is shorted, the mica condenser protects the oscillator tube and coil. It has no effect on the tuning, since it offers practically no impedance to radio frequencies.

After adjusting the *B* battery voltages to the right values, with 45 volts for all tubes up to and including the detector, 90 to 135 volts for the 1st audio tube, and 135 to 180 volts for the power tube, tune in a local station, and lower the volume to a point somewhat below normal by adjusting the volume control potentiometer at the left hand end of the panel. It will be found that the station can be brought in at two points on the right hand dial, so that the best setting for local conditions, where no interference with other stations is had, should be selected. Adjust the detector rheostat for best sensitivity, and tone quality. If the filament current is too low, the tone will become muffled and hollow. With the type 200-A detector, the sensitive spot will be very definite in a certain position of the rheostat; with the ordinary type *A* tube, this setting will not be critical. The remaining rheostat should be adjusted for maximum sensitivity, and will probably not again need adjusting.

The rheostat controlling the four r. f. amplifier tubes can be used as an auxiliary volume control, but for all practical purposes, the main volume control will be sufficient except for very powerful local stations. If regeneration is to be

employed, the feed-back condenser should be adjusted on a low wavelength station, setting the condenser to a point where a loud squeal is heard; then backing off the condenser until the oscillation ceases. It is better to use a variable mica condenser, mounted on the subpanel, and be content with a small amount of fixed regeneration. This will not be of much value for the long wave, but is particularly useful in preventing oscillation. Should a variable air condenser be used for the feedback, it should be left at zero setting when receiving local stations, for there is nothing more annoying in this type of circuit than to have the set oscillate and squeal violently at any setting of the volume control, only to find that the feedback condenser has been turned so that too much capacity is in the circuit.

HANDY HINTS

Ordinary three-ply veneer wood makes good panels for receiving or transmitting sets. Veneer is cheap and easy to obtain; it is thin and will not warp. A panel made of thin veneer wood is almost as good as a bakelite or hard rubber panel, if the wood is thoroughly dry and seasoned. It would be a good plan to bake the veneer panel in a warm oven for a half hour to make sure that there is no moisture left in the wood.

When a three-circuit (primary, secondary, and tickler windings) having fixed coupling (the coupling is determined by the distance between the primary and secondary windings) is constructed, the builder has to choose whether to place the primary and secondary windings close together (tight coupling) and get good volume of music but poor selectivity; or to place them farther apart (loose coupling) and get good selectivity but not so much volume. The best placing of the primary and secondary will have to be found by experiment, because the proper degree of coupling depends, to a great extent, on the nearness to powerful broadcasting stations. Either volume will have to be sacrificed for selectivity, or vice versa. The selectivity is good when a set tunes "sharply," and poor when it tunes "broadly."

Some good suggestions for the erection of aerial masts are contained in the Bureau of Standards Handbook No. 10 of Safety Rules for the Installation and Maintenance of Electrical Supply and Communication Lines. In accordance with these recommendations, wooden poles whose total length is 20 to 25 ft. should be set 5 ft. in the soil, 30 ft. poles 5.5 ft., 35 to 40 ft. poles 6 ft., 45 ft. poles 6.5 ft., 50 to 55 ft. poles 7 ft., 60 ft. poles 7.5 ft., 65 to 70 ft. poles 8 ft., 75 ft. poles 8.5 ft. and 80 ft. poles 9 ft.

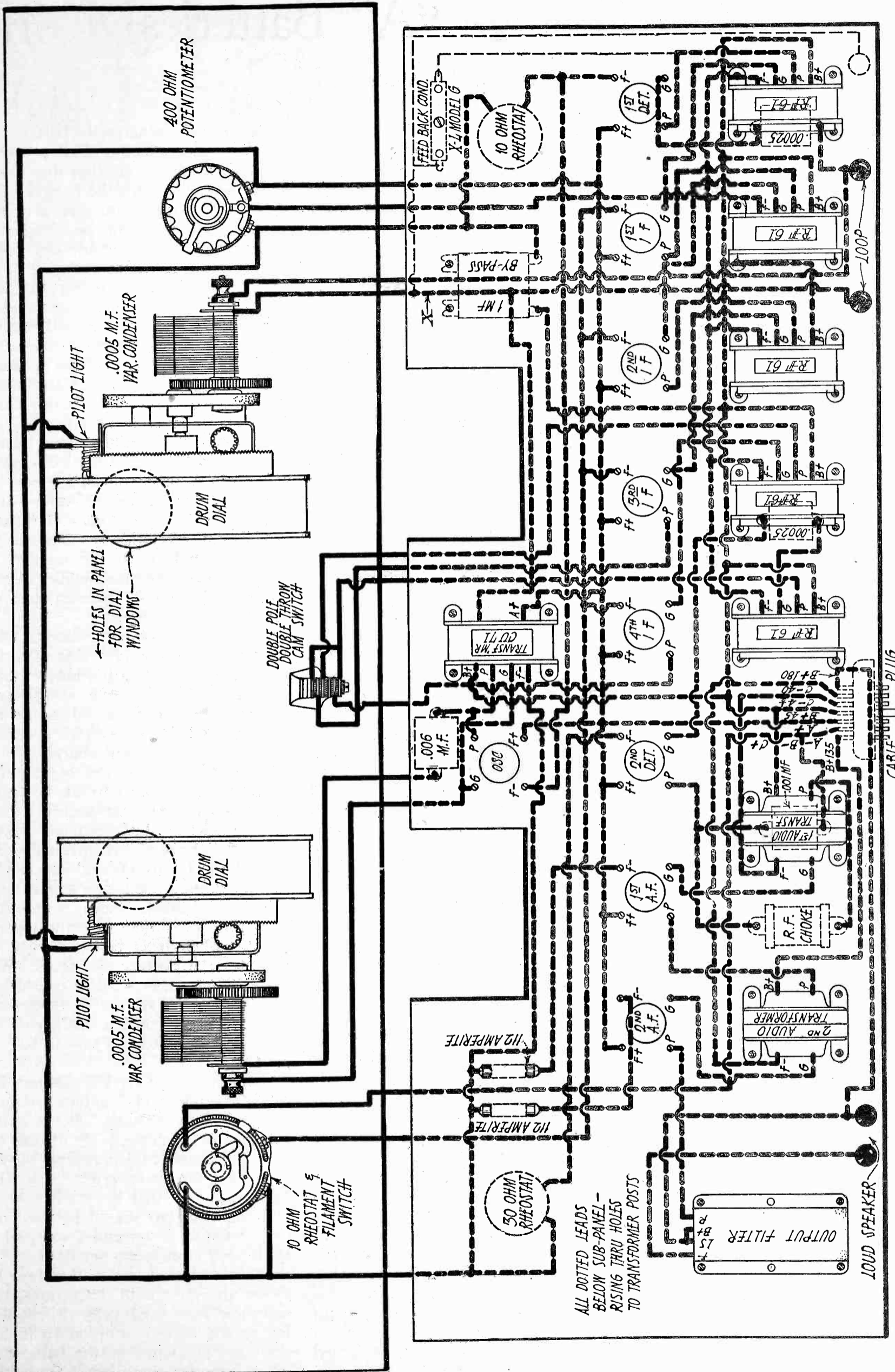

Fig. 2. Pictorial Diagram of Magnaformer 9-8

Anent Storage "A" Batteries

By Charles F. Felstead, 6CU

THE size of the plates in a lead-acid cell determines only the ampere hour capacity of the cell and in no way affects the voltage. A storage cell with plates as large as a room would have the same voltage as a storage cell the size of a thimble, if such existed. However, the current capacity measured in ampere hours would be immeasurably greater for the first cell than for the latter.

A fully charged cell remains at 2 volts for the first half of the discharge period. During the next quarter period the voltage remains at 1.95 volts. In the final quarter of the discharge, the voltage drops off rapidly to 1.8 volts, which is considered to be the lowest value to which the voltage of a radio cell should be allowed to fall.

Since there are three cells in the usual storage battery used as the filament battery for radio receiving sets, it will be seen that the open circuit voltage, which is the voltage of the battery when nothing other than the measuring voltmeter is connected to it, is 6 volts when the battery is fully charged. When the battery is totally discharged, it will show 5.4 volts on a circuit that draws a normal amount of current from the battery, a circuit such as an ordinary receiving set with all the tubes lighted. These voltage readings can be obtained easily if a sensitive direct-current voltmeter graduated in tenths of a volt is used.

It is not a good plan to use a large lead-acid filament battery in conjunction with a trickle charger in the filament circuit of a radio receiving set. A battery having a rated capacity of 100 ampere hours or more should be charged by a regular large-size battery charger, such as a Tungar or Rectigon. These will recharge the battery at a rate of 3 to 6 amperes, depending on the type used, whereas the average trickle charger provides a charging current of 0.35 to 0.7 amperes. If a 100 ampere hour battery is used with a trickle charger, and the battery once allowed to become completely discharged, there is little likelihood that the trickle charger will ever have an opportunity to fully recharge the battery, unless the receiving set is not used for quite a long time.

The battery probably will not be charged to more than 20 per cent of its full capacity at any time, because generally there will not be any long enough periods of charging between listening periods for the battery to get fully charged again. The result is that the other 80 per cent of the material in the battery plates will be idle, and that will cause the lead sulphate, which is nor-

mally in a finely divided form on the plates of a discharged battery, to coalesce gradually into larger crystals on the unused portions of these plates. The surface of one of these larger lead sulphate crystals is not nearly so great as the combined surfaces of the many small crystals of lead sulphate in the finely divided form that went to make up this one larger crystal. The portions of the battery plates that are covered with these larger crystals of lead sulphate are said to be "sulphated," and will not function properly.

Thus 80 per cent of the surfaces of the plates in the battery soon become unuseable, and are merely an unnecessary waste of space. So the battery in this case has really a capacity of only 20 ampere hours, although it probably cost twice as much as a regular 20 amp. hr. battery. The logical thing to do is to buy a battery with a 15 or 20 amp. hr. rating if a trickle charger is to be used with it.

Many inexperienced persons think that the capacity of a storage battery can be judged by the size of the battery case. Unscrupulous manufacturers have played on that belief by making 50 amp. hr. batteries, putting them in cases designed for the 100 amp. hr. types, and selling them for what the larger battery would bring. This form of deception cannot be detected except by taking the battery apart. And even in that case, an expert battery man must examine and test the battery to determine whether or not it was assigned a fraudulent capacity. It is safer always for the radio enthusiast to buy his storage A battery from some reliable battery manufacturer. The actual capacity of a storage battery is determined by the amount of active material the battery contains, and not by the outside dimensions of the battery case.

The capacity of storage batteries is referred to in terms of ampere hours, just as the capacity of a water tank is measured in gallons. If a storage battery is said to have a capacity of 20 amp. hr., it means that the battery is theoretically capable of delivering a current of 20 amperes for one hour, or 1 ampere for 20 hours, or any like quantity. When the battery is recharged after being completely discharged, an amount of electrical energy must be put back that is equivalent to the amount that was taken out by the circuit to which the battery was formerly connected. In other words, if a completely discharged 20 amp. hr. storage battery is connected to a trickle charger that delivers a current of 0.4 ampere, it will take fifty

hours to fully recharge the battery. This is true theoretically, but practically there is a slight variation due to electrical leakage within the battery.

Trickle chargers for use with radio storage batteries can be designed to charge batteries at almost any reasonable rate. The ideal charging rate is naturally one that, during the hours when the set is not being operated and the battery is on charge, will put back as much electrical energy in the battery as was used by the receiving set during the hours of operation. This ideal state of charge and discharge is one that is difficult to maintain. Naturally, it is not practical to build trickle chargers on a commercial scale that will maintain this even balance of charge and discharge; as the amount of current drawn each day from the storage A batteries by different receiving sets varies widely, for it depends upon the number and type of tubes used, the number of hours the receiving set is operated each day, and many other things.

So the manufacturers construct trickle chargers having a rate that is a trifle too high, rather than too low, so that it puts back slightly more electrical energy in the battery than was taken out when the set was being used. This overcharging is better than undercharging.

After the battery has become fully charged, the extra current heats and decomposes the water and electrolyte into bubbles of hydrogen and oxygen. The bubbles are of gas surrounded by a thin film of electrolyte and water. These minute bubbles rise to the surface of the solution and break, causing a fine spray. It is this spray that wets the top of a battery when it is being charged and corrodes the battery terminals. When these bubbles are rising in considerable numbers to the surface of the solution in a battery, there is a distinct odor of gas, and the battery is said to be "gassing."

Some makes of trickle chargers have *High*, *Medium*, and *Low* taps for corresponding rates of charge. If the battery remains fully charged all of the time and does considerable "gassing," it indicates that the charging rate is too high for the amount that the set is operated, and the *Low* tap should be used until this condition is remedied, or until the set is used more hours per day.

Many makes of lead-acid storage batteries are now built into transparent cases and have small colored balls floating in the battery solution to indicate the state of charge of the battery. In some batteries there are two of these

(Continued on page 51)

The Mysterious Mr. Hankins

By Volney G. Mathison

"HANKINS, HANKINS, all I hear is Hankins!" exclaims Old Kid Blennerkem, big boss of the Pacific radio tube trust. "Who the hell is this eely tube-bootlegger of a Hankins, anyway?"

"I never heard of him, Elder," I replies, loungin' back in one of the radio king's huge leather chairs, an' gazin' placid-like through one of the big open windows of his fortieth-story office-hang-out at the sparkling beauty of San Francisco Bay, which looks like a great bowl of shining silver set among the city-studded California hills. "Just one more insignificant flea, I suppose, on th' fat tummy of th' world's greatest vacuum-tube plutocrat. Why worry about a little bug? Live, an' let live; that's my motto."

Old Kid Blennerkem sticks out his long dog-faced jaw at me; and his pale china-blue eyes looks real unhappy.

"'Member, Elder, you was a kind of one-horse radio-junk bootlegger, yourself, back in 1913, when you were makin' tomato-can rectifiers and window-glass sendin'-condensers fer our brother hams, an' wonderin' where your next month's rent was comin' from; while I was gettin' rheumatism of th' ear-drums bangin' th' old straight-gap spark on my careenin' lumber-hooker, *Yosemite*, fer thirty beans a month. Now, it's th' glad year of 1922 A. D.; radio is rampant an' you are dishin' out carloads of these little silver-colored glass bottles with a patch a' tin in 'em, at six-fifty a throw---

"Insignificant flea! Little bug!" exclaims Old Kid Blennerkem, huffy-like. "I tell you, as sure as your name's Samuel Jones, that this bird Hankins is the biggest flea *you* ever saw! How'm I going to hold up the retail price of tubes at \$6.50, when he is sticking his tubes all over town at four dollars—pretty good ones, too! He has no license; and he owns no patents; and he does business in the basement of an old tenement house over in Oakland that faces on three alleys and has about a hundred doors in it. As fast as we get out an injunction to lock him up behind one door, he showers out his tubes through some other one. He's a sort of vacuum-tube volcano with thirty craters. And he changes the name of the outfit, like a chameleon does his colors. He's been the Great International Thorium Refin-



"I've come to work here as a typist."

eries, the Blue-Goose Tube Corporation, and this morning he is the Honkatron Laboratories of America. But the president and general manager is always Hankins. That damned Hankins!"

"Ahem, he must be a slick potato," I remarks, casual-like. "What kind of a lookin' gooney is he?"

"My stars, that's what I'd like to know!" busts out my old sidekick, wild-like. "I've had four private detectives on the payroll for the last dozen weeks; and they haven't even been able to get a look at his coat tails! We've got court summons galore for him; but we can't find him! We've been in his dungeon of a basement time and again, but there's never anybody in there but a little old snarling silvery-whiskered bantam, who claims he is the tenement landlady's janitor, and a long, lanky, hatchet-faced young fellow with towled red hair, who is always sitting on a packing case, half asleep, and says he is waiting for Hankins to come in, so he can ask him for a job. Says his trade is a plumber. Plumbing will be a lost art, before he ever finds Hankins. What would Hankins want with a plumber, anyway, I'd like to know?"

"Maybe he figures Hankins could use a plumber on his tube-making machinery," I observes, helpful-like.

"But there isn't a tube-making machine in the confounded place!" fumes Old Kid Blennerkem. "The infernal tubes come from nowhere out of the middle of the night, in big trucks—tens of thousands of them!"

Blennerkem mops his face with his big white silk bandanna.

"Sammy," he continues, reachin' over

across his desk an' clutchin' me by the arm. "Sammy, I want you to get this fellow, Hankins. You've been in all the bootleg-tube factories in New Jersey and made yourself famous from the Balkans to Kansas City with your stories in the Mazerka Magazine showing up the crooked doings of these gyps. I'll give you a hundred dollars a week and expenses."

"Ahem," I says, kind of unenthusiastic-like. "It looks like a deep, hard case; an' I've got a lot of irons in th' fire, just now. Give me a check for six weeks' pay in advance, an' about a thousand for preliminary expenses, an' I'll take a look at it. I ain't guaranteein' I can do nothin'. This Hankins—"

"Yes, this Hankins!" echoes Blennerkem, with a wail. "I'm dropping tubes to five dollars Saturday midnight, on account of him. Say, your terms are pretty stiff. A thousand dollars for expenses!"

"I'll need it," I snaps, short-like. "Microscopes . . . telescopes . . . dictographs . . . radiophoto machines . . . an' cartons of chewin' gum to stick around to catch fingerprints. This Hankins—"

"Yes, this hulking devil of a Hankins!" chimes in Blennerkem, an' he pushes a button for his cashier.

IN a couple of hours, I am over in the hangout of the Honkatron Laboratories of America. Lettin' myself into a small room in the middle of the basement, with a private key, I finds my grouchy little old janitor and right-hand bower up to his ears in orders and invoices piled all over a big empty breakfast cereal box, which serves as his desk.

"Look here, when I used to work for a regular tube-bootlegger in Newark, I

didn't have to do six men's labor!" he snarls at me, through a brown spray of tobacco juice. "Here's orders enough to keep Sears Roebuck busy for a week! An' McGurk wants his wages raised, again. Umph! Why don't you stay around some?"

"Ahem," I says, "I've been out raisin' a little capital. An' I've got rid of all them private gumshoes that been clumpin' around out in our alley, lately—I got their job myself."

"Umph! If you ain't no better secret agent than you are a tube-bootlegger, you won't be able t' keep track of your own hat!" snarls the Grouchy Gopher, real sarcastic-like.

"Yeh?" I retorts, kind of irritatedly. "I learned enough investigatin' tube-bootleggers to get 'em all closed up, an' then go into th' business myself. Listen, Old Kid Blennerkem is cuttin' to five dollars Saturday midnight. We'll have to come down to three—an' make a rebate to everybody who bought in the last thirty days."

"Rebate!" yells th' Grouchy Gopher, glarin' at me, ferocious-like. "Look here, when I used to work for a real tube-bootlegger in—"

"We got to protect our dealers," I interrupts him, grumpily. "This ain't no gyp outfit."

"Umph! You're goin' straight to th' pore-house!" snarls th' Grouchy Gopher. "Where do you want th' next carload of tubes from Newark to come to? The last was to Coyote, on the Santa Fe. It was a long ways for the trucks to go after 'em."

"Make th' next shipment to Vallejo Junction, on the Southern Pacific," I suggests. "There's a nice boulevard out that way."

"Umph! We got orders today from th' District Court to stop doin' business as th' Honkatron Laboratories of America. What'll our name be, tomorrow?"

"Ahem," I says, thoughtful-like. "Let's make it th' Independent Electronic Valve and Vacuum Corporation, Limited."

"Or th' Bankrupt Tube-Bootleggers, Inc!" rasps the Grouchy Gopher, nasty-like.

"Not while I got a job as Blennerkem's private detective, at a hundred dollars a week an' expenses, to go huntin' for myself!" I retorts, shortly, as I reaches for th' door.

Goin' out into my storage an' packin' room, I finds Dumb McGurk, my long, shamblin' hatchet-faced young shippin' foreman, busily ladlin' cartons of tubes into a big case. Upon hearin' my footsteps, he slumps down onto an empty box an' folds his long arms; while his freckled beak takes on a half-dead, sleepy look. Then, seein' it is only me, he gets up again an' goes back to work. "I thought you was one of them snoopin' gumshoes," he says, explanatory-like.

"It's all right to keep in practice with that pose," I replies, encouragingly. "Remember your th' Sleepin' Plumber lookin' fer a job."

"Yes, just as long as that Hankins don't walk in some day an' ketch me like that," he says, anxiously. "I wish't I could see him onc't. I want to strike him fer a raise. You seen him onc't, didn't you—a long, tall, dark man, with a black mustache?"

"Yes—I saw him once," I replies, guarded-like. "Th' time he gave me my job as outside salesman. He's as silent an' invisible as a ghost."

"Gosh!" says Dumb McGurk. "He might be watchin' us, right now!" He makes a grab at a pile of tubes an' slings them into an empty packin'-case, industrious-like.

THREE weeks later, I am again sittin' in one of Old Kid Blennerkem's luxurious leather chairs, smokin' one of his big black forty-cent cigars.

"Two thousand dollars more for expense!" he howls at me, outraged-like. "My stars, what are you doing with all this money?"

"It's a tough case," I replies, leanin' back, weariedly, as I had been drivin' a truck loaded with tubes half the previous night. "I've got to have another gross of magnifyin' glasses—an' a bigger telescope. . ."

"But haven't you seen Hankins, yet?" demands Blennerkem, wildly. "Haven't you even been able to catch a fingerprint of him? He's right on the job every day! He's cut the price of his tubes; and his ads are in all the papers! He's changed the name of the outfit again. . . Thoriated Radio Tube Production Factors of Belgium and Ireland—S. P. Hankins, president. And he's running magazine cuts of *our* tubes, with our trademark scratched off them and his 'Celebrated Yankee Doodle 201-X' in place of it. It's terrible!"

"He's a slippery onion," I agrees. Then, seein' that I've got to encourage Old Kid Blennerkem a little, I chucks my cigar out of the window, an' says, impressive-like: "Say, I've got a clue to Hankins."

The Pacific Coast vacuum tube emperor sits up like a shot.

"You have!" he gasps, excitedly. "Where? What is it?"

"A footprint," I replies, cautious-like. "A strange footprint in the mud, out in the alley behind his dump. I'm sure it's his. It don't belong to nobody else around there."

"My stars, his footprint! What does it look like? Is it long or short, or how? Did you get a plaster-cast of it? But of course you did. . . you're an investigator. You bring it over. I want to look at it. Where have you got it?"

"Ahem, I'm keepin' it locked up in a

safe-deposit vault," I replies, beginnin' to wish I hadn't started this yarn.

"But I want to see it!" insists Blennerkem. "You're doing fine, Sammy. You know, I was going to talk to you about getting an assistant on this case. I have a—"

"No assistants!" I says promptly, sittin' up. "If I got to have an assistant, I quit. A dumb assistant would only spill the beans. I'll get hold of Hankins for you yet. You just take care of my expenses, old dogbeak!"

"But these damned expenses'll ruin me!" wails the tube emperor, shovin' on a button which brings his office boy. "Cashier—check book. This hulking Hankins!"

WHEN I gets back to my hang-out over across the bay, that afternoon, an' lets myself into the Grouchy Gopher's hole. I finds him head over heels in invoices, an' snarlin' like a wolf.

"When I used to work for a real tube-bootlegger in Newark, I wasn't ground to death, like this!" he snaps at me. "Dumb McGurk has been playin' th' Sleepin' Plumber all morning—hasn't done a tap. And no wonder, neither! Just go an' see what's waitin' out there in the packing room! Just go an' look! But if it wants a job, don't you dare hire it! Umph! I don't want it here! Umph! I can do my work, myself. Go an' look!"

Peekin' cautiously out into the packin' room through a little slidin' shutter in th' wall, I gets an awful jolt. On a dusty box, opposite dopey-lookin' Dumb McGurk, is sittin' th' peachiest little black-haired cutie that ever wore a bob-olink dress. Her lips is a waterproof strawberry red, an' she has on lavender silk stream-line hosiery of th' kind you love to—er, I'm mixed up with th' face soap ad, now, I guess.

Real mystified-like, I steps out into the packing room. Instantly, she eats me all up, with her big brown cuddly eyes, an' then says, in a low mocking-bird voice,—

"Oh! Are you Mr. Hankins, sir?"

"Yes—er, that is, I'm th' detective that's lookin' fer him," I replies, kind of floored-like. "I just help out around here some times; dust things off a little an' so on—"

"Hey—remember *I'm* the janitor of this joint!" I hears the Grouchy Gopher hissing from th' other side of th' door, behind me. "Don't you crab my act, you sap!"

"Why," says Cuddle-up, kind of brisk-like. "I've come to work here as a typist. Mr. Hankins has given me a job."

"Th' hell he—er, why, what—" I sputters, clean flabbergasted.

"Psst! Say, if you drew her from an employment office by telephone, you've

(Continued on page 42)

Remote Control By Radio

A Detailed Description of a Receiver Which is Controlled by a Distant Transmitter So As to Operate a Large Transmitter

By G. F. Lampkin

TO the many thrills that come to an amateur in short-wave work may be added another, when he hears a transmitter some half dozen miles away start up, follow his keying, and stop when he stops. And though the object in making an outfit that will do this is not especially to get a thrill, still one gets quite a kick when the thing is working, and it makes a nice tale to tell.

In this particular instance there was a 40-meter, 400-watt, crystal-controlled transmitter at 8CAU; and there seemed no use in building up something as good at 8ALK, especially as the tubes, condensers, antenna system, and a few other items were not to be had at the latter station. The idea was, then, to put 10 or 15 watts into the antenna at 8ALK, send it through a control receiver at 8CAU, and there have it operate relays for controlling the large transmitter.

The purpose at the control receiver is to obtain the maximum change in direct current with a given signal input—this d. c. change to be used to operate a relay. The methods of doing it are almost as numerous as there are kinds of receivers. The most straightforward way would be to rectify the signal at the detector, and amplify this change in current by a "d. c." amplifier. But the B battery expense would be prohibitive.

The next best thing would seem to be an ordinary amateur receiver, autodyne detector, and audio-frequency amplifier, with rectification of the audio frequency in the last stage. The set need not be

elaborate, for neither sensitivity to weak signals nor quality of amplification are important. The wave on which the receiver should work can be settled when it is remembered how the locals used to

150-200 meter band. The wavelength used by the control transmitter and receiver was, therefore, 150 meters.

The circuit for the remote-control receiver is shown in Fig. 1. The dimen-

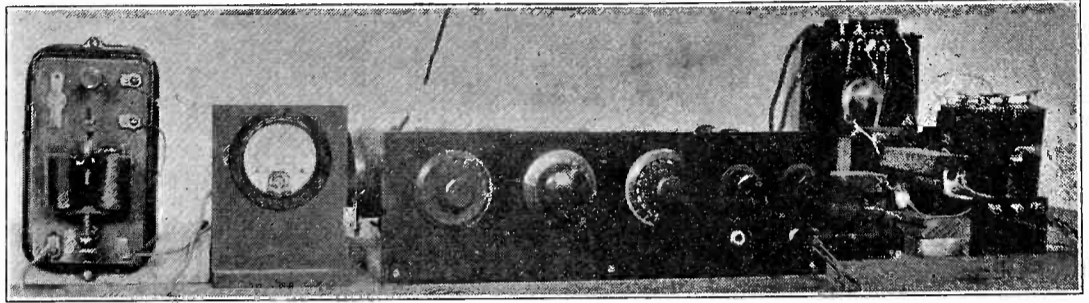

Control Receiver Layout—left to right—Bunnel Relay, Milliammeter, Receiver, "B" Eliminator

ensions of the parts are given for reference. The plate supply was taken from a B eliminator, and the amplifier filaments were lighted directly by a. c. This left only the detector A battery to be

put in on the 150-200 meter band; how the short-distance skip effects are present on the shorter waves; that the wider the gap between the control-receiver wave and the controlled-transmit-

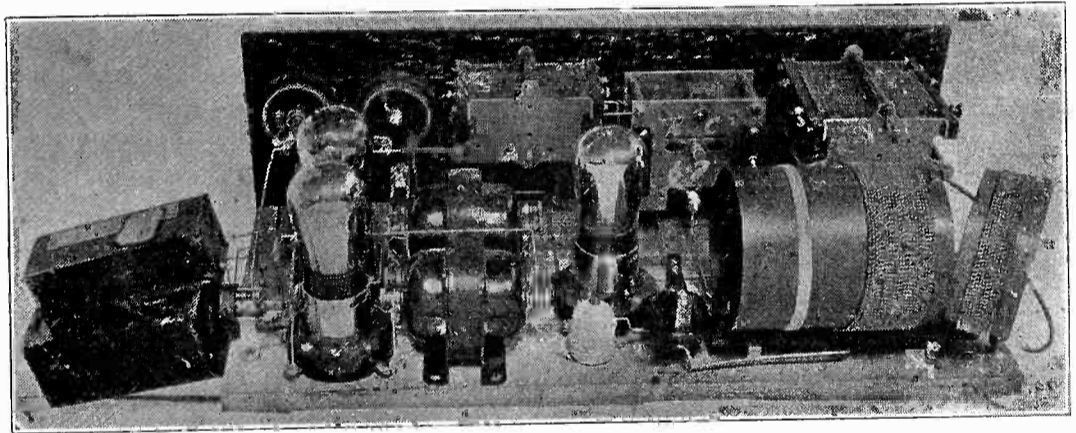

Rear View of Remote Control Receiver

ter wave, the better; and finally, how little interference is experienced on the long-wave band. Locally, at least, the 5- and the 3-4- meter bands are the only ones that are freer from QRM than the

bothered with. The picture of the receiver shows a 201-A in the detector socket; but a UX-199 was used, and the receiver could run for weeks without attention. There was some hum present,

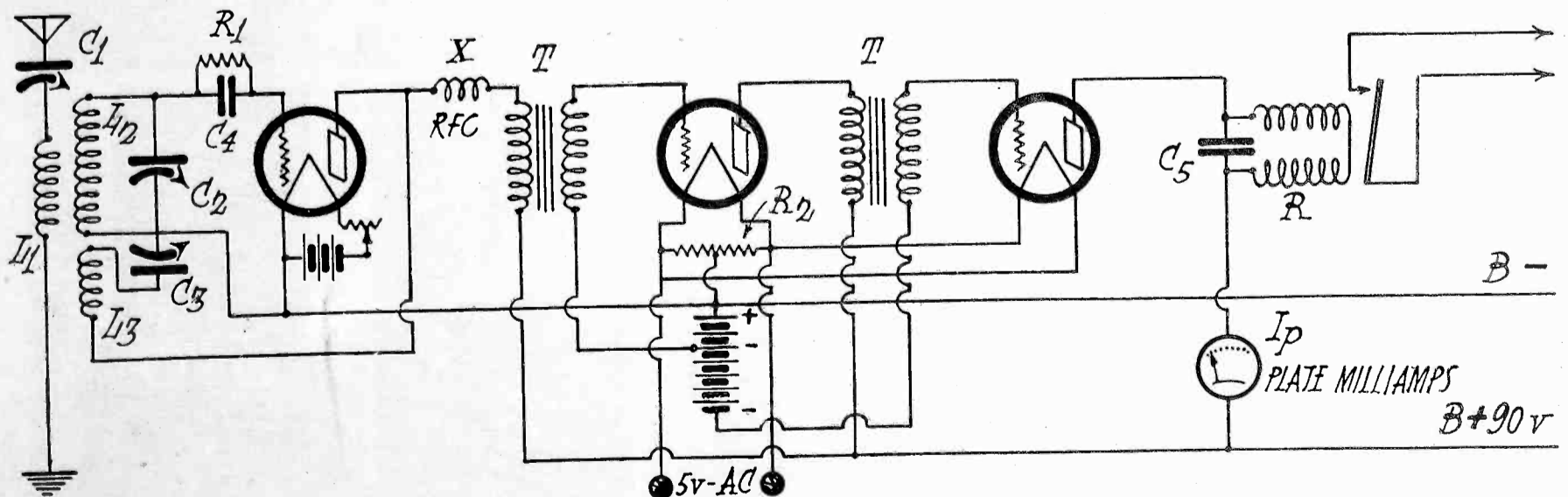

Fig. 1. Circuit for Remote Control Receiver

C₁—.001 mfd.
C₂—.00025 mfd.
C₃—.0005 mfd.
C₄—.0005 mfd. fixed.

C₅—1. mfd.
L₁—10 turns No. 18, 3½ in. diam.
L₂—10 turns No. 18, 3½ in. diam.
L₃—11 turns No. 22, 3½ in. diam.

R₁—10 ohms.
R₂—400 ohm pot.
T—UV-712 transformer.
R—2500 ohm relay.

due to the a. c. filament supply, but not enough to affect the operation of the relay in the receiver output.

In adjusting the receiver to obtain maximum change in the d. c. output, a heterodyne wavemeter was placed near and used as a miniature transmitter. The bias on the last audio-frequency amplifier, or rather rectifier, tube, was increased almost to the cut-off point—that is, till only about 0.1 m. a. plate current was flowing. Then the regeneration condenser was increased a few degrees at a time, and at each point the receiver was tuned through the transmitter wave and the maximum deflection on the plate-current meter read.

The results, shown on Curve No. 1, indicate that the stronger the local oscill-

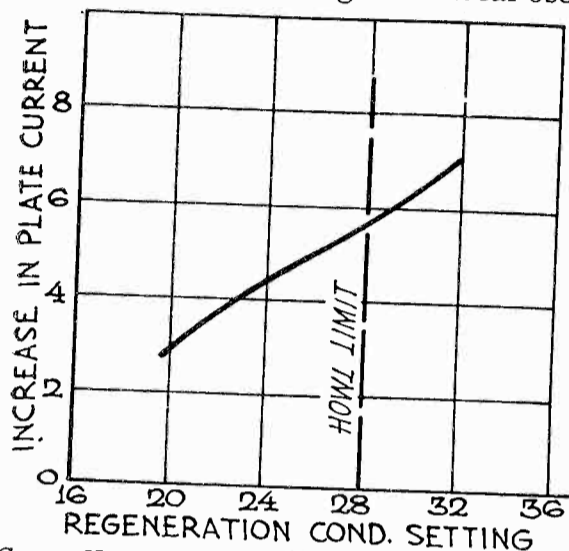

Curve No. 1. Receiver Output vs. Regeneration

lations, the louder the beat note, and consequently the greater the rectified current. However, if the regeneration condenser was turned up too high, the set would howl, and would not stop until the condenser was backed off considerably. It would be fatal for the set to howl when hooked up with the relay system, for the transmitter would be started up and the key held down, until a trip was made to shut the thing off. The dashed line shows the lower limit of condenser setting at which the receiver howled; in all later tests, the regeneration condenser was turned up till the set howled and then backed off until it ceased, to make sure that the setting was below the danger point.

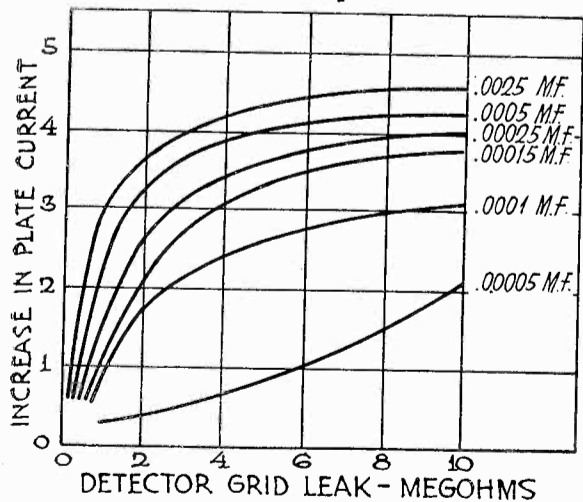

Curve No. 2. Receiver Output vs. Grid Condenser and Leak

Curve No. 2 shows how the size of grid condenser and leak for the detector were chosen. The grid leak was varied

from .5 to 10 megohms, for each size of grid condenser. Obviously, the 10-megohm leak was best, and in the receiver this size was used, with a Sangamo .0005 fixed condenser.

Curve No. 3 shows that it is best to work the last tube, the rectifier, just slightly above the cut-off point, to get maximum d. c. change. The grid bias on this tube was varied, and for each value the increase in plate current, due

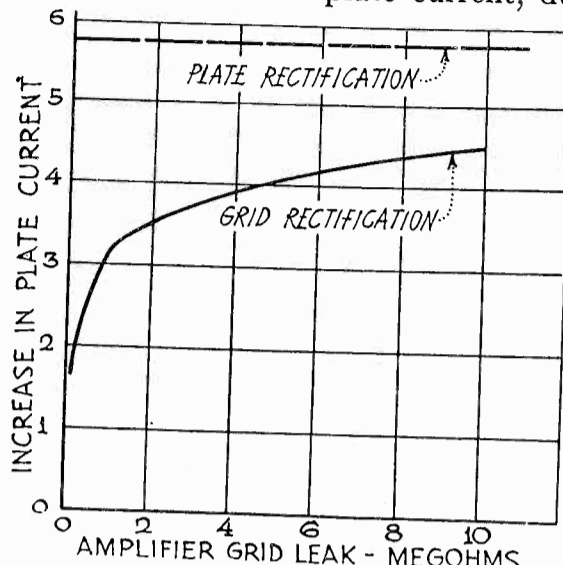

Curve No. 3. Remote Control Receiver Plate Rectification

to tuning through the signal, was noted. This was done for plate voltages of 40 and 62. The curves show the increase for different biases; when compared with the static characteristics, they show that it is best to increase the bias till only a tenth or so of a milliampere is flowing—in other words, to work at the point of greater curvature of the characteristic.

Theoretically, rectification of the audio frequency with a grid condenser and leak should give greater change in plate current than plate rectification, for the input is first rectified at the grid and then amplified in passing through the tube. Curve No. 4 indicates that such was not true, in the present case. The size of the grid condenser had practically no effect on the output; with a condenser of .002 mfd. capacity, the output varied with the value of grid leak

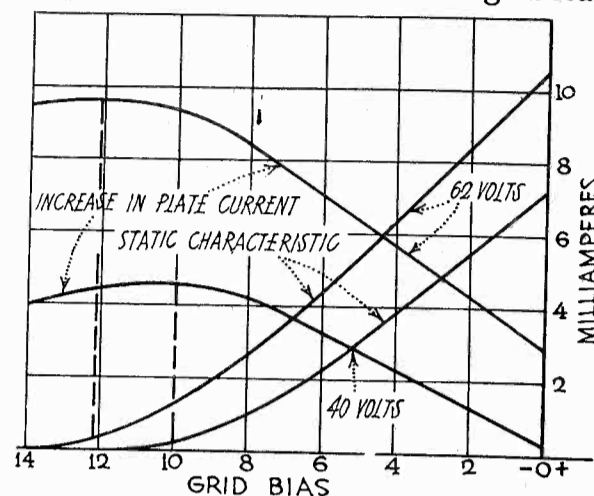

Curve No. 4. Comparison of Plate and Grid Rectification

as shown. But it did not come near the output obtained by plate rectification, with the same signal input. The latter output is indicated by the dashed horizontal line.

The output obtained at the receiver from the signals of 8ALK, 4.5 miles away, was 7.5 milliamperes. This output was used to operate a Bunnell, 2500 ohm, gooseneck relay. The latter is

(Continued on page 54)

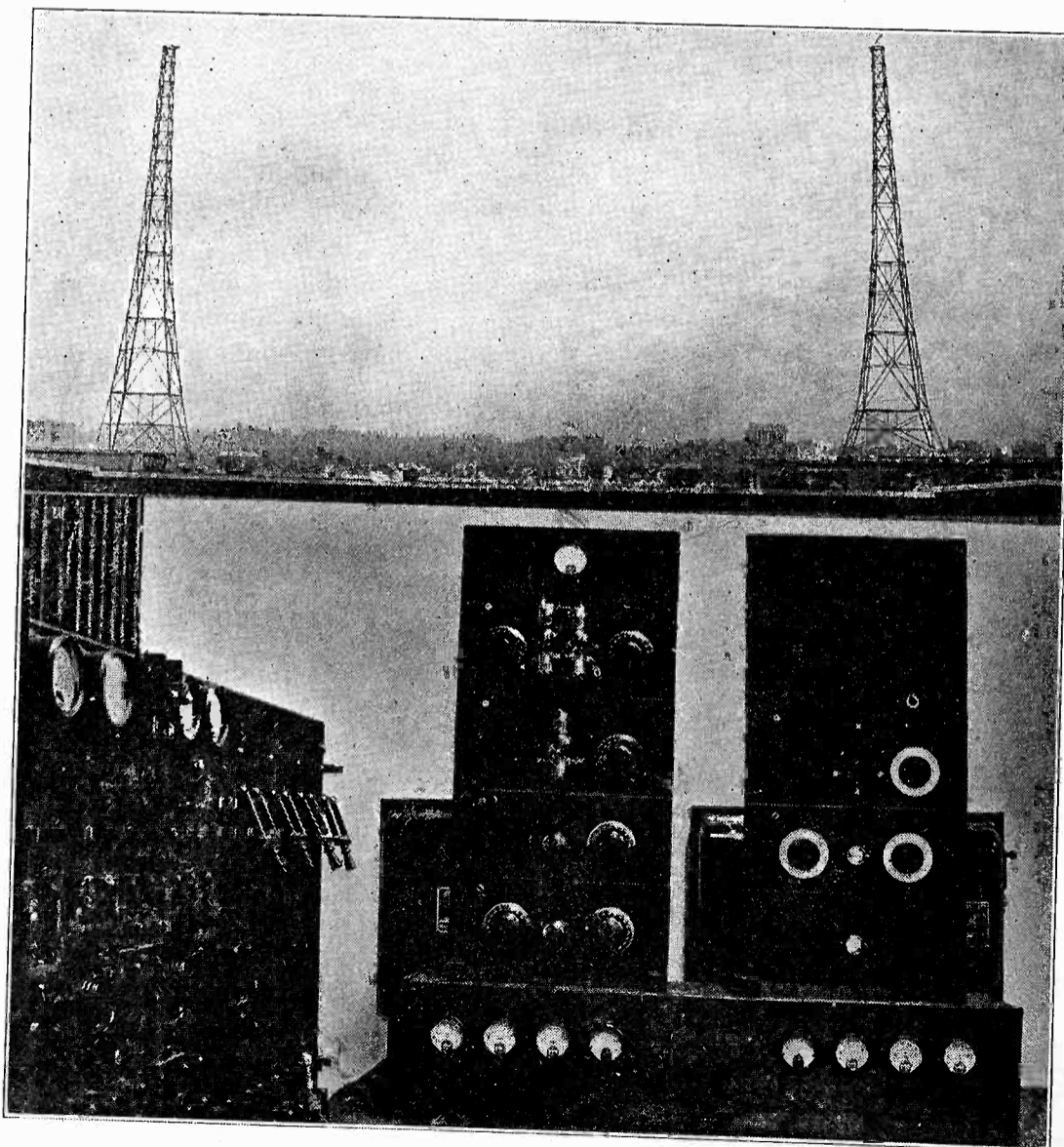

Radio Station 8CAU

A Selective R. F. Amplifier Tuner

Details Concerning the Construction of a Selective Antenna Coupler
For a Superheterodyne

By G. M. Best

THE recent revival of an old method of tuning a multi-stage r. f. amplifier has aroused considerable interest. Ordinarily the tubes are placed between the tuned secondary and untuned primary of two r. f. transformers, tuning being accomplished with variable condensers. When from two to four stages of tuned r. f. amplification are employed, difficulty is experienced from coupling between the transformers and from oscillation caused by unbalanced tube capacities.

This difficulty has been met by several manufacturers who are using a separate tuner ahead of a series of impedance coupled tubes in an r. f. amplifier. It is thus possible with four tubes to secure a selectivity and sensitivity equal to that ordinarily secured with three stages of tuned r. f., and without the usual trouble of neutralization and coupling.

While this application may not appeal to the average experimenter who is able to prevent oscillations, it is of especial value in improving the selectivity of any superheterodyne receiver operated from an outdoor antenna. The model shown in the picture was designed for this purpose, and when used in place of a loop antenna, with a conventional type of 8 tube superheterodyne, the selectivity was increased to a remarkable degree, while the sensitivity was in no way impaired. This will make the new tuner of great value in congested localities where the problem of cutting out the locals and getting distant stations is paramount at the present time with superheterodyne owners, who often find that due to the particular intermediate frequency they are employing, interference is had between stations on the oscillator dial. The only satisfactory way to cure this trouble is to make that part of the circuit ahead of the first detector more selective, and usually a stage or more of tuned r. f. is

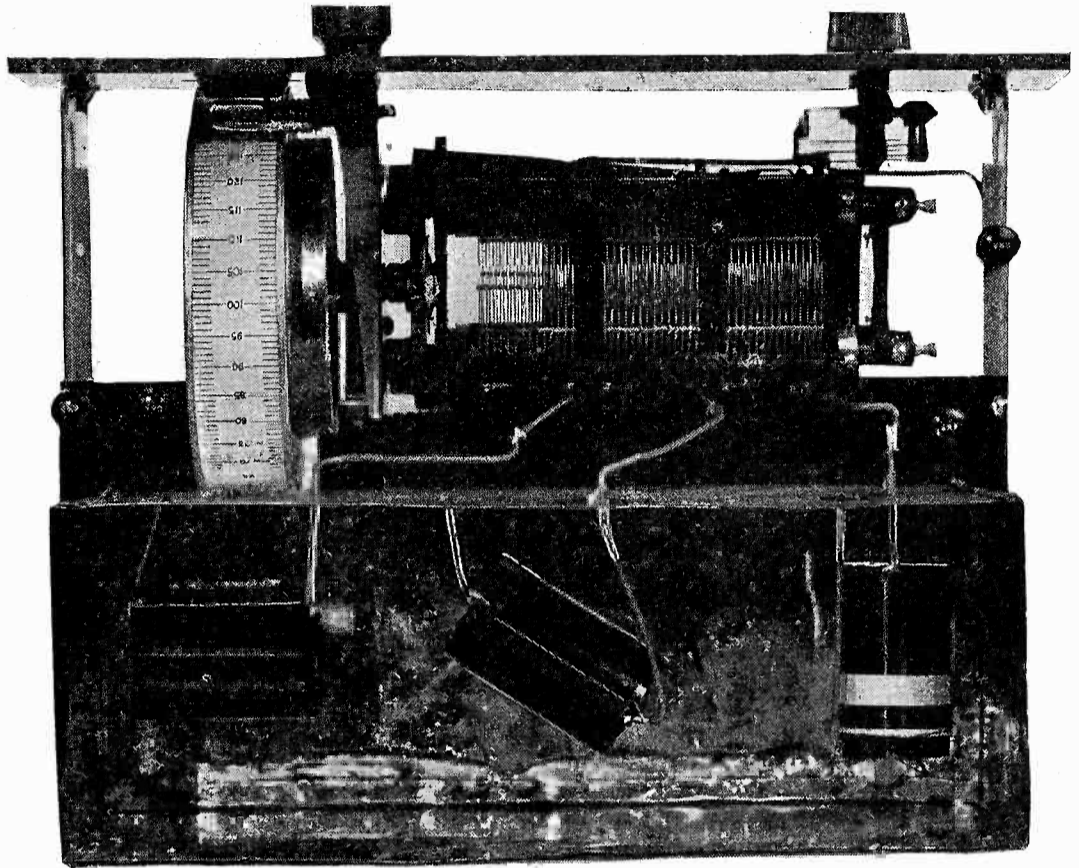

Complete Three Circuit Tuner Assembly

installed to accomplish the desired result.

Fig. 1 and the picture of the tuner show the principle of the circuit quite clearly. It consists of three inductances of identical dimensions, wound on 1 3/8 in. tubing, with 107 turns of No. 27 enameled wire, each coil being tuned by a .00035 mfd. variable condenser. The antenna is coupled to the first coil by an aperiodic winding, which consists of 15 turns of No. 27 enameled wire wound over the 107 turn coil, at one end. The tubing supporting the coil is mounted inside the shield in such a position so that the axis of the coil is vertical with respect to the front panel. The second tuned circuit is placed approximately 4 in. from the antenna coil, with the axis at an angle of 45 degrees with respect to the first coil. The third tuned circuit, which is at 45 degrees angle with respect to the second circuit, is thus at right angles with respect to the antenna coil. Hence, when all three tuned circuits are adjusted to identically the same wavelength, energy from the antenna coil is transferred to the secondary of the first tuned circuit, is then absorbed by the center tuned circuit, and finally absorbed by the third tuned circuit. Naturally, a part of the original energy from the antenna is lost in this transfer. But the combination of the three circuits, the center one being

the intermediate or transfer circuit, produces a resultant selectivity far beyond that obtainable with the ordinary antenna tuner.

The input to the first detector of the superheterodyne, with which the tuner is to be used, is connected across the terminals of the third tuned circuit. This changes the tuning curve of the third coil somewhat, due to the grid-filament capacity of the first detector tube, but this can be compensated for by means of a trimmer condenser associated with the tuning condenser used across this coil. In the new factory built receivers employing this circuit, the third coil has an output winding placed inside the tuned winding, so that it is in effect a tuned r. f. transformer with the primary winding tuned, and the secondary aperiodic, just the reverse of customary practice. The extra output winding may be used, but is not absolutely necessary in the case of the superheterodyne.

In constructing an experimental tuner, a Remler three gang condenser, with drum dial, was mounted on a bakelite panel 7x12x3/16 in., and the three inductance coils were placed in a metal box 11 in. long, 5 in. high, 4 in. wide, in back of the condenser. This box can be made from aluminum, copper or tin plate. The connecting leads from the

(Continued on page 56)

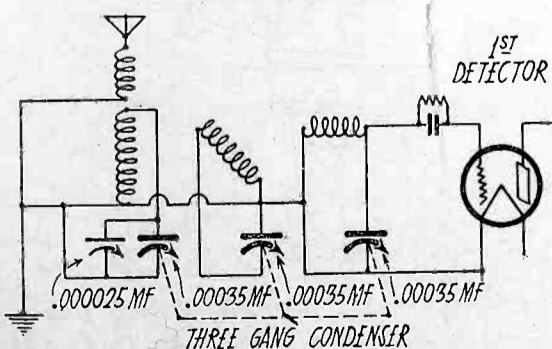

Fig. 1. Circuit and Placement of Coils

The Improved Impedance Equalized Receiver

Whereby Better Quality and Volume Are Secured With High Mu Tubes and "Motor-Boating" is Eliminated by a Filter System

By Francis Churchill

THE r. f. amplification of the impedance equalized receiver described in August RADIO is considerably increased by using high mu tubes as r. f. amplifiers. In this circuit the high mu tubes give more gain with far less regeneration than when the 201A type tubes are used. Consequently the quality is much better, as the actual curves of performance show that there is very much less cut-off on the high frequencies when using the new arrangement.

Since high mu tubes were to be used in the r. f. amplifier and detector, they were used throughout, except for a power tube in the last stage. All C batteries are eliminated and only one B battery voltage is used in order to simplify battery connections. The C battery bias is obtained for each of the high mu tubes through the 1 volt drop in the Amperite filament resistances, and the bias for the power tube obtained from the plate current drop through a series resistance. This resistance is a heavy-duty Centralab variable up to 2000 ohms, so either a 112 or 171, preferably the latter, can be used by simply varying the resistance. Since this resistance R_8 in Fig. 1 is in the common battery lead, it provides a coupling to the preceding tubes so the chances of "motor-boating" are excellent unless precautions are taken.

Most resistance coupled audio amplifiers will howl or "motor-boat" if the B batteries are old or if a B eliminator is used. In order to eliminate two resistance filters, a grid choke instead of leak used in the last stage, and several bypass condensers were used to advantage. The amplifier as shown in Fig. 1 can be

used with any B eliminator that will deliver the required voltage and current. In fact a variable resistance can be inserted in the positive B battery lead and any value of resistance tried, with the same result no motor-boating or howling. Try that on any other type of resistance or impedance coupled audio amplifier and watch it start to "thump." Nor will most transformer coupled sets pass this test.

The two resistance filters consist of R_1 and R_2 in Fig. 1 and the two condensers C_1 and C_2 . R_1 and R_2 are 50,000 ohm grid leaks (metallized) and C_1 and C_2 , 1 and 4 mfd. bypass condensers respectively. The purpose of these filters is to reduce the common plate battery impedance coupling which would provide an undesired feedback voltage. The value of 50,000 ohms is sufficient to work properly and yet does not drop the impressed plate voltages too much. The use of these two filters makes it possible to use the power tube biasing resistance R_8 and so eliminate the usual C battery.

The use of a grid choke instead of a grid leak in the last stage is desirable in order that any plate overload in this tube will not cause the tube to block and start to motor-boat. If the grid does start to swing slightly positive and so take current, an AF choke allows this without the usual audible distortion which would result with a grid resistance. A good audio transformer makes an ideal choke for this purpose since the primary and secondary can be connected in series and so an extremely high impedance results. It will ordinarily be found that the posts marked P and -F should be strapped together in order to

obtain a series aiding arrangement in most audio transformers.

The panel and baseboard layout are nearly the same as in the original receiver so no details are given here. Nearly any arrangement is satisfactory so long as the input and output leads of the AF amplifier are well separated in order to eliminate feed-back.

This audio amplifier gives exceptionally good reproduction, better than the most expensive transformer coupled set. It is only down about 4 or 5 TU between 1000 and 30 cycles which is quite remarkable for a three step amplifier.

The r. f. amplifier does not cut off the higher audio frequencies unless the phase controlling condensers C_3 and C_4 are turned up quite high so that the amplifier is nearly oscillating. This condition gives greater sensitivity but poorer quality.

Actual measurements when using high mu tubes showed a gain of 43 TU in the r. f. amplifier, two stages, as against 26 TU when using 201A tubes with the maximum amount of regeneration allowable with excellent quality. These figures show that the high mu tubes in two stages give more gain than would three stages of the 201A type tubes.

Tuning the antenna circuit, as an experiment, increased the gain between 5 and 10 TU depending on the size and resistance of the antenna system used. This adds a third control and is not recommended except for the super-dx fiend who will do anything to get a few hundred additional miles.

The adjustments of the phase controlling condensers C_3 and C_4 , and the impedance condensers C_5 and C_6 are the same as when 201A tubes are used.

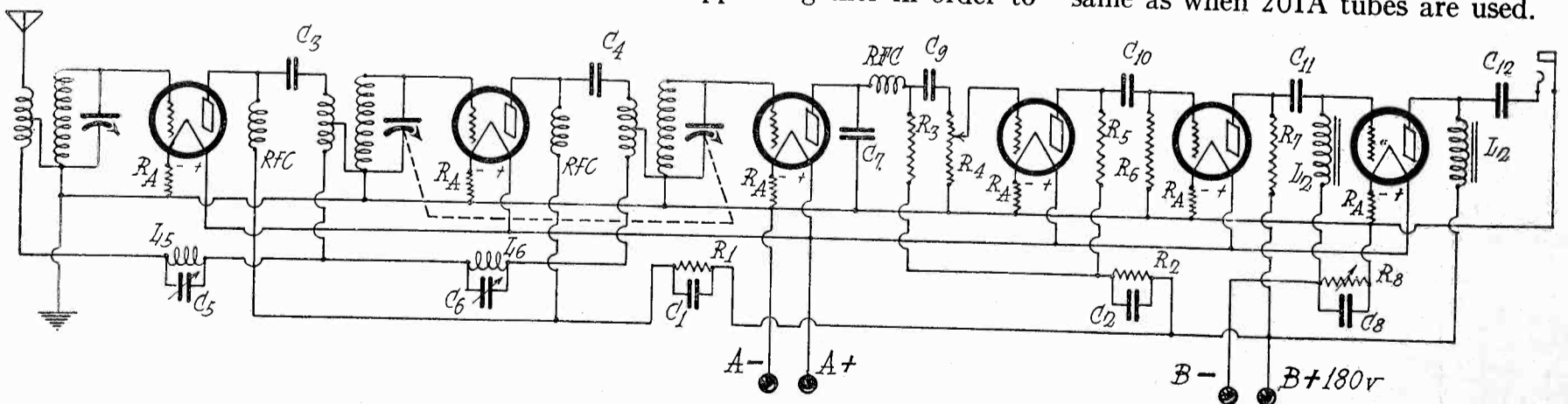

Fig. 1. Circuit Diagram of Improved Impedance Equalized Receiver.

R_1 —50,000 ohm leak.
 R_2 —50,000 ohm leak.
 R_3 — $\frac{1}{2}$ megohm leak.
 R_4 —0-500,000 ohm potentiometer and filament switch.
 R_5 — $\frac{1}{4}$ megohm leak.
 R_6 —2 megohm leak.

R_7 — $\frac{1}{4}$ megohm leak.
 R_8 —0-2000 ohm variable resistance.
 L_1 —a. f. trans. pri. and sec. in series.
 L_2 —30 henry choke.
 C_1 —1 mfd.
 C_2, C_8 —4 mfd.

C_3, C_4 —.001 max. XL variodenser.
 C_5, C_6 —.0005 max. XL variodenser.
 C_7 —.0001 mfd. by-pass.
 C_9 — $\frac{1}{2}$ mfd.
 C_{10} —.1 mfd.
 C_{11} — $\frac{1}{2}$ mfd.
 C_{12} —2 mfd.

RADIO FOR SEPTEMBER, 1927

Experimental Shop Practice

Simple Methods For Measuring Resistance, Capacitance and Inductance

By Samuel G. McMeen

RESISTANCE, voltage, current, inductance and capacitance are the five principal things one needs to know in terms of their respective units when dealing with electrical problems. Let us give first attention to the measurement of resistance by means of meters, as distinguished from the Wheatstone bridge method described in an earlier article.

Put the resistance whose value is to be learned in series with an ammeter and a battery, choosing the latter carefully so that the current will be within the range of the scale of the ammeter, and at the same time will not burn the resistance. Start with a single cell and only a momentary contact. Then put a voltmeter in shunt with the resistance. Read both instruments. Divide the volts by the amperes and you have the resistance in ohms.

In case the resistance is high, a milliammeter may have to be used, which makes only the difference that one must remember in calculating to express the milliammeter reading as thousandths of an ampere.

What we have done is to determine resistance by Ohm's law, which says that the volts (the cause of current), divided by the amperes (the amount of current) gives the ohms (the resistance that limited the current).

An equation of three quantities can be put into three forms, and these three forms of Ohm's law may well be memorized, to save the delay of recasting the first one into the other types when needed:

$$\text{Ohms} = \frac{\text{Volts}}{\text{Amperes}} \quad \text{Amperes times Ohms} = \text{Volts}$$

$$\text{Amperes} = \frac{\text{Volts}}{\text{Ohms}}$$

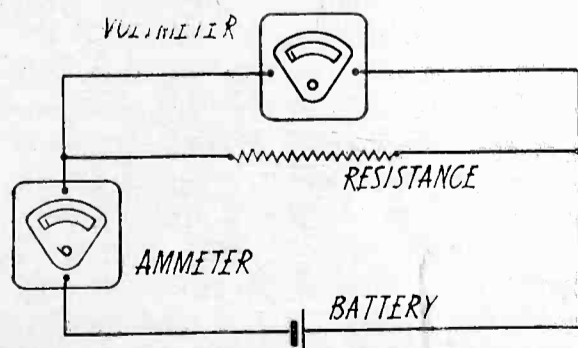

Fig. 1. Measuring Resistance with Voltmeter and Ammeter

In the circuit shown in Fig. 1, the current read by the ammeter is that which passes through the resistance plus that passing through the voltmeter, but the latter is usually very small. For example, with a voltmeter of 10,000 ohms

resistance and a voltage of two volts, the excess ampere-reading would be a fifth of a milliampere, a quantity not readable on the scale of an ammeter and only just readable on the scale of a milliammeter. However, if one wishes to go all the way toward getting the iron-clad facts, he may disconnect the voltmeter at one side while reading the amperes. This will eliminate even the microscopic error just mentioned.

Thus in two readings and one slight calculation we have learned voltage, current and resistance. There remains capacitance and inductance. Let us consider the former.

CONNECT a galvanometer, a key, a battery and a condenser of known value as shown in Fig. 2. The key shall be one having a normally

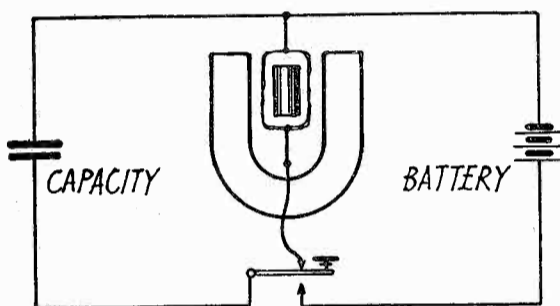

Fig. 2. Measuring Capacitance with Galvanometer

closed and a normally open contact. When the key is pressed the galvanometer is disconnected on one side and the battery and condenser are connected in a simple circuit, thus charging the condenser to the voltage of the battery. Now release the key. The battery is thus disconnected and the galvanometer placed directly across the terminals of the condenser, allowing the latter to discharge through the galvanometer coil, giving a deflection. Read this and record it.

Now substitute the condenser to be tested for that first used, of which the value was known. Charge and discharge as before, again noting the deflection. Then the four things—two values and two deflections—form a proportion, thus: Known capacitance is to desired capacitance as deflection from known condenser is to deflection from unknown condenser. Expressed as an equation it is, where A is the known capacitance, X the unknown, and B and C are the deflections from known and unknown respectively:

$$A : X = B : C \text{ or } X = AC \div B$$

Therefore we have only to multiply together A and C and divide by B to get X . That is, multiply together the unknown deflection and the known capaci-

tance and divide by the known deflection, getting the desired capacitance.

How many cells of battery to use will depend on the size of the condensers. Use a small battery as a test, the requirements merely being that the charge given to the condenser, known or unknown, shall be such as to give a deflection that will stay on scale of the galvanometer.

INDUCTANCE measurements are as simple as the first-described measurement for the determination of resistance, but the calculation is a trifle longer. It involves only arithmetic, however.

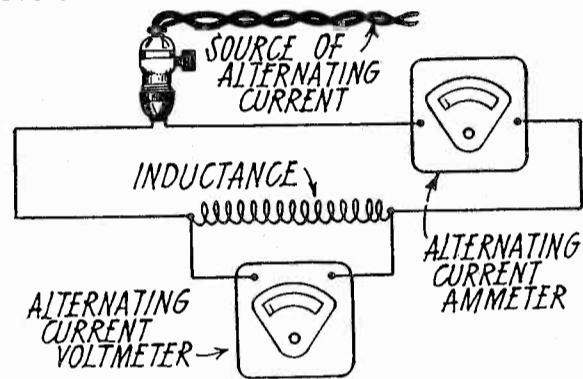

Fig. 3. Measuring Inductance with Voltmeter and Ammeter

Fig. 3 shows the connections of an alternating current voltmeter and ammeter, to measure the impedance of the inductance coil under test. The voltage is supplied from an alternating current source of known frequency. Let us assume that it is 60 cycles. If the voltage is known, the voltmeter need not be used at all. Divide the volts reading by the amperes reading to get the ohms of impedance. Then determine the resistance of the coil by the method shown in Fig. 1 and first described herein. Square the impedance. Subtract the squared resistance from the squared impedance. Extract the square root of the quantity left after the subtraction. You now have the reactance.

To get the inductance, divide this reactance by the product of 2 times 3.1416 times the frequency. The result is the inductance in henrys. If the frequency is 60 cycles, as assumed, then the last-mentioned divisor is 377, and will always remain so with the frequency.

The measurement of high resistances, say of the order 1 megohm (a million ohms) or more, requires a method different from that first described herein, and different from the Wheatstone bridge method, for the reason that in the case of the latter the ratio between the two portions of the bridge is so great that it is difficult to get certain evidence

when the null point, or point of no deflection, has been reached. The volt-meter-ammeter method is unsuitable for such high resistances for the reason that it is difficult to get a suitable deflection on the ammeter through such a high value.

Fortunately, however, there is a method that fits the case. It is a method of direct comparison. The connections for it are shown in Fig. 4. The galvanometer is provided, as shown, with three resistances, either one of which can be put in shunt with the galvanometer coil.

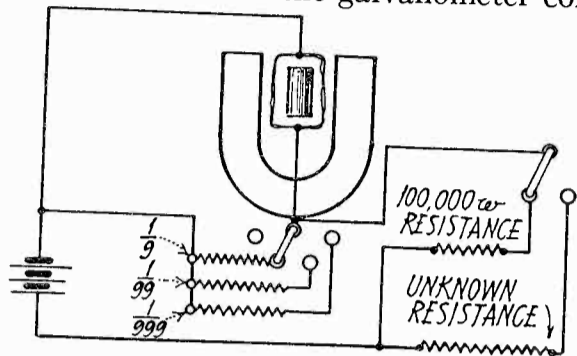

Fig. 4. Measuring High Resistances

These resistance are respectively $1/9$, $1/99$ and $1/999$ of the resistance of the galvanometer coil. Then, if the $1/9$ shunt is used, only $1/10$ of the current that issues from the battery will pass through the galvanometer; with the $1/99$ shunt, $1/100$, and with the $1/999$ shunt, $1/1000$. Therefore the readings will be either $1/10$, $1/100$ or $1/1000$ of the reading without any shunt at all.

There is also provided another resistance, shown in the drawing as being 100,000 ohms, or tenth of a megohm. It can have any high value, but a tenth of a megohm costs enough and does well. Connect it at the switch so that it will be in series with the battery and the shunted galvanometer, and read the deflection given with, say the $1/99$ shunt. Let us assume that the deflection is 120 scale divisions. Remembering that the $1/99$ shunt allows only $1/100$ of the current from the battery to go through the galvanometer, this is equivalent to a deflection of 12,000 scale divisions without a shunt. Now since this is the result through a tenth of a megohm, it would have been one-tenth as much through a whole megohm, or 1200 scale divisions. This 1200 is the galvanometer's constant.

Let us stop and sum all this into a rule of action: *Read the deflection through the standard resistance, with the necessary shunt; multiply the reading by the power of the shunt, (10, 100 or 1000), and also multiply by the fraction of a megohm in the standard resistance.* The result is the constant of the galvanometer, and we are ready to make the final determination.

To do this last step, move the shunt switch to the dead point, so that there will be no shunt on the galvanometer. Move the other switch so that the unknown resistance is in the galvanometer circuit. Record the reading. *Divide the*

constant by it and you have the resistance of the previously unknown coil or object or line.

In case the resistance is not high enough to keep the last mentioned deflection on the scale, use a shunt and use its multiplying power as above indicated to get the equivalent no-shunt reading for the last-given rule.

The classes of work to which the foregoing method is particularly applicable in radio work are the measurement of the resistances of grid leaks, the insulation of antennas, and the insulation of the parts of sets from each other. It is possible to make very effective variable grid leaks by providing a plurality of conducting paths of cardboard soaked in liquid India ink and dried, and made selectable by a switch arm. It is also the method by which the insulation resistance of deep-sea cables is measured. As will be seen from the foregoing, it is adapted to resistances running into the hundreds of megohms if required.

RADIO GUIDANCE FOR AIR PLANES

Development of a radio guiding channel which will enable aviators to keep on a definite course, irrespective of weather or topographical conditions, has been announced by C. Francis Jenkins, of Washington, D. C., as the fourth of a series of inventions which he has recently evolved for the improvement of aviation conditions. The invention is receiving the consideration of some of the leading commercial aviation executives in the country preliminary to the adoption of the plan.

The radio guiding channel is brought about through the installation of a series of radio transmitting stations at intervals of 25 miles over any given course. These make use of short wave lengths. By the use of vertical antenna, of a height and separation bringing them one-half a wave length apart, the waves are radiated in one direction. The use of the short wave length limits the waves radiated by one station to approximately forty miles. The location of the stations causes this directional radiation of waves to overlay somewhat.

The airplane traversing this route is equipped with a simple receiving device which uses the power from this radio-energized channel to light a small indicator lamp on the instrument board of the plane. The aviator, by noting the intensity of this lamp, can tell at once when he is not keeping in the channel, for as he gets off the course, the light from the little bulb becomes dimmer. As he returns to the course, the light becomes brighter.

The constant transmission of radio waves from these stations along the radio channel makes it unnecessary for

the airman to even know the course which he is flying, it is stated.

"The radio guiding channel," Mr. Jenkins explained, "is especially suited to commercial or government uses, such as the air mail, where flying must go on through rain, fog, snow and sleet. The present system of beacon lights along the air mail courses serve their purpose well for night flying in clear weather, but when storms come or fog lowers, these are blotted out to a large degree. Then is when the radio channel guide will be most helpful."

Mr. Jenkins declared that the transmitting stations of his radio channel guiding system could be installed at a cost of about \$250 each, and that they could be located at the same points as the present light beacons, where they could be cared for by the same forces as now care for the beacon lights. The beacon light towers, he said, could also be used for the antennae supports.

"The advantages of this radio guiding channel," Mr. Jenkins said, "include the ability to change the direction of the course, so as to take the airplane through mountain passes or other rough ground.

"Another important advantage is that the channel will serve many planes traveling at the same time. Planes going East, for instance, can fly at 2,000 ft. and planes going West at 3,000. Along with this is the simplicity and automatic character of the transmitting and receiving devices.

"This might be compared with the submarine cable which is used to guide ships coming into New York in a fog, through the use of which ship officers are able to determine whether they are in the proper channel. The great difference is that we do not have to have a cable with its expensive initial cost and right of way. Another difference is that the distance from the ship to the cable is far less than that of the plane from the ground, making the radio channel the better for guiding airplanes.

"The area covered by the radio waves is sufficiently high that the aviator may fly far above buildings, hills and trees which might cause them to crash."

The other devices Mr. Jenkins has recently patented for the improvement of aeronautics include a launching runway which will enable a plane to get into the air in a second's time; a propeller-reversing device which permits a plane to be stopped in twice its own length on landing; and a landing altimeter, which will keep an aviator constantly informed as to the distance of his ship from the ground in gliding to a landing when weather conditions would prevent him from seeing the landing field.

Mr. Jenkins is both an experienced airplane pilot and a radio engineer of recognized ability.

Practical Wavemeter For the B. C. L.

A Simple Instrument For Bringing Tuned Circuits Into Resonance and For Measuring Inductance and Capacity

By B. F. Mc Namee

ANY radio builder can easily construct an inexpensive portable wavemeter whereby the several tuned circuits of a single-control receiver can be brought into resonance for all dial settings. It will also measure inductance and capacity almost as accurately as a much more elaborate instrument. Its construction involves merely the assembly of the several parts listed herewith as shown by the circuit

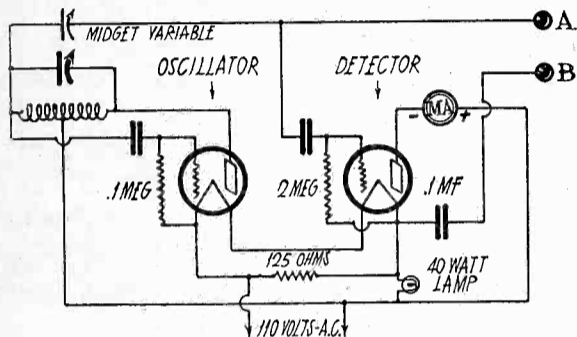

Fig. 1. Circuit Diagram of Wavemeter

diagram in Fig. 1. The arrangement of parts is not important. Filament and plate current is obtained from the a. c. lighting circuit, although batteries can be used if wanted.

The .00035 mfd. condenser should be of rugged construction with rigid plates and without play in the bearings so that its capacity will always be the same for any setting. A large dial is important and a vernier control desirable. The .00003 mfd. variable condenser is of the "Midget" type.

The coil may be wound on any size tubing and with almost any size wire at hand. Bakelite tubing should be used, and the winding center-tapped. Sufficient turns are used to cover the broadcast band with the condenser. The writer used 70 turns of No. 28 D. C. C. copper on a tube 2 1/4 in. in diameter. The completed coil should be painted with lacquer or collodion to hold the wire firmly in place.

It is unfortunate that there is no standard commercial electric light bulb which will pass exactly 1/4 ampere for lighting the filaments of the vacuum tubes. A 60-watt lamp would supply approximately 1/2 ampere for the two filaments in parallel, but this is a dangerous method because if one tube is taken out of its socket or if it burns out, the other tube will take all the current. For this reason the filaments are connected in series, and the current supplied through a 40-watt lamp, which passes about .33 ampere, and the excess current is shunted around the filaments through the 125-ohm fixed re-

- 1 Meter, 0-5 Milliamperes.
- 1 .00035 Mfd. Variable Condenser with Dial.
- 1 .00003 Mfd. Variable Condenser with Pointer or Small Dial.
- 1 Coil, 70 Turns No. 28 D. C. C. on 2 1/4 in. Tubing.
- 2 Vacuum Tube Sockets with 201-A Tubes.
- 1 Porcelain Lamp Socket with 40 Watt, 115 V. Mazda Lamp.
- 1 Fixed Resistance, 125 Ohms.
- 2 Fixed Grid Condensers, .00025 Mfd.
- 1 Fixed Condenser, .1 Mfd.
- 2 Grid Leak Mounts.
- 1 Grid Leak, .1 Megohm.
- 1 Grid Leak, 2 Megohms.
- 2 Binding Posts, ("A" and "B" in diagram).
- Suitable Case and Panel.

sistance. Another combination which will supply the correct current to the filaments is to use a 50-watt lamp and a fixed resistance of 65 ohms. Make sure that the fixed resistance is securely connected to the proper socket terminals before inserting the vacuum tubes.

When all connected up, it should be placed near a receiving set, tuned to some broadcast station whose wavelength is known. Then turn the wavemeter dial until a heterodyne whistle is heard, and set it as accurately as possible on zero-beat or the dead spot between the two heterodyne whistles. This whistle will be accompanied by a loud 60-cycle note, due to the A. C. plate supply on the oscillator. Make a note of the wavemeter dial setting and the wavelength of the broadcast station. Repeat this on as many stations as possible, and then draw a wavelength curve on cross-section paper.

It is possible to check the accuracy of several points on the curve by means of harmonics. Tune in on the receiving set any station below 275 meters wavelength. Heterodyne this station with the oscillator, just as when making the calibration. Let us say that the wavemeter shows the station to be operating on 209 meters. Then turn the wavemeter dial to 418 meters, and a heterodyne whistle should again be heard, somewhat fainter than the first one. This is because the oscillating circuit, when set at 418 meters, has a harmonic at exactly half that wavelength, or 209 meters. If this does not work out exactly, it indicates that either the upper or the lower point of the wavemeter is out somewhat.

To test a single-control receiver for resonance, set its control at any point of the scale, and remove the tubes. The batteries may be left connected, although this usually makes no difference. Place the wavemeter close to the set, and connect a wire from the negative A

terminal on the set to the binding post B shown on the meter diagram. Connect another lead from the wavemeter post A to the plate of the last R. F. tube (next to the detector).

This practically connects the plate coil, or transformer primary, to points A and B. (The path is completed through the by-pass condenser in the receiver.) As long as the secondary is not tuned to the wavemeter oscillator, the primary coil nearly short-circuits the grid and filament of the detector tube in the wavemeter, and the milliammeter reads high. When the secondary is tuned to the oscillator, a high R. F. voltage exists across the primary coil, which is applied to the detector grid, causing a drop in its plate current.

Set the midget variable condenser at maximum. Rotate the wavemeter dial slowly until a sharp deflection downwards is noted on the milliammeter. Now set the midget at the lowest capacity which will give a good sharp deflection that is easily seen. Now note the exact setting of the receiver dial.

Without disturbing the wavemeter, remove the lead from the plate of the last R. F. tube to the plate of the preceding one. Again rotate the receiver dial for maximum deflection, which should occur at exactly the same setting. If it does not, the tuned circuits following these two tubes are not in resonance. The one which requires the higher setting of the receiver dial has either lower inductance or lower capacity (or both) than the other.

The first tuned circuit is measured by putting the lead from post A on the antenna terminal of the receiver. It is usually unnecessary to move the other wire to the ground terminal, as the latter is connected to negative A in most receivers. If the above test is made every 15 or 20 divisions over the dial, and resonance is indicated in every case, the receiver may be assumed to be in resonance at every point.

If the receiver is found to be out of resonance, it may be due to unmatched variable condensers, unequal inductances or unequal minimum capacities.

First examine the variable condensers to make certain that they reach maximum at the same time. If not, it is usually possible to loosen the coupling between the rotors and reset them so that all rotor plates emerge from the stator plates at exactly the same time.

To determine whether the induct-

ances are equal, set the receiver condensers at minimum. This leaves the combined tuning effect of the inductances and the minimum capacities. Now take a small fixed condenser (preferably one of the mica-moulded-in-bakelite type) of about 300 micromicrofarads capacity, and connect it by means of very short leads to the stator and rotor of one of the variable condensers in the set. This can be done with spring clips, and leads about 2 in. long. See that the fixed condenser does not rest on the stator or rotor plates, or on any conductor. Tune the wavemeter for maximum deflection, as before. Then move the fixed condenser to the next variable condenser, and also move the plate lead. The deflection should come at the same point. A higher setting of the wavemeter means a higher inductance. The simplest way to correct unequal inductances is to find the lowest one, and then bring the others down to the same reading by taking off turns from the grid end.

This method of balancing the inductances practically eliminates the error due to variation in the minimum capacities. The minimum capacity of a circuit is the sum of the minimum capacity of the condenser, the capacity between leads, the distributed capacity of the coil, and the effective capacity between the primary and secondary windings. It also includes the tube capacity, but this is very nearly equal in each case, and is omitted in the measurements for convenience. A variation of only a few micromicrofarads in minimum capacities will cause a large difference in tuning of the circuits when the dial is at zero, because here the difference is a large percentage of the total capacity. By adding the fixed condenser to each circuit, this difference becomes a very small percentage of the total, so that for practical purposes we can assume the capacities equal, the condition necessary for balancing the inductances.

Now remove the fixed condenser, and leave the receiver dial at zero. If the circuits do not tune to the same wavelength now, it is due to a difference in minimum capacity. Several sets are provided with a minimum capacity adjustment, and in any case some method must be found to equalize it.

Lastly, turn the receiver dial to various settings, and check resonance. Any variation now must be due to the variable condensers themselves. Bearings out of adjustment, rotor plates not following exactly in the center of the spaces between stator plates or bent plates, are the usual troubles.

The ideal method of building a single-control receiver is to measure the inductances and variable condensers and match them carefully before installing them in the set, and then it will be

necessary to check only the minimum capacities.

To compare R. F. transformers for uniformity, connect them as shown in

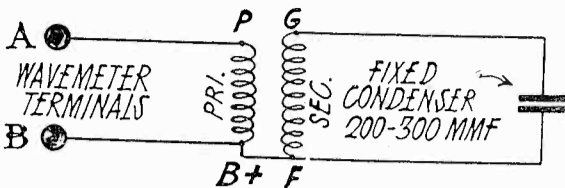

Fig. 2. Connections for Comparing Uniformity of R. F. Transformers

Fig. 2. The terminals A and B are the wavemeter terminals as shown in Fig. 1. Note that the plus B and filament terminals of the coil are connected together. Since the same fixed condenser is used on all coils, the deflection should occur at the same dial reading for all coils intended for one set.

To compare variable condensers, connect an R. F. transformer, such as is used in the receiver, to the wavemeter



Fig. 3. Connections for Comparing Variable Condensers

as shown in Fig. 3. Connect the secondary terminals of the coil with short leads to one section after another of the condenser, and repeat at several positions of the condenser rotor. At each position of the rotor all sections should give exactly the same reading.

It will be found that a very low setting of the Midget condenser is best on the short waves, while a somewhat higher setting is necessary to get a good deflection on the longer waves. Accuracy depends on using the minimum setting consistent with a readable deflection.

Electric light lines or door bell wires running parallel to a transmitting aerial will often pick up a quite heavy current when the transmitter is operated. The amount of current thus absorbed by the electric light wires is just that much energy stolen from the transmitter. This absorption is particularly troublesome on the short amateur wavelengths, because the natural period of the aerial formed by the door bell wires is often the same as the wavelength of the transmitter. Some time ago, the writer found that when the transmitting key of his CW set was closed, an electric light in the garage, about thirty feet away, lighted to nearly full brilliancy. The wires from the house to the light ran parallel to the aerial and directly below it. The current induced in these wires by the transmitter was pure loss. When the wires were put in metal conduit and buried in the ground the trouble stopped; and the antenna current of the transmitter jumped from one ampere to three amperes, after the transmitter had been retuned slightly.

THE EVOLUTION OF MARINE RADIO

By T. M. STEVENS, General Superintendent, Marine Department Radio Corporation of America

Looking back, it seems that marine radio for many years led a staid, dignified and hard-working sort of existence. It got along with the spark transmitter and simple receiver as best it could, even though it might well have cast an envious look landward, where transoceanic radio and radio broadcasting were enjoying the popularity which followed the latest advances in radio engineering. Yet slender threads of communication were established and maintained between ships and shore. Priceless human life and precious cargoes were guarded day in and day out, in the ceaseless stream of vessels over the Seven Seas. Radiograms were hammered out from ship to shore and from shore to ship, to the best ability of the radio operator and at the pleasure of the elements. Then, in moments of grave emergency, marine radio, with such equipment as it had, never failed to rise to the occasion, for there is none braver than "Sparks," the radio operator aboard ocean greyhound or wallowing freighter.

In 1920 the Radio Corporation of America found it necessary to establish a system of coastal stations in order to render prompt and efficient public radio telegraphic service to and from ships. Two-kilowatt stations were installed at New York and Cape Cod. Other spark stations were then in operation, or about to be placed in service, at Cape May, N. J., Babylon, L. I., Brooklyn, New London, Newport, Siasconset, Boston, and Bar Harbor. Shortly after, spark stations were established at East Hampton, L. I., and Rockport, Me. Thus we see that there were no less than twelve spark stations in operation along the coast from Cape May to Bar Harbor. All were operating on only two wavelengths, 600 to 450 meters. Approximately 90 per cent of the traffic to and from ships was handled on these waves. One may well imagine the bedlam of interference to radio telegraphic service caused by so many stations, with broadly tuned spark transmitters, working on two waves!

With the advent of broadcasting and its rapidly growing popularity broadcasters immediately took up channels on both sides of the 450-meter channel of marine radio, and crowded in more and more as broadcasting spread out with its ever-growing list of stations.

A veritable Tower of Babel appeared at hand, while radio broadcasters, for their part, were none too gentle in their comments on the dot-dash messages of marine radio which overflowed the 450 and the 600-meter channels and broke into their midst at the most inopportune moments. But ship operators held a

(Continued on page 60)



QUERIES and REPLIES



Questions of general interest are published in this department. Questions should be brief, typewritten, or in ink, written on one side of the paper, and should state whether the answer is to be published or personally acknowledged. Where personal answer is desired, a fee of 25c per question, including diagrams, should be sent. If questions require special work, or diagrams, particularly those of factory-built receivers, an extra charge will be made, and correspondents will be notified of the amount of this charge before answer is made.

Can a standard output transformer be used as a push-pull output transformer, by some rearrangement of connections? What is the actual difference in output between a pair of type 371 tubes in parallel, and a push-pull stage using the same tubes? Will a Best superheterodyne function satisfactorily with a push-pull amplifier?—M. R., Baltimore, Md.

You can connect a pair of resistances across the output transformer primary, as is shown in Fig. 1a, for use as a

larly on the announcements, and yet come in loud and clear late in the afternoon and evening?—J. H., Healdsburg, Calif.

Probably due to a small amount of fading, which is apparent especially during the announcements, when the announcer has a tendency to speak too loudly, and thus overload or overmodulate the transmitter.

What inductance, capacity and resistance should be used for a power ampli-

mary with a resistance to accomplish this.

Kindly outline a satisfactory method of matching intermediate frequency transformers for use in a superheterodyne.—R. E. A., Berkeley, Calif.

This subject has been covered in past issues of RADIO, but there have been so many questions about this subject that a new circuit has been prepared, Fig. 3, and a short description follows. The calibration apparatus necessary for measuring the peak frequency of intermediate frequency or filter transformers can be one of two types; it can be of the peak indicating type, simply giving an indication of when the peak frequency is located, or it can be of the voltage measuring type, giving the actual voltage amplification of the transformer and tube, as well as the peak frequency. As the latter is quite expensive to construct, and requires access to a laboratory in order to properly calibrate it, the diagram shows only the peak measuring outfit.

It consists of a calibrated oscillator of the stabilized type, an amplifier tube to be placed ahead of the transformer under test, a rectifier tube, and a direct current amplifier tube. The oscillator must give an output absolutely free from harmonics, must be constant in frequency, and must be independent of small changes in plate and filament voltage, so that as the batteries run down, the frequency of the oscillator will always remain the same, for given condenser settings. The oscillator is at the left, in Fig. 3, and consists of a type 112 tube, with 6 volt filament supply and at least 90 volts B battery, with 4½ volts C battery. The two oscillator coils should be of such design that when used with the condensers shown in the diagram, the frequency range of the oscillator will be within the range needed for the transformers under test. As some transformers have frequencies as low as 30 kilocycles, and as high as 300 k. c., a pair of 500 turn honeycomb coils will be needed from 25 to 75 kilocycles, and a pair of 200 turn coils for the range from 75 to 300 kilocycles. A double pole, double throw jack switch may be used to cut out one set of coils and cut in the others. The variable condenser controls the frequency of the oscillator, and when the range of the condenser is not great enough to lower the frequency to the desired value, the fixed condensers are cut in. The plate circuit of the oscillator has an r. f. choke, such as the primary or secondary of an intermediate frequency transformer, so that r. f. is

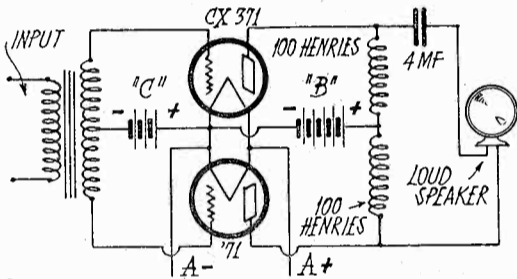
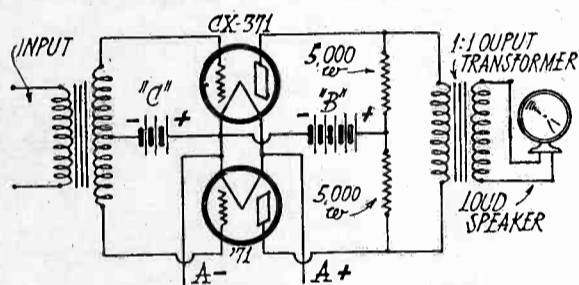

Fig. 1. (a) Push-Pull Output Using Resistance (b) Impedance Coupled Push-Pull Output

make-shift push-pull output transformer. However, it is better to have a center-tapped primary winding as is used in transformers especially designed for push-pull service. Another method of push-pull output is shown in Fig. 1b. and was used in the Radiola Regenoflex several years ago. Two chokes of 25 henrys or more, connected in series, will do in place of the tapped choke used in the Radiola. An output transformer having a 1 to 1 ratio can be connected with the windings in series, to form a center tapped choke, but requires a knowledge of the direction of each winding, for if the coils are connected in series opposing, the results will be nil.

A considerable increase in power output is had with the push-pull arrangement, over that obtained with two tubes having their grids and plates in parallel. In fact, in many repeaters used by the Bell System, a push-pull amplifier having two tubes similar to the type 371, on each side of the push-pull stage is used, with a total of four tubes, in order to have a high power output without using a plate voltage in excess of 150. Two type 371 tubes in a push-pull stage will give approximately the same power output as a type 310 tube with 350 volts plate.

Push-pull amplifiers can be used with any type of superheterodyne, and for that matter, any other circuit using a power amplifier stage.

Why does a certain broadcasting station about 100 miles distant sound mushy during certain times of the day, particu-

larly on the announcements, and yet come in loud and clear late in the afternoon and evening?—J. H., Healdsburg, Calif.

Probably due to a small amount of fading, which is apparent especially during the announcements, when the announcer has a tendency to speak too loudly, and thus overload or overmodulate the transmitter.

What inductance, capacity and resistance should be used for a power ampli-

fy with a resistance to accomplish this.

Kindly outline a satisfactory method of matching intermediate frequency transformers for use in a superheterodyne.—R. E. A., Berkeley, Calif.

This subject has been covered in past issues of RADIO, but there have been so many questions about this subject that a new circuit has been prepared, Fig. 3, and a short description follows. The calibration apparatus necessary for measuring the peak frequency of intermediate frequency or filter transformers can be one of two types; it can be of the peak indicating type, simply giving an indication of when the peak frequency is located, or it can be of the voltage measuring type, giving the actual voltage amplification of the transformer and tube, as well as the peak frequency. As the latter is quite expensive to construct, and requires access to a laboratory in order to properly calibrate it, the diagram shows only the peak measuring outfit.

It consists of a calibrated oscillator of the stabilized type, an amplifier tube to be placed ahead of the transformer under test, a rectifier tube, and a direct current amplifier tube. The oscillator must give an output absolutely free from harmonics, must be constant in frequency, and must be independent of small changes in plate and filament voltage, so that as the batteries run down, the frequency of the oscillator will always remain the same, for given condenser settings. The oscillator is at the left, in Fig. 3, and consists of a type 112 tube, with 6 volt filament supply and at least 90 volts B battery, with 4½ volts C battery. The two oscillator coils should be of such design that when used with the condensers shown in the diagram, the frequency range of the oscillator will be within the range needed for the transformers under test. As some transformers have frequencies as low as 30 kilocycles, and as high as 300 k. c., a pair of 500 turn honeycomb coils will be needed from 25 to 75 kilocycles, and a pair of 200 turn coils for the range from 75 to 300 kilocycles. A double pole, double throw jack switch may be used to cut out one set of coils and cut in the others. The variable condenser controls the frequency of the oscillator, and when the range of the condenser is not great enough to lower the frequency to the desired value, the fixed condensers are cut in. The plate circuit of the oscillator has an r. f. choke, such as the primary or secondary of an intermediate frequency transformer, so that r. f. is

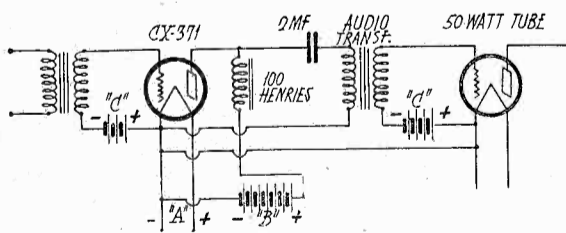

Fig. 2. Impedance Transformer Coupling Between Power Tubes

larly on the announcements, and yet come in loud and clear late in the afternoon and evening?—J. H., Healdsburg, Calif.

kept out of the B battery circuit. The oscillator feedback is through a 1 mfd. condenser and a 100,000 ohm lavite resistance used as a stabilizer, to the plate coil and thence to the filament. The tube sometimes will not oscillate with a resistance as high as 100,000 ohms, so that a lower value may have to be substituted for it. Do not use a variable high resistance, as the calibration of the oscillator will be useless once this resistance is varied. The resistance should be kept as high as possible in order to keep the oscillator free from harmonics. The oscillator output passes through another 1 mfd. condenser, through a 12,000 ohm fixed resistance and a 1500 ohm potentiometer. By varying the slider connected to the grid of the amplifier tube, the energy from the oscillator is amplified to any quantity desired.

The oscillator should be placed in a shielded box, and calibrated. The easiest method of calibration is to connect a two stage resistance coupled amplifier using at least a type 371 tube in the output, to the oscillator output circuit, and to the plate circuit of the power tube connect a 500 turns honeycomb coil. Couple this coil to the wavemeter being used as standard for calibration, and observe the deflection of the wavemeter galvanometer. This keeps the wavemeter away from the oscillator coils them-

made to read exactly $1\frac{1}{2}$ milliamperes. This is considered the zero setting of the meter when the outfit is running, and deflections of the needle will thus be downwards towards zero, when the peak of the transformer under test is reached. A voltmeter is also shown shunted across the series filament connection of the rectifier and d. c. amplifier tubes, but this may be the same meter as is used for the r. f. amplifier tube, by means of a multi-pole battery switch such as the Weston.

The procedure for testing a transformer is to connect it between the r. f. amplifier and the rectifier tube, and after adjusting the plate milliammeter to $1\frac{1}{2}$ milliamperes, turn on the oscillator and advance the output control a small amount. Now move the oscillator condenser dial back and forth until a deflection of the milliammeter needle is noted, this deflection being towards zero. If the deflection is more than $\frac{1}{2}$ milliampere, cut down the output of the oscillator, as it is necessary to limit the amount of oscillator current to the lowest possible value in order not to introduce an error in the measurements due to saturation of the transformer core, if it happens to be of the iron core type. If no deflection occurs, and the oscillator tube is known to be oscillating, the transformer has an open circuited pri-

to the reason for using the d. c. amplifier tube. This type of amplifier was described about a year ago in RADIO, and is used to amplify the plate current of the rectifier tube so that it can be more easily read. With the ordinary A tube used as a d. c. amplifier, and having an amplification factor of about 7, the plate current of the rectifier tube can be less than 100 microamperes, or .1 milliampere, and yet show in excess of .5 milliamperes deflection in the plate circuit of the d. c. amplifier. The reason for the drop in plate current in the amplifier tube is that the plate current of the rectifier, in flowing through the grid leak at the input of the d. c. amplifier, produces a voltage drop across the grid leak and hence changes the C voltage on the amplifier tube, increasing it so that the plate current decreases. If this amplifier tube was not used, the .1 milliampere plate current flow in the rectifier tube plate would be difficult to read with a $1\frac{1}{2}$ mil. scale milliammeter, and the input to the rectifier would have to be increased, with possible saturation of the transformer being measured, and errors in the results.

Could I use the new Raytheon $2\frac{1}{2}$ ampere cartridge in place of the bulb in my present battery charger?—E. J. M., Oakland, Calif.

Yes, as long as the transformer you

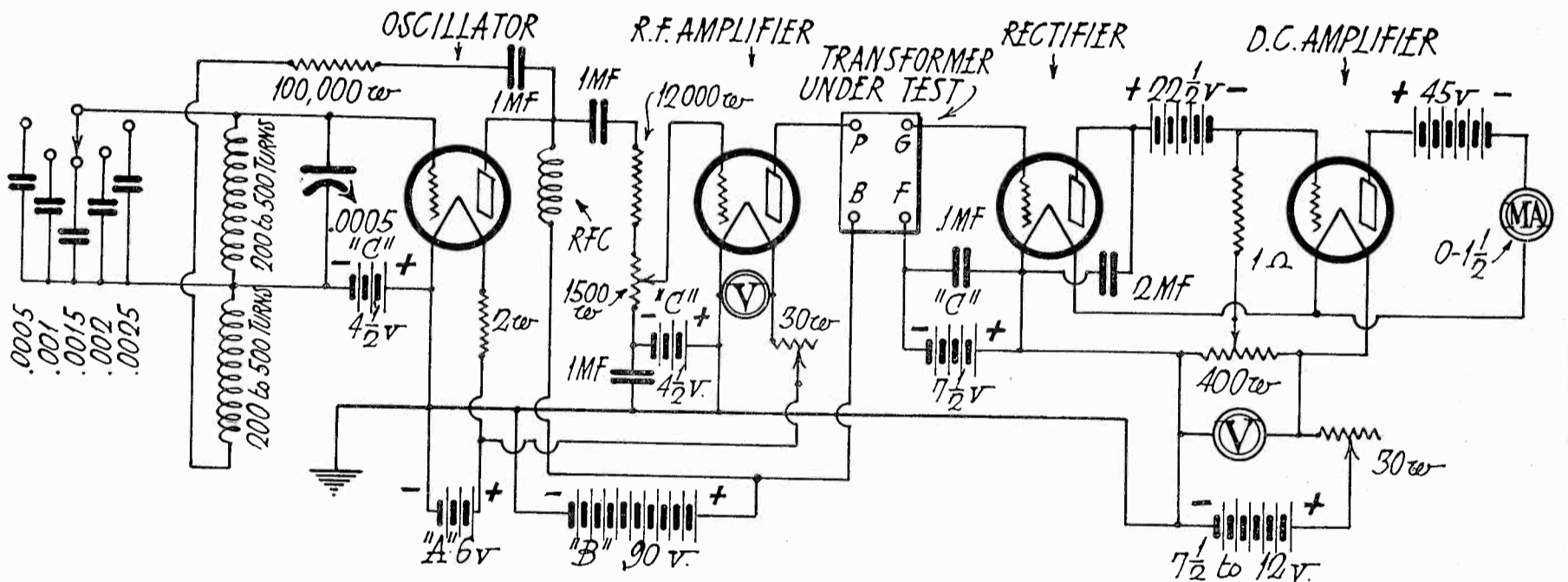

Fig. 3. Circuit For Measuring Peak Frequency of Transformers

selves, and prevents any change in frequency during the measuring work.

The amplifier tube following the oscillator, in Fig. 3, should be which ever type is to be actually used with the transformers to be tested. The same is true of the rectifier and d. c. amplifier tubes. If the transformers were designed for type 99 tubes, use that type in all three sockets; if for type A tubes, use type A tubes throughout. The amplifier tube filament is adjusted with a 30 ohm rheostat and a low range voltmeter, so that it will be in proper operating condition. The rectifier tube has $22\frac{1}{2}$ volts plate, from a separate B battery, and a C battery adjusted so that with no voltage being fed to the grid from the transformer under test, the plate current of the rectifier will be zero. The d. c. amplifier tube has a 45 volt B battery, separate from the others, and as will be noted in Fig. 3, has its filament in series with that of the rectifier. A milliammeter having a $1\frac{1}{2}$ milliampere scale is connected in the plate circuit of the d. c. amplifier tube, and by adjusting the slider of the 400 ohm potentiometer, the plate current is

mary. With a good transformer, however, the milliammeter will gradually drop $\frac{1}{2}$ milliampere or so, so that when the oscillator condenser is varied back and forth across the peak frequency of the transformer, the exact peak can quickly be determined. With an intermediate frequency transformer, this will require moving the oscillator over a band of perhaps 10 to 15 kilocycles to determine the exact peak, but with a filter transformer, this peak will be very sharp, and the needle of the meter must be watched closely to locate the point with accuracy.

One very important point to watch is the amount of oscillator current being fed into the amplifier tube ahead of the transformer under test, as stated above, and to check this point, temporarily remove the connections of the milliammeter, after a satisfactory deflection of the needle is had, and place the meter in series with the grid of the amplifier, next to the oscillator output. If grid current, even as small as .1 milliampere shows, the tube is being overloaded, and the energy input should be reduced.

Several questions have been asked as

have is provided with taps to adjust the secondary voltage to the right amount for the charging current you require.

BOOK REVIEWS

"The Law of Radio Communication" by Stephen Davis; 204 pp. 6 by 9 in. Published by McGraw-Hill Book Co., New York City. Price \$3.00.

A lawyer, like the law he serves, is ruled by precedent. As radio is unprecedented in many of its phases, the lawyer necessarily bases its precedents upon similar but not identical cases in other lines. Until the courts decide sufficient radio cases, there is no law concerning it. But a man with the legal experience of Judge Davis, combined with the knowledge gained during his years as acting head of the radio activities of the Department of Commerce, can intelligently forecast its probable trend.

Judge Davis here interprets his ideas of what the law will be. His interpretation is sound and thorough, as a resume of some of his opinions will show: An electrical impulse does not constitute trespass of private property. Yet it is subject to Federal regulation where it causes interstate interference or becomes of

(Continued on page 59)

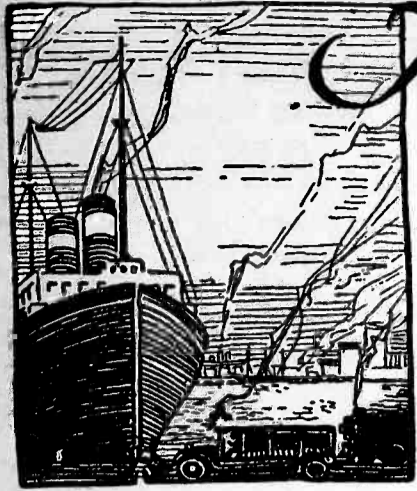

R. O. KOCH, *Great Lakes Correspondent*

GOING UP

Judging by the rapid strides of Aviation, and the world-wide enthusiasm and interest shown in this means of transportation, a new and more exciting field is soon to be opened to the brasspounder. Commander Byrd and his party, in their flight to Paris, established and maintained almost as good a QSO as the majority of ships which make that run. Smith and Bronte not only held communication from San Francisco to Hawaii, but were surprisingly successful in their use of radio as an aid to navigation.

The time has come for aviators to rely on radio communication. Larger planes are coming into use, making room for the radio operator; longer trips are being taken, making communication necessary; and, within a very few months, we shall see the United States following in the tracks of the European countries, establishing passenger service all over the country if not to all parts of the world. Radio will play its part in the development of this science. Just as it came to play an important part in marine transportation so will it be called upon to aid in the harnessing of the air. Keep your eyes on aviation, fellows. And if any of you who read this are already connected with that branch of radio service we'd appreciate it if you would keep us informed as to the progress of radio "aloft."

The COMMERCIAL BRASSPOUNDER

A Department
for the Operator
at Sea and Ashore



Edited by P. S. LUCAS

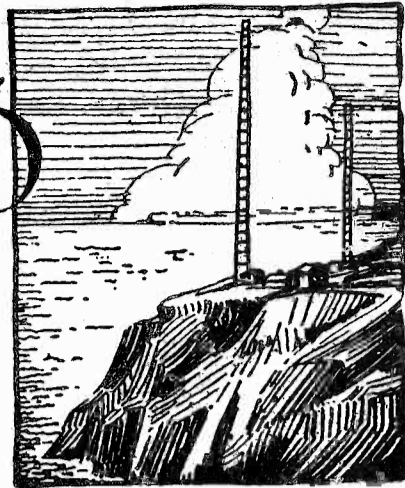

C. WILLIAM RADOS, *Boston Correspondent*

PLUG-IN-COIL "MICKY DORAN" SHORT WAVE ADAPTER

By FOREST RITZ

Micky Doran's article on Pacific Short Wave Press, which appeared in November Radio, and his description of a short wave adapter for reception of short waves, inspired the immediate construction of the herein described adapter, using the same basic circuit.

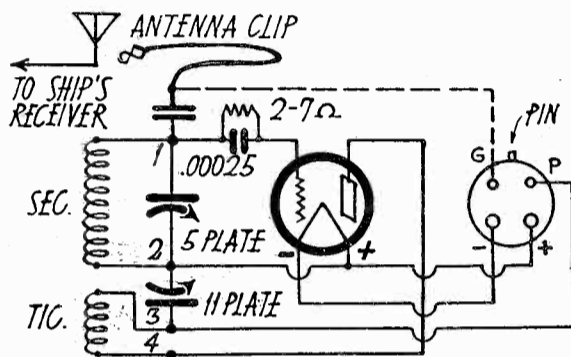

Circuit Diagram of Short Wave Adapter

The circuit diagrams and drawing of baseboard layout, and coil mounting system, show most of the details of construction. However the layout of parts is merely tentative, and the constructor should arrange placement to suit the requirements. It is suggested that the tube socket be placed on the side next to the receiver, so as to keep the cord out of the

field of the SW coils as much as possible. In fact the mounting of the coils at the top of the adapter at panel height, has been found, by comparative experiments, to be the best for that reason, thereby keeping energy absorbing articles out of the coil field.

The cost of construction of this adapter is slightly higher when plug-in coils are used. But if the constructor winds his own coils, the additional cost of coils and mountings

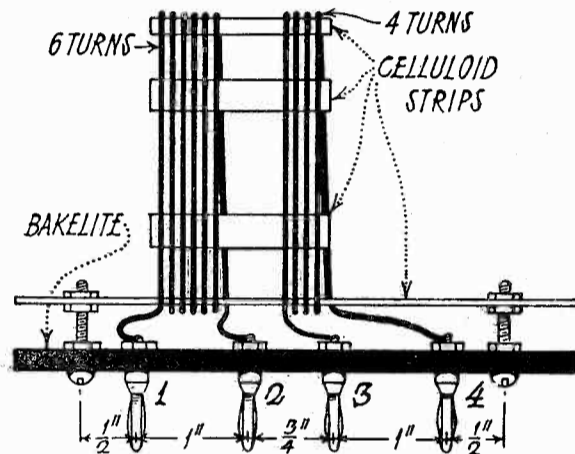

Coil Mounting System

does not amount to much. Doran suggests Kress Store parts to be used. If saving in cost of building is desired that is OK. But in short wave work too much stress cannot be laid on the necessity of low-loss parts. It is recommended that a good grade of grid condenser and tube socket be used. If Kress 1 buck variable condensers are used, don't fail to pigtail them, between the rotor and rear end plate. The secondary tuning condenser should be taken apart and reassembled, using 3 stator plates and 2 rotor plates. With a vernier dial this number of plates is easy to tune, and a greater wavelength range per coil is obtained than with a 3 plate variable.

All connections must be securely soldered, and care should be taken that it is a "hot solder job," and not a "cold solder job." A spare tube being available here to use for keeps in the adapter, it was soldered into a "Pyrex" UX type socket, and then mounted on a small rubber sponge in such a way to absorb vibration. It is practically impossible to get a tube that is not microphonic on short waves, and anyone knows how the average ship's radio shack vibrates. So some form of non-microphonic tube socket mounting is the answer. Number 14, round tinned copper busbar is as good as anything for wiring the adapter.

Hard rubber or bakelite is OK for the panel. However if none is available, a thin piece of box lumber may be used. This was done here, and has served very well. After cutting to size and sand papering smooth, it should be well shellaced to make it "damp" proof. Then reinforce at each end with narrow strips of the same material, to guard against the panel splitting, and to straighten any prevalent warp. It is a good idea to shield the back of the panel with thin copper sheeting. The rotors of both variable con-

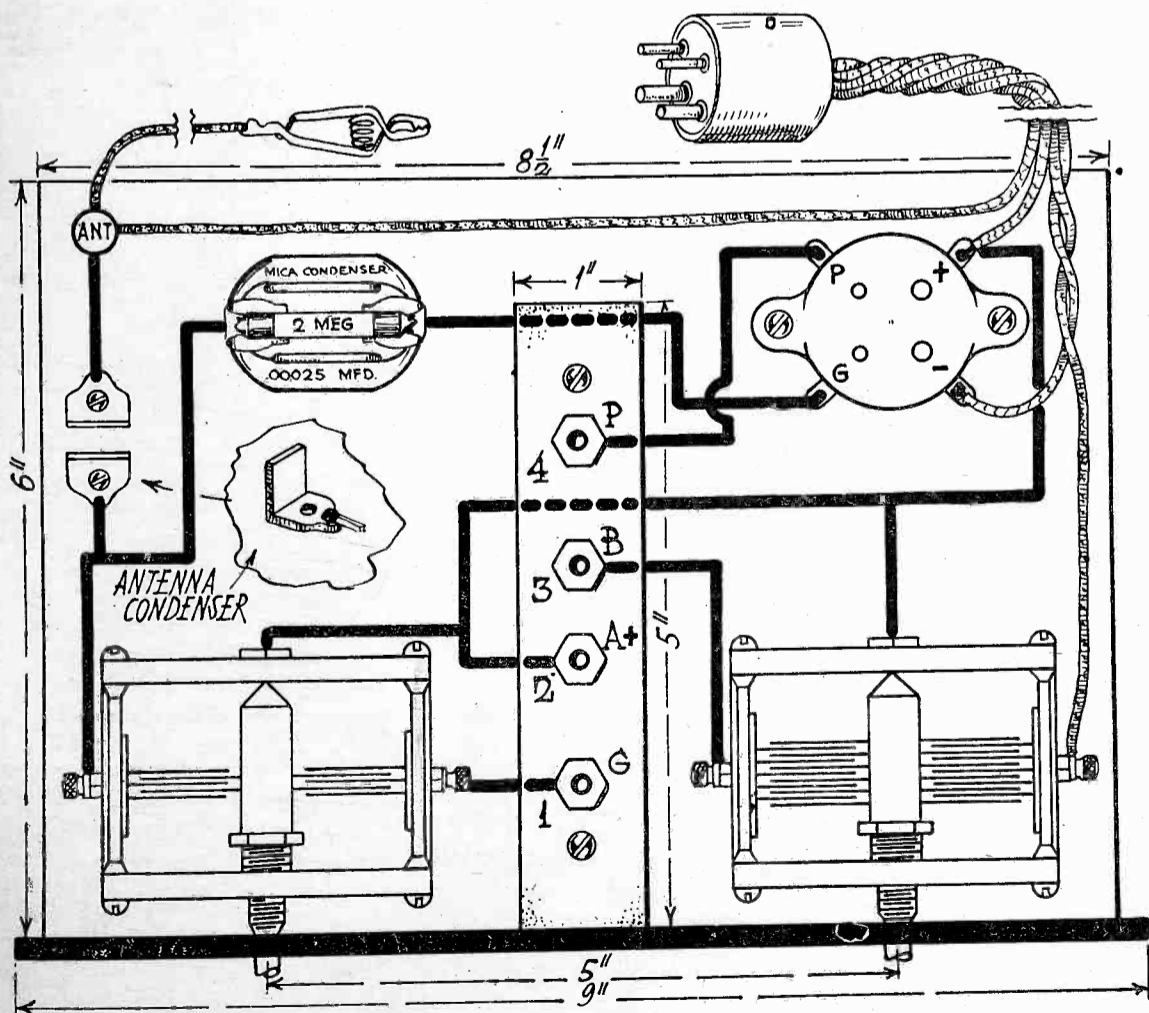

Baseboard Layout for Short Wave Adapter

With the Amateur Operators

CLICKLESS HIGH POWER DC TRANSMITTER

By DON C. WALLACE NU-6 A.M.

With a small transmitter it is quite simple to emit good DC, without attendant key clicks. With high power the job is not so simple. In fact, the writer has never seen or heard of an amateur transmitter of 1000 watts or so, which was both DC and "clickless."

The present transmitter at 6AM is entirely clickless. It is not pure DC, as pure DC to the writer is not desirable. It is what is generally termed "near DC," utilizing a moderate amount of filter after a mercury arc tube. Slight overtones from both the 50 cycle current, i. e., a tone of 100 cycles and one of the higher overtones in the neighborhood of 500 cycles, are apparent, giving what may be called "near DC" with a slight RAC superimposed which makes the note pleasant, and without the tiresome features of pure DC.

With grid leak keying there almost always is a "sput-sput" on such power. The same is true with the use of a separate tube for a grid leak. The so-called mid tap keying is out of the question because of terrific clicks. Keying in the high voltage leads would require a tremendous relay. In fact, any system of keying after the rectifier would allow the no-load voltage to build up between dots and dashes, putting a peak of voltage at the instant of contact, this peak being a decided thump as compared to the rest of the dot or dash.

Clearly the keying must be done in the power leads to the rectifier rather than after the rectification has taken place. This is comparatively simple on moderate powers, and when rectifier tubes such as Kenotron or Rectobulb, or Rectrons, are used, the job is simple. The lights will duck and the key will stick unless the line is of considerable resistance. The simplest way is to insert one or two ohms as shown at R_1 . This becomes absolutely essential on high power, otherwise it would take a 20KW key to hold 1 KW. The key sparks and sticking are further reduced by the insertion of the two RF chokes at RF_5 . Without these,

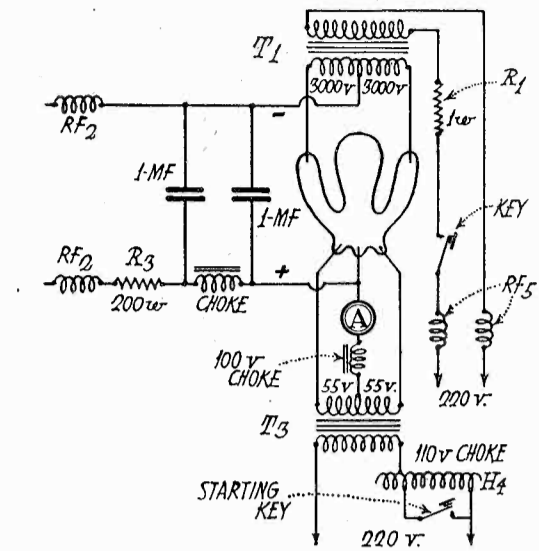

Fig. 1. Basic Diagram of Clickless Features

the key gets very hot; with them, the heat is reduced materially, indicating a cleaner make and break. In addition, these chokes tend to sharpen the wave, as they keep RF picked up from the vicinity of the transmitter from going back over the lines. These chokes at RF_5 are made of 75 turns No. 12 Enamel on a 1½ in. cardboard tube. Incidentally, the overall efficiency of the set went up 6 per cent when the chokes were inserted.

RF_2 chokes may appear to duplicate the RF_5 but plenty of RF chokes properly placed always help the efficiency, and better the keying as well. These chokes are wound of 200 turns No. 30 SCC spaced by a thread, wound on a 1 in. cardboard tube. These two chokes were tuned to 40 meters by taking off turns, although this is not essential.

Resistance R_2 does for the filter circuit what R_1 does to the 220 volt circuit. They both slow up any sudden surges due to the key landing on the peak of a cycle in the reverse phase from that of the core charge of transformer T_1 .

With this transmitter operating on 1000

watts, no click is audible in a broadcast receiver using an antenna from the same pole as the transmitter, although on certain waves pulsations may be noted in received broadcast programs due to the closeness of the two antennas. These, however, are negligible as compared to the clicks of bygone days, which would cover the entire dial, ruining reception. Reports from the neighbor across the street, and the one on the adjoining lot, are to the effect that they have never been bothered by 6AM while listening to a broadcast program.

The same principles of keying may be applied to circuits using self-rectification, with one tube on each half of the cycle, or with any of the tube rectifiers mentioned above. When going to high power, the only form available to the amateur is the mercury arc, which is becoming more and more popular.

Differing from the original circuits shown by the writer and others in various radio magazines, the keep-alive circuit may now be extremely simple. Fig. 1 shows this circuit complete. The ammeter is one of the 60 cent variety used on dash boards of automobiles. The clips on choke H_4 are set so that the arc starts (with starting key down) on about 20 or 25 amperes as shown on the ammeter A . When the key is released, the clips are adjusted so that it runs on 6 amperes. Thereafter nothing is necessary except to touch this key and tip the arc, whereupon it will ignite. Then the starting key is released and the arc will continue to run. As the keep-alive causes no interference in a 40 meter receiver it may be left on all night if desired, using break-in with foreign or US stations as desired. Keying such as described above makes this very simple.

Fig. 2 shows how the details of an automatic starting arrangement have been worked out at 6AM. The first dot of the key K starts the arc. The second dot is on the air. In starting up, simply start transmitting, as the arc starts itself when the key is touched.

The Leach break-in relay shown at M_3 is used and it surely is a pleasure to run a light

(Continued on page 58)

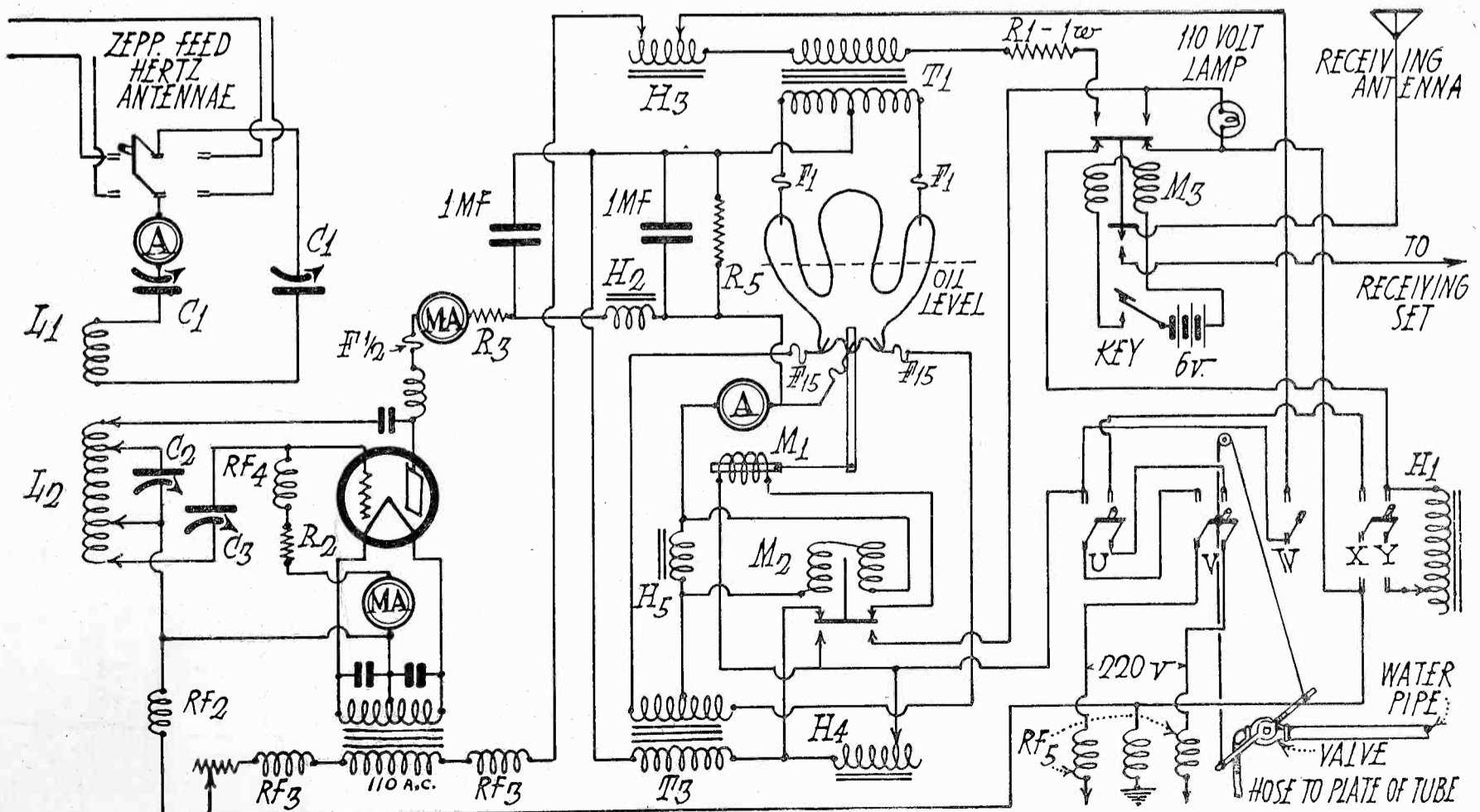

Fig. 2. Circuit Diagram of Complete Transmitter at 6AM, with Mercury Arc and Water Cooled Tube

Practical Hints For Amateur Radiotelephony

By G. M. Best

THE average amateur radiotelephone installation resolves itself into two parts; the transmitter, with associated power supply, and the equipment for modulation, including speech amplifier (usually correctly termed a speech distorter in most "ham" installations). The transmitter proper is usually well designed, and emits a fairly steady carrier wave, so that whether the circuit be a Hartley, a tuned grid-plate, or a Meissner, the carrier usually reaches out far beyond the voice waves impressed on it, and it is with the latter that these remarks deal.

A short session of listening on the amateur phone band in one of the large cities, soon disclosed the fact that only a few amateur phones can compare with a third rate broadcasting station. Either the carrier is all cluttered with noise, coming from the generator, filament lighting transformer, or rectified a. c. plate supply, or the modulation is terrible. Of course it is realized that after scraping together all available cash with which to purchase tubes, meters and other expensive equipment to even get on the air, nothing is left with which to buy the costly apparatus by which the commercial stations obtain their high quality, and it is not intended to criticize in any way the work being done by the amateur. No doubt if one could but see the meager equipment at some of the stations, it would set us to wondering how anything at all could be done in the way of telephony.

Probably the greatest stumbling block in the way of a successful radiophone has been a quiet source of direct current for plate supply. Motor generators are expensive, and thus are limited to those who have plenty of cash; even when a m. g. set is used, the carrier is often full of commutator ripple, due either to imperfect commutation, or lack of proper filter in the output circuit. Electrolytic or "jar" rectifiers are rather messy to build, and require frequent attention, although a well built jar rectifier used in connection with a real filter can and does give a d. c. output free from noise. Kenetron or tube rectifiers represent one of the most satisfactory solutions of the problems of d. c. plate supply for the low powered transmitter, although for transmitters of 100 watts or more, the cost of the rectifier tubes, power transformer and filter parts

mounts so rapidly that the generator is perhaps more satisfactory.

As most of the short wave phone work is with low power, generally a 7½ watt type 310 oscillator, and a modulator of the same size, the plate current requirements will not exceed 100 milliamperes at 500 volts. It is asking too much of a CX-316-B half wave rectifier to deliver 100 milliamperes at that voltage, and hence it has been necessary to build a full wave rectifier using two of these tubes, with a transformer having an 1100 volt center tapped secondary for plate supply. Fortunately, the new CX-381 rectifier is now on the market, and will supply 120 milliamperes at 500 volts when used as a half wave rectifier, thereby cutting the cost of rectifier tubes in half, and allowing the use of a power transformer having a 520 volt secondary, much smaller in physical dimensions, and less expensive to build or buy ready made.

With the idea of showing what could be done with this new rectifier, and at the same time incorporating it into a complete phone transmitter, the diagram in Fig. 1 was prepared. It indicates the circuit of a 7½ watt outfit with a single stage of speech amplification, and tube rectifier plate supply. The transmitter proper uses the same circuit as the now famous "Bumblebee," described in May 1927 RADIO, with the tuned grid-plate circuit slightly modified to permit operation on the 85 and 150-200 meter bands. The grid and plate condensers have been increased in size, and a different combination of inductances for the grid and plate tuned circuits must be used. The grid coil, for 150-200 meter range, should be 18 turns of 2¼ in. diameter, and the plate coil should be 20 turns of the same diameter as the grid coil. The antenna will probably be worked on the fundamental, and the antenna coupling inductance turns will have to be determined by experiment. For 85 meters, the grid and plate coils should be 14 and 15 turns respectively.

The modulation system used in Fig. 1 is the ever popular Heising method, used at 90 per cent of the broadcasting stations. The plate of the modulator tube is placed in parallel with that of the oscillator, with a 3 millihenry r. f. choke between the two plates to keep r. f. out of the modulator circuit. In the common

B supply lead is an audio frequency choke, of the iron core variety, and designed so as to avoid saturation of the core when the combined plate currents of both oscillator and modulator are flowing through it.

It is not necessary to discuss the theory of the Heising system, except to say that the larger the inductance in the audio frequency choke, the better the modulation, especially at the low frequencies in the audio range. When broadcasting first came into popularity, the size of this choke was usually 2 henrys, but it was soon found that this should be increased to a much higher value. In the 500 watt Western Electric broadcast transmitters, this choke consists of two 5 henry inductances in series, and in many of the high powered installations the inductance is 20 henrys or more. As the current flowing through this choke is high, a core with the proper sized air gap must be used, and the wire used to wind the choke must be heavy enough to carry the current without causing a large voltage drop, and consequent heating.

It is fortunate that the development of the new 350 milliampererectifier tubes for ABC supply of receiving sets has caused the parallel development of 10 and 20 henry chokes with 350 milliampererectifier current carrying capacity without core saturation. Complete data on these chokes will be found in the June and July issues of RADIO. Dimensions and winding details for homemade chokes of this type are given on page 12 of the June issue, and the factory built chokes are described in the July number.

The 3 millihenry choke may be a 400 turn honeycomb coil, or may be wound as follows: in a 1 in. slot of a wooden spool having a 1 in. hub, wind 450 turns of No. 24 d. c. c. wire, with haphazard method of winding. If the phone is to be used on waves below 150 meters, this choke should be wound on a cardboard tube, and so designed as to be effective at whatever wavelength the transmitter is to be used.

The plate voltage supply consists of a transformer with 110 volt primary, 520 volt plate secondary, and two 8 volt filament lighting secondaries. One lights the filament of the rectifier tube, and the other, the center tapped one, lights the modulator tube filament. In order

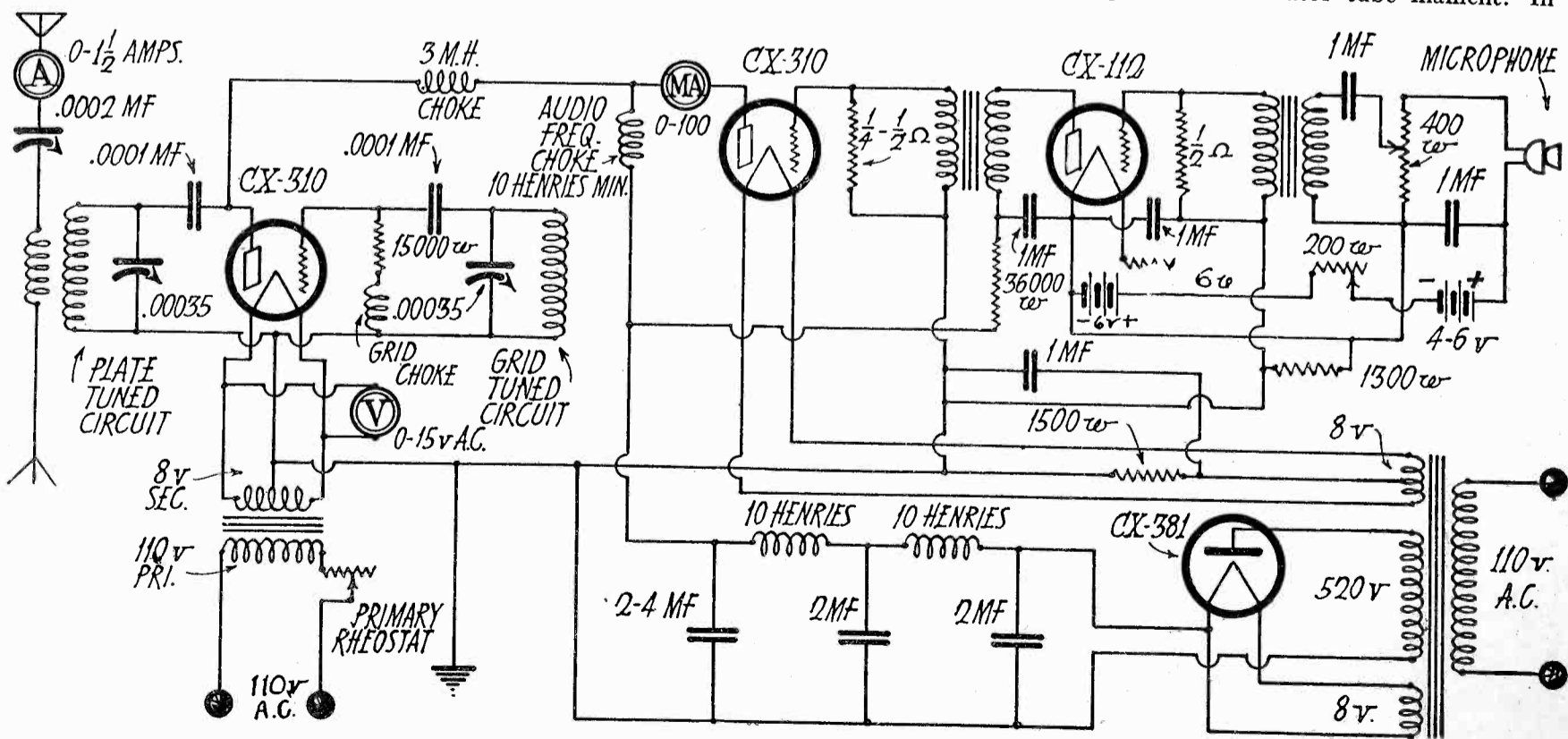

Fig. 1. Diagram of 7½ Watt Radiotelephone Transmitter

to provide regulation of filament temperature, and to keep the a. c. hum at a minimum, a separate filament lighting transformer is shown for the oscillator tube filament. The oscillator filament could be run from the modulator filament winding if necessary, but as the latter is designed for one CX-310 tube, without the need of voltage regulation, the addition of another filament would undoubtedly lower the voltage of the secondary below $7\frac{1}{2}$ volts, and the power output of both tubes would thus be lowered. Transformers such as the Amertran PF-52 are excellent for this work, as they are conservatively rated, and will stand a large overload for short periods without overheating.

The filter system shown in the diagram contains the minimum size of chokes and condensers which will enable the experimenter to get by without heavy 60-cycle modulation of the carrier. It uses two of the 10 henry chokes recommended for the modulator plate choke. A pair of the 10 henry chokes in a metal can cost \$15.00, or two can be made up by using the data given in June RADIO. If but one speech amplifier is used, 6 mfd. in the filter will probably be sufficient to give a quiet d. c. output, but if more than one speech amplifier stage is to be installed, at least 4 mfd. must be used at the filter output, and more if the extra condensers are available. Condensers must stand 600 volts continuous d. c. at this point in the circuit; not 600 volts flash test, but 600 working volts, as indicated on the label.

In Fig. 1, a single stage of speech amplification is shown. This is based on the assumption that an ordinary single button carbon grain microphone, such as is used in regular wire telephony, is on hand, unfortunate but true in the case of most "ham" stations. Double button microphones used in broadcasting installations cost from \$100 up, and are out of the question for anyone but a plutocrat. They have the advantage of giving a practically uniform output at frequencies from 60 to 5000 cycles, but have the disadvantage of being so low in power output as to require a minimum of two stages of amplification before the power lever can be brought to that produced by the common single button microphone.

For those who are interested in the double button microphone the speech amplifier modifications are shown in Fig. 2. This amplifier consists of an input transformer having a primary impedance of 200 ohms, and a secondary impedance of 100,000 or more, a stage of high- μ amplification, impedance coupled to a type 112 power tube, which in turn is transformer coupled to the modulator circuit. The plate voltage for both tubes is reduced to their operating limits of 180 and 157 respectively by means of fixed resistances, and the grid voltages are had from the voltage drop across resistances in the filament and negative B circuits. A 4 ohm resistance in the high- μ tube negative filament gives sufficient C voltage for that stage, and a 1300 ohm resistance

in the negative B lead provides $10\frac{1}{2}$ volts negative grid for the CX-112 second stage.

This amplifier is designed for the amateur station, and assumes that the operator will use the microphone for close talking, and not for picking up music in a studio. If the latter were the case, another stage of impedance coupled high- μ amplification would have to be added, to bring the total gain of the amplifier up to a point where effective modulation of the carrier could be had. The input transformer shown in the diagram has no center tap. A center tapped transformer for this circuit is made by the Thordarson Company, but it is rather expensive, and is used mostly in broadcasting installations. The two 100 ohm fixed resistances are a 200 ohm potentiometer adjusted so the slider is in the exact center will accomplish the same purpose, and a 200 ohm potentiometer between the center of the resistances and the positive of the battery supply will enable adjusting the current through the microphone buttons to the right value. Western Electric microphones require about 20 milliamperes per button, so that jacks are shown in the diagram for the insertion of a milliammeter to measure the current. If a great deal more current flows through one button than through the other, the microphone is unbalanced, and defective.

So-called modulation transformers designed some years ago for amateur phone work are hardly suitable for high quality transmission, and the writer made a satisfactory substitute by rebuilding a burned out Rauland Lyric audio transformer primary, with a low impedance primary winding. The core was disassembled, and the burned primary coil, which is outside the secondary, removed. In its place, a coil of the same physical dimensions as the old primary, but having 250 turns of No. 28 silk covered wire with center tap was substituted, and the transformer reassembled, using the same secondary winding. This transformer is suitable for either the double button microphone circuit of Fig. 2, or the single button transmitter of Fig. 1. It will be efficient at the low frequencies as well as those up to 5000 cycles, and has a fairly uniform amplification curve.

Referring again to Fig. 1, the microphone circuit consists of the carbon grain transmitter, a 400 ohm potentiometer so connected that the resistance is always in the microphone circuit, a 200 ohm current adjusting resistance, the 6 volt storage battery used to light the speech amplifier tube filament, and a booster battery of 4 to 6 volts, depending upon the current required for the microphone.

The Western Electric type 323-W transmitter, which is the favorite at many "ham" stations, requires 125 milliamperes. Another Western Electric transmitter known as the 337-W requires only 40 or 50 milliamperes to give the same power output as the 323-W, and has slightly better quality. The latter will work without a booster battery, since the current requirements are low.

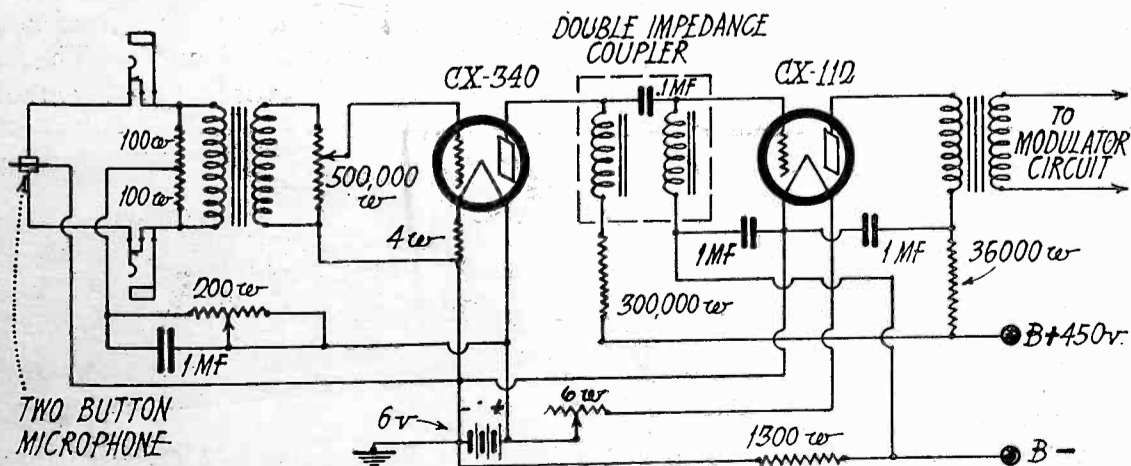

Fig. 2. Speech Amplifier for Double Button Microphone

The input transformer is connected to one side of the potentiometer and the slider, through a 1 mfd. condenser, so as to avoid changing the d. c. current in the microphone button. By varying the slider, the volume can be controlled nicely from zero to maximum.

A CX-112 tube is used for the amplifier, and is coupled to the modulator through an audio frequency transformer such as is used in the second stage of a receiving set amplifier. Here, as at the input, it is essential to have a high quality transformer, one capable of amplifying the low notes as well as the high, and having a primary impedance suitable for the 112 tube.

As was explained in connection with the double button microphone amplifier, the B voltage is reduced to 157 by means of a 36,000 ohm fixed resistance, and the C voltage is had from the voltage drop across a 1300 ohm resistor in the negative B lead. 1 mfd. bypass condensers must be connected as shown in the diagram, to prevent oscillation at audio frequencies due to coupling through the resistances. The bypass condenser from the secondary of the input transformer to the filament need be a low voltage type, but the condenser from the B supply to the filament should be the same type as is used in the filter, for if the rectifier were to be turned on first, before the speech amplifier tube filament were lighted, the full output voltage of the rectifier would be impressed on the condenser, and if it were of the 200 volt d. c. type, it would quickly be ruined.

The necessary C voltage for the modulator tube can be had from C batteries, or by means of a 1500 ohm resistance in the negative B lead. The latter will give 30 volts negative grid, and when shunted with a 1 mfd. bypass condenser, the resistance will not cause any trouble from oscillation. A 100 milliamper scale milliammeter in the modulator plate lead will indicate the degree of modulation.

Contrary to expressed opinion from many amateurs, this meter should not fluctuate violently when full modulation is obtained, but should show only a slight upward deflection. Violent agitation of the needle means distortion, usually heard as blasting at the receiving end. Many broadcasting stations pay little attention to this particular meter, but install a 0-1 $\frac{1}{2}$ milliamper scale milliammeter in the C battery lead to the secondary of the modulator input transformer, and just as soon as the slightest deflection of the needle on this meter occurs, the volume is cut down, for grid current flow means rectification, and the distortion that goes along with it.

To economize on meters, the milliammeter in the modulator plate can be switched to the oscillator plate circuit, between the r. f. and the audio chokes, with a switch arranged to flop the meter from one plate lead to the other. When modulating strongly, the radiation current in the antenna circuit should rise slightly, although the fact that it does not rise will not arbitrarily mean that no modulation is taking place.

Should increased power for the transmitter be desired, the principal complication would be in the plate voltage supply, if rectifier tubes are still to be used. If the oscillator and modulator tubes are the new UX-852, or the DeForest types RO and RM, a special transformer having a higher voltage secondary for the plate, and 10 volt filament secondaries would be required, and the filter condensers would have to be capable of withstanding the maximum d. c. output of the rectifier. The chokes recommended for the $7\frac{1}{2}$ watt installation would be suitable, as they will carry 350 milliamperes. A motor-generator or mercury arc rectifier would undoubtedly be the best solution of the plate supply, as rectifier tubes for 2500 volt output are scarce and expensive, to say the least.

(Continued on page 59)

Some of the New Factory-Built Receivers

THE AMRAD LINE

The new Amrad Neutrodyne is made in various table compact and console models, housing either a six-tube or a seven-tube chassis. These receivers are manufactured under a R.C.A. license as well as under the Hazeltine and La Tour patents.

The six-tube chassis has three stages of neutralized tuned radio frequency, detector and two stages of transformer-coupled audio frequency amplification. Single control of its four tuned circuits is effected by connecting the rotors of four variable condensers with a single continuous shaft.

The condenser rotors are designed to give straight line wavelength tuning. Two rotor plates in each condenser sec-

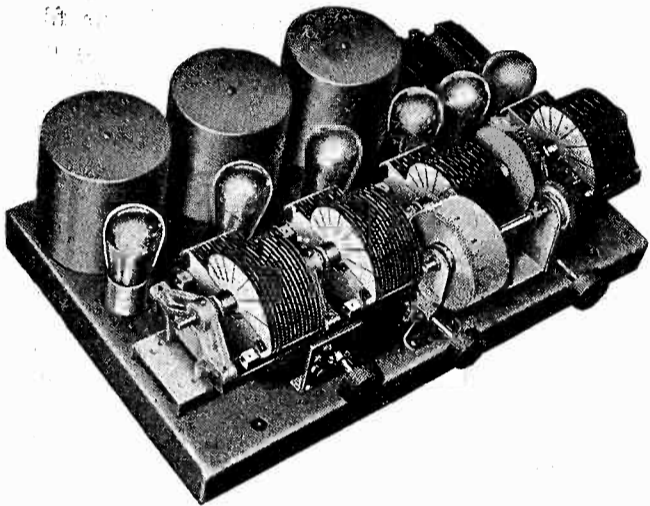

Amrad Six-Tube Chassis.

tion are radially slotted so as to give independently adjusted segments which can be bent so as to make each of the four condensers identical in capacity. An air gap of .004 in. is provided between the rotor and stator plates.

Each of the r. f. transformers is enclosed in a cylindrical copper shield so as to prevent interstage magnetic and electrostatic coupling between the coils. The coil forms are moulded with grooves in which the enamelled wire is wound. Great care is exercised to produce uniform coils. The copper shielding is designed so that an exceedingly efficient r. f. transformer results. In addition to the individual shielding of each coil an outer shield is also provided.

By means of these various precautions, exceedingly stable operation is secured with a loop or antenna. The circuit constants have been chosen so as to give high amplification at the longer wavelengths or lower frequencies.

A fine characteristic is secured in the audio frequency system by using a turns ratio of $3\frac{1}{2}$ to 1 in the first audio transformer and of 3 to 1 in the second. A novel feature of the audio amplifier is the use of a detector plate filter. This consists of a condenser and resistance so arranged that any resistance in the B batteries cannot be common to the

detector plate circuit at audio frequencies. Thus the harmful effects of regeneration at audio frequencies due to high resistance B batteries are entirely avoided.

All models are equipped with an illuminated wavelength scale. In addition to the table compact model illustrated



Amrad Windsor Seven-Tube Compact.

the six-tube chassis is also contained in a console with an efficient built-in loud speaker of the rigid cone type, which gives no undesired resonant effects from cabinet cavities. The speaker is equipped with a filter which begins to cut off at 4000 cycles.

Besides the conventional filament battery and plate battery or socket power supply, one of the console models is equipped for a. c. operation. It uses four UX226 oxide filament tubes, one UX227 filter type and one UX171 power tube, together with the necessary step down transformer. The socket power rectifier and filter for plate supply uses a UX280 rectifier tube and Mershon condenser.

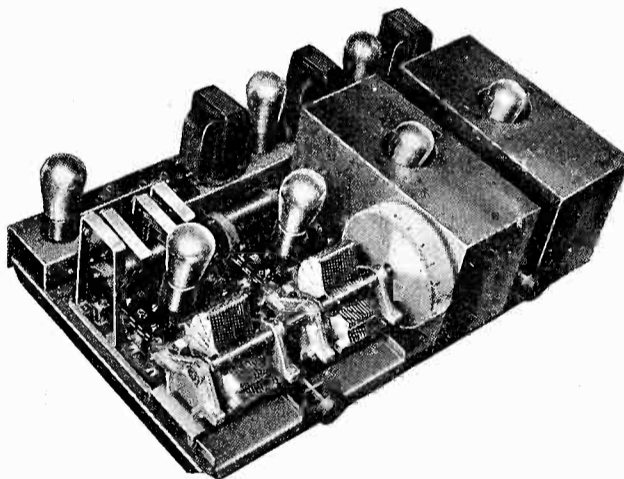

Amrad Seven-Tube Chassis.

The seven-tube chassis has four stages radio frequency amplification, one untuned and three tuned. It is doubly shielded, the entire r. f. system being housed in a heavy copper box. Tuning is accomplished by the same method as is employed in the six-tube model without need for any control auxiliary to the single dial. It gives extremely high amplification and great selectivity with either loop or outside aerial.

The audio amplifier is similar to that of the six-tube model except that an output transformer is included. The seven-tube chassis is furnished as a table compact, as a battery operated

console with built-in cone speaker and baffle board, or as a complete lamp-socket operated console using the new a. c. tubes.

ALL-AMERICAN

The All-American Radio Corporation announces a new line of receivers for the 1927-1928 season. These are manufactured under license from the R.C.A. group and include five, six and seven tube models in various console, hiboy and cabinet mountings. Various styles are made for battery and batteryless operation.

The six and seven tube models employ the Rice system of neutralization for three or four stages respectively of tuned r. f. amplification. All are equipped for single drum-type control with indicator graduated in degrees and kilocycles.



Six-Tube A. C. Socket Power Receiver in Console with Built-in Loud Speaker.

The six tube a.c. socket power chassis is of rigid steel construction and is mounted in a drawer which can be pulled out so as to give easy access to the tubes. It uses UX226 tubes in the r. f. and first audio stage, a UX227 as detector, and a UX171 in the second stage of transformer coupled audio. The circuit is properly balanced for all antenna

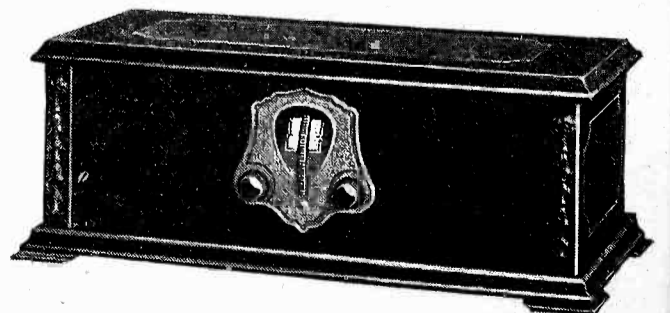

Six-Tube Battery-Operated Cabinet Model.

(Continued on page 45)

The Aero-Seven Broadcast Receiver

Directions For the Easy Assembly of a Tuned R. F. Receiver Having Remarkable Selectivity, Sensitivity and Tone Quality

By Zeh Bouck

THE Aero-Seven broadcast receiver is a combination of time-tried circuits which are assembled so that the performance of the completed instrument closely conforms to the requirements for the present-day ideal receiver. These requirements include single dial control, 10 kilocycle selectivity, volume control in the r. f. circuit, and an audio amplifier worthy of the electrical efficiency secured in the rest of the set.

Single dial control is achieved by tandem tuning of carefully matched Aero coils by means of a compensated Amsco Triplet condenser. Stray inductive effects are avoided in the design of the coils and by the layout and design of the wiring shown in the pictures. The antenna is coupled to the first tube by a resistance connected between the antenna and ground so as to eliminate any effect from the antenna circuit on the first tuned circuit. The first r. f. tube therefore acts as an untuned r. f. amplifier.

The 10 kilocycle selectivity, 5 k. c. on each side of the fundamental fre-

quency is closely approximated throughout the broadcast waveband. Whatever broadening exists is due to reduced regeneration. The potentiometer volume control is designed to have no effect on the damping of the tuned oscillatory circuits.

Audio amplification is effected by means of resistance coupling, which is acknowledged by most engineers to give the closest approach to distortionless amplification. The list of parts published herewith is that used in the receiver illustrated in the pictures and diagrams, which also indicate the method of construction more clearly than would a detailed word description.

The picture wiring diagram spreads the parts so as to show clearly the connections between them, irrespective of the exact spacing of the parts or the exact directions taken by the wires. Check your wiring against all illustrations and diagrams as the set nears completion.

The condenser is mounted so that the compensating condensers are up. That is, with the shaft extending to the right and the rotors opening in toward the front panel. The correct instrument layout will be greatly facilitated by using the specially prepared front and sub-panels. This receiver is not at all difficult to build—but any job worth doing

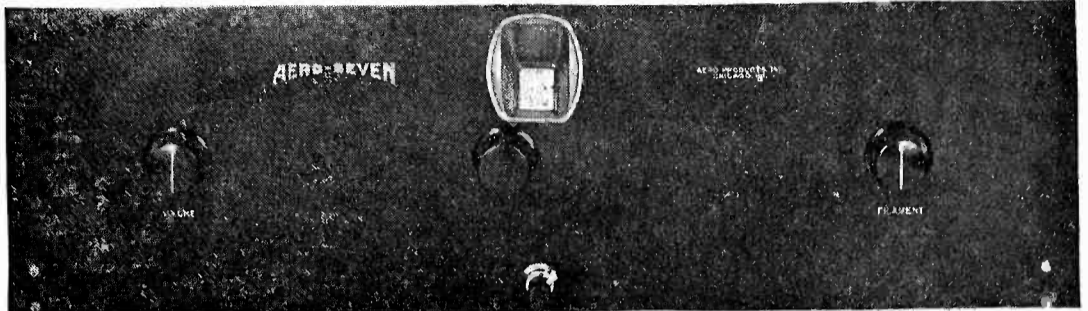

Panel View of Aero-Seven Receiver

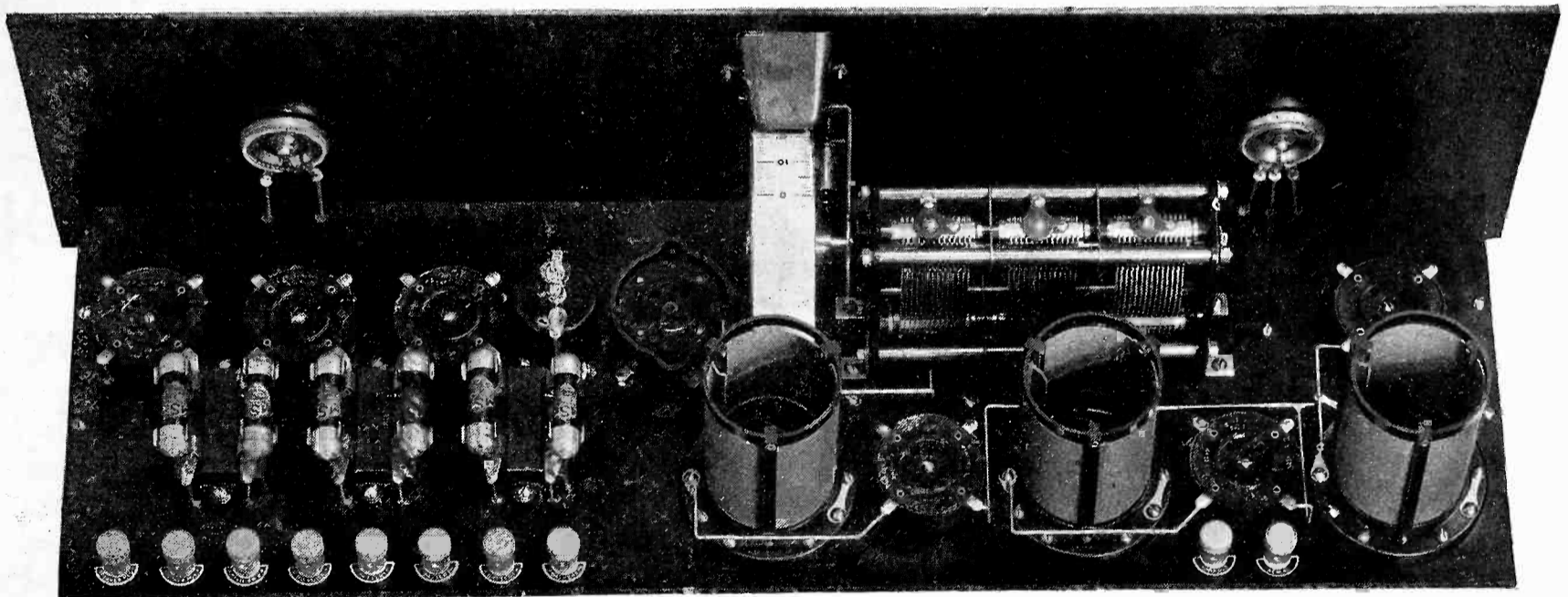

Rear View of Aero-Seven Receiver

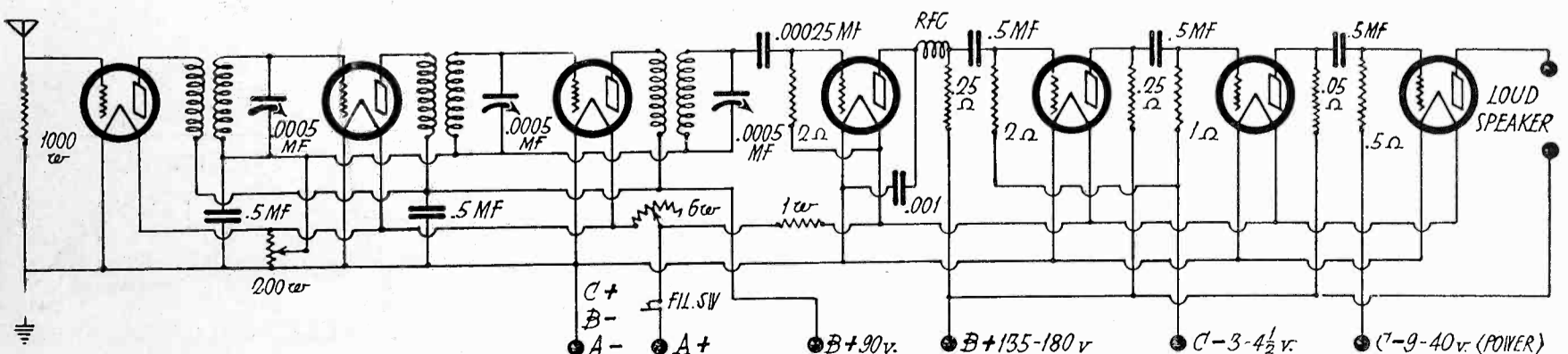

Circuit Diagram of Aero-Seven Receiver

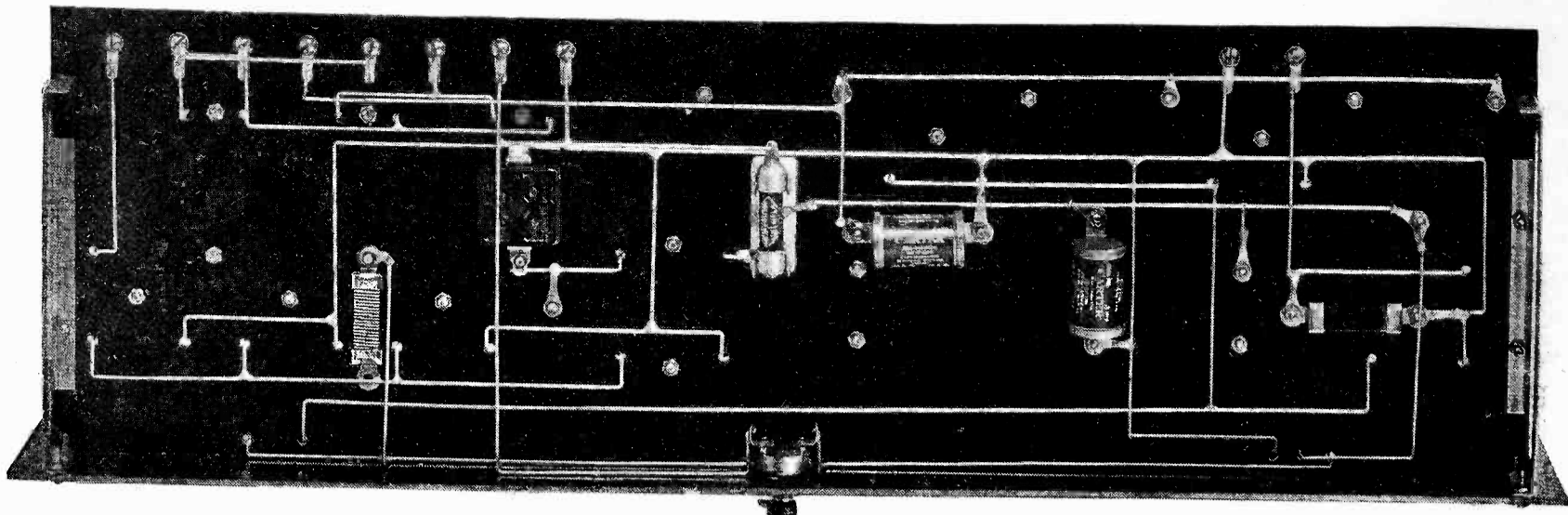

Bottom View of Aero-Seven Sub-Panel

is worth doing well.

There is only one set of adjustments to be made on this receiver, and these are effected when it is completely finished and wired to the usual power sources for reception. These are the compensating condensers on the Amsco triplet condenser. The condenser leaves the factory with the compensators screwed down tightly. Turn these two full turns counter-clockwise. (It is desirable, in making all adjustments on the compensators, to use a wooden screw driver. This will eliminate over-compensation due to body capacity effects. Any small stick can be shaved down into a satisfactory tool.) Tune in a station, preferably a local. Adjust the compensators, one at a time, by screwing in, until the station tunes the sharpest. Retune with the main dial following every adjustment of the compensators. Temporary adjustment of compensator can be effected by pushing it down slightly with the wooden adjusting tool, while the main dial is tuned. This will show immediately what particular compensator should be screwed down. That is all there is to it. Once adjusted, the condenser need never again be touched.

Either Cunningham or R. C. A. tubes should be used in the Aero-7. Note that high mu tubes are used in the first five sockets. The Aero coils are designed to take advantage of the high amplification constant of 30 which characterizes these tubes. Radio frequency coils must be especially designed to do this. The second audio stage employs a 201-A tube to add additional stabilization to the amplifier, and to take care of unusual power surges. A 171 type power tube is used in the output stage to provide unusual volume without distortion. It is desirable, though not absolutely necessary, to couple this tube to the speaker through some output arrangement such as the Amsco Orthophone.

The operation of the Aero-7 is merely a matter of turning the tuning dial to the selected station, and adjusting the volume control to the desired point. The receiver will operate from any antenna, short or long, indoor or outdoor, excepting a loop. It will operate from A, B

and C batteries or eliminators, or any battery-eliminator combination.

LIST OF PARTS FOR AERO - SEVEN

- 1 Aero Seven Foundation Unit.
 - 1 Aero TRF Kit, Code U-12 (3 coils).
 - 1 Aero Choke No. 60.
 - 1 Silver-Marshall Drum Dial.
 - 1 Carter Battery Switch D.
 - 1 Carter 200-ohm "IMP" Potentiometer.
 - 1 Carter 6-ohm "IMP" Rheostat.
 - 1 Carter H-1000 Resistor.
 - 1 Carter H-1 Resistor.
 - 1 Carter .00025 Mfd. Condenser with Clips.
 - 1 Carter .001 Mfd. Condenser.
 - 2 Carter 1/2 Mfd. Bypass Condensers.
 - 10 X - L Binding Posts, Lettered—Aerial, Ground A+, A-, 2C-, B90+, Amplifier, B+, Speaker+, Speaker-.
 - 1 Amsco Floating Socket.
 - 6 Amsco Plain Sockets.
 - 1 Amsco .0005 Mfd. Triple Condenser.
 - 1 Amsco Grid Gate Mounting.
 - 1 Amsco 5 Meg. Grid Gate.
 - 1 Kit AMSCO Aero-7 Resistance Coupled Audio.
- Screw Assortment and Bus Bar.

HINTS ON WAVEMETER CONSTRUCTION

A WAVEMETER usually consists of a variable condenser, shunted across an inductance coil so as to comprise a tuned circuit. For use with an oscillating type receiver, such as a regenerative short wave set, the coil and condenser are the only pieces of apparatus required to make a first class wavemeter. When the instrument is to be used for measuring the wave of a transmitting station, however, some sort of indicating device must be added, and this usually takes the form of a thermocouple or hot wire milliammeter, placed in series with the inductance coil so that when the wavemeter tuned circuit is in resonance with the transmitter, current will be absorbed by the tuned circuit and the meter will indicate resonance by a deflection of the needle. A flashlight bulb can also be used, in place of the milliammeter, the brilliancy of the filament indicating the degree of resonance.

If the wavemeter is to be used to calibrate a non-oscillating receiver, it may be of the vacuum tube oscillator type, with filament and plate supply from the 60 cycle lighting circuit, or it may be the same as the conventional type of wavemeter, with a buzzer as a source of power. In this type of wavemeter, the condenser is adjusted so that the tuned

circuit is in resonance for any particular wavelength wanted, and sends out energy in the form of a modulated high frequency wave, which is picked up by the receiving set, and thus indicates the wavelength to which the receiver is to be adjusted.

In building a wavemeter, the principal points to remember are to use the highest grade variable condenser possible, consistent with the size of the pocketbook, and to wind the inductance coil so that it will be absolutely rigid and solid at all times. There is nothing worse in the way of a wavemeter than one having a condenser with loose bearings and end-play together with an inductance coil whose turns are loose, or terminals are wobbly, so that the wavemeter settings will never be the same twice in succession. The variable condenser should preferably be of the straight line frequency or wavelength type, depending on whether the wavemeter is to be calibrated in terms of frequency or wavelength.

FROST-RADIO

Parts for the
INFRADYNE

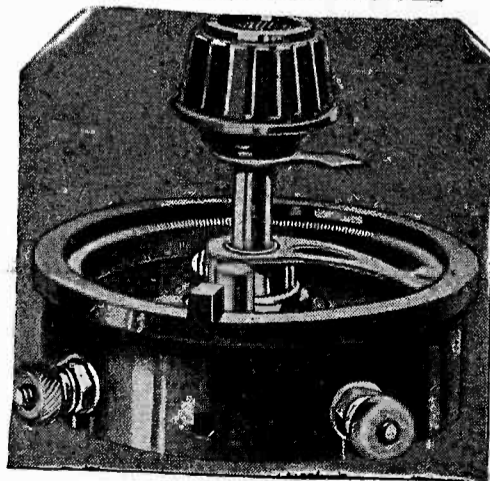

No. 660 Rheostat

Has Bakelite base and knurled Bakelite knob fitted with pointer. For base mounting. Genuine Chromel "A" wire is used in this and all Frost-Radio Rheostats, absolutely insuring freedom from burn-outs.
List: 75 cents.

HERBERT H. FROST, INC.
160 North La Salle Street, Chicago
NEW YORK LOS ANGELES

REMLER

Better Than Ever Before

—easier to build

—easier to operate

The New 1928

INFRADYNE

Now, you can buy Remler units for assembling the complete Infradyne Radio Set. The new Radio Frequency Amplifier gives you a "front-end" that is simple, efficient and trouble-free. The Foundation Kit does away with the bother of purchasing numerous small parts and makes the construction of the set a genuine pleasure. Complete diagrams take all the guess-work out of wiring. Almost everybody knows that 1928 is an Infradyne year.

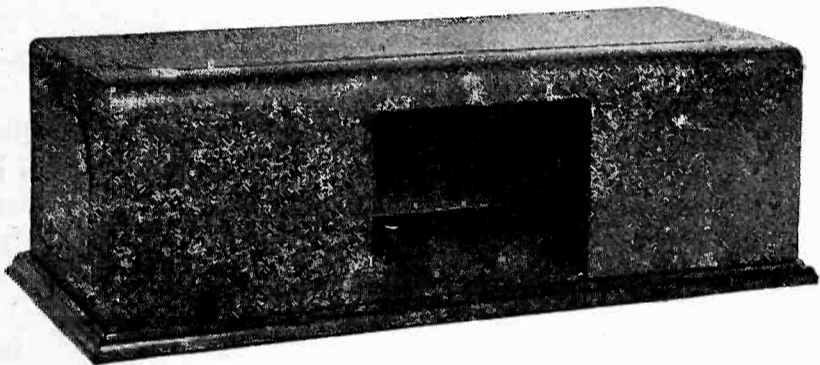

REMLER INFRADYNE CABINET

The embossed copper cabinet, finished in two-tone brown crystalline enamel and the decorative wood base insure a finished appearance equal to that of the highest type of factory-built set. No. 760.....Price \$15.00

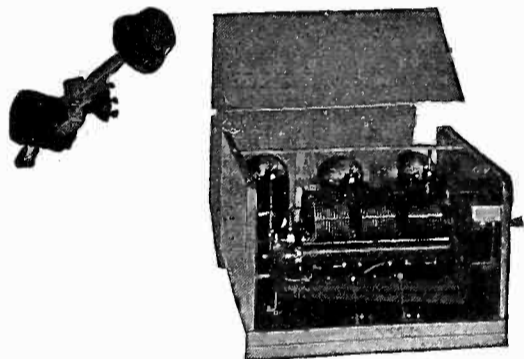

REMLER R. F. AMPLIFIER AND ANTENNA COMPENSATOR

The No. 710 R. F. Amplifier incorporates two stages of R. F. Amplification and a detector. Entirely enclosed in a sheet copper case which gives complete electro-magnetic shielding. It is designed for single-dial control, either with the Remler Drum Dial or the ordinary 360° vernier dial. An Antenna Compensator, supplied with the Amplifier, nullifies the detuning effect of the antenna, which interferes with efficient operation in the usual single-control R. F. Amplifier. A Switch is provided for selective or non-selective tuning. Included in the Remler No. 710 Amplifier are special solenoid-type, small diameter coils; the Remler 3-in-Line Condenser; and Remler No. 50 Sockets.

No. 710.....Price \$55.00

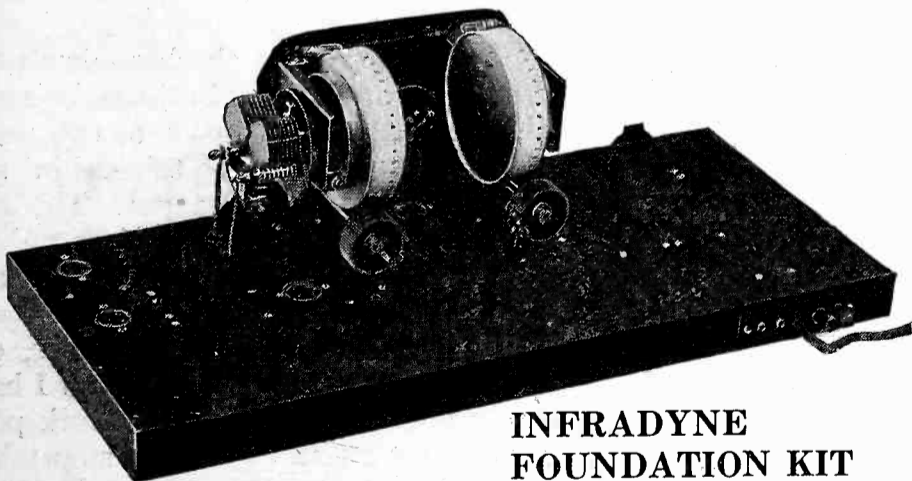

INFRADYNE FOUNDATION KIT

The No. 750 Infradyne Foundation Kit includes all the parts necessary for the construction of the 1928 Infradyne Receiver with the exception of the No. 700 Infradyne Amplifier, the No. 710 Radio Frequency Amplifier, the No. 760 Cabinet and Base, audio and output transformers, voltmeter, tubes and batteries. The Foundation Kit contains a completely drilled, black-enamelled pressed steel base on which all units are to be mounted, a pressed steel instrument panel, a bronze control panel, Remler Drum Dials, Remler Type 659 Condenser, battery cable, special cable, all necessary sockets, fixed condensers, rheostats, jacks, binding posts, choke coils, switch, wire, screws and nuts. The Foundation Kit obviates the necessity of purchasing numerous small parts from many sources. Using the Foundation Kit, the novice can build the complete Infradyne in a few hours and he will be assured of a perfectly functioning receiver which is attractive in appearance.

No. 750. Infradyne Foundation Kit.....Price \$52.00

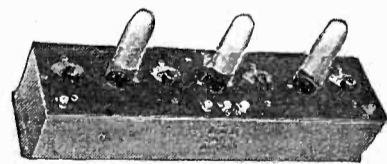

REMLER INFRADYNE AMPLIFIER

A three-stage radio frequency Amplifier functioning at a fixed frequency of 3500 k.c. Provides high amplification of the received signal without marked increase in the background and makes possible enjoyable reception of distant stations. The No. 700 Infradyne Amplifier embodies the highest type of mechanical and electrical construction. The panel is of polished bakelite; controls and fittings of molded bakelite and nickel-plated brass. Enclosed in bright lacquered copper case.

No. 700 Infradyne Amplifier

.....Price \$27.50

Remler Division of
GRAY & DANIELSON MFG. CO.

260 First Street, San Francisco

Eastern Warehouse: Elkhart, Ind.

Chicago

New York

Tell them that you saw it in RADIO

NOW READY—

1928 Infradyne Parts and Kits

ORDER BY MAIL

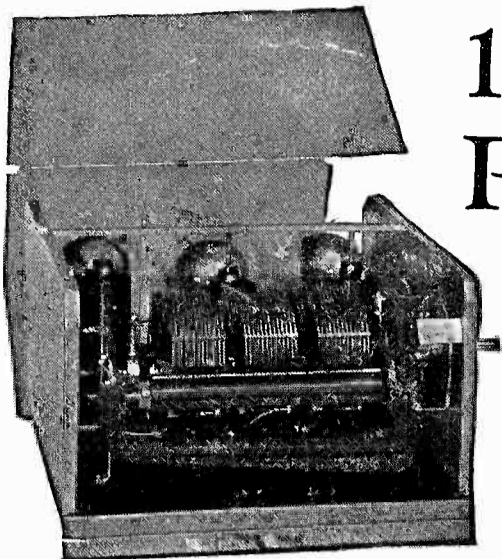

NEW R. F. AMPLIFIER

You can build your 1928 Infradyne now. The parts are ready for you—individually or in complete kit form. The new Remler r. f. amplifier shown here is the latest front end for the Infradyne. A genuine laboratory product with accurately balanced three gang condenser, automatic coupling on the coils and tube sockets in place. Individual stage shielding. Completely wired. Housed in pure copper case.....\$55.00
With this r. f. amplifier is included an antenna compensator, illustrated at the bottom of this advertisement.

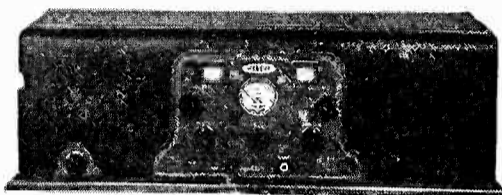

NEW COPPER CABINET

The new Cabinet for the Infradyne is die stamped—of pure copper with beautiful embossing effects. Finished in lacquered crystalline. A sturdy job—adding tremendously to the appearance of your receiver and giving it another means of complete shielding. A polished hardwood base goes with each cabinet. Price—with base.....\$15.00

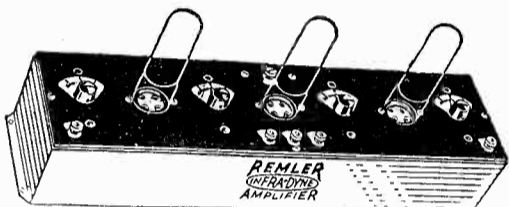

SARGENT INFRADYNE AMPLIFIER

Sargent-Raymont Infradyne Amplifier, the heart of the Infradyne. This well known device has revolutionized radio reception. Comes completely wired. In copper container\$27.50

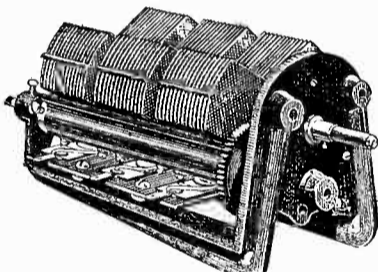

REMLER CONDENSER

Remler 3-in-line condenser for those who want to convert their old Infradyne into the newer model. Also suitable for other radio circuits. Staggered grid connections and trimmers on this condenser make it one of the season's finest products\$15.00

NOTE—This condenser is of the famous "twin rotor" type with grounded shaft, preventing body capacity effects.

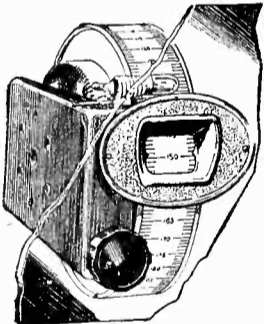

DRUM DIAL

Mail
Orders
Given
Prompt
Attention

! TRY !
◆ US ◆

Remler Drum Dials—right or left—for the 1928 Infradyne will give you the newest in tuning systems. Illuminated with 6 volt lamp, supplied with each dial. Clockwise or counter-clockwise rotation. Logging strips come with dial. Can be easily attached to panel. Only two round holes to drill. Finished in brass with white logging strips. Vernier tuning. Finely meshed geared drive system used. Each\$4.50

RADIO CONSTRUCTORS CORP.

357 TWELFTH STREET
OAKLAND, CALIFORNIA

We Repair and Rebuild Infradynes

SEND COUPON WITH YOUR ORDER FOR PROMPT SERVICE

Radio Constructors Corporation,
357 Twelfth Street, Oakland, California.

Send me the following new parts for the 1928 Infradyne as advertised in RADIO for September. Remittance of \$..... is enclosed in full payment.

Name.....

Address.....

THE MYSTERIOUS MR. HANKINS
(Continued from page 22)

got th' luck of a pink-whiskered goat!" whispers the Grouchy Gopher, at my back. "An' don't you dare fire her, now! I need a typewriter-clicker!"

"But!" I gasps, turnin' on him. "I never—"

Dumb McGurk suddenly comes to life.

"Miss, have you seen Mr. Hankins!" he exclaims, starin' at her from over his peaked nose. "A long, tall, dark, mysterious-lookin' man with a black mustache?"

Cuddle-up gives him an amused glance. "Sure, I know him," she replies, as easy as if she was speakin' to her grandmother. "He's promised to take me out to lunch, some time."

"Gosh!" says Dumb McGurk, his eyes wide open an' his tongue half hangin' out.

"Well, may hell burn me!" I mutters, under my breath.

"He said he'd give me forty dollars a week—and that there'd be somebody here to show me what to do," she continues, smilin' at me with her big brown eyes. "So here I am."

"You're to help me with makin' out invoices!" says th' Grouchy Gopher, suddenly takin' th' bit between his teeth an' throwin' me over his head. "I been doin' six men's work 'round this joint long enough. You come right in here to this old typewriter an' do your business!" He leads her away from there, leavin' me all dumbfounded.

Dumb McGurk twitches my sleeve.

"Mr. Jones," he whispers, incredulous-like, "do you think she could of seen Hankins? Th' real Mr. Hankins, with his black mustache—"

"Come on, roll your hoop!" I snaps, irritated-like. "How do I know? Maybe she has."

Cuddle-up claims she has come to us from th' iron foundry business, or something like that; but inside of two weeks she has fitted into our tube-sellin' system, like a pansy in a pot. The way she can wade through invoices an' orders makes us sit up an' take notice.

"She's a regular tube-bootlegger's angel," says the Grouchy Gopher, one day. "She runs the works, an' all I have to do now is help Dumb McGurk pack up tubes. Umph! You better stop takin' her to lunch all th' time, though. She'll be throwin' you with a marriage license, in another month."

"You mind your own business, you jealous old woodpecker!" I growls, savage-like. "I been wanderin' 'round th' world long enough, I guess. It's time I was thinkin' of gettin' a home an' a family."

Meanwhile, Old Kid Blennerkem is ringin' up my hotel telephone day an' night, an' nearly goin' into a fit, demandin' to see th' plaster-cast footprint

(Continued on page 44)

Restored Enchantment



This is the Eveready Layerbilt that gives you Battery Power for the longest time and the least money.

THERE is no doubt of it—radio is better with Battery Power. And never was radio so worthy of the perfection of reception that batteries, and batteries alone, make possible. Today more than ever you need what batteries give—pure DC, Direct Current, electricity that flows smoothly, quietly, noiselessly. When such is the current that operates your receiver, you are unconscious of its mechanism, for you do not hear it humming, buzzing, crackling. The enchantment of the program is complete.

Batteries themselves have improved, as has radio. Today they are so perfect, and so long-lasting, as to be equal to the demands of the modern receiver. Power your set with the Eveready Layerbilt "B" Battery No. 486. This is the battery whose unique, exclusive construction makes it last longer than any other Eveready. Could more be said? In most homes a set of Layerbilts lasts an entire season. This is the battery that brings you Battery Power with all its advantages, conferring benefits and enjoyments that are really tremendous when compared with the small cost and effort involved in replacements at long intervals. For the best in radio, use the Eveready Layerbilt.

EVEREADY
Radio Batteries
—they last longer



Radio is better with Battery Power

At a turn of the dial a radio program comes to you. It is clear. It is true. It is natural. You thank the powers of nature that have once more brought quiet to the distant reaches of the radio-swept air. You are grateful to the broadcasters whose programs were never so enjoyable, so enchanting. You call down blessings upon the authority that has allotted to each station its proper place. And, if you are radio-wise, you will be thankful that you bought a new set of "B" batteries to make the most out of radio's newest and most glorious season.

NATIONAL CARBON COMPANY, INC.
New York  San Francisco

Unit of Union Carbide and Carbon Corporation

Pacific Coast Stations—9 P. M., Pacific Standard Time
KPO—KGO—San Francisco
KFOA—KOMO—Seattle

KFI—Los Angeles
KGW—Portland

Have you heard the new Victor record by the Eveready Hour Group—orchestra and singers—in Middleton's Down South Overture and Dvořák's Goin' Home?

Tell them that you saw it in RADIO



—And now the Fada "Special"

—Harmonated Reception at a Popular Price

Without question the simplest, high-powered and low-priced 6-tube shielded set ever presented. Designed by Fada engineers—every part made by Fada workmen according to Fada's rigid standards, in the Fada plant—it excels in all-round performance anything offered at anywhere near its price! Hear it today! You'll be amazed!

F. A. D. ANDREA

CHICAGO
SAN FRANCISCO
NEW YORK

Fada Cone Speaker

22 inch, free floating cone—permanent Parkerized magnet, Cone of Grecian design. Antique bronze finished trifoof.
Pacific Coast Price \$37.00

The Fada Special

6 tube—3 radio frequency stages detector—2 audio amplification stages. Individual stage shielding. Equalized amplification.
Pacific Coast Price \$99.00

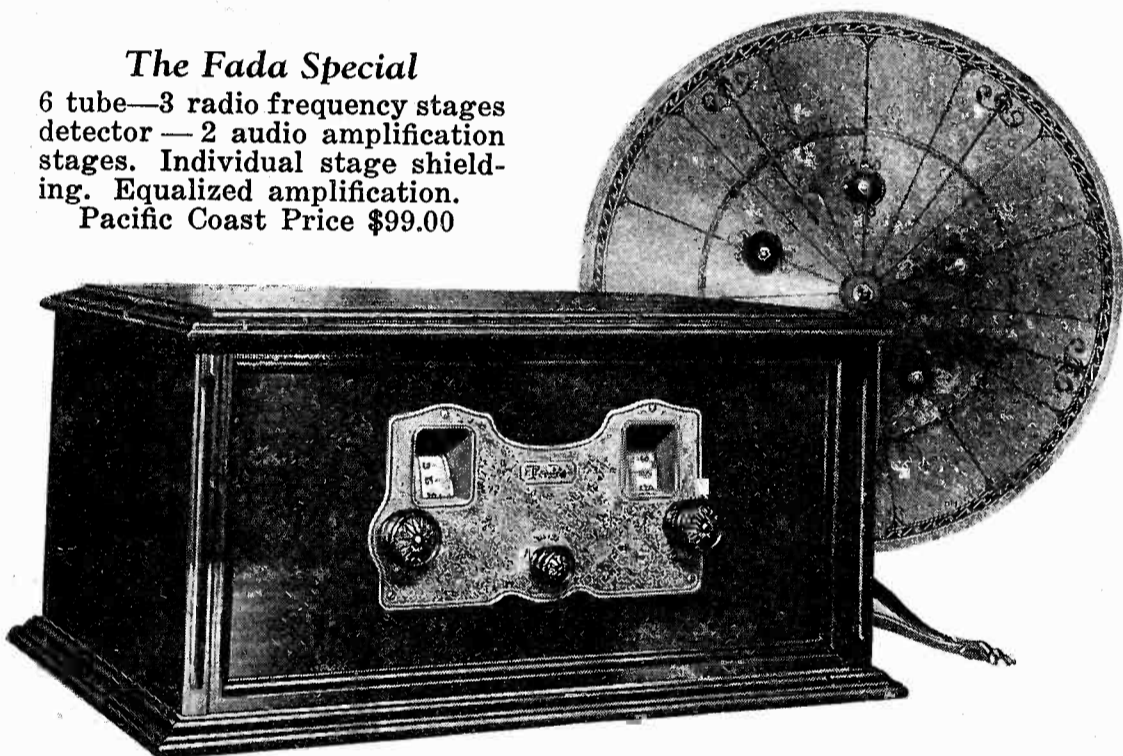

Licensed under Hazeltine Corp. patents, Latour Corp. patents, Radio Corp. of America patents, General Electric Company patents, Westinghouse Electric and Manufacturing Company patents, American Telephone and Telegraph Company patents; licensed only for radio amateur, experimental and broadcast reception.

of Hankins. Seein' I've got to do some-
thin', I gets a big paper bag of plaster
of Paris an' mixes it up with water in
a small wooden box, in the packin'
room; an' then I tries to get Dumb Mc-
Gurk to plant his hoof in it. But Mc-
Gurk thinks he smells some kind of a
rat, an' he refuses to do it; so, disgust-
ed-like, I sticks my own brogan into the
hardening plaster, an' makes a big foot-
print.

"What's the funny idea, Sammy?"
titters Cuddle-up, comin' out into the
packin' room, an' catchin' me at this.

"It's for Old Kid Blennerkem, th'
big boss of th' tube trust," I explains
to her. "It's suppose to be a footprint
of Hankins. When you're a detective,
you gotta earn your money, someway."

"Gee, you're a kick, Sammy!" says
Cuddle-up, pinchin' me on th' cheek.
"You sure are a slick devil. You ought
to be president yourself of the—what
is it this week—The Mocking Bird
Tubes, Inc."

"Named it after you—you're th' little
mockin' bird in this joint," I says,
mushy-like; an' then I adds, cautiously,
"that is, I suggested it to Hankins—"

"Oh!" exclaims Dumb McGurk,
droppin' a whole armful of tubes. "Have
you seen Mr. Hankins?"

About this time, there is a sudden up-
roar, like a volcano goin' into action,
back in our inner hole-in-th'-wall office;
an' then out busts th' Grouchy Gopher,
wavin' a letter an' lookin' wild as a
maniac.

"Hey, Hank—Jones—Sam! What's
this!" he yells at me, hoppin' up an'
down, like a kangaroo with its tail in
a trap; an' he starts readin' to me out
of the letter, which I sees is from New-
ark,—

"Mr. S. P. Hankins, Pink-Tip Tube
Company, Oakland, California, Dear
Sir:—Umph!—'Oowining to your de-
lay in remitting check for your previous
order'—Umphy! We remitted it—and
considering that your business is unlist-
ed in Bradstreet & Duns'—Umph—we
have been compelled to ship C. O. D.'
—Umph!—'C. O. D. your order No.
1215 for 25,000 201-X tubes marked
Celebrated Yankee Doodle to Walnut
Creek, California. We trust you will
realize that in view of the precarious-
ness of the tube industry, and in the
face of the financial difficulties of our
own, we felt'—Umph!—so forth and so
forth!"

"Well, may hell burn 'em—that's a
dirty trick!" I growls, angrily. "We
ought'a let their blasted tubes lay in
Walnut Creek an' rust!"

"But we ain't got a tube in th' place,
an' there's all kinds of orders to be
filled!" storms the Grouchy Gopher.
"We got to have 'em! They're good
tubes, too—not like some of them

IT'S HERE!

You Will Like It—and Profit!

THE WORLD'S GREATEST

RADIO CATALOG

Now Free—Send for your copy today!

The best in Radio—at a **big saving**—all under one roof. You don't need to look elsewhere. Contains all the information you need.

Complete stock carried. Prompt, efficient, dependable service, always.

Established 1918

TELEPHONE MAINTENANCE CO.
123-D South Wells Street Chicago, Illinois

CHICAGO'S OLDEST RADIO HOUSE

WHOLESALE ONLY

ALL - AMERICAN RECEIVERS

(Continued from page 38)

lengths and is designed so as not to oscillate. Power supply is obtained directly from the a. c. light socket through a power unit that furnishes correct *A*, *B* and *C* voltages. Compensation is provided for any variation in line voltage.

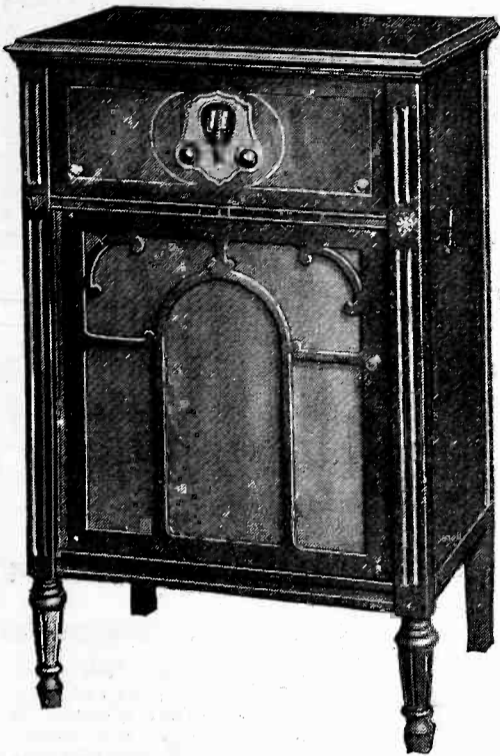

Six-Tube Battery-Operated Receiver with Built-in Speaker in Hiboy Model.

Another six tube chassis having two stages of tuned r. f. and three stages of audio uses five UX199 tubes with filaments in series and a UX112 tube in the last audio stage. A specially designed power unit using a Raytheon rectifier supplies *A*, *B* and *C* voltages from the a. c. light socket.

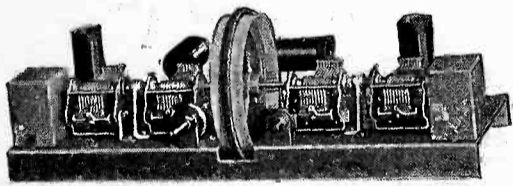

Chassis for Six-Tube Battery-Operated Model.

The battery-operated six-tube model can also be operated by independent socket power units. UX 201A tubes are used in the three stages of tuned r. f., detector and first audio sockets and a 112 or 171 in the last audio. The steel chassis has three-point suspension, floating condenser assembly and rugged construction. Single drum control is used.

The five-tube chassis has four series filament connected 199 tubes in its two stages of tuned r. f., detector and first audio and a UX112 in the last audio stage. The necessary d. c. voltages are furnished from an a. c. source through a compact power unit.

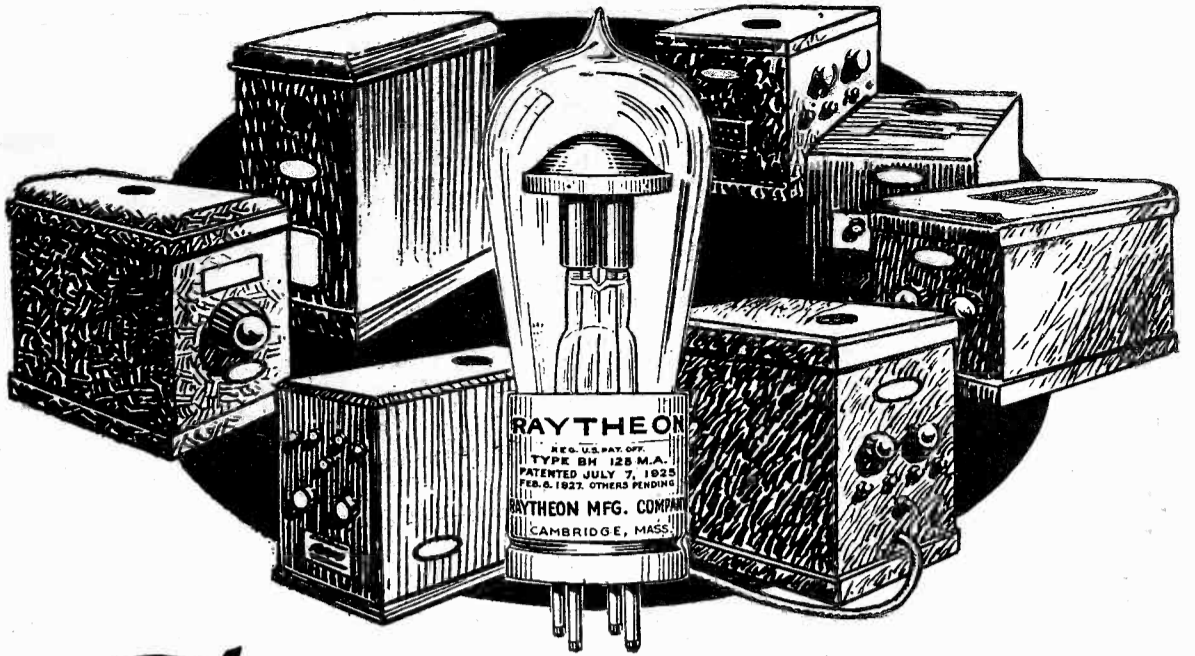

The Outstanding Radio Power Units

What does it mean to you that over fifty leading manufacturers of light socket power units submitted their designs to the Raytheon research laboratories for approval and right to use Raytheon long life rectifying tubes? Just this—that Raytheon's technical personnel and unusual scientific facilities in conjunction with the use of the Raytheon rectifier are invaluable aids in the making of a *reliable* radio power unit.

Look over the Raytheon-approved devices. They are the outstanding radio power units by reason of their highly dependable performance. Today, over 700,000 receivers are performing at the height of their efficiency by being powered with Raytheon-approved light socket power units.

Your dealer can show you a Raytheon-equipped unit exactly suited to the needs of your receiver.

RAYTHEON MANUFACTURING CO.
Cambridge, Mass.



When you see this green Seal of Approval on a power unit you know that it is a Raytheon-approved unit and can buy it with full confidence in the integrity of its makers and the performance of the device.

Raytheon

THE HEART OF RELIABLE RADIO POWER

Intermediate Transformers MATCHED

Let Gerald Best and D. B. McGown match and "peak" the intermediate transformers for your super. Proper fixed condensers will be attached. This entire service for \$2.50. Condensers extra. Laboratory of "RADIO," San Francisco

FREE NEW CATALOG

Dealers and Set Builders—Write today for our new 1928 Catalog. It's FREE. Shows latest and best nationally advertised radio equipment. Complete Kits as specified in articles in leading radio magazines now ready for shipment. No delays in filling orders. Best Prices.

MILLER - WELLES CO.
18 W. Kinzie St. Chicago

HEAR the wonderful
New Acme Speaker at
your dealer's

ACME
for amplification



5 TUBE RADIO
ONLY \$19.98

It's a wonder for power and selectivity. Famous ARL circuit. Coast to coast reception! Finely built of selected, tested parts. Thousands now in use. FREE Log and Call Book and New 132-p. Catalog with thousands of nationally advertised bargains. Latest in radio at big savings. Write for Free copy. AMERICAN AUTO & RADIO MFG. CO. HARRY SCHWARTZBERG, PRES. Dept. 141 American Radio Bldg., Kansas City, Mo.



Tell them that you saw it in RADIO

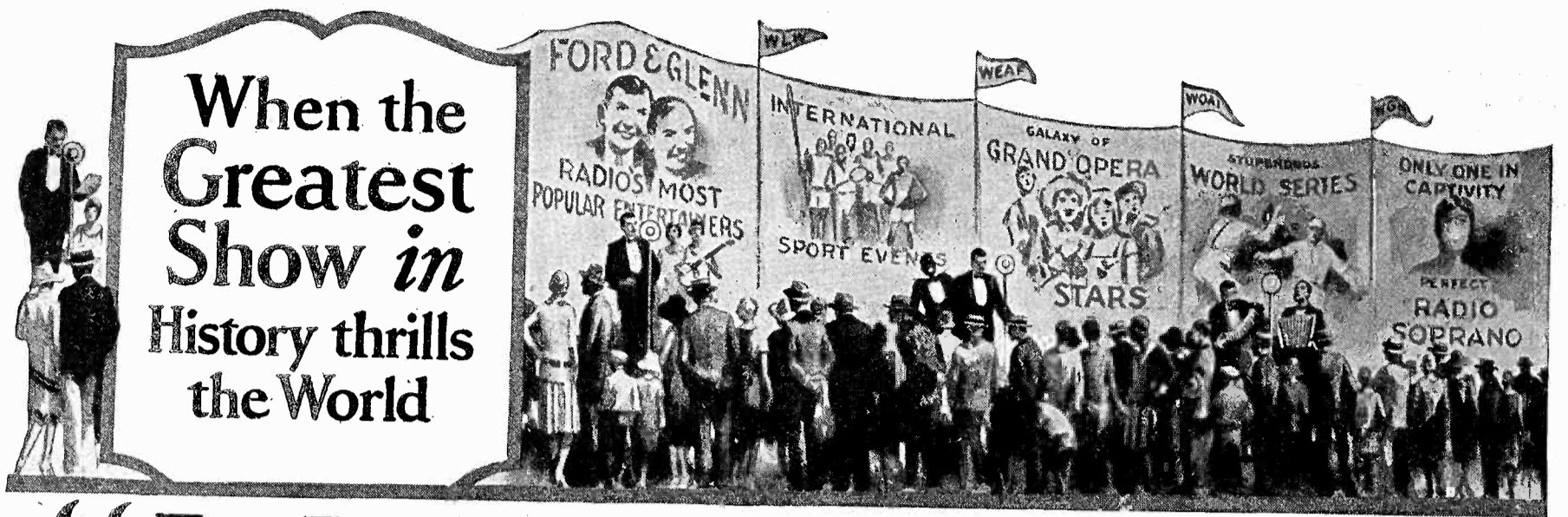

When the
Greatest
Show *in*
History thrills
the World

.... "You're there"

Prices slightly higher
west of the
Rocky Mountains

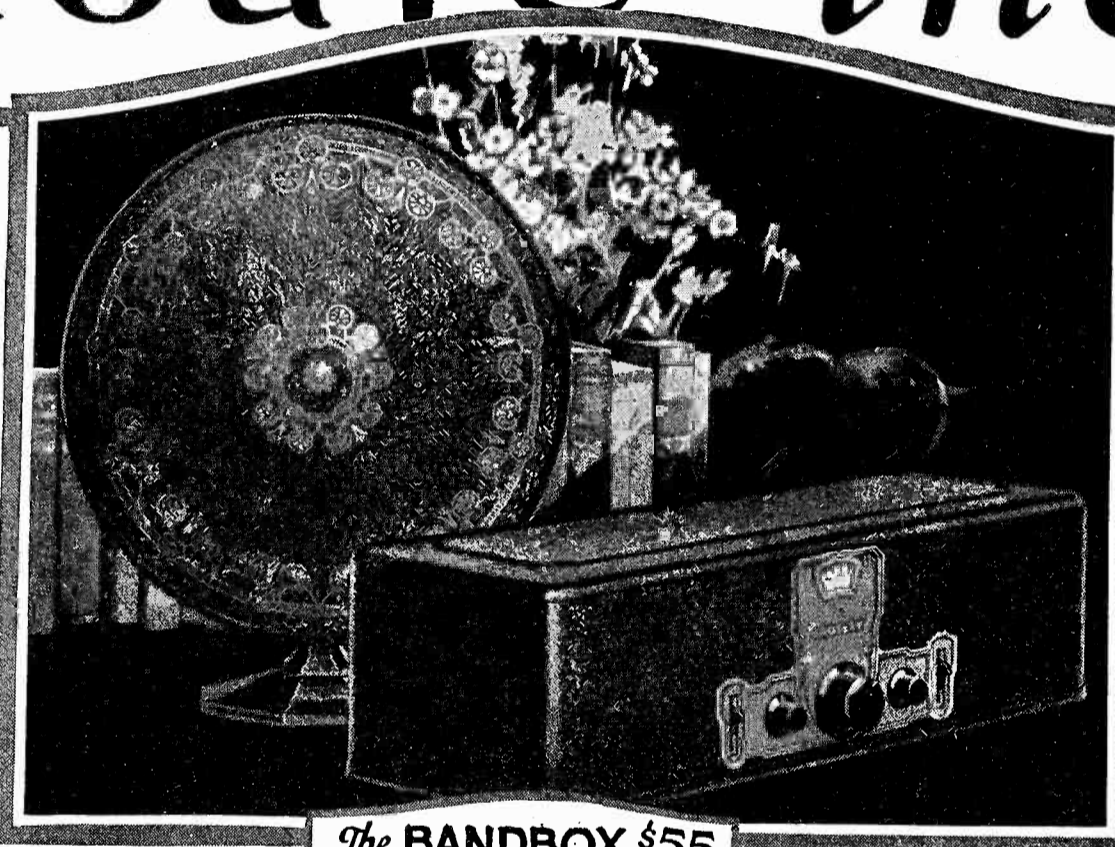

IMPROVED MUSICONES

Although Musicones improve the reception of any radio set, they are perfect affinities in finish, beauty and reproductive effectiveness for Crosley Radios. A new model built in the form of a Colonial Tilt-Table with brown mahogany finish, stands 3 feet high. Price \$27.50.

16-Inch Super Musicone
(As pictured with Bandbox) \$12.75

12-Inch Ultra Musicone \$9.75



The BANDBOX \$55
A 6 tube Receiver
Brown frosted Crystalline finish-
Bronze Escutcheon.

These approved cabinets have been selected by Powel Crosley, Jr., as ideal consoles, acoustically and mechanically, for the installation of the Crosley "BANDBOX". Genuine Musicones built in. Crosley dealers secure them from their jobbers through
H. T. ROBERTS CO.,
914 S. Michigan Ave., Chicago, Ill
Sales Agents for
Approved Console Factories:
SHOWERS BROTHERS COMPANY
THE WOLF MFG INDUSTRIES

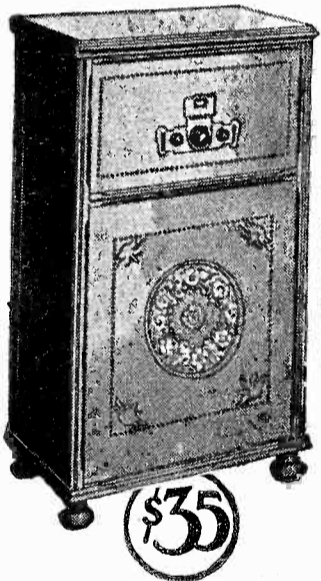

\$35

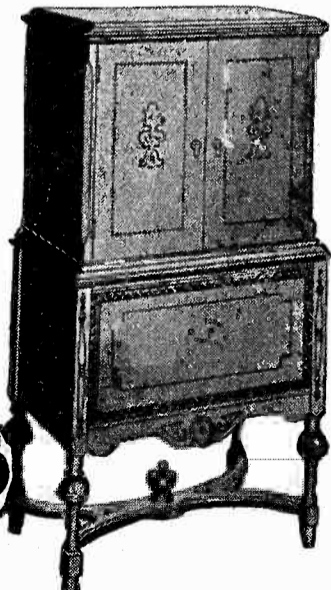

\$85

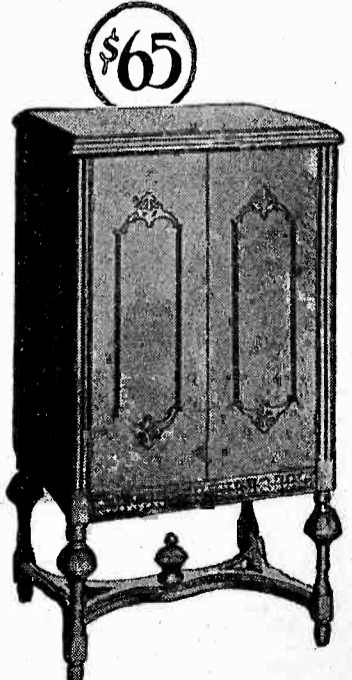

\$65

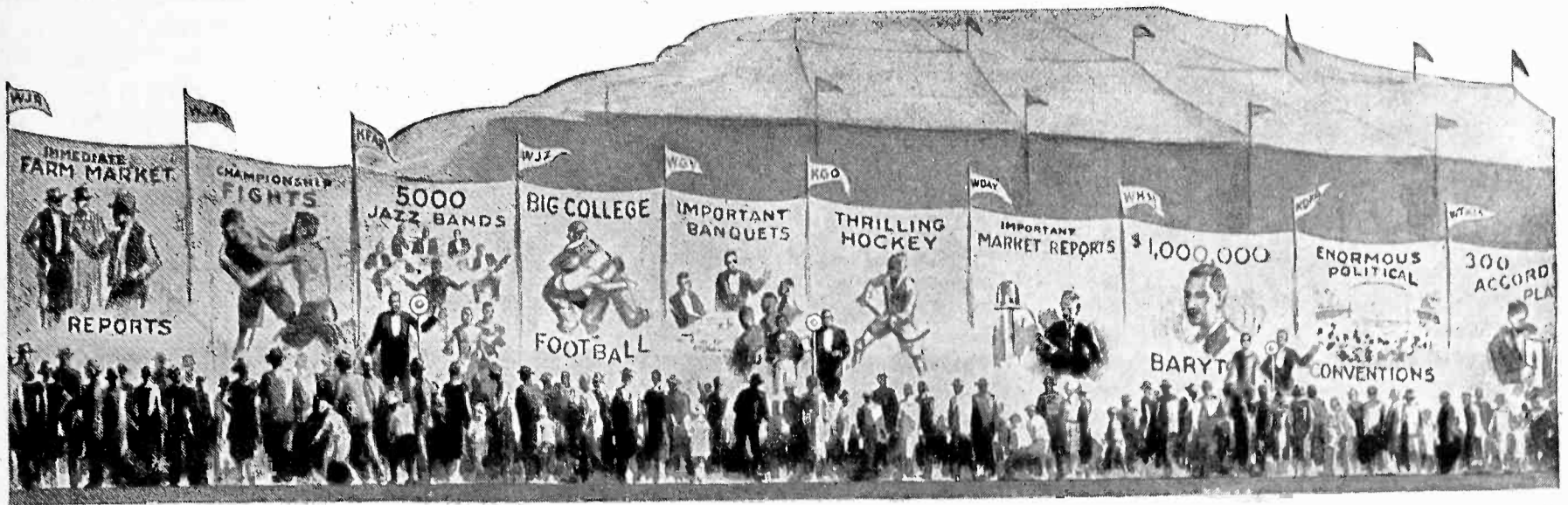

with a Crosley

The "BANDBOX"—a phenomenal Crosley radio receiver for the complete enjoyment of the 1927-28 Radio Season!

Recent court decisions which clarified the radio patent situation have paved the way for, still greater Crosley triumphs.

Now—completely available to Crosley—and amplifying Crosley supremacy in fullest measure, are the enormous resources, great discoveries and ideas embodied in patents of

- 1—The Crosley Radio Corporation.
- 2—The Radio Corp. of America.
- 3—The Westinghouse Co.
- 4—The General Electric Co.
- 5—The American Telephone & Telegraph Co.
- 6—The Hazeltine Corporation.
- 7—The Latour Corporation.

under which Crosley is now licensed to manufacture.

Here are the seven big things which represent radio's greatest advancement, brought together by Crosley and combined with the experience, mass production method and leadership of the Crosley organization. No wonder a waiting radio world pronounces the "Bandbox" at the unprecedented price of \$55, Crosley's paramount achievement.

The Bandbox is Shielded

Radio coils are surrounded by magnetic fields similar in every respect to the magnetic field around the earth that moves the needle of a compass but around radio coils these fields make nuisances of themselves by feeding back on each other. Heretofore it has been customary to make inefficient coils with inefficient fields to prevent such feeding back. The Crosley Bandbox incorporates copper shields around each coil to prevent such feeding back. The coils consequently can be made and



are very much more efficient. The amplification of the receiver is, therefore, much higher—the sensitivity is greatly increased. Condensers are also completely shielded from each other in separate metal compartments. Hitherto, only high priced sets have enjoyed this super radio advantage.

There Is No Oscillation

The Bandbox employs completely balanced or neutralized radio frequency stages to prevent oscillation, instead of the common form of lossier method. More costly, to be sure, but extremely necessary in achieving such results as are obtained by this marvel of radio reception.

For Sharpness--The Acuminators

"Bandbox" acuminators enable "fishers" for distant stations to bring them in loud and clear. As powerful telescopes magnify distant scenes, acuminators increase the volume of far-a-way signals so they seem like local programs.

Volume Control

This is another big "Bandbox" feature which permits full brass band power for those who want their dance notes strong and loud. For others, it cuts volume down to a soft and gentle murmur, without distortion.

Illuminated Dial

A Master Station Selector has an illuminated dial for easy reading in shadowy corners. A single knob

permits full tuning for ordinary reception of local, nearby and super-powered stations.

Installation Simplified

A woven cable, containing vari-colored rubber covered leads makes installation and hook-up easy for the veriest novice. No waiting for the radio service man, should the batteries be changed.

Easily Adapted to Consoles

Simply remove screws in escutcheon and in base of set. Lift off metal case. Chassis now stands ready for installation in console cabinet. Opening in console cabinet permits control shafts to protrude. Escutcheon screws in place and—Presto! the console radio is complete.

For A C Operation a special Bandbox is available at \$65, wired specially for use with the Crosley Power Converter at \$60. This special Bandbox utilizes the new R.C.A. AC tubes which have made the operation of radio receivers direct from house current so simple, efficient and dependable. The first three tubes employed in the A C model are UX 226. These go into the radio frequency sockets. The detector tube is UY 227, with

indirectly heated emitter. Another UX 226 is used in the first audio stage. Raw A C current heats the filament of all UX 226 tubes. Power tube UX 171 is in the

last audio socket. This makes the "dog houses" rumble sonorously and the bass drums deeply boom.

The Power Converter

The power converter which smooths the alternating current is a marvel of engineering ingenuity. Only half the size of an ordinary "A" storage battery, it supplies the required A, B and C currents, without hum. Finished in brown frosted crystalline. There are models for 25 and 60 cycle current. A snap switch shuts down the set and power converter completely.

Price of Power Converter—\$60

You owe it to yourself to see the "Bandbox" and listen to its remarkable performance. If you cannot easily locate the nearest Crosley dealer, his name and address will be supplied on request. Write Dept. 19.

CROSLEY RADIO

Crosley Radio is licensed only for Radio Amateur, Experimental and Broadcast Reception.

201-A Radiotrons and one UX171 equivalents which are furnished at standard tube prices, with each \$5 180-volt tube, it gives a superior performance for 135-volt "B" batteries.

THE CROSLEY RADIO CORPORATION
Powel Crosley, Jr., Pres.
CINCINNATI, O.

Tell them that you saw it in RADIO

There is a Vitrohm Radio Resistor for EVERY power unit

More than 90 standard Vitrohm Resistors and Rheostats cover the resistance need of every socket power circuit now on the market.

Resistance is the heart of power circuits. Make sure of quiet, permanent, and unfailing service by insisting on Vitrohms for radio.

Vitrohm Resistors and Rheostats are guaranteed unconditionally for continuous-duty in any circuit where they operate within their watts dissipation rating—Vitrohm Resistors have the highest continuous-duty rating without resistance change of any resistor.

New Vitrohms

The list below of new resistors and rheostats is partial. A full description of new Vitrohms for Radio is available without charge. Send for it.

RAYTHEON 350 M. A. UNITS

Vitrohm Resistor 507-70 \$8.75
Vitrohm Rheostat 507-59 5.50

QRS 400 M. A. CIRCUITS

Vitrohm Resistor 507-62 \$8.75
Vitrohm Rheostat 507-59 5.50

SILVER-MARSHALL UNITS

Vitrohm Resistor S-M 653 \$2.50
Vitrohm Resistor S-M 655 2.50
Vitrohm Resistor S-M 657 5.00

THORDARSON POWER PACKS

Vitrohm Resistor for R-171 \$2.15
Vitrohm Resistor for R-210 2.65
Vitrohm Resistor for R-210 with UX874 Regulator Tube 4.90

The Adjustat

A new Vitrohm Rheostat, dissipating 20 watts, having 15 steps of resistance. The Adjustat is priced at \$3.00.

11 types are available in the following resistances and current capacities:

507-79, 1 ohm, 4 amp.—507-71, 2 ohms, 3 amp.—507-72, 6 ohms, 1.5 amp.—507-73, 20 ohms, 1.0 amp.—507-74, 30 ohms, 0.75 amp.—507-80, 50 ohms, 650 m.a.—507-81, 600 ohms, 180 m.a.—507-75, 1000 ohms, 125 m.a.—507-76, 2250 ohms, 90 m.a.—507-77, 10,000 ohms, 40 m.a.—507-78, 25,000 ohms, 10 m. a.

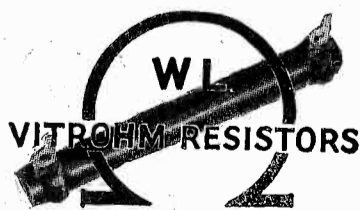

WARD LEONARD
ELECTRIC COMPANY
MOUNT VERNON, N. Y.

FROM THE RADIO MANUFACTURERS

The new Tower cone speakers are designed to give fine tone quality and volume together with an appearance that will harmonize with home surroundings



and meet various personal tastes. Two of the five new models, the "Adventurer" and the "Castle" are here illustrated. The former pictures a sailing ship cast in bas-relief with vivid natural colorings.



It stands 18 in. in height. The latter pictures a medieval castle with embattled turrets cast in relief and finished in two-tone bronze. Both employ a high-powered armature unit to drive a 17 in. free-edge cone protected by a metal rim.

The Willat cone modulator is intended to lower the tone of a cone type loud speaker. It is attached to the tip of the

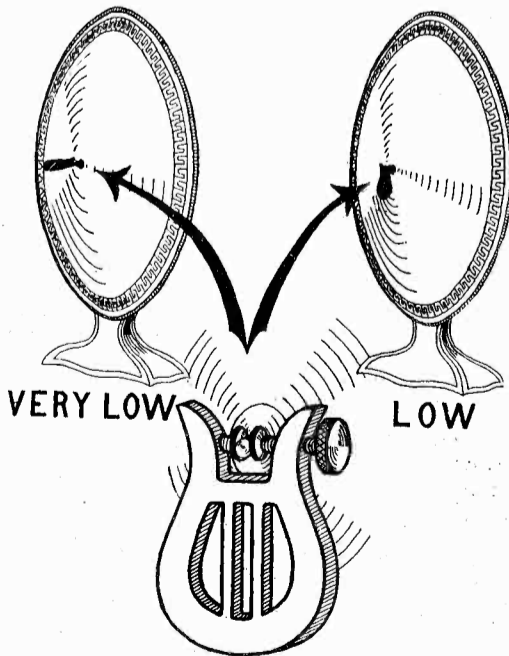

cone by a single clamp. Its angle relative to the cone axis is adjustable, thus modifying the tone to that designed.

Tell them that you saw it in RADIO

(Continued from page 44)

squealin' peanut-wagon-whistles we've had around here! Umph!"

"Harrumph!" I says. "How much jack we got in th' corporation treasury?"

"Enough to lift the shipment," says the Gopher, consulting our check book. "But it'll take every last dollar! Every dollar!"

"All right!" I says, business-like. "You get the money out of the bank an' toddle out to Walnut Creek with th' trucks, right away. Meanwhile, I'll take my plaster-cast footprint of Hankins over to Old Kid Blennerkem an' collect a few hundred dollars of my private-detective salary, to carry us over."

"Gee, you're wonderful, Sammy!" says Cuddle-up. "Mr. Hankins ought to raise your wages, I think."

"Ahem," I replies, kind of embarrassed-like. "You know, kiddie, he said he would—if I would get married an' settle down—"

"Then you have seen Hankins?" demanded Dumb McGurk. "The long, dark—"

"Oh, go sit on your ear!" I snaps at him, short-like; an' I breezes off with my plaster footprint rolled in a newspaper.

This time, I finds Old Kid Blennerkem as joyful an' excited as a kid with a sockful of Christmas presents.

"Hurrah!" he gibbers, fairly fallin' on my neck. "Sam, I've cooked the Hankins goose! I've cooked the Hankins goose!"

"Huh!" I gasps, settin' my plaster-cast down with a bump on his desk.

"Oh, there it is!" exclaims Blennerkem, catchin' it up an' starin' at it. "Well, we hardly need it, now. Say, Sam, I've planted the prettiest little kewpie-doll of a detective right in the Hankins works—and she's floored him. By George, she's floored him. Got all kinds of signatures, secret photographs, papers, letters, fingerprints! Say, she knows about your footprint; and she's promised to bring the man right over here that fits it. Hankins himself! Been working on the case a month, and wouldn't let me say anything about it; but it's too good to keep! And she says I'm acquainted with Hankins. Says I'll know him when I see him! Whaddaya think of that, Sammy? Say, she's run rings all around you, as a detective, old boy. And you'd never think she knew a thing. Talk about a pretty baby. And what she knows about the bootleg-tube business! But you must have seen her over there, Sammy—bookkeeper, typewriter-girl, or something. Big brown eyes, cuddly, you know. You saw her over there, Sammy, eh?"

"Ahem!" I says, feelin' like I have drunk a milk-can full of hop. "Yes, I think I've seen her."

"And say, I haven't told you the best of it, yet!" blabbers Blennerkem. "You

(Continued on page 50)

LEUTZ

UNIVERSAL TRANSOCEANIC

9 TUBES

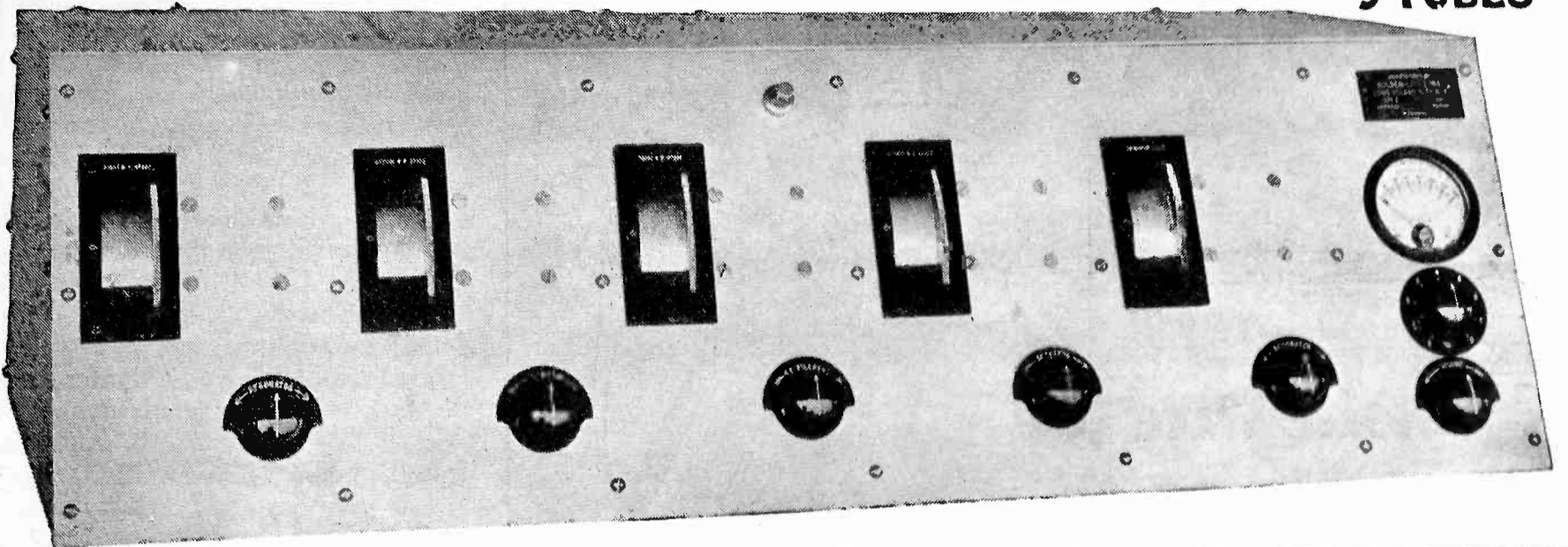

TRUE SELECTIVE POWERFUL

NEVER before has any radio ever provided at so low a price, so many QUALITIES and exclusive features. Modern to the minute in design, offering True distinction in appearance, built of fine materials, master workmanship, — the "UNIVERSAL TRANSOCEANIC" is the outstanding triumph of the most favorably known builders of powerful radio receivers.

Write For Our New Literature Today.

C. R. LEUTZ, Inc.

Sixth and Washington Aves., Long Island City, N. Y.

NOW

\$150

DIRECT

FROM OUR FACTORY

TO YOU

QUALITY AT LOW COST

Tell them that you saw it in RADIO

ACME



Flexible Celatsite Wire

A cable of fine, tinned copper wires with non-inflammable Celatsite insulation. Ideal for sub-panel or point-to-point wiring. Strips easily, solders readily. Nine beautiful colors; sold only in 25 ft. coils, in cartons colored to match contents.

Acme Celatsite Wire

Tinned copper bus bar hook-up wire with non-inflammable Celatsite insulation, in 9 beautiful colors. Strips easily, solders readily, won't crack at bends. Sizes 14, 16, 18, 19; 30 inch lengths.



Spaghetti Tubing

Oil, moisture, acid proof; highly dielectric — used by leading engineers. Nine colors, for wire sizes 12 to 18; 30 inch lengths. (We also make tinned bus bar, round and square, in 2 and 2½ ft. lengths.)

Stranded Enameled Antenna

Best outdoor antenna you can buy. Seven strands of enameled copper wire. Presents maximum surface for reception, resists corrosion; this greatly improves the signal. Outside diameters equal to sizes 14 and 16. (We also offer solid and stranded bare, and stranded tinned antenna.)



Loop Antenna Wire

Sixty strands of No. 38 bare copper wire for flexibility, 5 strands of No. 36 phosphor bronze to prevent stretching. Green or brown silk covering; best loop wire possible to make.

Battery Cable

A rayon-covered cable of 5, 6, 7, 8 or 9 vari-colored Flexible Celatsite wires for connecting batteries or eliminator to set. Plainly tabbed; easy to connect. Gives set an orderly appearance.



Send for folder
THE ACME WIRE CO., Dept. R
New Haven, Conn.

Dubilier

Light Socket Aerial

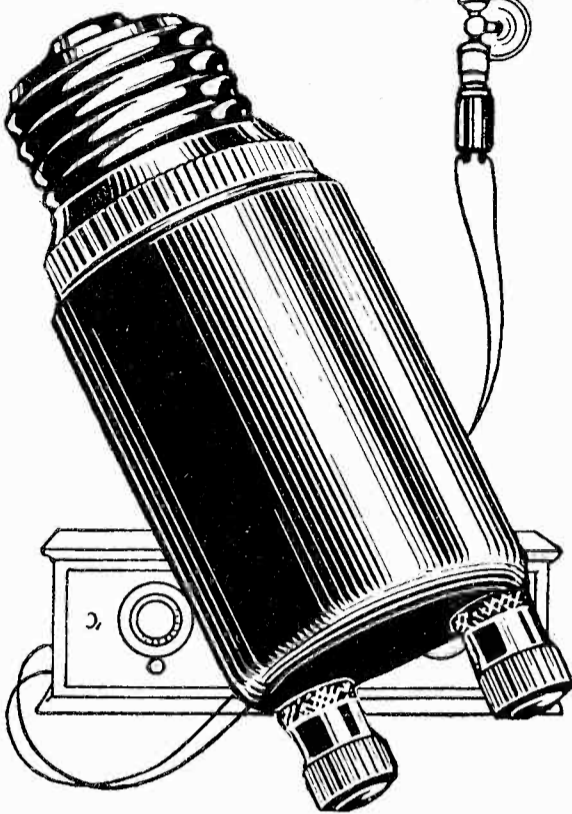

All You Need Today—

Five years ago we needed all the aerial we could swing to bring in uncertain broadcasting on our little two tube sets—but today it's different!

Screw a Dubilier Light Socket Aerial into the nearest 110 D.C. or A.C. outlet. Connect it to your receiver and listen! The static is about gone, interference is reduced and you've done away entirely with sooty aerials, lead-in wires, ground switches and lightning arresters. The device consumes absolutely no current and needs no attention whatever.

Price \$1.50

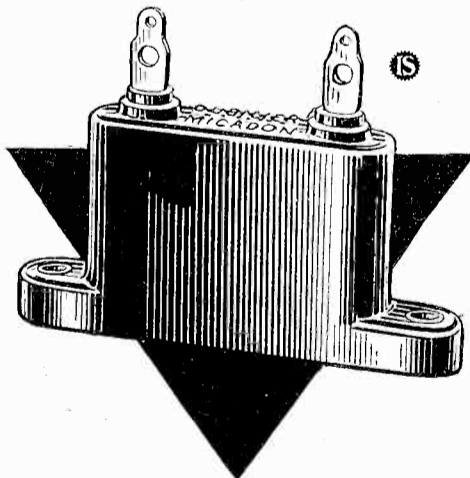

The New Dubilier Micadon

The famous "Standard Fixed Condenser of Radio" in a more modern shape, and more efficiently insulated by its new case of molded Bakelite. Terminals are adaptable to either screwed or soldered connections.

Lowest-dielectric loss
Lowest variation in capacity
In all capacities . . . Prices \$.45 to \$1.50

Dubilier Condenser Corp.
4377 Bronx Blvd. New York

Dubilier

Tell them that you saw it in RADIO

(Continued from page 48)

know, she located the address of the outfit back in Newark that was furnishing the tubes. Took her only three days. My office in New York went and slapped an injunction right on them. They cleared out with their machines; and then we stampeded 'em into selling their capsized layout to us for a sandwich—just about. Little Tillie held back one of Hankins' big checks, till we got in on the ground floor, and it fell right into our lap. Great stuff, eh, Sammy?"

"Yeh, great, all right," I mutters, sinkin' into a chair, like a scuttled ship in a China typhoon.

"But wait, I've got a better one to tell you!" chortles Blennerkem, holdin' his sides, like he is goin' to bust. "This damn Hankins wires for 25,000 tubes; he was paying a dollar-thirty and expressage. Har, har, har, hee, hee! We packed up 250 big cartons full of newspapers and bricks and shipped 'em C. O. D.! C. O. D., \$33,000. Haw, haw, haw, can you beat it, Sammy? Tillie's idea! Ain't it a banana! Har, har, har, har, har, hee, hee—by George, ain't it a raspberry on ice—say, what's th' matter, are you going to pass out?"

"Yeh—er, no, I got an attack of leprosy or somethin'—comes on me every once in a while. I think I better go home!" I gasps.

"Be sure to be here tomorrow and have a look at Hankins!" sings out Blennerkem, as I stagger out through the door. "I'll bet he'll look sick. Haw, haw, haw, hee, hee, hee! Oh, my stars!"

When I gets back to the dump, I finds the Grouchy Gopher rippin' open the cartons from Walnut Creek an' raisin' a tornado of newspapers an' bricks; while Dumb McGurk is standin' by, with his mouth open about a yard.

"Ye gods!" howled the Gopher, jumpin' around, when he sees me. "What's this, anyway?"

"I guess it's th' end of th' world," I groans.

"Umph! I'm going back to Newark," says the Grouchy Gopher, dustin' off his vest an' reachin' for his hat.

"You can ride with me in my old gas-bus as far as Kansas," says Dumb McGurk. "That's where I come from and that's where I'm goin' back to."

I journeys with th' Gopher an' McGurk up into Nevada; for I am feelin' a longin' fer th' hills an' woods, far away from th' roarin' cities full of tube-trusts an' deceivin' females. All the while, Dumb McGurk sits at the loose-jointed wheel of his ancient gasoline-hack, with a perplexed frown on his freckled beak.

"Say!" he exclaims, comin' to a jarrin' stop an' turnin' around to look at me. "What has become of Hankins?" "Ahem," I says, sadly. "Hankins has died."

"Oh," sighs McGurk; an' we goes chuggin' onward.

ACME WIRE
MAKES BETTER RADIO

STORAGE BATTERIES

(Continued from page 20)

"ball floats," but generally three are used. They are held in a glass compartment at one end of the transparent case, so that they will not float around loose in the battery solution. They are of different colors; and they are weighted in such a manner that one ball will sink to the bottom of the battery when the battery is fully charged, another when the battery is half discharged, and the third will sink only when the battery is completely discharged. The floating of the differently-weighted colored balls is due to the differences in the density of the battery solution at the various conditions of charge and discharge. The differences in the density or weight of the battery solution is due to variations in the amount of acid in the solution, which in turn is governed by the state of charge of the battery. The density or weight of the battery solution as compared to that of chemically pure water is measured in terms of specific gravity. When the battery is fully charged, there is more acid in the solution than when the battery is discharged. The specific gravity of a fully charged lead-acid storage battery is 1.280, which means that the battery solution has a density 1.28 times the density of distilled water. Likewise, the specific gravity of a nearly discharged battery is about 1.175, and that indicates that most of the acid has gone out of the solution and into the plates, forming lead sulphate. The ball float type of hydrometer is coming into quite general use because it is so much handier and easier to read than the ordinary bulb-type hydrometer.

The lead terminals on storage batteries are liable to corrode. The white, moist powder that collects on the posts should be wiped off as it collects. This powder can be kept from adhering to the posts by thinly coating them with automobile grease.

Why is it that radio set owners make such a fuss about putting a little distilled water in their storage A batteries; and yet willingly and religiously remove the floor boards from their automobiles once a week and put water in their car batteries, although they have almost to tie themselves in knots and stand on their heads to do so? A radio storage battery can be ruined just as quickly and thoroughly as an automobile battery if it is not given a drink occasionally.

A regular bulb filler is very handy to use to add distilled water to a storage battery, and is quite inexpensive to buy. A bulb filler is a large rubber bulb connected to a short, hard-fibre tube. The bulb holds about a half pint of water. Filling a battery from a bottle is a sloppy, mussy business, as most battery owners have found out. The distilled

(Continued on page 52)

Still the Standard of Excellence in Audio Transformers



The AmerTran DeLuxe
for 1st and 2nd Stages \$10.00 each

MONTH after month, and on into years, speeds the development of new radio units. Yet today the AmerTran DeLuxe is still the measure used to judge transformer quality. Time has taken no toll of the AmerTran DeLuxe. Rather, it has broadened its acceptance as *the* faithful amplifier of natural quality.

Research and test laboratories—some of the best known in the country—use the AmerTran DeLuxe as it comes nearest in their opinion to perfection in this type of apparatus. Structural ruggedness has made the AmerTran DeLuxe stand up in the climate of Central America. It has proved itself under all conditions. With the proper tubes and loud speaker, and clear signals from the detector tube, these transformers will produce the truest quality with most volume.

AMERICAN TRANSFORMER CO.

178 Emmet Street

Newark, N. J.

"Transformer Builders for Over 26 Years"

Pacific Coast Office: Rialto Building, San Francisco

ø ø ø

Other AmerTran Radio Products:

Type PF-52 Power Transformer.

Type PF-281 Power Transformer for Filament plate supply with new tubes.

Type H-67 Filament Heating Transformer.

AmerTran Resistor Type 400.

AmerChokes Types 854, 709 and 418.



Use a Milliammeter

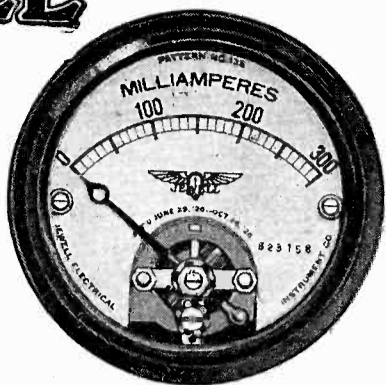

Pattern
No. 135
Milliammeter

A sensitive milliammeter in series with the plates for indicating the current in these circuits and the power of the tubes, or in the grid circuit for showing the grid current flowing, is the best means of observing the operating condition of a radio set.

The Jewell Pattern No. 135 Milliammeter is a 2-inch round moving coil instrument for the set owner that will indicate the conditions given above, and will make an attractive addition to any set. Used in connection with the Jewell Pattern No. 135-B Voltmeter, which is the same size and appearance, it tells at a glance just when the filament voltage is at the proper value to give maximum set efficiency.

Write for a copy of our Radio Instrument Catalog No. 15-C

Jewell Electrical Instrument Company

1650 WALNUT STREET, CHICAGO

"27 Years Making Good Instruments"

Why **CC** Tubes Last Longer

CeCo Tubes are
evacuated by an

exclusive process developed by our engineers and the exceedingly high vacuum thus obtained is one important reason for the longer life of CeCo Tubes.

Thorough inspection of materials and parts, critical testing to highest standards assures uniform quality, steady performance, longer life.

There's a CeCo Tube for every radio need.

Ask your Radio Dealer for
Complete CeCo Data Sheet

C. E. MFG. CO., Inc. PROVIDENCE, R. I., U. S. A.

CC

RADIO
TUBES

Exclusive Method of
Evacuating Ce Co Tubes

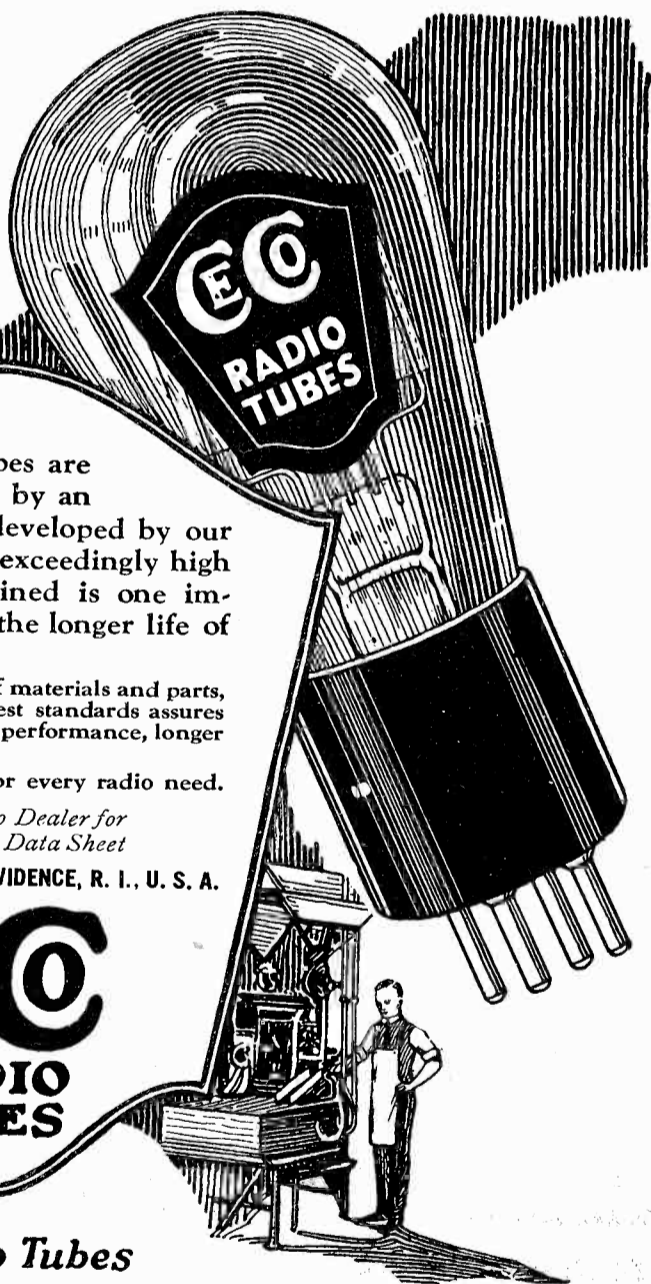

FILTER CONDENSERS

Manufactured by Dubilier Condenser & Radio Corp.

1 $\frac{3}{4}$ mfd. 1000 volts rated D.C. Working Voltage. Extra Special at \$1.35 each
7 mfd. 600 volts rated D.C. Working Voltage. Extra Special at \$3.50 each



Manufactured by Stromberg-Carlson Tel. & Mfg. Co.

3 $\frac{1}{2}$ mfd. 600 volts rated D.C. Working Voltage. Extra Special \$1.75 each

All of these High Quality Filter Condensers are brand new, and guaranteed as rated. They are excellent for use in your Eliminator, Transmitter, or Experimental Work.

AMERICAN SALES CO.

21 Warren Street, New York City

(Continued from page 51)

water should be kept in a corked bottle when not needed, so that dirt and dust will not get into it.

Quite often radio set owners who use storage batteries that have ball-float hydrometers incorporated in them complain that the ball floats are not accurate; or that the battery is worn out before such is really the case. They base their assumptions on the fact that sometimes when a battery is entirely discharged, it can be put on charge for an hour or so and the float balls will come to the surface of the battery solution, indicating full charge. When the battery is again connected to the receiving set, the balls will sink to the bottom in a few minutes. This leads the battery owner to believe that his battery is worn out, or that the float balls are defective.

What really happens is that the charging of the battery breaks up the chemical elements of the electrolyte, causing minute bubbles of hydrogen to be formed, which rise to the surface of the solution. The bubbles attach themselves to anything with which they come in contact. Many of them naturally adhere to the ball floats, and completely cover the surfaces of the balls. The thin films of hydrogen gas that thus cover the balls act in the same manner as the gas in a balloon. The result is that this balloon effect of the bubbles raises the balls to the surface of the solution, regardless of whether the battery is or is not fully charged. If all the float balls rise to the surface of the solution, which normally indicates a fully charged condition of the battery, a few minutes after the battery is put on charge, the battery owner is led to believe that the battery was not completely discharged in the first place, and that it is all right now; and so he connects it back to the receiving set. In a few more minutes the bubbles release their hold on the float balls and allow them to sink. After this has happened several times, a battery man is usually sent for, and that is a needless bother and expense. Generally it is the slight jar to the battery when it is switched from the charger to the receiving set that releases the bubbles from the float balls; but, if that does not release them, they can be shaken loose by tapping the battery case.

Some manufacturers combine a storage *A* battery with a system of electrolytic rectification for the *B* power supply. By means of a relay switch the battery is put on charge when the filament switch is turned off. One manufacturer provides a high rate of charge to a $\frac{1}{4}$ ampere or less as the battery approaches its full charge, the rate of charge being indicated by an ammeter.

Subscribe Now To
"RADIO"
\$1.00 for six months

Now We Can Serve You

THE season has opened. New sets are being built in accordance with specifications in radio magazines. A number of unusually excellent new ideas in radio kit construction will be announced monthly. Let us help you build the best in radio by supplying you with laboratory matched and personally selected parts. The laboratory of "RADIO" is at your service. When you get a tested kit of parts from us you know in advance that you will get the most out of your completed receiver. We have equipped our laboratory with several thousand dollars' worth of precision equipment to perform this service. Decide on the kind of a set you are going to build and let our laboratory supply you with the matched and tested parts. We make no charge for matching and testing. Parts are supplied to you at the regular retail prices. Tell us what you want and we will do the rest.

Readers of "RADIO" in many parts of the country are buying their matched parts from us by mail. We can take care of your requirements no matter where you live.

Special Facilities for Matching I. F. Transformers

SETS CHECKED: Complete laboratory test and check of all parts, including any type or make of set	5.00
This includes a complete check-up of all parts, matching of radio frequency coils, elimination of "bugs," etc. Sets must be shipped complete with tubes and circuit diagram, unless of standard type or make, when diagrams may be omitted. (Extra charge if diagram is not supplied.)	
Intermediate Frequency Transformers. Transformers matched, to optimum frequency and filter tuned to resonance.....	2.50
Condenser to tune filter extra. Transformers rewound and calibrated to a specified frequency for \$2.00 per transformer. STATE TYPE TUBE TO BE USED. set.	
Radio Frequency Coils. Matched to resonance with a gang or bank condenser, per set of 3 coils	2.50
(Coils and condensers both must be submitted.)	
WAVEMETERS and Oscillators. Covering all wavelength (frequency) bands from 10 meters up, with 1 coil only. At least 5 points furnished.....	2.50
Additional coils, per coil.....	1.00
Curves drawn, per curve.....	1.00

WRITE FOR QUOTATIONS ON SPECIAL TESTING AND ENGINEERING SERVICE

PARTS

Any part made by any radio factory can be supplied by us. Before parts are shipped to our customers we make a careful inspection. When you buy parts from the laboratory of "RADIO" you know in advance that you can't go wrong.

HOW TO ORDER

When ordering parts from the laboratory be sure to specify Manufacturer's name, type number and style. C.O.D. orders accepted if half cash accompanies order. Prompt deliveries assured.

Testing and Calibration Laboratory

Pacific Radio Publishing Company

Established 1917



KITS

The many new kits of the season can be supplied by the laboratory of "RADIO." Let us send you a real matched and tested kit for any circuit. The usual retail prices prevail. No extra charge for matching.

Tell them that you saw it in RADIO

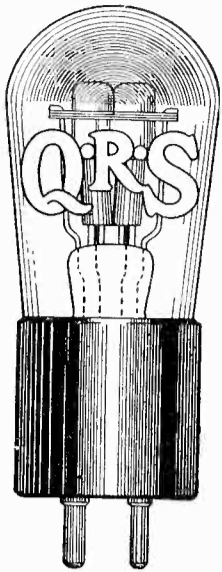

For Your "B" Battery Eliminator,
Ask Your Dealer for Guaranteed

Q · R · S
Trade Mark
Registered

**GASEOUS
Rectifier Tubes
ARE BETTER**

60 Milliamperes

\$4.50

85 Milliamperes

\$4.50

400 Milliamperes

With Ionizer 300 Volts
for A, B and C Eliminators
with Charts and Diagrams

\$7.00

Manufactured by **The Q · R · S Company CHICAGO**
MUSIC

Established 1900. References: Dun, Bradstreet or any bank anywhere

**Great
Sensitivity**

Made with our exclusive, superior feature—the TELEVOCAL SUPPORT. Televocal Quality Tubes won't short and are non-microphonic. Manufactured, tested and balanced by technical experts, they combine sensitivity with high amplification. Insist on Televocal—the quality tube that's guaranteed.

If your dealer cannot supply you, write us giving his name. Televocal Tubes are made in all Standard Types.



Televocal Corp., Televocal Bldg.
Dept. C. 588 12th St.
West New York, N. J.

**TELEVOCAL
QUALITY
TUBES**

New!

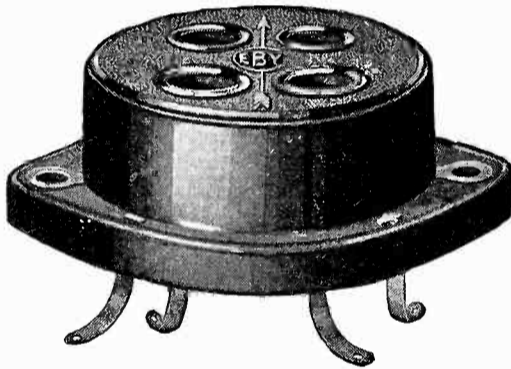

and Much Better

The prongs are completely enclosed and *can't* spread. No more socket trouble to shoot!

After all, a socket's only job is to provide a perfect contact. The Eby three point wiping spring contact is the most scientifically perfect type known.

Easy to mount above or below Bakelite, Wood or Metal.

Specified in Hammarlund Roberts Hi-Q6 and other popular circuits.

List Price 40c

THE H. H. EBY MFG. CO.
INCORPORATED

4710 Stenton Ave., Philadelphia, Pa.

Makers of Eby Binding Posts

**LYNCH
RESISTORS**

ARTHUR H. LYNCH, Inc.

1775 Broadway General Motors Bldg. New York City

REMOTE CONTROL BY RADIO

(Continued from page 24)

shown in the picture of the receiver set-up. It could be made to follow keying at 30 words per minute on a current of less than a milliampere, so there was a reasonable factor of safety. The relay was connected across the key in a conventional automatic starting system.

The lower contact screw of the relay was replaced by a carbon contact, to make sure that the contacts would not stick. Sticking contacts on the relay would be as disastrous as a howling receiver. A 1 mfd. condenser was placed across the operating coil of the relay, to fill out the hollows in the rectified audio-frequency. Its use nearly doubled the d. c. reading of the output meter.

Considerable difficulty was at first experienced from interference of the 40-meter transmitter, which was about 10 feet from the control receiver. A cure was finally effected by putting 1 mfd. by-pass condensers across the B eliminator supply, right at the receiver. Later it was found that leaving the ground off the filaments of the receiver eliminated the trouble. Tuning the antenna circuit of the set helped greatly to increase the d. c. output.

Static did not present any particular difficulty in the operation of the system. The signal to noise ratio was so great that only local lightning storms operated the relay. Ordinary noise did not kick the output meter more than .7 or .8 of a milliampere, and the Bunnell relay was set above this. The contacts of all relays were well cleaned, and, where necessary, condensers and resistors were used to soak up sparking. If sparking were present, it would be picked up on the receiver, and the noise passed through to the relay, where it would hash up the transmission.

The control transmitter at 8ALK consisted of an H tube working into a loose-coupled Hartley circuit, on 150 meters. The input to the tube was 25 watts from a synchronous rectifier. The antenna was a single wire 65 ft. long, and was worked above the fundamental to allow a comparatively large antenna current—around one ampere. At short distances it seems that the signal strength is more or less proportional to the antenna current at the transmitter. A small condenser with a 2-ft. wooden handle was placed in parallel with the primary condenser of the transmitter. If for any reason—weather, changing voltage, etc—the system failed to operate, it was pretty certain that the wave had shifted. By listening on the 40-meter wave and changing the vernier adjustment on the 150-meter control transmitter, it was possible to get the system in operation again. Of course, the ideal way would be to use crystals on the control receiver and transmitter,

(Continued on page 56)

RADIO WHOLESALE
Write for my Big 1928 Radio Catalog—just off the press. Thousands of marvelous bargains in nationally advertised goods. All the LATEST IN RADIOS and equipment. Lowest wholesale prices.
FREE Agents Wanted.
It's a regular encyclopedia on Radio. All about trouble finding. **FREE Log and Call Book and Catalog.** Get your copy today. Send postcard now!
DEALERS NEW 1928 CATALOG
American Auto & Radio Mfg. Co.
HARRY SCHWARTZBERG, PRES.
Dept. 143 American Radio Bldg., Kansas City, Mo. 3

Tell them that you saw it in RADIO

New

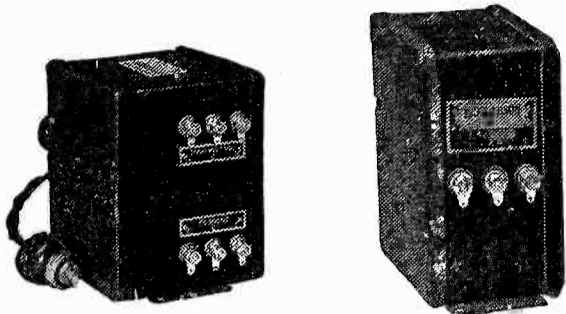

130 M. A. FULL WAVE RECTIFIER

Here is a power unit that will satisfy the ever increasing demand for improved quality of reception. A split secondary 550 volts either side of center, makes possible full wave rectification, using two 216-B or two 281 tubes. Current capacity, 130 milliamperes. The low voltage secondary, 7½ volts, will supply two UX-210 power tubes, enabling the use of push-pull amplification in last audio stage. The Double Choke Unit 2099 is designed for this power unit. Contains two individual chokes of 30 henries, 130 milli-amperes capacity each.

T-2098 Transformer, 4½" x 5¼" x 5¾"
List Price, \$20.00

T-2099, Choke Unit
3¼" x 4⅞" x 5⅝"
high

List Price
\$14.00

Realistic tone quality, that elusive but much talked of characteristic of radio reception — can be obtained only through the use of apparatus of the finest materials and workmanship. For years Thordarson transformers have been the choice of many discriminating manufacturers of quality receiving sets. Follow the lead of the leaders. If you enjoy good music specify Thordarson transformers

THORDARSON ELECTRIC MANUFACTURING CO.
Transformer Specialists Since 1895
WORLD'S OLDEST AND LARGEST EXCLUSIVE TRANSFORMER MAKERS
Huron and Kingsbury Streets — Chicago, Ill. U.S.A.

THORDARSON POWER TRANSFORMERS

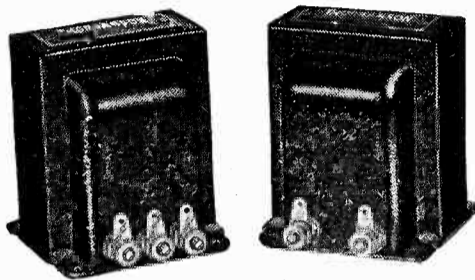

POWER PUSH-PULL TRANSFORMER and CHOKE

Quality reproduction that cannot be obtained with straight audio amplification, is made possible through the Thordarson power push-pull combination. This arrangement is designed for use with power tubes only and has sufficient capacity for all tubes up to and including the UX-210. Makes an ideal power amplifier when used with power supply unit T-2098.

Input transformer couples stage of straight audio to stage of push-pull. Output choke is center-tapped with 30 henries on either side of center tap. Dimensions of both transformer and choke, 2½" x 2½" x 3" high.

Input Transformer T-2408

List Price, \$8.00

Output Choke T-2420

List Price
\$8.00

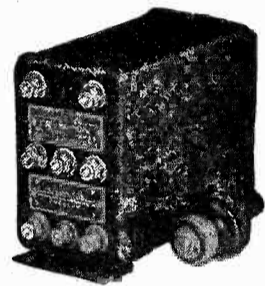

A. C. TUBE FILAMENT SUPPLY

The new R. C. A. and Cunningham A. C. filament tubes will be very popular with the home constructor this season. The Thordarson Transformer T-2445 is designed especially for these tubes. Three separate filament windings are provided.

Sec. No. 1, 1½ volts, will supply six UX-226 amplifier tubes.

Sec. No. 2, 2½ volts, will supply two UX-227 detector tubes.

Sec. No. 3, 5 volts, will supply two 5 volt power tubes.

In addition to the above, this transformer is equipped with a receptacle for the B-supply input plug. Supplied with six-foot cord and separable plug for attachment to the light circuit. Transformer in compound filled, crackle-finished case. Dimensions — 2¾" x 5¾" x 4¾".

A. C. Tube Supply, T-2445

List Price, \$10.00

THORDARSON ELECTRIC MFG. CO.
500 W. Huron St., Chicago, Ill.

Gentlemen:

Please send me your booklets describing your new power supply transformers.

Name.....

Address.....

City..... State.....

(3562)

Tell them that you saw it in RADIO

New AERO Circuits Worth Investigating

The Improved Aero-Dyne 6 and the Aero 7 and Aero 4 are destined to be immensely popular this season!

Here are three new Aero circuits of unusual merit. Each is constructed around a set of improved Aero Universal Coils—the finest and most adaptable inductances ever offered! Learn about them NOW if you are interested in securing finest selectivity, greatest range and power, truest tone quality and best all-round radio reception.



AERO Universal Tuned Radio Frequency Kit

Especially designed for the Improved Aero 6. Kit consists of 4 twice-matched units. Adaptable to 201-A, 199, 112, and the new 240 and A. C. tubes. Tuning range below 200 to above 550 meters.

This kit will make any circuit better in selectivity, tone and range. Will eliminate losses and give the greatest receiving efficiency.

Code No. U-16 (for .0005 Cond.).....\$15.00
Code No. U-163 (for .00035 Cond.).... 15.00



AERO Universal Tuned Radio Frequency Kit

Especially designed for the Aero 7. Kit consists of 3 twice-matched units. Coils are wound on Bakelite skeleton forms, assuring a 95% air di-electric. Tuning range from below 200 to above 550 meters. Adaptable to 201-A, 199, 112, and the new 240 and A. C. Tubes.

Code No. U-12 (for .0005 Cond.).....\$12.00
Code No. U-123 (for .00035 Cond.).... 12.00

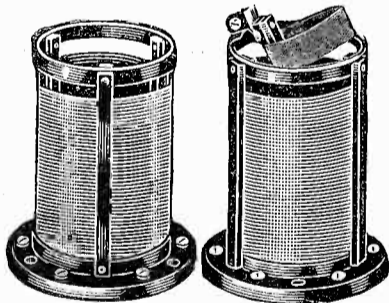

AERO Radio Frequency Regenerative Kit

An exceptionally efficient kit for use in the Aero 4 and other similar circuits. Consists of one Aero Universal Radio Frequency Transformer and one Aero Universal 3-Circuit Tuner. Uses 201-A, 112, 199 and new A. C. Tubes.

Code No. U-95 (for .0005 Cond.).....\$9.50
Code No. U-953 (for .00035 Cond.)..... 9.50

A NEW SERVICE

We have arranged to furnish the home set builder with complete Foundation Units for the above named Circuits and for the Chicago Daily News 4-Tube Receiver and the Aero Transmitter Set, drilled and engraved on Westinghouse Micarta. Detailed blueprints and wiring diagram for each circuit included free. Write for information and prices.

You should be able to get any of the above Aero Coils and parts from your dealer. If he should be out of stock order direct from the factory.

AERO PRODUCTS, Inc.
1772 Wilson Ave. Dept. 103 Chicago, Ill.

Like a Long Arm

Tune out a poor program and bring in a good one—without leaving your easy chair. Only tuning unit of its kind.



The NEW
Thermodyne

**REMOTE CONTROL
RADIO TUNING
UNIT**

Easily attached to any single dial receiver with removable dial by removing old dial and attaching Remote Control adapter plate.

Mechanical Model.....\$18

Electrical Model..... 60

Write for illus. descriptive circular

ALGONQUIN ELECTRIC CO.
245 Fifth Avenue, New York City

New LOG BOOK Now Ready

A clever log book giving spaces for logging dial setting for any U. S. or Canadian station. Also a complete list of all stations by call letters. A separate list of stations by states. Another list of stations by meters, starting at low wavelengths in numerical order. A directory of stations. Calls, waves, kilocycles and meters in alphabetical order. Printed on bond. Handy size. The best 25 cent investment you can make. Limited edition. Order your copy NOW.

**25c PER COPY
POSTPAID**

PACIFIC RADIO PUB. CO.
Pacific Building San Francisco

**\$5.50 buys
this famous
cabinet!**

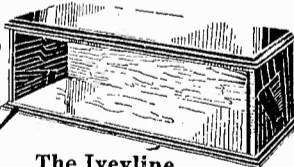

The Iveyline

Our dealing direct brings this cabinet to you at half the retail price. Made either from selected hardwood, with Mahogany finish or from solid Walnut, rubbed to a beautiful piano lustre, the Iveyline Cabinet makes a fitting climax to your set-building efforts. It has full length, nicked lid support, rubber feet to prevent vibration and lid splined to avoid warping. Fully illustrated catalogue available. Just write. If you send us your order today, the cabinet will be on its way within 12 hours from receipt of order. Se-

lect your size and finish and mail your order today. Cash with order or if C. O. D. half price with order.

Dimensions and Prices

	Mahogany	Solid
	Finish	Walnut
7x18x10	\$5.50	\$6.50
7x21x10	6.00	7.00
7x24x10	6.25	7.50
7x26x10	6.75	8.00
7x28x10	7.00	8.50
7x30x10	7.25	8.75
7x18x12	7.00	8.00
7x21x12	7.50	8.50
7x24x12	7.75	9.00
7x26x12	8.25	9.50
7x28x12	8.50	10.00
7x30x12	8.75	10.25

All prices f.o.b. factory

12 HOUR SERVICE FACTORY TO YOU

Southern Toy Co. Inc.
MANUFACTURERS HICKORY N.C.

(Continued from page 54)

ground to give a 1000 cycle beat note.

The picture of the layout at 8CAU shows why it was desired to control the transmitter there. The antenna is a single semi-vertical wire, running from the radio room below the tower on the right to a rope swung between the towers. In the picture of the transmitters, the one on the right is an embryo 80-meter crystal-controlled outfit. The H tubes on the 40-meter transmitter, to the left, have expired since the picture was taken. In their place are two UX-852 tubes in the last stage, and the intermediate stage has been cut out; the output is as good as ever.

This scheme might well be used by the members of a radio club. They could pool their resources to build an ether-buster in an ideal location and each member could operate it from his own small station. This would open up some interesting possibilities. There would be as many logs for the station as there are operators; an operator would find difficulty in forwarding a message that had been received at the station by another operator; some consideration would have to be given to call letters. Suppose two operators tried to use the station at the same time!

The system is not limited to control of a transmitter, as it could easily be modified for controlling almost any desired mechanical action. If combined with automatic switching as used in telephone work its possibilities are indeed numerous.

R. F. AMPLIFIER TUNER

(Continued from page 25)

coils to the condensers were made with No. 14 insulated wire, so that the leads would be strong enough to act as supports for the coils. A variable trimmer condenser of .000025 mfd. was shunted across the antenna secondary coil, to supplement the variable mica trimmers.

In adjusting the three tuned circuits, a local station is tuned in, and the center coil is disconnected. If the station can still be heard, the third coil, at the right hand end of the group, looking at it from the front of the panel, is moved slightly by bending the connecting wires, until the signal disappears. The second coil is then restored to the circuit, and adjusted so as to produce the best possible condition of selectivity, consistent with signal strength.

The three condensers in the gang mounting should be lined up by varying the mica trimmers with the wooden screwdriver, until the stations are heard at only one point on the dial. If there are several pronounced humps in the tuning, for any given station, the condensers are out of line. Sometimes this is indicated by a broadness of tuning, without noticeable humps; when properly lined up, the stations should tune in and out with knifelike selectivity.

A Completely NEW Standard of Radio Engineering

THE history of radio engineering is that of every other industry. From simplicity to complexity—and in its final state of perfection, back to *simplicity* again. And the Royal Series AMRAD Neutrodyne brings radio engineering to its present state of unbelievable simplicity, united with a ruggedness hitherto unapproached.

True one-dial control which gives every phase and range with ease and assurance. Genuine full copper-shielding, eliminating interference. The exclusive AMRAD tone-filter for purity of reproduction, illuminated dials, which are calibrated with wave lengths, which means you simply turn to

400 when you want a station broadcasting on 400 meters. And as the result of fine construction, you have — *ultra selectivity* and simple operation, with a *wonderfully deep, smooth, mellow tone*, richly beautiful and natural. Let us send you descriptive booklet, with name of nearest dealer.



THE BERWICK (Above)
Six-tube Console, in dark selected walnut with built-in cone speaker. Single-dial control. Pure and sweet tone quality. Very selective. Loop or antenna operated.

\$195

Equipped for lamp-socket operation, requiring no batteries of any kind.

\$295

**THE WINDSOR
(To the right)**
Seven-tube Compact, pure one dial control, extremely selective. Operated on loop or antenna. All parts completely copper-shielded.

\$195



THE HASTINGS

Single-dial control, seven-tube Console, operated by loop or antenna; one of the richest cabinets ever used for a radio set. Built-in cone speaker, mounted on special baffle board. Panelling of beautiful etched crotch walnut on the outside, and selected figured walnut on the inside.

\$295

Equipped for lamp-socket operation, requiring no batteries of any kind.

\$395

Amrad sets are manufactured under license contract between Radio Corporation of America and Crosley Radio Corporation. Licensed under Hazeltine and LaTour patents issued and pending, for radio amateurs, experimental and broadcast reception.

THE AMRAD CORPORATION
MEDFORD HILLSIDE, MASS.

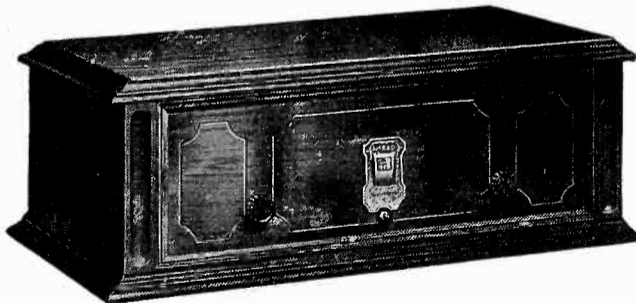

Prices slightly higher west of the Rockies

The
Royal
Series

AMRAD
NEUTRODYNE

Tell them that you saw it in RADIO.

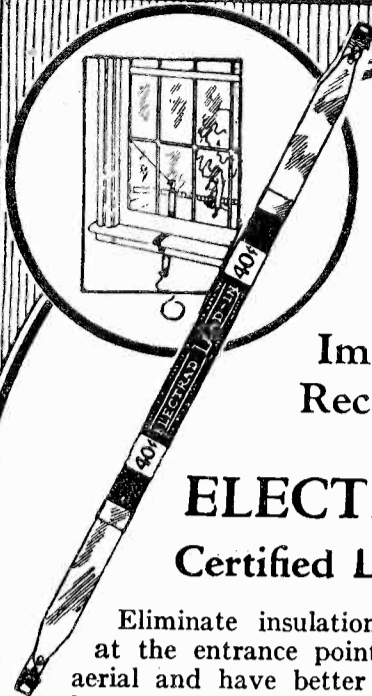

Improved Reception!

ELECTRAD
Certified Lead-In

Eliminate insulation troubles at the entrance point of your aerial and have better reception by using this superior constructed Lead-In.

Bends any shape to fit around corners and under locked doors or windows. Triple-ply insulation full 10 in. long, covered with water-proof webbing. One piece copper strip heavily tinned to prevent corrosion.

Protect yourself by looking for the Electrad name. Price 40c each. At your dealers.

Write for descriptive circular
Dept. 56, 175 Varick St., New York

ELECTRAD



VARIO DENSER

MODEL "N"—Slight turn obtains correct tube oscillation on all tuned radio frequency circuits. Neutrodyne, Roberts two tube, Browning-Drake, McMurdo Silver's Knockout, etc. Capacity range 1.8 to 20 micro-microfarads.

Price \$1.50

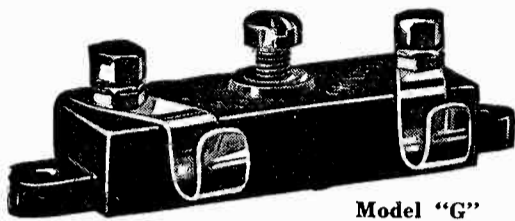

MODEL "G"—With grid clips obtains the proper grid capacity on Cockaday circuits, filter and intermediate frequency tuning in heterodyne and positive grid bias in all sets.

Capacity range:

Model G-1	.00002 to .0001	M. F. D.
Model G-5	.0001 to .0005	M. F. D.
Model G-10	.0003 to .001	M. F. D.

Price \$1.50

X-L PUSH POST—Push it down with your thumb, insert wire, remove pressure and wire is firmly held. Vibrations will not loosen. Releases instantly.

Price 15c



X-L Push Post

X-L PUSH POST PANEL—Permanently marked in white on black insulating panel. In box including soldering lugs, raising bushings and screws for mounting, etc.

Price \$1.50

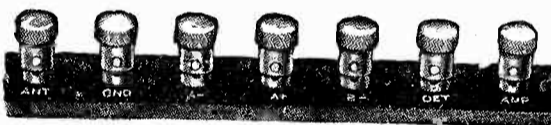

X-L Push Post Panel

Build the new LOFTIN-WHITE constant coupled radio frequency circuit. FREE wiring diagrams showing use of this and other popular circuits sent on request.

XL Radio Laboratories

2428 Lincoln Ave. Chicago, Ill.

SARGENT'S INFRADYNE MANUAL

Describing Last Season's MODEL

Is now ready for
Immediate Delivery

Order your copy now
by sending 25c in coin or
stamps to

"RADIO"

433 Pacific Bldg., San Francisco

CLICKLESS TRANSMITTER

(Continued from page 35)

telegraph key, knowing that the dots and dashes are firm and steady on a full power transmitter. One pair of contacts does the keying. One pair opens the receiving antenna, as a receiving antenna picks up so much energy that 40 meter receiving tubes are burned out otherwise. The third pair of contacts is used to close the circuit, operating M_1 , a 110 volt solenoid which tips the arc. When the arc strikes, DC flows through A as explained above, also through choke H_5 and the coils of relay M_2 , an old telegraph sounder. When the DC flows, M_2 opens two sets of contacts, one set opening the starting key around H_4 , and the other contact opening the circuit to solenoid M_1 , allowing the arc tube to right itself by means of a spring.

If, as occasionally happens, the arc does not start on the first dot, the next one coming along the key will start it. Thus to send, simply send, and to receive, simply receive. The key does everything except to turn the filament of the tube off and on.

On 5-meter tests, an automatic transmitting dial of the omnigraph type is used. Thus the writer can go out in the car to listen, or mow the lawn, knowing that if the arc stops it automatically starts immediately, allowing maximum convenience in testing with minimum amount of attention.

Just to stave off a lot of questions, the descriptions of some of the other parts of the circuit are as follows:

H_4 keeps the filament steady. It consists of 50 turns No. 12 DCC wire on a 1 in. iron core. It is tapped every turn, and by moving the clips during transmission, a point will be found where the filament voltmeter remains steady during transmission.

The receiving set is still the 30 meter Browning Drake receiver described in February 1927 RADIO.

The 110 volt pilot light indicates when the arc is out. This light is next to the key, simply indicating that the arc is out and one dot will not go out over the air.

C_1 and C_2 are National TM 150 transmitting condensers.

C_2 is a special built condenser of 1 in. spacing.

C_1 is a National TM 100 transmitting condenser.

RF_1 and RF_2 are RF chokes of 150 turns No. 18 DCC wound on 2 in. forms.

R_5 are 5 Lynch 100,000 ohm resistances (wire wound) in series so that a voltage charge will leak off from the 1 mfd. filter condensers forming the filter. This resistance draws but a very few mils, and will save many shocks when working on the transmitter.

H_1 , H_4 and H_5 are all 110 volt iron core chokes with closed cores.

F_1 are 1 amp. fuses. F_2 , half amp. fuses. F_3 , 15 amp. fuses.

RF_4 is similar to RF_2 without the thread spacing.

R_2 is 5000 ohm, and R_4 is a 110 volt filament rheostat.

L_1 and L_2 are 4 in. in diameter, 1/4 in. copper tubing.

The switches are as follows:

N switches from the 39 meter "Zepp" to the 21 meter "Zepp." On 79 and 5, separate antenna systems are clipped on.

U controls the 220 volt line only. V is the main line switch connected by string and pulley to the water switch so that no current is possible in the set, unless water passes through the water cooled tube.

W opens plate and filament circuits only, leaving the arc idle.

X and Y form four variations of power. 100 ma, 200 ma, 300 ma and 400 ma, controlled by choke H_1 .



CLAROSTAT

The hand on the throttle --

Just as an engine can be no more useful than its throttle, so with the radio power unit and its controls. But the CLAROSTAT is an ideal electrical throttle—positive settings, tremendous resistance range in several turns of knob, silent operation, ample capacity, fool-proof, reliable and long life. What's more, there's a CLAROSTAT for every purpose—from the tiny volume control for receivers to the giant power type for A-B-C radio power units. That's why you find CLAROSTATS in all good radio equipment.

Whether you are a manufacturer, jobber, dealer, set builder or listener-in, write for your facts on CLAROSTATS.

AMERICAN MECHANICAL LABS., INC.
285 N. 6th Street Brooklyn, N. Y.

The CLAROSTAT is being imitated.
Look for the name stamped on the shell for your protection.



In all, the transmitter is very convenient and flexible, making for enjoyable transmission. Reports of R-9 have been received from Japan, Philippines, Australia and Chile. As high as 12 European cards in one mail have appeared at times reporting reception of 6AM. Withal it is clickless, and the more we are able to work along the development of high power transmitters, minimizing the difficulties, the better amateur radio will become.

AMATEUR RADIO TELEPHONY

(Continued from page 37)

In closing, a remark about the use of single button microphones is in order. Don't climb into the mouthpiece and shout at the top of your voice, to get your message across. Keep at the same distance as you would when talking into your wire telephone on a local conversation, and use sufficient speech amplification to give you the power at the modulator input which you may require. The volume control at the output of the microphone will give you smooth control over the total amplification, and by watching the modulator plate milliammeter, you can obtain the best possible quality with the equipment you have on hand. Don't increase the current through the microphone above 125 milliamperes unless you have one specially designed for high current flow, for the carbon grains will soon pack, and may burn out entirely. If you have a motor-generator set, keep it in a sound proof box, or in another room from the microphone, for it is surprising how much noise can be picked up by the microphone and sent out on the carrier, when the generator is not properly muffled.

BOOK REVIEWS

(Continued from page 32)

service to the public. It is also subject to local legislation when it becomes a local noise nuisance. Copyright material should not be broadcast without the consent of the owner thereof. Radio is amenable to the laws of libel and slander.

These excerpts indicate the subject matter discussed. The Radio Act of 1927 is analyzed. The general principles of international law affecting radio are summarized. The entire text should be of interest and value not alone to lawyers but to anyone having to do with the transmission and reception of radio.

"Drakes Radio Cyclopedia" by Harold P. Mawly, 870 pp. 6 by 9 in., 950 illustrations. Published by Frederick J. Drake Co., Chicago, Ill.

Seldom is any subject so comprehensively and practically explained as is that of radio in this volume. Its alphabetical arrangement, while somewhat disjointed for continuous reading, makes it an easy reference text. It contains a great mass of useful information which is clearly and adequately presented in a non-technical style. The author has displayed an unusual excellence of judgment in his choice of individual subjects which are given extensive treatment and in the brevity or omission of non-essential material. It will be found of value by the set-builder and designer, the service and repair man, the experimenter and the student, and the set owner and operator. It is unqualifiedly the most complete and simplest book for the novice which has yet been reviewed in these columns. With a foundation of the knowledge here so well presented the serious reader is well-prepared to study the more advanced texts. Contrary to the usual text book it is little concerned with obsolete equipment and is well up to date on recent developments in socket-power devices, a. c. tubes, and standard circuits.



**OUR
SUPER-EXCELLENT
CABINET ON
SPEAKER CONSOLE**

Radio Cabinets

This cut shows our Super-Excellent Table Cabinet on our Super-Excellent Speaker Console. This is only one of our 10 latest conceptions of Radio Furniture. We have an unusual display of Furniture designed and built exclusively as Radio Furniture.

Send for catalog and descriptions and you will find that we are listing and carrying, ready for immediate shipment a very beautiful line. From all forecasts it is apparent that Radio Furniture will be the dominating factor in radio sales this coming season. Sets in our Cabinets will make sales. Special Cabinets Built to order in quantities.

Ehlert Radio Furniture Company
2468 Lincoln Avenue, Chicago, Ill.

Show Rooms and Large Stock Carried in Chicago.

Manufacturers of: **RADIO CABINETS, RADIO DESKS, RADIO CONSOLES, RADIO TABLES.**



The SHELBURNE

"DIRECTLY FACING THE SEA"
ATLANTIC CITY

"European Plan"

Famous French Grill and Restaurant

"A rendezvous for those who seek
the best"

MUSIC
SHELBURNE CONCERT ORCHESTRA
Proprietary-Management,
JACOB WEIKEL

Portable Short Wave Transmitter

Complete with all accessories
including one power supply

\$90.00

We are glad to quote prices on complete amateur and commercial installations

Crystal Control a Specialty



\$17
Complete

Wavemeter
10 to 110
Meters



\$2.00

50-Watt
Socket

TRANSMITTING EQUIPMENT LABORATORIES

3675 Moneta Avenue Los Angeles, Calif.

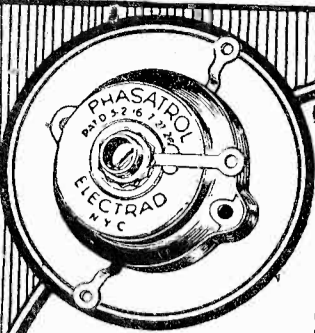

Licensed by
Rider Radio
Corporation
Pats. Pending
Pat'd 5-2-'16
Pat'd 7-27-'26

Stop
Oscillation
Troubles

Phasatrols

A True Balancing Device for All
Radio Frequency Amplifiers

Price \$2.75

Now's the time to perfect the set
you have built! Eliminate those
squeals due to oscillation by in-
stalling Phasatrols.

Very easy to install in home-built
or standard receivers, but if you
prefer, your dealer or service man
will gladly install it.

Write for free hook-up circular
for any set or circuit.

Dept. 52A, 175 Varick St., New York

ELECTRAD

Build Sets make \$100.00 a week

GET INTO RADIO GAME

Let us show you how to make money
in your spare time building Infrac-
dyne receivers. The sale of one set
with accessories nets you a sub-
stantial profit. The new 1928 Model
DX Infracdyne will be the season's
winner.

PROFITABLE, FASCINAT- ING WORK. START NOW!

Get going now—let us send you
complete circulars outlining our en-
tire system. Anybody with ordinary
mechanical ability can profit from
this new method.

THE SEASON HAS OPENED

August 1st is the opening date of
the new radio season. Long dis-
tance reception will be good this
year. You can make Infracdyne
demonstrations now and outperform
any set on the market.

GET OUR PLAN NOW

The plan is ready for you—now. A
post card will bring complete details.
Be the first man in your town to
get into the INFRADYNE business.
Don't delay!

RADIO CONSTRUCTORS CORPORATION

Dept. "R," 357 12th St., Oakland, Cal.

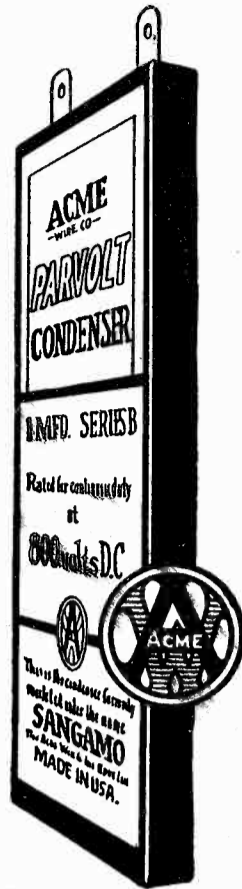

for
power circuits

It has become standard
practice to use

Parvolt Wound Condensers

in circuits which quickly
break down ordinary by-pass
or filter condensers.

You will find that the same
characteristics of accuracy,
high direct current resistance,
and the ability to give con-
tinuous duty at full rated
voltage, make them desirable
in circuits where even a poor
condenser might "get by."

THE ACME WIRE COMPANY
New Haven, Connecticut

PARVOLT WOUND CONDENSERS

KARAS EQUAMATIC MANUAL Price 10c.

Build the Karas Equamatic 5-Tube Radio Sen-
sation—the most selective receiver ever de-
signed. Mail 10c today for 16-page Manual
of wiring diagrams and complete instruc-
tions for building this remarkable receiver.
Address:

KARAS ELECTRIC COMPANY
4031-H No. Rockwell St. Chicago, Ill.

RADIO ACCESSORIES at WHOLESALE

Radio Sets, "B" Eliminators, Chargers,
Tubes, Kits, Parts—everything new in
Radio at lowest wholesale prices. Thou-
sands of nationally advertised bargains.
All listed and illustrated in my Big New
Catalog and FREE Call Book.
132 Pages of valuable Radio in-
formation—trouble finding, set
building—Radio knowledge of all kinds.
Write today. HARRY SCHWARTZBERG PRES.
AMERICAN AUTO & RADIO MFG. CO.
Dept. 144, American Radio Bldg.
Kansas City, Missouri



**FREE
BIG
BARGAIN
CATALOG**

MARINE RADIO (Continued from page 30)

similar opinion of broadcasting pro-
grams, which broke up their traffic, so
that honors were about equally divided.

It was in these trying times that ne-
cessity, as the novelist would have it,
gave birth to the vacuum tube transmit-
ter for radio telegraphic work. The first
transmitter of this type for commercial
telegraphic use in this country, was in-
stalled at Marion, Mass. It was oper-
ated on 2200 meters, and remotely con-
trolled from the receiving station at
Chatham, some 55 miles away. A few of
the transatlantic passenger vessels were
by this time equipped with either arc
or tube transmitting equipment for con-
tinuous-wave operation. In short order
the shipboard operators, as well as those
at Chatham, were astounded at the re-
markable distances covered with the
continuous-wave vacuum-tube transmit-
ters. The larger ships began to use the
long-channel almost exclusively for their
traffic, and it became necessary to pro-
vide additional receiving channels at
the Chatham station. The shipboard
transmitter could then be quickly shift-
ed from 2100 meters (the usual calling
wave used by ships) to 2,000, 1900,
1800, etc. Thus Chatham could receive
from three ships and transmit to a
fourth vessel all at the same time.

It will therefore be noted that the
use of CW (continuous-wave) vacuum-
tube transmitters not only increased the
range of marine communication, but
greatly facilitated the movement of traf-
fic due to the possibilities in multiplex
operation. Also, a heavy load was re-
moved from the shorter wavelengths,
aiding the smaller ships in clearing their
traffic.

The increased range also made un-
necessary the further operation of nu-
merous stations along the Atlantic
Coast. The Bar Harbor station prac-
tically ceased commercial activities;
stations at Rockland, Me., Newport,
Siasconset, New London, Babylon, and
Cape Cod were closed.

As the radio broadcasting activities
rapidly expanded, the elimination of
spark stations on land was pushed with
all possible speed. The 5-kw. spark
transmitter at Bush Terminal gave way
to a tube transmitter. The Chatham
station was expanded by the addition of
two 5-kw long-wave transmitters, in-
stalled at Marion, and two short-wave
transmitters at the station itself. The
Tuckerton station, replacing Cape May,
used a 5-kw. vacuum tube transmitter.
A 1-kw. set replaced the 5-kw. spark at
Boston. The same type set replaced
spark equipment at Galveston. Appar-
atus similar to that of Chatham replaced
spark sets at San Francisco, and a spe-
cial CW set was installed at Los An-
geles. The Chicago coastal station for
the Great Lakes was provided with tube

Tell them that you saw it in RADIO

equipment similar to that at Galveston and New York. And thus all RCA coastal stations did away with spark transmitters and their former interference with broadcast entertainment. The Army, the Navy and the Coast Guard, during the past year, have also made remarkable progress in eliminating spark interference, so as to round out a nearly ideal condition.

Let me add, however, that the coastal or land station end has been only one part of the huge task of bringing marine radio up to the very peak of present-day efficiency. There has remained the major part of equipping and re-equipping the many ships with the vacuum-tube apparatus, so the advantages of continuous-wave transmission might be enjoyed at both ends. It has been no easy matter to discard the hundreds upon hundreds of spark and other obsolete transmitters in use on ships, in favor of the new tube sets. The investment represented in the older types, together with the expense of the new equipment and the vast production called for, has tended to make the change more or less gradual. So that new installations have been of the new tube type, while some 300 existing spark transmitters have been rebuilt into the modified tube type to minimize the cost of the change-over. Engineers of the Radio Corporation of America, the General Electric Company and the Westinghouse Company have shown no little ingenuity in converting existing spark sets into tube transmitters. The spark transmitter elements of the usual transmitter have been replaced in large part by the vacuum tube elements, to form an ICW (Interrupted Continuous Wave) transmitter, comparing favorably with pure CW and representing at least 100 per cent improvement in performance over the former spark transmitter.

The work of equipping and re-equipping in the change from spark to vacuum tube has been going on steadily during the past two years. Already several hundred ships are equipped with vacuum tube apparatus or will be very shortly. Spark signals are becoming a rarity, except for the occasional small foreign ship which comes into an American port and proceeds to squat on the 450-meter or 600-meter channels in unloading its traffic amid a world of broadcast entertainment, and also a few coastal stations still operating with spark transmitters.

Vacuum tube transmission has more than justified the fondest expectations. With the vast increase in distances spanned, ships are now keeping in touch with the land stations on the transatlantic course, even beyond the half-way mark across the ocean. Coastwise ships have little difficulty in maintaining contact with Tuckerton even to the Caribbean and beyond. The static-infested

LOBOY MODEL \$160 (without tubes)

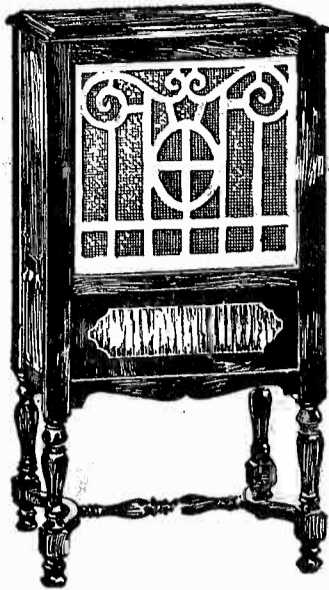

MAGNAVOX

Power Cone Speaker (Dynamic)

*Now—a speaker to
match the finest set*

Improved quality of reception is the keynote of the new sets and tubes. Magnavox matches the finest with its new power speaker. Built on electro-dynamic principles under patents controlled exclusively and made famous by Magnavox.

All the music in ALL its natural beauty is possible only with this type speaker. Even extreme upper and lower register fundamental notes can come through with complete fidelity. Volume ranges from pianissimo to fortissimo without the slightest distortion.

Uses one 216B and one 210 type tube. For connection with alternating house current, doing away with B batteries and B eliminators. Works directly from light socket.

Magnavox Electro-dynamic speaker unit only, type R4, for 6 volts 1/2 ampere field winding \$45.00.

Type R5, unit only, for use in Electric phonograph 100 volt 40 milliamperes field winding \$45.00.

Type R50, unit only, as used in Loby Speaker complete with amplifier and eliminator \$110.00.

Warwick Model Cone

Permanent magnet type handles power tube volume without distortion \$27.50.

Type M7 Self contained, complete permanent magnet cone, unit only, 8 1/2" diameter \$12.50. If you don't know a Magnavox dealer, write us.

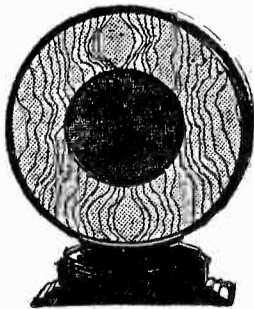

THE MAGNAVOX CO.
Oakland, California
1315 So. Michigan Ave. Chicago



Power Transformers and Chokes

—insist on Dongan

It's a "power year"—for the buying public and the manufacturer. To the designer of sets it resolves itself into a matter of the proper selection of type and design.

One thing you can be certain of—for all types of AC and Rectifier Tubes—Dongan Power Parts (transformers and chokes) are standard. In fact Dongan laboratories helped to develop several of the leading types. Whatever you prefer you can secure Dongan Power Parts designed for that particular type.

Send your specifications—or problems—to our engineering department. For experimental work or quantity production Dongan is in a position to co-operate with you on all approved types of Transformers and Chokes—now.

Power Transformer No. 3591



Used with 350 - 400 m.a. rectifier tubes, making a thoroughly satisfactory and practical ABC eliminator. Specify make of tube you will use.

\$15 List

Choke No. 3584

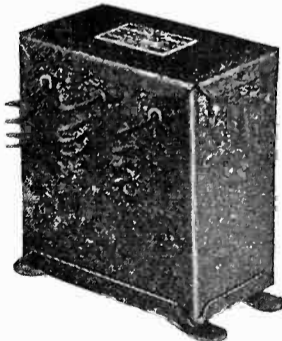

Used together with above transformer and 350 - 400 m.a. rectifier tubes.

\$15 List

You can secure immediate delivery on the power parts shown here. If your dealer cannot supply you send check or money order to factory direct. Also write for information on Transformers for the new AC Filament Tubes.

DONGAN ELECTRIC MFG. CO.
2991 - 3001 Franklin Street, Detroit, Mich.

TRANSFORMERS of MERIT for FIFTEEN YEARS

Tell them that you saw it in RADIO



Exclusively Licensed by Technidyne Corporation under U. S. Patent No. 1593658, July 27, 1926

Quality Unsurpassed

ELECTRAD

Royalty Variable
High Resistances

Frequent and repeated tests by radio authorities have proven these resistances to be unapproached in accuracy and reliability. Note these quality features.

1. Contact made positive by metallic arm on wire wound strip.
2. Same resistance always obtained at the same point.
3. Resistance element not exposed to mechanical wear.

A range for every purpose — 11 in all. Type E \$2.00. All other types \$1.50.

Write for Hook-up Circular
Dept. 53A, 175 Varick St., New York

ELECTRAD

Make Your Cone Speaker Sound Like an \$80.00 Model. Great New Discovery Improves Tone Quality 100%

"CONE MODULATOR"—What a difference this clever device makes. You must hear it to appreciate it.

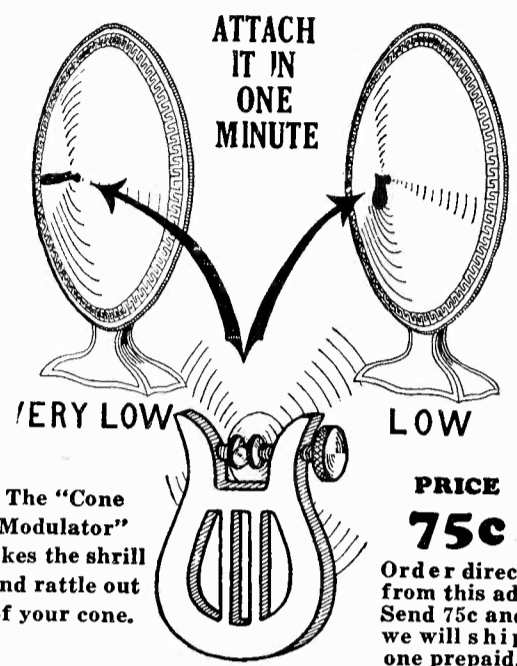

ATTACH IT IN ONE MINUTE

VERY LOW LOW

The "Cone Modulator" takes the shrill and rattle out of your cone.

PRICE 75c

Order direct from this ad. Send 75c and we will ship one prepaid.

DEALERS — Order a dozen of these now. Attractive discounts. Jobbers also write for territory.

WILLAT PRODUCTION CO.
1121 HOWARD STREET
SAN FRANCISCO, CALIF.

Gulf of Mexico finds vacuum tube transmitters getting through hundreds of miles of space in broad daylight, with precision and certainty.

But the climax of vacuum tube technique is to be found at the very elbow of Cape Cod, where the Chatham station stands guard over the transatlantic shipping. Here the visitor finds a brick building, alongside a large hotel and several brick dwellings to accommodate the station crew. Upon entering the building, the visitor is confronted with the busiest scene imaginable, both to the eye and to the ear. There are rows upon rows of operating tables, some for the radio circuits that extend out to ships at sea, and others for the telegraph lines stretching to the distant main traffic office in New York City, and to the traffic office in Boston. And the scene is most suggestive of a busy telephone central. The operators are seated before tables with high backs containing the receivers—13-tube superheterodyne sets, working on the Beverage wave antenna some mile and a half long! A supervisor, listening in to all incoming traffic, assigns each operator to a given ship, whereupon the operator tunes in and receives the traffic, pounding away the radiograms on his typewriter just as fast as the distant ship operator can "shoot" them in. When the Chatham operator's turn comes to "talk," he does so through the long-wave transmitter, of which there are two, at Marion, 55 miles away via remote control wires, or through one of the short-wave marine transmitters in a nearby building. A flip of a switch on the operating table throws in the desired transmitter just when it is needed, provided colored lights do not flash on the table to inform the operator that the facilities are being used by another operator. And just as fast as the radiograms are received at Chatham, from ships at sea, they are copied on the perforator keyboard so that the perforated paper tape may be whizzed through the automatic transmitter which speeds the radiograms over the telegraph line to New York or Boston. Meanwhile, an avalanche of traffic in the opposite direction is bringing radiograms into Chatham for ships scattered near and far.

That, in brief, is a picture of marine radio today.

Something New Again!

Two Shows in One

New England's
Radio and Aero Show
Week of Sept 26.-Oct. 1
Seventh Annual Boston
Radio Exposition

Sheldon H. Fairbanks, Director

Office: 209 Massachusetts Avenue, Boston, Mass.

6 TUBE RADIO

ONE DIAL Latest advanced circuit. All steel chassis totally shielded. Balanced parts of best quality. Marvelous power and selectivity. Gets the long range stations as clear as a bell. One dial single control. An unsurpassed value—just one of our many mighty bargains.

Only \$32.50

FREE Log and Call Book and Big New Catalog—just off the press. Full of Radio Bargains. Send for your free copy now!

American Auto & Radio Mfg. Co.
HARRY SCHWARTZBERG, Pres.
Dept 142 American Radio Bldg., Kansas City, Mo



THE SEA-GOING RADIO OPERATOR

By M. R. UPTON

These comments and reminiscences of an old-timer give an intimate view of a brass-pounder's life. Mr. Upton is now masquerading as Simpleton Fitts, who broadcasts from the Seal Rocks every morning over KFRC. But it does not require much imagination, after reading his story, to know where his heart is.

In 1918, just entering the profession as second operator on the Pacific Mail Panama run out of San Francisco, I was full of awesome admiration for the old-timers in the game who were sailing on big off-shore passenger vessels and round-the-world freighters. After a four or five months' cruise, entailing sojourns in half a dozen or more such ports as Honolulu, Yokohama, Shanghai, Saigon, Singapore, Batavia, Colombo, Port Said, Genoa, Marseilles, Antwerp, London and New York, one of them would make a casual landing at the radio service company's waiting room (known as the static room) drop an overstuffed Shanghai suitcase in a corner, loosen a slightly superior glance for a possible friend at the row of envious, potential sailors tilted back against the wall in chairs, and then seek out his mail in the nest of A to Z pigeon holes over the desk. Interest in him was not entirely romantic; he might be quitting his ship and one of us might be chosen to take her out!

Salty Noble, with quite a few years of sea life behind him, excited my respect and envy with his apparently good natured contempt for the life of a sailor. He had all that seemed desirable to me then: experience and an experienced man's choice of ships and runs. I felt that his depreciatory air was pure pretense, that he really loved the life, for I could conceive of no other attitude.

While waiting for a conference with the chief operator in the inner sanctum, Salty took the opportunity to impress some of us "lids" (the stigmatic sobriquet an old-timer uses for the beginner) with the potency and flavor of one of his recent adventures. His own pretended disdain of the importance of the adventure was humbly accepted by us as the logical complement of his greater experience. He was a big fellow, wearing a brown suit that seemed to wrap him up rather than fit him and most of his attack upon life was apparently centered upon the chewing of an inevitable cigar—one felt he would be helpless without it.

His ship, the *Western Navigator*, has stood by the wooden, war-period built vessel *Coos Bay*, while she sank in the Gulf of Tehautepec, and rescued the entire crew, putting them ashore at Corinto, Nicaragua. It was on the night "twelve-to-four" watch and Salty was conscientiously pounding an ear in his bunk, a sport at which, if you believe his shipmates, all operators should be very skilful, considering the great amount of practice they get, when the second mate, drowsing about on the bridge, sighted the lights of another steamer nearby. A few minutes inspection convinced him that she was acting queerly. So he sent a quarter-master to rouse a reluctant Salty from entirely adequate bed springs.

The message that came down the *Western Navigator's* aerial and out the end of Salty's nervously pushed pencil woke him up wide. It stated that the *Coos Bay's* seams had opened up, the water was rapidly gaining on the pumps, and the crew was taking to the boats. An hour later there was another unit added to Davy Jones' already gigantic fleet and a coast to coast freighter was proceeding on her leisurely way with enough men aboard for a double crew.

Only the other day I met Salty again. He had grown more cautious and less boastful
(Continued on page 66)

O
N
S
A
L
E
N
O
W

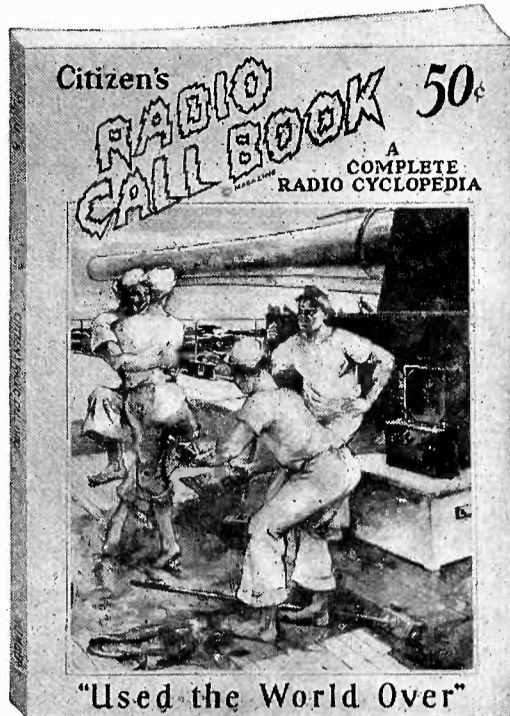

O
N
S
A
L
E
N
O
W

The September issue of the CITIZENS RADIO CALL BOOK is now on sale.

This issue contains a complete and up-to-date list of all broadcasting stations with new assignments of wavelengths, etc., a wonderful rotogravure section showing pictures of your favorite radio artists and the latest hints on how to improve your receiver for best reception.

Also, a wonderful array of construction articles showing how to build all of the latest circuits which have been thoroughly tested and designed in our laboratory complete with fine drawings and illustrations so simply arranged that any novice can build the highest grade receivers.

On sale at all the leading radio stores and newsstands.

Published four times yearly.

CITIZENS RADIO CALL BOOK

508 S. DEARBORN STREET
CHICAGO, ILL.

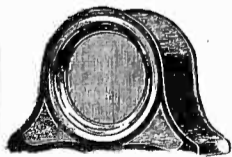

Stamford Model

MAGNAVOX Cone Speakers

These beautiful speakers must be seen and heard to be really appreciated. They cover the complete tonal scale from 50-10,000 cycles without distortion or snary effects.

They have full floating cones, (free edge) resiliently mounted to give free movement to the entire cone, which will stand powerful or weak volume equally well, and reproduce with wonderful clarity.

STAMFORD MODEL, genuine two-toned Mahogany.

List price \$35.00 each.

Special at \$9.75 each



Cornell Model

CORNELL MODEL, artistic, non-resonant, metal finish.

List price \$22.50 each.

Special at \$7.25 each

Each speaker is brand new and packed in original factory sealed cartons. Complete with standard cord and plug.

AMERICAN SALES COMPANY

21 Warren Street, New York City

Tell them that you saw it in RADIO

Why Music Sounds Better with the Infradyne

The wise radio man knows that it is impossible to get good tone quality out of a receiver unless perfect music is put into the audio amplifier. The received signals must be clear, sharp, noiseless and pure when they come out of the radio frequency amplifier. They must then again be amplified before entering the audio stages. After the signals pass through the r. f. amplifier of the INFRADYNE receiver, they are again tremendously amplified by the three stage Sargent-Rayment Infradyne Amplifier, operating at a frequency of 3,200,000 cycles. At this high frequency there is no long wave interference—no background noise and no distortion. The automatic coupling on the coils of the r. f. amplifier, the method of controlling oscillations and the peculiar design of the Infradyne Amplifier gives you a combination of the finest pick-up system known to the radio art. So different is the music as received on an Infradyne that thousands have marvelled at its purity and clarity of tone. Just convince yourself of the truth of these statements by plugging into the detector of the receiver—before the signals pass through the audio amplifier—and note the surprising clarity of tone. It is a revelation to the music lover. It is life itself. Tone quality and extreme selectivity, coupled with its ability to reproduce long distance loudly and clearly, have put the new 1928 Infradyne in a class by itself. You can really enjoy loud speaker music from stations many miles away if you have an Infradyne. Signals ordinarily inaudible on most receivers are brought in with a bang on the Infradyne. Small wonder that the Infradyne is breaking sales records. Why be satisfied with less than an INFRADYNE?

Long Distance as You Never Heard It Before

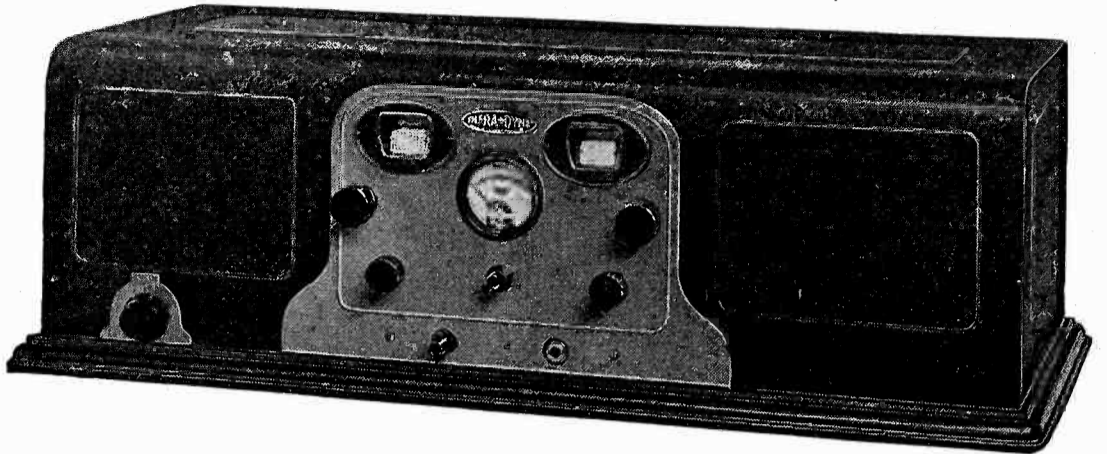

Indications point toward a banner season for distance reception. Mid-summer results prove the new 1928 Model DX Infradyne capable of bringing in St. Louis from San Francisco with loud speaker volume. During the 1927 season this station was not audible in San Francisco until the end of August. Get set for the best DX season in years. Hear stations on the loud speaker you never heard before. The new Infradyne is THE set for 1927—and for 1928 and 1929. It will be in style for years. Its construction is radical. It is going over with a bang. No complicated wiring system. You work from a simple color chart. The individual units are wired before you receive them. You merely hook them together. Throw a switch to the center and you have a 5 tube local receiver with single dial control operation. Throw the switch to the right and the mighty Infradyne swings into action. It's a revelation.

Set Builders—

Dealers—

Your customers will demand Infradyne kits this season. A large national advertising campaign is behind this sensational development. Write us at once for data on how to increase your kit business. We are in a position to make immediate deliveries.

Professional set builders who feature the 1928 INFRADYNE eliminate the grief in radio construction. No assembly work to occupy your time. No laborious wiring system. The 1928 Infradyne comes to you completely assembled as illustrated in this advertisement. The battery wires are in place. You hook together three units—in less than an hour's time—and your Infradyne is ready for a demonstration. We supply the wants of the set builder. Let us have your next order and show you what real radio service means. We ship to any part of the world.

Write Now For Your Free Copy Of Interesting Booklet

Tell them that you saw it in RADIO

Enjoy the Real Thrills of Radio

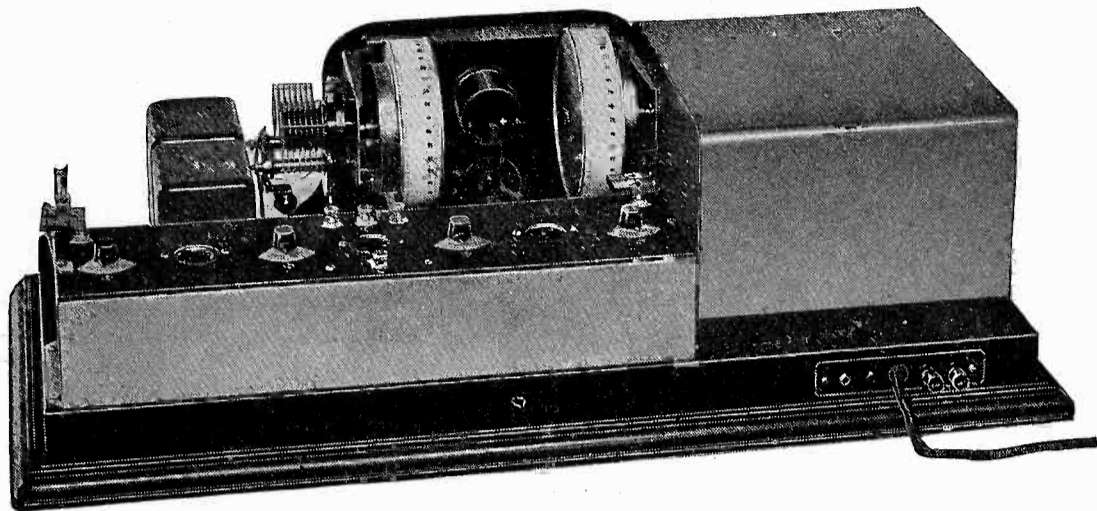

'Most any good multitube receiver will bring in the "DX" stations but it takes the 1928 Infradyne to bring them in with a wallop. To enjoy extreme long distance reception it is essential that back ground noises be cut to a minimum. If your receiver is working at the breaking point you will not get good tone quality. The Infradyne principle of reception combines distance with clarity and volume. So superior is the music as received from distant stations on the Infradyne that you can hardly compare it with other receivers. There is no cutting of the side-bands—no "spillover" and no distortion. It's music—pure music, and that's all. Infradyne amplification at 3,200,000 cycles is the thing for 1928. Built like a battleship, but with the precision of a chronometer. A masterpiece of radio engineering.

Buy This Receiver Now

Insure Immediate Delivery By Sending Your Check Today—

MAIL ORDERS FILLED WITHIN EIGHT HOURS

\$179.50

is the price of the completely assembled receiver with all of the current supply wiring in place—the sockets wired. After you connect

a few leads to the various units your receiver is ready for operation. It takes less than an hour. The price of \$179.50 includes the metal chassis, cabinet and baseboard, control panel with Jewell meter and Remler drum dials,

Infradyne Amplifier, two SM 220 audios and the new Remler r. f. amplifier with antenna compensator. Absolutely nothing else to buy. Parts also sold separately at the following prices—Foundation unit with all small parts, wires and control panel, drum dials, condensers, etc., \$52. R. F. Amplifier in copper container with compensator, \$55. Infradyne Amplifier, \$27.50. S. M. audios, 220, each, \$8. Unassembled complete kit with all parts and wires, including wiring chart, \$172.50.

C. O. D. shipments accepted when half cash accompanies order.

Radio Constructors Corp.
357 TWELFTH STREET : Dept. R : OAKLAND, CALIFORNIA

See it displayed by Remloc Radio Co., 206 Pacific Bldg., San Francisco, Calif., or at Pioneer Radio Co., 1200 Franklin Street, Oakland, Calif.

On This New Receiver — "RADIO PAR EXCELLENCE"

Tell them that you saw it in RADIO

Outstanding Exclusive Features

Try to find as many improvements as these in any other receiver—

1. You can wire it in less than an hour.
2. No critical adjustments.
3. Individual stage shielding.
4. Extremely low background noises.
5. Antenna compensator.
6. Illuminated drum controls.
7. Five or ten tube operation by the throw of a switch.
8. Tubes protected against burn-outs.
9. Automatic coupling on r. f. amplifier.
10. Die stamped heavy metal chassis.
11. "Harness" wiring cable in colors.
12. Bronze control panel with Jewell meter.
13. Loud speaker jack in rear of set.
14. Headphone jack in front of set.
15. Switch for broad or selective tuning.
16. "Single Spot Tuning"—no overlapping of stations.
17. Hair-splitting selectivity.
18. Greatest volume on distant stations.
19. Cable attached for current supply.
20. R. F. Amplifier adjustable for sharp or broad tuning.
21. Purest tone. You do not work at the "breaking point."
22. Copper cases on r.f. amplifier and Infradyne amplifier.
23. No body capacity effects.
24. Coupling adjustable for tight or loose.
25. Staggered grid connections on r.f. gang condenser.
26. Most beautiful receiver of the season.
27. When you buy an Infradyne you get a new conception of what a real radio set should be.

A universal receiver—5 tubes for local reception in the daytime and, by the snap of a switch, 10 tube Infradyne operation for breaking distance records at night. The logical choice for the man who looks ahead.

Mathison's Radio Buster

Radio's best writer of fiction has twelve rib-tickers in his 112 page book of radio humor—"THE RADIO BUSTER." In this book you will find many cleverly written stories.

There are only a few copies of the **RADIOBUSTER** available. First come—first served. This will be one of your last chances to get the book. It is printed on excellent stock with a heavy cloth cover. Get acquainted with "Samuel Jones" now. His adventures are very humorously described by Mathison.

\$1.00 PER COPY
Postpaid in U. S.

VERY LIMITED SUPPLY

PACIFIC RADIO PUB. CO.
Pacific Building San Francisco

Now
You can build the
kind of a radio you
have always wanted

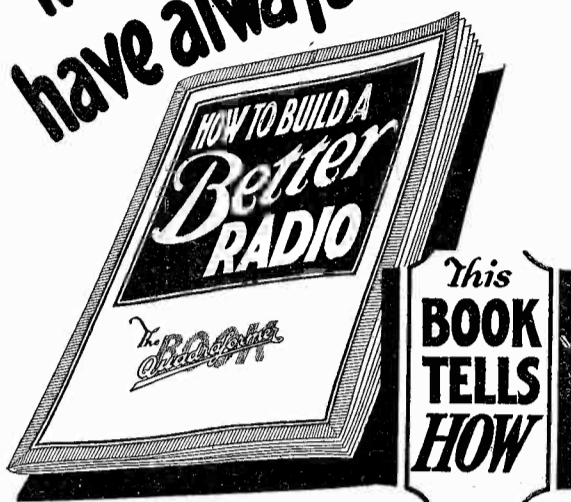

No matter whether you want to improve a set you now have or build a new one—*get this book first.* Tells how to build the latest one, two and three dial receivers—5 to 7 tubes.

10¢ PREPAID
GEARHART-SCHLUETER, Fresno, Cal.

(Continued from page 63)

but he still chewed desperately upon a cigar and wore clothes of sombre hue. He happened to be casting about for a ship before his rapidly dissolving pay-day had joined a hundred other similar pay-days.

A penniless radio operator off the water is as helpless as the fish out of it. Barring the few jobs in shore stations that handle traffic with ships there are only two fields that lie within his own special province open to him and neither of these is very satisfactory. He may compete with amateur electricians servicing broadcast receivers for retail radio dealers—only a starvation job if he does succeed in landing it—or, he may be lucky enough to connect with a slightly better paid and more dignified position, that of radio operator in a broadcast station. But even this isn't remunerative or absorbing enough for the operator with an encrustation of salt upon his frame and it is more than likely that he will soon have a rhythmically heaving deck under him again. With a great sigh of relief he once more resumes his brass pounding, especially if he hasn't had any better income during his last few days on the beach than the meager and disastrous one involving Hebrews and pawn tickets.

The true radio operator loves his work. I distinguish between the true operator and his less fortunate brother because there are many who follow the sea for a year or two "under protest." It was usually a feeling for romance that sent them all off to sea in the first place. But the majority were quickly cured of the malady because no tangible results accrued. Real or imagined inability to make a living ashore keep these on the water.

But a few others, though they obtain no career from the life, as is the case in England's merchant marine, derive much thrill and satisfaction from the work itself. This thrill and satisfaction must be what is referred to by the people, not always old ladies, who ask: "My, isn't your work interesting?" An operator can rely upon this question nine times out of ten from a stranger.

The satisfaction comes largely from the opportunities offered for the exercise of good judgment. It might be mentioned, also, that many of the old-timers feel themselves justified in deriving satisfaction from perfecting an imprecatory vocabulary to direct against the bulk-head when naive and apparently deaf "lids" or uncomprehending Japanese operators cause unnecessary and maddening interference.

The wavelength bands allotted to ship work are extremely overcrowded and this is particularly unfortunate in areas where there are very many ships, like in the North Atlantic. At night the man at sea usually has anywhere from half a dozen to forty ship and shore stations assaulting his ears at once, and out of the melee he is able to pick perhaps two or three, the remainder interfere too much with one another. Add to this radio's arch enemy "Old Man Static" and you have a state of affairs that often amounts to a serious problem when one's ship is many hundreds of miles off shore and there is traffic to get through.

The less experienced, or less intelligent, rely almost entirely upon obstinacy; at the expense of much wasted electric current (which means oil to the chief engineer) and useless interference to others, he calls and calls and calls, with the single desperate thought in his mind to get his message off, until finally a shore station answers him. But the prideful operator squanders a little thought upon the situation before he starts closing switches. When he does go on the air he will have chosen the moment to wedge in a call that he feels will be productive of the most good, either to clear his own traffic with a shore station or, providing he is strategically situated, relay for another ship. Some confident and hard working operators will even gather

(Continued on page 68)

Transformers Rewound to any Frequency up to 50 Kilocycles

Many of the season's new circuits specify the use of an intermediate frequency transformer ranging from 25 to 50 kilocycles. If you have the type 271 General Radio Medium Frequency transformers in your present receiver we can rewind these for you to any desired frequency. The price for rewinding a transformer is two dollars. We guarantee to give you the exact frequency specified. Frequencies best suited for your particular conditions will

vastly improve your set. When sending transformers to us for rewinding please tell us in what location you desire to operate the set and we will do the rest. General Radio 271 Medium Frequency Transformers sold separately at \$5.00 each. An additional charge of \$2.00 is made for changing the frequency by rewinding the transformer. Ship your transformers by parcel post or express. They will be returned to you within eight hours after we receive them.

D. B. MCGOWN
435 Pacific Building, San Francisco, Calif.

TOBE

And NOW...

The Infradyne

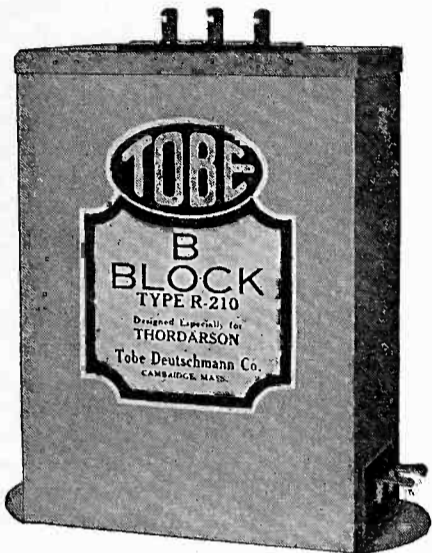

TOBE R-210

Surer than any other test of the true merit of a product is the place it holds in the esteem of men who know.

McMurdo Silver has chosen TOBE condensers above all others for use with the Silver-Marshall Unipac. He says they are "superior to all condensers tested." It is needless to point out that Silver and his engineers made exhaustive tests of ALL condensers before TOBE was finally selected.

The popularity of TOBE condensers and resistors is widespread. EVERY radio engineer and writer of any prominence has unstintingly endorsed TOBE products.

TOBE R-210 B Block enjoys the sole approval of the originators of the Infradyne for use with the Infradyne power unit.

8

TOBE condensers and resistors are always recommended by the following engineers and technical writers.

They have been approved for all the circuits mentioned.

- | | |
|--------------------|------------------------------------|
| Jas. Millen | Raytheon A-B-C 350 M. A. Rectifier |
| Keith Henney | QRS A-B-C 400 M. A. Rectifier |
| Volney Hurd | Silver-Marshall Unipac |
| Zeh Bouck | Thordarson 171 and 210 Compacts |
| Austin Lescarbours | AmerTran Power Pack |
| Joseph Calcaterra | Browning-Drake |
| Milton Sleeper | R. B. Lab. Receiver |
| Hollis De Neefe | L. C.—27 |
| Wilmer S. Trinkle | Worlds Record Super |
| Stuart Rogers | Nine in Line Super |
| Larry Cockaday | Samson Super |
| McMurdo Silver | Infradyne |
| Lloyd C. Greene | Hammarlund-Roberts Hi-Q |
| Perry Graffam | Lincoln Super |
| Kendall Clough | |
| Glen Browning | |
| Gerald M. Best | |
| E. M. Sargent | |
| John C. Brennan | |

Tobe Deutschmann Co.
Cambridge Mass.

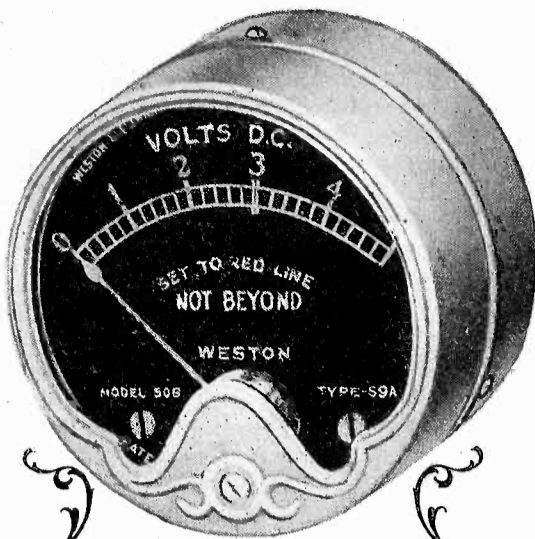

IN KEEPING
'WITH THE CHARM
OF THE FINEST SET

THIS little instrument with its green gold finish and black dial with gold markings will richly adorn even the most expensive cabinet.

Unusual accuracy and other typical Weston features augment this attractive design, but its great value, however, is its aid to better reception and the service it renders in extending the useful life of tubes and batteries.

It is intended for use with dry cell operated sets equipped with voltmeter pin-jacks—inexpensive, too, so that every set should have one. Accurate for a life-time and this mark is your guarantee of highest quality.



This new model 506 Pin-Jack Voltmeter is an ideal instrument for insuring the best performance from your Radiola 20 or 25, Victor or Brunswick set. Because of its unusually high internal resistance (125 ohms per volt) it requires only a very slight amount of current for its operation, and may be left permanently plugged in on the set without wasting the batteries.

Adjusts upright with any pin-jack arrangement.

PACIFIC COAST REPRESENTATIVES:
Graybar Electric Company, Inc.
84 Marion St., Seattle, Wash.
J. H. Southard, San Francisco, Cal.
A. A. Barbera, Los Angeles, Cal.
Repair Service Laboratory
682 Mission St., San Francisco, Cal.

WESTON ELECTRICAL
INSTRUMENT CORPORATION
156 Weston Avenue Newark, N. J.

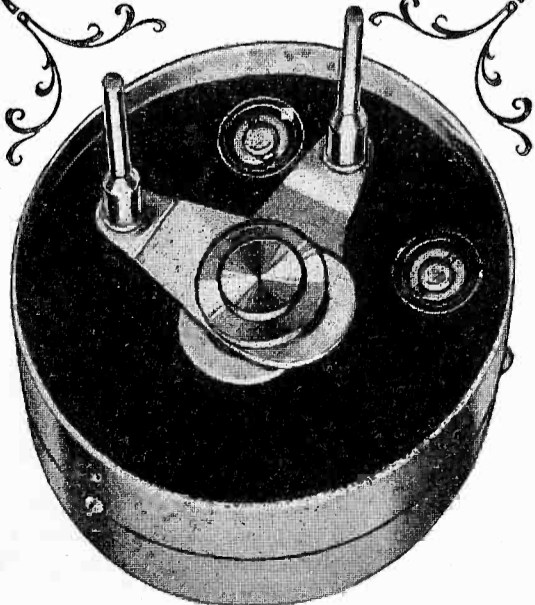

Tell them that you saw it in RADIO

POWERIZER

REG. U. S. PAT. OFFICE



PLUS NEW
AC Radiotrons
EQUALS
EXQUISITE

TONE
VOLUME
and
Complete ABC
Elimination
for ANY Set

THE newest POWERIZER will give your old set or any new set, the famous POWERIZER tone and faithful reproduction plus genuine, complete ABC elimination. The tone of a Powerized radio set is equal to that of the finest deluxe sets and electric phonographs. POWERIZER strikingly improves the tone quality and gives ample volume for dancing, concerts, etc. Your dealer will gladly demonstrate the POWERIZER for you on your set, in your own home.

Model PXY—Radiola 20, illustrated above, uses no batteries, liquids or paste. Made complete in a compact, beautifully finished container. Draws between 40 and 50 watts only when set is on.

PXY—A. K. is for the Atwater Kent. There is a POWERIZER for every set . . . YOUR set. HEAR one TODAY!

Jobbers and Dealers:

Send for booklet 1009-P, "Real ABC Socket Power with Real Tone." It contains much information that will make money for YOU this season.

Licensed by Radio Corporation of America and Associate Companies.

RADIO RECEPTOR CO., Inc.
106 SEVENTH AVE., NEW YORK CITY

Most
Powerful
"B"
Eliminator

Majestic
Super
"B"

COMPLETE
WITH TUBE

LIST PRICE

\$29.50

See us at the
Radio Exposition in San Francisco
August 20 to 27th

Grigsby-Grunow-Hinds Co.

4580 ARMITAGE AVENUE
CHICAGO, ILL.

W. J. SEROY, Pacific Coast Sales Mgr.
122 Broadway, Oakland, Calif.

Build Sets!
make \$100⁰⁰-a week

**WRITE
NOW
FOR
FREE
DATA**

Dept. "R"

Radio Constructors Corp., 357-12th St., Oakland

Get into the radio business. Let us show you how to make spare time money—easily and surely. **COMPLETE SYSTEM** No obligations. Get our system now—today. A post card brings full details.

NEW RADIO LOG - 25c

All the New Listings right up to date
"RADIO" - Pacific Building - San Francisco

(Continued from page 66)

up a string of messages and position reports from near-by ships in the day time, promising to relay to a coastal station before morning. One good operator on the ocean is often responsible for a dozen "lids" having their position reports in the morning papers.

This is work that is highly remunerative in achievement for the man who loves to operate and knows how. It is conceivable, given an ocean of alert and experienced operators, that any one station would seldom seriously interfere with any other station. This would eliminate the great amount of repeating of calls and messages that is caused by such interference and all business would be cleared in less than half the time required at present. It is something for conscientious operators to shoot at but there is much to discourage him.

I have seen Pat Haley, who was an old-timer when I made my first trip in 1918, chuck pencil and headphones into a corner, lean back in his chair and with righteous indignation direct a stream of picturesque oaths against some unseen lid, many miles away, who had opened up his transmitter at a moment that proved disastrous for Pat and of no earthly use to the lid.

The most that usually gets out on the air is an emphatic QRT, which is an international abbreviation for "please stop sending." It is a sad fact that QRT seldom does any good. Yet, in spite of his extreme troublesomeness (his superiority in numbers keeps the ocean's radio air almost perpetually in turmoil) and the contempt with which he is regarded when he is no more than a series of dots and dashes, ashore the old-timer forgets all about it and accepts him affectionately as one of his own trade.

A necessary factor in the above mentioned ideal state of affairs is economy in the use of words and letters that made up the words. Such economy is productive of a feeling of power in the operator, sometimes almost amounting to a passion with him. Now that long distance work is commonplace and short wave communication has taken all the wind out of his records, next to the exercise of his judgment, he relies upon abbreviated expression for a feeling of accomplishment. He cultivates a brisk and snappy style that uses only the barest essentials necessary to establish communication and clear the traffic on the hook.

I once overheard an exchange of signals between the Motor-Ship *Admiral Peary* KPL and the Federal Telegraph Station KEK at Portland, Oregon, when KPL was entering that port which illustrates this jaunty pride in economy so characteristically American. To start off KPL merely touched his key to make a short dash and the Portland KEK operator, divining that some one wanted to communicate with him, countered with a similar dash. KEK didn't know who KPL was, yet, but he knew that KPL could distinguish him by his proximity and the note of his set. The various shore stations are usually identifiable to operators by the nature of the tone of their transmitters. The *Admiral Peary* then sent her call letters: KPL. If he had had a message for the Portland station he would have sent it. As it was, Portland (KEK) understood that he had nothing for him and was only anxious to know if the shore station had anything for the ship. KEK had nothing so he sent N, abbreviation for NIL, abbreviation for I have nothing for you. KPL closed the affair with TU which stands for Thank you. He might have used TNX which stands for the same thing.

Of course, this extreme case was only possible over a short distance and in the day-time when the air is comparatively quiet. Perhaps nine-tenths of the work is done at night. But a lid would have followed the conventional manner and first established communication by calling KEK three times and signing KPL

three times. Then, after receiving an answer, he would have repeated the six calls and said QRU or NIL, meaning the same thing, and QTC? Have you anything for me? KEK, gauging his degree of skill by all this would very likely have sent: KPL, KPL, de KEK NIL. Then the lid might have condescended to shorten the preamble of his acknowledgment by only repeating each group of call letters once. Probably about fifty characters would have been transmitted back and forth whereas in the instance cited only six and two short dashes were required and a thank you included besides.

This is a story about another operator entering Portland, a Japanese operator this time. KEK asked him a question in English because he wasn't able to cover it with an international abbreviation. The Japanese was silent for a couple of minutes during which time he was doubtless consulting his English-Japanese book. Finally he came back with: "Please send more slow, this virgin operator."

A couple of old-timers, within a few hundred miles of each other on a sparkling tropical sea, a few thousand miles from shore will "chew the fat" for hours and a curious lid listening in derive only a sense of awe from the break-neck speed and the baffling abbreviations.

There is a catalogued list of abbreviations unofficially filched from Morse land-line telegraphy that is used, besides many impromptu ones. All U. S. A. calls begin with the letters N, W or K. All N calls are allotted to the Navy, W and K to ships, shore stations or broadcasting stations. Ship calls beginning with K are usually four letter calls, like KDOT, KDSV, etc. In friendly, unofficial communication operators like to drop the first 2 letters. One day down in the South Atlantic KDOS was working unofficially with a friend on KDYA and he was so absorbed in the conversation that he failed to notice his call, when repeated, had become a series of S O S. The breach of international regulations was reported and the Radio Inspector sentenced the offender to three months on the beach by suspending his license for that period.

I advised a friend of mine, an old Irishman who had something he thought he could sell radio operators, to call at the Alpine Hotel on Pine street. This drab looking brick structure is known among "juice jerkers" as the Dog-House because at one time the picture of a bull dog decorated it's stationery. He inquired at the desk if there were any radio operators stopping there. "Lord yes!" the clerk said, "the place is full of 'em." But it was only after two futile attempts that he cornered any, they seemed to be permanently drawn away, except to sleep, by the city's abstractions. The clerk said they were probably out dancing. Finally he encountered a conversing half-dozen in the lobby. Whether the old fellow sold them anything or not I don't know but he told me that he came away rather dazed by their line of talk. "Why," he said, "they talked of Yokohama, Cape Town, Buenos Aires and Marsailles like I talk of Sausalito, Alameda, Oakland and San Jose."

To lazily wander into a San Francisco Market street movie on a rainy January day and a few weeks later be doing business with a Singhalese money changer under a sunny Colombo sky, or watching a Punch and Judy show on Liverpool's Lime street between fogs, and the American bar with a statuesque and amiable bar-maid as hostess only a few doors away, is the fascination and tragedy of the sea-going radio man's life.

It is never necessary for him to really face the responsibilities of life. He signs the articles for an off-shore voyage and knows he will be taken care of for from three to eight months, then it is the same thing all over again. Whether such a life in time makes him a confirmed wanderer who can only tolerate

(Continued on page 69)

short periodic returns to the old homestead (if he has any), or whether the natural yearning for a home continues to grow at the expense of his content, depends entirely upon the individual. That the average operator's term at sea is about two years attests not only to the inadequate pay but also to the fact that most of them decide romance needs to find a mooring place in the person of a young lady. At this stage a shore job is necessary in order to stabilize and perpetuate the situation.

The case of Bill Clampett illustrates the incompatibility of worldly ambition and the desire for marriage with real content in a sailor's life. Bill sums up the life of an operator at sea with the words: "There's nothing in it." He had an East Coast South American run last and during the two weeks in port after every three months' trip he would dash desperately about town looking for some sort of a job ashore. A sailing day was a sad one for Bill. Though he often enjoyed the foreign ports he couldn't escape the helpless feeling that he was getting no place in life. It dogged his heels continually and occasionally would even jump up and take him by the throat, and then it was that he would make determined resolves to stop ashore that trip if he had to tidy up the streets for a living.

One trouble with Bill that interfered with such resolves was the fact that he couldn't resist a fitting celebration of arrivals in port after many monotonous days at sea, and such fitting celebration invariably ran into money. As a result he seldom paid off in the home port with enough to keep him out of the Salvation Army's Wood Yard for more than a week. So he had to ship out again.

Finally he sentenced himself to a tanker. A tanker loads a cargo of oil in from six to twenty hours and pumps it out again in from twelve to thirty-six so very little time is permitted for celebrations, though I have heard operators boast that they could get rid of all they made in that time without much trouble. But Bill saved his, and when he came ashore he met a man who let him sell insurance for him. He made good, married, and I believe is happy with his acquirements and ambitions.

An infinitesimal part of the June Sunday crowd at the Beach with his wife, and three-year-old Margaret joyously sampling the edge of the surf with her bare little legs, he can watch a deeply laden freighter slowly emerge from the Golden Gate to unconcernedly face a one, two, or three thousand mile journey to foreign lands and as she is dissolved by the distant meeting of the two blues inwardly rejoice that he is not aboard the "dirty old hooker."

Perhaps only a writer can obtain spiritual dividends from the purely romantic aspect of a sea-faring man's life; certainly it is a rare individual who does. George Harrison, although he wasn't a writer or even a person who could be called romantic, possessed qualities which adjusted him more snugly to the life of a wanderer than any other operator I have ever known. He seemed to lack the usual desires and ambitions which make shore life so attractive to most sailors, yet his was not a negative nature. A need for marriage, safety, worldly possessions and the esteem of his contemporaries never dampened his buoyant personality in the least. He never missed them so it never occurred to him to set out to acquire them. It seemed as though he loved most everything and everybody as things and people happened along. When his ship-mates, with admiration and affection in their tones, referred to him as a fellow who "didn't give a damn about anything," they meant that he had no fear of anything, it only seemed as though he cared for nothing because he loved everything. He loved his work, loved to fish, sing, get drunk, talk and tell stories, fight; he loved the long watches at

sea as well as the hilarious nights ashore. He had no especial friends among his ship-mates, they all looked alike to him and all were equally welcome in his cabin where they congregated almost daily. If they woke him up during his watch below without any good and sufficient reason, such as a drink or a scheme for mischief to offer, they always found him cheerful. Crankiness, impatience, melancholy or the pains of desire never interfered with his contented interest in whatever was at hand.

George was a substantially built, slightly stoop-shouldered chap, about thirty years old when I knew him. He wore a suit of clothes as it is said a suit of clothes should be worn, totally unconscious of it, and this would have been splendid had he perspicacity enough to choose a trustworthy tailor, which he hadn't. The result was that he always wore an ill-fitting suit which, aside from its utilitarian purpose, only served by contrast of its awyness to recommend his strapping physique beneath. I remember him striding up and down the deck for exercise. If anyone approached he would greet him with a smile suggesting that the sudden meeting was the delightful prelude to some sort of an interesting adventure just ahead. His natural and unconscious optimism was contagious, that was the secret of his popularity.

A young lady in Iquique, Chile, who was socially and financially interested in shipping, particularly American shipping, took a strong liking to George (nearly all girls did). She had been hanging around while we discharged lumber at that port. She decided that she would like to make his acquisition permanent. So she kept his overcoat and watch as security for a promise to return at midnight of the day as we were scheduled to sail at 8 p. m. The reason George finished wearing out the overcoat and watch is because the sailing date was delayed a day and he was able to return; and more material-minded ship-mates descended in a belligerent body upon the young lady and by devious and ingenious means separated her from her security. But had we left them in the weeping lady's possession George's spirits would have been no more dampened than they were at parting from his amour. His instinct of possession seemed to be completely atrophied and there were girls in the next port who would serve to amuse him just as well.

All natures are not so satisfactorily adjusted to ship or shore as George's and Bill's, however. Many can't get over wanting both. Some of these may be observed reading the shipping news on early morning street cars, sometimes a trifle wistfully when they note that the *West Cahokia* has arrived at Marseilles or the *Eastern Sailor* is 2100 miles out of New York bound for Liverpool; or the *President Grant* left Kobe for Shanghai. Others drift dissatisfiedly around over the oceans, enjoying the life the best they can when they really desire a home and family and are reluctant to take the punishment attached to setting about to acquire them. The longer they drift the further they get from the state of mind necessary to attack the problem. During occasional forays ashore their determination to work up to affluence from a distasteful (after the easy life at sea) job at a hundred dollars per month is very apt to gradually subside and after a few weeks or months the chief operator of the radio service company is glad to see them again; for the old-timers are usually far the best operators.

INFRADYNE MANUAL
25c Showing Last Year's Model
"RADIO"—San Francisco

Hoyt

Model 300

RADIO SERVICE SET TESTER



Makes All Tests On Any Radio Set

Equipped with precision voltmeter, 1,000 ohms per volt with 3½ inch hand-calibrated 4-range scale—0-10 and 0-500 volts, — 25 and 100 M. A. Cased in polished hardwood box with cover and leather carrying handle.

Price, complete with Adapters, \$65.

Send for new Radio Catalogue P-9

8

BURTON - ROGERS CO.

Sole Selling Agents

BOSTON

MASS.

METERS

WE REPAIR THEM
REGARDLESS OF MAKE

VOLTMETERS
AMMETERS
WATTMETERS

Send Them To Our Laboratory

HEIKON PRODUCTS
HEINTZ AND KAUFMAN
SCIENTIFIC INC. APPARATUS

219-221-223 NATOMA STREET
SAN FRANCISCO



Live

Where uptown and
downtown meet

That's what everyone would like to do—combine country quiet with Broadway activities.

And that's exactly what this hotel offers you.

The serenity of Central Park; where two of New York's most desirable thoroughfares meet. Central Park West and 72nd Street,—and yet just 10 minutes from leading shops and theatres.

Appointments, service, cuisine unexcelled, in keeping with its international reputation.

Booklet sent free on request

Opeland Townsend

Proprietor

Majestic Hotel
and
RESTAURANTS

Two W. 72nd St., New York

Entire Block Fronting Central Park

General Headquarters:

New York Automobile Club

The Majestic Hotel, Central Park West
at 72nd Street, New York City.

Without obligating me, please send me floor plans and information as to arrangement for a party of.....people.

Name.....

Address.....

DOPE ON SKEDS

(Continued from page 34)

(NSS, WII, POZ and GBR can be copied every day on the voyage.)

	TIME		
POZ	1155, 2355	18050	CW
FL	0928, 2228	2600	CW
LY	0800, 2000	19800	CW
NAA	0300, 1700	2655	ICW
NSS	0300, 1700	17145	CW
CTV	0930	600	Spk.

"PRESS"

By W. E. CLYNE, S. S. OAKRIDGE

Here's where I unburden myself of much excess steam pressure, induced by listening night after night to what is misnamed "Press," as sent out by ambitious aspirants at the key of various high powered radio stations.—I. E., the unintelligible hash of signals, which constitutes the Press of some stations, notably San Diego, California.

I always was a great booster for San Diego (NPL) until about a year ago, but since then they have steadily deteriorated to what can be termed the prize Bologna of the lot. Their

sole redeeming feature is the promptness of their press schedule, but they are neck and neck as rivals of the famed NAA for rotten sending and more rotten press.

By heavy concentration and by dint of much cussing, one can generally copy the sending of even the worst key clicker, but that's the least part of it. After you have cussed until the surrounding air is blue and all the brasswork tarnished, we look over our 60 minutes effort to discover that what we have been copying is not press at all, but the worst conglomeration of bunk that was ever assembled on one sheet of paper.

For the week previous to this outburst, and due to the almost constant interference of real Press news from real stations; I have been forced against my will to copy the 2 AM Press items from Navy Radio San Diego. During this time, I have absorbed approximately 25 Los Angeles items, 35 San Diego items, and numerous and sundry items from such well known international cities as Paso Robles, Auberry and Redding, California. All of these brain storms telling about some trifling incident which struck the fancy of the adde-

INTER-COASTAL RUN WEATHER SCHEDULES

By Paul Otto

May 1, 1927

STATION	CALL	WAVE	SYSTEM	AM. 75th Meridian Time	PM. Type of Bulletin
Boston	NAD	1363	2939 CW	8:00 11:00 5:00	L. I. S. to Canada
Newport	NAF	950	2650 CW	10:45 11:15 12:30	5:00 Local, forecast
East Moriches	WSA	650	SPK	9:00	Sandy Hook
New York	WCG	600	SPK	8:45	Sandy Hook
New York	NAH	950	2776 CW	10:30 10:45 5:00	Local, forecast
Tuckerton	WSC	650	ICW	9:00 to 9:30	5:00 Sandy Hook
Philadelphia	NAI	1304	2828 CW	10:45	5:00 N. J., Del., B'kwater
Arlington	NAA	2677	CW	10:30	10:00 10:30 Hydro
Norfolk	NAM				Local
Charleston	NAO	2776	CW	10:30	6:00 Local, forecast
Savannah	NEV	1428	SPK	11:00	6:00 Local, forecast
St. Augustine	NAP	2342	SPK	11:15	Local
Jupiter	NAQ	950	1304 SPK	8:30 11:30	6:00 Local
Key West	NAR	2939	5766 CW		Noon 10:00 Hydro, SE U. S.
San Juan	NAU	2828	4836 CW	July 1 to Nov. 14	7:45 Hydro
Guantanamo	NAW	4543	CW		9:00 Re-sends NAU
Navassa Island	WWEA	600	SPK	Request	Local
New Orleans	WNU	3331	CW	11:30	10:00 11:30 Gulf, Carib. Sea
Brownsville	NAY	4997	CW	Midnite	Noon 7:00 Hydro, Gulf
Almirante	UB	4075	CW		12:30 11:45 Re-sends WNU
Colon	NAX	2271	VAR	5:00	1:00 Local
Balboa	NBA	6518	CW	AM. 120th Meridian Time	PM. Local
Cape Mala	NNT	600	SPK or ICW	2:00 10:00	10:00 Local
Mexico City	XDA	2800	CW	5:00 10:00	5:00 Local
San Diego	NPL	600	2988 CW	11:00	5:00 Hydro for Mexico
Point Firmin	NPX	800	ICW	8:30	2:00 8:30 Local, forecasts
Pt. Hueneme	NMD	800		Request	May be sent by KSE. Local
Pt. Agruello	NPK	800	ICW	Request	Local
San Francisco Lt. V.	WWBV	600	SPK	12:00, 4:00, 8:00	12:00, 4:00, 8:00 Local
San Francisco	KUO	690	FONE	8:00	Noon 8:10 Local
Mare Island	NPG	7006	CW	8:45 10:00	12:30, 2, 4, 6:30 Pt. Reyes, Lobos, S. F.
Bolinas	KPH	675	2200 CW	9:00	7:30 Hydro
Blunts Reef	WWBU	600	SPK	9:00 9:10	8:10 8:20 Re-sends NPG, part
Eureka	NPW	2875	CW	8:00	Noon 8:10 Local, Lt. V.
Marshfield	KN	600	ICW	8:00	Noon 8:00 Local, forecast
Col. River Lt. V.	WWBQ	600	SPK	8:00	12:00, 4:00, 8:00 Local
North Head	NPE	2700	CW	8:00	Noon 8:10 Local
Tatoosh	NPD	800	SPK	5:30 9:00	1:30, 5:30, 8:30 Local, N. W. States
Swiftsure Bank	WWBO	600	SPK	5:00 9:00	1:00, 5:00, 8:00 Local, Sd., Straits
Seattle	NPC	2499	CW	8:00	Noon 8:10 Local, Lt. V.
Estevan	VAE	675	SPK	5:00 9:00	1:00, 5:00, 8:00 Local, Sd., Straits

Wave in red sent at time typed in red.
 NAQ 950 meters CW.
 NPL 600, KPH 675 meters ICW.
 XDA hydro sent in Spanish but easy to translate.
 Also NLH, NPI, NLG, NYW, 800 meters sometimes sent on request.

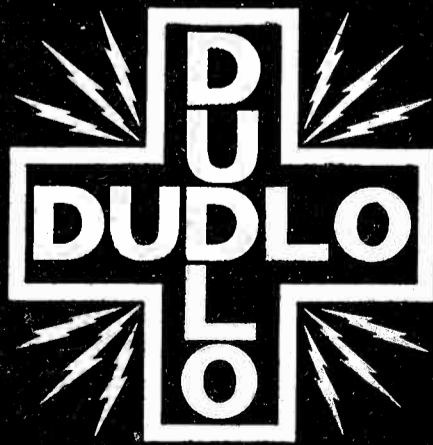
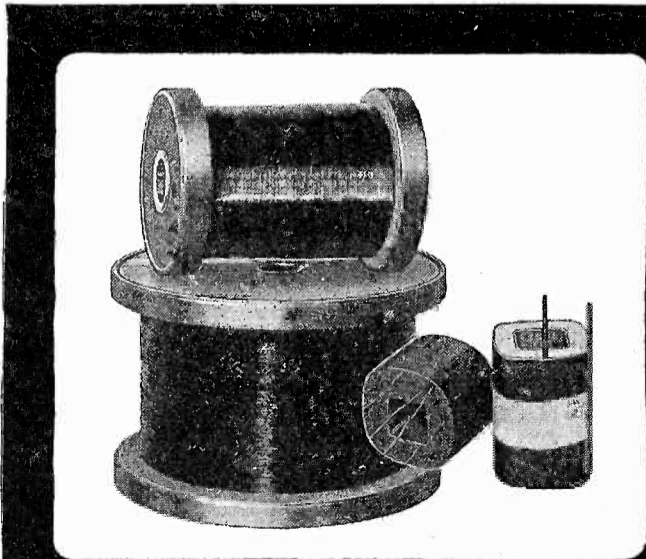

PACIFIC COAST HEADQUARTERS
for
MAGNET WIRE and WINDINGS

A. S. LINDSTROM CO.
324 N. San Pedro St.
Los Angeles

274 Brannan St. San Francisco 95 Connecticut St. Seattle

221 S. W. Temple Salt Lake City 146 1/2 N. 10th St. Portland

DUDLO MANUFACTURING CORPORATION FT. WAYNE, IND.

brained composer of the said Press, and which was of absolutely no interest outside of the cities named.

I was never one to ridicule the sunshine state, but if things keep up as they have been doing in this particular line, I will be ordering my oranges from Florida hereafter.

At the present time there is a great civil war going on in China and of interest to every nationality on the face of the earth, with many hundreds of American Marines there to protect American lives and property. Well, as we in particular are bound for the center of unrest, otherwise known as Shanghai, and about 75% of vessels on the Trans-Pacific run will call in at Shanghai on their voyage, we think it might be of some interest to Mariners on the Pacific to hear news of the latest developments in China.

Every station sending Press today finds it of sufficient importance to include an item or two about this situation, but do you think San Diego does? They certainly won't while there is an international news item from Auberry telling the tale of a cow which had two calves in three months!!!

What does anyone outside of San Diego care about how much money the Public Works Department will allow next year for keeping the rain from washing away the city streets?

If this particular type of news is supposed to interest "All U. S. Navel vessels and stations" then we change our good opinion of the navy personnel.

I have been told many times by foreign wireless operators (yes, there are foreign ships sailing the Pacific), that our press was of no value to them, because of its local character, as they were not especially interested in what happened in New York, Chicago and Washington, unless it was of some international importance.

Heretofore it has been broad enough in its scope to interest Americans, but believe me, it's sure getting some localized when the most distant source of news is within 200 miles of the transmitting station. It is a distinct benefit to the sea-going Americans of the present age, that the one and only press broadcasting station is not located in Paradise, Montana or some other such city. When the crops were in and all roads blocked with 10 ft. of snow, and everyone had hibernated for the winter, what would the station do for press news? Guess they would have to hibernate also.

If any station now broadcasting press items does not know just what constitutes news, please sit in on the United Fruit Station at New Orleans twice a day at 8:30 a. m. and p. m. Pacific standard time, and listen to real honest to gosh press. The sending is always fast, but never is used as a practice hour for United Fruit Company operators,—they don't need it. This fast sending can be copied just as far as the signal can be heard, and I find that to be 3,000 miles west of the Oregon coast.

The press from KPH, San Francisco, can be copied on an average ship's receiver at a distance of 4,000 miles without trouble, but more and more spark interference from Russian and Japanese stations to the north and from Apia to the south, has just about made it an impossibility to copy this press anywhere over 2500 miles.

It sure would be a distinct benefit to humanity in general and wireless operators in particular, if the Radio Corporation of America would utilize the testing periods at Bolinas, and give us some press on 29 meters from KEL. Considerable time is put in at this station in testing high frequency transmission, and press could be sent very well on their test schedule.

Station KEL booms in all over the Orient, and sometimes just about knocks one's ears off. Such a service would sure be appreciated

as there are few ships now that haven't had their little short wave experimenting.

After copying considerable press from several English stations, and all stations in North and Central America for several years, I have come to the conclusion that the best press put out at the present time, is from New Orleans (WNU). But, according to law, we are forbidden to copy this excellent stuff.

The crews of merchant ships today are not illiterate as many Americans think, and they all appreciate having the largest baseball scores, fight returns and events of great interest to everyone. When there is an earthquake in Sweden; that makes news for many people and we all don't have to be Swedes to be interested in it.

Most of the operators going to sea today are well past their code practice days so no one finds it necessary to struggle through static and interference for hours just to listen in on an operator pushing kilowatts into the surrounding ether for code practice.

If naval operators at 300 KW shore stations must practice the code, then let them lock themselves in a sound-proof booth with a key and buzzer instead of inflicting their fists on a poor guy out at sea. We hate to slam anyone doing us a service, but at least the service ought to be half-way decent. My criticism is not aimed at any individual in the navy or at commercial stations, but rather at all stations that read this and say: "This means me."

There are some very good operators in the navy, but the majority of them do not care about sending press, so put on the beginner for that ungrateful job. If the experienced operator with the good fist will not condescend to send the press, then put the old machine on for awhile.

This article has almost turned into a direct slam against San Diego, but at the present time, they are the worst offender in the manner mentioned herein.

Going to sea for living is no bed of roses in spite of alluring pictures of life at sea, and any little courtesy that could be extended to us from shore folks, and any other little consideration shown us, is always appreciated on any ship that I ever was a member of its crew.

And that's that.

LOCAL RADIO LEGISLATION

Local radio legislation, in the opinion of Frank D. Scott as expressed to the Federated Radio Trade Association, will be largely based upon the police power of the state or municipality, which is not particularly limited by state or national constitutions. There has been some such legislation to lessen interference, to determine station location and power, to regulate remote control, to license and to tax. He knows of no instance where the courts have passed final judgment on such laws.

The authority of states and municipalities to control interference caused by forces other than another radio station, especially when the interference can be removed by corrective measures, is seldom questioned. When the Radio Act of 1927 is sustained there will be no necessity for local legislation to prevent interference between stations. But local laws can perform a useful public service in preventing interference from other local forces. Most municipalities have the power to determine the location of an industry, including a radio station.

RADIO ADS

δ δ δ

A Classified Advertising Section Read by Better Buyers.

δ δ δ

The rate per word is eight cents net. Remittance must accompany all advertisements. Include name and address when counting words.

δ δ δ

Ads for the October Issue Must Reach Us by September Fifth

BAKELITE PANELS, Tubes and Rods. Engraving and Drilling. W. A. Vetter, 24 12th St., San Francisco, Calif. (6T)

DOUGHNUT COILS Brand New—high grade coils, \$1.00, each, or \$3.00 per set of three, which includes 1 antenna coil and two tuning units. Limited number; order quickly. D. B. McGown, 435 Pacific Bldg., San Francisco, Cal.

"BEST CRYSTAL ON EARTH"—Postpaid, fifty cents each. Fully Guaranteed. Harry Grant, Jr., 904 Oak Grove Ave., Burlingame, Calif.

GET the 1927, Third Edition Revised of "Radio Theory and Operating" by Mary Texanna Loomis, member Institute of Radio Engineers. President and lecturer on Radio, Loomis Radio College of Washington, D. C. This is a thorough text and reference book of 886 pages, 700 illustrations and bound in flexible, red Kraft leather, lettered in gold. Used by practically all the radio schools in U. S. and Canada in addition to many Universities, Technical Colleges and High Schools. The standard reference book of the Department of Commerce, Radio Supervisors, and used by U. S. Naval Training Schools and Coast Guard Academy. The only radio book that is right down to date; contains much valuable matter never before published; it covers the field more thoroughly than any six radio books on the market. Price \$3.50, postage paid to any place in U. S. and Foreign countries. Get it of your book dealer. If he does not handle, send check or money order to Loomis Publishing Company, Dept. X, 405 9th St., Washington, D. C.

SET BUILDERS—Substantial discounts on parts for the new 1928 INFRADYNE are allowed to those who specialize in home-built sets. Write now for complete illustrated circulars. RADIO CONSTRUCTORS CORPORATION, 357 Twelfth St., Oakland, California.

NEW TUBES—Several new 6V Radiotron tubes. Will exchange for motion picture projection machine or sell. WILLETS, Apt. 41, 890 Geary St., San Francisco, Cal.

RADIO AGENTS—Make Big Money—Easy! Selling Marvelous New Sets and accessories. Buy from factory at lowest prices. Get New Catalog with thousands of nationally advertised bargains. FREE Call Book. Write today. American Auto and Radio Co., Dept. 148, American Radio Bldg., Kansas City, Mo. (3T)

DO YOU GET TIRED of buying "B" batteries? A lifetime Edison will solve your troubles. Good, live, large size elements connected with pure nickel wire, electrically welded, 7c pair. All parts for sale. Sample cell and dope sheet, 10c. Paul Mills, Woodburn, Oregon.

36-INCH CONE KITS \$12.50, including: 2 metal rings and bracket, 1 Radiocieve double drive unit, 2 36-inch sheets of ALHAMBRA, 1 printed and 1 plain, 1 tube cement, Apex hardware and directions. Dealers write for discounts. Solatone Radio Co., 148 Greenwich St., New York City, N. Y.

Now! ⁹great Radio Training made greater!

If you want to get into the Radio Profession, or if you're in it and want to get ahead—

Read This Announcement!



J. E. SMITH,
President

Here's a message of importance to every man who hopes to better himself along the lines of Radio. Never before has there been a Radio training course that could be made to fit the needs of all—both experienced men who wish to better themselves and inexperienced men who wish to start from the beginning. There is one now. I am prepared to help the beginner start in Radio from the very beginning. And I am prepared to help the Radio dealer, the experienced Radio operator, the Radio service man, the college engineering student, the graduate engineer, the Radio fan, the "ham," the factory or broadcast man who wants to get a more responsible job.

An old, established system of Radio home-study training has now been developed, improved, tested, and enlarged in scope so that now it not only will help anyone who wants to get into the Radio profession, but more, can be adapted to help almost any man now engaged in Radio (Radio engineers of experience and standing excepted).

If you want to get into Radio, or if you're already in it and want to add to your knowledge and get ahead, let me send you my free 64-page book of information about this new and greater Radio training system.

The Good Jobs Pay \$50, \$75, Up To \$200 a Week—Some Pay More

If you're earning a penny less than \$50 a week, you're not earning what you should be able to get out of Radio. Thoroughly-trained Radio men—men whose knowledge of Radio is practical and completely rounded out on every point—earn up to \$200 and \$250 a week. Radio is a new industry with plenty of fine positions unfilled. There are countless opportunities in Radio for a man to earn a splendid salary. But these are not opportunities as far as you are concerned, unless you are fully qualified for them. The only way to qualify is through knowledge—training—practical, complete training that fits you to get and hold a better position in the Radio field.

For the beginner, I have a complete training that will take him from beginning to end. To the Radio dealer I'll give the technical and practical knowledge he has to have. I will round out and bring up to date the experienced Radio operator's knowledge. I can take a Radio service man who has a pretty good idea of the "how" but very little idea of the "why," and give him the practical and theoretical knowledge he must have before he can hope to climb higher on the Radio ladder. I can take the college engineering student, or the graduate engineer, who wishes to specialize in Radio, and give him what he needs.

What other line offers such an opportunity as Radio? From \$2,000,000 a year in 1920 to \$500,000,000 a year in 1926; from 1,000 persons engaged in Radio in 1920 to 300,000 in 1926. That's its record. The accomplishment of television and the many other inventions constantly being made promise the same sort of boom for the future.

If you're already in the Radio business, stay in it. But prepare yourself for advancement and more money. If you're not in Radio yet, get in. Men always do their best at work that interests them.

Send Coupon For Free 64-Page Book

My free 64-page book is filled with facts and photos relative to Radio and its opportunities, and tells all about my new and greater system of Radio training. Under my practical methods, you can study at home in your spare minutes, and get a thorough, clear, practical and expert knowledge of Radio in from 4 to 12 months. The time required depends on your previous knowledge, your ability, and the time you can spare for study. You keep right on with the job you have—no necessity for your leaving home or living on expense.

This proposition is open to anybody who is not satisfied with his job, his prospects, or his Radio knowledge. Regardless of how much you know already (or if you don't know the first thing about Radio technically) I'll fit my methods to suit your needs. No particular amount of general education is needed to start—many men I've trained didn't even finish the grade schools.

If you want to enter into any correspondence about your own situation, anything you write will come directly to me and will be held strictly confidential. Send the coupon at the right, or write me a letter today.

Address: **J. E. SMITH, President**

National Radio Institute

"Oldest and Largest Radio Home-Study School in the World"
Washington, D. C.

Employment Service to all Graduates

Originators of Radio Home Study Training

The Beginning of Radio—1898-1902

Below is the historical Marconi apparatus. These "jiggers" are transmitters and receivers, used by Marconi in his first Radio experiments.

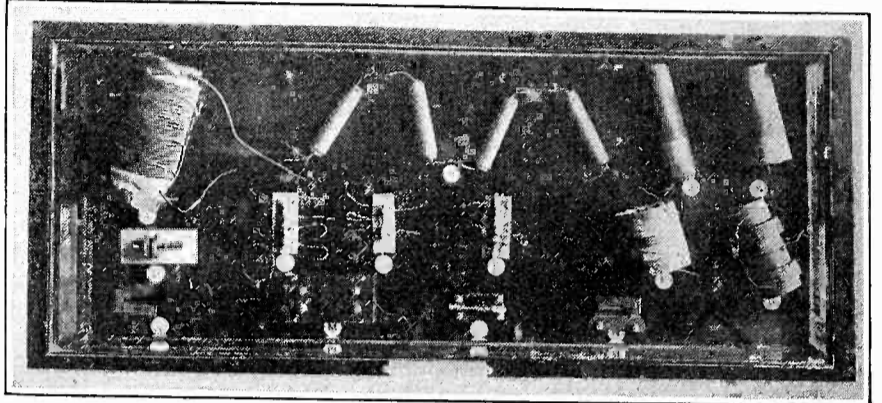

Radio Television— First Demonstration, 1927

Below, television apparatus in operation—perhaps the best indication of the enormous progress made by Radio during the past 25 years. Now we not only can transmit any sound by Radio, we have learned to SEE by Radio as well.

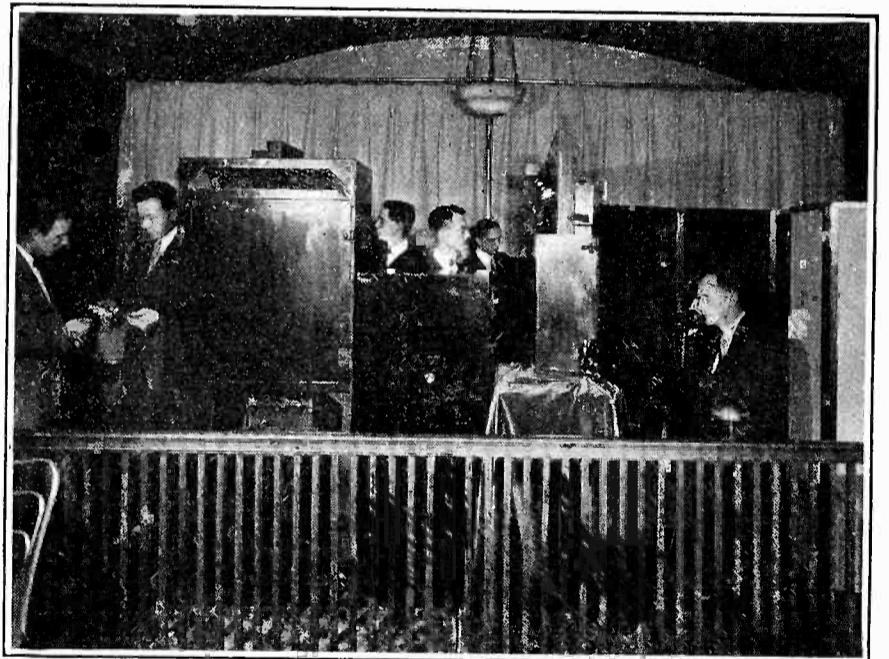

**Mail this Coupon
for free information**

**J. E. SMITH, President,
National Radio Institute,
Dept. HB-5, Washington, D. C.**

Dear Mr. Smith: Kindly send me your free 64-page book about your new and greater Radio training system. I understand this request places me under no obligation, and that no salesman will call on me.

Name.....

Address.....

Town..... State.....

Complete A. C. Operation A Practical Reality

For the past several seasons the trend has been toward complete battery elimination. Many satisfactory plate supply units operating from A. C. have been developed but filament operation from an A. C. source has presented more of a problem due to the larger currents required and increased expense in the rectifier and filter circuit.

The newly announced A. C. tubes offer an excellent solution to this problem.



**Type 440-A
Low Voltage Transformer**

The alternating current tubes require a source of low voltage capable of delivering large current. The various types of tubes require several different voltages. The type 440-A transformer supplies voltages for all popular A. C. tubes and sufficient current for all ordinary receiver requirements. Filament supply is provided for filament, separate heater, power amplifier and rectifier tubes. The following voltages and currents are available. Pri. 115 (for lines 105-125 volts) 60 cycles.

Sec. 2	volts.....	8	amperes
	3.5	volts.....	2
	5	volts.....	2.5
	7.5	volts.....	2

Price \$10

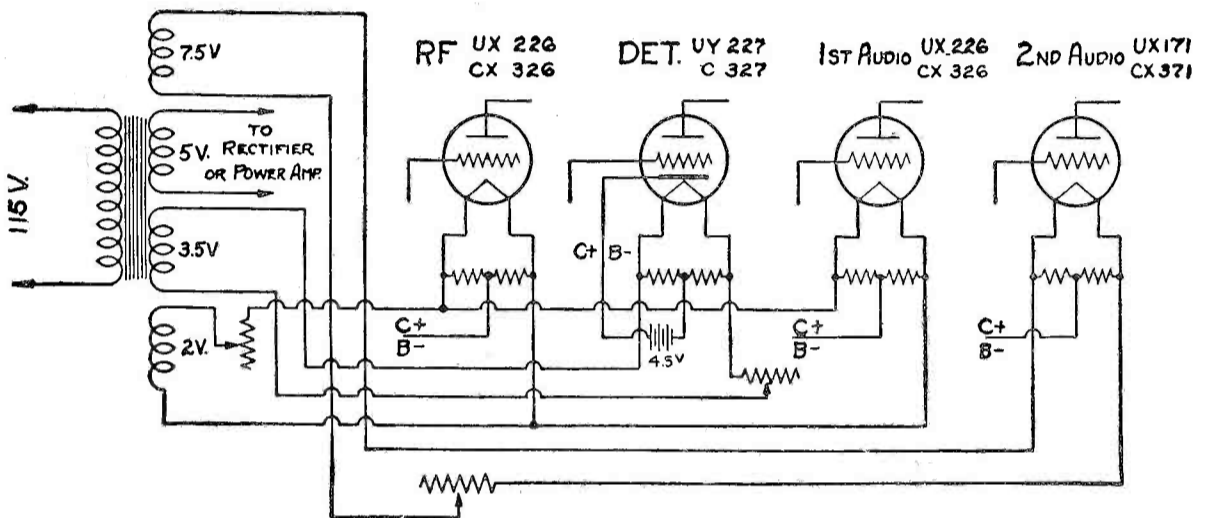

The above diagram shows how to adapt the filament wiring of the popular type of receiver to A. C. operation by use of General Radio parts especially designed for this purpose.

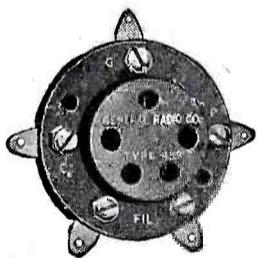

Type 438 Socket

The new type UY-227 or CX-327 detector tube has a separate heating element and requires a socket designed to take the new five prong base.

Type 438 socket.....\$0.50

The various types of A. C. amplifier tubes are designed with standard UX or CX base having four prongs.

Type 349 socket.....\$0.50

Type 439 Center Tap Resistance

All the new A. C. tubes require a resistance with center tap across the filament as shown in the diagram. The Type 439 Resistance is adaptable to any socket in which the new A. C. tubes may be used.

Type 439 Center Tap Resistance.....\$0.60



Type 410 Rheostat

The new A. C. tubes require low resistance rheostats capable of carrying appreciably more current than those used with D. C. tubes.

Resistance	Current	Price
.5 ohm	3.5 amperes	\$1.25
1.5 ohm	2.0 amperes	1.25

Your local dealer should have the necessary parts in stock. If he is unable to supply you with all the items required, we shall be glad to send them to you prepaid upon receipt of list price.

GENERAL RADIO CO., Cambridge, Mass.

GENERAL RADIO

LABORATORY EQUIPMENT

PARTS and ACCESSORIES

The NEW BROWNING-DRAKES

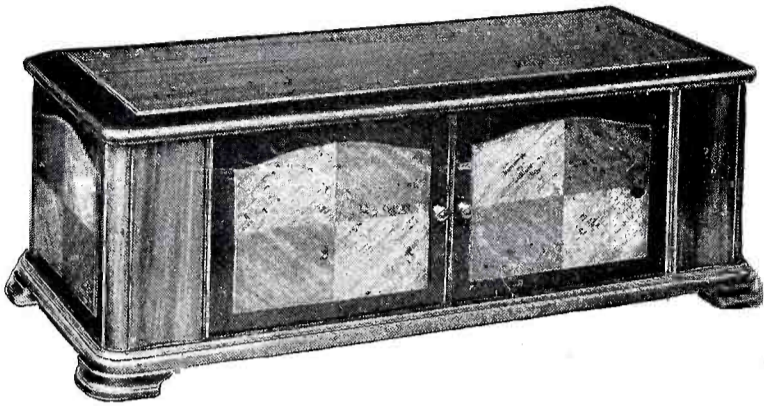

MODEL 7-A
SINGLE DIAL - SEVEN TUBES
COMPLETELY SHIELDED
ILLUMINATED
DRUM CONTROL
SUPER-SELECTIVITY

AFTER several years of intensive research by Prof. Glenn H. Browning and Dr. Frederick H. Drake, the laboratories of the Browning-Drake Corporation have brought to commercial form, a new conception of the world-famous Browning-Drake Receiver.

Browning-Drake has been known for its unusually fine tone quality and has a record of transcontinental reception on seven consecutive nights. The ability of the new receivers to demonstrate even more remarkable distance performance, to give fine tone and cut through the strongest local interference, gives them an unmistakable appeal. The model 7-A above and the 6-A below are the first Browning-Drakes to use more than five tubes. These new models embody many mechanical refinements, including a highly efficient and novel tuning drive system.

These receivers are the result of nearly five years of exhaustive research and steady progress. Backed by the reputation of the Browning-Drake Corporation, we believe they will occupy a paramount position in radio this year. The still popular 5-R model will be continued as long as there is a demand for it. High grade dealers throughout the country are prepared to offer the Browning-Drake line as well as the Official Browning-Drake Kit Set for home assembly, which has won nation wide popularity.

Look for this



Trade Mark

Model 7-A can be had in either a two-tone mahogany or walnut. This receiver is thirty inches long, fifteen inches deep and eleven inches high. A console base can be had for this model if desired. List without tubes \$145.00; with console \$185.00.

BROWNING-DRAKE CORPORATION
CAMBRIDGE MASS.

DEALERS: Browning-Drake now offers a complete line of receivers and kit parts. Almost three times as many Browning-Drake parts are sold as those of nearest competitor. Write or wire for further information TODAY.

MODEL 5-R

This still popular model is a five tube receiver with three stages of resistance-coupled amplification and special input system. Famous Browning-Drake slot-wound radio frequency transformer is used. Provision for power tube in last audio stage. Cabinet is two tone Duco mahogany finish. List without tubes and batteries \$95.00

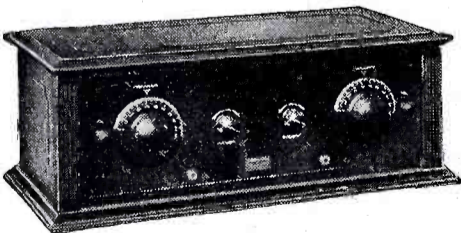

MODEL 6-A

A six tube Browning-Drake using conventional Browning-Drake circuit with slight modifications. Audio amplifier has been increased to four tubes to give greater volume and improved tone. Single dial. Illuminated drum control. Cabinet is two tone Duco walnut. 37 in. long, 15 in. deep and 11 in. high. List without tubes \$105.00

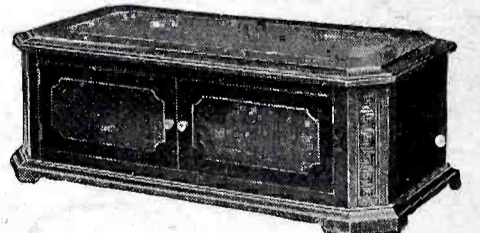

BROWNING-DRAKE RADIO

H. L. KRIEDT CO., SAN FRANCISCO, CALIF.