

* Inverse Duplex
JANUARY, 1927

Steady

25 CENTS

RADIO

(REG. U. S. PATENT OFF.)

Hull's Shuttled Grid Tube

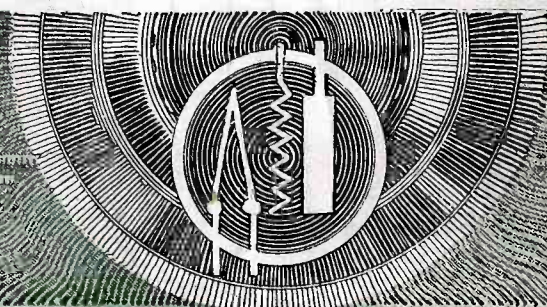
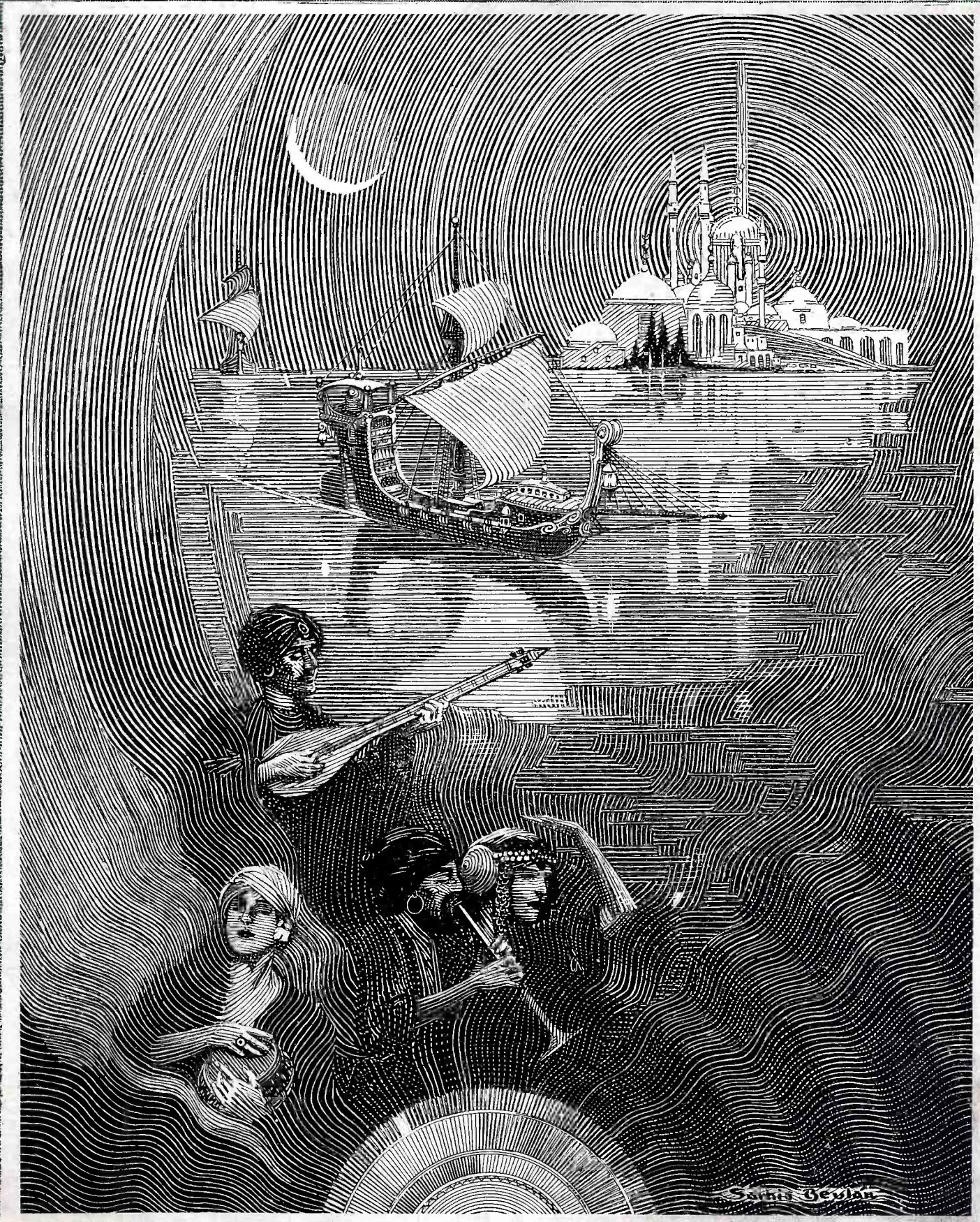

Cunningham

RADIO TUBES

Since 1915
Standard for all sets



1 type in 1915
2 types in 1920
15 types in 1926

RADIO progress has set a fast and exacting pace these past few years. One single type of tube seemed adequate ten years ago. Four years ago two types apparently served the purpose. And today, with its greater and more exacting demands for improved radio reception, the research and engineering talent back of Cunningham Radio Tubes contributes its share to radio progress with fifteen perfected special purpose types, each one efficiently mastering its particular task.

To know the individual and special task of each one of these tubes when used in your set will bring to you an appreciation of increased radio enjoyment and more realistic tone reproduction.

Consult your nearest Cunningham Radio Tube dealer—learn how the RIGHT COMBINATION OF CUNNINGHAM RADIO TUBES will bring your present radio equipment up-to-date. Be sure that your receiver has the right combination of detector, voltage amplifier, power amplifier, and rectifier tubes to give it present day standards of performance in sensitiveness—in selectivity—in tone value.

Fifteen Types
All in the Orange and Blue Carton

A. J. Cunningham, Inc.

NEW YORK CHICAGO SAN FRANCISCO

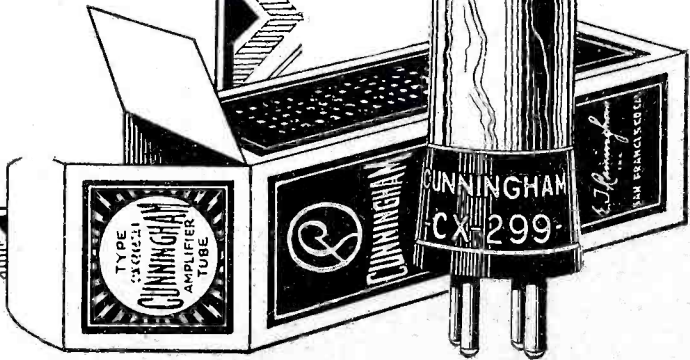



The Tower cone

\$9.50

Brings to You Every Note of the Symphony

DEEP, rich and clear, the Tower Cone offers a quality of reproduction truly delightful. Acoustically and chromatically perfect (due to scientific design exclusively Tower), this amazing reproducer value is easily in a class by itself. The direct-drive unit, the eight

contact points between unit and cone (instead of only one as in most cones), the beauty of design, the non-warping cone, the rugged construction — these are the superior mechanical features that bring to you the best that radio offers—in the manner you most desire.

*The Tower Cone Is Sold From Coast to Coast.
Ask Your Dealer to Demonstrate.*

TOWER MFG. CORP. BOSTON, MASS.

UNIVERSAL

TWO NEW COMPANIONS

TRANSOCEANIC "NEW PHANTOM"

SEVEN TUBES—100% SHIELDING—TUNES 35 METERS TO 3600 METERS

\$220.00 (No Accessories)

"On the Air"

COMPARE THESE FEATURES WITH ANY RADIO

* Indicates Original Golden-Leutz Feature as applied to Broadcast Receivers, ‡ Exclusive Feature

		Golden-Leutz Trans-oceanic	Any Other Radio
1.	100% shielding—Interstage shielding—Complete external shielding against extraneous disturbances*	V	
2.	Totally shielded low loss variable condensers to prevent interaction between condenser and transformer fields* ‡.....	V	
3.	Complete shielding between stators (grid circuit) of multiple condensers*, scientifically determined	V	
4.	Use of Indicating Meters and special switch to read "A," "B" and "C" battery voltages*; total of 8 different readings.....	V	
5.	Licensed under Hogan Patent 1,014,002 for single control (first licensee)*—Vernier Adjustments for short wave work.....	V	
6.	Optional individual control or simultaneous control of all tuning controls*, instantly changeable	V	
7.	Use of interchangeable tuned radio frequency transformers to tune all broadcast wavelengths in the world, viz, 35 to 3600 meters* ‡	V	
8.	A special filter circuit in the output to exclude detrimental plate current from the Loud Speaker, Power Audio Amplifier included	V	
9.	Use of Resistance Coupling in the Audio Amplifier, combined with impedance and transformer coupling for perfect reproduction* ‡	V	
10.	Adjustable Antennae Coupling to adapt set to all various types and sizes of broadcast antennae* ‡.....	V	
11.	Antennae Series Condenser for Extreme Selectivity in congested districts* ‡—Distant reception through locals possible.....	V	
12.	Sealed Chassis to exclude moisture and dust* ‡—Design equally suited to any climate in the world.....	V	
13.	Last stage, power audio, adaptable to 201A, 112,171 or 210 tubes, 550 volts maximum capacity for great volume* ‡.....	V	
14.	Separate B Voltage Taps for Detector, Radio Amplifiers, Audio Amplifiers and Power Amplifiers*, adjustable for all tubes.....	V	
15.	Separate Bias Voltage Taps for Radio Amplifier, Audio Amplifiers and Power Amplifiers*, adjustable for all tubes.....	V	
16.	Power Audio Tube Filament arranged for heating by either battery or alternating current*	V	
17.	No rivets to corrode, all connections soldered in accordance with Navy Specifications*, all wires heavily insulated.....	V	
18.	Only piece of steel used is in condenser shafts, detrimental steel supports purposely omitted, all other material non-magnetic.....	V	
19.	Metallized heavy current carrying, permanent value grid leaks and resistors—Fixed condensers made to special order.....	V	
20.	Direct Disc Vernier Adjustments, Etched Black Brass Dials, Silver Graduations 0-100	V	
21.	Indicating rotors upon which calibrations can be recorded for reference, all graduations are permanent.....	V	
22.	All insulating material Genuine Bakelite include sub-panels—coil bases—coil forms: Sockets new UX-Type positive contact.....	V	
23.	All Screws, Bolts and Nuts securely fastened by bronze lock washers* ‡ and non-magnetic rust-proof material.....	V	
24.	Most Compact Multiple Tube Sets made, 9 tube less than 2 cubic feet; 7 tube less than 1 cubic foot, size 27 $\frac{7}{8}$ x13 $\frac{1}{8}$ x8 inches.....	V	
25.	Scientifically determined distance between transformers and shield, not detrimentally close* ‡ practically no shield losses.....	V	
26.	Volume Control device to regulate volume to any desired value without affecting quality, musical reproductions finest possible.....	V	
27.	Can be used with "B" and "C" Eliminators, special Golden-Leutz Eliminator made to match, which supplies up to 450 volts.....	V	
28.	Practically all parts, except the meter and a few small parts, are manufactured in our factory and laboratory tested.....	V	
29.	Each receiver tested at night and calibrated to a station at least 2000 miles distant, guaranteeing long range performance.....	V	
30.	Adaptable to Electric Socket Operation using Golden-Leutz A-B-C Eliminator	V	

GOLDEN-LEUTZ, INC.

"Manufacturers of the Highest Class Radio Apparatus in the World"

MAIN OFFICE AND WORKS:

Sixth and Washington Avenues, Long Island City, New York, U. S. A.

Cables: "Experinfo" New York—All Codes

DEALERS OR JOBBERS WIRE OR WRITE FOR SAME TODAY

TRANSOCEANIC

TO THE "SILVER GHOST"

TRANSOCEANIC "PHANTOM"

NINE TUBES — 100% SHIELDING — TUNES 35 METERS TO 3600 METERS

\$250.00 (No Accessories)

To Everywhere"

With respect to Receiving Range, Selectivity, Simplicity of Operation, Electrical Design, Mechanical Construction, Total Amplification and Quality of Musical Reproduction, we believe this Phantom Model easily exceeds all present designs.

Phantom Models are already in use on U. S. S. Vega and U. S. S. Utah

"MOST POWERFUL IN THE WORLD"

9 TUBE TRANSOCEANIC "PHANTOM"

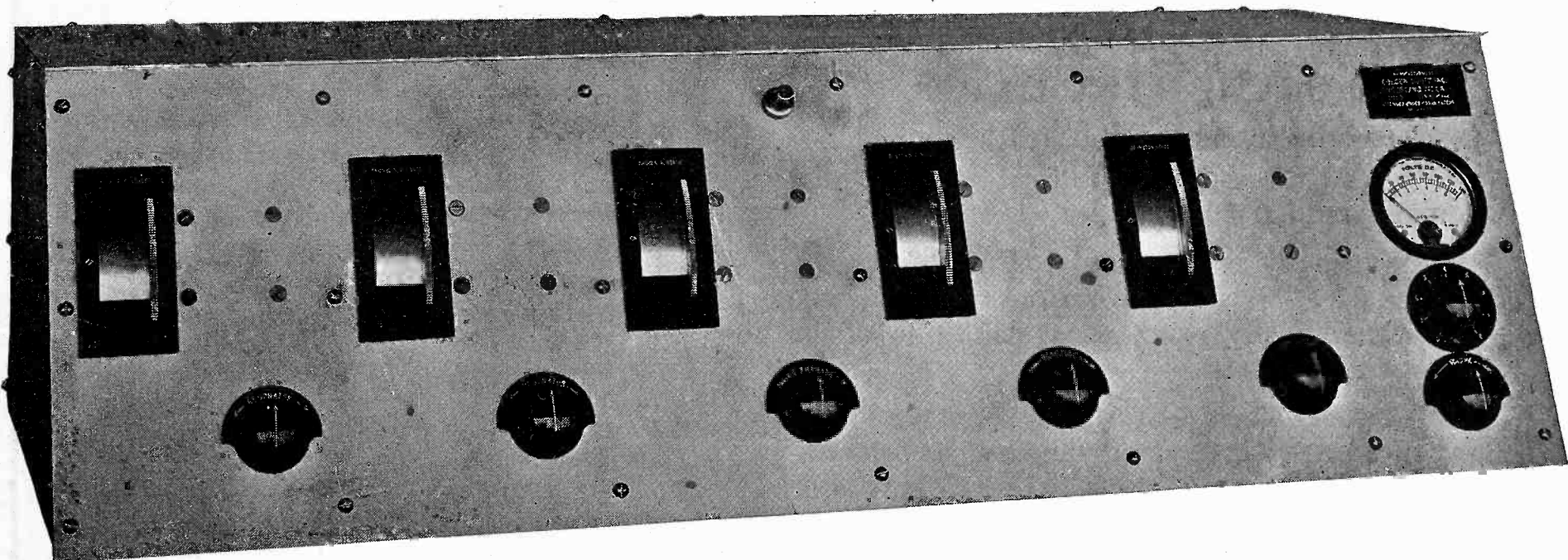

UNIVERSAL TRANSOCEANIC "NEW PHANTOM"

Item	Quan.	DESCRIPTION	Price
1	1	Universal Transoceanic "New Phantom" Broadcast Receiver, 7 tubes, 2 tuned radio, detector, three audio and power audio amplifier. Including "A" Transformers for 200 to 560 meters tuning range. (No accessories included.)	\$220.00
EXTRAS			
2	1	Set selected tubes including detector and 210 power tube	21.50
3	1	Set "B" Transformers for tuning 80 to 210 meters.....	15.00
4	1	Set "C" Transformers for tuning 35 to 90 meters.....	15.00
5	1	Set "AA" Transformers for tuning 500 to 1500 meters....	15.00
6	1	Set "BB" Transformers for tuning 1200 to 3600 meters....	15.00
7	1	6 volt 120 A.H. Storage Battery.....	24.00
8	1	New Type Farrand Senior Loud Speaker, Cone Type.....	32.50
9	1	Golden-Leutz Special Current Supply for 110 volts 50/60 cycle A. C.	135.00
10	1	Antennae Equipment	4.00
Total all accessories			\$497.00
11	1	Complete Knocked down Kit of all Transoceanic "New Phantom" Parts ready for assembly including Constructional Drawings (no accessories) "A" Type Transformers for 200 to 560 meters included.....	\$190.00
12	1	Complete set of Constructional Drawings and Operating Data on Transoceanic "New Phantom" only.....	2.00

Special Quotation for Dry "B" Battery Operation Will Be Made on Request

UNIVERSAL TRANSOCEANIC "PHANTOM"

Item	Quan.	DESCRIPTION	Price
1	1	Universal Transoceanic "Phantom" Broadcast Receiver, 9 tubes, 4 tuned radio, detector, three audio and power audio amplifier. Including "A" Transformers for 200 to 560 meters tuning range. (No accessories included.).....	\$250.00
EXTRAS			
2	1	Set selected tubes including detector and 210 power amplifier	25.50
3	1	Set "B" Transformers for tuning 80 to 210 meters.....	25.00
4	1	Set "C" Transformers for tuning 35 to 90 meters.....	25.00
5	1	Set "AA" Transformers for tuning 500 to 1500 meters....	25.00
6	1	Set "BB" Transformers for tuning 1200 to 3600 meters....	25.00
7	1	6 volt 120 A.H. Storage Battery.....	24.00
8	1	New Type Farrand Senior Loud Speaker, Cone Type.....	32.50
9	1	Golden-Leutz Special Current Supply for 110 volts 50/60 cycle A. C.	135.00
10	1	Antennae Equipment	4.00
Total all accessories			\$571.00
11	1	Complete Knocked down Kit of all Transoceanic "Phantom" Parts, ready for assembly including Constructional Drawings (no accessories). "A" Transformers for 200 to 560 meters included	\$220.00
12	1	Complete set of Constructional Drawings and Operating Data for Transoceanic "Phantom" only.....	\$2.00

Special Quotation for Dry "B" Battery Operations Will Be Made on Request

INDIVIDUALS MAY ORDER DIRECT FROM FACTORY IF DESIRED

Tell them that you saw it in RADIO

BREMER-TULLY COUNTERPHASE-EIGHT

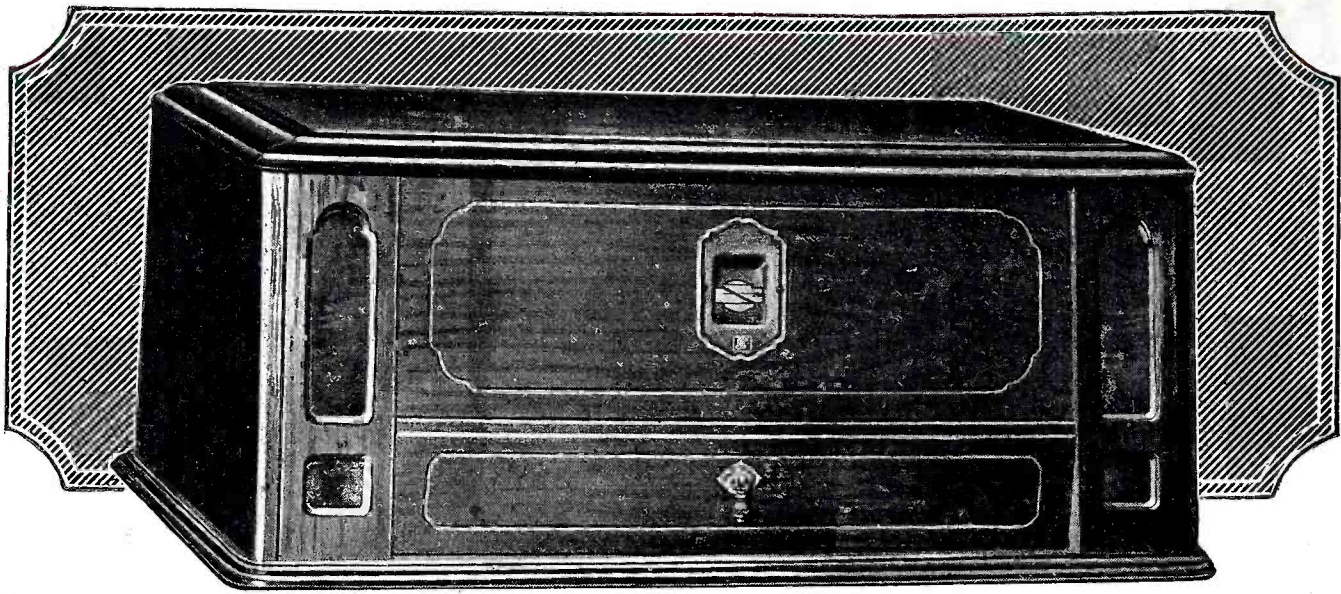

Here is a receiver that is "SINGLE CONTROL" and also sufficiently selective for YOUR requirements no matter where you live.

It sounds impossible? It would be except for the REJECTOR STAGE, an old principle now applied successfully for the first time in radio. It's a feature you'll find only in the *counterphase-Eight* and *Six*.

STATION INDICATOR

Another exclusive B-T feature:

Read wave lengths direct without dial numbers or log book.

On every set, on any part of the scale—a glance at the *Station Indicator* tells you the mathematically exact wave length to which your set is tuned.

It tells where to turn for the wave length you want. There are no allowances or variations. Each set is calibrated to hair-line accuracy.

The daylight records made by users in all sections of the country are proof of the superiority of the *Counterphase*.

Here is a sample letter:

Niles, Mich., Nov. 15, 1926.

We are submitting a signed statement of reception on a B-T Counterphase-Eight sold to a doctor in this city.

The stations listed below were received at the Doctor's home in Niles between the hours of 1:30 and 4:35, Saturday afternoon, Nov. 13, 1926 (daylight reception).

<i>WEAO Columbus</i>	<i>WEAF New York</i>
<i>WBT Charlotte, N. C.</i>	<i>WOC Davenport</i>
<i>WSMB New Orleans</i>	<i>WOS Jefferson City</i>
<i>WHA Madison, Wis.</i>	<i>WDOD Chattanooga</i>
<i>WCCO Minneapolis</i>	<i>KMOX St. Louis</i>
<i>WJZ New York</i>	<i>WHAS Louisville</i>
<i>WWJ Detroit</i>	<i>KOA Denver, Colo.</i>
<i>WTAM Cleveland</i>	

*RADIO SERVICE LABORATORIES
(The doctor has certified this reception)*

The New Counterphase is a set full of surprises. The tone will give you a new standard by which to judge radio. Tuning is simplicity itself. The cabinet design is exclusively B-T and there is no better furniture in radio.

You must hear this set to appreciate its superiority. ANY AUTHORIZED DEALER WILL DEMONSTRATE. Circulars free on request.

B-T POWER UNIT

The B-T Power Unit introduced a new design which without any doubt will become the only one as soon as the public understands it.

There are no variable resistances—no knobs to turn—no guess work about the voltage delivered.

Eventually you'll use this type. Save trouble and money by buying it first.

Maximum capacity 150 volts at 60 mls.
Price, east of Rockies \$49.50

BREMER-TULLY MFG. COMPANY

520 SO. CANAL ST., CHICAGO, ILL.

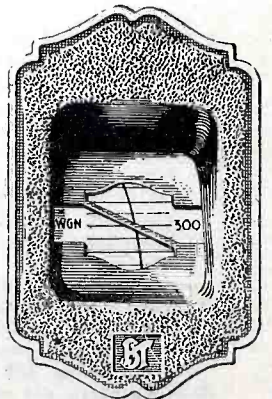
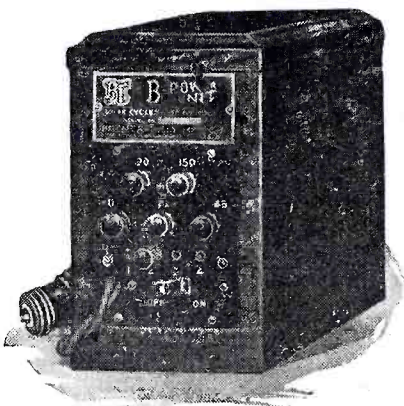

STATION INDICATOR
(Pat. 9-28-26)

Wherein—

Actions Speak Louder than Words.

- **Distance**
- **Performance**
- **Sensitivity**
- **Selectivity**
- **Tone Quality**

How often we have read and used the same old words. Everybody's doing it—and the old stand-bys have almost lost their meaning.

It is so easy to make extravagant claims—and so hard to make good 100% in actual practice. That is why we want you to test Remler Radio Apparatus as part of your own set.

When you do test it, you will know that the Remler name stands for downright reliability and technical excellence. You will realize why we put so high a value on a reputation which was won in the early days of radio.

Here at the Remler factory we want results. Words count for mighty little. Performance—plus is the strict standard by which every piece of Remler Apparatus is judged.

We ask that you judge it by the same standard. Reliable dealers everywhere sell Remler Parts.

REMLER

Division of

Gray & Danielson Manufacturing Company

CHICAGO

260 FIRST STREET
SAN FRANCISCO

NEW YORK

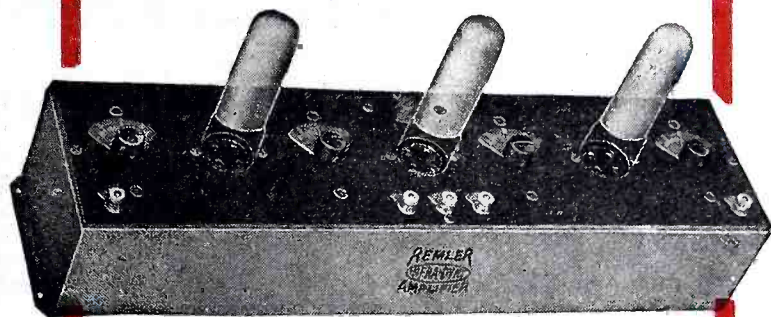

REMLER INFRA-DYNE AMPLIFIER

No real Radio enthusiast can pass up the Remler Infradyne Amplifier. It gives new meaning to radio reception; it makes the best results of a year ago look like also-rans; it marks a milestone in radio research.

You take no chances when you sign up with the Infradyne to make radio reception what it ought to be.

Price **\$25.00**

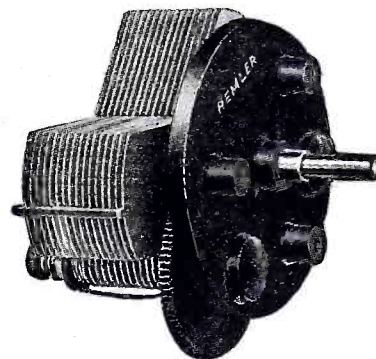

REMLER TWIN-ROTOR CONDENSER

Insulation of Twin-Rotors eliminates body capacity. Plate surfaces embossed, insuring absolute evenness. Radio-frequency currents are confined to brass—a low-resistance metal.

**Straight Line
Frequency**

**Straight Line
Wave Length**

Capacities .0005 and .00035

Price **\$4.50** Less Dial

Tell them that you saw it in RADIO

protection

OUR recommendation of the specified list of parts for building the Sargent-Rayment INFRADYNE will be adhered to without change for at least six months. If you are a radio jobber or dealer you can safely "stock up" on parts for the INFRADYNE. If you contemplate building this revolutionary receiver you need not wait for "new improvements." There will be none for six months or more. Thousands of INFRADYNE Owners are hearing stations they never heard before. Dealers and jobbers report heavy sales of parts for the INFRADYNE. Build yours now. Long distance reception is at its best this year—and the INFRADYNE is making radio history.

Full size blueprints, templates and instruction book for building the INFRADYNE can be secured from your dealer for \$1.00 or from L. C. RAYMENT, 1200 Franklin Street, Oakland, Calif.

E. M. SARGENT & L. C. RAYMENT, 1200 FRANKLIN ST., OAKLAND, CALIF.

INFRADYNE

Tell them that you saw it in RADIO

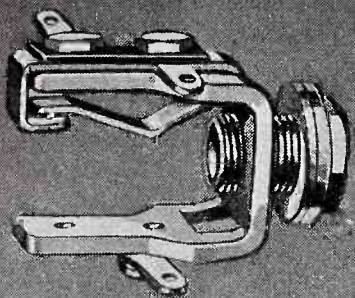

FROST-RADIO Gem-Jac
No. 954 Price 45c

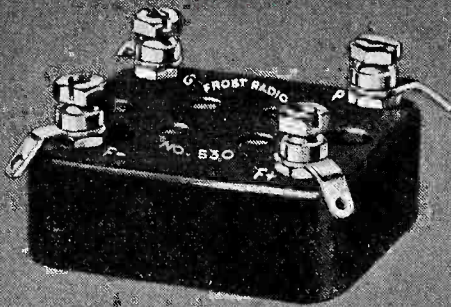

FROST-RADIO No. 530 Bakelite Socket Price 40c

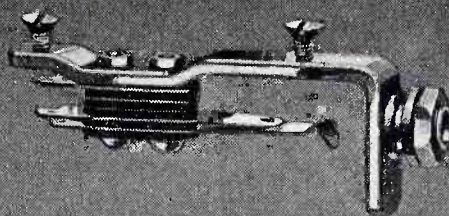

FROST-RADIO Pan-Tab Jack
No. 234 Price 75c

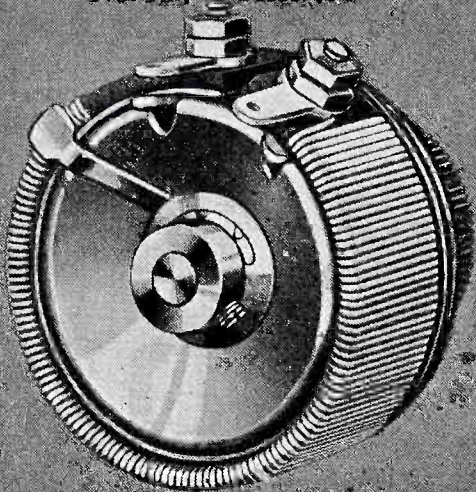

FROST-RADIO Type 700 Metal Frame Rheostat Price 50c

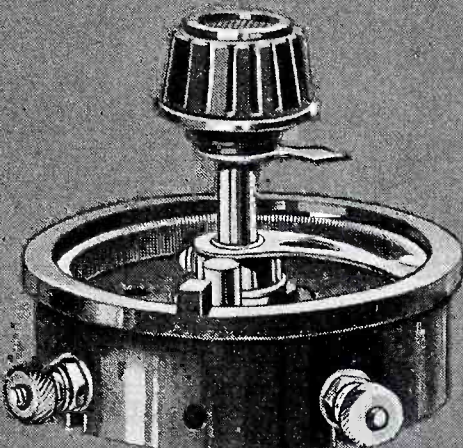

FROST-RADIO Type 660 Bakelite Rheostat for base mounting Price 75c

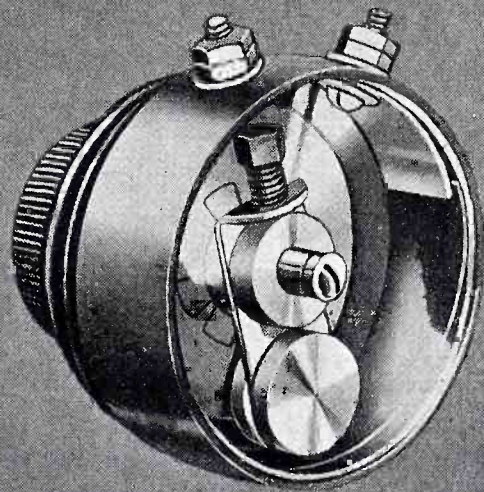

FROST-RADIO Type 886 Super-Variable High Resistance Price \$1.50



FROST-RADIO Parts for the Infradyne

When you decide to build your Infradyne set you will build it because you want better, finer results. If you want to be sure of getting the utmost efficiency from this receiver it is not only important to use the principal parts specified, but to see that every part that goes into your set is of the highest quality. Don't overlook such parts as sockets, jacks, rheostats and high resistance units. Once these parts are installed they are usually forgotten, but later they often prove a source of trouble that is hard to locate.

Make sure that these parts bear the name **FROST-RADIO** and you can be absolutely certain of permanent electrical and mechanical properties. Just install them and forget them.

Ask Your Dealer for these **FROST-RADIO**
Infradyne Parts

	LIST
No. 660 FROST-RADIO Bakelite Rheostat, base mounting . . .	\$0.75
No. 530 FROST-RADIO Bakelite Socket40
No. 730 FROST-RADIO Metal Frame Rheostat, 30 ohm50
or, if preferred,	
No. 830 FROST-RADIO Bakelite Rheostat, 30 ohm75
No. 710 FROST-RADIO Metal Frame Rheostat, 10 ohm50
or, if preferred,	
No. 810 FROST-RADIO Bakelite Rheostat, 10 ohm75
No. 886 FROST-RADIO Super-Variable Resistance, 50,000 ohms	1.50
No. 608 FROST-RADIO Push-Pull Switch30
No. 954 FROST-RADIO Gem-Jack45
or, if preferred,	
No. 234 FROST-RADIO Pan-Tab Jack75
No. 953 FROST-RADIO Gem-Jack40
or, if preferred,	
No. 233 FROST-RADIO Pan-Tab Jack65



FROST-RADIO

Parts and Accessories



No. 141 Automatic Plug Price 75c

FROST-FONES

Nothing else can quite replace a pair of sensitive **FROST-FONES** when tone quality and clearness on distant stations are what you want most. On those favorite far-off stations **FROST-FONES** turn weak signals into clear, pure reception. Being only about half the weight of old style head sets they are worn with perfect comfort. Try them and compare with others at your dealer's. Prices \$3.00 to \$6.00.

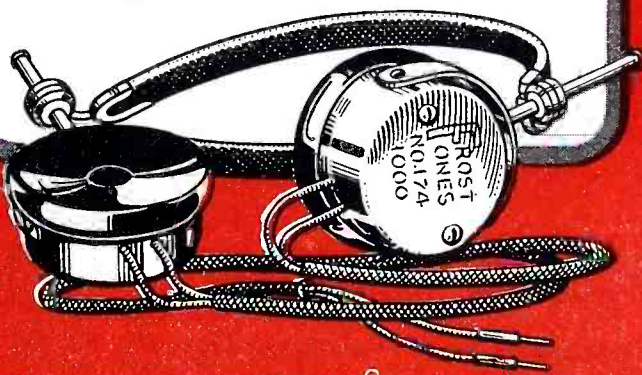

HERBERT H. FROST, Inc.

160 North La Salle Street

CHICAGO

New York

Los Angeles

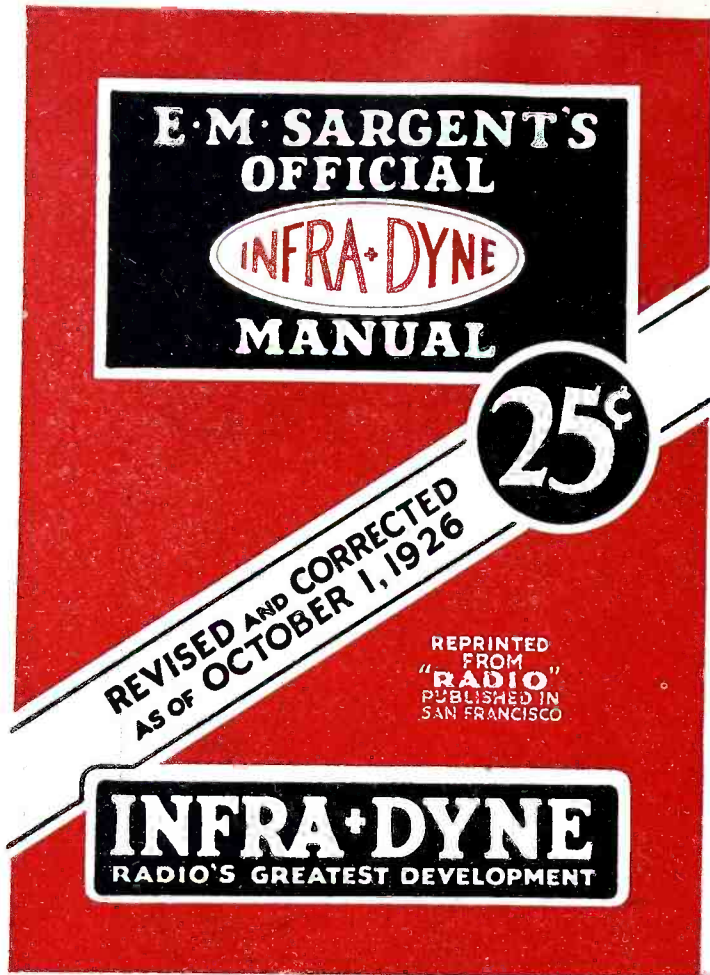

THE INFRA-DYNE

MANUAL

Tells You How To Build
Radio's Greatest Receiver

25 cents

Start NOW! Build the receiver that has revolutionized radio reception. Get a copy of Sargent's Official Infradyne Manual—telling you all about it. Diagrams, illustrations and directions for building and operating the Infradyne. The complete story of this receiver in a handy pamphlet — selling for twenty-five cents. More than 20,000 have already been sold. It tells you how to balance and adjust the circuit—how to wire it for maximum results and how to get the most out of it. If you are a prospective radio set builder it will be to your advantage to get a copy of this Manual. Copies will be sent postpaid upon receipt of a quarter in coin.

The story of the Infradyne is contained in this Manual. People everywhere are discussing the Infradyne. It has convinced thousands that no circuit in the history of radio is as good as the Infradyne. Back ground noise is eliminated, stations come in on only one point of the dial. Stations from 10 to 20 kilocycles apart are brought right through the powerful locals and long distance reception on the loud speaker from stations two thousand miles away is easily accomplished under normal conditions. The inventors built 500 models before the circuit was announced to the public. Years of research are behind the Infradyne. It is the last word in radio.

Send the Coupon and 25 cents for your copy

"RADIO,"
Pacific Building,
San Francisco, Calif.

Send me Sargent's Official Infradyne Manual
by return mail. I enclose a quarter in coin.

Name.....

Address.....

Published by the

Publishers of "RADIO"

Pacific Bldg., San Francisco

Northern California
dealers can secure copies
from the United Radio
Supplies Co., 693 Mis-
sion St., San Francisco,
California.

Jobbers and Dealers are invited to write for trade proposition. Every radio dealer should have this manual to know what the Infradyne is and does.



TRADE MARK

FILTER CONDENSERS

Specified for the INFRADYNE!

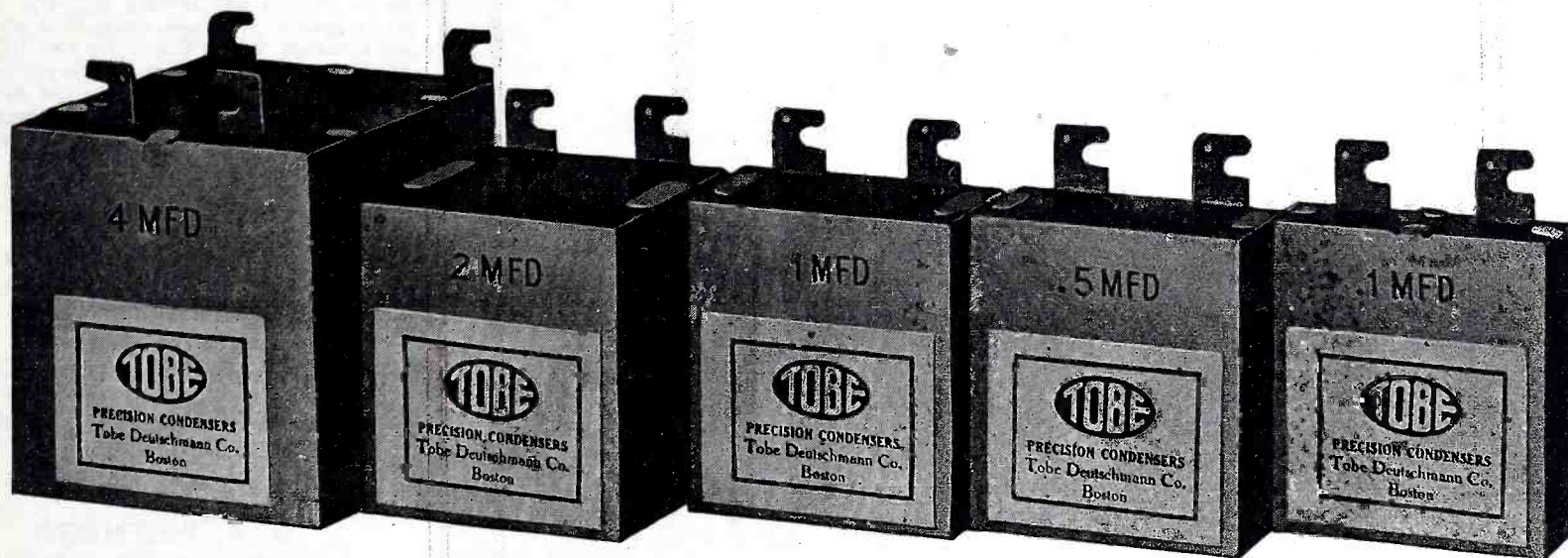

The TOBE Filter Condensers, specified for the Infradyne by E. M. Sargent, are still "the better condensers." This is definitely recognized by leading authorities in Radio engineering. ¶ TOBE Filter Condensers are found in the laboratories of the technical schools of the leading universities of the country, in use in precision apparatus. ¶ They are found in leading Radio circuits of proven worth, as specified by E. M. Sargent, G. M. Best, Laurence Cockaday, Arthur H. Lynch, Keith Henney, Volney D. Hurd, C. F. Bragdon, Lloyd Greene, M. B. Sleeper, and countless other prominent Radio editors and engineers. ¶ They are used in such outstanding Radio sets as KING and BROWNING-DRAKE. ¶ In the B-Eliminator field, TOBE Filter Condensers, incorporated in the TOBE B BLOCKS, are standard factory equipment of Philco, Storad, Modern, General Radio, National Company, and other leading manufacturers.

You Make No Mistake When You Buy TOBE FILTER CONDENSERS

Cased in the characteristic TOBE silvered metal container, now standard with tinned ground lug. Each condenser individually tested and stamped with date of test.

TOBE Filter Condensers are guaranteed for working voltages up to a maximum of 300 volts D. C.



The New Tobe 400-Volt Condenser

This is a new line of TOBE High-Voltage Condensers, for 400 volts continuous operating voltage. The advent of the Raytheon BH Tube has made necessary condensers for higher working voltages than those formerly employed, in cases where the B-Eliminator Transformers deliver voltages in excess of 300 volts. The TOBE 400-volt Condenser is of the short-path type, is cased in a substantial metal container with heavy lugs, for attachment to baseboard or sub-panel and is equipped with new and unique base terminals, for shortness of wiring and safety. These terminals are not found on any other make of condenser.

In the characteristic TOBE silvered finish,

No. 401, 1 Mfd.....	\$2.00
No. 402, 2 Mfd.....	2.75
No. 404, 4 Mfd.....	4.50

SEND FOR PRICE-SHEET 12-R.

Types	Sizes	Prices	Types	Sizes	Prices
401	0.1 Mfd.....	\$0.70	410	1.0 Mfd.....	\$1.25
402	0.25 "75	420	2.0 "	1.75
405	0.5 "90	440	4.0 "	3.75

Tobe Deutschmann Co.

Cambridge, Mass.

Tobe Output Filter Condenser

This 4 Mfd. TOBE Condenser,—maximum working voltage 250 volts,—has been specially designed to save space in the construction of power tube output filters, now so generally required between the power tube plate of a Radio set and the speaker,—for construction of speaker windings and improvement of tone quality. An output device of this kind is recommended with the UX-171 and all other high-voltage power tubes.

Price—\$3.50

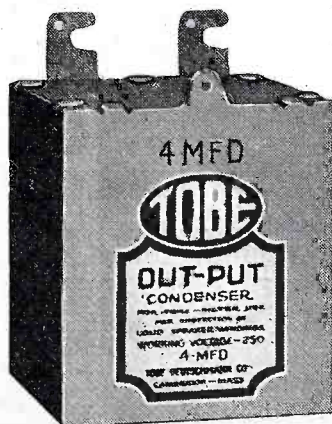

Tell them that you saw it in RADIO

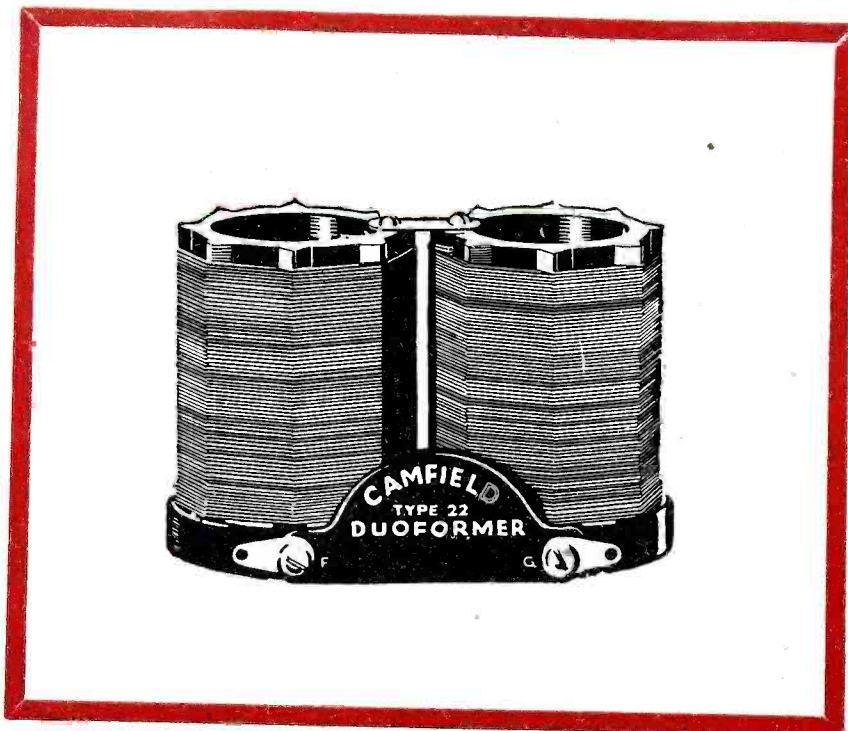

Camfield Duoformers

Are Now Specified

EXCLUSIVELY

by SARGENT for the

INFRADYNE

PRICE
\$10.00
At Your
Dealers
or Direct
From Us.

Improve Your Infradyne by
Replacing the Radio
Frequency Coils with
Camfield Duoformers

DUOFORMERS
are the best
Transformers
obtainable for
TUNED R. F.
CIRCUITS.

Send 10c for
Instruction Book

CAMFIELD RADIO MFG. COMPANY

NEW YORK

57 EAST WACKER DRIVE, CHICAGO

SAN FRANCISCO

**ENGRAVED and
DRILLED**

\$8.00
Postpaid

Jobbers and Dealers stock our panels.
Some territory is still open for reliable
jobbers. Wire or write us.

Infradyne Panels

We believe we have sold more Infradyne panels than all other panel manufacturers combined. "QUALITY" is the reason for this supremacy. Our panels are drilled exactly as specified by Sargent and Rayment. The engraving is also exactly as specified. Our beautiful $\frac{3}{16}$ " thick Bakelite Panels are the "dress for your set." Take no cheap substitute. Insist on Heintz and Kohlmoos Infradyne Panels. Look for the trade-mark.

Baseboards	\$2.85
Jewell Meters	7.50
Binding Post Strips, with all posts..	2.25
"Solderdip" Lugs, pkg.25

HEINTZ & KOHLMOOS

219-221-223 Natoma Street, San Francisco, Calif.
MANUFACTURERS FOR MANUFACTURERS

NOTICE

Of New Distribution For Infradyne Blue Prints

Effective November 20th, 1926, the Official Infradyne Blueprints will be exclusively distributed to the trade East of the Rockies by the Herbert H. Frost organization. Distribution to radio dealers will be made from any of the Frost offices listed below.

Delivery will be made on and after November 26th. Stocks of blueprints will be carried at each Frost office.

Radio dealers are invited to write now for trade prices. The new blueprints have been prepared by L. C. Rayment and have been revised and corrected as of November 20th. There will be no changes in the blueprints for at least six months, thus affording full protection to the dealer and set builder.

Herbert H. Frost, Inc.

160 North La Salle St., Chicago, Ill.

P. A. KILEY

30 Church St., New York, N. Y.

B. B. DOWNS & SON

2360 University Ave.
St. Paul, Minn.

M. A. WETMORE

1324 Hibernian Bank Bldg.
New Orleans, La.

H. B. PARK

305 Seventh Ave., Pittsburgh, Pa.

CAMPBELL & KNIBB

Colorado Bldg., Room 520
Washington, D. C.

EAMES CORPORATION

10 High St., Boston, Mass.

S. J. HUTCHINSON JR.

Bourse Bldg., Philadelphia, Pa.

Official Service Representative of Infradyne

AFTER thorough investigation of our facilities and experience, we have been appointed official service station for the New York Metropolitan area by Mr. E. M. Sargent, inventor of the Infradyne Circuit.

We also received from "Radio," which sponsored this circuit, official recognition and approval as service station on the circuit for the New York Metropolitan territory.

Radio  Service

Rossiter, Tyler & McDonell, Inc.

Telephone Rector 2538
136 Liberty Street, New York

NATIONAL

POWER AMPLIFIER

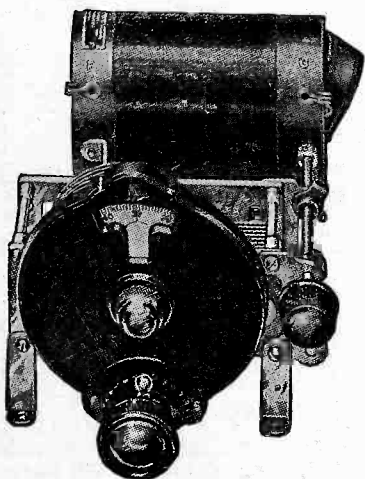
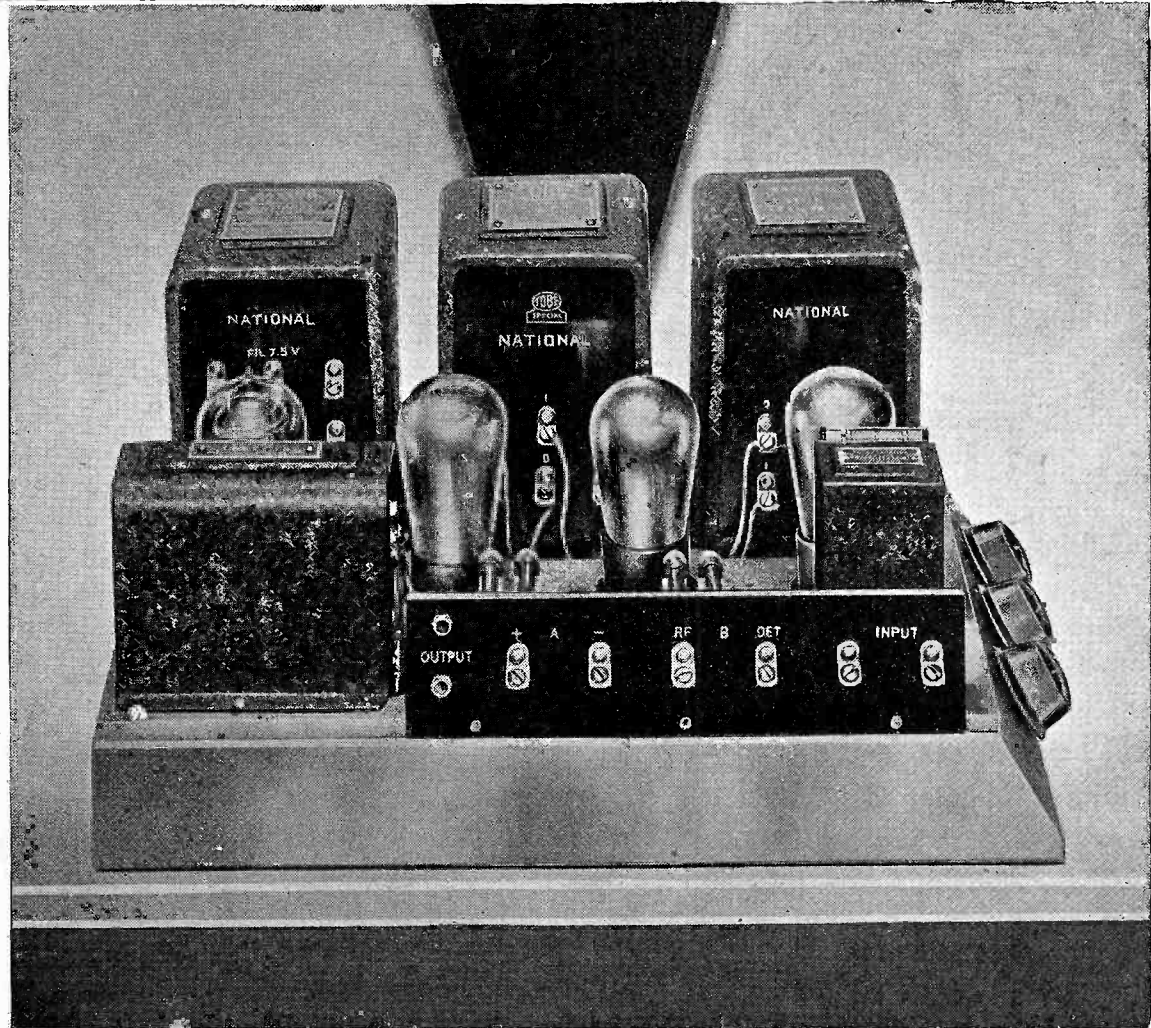

NATIONAL TUNING UNITS

—comprise the wonderful BROWNING-DRAKE R. F. Coils and Transformers with their SLOTWOUND primary and SPACEWOUND secondaries, EQUICYCLE wide-spacing condensers and VELVET VERNIER Dials. They make good Radio sets.

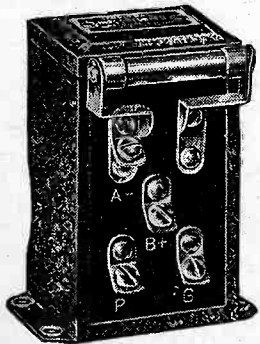

NATIONAL IMPEDAFORMER — Type B

—includes in one case audio choke coil 0.1 Mfd. TOBE Condenser, mounted Lynch Resistor—for modern audio amplification. Price \$5.50 each

MAKES your present Radio Set the last word in Fidelity of Reproduction—and supplies all B and C current from the lamp socket. Designed on sound engineering principles in collaboration with Arthur H. Lynch and James Millen, it combines a B Power-Supply and complete audio amplifier of the highest type. It is made to use either the Raytheon BH or Rectron Rectifying Tube. Each unit is newly designed for heavy and continuous duty, built to established NATIONAL standards. ¶ The NATIONAL Power Amplifier is designed to plug directly into the detector output of any Radio Set and has one stage of NATIONAL Impedafomer and two stages of Resistance Coupling with Lynch Resistors. Output from the UX-171 semi-power tube is through a NATIONAL Tone-Filter, protecting the loud-speaker and still further improving quality. All of the parts mount on a drilled and cored metal base. ¶ Sold in complete kit form, including Raytheon BH Tube and every accessory and piece of wire required (except audio tubes). Easily assembled in an evening. Price \$85.00.—The units are also sold separately. Price of Kit as above but completely assembled, ready to run—\$95.00

The NATIONAL POWER AMPLIFIER

NATIONAL products are built to engineering standards of excellence. Anyone who ever built a set using NATIONAL BROWNING-DRAKE Coils and Transformers knows what that means. Send for Bulletin 116-R.



National Co., Inc., Engineers and Manufacturers, W. A. Ready, Pres., Cambridge, Mass. Makers of NATIONAL BROWNING-DRAKE Coils and R. F. Transformers, Impedafomers, Condensers, Power Transformers, etc., for Radio.

Tell them that you saw it in RADIO

Cardwell Condensers

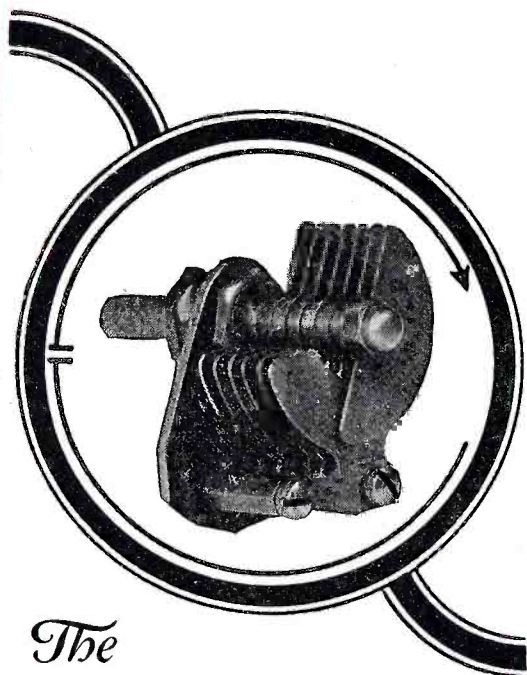

The
"BALANCET"

is new!

THE Cardwell **BALANCET** is a trimming condenser designed to provide for adjusting the sectional capacity of a multiple condenser, such as the 317-C in the "INFRADYNE", without adding any losses.

Its unusual compactness, single hole mounting and extremely low losses make it ideal for all purposes where a neutralizing, trimming or vernier capacity is required.

There is an ample stock of Type 317-C condensers for the "INFRADYNE" now available. Get a set of three **BALANCET** condensers to go with yours.

**"THE STANDARD
OF COMPARISON"**

Send 15c for 36-page Booklet
Allen D. Cardwell Mfg. Corporation
81 Prospect Street, Brooklyn, N. Y.

Pacific Coast Agent
for the

"BALANCET"

Baldwin Pacific Co., Pacific Bldg.
San Francisco

**Selected
for the
Infradyne**



Approved by the designers
of the Infradyne because it's

Metallized!

THE Durham Metallized Resistor is a laboratory perfected grid-resistor developed by two scientists of a leading university.

A tiny glass wire is passed through an ingenious, chemical and high-temperature process, forming a thin conducting layer of high resistance. The Metallized unit is next treated with a protective insulating material, rendering it impervious to atmospheric conditions. It is then mounted in a glass tube and soldered to terminal, brass caps.

Specified in

"Diamond of the Air"

10 megohms to 500 ohms, from
50 cts. to \$1.00

DURHAM
METALLIZED
RESISTORS

International Resistance Co.

Perry Bldg., Philadelphia, Pa.

\$118.00 for all
of the
parts needed for

THE INFRADYNE

Here Are the Official Parts
Which We Sell:

- 1 Remler Infradyne Amplifier
- 1 Cardwell three-gang condenser
- 3 Silver Marshall No. 340 condensers
- 1 Remler .00035 condenser
- 1 Frost No. 886 Resistance, 50,000 ohms
- 1 Tapped inductance
- 1 30 ohm baseboard rheostat
- 1 Set, 3 Camfield coils
- 2 National Dials, Type B, CCW
- 7 Benjamin UX base sockets
- 1 112 amperite
- 1 No. 1 amperite
- 1 30 ohm panel rheostat
- 1 Centralab 200,000 ohm resistance
- 3 2-inch dials
- 1 Filament switch, Electrad
- 1 Single closed jack, Frost
- 1 Single open jack, Frost
- 1 Jewell Pat. 135 voltmeter
- 1 Electrad grid leak mount
- 1 1 meg. Durham grid leak
- 1 2 meg. Durham grid leak
- 1 .0001 Fixed condenser, Electrad
- 1 .00025 Fixed condenser, Sangamo
- 2 .0005 Fixed condensers, Electrad
- 2 Silver Marshall audio transformers
- 2 1 mfd. Electrad condensers
- 2 Binding post strips with Eby Posts
- 1 Bakelite Panel, drilled and engraved,
3/16" thick
- 1 Baseboard, Poplar, Egyptian lacquered

All of Above, \$118.00

LET us simplify your problem of purchasing specified parts for the Infradyne. Order everything from us. For the past three months we have been supplying the wants of the Infradyne builder. We have shipped our merchandise to widely scattered parts of the U. S. and Canada. We give you prompt service—the kind you are entitled to. Sargent and Rayment specify a list of parts made by reputable manufacturers of high-quality merchandise. To get the most out of your Infradyne you need GOOD PARTS. We have assembled all of these SPECIFIED parts for you in one box—ready for shipment. Complete instructions for building the Infradyne go with each set of parts.

When ordering, please address your inquiries to Department M. Telegraph orders filled if half cash goes with wire. Balance C.O.D. We ship prepaid if the complete set of parts is purchased from us.

**We Test, Repair Service and
Guarantee Infradynes
SUCCESS ASSURED**

International Radio Sales Co.
5441 California Street
San Francisco, California
Dept. M

LOG 'EM--

You hear so many stations on your Infradyne that you will need a log book with many pages to keep an accurate record of the stations heard. The publishers of "RADIO" have prepared an inexpensive 8-page pamphlet for logging stations. It is just the thing for the Infradyne. You can use separate pages for local and DX listings and each column is so arranged as to give ample room for making notations, such as oscillator settings, etc. It's a mighty handy little pamphlet to keep in front of you at all times. LOG THE STATIONS AS YOU HEAR THEM and then you will have no difficulty in finding them later. The Log Book sells for ten cents. It will be mailed to you, postpaid, on the day your order is received. Stamps or coin accepted. Because only a limited number of these booklets have been printed, we will not be able to supply copies to dealers or jobbers.

The Coupon and 10c Brings It to You

"RADIO,"

Pacific Building,
San Francisco, Calif.

Here is 10c. Send me a copy of
the RADIO LOG BOOK.

Name.....

Address.....

City and State.....

SM

The Lure of "DX"

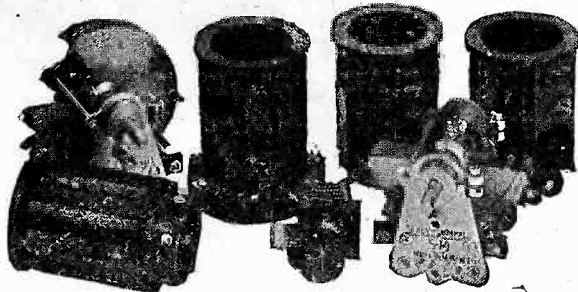

Interesting, isn't it—that with a simple short wave set you can hear programs rebroadcast from Schenectady, Pittsburgh and other stations, when your regular six and eight tube set won't bring in these stations—that your little short wave set would

put you in touch with amateurs all over this country—in England, France—all Europe?

Wouldn't you get quite a thrill when you really heard a station in New Zealand, Australia or, say, South Africa?

S - M short wave parts have formed the basis of these popular receivers—what more recommendation can be asked?

Radio Broadcast Dyott Expedition Set.

Radio Mechanics Hush-Hush II.

Radio Engineering Short Wave Set.

Callies Two-Tuber.

Best's Short Wave Receiver.

It's perfectly simple — thousands of users of S - M short wave kits are "listening to the world" every night. And, as broadcasting goes on, more stations in this country, as already in Europe, will go down to short waves. Why not build a short wave set and be all set for the clearest, best programs you've yet heard, and your greatest distance thrill—not a thousand miles but three, five, even ten thousand—tuned in just as easily as you now get locals?

The type 117 coil set consisting of 4 coils and coil socket is \$11.00. The 635 Short Wave Kit, including all coils and necessary condensers, is \$23.00.

LEADING!

Do you want the best in audio amplification? Do the following facts tell you that S-M audios and outputs are the best?

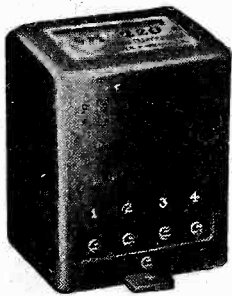

S-M 220 and 221 transformers on the market less than six months, have been specified for more circuits by more authorities than any other type. Sold on a money-back guarantee of perfect satisfaction, less than one out of every four thousand has come to the factory for replacement.

What more can you ask — when you can get the best for \$6.00 each from any good dealer?

Prices 10% Higher West of the Rockies

SILVER-MARSHALL, INC.

852 W. Jackson Boulevard

Chicago, U. S. A.

“Remarkably
better
reproduction”

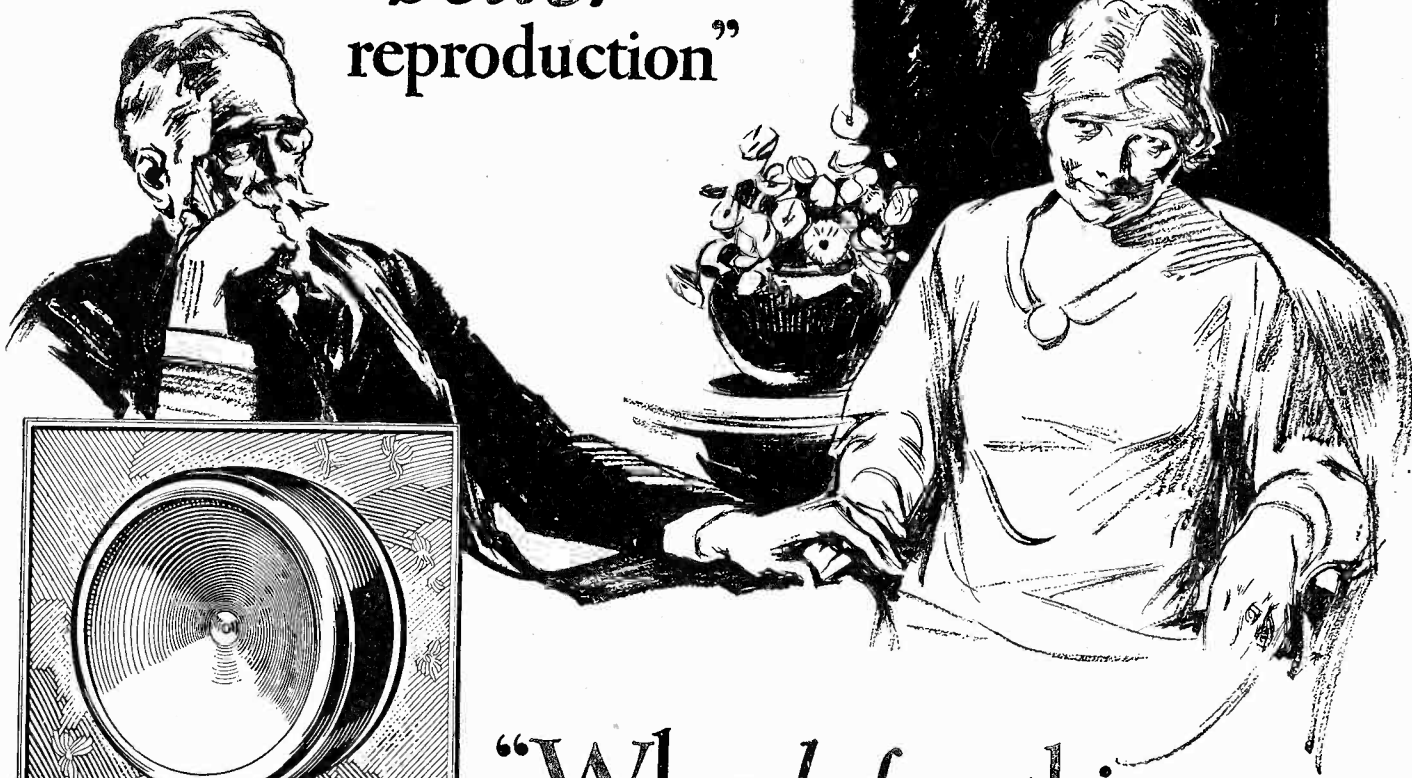

“Why, before this
I couldn't tell one
voice from another!”

Acme K-1 Enclosed Double
Free Edge Cone Speaker,
(shown above). Diameter of
Cone, 14 ins. Tan metal case.
Price: **\$25.00**

Acme K-3 Enclosed Single
Free Edge Cone Speaker.
Diameter of cone, 11 ins.
Green bronze metal case.
Price: **\$18.50**

1 1 1

Acme Enclosed Free Edge Cones
and Acme Reproducing Units,
(Designed for use exclusively
with the free edge cone) elimi-
nate resonance and preserve the
tones, pure, round and clear. A
fixed edge cone, to produce the
same results, would have to be
three times the diameter, too
clumsy for your living-room.
High notes are reproduced to-
ward the center of the cone; low
notes, toward the edge. The
laws of vibration make it possi-
ble to produce low notes with a
small cone, provided the edge is
free and enclosed, and provided
the reproducing unit is espe-
cially designed for use with a free
edge cone.

Write us for circular describ-
ing full line of Acme products.

“...I used to wonder why these opera
stars were considered so wonderful. Now
I know. With my new Acme Speaker I
can really appreciate for the first time,
the individual personality and beauty of
each voice...”

The wonderful new Acme Loud Speaker
successfully reproduces voices and music,
in your own home as clearly as they
were originally created in the broadcast-
ing studio. It reproduces the voice of
the singer in all its thrilling, tender
beauty. It brings out the different per-
sonality in each voice, so that you can
tell one voice from another. It recreates
orchestral music so clearly that you can
hear each instrument playing. It repro-
duces low notes and tones as clearly as
high notes and tones. You hear the bass
and treble, harmony and melody.

All this was not done in a moment, Acme
engineers worked five years and made

256 experimental speakers, before they
arrived at the new Acme Enclosed Free
Edge Cone and Acme Reproducing Unit,
which together are responsible for this
great increase in radio enjoyment.

See this new Acme at your dealer's

TRY OUT this new Acme for yourself. See if
all we have said about it is not true. Compare
it with others in the dealer's store. Drop in at
your dealer's today and hear this remarkable
new speaker. Made by Acme Apparatus Co.,
Pioneer Radio and Transformer Engineers and
Manufacturers, Cambridge, Mass., U. S. A.

Send for this Acme Book

“Amplification Without Distortion”, now in
its 13th edition. Written by a prominent radio
engineer in a non-technical and interesting
manner. It gives you a clear picture of radio
reception, and shows exactly how you can
eliminate distortion and improve the operation
of your set. It also describes fully these won-
derful new Acme loud speakers—and includes
details of the complete Acme line of trans-
formers, impedances, condensers, potrehos,
choke coils, etc. Send coupon below.

Mail this Coupon for “Amplification Without Distortion”

ACME
~ for amplification

ACME APPARATUS CO.,
Dept. D-23, Cambridge, Mass.

Enclosed find 10 cents (stamps or coin) to cover cost of send-
ing me one copy of “Amplification Without Distortion”, 13th
edition.

Name.....

Street.....

City..... State.....

RADIO

WITH WHICH IS INCORPORATED "RADIO JOURNAL"

VOLUME IX

JANUARY, 1927

No. 1

Radiatorial Comment

NOTWITHSTANDING differences of opinion as to the form of Congressional legislation on radio, there seems to be a general agreement that a new law is imperative and that some kind of Federal control is essential. Local court injunction may suffice to restrain the operation of an interfering station temporarily, but it is not far-reaching enough in its effect. No one state can adequately control nor has it jurisdiction over a force that is interstate and international in character, as is radio.

The Illinois Circuit Court, for instance, has enjoined a Chicago broadcaster from using a wavelength that interferes with WGN and WLIB, who share 302.8 meters. But could it forbid the operation of California station KTAB on the same wavelength, and of WPG at Atlantic City, KSL at Salt Lake City, KOMO at Seattle or KDKA at Pittsburgh on nearby wavelengths? While these cases are perhaps extreme and bother comparatively few people, they illustrate the principle.

When the Fourth Radio Conference was faced with this problem of assigning frequencies to more than five hundred stations within an 890 kilocycle band, its recommendations were based upon a careful survey of station power and location throughout the nation. As many as twenty-five small stations were given the same frequency because their power was not considered sufficient to seriously interfere with another distant station. Two or three large stations a thousand miles or more apart were likewise placed on the same wavelength. Yet in spite of these intelligent efforts to minimize interference, they were not entirely successful because of the large number of stations to be accommodated.

How much less is the likelihood of success under a system of unco-ordinated local decisions? Furthermore these considerations of the far-reaching effects of radio have seldom governed newcomers who have elbowed their way into the crowd. The process of wavelength selection under non-regulation has been largely hit-or-miss. While state courts may curb and cure local cases, they cannot remedy the national situation. Federal allocation and control is the only obvious solution to the problem.

Assuming that the greatly-needed relief will be provided by Congress before it adjourns, the first duty of the new radio department or commission will be to unscramble the eggs. This will be a difficult task even if only the present broadcasters are considered without providing for new ones. It may finally require a determination of the relative value of an established and of a proposed service. While some stations are sincerely trying to serve and not exploit the public, others are devoted to distasteful propaganda and obnoxious advertising. To discriminate between the sheep and goats will require the wisdom of a Solomon and the courage of an Alexander.

Some measure of relief would be afforded by opening up

the 150 to 200 meter band, thus providing fifty more 10 kilocycle channels. This proposal need work but little hardship on the B.C.L., for his set can be easily and cheaply made to receive the shorter waves. While it would encroach upon the amateur's present territory, he undoubtedly will be generous in not adopting a dog-in-the-manger attitude. His results are so much better on 80, 40 and 20 meters that he has voluntarily almost completely abandoned the higher waves.

MANY newspapers have published sensational advertisements of radio receivers at prices below the actual cost of manufacture. Even without the essential accessories of tubes, batteries and loud speakers, these sets represented a distinct saving over the prices at which they originally sold. But thousands of these bargain sets are today largely responsible for minor complaints of the imperfections of radio reception.

The main reason for their low price was the tremendous over-production of radio sets two years ago, when five hundred different makes—good, bad, and indifferent—were feverishly dumped on the market. Today perhaps twenty-five different makes are responsible for nine-tenths of the sales of factory-built sets handled through established channels of radio trade. Thus, of every one hundred of these old makes, ninety-nine are orphans looking for homes.

Most of these orphans were an ill-begotten lot. They flooded the market just as a well-informed public became more discriminating in its demands for selectivity and good tone quality. Simplicity of tuning had superseded the multiplicity of knobs and dials that formerly characterized a good receiver. Most of the "ninety - and - nine" were relatively as obsolete as a horse and buggy.

A few wise buyers picked up these bargains and brought them up-to-date by putting in new condensers, transformers and power amplifiers. The misfortune of the ill-advised manufacturer became their gain. But most of the orphans are still blooming, howling and distorting with all their pristine imperfections.

From time to time in the future, similar opportunities will be offered the bargain hunter. He can walk out of a store with a \$27.13 set under his arm and have lots of fun with it. Of course he may eventually spend nearly as much in replacing faulty material or workmanship as he would have paid for an up-to-date receiver in the first place. He may even strengthen his profane vocabulary by much exercise thereof. But he has bought a bargain.

Ultimately, profiting from early experience, he may buy a new set from a dealer who not only sells his goods but tries to keep them sold, who follows up the sale with periodic inspection and feels a personal responsibility in the proper functioning of a set. But this kind of dealer seldom sells "bargains." He cannot afford to. There's a reason, from the buyer's as well as the seller's standpoint.

The Shielded Grid Vacuum Tube

A Means for Reducing Inter-electrode Capacitance so as to Give A Voltage Amplification of Two Million Times in A Non-Regenerative Circuit

By Edwin E. Turner, Jr.

A VACUUM tube with a shielded grid has been devised by Dr. Albert W. Hull of the General Electric Co. Its purpose is to reduce inter-electrode capacitance to such a low value as to eliminate feed-back due to this cause. Although its immediate commercial development is not contemplated, its advantages will undoubtedly make production necessary before long.

In the ordinary tube, with socket and wiring, the capacity between grid and plate may be from 12 to 40 mmfd. As a consequence, the energy fed back from the plate circuit to the grid circuit may be 10,000 times as much as is required to maintain sustained oscillations at 300 meters with tuned circuits of average resistance. This internal feed-back has been more difficult to eliminate than any other cause of feed-back.

External feed-back due to electromagnetic or electrostatic coupling between the input and output circuits may be corrected by shielding, coil placement, separation of parts and wiring, or by inductances having confined fields. When caused by common resistance or inductance in the battery leads of several stages, it may be eliminated by filtering the current supply to each stage.

Heretofore, internal feed-back through the grid-plate capacity of each tube has been compensated in the neutrodyne by another feed-back of equal intensity but opposite phase. High resistance circuits or the introduction of loss into some part of the resonant circuit is used in many tuned radio frequency sets to produce losses slightly in excess of the energy fed back. In the regenerative circuit, which in the last analysis, is a single stage of radio frequency amplification, this feed-back due to inter-electrode capacity is turned to a useful purpose by arranging the circuits so that the plate and grid voltages are approximately in quadrature. While this may give an amplification of 100-fold, its use is confined to a single stage.

Dr. Hull's new method of preventing internal feed-back in the tubes of a cascade radio frequency amplifier is to electrostatically shield the control grid from the plate by placing a second grid between them. This is maintained at a positive potential, less than that of the plate. Furthermore, the grid and plate leads are shielded. Thus the electrostatic lines of force are intercepted in their path between grid and plate and the grid-plate capacity reduced to .006

mmfd., which is less than 1/5 of 1 per cent of the usual inter-electrode capacitance.

The construction of the tube is shown in Fig. 1. Two grids, G_1 and G_2 , are interposed between the cylindrical plate P and the filament F . The control grid

same type as the control grid, *i.e.*, of fine wire in helical shape, but it was found that the wires of the shielding grid had to be placed so close together in order to secure sufficient shielding, that a great number of electrons passing from filament to plate were intercepted. The slat type of shielding grid was found to give perfect shielding without interference with the electron stream.

In constructing the tube it was found advisable to make the shielding grid considerably longer than the control grid at both ends. The control grid terminal is taken out through the top of the tubes and the shielding grid terminal, together with the filament and plate terminals at the bottom. In this way the maximum of separation between grid and plate leads is obtained. The few lines of force still remaining between the top of the plate and the control grid lead, even with the shielding grid in position, necessitate the metal shields completely surrounding the plate, and connecting with the control grid at the top of the element assembly. This may take the form of a metal coating on the inside of the glass wall of the tube, connected by means of a suitable metal disc with a hole in the center to the control grid at the top and by a spring contact with the control grid lead at the seal.

The shielded grid tube exhibits static characteristics differing from those of the ordinary triode mainly in that the plate resistance is almost infinite for all plate potentials less than that of the screening grid and very high for plate voltage values in excess of that of the screening grid. This characteristic, combined with the negligible inter-electrode capacitance, enables the tube to operate as a pure unilateral amplifier. The mutual conductance of the shielded grid

(Continued on page 64)

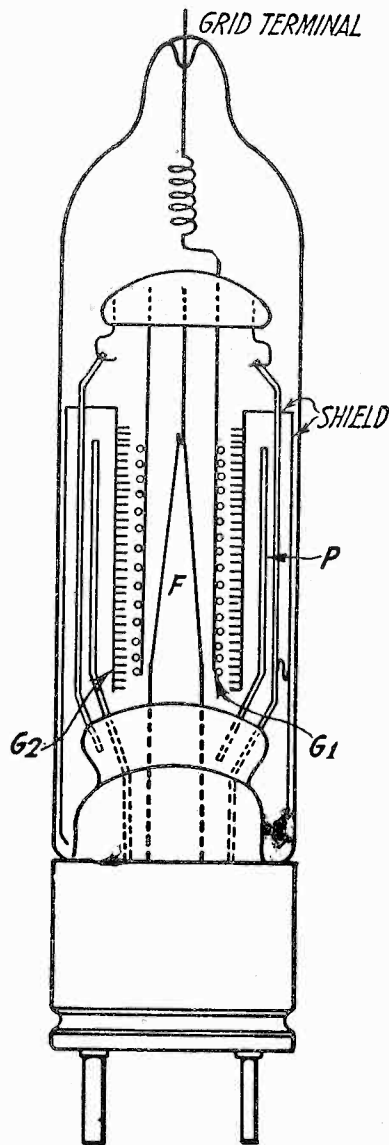

Fig. 1. Structural Details of the Shielded Grid Tube.

G_1 is composed of a number of turns of fine wire. The shielding grid G_2 consists of a number of flat circular discs or rings 3mm wide spaced 3mm apart. The shielding grid may be made of the

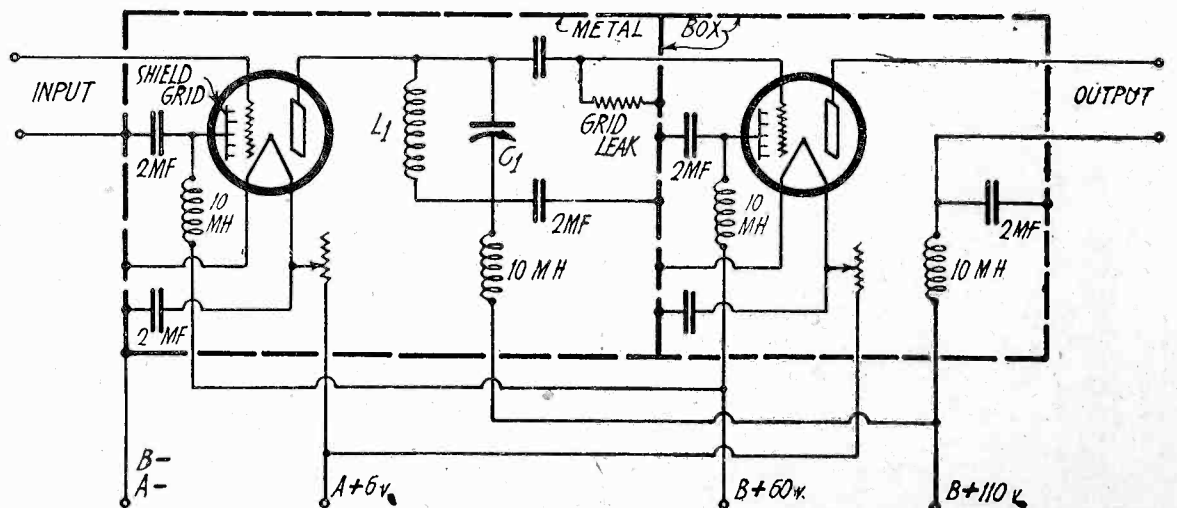

Fig. 2. Circuit Diagram of Two Stage Amplifier Using Shielded Grid Tube.

Charged With Battery

By Keith LaBar

Illustrated by Louis McManus

ONE of the interesting by-products of modern civilization is the technical article in the radio magazine. Although the radio experimenter likes to know what is going on in the old set, to read an abstract article on the theory of radio is dull indeed. And so, to quell the insistent voice of conscience, as the poets say, the article is laid aside with a hazy mental promise to reform and read it at some future date.

This is very much too bad. For there is many a human interest story in these articles for those who can read between the lines. Jealousy, love, hate—name your favorite thrill. To see this interesting announcement proved, Now Read On, as the synopsis so commandingly tells us.

This is a story of the great open spaces, the spaces between the plates of the variable condenser you twirl every evening. And in order to understand the drama as played today it is necessary to turn back the pages of time quite a few chapters.

Along with the beginning of civilization came the use of amber for jewelry and ornament. In common with gold and other substances reflecting the sun, "Elector," amber came to be called by the Greeks "electron."

The Syrian women called amber "the clutcher." This came from the use of this precious substance as the spindle of their spinning wheels. Electrified by rubbing against the clothing of the spinner, chaff from the floor would be attracted as the spindle descended and would get into the thread.

Pliny, who made this reference to the Syrian women, also commented on the power of the electric eel and makes frequent references to the lodestone, and to the iron rings, magnetized with a lodestone, and sold by the get-rich-quick

boys to the ever credulous populace, who had erroneous beliefs regarding the power of magnetism. The world, as you see, has not changed much in twenty-three centuries.

Nothing much seems to have been done scientifically in the study of electricity up to the time of William Gilbert, physician to Queen Elizabeth. This was only about three hundred years ago, so you see that we are getting warm.

Not taking the word of the philosophers in vogue, Gilbert began to check up on some of their sayings. In his experimenting he found that besides amber, there was the diamond, sapphire, and a whole list of substances having this power of attracting light substances when rubbed. And to this list of substances having the amber-soul he gave the name electrics, from which the name electricity is derived.

Things jogged along pleasantly with intermittent squabbles between jealous experimenters until Otto von Guericke, in 1663 announced his sulphur globe. Guericke, it will be remembered, is the boy who demonstrated the terrific force of the atmosphere by hitching a team of horses to the ends of two hemispheres. Equally good results could have been obtained by hitching one hemisphere to

would result, with the hissing snap of the familiar brush discharge. Listen to the insulators on a high tension line on a rainy evening and observe this effect.

This globe, von Guericke thought, has many virtues—the virtue of light, the virtue of sound, the virtue of attraction and repulsion and other desirable moral qualities. He should have tried the more modern experiment of cleaning silk dresses by rubbing with gasoline and observed the bang-bang virtue.

This scientific business as a paying pastime began to get started about 1666. The Royal Academy of Sciences was established in France to match the English Royal Society of London. This Academy was much bothered by the king, who made them do real work, such as laying out waterworks and calculating winning systems on all the gambling games included in kingly dissipations.

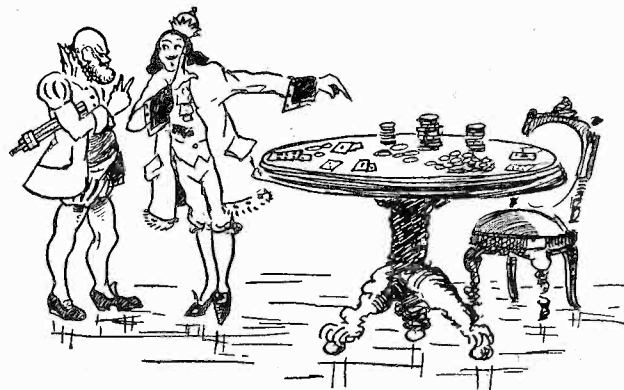

The King Gets the Royal Low-down from the Royal Mathematician.



Von Guericke Chases a Feather Around the Room.

a post, but it was necessary to play to the gallery in order to keep the royal treasurer in the mood for signing checks.

This sulphur globe was merely a small globe on the end of an iron rod. If rotated and rubbed with the hand it would become electrically charged and attract light particles. And what was more wonderful to relate, the globe could be made to repel a body having the same electrical charge, thus showing the presence of positive and negative charges. And, wonder on wonder, if the globe was taken into a dark room and rubbed with the palm of the hand light

Under financial urging scientific knowledge regarding electricity begins to pile up. In 1645 the forerunner of the modern condenser, the Leyden jar, was invented. Von Kleist, of Germany, found that if a flask were held in the palm of the hand, some mercury put into the flask, a nail put into the mercury, and an electric charge put into the nail, a regular wallop of a shock could be obtained by touching the nail with the other hand. Touching the bottle while it was resting on the table gave a slight hiss, but no more.

The same experiment was tried by an experimenter in Leyden, who tried water in the flask. He received such a shock from this that he was knocked over, and in the ensuing excitement and publicity the name Leyden jar stuck.

Benjamin Franklin, in 1748, made the experiment that showed where the electricity went when it went into the jar. Previously the idea was that the element fire was soaked up by the water and was in the jar. If that were so, reasoned Franklin, the water soaked electricity could be poured into another



Selling Magnetism 2000 Years Ago.

jar. Trying the simple experiment, which seemed never to have occurred to anyone else, nothing happened. The water, when in the second jar, was as dead as the proverbial door nail.

Where, then, was the electricity? On a hot scent, he took a plain sheet of glass instead of a jar and put a lead plate on each side and charged and discharged this condenser with the usual sparks. Charging it and taking the glass out from between the plates he found that a slight prickling shock could be obtained by touching the glass at any



A Drink from Ben Franklin's Electrical Bumper—Wine Charged with Electricity.

spot. The electric charge was on the two surfaces of the glass and the function of the conducting plates was merely to electrically connect the large surface of the glass.

We know now that the process of charging causes a sort of elastic strain in the dielectric, the insulating material, between the two conductors. For this reason, the capacity naturally varies with different dielectrics, their electrical properties being different. Two plates with a sheet of glass between them have four to ten times the capacity of the two plates separated by air. The capacity varies inversely as the distance between the two conductors.

A condenser acts as a sort of tank to hold electricity. The amount it can hold is not fixed, but varies with the amount of pressure used to fill it. If too much electricity is forced in, the dielectric will break down, puncture in fact. The remedy is to buy a new condenser. A one farad condenser will hold one coulomb of electricity at a pressure of one volt. Since this unit is so large we usually rate capacity in microfarads (mfd.) one millionth of a farad.

A good condenser will, obviously, not leak. A test for a condenser is to charge it with a ninety volt B battery and wait a couple of minutes for leakage to occur and then connect a pair of fones. A healthy click is a sign that the charge is not playing hide and seek.

The most leaky spot in an air condenser is a sharp edge. Brush discharge

takes place very easily from a sharp edge or point—look at the lightning rod. Cheap variable condensers are apt to have feather edges on the plates, making the condenser the electrical equivalent of a sieve.

The electrical elasticity of a condenser supplied that electrical springiness so necessary to produce and receive wave motion. An antenna system is merely a condenser with a little resistance and inductance.

But, you may ask, what is an electric charge anyway? And what is a positive and negative charge?

The explanation is, that the atoms of a substance have electrons—negative charges of electricity—associated in such a manner with the atom, circulating around the nucleus, that they can be pulled right out of the atom. That is, an atom having eighty electrons or so can lose one or two of them. And if it loses one, the atom has what we know as a positive charge. If it gains one, it has a negative charge.

From this we can see that nothing is lost, nothing is gained. There is always a negatively charged body to a positively charged one. In the case of electrification by rubbing, it is thought that the friction actually rubs off electrons and in this way produces a charge.

The best explanation in simple analogy is the one given by a prominent chemistry professor to his class of dumb freshmen.

"A body with no charge may be considered as a great number of squirrels' nests, all with one squirrel in each hole. But suppose that a number of squirrels decide to go visiting. Then we have for the positively charged body the long lines of empty nests, and for the negatively charged object the nests with two squirrels in them. Obviously a nest with two or more squirrels is very uncomfortable and so the tendency is for things to return to equilibrium, with one squirrel in each squirrel hole. This return to equilibrium can be prevented by opening the circuit, thus making the squirrels prolong their call."

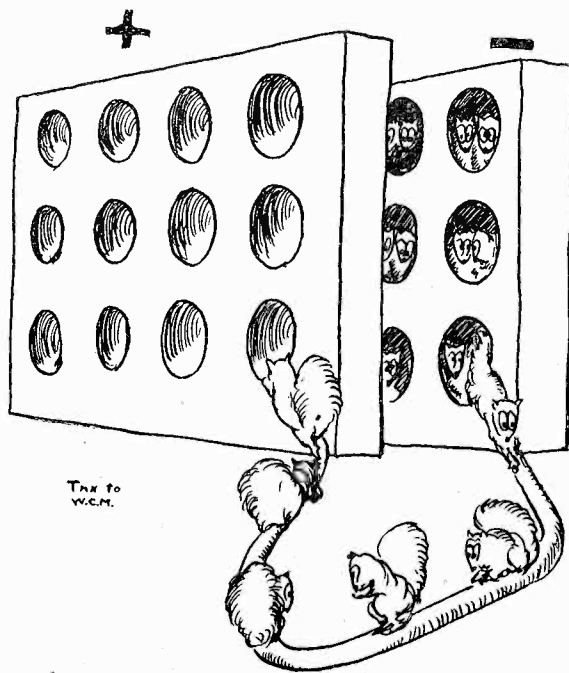

The Discharge of A Condenser.

From this lucid but nutty explanation the university freshmen got a picture of what it is all about. Are you as good as a freshman?

AN AUDIO-FREQUENCY OSCILLATOR

By L. J. N. DU TREIL

In giving telegraph code lessons the buzzer has long been the only instrument in use for the production of an audio-frequency note. The operation of most buzzers is unsatisfactory because the note produced is of varying frequency and the amplitude or strength of signals varies. The disadvantages of buzzer operation can be entirely obviated by the use of a vacuum tube with an audio-frequency transformer. Such a system can be made to emit a note of unvarying frequency and amplitude as long as the controls are not changed.

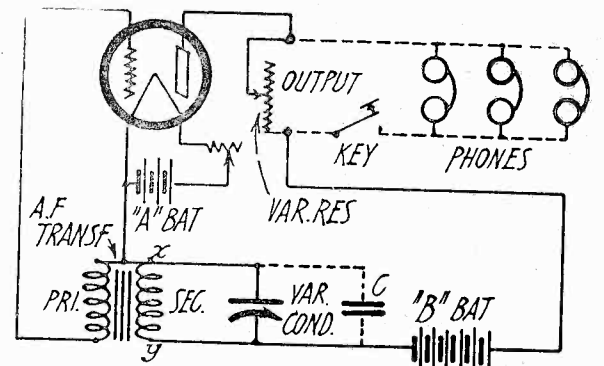

Fig. 1. Circuit Diagram of A. F. Oscillator.

The apparatus required for the oscillator is as follows:

- 1 Vacuum tube, 199 type.
- 1 Socket.
- 1 Filament rheostat, or ballast.
- 1 Audio-frequency transformer, 3-1 ratio.
- 1 Variable condenser, maximum capacity .0005 mfd.
- 1 Fixed grid condenser, capacity .00025 mfd.
- 1 Variable resistance, maximum 5000 ohms.
- 1 "A" Battery.
- 1 "B" Battery, 45-90 volts.

Connections are made as in Fig. 1. It will readily be seen that the circuit is of the regenerative or "feed-back" type, the primary of the audio-frequency transformer being the grid coil and the secondary being the plate coil. The variable condenser controls the frequency of the note within certain limits. Should frequencies other than those within the range of the condenser be desired additional fixed condensers approximating the maximum capacity of the variable condenser may be shunted thereto as indicated by C, Fig. 1.

The variable resistance controls the strength or amplitude of the signals in the telephones.

It may be possible that the system will not operate upon first trial due to the fact that the windings of the transformer are not in proper relation to each other, in which case it is merely necessary to interchange the connections to the transformer at "x" and "y."

If the oscillator is used for code practice a condenser of large capacity should be connected across the contacts of the telegraph key or automatic code transmitter.

A Home-Built "A" Battery Eliminator

For Supplying 2 Amperes of Rectified Filtered Current at 6 Volts
Without the Use of A Battery

By G. M. Best

ALMOST all of the devices hitherto described for the complete replacement of the *A* battery by a.c. socket power have required that the tube filaments be wired in series. While this enables the use of a rectifier of limited current capacity, it has introduced several complications and limitations that are not found when the filaments are connected in parallel. Consequently there is a demand for a power system to supply at least 2 amperes at 6 volts directly from a 110 volt alternating current line.

This demand can be satisfactorily met by the *A* battery eliminator here described. It employs two small Tungar bulbs in a full wave rectifier. The difficult part of the problem was the design of a filter of sufficient current carrying capacity. A 50 henry choke capable of carrying 2 amperes would be so unwieldy and expensive as to preclude its use for this purpose. So the main reliance for filter action must be placed on the capacity element. This is thoroughly practical by using a .25 henry choke and a shunt capacity of at least 60 microfarads, which can be economically secured either by the use of Mershon condensers or of shunt resistance, as originated by Dr. J. E. Lilienfeld.

The construction of both types of filters is here described. Either gives a quiet d.c. output for the operation of 8 "A" tubes whose filaments are connected in parallel.

The construction of the rectifier unit is the same for either type. The rectifier tubes should be 2 ampere Tungar bulbs, either of the old style with the plate terminal projecting through the top of the tube, and coded No. 195,528, or the new style, No. 277,465, which screws into a standard Edison base, with the plate terminal connected to a metal jacket on the side of the tube, for making contact with part of the Edison base. As the latter type bases are not easily obtained, it is a simple matter to solder the plate connection to the metal jacket after the tube is screwed into a standard mogul base.

The power transformer has two pairs of secondaries, one a 2 volt pair for lighting the filaments of the rectifier tubes, and the other a 21 volt pair for the plate circuit of the rectifiers. The filament secondaries must be capable of carrying about 15 amperes, so that No. 8 wire must be used. The plate secondaries, not carrying more than 2 amperes, need not be heavier than No. 16.

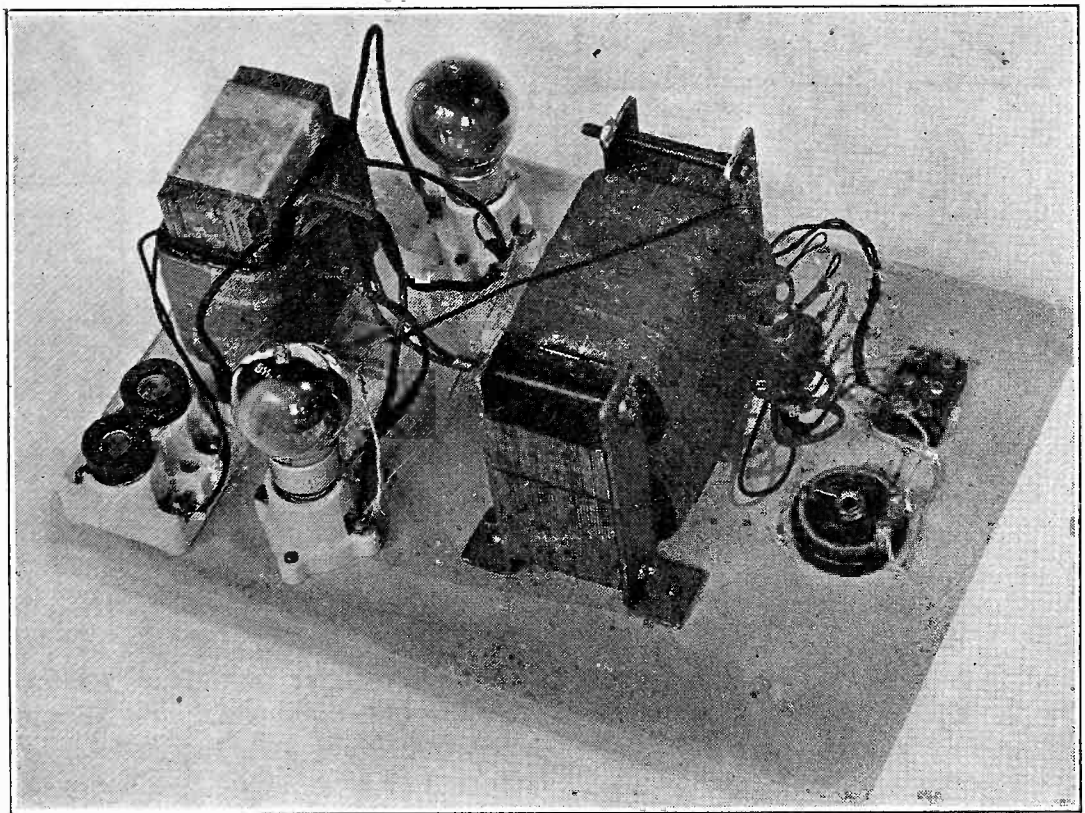

Complete "A" Eliminator.

The dimensions of the core, for a good grade of silicon steel core material, are given in Fig. 1 (a). The core is assembled with silicon steel pieces $1\frac{1}{4} \times 2\frac{3}{4}$ in. for the short sides of the core, and $1\frac{1}{4} \times 4\frac{3}{4}$ in. for the long sides, making the rectangular window in the center of the core $1\frac{1}{2} \times 3\frac{1}{2}$ in.

The primary may be wound in two sections, one on each leg of the core,

each section consisting of 195 turns of No. 18 enameled or cotton covered wire. After insulating the primary with a layer of empire cloth, the filament lighting secondaries, of 2 volts each, may be wound on top of the primary, each winding consisting of 8 turns of No. 12 enameled wire. After another layer of empire cloth is placed over each coil the plate secondaries are wound, each consisting of 75 turns of No. 16 cotton covered or enameled wire to provide 21 volts per winding.

After the coils are wound and assembled on the core, the assembly should be clamped tight with two pairs of metal clamps, to prevent vibration. The completed transformer is shown in the picture, mounted between the two tungar bulbs.

The choke presents a different problem, in that it must have an air gap, to prevent saturation of the core when direct current is flowing through the windings. The dimensions of the core are given in Fig. 1 (b), the general shape being the same as for the power transformer, but of course much larger. After the coils are wound and ready for mounting, the core is assembled inside the coils and a $\frac{1}{32}$ in. air gap provided, as shown in the sketch. A thin piece of cardboard, cut to size, can be used to prevent the core pieces from touching, and can be taped into place with friction tape. The two choke coils are identical in construction, and consist of 600 turns

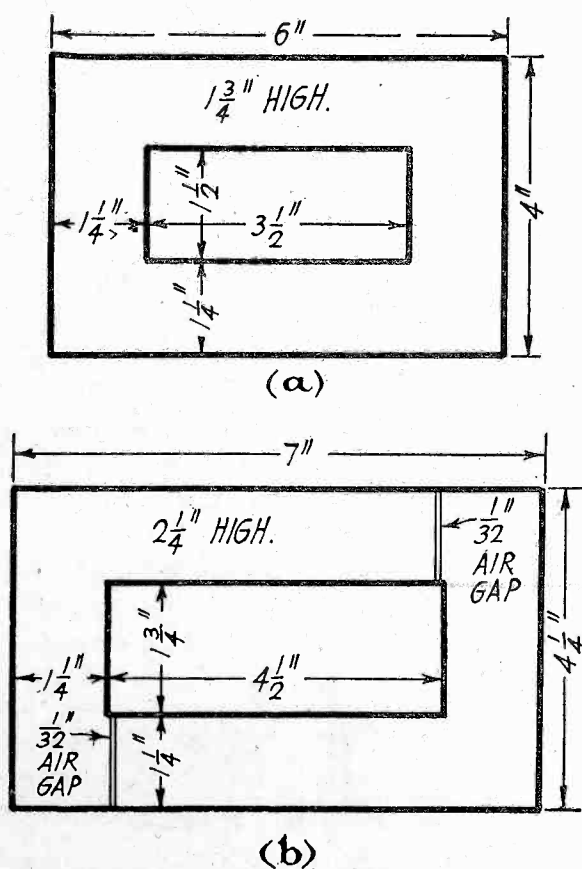

Fig. 1. Core Dimensions: (a) Transformer, (b) Choke.

each of No. 18 cotton enameled wire, tapped at the 150th, 300th and 450th turns. The coils are mounted one on each leg of the core, and care should be taken that the windings do not oppose each other. The outside terminal of one should be connected to the inside terminal of the other coil, so that the completed choke is really in 8 equal sections.

The final arrangement of the chokes is shown in Fig. 2, which is a wiring diagram of the complete outfit. As the power transformer secondary is wound in two sections, the center tap becomes

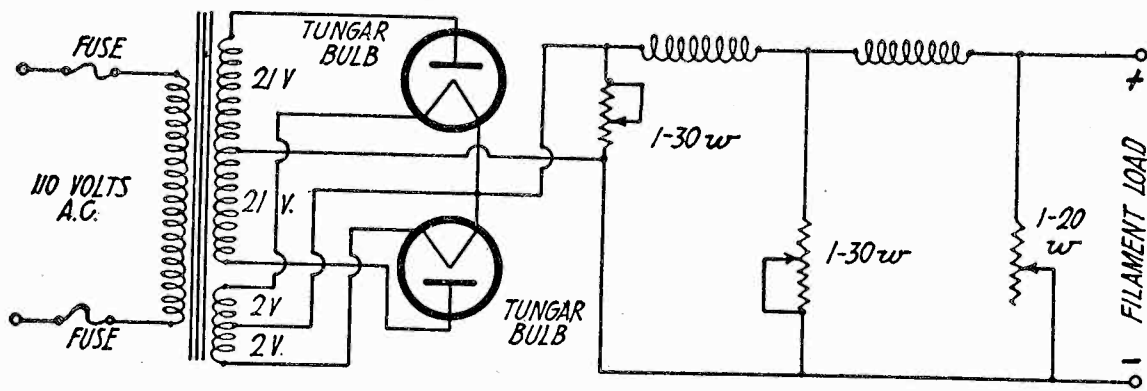

Fig. 2. Wiring Diagram for Complete "A" Unit, Using Resistances in Filter.

the connecting point of the two secondaries, this being the negative d.c. line. The positive connection for the rectifier is taken off at the center point between the two tube filaments, to which the choke is connected.

The power plant is now ready for the addition of either a set of electrolytic condensers, or a set of variable resistances. Fig. 2 shows the resistance method, by which the output of the filter is controlled, and at the same time the impedance of the filter is made so low that effect of alternating current ripple is made very small.

In the experimental model, the resistance across the output of the filter was a 20 ohm filament rheostat, with a 30 ohm rheostat at the center tap, and another of the same size at the input of the filter. The adjustment of these resistances depends upon the current requirements of the set with which the filter is to be used. For the choke sizes given, it is doubtful whether current for more than 8 type A tubes, or their equivalent current drain of 2 amperes, can be obtained, with the output resistance adjusted to 20 ohms. If the current drain is to be less than 2 amperes, the entire choke should be retained in the circuit, and the shunt resistances lowered in value until they bypass sufficient current to lower the output voltage. This places an additional load on the rectifier, but also lowers the impedance of the filter materially, and hence reduces the possibilities of a.c. hum in the receiver. The resistances at the mid-point and input of the filter will probably remain at above 25 ohms, although the input resistance may have to be higher, depending upon the current drain. If the rectifier will not give 2 amperes at 5 volts at the output, due either to low transformer secondary voltages or other causes, sections of the

choke should be cut out by taking advantage of the taps provided for that purpose, until the current rises to the required value.

It is also important to remember that when using filament rheostats for resistances in the filter circuit, if too much resistance is cut out, the current flowing through the remaining turns of the rheostat may be too much for the size of wire used, and the rheostat will burn up. An ammeter with a maximum scale of 1 ampere is handy to check up on this point, placing the meter in series with

each resistance to check up the current flow.

This resistance method is wasteful of current, but *does* work and is a cheap way of arriving at a successful A eliminator. For sets having five tubes or less, the output shunt resistance can be made quite low in value, with the total current drain on the rectifier adjusted to about 2 amperes.

Electrolytic filter condensers suitable for such low voltage work are easily made by filling three clean pickle jars or jelly glasses at least 6 in. high and 2½ in. in diameter to within ½ in. of the top with a concentrated solution of ammonium diphosphate, which can be obtained at practically any chemical supply house or drug store. For the outer plate of the condensers, obtain three sheets of chemically pure aluminum, at least 1/32 in. thick and 5 in. square. Bend the sheets into cylinders, so that they will pass through the mouth of the bottle, and after placing the cylinders in the bottles, bend them out so that they will fit close to the inside wall of each jar. This is the negative electrode from which a terminal should be brought out for connection to the filter circuit. The positive electrode may be a bar of pure aluminum, at least ½ in. thick and 5 in. long, suspended in the center of the jar. A terminal is brought out for the filter connections, preferably to the positive side of the filter circuit. A small amount of light lubricating oil should be poured over the surface of the electrolyte to pre-

- LIST OF PARTS**
- 1 Power transformer—110 pri., 2, 2, 21, 21 v. secondaries.
 - 1 Filter choke—.25 henry.
 - 2 Porcelain lamp sockets.
 - 2 Tungar bulbs—Nos. 277, 465—2 amps.
 - 1 Fuse Block.
 - 3 Electrolytic condensers, or 3 rheostats (see text).

vent evaporation. That part of the aluminum rod which sticks above the surface of the electrolyte should be covered with rubber okonite tape, to prevent arcing.

When the condenser is first connected in the circuit, a certain amount of current will be drawn, and sparks will be noted around the electrodes, but as soon as the electrodes are formed with a thin layer of compound, this current will be reduced to a very low value, and the sparks around the electrodes should cease. Distilled water must be added to these condensers from time to time as the solution level drops.

The arrangement of the filter condensers and choke is shown in Fig. 3.

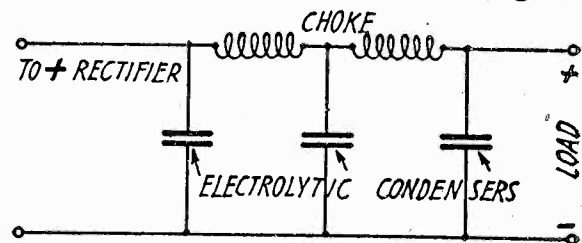

Fig. 3. Arrangement Using Condensers.

It will be noted that the electrolytic condensers take the place of the 20 ohm rheostat across the output and the 30 ohm rheostat across the center tap of the choke in the resistance model. The 30 ohm rheostat at the filter input should be retained so as to control the current output. The negative lead of the filter circuit should be grounded. If the positive A terminal of the receiving set is normally grounded the connection should be removed so that the ground will be on the negative end.

An Amertran No. 418 heavy current choke, which has an inductance of .25 henry, can be used with the condenser type filter. As it has no taps it cannot be used for the resistance type of filter.

The experimental models gave humless operation for sets using up to eight "A" type tubes. When the 99 type is used there is possibility of noise due to unbalanced resistance and to their sensitivity to minute disturbances in the filament circuit. But this can also be eliminated by careful adjustment.

REDUCING KEY-THUMP

IN THE neighborhood of amateur stations in any city listeners are constantly bothered with key-clicks from transmitters. A fairly powerful short-wave transmitter, even in the immediate vicinity of nearby listeners on the broadcast band, cannot be directly heard, but an objectional key-click may sometimes be heard for a good distance. A key-click is nothing but a sudden bringing of the transmitter into oscillation. This may be overcome by having the tube oscillate weakly all the time and only oscillate strongly when the key is depressed. On low-powered transmitters this may be accomplished by shunting a suitable high resistance across the key. The value of this resistance in ohms should be about 10 or 12 times the plate voltage in volts, for best operation.

The Double Beam Radio Beacon

As Developed for the Guidance of Aircraft

By S. W. Winters

A MODEL of a miniature airplane guided by radio signals from a miniature transmitting station is on exhibit in the radio laboratory of the Bureau of Standards to illustrate the application of the double beam radio beacon to the navigation of flying machines through darkness, fog, or other adverse weather conditions. As you turn a switch, plug in the headphones, and move the plane slightly to the right or left, there is a difference in the intensity and characteristics of the emitted radio signal. But as long as the plane remains on the center line of the box, the signals are uniform.

This model station represents that system now in experimental use by the Air Service at McCook Field, Dayton, Ohio. It is the basis of the work being done by the Bureau of Standards in perfecting the idea for practical use on a wavelength of 1034 meters which has been assigned for aviation beacons.

The principle of operation may be illustrated in the following manner: The pilot in trying to keep his course in the direction of the transmitting beacon hears certain signals. To the right and left of the course, these signals have somewhat the character of the International Morse telegraph code "N" and "A" respectively. On the course, where these two interlocking signals are of the same intensity, a third signal is formed, such as the Morse letter "T," which is a continuous and unbroken sound.

If the sound becomes broken into either of the two signals just described, the pilot knows he is to the right or the left of the course and must try for correction by resetting the nose of the airplane until he hears the constant signal once more. The chief difficulty with this system of signaling has been that the aviator has had to depend entirely upon his hearing, involving considerable concentration and possibility of personal error. To correct this difficulty, a visual indicator has been devised.

This consists of three small lights, mounted on the instrument board of the airplane and connected to the radio receiving set, which flash constantly. The unbroken signal obtained by the interlocking of the two separate signals at a point of equal intensity causes a relay to operate a telephone selector which, in turn, causes a white light to flash. While the white light is flashing, the pilot knows he is on the correct course. To either side of the course, the component

signals operate relays which, in turn, cause the selector to close the circuit, lighting a green or red light to the right or the left of the course, respectively.

When fully perfected by the Bureau of Standards, the double-beam radio beacon is likely to be of great value on well-defined courses of air travel, such as on airways of the Air Service and by the Air Mail Service. Commercial flying interests may also utilize the radio beacon. This marvelous device has passed the experimental stage and Dr. J. H. Dellinger, Chief of the Radio Laboratory of the Bureau of Standards, states that its practical utility value is assured. It is another marvel to be credited to the invisible, ubiquitous, and pliable radio waves.

Tubes in Parallel

SOME interesting things happen when tubes are operated in parallel at the higher frequencies. In the first place,

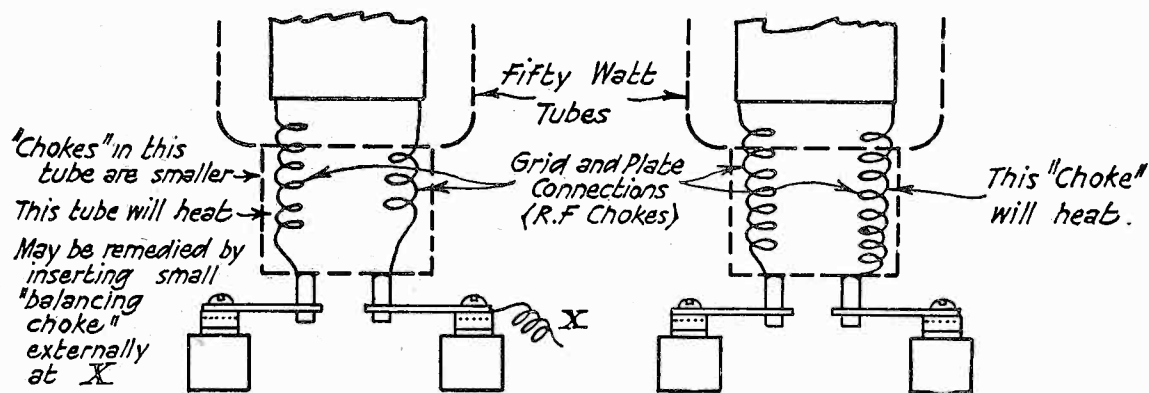

Working Large Tubes in Parallel on Short Wavelengths.

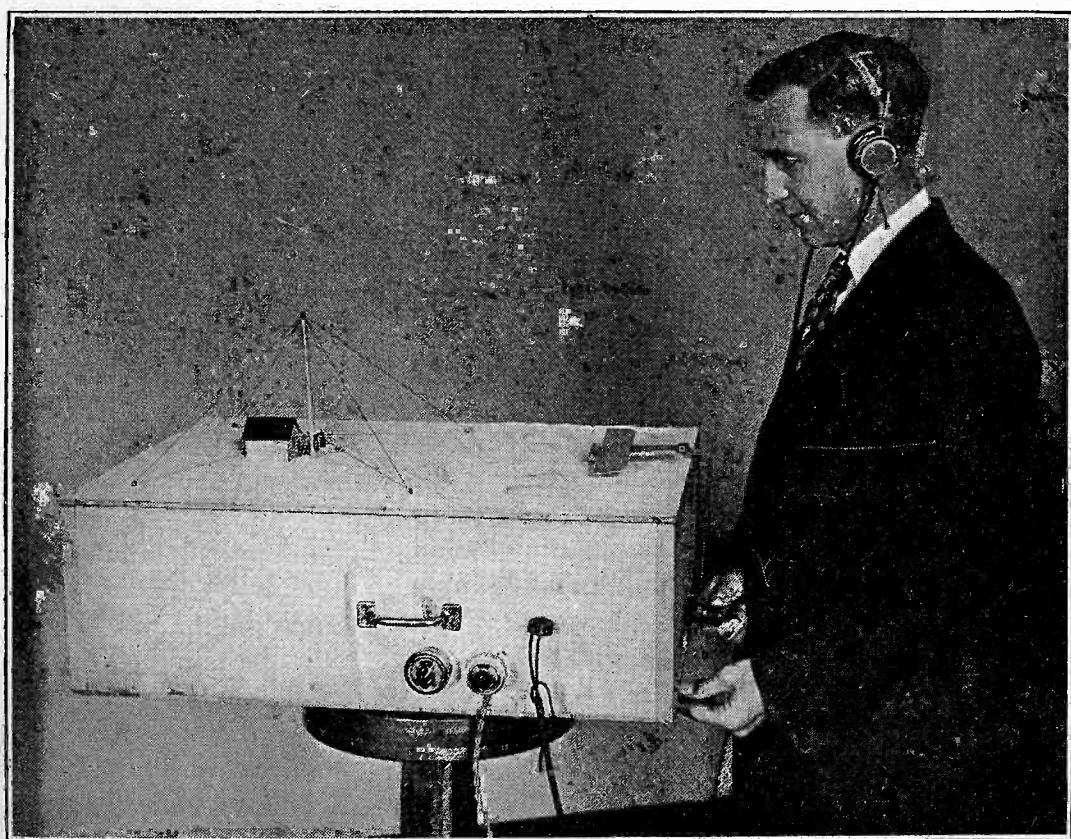

Model of Double Beam Radio Beacon for Guiding Aircraft.

the tubes were not designed to be used on the short waves and no attempt has been made to redesign them for such operation. The power supplied to these tubes in parallel will divide unevenly. Sometimes this becomes so bad that one plate will heat excessively and the other will remain cool. The only remedy is to determine which "inductance" is the larger and then add a small exterior "balancing choke" of the proper size to offset the larger as in Fig. 4. It may even be necessary to take a few readings with proper meters to determine if the power supplied each tube is the same.

This is especially noticeable on parallel operation, for which the tubes were probably not designed. It is not particularly objectionable when the tubes are operated separately. If when employing one of these tubes as a 5-meter oscillator, and you are in doubt whether your oscillator is oscillating or not, just watch the plate lead; it will only heat when the tube is oscillating.

A Reversible Inductance Chart

Giving Either the Inductance of a Coil or the Coil Size Required for a Given Inductance

By A. C. Kulmann

OF THE various formulas necessary in the design of radio parts, that most frequently used is the Nagoka formula for the inductance of a single layer coil or solenoid. Even after this is reduced to its English equivalents it is rather cumbersome to handle and recourse is generally had to tables. Furthermore, while it is easy to find the inductance of a given coil, the reverse process of calculating dimensions of a coil of any size of wire to give a specified inductance is somewhat tedious.

These problems were simplified by W. C. Eells in an article published in July, 1926, RADIO, where he develops formulas and presents tables for such reversible calculations. His basic formula reduces to $L=d^3n^2/c$, when L is the inductance in microhenries, d is the diameter of the coil in inches, n the number of turns, and c a constant depending upon the ratio of coil diameter to coil length. By using his computed values of c the calculation is relatively simple.

But this can be still further simplified by using the chart on the following page, which embodies Mr. Eells' formula and approximate constants. The central portion of this chart consists of a series of curves which graphically give c for various ratios of coil diameter to coil length. At the left is a double scale of inductance values, 4 to 1000 microhenries on the left side and 100 to 20,000 microhenries on the right side. The right hand "turns per inch" has likewise a double scale of values along its central heavy line, 10 to 45 on the left, and 45 to 200 on the right. Associated with this right hand scale is a graphic representation of the approximate number of turns per inch for single and double silk and cotton covered wire.

Its use is best illustrated by a typical example. Suppose that you wish to know the inductance of a coil consisting of 90 turns of No. 24 s.s.c. wire wound on a coil 2 in. in diameter. From the right hand scale you note that for No. 24 s.s.c. wire there are 41 turns per inch. Consequently the coil length is $90 \div 41 = 2.2$ in.

Locate the 2.2 in. point along the bottom "coil length" scale of the central chart. Follow up the vertical line from this point until it intersects the 2 in. curve of coil diameter. Then follow the horizontal line of intersection thus found until it meets the vertical line at the extreme left edge of the central chart. Then lay a straight edge, such as a ruler or card, so that it passes through the

point located on the left vertical line of the central chart and also through the 41 turns per inch point on the right hand scale. Finally read the inductance in microhenries at the left side of the left hand scale, the answer being 266 microhenries in this case.

If the wire size is such as to give less than 45 turns per inch the inductance values are read on the left side of the inductance scale. If the wire is such as to give more than 45 turns per inch the inductance values are read on the right side of the inductance scale.

Briefly stated, to determine the inductance of a coil of a given number of turns of specified wire wound on a given diameter, first find the coil length by simple division, then locate the point corresponding to the ratio of diameter to length, and finally pass a straight edge through this point and the point corresponding to the number of turns per inch so as to read the required inductance

Equally simple is the converse problem of finding the required number of turns of a specified wire wound on a coil of given diameter so as to give a required inductance. Suppose that a 150 microhenry coil is required to cover the broadcast band from 200 to 600 meters when used with a .0005 variable condenser. How many turns of No. 26 d.c.c. wire will be necessary if wound on a 3 in. coil?

No. 26 d.c.c. requires 36 turns per inch, as found from the chart. So by means of a straight edge we connect this point on the right hand scale of "turns per inch" with 150 on the left hand scale of inductance, noting the point where the straight edge cuts the left hand vertical line of the central chart. Follow along the horizontal line cutting this point until it cuts the curve corresponding to 3 in. coil diameter. This also cuts the 1.15 vertical "coil length" line at this point. So the coil is 1.15 in. long or $36 \times 1.15 = 41.4$ turns.

It should be remembered that the values obtained by such charts and even by the formulas are only approximate. They give a rough idea as to the number of turns or the inductance, which must be checked by actual measurement if accurate results are required.

Many inductance coil problems require that the value of the inductance required to give resonance with a given variable condenser be computed from the LC constant corresponding to the frequency. This constant may be found in

published tables such as the following:

Wavelength	Frequency	LC Constant
100 meter	3000 k.c.	.00281
150 "	2000 "	.00633
200 "	1500 "	.01126
300 "	1000 "	.0253
400 "	750 "	.045
500 "	600 "	.0704
550 "	545 "	.0851
600 "	500 "	.1013
700 "	428.6 "	.1379
800 "	375 "	.1801
900 "	333.3 "	.228

For 10 to 90 meters multiply frequency by 10 and LC constant by .01, thus for 20 meters LC is .0001126.

The LC constant is the product of the inductance L in microhenries and the capacity C in microfarads. If the capacity is unknown, inductance is figured by dividing it into the LC constant.

Suppose that it is desired to wind a coil for use with a .00035 mfd. condenser to cover the waveband from 200 to 600 meters. For 600 meters LC is .1013 and the required inductance is therefore $.1013 \div .00035 \text{ mfd.} = 290$ microhenries. As the LC constant for 200 meters is .01126 the capacity to be associated with 290 m.h. is $.01126 \div 290 \text{ m.h.} = .0000388$ mfd. which is well within the .00003 mfd. minimum of the average condenser.

If the coil is to be made by winding No. 24 d.c.c. on a $2\frac{1}{2}$ in. form we first find from the chart that it occupies about 31 turns per inch. Therefore connect 31 turns per inch on the right hand scale with 290 m.h. on the left hand scale so as to locate a point on the left hand vertical line of the central chart. Follow the horizontal line from this point till it meets the $2\frac{1}{2}$ in. curve, thus finding a coil length of 2.7 in. or $2.7 \times 31 = 84$ turns.

A common problem in the design of a short wave receiver is to determine the number of turns of No. 20 d.c.c. on a 2 in. form necessary to cover the band from 40 to 90 meters with a .00015 variable condenser. The LC constant for 90 meters is .00228 and consequently the inductance should be $.00015 \div .00228 = 15.2$ microhenries. The computed capacity for resonance with 15.2 m.h. at 40 meters is well within the lower limits of the condenser so that 15.2 m.h. may be safely taken. From the chart it will be noted that No. 20 d.c.c. has 24 turns per inch and that 15.2 m.h. requires .7 in. length or say 17 turns on a 2 in. coil.

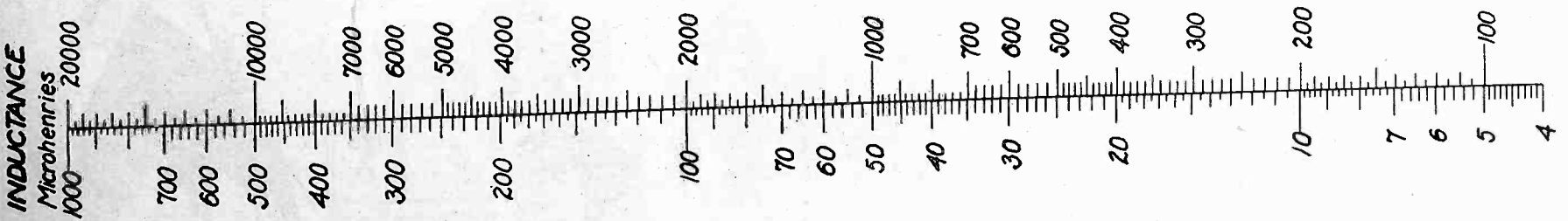
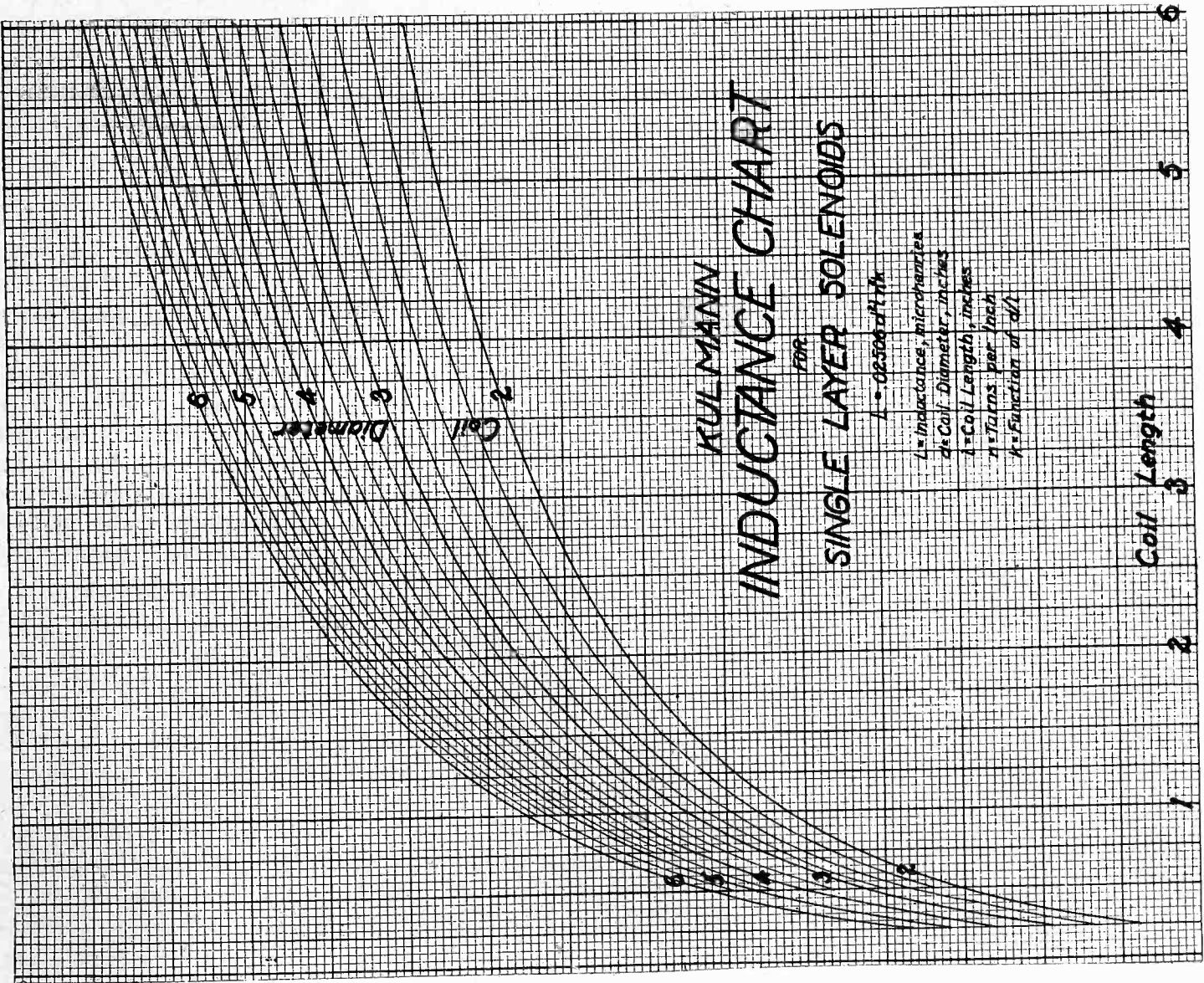
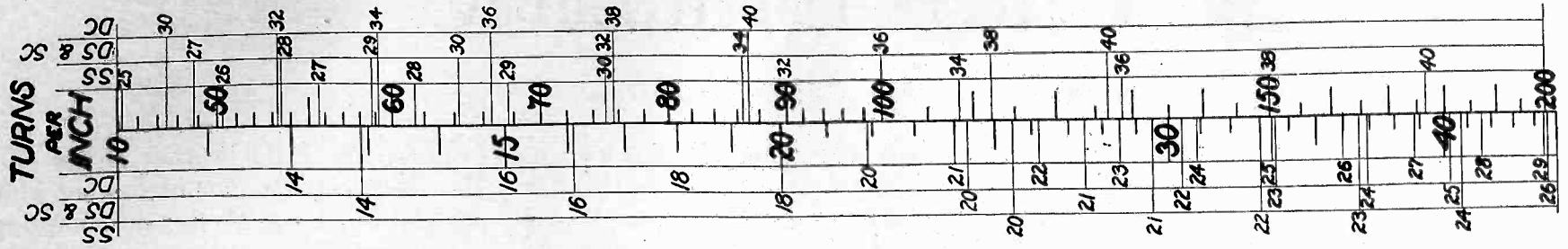

Reversible Inductance Chart.
(See Preceding Page for Explanation of Its Use.)

"Letters From Larry"

By Jack Bront

Nr. 23, Check \$3.98, Radio, SS. Lake Discomfort, 2.78 Pm, Date. George Hassenpeffer, 218 River Street, Hoboken.

Dear Gimmick well I got aboard this packet all KO and sailed at noon (stop) I had a accident right away though (stop) The antenna blew down first day out (stop) I got up the mast to fix it and I fell down (stop) I didnt get hurt though (stop) I had on my light fall coat (stop)

The first thing the steward asked me how I liked my room (stop) I told him the room was KO but shiver my spanker boom if the bed aint the bunk (stop)

Just yesterday the ship doctor came around and says are you sick (stop) No I says just a little cold (stop) Great wonder you aint got a cold all the time says he (stop) Why I says (stop) Well he says just look how much of you is turned under for feet on the cold cold deck (stop)

On the trip down the captain came into the radio room and he says whats all this rumpus (stop) A passenger says why I gave this operator a message to send (stop) Well says the skipper did he send it (stop) No says the passenger I wouldnt let him (stop) Just as soon as I handed it to him he started reading it the fresh thing (stop)

On Friday a passenger came into the radio cabin and he says aint you got no loudspeaker (stop) Yes I says but she is visiting friends in Portland this week (stop) Why he says I thought you called your wife your meatburner (stop) Well I says loudspeaker or meatburner little diff (stop) Theras a lot of frying and sizzling connected with either of them (stop) They keeps you awake nights and take lots of upkeep (stop)

Professor Fleisch Esseh, a passenger for the Sandwich Islands came into the radio room to talk radio (stop) Do you think the ether is a myth (stop) No I says I think its a myhtery or a an-aesthetic (stop) Why says he (stop) Well I says look at all the broadcast announcers that put you to sleep (stop)

Yesterday afternoon a Scotchman came into the radio room at noon and wanted to send a nite-letter (stop) Ye canna doo ut I says (stop) Hoot mon hoot he says (stop) Hold yer hand out I says as you go round the corner (stop) Ye canna park here and blow yer horn (stop)

Well Gimmick I run out of cigars again this trip (stop) Everybody that comes into the radio room helps themselves (stop) Theyd take out the in-nards of the VTs if they wasnt sealed (stop) I was just lighting my last El Ropo when the mates false teeth blew off the shelf in the pilot house and bit the smoke in two (stop)

Just then the Chief Engineer came along and says he whats the matter Sparks (stop) Look at your feet I says (stop) Whats the matter with them he says (stop) Well they aint mates I says (stop)

Well a lady came into the radio cabin today and she says can I send a radio to my sheik (stop) Well I says lady we dont communicate with Arabia (stop) Wont a substitute do I asks (stop) I aint so very busy after the weather report comes in (stop) QRT she says (stop) Save your batteries your arc is bubbling she says (stop) But lady I says Im just a poor lonesome radio-operator and theres only one thing that will warm my barren heart (stop) Try a hotwater bottle she says and I takes out my revenge on a poor Shipping Board up down the coast who is testing his squeak box (stop)

Some passenger called up on the ship phone yesterday (stop) Is this the radio he says I want to send a message and Im down below (stop) How far down are you I asks (stop) Oh to hell and gone down here (stop) Well I says you dont want to send a radio you need ice—call the bell hop I says (stop)

Well OM we are getting into port now and I gotta get up town to the office (stop) C U next trip (stop) 73 (stop) (sig) Larry

Nr. 163 Check \$9.98, Radio S. S. Lake Discomfort, Filed 8.87 A. M. Date. George Hassenpeffer, 218 River Street, Hoboken.

Dear Gimmick (stop) Well OM we had a fine trip this time (stop) We tuned in on them Hale-Fellows-Well-Met at Frisco and they sure had a swell musical number OM (stop) Some swell soprano sung that old song quote refrain from smoking unquote (stop)

Well OM my swell stewardess friend quote Blonde Preferred unquote come up to the shack when we sailed and

brought her little brother along (stop) He cant sleep account of the fog whistle she says (stop) Well thats nothing I says when I was working night trick up in the fog belt on the coast my little cousin was twelve years old before he ever seen the sun (stop) And I says the skipper let me take him out on a coast-wise ship so he could see it (stop) Oh switch to your batteries she says your breaker kicked out (stop)

A passenger put his head in the radio shack and he says dont them sea gulls get shocked up on the antenna not any atall he says (stop) No I says it dont ever shock anything that way except I says one time when I was using the hot compensation loop on CW and the juice jumped through three of my finger nails well I says that time every body within a thousand miles got shocked (stop) My land he says (stop) You must run a farm I says and starts on scattering a few quote Love and Kisses unquote gags for the customers (stop)

I forgot to tell you OM we got a swell tone color amplifier now (stop) I guess its KO because when we first tuned in with it we all seen red (stop) I guess they put in them peaked transformers (stop) They sure look peaked and scrawny-like OM (stop) Its home made though and its tone color is a picture no artist can paint OM (stop) They say the grid leak changes tone color OM but ours dont change any at all it just stays black OM (stop)

Blonde Preferred says I brought up little brother to see your set (stop) Hes a BCL she says and he can listen in so fast that all the other BCL boys in the neighborhood cant copy him (stop) Youre a dear Preferred I says (stop) Yeah she says thats what all the radio men says (stop) Dont you ever set foot in this radio shack again I says Pre-

(Continued on page 50)



More About the New Inverse Duplex

A Discussion of The Effects of Phase Relationships in Radio Frequency and Audio Frequency Reflex Circuits

By David Grimes

THE outstanding feature of the new inverse duplex circuit, whose general theory was explained in December RADIO, is its uniform amplification and selectivity throughout the broadcast band. Uniform amplification is easily obtained by either the variable "loss" or variable coupling method. But the former tends to broaden the tuning of the short waves and the latter of the long waves. Thus selectivity is lost.

Selectivity may be retained without impairment of amplification by means of a filter circuit made up of two by-pass condensers and an r.f. choke coil, which appear in the circuit diagram of Fig. 1.

The choke is the same as is also used to limit the feed-back of r.f. current from Tube No. 1 (the second audio stage), through the resistance coupling, to Tube No. 2 (the first audio stage). But as these two tubes are also respectively the first and second radio stages, any r.f. feed-back will either aid or oppose the r.f. amplification, depending upon the phase relationship.

Negative feed-back decreases the signal strength. Positive feed-back increases it and, in excess, causes oscillation and instability. Thus by a proper choice of choke and by-pass condensers, the feed-back can be completely eliminated for short waves needing no reinforcement, and automatically increased for the long waves, thus increasing their

amplification while reducing the circuit resistance and sharpening the tuning. A .001 mfd. condenser for A, a .00025 mfd. for B, and .75 millihenries for the choke does the job. With a variable non-inductive 2000 ohm resistance in series with the choke, for control, we have an effective choke at 200 meters and a fairly conductive circuit at 550 meters.

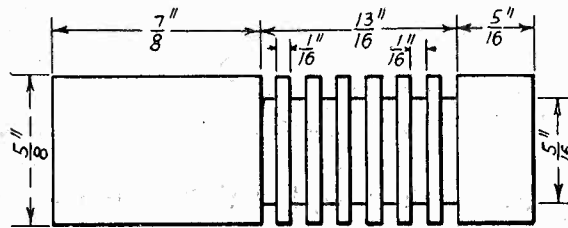

Fig. 2. Choke Coil Form.

Fig. 2 shows the construction of the form upon which the choke coil is wound. Each of the seven slots is wound with 5 1/2 ft. of No. 36 D.S.C. nickel-chrome wire, giving an inductance of .75

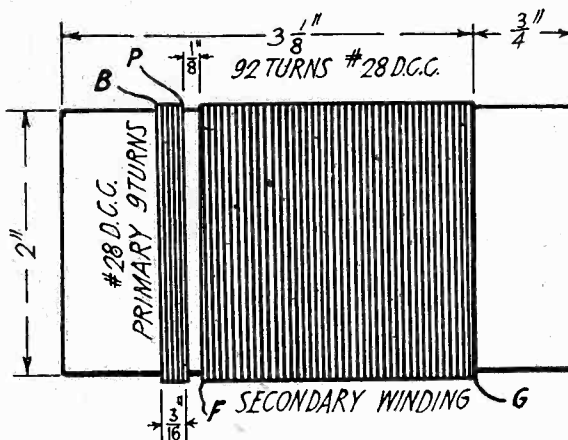

Fig. 4. Intermediate Tuning Coil.

millihenries and a resistance of 1000 ohms.

Fig. 3 shows the details of the antenna coil and Fig. 4 of the two intermediate tuning coils. The secondary of each of the three coils consists of 92

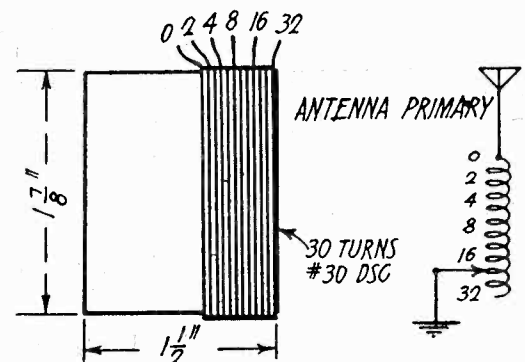
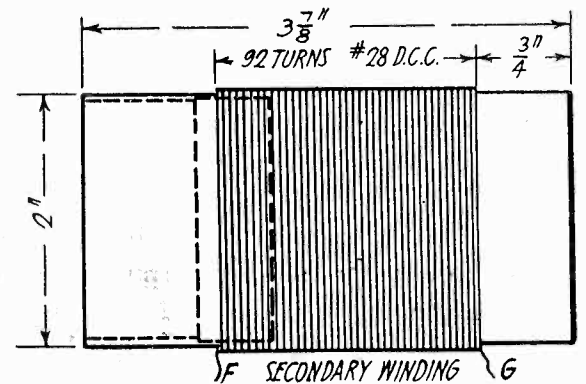

Fig. 3. Antenna Coil.

turns of No. 28 D.C.C. copper wire wound on 2 in. bakelite tubing, thus covering the broadcast band when tuned with a .00035 mfd. variable condenser.

The antenna primary consists of 32 turns of No. 33 D.S.C. wire tapped at the 2nd, 4th, 8th and 16th turn, giving

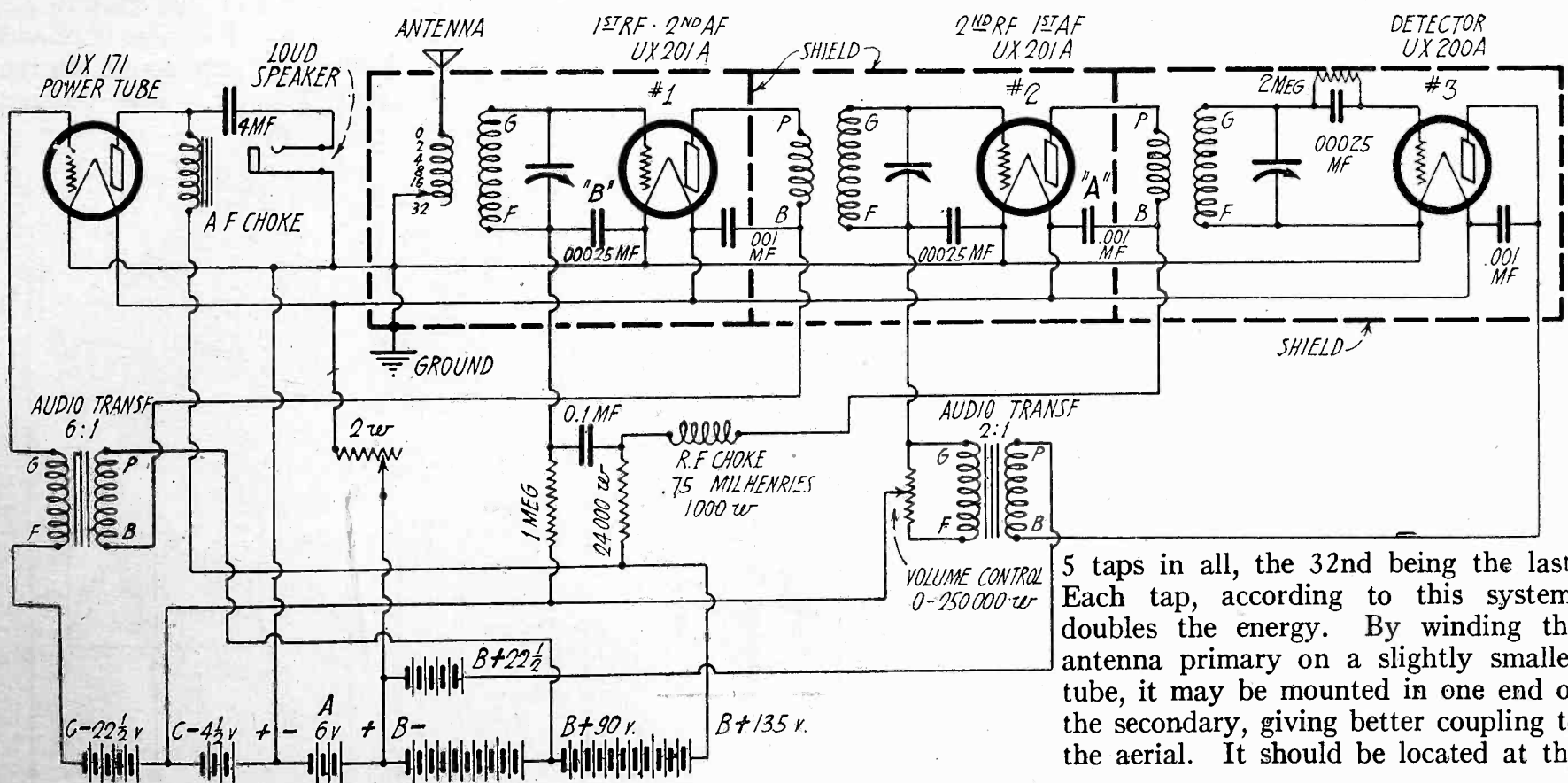

Fig. 1. Circuit Diagram of New Grimes Inverse Duplex.

5 taps in all, the 32nd being the last. Each tap, according to this system, doubles the energy. By winding the antenna primary on a slightly smaller tube, it may be mounted in one end of the secondary, giving better coupling to the aerial. It should be located at the

(Continued on page 60)

How and Why the Infradyne Works

A Simple Explanation of Its Action and An Analysis of Its Theory

By Raymond B. Thorpe

NATIONAL interest in the infradyne receiver recently announced by Sargent has been followed by a desire for an explanation of how and why the infradyne works. Thus far published articles have been largely of a descriptive or constructional nature. Now, however, we will look into the interesting features of this receiver so as to discover the reasons for its behavior.

Every radio receiver, infradyne included, may be considered as a group of associated elements, each with a specific function, such as the antenna or pick-up device, the detector, and the audio frequency amplifier. Fig. 1 will

tube with the output of the oscillator tube to form a new frequency in the short wave range — 3500 kilocycles. This new frequency is amplified by the intermediate or infradyne amplifier and is then applied to the second detector which extracts the voice frequency components. These are then amplified by the audio frequency amplifier to sufficient strength to operate the loud speaker. The circuit diagram is shown in Fig. 2 except that the details of the infradyne amplifier are omitted. The circuit of this unit is shown in Fig. 4.

It is well known that a short low antenna is much more selective than a long high antenna, but that at the same

frequency amplifier by making a few turns in the input coil common to the antenna circuit.

The radio frequency amplifier is of very simple design. No neutralization or other special arrangements are provided, since the total gain of the radio frequency amplifier need not be especially large. For this same reason it is quite feasible to use single dial control for the three tuned circuits.

A word or two on the volume control arrangement may well be here introduced as a part of the r. f. amplifier explanation. It consists of a 200,000 ohm variable resistance placed in series with the common B battery lead to the plates of the r. f. amplifier tubes. Increasing this resistance increases the plate impedance and correspondingly reduces the plate current and the gain of the r. f. amplifier. Decreasing this resistance decreases the plate impedance and correspondingly increases the plate current and amplifier gain.

The presence of this high resistance in the common plate lead would disturb operation if alternating currents were allowed to flow through the resistance. It might even cause the amplifier to oscillate for small values of resistance, though for large values the total amplification will fall off sufficiently to prevent further oscillation. Such effects are prevented by placing a 1 mfd. condenser between the filament circuit and the plate end of the control resistance. The a.c. path is thus made independent of the adjustment of this resistance.

Further control of volume is provided by a variable resistance across the input to the first detector. This resistance

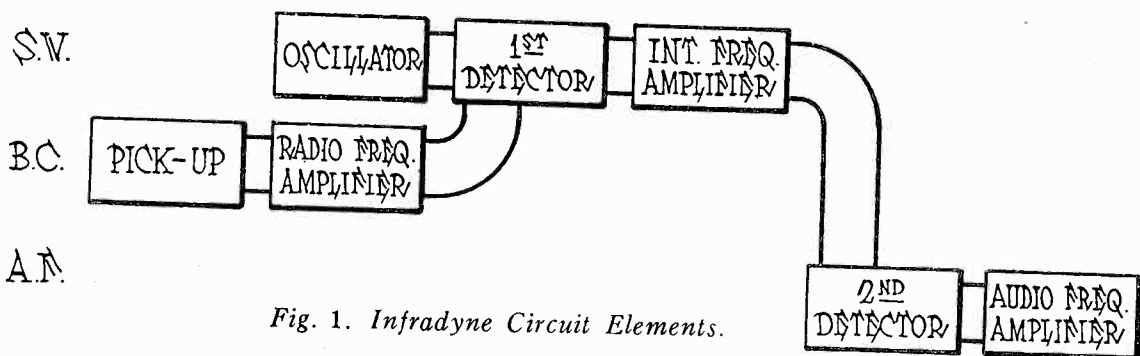

Fig. 1. Infradyne Circuit Elements.

help us to keep clearly in mind the several elements of the infradyne receiver and their functions.

The complete receiver consists of (1) a pick-up device, (2) a radio frequency amplifier, (3) a first detector variously known as a modulator or mixer tube, (4) an oscillator, (5) an intermediate amplifier, (6) a second detector, and (7) the audio frequency amplifier. The incoming (500 to 1500 kilocycle) signal is picked up by the aerial. After passing through the radio frequency amplifier it is combined in the first detector

time it gives much weaker signals. Since the infradyne provides an enormous amount of amplification, it is generally satisfactory to use a short low antenna and make up for the difference in signal strength by means of the amplification in the receiver itself. The infradyne antenna system is not tuned, although something could be gained by doing so. But this would complicate the control and might not add enough to make the additional variable condenser worth while for the average user. The antenna is coupled to the input of the radio fre-

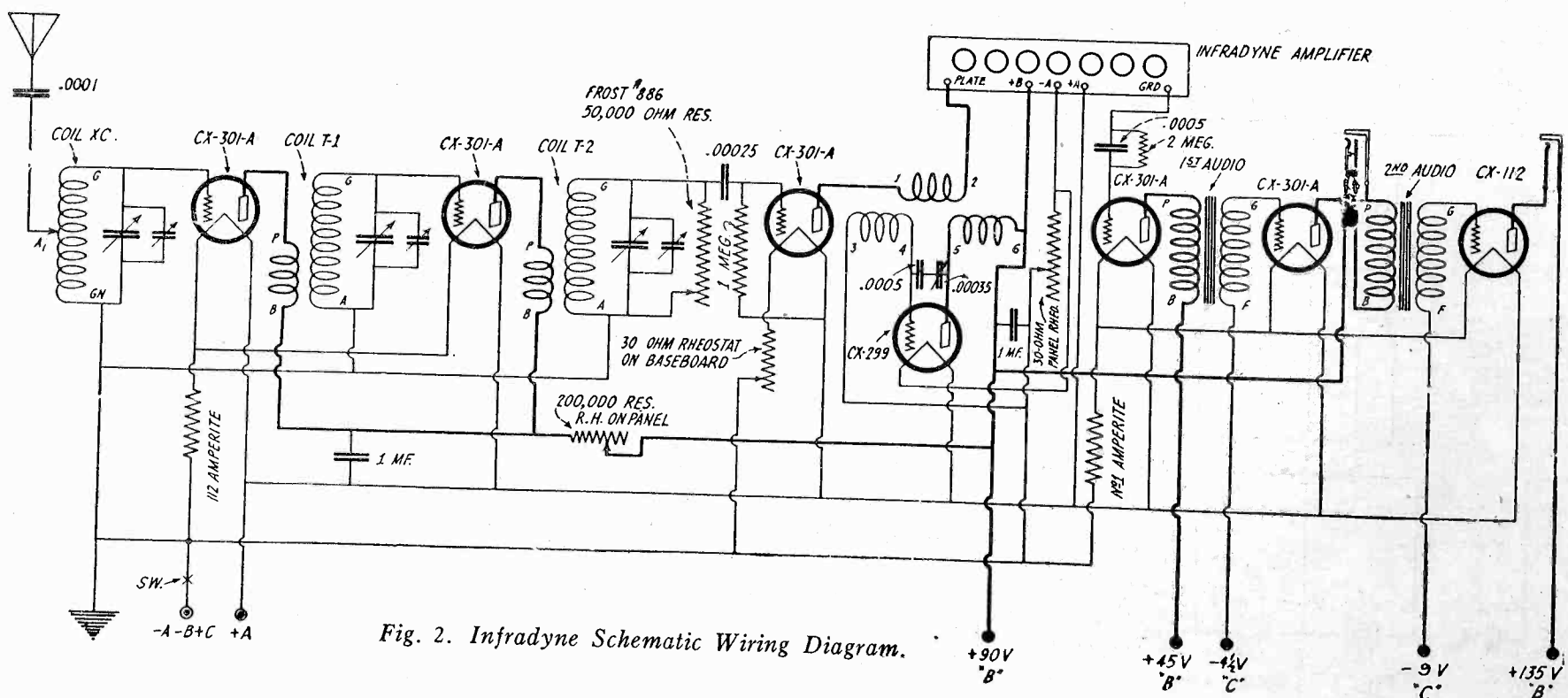

Fig. 2. Infradyne Schematic Wiring Diagram.

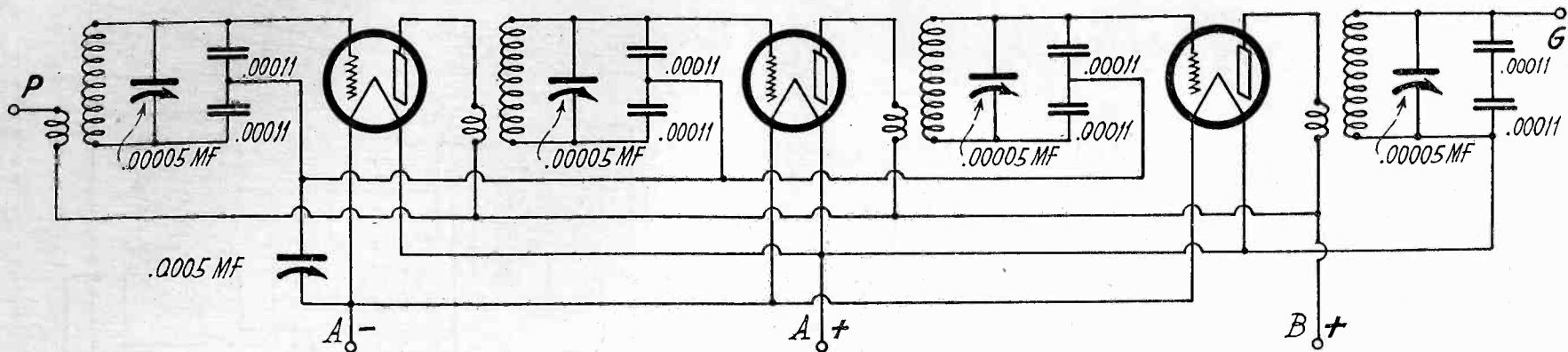

Fig. 4. Circuit Diagram of Infradyne Amplifier Unit.

damps a very loud local signal, when the interference due to consequent loudness of tuning is not a problem. It is cut out and the tuning is correspondingly sharpened and the volume increased when the greatest selectivity and amplification are required.

THE most puzzling feature of the infradyne, to the casual reader, is the action of the first detector or mixer tube. This combines the amplified incoming radio frequency, which is applied to its grid, with a locally generated very much *higher* frequency, which is applied to its plate by inductive coupling from a separate oscillating tube. This most unusual procedure is the basis of the infradyne principle. Some people who are familiar with the combination of the incoming radio frequency with a locally generated *lower* frequency in the superheterodyne and the consequent production of a heterodyne or "beat" note at the *difference* frequency, have failed to understand how the *sum* frequency is nothing but a modulation of the locally generated high frequency by the incoming radio frequency.

That such a *sum* frequency does exist and that the mixer tube modulates it with the radio frequency, may be proven mathematically without much difficulty or may be inferred from the operation of broadcast stations or telephone car-

rier systems. Let us first consider the mathematical proof and then show how the same results can be predicted, though with less certainty, by a consideration of the usual vacuum tube action.

The basic equation for the plate current i_p , of a detector (or modulator) tube, as developed by the writer in October, 1926, RADIO, is

$$i_p = K (E_p + \mu E_c)^2 \dots \dots \dots (1)$$

where E_p is the plate voltage and E_c the grid bias voltage.

This equation merely states that the plate current is proportional to the squared total voltage acting in the plate circuit. This voltage consists of the B battery voltage plus μ times the C battery voltage.

If an alternating voltage e_1 is applied to the grid of the tube there will be a third term μe_1 in the equation. A second alternating voltage might also be present introducing a term μe_2 , etc. The result would be

$$i_p = K (E_p + \mu E_c + \mu e_1 + \mu e_2)^2 \dots \dots \dots (2.)$$

It is obvious that the same result would be produced if, instead of the voltage e_2 being applied to the grid of the tube, we should apply to the plate circuit a voltage e_3 which is μ times as great as e_2 . We will not stop here to develop again the mathematical relations which exist, but we may well set down the final outcome which would result

if the voltage e_1 were a radio frequency voltage, $a \sin pt$, and e_3 another and higher radio frequency voltage, $b \sin qt$. In the resulting equation, given in the appendix to this article, appears the term $2aba_2 \sin pt \sin qt$. By a trigonometrical relation this may be written $a_1 \sin (q-p)t + a_2 \sin (q+p)t$. The first of these terms will be a voltage whose frequency is the difference between the two original frequencies and the second term a voltage whose frequency is their sum. This is the proof that sum frequencies do exist and further that they will result from the mixer tube arrangement of the infradyne provided only that the grid circuit of the infradyne behaves essentially the same as that of a tube with large negative C battery. This was shown to be the case in the article above cited.

The existence of sum frequencies has not only been experimentally verified, but actually put to use even before the advent of the infradyne. In one of the earliest forms of carrier telephone systems, of which many are now in use, not only the carrier itself but also the lower side band (difference frequencies) are suppressed, leaving only the sum frequency components in the telephone circuits.

Without mathematics it is quite easy to see how this detector works, once we realize that detection takes place in the

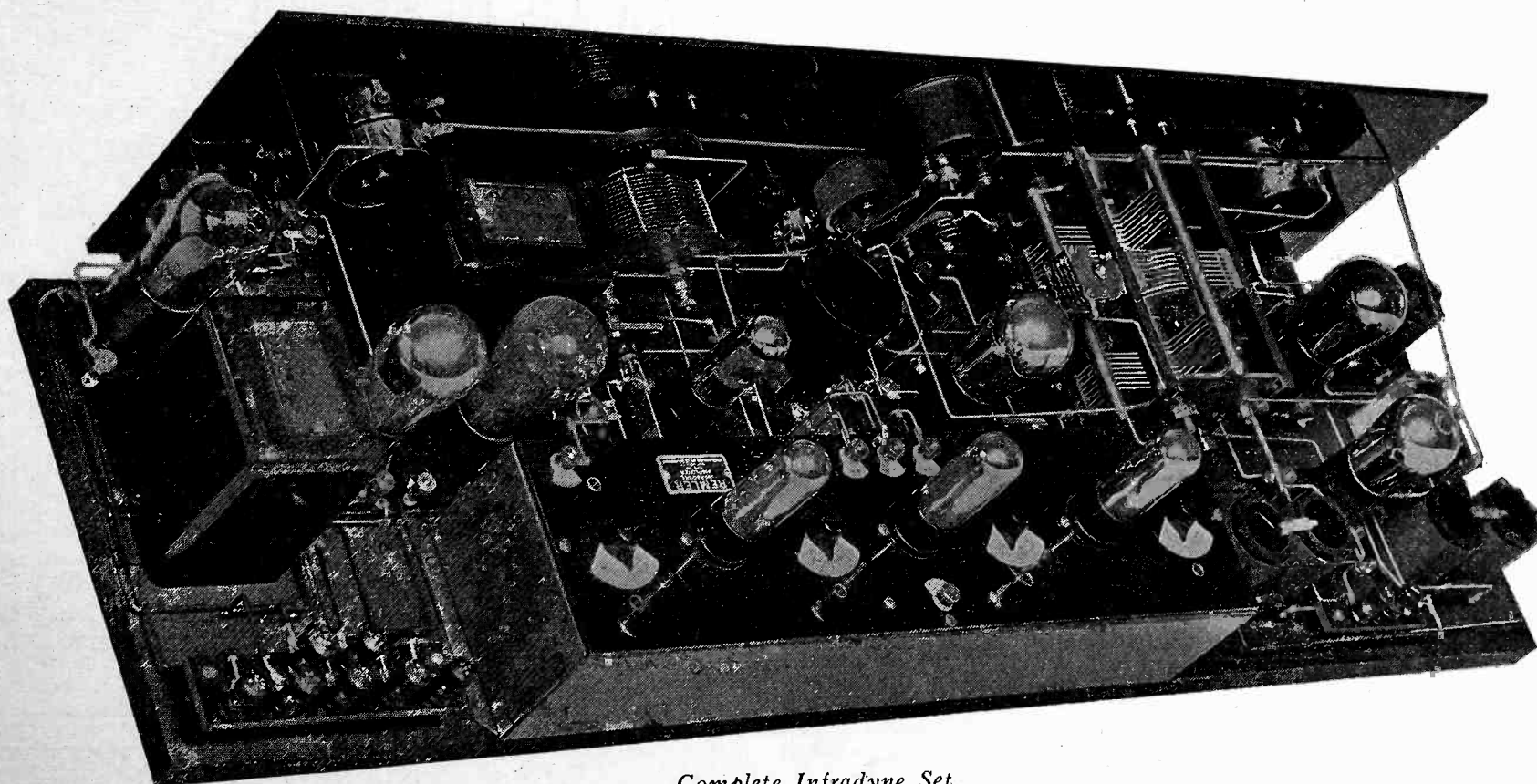

Complete Infradyne Set.

A Stabilized High Gain Regenerative Receiver

Suggestions for Preventing Oscillations Which Should Interest Every Experimenter

By Frank C. Jones

THE receiver described herein is the result of considerable experimenting with reflex and regenerative receivers. The main objection to various types of regenerative receivers is that they oscillate and so bloop the whole neighborhood. Generally the regeneration control is used so that the detector is on the verge of oscillation, or even oscillating for "zero beat" reception. Usually the novice, or practically everyone using a regenerative receiver, will tune for distant stations with the set oscillating so as to pick up the carrier wave and then try to "back" it down from that point in order to make the music or speech intelligible. Everyone knows how those nice little whistles caused by one or several of these receivers kill all chance of any dx for anyone else in town.

The regenerative receiver circuit shown in Fig. 1 is interesting in that the feed-back can be limited so that the detector will not quite oscillate any place in the tuning range of the receiver. This means that the extreme sensitivity of a good regenerative receiver is obtained over the whole broadcast range and yet no chance of it oscillating and so blooming everyone else in town. As much or as little regeneration as desired can be used simply by adjusting the second variable condenser C_2 which is one of the two controls of this set. The maximum amount of regeneration is adjusted once and for all, as long as tubes, etc., remain the same, by means of the semi-variable neutralizing type condenser C_4 .

This type of regenerative control requires an extra tube which serves a double duty as used both as a radio and as an audio-frequency amplifier, resulting in a three tube set. By regeneration control is meant that the radio frequency component in the detector plate circuit is applied through a tuned radio frequency transformer to the grid of a second tube, amplified and fed back by

capacitive coupling through C_4 to the grid circuit of the first tube, or detector.

The variable condenser C_2 tunes this circuit to the same wavelength as the grid circuit of the detector in order to pick up the feeble radio frequency component in the detector plate circuit. Unless this condenser is tuned properly, the r. f. component through the plate coil will not produce any appreciable voltage across the grid of the second tube.

This is very nice, as no regeneration is needed for local stations ordinarily, so the second condenser C_2 needs only to be turned either side of the particular resonant point used, to kill all regeneration. It is important to make the

feed back condenser C_4 small enough so that the set will not oscillate at any setting possible on the two dials. With a correctly designed set this condenser can be left in one adjustment for maximum regeneration over the whole broadcast range as both dials are rotated.

Since a tuned radio frequency transformer is used, the detector is liable to oscillate from the effect of a tuned circuit in plate circuit of this tube. To overcome this, the detector is neutralized by means of the neutralizing condenser C_3 in the same way that an ordinary neutrodyne set is neutralized. It seems rather odd to neutralize a detector but in this case it is necessary in order to obtain maximum efficiency over the whole broadcast range.

The method of neutralizing is quite simple, the neutralizing condenser C_2 being varied until the detector tube will not oscillate for any setting of the two control dials when C_4 is left out. It is possible to hear the detector go in and out of oscillation by listening with a pair of telephone receivers in the output of the second audio amplifier.

The radio frequency transformer should have a rather large number of

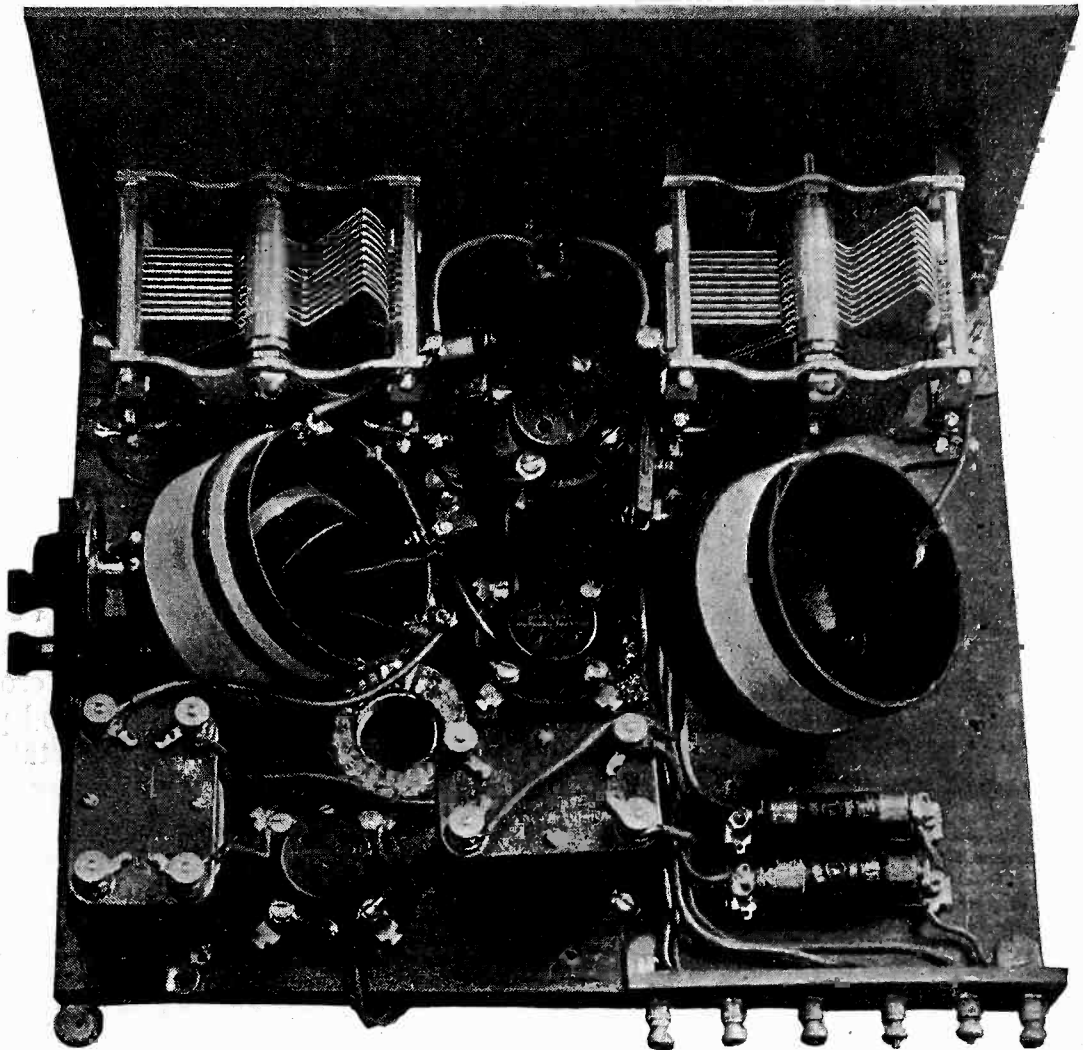

Rear View of Three-Tube Experimental Set.

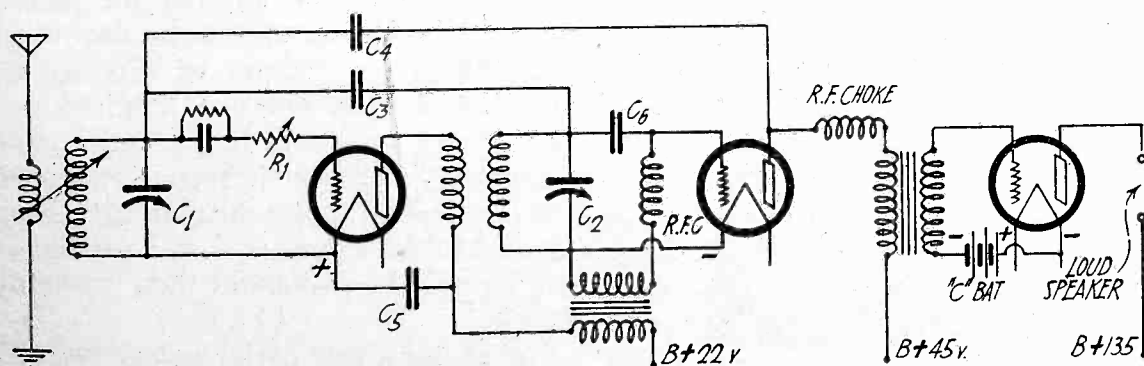

Fig. 1. Circuit Diagram of Stabilized Regenerative Receiver.

Safety Plus Radio

By Boris S. Naimark

primary turns so that the detector will oscillate when tuning the condenser C_2 and both C_4 and C_3 out of the circuit. Two values of C_3 will be found, while C_4 is still left disconnected, at which the detector will start to oscillate. The neutralizing condenser C_3 should be adjusted half way between these two settings and left there after which C_4 can be connected into the circuit.

In the reflexed tube the audio transformer is connected directly through a r. f. choke across the grid of this tube and a very small blocking condenser, .00005 mfd., used to prevent the tuned r. f. transformer from shorting the audio transformer secondary. The r. f. choke, 600 or so turns of fine wire on a spool or in the form of a miniature honeycomb coil, prevents the audio transformer from affecting the high frequency circuit in the grid of this tube. A small blocking condenser C_6 should be used, of .00005 or less, in order to eliminate as far as possible the distorting effect of such a condenser across the secondary of an audio transformer. The other radio frequency choke in series with the second audio transformer, separates the high and low frequency components in the plate circuit of the reflex tube and may be of the same type as the other r. f. choke.

Any type of tubes can be used in this receiver. In case the coupler and radio frequency transformer are home-made, they can be of 60 turns of No. 24 or No. 26 wire on a 3 in. tube. The primary of the coupler should have about 20 or 25 turns on a smaller tube and be arranged for variable coupling to the secondary in order to obtain the best antenna coupling to the detector tube. Once set so that it is possible to cut through local stations and still receive distant stations, this coupling between the antenna coil and the secondary coil

ALTHOUGH a radio installation ordinarily offers little chance of danger, there are enough cases on record to justify reasonable caution in operation, particularly of transmitting equipment. Most of the accidents that have occurred are due to carelessness. Thus on July 11, 1926, Lester J. Wolf, a young licensed operator at station WOK, was killed when he tried to

of the coupler can be left alone. For this reason it is not necessary to control it from the front of the panel as it is only a preliminary adjustment. The primary coil of the radio frequency transformer can be of 25 turns of small wire, No. 32 gauge, wound over the filament end of the secondary.

No further details of the set shown in the pictures is necessary, but in making up such a set it would be advisable to use a slightly larger panel, about 7x18 inches and so avoid crowding of the apparatus. It is a good plan to use automatic filament rheostats so that the filaments may be left alone and thus avoid a means of starting the set to oscillating after all of the condensers have been adjusted. The resistance in series with the grid of the detector tube stabilizes it so that the peak of regeneration can be obtained over the entire tuning range of the receiver.

Another two tube set is also shown which uses the same circuit but is made up with standard coils and parts. With this set better dx was obtained than on a standard two-stage tuned r. f. receiver using the same antenna.

replace a blown-out fuse without first shutting off the power.

Most of the accidents in connection with receiving sets are due to falls while erecting outside aerials. This is illustrated by the case of a radio shop owner at Ravine, Pa., whose neck was broken and skull fractured in a fall from a high tree. A radio amateur at San Diego, Calif., Lester Picker, fell when a flimsy aerial pole broke, and was permanently disabled from a broken back. Many similar cases can be cited.

It is common practice to supply the deficiency of natural aerial supports by unlawfully using telephone or electric light poles or by making a "pole" from any small pieces of wood around the house. Both practices are dangerous, one from the chance of electric shock and the other from the chance of a fall. Just plain luck is the reason that they have not caused more casualties. So observe the following if you want to be safe:

Never climb a pole to which any wire is attached other than aerials or guys. Any wire may be in contact with high voltage lines, accidentally or otherwise.

Erect your aerial in accordance with the regulations of the "National Electric Code." This specifies that an outside aerial or counterpoise "shall be kept away from all electric light and power lines of any circuit of more than 600 volts." When in doubt about a wire, keep away from it.

The code also requires that aerial supports must be "constructed in strong and durable manner, and shall be located so" as to provide necessary clearances to prevent accidental contact with any wires through sagging, swinging, or an accidental break in the aerial support or the aerial wire itself. A pole attached to a chimney by means of wire or clothes line does not constitute an aerial support installed "in a strong and durable manner"; there are accidents on record, both serious and fatal, caused by falling bricks loosened from their cement nests because of the aerial poles attached to the chimneys. The use of a chimney as a pole is not advisable for the same reason.

When buying or making an aerial, remember that you may some day want to climb it for repairs or alterations, and that if it is not one hundred per cent it may bend and break under your weight as you reach its top. Remember that the aerial poles are at all times exposed to the elements, and must therefore be able to withstand their constant attacks.

Never use a kite aerial *unless you are*
(Continued on page 68)

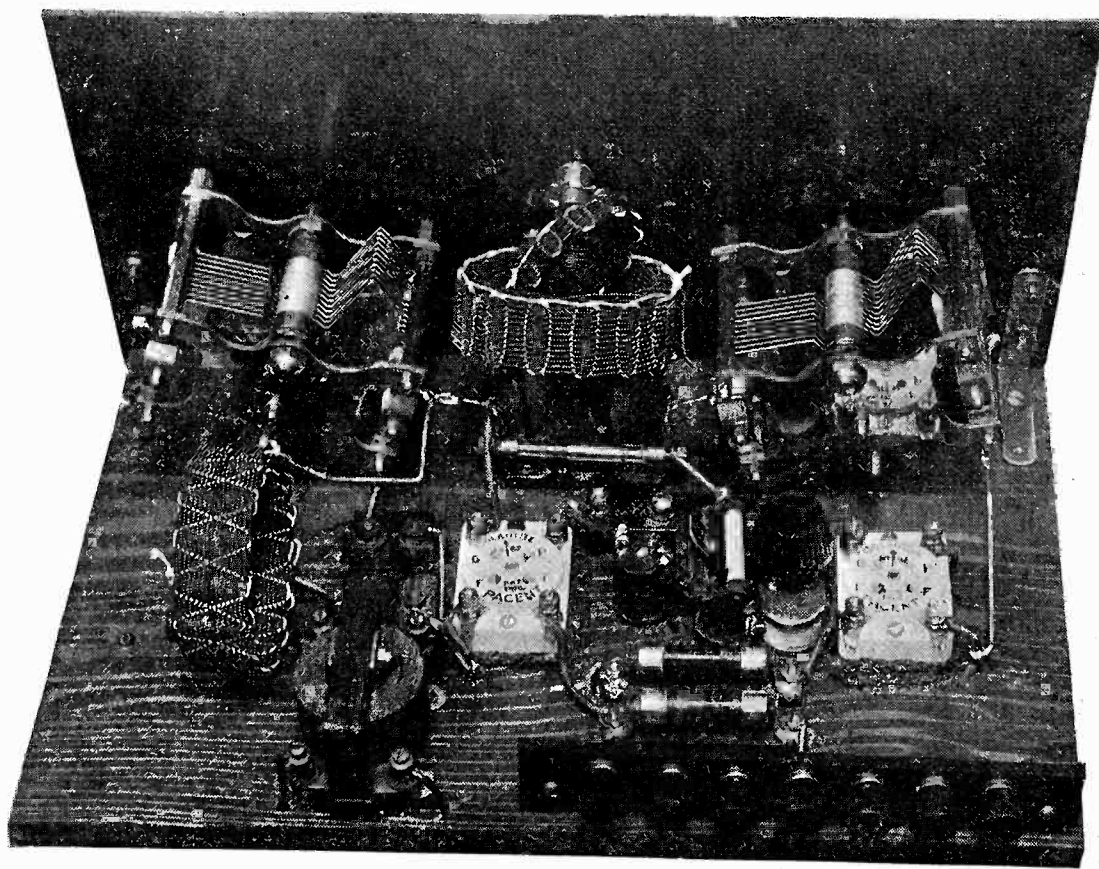

Rear View of Two-Tube Experimental Set.

Automatic Relays for Radio Power Supply

By Clinton Osborne

THE average radio receiving installation consists of the radio receiver with its loud speaker, a storage battery and charger (either trickle or heavy duty), a *B* power supply from the a. c. lines, and quite often an a. c. operated power amplifier. Usually, when turning on the set, it is necessary to first turn off the trickle charger, turn on the *B* power supply, and the power amplifier switch, if the latter is used. After all the a. c. power devices are attended to, the filament switch of the receiver is then turned on, and the set is ready for operation. To simplify these operations, a number of relay devices are now on the market, and a brief description of several of these will be given, as well as directions for a home made relay.

Fig. 1 shows the interior and exterior of one type, known as the series relay,

receiving set, usually the positive filament lead. When the filament switch is closed, current flows through the relay windings, and the armature is pulled over against the pole pieces. In moving through its full swing, an insulated ball on the end of the armature moves a heavy contact spring so that it breaks one electrical circuit, and makes another. Connected to the circuit which is broken when the relay operates is the trickle charger, so that when the filament switch is closed, the trickle charger is at once disconnected. When the spring makes the new contact at the full swing of the relay armature, the *B* power supply unit is turned on, and the set receives its proper *B* voltage. To the same attachment plug can be connected the power amplifier, so that the two power devices may be started at the same time.

late model sets, the maximum resistance could be only .44 ohms. As the storage battery drops below 6 volts during the latter half of its discharge cycle, the resistance of the relay, if more than the above figures, would not permit the proper voltage to be applied to the tube filaments, so that care must be taken to see that the resistance is as low as possible.

The other method of relay control is by shunting the windings of the relay across the filament circuit, with one side of the field coils connected to the negative *A* battery, and the other side to the filament switch, on the tube side of the switch contacts. Such a relay is shown in Fig. 3, and its method of connection

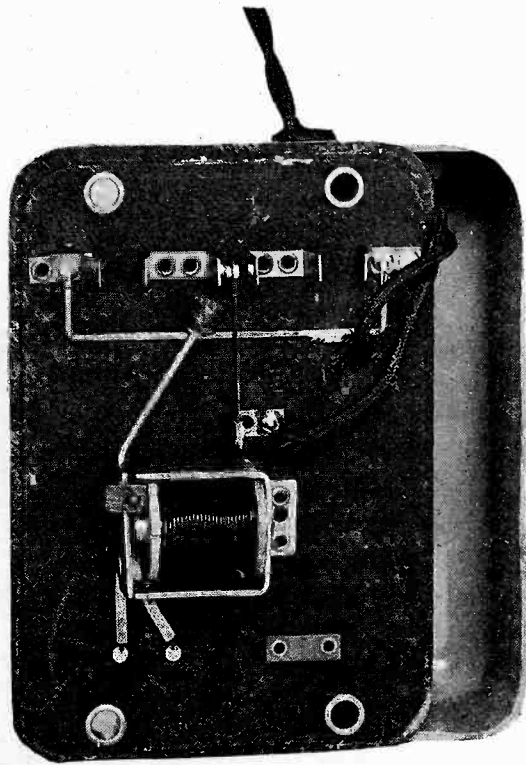

Fig. 1.—Series Type Relay, for Two Power Circuits.

the circuit of which is shown in Fig. 2. Its principle of operation is simple. The field coils of the relay are wound with large gauge wire, having low direct current resistance, and are connected in series with the filament circuit of the re-

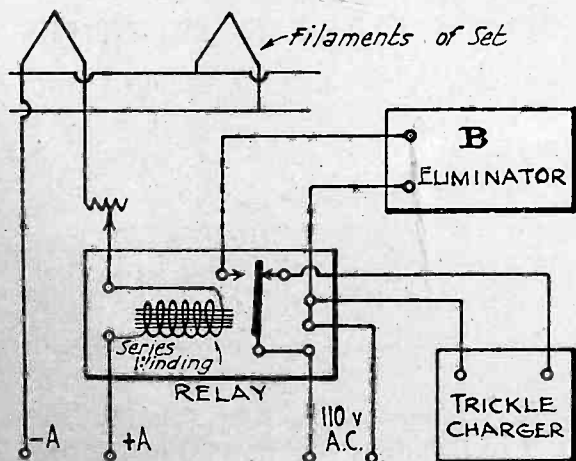

Fig. 2. Circuit of Series Relay.

Vice versa, when the set is turned off, the armature swings back to its open position, the *B* power unit or power amplifier is turned off, and the trickle charger again connected. The series type relay has one drawback, however, due to the fact that it introduces resistance into the filament circuit of the receiver. The tubes in the set require 5 volts, and usually .25 amperes each, with .5 ampere for the power tube. With the storage battery averaging 6 volts, only 1 volt drop can be permitted in the relay windings and battery leads. Assuming that the set is a 5 tube set, with a power tube, the filament current is 1.5 amperes, and by simple figuring we find that the maximum permissible resistance of the relay winding is .66 ohms. If the set had 8 tubes, with 2.25 amperes filament drain, and this is not uncommon with

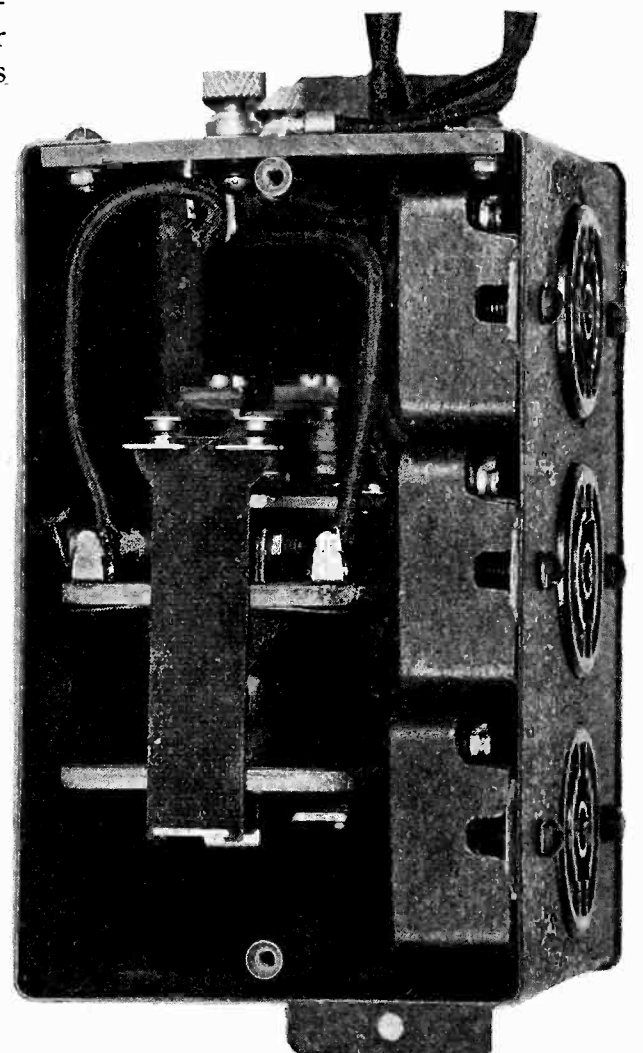

Fig. 3. Shunt Relay, with Three Power Circuit Contacts.

in Fig. 4. This type of relay has a rather high resistance, and does not draw as much current from the *A* battery as a single vacuum tube, so that its use will not be detrimental to the battery. As can be seen from the picture, a set of
(Continued on page 62)

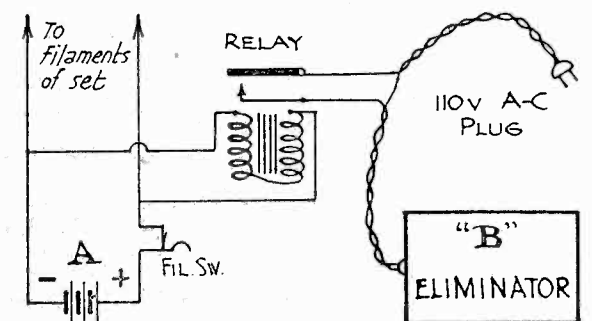

Fig. 4. Circuit Connections for Shunt Relay.

Noises in Radio Receivers

By George Imlach

Noises arising from causes within a radio receiver are due either to defective apparatus, microphonic tube effect, or to oscillation.

The crackling noises often mistaken for static are generally due to old *B* batteries. If any one of the 15 or 30 cells in a dry cell block is run down or polarized, amplification of the resulting voltage fluctuations causes crackling in the loud speaker. This can be tested by substituting a new battery. Any battery showing less than 60 per cent of its initial voltage is suspicious. If the voltage is nearly up to par the fluctuations may be minimized by shunting a 1 mfd. paper condenser across its terminals.

The next place to look for trouble is in the *A* battery. If dry cells are used, the only remedy is replacement. In the case of a storage battery, noises are likely to arise when the battery is old, particularly if it is of a cheap make. Noises may not be noticeable when the battery is fully charged, but, on beginning to run down, noises will set in due to irregularity in the discharge, frequently caused by the collection of gas on the plates. A new battery is the only real remedy. Temporary relief may be had by shaking the battery and refilling with new acid.

One of the most troublesome pieces of apparatus is the grid leak. Those made of India ink and pencil lines are notorious for their fluctuations in resistance values, these variations being mostly due to climatic changes. Grid condensers are also likely to cause trouble. If replacement of the grid leak does not eliminate the noise, short-circuit the grid condenser and connect the grid return to the negative side of the detector tube. If the noise is still present it is safe to assume that the grid condenser and leak are in good condition.

Audio transformers with poor insulation will cause any amount of trouble. This applies particularly to insulation in the primary winding and between the windings. These noises may often be reduced by connecting all transformer cores to either the positive of the *B* battery or to ground. The remarks about grid leaks apply equally to resistances in resistance coupled amplifiers, which should be of the best quality and of sufficient current carrying capacity.

All wiring in the set should be rigid and all connections tight. Soldered connections are liable to cause noises, these connections becoming loose or making bad connections due to a coating of flux remaining between the solder and the wire or the two wires at the joint.

Binding post strips should be made of high grade material. The majority of those on the market are made of compo-

sition and, when it is realized that the *B* battery voltage is placed across only an inch or so of this low insulating material, it is obvious that noises will be greatly enhanced.

When plug-in coils are used, the coil and coil-holder prongs should be well cleaned. This also applies to tube prongs and socket springs. See that sufficient tension is placed on the springs to enable a good connection to be made with the tube prongs.

A certain amount of vibration of the elements in the tube will be present where the receiver is subject to vibration. This movement of the grid with respect to the plate and filament will cause fluctuations in the value of the current passing through the tube, thus causing clicks in the loudspeaker. Microphonic noises have been eliminated to a large extent by the manufacture of sockets with cushioned bases, utilizing either springs or rubber. Where a radio set is subject to vibration, such as on board ship or in automobiles, the tube sockets should always be of the cushioned type.

Bad tubes cause quite a large amount of microphonic noises. It is not unusual to see a person spending a hundred dollars on a radio set and putting in cheap tubes of a questionable make. A good set deserves good tubes and enables the receiver to work at a maximum of efficiency.

Irregularity in electron emission from the tube filament also cause variations in the current passing through the tube. These irregularities are probably due to surface impurities of the filament. Unfortunately the noise due to these irregularities is not capable of remedy at the hands of the operator of the receiver. Until these irregularities can be overcome in the laboratory we will still have a certain amount of noise from this source.

When tuning in to a station with the receiver oscillating, a whistle will be picked up. This is the result of the local oscillations in the receiver heterodyning the carrier wave of the transmitting station. When the station is brought in as well as required, the local oscillations should be eliminated, either by slackening the tickler coupling, placing positive grid bias on the radio frequency tubes by means of a potentiometer, or by turning down the rheostats of the radio frequency or detector tubes, depending on the type of set in use. The transmission should then come in clear without the whistling.

Occasionally a whistling noise will be due to a BCL tuning in to the same station with his receiver in a state of

oscillation, or to two broadcast stations heterodyning each other. These noises are difficult to eliminate, as it is no easy matter to find the culprit who listens in with his set oscillating; and with the present crowding of the air on the broadcast band it is to be expected that interference between stations to some extent will be present. Squealing may also be caused by excessive regeneration. The remedy is obvious; cut down regeneration.

Audio frequency howls may be caused by placing the audio transformers too close together. To stop the squeals increase the distance between the transformers. Placing a condenser of approximately .0005 mfd, or a resistance of 1/10 to 1/2 megohm across the secondary of the last transformer will assist in eliminating howls in the audio frequency amplifier.

A receiver may be made to oscillate at audio frequency by increasing the value of the grid leak, or by using no grid leak. If the receiver is made to oscillate at radio frequency, the oscillations will build up a negative charge on the grid, but, as the grid leak will be of high value, this negative charge will not be able to leak off fast enough. The result will be a building up of the negative charge on the grid of the tube until the grid becomes so negative that the receiver stops oscillating. The negative charge will now gradually leak off the grid until a value is reached where the set begins to oscillate again. The negative charge will again build up on the grid and the same cycle of operation will go on. The frequency at which this charging and discharging of the grid occurs depends on the value of the grid leak and, to some extent, the temperature of the filament. This causes an audio frequency note or squeal to be heard in the phones or loudspeaker. To eliminate this type of audio howl the grid leak should be reduced in value, which, for general purposes, should be around 2 megohms. Too high a value of grid condenser will also cause this effect.

AUSTRALIAN BROADCAST NOTES

2FC has reduced its wavelength from 1,100 to 442 meters. Its power is 5,000 watts. The children's hour commences at midnight and the regular evening session at 2:00 a. m. P. S. T.

Station 2BL (Broadcasters Ltd., Sydney) has increased its power to 3,000 watts. Transmission times similar to 2FC.

2GB (Theosophical Broadcasting Station, Ltd., Sydney) is now transmitting on 326 meters with 3,000 watts.

The Simplicity Receiver

An Easily Built, Single-Control Four Tube Set

By C. W. Morris

THE excellent results secured with the L-C circuit, first introduced in October, 1925 RADIO, have created interest in the possibility of assembling the set with ready-made instead of home-made coils. This circuit, which was originated by Dr. Hull of the Bell Telephone Laboratories, is now arranged for single control in tuning local stations. It compares most favorably with any four-tube set as to selectivity, sensitivity and tone quality.

The set consists of one stage of r. f. amplification neutralized by the Rice method and coupled to the detector by an auto transformer, (the so-called Bridge method), a detector with capacitive regeneration, and two stages of transformer coupled audio.

The panel may be either sloping, as shown in the picture, or vertical. Angle brackets are convenient for fastening to the sub-panel or baseboard in either case. The layout in Fig. 2 gives required dimensions. To cut the hole for from the template furnished, with a scribe and drill a number of small holes inside the line, so that with a hack saw blade or sharp chisel the material between holes can be cut out, and the block of bakelite removed. After the hole is cut, the ragged edges can be smoothed off with a flat file, using the line scratched in the panel for a guide.

In fastening the panel to the base-panel, hold the brackets to the back of the front panel with the fingers, until the correct panel slope is obtained, and have someone mark the position of the holes where the brackets are to be fast-

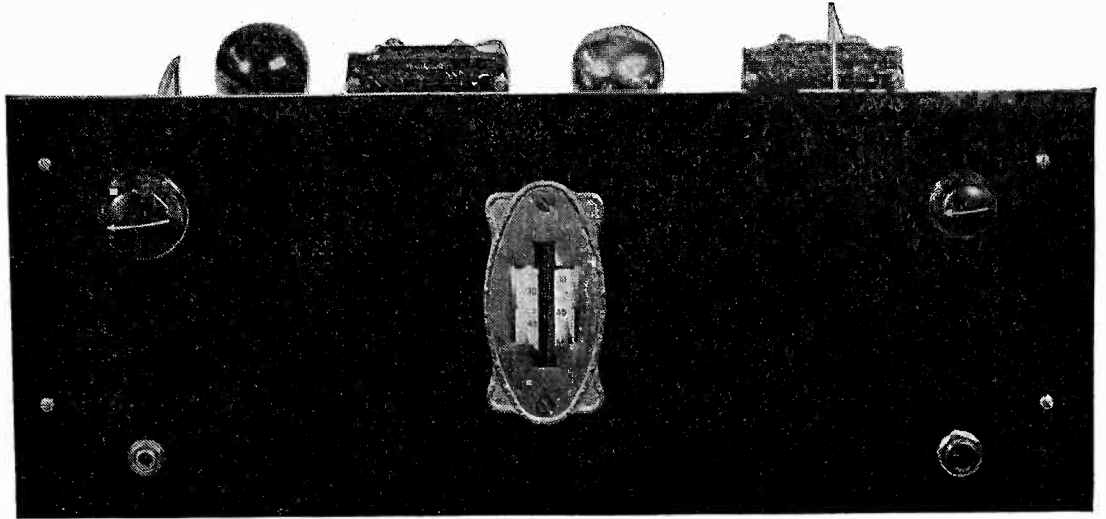

Panel View, Showing Drum Type Dials.

ened to the subpanel. Drill these holes and fasten the brackets to the subpanel, after which the front panel holes can be easily marked, drilled with a No. 27 drill, and tapped for 6-32 machine screws. If bakelite is used for a sub-panel, all mounting holes should be drilled for 6-32 machine screws. If of wood, $\frac{1}{2}$ in. wood screws will be needed.

Fig. 2 gives the complete sub-base layout, showing the relative positions of the apparatus. The arrangement of the audio amplifier is not critical, and may be made to suit conditions. It is important that the r. f. and detector sockets be in the position shown, with the grid condenser fastened directly to the socket grid terminal. The by-pass condenser is placed directly beneath the r. f. transformer, so that the leads to the tap in the coil will be as short as possible. The r. f. chokes are provided with small mounting brackets, where a

wood sub-base is used, but with bakelite base it is only necessary to drill a hole and tap for a 6-32 machine screw, after which the choke may be fastened in place with the mounting screw that passes through its center.

After the apparatus on the sub-base is assembled, the panel equipment should be mounted. The tuning unit must be modified somewhat to adapt it to the circuit used, but the job is not difficult. The secondary of the antenna tuner must be tapped in the center in order to use the Rice system of neutralization, and as the coil has 56 turns, wound on glass rod supports, it is easy to unwind 28 turns, solder in the tap, and wind the turns back on again. Care should be taken not to injure the insulation of the wire, as short circuited turns might result if the insulation is poor. The antenna coil is the left tuning unit, looking at it from the front, and the r. f.

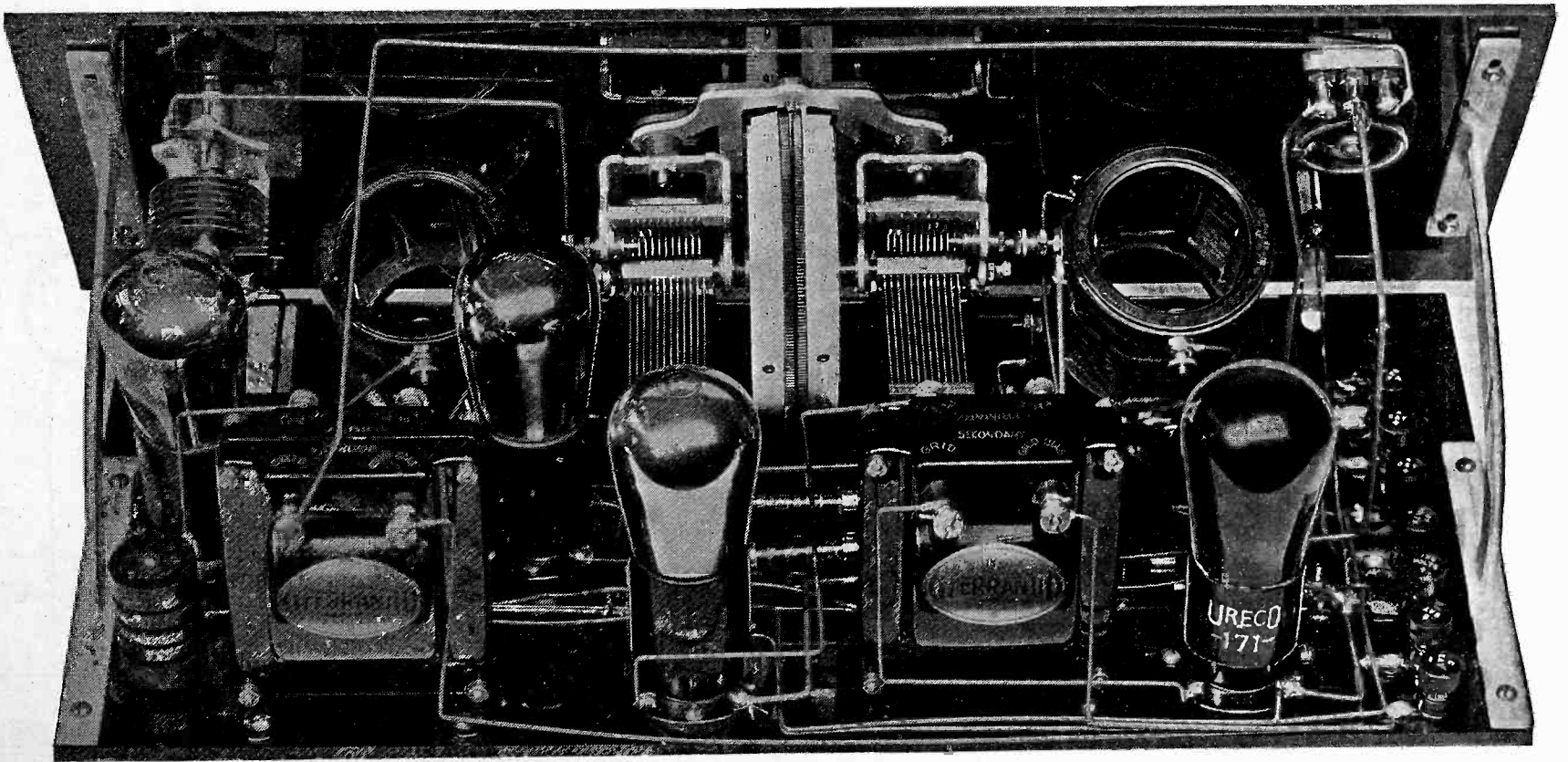

Rear View of Completed Receiver.

RADIO FOR JANUARY, 1927

transformer is at the right. The latter comes equipped with a 10 turn primary, which is wound with green silk wire, and which should be removed. The secondary, which is to be the auto-transformer, has 56 turns, and 19 turns should be unwound so as to bring out a tap. Cut the wire at this point, and bring the two ends to the unused terminals formerly connected to the primary, which was abandoned. Wind back the secondary wire which was removed, and it will be found that there is sufficient wire for only 18 turns, as one turn was used up in bringing out the taps.

The tuning unit has a frame to which the stator plates of the right hand tuning condenser are common, so that in order to prevent body capacity, place fiber washers under the two nuts which hold the condenser to the frame. As the stators are supported on bakelite shafts, the rotor and stator plates of each condenser are completely insulated from the panel front, and no trouble will be had from hand capacity effects.

In case the auto-transformer method of coupling is not wanted, or the constructor does not care to tap the r. f. transformer, a Model CF tuning unit may be substituted for the one specified. The r. f. transformer in the Model CF has three windings, for primary, secondary and tickler, wired in the same manner as specified for the Sargent series of circuits recently published in RADIO. This method of connection is shown in the Queries and Replies Department of this issue, and differs from the "Bridge" method only in the use of a separate primary.

In wiring the set, using the diagram shown in Fig. 1, the filament, negative C and positive B battery leads are arranged in compact form, cabled if desired, using insulated wire. The leads to the r. f. transformer and r. f. amplifier tube should all be as short and direct as possible, especially the feedback and grid leads of the detector, and the wiring to the 1 mfd. by-pass condenser. The neutralizing condenser is mounted on the sub-base close to the

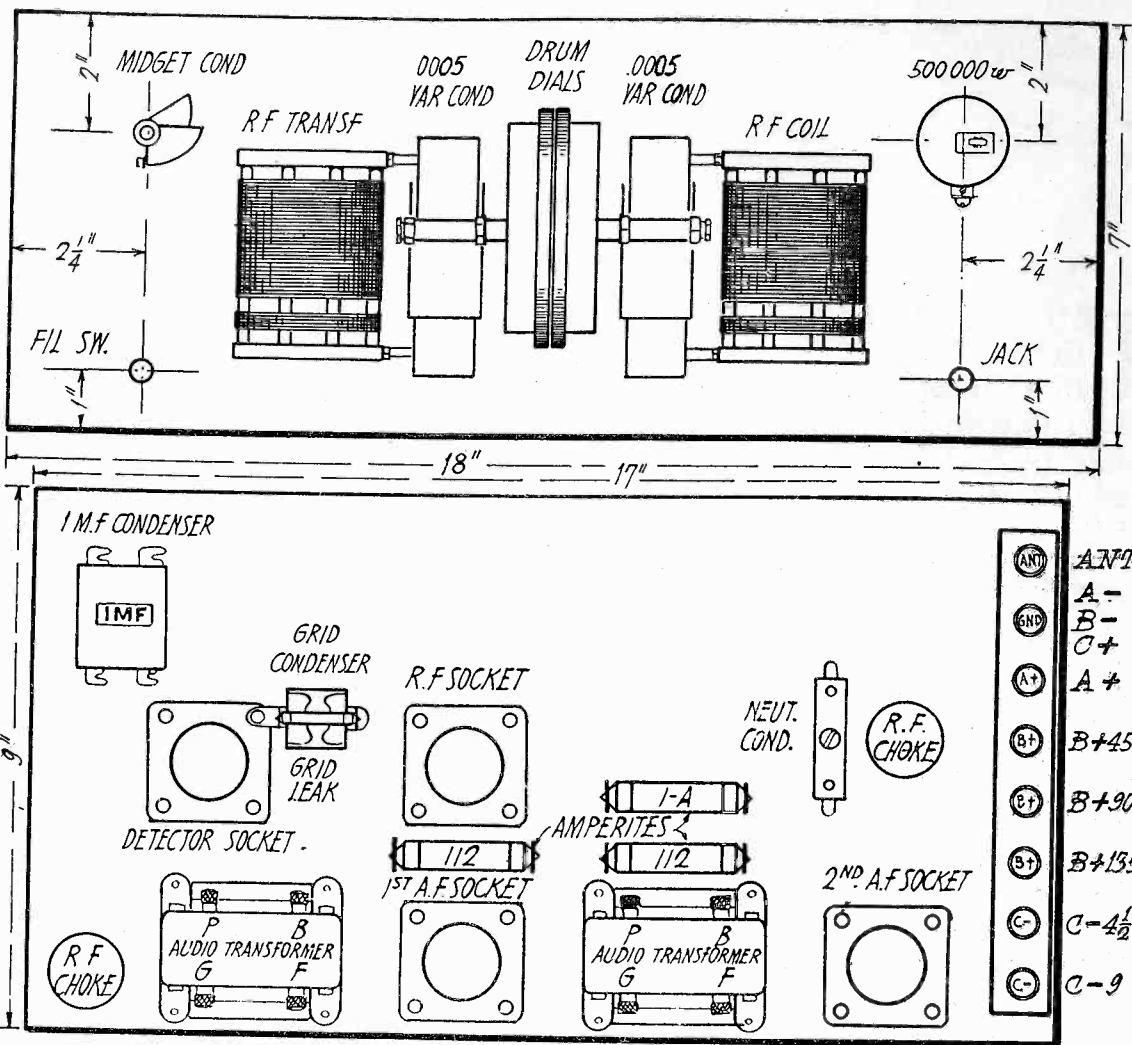

Fig. 2. Arrangement of Sub-Base Apparatus, With Panel Drilling Instructions.

antenna tuning unit, so that the wiring will be very short.

As the C batteries are mounted external to the set, an r. f. choke is placed in the grid return lead of the r. f. amplifier tube, to prevent r. f. currents from entering the C battery circuit, and at the same time stopping undesirable oscillating conditions occasionally found in r. f. amplifiers, in the same manner as was described in the Equamatic system published in October RADIO.

There are no connections which cannot be made with the panel mounted in place. Volume control can be accomplished by either placing a 20 ohm filament rheostat in the positive lead to the r. f. tube, in place of the Amperite, or by the use of a variable resistance across the secondary of the first audio transformer, the latter being shown as the most practical.

To prevent any possibility of the audio amplifier howling, it is necessary to ground the frame of each audio transformer. The Ferranti transformer has a terminal marked "Earth," near the bottom of the case, and this terminal should be connected to the negative A battery binding post. If the transformers do not have such a terminal, a soldered connection to the metal case will suffice. In order to reduce the number of binding posts needed, the A post is also used as the -B, plus C and the ground connections. Usually the -B and -A connection is made at the batteries, and this reduces the number of wires coming to the one post.

The usual precautions for testing the wiring before connecting the B batteries should be followed. The most satisfactory method is to connect the -A bat-

(Continued on page 56)

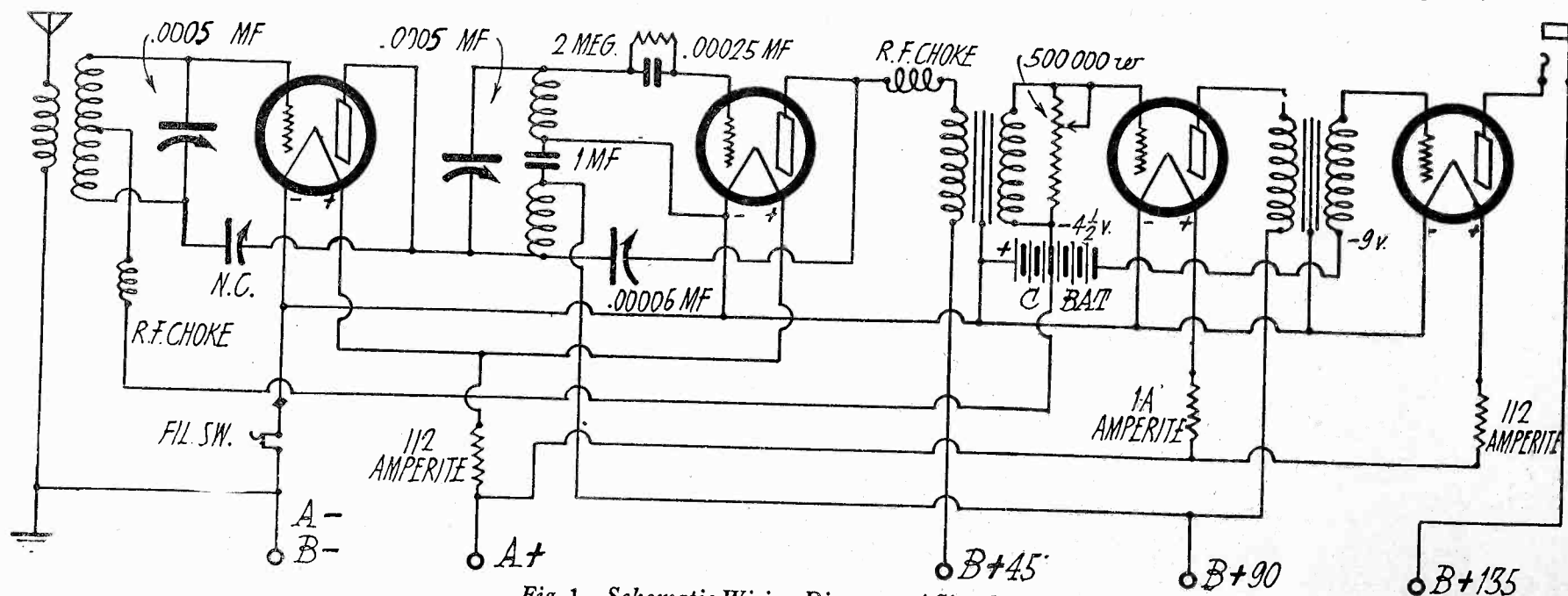

Fig. 1. Schematic Wiring Diagram of Simplicity Receiver.



QUERIES *and* REPLIES



Questions of general interest are published in this department. Questions should be brief, typewritten, or in ink, written on one side of the paper, and should state whether the answer is to be published or personally acknowledged. Where personal answer is desired, a fee of 25c per question, including diagrams, should be sent. If questions require special work, or diagrams, particularly those of factory-built receivers, an extra charge will be made, and correspondents will be notified of the amount of this charge before answer is made.

Have built a Sargent 4-tube set as described in May RADIO, except that I used transformer coupling in the last audio stage. Sometimes the quality is mushy, and not clear. Would like a diagram of this circuit with transformer coupling, and with a stage of tuned r.f. ahead of the present r.f. stage. Would a crystal detector give superior results to a vacuum tube in this circuit? Is a stage of regenerative r.f., capacity controlled, practical?—A. M. B., San Anselmo, Calif.

A circuit similar to the Sargent 4-tube receiver, with two stages of tuned r.f., regenerative detector and two stages of transformer coupled audio, is shown in Fig. 1. As some of the parts recommended for the original circuit are no longer made, the r.f. transformers, particularly the regenerative r.f. transformer, should be changed to a type now available, such as the Silver-Marshall type 110-A for the straight r.f. transformers, and the 111-A for the regenerative transformer. A crystal detector would not be appropriate for use in this particular circuit, especially if regeneration is desired. A high-grade crystal usually gives about the same results as a non-regenerative vacuum tube. Capacity controlled regeneration is practical, provided that an r.f. choke is employed as shown in Fig. 1, and the feedback condenser is large enough to enable regeneration at the upper end of the broadcast wave-band.

Have a 6-tube factory built super-heterodyne and wish to know of a good "A" and "B" battery eliminator to use with it; one which is not very expensive.—W. A. R., Berkeley, Calif.

The only real A battery eliminators on the market are all expensive. A number of reasonably priced A battery combinations consisting of charger, filter circuit, small storage battery, and operating relay, are now on the market, and permit noiseless reception. They all contain storage batteries, however, and

cannot rightfully be called A battery eliminators. The number of bona fide B battery eliminators are legion, and many have been described in detail in RADIO. Types using the Raytheon tube are very popular at the present time, and can be obtained ready made, or you can put one together yourself from the instructions given in these columns in past issues.

Have built an electrolytic B eliminator as described in RADIO by Clinton Osborne, and get fine results from it. I want to increase the voltage delivered by the rectifier, and improve the filter at the same time. How may this be done?—C. W. V., Oakland, Calif.

The maximum output voltage is about twice the line voltage, or around 230 volts. To increase the voltage above this value, you will require a step-up transformer. One having a 110-volt primary and a 200-volt secondary would give you nearly 400 volts output, and such a transformer, designed for use with the Raytheon tube, is easily obtained. It would be best to add at least one rectifier jar to each side of the present set of four jars, in order to insure safe operation of the rectifier. These jars need not be large in size, but may be made up out of large size jelly glasses, with electrodes 4 or 5 in. long.

In March, 1926, RADIO was published the circuit of the modified Browning-Drake receiver. What type of coils can be used with this set, and how are they constructed? Would also like to know the type of coils used by Sargent in his two-tube set described in February 1926 RADIO. Are aero coils procurable in RADIO.—C. Y. S., Cootamundra, N. S. W., Australia.

A set of National Browning-Drake coils and condensers is recommended for this set, and the following dimensions are reprinted from RADIO, in case you wish to construct the coils yourself. The antenna coil consists of 50

turns of No. 20 double silk wire wound on a piece of 3 in. bakelite tubing, 5 in. long. It is tapped at the center so that different adjustments for the particular antenna in use may be made. The r.f. transformer is made up of three windings, primary, secondary and tickler. The secondary consists of 75 turns of No. 20 double silk wire, wound on a 3 in. bakelite tube 5 in. long; the primary is made by winding 24 turns of No. 30 d.c.c. wire in a slot cut in the tubing, at the filament end of the secondary winding. The tickler consists of 30 turns of No. 28 silk or cotton covered wire wound on a 2 in. piece of tubing 1 in. long, and placed inside the secondary coil, in such a manner that it can be rotated with respect to the secondary by means of a shaft projecting through the panel. The antenna coil is tuned with a .0005 mfd. variable condenser, and the r.f. transformer secondary with a condenser of .00035 mfd.

A suitable coil for the Sargent 2 tube set would be the Silver Marshall Type 111-A, as the coil originally used is no longer made.

Have a secondary winding of a power transformer, consisting of two sections of 2750 turns each of No. 31 enameled wire, with inside diameter 1½ in. Would like to use this secondary on an appropriate core for "B" eliminator service, and want the data on the core, the primary winding and the filament lighting secondary for 5 or 7½ volt filament tubes.—E. L. McCULLOUGH, Chicago, Illinois.

Using the secondary on hand, and a core made of commercial grade of silicon steel, the primary winding should consist of 550 turns of No. 20 or 22 cotton enameled wire, wound on one leg of a core 1¼ x 1¼ in. cross section, and with a square window large enough to clear the two secondary windings plus the primary and secondary to be added. Ordinarily, for such a transformer, a window 2x3 in. is sufficient. The filament lighting sec-

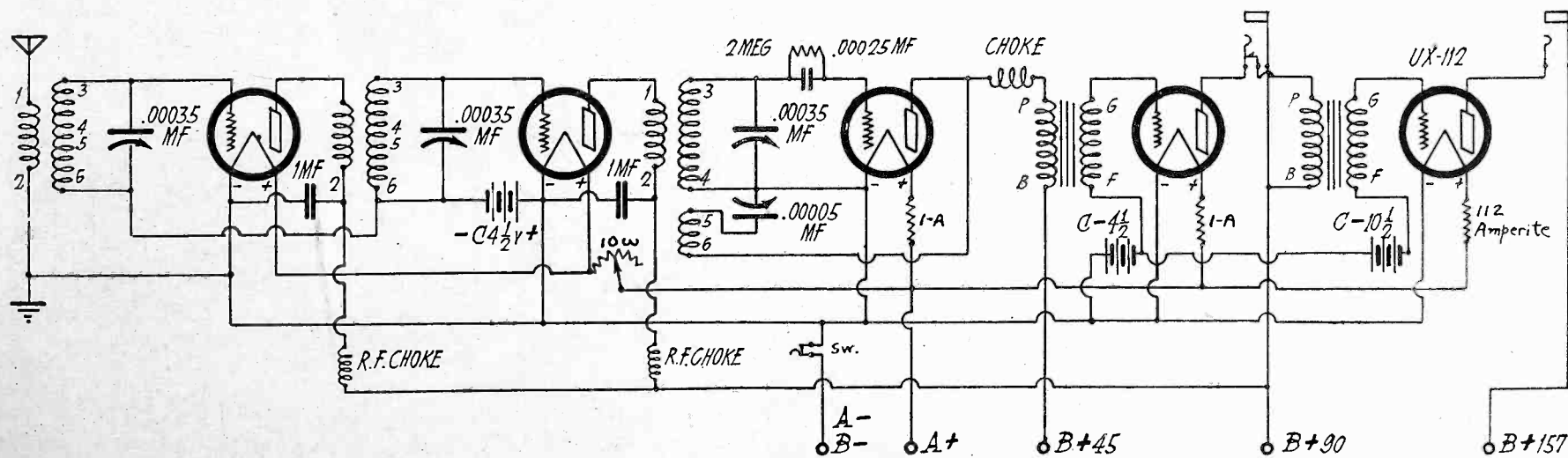

Fig. 1. Five Tube Receiver With Regenerative Detector.

CENTRAL AMERICAN SKEDS

By F. E. BEAULIEU

On a vessel on the South American trade from West Coast ports it is often very difficult, and sometimes impossible to get traffic off via KFS or KPH, due to the heavy QRN, especially in the summer time. The T. R. T. has a chain of stations in Central America which give very good service to ships on that run that are equipped with arc apparatus. They relay direct to WNU.

Following is a list of these stations, their calls, and the wave they work on. Also some of their listening in schedules.

Name of Station	Works on Meters
Almirante, Panama	Call—UB 600-1200-4075
Bluefields, Nicaragua	Call—UQ 600- 950-1850-2100
Cape Gracias, Nicaragua	Call—UW 650-2000
Cartago, Costa Rica*	Call—UR 600-2200-4235
Limon, Costa Rica	Call—UX 600-1425
Managua, Nicaragua	Call—UL 600-1800-2400-4600
Puerto Castilla, Honduras**	Call—UA 600- 775-1000
Swan Island, Caribbean Sea	Call—US 600- 650-2400
Tela, Honduras***	Call—UC 600-2400
Tegucigalpa, Honduras	Call—UG 600-1950-4330

*Accounts should be rendered to Compania Radiografica Internacional de Costa Rica, First Nat. Bank Bldg., Boston, Mass.

**Accounts should be rendered to Truxillo Railroad Company, 1 Federal Street, Boston.

***Accounts should be rendered to Tela Railroad Company, 1 Federal Street, Boston.

Time	Station	Wave	Schedule
0530	UR	2200	TFC List. Ans. 2100
0545	US	2400	TFC List. Ans. 2400
(Spark)			
0600	UL	2400	TFC List. Ans. 2100-2400
0615	UL	2400	TFC List. Ans. 2100-2400
0615	UC	2400	TFC List. Ans. 2400
0630	UR	2400	TFC List. Ans. 2400
0700	UF	2100	TFC List. Ans. 600
0715	UC	2400	TFC List. Ans. 2400
0800	UC	2400	TFC List. Ans. 2400
0820	UR	2200	TFC List. Ans. 2100
0900	UL	2400	TFC List. Ans. 2100-2400
0930	UC	2400	TFC List. Ans. 2400
1030	UC	2400	TFC List. Ans. 2400
1130	UL	2400	TFC List. Ans. 2400
1145	UL	2400	TFC List. Ans. 2400
1215	UC	2400	TFC List. Ans. 2400
1300	UR	2200	TFC List. Ans. 2100
1330	UC	2400	TFC List. Ans. 2400
1415	UF	2100	TFC List. Ans. 600
1450	UC	2400	TFC List. Ans. 2400
1500	UL	2400	TFC List. Ans. 2400
1515	UL	2400	TFC List. Ans. 2400
1600	UC	2400	TFC List. Ans. 2400
1615	UR	2200	TFC List. Ans. 2100
1830	UC	2400	TFC List. Ans. 2400
1930	UC	2400	TFC List. Ans. 2400
2040	UB	4300	TFC List and Weather
2000 to 2200	UC	2400	Listens in on 2400

All schedules in 120th Mer. Time (S. F. Time).

secondary for 5 volt tubes would consist of 27 turns of No. 16 or 18 cotton enameled wire, and for 7½ volt tubes the winding should have 40 turns of No. 16 cotton enameled wire, both windings being center tapped. This type of transformer would be suitable for use with the new Raytheon BH tube, as the voltage of each secondary winding under load would be at least 400 volts.

Why does my Browning-Drake receiver not tune below 275 meters when the condenser is not in the antenna circuit? Why does the acid in my trickle charger turn black after considerable use?—L. E. H., San Francisco, Calif.

Your antenna system, used in connection with half the inductance of the antenna coil, undoubtedly has a fundamental wave length around 275 meters. By placing a condenser of small value in series with the antenna, this fundamental is cut to a point below 200 meters, and you can then tune through the entire broadcast wave-band. The acid in your charger should not change color if the acid were free from contamination when placed in use, and the jar and rectifier elements free from dirt. Trickle chargers using borax or other salts will occasionally form a compound which is black, and causes the solution to become muddy. When the solution becomes opaque it should be discarded and new solution prepared.

I have a number of grid leaks which I would like to check and throw out those which are noisy or otherwise defective. As many of them are of the wrong value for use with the regular grid condenser in a detector tube circuit, I cannot test them for noise in the customary manner. Please publish a circuit for testing the leaks.—F. A. H., St. Louis, Mo.

The easiest method is to remove the first audio amplifier tube from your set, and temporarily disconnect the leads to the primary winding of the second audio transformer. Connect the leak to be tested in series with a 45-volt B battery, if its resistance is from .5 megohms up, and place the combination across the primary terminals of the transformer. With the last audio tube turned on, and working properly, listen in with a pair of headphones. If there is a scratching or unsteady hissing sound in the phones, the leak is defective, and should be discarded. If the leak is below .5 megohms, the B battery placed in series with it should be reduced to 22 volts.

Please publish the circuit for a stage of r.f. amplification ahead of the Pressley Superheterodyne. I expect to use type 99 tubes throughout, except a type 112 tube in the power stage. Wish to use a loop, if practicable.—W. L. J., San Jose, Calif.

The circuit for the Pressley Super, with the stage of r.f. ahead of the first detector-oscillator tube is shown in Fig. 2. The actual construction of the r.f. amplifier is the same as for the one described in June 1926 RADIO, the two r.f. coils being wound on 2 in. tubes, with 90 turns of No. 26 enameled for each

secondary, and a primary on a 1 in. tube, with 25 turns of No. 30 silk covered wire. It is assumed that you are using a set of standard parts as originally specified for this particular superheterodyne, and hence the terminal markings for the transformers and other coils are taken from the original diagram.

Have an 8 tube unshielded Best Superheterodyne using Remler transformers. Would they work in the superheterodyne described in October RADIO, and could the large tubes be used in the oscillator and first detector to better advantage than the 99 tubes?—L. S. M., Los Angeles, Calif.

It would be preferable to use transformers having a closed core, in the shielded model described in October RADIO. The Remlers have an open iron core, and are designed for baseboard model sets, and with type 99 tubes only. No advantage would be gained by using the large tubes in the positions you mention.

Have built a 5 tube r.f. set according to diagram I am sending. The amplifier rheostat is very critical, but the detector is not. Can the set be improved in any way? Will a C battery help and where should it be placed?—D. L. S., Ardmore, Pa.

Your circuit is more or less standard for a 5 tube tuned r.f. set. A C battery should be inserted in the grid return circuits of the two r.f. amplifier tubes, by disconnecting the present grid return wires of the first and second r.f. transformers, connecting the two grid return terminals together, and to the negative of a 4½ volt C battery. The positive of the C battery should be connected to the negative end of filament. A 200,000 ohm variable resistance placed in the B battery positive lead to the r.f. amplifier would be a better control of sensitivity and volume. A 1 mfd. bypass condenser should be connected between the positive B bus bar wire to the r.f. amplifier, and the negative filament bus bar wire.

I have a 40 ampere hour Edison 5 cell battery which does not seem to hold its charge very long. What should be done to the battery to make it hold the charge for at least a week, using the battery at 1 ampere drain, 2 hours a day?—F. P. T., Chicago, Ill.

Your battery probably needs new solution, or it has become sluggish due to low charge and discharge rate. Try the following suggestion before having the solution changed: short circuit the terminals of the battery together, until the battery is totally discharged. This may take some time if the cells are sluggish. Then charge the battery backwards for a few hours, using at least a 5 ampere charging rate. Then reverse the battery again, and charge in the proper direction for at least 24 hours, after which it should deliver its rated capacity, and hold the charge over a considerable period of time. If the battery is still sluggish, it should be taken to an authorized Edison service station, where the solution can be changed.

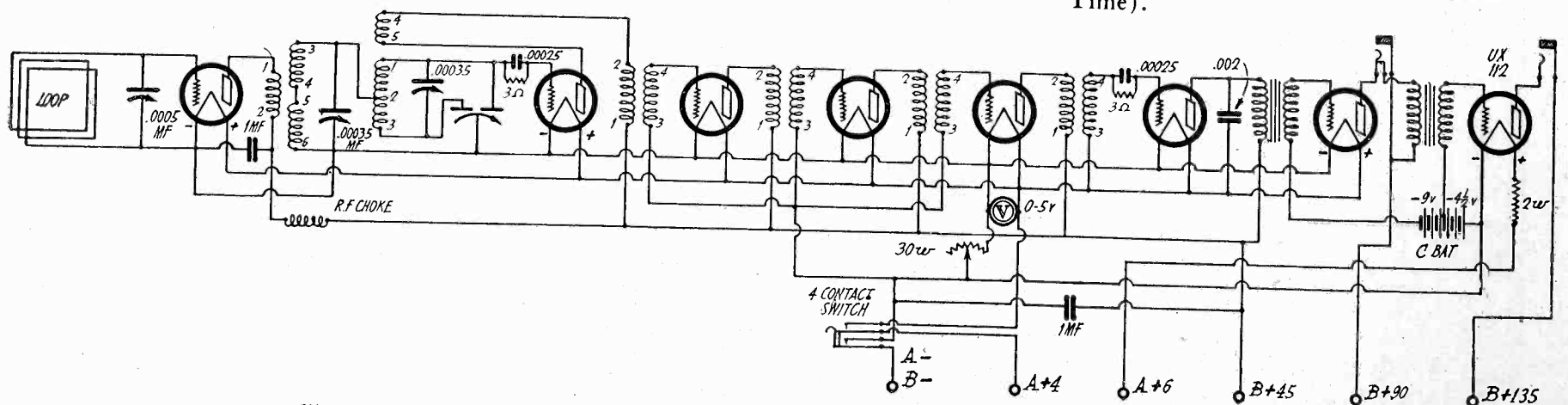
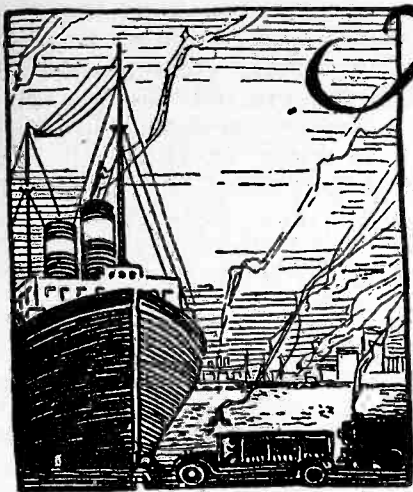
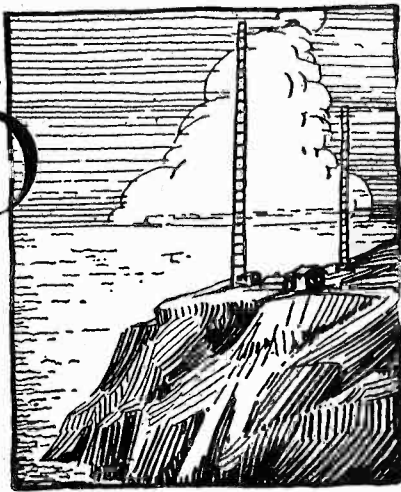

Fig. 2. The Pressley Superheterodyne With Stage of R.F. Amplification Added.



The COMMERCIAL BRASSPOUNDER

A Department for the Operator at Sea and Ashore



R. O. KOCH, *Great Lakes Correspondent*

Edited by P. S. LUCAS

C. W. RADOS, *Boston Correspondent*

BEING A BRASSPOUNDER

We hope no one will take this little editorial in the light of a Sunday school lesson. It all started when a couple of us got together and began talking over old times. Before we had been at it ten minutes we caught the sea fever and felt the urge to pack the grip and climb aboard any old hack, bound anywhere. We recalled the pleasure and fascinations of a boat ride out on the big drink, the joyous hours we had passed chewing the rag with the second mate, listening to the splash, splash of a clean, choppy sea slapping against the bows, sampling the offerings of a good cook, breathing air that never finds its way into the heavy atmosphere of cities; and the satisfaction accompanying a good husky time tick, a full sheet of PX or a clear hook following a long night's work. Yep, we'd have given a lot to let go the mud hook, chain and all.

Then, all of a sudden, one of us remembered a certain night he had spent, trying to clear WSH or WCC or any station willing to handle his traffic without sending in a land line bill in four figures, and of how the QRN was smashing in so loud that his ears rang for weeks, and the QRM seemed to be timed just right to smear up the intermissions in the static (such as they were). And then we remembered the time the M.G. got so hot that the solder ran out of the lugs, letting the armature coils go their own way, just before daylight, as we were in the midst of clearing our hook to KFS.

By this time most of our illusions had disappeared, to be replaced by a remembrance of reality; and events were recalled which put

us in a more satisfied frame of mind. (Satisfied, that is, with our anchorage.) Prunes and corned beef; squabbles with the mate; a bunk full of salt water, direct from the ocean; etc., etc. Back to the old, old truth: Compensation.

So, having satisfied ourselves on that question, we tried to determine why men go to sea as wireless operators. No doubt it is partly the lure of the sea and foreign shores; partly the fascination of pounding brass. There are other reasons, of course, but these are probably the most important. Anyone who has ever been to sea knows the thrill of viewing a high-powered storm from the rolling deck of a ship; and the fascination of listening to the outpourings of a good old-fashioned spark or arc transmitter break through with a message. It is so satisfactory to some fellows that they make it their life work. Others make it their life work because, after repeated attempts to get their feet into something ashore, they give it up as a bad job and decide that they were not "meant" to be landlubbers.

Now this last mentioned fact is no light matter. Most sea-going operators, having enjoyed a couple or three years on the ocean, sooner or later make up their minds to settle down ashore and have a home and a family. They have reached their limit as operators, and would have to drop back a couple of notches to learn navigation or engineering, which no one likes to do, even if he should choose one of those occupations. Therefore he goes ashore to settle down.

Unless he can become an operator in a broadcasting station or coast station, he is

usually pretty hard to please; and if he is not prepared for any special line of work, other than radio, he is soon discouraged, or out of funds. After trying it several times he finally resigns himself to his fate and signs on "for life."

When a fellow wants to settle down and work himself up to what is looked upon as success, he should not be cheated out of that right. Yet he, himself, is the only one who can come to his own rescue. Take the fellow who sets aside an hour or so every day in which to develop his mind and his talent along certain lines, he's safeguarding his future. Knowledge is more valuable to a man than insurance. It is something to live for; insurance is just something to die for.

In summing up this spasm, we, who were ruminating on the good and bad of a wireless operator's life, decided finally that with the exception of some experience with foreign lands and peoples, knowledge of radio apparatus and a slight knowledge of shipping, the years an operator spends at sea are practically wasted years, *unless* he has taken advantage of his spare time to prepare himself for his future. An operator has this opportunity, and sometimes takes advantage of it. And he who does take advantage of it, will discover that his years at sea are almost as well spent as if he were at college. A certain college professor remarked, not long ago, that a well-read man is more valuable than the man who just has a college degree. And in a way he was right.

THE BOSTON SITUATION

By C. W. RADOS

The operating companies are trying to get more men. Any operator who needs a ship will be welcomed with open arms in Beantown. The same situation exists in New York. As a result the radio schools are placing misleading advertising again to the extent that operators receive \$35 and \$40 weekly plus board. It would be hi hi if it were not a tragedy to some young fellows.

This is one thing a strong union could stop. A strong association of radio operators would also be in a position to force wage increases. I believe that every radio man should receive as much for his services as the third engineer or mate. In fact, if he received more it would only compensate for his inability to rise to a four stripe job (as an engineer or mate can) and for the fact that he is usually discharged when a vessel ties up, whereas the other officers can be retained. With the tremendous and increasing use of radio for marine commerce the large operating companies are earning large incomes from this work. The shipping company profits by the use of radio and so do the passengers and freight agents. But the operator is paid as little as possible. His only means of getting an increase is by the formation of a strong organization. More power to it.

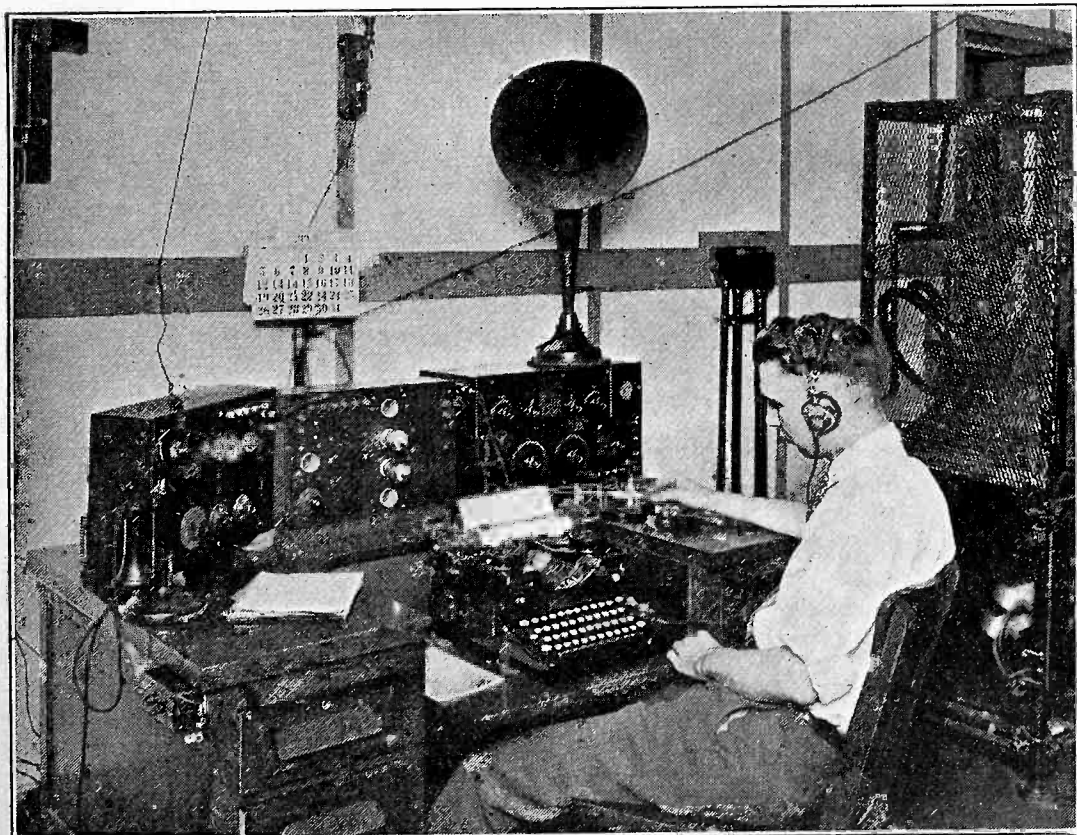

Short and Long Wave Telegraph Receiving Sets and Transmitter Control at WBZ.

TAKING ANOTHER SHOT AT QRM

By CARTA McCORMICK, KDIW

The McCaa band eliminator has not received the attention which its importance deserves, probably on account of the bad name that is attached to all forms of static eliminators. While still in experimental stage it gives better promise of success than any remedy yet proposed. It seems particularly applicable to clearing up code signals.

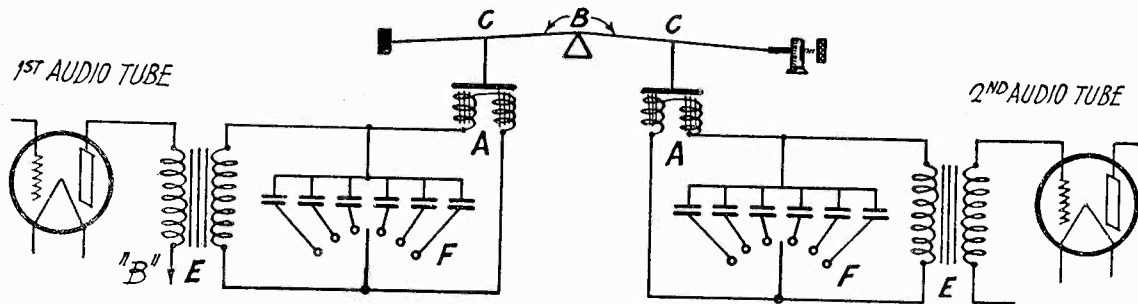

Circuit Diagram of McCaa Band Eliminator.

- A. Baldwin Phones.
- B. Thin steel band (20 in.) with bridge in middle, tuned to frequency of signal to be received.
- C. Connection from phone diaphragm to mid-points of steel band.

- E. Special audio transformer.
- F. Bridging condenser to introduce resonance into tank circuit; not touched after first adjustment for best signal strength.

The device is placed between the first and second stages of the audio amplifier. Its function is to pass the audio frequency current to which it is tuned and to suppress all extraneous frequencies. For sparks and I.C.W. this requires an extra adjustment in tuning the band to the tone of the signal.

Its mode of operation is self-evident from the circuit diagram and caption. I have seen one of these working and should like to see more of them, as it really helps present conditions on 600, 715, and higher waves.

WHO'S WHO AND WHERE

"Sparkplug" Guersdorff, after shaking down the Hobart building in San Francisco, decided that L. A. wasn't so bad after all, so is back splitting the ether with the Clearwater point to point arc.

Victor Kemp, who was on the *Solano* when she went ashore at Purissima Point, just five miles north of the place of the famous "Destroyer Destruction," if we may call it that, a few years ago stood watch for 72 consecutive hours. When the excitement was all over he was pretty well played out, and the Associated Oil Company, owners of the *Solano*, awarded him with a fifty-dollar bonus for his excellent service.

Maurice Kennedy, after making two round trips to Mexico on the *Oaxaca*, was relieved by Tommy Judson of the *Emma Alexander*.

KNT, the *Fisherman*, has been QSO, 6API, 6DDO, 6MU and others on the 40-meter band steadily since leaving. She was last reported 1100 miles SE of KSE.

The *La Brea* continues to hold her own with the best of 'em. Last trip she was QSO, KFS 200 miles up the Yanktse Kiang, on her way to and from Hankow. She was never out of communication with KFS all trip. Leo Shapiro is still aboard her.

H. R. Packwood, ex-SS. *Liebre*, has just returned from South America on the *Coalinga*.

FAMOUS MISTAKES ON THE GREAT LAKES

WG for WME; WQ for WTK; JL for WTL; 1W for WMW; WFTS for WFB; WM 2 for WMIO; WMJ for WGO; WTKF for WQF; WTKE for WQE; C for TR.

Zlwaukee for Milwaukeee; Gnominee for

(Continued on page 48)

THE PASSING OF THE SPARK ON THE GREAT LAKES

By C. O. SLYFIELD.

Here's a fine story of the Great Lakes Situation. Looks as if some of the other sections of the country had better step on it if they want to keep up to date. By the way, why don't some of you other old-timers shoot us a line about your section of the country?

Not so many years ago, and yet it seems a long time, the raucous notes of the old

marks whenever a spark set would start operating and "gum up" a program to which they were listening, little realizing that these spark stations had been operating years before broadcasting was ever thought of. Finally, considerable pressure was brought to bear on the companies controlling these spark stations and, in order to co-operate with BCL's and keep pace with the rapid strides which radio was making, these companies began to consider the possibilities of discarding the spark sets and replacing them with modern tube equipment.

To either WTK (Cleveland) or WLC (Rogers City, Mich.) goes the honor of being the first to change from spark to modern tube apparatus. These installations were closely followed by those at WSK (Sheboygan, Wis.) and WGO (Chicago).

The spring and summer of 1926 have been eventful ones on the Great Lakes insofar as elimination of spark transmitters is concerned. During this period, practically all of the shore stations of the Canadian Marconi Company were equipped with powerful tube transmitters which, by the way, are a great improvement over the broadly tuned spark sets which they had used for many years. During the summer, modern tube transmitters replaced the spark sets at WOH (Manistique, Mich.), WMW (Manitowoc, Wis.), WFK (Frankfort, Mich.) and WLD (Ludington, Mich.) in the order named. On October 1st, the Radio Corporation placed a CW-ICW transmitter in commission at Cleveland (WCY) which is now working on low power but which, we are informed, will shortly blossom forth with 2 kilowatts which should tear an awful hole in the ether surrounding these Great Lakes. Also, before you read this article, a new CW-ICW installation will have been completed by the Ann Arbor Railroad Company at Menominee, Mich., which will have one of the same efficient type of transmitters as those now in use at WOH, WMW, WFK and WLD.

The shore stations WOH, WMW, WFK and WLD are all equipped with RCA Type ET-3634 CW-ICW transmitters employing one UV-211 (rated at 50 watts) as a master oscillator and four tubes of the same variety as power amplifiers. These transmitters are equipped with Leach break-in relays which make them especially adaptable for speedy traffic handling.

In addition to the shore station conversions, the seven car ferries of the Pere Marquette Railway Company and the five car ferries of the Ann Arbor Railroad Company, all plying on Lake Michigan, have thrown their spark transmitters into the discard and in their places appear neat little 100-watt ACW RCA transmitters.

Fellows, there is no argument as to the relative efficiency of the spark and tube transmitters, but don't you feel sometimes as though there is something sadly lacking now that all of these famous old spark transmitters have gone into oblivion? Their notes were distinctive and practically every operator who had served on the Great Lakes for any length of time could tell what station he was hearing before that station had signed. The old rotaries made lots of noise in the stations and created a great deal of interference to other services, but, after all, there was a certain amount of satisfaction in sitting down, poking the key and hearing and seeing that ball of lightning which started the signal on its way. True enough, the old gaps were hard on the ears of the radio inspectors when plotting resonance curves and taking readings, but after all, fellows, it will take us a little while to get accustomed to the whirr of a motor-generator instead of those old spark gaps which absorbed all the abuse we wanted to give them and seldom complained.

straight gaps of the American Great Lakes radio stations were suddenly and completely transformed into what seemed music to our ears by the addition of non-synchronous rotary gaps. Previous to this time, we had listened to and admired the musical notes of the Canadian stations which were using 240 cycle synchronous transmitters. But to have something in our own service of this nature was, indeed, a welcomed addition.

It was in July, 1915, I believe, when this revolutionary (in our estimation) change came about and I am wondering if any of you fellows who were pounding brass on the Lakes at that time experienced the thrill that was mine. I happened to be tuning in on the old type "D" tuner on WDP and adjusting the cat-whisker on the carborundum detector (it was really silicon but we were cautioned, in a low breath, to swear by all that was right and good, that it was carborundum on account of the patent situation) when WFK put on the rotary gap and started to test. It certainly was a treat to listen to that musical note after having strained our ears and almost ruined our nerves trying to decipher the notes of the old straight gaps, especially so during the summer months when static conditions were at their worst.

We really thought at this time that these transmitters had just about reached the height of perfection and I believe they had, for there was nothing done to them except improve their general efficiency in the ten years which followed.

Close on the heels of this change, the ship stations were also equipped with rotary gaps, these transmitters remaining in general use until the summer of 1920 when the Radio Corporation brought out a small, compact $\frac{1}{2}$ K.W. 500 cycle transmitter to which they attached the name Q.M.S., meaning *quenched multiple spark*, and which some one quite appropriately dubbed QRM transmitters. These transmitters were of the vest pocket variety and could be installed in exceptionally small space and were practically noiseless in the radio room, but created quite a disturbance in the ether. About 1923, the Intercity Radio Telegraph Company replaced many of the old rotary sets still in use with $\frac{1}{2}$ K.W. and 1 K. W. panel sets which practically eliminated all rotary gaps on the Lakes except those which were still in use at the coastal stations.

Broadcasting having grown to such an extent that it had become an industry in itself, created millions of BCL's who were considerably "peevish" and made very displeasing re-

A Short Wave Receiver for the B. C. L.

By G. M. Best

THE increasing number of kits and circuits for reception in the waveband from 20 to 150 meters is a good indication of the interest shown by the B.C.L. in the work being done by the amateur, as a large number of these kits are undoubtedly going into the hands of the broadcast fan. With several stations broadcasting good programs on wavelengths below 100 meters, the B.C.L. who cannot understand the code can still have his fun with long distance, short wave reception. Most of the circuits shown in past issues of RADIO have included the short wave tuner, a detector and one stage of audio frequency amplification. As most B.C.L. readers already have at least a two stage audio amplifier, or its equivalent, they are particularly interested in a tuner and detector unit which can be connected to their present audio amplifier with a minimum of complications.

A very compact and easily constructed unit, containing as few parts and connections as is possible, is shown in the pictures, and a brief description of its assembly and operation follows. Practically all short wave tuners are a form of the standard regenerative circuit, with energy fed back from the plate of the detector to the grid circuit by means of a tickler coil. Usually the control of energy is obtained by placing a variable condenser in series with the fixed tickler, instead of having the tickler variable, as is often done in sets for use on the broadcast band. In the circuit shown in Fig.

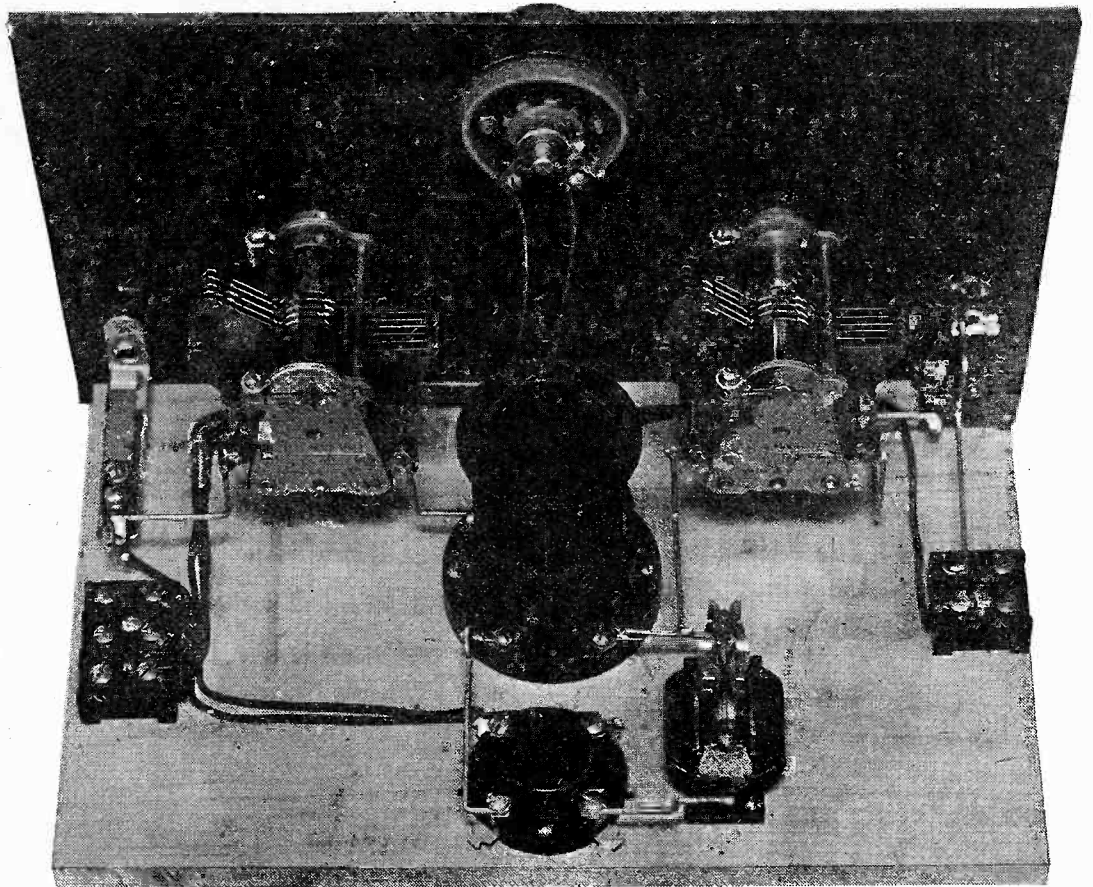

Completed Short Wave Receiver.

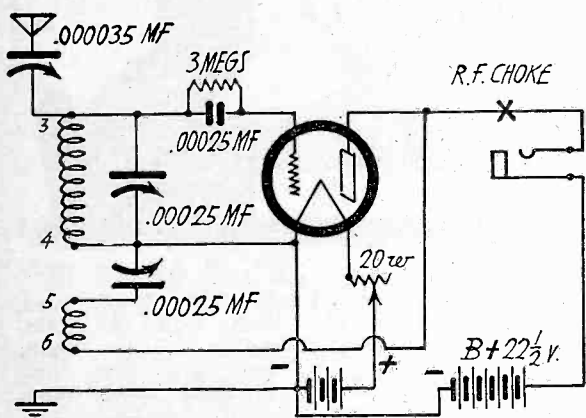

Fig. 1. Schematic Wiring Diagram

1, the tickler and secondary coils are wound adjacent, on a 2 in. ribbed form, which is plugged into a mounting to which the connections to the rest of the apparatus are permanently wired. A set of four coils, with proper turns design, enables tuning over the waveband from 20 to 150 meters, with .00025 variable condenser.

A list of parts showing the apparatus used in the set will give an idea of the small cost of the receiver. The 7x12 in. panel was drilled for a symmetrical apparatus layout, with the two variable condensers placed one at each end, the filament rheostat in the upper center, the antenna series condenser at the lower left, and the output jack at the lower right. On the baseboard, the coil mounting was placed between the two condensers, with the detector tube in back, together with the grid condenser and leak.

The following data are given for the convenience of those who wish to wind their own coils:

Coil No.	Wavelength range	Secondary turns	Plate coil turns
117-P	18-32	4	3
117-O	30-52	8	7
117-N	50-100	13	10
117-M	100-175	26	15

Both coils are wound on 2 in. forms, with a separation of about 1/4 in. between windings.

The antenna is connected directly to the grid terminal of the secondary coil, through a midget variable condenser having a maximum

LIST OF PARTS

- 1 Panel 7x12x1/8 in.
- 2 Silver Marshall variable condensers .00025 mfd.
- 1 Silver Marshall No. 515 coil mtg.
- 1 .00025 mfd. fixed mica condenser.
- 1 3 megohm grid leak.
- 1 Vacuum tube socket.
- 1 Silver Marshall No. 340 midget condenser.
- 1 20 ohm rheostat.
- 1 Electrad single contact jack.
- 4 Silver Marshall coils, Nos. 117 M, N, O and P.
- 1 Baseboard 8x11x1/2 in.
- 1 Silver Marshall No. 275 r.f. choke (optional).
- 5 Binding posts.

of 35 mmf. so that no primary coil is needed. The plate of the detector is connected to the tickler coil, and the output, for phones or amplifier, is connected from the plate to the positive B battery. A radio frequency choke, consisting of 200 turns of No. 28 or 30 cotton covered wire wound on a 3/4 in. spool may be placed at the point shown in the diagram, if the proper amount of regeneration is not obtained over the entire range of each coil, or if an audio frequency howl occurs at certain settings of the plate condenser.

In setting up the outfit for use with a broadcast receiver, it is necessary to remove the detector tube from the broadcast set, and connect the short wave detector tube plate to the P terminal of the audio transformer primary. As the B terminal of the transformer is connected to the 22 1/2 or 45 volt B battery supplying the broadcast receiver, only one wire is needed, so that an ordinary phone plug with a wire connected to the tip terminal can be used. As the jack is of the open circuit type, the connection to the 22 1/2 volt B battery required when a pair of headphones is used, may be left intact, as no short circuit can be had just so long as no connection is made between the other terminal of the phone plug and the B terminal of the audio transformer.

Some may prefer to take an old vacuum tube base and connect the wire from the phone plug to the plate prong of the tube base, thus making it simpler to connect the short wave set. The frame or main part of the phone plug is always connected to the frame of the jack, which is wired to the positive B battery, so care should be taken not to connect the audio transformer primary to the wrong part of the plug.

Tuning is comparatively simple. The antenna condenser should be adjusted to about half scale, and with the coil for the 35-70 meter range inserted in the coil mounting, the plate, or throttle condenser should be varied until the faint rushing sound of an oscillating vacuum tube is heard. At this point, varying the secondary condenser should bring in continuous wave telegraph stations in the form of whistles. The setting of the plate condenser at a point where cutting out any more capacity will stop the whistles is the point of maximum regeneration, and greatest range for the set. It is a fairly easy matter to tune in KDKA on 62 meters, anywhere in the U. S. After the carrier whistle is tuned in so that zero beat, or no whistle is heard, capacity in the throttle condenser should be lowered until the detector stops oscillating, and the voice or music comes in clearly. Naturally, tuning at this wavelength is more or less critical, and a certain amount of practice must be had before the stations can be brought in with maximum volume. If the set does not seem sufficiently sensitive, and no trouble is had with interference from local amateur transmitters, the capacity in the antenna condenser may be varied, and increased until greater coupling is obtained.

The average broadcast type antenna is suitable for use with short wave receivers, and no special construction will be necessary. It has even been established that receiving antennas of 500 feet overall length are satisfactory, as was described by Don Wallace in a recent issue of RADIO. With the midget condenser set at zero, the set can be permanently connected to the antenna binding post of the broadcast band receiver, without affecting its operation.

With the Amateur Operators

RADIO STATION 6DDO

A very interesting amateur station is that of U-6DDO, owned by H. G. Pearce, 200 W. 42nd Place, Los Angeles, California. Mr. Pearce followed amateur radio with a receiving set only over a period of years and finally the itch to transmit as well as receive grew so strong that the outfit shown in the picture is the result. He started with a receiving tube operated from batteries and

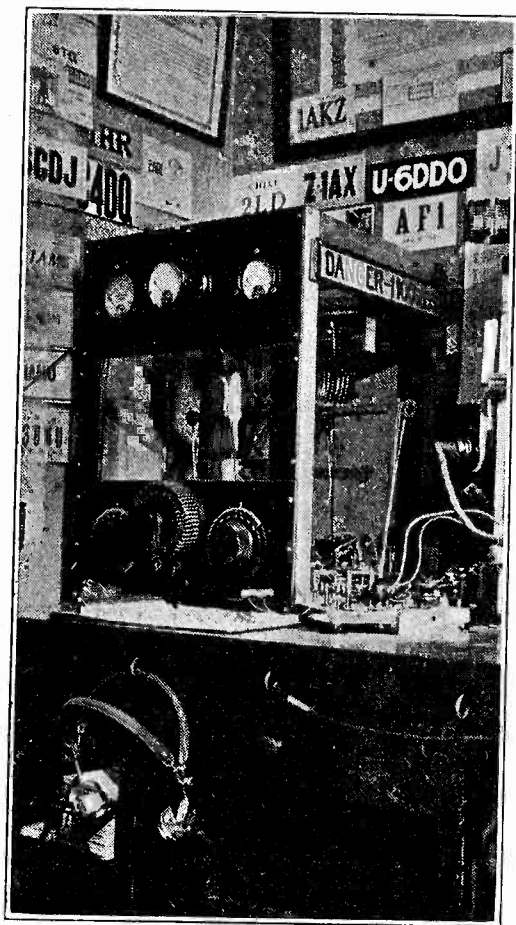

Transmitter at U-6DDO.

finally worked up to his present 50 watt with which he has done very fine work. The circuit he uses is a conventional Hartley, inductively coupled to a vertical antenna, operated on the fundamental. With a 1000-volt electrolytic rectifier with properly filtered output, 6DDO's d.c. note has been heard in most of the countries where there are active "hams."

Mr. Pearce is one of those particularly faithful members of the amateur fraternity who Q.S.L.'s all cards received and is always ready to co-operate in experimental work for the betterment of the amateur radio.

STANDARD FREQUENCY STATION NEEDED

A suitable station is wanted to Transmit Standard Frequency signals on the Pacific Coast under the auspices of the American Radio Relay League's Official Wavelength Station (OWLS) Committee. Schedules would be transmitted on 80 and 40 meter bands alternate Friday nights, and on the 20 meter band one Sunday afternoon per month; the schedules, dates and times would be exactly the same as the present schedules from IXM, Cambridge, Mass., except that Pacific Coast Standard Time would be used (see QST). Requirements would be summarized somewhat as follows: (1) Accuracy of 0.1% guaranteed; (2) some organization to insure regularity of schedules; *one man cannot do it alone*; (3) the transmitter should be controlled by an organization or institution widely and favorably known so that even without the backing of the OWLS Committee public confidence in the accuracy of its signals would be had.

Further, but not absolutely essential characteristics, would be: (1) central location on Pacific Coast; (2) 250 watts power; (3) ability to transmit an extra schedule early Sunday morning once a month for the benefit of Far Eastern stations. The A. R. R. L. cannot furnish any apparatus for this purpose, but will arrange through the courtesy of Mr. Clapp of IXM for the calibration of a piezo crystal submitted by the prospective "OWLS-SF" (Official Wavelength Station—Standard Frequency) to a degree of accuracy considerably better than that required of the signals to be transmitted. Anyone interested please write to K. V. R. Lansing, in charge of A. R. R. L. Standard Frequency Stations, 2227 Lake Shore Avenue, Los Angeles, California.

KFWH AND THE TRANS-PACIFIC YACHT RACE

By S. F. WAINWRIGHT, 6BVG

In the 1926 San Pedro-Honolulu racing classic the 106-ft. yawl *Poinsettia* of the California Yacht Club, formerly owned by the Crown Prince of Germany, successfully utilized short wave transmission in keeping the world informed of her progress. On a wave of 37 meters the *Poinsettia* was the only yacht in the race so equipped and having continuous contact with shore.

Equipment from 6BVG was revamped to accommodate a single 203A tube in the circuit popularized by the Burgess Battery Co. A 1/2 k.w. 500 cycle Navy standard motor-generator was hastily secured for plate supply and the equipment installed two days prior to the start of the race.

The antenna possibilities aboard the yawl with its mass of steel shrouds and halyards at first looked hopeless. As we were to be on the starboard tack for practically the entire run to Honolulu an antenna consisting of 25 feet of No. 14 enameled wire was run vertically up from the wardroom hatch. The distance between the antenna and shrouds was approximately 10 ft. A 12-ft. length of copper tubing served as lead-in. It was impractical to use a counterpoise, so a ground connection was made to the steel hull. There was no time or opportunity for testing the set before sailing.

After the rough weather of the first two days had subsided and the northeast trade winds had put us on a more even keel, communication was established with 6CGW of Long Beach and thereafter nightly en route to Honolulu. 6CGW's audibility steadily increased as we went westward. He deserves considerable credit in copying our long QSS-ing press and position reports. No doubt all who heard KFWH knew that we were rolling our way across—and we did!

Hu6TQ was the first Hawaiian station to pick up KFWH when we were three days out from San Pedro and was QSO nightly for the rest of the trip. Hu6BUC picked us up after four days out and, keeping a continuous key watch, faithfully handled our Honolulu traffic. The best DX worked was u4SI of Atlanta, Georgia, and u9AEK of Topeka, Kansas. A station which sounded about a mile away on the morning of June 19th proved to be Alaskan 7MN of the U. S. Naval Aerial Survey Expedition at Ketchikan. The distance on the chart was 2200 miles. I have never heard such a phenomenal signal strength for that distance. 7MN was worked and given several messages.

The stations worked and who took traffic from KFWH were: 4si, 6aij, 6afs, 6bye, 6boy, 6cae, 6cgw, 6chy, hu6buc, hu6cfq, hu6tq, 6zjb, 6dek, 6np, 6ry, 7mn, 9aek, 9bpt and npm. There is not room here to list the stations

heard, though I might say that some east coast stations came in with loud speaker volume.

Short wave radio conditions aboard a yacht on an off-shore race are quite different from those found in the average amateur's station or even aboard a 20,000-ton passenger steamer. There is more salt dampness to contend with; antenna limitations; noise due to the rigging and the constant changing of antenna capacity. Again if the antenna is carried away while a spinnaker is being bent and the operator in the middle of a message he must not lose his patience. In spite of the above difficulties the press received our daily report and a considerable number of personal messages were handled.

On arrival in Honolulu the operator was extended a warm welcome by the radio fraternity there and for ten days enjoyed the hospitality of the Radio Club of Hawaii.

On the return trip to San Francisco, in which some 3,500 miles were sailed in a little over three weeks, communication with the shore was less frequent due to heavy weather and dampness, still there was the feeling of safety amongst the men. This was due to the reliability of the short wave equipment as well as to the ever watchful amateur ashore.



By 9APY, 3337 Oak Park Ave., Berwyn, Ill. (1ae), (1aer), 1aci, 1 aff, 1akz, 1ami, 1azr, 1beq, 1bez, (1bhg), 1bhs, 1bxh, 1cjh, 1kc, 1xm, 2afv, 2ali, 2alm, 2arm, (2ars), 2aua, 2baa, 2bab, 2bl, 2brb, (2cc), 2cei, 2cxl, 2fo, (2gy), 2im, 2nm, 2oi, 2qi, 2sz, 2tb, 2uo, 2xg, (3aea), 3ahj, 3buv, 3sn, 3uv, 4bq, 4fa, 4iz, 4li, 4ll, 4me, 4qq, 4tk, 4wj, 5aao, 5afs, 5afn, 5ajs, (5anl), 5amw, 5api, 5hy, 5jd, 5rg, 5tt, 5ud, 6abm, 6adv, 6am, 6ano, 6anw, 6bch, 6bpn, 6bvg, 6cua, 6cuc, 6dcq, 6jn, 6mu, 6to, 6ub, 7aab, 7av, 7pu, 7vq. Jamaica, jm2pz; Hawaii, hu6def; Mexico, mxda; Canadians, c-1ar, (c-2al), (c-2ax), c-3fc, (c-5gf); miscellaneous, nar, nmba, nkf, npg, npn, wiz, wvy, 4nkf (?).

By Frederic J. Barnett, 60 Central Workshops, Sentul, Kuala Lumpur, Federated Malay States. y2ak, y1cd, y1bu, f8mul, f8jf, s2co, nopm, reb8, p9aa, k4abg, k4yae, cbf2. Bz.: 1bi, 1ao, 1aj, 1qa, 1am, 1an, 2ab. U.: 8aly, 6bvy, 6awq, 6adp, 6vz, 6ae, 6che, 6ea, 6daq, 6civ, 6btj, 6ew, 6asd, 6ex, 6zat, 6lat, 6bzm, 6ahp, 6bbi, bb3.

By 8DED, William Sackers, Russell Sackers, 53 East 7th Street, Holland, Mich. U. S. A.—6aah, 6aas, 6abg, 6abm, 6ab, 6adv, 6agd, 6age, 6agr, 6ahs, 6aig, 6aix, 6ajm, 6akm, 6alg, 6am, 6anp, 6anw, 6ao, 6are, 6asd, 6aut, 6ave, 6bam, 6bbq, 6bch, 6bhi, 6bjl, 6bjr, 6bhx, 6bpn, 6bs, 6bux, 6bvg, 6bvo, 6bvq, 6bws, 6bxi, 6bya, 6byh, 6bzf, 6bzm, 6bzq, 6ccm, 6cgw, 6cgm, 6chk, 6chn, 6ckv, 6clz, 6cnh, 6cnn, 6co, 6cqa, 6cqm, 6cqw, 6ctx, 6cua, 6cuc, 6cub, 6cui, 6cuw, 6cyn, 6cyu, 6dag, 6dan, 6dam, 6dcq, 6ddn, 6dn, 6er, 6ew, 6gw, 6ku, 6mi, 6mu, 6np, 6oi, 6ub, 6ud, 6uo, 6vr, 6hn, 6zat, 6zjb, 7aao, 7afg, 7al, 7av, 7bb, 7dd, 7fl, 7gj, 7ek, 7hp, 7hx, 7ob, 7oo, 7ti, 7uw, 7vh, 7wu. Australia: (3an), 2sh, 4om, 5bg, 5bo. Bermuda: 4ed. Brazil: 1aw, 2af, 1ax, sq2. Canada: 1bf, 2bg, 3aj, 3in, 3jl, 3nj, 3wg, 4bb, 4aq. Chile: 2ac, 2as, 2ld. Hawaiian Islands: 6asr, 6dea. France: 8ct, 8jf, (8yor). Mexico: 1af, 1t, 1j, 5b, 5c, 9a. South Africa: a3b, (a5o). Argentina: cb8. Netherlands: porr. Italy: (1co). Uruguay: 1am, 1bu, 1cd, 1og, 2ak, 2pz, jm. Porto Rico: 4sa. Philippine Islands: wve. New Zealand: 1ax, 4ac, 2xa. Miscellaneous: aaj, aa7, lpl, naw, nkf, neuv, cf5ef, wiz, wwdo, wyj, vxw, ocdj. Will be glad to have reports on my signals. 50 watts on 38 meters. Qsl ok.

By 6ALH-6BZW, P. M. Hayes, 1201 N. Detroit,
Hollywood, Calif.

1abt, 1adm, 1als, 1bbv, 1bcq, 1xv, 2aim, 2ahm, 2cxl, 2ee, 2uo, 3uc, 3cjn, 3buv, 3zo, 4aae, 4al, 5ev, 5amt, 5cr, 5dg, 5dl, 5lg, 5uk, 5zxx, 6bzf, 6bzm, 6bxr, 6bxj, 6bxw, 6bye, 6byd, 6bbv, 6bjd, 6bdm, 6ccl, 6cuc, 6cls, 6cmo, 6bzn, 7abb, 7cw, 7dx, 8bn, 8dp, 8pl, 8eu, 8cgz, 8bqk, 9dpv, 9egu, 9acq, 9aav, 9jr, 9baz, Hu-6aff, Hu-6axw. Alaskan: 7ks. African: (o-a50), a3e, ch-2ar, ch2ld, z-1au, z1ax, z2ac, z4aa, z4az, z4am. Miscellaneous: wiz, djc, airx, afl, npg, nrm, nkf, wwdo.

By 6BBN, J. Findley, 3809 South Denker Ave.,
Los Angeles, Calif.

a2bk, a2cs, a2sh, a2yi, a3ef, a3en, a4kp, a5kn (?), a4rb, a5bg, a5lx, z1ao, z1ax, z2ac, z2al, z2gk, z2xa, z3ar, z3xb, z4aa, z4ac, z4am, bz1ak, y2ak, c3by, c4du, c4dg, c4bb, c4aq, c5ad, c5ar, c5au, c5bf, c5fk, mjh, mlj, m5b, m5c, m5n, m9a, ch2ar, ch2as, ch2ld, pilbd, au7kx, rbal, rxy, oa50, oa3e, npl, ngd, njt, nkf, pjc, fx1, npa, lp1, bb3, wvr, ab1, nrm, wgy, wvx, lbl, wvc, joc, fw, glg, jts, npc, av7, gejn (?), aa7, wiz, xda, wvy, xc51, wik, sgl, ardi, jm2pz, wwdo, hu6bdl, hu6ajl, hu6nl, hu6xk, hu6axw, hu6buc, hu6adh, hu6dea, hu6def, hu6ahh, hu6akp, hudm2.

AMATEUR RADIO STATIONS IN SOUTH AFRICA

With the approach of the winter DX season, and the increased interest in short wave radio which always takes place at that time, a reliable list of foreign "hams" is always useful. While we cannot devote the space to publish the addresses of all foreign amateurs, we have prepared lists of amateurs in some of the countries most distant from the United States, such as South Africa.

Most of the amateurs are in the Union of South Africa, which includes Cape of Good Hope, Orange Free State, Transvaal, and Natal, while a few are scattered in Rhodesia and the British East and South West territories. Most of their transmission is between 30 and 32 meters, with a few on 70 meters, so that they can be looked for below the 33 to 35 meter band generally used by the Australian and New Zealand amateurs.

Call list—Intermediate "O".

- A3A Walker, R. W., 8a Clarence St., Troyeville, Johannesburg.
- A3B Marks, E., 170 Stanton St., Turfontein, Johannesburg.
- A3C Calvert, F. G., 49 Chapel St., Maritzburg.
- A3D Todd, W., Elizabeth Mansions, Plein St., Box 5439, Johannesburg.
- A3E Heywood, H. W. (Div. Hon. Sec., Natal), 91 Berea Park Rd., Durban.
- A3F Stanford, A. W., Alwyn's Poort, Kokstad.
- A3G de Gruchy, H. L., Port Elizabeth.
- A3H Brand, W., H. M. Dockyard, Simons-town.
- A3J Grey, G. H. A., "Mya," Park Road, Mowbray, Capetown.
- A3K Fisher, R. S., 74 Stiemens St., Johannesburg.
- A3L Paterson, A., Brookside, Kokstad.
- A3M Hegarty, J. A., Main Road, Observatory, Capetown.
- A3N Reid, W. S., 369 Commercial Rd., Maritzburg.
- A3O Smith, M. E., "Electron," Umlaas Rd., Natal.
- A3P Cumming, N. D., 30 Overpoort Drive, Durban.
- A3Q Rogers, A. H. E., "Elburton," Pine-lands, Garden City, Maitland.
- A3R Registrar, University of Capetown.
- A3S Adendorff, G. V., Hilliards Chambers, Capetown.
- A3T Coyte, H. D., "The Willows," Kokstad.
- A3U Zietman, F. L. W., "Lindela," Kokstad.
- A3V Bennett, W. E. Dixon, 5 First St., Bloemfontein.
- A3W Collin, H. J. W., 614 Schoeman St., Pretoria.
- A3X Allaway, G. N. P., 146 Umbilo Rd., Durban.
- A5C Radio Society of South Africa, 83 Castle St., Capetown.
- A5D McCulloch, E. G., Capetown.
- A5E Sadler, G. H. J., Box 43, Simons-town.
- A5F Marks, E. (for Auto. Elec. Supply Co., Ltd.), cor. Rissik and Anderson St., Johannesburg.
- A5G Archer, C. A., Balfour St., Woodstock.
- A5H Kenneth, F. Scott, 5 Carlton Terrace, Three Anchor Bay.

(Continued on page 58)

QUALITY PRODUCTS

50 Watt Coupled Hartley

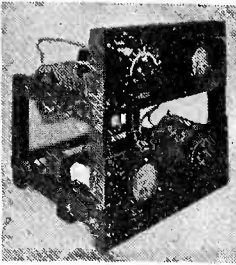

Transmitting Kit, TR-50. A hard one to beat for appearance, performance and quality.

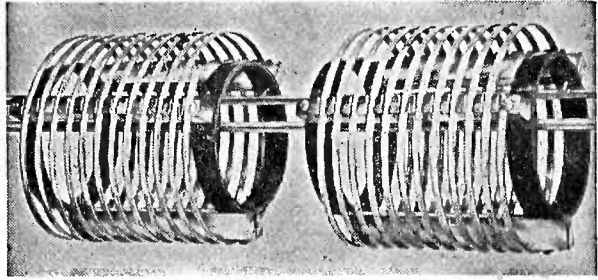

These Transmitting Inductances are Flatwound on Glass. Unsurpassable efficiency at all times. Especially

A real buy at.....\$63.00

designed for Short Wave C. W. Transmission. Type L—(40, 80, 150 meters wave lengths); Type S—(20 meters and less). Single unit, either type with three clips.....\$5.50

Double unit, either type with six clips and two glass coupling rods..... 11.00

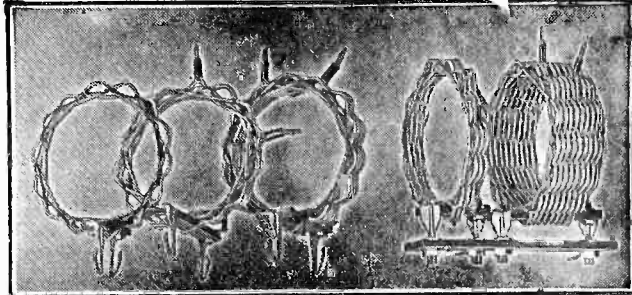

REL Low Wave Plug-in Coils—The Pioneer in its field. Unit consists of five coils, wave length range 10-110 meters, plugs and mounting. Adaptable to all modern circuits. Inexpensively priced at.....\$4.50

SEND today for the new REL Short Wave Booklet. Contains latest data and hookups. Invaluable to every devotee of Radio. Get It! 25c.

**RADIO ENGINEERING
LABORATORIES**
27 THAMES ST., NEW YORK CITY

Amateurs - - Attention!

We will have the Fall Issue of the Citizen's Radio Amateur Call Book off the press late in September. This will be a brand new book—containing the best list of American, Canadian, English and the whole world's listing of amateur stations—right up to date. It will also contain the A. R. R. L. list of official relay stations. This and succeeding issues will be on sale at most stores catering to "Hame." If unable to get one, send 75 cents, United States stamps or coin. If you send check, add 5 cents for exchange. Get your order in early. Last issue was 'way oversold. Will be mailed out as soon as it is off the press.

CITIZENS RADIO CALL BOOK
508 SOUTH DEARBORN ST., CHICAGO, ILL.



PRICES TALK AGAIN

PROMPT-RELIABLE-SERVICE. Thordarson, filament and plate transformer for 7½ watt transmitters. This transformer has 650 volt plate winding and 10 volt filament winding with center taps. SPECIAL PRICE \$6.25. Thordarson filament transformers, 80 watt for one to four 7½ watt tubes, \$6.15, 150 watt, for one to four fifty watters \$7.95. Thordarson plate transformers 100 watt, \$10.95. 450 watt \$15.95. Acme transformers reduced. Acme 30 henry 150 mil choke \$16.20, 30 henry 300 mil \$22.00. Jewel 3 inch flush or panel mount meters, all sizes of milliammeters, A. C. voltmeters and ammeters. D. C. voltmeters and ammeters. SPECIAL \$6.00 each. All sizes of Thermo-couple antenna current ammeters \$9.50. Genuine Cardwell double spaced transmitting condensers cap. .00022, 3,000 volt breakdown voltage, SPECIAL \$3.45. Genuine Cardwell .0005 23 plate condensers \$1.20, .001, 43 plate \$1.80. R.E.L. transmitting inductance (double with rods) \$8.95, single \$4.65. R.E.L. plug-in coils \$3.50. RCA UC 1808 condensers, 10,000 volt breakdown fixed condensers for Hartley and tuned plate & grid transmitters for grid and plate blocking, SPECIAL \$.75 each. Crescent Lavite 5,000 ohm transmitting grid leak \$2.20. Ward Leonard 5,000 leak 200 mil capacity \$1.85. Fleron lead-in insulators \$.90. ARSCO coupled pancake inductance 20-40-80 meter \$4.45. Aero short wave kit \$9.35.

All merchandise guaranteed and sold on a money back basis. It will pay you to deal with a brother ham. 2MA-207 Neptune Avenue, Brooklyn, New York



Never Before At This Sacrifice Price
HIGH VOLTAGE

 **KENOTRON RECTIFYING TUBES** 
MODEL U. V. 217

A. C. Plate Voltage 1500 volts. Filament Voltage 10 volts.

Used with U. P. 1016 Power Transformer or similar Transformer.

These GENUINE R.C.A. U. V. 217 Tubes are very efficient Rectifiers and they will pass plenty of current and voltage for 50 watters and H. Tubes and also can be used for 250 watters.

EVERY TUBE IS BRAND NEW AND PACKED IN ORIGINAL CARTON

List Price \$26.50 ea.

EXTRA SPECIAL \$12.50 EA.

AMERICAN SALES COMPANY

21 WARREN STREET

NEW YORK CITY

FROM THE RADIO MANUFACTURERS

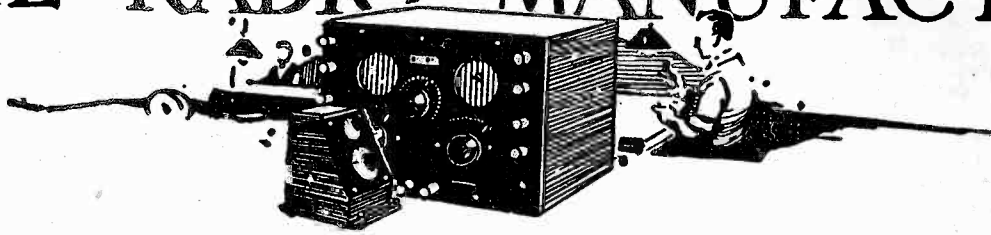

The Jefferson choke coil, No. 358, is designed to be used in connection with a large fixed condenser so as to connect the output from a high voltage power amplifier to a loud speaker. This not only prevents tone

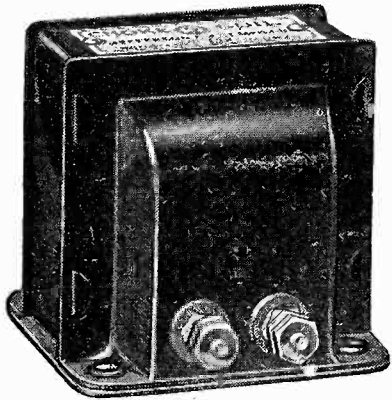

blasting but also obviates burn-out of the coils in the speaker. This choke has an inductance of 30 henries and is enclosed in a neat enamel case $2\frac{1}{4} \times 2\frac{3}{8} \times 2\frac{3}{4}$ in.

Radi-"A" is a small, compact unit intended to replace the usual A battery and charger. It supplies 2 amperes of direct current at 6 volts from a 110 volt a. c. socket. It consists of a step-down transformer, tungar rectifying bulb, electrolytic condenser, choke coil, and automatic switch, all assembled in a pressed steel cabinet. The electrolytic condenser is a small storage battery with jelly electrolyte.

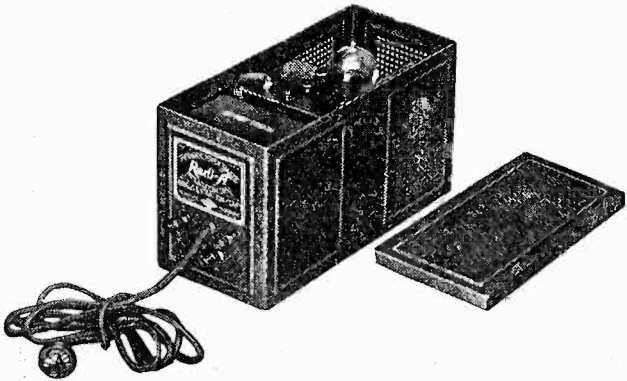

This serves the dual purpose of a filter condenser and automatic regulator. The automatic switch is controlled by the "on-and-off" switch on the receiver. A B eliminator may also be plugged into a receptacle on the Radi-"A" so it also is controlled by the same switch on the receiver. The unit is silent in operation and delivers a smooth current to the set. Its maximum current consumption is 75 watts.

The Amrad Neutrodyne is a five-tube set with three dials. It has two stages of tuned r. f., detector, and two a. f. stages. It is made in both cabinet and console models. It is claimed to combine accuracy and selectivity of tuning with fine tone quality.

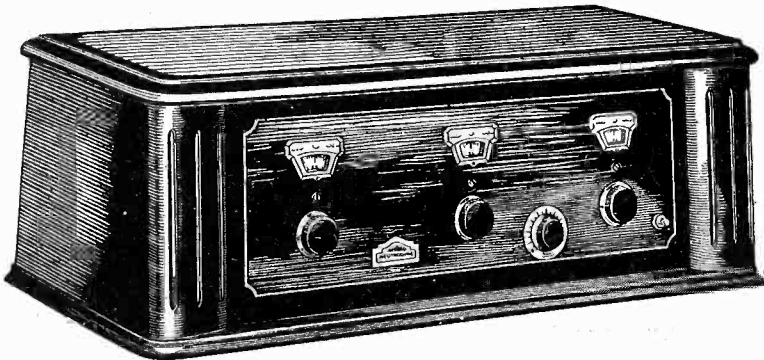

The Jones W. B. multi-plug consists of a standard seven contact socket mounted on a switch-box cover and a seven wire cable and plug. By installing this socket in the

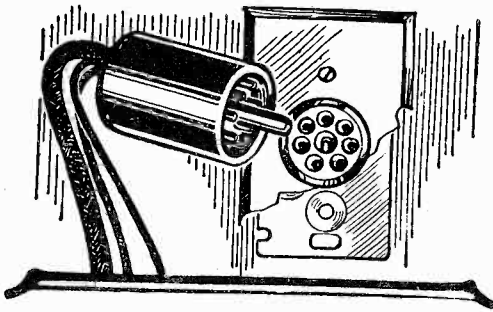

baseboard of the radio room a neat and efficient connection can be made to batteries or eliminators placed in the basement or near-by closet.

The Thorola table cone speaker combines an attractive loud speaker with compartments for holding "A" and "B"



batteries. Placed beside a radio set on a table it greatly improves the usual appearance of radio equipment.

The Bremer - Tully Micro - Mike condenser is designed for use in neutralizing tuned r. f. sets. It has a movable metal cylinder set inside a fixed cylinder, with the movable plate arranged so that by means of a set-screw, the plate can be raised or lowered to decrease or increase the capacity. As the screw has a fine thread, a close adjustment of capacity can be obtained.

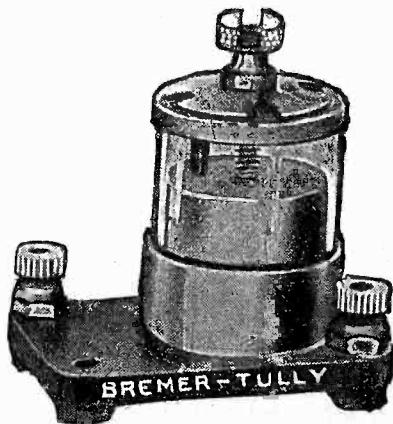

The Samson neutralizing condenser for use in radio frequency circuits has a

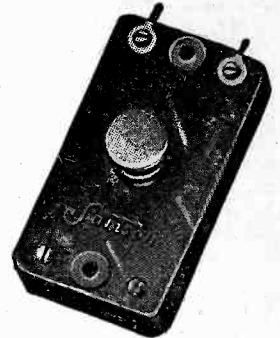

minimum capacity of .0002 mfd. and a maximum of .00015 mfd. It is variable by fine gradations and stays permanently where adjusted.

The Tobe 400 condenser has been designed especially to meet the demand for a high voltage condenser to be used in

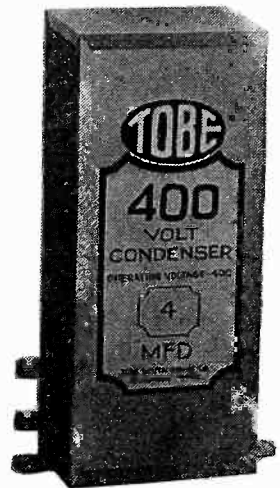

B-eliminators. It is made in 1, 2 and 4 mfd. sizes for continuous operation at 400 volts. The case is of silvered metal with strong attachment lugs and convenient side terminals.

The Auto-B delivers 100 milliamperes at 100 volts (25 m.a. at 182 volts and 65 m.a. at 135 volts) for plate current supply of vacuum tubes. It uses an electrolytic rectifier, the "recto-cell," a transformer, filter and suitable resistance to convert 110 volt a. c. to direct current of desired voltages. It is provided with four taps and is furnished with attachment cord and light socket plug.



New!



ALL-AMERICAN TRADE MARK AUDIO TRANSFORMER

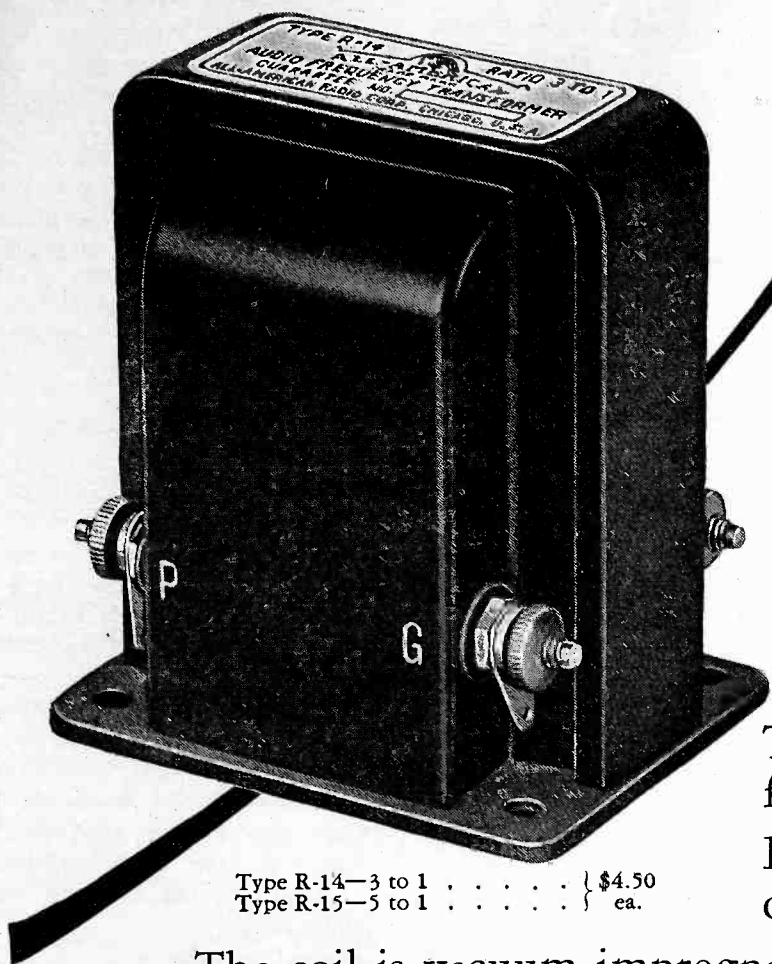

Type R-14—3 to 1 : : : : \$4.50
Type R-15—5 to 1 : : : : ea.

This latest development meets the new demands for compact wiring and longer life—
Binding Posts are conveniently located for straight or sub-panel wiring—

The coil is vacuum impregnated—

After assembly the shell is filled with special compound and the complete unit hermetically sealed. *A transformer that sets a new standard.*

Tone Quality Is the Keynote

No standards of quality can be higher than those we set for our own products; no inspection is more rigid; no tests more severe.

Each of these All-American Transformers plays its part in determining the quality

of radio reception. Each is designed and made with the same care that goes into the finest receiving sets.

These products have helped to create All-American leadership.

New 1927 Radio Key Book

Everybody who enjoys radio should read it— an interesting 48-page analysis of radio in terms anybody can understand; with complete constructional details of the leading types of circuits. Send 10c in coin or stamps for your copy.

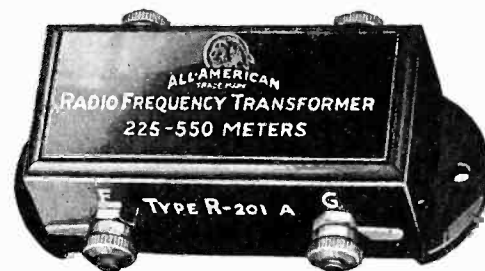

SELF TUNED R. F. TRANSFORMER effectively amplifies all frequencies. Designed to match tube characteristics

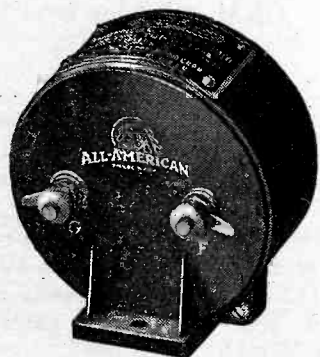

UNIVERSAL COUPLER highly efficient both as antenna coupler and tuned R.F. Transformer

All-American Radio Corporation
4215 Belmont Avenue CHICAGO

RAULAND-TRIO
An inductance, a resistance and a capacity perfectly balanced in one shell—a compact factory-built unit for impedance coupled amplification

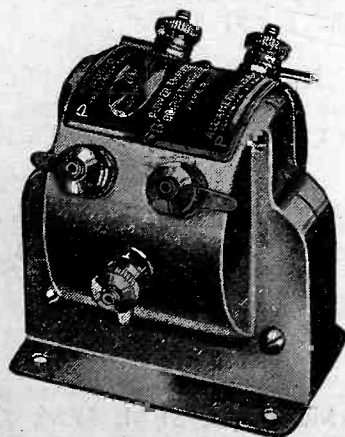

POWER (PUSH-PULL) AMPLIFYING TRANSFORMER, gives power amplification without distortion where excessive volume is demanded

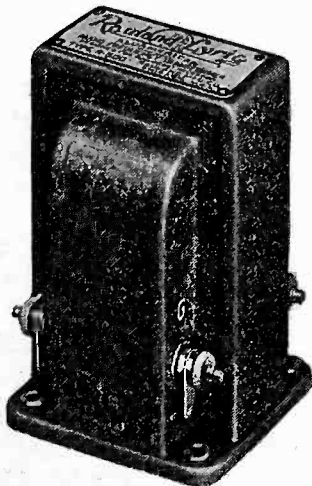

RAULAND-LYRIC
An audio Transformer, famous for its perfect tone reproduction—an outstanding product. Made with painstaking thoroughness without regard to cost

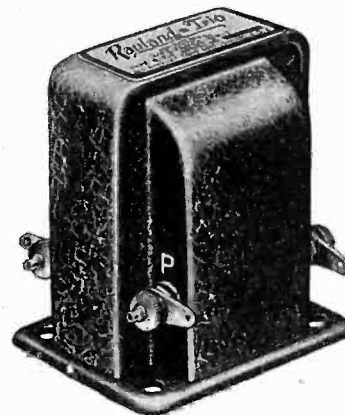

Tell them that you saw it in RADIO

WHO'S WHO AND WHERE

(Continued from page 42)

Menominee; Qnitowoc for Manitowoc; Cwaunee for Kewaunee; Greek for 'Most anything.

WGO certainly lost its punch when the location was changed from Chicago to South Chicago. The reason is partly due to QRP. The new set is but 750 watts. The Windy City station used to blow out a much healthier signal. We understand that the change was made in order to get away from the QRM of the many broadcasting stations, which is contrary to the belief that the operators are afraid of machine guns! Hi.

WEST INDIES ITEMS

By J. J. FLAHERTY

PJN, Paramaribo, Dutch Guiana, is installing a 1½ k.w. short wave transmitter for direct communication with The Hague. A 5 k.w. Telefunken is now used for commercial traffic.

HIK, Barahona, Santo Domingo, 50-watt short wave set, was heard by the S.S. W. M. Irish while in the English Channel. The set has a self-rectifying circuit and W. E. tubes.

WPR, Ensenada, Porto Rico, gave warning to WAX, Miami, Fla., five days before the great hurricane struck Florida, relaying warnings from San Juan.

The area bounded on the west by Haiti, on the east by St. Martins, on the southeast by Paramaribo, and on the southwest by Aruba has 35 coast stations, whose power ranges from 2 to 50 k.w. input on spark, and a 200 k.w. arc at NAU. BZL has a 30 k.w. arc and WPR a 5 k.w. This congestion, together with the elephant-like trumpeting of the static, which acts like a blanket, gives WPR an unsurpassed location for observing radio phenomena (hi.)

INTERCOASTAL NOTES

By KARL E. ZINT

NSC—U. S. Navy Station, Port Au Prince, Haiti. Works ships on 600 meters spark at 1 AM, 630 AM, 1230 PM, 1PM. 630 PM. EST. If QRZ or QRM ask him send 2250 meters spk. No ship skeds on 2100.

UB, TRT Co. Station, Almirante, Panama. Works ships on 600 meters at 9 AM, 2PM, 5PM and 9 PM EST. Sends on 600 ICW. Listens 5 minutes each on above skeds then listens on 2100 and 2400. Answers 2100 and 2400 meter calls on 4075 meters high power CW. QST WX and Ship tfc same as WNU at 1230 PM and 1145 PM EST, on 4075 meters. All ship tfc for U.S. same rates as through WAX or WNU.

NBA, U. S. Navy Station, Balboa, C. Z. Sends complete traffic list on 2100 meters and listens for ships on same wave at 7 AM, 12NN, 5PM, and 6 PM EST.

WAX—TRT Co. Station, Miami, Fla. On 2100 last 15 minutes each hour. Rest time on 600. Sends PX to KUS on 5551 CW at 630 AM EST.

XDA—Mexico City, now sending time sigs, same method as U. S. Navy stations, at 1055 AM PST on about 2600 meters CW. A weather report for Mexico immediately follows the Time. WX is in Spanish.

KPE, Seattle, Wash. 2400 meter ship skeds at 9 AM, 11AM, 1 PM, 3PM, 5PM, 7PM, 9PM, and s100 meter skeds at 11PM and 1AM PST.

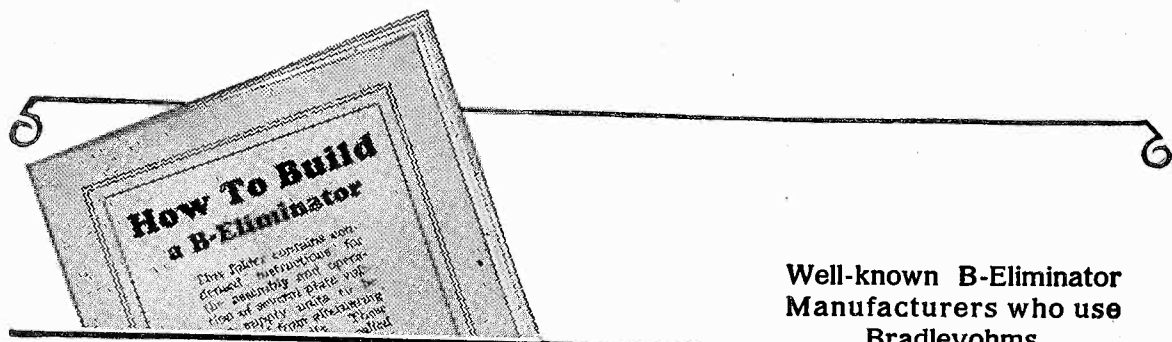

SEND FOR THIS RADIO FOLDER

Contains seven hookups for B-Eliminators published in a prominent radio magazine.

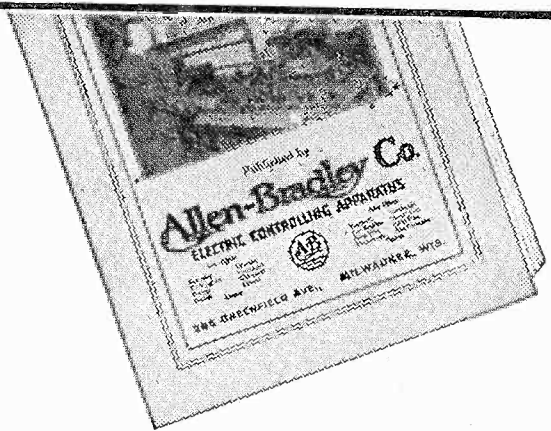

Well-known B-Eliminator Manufacturers who use Bradleyohms

Acme, All-American, American Bosch, Brown & Green, DeWitt LaFrance, Farrand, Forest Unitron, Grigsby Grunow-Hinds (Majestic), Kellogg, Philadelphia Storage Battery (Philco), Precision, Radio Receptor; R. A. Rothermel, London; Spartana, Valley, Willard, Wilson.

When You Build a B-Eliminator

Use Bradleyohm-E for the Variable Resistors and Bradleyunit-A for the Fixed Resistors

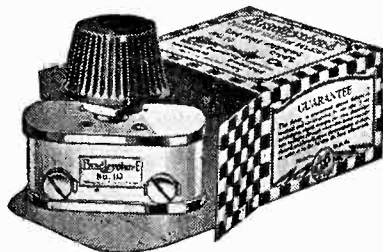

Bradleyohm-E

For B-eliminator service requiring wide voltage control, Bradleyohm-E is essential. It is an oversize Bradleyohm with sufficient capacity to handle all normal B-eliminator requirements. Be sure to ask for Bradleyohm-E in the checkered carton. Your dealer can get them for you.



Bradleyunit-A

This solid, molded, fixed resistor has no glass or hermetic sealing in its construction. It is a solid unit with silver-plated end caps and is not affected by temperature, moisture and age. By all means, use Bradleyunit-A when you need a fixed resistor.



ALWAYS insist that Bradleyohm-E and Bradleyunit-A are included with your B-Eliminator kit, if you want to be assured of perfect voltage control. The leading manufacturers of B-Eliminators have long since adopted these Allen-Bradley variable and fixed resistors as standard equipment for their B-Eliminators. In fact, Bradleyohm-E is used almost as universally as the Raytheon tube, itself.

You cannot afford to risk the use of inferior substitutes for the scientifically treated discs used in Bradleyohm-E. This remarkable variable resistor handles the strenuous requirements of B-Eliminator service without the slightest strain. Ask your dealer for Allen-Bradley Perfect Radio Devices, today.

MAIL THE HANDY COUPON

Allen-Bradley Company
279 Greenfield Avenue
Milwaukee, Wisconsin

Please send me, FREE, your radio folder with seven B-Eliminator hook-ups.

Name

Address

CROSLLEY

BETTER... COSTS LESS

RADIO

CROSLLEY RADIO INSTRUMENTS

Each item the utmost in radio at its price. All prices slightly higher west of the Rocky Mountains. Prices without accessories.

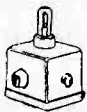

THE "PUP" \$9.75

This little double-circuit one-tube set has brought happiness to thousands and made records for long distance receiving.

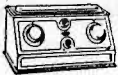

THE "4-29" \$29

A 4-tube receiver of amazing efficiency. Crescendon equipped! Everywhere considered marvelous at its price.



THE "PORTABLE" \$33.00

The 4-29 in portable form, handy, compact, efficient.

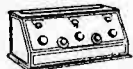

THE "5-38" \$38

A five-tube tuned radio frequency set, with two stages of non-oscillating radio frequency amplification, Crescendon controlled, two stages of audio frequency amplification.

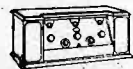

"RFL-75" \$65

5-tubes. True cascade amplification, non-oscillating, non-radiating even under any mis-handling. Its perfect balancing achieved by Wheatstone bridge in each stage of amplification. Exceptional selectivity and tone.



THE "MUSICONSOLE" \$32.00

Embodies the Musicone in a beautiful console of two-tone mahogany finish and provides room for batteries and accessories; 24 1/2 inches long inside.



6-TUBE "RFL-90" CONSOLE \$90

Introducing the double drum station selector! Includes Musicone in exquisite console. Room for batteries and all accessories; 40 inches high by 30 1/2 inches wide.

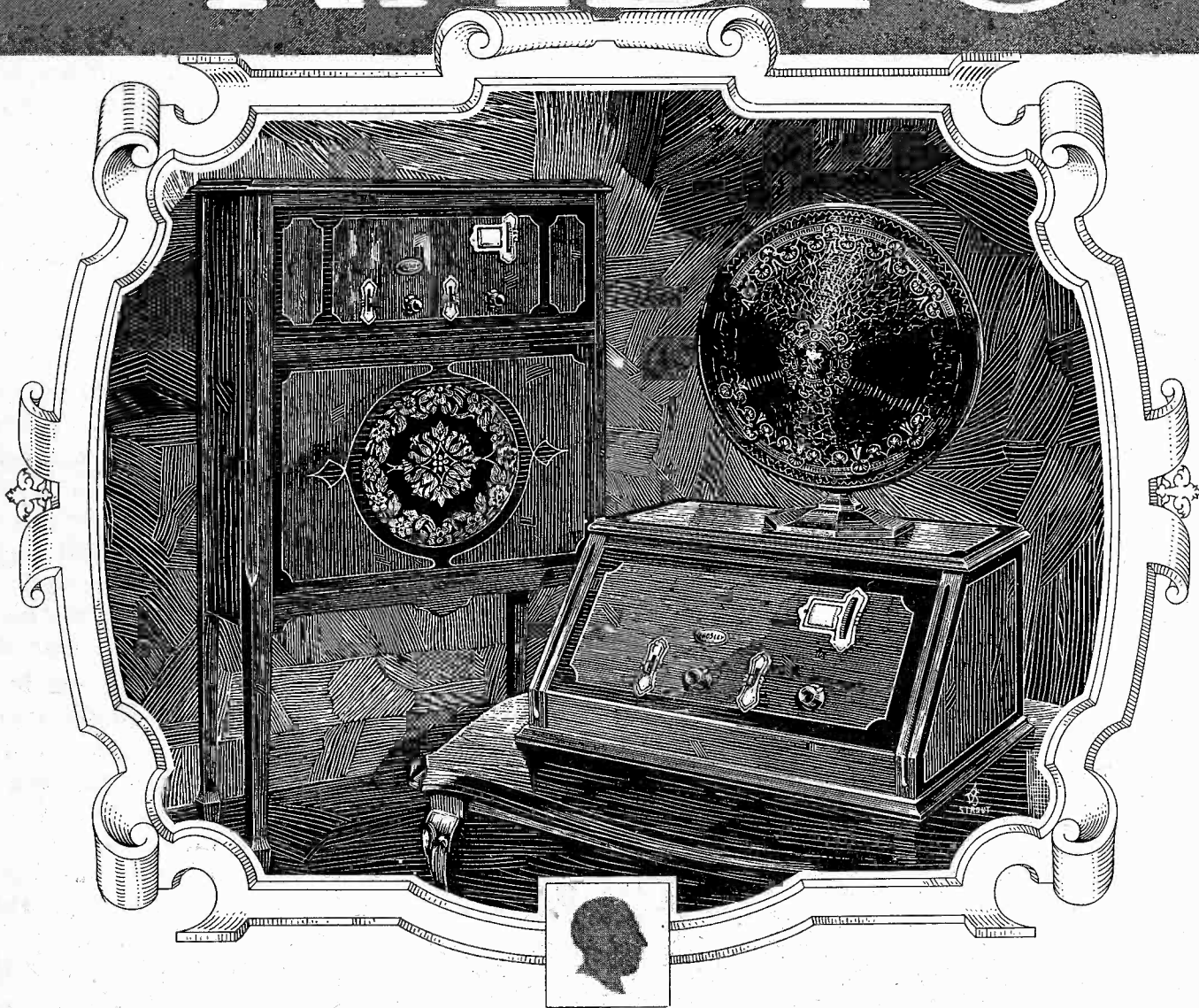

CROSLLEY 1927 FEATURES

Many exclusive—others found only in highest priced radios.

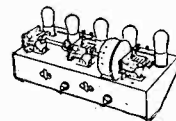

ALL-METAL SHIELDED CHASSIS

This truly great radio achievement, found in several Crosley sets, furnishes a substantial frame for mounting elements, produces excellent alignment of condensers, shields the units from each other, prevents interstage, improves the stability of the circuit, increases selectivity and saves costs by standardizing this phase of manufacture.



"THE ACUMINATORS"

Crosley Acuminators permit tuning in—loud and clear—weak stations passed over and entirely missed by ordinary single dial radios. In tuning high powered and local stations they are not used. They are an exclusive Crosley feature.

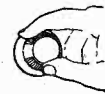

THE "CRESCENDON"

When, on ordinary radios ears must strain to catch a station miles away, a turn of the Crescendon on Crosley radios instantly swells reception to room-filling volume. An exclusive Crosley feature.

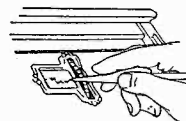

THE SINGLE-DIAL STATION SELECTOR

Nothing in radio equals the joy or the convenience of single dial control. Crosley single drum control enables you to find the stations sought without log book or "tuning."



POWER TUBES

Power tube adaptability marks the Crosley "5-50", "5-75" and "RFL" sets. This feature typifies Crosley provision for best radio reception at moderate cost.

Amazing single dial control and reproduction

THE 5-50

Such a success! Enthusiastic owners report amazing performance—a drum dial delivering stations loud, clear, sharp; each an almost imperceptible turn of the drum apart. Write station letters on the drum; return to them at will. This marvelous receiver containing these advanced ideas in radio (some of them exclusive to Crosley), including metal shielding and power tube adaptability indicates Powel Crosley, Jr.'s genius in lowering prices by mass production methods.

THE SUPERMUSICONE

Listen to this wonder reproducer of broadcasting! Then you'll understand why it is the biggest selling loud speaker on the market EVERYWHERE, and the most imitated. Its shape, however, is NOT the secret of its wonderful performance. Its delightful tone and the fidelity of its reproduction is achieved solely through the Crosley patented actuating unit. Avoid imitations. There is only one genuine MUSICONE. Smaller model, 12-inch cone, \$12.50.

THE 5-75 CONSOLE

This set includes ideas for radio reception perfection NOT found in any other radio. Marvelous exclusive Crosley "Crescendon" and "Acuminators" increase volume on distant stations and bring in programs entirely passed by and missed on ordinary one dial control radios. Console is 40 inches high with ample room for batteries and a genuine Crosley Musicone is built in. Radio chassis same as in the 5-50 receiver. Beautifully finished two-tone mahogany cabinet, rose gold fittings.

\$50.

\$14.75

\$75.

Prices slightly higher west of the Rocky Mountains

Write Department 19 for Illustrative Literature.

Crosley manufactures radio receiving sets, which are licensed under Armstrong U. S. Patent No. 1,113,149, or under patent applications of Radio Frequency Laboratories, Inc., and other patents issued and pending.

THE CROSLLEY RADIO CORPORATION

CINCINNATI, OHIO. POWEL CROSLLEY, Jr., President

Tell them that you saw it in RADIO

(Continued from page 28)

ferred you know I thought that we— well you know I been saving my money and Ive always wanted a home—just a little home maybe out on an island some place—(stop) Gee she says kindly and I know a swell place too she says that youd like (stop) Yes go on I says (stop) Yeah she says you might go up there and she says Staten Island sure is a swell island and she says I know youll like Snug Harbor fine (stop) Well old man you could have knocked me over with a capstan bar (stop) And now here I am eating out my heart and trying to drown my sorrer in putting RF in front of a regenerative set though goodness knows that dont detract from it OM (stop) Preferred is like the QRM over in the British Channel OM you cant get a word in edgewise and make it stick OM (stop)

Say OM last trip Honk got a BCL receiver which he said some Scotchman made (stop) Theres covers made for the voltmeters so you can cover them up when you aint looking at them (stop) And it has a clock on the panel OM (stop) The directions are in the Scotch language OM and they say to be careful to stop the clock every night and start it in the morning (stop) it sure stops wear and tear Honk says (stop)

Well OM I see in a British paper that some Englishman blames a late magnetic storm on a small sun spot (stop) Since the sun is about ninety million miles away OM I hear the quote radio pie-on-ears club unquote decided after a stormy meeting that they wouldnt bother doing anything about it OM (stop)

Say OM the third says hes going to stand his own watch now and thats all there is to it (stop) Well I says the company furnishes a nice swivel chair and cushion and I says why not put it to good use (stop) Ah he says you dont get me (stop) Well I says if the RI hears you sending them CQ-S every three minutes why he will get you OM (stop) Oh I aint doing nothing he says (stop) Yeah I says thats just the trouble and I says you better stay off the air when you aint got nothing to do on it (stop) Bah he says (stop) Yeah I says up in Wyoming ba ba yourself and I says try and rehabilitate that there spark panel before the RI sends down the board of health (stop) The third is a good skate OM but he is flighty-like (stop) He was in the air service once I guess (stop) Signal Corpse P guess (stop)

Well more next trip OM (stop) Send me that new 120 volt filament hook-up you used har har (stop)

(sig) Larry

Tubes weaken as do batteries

DOES your set bring in the distant stations you got when it was new? Is your volume as great as then? If not, look to your tubes.

To keep large or small type tubes at highest efficiency, attach a Jefferson No. 275 Tube Charger to the light socket and connect it for 10 minutes, once a month. Improved reception—plus longer life of tubes and batteries—will be worth many times the price to you. Guaranteed and made only by Jefferson. Get one today.

JEFFERSON ELECTRIC MFG. CO.
Largest manufacturers of small transformers
502 So. Green Street • • • Chicago

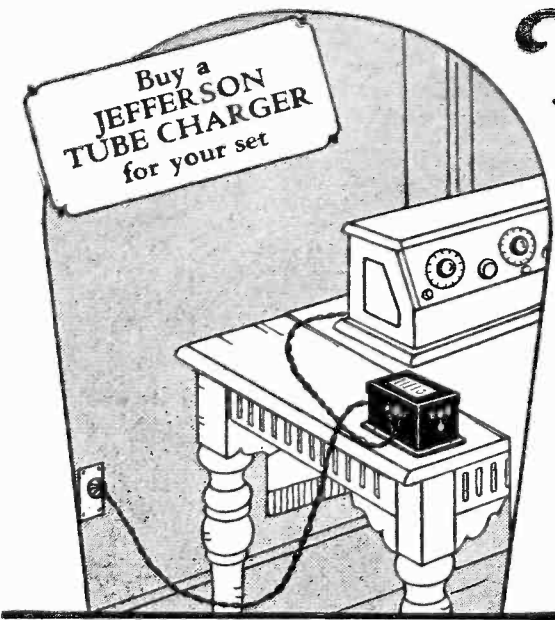

KEEP TUBES LIKE NEW—CHARGE THEM MONTHLY and ALL AT ONCE

\$ 5.00 at your dealers

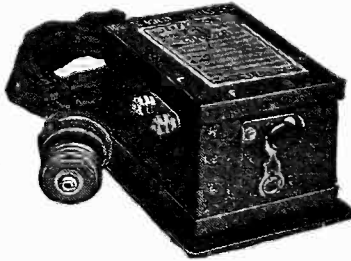

Jefferson No. 275 Tube Charger

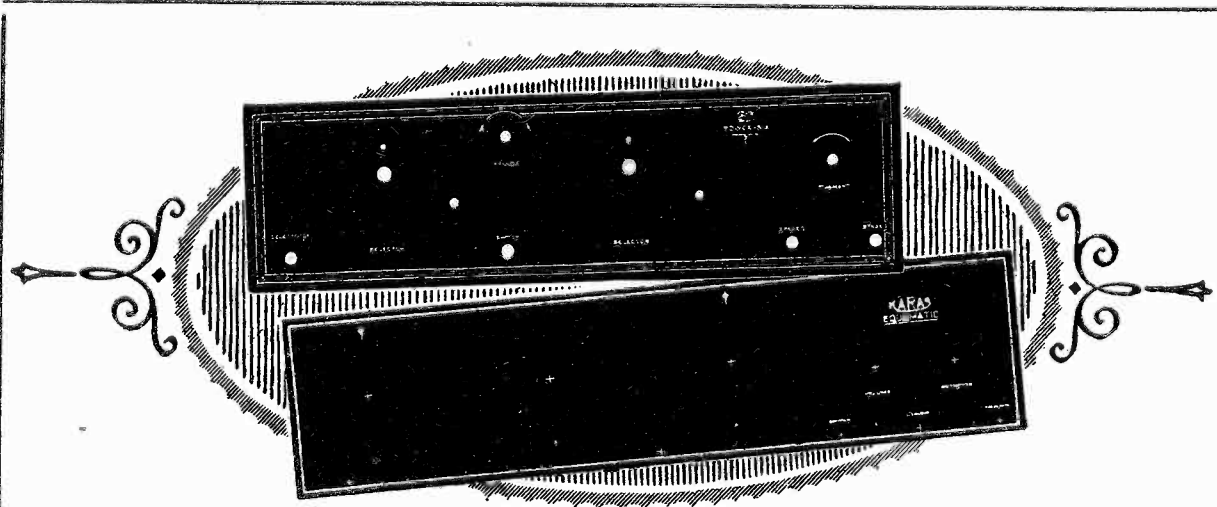

POWER SIX, KARAS, H. F. L.

ADDED to the list of handsomely Veri Chromed Formica kit panels are now the Bremer Tully Power Six, Karas Equamatic front and sub panels, H. F. L. Nine in Line Superheterodyne with sub panel, Victoreen Universal single dial control. There are also Infradyne 7 x 28, and 7 x 30, Aerodyne, St. James 8 Tube, Bremer Tully Counterphase, Browning Drake National, Madison Moore Superheterodyne, Camfield Duoformer. They are sold by leading jobbers and dealers.

Special panels cut to size and Formica tubing are also available for Amateurs

The FORMICA INSULATION COMPANY

4616 SPRING GROVE AVENUE

CINCINNATI, OHIO

Hear the FORMICA Orchestra Tuesdays 9 to 10

FORMICA

Made from Anhydrous Bakelite Resins
SHEETS TUBES RODS

Formica has a Complete Service on Insulating Material for Radio Manufacturers

Tell them that you saw it in RADIO

What Really Comes Through Your Transformer?

We know what you want to get out of your set. Everyone wants it. It is clear, pure-toned reception—and you don't want to miss a note from the muffled base of the kettledrum or the profound booming of the baseviol to the shrill "sky-high" tones of the fife and piccolo.

So much depends on your circuit, so much on your speaker—but even more on your transformers. To render sweet music and to get the full range of orchestral or instrumental performance, the transformer must faithfully reproduce all frequencies.

The FERRANTI TRANSFORMER

Meets Every Condition of Good Audio Reception

It takes two and a half miles of wire for the coils of the A.F. 3 and one and a half for the A.F. 4 plus the many refinements which the genius of Dr. Ferranti has made possible, to create transformers whose amplification curve is almost perfect—almost a straight line. By installing Ferrantis you can modernize your old set or perfect your new one. Ferranti will give you an uncensored message from the sending station.

If you want to make the best of the power tube feeding the loud speaker, use Ferranti.

Ask your dealer for a Ferranti. Don't be satisfied until you have installed one. If he does not carry Ferranti Transformers, write us and we shall tell you where you can get one. No better transformer is available at any price.

For the best available transformer results—Ferranti Audio Frequency Transformer A.F. 3—ratio $3\frac{1}{2}$ to 1—\$12.

For a transformer far superior to the average, use Ferranti A. F. 4—ratio $3\frac{1}{2}$ to 1—\$8.50.



HIGHSPOTS

High amplification ratio with flat curve.

Ferranti brings out the fundamental frequency of low tones—none are heard merely by inference from higher harmonics.

Every transformer tested ten times—all short-circuit turns eliminated.

Windings have high impedance.

Built by an established manufacturing company with forty years' experience in the winding of coils of fine wire for electrical instruments and meters.

Primary shunted with built-in condenser of correct capacity

Tested to 1000 volts between primary and secondary and between primary and secondary and ground.

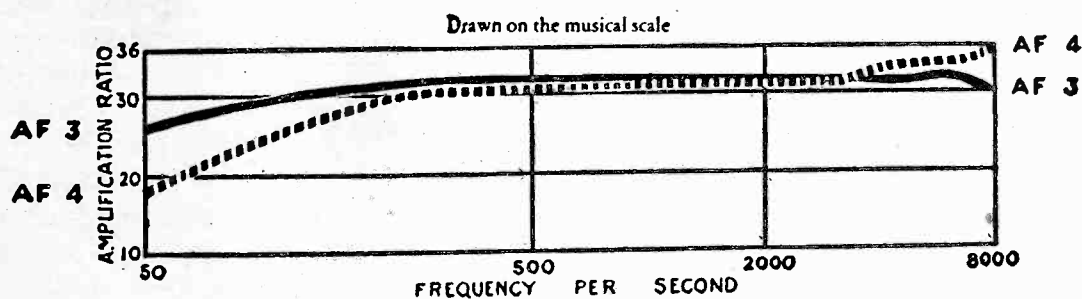

This graph is drawn on a musical scale—the only accurate way of showing the full value of each tone which your set receives. Note that the evenness and fullness of amplification in both the Ferranti A. F. 3 and the A. F. 4 extends throughout the range of the organ, cello and the human voice.

Pacific Wholesale Radio Co.,
1310 South San Pedro St.,
Los Angeles, Calif.

FERRANTI, INC.
130 West 42nd Street
New York, N. Y.

The Electric Corporation
1050 Santee St., Los Angeles, Calif.

Pacific Wholesale Radio Co.,
127 12th St., Oakland, Calif.

Tell them that you saw it in RADIO

RADIO IN THE ARMY

(Continued from page 19)

headquarters station to the stations of his zone of operations.

The greatest importance of radio to the Army is in the transmission of tactical messages during combat. Since radio transmission is not secret these messages must be encoded, otherwise they would be of value to the enemy. This enciphering results in a marked delay in the handling of radio message traffic, besides introducing additional chances for errors. But this disadvantage is outweighed by the fact that radio transmission is independent of road or traffic conditions and is only slightly affected by conditions of intervening terrain.

In addition to these general requirements and limitations imposed upon military sets, there are special problems such as radio between airplanes and between airplanes and the ground, the latter being of considerable importance in adjustment of fire for artillery. Another case is radio communication from a moving tank, where, in addition to the vibration and noise of the engine, the tank is a close approach to Faraday's metallicly inclosed chamber, which he showed to be proof against electromagnetic waves.

A typical army set is one used to transmit and receive signals between forward infantry battalions and supporting artillery battalions, and between these units and their respective regimental headquarters. This set is known as the type SCR 77 or more commonly "the infantry loop set," as its antenna equipment consists of a tubular brass loop about 3 ft. in diameter. As its total weight, including a 4 volt storage battery, is only 54 pounds it can be carried and quickly set up. As the units using this set are invariably within a three mile radius, the maximum transmission range has been designed for five miles.

The range of wavelengths is between 74 and 76 meters and the tuning is so sharp that eight stations can carry on communication without interference. This feature lends itself admirably to the net operation scheme. Three type VT-1 tubes are used, one as an oscillator to furnish power for transmitting and to heterodyne the incoming signal, the other two are audio frequency amplifiers used to amplify the incoming signal that was heterodyned in the first tube.

When receiving, a key-switch such as is used as in commercial wire telegraph, is kept closed. The set generates oscillations continuously as long as this switch is closed. The transmitting set, however, with its key-switch open generates oscillations only when the key is closed to make dots and dashes. Hence when the sending operator works his key he hears his own signals because the oscillations produced by the receiving

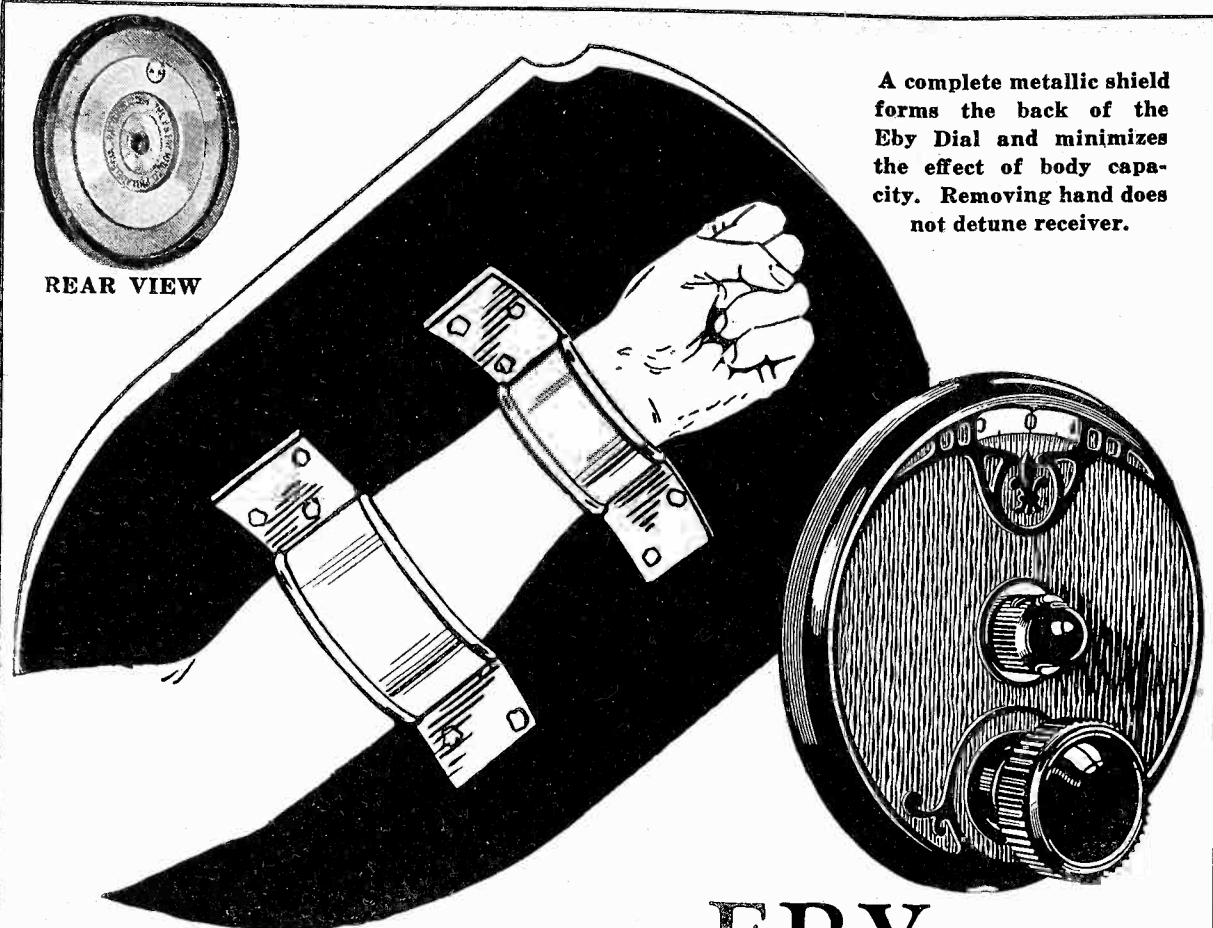

A complete metallic shield forms the back of the Eby Dial and minimizes the effect of body capacity. Removing hand does not detune receiver.

REAR VIEW

EBY SHIELDED DIAL

Even the best instruments are inefficient unless properly controlled and accurately set. This sensitive, finely constructed indicating device is scientifically designed for exact micrometer tuning.

Hairline accuracy is obtained by smooth positive friction drive, eliminating all back-lash. No gears or washers. The Eby Shielded Dial operates any type condenser, clockwise or counter-clockwise. Graduated from 0 to 100 and 100 to 0. Easy to mount by drilling one additional hole. List Price \$2.50.

Eby Products are recommended and specified for many popular circuits, including:

Hammarlund Roberts
Infradyne
Cockaday
L. C. 27
Browning-Drake
Victoreen
Madison-Moore
Lynch and Varion
Power Units

EBY BINDING POSTS and SOCKETS

Eby Binding Posts are made in six different types and engraved in 35 different markings. List Price 15c. Eby Sockets assure a positive three-point wiping contact at all times. List Price 50c.

THE H. H. EBY MFG. COMPANY
4710 Stenton Ave. Philadelphia



Turn 1 Dial-get stations everywhere: - 30 Days Free!



Built to look like and perform like a \$200 set. Users report:

MIRACO RADIO GETS 'EM COAST to COAST

Send for Proof!

ONE DIAL CONTROL
Only One Dial to turn for all programs.

Sent on 30 Days Free Trial. Enormous demand for Miraco 5's makes possible hosts of costly new refinements and improvements at lower prices than ever. Genuine Bakelite sloping panels, dials beautifully finished in walnut to match cabinets; Connect E-Z Battery Cables; features (too numerous to mention) of high-priced sets. Send for Amazing Low "Unitune" Price!

28 in. Long

Beautiful Hand-rubbed Solid Walnut Cabinet

SPECIAL WHOLESALE PRICES

to user-agents who show the set to friends.

DEALERS WRITE!

SEND COUPON FOR AMAZING SPECIAL OFFER!
NOTE: This offer is made to prospective buyers by famous Big Radio Corporation, one of America's oldest reliable manufacturers of fine sets—seventh successful year. Many satisfied users in every state. Postal or coupon brings testimony of nearby users and proof Miraco's outperform sets costing up to 4 times as much. Very easy to operate

BEAUTIFUL-BIG-POWERFUL
Ultra Selective MIRACO Unitune 5

Users report Miraco Radios get programs Coast to Coast, also Canada, Cuba and Mexico, loud and clear on speaker; outperform \$100 to \$200 sets. Some have heard Europe, S. America. Don't confuse Miraco with small cheap sets. Unless trial proves it **MOST SELECTIVE, CLEAREST TONED, and MOST POWERFUL DISTANCE-GETTER** among beautiful big 5-tube sets, don't buy it. Every Miraco comes completely assembled, rigidly tested and fully guaranteed.

Our Factory Prices Save You Up to 1/2!

SEND NO MONEY! Save or make much money on sets, speakers, tubes, batteries—write for **AMAZING OFFER.** Ultra-5 (not illus.) is marvelous value in a big **Guaranteed 5-tube, 3-dial set: Retail List \$49.75**

MIDWEST RADIO CORPORATION, Pioneer Builders of Sets
414-G Miraco Bldg., Cincinnati, Ohio
WITHOUT OBLIGATION, send free literature, **AMAZING SPECIAL OFFER,** testimony of users, etc.

NAME: _____
ADDRESS: _____

set (the other station) heterodyne his own signals, thus making them audible. If the receiving operator wishes to interrupt, he opens his key-switch; this stops his set from producing oscillations and the sending operator can no longer hear his own signals, which informs him that the receiving operator desires to send. The sending operator then closes his key-switch and listens for the message from the other operator. In other words the stoppage of the audible signals in the operator's own telephone headset when he is transmitting is a signal that the receiving operator desires to send. The closing of the key-switch on the sending set at once enables the message in the reverse direction to be received.

Before this set was issued to the Army it was severely tested at the Field Artillery School, Fort Sill, Okla. Among other things it was jolted about on artillery tractors and then operated from shell-holes, dugouts, and in dense woods.

In addition to furnishing radio for combat communications, the Signal Corps is also charged with providing equipment and personnel for the operation of the Radio Intelligence Service. This involves operation of goniometric stations as well as of radio and earth intercept station.

The radio goniometric stations are radio receiving stations used to locate enemy transmitting sets, thus indicating the tactical disposition of the hostile troops. By the use of directional antennas, operating in groups, and plotting the bearings of the enemy radio sets, the stations may be located by intersection.

The Intercept Section operates listening-in stations to copy enemy radio messages. These are turned over to code experts who attempt to break down the code or cipher and determine the contents of the messages. Separate stations are assigned to copy messages from hostile aircraft and are usually located with the goniometric station that attempts to locate the airplane itself. In addition to copying enemy messages the intercept operators can generally tell when a change of units in line has been made since radio sets are changed when one organization relieves another in a sector. Even when the station location remains the same, the intercept operators will distinguish a changed note of the set or a different "fist" on the key. In the World War both sides depended upon radio intercept for knowledge of relief of units in line. The French had so much faith in intercept work that they once relieved an entire infantry division for use on another part of the front, but left its radio sets in the sector to mislead the Germans into thinking the unit had not been withdrawn.

The earth intercept stations are used in trench warfare to pick up telephone messages resulting from leaky lines, causing earth currents. They operate

AMERTRAN RADIO PRODUCTS

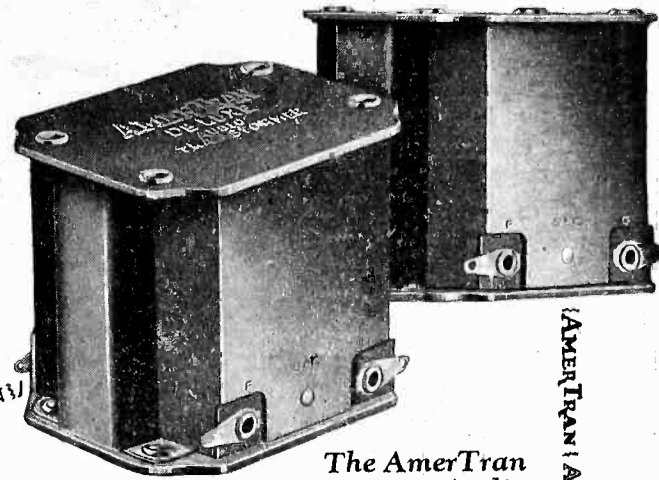

The AmerTran
De Luxe Audio
Transformer
Made in 2 Types

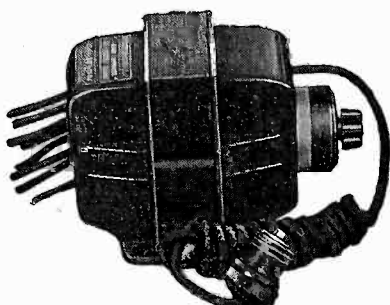

The AmerTran
Power Transformer
Type PF-52

Type PF-52 is intended for use in the better type of power supply developments. It will convert the standard 110 volt, 60 cycle alternating house lighting current to a higher voltage for the plate and lower voltage for filament supply.

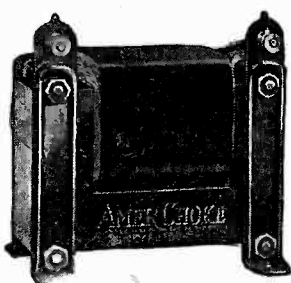

The AmerChoke
Type 854

This is a scientifically designed impedance or choke coil of general utility, designed primarily for use in filter circuits. As an output impedance for by-passing direct current from the loud speaker it is both efficient and economical.

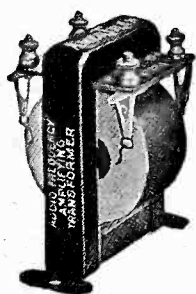

AmerTran Types AF-7
and AF-6

AmerTran Audio Transformers, types AF-7 and AF-6, have been considered for years among the leaders in audio amplification. These popular and efficient models are made in two types—AF-7 (ratio $3\frac{1}{2}$:1); AF-6 (ratio 5:1).

Those Who Know In Radio

Those who take their radio seriously such as experienced engineers and experimenters use AmerTran De Luxe Audio Transformers. And the reasons are true tone quality and realistic reproduction which result from ideal amplification.

These men know by test and comparison that the AmerTran De Luxe makes a transformer coupled amplifier excelling all other forms of amplifiers. They know, too, how well the AmerTran De Luxe performs in Power Supply Developments. Used with other AmerTran Products, it will make a power unit capable of dependable, satisfactory service.

Every AmerTran De Luxe is manufactured to maintain a high laboratory standard. Its improved performance recommends it especially to those seeking "better than the average" radio reception.

Write for free booklet

"Improving the Audio Amplifier"
It contains valuable technical data.

American Transformer Co.

178 EMMET ST. NEWARK, N. J.

"Transformer Builders for over 26 Years"

Pacific Coast Office

Rialto Building, San Francisco

Tell them that you saw it in RADIO



For Filament Control

If you are not using a voltmeter for controlling the filament voltage of your radio tubes—it is safe to say that you are losing much of the value of the receptive power of your set.

Many set manufacturers, recognizing the value of filament control, have either equipped their sets with panel mounted meters or have installed phone jacks directly connected to the filaments of the tubes.

The tip-jack voltmeter illustrated is especially designed for regulating filament voltage of Radiola, Victor, Brunswick and other sets provided with phone jacks. It has an exclusive adjustment feature found in no other instrument, which consists of a revolving back plate with individually adjustable prods which plug into phone jacks and allow the scale to always be rotated to the horizontal position.

Scale ranges of 0-5, 0-7 or 0-30 volts, can be obtained.

Send for descriptive form No. 1015

Jewell Electrical Instrument Company

1650 WALNUT STREET, CHICAGO

"26 YEARS MAKING GOOD INSTRUMENTS"

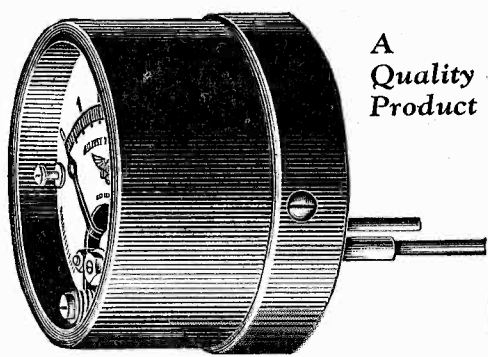

A
Quality
Product

Pattern No. 135-A
Tip-Jack Voltmeter

Hoyt

CELLCHEK

The HOYT CELLCHEK is a new and more accurate instrument for testing Radio storage batteries. The electrical meter indicates instantly whether the battery needs re-charging, is low or in good condition and the CELLCHEK operates without the withdrawal of a drop of acid, keeps hands clean, protects rugs and furniture. We know of no more useful accessory for the Radio owner. Can be used on Trickle-Charge outfits also.

Price \$2.50

BURTON-ROGERS CO.

BOSTON, MASS.

Sales Department for HOYT Electrical Instrument Co.

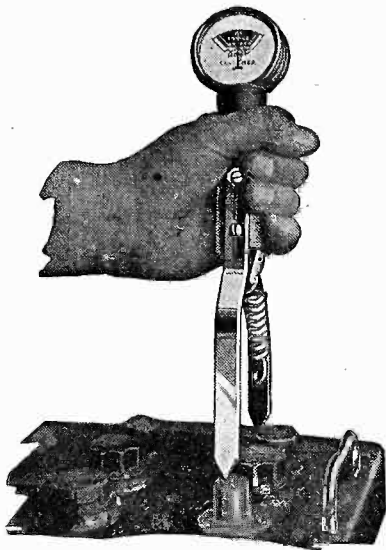

Bradleyometer

THE PERFECT POTENTIOMETER

Uses graphite disc resistors which are noiseless and not affected by atmospheric conditions. Metal parts are nickel plated. One hole mounting. Finish and knob match Bradleystat. Made in 200 and 400 ohm ratings.

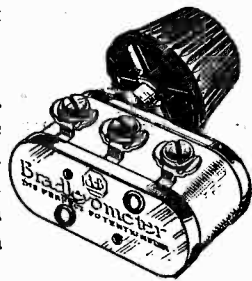

Allen-Bradley Co.

Electric Controlling Apparatus

279 Greenfield Avenue Milwaukee, Wis.

FIVE TUBE RADIO

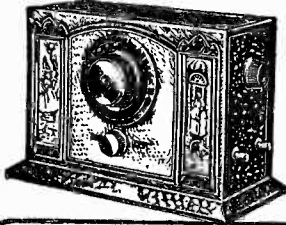

\$25.00

**AGENTS
WANTED
BIG
COMMISSION**

Demonstrating agent wanted; every county. Exclusive to right man. Sell what public wants—five tube, long distance, loud speaker radio with single dial control. Price within reach of all, \$25.00 retail; liberal discount to agents. Sell in spare time—evenings. No selling or radio experience necessary. Territory going fast. 100 page Radio Book FREE. Write today—don't delay. C. D. FISCHER, 122 W. Austin Ave., Chicago

Let Us Send "RADIO" to Your Home for a Full Year, \$2.50
"RADIO" San Francisco

as close to the front lines as possible, having a ground rod or mat buried near the enemy trenches. To place this ground connection and lead a wire back from it is a hazardous piece of work and can be done only at night by a group trained in patrolling. In the last war the operators of these stations had to understand German. The enemy earth intercept operators likewise had to be familiar with English. Knowing that the Germans were picking up his telephone messages by intercept, one ingenious American colonel commandeered two Choctaw Indians in his outfit to transmit and receive messages in their own tongue. This strange language completely nullified the German intercept service on that part of the front as long as the regiment remained in line.

The War Department radio net is a peace time activity that has grown amazingly since its establishment in January, 1922. Briefly, it is a radio system operated by the Signal Corps for the transmission of official governmental message traffic, of the various departments and bureaus, that was formerly handled by commercial telegraph companies. It now comprises 126 land stations in the United States, Alaska, Panama Canal Zone, Hawaii and the Philippines, and 53 ship stations on vessels of the Quartermaster Corps of the Army. In one six-months period 106,000 messages containing over 4½ million words were handled in the net. The efficiency of the system is best illustrated by citing the cases of two messages recently received at the War Department from widely separated stations. One message was filed at Fort Sam Houston, Texas, at 9:30 a. m. central time and delivered in Washington at 11:15 a. m. eastern standard time, or in exactly 45 minutes. On the same day a message was filed at Anchorage, Alaska, at 9:41 a. m. Pacific Coast time. It was sent by cable to Seattle and thence relayed by radio through San Francisco, California, and Fort Leavenworth, Kansas. Delivery was made in Washington at 2:19 p. m. eastern standard time, the entire transmission having been made in an hour and thirty-eight minutes. These messages were handled in a routine manner and under normal operating conditions.

One of the greatest tributes to radio for military use is found in the following extract from the account of the operations of the Fifth Field Signal Battalion U. S. Army in July, 1918:

"A signal platoon under First Lieut. W. E. Herb swam the Marne to carry a line up for the 4th Infantry. In fifteen minutes July 14th every wire line of the 4th Infantry was severed. Sergeant Leck took a buzzerphone into an open field and got a message through to brigade but was killed before he could get back to shelter. Eight pairs of linemen went out and every man was either killed or wounded. Then radio was resorted to and it was successful."

Could there be a more striking testimonial to the efficacy of radio and its importance as a means of communication for military forces?

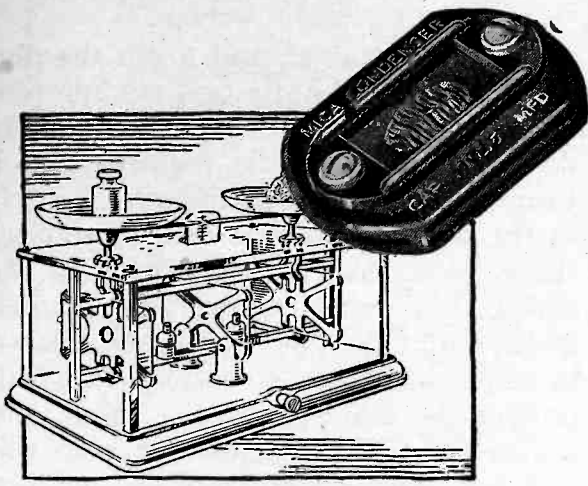

"Weighs out right capacity as accurately as the apothecary weighs out a precious drug."

A. C. L.

TECHNICAL men were quick to appreciate Sangamo condensers in intermediate capacities. One engineer, well known to readers of radio publications—Austin C. Lescarbours—sends us the following characteristic comment, which is published with his consent:

"In my laboratory we develop new circuits and variations of old circuits, publishing the results in radio magazines. Needless to say, we are using and specifying Sangamo condensers throughout. In my opinion there is no other fixed condenser that can compare with the Sangamo in accuracy, permanent capacity value, neatness and handiness.

"The Sangamo condenser weighs out just the right capacity as the apothecary weighs out a precious drug."

SANGAMO

Mica Condensers

are made in 34 sizes, ranging from 0.00004 mfd. to 0.012 mfd. Sangamo Wound Condensers are ready in capacities from 1/10 mfd. to 4 mfd.; Series A guaranteed for continuous operation at 250 volts AC, 400 volts DC; Series B guaranteed at 500 volts AC, 1000 volts DC; also 12 and 14 mfd. blocks.



Sangamo Electric Company

6332-20 Springfield, Illinois

RADIO DIVISION, 50 Church Street, New York

SALES OFFICES—PRINCIPAL CITIES

"PHASATROL"

Coming-Coming

A True Balancing Device for All Radio Frequency Sets

A Revolutionary Innovation
ELECTRAD, Inc.

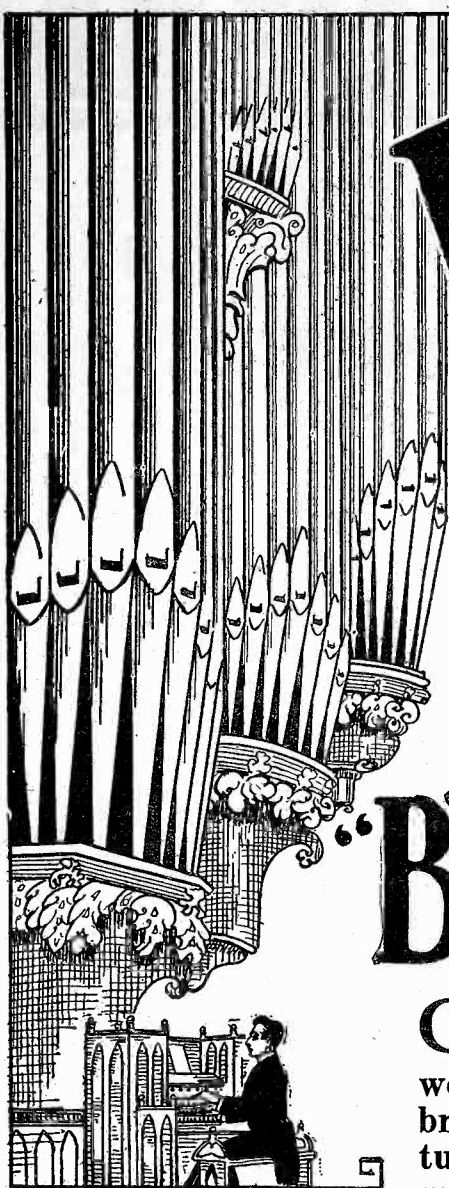

Power

for
the deep
tones
PLUS a
"B" Eliminator

COMPLETE realism in radio reproduction requires that the deep bass tones as well as the high notes be prominently brought out. Only a UX-210 (or CX-310) tube, using up to 400 volts in your last audio stage, has sufficient power to do this.

To use this tube directly in your set, rewiring would be required to take care of the increased voltage. Now by merely attaching a POWERIZER and eliminating your present last tube, you can not only use this real power tube without rewiring, but eliminate "B" batteries as well.

POWERIZER operates from the lamp socket, using two power tubes—one the 210 or Super-Amplifier giving such marvelous tone that it has come to be known as the "Tonifier," the other a UX-216 (or CX-316) rectifying tube, making the POWERIZER a heavy duty super "B" eliminator.

You cannot KNOW what really perfect tone quality is until you hear POWERIZER. POWERIZER can be attached to any set in a few minutes with no technical knowledge whatever. Ask the nearest POWERIZER dealer to demonstrate it to you today.

Our new descriptive leaflet, "New Tone for Old," will gladly be sent upon request. Write for it.

POWERIZER

REG.

TESTED and APPROVED by ALL
Leading Laboratories

Power Amplifier and "B" Eliminator combined—at cost of a good "B" Eliminator alone.

\$ **49**⁵⁰

(West of the Rocky Mts. \$51.50)

RADIO RECEPTOR CO.
106 Seventh Ave. New York

Western Sales Agents
JAEGER RADIO CO.
22 Connecticut St., Seattle, Wash.
PACIFIC RADIO LABORATORY
256 So. Los Angeles St., Los Angeles, Cal.

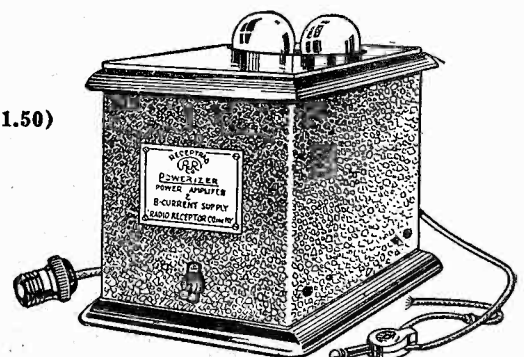

Tell them that you saw it in RADIO

ELECTRAD

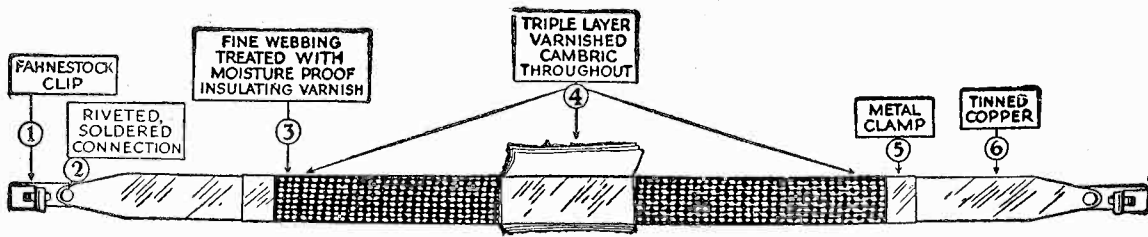

"THE SIX-POINT LEAD-IN"

Improved Reception with ELECTRAD Accessories and Parts

NO LOSSES, no troubles, with this Electrad Certified Lead-In. Just study this sketch and see why. REAL insulation (10 inches long), three-ply, covered with waterproof webbing. One-piece copper strip, tinned to prevent corrosion. Fahnestock clips, all connections RIVETED and SOLDERED.

Fits under locked windows or doors. Can be bent to any shape. No need to ruin walls, door or window trim. For your own protection and to insure perfect reception, demand the Genuine Electrad Certified Lead-in. Beware of cheap imitations. Price U. S. 40c, Canada 60c.

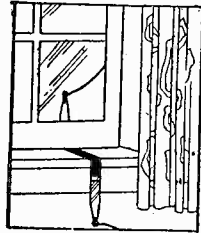

Want Clearer, Purer Reception?

Do This:

Place an Electrad Certified Audiohm across the secondary of your transformer. Get the low notes and high notes full, clear and undistorted. Whatever set you have, the Audiohm will make it better. Can be attached instantly. No soldering. Comes all equipped. Buy one today. Good radio stores have them. Price U. S. \$1.50, Canada \$2.10.

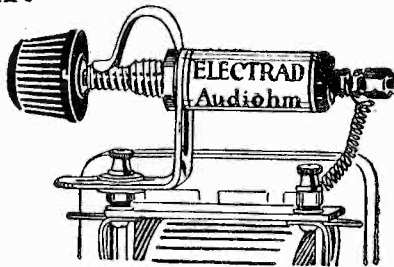

For Perfect Tone and Volume Control, Use Electrad Royalty 500,000-ohm Compensator

The remarkable results secured by the use of this perfected device are due to the fact that it controls the output without any distortion or noise, so that pure music is received through the loud speaker. Note these six important features of design and construction:

- 1—Resistance element is not exposed to any mechanical operation.
- 2—Electrical contact is made positive by a metallic arm on the wire-wound strip.
- 3—The same resistance is always obtained at the same point.
- 4—The resistance value is under control in the process of manufacture and does not change in use.
- 5—The entire range of resistance is covered with less than a single turn of the knob.
- 6—There is no mechanical binding and the shaft is turned over the entire range with a perfectly smooth operation.

Made in various types for various purposes. Prices, \$1.50 to \$2.00; in Canada, \$2.10 to \$3.00. Write for circular.

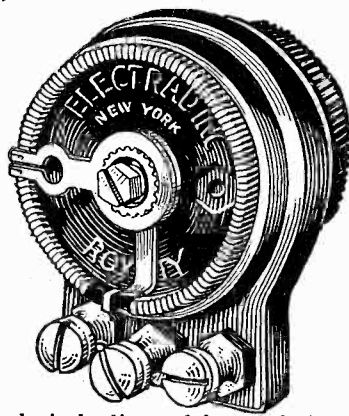

Exclusively licensed by Technidyne Corp., under U. S. Pat. No. 1593658, July 27, 26.

For perfect control of tone and volume use the Electrad 500,000 ohm compensator. For free hook-up write 428 Broadway, N. Y. City.

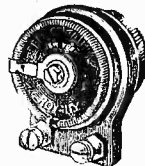

ELECTRAD

THE SIMPLICITY RECEIVER (Continued from page 38)

tery to its terminal, and touch the plus *A* lead successively to each binding post of the *B* battery group. If the tubes do not light, with the filament switch turned on, there are no disastrous shorts in the wiring, and it is safe to connect the *B* batteries. If in doubt about the wiring, a 25 watt mazda lamp shunted by a 1 mfd. by-pass condenser, placed in series with the *-B* battery wire will protect the filaments of the tubes, and if there is a short circuit, the lamp will glow and give visible warning without burning out anything. The r. f. and 1st audio tubes require 90 volts plate and $-4\frac{1}{2}$ volts *C*, while the power tube may be either a type 112, with 135 to 180 volts plate, and -9 to -12 volts *C*, or a type 171 with 135 to 180 volts plate, and -22 to -40 volts *C*. If the higher plate and *C* voltages are used with the 171 tube, an output transformer or output filter must be used to by-pass the plate current around the loud speaker unit.

PARTS USED IN BUILDING SET

- 1 Bruno Model RF Unitune (Model CF optional).
- 4 Vacuum tube sockets.
- 1 Hammarlund Type MC-15 condenser .00006 mfd.
- 1 Electrad Type E 500,000 ohm variable resistance.
- 1 Bruno Filament Switch.
- 1 Electrad Single contact jack.
- 2 Precision No. 340 r.f. chokes.
- 2 Ferranti Type AF-3 audio transformers.
- 1 Polymet 1 mfd. by-pass condenser.
- 1 Polymet .00025 mfd. grid condenser, with clips.
- 1 2 megohm Polymet grid leak.
- 1 XL Model N neutralizing condenser.
- 1 1-A Amperite.
- 2 112 Amperites.
- 2 Mounting brackets—Bruno adjustable, or Tait sloping front.
- 8 Eby binding posts.
- 1 Bakelite or Formica panel $7 \times 18 \times \frac{1}{8}$ in.
- 1 Sub-base Bakelite $9 \times 17 \times \frac{1}{8}$ in. (if wood, $\frac{1}{2}$ in. thick).

With the regeneration condenser set at minimum capacity, and the volume control half way around, tune in a station by turning the dials, and note whether or not the set oscillates as the resonance point is reached. Probably this will occur at certain settings of the dials, and with a piece of wood whittled into the form of a screwdriver, the neutralizing condenser should be adjusted until no oscillation occurs at any setting of the tuning dials.

A handy method, similar to that employed in the Browning-Drake, is to advance the midget feedback condenser until the detector oscillates. Tune in a station, which will produce a squeal in the loud speaker. Hold the right hand

(Continued on page 58)

So That Your Enjoyment Might Be Uninterrupted

Today you can be as sure of your B-power supply as you are of your electric lights. No longer need you worry whether your B batteries will run out at the most crucial moment of some national sporting event. No longer need you hesitate to invite the neighbors over to hear the opera for fear that your B-power unit will fail for lack of proper attention.

Raytheon has made possible absolutely reliable B-power that requires no attention. For years Raytheon Engineers studied the application of light socket power to the operation of radio in the home. Eventually the Raytheon rectifying tube was produced, giving an abundance of power, long life (no filament) and complete elimination of all service.

At this point the leading makers of radio equipment took up the task of incorporating the Raytheon rectifier in a complete B-power unit, ready for installation in the home. This has been accomplished with great success by the organizations represented on this page.

Their units, all tested and approved by the Raytheon Laboratories, represent a wide variety of styles and prices. Your dealer will be glad to recommend one best suited for your set. The fact that it is Raytheon-equipped means that unfailing B-power is yours at the touch of a switch.

Raytheon is the heart of reliable radio power.

RAYTHEON MANUFACTURING CO.

CAMBRIDGE, MASS.



Organizations Manufacturing B-Power Units
RAYTHEON-EQUIPPED

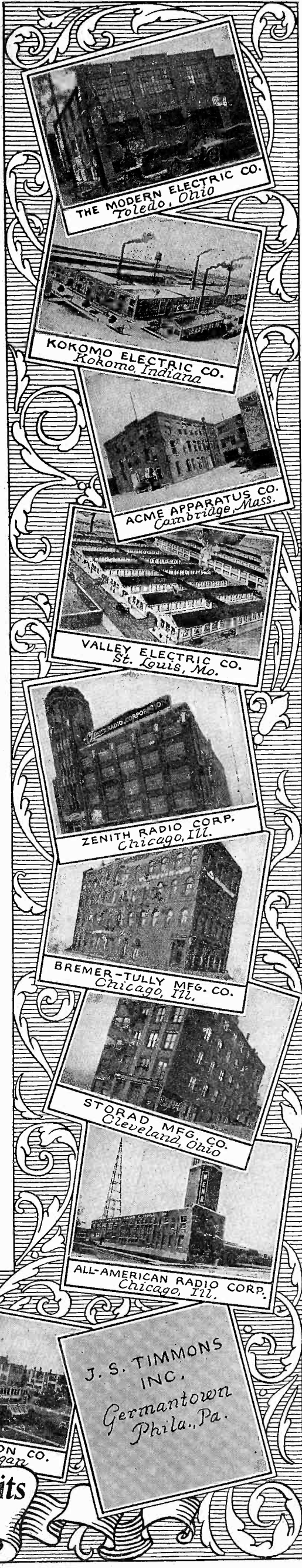
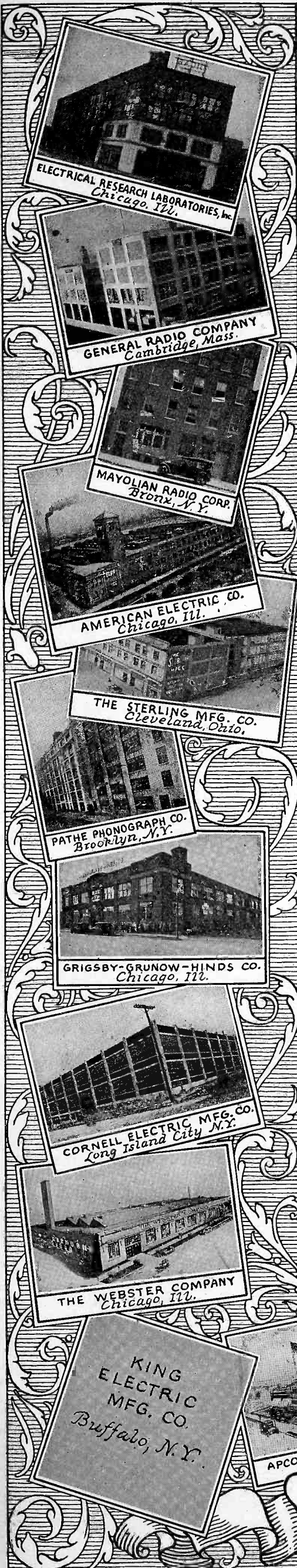

ELECTRICAL RESEARCH LABORATORIES, INC.
Chicago, Ill.

GENERAL RADIO COMPANY
Cambridge, Mass.

MAYOLIAN RADIO CORP.
Brooklyn, N.Y.

AMERICAN ELECTRIC CO.
Chicago, Ill.

THE STERLING MFG. CO.
Cleveland, Ohio.

PATHE PHONOGRAPH CO.
Brooklyn, N.Y.

GRIGSBY-GRUNOW-HINDS CO.
Chicago, Ill.

CORNELL ELECTRIC MFG. CO.
Long Island City, N.Y.

THE WEBSTER COMPANY
Chicago, Ill.

KING ELECTRIC MFG. CO.
Buffalo, N.Y.

APCO MANUFACTURING CO.
Providence, R.I.

SPARKS-WITHINGTON CO.
Jackson, Michigan

J. S. TIMMONS INC.
Germantown, Phila., Pa.

THE MODERN ELECTRIC CO.
Toledo, Ohio

KOKOMO ELECTRIC CO.
Kokomo, Indiana

ACME APPARATUS CO.
Cambridge, Mass.

VALLEY ELECTRIC CO.
St. Louis, Mo.

ZENITH RADIO CORP.
Chicago, Ill.

BREMER-TULLY MFG. CO.
Chicago, Ill.

STORAD MFG. CO.
Cleveland, Ohio

ALL-AMERICAN RADIO CORP.
Chicago, Ill.

Valley Electric

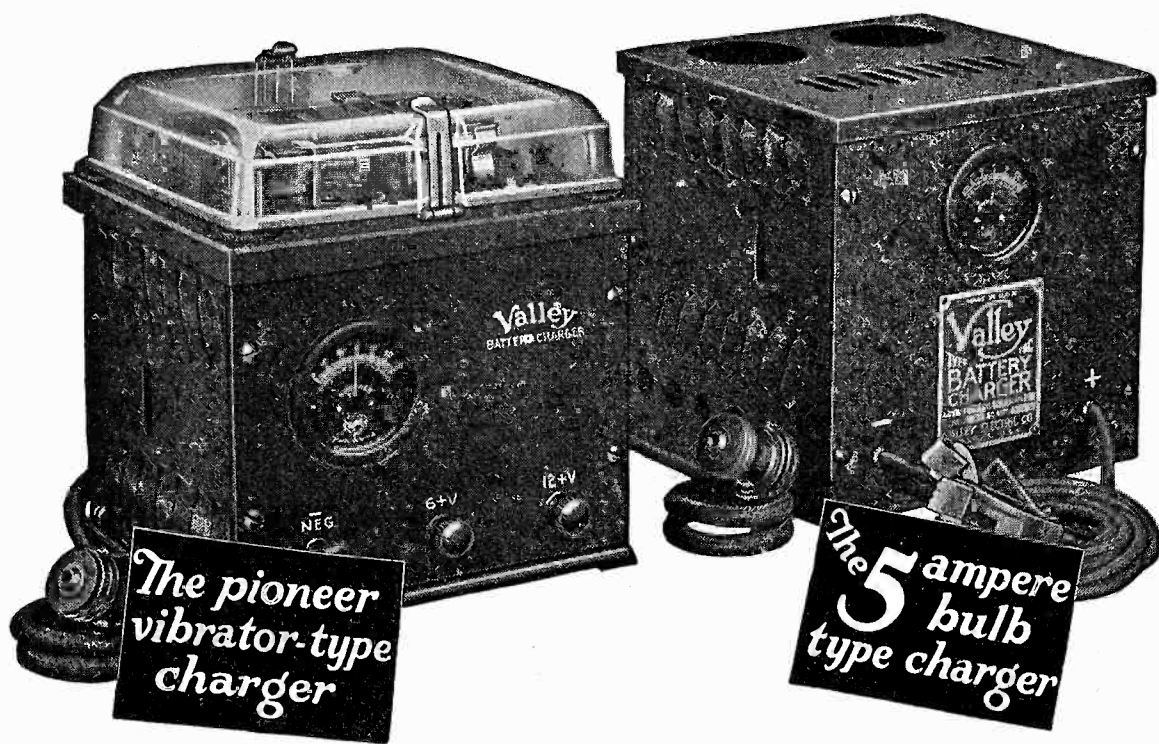

Use either one for a dependable source of "A" battery current

You can get the famous Valley Battery Charger in both vibrator and bulb types. Use either one for a dependable source of A battery current.

The Vibrator Type: This is the pioneer of radio battery chargers. Nearly a quarter of a million of this type of Valley Charger has gone into service all over the world.

Charges 6-volt batteries at 6 amperes, 12-volt batteries at 3 amperes, Quiet. Efficient. Cannot harm the battery.

Mounted in black case with bakelite panel and glass top. Pleasing in appearance and will harmonize with finest radio receiver. Complete with cord and plug, and leads and clips.

The Twin Bulb Type: The twin bulb design of this Valley Charger overcomes the only objection to the bulb type charger, i. e., the slow charging rate.

Using both bulbs, you have a 5-ampere charger. Using only one bulb, you have a 2½-ampere charger. Thus the charging rate and the purchase of one bulb or two are entirely optional.

Absolutely noiseless. Built in handsome black grained metal case. Complete with cord and plug, and leads and clips.

Other Valley Radio Units

The two small cuts below show the Valley B Power Unit and the Valley Radio Receiver.

The B Power Unit supplies plate voltage from the house circuit. For sets of 12 tubes or less. May be used with a power tube or unit. Fitted with the Raytheon Tube only—"for reliable reception."

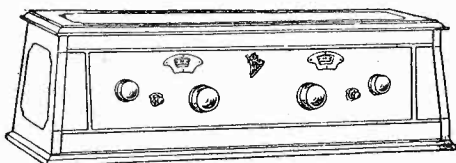
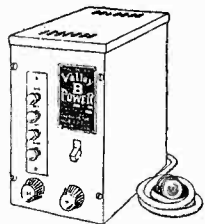

The Valleytone is a 5-tube, tuned radio frequency receiver. Two-dial control. Wired so that use of power tube is optional.

VALLEY ELECTRIC CO. · RADIO DIVISION · ST. LOUIS, MO.

District Offices: Boston, Chicago, Cleveland, Indianapolis, Kansas City, Minneapolis, New York, Philadelphia, San Francisco

THE SIMPLICITY RECEIVER

(Continued from page 56)

drum dial with the fingers while the left hand dial is rotated, and if the r. f. tube is not properly neutralized, the squeal will suddenly change its tone and perhaps will rise above the audible range if the neutralization is poor. The neutralizing condenser set-screw should then be moved around until the squeal remains fairly steady when the resonance point is reached, after which it should not again be touched unless the r. f. tube is changed.

It is essential that a feedback condenser of at least 60 mmfd. be used, for if a smaller size is employed, it is quite possible that regeneration cannot be had on the waves above 400 meters.

While the receiver has a regeneration and volume control, it can be considered single control when receiving local stations, insofar as the tuning is concerned. By the use of a tandem condenser mounting with drum type dials, the two condensers can be rotated simultaneously with one hand, and while the settings of the two condensers will vary slightly with respect to each other, on different wavebands, the dials can be moved together on all stations except the distant ones.

SOUTH AFRICAN AMATEURS

(Continued from page 45)

- A5J Heywood, H. W., Official Relay Station, S.A.R.R.L., Natal, Div. 5.
- A5K Werner, B., Piet Retief.
- A5L Whatley, M. F., 6 Upper Hillside Terrace, Green Point, C. P.
- A5M Elliot-Wilson, F. C., "Humewood," 3rd Ave., Roodepoort North.
- A5N Layzell, W. F., 23 S.A. Mutual Bldgs., Johannesburg.
- A5O Becker, H. W. G., Box 135, Port Elizabeth.
- A5P Davis, E. A. C., Second Ave., Walmer, Port Elizabeth.
- A5Q Harvey, A. Q., 34 Western Rd., Port Elizabeth.
- A5R Hodges, 112 Main St., Port Elizabeth.
- A5S Kovachi, V. H., Ashley House, Have-lock St., Port Elizabeth.
- A5T Lambson, R., King Edward Hotel, Belmont Terrace, Port Elizabeth.
- A5U McWhannell, F., 5, Cappel St., Port Elizabeth.
- A5V Makepeace, R., care Box 344, Port Elizabeth.
- A5W Wood, E., Sixth Ave., Walmer, Port Elizabeth.
- A5X Jacobs, A. J., 4, Loch Ave, Parktown West, Johannesburg.
- A6Z Betts, Hubert, Queensville, Queen's Road, Sea Point.
- A7A Boyce, David R., Orange Grove, Greenwood Park, Durban.
- A7B Perrot, R. N., M.A.M.B., "Ifod," First Ave., Walmer, Port Elizabeth.
- A7C Neseman, A. E., 13 Medusa St., Kensington, Johannesburg.
- A7D Buckley, H. J., "Longacres," Lot 5, Little Amamzitoti, Natal.
- A7E Bone, C. M. C., Bulawayo House, Celliers St., Pretoria.
- A7F Suttner, Ralph, 39 Ockerse St., Johannesburg.
- A7G V. K. Vyvyan, Richmond, Natal.
- A7H E. Levine, 20 Powell Road, Durban.
- A7J C. M. Lefevre, Richmond, Natal.
- A7K D. L. Gordon, 26 Richmond Ave., Auckland Park, Johannesburg.
- A7L W. Todd, P.O. Box 5439, Johannesburg (Experimental Portable Set).
- A7M
- A7O A. T. Law, 49, Sixth Ave., Parktown North, Johannesburg.
- A7W J. Paver, Aliwal North, Durban.
- A3Y Innes, A. S., Johannesburg (portable).
- A3Z Hill, B., 71 Cape Rd., Port Elizabeth.
- A4A Warren, W. F., Berg St., Potchefstroom.
- A4B Mauch, G. A., 8 Ayton St., Pretoria.
- A4C Mowbray, E. W., Box 383, Kimberley.
- A4D Bull, W. H., 47 Milner St., Kimberley.

(Continued on page 62)

A·B·C Light Socket Power

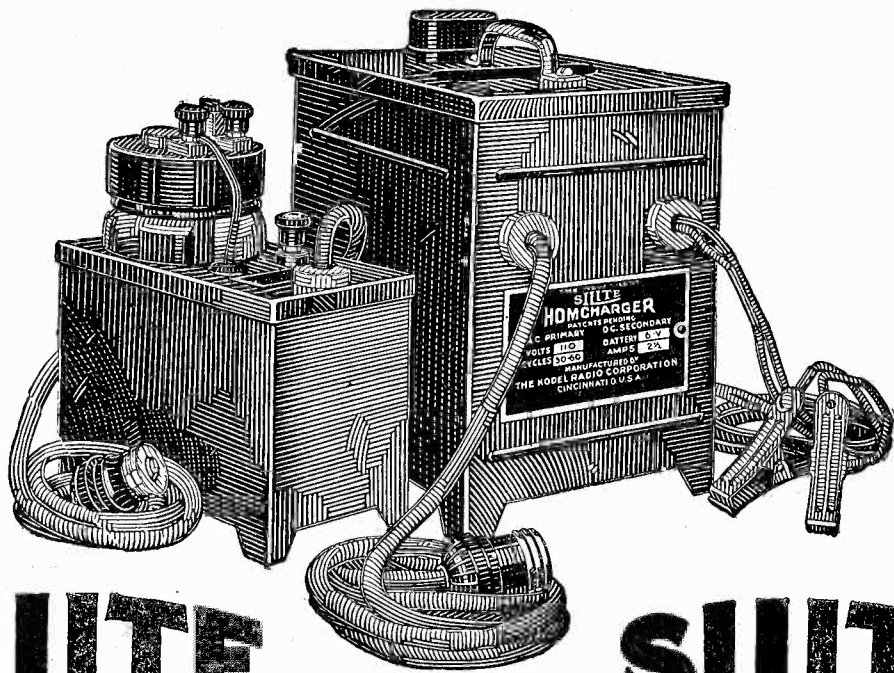

SILITE
TRICKLE CHARGER

SILITE
HOMCHARGER

Your battery troubles are over, at last. Now all radio power is in your light socket.

For continuous unflinching "A" current, connect either the Silite Homcharger or the Silite Trickle Charger to your present storage battery. Absolutely noiseless, without bulbs, moving parts, or adjustments, Silite Trickle Charger makes a power unit of your battery—keeps it always at top efficiency. Left permanently on charge, Silite Trickle converts light socket current into radio power and stores it in your battery ready for use at any time—you simply forget about battery charging forever. For exceptionally large sets where a high charging rate is necessary, the Silite Homcharger is recommended. Either model may be used while the set is operating.

SILITE TRICKLE CHARGER
.6 ampere charging rate.

Complete.....\$10.00

SILITE HOMCHARGER
2½-3 ampere charging rate.

Complete.....\$19.50

Kodel A&B Transifiers

Kodel A and B Transifiers actually deliver all A, B, and C current direct from the light socket—smooth, constant, never-failing power that operates your set always at its greatest efficiency. Vastly different from and superior to the ordinary power unit, Kodel Transifiers consume current only while the set is operating—maintenance cost is less than one-half cent for every hour you use your set. Any radio dealer can show you Silite Battery Chargers and Kodel Transifiers.

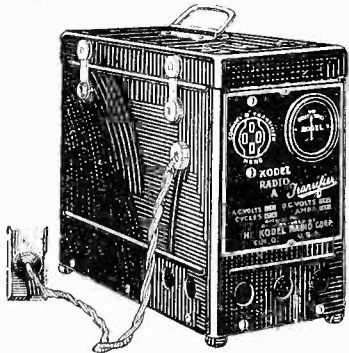

MODEL 10 "A" TRANSIFIER

Supplies 2, 4, or 6-volts "A" current direct from the light socket. For sets using up to 10 tubes.....\$42.50

MODEL 10 "B" TRANSIFIER

22½ to 150 volts "B" current; 4 to 10 volts "C" current for any size set. Operates power tubes.....\$42.50

MODEL 61 "B" TRANSIFIER

22½ to 90 volts noiseless "B" power for sets up to 6 tubes.....\$28.50

(Bulbs extra)

["Behind the Scenes in a Broadcasting Station" an interesting 24-page booklet, will be mailed free on request, together with literature describing Silite Chargers and Kodel Transifiers.]

The Kodel Radio Corporation, 514 E. Pearl St., Cincinnati, O.
Owners and Operators of Broadcasting Station WKRC

Pacific Sales Office

BERTRAM SMITH, 400 San Fernando Bldg., Los Angeles, Calif.

Battery Chargers
Power Units

KODEL Radio Receivers
Loud Speakers

POWER SPECIALISTS SINCE 1912

ABOUT THE INVERSE DUPLEX

(Continued from page 29)

filament end of the secondary in order to reduce the capacity coupling which is bound to occur between the two coils.

The primaries of the two intermediate tuning coils are wound with 9 turns of No. 28 D.C.C. copper wire—placed ½ in. away from the filament end of the secondary coils on the same tubing. The primaries are wound in the same direction of rotation as the secondaries and the plates of the tubes are connected to the end of the primary nearest the secondary. These are important points as the radio phase of the reinforcing currents is thus made aiding and positive. Either a reversal in connections or in rotation of winding will make the feedback opposing, reducing the amplification and efficiency. These connections and winding rotations are clearly shown in Fig. 4.

The audio circuit consists of a 2 to 1 ratio transformer in the first stage, resistance coupling using a .1 mfd. condenser in the second stage, and a 6-1 transformer in the third stage. The volume is controlled by a 250,000 ohm potentiometer connected across the secondary of the first audio transformer. This loading resistance also reduces amplification peaks and resultant howls caused by resonance in the transformer windings.

This tendency to sing at certain peak frequencies is still further corrected by the stage of resistance coupling. With straight transformer coupling a. f. oscillations may be set up in the oscillatory circuit made up of the tube capacity, the grid inductance due to the secondary of a transformer, and the plate inductance due to the primary of the succeeding transformer. An intermediate stage of resistance coupling eliminates this grid-plate inductance and stops any tendency toward regeneration.

Much of the howling that characterized the operation of early reflex designs was found to be due to the inter-action between audio frequency and radio frequency currents in the same overloaded tube. By substituting 4½ volts C battery instead of the 1 volt negative bias first used, the tube grid no longer became positive with respect to the filament and the inter-action was stopped up to the point that the tube became overloaded by a strong local signal. In the latter case the resistance coupling chokes up so as to produce a low-pitched buzzing which is stopped by turning down the volume control potentiometer.

This solution of the tube overloading problem takes care of any trouble in the first audio stage, which is phased so as to always have a negative grid instead of an occasional positive grid. As the phase relation depends not only upon the primary and secondary windings being wound in the same direction but

(Continued on page 62)

Just try a WORKRITE

Licensed by
Independent Radio Manufacturers, Inc.
NEUTRODYNE
Reg. U.S. Pat. Off. Pat. March 27, 1923 and April 1, 1924.
Pat. Nos. 1,450,080 and 1,450,228
Other Patents Pending.

The Sensation of the Season

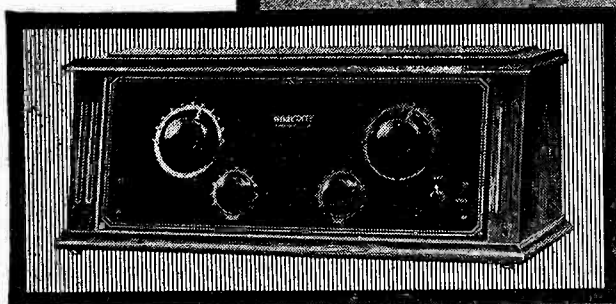

WorkRite Model 16

A 6-tube Neutrodyne Receiver. Two-dial control. Beautiful walnut cabinet with panel to match, gold trimmed.

Price \$80.00

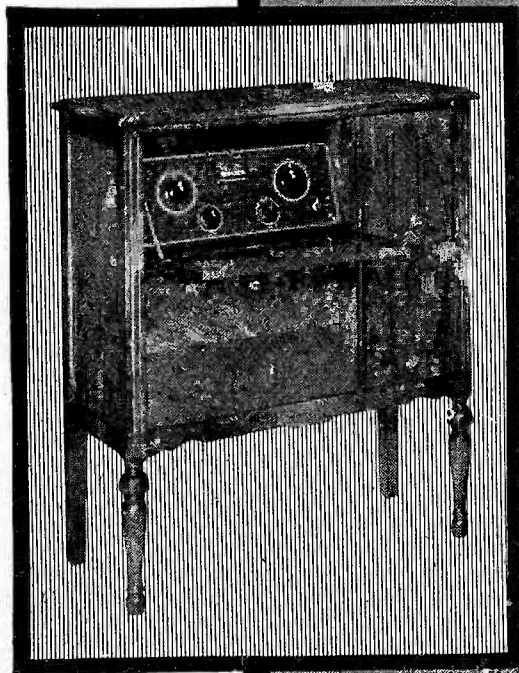

WorkRite Model 26

The same circuit and control as Model 16 mounted in a handsome walnut console cabinet. Three-way switch. Large built-in cone speaker. Wired for power units. Best value console on the market today.

Price \$160.00

WorkRite Model 36

(See large illustration in center)

The supreme accomplishment of the season. Six-tube transformer and resistance coupled Neutrodyne circuit. TWO-IN-ONE dial operates all three condensers from one control. Has three-way switch. Large built-in cone speaker 24" wide. Beautiful walnut cabinet, is a pleasing piece of furniture.

Price \$210.00



WORKRITE Radios WORKRITE

Practical Refinements

in Control and Circuit

together with more attractive cabinets and fittings make the new WorkRite Super Neutrodyne radios the sensation of the season. This is a big Neutrodyne year and WorkRite is one of the leading licensed Neutrodyne.

All WorkRite models are designed to operate with power units from lamp socket or with batteries.

All console models have built in cone speakers.

A WorkRite Super Neutrodyne will satisfy your every radio desire. Visit a licensed WorkRite dealer today or write us for beautifully illustrated literature.

The WorkRite Manufacturing Co.

1837 E. 30th St.

Cleveland, Ohio

Supreme in MUSICAL PERFORMANCE!

Tschaikowsky, Beethoven, Brahms — would you listen with rapture to the rendition of their master pieces by the "hungry six" corner band? You would not!

Then why distort the masterful programs of the better broadcasting stations to the "hungry six" type of reception when Thordarson transformers are available at every dealer's?

Thordarson transformers are found in the majority of quality receivers, where musical performance is the first consideration — A conclusive proof of the musical supremacy of Thordarson amplification.

THORDARSON RADIO TRANSFORMERS



THORDARSON ELECTRIC MANUFACTURING CO.
Transformer Specialists Since 1895
WORLD'S OLDEST AND LARGEST EXCLUSIVE TRANSFORMER MAKERS
Huron and Kingsbury Streets — Chicago, Ill. U.S.A.



R-200
Amplifying Transformer

The transformer for the musical epicure. Has unusually faithful reproductive powers. Specified on such quality receivers as Zenith, Kennedy and Howard... \$8.00



Standard
Amplifying Transformer

A good reproducing transformer suitable for the requirements of the average ear.
2 to 1 ratio \$5.00
3 1/2 to 1 ratio 4.00
6 to 1 ratio 4.50



Autoformer
All Frequency
Impedance Amplifier

Amplifies every note in the musical scale. An impedance with a step-up ratio, giving the even amplification of the impedance with the amplification increase of the transformer. \$5.00



R-210
Power Compact

A complete foundation unit for power amplification and B-supply. Contains a power supply transformer and two chokes for power amplifier using UX-210 power tube. \$20.00



R-171
Power Compact

Similar to the R-210 type but designed for UX-171 power tube and Raytheon rectifier. Contains buffer condensers as well as power supply transformer and \$15.00



R-197
Power Supply
Transformer

A Power Supply Transformer designed for B-supply using the R. C. A. UX-213 type full wave rectifying tube. Will supply up to 180 volts B. \$7.00



R-196
30 Henry Choke

Designed either as a filter or an output choke. Completely shielded. Current carrying capacity 80 MA. Inductance 30 henries. D.C. resistance 280 ohms. \$5.00



R-76
Speaker Coupling
Transformer

An output transformer designed as a protective device to keep the high direct current voltage of power amplification out of the speaker unit. \$6.00

ABOUT THE INVERSE DUPLEX

(Continued from page 60)

also upon which end of the primary winding the tube plate is connected, it may be necessary to reverse the primary terminals so as to bring about the correct phase relationship. In Fig. 1 the P post is therefore connected to the 22 1/2 volt positive B battery and the B post is connected to the plate of the detector tube.

Likewise, due to the howl that may be occasioned by a run-down common B battery, a 200 ohm variable resistance is inserted in the B battery lead to the primary of the second audio transformer. Resistance is cut out as the B battery runs down, thus obviating any whistling.

The next article of the series will be devoted entirely to the discussion and plans of the unshielded I.D.S. for the benefit of those whose locations are such as not to demand the last drop of efficiency and for those who are not inclined or not equipped to cut and bend aluminum for shielding. Because of a circuit rearrangement in the unshielded set, some extraordinary results have been obtained which would otherwise have been impossible without shielding. Several possible troubles, their symptoms and remedies will also be described.

AUTOMATIC RELAYS

(Continued from page 35)

three convenience outlets are mounted on one side of the metal box holding the relay, so that the charger, B eliminator and power amplifier attachment plugs may be plugged into the relay without extra connections.

A relay of the shunt type may be made from an ordinary telegraph relay, such as the Manhattan or the Bunnell, and requires no re-winding or extra contacts if used for turning on the B power supply only. A relay having a resistance of 40 ohms will draw only a small amount of current from the storage battery, and does not take up much room on the radio table. If it is necessary to turn off the trickle charger at the same time that the relay is closing the a. c. circuit for the B power unit, the relay armature can be made the common a. c. terminal for both the charger and the B unit, and a separate contact installed. This contact can be mounted on a small piece of bakelite which is attached to the frame of the relay, at the end of the projecting arm, the set screw for adjusting the swing of the armature being removed.

SOUTH AFRICAN AMATEURS

(Continued from page 58)

- A4E Innes, A. S., 47 Rockey St., Bellevue East, Johannesburg.
- A4F Roy, W. L., 29 Muller St., Johannesburg.
- A4G Gilmour, P., Main Rd., Muizenberg.
- A4H Jeffs, F. J., Worcester Rd., Sea Point.
- A4K Griffiths, H. J., op. B. G. E. Stn., Castle St., Capetown.
- A4L Oxenham, R., 136 Long St., Capetown.
- A4M Pleass, S. C., "Pinecote," Bramley, Johannesburg.

(Continued Next Month)

DX FANS

Get Weekly Station Schedules.

Corrected Every Seven Days.

YOU NEED IT
10 Cents Per Copy

BROADCAST WEEKLY

Pacific Building

San Francisco

RADIO LISTENER'S RED-BOOK

enables you to definitely locate each station on your dials and to reduce the squeals and howls of "hit-or-miss" tuning. It is

A GUIDE TO BETTER RADIO RECEPTION

Two-page, two-color broadcasting station map gives distance, direction and time divisions.

Two-page "Radio Doctor" tells how you can determine and remedy the common troubles of radio sets, batteries, tubes, etc.

Complete information regarding each station including new licenses and latest changes listed and cross-indexed three ways.

If not sold by your radio or news dealer, copies mailed post-paid for 25c each, stamps or coin.

ANDREWS RADIO DIRECTORY AND LOG-BOOK
Ft. Wayne, Ind., P.O. Box 158 B

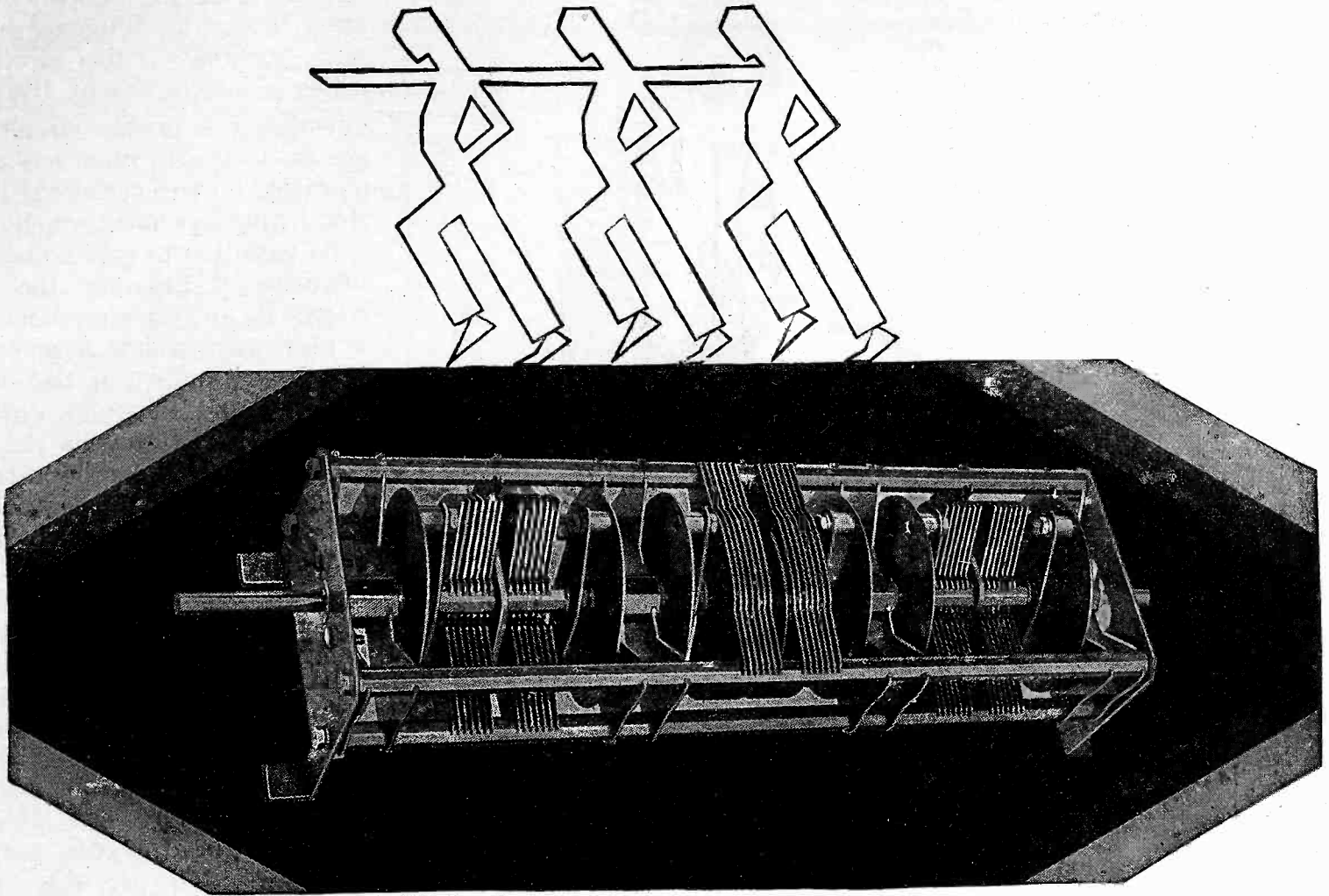

THEY WORK AS ONE

It is a simple matter to mount three condensers on one shaft—but, sad to relate, they won't necessarily work as one.

Enter — Standardization, mechanical genius, electrical measurement—and the gang condenser problem is solved.

The new 3-gang AMSCO Allocator is an electrically accurate condenser for Simplified Control. It makes one-dial tuning really practical—not a theory.

Each of the matched units is a modified frequency condenser (straight tuning line) designed to allocate the stations in accordance with wave-length divisions.

They work—as One!

AMSCO Allocating Condensers are also furnished Single or Siamese—allocating by Frequencies (S. F. L.), by Wavelengths (S. T. L.), or by capacity variations (S. C. L.). Write for descriptive leaflets.

AMSCO PRODUCTS, INC.

Broome & Lafayette Streets New York City



AMSCO

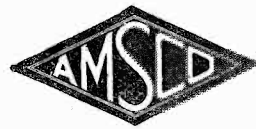

ALLOCATING CONDENSERS

Tell them that you saw it in RADIO

THE NEW SHIELDED HAMMARLUND-ROBERTS Hi-Q RECEIVER

Thoroughly tested circuit, newest features and guaranteed parts selected for perfect synchronization produce reception unexcelled by ready-made sets worth \$200 or more!

\$63.05 Cabinet extra

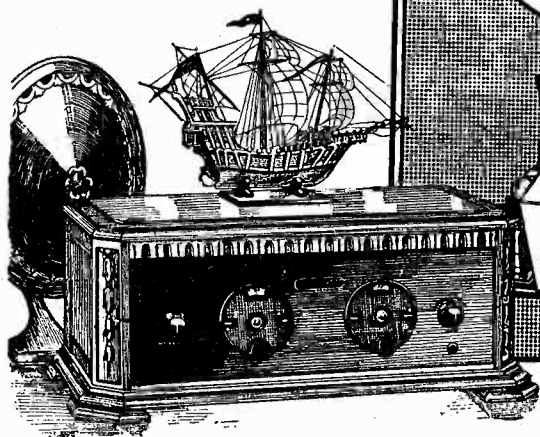

Build Your Own Masterpiece!

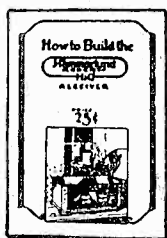

The simplest and most complete instruction book ever printed. Covers every detail

25¢

Associated

Manufacturers

- Benjamin Electric Mfg. Co.
- Carter Radio Co.
- Durham Resistors
- Eby Mfg. Company
- Hammarlund Mfg. Company
- Martin-Copeland Co.
- Rackall Company (Amperite)
- Samson Electric Co.
- Sangamo Electric Co.
- Westinghouse Micarta

IMAGINE a radio without oscillation, without variation of volume on different wave lengths! Imagine a 5-tube receiver with the power of most expensive 8-tube sets! Imagine knife-like selectivity even in crowded areas. And imagine tone quality that is clear and pure as the natural unbroadcast signal!

That describes the 1927 Hi-Q Receiver! Automatic Variable Coupling and complete stage shielding are two important new features. And the group of *guaranteed* parts selected by ten of America's leading Radio Engineers completes this triumph of modern radio design.

You can build this wonderful receiver yourself at home in a few hours and save at least \$50 over a factory-made set of anything like the same efficiency. Get the "How to Build" book to-day from your dealer and have the receiver designed by Radio's Master Minds.



*High ratio of reactance to resistance. High ratio—Great selectivity—Loud signals

Hammarlund-Roberts

1182-F Broadway

New York

SHIELDED GRID VACUUM TUBE

(Continued from page 20)

tube averages about 30 per cent lower than that of the equivalent three element tubes, the difference being due to that portion of the electron stream which is intercepted by the screen grid.

Under the proper circuit conditions the shielded grid tube acts as a perfect repeating device, variations in plate current being dependent wholly and solely upon variation in grid voltage. Mutual conductance becomes the sole operational factor, therefore, and the voltage amplification which may be obtained, being the product of the mutual conductance and the plate circuit impedance, is limited only by the amount of impedance which can be introduced into the plate circuit of the tube. By the use of resonance, extremely high impedance values may be built up, particularly at low frequencies. Since it becomes increasingly difficult to secure high impedance values with increasing frequency, the amplification obtainable at low frequencies should be considerably greater than that obtainable at high frequencies. This was experimentally confirmed by Dr. Hull. It was found possible to secure voltage amplification of 200 per stage at 50,000 cycles, 40 per stage at 1000 kilocycles (300 meters), and 7 per stage at 10,000 kilocycles (30 meters). Any desired number of stages could be employed in series with complete stability and with no evidence of feed-back. At 300 meters a four stage impedance coupled amplifier using the shielded grid tubes gave a total amplification of 2,000,000, corresponding to a gain of 38 per stage. No evidence of regeneration was found.

The actual circuit used by Dr. Hull in his amplification measurements is reproduced in Fig. 2. The amplifier consisted of a number of stages of impedance coupled elements. By means of jacks any number of stages up to six could be used, the last tube in the train acting as the detector because of the form of coupling employed. Each stage was contained in its own metal box, the grid terminal of the first stage tube projecting into the second stage box which was placed on top of the first, and so on. The plates of the tubes were maintained at 110 volts and the shielding grids at 60 volts by means of a common battery. The plate supply to all stages was individually filtered by means of a 10 millihenry choke in the positive B battery leads of each stage. Large bypass condensers were connected from the B positive leads and from the positive side of the filament in each compartment to the grounded metal shielding. Tuned impedances L_1, C_1, L_2, C_2 comprised the coupling medium between stages, together with the usual condenser and leak.

Measurements of the amplification of this cascade amplifier were made with tuned and with untuned input circuit with complete stability in either case.

(Continued on page 66)

See Jay Power Unit

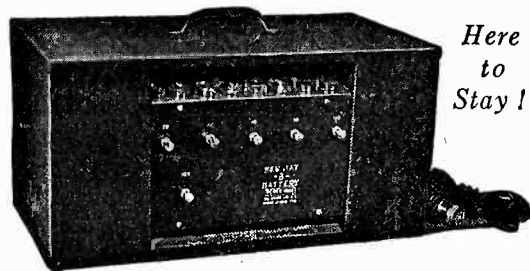

Here to Stay!

This Battery Never Runs Down!

A combination alkaline element battery and trickle charger all in one. Price, shipped dry with solution, \$16.00. Tube extra \$1.00. 100 volt with chemical charger \$12.00. 140 volt \$17.00.

Write for our illustrated 32 page booklet
Send No Money—Pay Expressman

SEE JAY BATTERY COMPANY
919 Brook Avenue New York City

Potter Condensers

Potter condensers, American made of highest quality materials to full capacity, build the best Socket Power Devices, Power Amplifiers, Impedance Amplifiers. And they are best for Filter Uses, Rectifiers, By Pass, and Blocking D.C. All types and sizes.

POTTER MANUFACTURING CO.
North Chicago, Illinois

LOG THOSE STATIONS

10¢ For A Handy Pamphlet "RADIO"

433 Pacific Building San Francisco

Tell them that you saw it in RADIO

THE Simplicity of tuning
THE Efficiency of the Bakelite Shaft Condensers
and the Beauty of the Bronze Front Plate

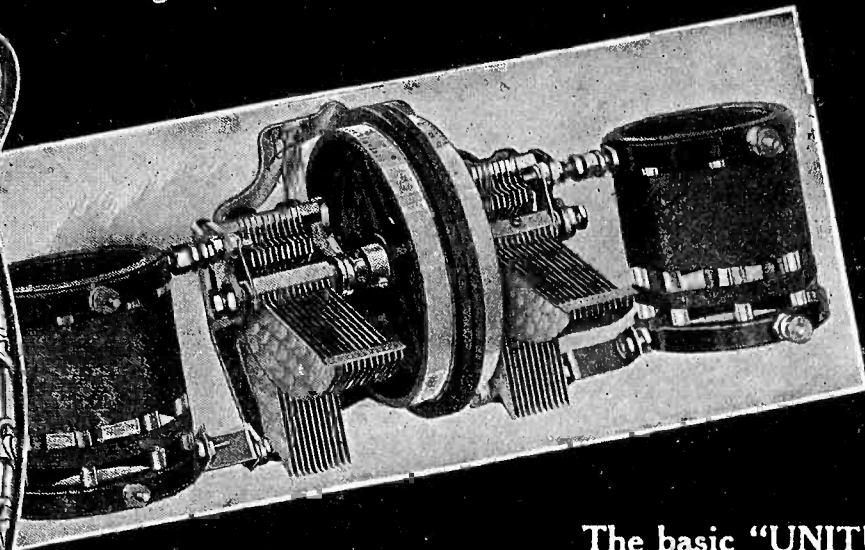
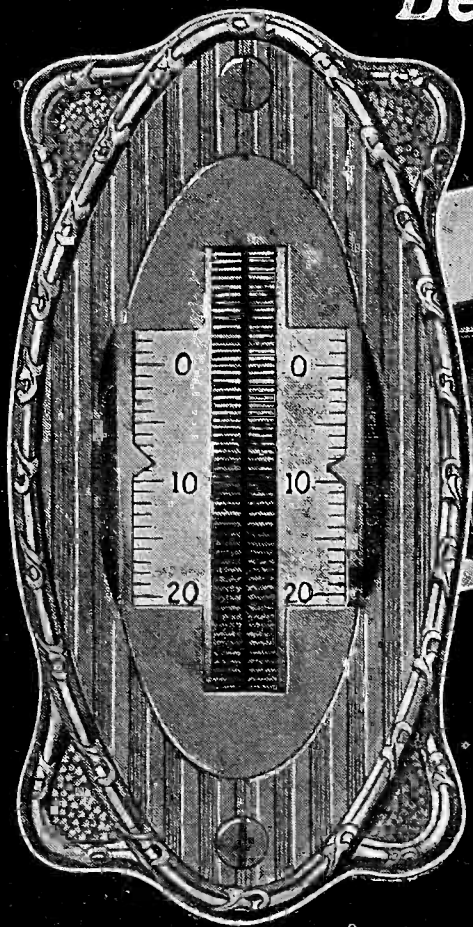

Makes the "UNITUNE" the most desirable tuning device ever designed.

ALL BRUNO "UNITUNES" may be mounted on a panel with only two screws.

The basic "UNITUNE" consists of a frame upon which are mounted two condensers operated independently by two bakelite drums projecting thru a beautiful bronze plate. It may be obtained in all standard capacities. Completely assembled it lists at \$11.00.

Other "UNITUNES" assembled with one or more Quartzite Coils for all popular circuits range from \$12.00 to \$21.00.

Booklet of Instruction and Blue Prints—25.

BRUNO RADIO CORP., LONG ISLAND CITY, N. Y.

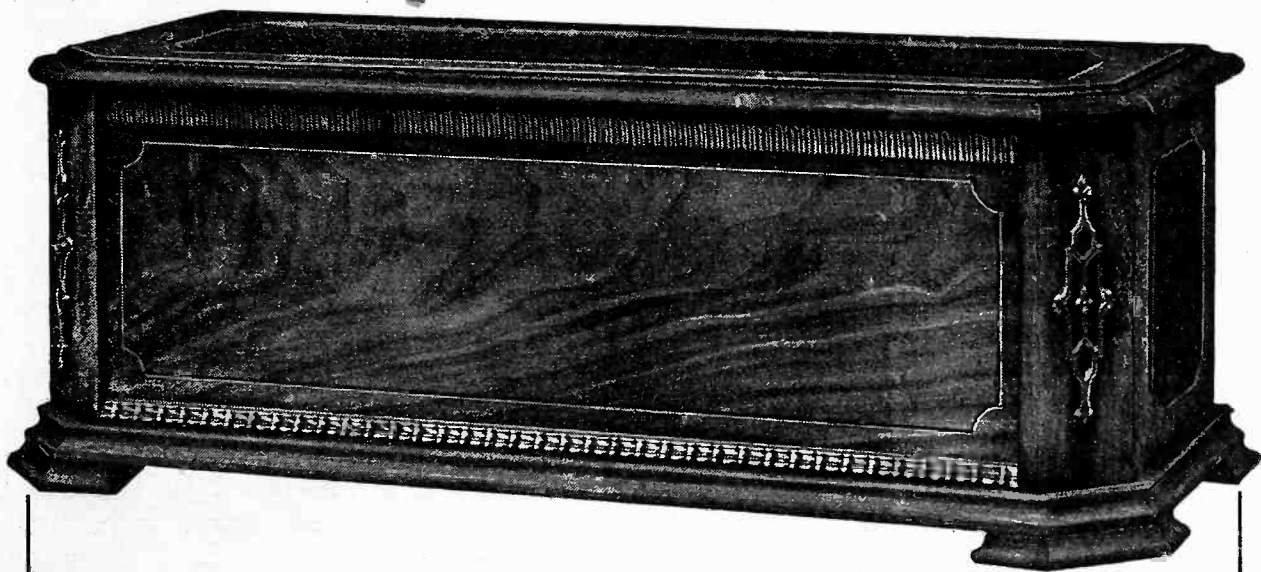

GLORIFY YOUR INFRADYNE

EXQUISITE Beauty. An appropriate "dress" for your splendid Infradyne Receiver. Do justice to your set by housing it in a CORBETT cabinet—specially designed and built for the Sargent-Rayment Infradyne. The illustration fails to justify it. The workmanship is of the usual Corbett quality. We specialize in building

radio cabinets. The Corbett Infradyne Cabinet will accommodate a 7x30-inch panel. The cabinet is 10 inches deep. Built of Walnut, beautifully finished. The lid is equipped with a continuous hinge. The cabinet is correctly moulded and decorated. Hand-rubbed duo-tone piano finish.

Each cabinet is securely packed and crated for shipment. Mail orders for these cabinets will receive prompt attention. Write for folders showing our complete line of radio furniture.

PRICES:

Walnut Cabinet for Infradyne, 7x30-inch panel space, 10 inches deep.....	\$30.00
Corbett Walnut Plywood Panel to match.....	2.10
Splined and Varnished Mounting Board, 10x34 inches.....	2.00
Walnut Table to match, and for above cabinet with 14-inch high battery compartment.....	36.00

CORBETT CABINET MFG. COMPANY
 ST. MARY'S PENNSYLVANIA

BUILD THESE WONDER CIRCUITS

SIMPLICITY 4 TUBE RECEIVER

as described in this issue COMPLETE PARTS with instructions \$52.50

Other popular kits ready for shipment. Every kit includes full instruction sheets for wiring.

NEW IMPROVED "DIAMOND OF THE AIR" KIT

complete parts \$37.50
 with ABC Eliminator Kit \$75.00

Licensed under Armstrong Patent 1,113,149. Manufactured by Clapp-Eastham Co. exclusively for the Bruno Radio Corp.

	Complete Kit
Hammarlund-Roberts Hi Q.....	\$63.05
Improved	
Browning-Drake Receiver	\$65.90
Henry-Lyford Receiver	\$69.50
Silver-Marshall	\$95.00
Shielded Six	

The Infradyne\$118.00
 and other kits, eliminators, speakers, etc.
 Always in stock.



PRODUCTS

Acme Carter
 Aero Samson
 Bodine Silver-Marshall
 Ceco tubes and others

Send for New Booklet

B. C. L. Radio Service Co., Inc.
 221-R Fulton St. New York, N. Y.

USE THESE COILS AND IMPROVE ANY RADIO RECEIVER!

AERO COIL

SUPER-SENSITIVE
INDUCTANCE UNITS



Tuned Radio Frequency Receiver \$12.00

The Aero Coil Tuned Radio Frequency Kit illustrated above will positively improve the performance of any receiver. Patented Aero Coil construction eliminates radio frequency losses and brings tremendous improvement in volume, tone and selectivity. Kit consists of three matched units. The antenna coupler has variable primary. Uses .00035 condenser. 8 page color circuit, layout and instruction sheet for building the supersensitive 5 tube Aero-Dyne receiver packed FREE with each kit. Extra copies, 75c each. Instructions include insert showing how to wire up for a power tube if desired.

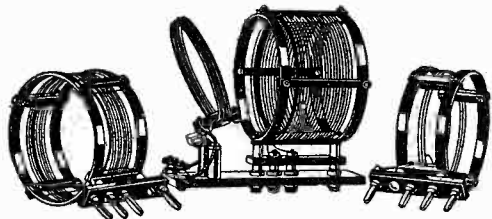

Low Wave Tuner Kit \$12.50

Completely interchangeable. Adapted by experts and amateurs. Range 15 to 130 meters. Includes three coils and base mounting, covering U. S. bands, 20, 40 and 80 meters. You can increase the range of this short wave tuner by securing coils No. 4 and 5. Combined range of 15 to 550 meters. Both interchangeable coils fit same base supplied with short wave kit and use the same condensers. Coil No. 4 price \$4.00; Coil No. 5, price \$4.00.

*Get these coils from your nearest dealer.
If he should be out of stock, order
direct from the factory.*

AERO PRODUCTS, INC.

Dept. 103

1772 WILSON AVE.

CHICAGO, ILL.

SHIELDED GRID VACUUM TUBE

(Continued from page 64)

Some evidence of feed-back occurring with the input circuit tuned completely disappeared when separate batteries were used for the first two stages, illustrating that the common battery is a bad offender in this respect. The amplification of the device was measured by impressing impulses of known voltage upon the input circuit and measuring the output voltage in the usual manner by the deflection of a galvanometer in the plate circuit of the detector, after the manner of the vacuum tube voltmeter. The known input voltages of extremely small values at any frequency were obtained by the inductive drop in a short piece of copper rod, through which a current of the frequency under measurement was passed. The amplification above referred to is that of the tubes only, no step up ratio being employed in the coupling medium.

The observed voltage amplification of 2,000,000 is very near to the maximum amplification which can be employed in practice, because with greater amplification the noise of the electrons impinging on the plate of the first tube of the train after amplification is sufficient to fill the operating range of the detector. This phenomenon, known as the "shot effect" establishes a real limit to the amount of amplification which may be employed. The only limit to the frequency of impulses which may be amplified in true cascade fashion by the shielded grid tube is that of the time of transit of an electron from filament to plate. Thus it is seen that enormously high frequencies may be amplified with the device, frequencies beyond the range of any other known amplifier.

Theoretical consideration of the problem of feed-back in a cascade radio frequency amplifier, as advanced by Dr. Hull, points out that the shielded grid tube is capable of greater non-regenerative amplification than any other device available at this time. It is evident that in a cascade amplifier, each tube of which has a capacity of C between grid and plate, the last plate is coupled to the first grid by a capacity of C/N where N is the number of stages. Since this capacity decreases arithmetically with successive stages while the amplification increases geometrically, a point must eventually be reached where the energy fed back from the last tube to the first is greater than the input losses. Under these conditions free oscillations set in and amplification is impaired. It can be shown mathematically that the maximum stable amplification which may be secured is a function of the mutual conductance, the inter-electrode capacitance, the plate resistance of the tube and the frequency being amplified. With a representative three element tube the maximum stable voltage amplification which may be secured at 300

(Continued on page 68)

COMING!

A Great Issue — The Next Issue of "RADIO"

It will contain a feature article on the use of the Infra-dyne Amplifier in connection with the Browning-Drake, Hammarlund Roberts, Bremer Tully Counter-phase and Silver Marshall shielded six receivers. Pictorial wiring diagrams and a complete constructional article for using the Infra-dye amplifier with any of these sets will give you this highly important and timely data all in one issue — "RADIO" for FEBRUARY. Better subscribe now to insure receipt of copy. The subscription price is \$2.50 per year.

Don't Miss It

Make Your Own Three-Foot Cone Speaker in Less Than an Hour

WORLD'S FINEST LOUD SPEAKER
GENUINE
"ENSCO" 3" CONE KIT

ONLY \$10
Can be Assembled
in Less Than an
- HOUR -
BULLYACHEE!!
The Original Three-Foot
Cone Speaker
- KIT -
ONLY \$10

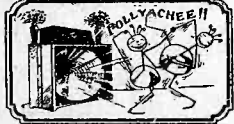

NO DISTORTION **THE SOLUTION OF THE LOUD-SPEAKER PROBLEM** **PERFECT FIDELITY**
The Choice of Leading Engineers

Complete parts furnished in kit form. We guarantee this speaker the equal of any manufactured cone speaker at any price.

With this **THREE FOOT CONE SPEAKER** you hear all the tones. It brings out the true depth and beauty of orchestral and instrumental music. Can be operated softly for Living Room Music or full volume for dancing, and without trace of distortion.

Kit includes famous "ENSCO" cone unit, the only direct-drive, distortionless unit for large cones; Alhambra Fonotex for big cone, with brass apex, two Sepia Prints showing cabinet or simple stand construction. All necessary instructions.

Buy this wonderful speaker under our absolute guarantee. Your money back if you are not convinced that it is the finest reproducing medium obtainable at any price. It works on any Set, with ordinary Tubes or with Power Output.

Engineers' Service Company
25 Church St. (Desk Y)
New York City

Send No Money!

Write your name plainly, as indicated below, then mail and complete kit will be forwarded to you. Just pay postman \$10.00 upon delivery.

Engineers' Service Company
25 Church St. (Desk Y)
New York City

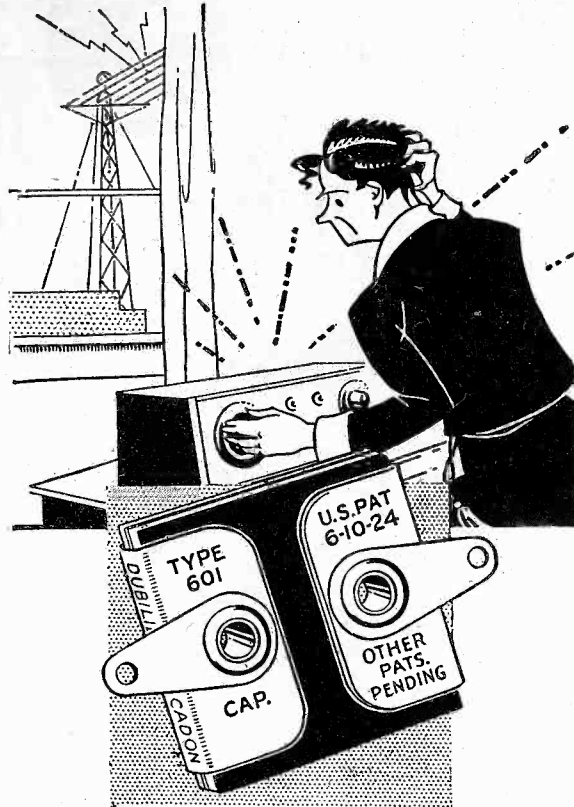

Can't tune 'em out?

TRY a Micadon 601 in series with the antenna of your set, if you find it hard to "tune out" nearby stations.

The Micadon will have the same effect as "loose coupling," and the selectivity of your set will be greatly improved. Capacities from .0001 to .0005 mfd. may be used—you will find a full explanation in our 32 page booklet, "Seventeen Ways to Improve Your Set."

Micadons, because of the patented principles of low-loss insulation and protection against variation in capacity which they embody, are a vital element in the improved reception of thousands of radio sets. The tone, the efficiency, and the satisfactory operation of your set depend on the quality of the fixed condensers used.

If you want to be sure that your set will do all it was meant to do, be sure that the fixed condensers bear the name of Dubilier.

Send 10c in stamps or coin for your copy of "Seventeen Ways to Improve Your Set."

Dubilier

CONDENSER AND RADIO CORPORATION

4377 Bronx Blvd., New York, N. Y.

Tell them that you saw it in RADIO

Radio Ops See Foreign Lands

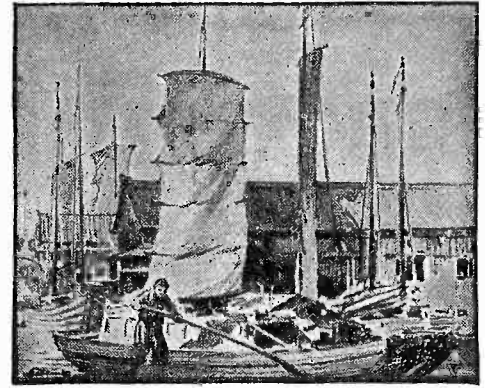

Radio operators on ships have marvelous opportunity for travel and adventure. They earn good pay—in addition to board and sleeping quarters.

Study at home now for a voyage next summer.

Radio Institute of America — world's oldest radio school — offers Home Study Courses that qualify you to pass the U. S. Government Commercial or Amateur License examinations.

Radio Institute conducts a special technicians' course for radio dealers, jobbers and service men. Write for booklet.

**RADIO INSTITUTE
OF AMERICA**

formerly Marconi Institute
Established in 1909
322 Broadway, New York City

Mail coupon for complete description of course.

----- CUT HERE -----

Radio Institute of America A
322 Broadway, New York City
Please send me your free booklet.
 I am interested in the radio course which prepares for the Government Commercial, Broadcast or Amateur License.
 I am interested in the technicians' course for jobbers, dealers and service men.

Name.....
Address.....



Aristocrat
E-Z TOON
Vernier Pointer

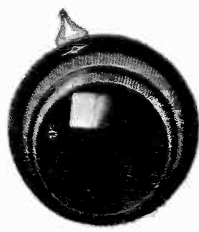

The NEW "Aristocrat" Vernier Port Dial

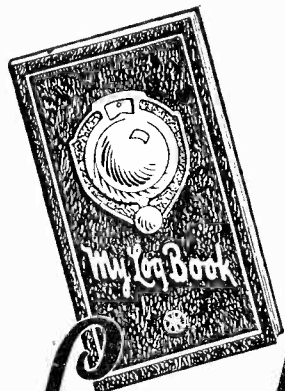

free!

This marvelous, recently compiled, 48-page Log Book (worth \$1) is given FREE with every set of three Aristocrat Vernier Port Dials. Bound in beautiful, two-tone, Mocotan Leather with embossed cover. Lists every United States and Canadian Radiocast Station of record June 1st, using power of 250 watts or more. Indexed by call letters, wavelengths and location. Also includes the principal foreign stations. Ask your dealer to show you a copy.



THE new, improved Aristocrat Vernier Port Dial is the greatest dial value on the market. Despite its many outstanding advantages, the Aristocrat costs no more than ordinary vernier dials.

If you want the finest-looking, finest-tuning vernier dial, be sure you get the Aristocrat. Made of Bakelite. All mechanism and shaft ends are concealed. Calibrations appear in a beveled port with a peaked indicator that makes misreading impossible.

Simple friction action is smooth, sure and quick. No gears, chains or cogs to backlash, wear out or get out of order. It may be installed in a few minutes. The famous Kurz-Kasch Split Bushing fits all condenser shafts—*aligns rite, holds tite!*

You'll be surprised at the difference a set of Aristocrat Vernier Port Dials will make. In appearance your radio will look better than the season's prettiest models. And, due to the fine, 14 to 1 vernier ratio, you'll enjoy better and clearer tones, more volume, and countless stations you've never before logged.

The Aristocrat Vernier Port Dial is supplied in three attractive finishes to match any radio—black with white markings, mahogany and walnut with gold markings. The price is \$2 each—in the finish you prefer. With a complete set of three Aristocrats, we are making a special limited offer. We are giving away the beautiful, 48-page, authentic Log Book illustrated here. You'll appreciate this gift when you see it. Ask the better radio dealer near you to show it to you.

THE KURZ-KASCH COMPANY, DAYTON, OHIO
Moulders of Plastics

OFFICES: New York, Chicago, San Francisco, Los Angeles, Portland, Spokane, Denver, Toronto

KURZ KASCH

Aristocrat Dials and Knobs

SHIELDED GRID VACUUM TUBE (Continued from page 66)

meters is about 5. Double grid tubes of the usual type wherein the additional grid is employed to neutralize space charge should be capable of 10 per stage. Three grid tubes, employing both the shielding grid and the space charge neutralization grid, according to the formula derived by Dr. Hull, should be capable of voltage amplification of well over 100 per stage at that frequency, while it should not be difficult to obtain as high as 150 per stage with tubes of the slab grid type here described.

That the laboratory is far in advance of the factory cannot be doubted when it is apparent what is being done there. The great scientific minds of the country are treading pathways over which the ultimate consumer follows, perhaps years after, as he makes use of the principles which have been unearthed that he may derive greater and greater enjoyment from his sport. Hats off to the scientists. They are the real builders of this great industry of ours.

SAFETY PLUS RADIO

(Continued from page 34)

positive that there is no chance of accidental contact with power wires, or any wires that are doubtful in their nature. Remember that you have no control over a kite aerial once it starts falling; you can never tell just where it will land.

Many radio owners have become needlessly alarmed over the possibility of lightning striking their aerials. The myth of lightning being attracted by an aerial has been exploded more than once. A properly installed aerial, grounded through an approved lightning arrester, is a protection rather than a hazard. It has the same construction and characteristics as a lightning rod. The chance of lightning striking an aerial is one in about 85,000 and the actual damage will probably not exceed a few dollars.

S. W. Cornwell, assistant secretary of the Etna Insurance Company, of Hartford, Connecticut, says: "Our loss experience through fire occasioned by radio equipment is very limited. We have a record of only a very few fires which can be charged to radio installments, and almost without exception these losses were occasioned by an improper installation of the equipment. One of the most common faults of radio installations is the absence of a properly installed lightning arrester and this defect frequently leads to trouble. Fortunately the trouble is usually confined to destruction of the radio equipment and so far in our experience fire has very seldom extended beyond the equipment itself."

Fire insurance policyholders are aware that according to the terms of their

(Continued on page 78)

ACME CELATSITE WIRE



—a tinned, copper bus bar wire with non-inflammable "spaghetti" covering, for hook-ups. 5 colors; 30-inch lengths. We also offer the highest grade of "spaghetti" tubing for Nos. 10 to 18 wires. 5 colors; 30-inch length.

Flexible Celatsite

Flexible, stranded wire for point-to-point and sub-panel wiring. Non-inflammable "spaghetti" covering. In black, yellow, green, red and brown; a color for each circuit. Put up in 25-foot coils.



Celatsite Battery Cable

—a silk-covered cable of vari-colored Flexible Celatsite wires, for connecting batteries to set. Prevents "blowing" of tubes; gives your set an orderly appearance.



Stranded Enameled Antenna

Best outdoor antenna you can buy. 7 strands of enameled copper wire; maximum surface for reception. Prevents corrosion and consequent weak signals.

Send for folder

THE ACME WIRE CO., DEPT. R
NEW HAVEN, CONN.

ACME WIRE MAKES BETTER RADIO

Heavy-Duty RADIOHM

for Simple
Control of
B-Battery
Eliminator

A single turn of the knob gives full resistance variation to control eliminator's output voltage. Permanent resistance as adjusted. Insulated for 1500 volts. Approved by Raytheon Laboratories. Outlasts eliminator, giving full efficiency from it.

\$2 at dealers, or from us.

Central Radio Laboratories,
14 Keefe Ave., Milwaukee, Wis.
69 standard set makers use our
variable resistances

Centralab

Now—
American
RADIO
50% DISCOUNT
ON
RADIO!
BIG NEW 1927
CATALOG—FREE

Dealers, Agents, Set Builders—get our big 1927 Catalog—225 nationally advertised lines. Lowest prices in America! Largest, most complete stock. Radio's latest developments. It's FREE—send for your copy now. AMERICAN AUTO & RADIO MFG. CO., Inc. 1425 McGee Street, Kansas City, Mo.

HAMMARLUND Condensers and Coils

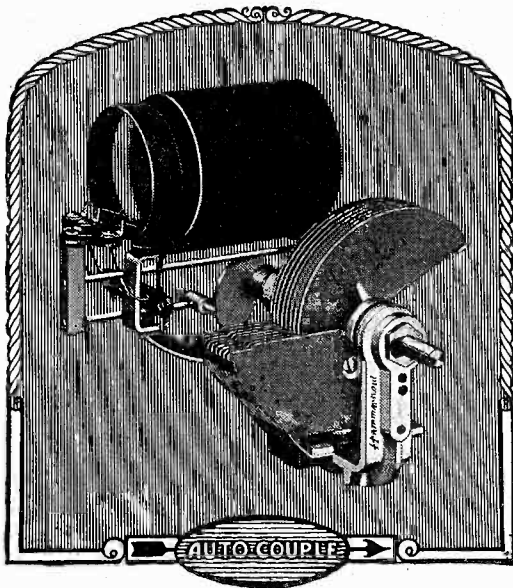

Used in Many of the Season's Featured Circuits

What better evidence of Hammarlund leadership could there be than the fact that twenty-seven recognized designers—men who "know their stuff"—selected Hammarlund Precision Products for use in these outstanding 1927 receivers?

HAMMARLUND-ROBERTS "HI-Q"
COCKADAY "LC27"
BROWNING-DRAKE
SARGENT "INFRADYNE"
MORRISON "VARION"
ST. JAMES SUPER.
VICTOREEN SUPER.
NEW HARKNESS
HENRY-LYFORD
LOFTIN & WHITE
LACAULT "LR4"
PACENT "ULTIMAX"
CARBORUNDUM
POPULAR SCIENCE
MONTHLY "POWERFUL"
HAYNES "DX2-MULTI-VALVE"

We shall be pleased to refer to the proper authorities any inquiries regarding the above circuits.

HAMMARLUND MFG. CO.
424-438 W. 33rd Street, New York City

For Better Radio
Hammarlund
PRECISION
PRODUCTS

Tell them that you saw it in RADIO

Absolutely NOISELESS

Permanently Accurate—
Dependable!

METAL long has been recognized as the best of electrical conductors. The Lynch Metallized Resistor gives *conductive, non-arcing* resistance that means absolutely silent operation, permanent accuracy, dependability.

Leading engineers, test laboratories and experimenters have found that this fixed resistor wins in the acid tests of time and service. It marks as great an advance in its field as did the tungsten lamp over the old carbon bulb. If your dealer cannot supply you, we will ship postpaid—same day order is received.

Dealers—Write us!

ARTHUR H. LYNCH, Inc.
Manufacturers of Radio Devices
Fisk Bldg., Broadway & 57th Street
New York, N.Y.

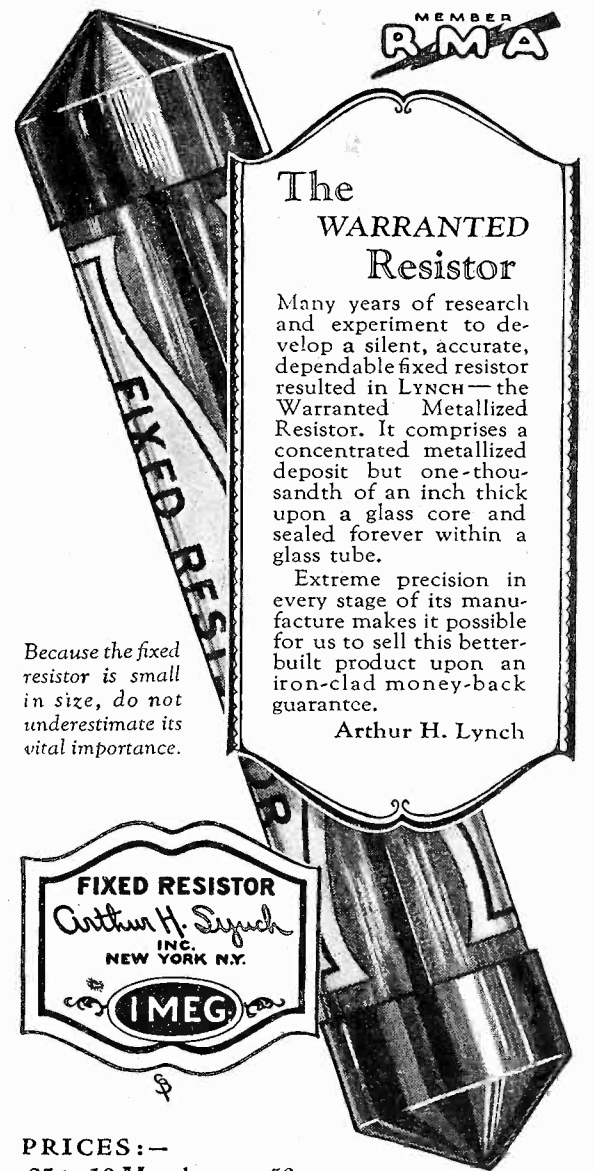

The
WARRANTED
Resistor

Many years of research and experiment to develop a silent, accurate, dependable fixed resistor resulted in LYNCH—the Warranted Metallized Resistor. It comprises a concentrated metallized deposit but one-thousandth of an inch thick upon a glass core and sealed forever within a glass tube.

Extreme precision in every stage of its manufacture makes it possible for us to sell this better-built product upon an iron-clad money-back guarantee.

Arthur H. Lynch

Because the fixed resistor is small in size, do not underestimate its vital importance.

PRICES:—
.25 to 10 Megohms .50
above .01 to .24 " .75 Single Mounting .35
.001 to .01 " \$1.00 Double " .50

LYNCH
METALLIZED
FIXED RESISTORS

goodbye
mister howl!

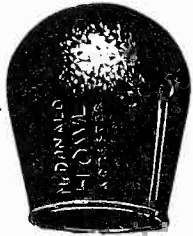

Patented Dec. 7, 1926
No. 1,610,208

75¢ each
At all dealers

Once this little jacket of live rubber slips over the tube—you're through!

All over in less than one second! You can get it in sizes to fit every tube. Just ask for the



**McDONALD
HOWL
ARRESTER**

"It Stops that Howl!"

(TRADE MARK)

Sole Selling Agents for the U. S. A.
SPARTAN ELECTRIC CORPORATION
350 West 34th Street, New York City

Licensed and Manufactured by the
Scientific Products Canada, Ltd.
MADE IN U. S. A.

UNIVERSALS
Covers every resistor requirement

current carrying capacity 20 watts

noiseless

one-hole mount

From practically 0 to 300,000 ohms

wherever a variable resistance is specified

CLAROSTAT \$2.25

Wherever a variable resistance is specified pin your faith on
CLAROSTAT

Manufactured by
AMERICAN MECHANICAL LABORATORIES
Brooklyn, New York

KARAS EQUAMATIC MANUAL
Price 10c.

Build the Karas Equamatic 5-Tube Radio Sensation—the most selective receiver ever designed. Mail 10c today for 16-page Manual of wiring diagrams and complete instructions for building this remarkable receiver. Address:

KARAS ELECTRIC COMPANY
1049 Association Building Chicago, Ill.

GET AN ELECTRIC
SOLDERING IRON

F R E E

With a one year's subscription to
"RADIO"

\$2.50 "RADIO"
San Francisco

WHY THE INFRADYNE WORKS

(Continued from page 32)

Because of the sum frequency arrangement and the very high intermediate frequency used, the practical tuning results with the oscillator dial are vastly different from those obtained with the super-heterodyne. In the latter, the difference frequency is used in the intermediate amplifier. For a given intermediate frequency there are always two difference frequencies, according as the oscillator frequency is higher or lower than that of the signal. On the other hand there can be only one oscillator setting for which the sum of these frequencies is a given amount. Consequently, in sweeping once across the broadcast range only one setting of the infradyne oscillator occurs for each station.

It also happens in the super-heterodyne that the upper oscillator setting for one station may be nearly the same as the lower setting for some other station so that an objectionable beat note in the loud speaker results. Since there is only one setting for each station on the infradyne oscillator, such beat notes cannot occur unless the stations themselves are so close together in frequency as to produce an audible beat. In this case the beat note would be received by any set—even a crystal.

THE next element of our receiver is the infradyne amplifier itself. Its circuit, as shown in detail in Fig. 4, presents several interesting features. Probably the most notable of these is the fact that the grid of each vacuum tube is completely insulated from the filament circuit by the two small balancing condensers.

This is not as alarming as it might at first appear. There is no danger that these grids will become charged with such a large negative potential as to completely stop the plate current, even though the insulation of the condensers, tube sockets and tube bases may be very high. This is due to the fact that a small amount of gas is present in even the hardest of vacuum tubes which is ionized by the current that flows from the filament to the plate of the tube. The positive ions so formed are attracted to the more negative electrodes of the vacuum tube, viz. the filament and the still more negative grid. These positive charges tend to neutralize the negative grid charge which results from electrons being picked up by the grid. The free voltage of the grid will, therefore, be a condition of balance between these two accumulating charges.

A number of actual tests have been made to verify these statements. The average insulation resistance of the balancing condensers is more than 600 megohms and in individual cases was as high as 10,000 megohms. Leakage

(Continued on page 72)

NEW

MUTER

Dependable Products

—for the 1927 Season

Muter Products
Are Distributed to the
Western Jobbers by

A. S. Lindstrom Co.

SEATTLE—PORTLAND
SAN FRANCISCO—LOS ANGELES
SALT LAKE

Leslie F. Muter Co.

76th and Greenwood Avenue
CHICAGO, U. S. A.

Knife Throw Switches

Moulded Bakelite base—Spring brass contact—Moulded insulated handle.



Single Pole, Double Throw
Base 2 1/4" x 3/4"
Stock No. 2010.....70c list



Double Pole, Double Throw
Base 2 1/4" x 1 1/4"
Stock No. 2020.....\$1.00 list



Triple Pole, Double Throw
Base 2 1/4" x 2"
Stock No. 2030.....\$1.50 list

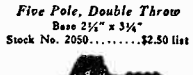

Five Pole, Double Throw
Base 2 1/4" x 3 1/4"
Stock No. 2050.....\$2.50 list



Antenna Plug
Black moulded Bakelite. 2 1/4" long.
Stock No. 2060.....60c list



Resistance Amplifiers
Completely wired, ready for installation. Individually packed, with instructions.
Stock No. 1410 (2 stage).....\$6.00 list
Stock No. 1400 (3 stage).....8.00 list

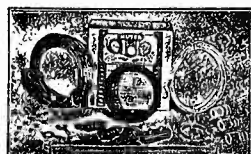

Standard Complete Aerial Kit
Contains all necessary parts to erect. Attractive individual cartons.
Stock No. 250.....\$3.50 list



Audio Frequency Transformers

Highly efficient—popular price—fully shielded in an enameled metal case.
Stock No. 1500.....\$2.25 list
3 1/2 to 1 ratio.....\$2.25 list
Stock No. 1550.....2.50 list
5 to 1 ratio.....2.50 list



Variable High Resistance

Controls oscillation and regulates quality and volume. Highly shielded plated metal shell with moulded Bakelite knob.
Range 0 to 200,000 Ohms
Stock No. 2120.....\$1.25 list
Range 0 to 500,000 Ohms
Stock No. 2150.....\$1.25 list



Interference and Static Eliminator

Moulded Bakelite case with insulated adjusting screw.
Stock No. 1800.....\$2.50 list

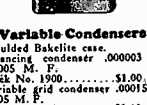

Variable Condensers

Moulded Bakelite case. Balancing condenser .000005 to .00005 M. F.
Stock No. 1900.....\$1.00 list
Variable grid condenser .00015 to .0005 M. F.
Stock No. 1950.....\$1.00 list

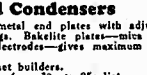

Fixed Condensers

Highly polished metal end plates with adjustable soldering lugs. Bakelite plates—mica insulation—brass electrodes—gives maximum results.
Used by leading set builders.
All popular sizes—from 30e to 85e list.

"used
in the
LC-27"

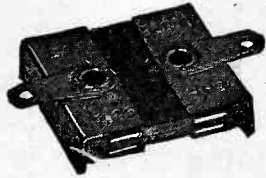

AEROVOX

"Built Better"

FIXED CONDENSERS

are Specified in

LC-27	by L. M. Cockaday
Diamond of the Air	" Herman Bernard
To be announced soon(?)	" John Rider
Raytheon "B" Eliminator	" Raytheon Mfg. Co.
Ultradyne	" R. E. Lacault
To be announced soon(?)	" R. E. Lacault

AEROVOX fixed condensers have been approved by M. I. T. and Yale Universities.

AEROVOX WIRELESS CORP.
489-491-493 Broome Street
New York

"B" BATTERY ELIMINATOR

Only \$ **7.95**

MONEY-BACK GUARANTEE
No more worry with "B" Batteries! Hook up a Roll-O "B" Battery Eliminator and forget battery troubles forever. This wonderful new invention means better reception, sharper tuning. Gives you more real pleasure from your set.

Completely Equipped—No "Extras" to Buy
Operates perfectly on direct or alternating current, giving up to 90 volts current, and using the full wave of the power supply. Simple directions enclosed—anyone can plug it in to any kind of set up to six tubes. Constant voltage gives set more power. Costs no more than set of good "B" Batteries. Solidly built in beautifully finished metal case, with genuine Bakelite top.

SEND YOUR ORDER NOW
Don't blame your set because run down "B" Batteries won't let it work right. Order your Eliminator NOW. Write name and address on a piece of paper, pin a dollar bill to it, and mail it TODAY. Pay postman balance (\$6.95 plus a few cents postage) when he delivers your Eliminator. Use it ten days. If not more than satisfied, return it and get your money back. Roll-O Trickle Charger, for either "A" or "B" Batteries, only \$3.95 (plus few cents postage). Send \$1.00 with order—balance C. O. D. Satisfaction guaranteed or money refunded.

THE ROLL-O RADIO CO.
Dept. Q-6 Third and Sycamore, Cincinnati O.

I. C. A. PANELS AND INSULATING PARTS

"DIAMOND OF THE AIR," 7x24x $\frac{1}{8}$ "; Black Insuline, \$4.25; Black Bakelite, \$6.00. "INFRADYNE," 7x30x $\frac{1}{8}$ "; Black Insuline, \$5.50; Black Bakelite, \$6.85. All panels drilled and engraved. Also panels for over 70 other popular circuits. Write today for Catalog 12.
INSULATING CO. OF AMERICA, Inc.
59 Warren Street, New York City



U. S. Patent, Oct. 12, 1926

The new Balkite Combination—with your "A" battery it supplies all radio power automatically from the light socket

NOW AT YOUR RADIO DEALER'S

FANSTEEL PRODUCTS COMPANY, Inc., North Chicago, Ill.

PRECISION
ARBORPHONE
PRODUCTS

ARBORPHONE

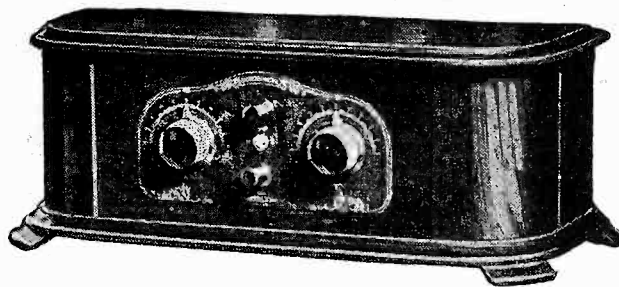

A HAPPY blending of Radio's latest advancements with ultra-precision construction methods makes Arborphone the outstanding receiver of the year.

THE strikingly beautiful Arborphone cabinet assures an ever-active market to the franchised Arborphone dealer. Write or wire for information in your territory.

\$60



\$105

Includes Receiver
Table and Built-in
Loud Speaker.

PRECISION PRODUCTS COMPANY
335 South Main Street
Ann Arbor, Michigan

National Factory Representatives
SANFORD BROS.
30 W. Walton Place
CHICAGO ILL.

Tell them that you saw it in RADIO

INFRADYNE

has revolutionized radio reception. It is the ultimate in radio. New Full Size Blue Prints, prepared by E. M. Sargent, One Dollar.

MAILED POSTPAID

L. C. RAYMENT

1200 Franklin St., Oakland, Cal.

RADIO DX HOUNDS

Get "Broadcast Weekly" to keep posted on operating schedules and wavelength of U. S. Stations. Send 10c for Copy.

BROADCAST WEEKLY

433 Pacific Building,
San Francisco, Cal.

PATENTED SUBANTENNA!

The One Great New Thing In Radio

Amazing New UNDERGROUND ANTENNA
Eliminates All INTERFERENCE
Gets Distance Clearly.

Here you are, "Distance" fans! Install this new type underground "pick up system." Get distant stations loud and clear like local. SUBANTENNA banishes STATIC and all other air noises. Lets the broadcast come through clean.

Uses Filtered Ground Waves. Power line leaks, STATIC and all air noises are filtered out from the broadcast and grounded by SUBANTENNA before the broadcast reaches the set. The greater distance and clarity of your set will amaze you.

Nothing Else Like It. Not just a wire. Consists of special composition wire differently insulated and sheathed in a lead jacket and containing a series of three "building up" coils. Nothing else will do what SUBANTENNA does. Nothing else in the world like it.

FREE TRIAL OFFER! We want you to test SUBANTENNA. We want you to enjoy the thrill of loud, clear DX reception when your old aerial will give you nothing but STATIC and crackles. Write at once for FREE TRIAL OFFER and scientific explanation of SUBANTENNA. Write NOW!

CLOVERLEAF MANUFACTURING CO.,
2716-C Canal St. Chicago.

Yale GROUND HOG

The Perfect Ground

DOUBLES POWER AND DISTANCE

Marvelous newly-invented ground gives incredibly improved reception. Doubles power and distance users say. Reduces leakage. Stops jangling even in mid-summer. Results never before equalled. Satisfaction guaranteed or money back at once. Approved by Highest Radio authorities after exhaustive tests. Proven absolutely essential to clear, powerful distance reception. Draws and holds moisture indefinitely. Highly sensitive to radio energy. SEND NO MONEY —to introduce we offer to those who act at once, regular \$5.00 size for only \$2.00. Send name today and pay \$2.00 plus 17c postage on delivery. Or send only \$2.00 with order and save postage. FREE —Full description of Ground Hog and details of amazing special offer on request—write today.

YALE SPECIALTY SUPPLY COMPANY
139 W. 5th St., Kansas City

WHY THE INFRADYNE WORKS

(Continued from page 70)

through such a resistance would scarcely be sufficient to quickly restore the grid to a proper potential in case it had been over-loaded by the direct application of the oscillator output. The free grid potential of a number of C-299 vacuum tubes was measured and found to average -1.5 volts with very slight variations

current falls to zero and then becomes opposite in sign as the grid becomes more negative. This "negative" current is due to the positive ions referred to above.

In case the grid of the vacuum tube becomes very negative because of an over-load, this positive ion current tends to bring it back to the normal value.

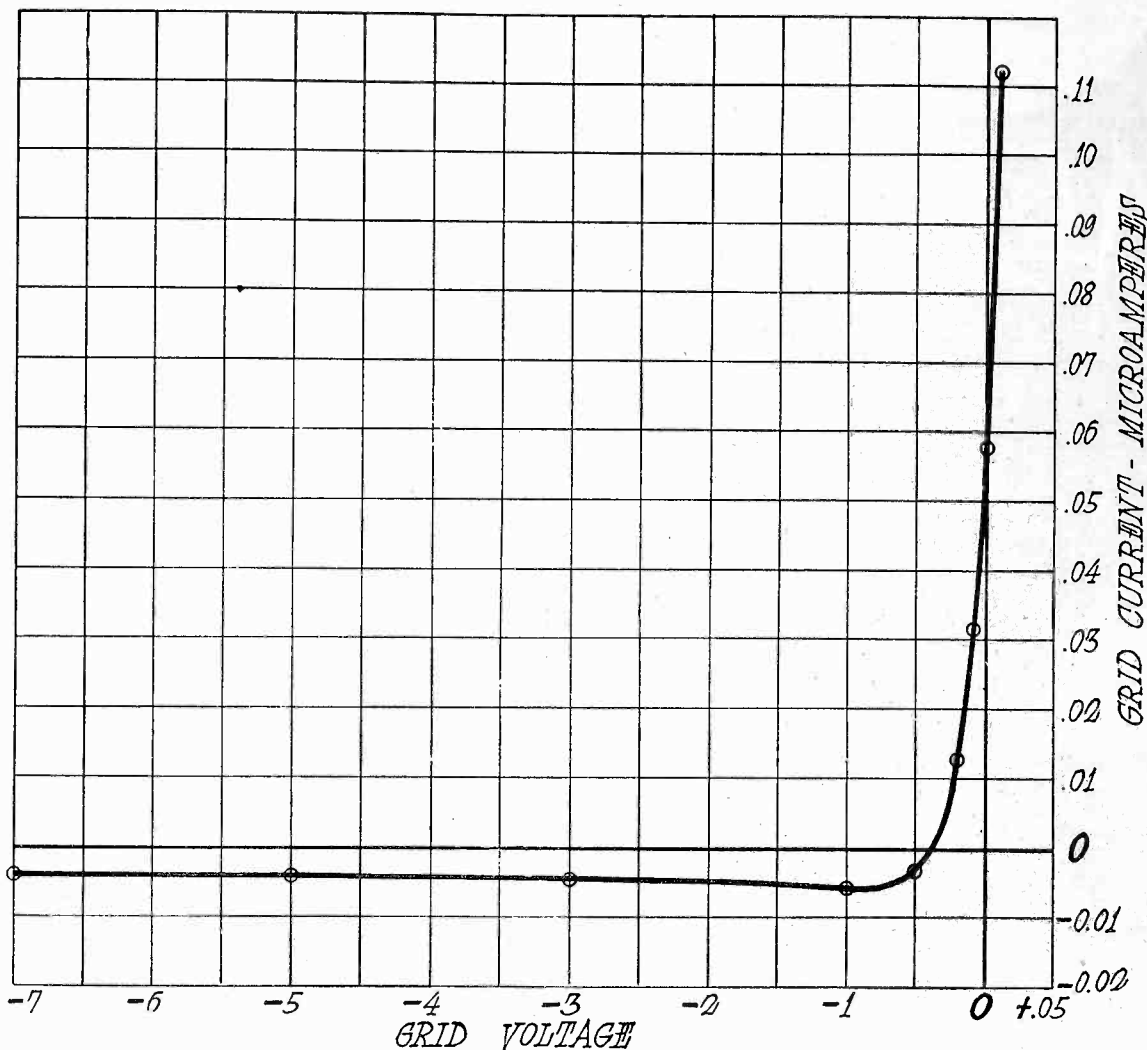

Fig. 5. Variation of Grid Current with Grid Potential.

from tube to tube. It depends, of course, on the condition of the operation of the circuit. In this case a filament potential of 3 volts and plate potential of 90 volts were used.

As a further check the grid current

The time required will depend upon the capacity of the grid circuit, which may be determined from Figs. 6a, b and c. Fig. 6a shows the input circuit to a single vacuum tube. Since we are dealing with direct currents the coil effect-

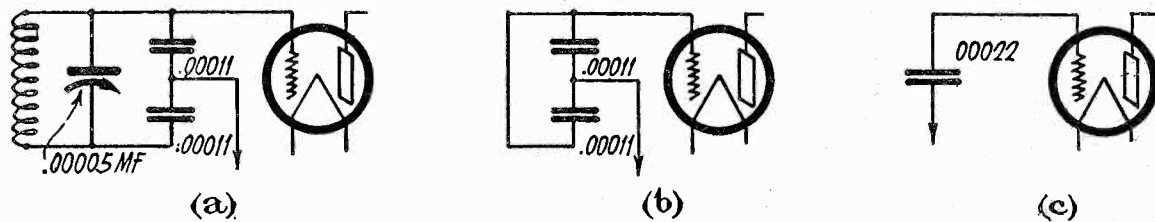

Fig. 6. Input Circuit and Its Equivalents.

of one of these tubes was measured for various grid potentials—the result is shown in Fig. 5. Note that for positive grid potentials the usual current, due to accumulation of electrons, exists, but that at about minus 0.4 volts the grid

ively short circuits the .00005 mfd. condenser so that the circuit might be equally well represented by Fig. 6b. This is equivalent to Fig. 6c, showing that the capacity of the grid circuit is

(Continued on page 74)

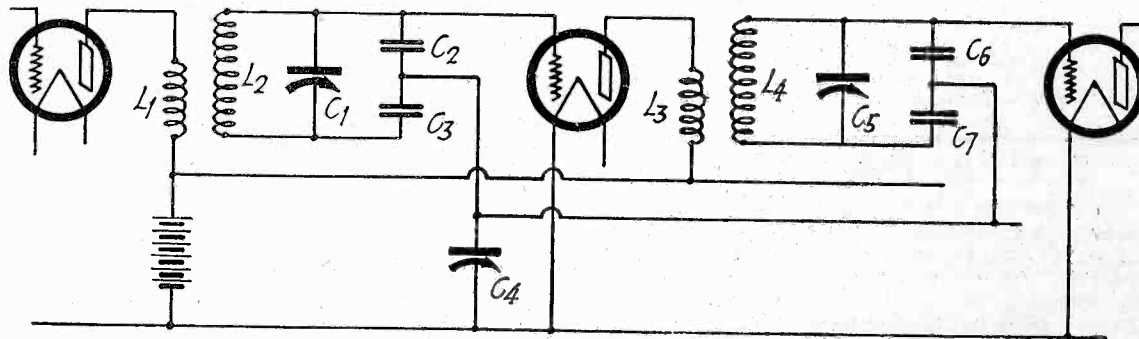



Fig. 7a. Portion of Infradyne Amplifier.

Tell them that you saw it in RADIO



Oh boy
KESTER
Rosin Core
Radio SOLDER
Sure is Safe and Simple

Approved by
Radio Engineers
A Genuine Solder
 CHICAGO SOLDER COMPANY
 4254 Wrightwood Ave., Chicago, U.S.A.

*Originators and
 World's Largest Manufacturers of
 Self-Fluxing Solder
 YOUR DEALER
 CAN SUPPLY YOU*

AUDIO AMPLIFICATION **FREE**

The four types thoroughly explained in a fully illustrated booklet 9x12". This book will be sent to you absolutely FREE if you will send me six cents in stamps to cover cost of handling and postage.

W. McMANN

64 Church St., Dept. R. New York City

"RADIO"—\$2.50
 Mailed to Your Home for One Year.

Real Sensation of the Year
CHELSEA
 TRUPHONIC SIX—\$60.00

Write us.
Chelsea Radio Co.
 Chelsea, Mass.

Bradley-Amplifier
 Resistance-Coupled
PERFECT AUDIO AMPLIFIER

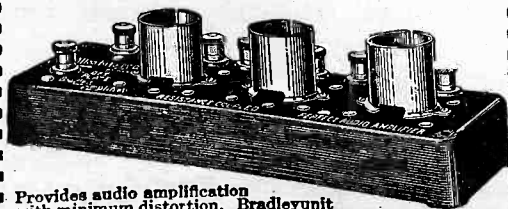

Provides audio amplification with minimum distortion. Bradley unit molded resistors used in the Bradley-Amplifier do not vary with age and are not affected by atmospheric conditions. Can be used to replace transformer amplifiers in standard radio sets with decided increase in tone quality.

Allen-Bradley Co.

Electric Controlling Apparatus
 279 Greenfield Avenue Milwaukee, Wis.

QUALITY DONGAN PRODUCTS

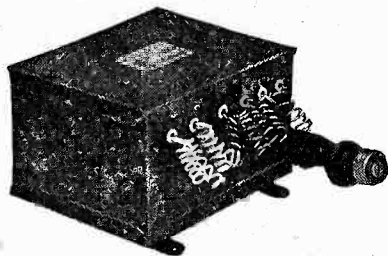

A Conspicuously Successful B-Eliminator

incorporates
Dongan Radio-Power Unit
 No. 1582
 for use with the Raytheon Tube

Thousands of these B-Eliminators have been built and are giving 100 per cent satisfaction. Dongan No. 1582 consists of 1 Transformer and 2 Chokes, designed in conjunction with Raytheon engineers. The Radio-Power supply is quiet, smooth and consistent all the time. Built into handsome black metal case—very durable. Complete instructions for building. Send check or money order at once.

No. 147 transformer designed for use in connection with the output circuit avoids the loss of B voltage due to the high resistance of the loud speaker and eliminates all risk of damage to the speaker. List \$4.50.

Dongan Electric Manufacturing Company
 2981-3001 Franklin St. Detroit

TRANSFORMERS of MERIT for FIFTEEN YEARS

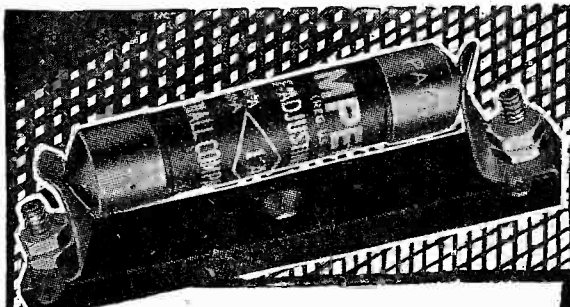

In Your Set

Tube life and efficiency, tone clarity and accurate tuning—all depend on filament control.

AMPERITE, the only self-adjusting filament control, regulates the tube current that governs these vital points. Eliminates hand-rheostats, simplifies set-wiring.

Accepted as standard equipment by every leading engineer, AMPERITE is specified in the feature circuit in this issue—E. M. Sargent's INFRADYNE.

Write for FREE COPY of "The Radiall Book" to Dept. R-1.

Radiall Company
 50 FRANKLIN ST., NEW YORK

AMPERITE
 REG. U.S. PAT. OFF.

The "SELF-ADJUSTING" Rheostat

LOG YOUR STATIONS

10c For a Copy of the Radio Log Book. 16 Pages.

"RADIO," San Francisco

Helical Wound



Restore the Naturalness
 to Radio Music with

SAMSON Transformers

IF you want to get the "double-bass" notes clearly—without smudging, blurring and "growling"—your audio frequency transformer must have many turns of wire, a specially treated core, and negligible distributed capacitance effect—features found in Samson Audio Transformers.

With Samson Transformers you don't lose a note—no matter how far up or down the scale it may be. And you know, without an adequate bass and the upper harmonies any musical composition loses its "balance."

Only the Samson Audio Frequency Transformer can do this, for it alone has the Helical Winding which nullifies distributed capacitance effect which is the cause of other transformers cutting off the higher frequencies and giving what is known as "drummy" reproductions.

Samson Transformers are hermetically sealed and designed for use with the largest power tubes. (Ask to hear them.) Furnished in three ratios, 2-1; 3-1; 6-1. Price, any ratio, \$5.00.

Our book—"Audio Amplification"—already accepted as a manual of audio design by many radio engineers—contains much original information of greatest practical value to those interested in bettering the quality of their reproduction. Sent upon receipt of 25 cts.

SAMSON ELECTRIC COMPANY



Main Office
 Canton, Mass.

Manufacturers
 Since 1882

Tell them that you saw it in RADIO

LEADING PUBLICATIONS

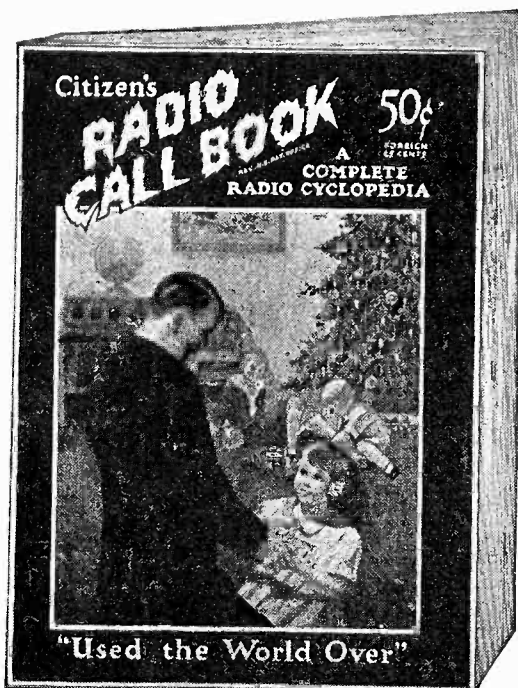

The CITIZENS RADIO CALL BOOK is Radio's Greatest Publication. Circulation 300,000. Contains all the latest information of construction so simply told anyone can build superheterodynes as easily as laboratory men. Large rotogravure section contains beautiful photos of leading station announcers and entertainers. Also contains the most complete list of the World's broadcasting stations—every one—their transmitting schedules, wavelengths, slogan and plenty of space under each to log that station for future reference. Really Radio's Greatest Publication. You'll be delighted.

Price only 50 cents postpaid



The CITIZENS RADIO AMATEUR CALL BOOK is an international list of call letters, names and addresses of the World's amateur transmitters—ARRL official traffic relay stations list. Compiled from official sources and the most authentic list obtainable anywhere. Remember, the whole World, U. S., Canada, Australia, France, Germany, etc. The whole international list. Also commercial ship and land stations.

Price only 75 cents postpaid

If you are unable to obtain either of the above mentioned publications from your news dealer or radio store, they will be sent postpaid upon receipt of the amount in U. S. stamps, coin check or P. O. money order.

Citizens' Radio Call Book

510 S. Dearborn St.

Chicago, Ill.

WHY THE INFRADYNE WORKS

(Continued from page 72)

about .00022 mfd. Since the reversed grid current is about .004 microamperes it will require about 0.055 seconds to charge this capacity to a potential of 1 volt. In other words, any existing negative charge on the grid will be neutralized at the rate of about 20 volts per

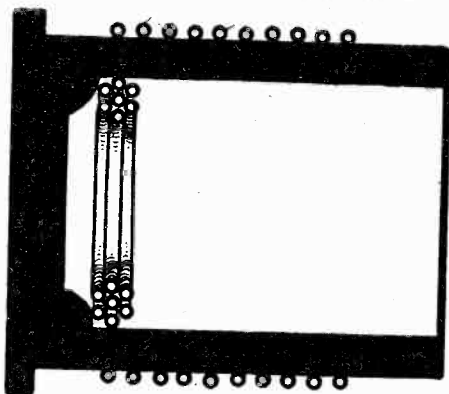

Fig. 8. Cross Section of Infradyne Transformer.

second. This is so fast that the blocking effect would not be noticed.

It is almost hopeless to attempt an accurate analysis of all the interactions which take place in the infradyne amplifier. We can, however, consider the most important of these and to some extent their individual effects and even guess at their relative magnitudes. In Fig. 7a is shown a portion of the infradyne amplifier. Keeping in mind the fact that we are concerned with alter-

shows L_1 placed near the end of L_2 farthest from the grid.

More important than this unequal inductive coupling is the capacity coupling between the primary and the secondary windings. As stated above, the primary winding is placed just beneath the first turn of the secondary and consequently there is a capacity between these two windings. Its average effect is that of a condenser connected between the mid point of the primary coil and a point near the end of L_2 as shown by C_8 in Fig. 7b. The value of this capacity may be computed from the dimensions of the coil but not with very great accuracy. An approximate value computed in this way is 3.6 mmfd. A more accurate value can be obtained by measurement and the average of several such measurements is 4.5 mmfd. when the coils are disconnected from the rest of the circuit. A somewhat higher value will be found if the coils are measured in their normal connections.

This capacity is important in the neutralizing arrangements of the system. It is apparent from Fig. 7 that the circuit resembles one of the familiar neutralizing arrangements except that the terminal of L_2 opposite the grid end is hanging free, whereas in the customary circuit it is returned through a small neutralizing condenser to the plate of

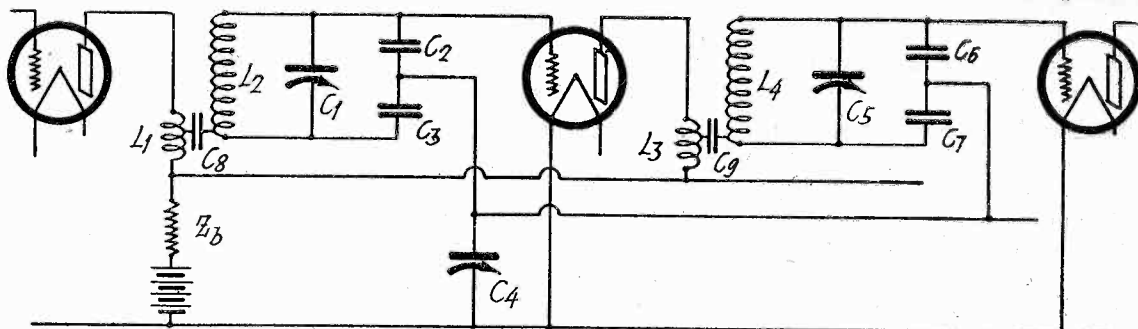

Fig. 7b. Equivalent of Portion of Infradyne Amplifier.

nating current of very high frequency we may redraw the circuit in a way which will show its action better.

The space relations of the apparatus introduce elements which are not apparent from the circuit diagram. For example the primary L_1 of the radio frequency transformer is inductively coupled to the secondary L_2 , but so placed that it couples more effectively with one end of the coil L_2 than with the other. The actual placing of these coils with respect to each other is shown in Fig. 8, which is a cross section of one of these radio frequency transformers. The primary is a compact coil placed inside the form cylinder and held firmly at one end. The secondary winding is a single layer coil about $\frac{1}{2}$ in. long with its first turn wound directly over the primary. The primary, therefore, couples tightly with the first few turns of the secondary coil and much more loosely with the last few. Hence the greater part of the induced voltage will appear in the nearest half of the secondary coil. To represent this condition Fig. 7b

the same tube. Now the essential requirement of neutralization is that a small voltage shall be fed back from the plate circuit of a tube to the grid circuit of the same tube in opposite phase to the voltage resulting on the grid because of its capacity relation with the plate. The condenser C_8 would provide the necessary coupling to produce this effect if enough of the voltage on the plate of the second tube could appear across this small capacity. Ordinarily all the voltage in the plate circuit of the second tube will appear across L_3 (except that portion which is within the tube itself) unless there is some common impedance in series with the B battery. The internal resistance of the B battery itself is such an impedance and, although small, its effect is not to be neglected. This resistance is on the order of 20 to 50 ohms in new batteries and higher in old ones. If then the phase relations are correct a part of our neutralizing effect might result from this source.

A second source of interconnection

(Continued on page 76)

Tell them that you saw it in RADIO



YAXLEY
APPROVE RADIO PRODUCTS

**Automatic
Power Control**

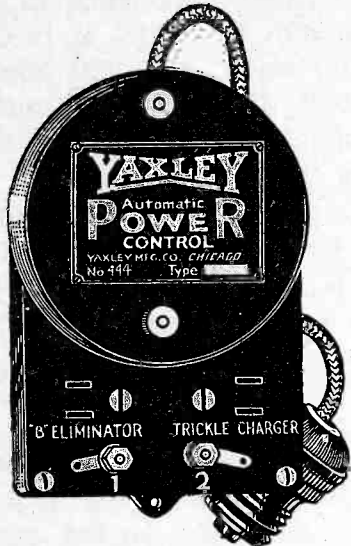

HERE is a gift of gifts for your radio friends—the latest radio convenience that every set owner will want. The Yaxley Automatic Power Control does all the extra switching for you. It takes care of your B eliminator or trickle charger or both. When you turn your set on, the trickle charger is off, the B eliminator is on. When you turn the set off, the Power Control is standing guard for you. It works automatically and without fail to turn off the B eliminator and turn on the trickle charger.

No. 444, Series Type—for use with sets with tubes having a current draw equal to or greater than 6 UV-199 type tubes. Each \$5.00

No. 445, Multiple Type—for use with any set, but especially for sets having tubes with a current draw lower than that of 6 UV-199 type tubes.....Each \$6.00

At your dealer's. If he cannot supply you, send his name with your order to

California Representative

Henger-Seltzer Co.

Los Angeles 1111 Wall Street San Francisco 377 Brannan Street

Northwest Representative

D. H. Burcham

1553 E. Everett St., Portland, Oregon

Yaxley Manufacturing Co.

Dept. A, 9 So. Clinton St., Chicago, Ill.



LISTEN—

Can you afford to miss the big February issue of "RADIO" with four complete stories on adapting the Infrodyne amplifier to four popular sets? And look at the forecast on page 2. This issue will be the biggest 25 cents worth of radio information yet put out by us. There will be a heavy demand for copies. A subscription at \$2.50 will insure receipt of the magazine by you for a full year. Treat yourself to a holiday gift by sending us your subscription now.

"RADIO," Pacific Bldg., San Francisco.

A Striking Example of Radio's Real Prowess



Listen to

MU-RAD
The SUPER-SIX-RECEIVER

Ask Your Dealer for Demonstration or Write to

MU-RAD RADIO CORP. ★

DEPT. F. ASBURY PARK, N. J.

Precision Coils--for Better Reception

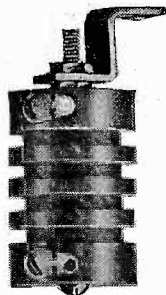

R. F. Choke Coil No. 340

Very low distributed capacity due to the slotted form of winding.

Can be used wherever this type of coil is necessary. Very compact. Only one inch in diameter. Can be mounted on sub-panel or baseboard. List price \$1.00.

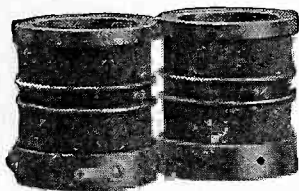

Duo-Octaform Coil No. 320

Especially designed for maximum amplification at radio frequencies within the broadcast range. Specified by Cockaday for his new LC-27 Receiver. Has a higher inductance than any other type of tuning unit for the range to be covered. List price \$3.50.

There is a Precision Coil for practically every designed receiver. The Precision Coil Co. also produces several condenser blocks at attractive prices. Write us.

Build Laurence Cockaday's New LC-27 Receiver

Now for the first time you can build a receiver embodying the three necessary requirements for perfect tone results—a clean undistorted signal through the detector—uniform amplification of all voice and musical frequencies—and a filtered output by which nothing but pure voice current is permitted to actuate the loud speaker. Perhaps the foremost example of what can be accomplished by the handiwork of the amateur set-builder.

Complete List of Specified Parts

1—Hammarlund mid-line dual condenser, .000275 mfd.	\$7.50	2—Mar-Co small controls for LC-27.....	1.50
1—Hammarlund mid-line single condenser, .000275 mfd.	4.65	1—Carter battery switch..	.65
1—Precision Duo-Octaform coil set, one antenna coupler and two inter-stage couplers	10.50	1—Samson radio-frequency choke coil No. 85.....	1.50
1—Amertran DeLuxe first-stage transformer	10.00	3—Aerovex mica fixed condensers, .00025 mfd.....	1.05
1—Amertran DeLuxe second-stage transformer.....	10.00	1—Durham resistor, 4 megohms50
1—Amerchoke No. 854....	6.00	1—Lynch grid leak mounting35
1—Dubilier No. 902 filter condenser, 4 mfd.....	5.50	1—Carter Gem Jack.....	.25
1—Dubilier No. 907 filter condenser, .1 mfd.....	.60	1—Carter resistance, 0 to 10,000 ohms	2.00
1—Mar-Co. illuminated control, scale 0 to 100	\$3.50	12—Eby binding posts.....	1.80
		5—Benjamin UX sockets..	3.75
		1—Amperite	1.10
		Mechanical Kit consisting of aluminum shields, binding post strip, decorated panel and Tait Brackets.....	12.50
		Complete.....	\$85.20

Corbett Cabinet \$18. Built Complete \$113.20

Every part exactly as specified by Mr. Cockaday. Write us today. Send check or money order or we will ship C.O.D. Free descriptive folder sent on request.

The New LC Senior Power Pack

Supplies the "A," "B" and "C" voltages for the new UX210 tube in the last stage of audio frequency amplification. Works perfectly in conjunction with the LC-27 Receiver, and opens the way to elimination of all batteries. Price for kit of specified parts, \$65.20.

PRECISION COIL CO., INC., 209 Centre Street, New York

Tell them that you saw it in RADIO

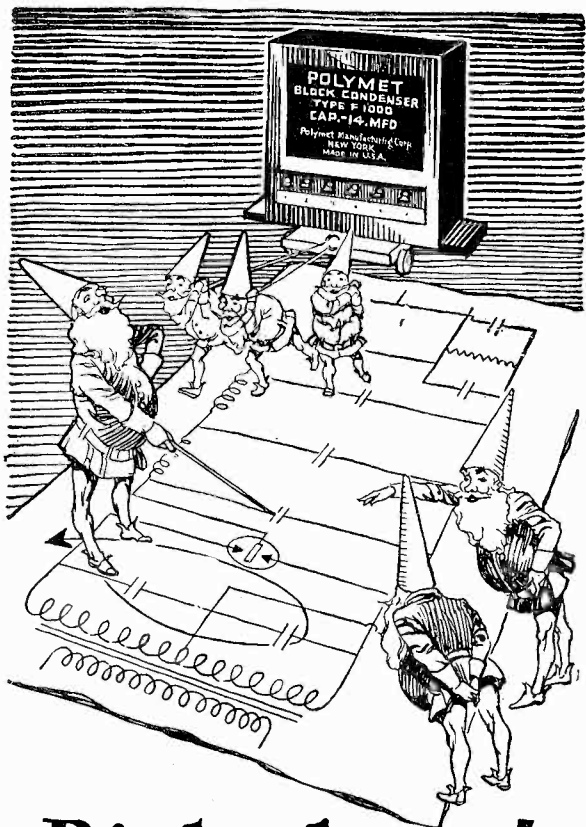

Right here!

You can't go wrong when you use Polymet High Voltage Condensers in sets or power units. Built to withstand 1,000 volts permanently, and individually tested for this rating, their obvious superiority, both in workmanship and performance, definitely establishes Polymet's leadership as condenser manufacturers.

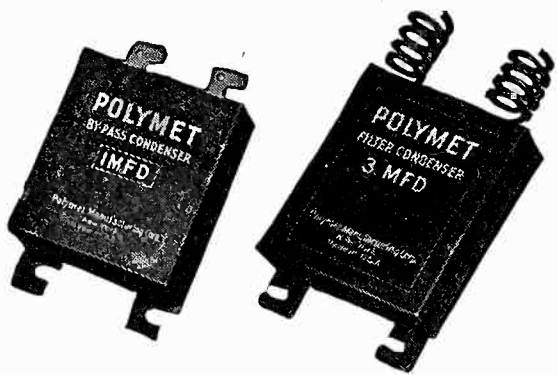

Polymet condensers incorporate finest insulating paper, best foil and specially prepared impregnating compounds. An exclusive, new and improved process renders them non-inductive, with high dielectric resistance for long life. Obtainable as individual units or in blocks; in cans or unmounted; with fixed or flexible leads.

Capacities .1 to 5. Mfd. . 60c to \$4.50

Raytheon Circuit Blocks

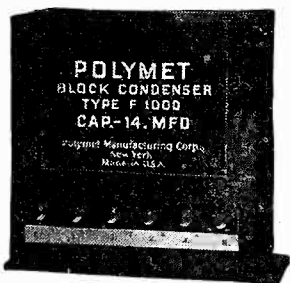

Tested by the Raytheon Laboratories, they have passed with highest honors and been given an enviable rating.

F1001 .1-C-.1 Mfd. . . . \$2.00
F1000 14 Mfd. 9.50

Polymet Products are used by over 125 high grade receiver and power unit manufacturers. There's a reason—Polymet Products have passed their exhaustive tests! Follow the manufacturers—specify Polymet Products—at all good dealers everywhere.

Illustrated descriptions sent FREE on request.

Polymet Manufacturing Corporation
599 PR Broadway - New York City

"World's Largest Manufacturers of Radio Essentials"

POLYMET

MODERN "B" Compact

"What a difference it makes!"

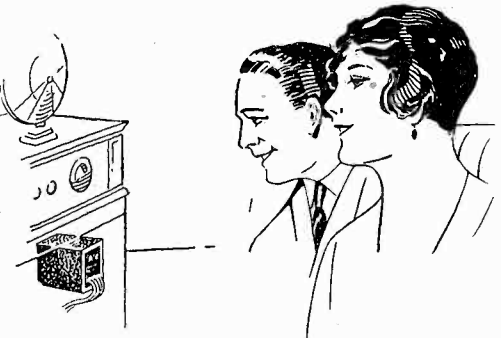

YOU will be astonished to find what greatly improved reception you will get from your present set when you try a Modern "B" Compact.

It furnishes quiet, uniform current that eliminates many battery noises often mistaken for static, connects to your light socket and does away with "B" Batteries.

Ideal for sets up to six tubes including power tube. Has three B+ taps and two variable voltage controls. Complete with Raytheon tube.

\$30.00 \$32.00

(East of the Rockies) (West of the Rockies)

If your dealer can't supply you write us direct

The Modern Electric Mfg. Co.
Toledo, Ohio

MODERN "B" POWER UNIT
FOR SETS LARGER THAN SIX TUBES
\$50.00 East of the Rockies

*Constant as Niagara
Silent as the Sphinx*

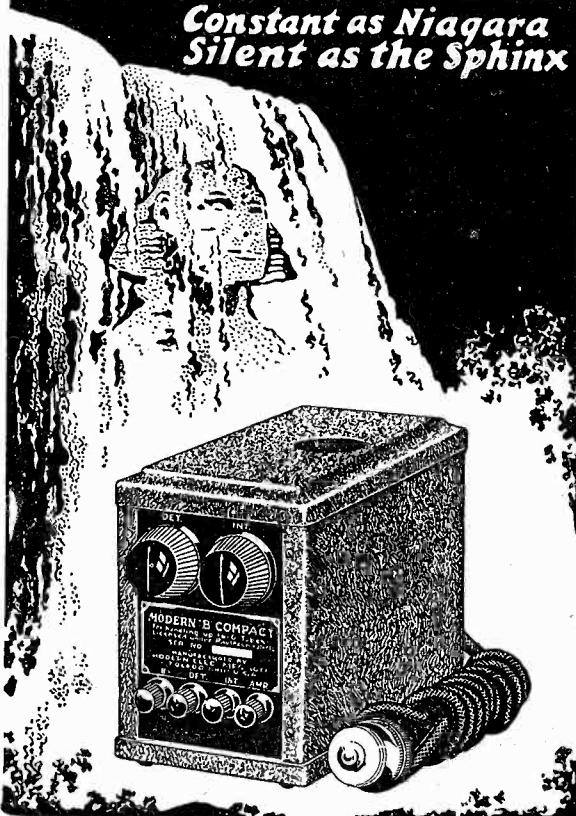

WHY THE INFRADYNE WORKS (Continued from page 74)

between one of the grid circuits and the preceding one appears in the common condenser C_4 which is placed in the grid return lead. This again involves the capacity between the primary and secondary of the transformer. For example, the condenser C_6 of 4.5 mmfd. has a reactance of 10,000 ohms at 3500 kilocycles. This is not so very large as a plate circuit impedance in a 16,000 ohm vacuum tube and it is connected approximately to the mid point of the inductance of L_3 of 24 microhenries which offers an impedance of about 530 ohms to these high frequency currents. Consequently a noticeable amount of current will flow through the condensers C_5 and C_6 and finally through C_4 on its way back to the filament of the second vacuum tube.

This small current through C_4 sets up a voltage which is applied to the grid of all three tubes simultaneously. If its magnitude and phase is correct it will also contribute to the neutralizing effect. Obviously its phase will be right for one tube and wrong for another, but if the value of C_4 is properly chosen, the system as a whole will be stable. The reactance of this condenser C_4 can be varied from 90 to 180 ohms by changing its capacity.

Still a third type of coupling between circuits is the magnetic coupling between either coil of the first transformer and either coil of the second or third transformer, etc. All of these coils have parallel axes and they are spaced rather close together, about $4\frac{1}{2}$ in. apart, so that this magnetic coupling may be of considerable magnitude. It is, of course, much less between the third transformer and the first than between the second and the first, or any adjacent pair.

In addition to the various types of coupling between successive stages of the amplifier a further complication is introduced by the presence of the shield in which the amplifier is mounted because it tends to disturb both the magnetic and electric fields. Fortunately, however, we do not need to concern ourselves about the exact result of each individual effect since the overall result is the thing which most interests us. We find on actually setting up the amplifier that by varying the common impedance in the grid return lead (C_4) or that of the common B battery lead we may control the stability of the amplifier, carrying it through the condition of neutralization to one of oscillation as we wish. Since regeneration is normally produced in this amplifier by increasing the capacity of C_4 , thereby reducing its impedance and the resulting voltage, or by adding a small choke or additional resistance in the common B battery lead, thereby increasing its impedance, we are lead to conclude that these two common impedances have opposite effects on the neutralizing of the amplifier.

It is interesting to note that there is usually a critical adjustment of the filament rheostat on the first detector tube. At first glance this seems to be rather mysterious and it cannot be explained with much exactness but it is easy to see how such an effect may occur. In the first place it is noted when the infradyne amplifier is in a highly sensitive condition and close to the point of oscillation. The impedance facing the infradyne amplifier, will of course, affect its tendency to oscillate, as will also the temperature of filaments of the amplifier tubes. Consequently it is not surprising that changing the filament current in the first detector tube should produce very greatly increased amplification or even start oscillation, since it not only changes the plate impedance which faces the infradyne amplifier, but also makes a slight change in the current supply to the other tubes in the set, including those of the infradyne amplifier itself. It also makes a difference in the amount of high frequency current supplied to the amplifier from the oscillator, since the current which flows in the oscillator pick-up coil and hence through the input of the infradyne amplifier must also flow through the plate impedance of the first detector tube. This is controlled by the filament current since lower filament temperatures means lower emission and higher plate impedance.

Regeneration in the amplifier is a very convenient means of making it very selective. Because of the frequency with which we are concerned, a relatively small amount of distortion results from this regeneration. It is a common experience to have the quality in a regenerative set become so poor when the system is on the point of oscillation that speech is scarcely recognizable. This is due to the fact that the circuit becomes so very sharp that only a very narrow band of voice frequency succeeds in getting through. However, for the same degree of sharpness, a regenerative circuit working at 1,000 kilocycles (300 meters) will pass only one-third as wide a voice band as a circuit working at 3500 kilocycles. For this reason much more regeneration can be used in the infradyne amplifier than in the ordinary circuit.

By adjusting the capacity of C_4 to the point of maximum sharpness, the frequency band may be reduced to a width of 4 kilocycles. At this peak point a voltage amplification of 125 times can be attained. As the upper and lower sidebands of the carrier wave from a broadcast station cover a 10 kilocycle band, this great amplification and selectivity is secured at the cost of poorer quality.

By adjusting C_4 to give smaller degrees of regeneration, the tuning may be broadened to give good quality with

(Continued on page 78)

PERRYMAN RADIO TUBES

"Distance without Distortion"

CLEAR!

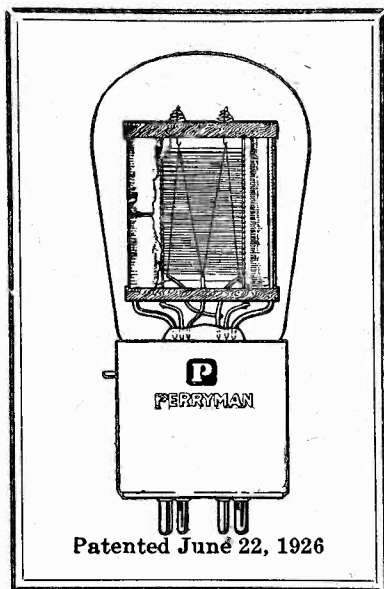

Above is the clear glass demonstrating tube showing the patented Perryman Bridge which holds the elements in place at the distance of greatest efficiency. Ordinary jars or jolts do not affect Perryman Tubes.

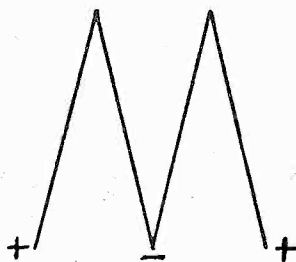

Notice the double filament which distributes the electron emission over the full area of the plate, giving greater capacity without overloading. You get natural tone for the life of the tube and the life of the tube is exceptionally long. The double filament doubles the life of Perryman Tubes.

A POWER amplifier is quite like an ordinary detector - amplifier, but it is made to handle larger currents at greater voltage. The power tube which amplifies with the least effort does so without distorting tones. The twin filament construction and the patented Perryman Bridge combine to make Perryman power tubes extremely efficient. They handle big loads with amazing ease and without distortion.

See the Perryman clear glass demonstrating tube at your dealer's. Look at the rigid reinforcements which keep its elements parallel at the point of greatest efficiency.

See the patented double filament. Then listen to a set equipped with Perryman Tubes. That's all we ask.

The Perryman line consists of detectors, amplifier-detectors, power-amplifiers, super-power amplifiers, full wave and half wave rectifiers listing from \$2.00 to \$9.00. These tubes are made in all types of bases for both storage and dry battery operation.



The PERRYMAN ELECTRIC CO., Inc.

33 West 60th Street

New York City

Pacific Coast Representative:

Atlantic-Pacific Agencies Corp., 383 Brannan St., San Francisco



CARTER Parts

as usual---are specified in

HENRY-LYFORD Circuit

as in all other really popular circuits

In Canada:
Carter Radio Co.,
Limited, Toronto



Any Dealer can
supply
MEMBER
R.M.A.

Tell them that you saw it in RADIO

CeCo Type J-71

The New Output Tube

Will handle sufficient power to operate the largest loud speakers at full volume. Does not require high voltage plate supply. At 90 volts it will give twelve times the undistorted power of the ordinary "A" type.

To be used in receivers where a separate "C" Battery connection for the last tube is furnished. Can be used on voltages up to 180 with enormous volume output, provided a special output circuit is used to protect the loud speaker. Filament 5 Vol. — ½ Amp.

Price \$4.50

CC

A Type for Every Radio Need

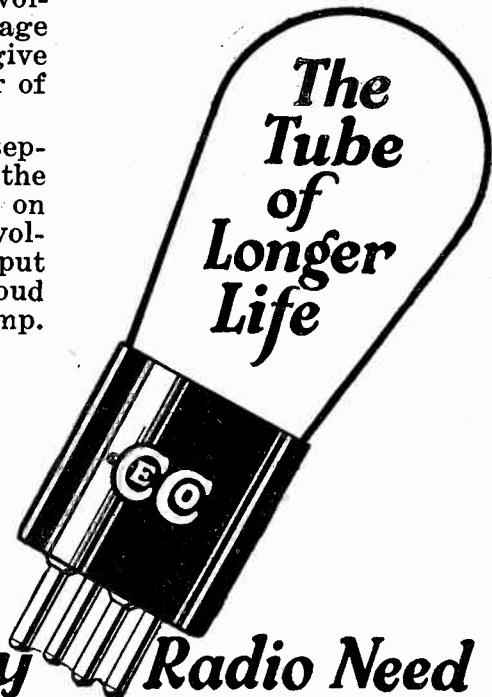

WHY THE INFRADYNE WORKS

(Continued from page 77)

somewhat less amplification. Thus the call letter of distant stations may be distinguished by adjustment for extreme selectivity and sensitivity on local programs may be heard with fine tone quality, as suits the user.

The average of many careful measurements made with the infradyne amplifier unit cut in and out of the circuit shows that it increases the signal strength about 100 times. Assuming 60 as an average value for a good two stage r.f. amplifier and 300 for an audio amplifier, the overall amplification is 1,800,000 times that of a single detector tube.

The remaining elements of the receiver need no comment since the detector and audio amplifier are familiar types and do not involve any unusual arrangement or effects.

Appendix—The complete equation for the current flowing in the output winding of a detector tube transformer is: $i_o = a_1 a \sin pt + a_1 b \sin qt + a_2 a^2 \sin^2 pt + 2a_2 ab \sin pt \sin qt + a_2 b^2 \sin^2 qt$, wherein $a \sin pt$ and $b \sin qt$ are two alternating voltages applied either to the grid or the plate circuit of the tube and a_1 and a_2 are simple expressions involving E_p , E_c and μ .

Note: if both alternating voltages are applied to the plate circuit μ does not appear in a_1 and a_2 .

SAFETY PLUS RADIO

(Continued from page 68)

contracts, alterations in the status of the risk, such as an increase in the hazard, made without the consent of the insurer, may automatically void the policy. It is therefore advisable for one whose property is insured against fire and who contemplates, or has already made, an installation of a radio set in the premises, to request his insurance company for a radio permit, which, when attached to the policy will form a part of it and will protect against misunderstandings with the insurance company that might otherwise arise.

Start the New Year Right!

Among your resolutions include a one-year subscription to "RADIO," at \$2.50. Every issue of "RADIO" contains a wealth of information not found in other publications. The thousand of news stand buyers of "RADIO" can save money by subscribing. It costs \$3.00 a year to buy "RADIO" from a dealer whereas the subscription costs but \$2.50 — saving you 50 cents.



IT HOWLS

Now it doesn't!

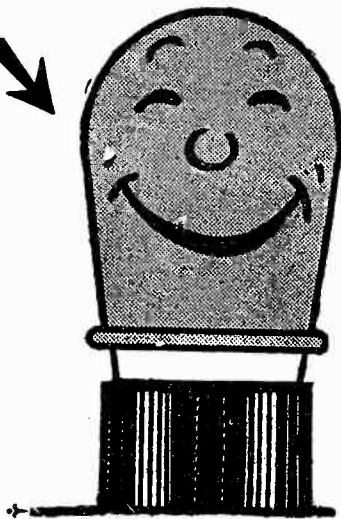

McDONALD HOWL ARRESTER

"It Stops that Howl!"

Slip one of these live rubber jackets over each trouble-making tube and the Howl stops.

Remember the name! You can get it for every size tube. It sells for 75c each. Just ask your dealer, or write.

Sole Selling Agents for the U. S. A.

SPARTAN ELECTRIC CORPORATION
350 West 34th Street, New York City

Manufactured in the U. S. A., by the
SCIENTIFIC PRODUCTS CANADA, LTD.

"It Stops that Howl!"

It's Surprising
what a big difference
a little thing makes

SEE
THAT
SCREW



A screw-driver
adjusts an X-L
in crowded
places.

X-L
VARIO
DENSER

Results in easier tuning, more distance, volume and clarity—greater stability. Indorsed by leading radio authorities.

MODEL "N"—A slight turn obtains correct tube oscillation on all tuned radio frequency circuits. Neutrodyne, Roberts two tube, Browning-Drake, McMurdo Silver's Knock-out, etc., capacity range 1.8 to 20 micro-micro farads. Price.....\$1.00

MODEL "G"—With grid clips obtains the proper grid capacity on Cockaday circuits, filter and intermediate frequency tuning in heterodyne and positive grid bias in all sets.

Model G is made in three variable capacities:

G-1-.00002 to .0001 MF.
G-5-.0001 to .0005 MF.
G-10-.0003 to .001 MF.

Price Each With Grid Leak Clips, \$1.50

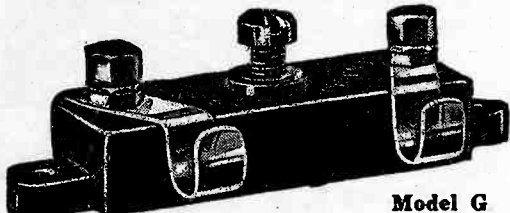

Model G

X-L PUSH POST—Push it down with your thumb, insert wire, remove pressure and wire is firmly held. Releases instantly. Price 15c.

PUSH POST PANEL permanently marked in white on black insulating panel. In box including soldering lugs, raising bushings and screws for mounting, etc. Price \$1.50.
Write for details



X-L RADIO LABORATORIES
2428 LINCOLN AVENUE, CHICAGO, ILL.



ELIMINATE ALL BATTERIES

Run ANY set, ANY number of ANY type tubes from 110 volt A.C. No hum. Easily done with NEW TYPE ELIMINATOR quickly made for few dollars from STANDARD parts. No liquids. No salts. NO TRICKLE CHARGER! No battery of any kind. Gives perfect "A" and "B" current in any quantity. Nothing like it. Dollar bill brings detailed blue prints and instructions that assure perfect results. J. M. MULLEN, Consulting Eng., Lab. C., 6549 N. Washtenaw Ave., Chicago.

CONE UNIT

For any cone up to 4-foot size. Gives wonderful tone at any volume. Sold on rigid money-back guarantee. C.O.D. or Prepaid, \$7.50.

Tunbar Radio Co.
26 Cortland Street, New York, N. Y.

AERIAL WIRE

ENAMELED
TINNED COPPER
BARE COPPER
SOLID
STRANDED
BRAIDED

COILS

MAGNET WINDINGS
FOR LOUD SPEAKERS
TRANSFORMER AND
CHOKE WINDINGS
FOR BATTERY
CHARGERS
AND ELIMINATORS
COILS FOR AUDIO
TRANSFORMERS

MAGNET WIRE

ENAMELED
COTTON COVERED
SILK COVERED
SINGLE OR DOUBLE
WHITE OR COLORED

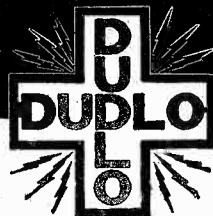

Dudlo Manufacturing Corporation

FORT WAYNE, IND.

A. S. LINDSTROM CO.—Western Representative

274 Brannan Street
San Francisco

324 N. San Pedro Street
Los Angeles

95 Connecticut Street
Seattle

146½ N. 10th Street
Portland

221 South West Temple
Salt Lake City

RADIO ADS

A Classified Advertising Section Read by Better Buyers

8 cents per word, net. Remittance must accompany all advertisements. Include name and address when counting words.

ADS FOR FEBRUARY ISSUE MUST REACH US BY JANUARY 3rd

HOFF'S Radio Trouble Finder explains what to do when radio gets out of order. Contains list broadcasting stations. Postpaid \$1.00 per copy. Information free. Heckenlively, Box 375, San Pedro, Calif.

CHOKES for Filter or Speaker Circuit; 5oh., 60ma., \$2.10; Audio Transformers, \$1.00; 275v Transformer from 110, \$2.10. Use two for Raytheon tube. All postpaid. Write for lists of parts. RADIO PARTS SALE CO., Box 24, Orange, N. J.

OLD NUMBERS WANTED. The New York Public Library, 476 Fifth Avenue, New York City, wants to acquire by gift or purchase, Nos. 1 to 5 of Vol. 1, Nos. 5 and 10 of Vol. 2, and Nos. 4 and 5 of Vol. 3 of "RADIO." Any reader willing to dispose of them is invited to write to the library.

GENERAL ELECTRIC 24/1500 volt .233 amperes dynamotors, \$38.00 with shaft extension for either battery or belt drive. Government cost \$92.50. Several hundred in use. Navy SE 1012 receivers range 50-1000 meters new \$45.00. Fotos. Henry Kienzle, 501 East 84th Street, New York.

SEAGOING OPERATORS—Blueprint of two kilowatt spark converted to ICW and commercial radio traffic manual—only book of its kind in world. Both for one dollar. Howard S. Pyle, 1922 Transportation Building, Chicago. (TC)

MORO CRYSTAL: Guaranteed sensitive. Price, 50 cents. William Ebel, 3448 Hartford S. W., St. Louis, Mo.

DO YOU GET TIRED of buying "B" batteries? A lifetime Edison will solve your troubles. Good, live, large size elements connected with pure nickel wire, electrically welded, 7c pair. All parts for sale. Sample cell and dope sheet, 10c. Paul Mills, Woodburn, Oregon.

TYPE 201A RADIO TUBES, tested, guaranteed, \$1.00. Grayson Radio, 929 Broadway, New York.

MAKE \$100 weekly in spare time. Sell what the public wants—long distance radio receiving sets. Two sales weekly pays \$100 profit. No big investment, no canvassing. Sharpe of Colorado made \$955 in one month. Representatives wanted at once. This plan is sweeping the country—write today before your county is gone. OZARKA, Inc., 431 N. LaSalle Ave. B, Chicago.

CRYSTAL SETS with crystal complete, 50c, stamps or money order. Nathan Bros., 2036 Polk St., San Francisco, Calif.

RADIO TROUBLES OVER. Heff's trouble finder locates, explains remedy, 103 radio ailments. Particulars free. Smith, 516 Main, St. John, N. S.

WILL SELL Rhamstone "B" eliminator with new tube for \$15; cost \$25. Crosley 3 tube set, \$12; cost \$25. F. MEEK, Rockbridge, Illinois.

GOSILCO—Latest Type Aerial Wire. Pure Gold over Silver Plated No. 14 Soft Copper. 3 cents per foot, postpaid or C.O.D. anywhere. Greatly increases Distance, Volume. Tunes much Sharper—Improves Tone. Endorsed by RADIO, Radio News, Popular Radio. AMERICAN LUMINOUS PRODUCTS CO., Huntington Park, Calif.

FEDERAL Headsets, 2200 ohms, regular \$7.00 phones for \$2.50, postpaid. Robert Wade, Box 531, San Angelo, Texas.

SALESMEN—51 Stations in 15 minutes. Vertical Antenna makes any radio tune 100% sharper—like Super-heterodyne. \$9.00 profit each. 4412 Lisbon Ave., Milwaukee, Wis.

For quick sale. 1 Silver Marshall power transformer, \$3.00. 1 Silver Marshall Unichoke, \$3.00. 1 Silver Marshall condenser Bank, \$3.00. All three for \$7.50. 1 Set Thorola doughnut coils, used little, \$3.00 for 3. 1 Brach electric soldering iron, \$1.00. First money order takes. Radio Operator, 1486 Portola Drive, San Francisco.

Tell them that you saw it in RADIO

**RADIO
NEEDS
TRAINED
MEN!**

I Will Train You At Home To Fill a Big Pay Radio Job



"I give you all this apparatus so you can learn quickly at home the *Practical Way*"

J.E.S.

FREE OF EXTRA COST

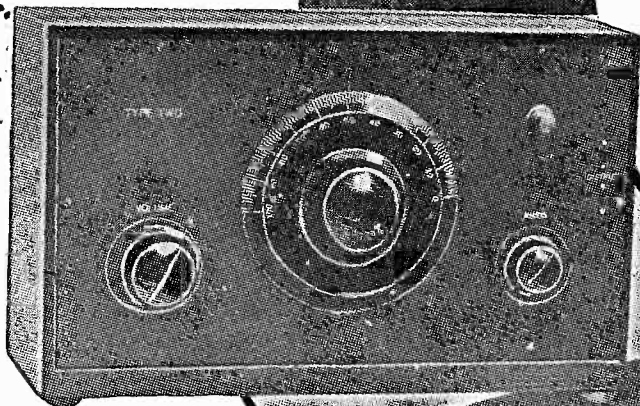

You Get All of This

All instruments shown here and others sent to all my students free of extra cost under short time special offer. Clip coupon now—find out all about this big unequalled offer while you still have time to take advantage of it. This training is intensely practical—these instruments help you do the practical work. You learn workmanship and get added confidence in your ability.

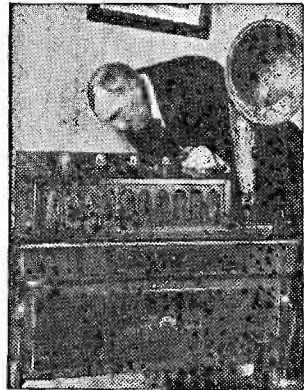

\$70 In One Day For T. M. Wilcox

"I am in business for myself and RECENTLY MADE \$70 in ONE DAY. I was an electrician of rich experience, occupying a splendid position as telephone superintendent when I enrolled with you believing it would open up greater opportunities—have not been disappointed. Estimate Radio will be worth tens of thousands of dollars to me in next few years." T. M. Wilcox, Belle Island, Newfoundland.

World Famous Training That "Pays for Itself"

My Radio course World-Famous as the training that "pays for itself." Make more money QUICK when you take up this practical course. Work on millions of antennae, receiving sets, offers you big chance to make spare time cash while you're learning. I'll show you how—teach you the latest "dope," furnish you with business cards, show you how to get the business and make it pay. My students don't wait a year to increase their income—they report QUICK INCREASES as a result of this course—often two or three weeks after starting. Howard Luce, Friedens, Pa., made \$320 in 7 weeks during spare time. D. H. Suitt Newport, Ark., writes, "While taking the course I earned in spare time work about \$900." Earl Wright, Omaha, reports making \$400 in a short time while taking course—working at Radio in spare time! Sylvester Senso, Kaukauna, Wis., made \$500. These records not unusual—these men a few of hundreds.

Your Satisfaction Guaranteed

We who know the results this practical tested training gets—the increased earnings it has brought to men everywhere—stand behind it all the way with a signed guarantee bond that we give you when you enroll. On completion if you're not entirely satisfied in every way, you get back every cent you've paid us. No strings to this offer—you yourself are the only judge. Get started today! It's your big chance for one of the bigger Radio jobs—mail coupon NOW for my Big FREE BOOK and proof! No obligation.

EMPLOYMENT SERVICE TO ALL GRADUATES

Originators of Radio Home-Study Training

If you're earning a penny less than \$50 a week, clip coupon now. Send for AMAZING FREE BOOK, "Rich Rewards in Radio." Why go along at \$25 or \$35 or \$45 a week, when you could earn \$50 to \$250 in the same six days, as a Radio Expert? Hundreds of N. R. I. trained men are doing it—why can't you?

Earn \$50 to \$250 a Week—

RADIO EXPERTS IN BIG DEMAND

Radio needs trained men. Get into this new live-wire profession of quick success. It's the trained man, the Radio Expert, who gets the big jobs of this profession—paying \$75, \$100, \$200 a week and up. Every day N. R. I. trained men are taking good places in the Radio field—men just like you—their only advantage is TRAINING. You can prepare just as they did, by new practical methods. Our tested clear training makes it easy for you. Big Free Book contains all the proof.

You Learn Quickly In Spare Time

So sure am I that I can train you successfully for a better future in this new Big-Pay profession, that I guarantee your training with a money-back bond. Lack of experience or education won't hold you back—common schooling all you need to start. You can stay home, hold your job, and learn quickly and pleasantly in your spare time. My practical, helpful methods enable you to start RIGHT AWAY toward one of the bigger Radio jobs paying \$50 to \$250 a week. No delay, no losing time from work—no scrimping or scraping to get your training.



Operates WMAQ

"Accepted a position with the Chicago Daily News Station WMAQ. MY INCOME PRACTICALLY DOUBLED, thanks to you. I handle all consultation, also do operating. Your course taught me not only the theoretical but also the practical knowledge that makes my work easy for me." Keith Kimball, Station WMAQ, Chicago, Ill.

Get This FREE BOOK

Most amazing book on Radio ever written—full of facts and pictures—tells all about the great new Radio field, how we prepare you and help you start. You can do what others have done—GET THIS BOOK. Send coupon today—no obligation.

J. E. SMITH, President
NATIONAL RADIO INSTITUTE
Dept. A-B5, Washington, D. C.



J. E. SMITH, President
NATIONAL RADIO INSTITUTE
Dept. A-B5, Washington, D. C.

Dear Mr. Smith—Without obligating me in any way, send me your free book, "Rich Rewards in Radio" and all information about your practical, home-study Radio Course.

Name..... Age.....
Street Address.....
Town..... State.....

GENERAL RADIO

Parts and Accessories have a Laboratory Background of more than a decade

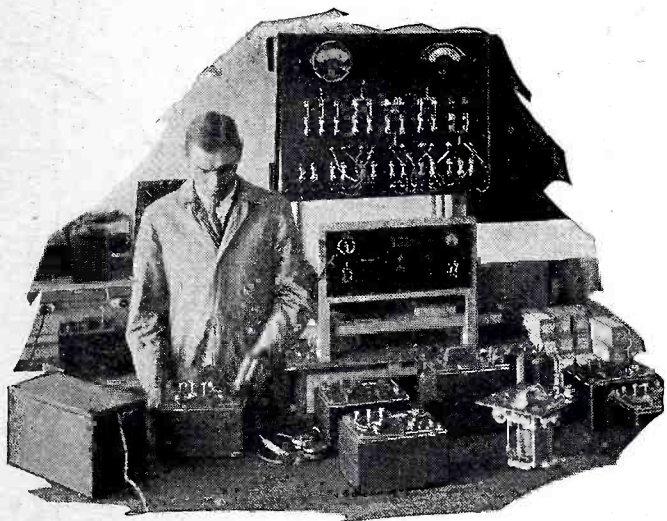
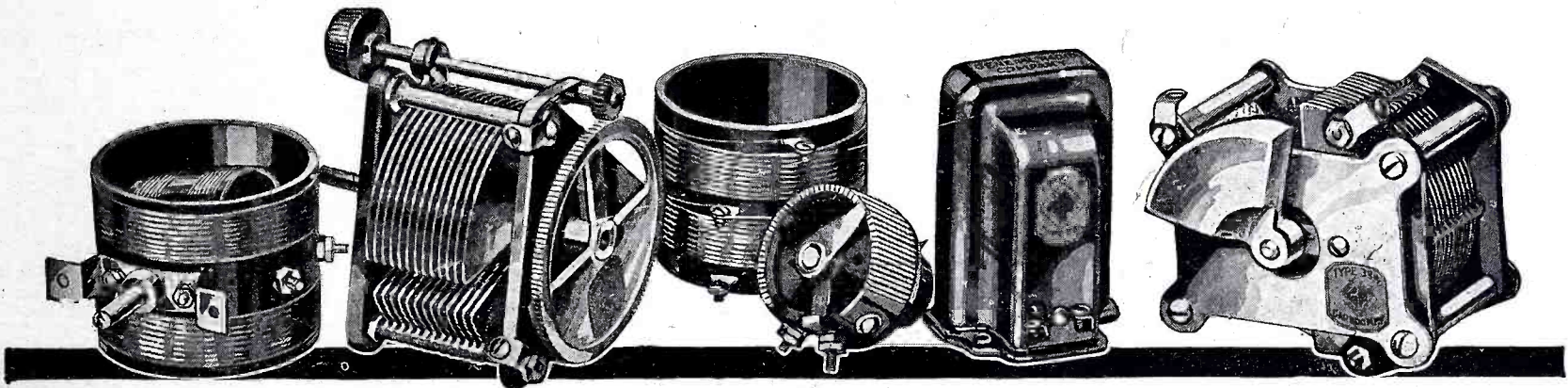

For more than a decade the General Radio Company has been manufacturing radio laboratory instruments and parts—the outstanding feature of which is *precision*. These instruments have been supplied in ever increasing quantities to many well known radio laboratories of the country, including the General Electric Company, Westinghouse Electric Mfg. Company, Bell Telephone Laboratories, Bureau of Standards, U. S. Navy, U. S. Signal Corps, as well as the leading engineering colleges.

Today, General Radio precision instruments are standard equipment in nearly all the radio laboratories throughout this and many foreign countries.

Through the merits of design, performance, and price, General Radio instruments for the scientist or set-builder are universally recognized as the Standards of Quality.

Since the early days of radio, amateur operators and set-builders have looked upon the General Radio Company as a time-tried producer of dependable apparatus.

The conservative buyer of radio parts looks first to the reputation of the manufacturer. He knows from his own experience and that of others whether this reputation warrants his confidence. It is this self-same confidence upon which the popular preference for General Radio parts and accessories is based.

In building a radio receiver, remember that its performance depends primarily upon two things; an efficient circuit and use of good parts.

Wherever you find a popular circuit you will invariably find General Radio parts.

Ask your dealer or write for our latest parts bulletin No. 926.

GENERAL RADIO CO.
CAMBRIDGE MASS.





more distance on the same set

Want more stations on that storage battery set of yours? Want the far-away ones you get now to come in more easily and regularly? The Radiotron laboratories have developed a *super-detector* that slips right into the socket where you have a Radiotron UX-201-A now. Just change that one to a Radiotron UX-200-A.

It makes your set sensitive to fainter signals—reaches out to farther stations—picks up weaker ones you couldn't get before. It makes a big change for a very small cost!

Bring your storage battery set up-to-date with
a power RADIOTRON UX-171 or UX-112
a detector RADIOTRON UX-200-A
and RADIOTRONS UX-208-A for all-round quality.

Bring your dry battery set up-to-date with
a power RADIOTRON UX-123
and RADIOTRONS UX-199 for all-round quality.

RADIO CORPORATION OF AMERICA
New York Chicago San Francisco

HEATING METAL INSIDE OF GLASS

EVERYONE knows that glass melts easily, and metal requires a high temperature. Yet, at the Radiotron laboratories, the experimenters can put a Radiotron in the coil of a "high frequency furnace" and melt the metal *inside it* without melting the glass. This is done by an electric current that is induced inside the glass bulb, right through the glass.

This extraordinary furnace is not only used for experiment. In manufacture, every single Radiotron goes for a moment through such a furnace, just after the air has been exhausted out of it. The inside metal is heated red hot in the vacuum, and the tiny air bubbles boil right out of the metal and the glass, and are pumped away. Never before could such an exhaust be obtained.

This means *real performance* when the Radiotron gets into your set. And it adds another reason for insisting on a genuine RCA Radiotron with the RCA mark on the base and the glass. There are Radiotrons for every purpose.



RCA Radiotron

MADE BY THE MAKERS OF THE RADIOLA