

DECEMBER, 1926

25 CENTS

# RADIO

(REG. U. S. PATENT OFF.)

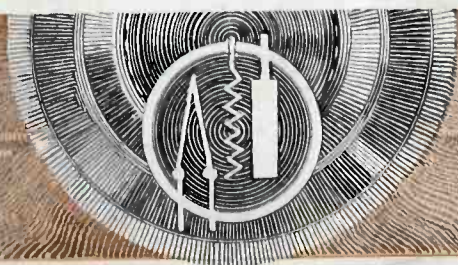
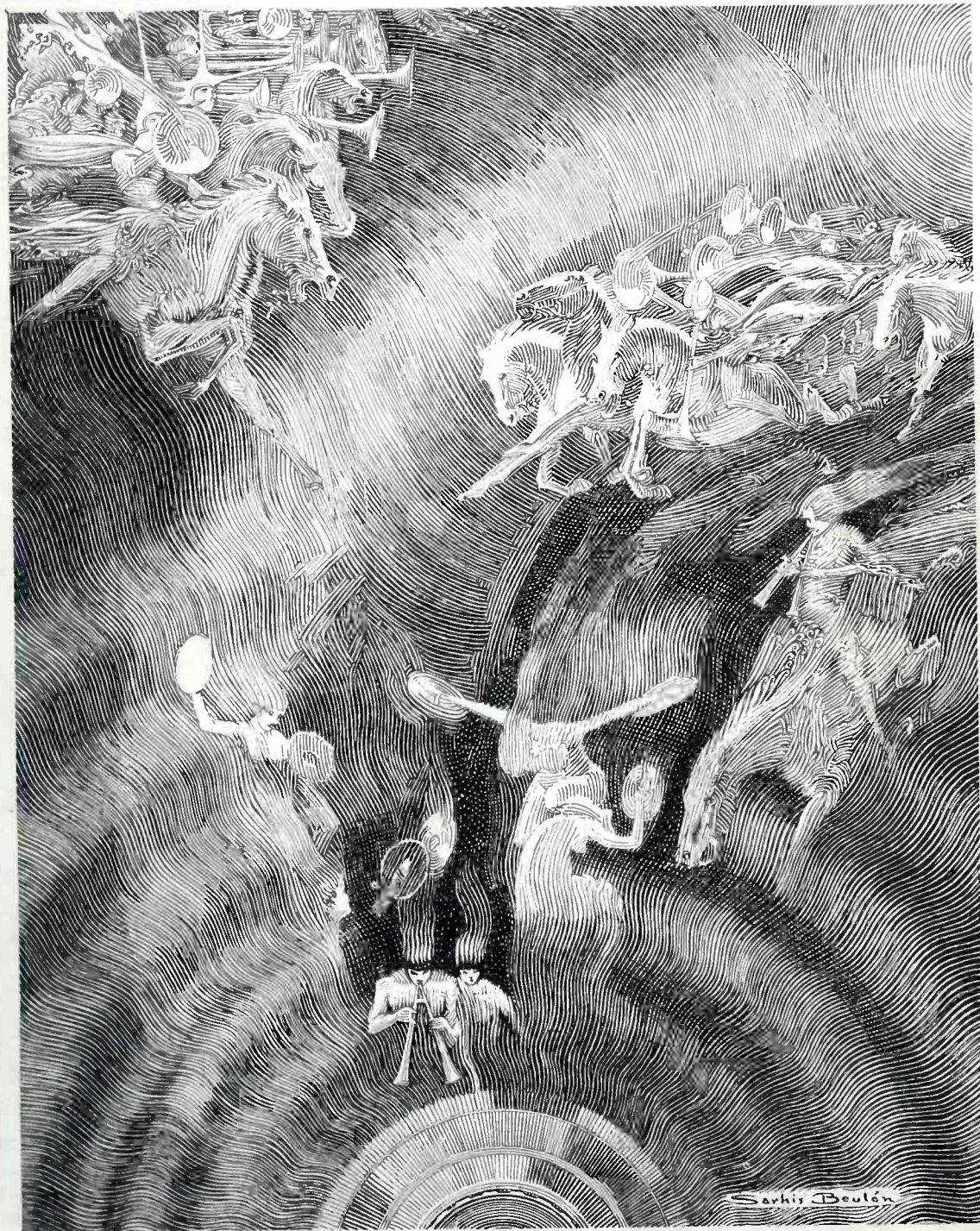





# Cunningham RADIO TUBES

*Since 1915—Standard for All Sets*



Cunningham  
Radio Tubes

are astoundingly good all the year 'round and at Christmas time you will receive even a greater appreciation of their quality performance because of the attractive Yuletide programs. These radio programs come in clear and full-toned when your receiving set is Cunningham equipped. ¶ Every broadcast station splurges a bit at Christmas time and gives you something extra good. ¶ Entertainers are stimulated to do their best by the knowledge that thousands of new sets are tuned in and that their already large and enthusiastic audience has swelled to even larger proportions during this Christmas and holiday time. ¶ Radio sets and radio equipment in general make immensely popular Christmas gifts. ¶ Why not increase someone's pleasure a thousand fold by the gift of a radio set this Christmas? ¶ If you want to make this lucky person's happiness complete, you will make sure that the set has a Cunningham Radio Tube in every socket. ¶ To bring increased happiness to someone who now owns a receiver, give him a set of Cunningham Radio Tubes, known since 1915 as standard for all sets.

*E. J. Cunningham, Inc.*

NEW YORK  
CHICAGO  
SAN FRAN-  
CISCO



# Tower



## Meistersinger CONE



TOWER has built a new Cone—the Meistersinger—a radio speaker of dignified beauty matched only by its rare tonal capabilities. Ideal for power tube operation, the new Meistersinger can also be used as a Wall Model by detaching base. The exclusive driving mechanism and free edge cone, 16" in diameter, is protected by a solid mahogany frame and metal base with dolphin motif.

Such quality heralds the Meistersinger as a value without precedent among cone speakers—a most appropriate Christmas gift.

*On Sale from Coast to Coast*

TOWER MFG. CORP.  
BOSTON, MASS.

**\$15.00**

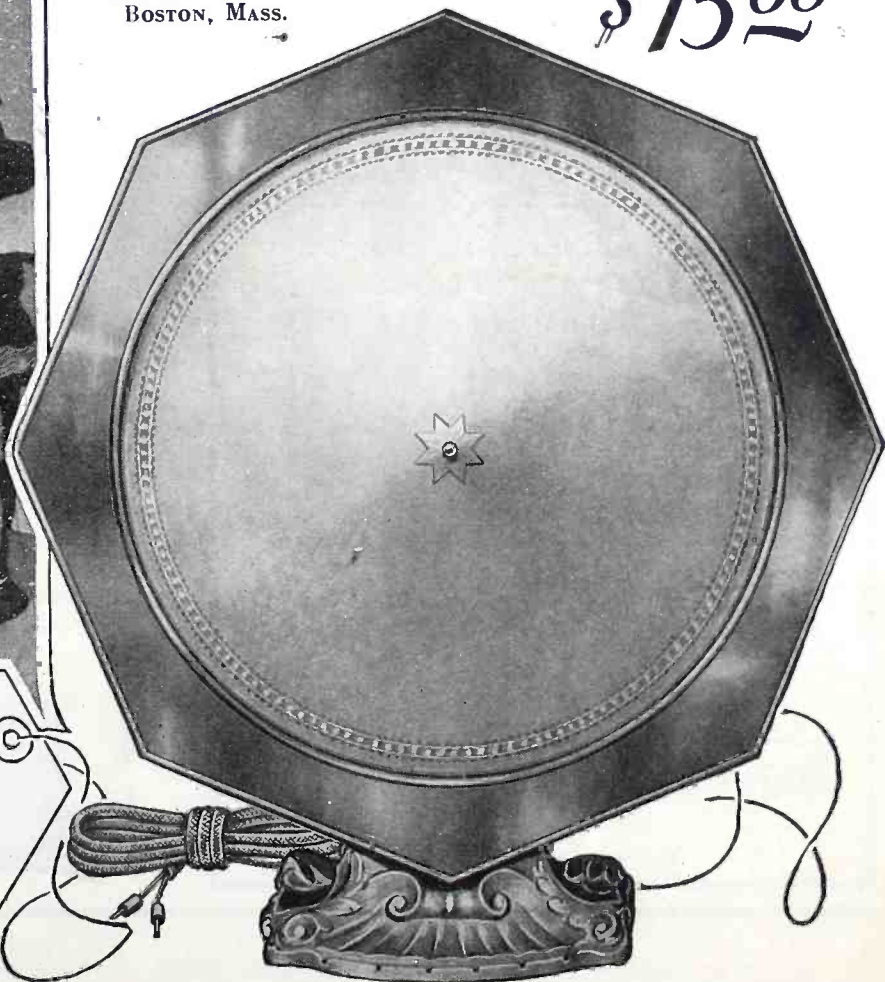

*Merry  
Christmas*

Tell them that you saw it in RADIO



# BREMER-TULLY B-POWER UNIT



Capacity 150 volts at 60 milliamperes. Adjustable to sets requiring less by the exclusive B-T method.

**Price, East of the Rockies, Complete with Raytheon tube, \$49.50.**

The expert who has access to expensive laboratory instruments can check the voltages delivered by a B-Battery Eliminator.

When the Bremer-Tully Unit is used, no expensive instruments are necessary, nor is it necessary to guess at the voltage.

The exclusive B-T method automatically delivers the correct voltage to your set at the touch of the switch.

Designed to insure the satisfactory operation of the B-T Counterphase-Eight, this unit may be adapted to all ordinary receivers.

When investing money in a B-Power Unit, it will prove economical to buy a good Unit the first time, one that will serve that bigger set you may build next year—and who can point to a firm with a better reputation for successful products than BREMER-TULLY?

## BETTER TUNING

Several pages in the 10th Edition of "Better Tuning" are devoted to discussion on B-Eliminators. It tells many things you should know.

Power-Six also discussed; how to change the Counterphase-Six to a Power-Six model. Counterphase-Eight factory-built set described and our views on many radio subjects, etc.

Sent postpaid for 10c.

## Best Tone for the Power-Six

There is no better form of audio amplification than good transformers. The B-T "Euphonic" audio transformer has demonstrated that it is the best for the Power-Six. With the power tube output, the tone is remarkable.

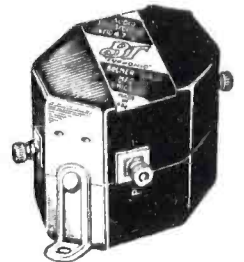

2.2 to 1 .....\$5.00  
4.7 to 1 .....\$5.75



## Well-known Parts Used in B-T Power-Six



No. 1R-3 3-Ohm "Imp" Rheostat

Self-cooling, all-metal frame, readily absorbs and radiates heat. Compact. Sturdy.

## No. 101 and No. 104 Jacks

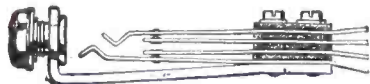

Carter Hold-Tite Jack No. 104.

Heavy phosphor-bronze springs and pure silver contacts insure satisfying operation.



"Imp" Battery Switch

Quarter-turn snap switch always makes positive contact.

## No. 3 Jack Switch

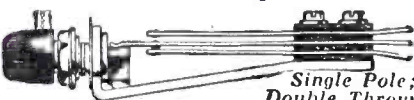

Single Pole; Double Throw

Same durable construction and reliability as found in Carter Jack.

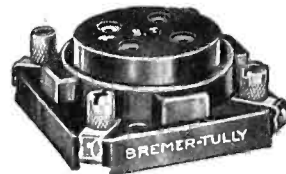

## UX Type Sockets

The B-T UX socket not only prevents injury to the tube but "snubs" the vibrations which follow jars. Tubes last longer—reception is quieter.—B-T is the only socket with these features.

UXA Type.....\$.75  
UXD Type.....\$1.00  
(For Detector)

## Tuning Control

The ratio 12 to 1 is just right for tuning the Power-Six. This dial is gear-operated,—positively no back lash. Dial readings in degrees, wavelengths or station call letters.

The longer this dial is used the better you like it.

Price, Black & gold.....\$2.50  
Price, Brown & gold.....\$3.50



## New Mikro Mike

This is the new Mikro-Mike Condenser furnished with the P-6 Kit. Available to those who want to change the Counterphase to a Power-Six model.

Price, \$1.00.

THE BEST YOU CAN BUILD

Tell them that you saw it in RADIO



## BREMER-TULLY

# POWER-SIX KIT SET

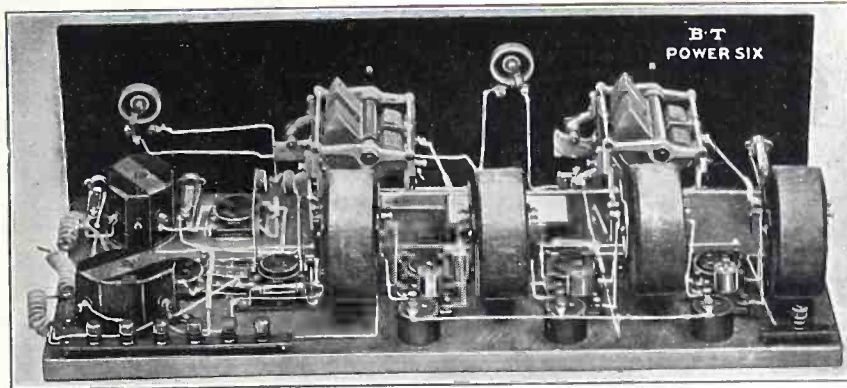

**T**HE new Bremer-Tully Kit set employs the basic superiority of the original Counterphase. It is easier to build, balance and operate. It provides for the use of the new detector and power tubes. The full-size colored picture wiring diagram is easy to understand and leaves no room for errors.

*The essential parts for the Power Six are available in kit form. The P-6 Kit contains the following parts:*

1 TA Torostyle Transformer .....	\$ 4.00
3 TC Torostyle Transformers, at \$4.00.....	12.00
2 LD-17 Condensers, at \$9.50.....	19.00
3 B-T MMF Condensers, at \$1.00.....	3.00
3 B-T R.F. Chokes, at 90c.....	2.70
1 B-T 500,000 ohm Resistance .....	2.00
3 1500 ohm Resistances, at 50c.....	1.50
1 Set Color Charts and Diagrams.....	.90
<b>PRICE OF PARTS SEPARATELY.....</b>	<b>\$45.10</b>
<b>ALLOWANCE IF BOUGHT AS COMPLETE KIT.....</b>	<b>3.60</b>
<b>PRICE OF POWER-SIX KIT.....</b>	<b>\$41.50</b>

Gerald Best, Technical Editor of Radio, says:

"The new Bremer-Tully Counterphase-Six is by far the best Bremer-Tully receiver yet developed.

"Its remarkable selectivity and simplicity of operation leads me to believe it will be one of the season's most popular circuits.

"It is one of the easiest circuits to wire of any I have seen.

"Its engineering principle is sound.

"Congratulations to Bremer-Tully on this new development."

### **SHE BUILT ONE—READ HER LETTER!**

KANSAS CITY, Mo., Oct. 27th, 1926.

Last spring I built your Counterphase-Six and we have had such remarkable success with it, I feel that I should tell you about it. We have tuned in stations on loud speaker from coast to coast and have also had PWX, Havana, Cuba. Also another Cuban Station. Get PWX quite often and have had it when the *K. C. Star*, one of our local stations, was on and had San Antonio WOAI to contend with at the same time. But we separated them in fine shape. Could take either PWX or WOAI at will. Yesterday I had KOA, Denver, at five o'clock, and held it for an hour.

With all your knowledge of radio, I don't know whether you would call this unusual reception or not, but to our limited knowledge it seems remarkable, especially since none of our friends with high priced sets can equal our record. I have had KOA and WSB and a station in Virginia in daylight hours before. I haven't found a set yet that can equal it. . . . I'm mighty enthusiastic about our set and take great pride in the fact that I made it. One could hardly go wrong in following your blue prints—your instructions are so simple and thorough.

### **BUT LOOK AT THIS!**

WASHINGTON, D. C., Oct. 29th, 1926.

I had previously thought it was impossible to improve on the Counterphase-Six and up to the time I changed to the Power-Six it was the best I had heard. Now that I have changed to the Power-Six the difference is really wonderful. It is unquestionably the finest set on the market today.

*Here is an opportunity for Mr. Average Set-Builder to provide himself with a real high-class set with all the latest improvements.*

*Construction is easy, balancing is easier—and it's a delight to operate the Power-Six.*

## BREMER-TULLY POWER-SIX

Tell them that you saw it in RADIO



# RADIO

With Which Is Incorporated "Radio Journal"

Established 1917

Published Monthly by the Pacific Radio Publishing Co.

ARTHUR H. HALLORAN

Editor

GERALD M. BEST,  
Technical Editor

H. W. DICKOW,  
Advertising Manager

**Branch Offices:**

New York City, 20 East 42nd St.  
Chicago, 807 N. Michigan Ave.  
Boston, 86 St. Botolph St.  
Kansas City, Mo., Davies & Dillon, 707 Land Bank Bldg.

**Rates:**

Issued Monthly, 25c a copy.  
Subscription price, \$2.50 per year in the U. S., \$3.00 per year elsewhere.

**Correct Addresses:**

Instructions for change of address should be sent to the publisher two weeks before the date they are to go into effect. Both old and new addresses must always be given.

**Advertising:**

Advertising Forms Close on the First of the Month Preceding Date of Issue.

Member Radio Magazine Publishers' Association  
Entered as second-class matter at Post Office at San Francisco, Calif.  
Copyright 1926 by the Pacific Radio Publishing Co.

Address all communications to

**Pacific Radio Publishing Company**

Pacific Building, San Francisco, California

VOLUME VIII

DECEMBER, 1926

NUMBER 12

## CONTENTS

	PAGE
RADIOTORIAL COMMENT .....	27
MODERN PRACTICE IN MARINE RADIO.....	28
<i>By D. B. McGown</i>	
LONG MAY IT WAVE.....	31
<i>By Keith La Bar</i>	
THE NEW INVERSE DUPLEX SYSTEM.....	33
<i>By David Grimes</i>	
THE COUNTERPHASE POWER SIX.....	35
<i>By G. M. Best</i>	
DIRECT ACTION .....	37
<i>By G. W. Weight</i>	
THE INFRADYNE AMPLIFIER.....	39
<i>By E. M. Sargent</i>	
THE RADIO SEASONS.....	40
<i>By C. Sterling Gleason</i>	
THE MAZE OF RADIO PATENTS.....	41
<i>By John Flam</i>	
THE "MINDECTOR" .....	43
<i>By O. C. Roos</i>	
MORE ABOUT THE HENRY-LYFORD.....	45
<i>By Elmore B. Lyford</i>	
AN OSCILLATOR THAT HOLDS CALIBRATION.....	46
<i>By L. W. Hatry</i>	
AN "LCR" MEASURING BOX.....	47
<i>By Sylvan Harris</i>	
AN IMPROVED "ABC" POWER PLANT.....	49
<i>By G. M. Best</i>	
QUERIES AND REPLIES.....	52
THE COMMERCIAL BRASS-POUNDER .....	53
GREAT CIRCLE DISTANCES .....	54
<i>By Harold Larson</i>	
THE LOS ANGELES RADIO CLUB.....	55
R.F. TRANSMISSION LINES.....	56
<i>By Frank C. Jones</i>	
MEASUREMENT OF ANTENNA FUNDAMENTAL.....	57
<i>By A. P. Peck</i>	
FROM THE RADIO MANUFACTURERS.....	58

## Forecast of Contributions for January Issue

The theory of the infradyne receiver is completely analyzed by Raymond B. Thorpe, who develops the reasons for its remarkable selectivity and sensitivity.

David Grimes explains how selectivity without impairment of amplification is obtained in the r.f. circuit of the new inverse duplex system and how the howl due to interaction between the audio and radio frequencies is eliminated.

In an article entitled "A Real 'A' Eliminator," G. M. Best details the construction of a full wave rectifier and filter which supplies 2 amperes at 6 volts without the use of a storage battery.

"Charged With Battery," by Keith La Bar, is a popular explanation of condenser action. It is written in a human interest style and is illustrated by Louis McManus.

Boris S. Naimark, in "Safety Plus Radio," warns against a few hazards to be avoided in radio installations.

Perry S. Graffam tells how to build a five-tube receiver, using three stages of impedance coupled amplification.

Clinton Osborne describes various types of relays as used to turn off and on a trickle charger and B eliminator.

Charles F. Felstead discusses different types of loop aerials for receiving sets.

George Imlach analyzes the causes of noises in radio receivers and tells how they may be eliminated.

C. A. Kulmann presents a reversible chart for the graphic determination of the inductance of a single layer solenoid. It instantly shows the inductance of a given coil or the coil dimensions necessary for a given inductance.

G. M. Best describes the construction of an unusually efficient short wave receiver having two tubes.

Jack Bront starts a series of "Letters From Larry." These are surcharged with static room humor and typify the experience of a green commercial operator.

"The Amplified God," by B. W. Wilson, is a weird story of the desert where radio plays an important part in bringing about the right kind of an ending.





# The Driving Power of a New Idea

*Here you see pictured the Force and Energy of a new Radio principle. You see it forging the links in a chain that every day is growing in Strength and Power.*

**T**URN this page, and the many pages that follow, to get the story of the Infradyne—and what it means to radio. This—the only “different” circuit in the last three years—has given positive proof of its outstanding superiority.

To the substantial and progressive manufacturers, whose announcements fill the pages of the Infradyne Section, goes credit for their support of a New Idea. They realize its Driving Power. They know it is already a demonstrated success.

Such co-operation in a single issue of a consumer radio magazine has never been equaled. Their unanimous support of the Infradyne Idea—backed by their large investment in it—is your safeguard in building the ultimate in radio receivers.

And finally—RADIO is justifiably proud of its introduction of the Infradyne to the radio enthusiasts of America. A success such as this marks a mile-stone in the progress of the art.

Tell them that you saw it in RADIO



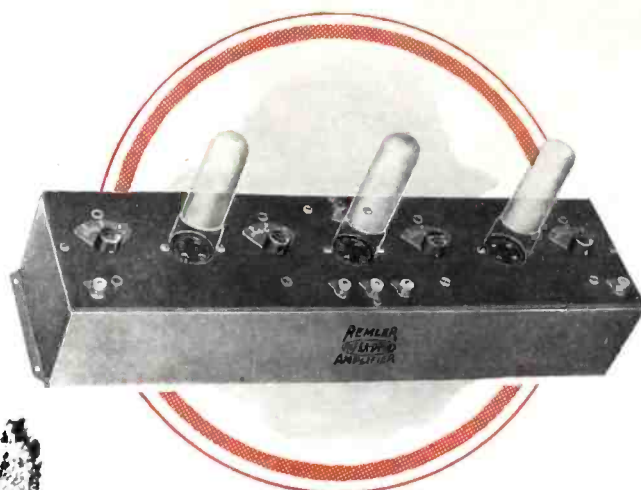
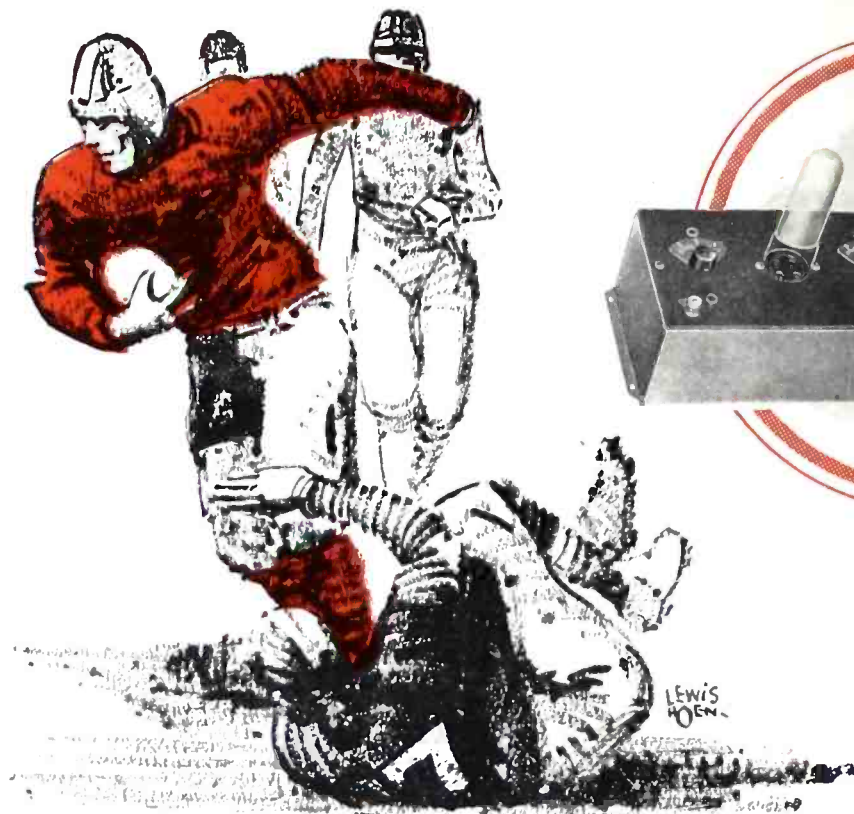

**REMLER**  
**INFRA-DYNE**  
**AMPLIFIER**

# Smashing all Barriers

**that stand between your set and the kind of radio reception that you want and need. That is exactly what the Remler Infradyne Amplifier is doing for thousands of radio owners and that is exactly what it can do for you.**

*Perhaps right now* you are thinking of buying a new receiver. How much better to keep the old reliable neutrodyne or tuned radio frequency set and add the Remler Infradyne Amplifier with associated parts. Then you will have a circuit that gives you all—and more—than you can reasonably ask.

*Most progressive dealers* already know the Infradyne story and what it means in improved reception. Ask your favorite retailer for full details. If he can't tell you all you want to know, write us for 2-color folder and complete instructions for building the complete Infradyne circuit and the Adaptor.

This is an Infradyne year — why drift along with the “also-rans” when it's so easy to lead the procession.

**Price \$25.00**

## **REMLER**

DIVISION OF

GRAY & DANIELSON MANUFACTURING COMPANY

CHICAGO

260 FIRST STREET - SAN FRANCISCO

NEW YORK



# REMLER

## TWIN-ROTOR

# CONDENSER

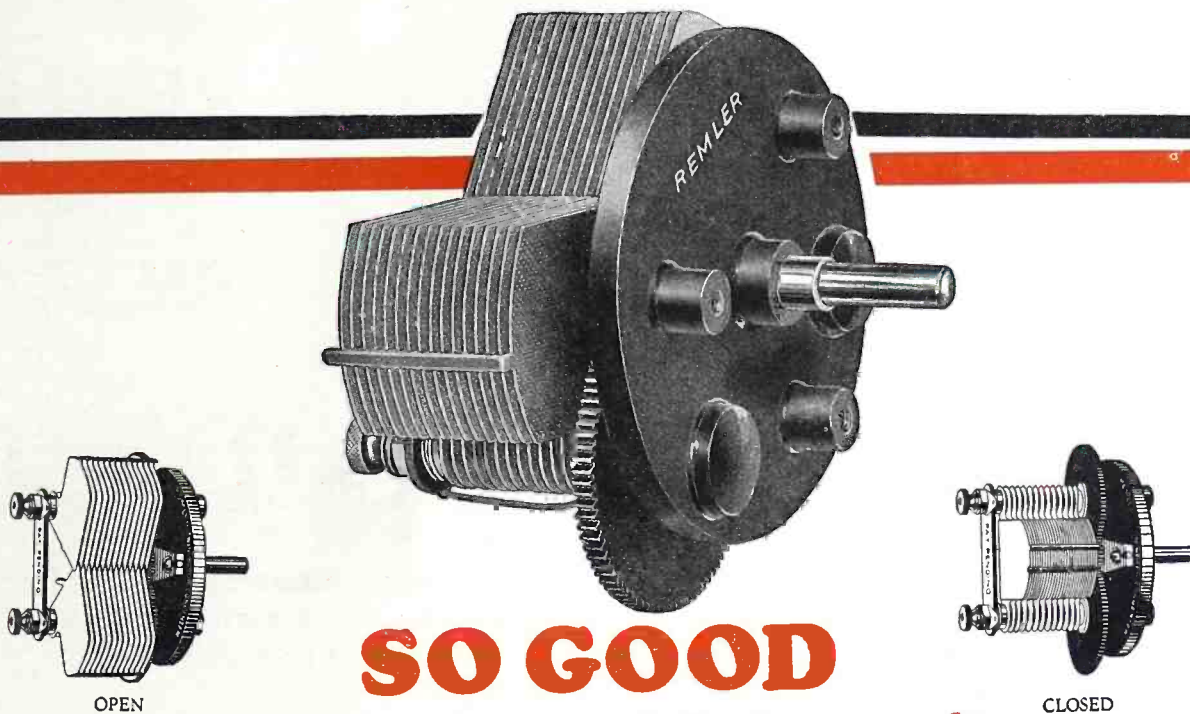

**SO GOOD**  
that your set certainly deserves it

Tuning is vitally important in the performance of your radio set. Condenser efficiency is the key to results that may improve the reception of your present set a full 100%.

The ordinary run of condensers cannot give the tuning efficiency you demand. Why not replace them with Remler Twin-Rotor Condensers and get all the performance of which your radio set is capable.

#### **Straight Line Frequency**

In this type equal divisions on the 360° dial represent equal frequency bands. A special adjustment permits variation of the minimum capacity over a limited range without any change in the maximum capacity. This allows the lowest wave-length station to be so located that the entire dial is used in covering the broadcast range.

No. 648—.00035 max. less dial . . . \$4.50  
No. 649—.0005 max. less dial . . . 4.50  
No. 659—.0001 max. less dial . . . 4.50

#### **Straight Line Wave-Length**

This type should be used to separate to the greatest extent the long-wave class "B" stations which usually offer the better programs. Equal dial divisions represent equal wave-length bands. The smaller low-wave length stations are slightly crowded to give maximum spacing for the higher powered class "B" stations.

No. 630—.00035, with dial . . . . . \$5.00  
No. 638—.00035, less dial . . . . . 4.50  
No. 631—.0005, with dial . . . . . 5.00  
No. 639—.0005, less dial . . . . . 4.50  
Dial complete .75

# REMLER

DIVISION OF

GRAY & DANIELSON MANUFACTURING COMPANY

CHICAGO

260 FIRST STREET - SAN FRANCISCO

NEW YORK

Tell them that you saw it in RADIO



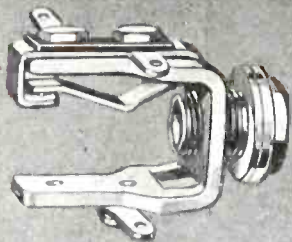

**FROST-RADIO Gem-Jac**  
No. 954 - Price 45c



**FROST-RADIO No. 530 Bakelite Socket** - Price 40c



**FROST-RADIO Pan-Tab Jack**  
No. 234 - Price 75c

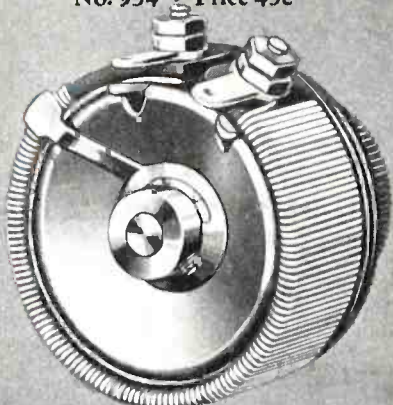

**FROST-RADIO Type 700 Metal Frame Rheostat** - Price 50c

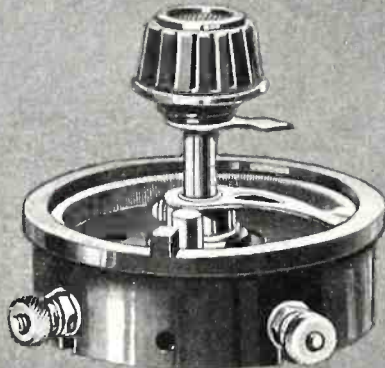

**FROST-RADIO Type 660 Bakelite Rheostat for base mounting**  
Price 75c

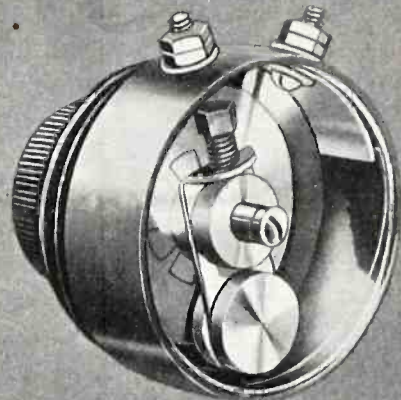

**FROST-RADIO Type 886 Super Variable High Resistance**, Price \$1.50



## FROST-RADIO Parts for the Infradyne

When you decide to build your Infradyne set you will build it because you want better, finer results. If you want to be sure of getting the utmost efficiency from this receiver it is not only important to use the principal parts specified, but to see that every part that goes into your set is of the highest quality. Don't overlook such parts as sockets, jacks, rheostats and high resistance units. Once these parts are installed they are usually forgotten, but later they often prove a source of trouble that is hard to locate.

Make sure that these parts bear the name **FROST-RADIO** and you can be absolutely certain of permanent electrical and mechanical properties. Just install them and forget them.

Ask Your Dealer for these **FROST-RADIO**  
Infradyne Parts

	LIST
No. 660 <b>FROST-RADIO</b> Bakelite Rheostat, base mounting . . .	\$0.75
No. 530 <b>FROST-RADIO</b> Bakelite Socket . . .	.40
No. 730 <b>FROST-RADIO</b> Metal Frame Rheostat, 30 ohm . . .	.50
or, if preferred,	
No. 830 <b>FROST-RADIO</b> Bakelite Rheostat, 30 ohm . . .	.75
No. 710 <b>FROST-RADIO</b> Metal Frame Rheostat, 10 ohm . . .	.50
or, if preferred,	
No. 810 <b>FROST-RADIO</b> Bakelite Rheostat, 10 ohm . . .	.75
No. 886 <b>FROST-RADIO</b> Super-Variable Resistance, 50,000 ohms	1.50
No. 608 <b>FROST-RADIO</b> Push-Pull Switch . . .	.30
No. 954 <b>FROST-RADIO</b> Gem-Jack . . .	.45
or, if preferred,	
No. 234 <b>FROST-RADIO</b> Pan-Tab Jack . . .	.75
No. 953 <b>FROST-RADIO</b> Gem-Jack . . .	.40
or, if preferred,	
No. 233 <b>FROST-RADIO</b> Pan-Tab Jack . . .	.65



# FROST-RADIO

## Parts and Accessories

No. 141



Automatic Plug

Price 75c

## FROST-FONES

Nothing else can quite replace a pair of sensitive **FROST-FONES** when tone quality and clearness on distant stations are what you want most. On those favorite far-off stations **FROST-FONES** turn weak signals into clear, pure reception. Being only about half the weight of old style head sets they are worn with perfect comfort. Try them and compare with others at your dealer's. Prices \$3.00 to \$6.00.

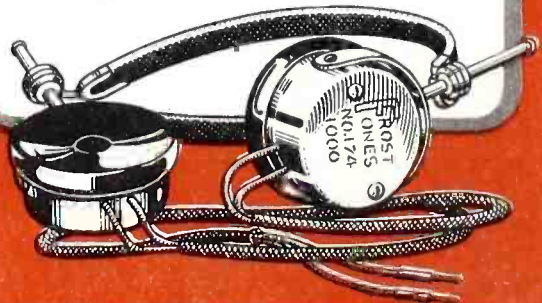

**HERBERT H. FROST, Inc.**  
160 North La Salle Street  
CHICAGO

New York

Los Angeles

Tell them that you saw it in RADIO



# FROST-RADIO

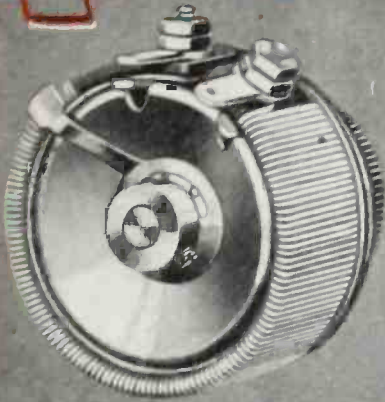

**FROST-RADIO** Type 700 Metal Frame Rheostats - Price 50c



**FROST-RADIO** Type 800 Bakelite Rheostats - Price 75c

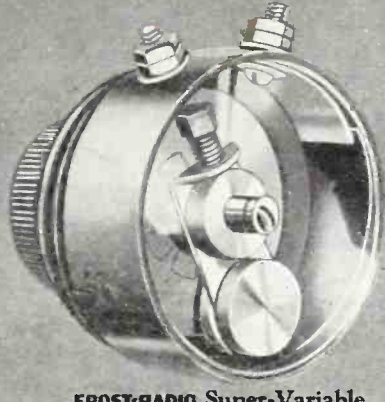

**FROST-RADIO** Super-Variable Resistance Units - \$1.25



**FROST-RADIO** No. 540 Bakelite Adapter, 25c

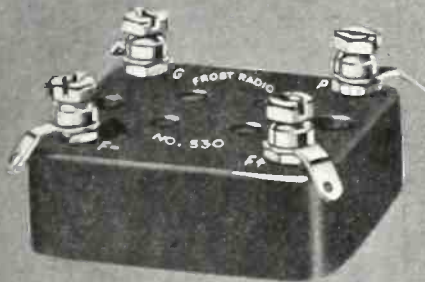

**FROST-RADIO** No. 530 Bakelite Socket - Price 40c



**FROST-RADIO** No. 611 Bakelite Adapter - 60c



**FROST-RADIO** Gem-Jacs 4 Types - 40c to 50c



**FROST-RADIO** Pan-Tab Jacks, 9 Types - 65c to 90c



**FROST-RADIO** Standard Jacks, 8 Types - 45c to 70c



**FROST-RADIO** No. 141 2-Fone Automatic Plug - 75c



**FROST-RADIO** No. 140 2-Fone Plug - 60c



**FROST-RADIO** No. 143 2-Fone Automatic Plug - 50c



**FROST-RADIO** No. 800 Ground Clamp - 30c



**FROST-RADIO** No. 253 Automatic Cord Tip Jack - Pair 30c



**FROST-RADIO** No. 250 Loop Plug and Jack - \$1.50



**FROST-RADIO** No. 622 Bakelite Toggle Switch - 50c



**FROST-RADIO** No. 608 Push-Pull Battery Switch, 30c

**HERBERT H. FROST, Inc.**

160 North La Salle Street

CHICAGO

New York

Los Angeles

Tell them that you saw it in RADIO



# SM



220 Audio Transformer - \$6.00  
221 Output Transformer - \$6.00

# Build Your

**A**RE you one of those who will realize all that the Infradyne is, just what it will do, when you sit down to tune it for the first time—and bring in stations you never heard before, with surprising selectivity, and tone beyond belief? Then you'll want to build YOUR Infradyne right.

Do you know that E. M. Sargent, inventor of the Infradyne, after months of experiment proved conclusively that S-M audio transformers were the finest available; specified them exclusively for the Infradyne in preference to all others? Do you know that one of the largest phonograph record manufacturers, after years of research, standardized upon S-M transformers for record reproducing equipment—that RADIO NEWS magazine selected S-M audio and power transformers for the new batteryless receiver, as did Gerald M. Best for his A.C. operated Browning-Drake?

Facts like these, coupled with the recommendation of every leading authority and magazine, are what assure you that you can't buy better transformers than S-M 220s and 221s. They account for S-M transformers, backed by a satisfaction-or-money-back guarantee, out-selling practically all other makes.

For over a year S-M plug-in inductances have been standard specified parts for nearly every important receiver design. Best has specified them for different receivers,



650-C Plug-In "B," complete, ready to operate, \$33.50, less CX-313 tube.  
650-D Plug-In "B," same as 650-C except unwired, for CX-313 or Raytheon, \$29.00, less tube.



# Infradyne Right!

RADIO BROADCAST sent them to South America with the Dyott expedition, the Silver-Cockaday receiver was built around them. In England they set a new standard of coil design, and have been copied by every important English coil manufacturer.

Why? Simply because S-M plug-in coils are the simplest and best inductances available. Do you know that the production uniformity of broadcast range types is less than a quarter of one per cent—that they will not vary with the years—that their resistance is surprisingly low—that you can obtain them in ranges to cover from 18 to 1500 meters, each type interchangeable in a standard socket?

E. M. Sargent knew all this, which is why he finally ended his experiments by selecting an S-M 110-B coil with a 515 coil socket for the Infradyne. That's why you'll do so too if you want to get the same results that the inventor obtains with his OWN Infradyne.

If you want to operate a six to ten tube set, you need a powerful "B" eliminator capable of furnishing far more power than ordinary receivers need. Do you know that an S-M 650-C or 650-D Plug-In "B" supply will furnish 60 milliamperes at 180 volts—much more than any other standard type? Do you know that the filtration of an S-M Plug-In "B" is just one and one-half to two times as good as that of ordinary types, because a selective filter is used, as well as the usual brute-force type? That's why Lawrence Cockaday chose the parts that make up an S-M Plug-In "B" for his LC-27 Junior Power Pack, why Best and RADIO NEWS did the same for their A.C. operated receivers. You, too, cannot make a mistake in buying a 650 Plug-In "B" for your set.

## Do You Know the Secret of Quality Reproduction?

Have you your copy of "The Secret of Quality?" This book tells you simply and concisely how to get the most out of your audio amplifier—how to get real quality. It contains laboratory data never before available even to many manufacturers. It is the only authoritative treatise on all types of audio amplification written in non-technical language ever published. It's free! Ask your dealer for a copy.

Prices 10% higher west of the Rockies

**SILVER-MARSHALL, Inc.**

852 WEST JACKSON BLVD., CHICAGO, U. S. A.



Interchangeable Coils, made in various types and ranges, \$2.50 to \$3.25 each  
Uniformly Interchangeable Coil Socket, \$1.00

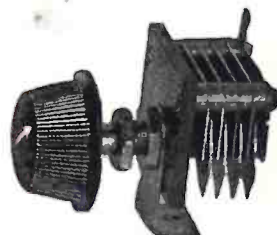

340 Compensating Condenser, \$1.50





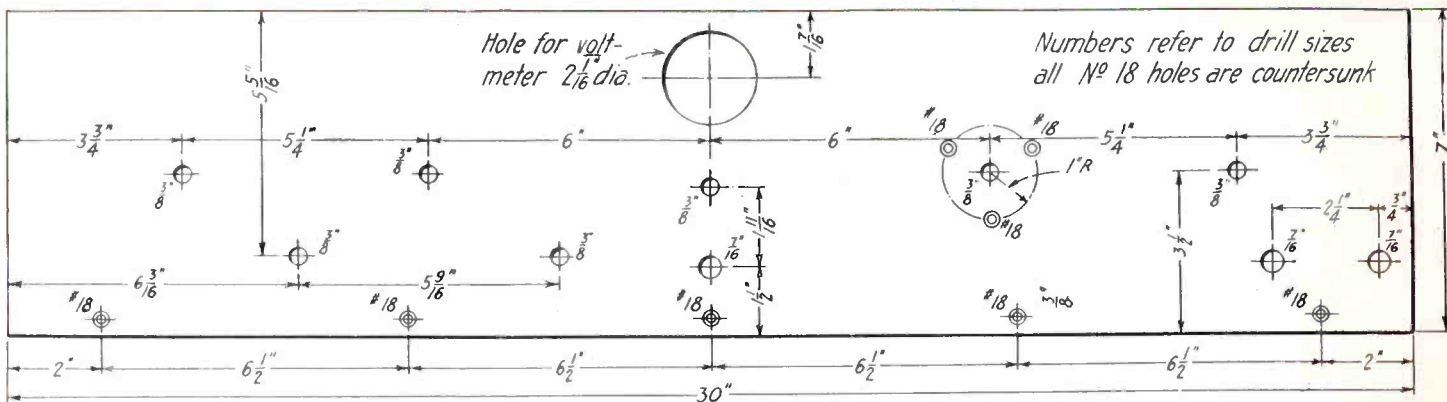

## DRILLED---ENGRAVED and FINISHED BAKELITE PANELS FOR THE NEW **INFRADYNE**

**\$8<sup>00</sup>**

The NEW PANEL for the NEW Improved Sargent-Rayment Infradyne, with holes drilled exactly as specified for the trimmer condensers and countersunk holes for mounting either the Cardwell or Hammarlund three-gang condenser. You can use either condenser with this panel because BOTH are drilled for you. The new panel is laid out and engraved just as Sargent and Rayment have described it. All of the engraving is beautifully carried out in either white or red—as you prefer. All holes are countersunk, where needed, and there are no rough edges. It is a FINISHED product—the highest type of panel workmanship you have ever seen. We specialize in INFRADYNE Panels and we also manufacture panels for the Infradyne adaptor. Genuine Black or Walnut Bakelite panels are optional—at the same price. We sell these panels retail and wholesale. Your remittance by mail will bring the panel to you at once. We have a substantial stock of panels on hand—ready for delivery to dealers and jobbers. We offer regular discounts to the trade. Wire your order for quick delivery. We guarantee these panels to be the finest you can buy for the INFRADYNE. We are selling hundreds of them.

### BASEBOARDS

Our Egyptian Lacquered Poplar Baseboard with tongue and groove end pieces is cut to exact size as specified for the INFRADYNE. A beautiful job. Makes your set look like a real factory product. Price, each, \$2.85.

### METERS

We carry the Jewell 0-5 Voltmeters for the INFRADYNE. This meter is the accepted standard and is specified by Sargent and Rayment. It can be easily mounted to the panel. We make immediate delivery. Price, each, \$7.50.

### BINDING POST STRIPS

Two sets of binding post strips for the Infradyne, as shown in the story by Sargent-Rayment. Genuine Eby posts used and marked exactly as specified. Mounted on genuine Bakelite strips with mounting screws and supports. The complete set of these mounting strips sells for \$2.25.

Order one each of the items listed on this page for the Infradyne and we will ship the complete assembly to you postpaid. We firmly pack this material for shipment to any part of the U. S. or Canada and we guarantee it to reach you in perfect condition. All merchandise is sold on a positive money-back guarantee if you are not convinced that our merchandise is what we claim for it.

### "SOLDERDIPT" LUGS

Heintz and Kohlmoos are the manufacturers of the now famous "Solderdript" lugs. What a convenience they are in building your set, and they will save you time and worry. They are dipped in solder and make a firm, positive connection to the wiring. These lugs are put up in attractive packages of 50 lugs and sell for 25 cents each. Large display cards for dealers, carrying a dozen packages of lugs, will help you sell these better lugs to radio constructors. A package of these lugs will be shipped to you by mail upon receipt of 25 cents.

### Jobbers and Dealers

Carry our Panels, Baseboards, Infradyne Binding Posts and Strips and Solderdript Lugs. Our national advertising campaign is creating a heavy demand for our products. We will ship COD for inspection if half cash accompanies order.

HEIKOH PRODUCTS  
**HEINTZ AND KOHLMOOS**  
• SCIENTIFIC INC. APPARATUS •  
219-221-223 Natoma Street San Francisco California

MANUFACTURERS FOR MANUFACTURERS



# CAMFIELD DUOFORMERS

*Are Now*  
SPECIFIED EXCLUSIVELY  
*By SARGENT For*  
THE INFRA-DYNE

**PRICE**

**\$10.00**

**At Your Dealers  
or Direct  
From Us**



**DUOFORMERS**  
Are the Best  
Transformers  
Obtainable  
for Tuned  
R. F. Circuits  
Send 10c  
for  
Instruction Book

**IMPROVE YOUR INFRA-DYNE**  
*By Replacing The Radio Frequency Coils*  
**WITH**  
**CAMFIELD DUOFORMERS**

---

**CAMFIELD RADIO MFG. CO.**

**57 EAST WACKER DRIVE**

**NEW YORK**

**CHICAGO**

**SAN FRANCISCO**

Tell them that you saw it in RADIO



**Selected  
for the  
Infradyne**



*Approved by the designers  
of the Infradyne because it's*

## Metallized!

**T**HE Durham Metallized Resistor is a laboratory perfected grid-resistor developed by two scientists of a leading university.

A tiny glass wire is passed through an ingenious, chemical and high-temperature process, forming a thin conducting layer of high resistance. The Metallized unit is next treated with a protective insulating material, rendering it impervious to atmospheric conditions. It is then mounted in a glass tube and soldered to terminal, brass caps.

*Specified in*

**"Diamond of the Air"**

10 megohms to 500 ohms, from  
50 cts. to \$1.00

**DURHAM**  
METALLIZED  
**RESISTORS**

**International Resistance Co.**  
Perry Bldg., Philadelphia, Pa.

## NOTICE

### Of New Distribution For Infradyne Blue Prints

Effective November 20th, 1926, the Official Infradyne Blue-prints will be exclusively distributed to the trade East of the Rockies by the Herbert H. Frost organization. Distribution to radio dealers will be made from any of the Frost offices listed below. Delivery will be made on and after November 26th. Stocks of blue-prints will be carried at each Frost office. Radio dealers are invited to write now for trade prices. The new blueprints have been prepared by L. C. Rayment and have been revised and corrected as of November 20th. There will be no changes in the blueprints for at least six months, thus affording full protection to the dealer and set builder.

#### Herbert H. Frost, Inc.

160 North La Salle St., Chicago, Ill.

#### P. A. KILEY

30 Church St., New York, N. Y.

#### B. B. DOWNS & SON

2360 University Ave.  
St. Paul, Minn.

#### M. A. WETMORE

1324 Hibernian Bank Bldg.  
New Orleans, La.

#### H. B. PARK

305 Seventh Ave., Pittsburg, Pa.

#### CAMPBELL & KNIBB

Colorado Bldg., Room 520  
Washington, D. C.

#### EAMES CORPORATION

10 High St., Boston, Mass.

#### S. J. HUTCHINSON JR.

Bourse Bldg., Philadelphia, Pa.

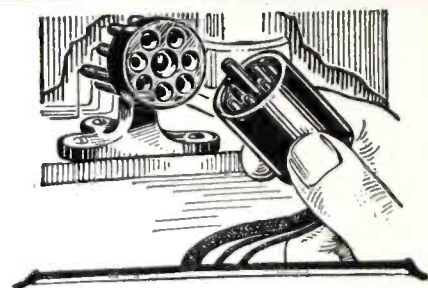

## There Is One Best Way!

#### The Standard Set Connector

Today the discriminate buyer chooses his set MULTI-PLUG equipped. The careful set builder much prefers the MULTI-PLUG instead of a series of seven binding posts. Why? Because the Jones MULTI-PLUG affords greater simplicity, safety and more convenience than any other method used to connect the radio receiver with the current supply.

#### Type B. M.

As illustrated, Type B-M. has its socket mounted in the base of the set and the wires soldered to the terminals. The Jones MULTI-PLUG'S 4-foot cable leads to the batteries, ground and aerial. Price, \$3.50.

#### Type W. B.—Radio Wall Socket

Now the unsightly batteries, ground and aerial wires can be hidden from view down in the basement or in an adjoining room or closet, through the use of the Type W. B. Jones MULTI-PLUG—the Radio Wall Socket. Plug your set right into the Standard Wall Box, easy to install. Four-foot cable. Price, \$3.50. Write for full particulars to

#### HOWARD B. JONES

618 S. Canal Street, Chicago, Illinois

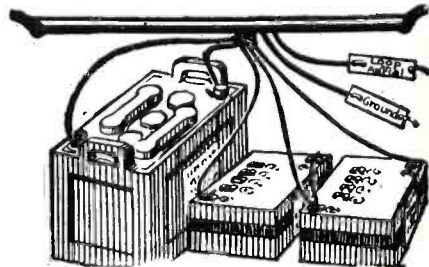

**Jones  
MULTI-PLUG**  
THE STANDARD SET CONNECTOR

(Trade Mark Registered U. S. Patent Office)

## LAST MINUTE BLUE PRINTS INFRADYNE

The new full-size blueprints for the very latest improved 1927 model Sargent-Rayment Infradyne have been revised and corrected as of November 20th. Mr. Sargent has made these blueprints. A complete instruction booklet for building the new model goes with each set of prints.

**\$1.00**

These prints, packed with instruction book, sell complete for one dollar. You can't go wrong if you use the OFFICIAL blueprints and instructions. Mail orders filled immediately. Jobbers and dealers are invited to write for trade prices. Telegraph your orders to us for prompt delivery.

**L. C. RAYMENT - 1200 Franklin St., Oakland, Cal.**



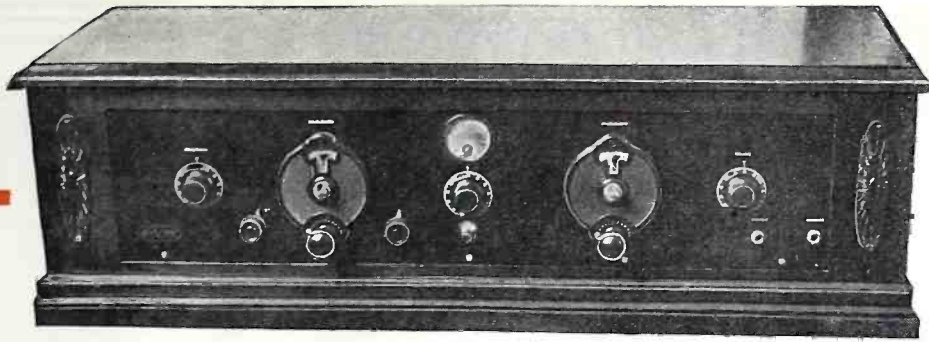

# A STATEMENT FROM THE INVENTORS

**T**HE Infradyne circuit, as originated by us, was first described in August, 1926, "RADIO." While we have no connection with this magazine, Mr. Sargent has agreed to write exclusively for it under his own name concerning the circuit. Otherwise our co-operation is freely given to anyone interested in its development and sale. We alone are responsible for the selection of the parts recommended for use in building sets which incorporate the Infradyne principle. This recommendation is based upon our personal experience and will be adhered to without change for at least six months. Consequently the parts specified herewith may be safely used in building the set. As the art progresses there may be new recommendations of parts perhaps better adapted to the peculiar needs of this circuit.

(Signed) E. M. SARGENT,  
L. C. RAYMENT.

## HERE IS THE LIST OF SPECIFIED PARTS

- |  |                                      |  |
|--|--------------------------------------|--|
| 1 Remler Infradyne Amplifier                           | 2 National Type B, CCW Dials         | 1 Durham Grid Leak Mounting                |
| 1 Carlwell 317CL Triple Condenser                      | 1 Frost 30 ohm Baseboard Rheostat    | 1 Yaxley Filament Switch                   |
| 1 Remler No. 638, .00035 Condenser                     | 1 Frost 30 ohm Panel Mount Rheostat  | 1 Tobe .0001 Fixed Condenser               |
| 3 Silver-Marshall Vernier Condensers, No. 340          | 1 Frost Single Closed Jack           | 1 Tobe .00025 Fixed Condenser              |
| 1 Silver-Marshall 110-B Inductance Coil                | 1 Frost Single Open Jack             | 2 Tobe .0005 Fixed Condensers              |
| 2 Silver-Marshall 220 Audio Transformers               | 3 Kurz-Kasch 2-in. Dials             | 2 Tobe 1 mfd. Fixed Condensers             |
| 1 Frost No. 886, 50,000 ohm Variable Resistance        | 7 Benjamin UX Type Cushion Sockets   | 9 Eby Binding Posts or                     |
| 1 Centralab 200,000 ohm Variable Resistance (or Frost) | 1 Amperite, No. 112                  | 1 Jones Plug and Cable                     |
| 1 Set (3) Camfield Duoformers                          | 1 Amperite, No. 1A                   | 1 Panel, 3/16x7x30                         |
|  | 1 Jewell Voltmeter, Pattern 135, 0-5 | 1 Baseboard, 3/4x10x34                     |
|  | 1 Durham 1 meg. Grid Leak            | 1 Corbett Cabinet                          |
|  | 1 Durham 2 meg. Grid Leak            | 1 Set Official Blueprints by L. C. Rayment |

# INFRA+DYNE

E. M. SARGENT and L. C. RAYMENT, 1200 FRANKLIN ST., Oakland, Calif.

Tell them that you saw it in RADIO





# CONDENSERS

## B-Blocks BH-Blocks

Vacuum Tipon Leaks  
Veritas Resistors

are used in the

## INFRADYNE

HENRY LYFORD RECEIVER  
LC 27

AMERTRAN POWER-PACK  
RAYTHEON PLATE-SUPPLY UNIT  
RAYTHEON BH A.B.C. SUPPLY

### ELECTROLYTIC RECTIFIER FILTER CIRCUITS

BECAUSE

The name TOBE and the name QUALITY  
go hand in hand.

#### THE TOBE BH BLOCK

This new Filter Condenser BLOCK, for use with the Raytheon BH 80-mil Tube, contains one 6 and two 4 Mfd. TOBE Filter Condensers. It is especially designed for use with the BH Raytheon ABC circuit, and is cased in the same fine silvered finish metal case, with terminals at base of block, as is found with the other TOBE B BLOCKS.

PRICE, \$11.00



#### THE TOBE B BLOCKS

The quality of the TOBE B BLOCKS is immediately apparent on sight. The perfection and beauty of their finish is simply a reflection of what is packed inside. The first B BLOCK for B-Eliminator filters,—and still in the lead.

Send for Price List 12-R

### TOBE DEUTSCHMANN CO.

Engineers and Manufacturers of Technical Apparatus  
CAMBRIDGE, MASS.

## LAST MINUTE BLUE PRINTS I N F R A D Y N E

The new full-size blueprints for the very latest improved 1927 model Sargent-Rayment Infradyne have been revised and corrected as of November 20th. Mr. Sargent has made these blueprints. A complete instruction booklet for building the new model goes with each set of prints.

**\$1.00**

These prints, packed with instruction book, sell complete for one dollar. You can't go wrong if you use the OFFICIAL blueprints and instructions. Mail orders filled immediately. Jobbers and dealers are invited to write for trade prices. Telegraph your orders to us for prompt delivery.

L. C. RAYMENT - 1200 Franklin St., Oakland, Cal.



### The New Hammarlund IMPROVED "SFL" Condenser

is specified by  
**E. M. SARGENT**  
for his new

### "INFRADYNE" Receiver

IT IS convincing testimony of Hammarlund quality when so many designers of construction kits specify Hammarlund Products. They cannot afford to endanger either their own standing or the successful operation of their receivers by including any but material of the highest possible efficiency.

The Hammarlund .000375 improved "SFL" triple condenser specified by Sargent is accurately matched and of standard Hammarlund construction, similar in every respect to the single "SFL" condenser pictured above. Soldered, non-corrosive brass plates with tie-bars; rib reinforced aluminum alloy frame; one small strip of bakelite dielectric for each unit; one-hole mounting with anchoring screw; bronze clock-spring pigtail; friction band brake. Your dealer sells the Hammarlund triple "SFL" condenser for \$12.00.

*Among the other new kits of this season for which Hammarlund Precision Products are specified are: Cockaday's "LC-27"; Lacault's "LR4"; St. James Super; the New Harkness; "Henry-Lyford"; Morrison's "Varion"; Victoreen Super-heterodyne; Loftin & White; Paent "Ultimas"; Browning-Drake; Popular Science Monthly "Powerful"; Hammarlund-Roberis "Hi-Q."*

**HAMMARLUND MFG. CO.**  
424-438 West 33d St., New York City

For Better Radio  
**Hammarlund**  
PRECISION  
PRODUCTS



Contrast the clumsy dials of only two years back... with the handsome illuminated controls MAR-CO makes today. Here is another good reason for building your set yourself!



## Now dials give place to glowing spots of light

PICTURE a soft, subdued light in the room . . .

- ✓ ✓ ✓ your set in the corner with glowing spots of light illuminating its swiftly readable *back panel* scales.
- ✓ ✓ ✓ this is radio at its handsomest . . .
- ✓ ✓ ✓ this is the panel arrangement the type of skillful tuning that distinguishes the 1927 trend in set construction.

Already, these new MAR-CO controls are specified or optional equipment in a score of this season's most advanced circuits. At once, they have become the standard in tuning control design. Use them, in whatever set you build, to give the final touch of style, and the utmost in precision control.

MAR-CO controls are easy to install. The steel template pro-

vided reduces panel-drilling to the simple, fool-proof operation illustrated below. The original MAR-CO "friction-drive"—the action that makes backlash impossible—has been strengthened, to accommodate gang condensers. The MAZDA lamp supplied runs on your "A" battery, using only .1 ampere. The switch that controls this lamp may also be used as your filament switch, the lighted scales then serve as pilots. Scales read 0 to 100, or 100 to 0, as preferred. Price, including template, bulb, and bezel, \$3.50. Replacement bulbs, \$20. Write today for the booklet that illustrates 15 standard makes of condensers mounted on MAR-CO back-panel controls. Martin-Copeland Company, Providence, R. I. Branch offices and representatives in principal cities.

Prominent among the advanced circuit designs which call for MAR-CO controls, is the

[ Infra-Dyne ]

## MAR-CO Illuminated Controls

Here's how you drill the panel..



Screw Template to panel



Drill holes through Template

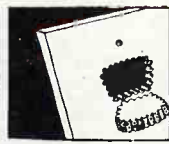

Remove window opening

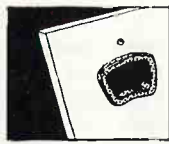

Bezel covers rough edge

that's ALL you CAN'T go wrong!



# EBY SHIELDED DIAL

FOR ANY TYPE CONDENSER

*Turns Clockwise and Counter-Clockwise*



A complete metallic shield torus the back of this new dial and minimizes the effect of body capacity. When the hand is removed the set stays tuned to the station coming in when your hand was on the dial.

Price  
\$2.50



Completely shielded by its metallic back, this dial minimizes the effect of body capacity and improves the appearance and performance of any set. Sensitive and finely constructed, it makes accurate tuning possible and keeps the instruments set even after your hand is removed from the dial.

The Eby Shielded Dial operates any type condenser, whether it turns clockwise or counter-clockwise. Graduated from 0 to 100 and from 100 to 0 with a hairline indicator and beautifully moulded black Bakelite housing.

No gears or washers to wear out. Smooth, noiseless, sensitive action obtained by an anti-backlash friction drive and non-microphonic construction. One hole mounting.

Eby Products are recommended and specified in the Infradyne, Hammarlund-Roberts, Cockaday, L. C. 27, Browning-Drake, Victoreen, Madison-Moore, Lynch and Varion Power Units and other popular circuits.

THE H. H. EBY MANUFACTURING CO.

4710 STENTON AVENUE

PHILADELPHIA, PA.

Manufacturers of Eby Binding Posts and Eby Sockets



## The Infradyne Owner Needs This---

A complete listing of all U. S. and Canadian broadcast stations, showing their wavelengths (meters and kilocycles), as well as their operating hours, distances from San Francisco, Los Angeles and other points, alphabetical listing of stations, listing of stations by call letters and a wealth of valuable data for every DX fan. There is a 64-page schedule and program magazine published in San Francisco every week—giving you the most complete and reliable schedules in print. It is known as "BROADCAST WEEKLY." 45,000 copies are in weekly use. It has been published for five years. It sells for only ten cents a copy and it will be sent to your home every week for a full year for only three dollars. The schedules are positively corrected and checked every week. Just keep this book in front of you when you tune-in stations and once you have used it you will find that you can hardly afford to be without it. A sample copy will be sent to you upon receipt of a dime in coin or we will enter your subscription for one year at \$3.00 on a money-back basis, refunding to you the full amount of your subscription if you do not believe that you have received double value for your money. Use the coupon.

### ---COUPON---

"BROADCAST WEEKLY,"  
426 Pacific Building,  
San Francisco, Calif.

Here is \$3.00 for a full year's subscription to "BROADCAST WEEKLY," as advertised in "RADIO."

Name.....

Address.....

City and State.....

# NOW! READY!

## FULL SIZE BLUE PRINTS INFRADYNE

It's surprising how easy it is to build the Infradyne from the full-size Official blueprints and instruction book compiled by the inventors themselves. These new blueprints, corrected as of November 20th, are ready for immediate distribution. Send one dollar for your set of blueprints. Immediate delivery assured. Start making your Infradyne while DX reception is at its best. You can't go wrong if you follow the OFFICIAL instructions.

**100**  
By Mail  
Postpaid

Jobbers and  
Dealers  
Write or Write  
for  
Territory

**L. C. RAYMENT**  
1200 Franklin Street, Oakland, Calif.





# For the New INFRA-DYNE

—builders and set owners will find the Jewell pattern No. 135 panel mounting voltmeter illustrated ideal for checking the voltage of tube filaments.

By its use complete control of the filaments—which really means control of filament emission, a very important factor in radio reception—can be had.

Tubes burned low give reduced reception. Tubes burned high produce distortion and overloading, with correspondingly shortened tube life.

There is a great deal of satisfaction in knowing that your set is functioning properly.

Our catalog—No. 15-C—showing our complete line of radio instruments will be gladly forwarded on request.

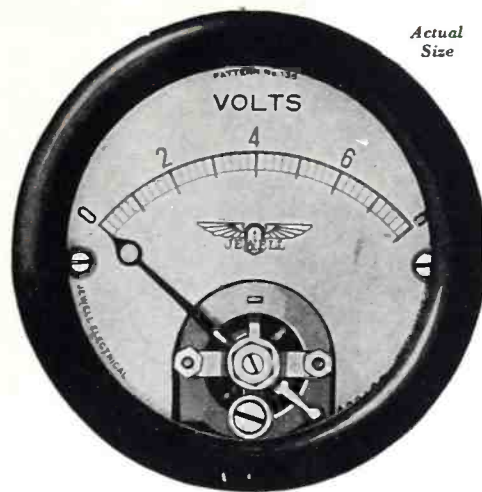

*Pattern No. 135 Voltmeter,—*

—recommended for the Infradyne set, is a 2-inch round instrument operating on the D'Arsonval principle and requiring such a small amount of current to operate that its continuous operation will effect no appreciable draw on the A-Battery. Its movement parts are all silvered and it is provided with a zero adjuster. The scale is silvered with black characters and the case is black enameled.

It is obtainable in the following ranges, of which the 0-5 volt has been specified for the Infradyne.

0-5, 0-8, or 0-10 Volts.  
0-10, 15, 25, 50 or 100 Milliamperes.

[ **Quality Instruments** ]

## JEWELL ELECTRICAL INSTRUMENT CO.

1650 WALNUT STREET, CHICAGO

*“26 Years Making Good Instruments”*



# This Manual Tells You How To Build the



*It is E. M. Sargent's  
Official Guide to better  
radio reception—*



**H**ERE it is—E. M. Sargent's own Manual for Building, Operating, Testing and Wiring the wonderful Infradyne. It shows you how the new Sargent-Rayment Infradyne will give hair-breadth selectivity. How it will enable you to hear stations you never heard before. How it will give you clearer, louder and better signals from stations thousands of miles distant. How it will enable you to get stations on one point of the oscillator dial. How it will give you tone quality such as you have long waited for. The Infradyne is not an experiment. It has proved itself to be the outstanding development in many years of radio. Thousands are already in use. Testimonials from wildly enthusiastic owners tell of almost unbelievable results. Australia has been heard by an Infradyne owner on the Pacific Coast. Los Angeles was heard in New York—with loud speaker volume. Consistent, dependable results are yours when you use the up-to-date circuit—the Infradyne. Sargent's Official Infradyne Manual sells for only 25 cents per copy. You should know the Infradyne. The Manual tells you all about it.

## Twenty-Five Cents, Postpaid

*Send a quarter in coin, along with the coupon. Your Manual will go forward to you on the day your order is received. We pay the forwarding charges.*

Published by the  
**Publishers of "RADIO"**  
Pacific Bldg., San Francisco

Northern California dealers can secure copies from the UNITED RADIO SUPPLIES Co., 693 Mission St., San Francisco, California.

"RADIO,"  
PACIFIC BUILDING,  
SAN FRANCISCO, CALIF.

Send me Sargent's Official Infradyne Manual by return mail. I enclose a quarter in coin.

Name .....

Address .....

**Jobbers and Dealers are invited to write for trade proposition. Every radio dealer should have this manual to know what the Infradyne is and does.**



# \$118.00 for all of the parts needed for THE INFRADYNE

Here Are the Official Parts Which We Sell:

- 1 Remler Infradyne Amplifier
- 1 Cardwell three-gang condenser
- 3 General Radio 218-a Midgets
- 1 Remler .00035 condenser
- 1 Frost No. 886 Resistance, 50,000 ohms
- 1 Tapped inductance
- 1 30 ohm baseboard rheostat
- 1 Set, 3, Thorola Doughnuts
- 2 National Dials, Type B, CCW
- 7 Benjamin UX base sockets
- 1 112 amperite
- 1 No. 1 amperite
- 1 30 ohm panel rheostat
- 1 Centralab 200,000 ohm resistance
- 3 2-inch dials
- 1 Filament switch, Electrad
- 1 Single closed jack, Electrad
- 1 Single open jack, Electrad
- 1 Jewell Pat. 135 voltmeter
- 1 Electrad grid leak mount
- 1 1 meg. Electrad grid leak
- 1 2 meg. Electrad grid leak
- 1 .0001 Fixed condenser, Electrad
- 1 .00025 Fixed condenser, Sangamo
- 2 .0005 Fixed condensers, Electrad
- 2 AmerTran audio transformers
- 2 1 mfd. Electrad condensers
- 2 Binding post strips with Eby Posts
- 1 Bakelite Panel, drilled and engraved, 3/16" thick
- 1 Baseboard, Poplar, Egyptian lacquered

All of Above, \$118.00

LET us simplify your problem of purchasing specified parts for the Infradyne. Order everything from us. For the past three months we have been supplying the wants of the Infradyne builder. We have shipped our merchandise to widely scattered parts of the U. S. and Canada. We give you prompt service—the kind you are entitled to. Sargent and Rayment specify a list of parts made by reputable manufacturers of high-quality merchandise. To get the most out of your Infradyne you need GOOD PARTS. We have assembled all of these SPECIFIED parts for you in one box—ready for shipment. Complete instructions for building the Infradyne go with each set of parts.

When ordering, please address your inquiries to Department M. Telegraph orders filled if half cash goes with wire. Balance C.O.D. We ship prepaid if the complete set of parts is purchased from us.

We Test, Repair Service and Guarantee Infradynes  
SUCCESS ASSURED

International Radio Sales Co.  
5441 California Street  
San Francisco California  
Dept. M



Aristocrat  
E-Z TOON  
Vernier Pointer



## The NEW "Aristocrat" Vernier Port Dial

THE new, improved Aristocrat Vernier Port Dial is the greatest dial value on the market. Despite its many outstanding advantages, the Aristocrat costs no more than ordinary vernier dials.

If you want the finest-looking, finest-tuning vernier dial, be sure you get the Aristocrat. Made of Bakelite. All mechanism and shaft ends are concealed. Calibrations appear in a beveled port with a peaked indicator that makes misreading impossible.

Simple friction action is smooth, sure and quick. No gears, chains or cogs to backlash, wear out or get out of order. It may be installed in a few minutes. The famous Kurz-Kasch Split Bushing fits all condenser shafts—aligns rite, holds tite!

You'll be surprised at the difference a set of Aristocrat Vernier Port Dials will make. In appearance your radio will look better than the season's prettiest models. And, due to the fine, 14 to 1 vernier ratio, you'll enjoy better and clearer tones, more volume, and countless stations you've never before logged.

The Aristocrat Vernier Port Dial is supplied in three attractive finishes to match any radio—black with white markings, mahogany and walnut with gold markings. The price is \$2 each—in the finish you prefer. With a complete set of three Aristocrats, we are making a special limited offer. We are giving away the beautiful, 48-page, authentic Log Book illustrated here. You'll appreciate this gift when you see it. Ask the better radio dealer near you to show it to you.



This marvelous, recently compiled, 48-page Log Book (worth \$1) is given FREE with every set of three Aristocrat Vernier Port Dials. Bound in beautiful, two-tone, Mocotan Leather with embossed cover. Lists every United States and Canadian Radiocast Station of record June 1st, using power of 250 watts or more. Indexed by call letters, wavelengths and location. Also includes the principal foreign stations. Ask your dealer to show you a copy.



THE KURZ-KASCH COMPANY, DAYTON, OHIO  
Moulders of Plastics

OFFICES: New York, Chicago, San Francisco, Los Angeles, Portland, Spokane, Denver, Toronto

# KURZ KASCH

## Aristocrat Dials and Knobs



# Leadership

with Benjamin Radio Products  
in Securing the Best Radio Results



All Benjamin Radio Products are of the same high standard as the far-famed Cle-Ra-Tone Sockets

You will find that almost every good radio set in the neighborhood has some or all Benjamin Radio Products in it. Radio experts and set makers have proved through long experience that only radio parts conscientiously and painfully made to improve delicate tonal quality, selectivity and volume can bring a leadership in securing the best radio results.

If you would have your set just as good or better than your neighbor's make sure that every component part is reliable and bears the trade mark of a manufacturer in whom you can place your full confidence. The world-wide recommendation of Benjamin Radio Products by radio authorities is the best testimonial for their scientific accuracy and uniformity in securing the best radio results.

### Rewards for Radio Reasoners

Awards for novel and original hook-ups, modifications of existing circuits, trade names; slogans; write our nearest office for full details.

If your dealer cannot furnish you with Benjamin Radio Products send amount direct to our nearest sales office with his name and we will see that you are promptly supplied.

### Benjamin Electric Mfg. Co.

120-128 S. Sangamon St.  
Chicago

New York: 247 W. 17th St.  
San Francisco: 448 Bryant St.

Manufactured in Canada by the Benjamin Electric Mfg. Co. of Canada, Ltd., Toronto, Ontario

### Improved Tuned Radio Frequency Transformers



Space wound; basket weave; cylindrical; highest practical air dielectric. Proved to give the best results in sharpness of tuning, increase in volume and improvement in quality. Authoritative laboratory tests and practical experience of manufacturers and amateurs shows that this type of coil excels in every important characteristic.

#### 2 1/4-inch Diameter Transformer

Compact. Especially desirable for powdered assembly. Eliminates interfering "pick-ups."

Set of Three, \$5.75  
Single Transformer, \$2.10

#### 3-inch Diameter Transformer

Capacity coupling reduced to lowest degree. For use with .0005 Mfd. Condensers.

Set of Three, \$6.00  
Single Transformer, \$2.25

#### "Leakless" Transformers



Uniform high inductance, low distributed capacity and low resistance. The external field is so slight that it permits placing coils close together without appreciable interaction.

Single Transformer, \$2.50

### Cle-Ra-Tone Spring Supported—Shock-Absorbing Sockets



Spring Supported, Shock-Absorbing. Stop Tube Noises. The greatest aid to non-noisy operation. Contacts always clean.

75 cents each

### Straight Line Frequency Condensers



Eliminates bunching of stations. Spreads the log evenly over the dial. Makes tuning easy. Adjustable turning tension. Compact. A beautiful instrument that not only improves reception, but adds to the good appearance of the set.

.00025 Mfd., \$5.00  
.0005 Mfd., \$5.50  
.00035 Mfd., \$5.25



#### Brackets

An aid to simplification in set construction. Supports the sub-panel, with room underneath for accessories and wiring.

Plain—70c pair. Adjustable—\$1.25 pair

#### Battery Switch

Quick, positive, clean-cut make and break. When it's "in" it's "off", eliminating danger of wasteful use of battery.



30 cents each





"The striking beauty of the exterior of this cabinet will reflect the quality of the receiver it houses."

# GLORIFY YOUR



**E**XQUISITE Beauty. An appropriate "dress" for your splendid Infradyne Receiver. Do justice to your set by housing it in a CORBETT cabinet—specially designed and built for the Sargent-Rayment Infradyne. The illustration fails to justify it. The workmanship is of the usual Corbett quality. We specialize in building radio cabinets. The Corbett Infradyne Cabinet will accommodate a 7x30-inch panel. The cabinet is 10 inches deep. Built of Walnut, beautifully finished. The lid is equipped with a continuous hinge. The cabinet is correctly moulded and decorated. Hand-rubbed duo-tone piano finish.

Each cabinet is securely packed and crated for shipment. Mail orders for these cabinets will receive prompt attention. Write for folders showing our complete line of radio furniture.

#### PRICES:

Walnut Cabinet for Infradyne, 7x30-inch panel space, 10 inches deep	\$30.00
Corbett Walnut Plywood Panel to match	2.10
Splined and Varnished Mounting Board, 10x34 inches	2.00
Walnut Table to match, and for above cabinet with 14-inch high battery compartment	36.00

### JOBBERS and DEALERS:

Corbett supplies your radio furniture wants. Your customers are asking for Infradyne cabinets. Get our circulars and trade proposition at once. The demand for Infradyne cabinets is steadily increasing. Order now. Full details by wire upon request. Orders should be sent early for the Xmas demand.

### OTHER CABINETS

We also manufacture a complete line of cabinets for popular sets. Our Model "C" is a headliner. It is an adaptation of the Italian Chest of the Renaissance period. 7x24 inches Model "C" will fit the Bremer-Tully or Diamond of the Air sets described in this issue of "RADIO." Price, \$19.00.

**CORBETT'S**  
♦ RADIO ♦  
**CABINETS**

**CORBETT CABINET MFG. CO.**  
ST. MARY'S PENNSYLVANIA

**CORBETT'S**  
♦ RADIO ♦  
**CABINETS**



# Cardwell Condensers



## "SPECIFIED FOR THE INFRADYNE"



### The Cardwell "BALANCET"

Type 609-A  
Cap.—.000033  
Price \$1.25

THE Sixth Christmas of the Cardwell Condenser finds its popularity undimmed, and during these years it is the only condenser whose basic design has not been radically changed.

During this period, editors and engineers have fallen into the habit, when quality is the only consideration, of invariably specifying "Cardwell".

Mr. E. M. Sargent has chosen the Type 317-C as the best condenser for the "INFRADYNE."

Another item of interest to builders of this excellent circuit is the Cardwell "BALANCET". A miniature condenser combining perfect "Low Loss" construction with extreme compactness, it is the finest "trimmer" obtainable at any price.

"THE STANDARD OF COMPARISON"

Write for 36-page illustrated booklet  
Allen D. Cardwell Mfg. Corporation  
81 Prospect Street, Brooklyn, N. Y.

Pacific Coast Agent, Baldwin Pacific Co., 640 Natoma St., San Francisco

# LOG 'EM--

You hear so many stations on your Infradyne that you will need a log book with many pages to keep an accurate record of the stations heard. The publishers of "RADIO" have prepared an inexpensive 8-page pamphlet for logging stations. It is just the thing for the Infradyne. You can use separate pages for local and DX listings and each column is so arranged as to give ample room for making notations, such as oscillator settings, etc. It's a mighty handy little pamphlet to keep in front of you at all times. LOG THE STATIONS AS YOU HEAR THEM and then you will have no difficulty in finding them later. The Log Book sells for ten cents. It will be mailed to you, postpaid, on the day your order is received. Stamps or coin accepted. Because only a limited number of these booklets have been printed, we will not be able to supply copies to dealers or jobbers.

The Coupon and  
10c Brings It to You

ENGRAVED and  
DRILLED

\$8.00  
Postpaid

Jobbers and Dealers stock our panels.  
Some territory is still open for reliable  
jobbers. Wire or write us.

## Infradyne Panels

We believe we have sold more Infradyne panels than all other panel manufacturers combined. "QUALITY" is the reason for this supremacy. Our panels are drilled exactly as specified by Sargent and Rayment. The engraving is also exactly as specified. Our beautiful 3/16" thick Bakelite Panels are the "dress for your set." Take no cheap substitute. Insist on Heintz and Kohlmoos Infradyne Panels. Look for the trademark.

Baseboards	- - - - -	\$2.85
Jewell Meters	- - - - -	7.50
Binding Post Strips, with all posts	- - - - -	2.25
"Solderdip" Lugs, pkg.	- - - - -	.25

**HEINTZ & KOHLMOOSES**  
219-221-223 Natoma Street, San Francisco, Calif.  
MANUFACTURERS FOR MANUFACTURERS

"RADIO,"

Pacific Building,  
San Francisco, Calif.

Here is 10c. Send me a copy of  
the RADIO LOG BOOK.

Name.....

Address.....

City and State.....



# Build It Now!

Get Going!!! Winter is here with its long distance opportunities. This is an excellent winter for long distance reception and the INFRADYNE will help you get the stations from those faraway points. We specialize on the INFRADYNE. We repair, test and service them. Ship us your set if you want it inspected and perfectly balanced. Write for our prices. We sell all parts for the Infradyne exactly as specified by Sargent-Rayment. Everything complete in one box shipped to you on same day your order reaches us for \$118.00. We sell Western Electric Loud Speakers (Cone) \$32.00. Accessories for any of the popular radio circuits shipped by mail. Send us a list of what you want, with 50% cash with order. Balance C.O.D. Inspect the merchandise before accepting it. We guarantee perfect satisfaction. Individual parts for the Infradyne in stock. Cardwell or Hammarlund three-gang condensers, General Radio, Silver-Marshall and Electrad parts. Wire your orders to us for fast delivery.

## MAIL ORDER SERVICE

Our service is gaining national recognition. "Ask Your Neighbor." We ship to any part of the U. S. or Canada. Get real service.

INFRADYNE BLUEPRINTS go with each set of Infradyne Parts sold by us. Infradyne Manuals - - - - - 25 cents each

International Radio Sales Co.  
Dept. M  
5441 California St.  
San Francisco, California



**Centralab Radiohm**



**HEAVY DUTY Centralab Radiohm**

Mr. L. S. Hillegas-Baird, 9HO, will cheerfully answer inquiries and supply circuits and descriptive literature.

## Non-Inductive Variable High Resistances

**C**ENTRALAB Radiohms with two terminals, and Modulators or Potentiometers with three terminals, provide gradual, noiseless control of oscillation or volume in any circuit. Specified for the Infradyne, S-C, Samson T-C, Henry Lyford, Universal, and many other circuits. Used as standard equipment on a large number of commercial receivers, and by both the U. S. Navy and Signal Corps.

There is a resistance and correct taper for every circuit. The No. 25 M or No. 51 M are ideal oscillation controls when shunted across the tickler coil of short wave receivers.

Bakelite base and knob. Single hole mounting. Resistance of Potentiometers, 400 or 2000 ohms. Modulators 500,000 ohms, Radiohms 2000, 25,000, 50,000, 100,000, 200,000, 500,000 ohms, \$2.00.

### Heavy-Duty Radiohm Gives Full Efficiency from "B" Eliminators

Centralab Heavy Duty Radiohms fully approved by the Raytheon Laboratories, will control the output voltage of "B" Battery Eliminators, resistance remaining permanent as adjusted and the same for any knob setting. Full resistance variation with a single turn of knob. Insulated for 1500 volts. Smooth and noiseless to outlast the eliminator, \$2.00

At your dealer's or mailed direct.

### CENTRAL RADIO LABORATORIES

14 KEEFE AVENUE MILWAUKEE, WIS.

Australian Representative  
United Distributors, Ltd., Sydney  
Canadian Representative  
Irving W. Levine, Montreal  
Great Britain Representative  
R. A. Rothermel, Ltd., London

Makers of variable resistances for 69 makers of leading standard sets.

# Centralab

## Your Christmas Gift--an INFRADYNE

**\$1.00**  
For Full Size Blue Prints---

—Mailed Postpaid—

E. M. Sargent and L. C. Rayment have just finished a complete revised set of full-size blueprints for building the new Infradyne--showing all of the very latest improvements. Large pictorial wiring diagrams, full-size baseboard layouts and a complete instruction book for constructing the set are made up in package form--selling complete for one dollar.

Retail orders filled on same day your order reaches us. Jobbers and dealers can be supplied from stock at once. **WRITE!**

**L. C. RAYMENT**  
1200 FRANKLIN ST., Oakland, Calif.

These new blueprints are revised as of Nov. 20, 1926. THE VERY LATEST.



“Every note –  
high and low –  
perfectly clear”

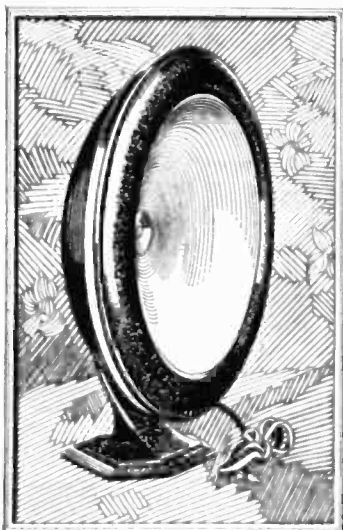

Acme K-3 Enclosed Single Free Edge Cone Speaker, (shown above). Diameter of cone, 11 ins. Green bronze metal case.

Price: \$18.50

Acme K-1 Enclosed Double Free Edge Cone Speaker. Diameter of Cone, 14 ins. Tan metal case.

Price: \$25.00.

Acme Enclosed Free Edge Cones and Acme Reproducing Units, (Designed for use exclusively with the free edge cone) eliminate resonance and preserve the tones, pure, round, and clear. A fixed edge cone, to produce the same results, would have to be three times the diameter, too clumsy for your living room. High notes are reproduced toward the center of the cone; low notes, toward the edge. The laws of vibration make it possible to produce low notes with a small cone, provided the edge is free and enclosed, and provided the reproducing unit is especially designed for use with a free edge cone.

Write us for circular describing full line of Acme products..



“We listen to  
our new Acme  
perfectly fascinated!”

“...With our new Acme Speaker, the voices and music that come in are so clear and beautiful that we just love to listen. It seems as if what we hear are the actual voices and music themselves...”

The wonderful new Acme Loud Speaker successfully reproduces voices and music, in your own home as clearly as they were originally created in the broadcasting studio. It reproduces the voice of the singer in all its thrilling, tender beauty. It brings out the different personality in each voice, so that you can tell one voice from another. It recreates orchestral music so clearly that you can hear each instrument playing. It reproduces low notes and tones as clearly as high notes and tones. You hear the bass and treble, harmony and melody.

All this was not done in a moment. Acme engineers worked five years and made 256 experimental speakers before they arrived at the new Acme Enclosed Free Edge Cone and Acme Reproducing Unit, which together are

responsible for this great increase in radio enjoyment.

See this new Acme at your dealer's

Try out this new Acme for yourself. See if all we have said about it is not true. Compare it with others in the dealer's store. Drop in at your dealer's today and hear this remarkable new speaker. Made by Acme Apparatus Co., Pioneer Radio and Transformer Engineers and Manufacturers, Cambridge, Mass., U. S. A.

Send for this Acme Book

“Amplification Without Distortion,” now in its 13th edition. Written by a prominent radio engineer in a non-technical and interesting manner. It gives you a clear picture of radio reception, and shows exactly how you can eliminate distortion and improve the operation of your set. It also describes fully these wonderful new Acme loud speakers—and includes details of the complete Acme line of transformers, impedances, condensers, potrehos, choke coils, etc. Send coupon below.

Mail this Coupon for

“Amplification Without Distortion”

**ACME**  
*for amplification*

Acme Apparatus Co.,  
Dept. D-22, Cambridge, Mass.

Enclosed find 10 cents (stamps or coin) to cover cost of sending me one copy of “Amplification Without Distortion,” 13th edition.

Name .....

Street .....

City ..... State .....



# RADIO

WITH WHICH IS INCORPORATED "RADIO JOURNAL"

VOLUME VIII

DECEMBER, 1926

No. 12

## Radiatorial Comment

THE development and application of various types of apparatus for supplying rectified alternating current to the plates and filaments of the tubes in a radio receiver has diverted much popular interest from radio circuits *per se* to rectifier and filter circuits. The theory and practice of rectifier circuits is comparatively simple, no matter whether the rectifier is a commutator on the shaft of the generator at the power house or whether it is an electrolytic mercury arc, or tube rectifier in the home. But as each of these rectifiers leaves more or less of a ripple in the wave form of the one-directional current that it delivers, the real problem is that of smoothing out these fluctuations by some form of filter.

This problem was first solved mathematically. Its solution represented one of the prettiest recent examples of the practical usefulness of mathematics. By its means, it is possible to figure the constants necessary to cut off or to pass not only a given single frequency but also an entire band of frequencies. One of its simplest applications is in the wave trap used to cut out an undesired broadcaster.

Theoretically, the filter for a current supply unit should deliver a non-pulsating direct current, which is an alternating current of zero frequency. Practically, this requirement is met by a filter which cuts off the fundamental 50 or 60 cycle fluctuation and its higher harmonics, especially the ninth, which is responsible for the usual "power hum" that is audible. This can be accomplished by passing the output from the rectifier through a circuit consisting of an inductance coil shunted by two fixed condensers of proper value.

Electrical energy consists of two components: current in amperes and pressure in volts. Any change in the current or electromagnetic component is opposed by the inductance in a choke coil. Any change in the voltage or electrostatic component is opposed by the capacity in a condenser. Hence, the fluctuations in current are smoothed out by the choke coil, which acts like a fly-wheel in regulating the electromagnetic output. The fluctuations in voltage are smoothed out by the condensers, which store up and give out the electrostatic component of the power.

Large currents require large choke coils of great current carrying ability. Low voltages require large condensers because a given difference in voltage at low pressure has a proportionately greater effect than the same difference at high pressure. Thus an *A* eliminator requires an inductance coil of large physical dimensions and condensers of relatively high capacity. On the other hand, the small amount of plate current required at higher voltages from a *B* eliminator enables the use of relatively small sized chokes and condensers. But plate supply equipment normally requires a large output condenser to store enough energy to take care of any sudden drain, such as may be caused by the reproduction of low notes.

The same common-sense principles also apply in the design

of plate current supply for amateur transmitters, due allowance of course being made for the greater effective a.c. resistance of the load. This latter factor must always be taken into consideration in filter design, the load impedance being an integral part of the equations used to compute filter constants.

If these simple facts tend to facilitate an understanding of the fundamental reasons back of the design of any filter the purpose of their presentation will be accomplished. They should at least help to simplify Jennings B. Dow's article on the "Design of Low Pass Filters," as published in April, 1926, RADIO, and Raymond B. Thorpe's articles on super-heterodyne band filters in the May and June issues.

THE illustration on the front cover of this issue is so radical in design and so different in idea, as compared to the human interest pictures heretofore used, that a few words of explanation seem to be due. It has been felt that our previous cover designs were unintentionally misleading as to the editorial character of this magazine. It was feared that the buyer might expect to find more information about what he may hear via radio than why and how he hears it.

Consequently, Sarkis Beulan, the artist, has tried to interpret the true character of the contents in a manner to suggest their semi-technical and practical nature. This is accomplished by means of the border, which will hereafter be the distinguishing mark of RADIO. It may be printed in different tints from month to month to mark different issues.

This border is made up of some of the conventional symbols used in radio circuit diagrams. It is intended to convey the thought that a knowledge of their meaning is essential to a complete understanding of the text in the magazine. Surely there is no excuse for anyone seriously interested in radio not knowing the signs which are used to indicate aeriels, grounds, batteries, inductances, headphones, transformers and vacuum tubes.

The central drawing, for which the border acts as a frame, may be changed from time to time. It will represent the artist's different interpretations of the marvel and mystery of radio reception. The initial picture completely reverses the usual artistic standards, in that the motion is toward the center and bottom of the picture instead of being away from it. This may be taken to typify radio reception.

The picture is that of a sound borne on wings of light. You can almost hear the peal of trumpets, the thunder of hoofs, the clash of cymbals, as they sweep by on the ether waves which they modulate. The facetiously minded may even detect the interference heard on a non-selective receiver. But mere words and the halting imagination of the writer fail to tell the complete story told by the artist. It is hoped that it will be studied, appreciated, and preserved.



# Modern Practice in Marine Radio

An Account of The Theory and Construction of Several Improvements In Transmitter Installations on Board Ship

By D. B. McGown

WHILE less generally advertised, progress in marine radio equipment has kept pace with improvement in broadcasting equipment. This covers advance in the design of both continuous wave, or c.w., and damped wave, or spark transmitters. For the spark, while obsolete, is not dead.

C. W. signals in the Morse code are formed by a key which starts and stops the radiation of a high frequency alternating current of constant value or amplitude. If this radiation is broken up by some mechanical or electrical device so as to give an interrupted continuous wave, or I. C. W., the key-made signals can be heard on any type of receiver, whereas all sets are not capable of receiving C. W. signals. Spark signals can be heard on any kind of a set.

C. W. transmitters are classified as tube or as arc according as a vacuum tube or a Poulsen arc is used as the generator

of the continuous wave. The tube installations on shipboard are made by the Radio Corporation of America and the arc installations by the Federal Telegraph Co., which, together with several

other manufacturers, also install spark transmitters.

The fundamental circuit of the R. C. A.'s vacuum tube transmitter is the master oscillator power amplifier, as

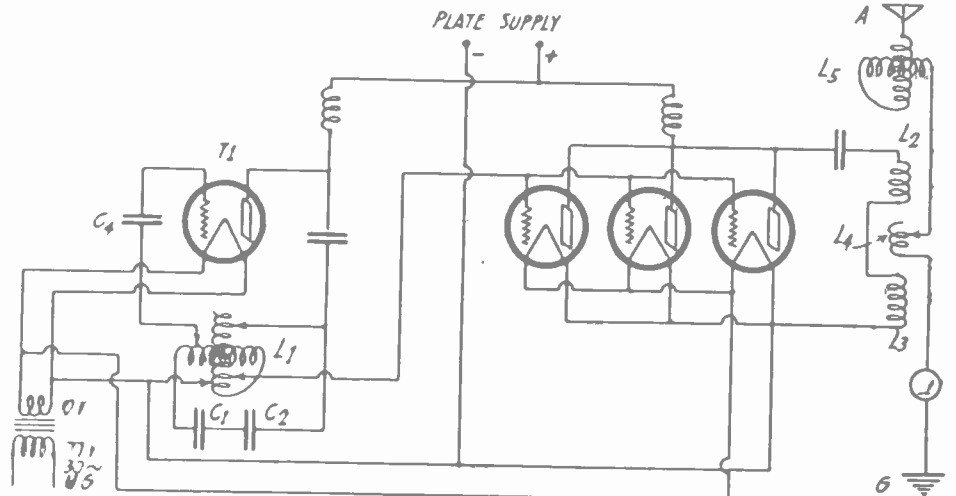
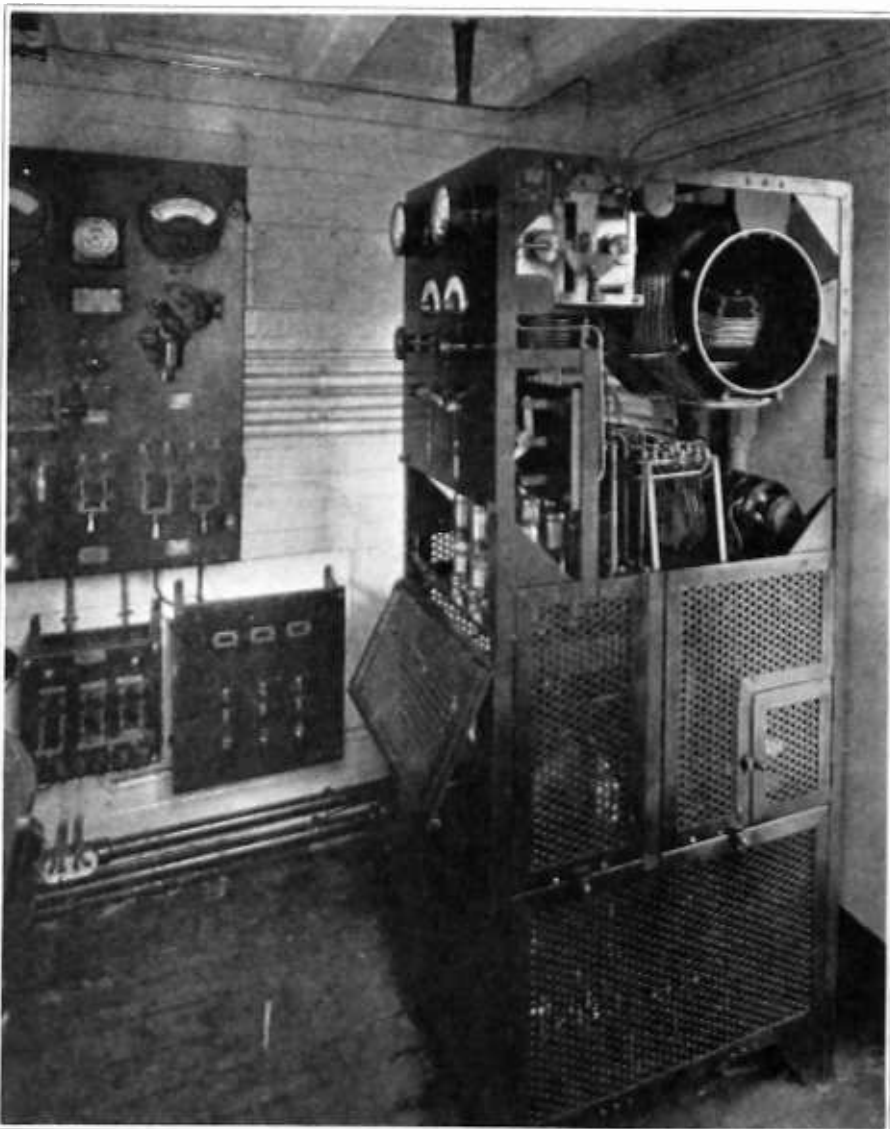

Fig. 1. Circuit Diagram of Master Oscillator Power Amplifier.



Master Oscillator Power Amplifier Transmitter on "Manoa"; Range 600 to 2400 Meters.

shown in Fig. 1. Here a small power tube is caused to oscillate at a fixed frequency into a closed circuit whose output is fed to a group of amplifying tubes which increase the radiated power to any desired amount. This circuit has the advantage of emitting a frequency which is constant notwithstanding any change in antenna capacity due to the rolling of the ship.

The inductance  $L_1$  is a variometer shunted by condensers  $C_1$  and  $C_2$ . This is designed so that 180 degree rotation covers the wavelength band ordinarily desired, additional loading inductances being added if higher wavelengths are wanted.  $C_3$  is the plate and  $C_4$  the grid feed condenser, fixed in value, so that variation in grid and plate input is accomplished by a clip or tap adjustment on the variometer.  $T_1$ , which oscillates into this closed circuit, forms the control or master tube. A variable clip is also provided, which includes a part of the circuit between the filament tap and the inductance, to supply the grids of the amplifier tubes. These are biased to prevent excessive plate current, through a tube rectifier, which is not shown in the diagram. Three tubes are shown in parallel, but as many as six are sometimes used.

The grid circuit of the amplifiers is fed constant frequency alternating current, and therefore the plate current varies exactly as does the grid supply, but at increased power due to the amplification of the tubes. The alternating current from their plates is then fed into

the antenna system, through a coupling system, which is shown as  $L_2$  and  $L_3$  in the plate system, and as  $L_4$  as the antenna coupling coil. The antenna circuit may be varied through certain limits by changes in  $L_4$ , but the antenna variometer  $L_5$  is used to tune the circuit to resonance, which is indicated as the maximum reading of the ammeter in the circuit.

Thus, reduced to simplest terms, it will be seen that the exciter circuit comprises a "Colpitts" oscillator, variable in frequency through certain limits when the variometer is adjusted, which feeds an amplifier system, coupled to an antenna circuit which is tuned to the same frequency as the exciter.

The power supply for these transmitters is obtained from the ship's power line, and is changed through suitable motor-generators to that desired for efficient operation. Ordinarily 110-125 volts direct current operates a direct current motor, to which are attached a high potential direct current generator for plate supply, and also a smaller machine, which generates alternating current at about 30 cycles 77 volts, to supply current for filament heating. In some cases, double current generators are provided to supply current for filament heating from one side, and 110 volts di-

rect current for field excitation, and the operation of relays and auxiliaries, without reference to the supply current. This permits the operation of a set from any convenient power source by a simple change in the driving motor, without disturbing the details of the equipment. Alternating current C. W. sets are frequently made by converting a spark set. Spark sets are fitted with motor-generators, to change the ship's d.c. supply to alternating current, which is then stepped up to charge condensers, which then discharge through a spark gap. Here we have all the necessary things for a tube set, except the spark gap, which is replaced by the tube. We may use the spark transformer for a source of high

voltage for plate supply, and the tuned circuits of the spark set for the closed circuit system, or we may use the spark transformer alone for the source of high potential, and switch over from tube to spark at will, and thus use both systems of transmission. As the motor-generator gives alternating current, which is usually 500 cycles frequency, the resultant signal may be either received as an I. C. W. or C. W. signal as desired.

Fig. 2 shows the fundamental circuit for such a converted spark set. The control key is placed in the primary of the spark transformer. The outer terminals of the secondary are connected to the plates of the vacuum tubes, through radio frequency chokes, which keep the oscil-

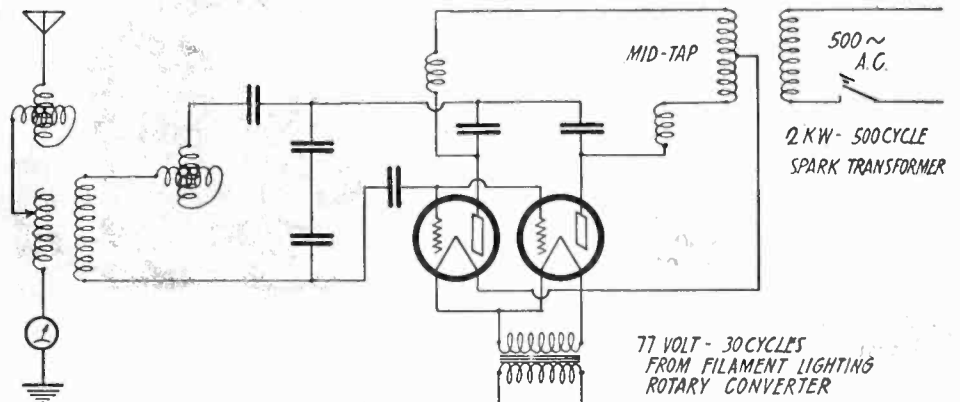

Fig. 2. Circuit Diagram of Converted Spark Set.



Telefunken Installation on "Shinyo Maru."



lating currents from reaching the transformer secondary. A mid-tap from the secondary is connected to the filaments. The plates are connected through a pair of blocking condensers, to the closed circuit. The grids are connected in parallel, through a coupling condenser, to the same tuned or "tank" circuit which is roughly tuned by taps, and accurately by a variometer. This is coupled to the radiating system, which also contains a resonating variometer. These variometers are not always used, tuning being accomplished by a simple variation of clips on the inductor, and by the original sliding arm on the antenna loading coil. Owing to the very poor voltage regulation of the 500 cycle machine, which often drops as much as 50% when the key is closed, it is not possible to operate the filaments satisfactorily from this source. So a small rotary converter, is provided to supply 77 volts 30 cycles a.c., for filament heating.

Various sizes and types of these tube sets are built by the Radio Corporation, starting with a simple affair using one master oscillator tube, of 50 watts capacity, and two tubes of the same size as amplifiers; to the large sets, rated at 1000 watts antenna input, which were first marketed as combination CW, ICW and telephone transmitters, but which

are now being converted to CW and ICW forms of transmission only. Equip-

ments are built which will fit, panel for panel, with the Marconi Company's  $\frac{1}{2}$  and 2 k.w. spark sets, thus converting them into tube transmitters, or, if desired, the spark sets may be left intact, and the tube attachment installed adjacent thereto.

As a contrast to the development in the United States, there is also shown a picture of a tube installation by the Telefunken Co., of Berlin, on Japanese and other foreign vessels. The source of power is a spark transformer, with a split secondary similar to the Radio Corporation's converted sets. But the high voltage alternating current is rectified to direct by two element rectifier tubes, and then filtered and led to the oscillator tube which is coupled to the antenna system through a condenser as shown in Fig. 3. The same inductor serves for the antenna and plate circuits. A variometer is included in the antenna for tuning. A variometer, used as a "grid tickler," is connected in the ground circuit to provide power for the operation of the grid circuit. Keying is accomplished by breaking the low potential 500 cycle supply, with the usual telegraph key, but as this is behind the filter, a rather sluggish signal may result in some cases. The tubes are rather larger than those used in American equipments, as they are rated at 3 k.w. input to the plate, at about 6000 volts. The use of the direct coupled system does not seem desirable, as any change of the relative position of the ship and the water, or of the antenna, if it is not tightly stretched, will result in a signal that "wabbles," and is hard to read.

The modern Federal arc C.W. set re-  
(Continued on Page 82)

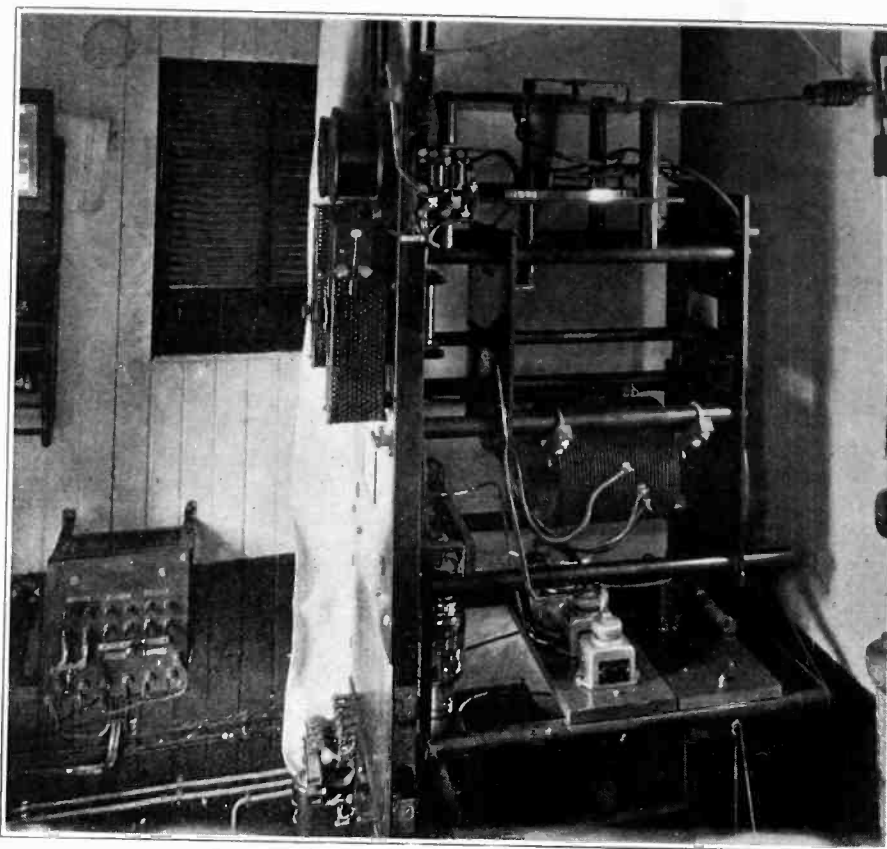

Converted Spark Transmitter on "Manoa."

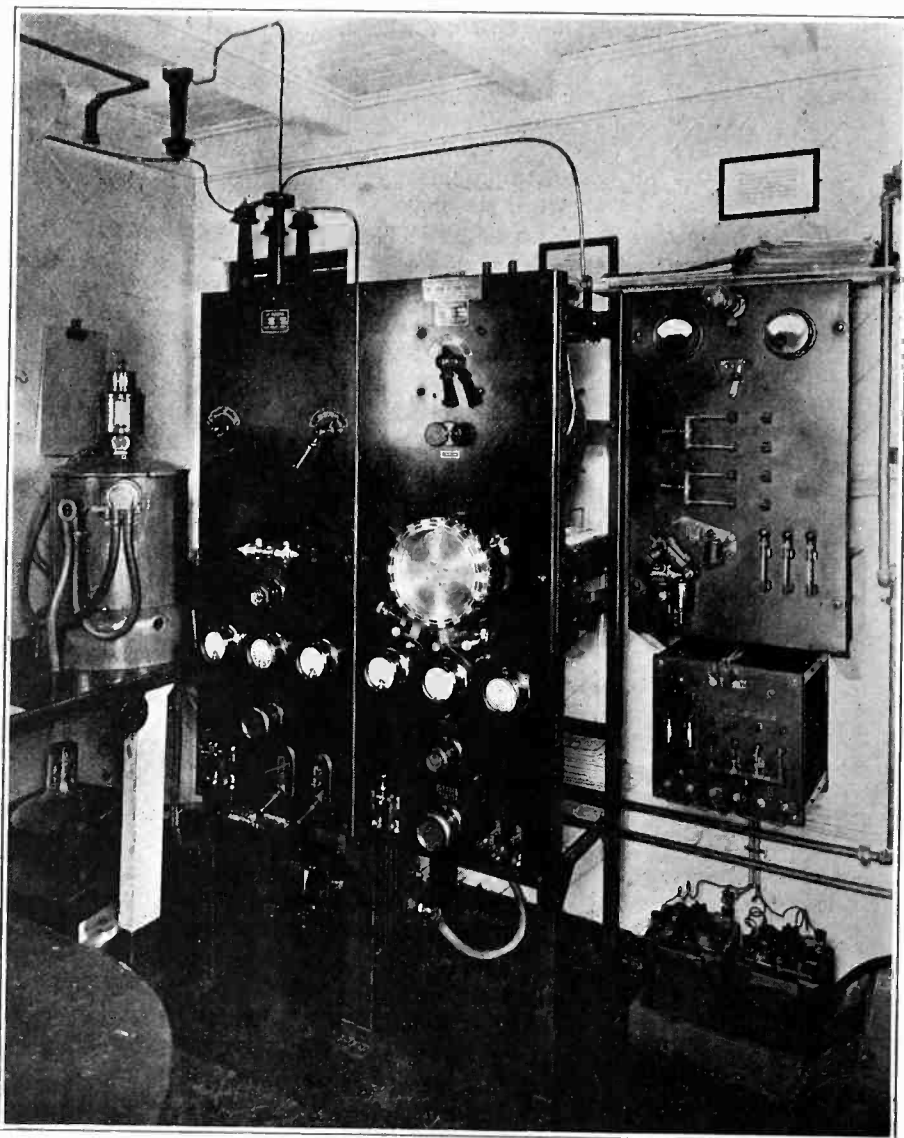

Federal Spark (on right) and Arc (on left) Transmitters on "Admiral Fiske," with Arc Converter at Extreme Left.

# Long May It Wave

By Keith LaBar

Illustrated by Louis McManus

**I**N ALL the world there is nothing we meet quite so regularly as wave motion. In the realm of physics and even in our everyday lives, it is so common that it attracts little attention. This is curious. That we should find inert matter vibrating either singly or in chunks at sometimes enormous speeds and should observe human beings doing likewise is, without a doubt, more than curious. It needs our investigation.

One might reason that everything is influenced by some simple physical law, and such, indeed, is the fact. The mathematician has analyzed it quite completely and with a handful of sines and cosines and queer figures has the whole history of a wave spread out before him, giving a better perspective than perhaps have you or I. But do not lose hope.

The commonest type of wave is the sine wave. Every wave form possible may be resolved or separated into its equivalent in sine waves, of varying wavelengths and strengths. You, frisking about in either the ocean or the bath tub, have observed these waves. Look at the shape as given in the picture of a sine wave.

But we must back up a trifle. Before there is a wave, there must be something causing these waves. A particle or object moving in a medium gives waves in that medium. A telephone receiver diaphragm vibrating in the air gives air waves. A dancer also produces air waves, but of such a low frequency that they are undetected.

A mass, moving in a suitable medium in simple harmonic motion, produces perfect sine waves. And to vibrate, there must be, beside mere mass, another property, elasticity. This may be a property of the mass, as in the case of a bell or rubber band, or it may merely be a force operating on the mass, tending to bring it back to normal position. Gravity is an example of such a force.

We have, then, a body acted on by an elastic force, tending to bring the body back to its original position. This force is usually proportional to the distance the body is moved or squeezed out of shape. Twice the load on a spring causes it to stretch twice as much. This uniformity is a property of many things. You recognize it instinctively when trying to pull a bent fender back into shape.

Bend a clock spring out of shape. It springs back, goes too far, springs back the other way, reverses, and keeps it up until friction causes the vibrations to die out. Friction is a combined curse and blessing in this matter. Electrical fric-

tion, in the form of resistance, uses up our perfectly good power. If we had no friction the aforementioned dancer theoretically could, by being elastic and by keeping all muscles tense, start dancing and after slight work to get herself started, keep on continuously without further expenditure of energy, though at slower speed, owing to other physical laws entering into the case.

The greater the restoring force and the smaller the mass, the higher is the rate of vibration. Is it not directly proportional; it is proportional to the square root of the two quantities. Four times the restoring force gives a speed twice as great and so on.

Let us apply this unsurprising fact to radio circuits. The inductance is the electrical mass, and the electrical elasticity is a property of the condenser, the smaller condenser giving the greatest elasticity, though, like a stiff spring. You all know that for the high frequencies or short waves it is necessary to use small coils and small condensers. And that resistance introduced into the circuit will snuff out wave motion even before it has a chance to start.

The philosopher can use these principles to advantage. Referring to the present tendency of the world today in the direction of jazz, some features check so well with the theory of simple harmonic motion that it is worth while to mention them. Back in the good old days of long ago it was no crime to be plump. Came with plumpness, as the title writers say, a lessening of physical energy. For who troubled to exercise?

With the day of the thin, automatically came jazz. Now the speed of jazz is approximately double that of the dance music of the dear, dead days. Since frequency is proportional to the square root of restoring force divided by mass, we see that the ratio of pep to girl has to increase four times. Assuming that the average weight is two-thirds of what it was back in the beefy days, then the



Ratio of Pep to Girl Increased Four Times

girls nowadays are two and a thirds times as strong. This shows the power of mathematics in solving the questions of the day.

Simple harmonic motion is related to the circle in a simple manner and it is from a study of the circle that the mathematician gets a start. You are familiar with the motion of the pistons on your car or the piston on a locomotive. From a complete stop at each end of the journey, speed is acquired until the half way position is passed, and from there the speed decreases to a full stop. And all the time the circle of reference is turning at a constant speed.

If we chart the progress, in one direction, of a point on the circumference of a wheel turning with constant speed we obtain the result shown in the diagram,

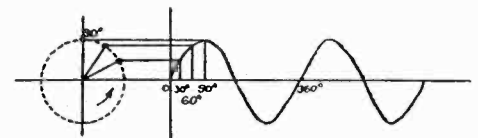

Generation of a Sine Wave

which is a pictorial record of the distance the point has wandered above or below the horizontal line.

This being a little difficult to interpret at a glance, it might be well to glance at the three cylinder arrangement shown. With the shaft turning at a constant speed, we have three objects moving in simple harmonic motion. Attached to wires they would produce in them the familiar waves. These waves will be one-third of a wavelength apart. Technically, they are 120 degrees apart.

This is the angle through which the

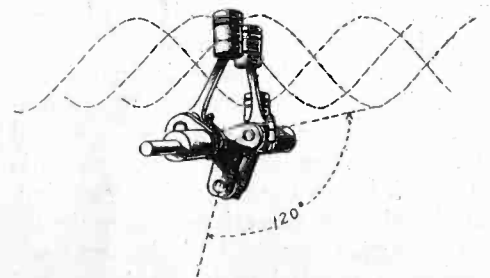

Three Objects in Simple Harmonic Motion.

circle of reference has turned. It goes to 180 degrees and then starts over again. If one wave has started and another one starts after it, the second point on the circumference of the circle lags behind the first by a definite amount. This amount is expressed in angular measure. In the case of alternating current with current lagging behind voltage or the other way around this angle is called the phase angle. If the phase



angle is large the power company gets worried, as it means lots of amperes and lots of volts, but not much power being clocked up in the meter. And lots of amperes means lots of power lost in heat losses, power that the meter declines to register.

This illustration shows the exact state of affairs in three-phase alternating current, the potential between any two wires being the difference in altitude of two pistons. You can see that the relation between any two is the same. That is, with three wires, there might be a pressure of 110 volts between any two, a rather puzzling thing when first introduced to it.

Simple harmonic motion and the effect, wave motion, are used quite interchangeably in popular usage of the day. We speak of a wave of laughter, a wave of crime, a hot wave. Yet there is no continued wave motion. It is merely a periodic variation in simple harmonic motion. This variation may take a half century or more to even come to a maximum.

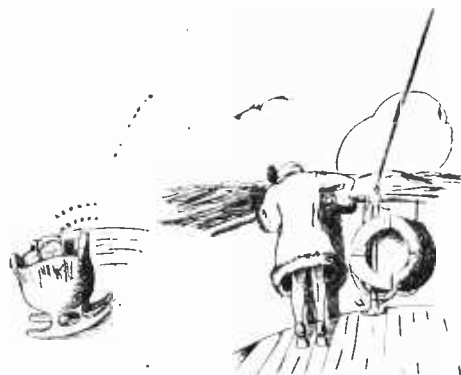

*Beneficent vs. Disastrous Effects of Simple Harmonic Motion.*

Light and radio waves are waves in the ether. An intermittent battle is now being waged as to whether there is any ether. Anyway, we must not think of ether as sort of an elastic jelly (according to one writer) but rather it is the seat of electrical and mechanical forces and knowing the laws of these forces is all we need to know.

A radio or light wave is an electromagnetic wave, and consists of two components, an alternating electric field and an alternating magnetic force. A radio wave as it leaves the transmitting station, has the electric vibrations perpendicular to the earth's surface and the magnetic component parallel to it. A horizontal antenna will be best for receiving these waves. Radio waves, notably the very short waves, tend to get twisted after traveling. Technically, we would say that the plane of polarization has been rotated.

If a strong radio wave, as it leaves the station, were to pass a body with an electric charge on it, the body would tend to vibrate up and down, while a magnetic pole would tend to vibrate horizontally. For this reason we speak of the wave having two components. But

there are not two waves. It is two ways of saying the same thing. All the energy can be expressed in electromagnetic units or electrostatic units. From the very nature of electrical phenomena they cannot be separated. Any varying magnetic field will cause a charged body to move at right angles to it. This right angle business holds for many electrical laws and gives rise to right hand rules and left hand rules for generators and motors, none of which are ever remembered.

Light waves are not polarized. The electric vibrations are not all in one plane, as in the case of radio waves, but are in all planes perpendicular to the direction they are traveling. Polarized light can be obtained by passing it through various crystals or reflecting it from glass or other surfaces at a certain angle. The light of the moon is partially polarized and seems to have an effect on the growth of plants.

A hurried glimpse of the wave spectrum might not be amiss. The shortest are the cosmic rays discovered a short time ago. Coming up the scale are the various rays from radium and the X-rays. These are "hard" rays and penetrate even lead. An imperfectly explored gap to the ultra violet light waves with a wavelength of .00000002 meters. Visible light ranges from .00000035 to .000007 meters, a mere two octaves. Expressed in frequency, a deep red object is sending out four hundred million million vibrations a second, while the violet is 800. Photographic plate can be made sensitive by dyeing to infra red and ultra violet.

Past the red comes heat, still imperfectly explored, and then radio waves. The shortest radio waves produced, one hundredth of a meter, are thousands of times larger than the red light waves. Plenty of room for experimentation. Radio waves then run up to 30,000 meters, but at that enormous wavelength the frequency is so low they can be received on an ordinary amplifying transformer attached between aerial and ground. Listen to the power hum received this way. If our ears were sensitive to radio waves, life in a city would be one continuous hum.

Our ears are sensitive to vibrations in the air of from 30 to 3000 vibrations a second, 10 octaves. Waves have been generated in air of a frequency of 100,000 to 400,000 per second, which is two or three octaves above the highest note heard.

They are generated by electrical excitation of a plate cut from a quartz crystal. In water, they are less than one-half inch long and travel faster than in air. When a beam of these rays is directed to the surface of water the water heaps up in a mound and becomes heated. Small fish and organisms are killed in less than a minute, so on a small scale at least, there has really been discovered the death wave.

Tabulation of Etherial Waves

OCTAVES	WAVE LENGTH	RADIO WAVES
9	Meters (M)	Trans-ocean radio Used by large ships Used by small ships Broadcasting Broadcasting, amateur, and commercial.
	25600	
	24000	
	10000	
	3200	
	2200	
	600	
	400	
	200	
	12.5	
13	Meters (M.)	HERTZIAN WAVES Chiefly used by Hertz. Now being invaded by amateurs. Shortest Hertzian wave produced by Lampa (1897) Shortest Hertzian wave measured by Rhigi.
	12.5	
	1.5	
	Millimeters (m.m.)	
	780	
	6.5	
3	4	SLIGHTLY EXPLORED REGION Long heat waves in this region received on radio receivers. No practical use has been found for this region. INFRA-RED, OR DARK HEAT WAVES Limit of heat rays measured by Rubens and Bazzone (1911) Limit reached by Rubens and Nichols in 1897-1898 Heat waves radiating from the earth Sylvine in their plates becomes opaque Rock salt begins to transmit Langley's longest measured heat waves Fluor spar in thin plates becomes opaque Limit of heat rays mapped by Langley Photographed by Abney 1885 Extreme red sometimes visible to acute vision.
	3.25	
	3	
	Microns	
	1625	
9	812.5	VISIBLE SPECTRUM Limit of perception of red to average eye. Red Orange Yellow Green Peacock Blue Violet Limit of perception of violet to the average eye. Extreme limit of acute vision.
	406.25	
	Microns	
	343	
	67	
	30	
	25	
	20	
	15	
	11	
5.5		
NEARLY 1	2.7	VISIBLE SPECTRUM Limit of perception of red to average eye. Red Orange Yellow Green Peacock Blue Violet Limit of perception of violet to the average eye. Extreme limit of acute vision.
	.8	
	.7	
	Angstroms (A)	
	6700	
	6500	
	5830	
	5510	
	5120	
	4750	
4490		
4004		
3900		
3600		

(Continued on Page 78)

# The New Inverse Duplex System

Preliminary Data for Modernized Circuit Using Four Tubes to Give Two Stages of Tuned R. F., Detector, and Three Audio

By David Grimes

THE need for greater selectivity over the entire range of broadcast wavelengths and for better audio quality than were obtainable with the original inverse duplex circuit as described by M. B. Sleeper in January, 1924, RADIO, has resulted in a complete new design which brings it up-to-date in every detail. This modernized design is based upon a long series of laboratory tests which have resulted in a single control instrument of the most efficient type.

These improvements can be best understood by tracing through the revised circuit diagram as shown in Fig. 1. The incoming radio energy is picked up by the antenna *A* and discharged to the ground through the tapped primary coil 32. The energy induced in the secondary winding 90 of the first radio frequency coil is tuned by a variable condenser and delivered directly to the grid of the first tube and to its negative filament through a .00025 mfd. by-pass condenser. Here it is amplified by the No. 1 tube and passed into the primary 9 of the second r.f. coil, thence back to the positive filament of the No. 1 tube via the .001 mfd. condenser.

This amplified r.f. energy is then induced into the secondary winding 90 of the second r.f. coil, where it is tuned and applied to the grid of the No. 2 tube and to the filament through the .00025 mfd. by-pass condenser. Here it is again amplified, this time by the No. 2 tube, and then passed on through the

primary 9 of the third r.f. coil, and back to the filament through the .001 mfd. by-pass condenser. From the primary of the third r.f. coil, it is induced into its secondary 90, where it is tuned and applied across the grid and filament of the detector tube No. 3 through the grid condenser and grid leak.

The radio energy is rectified and changed to audio energy in the detector tube in the usual manner. The audio energy travels through the primary of the first audio coupling, which is a 2 to 1 step up ratio transformer. It is then induced into the secondary winding of this audio transformer and fed to the grid of the No. 2 tube through the secondary 90 of the second r.f. coil. The .00025 mfd. by-pass condenser is so small that the audio currents cannot reach the filament by that path. The 250,000 ohm straightline volume control potentiometer regulates the amount of audio energy reaching the grid and filament of the first audio amplifying tube (No. 2).

The audio energy is next amplified in the No. 2 tube and is passed on through the primary 9 of the third r.f. coil, down through the r.f. choke, on through the 0.1 mfd. condenser to the grid of the No. 1 tube, by passing through secondary 90 of the first r.f. coil. The .001 mfd. by-pass condenser in the plate circuit of tube No. 2 is so small that no appreciable quantity of audio energy will escape through it to the filament, before passing on through the proper audio cir-

cuit. The r.f. choke, which will be explained in greater detail later, offers no objection to the passing of the audio energy through it.

The 0.1 mfd. fixed condenser is a part of the apparatus comprising a so-called resistance coupling unit. The 1 megohm resistance is the grid resistance and the 24000 ohm unit is the plate resistance. The special features of this resistance coupling will be explained in detail later.

The audio energy reaching the grid of the No. 1 tube is here amplified and passed on through the primary 9 of the second r.f. coil and down through the primary of the 6-1 step-up ratio audio transformer used in the 3rd audio stage. The action of the .001 mfd. by-pass condenser in the plate circuit of the No. 1 tube is the same as the one in the plate circuit of the No. 2 tube. All of these by-pass condensers will allow radio frequency to pass through them with little or no objection but will not permit audio currents to go through them. The .00025 mfd. by-pass condensers in the grid circuits of the No. 1 and No. 2 tubes act in the same manner and for the same purpose.

The audio energy in the primary of the third audio coupling is induced into the secondary of this 6 to 1 ratio transformer and is then applied to the grid and filament of the last power stage.

It will be noted that the plate of the power tube is supplied with direct current through a 20 henry choke coil. This

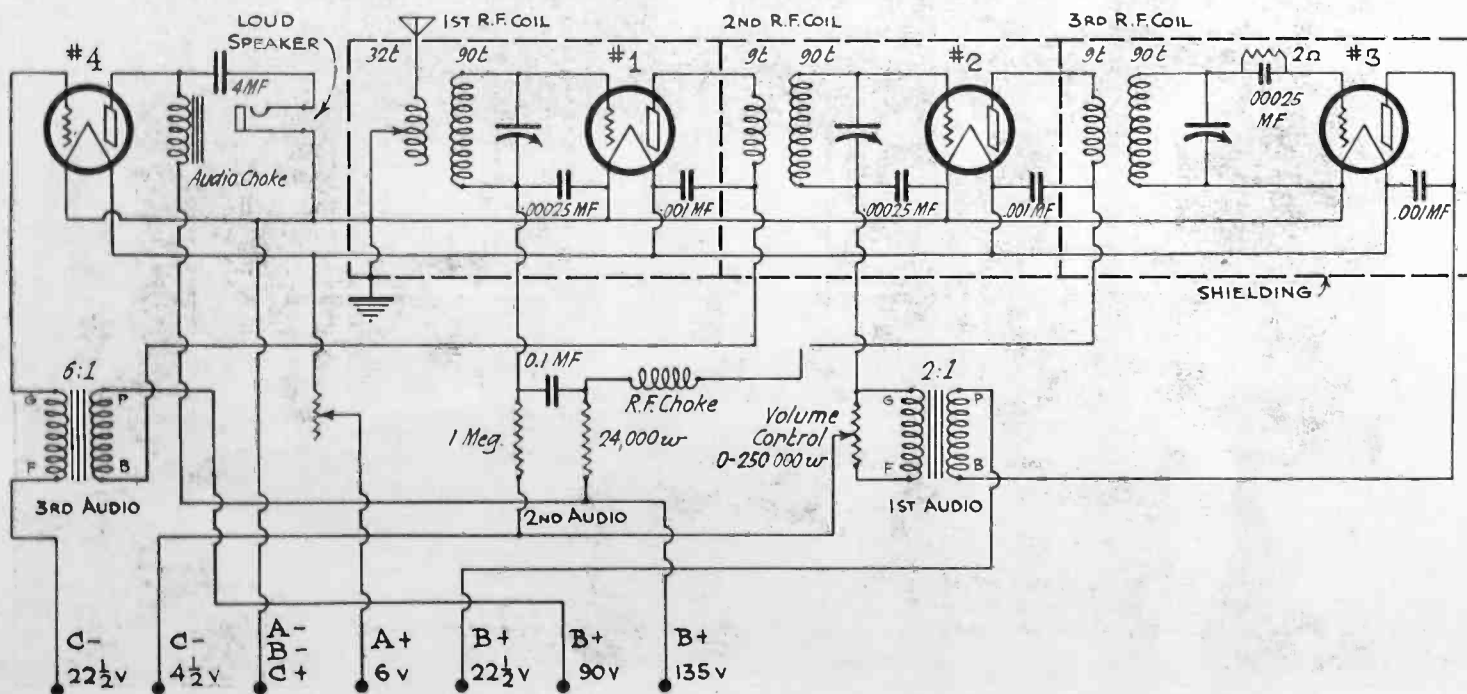

Fig. 1. Circuit Diagram of Grimes New Inverse Duplex Receiver.



audio choke forces all of the audio energy through the 1 mfd. fixed condenser, and into the loud speaker. The 1mfd. fixed condenser, of course, does not permit the direct plate current to flow through the loud speaker. The audio choke is built of fairly large wire to handle the plate current without burning out, while most loud speakers are not so built. Incidentally many reproducers are biased by direct current flowing through their field windings and if the polarity of the speaker connections is not watched, the current may be allowed to flow through the speaker in the wrong direction, giving poor quality, reduced volume, and eventually doing injury to the magnets.

By following the circuit through, as above, it will be seen that there are two stages of tuned radio frequency, a tube detector, and three stages of audio frequency amplification. Furthermore, it will be noted that the No. 1 tube is the first radio amplifier and is also the second audio amplifier, performing both functions simultaneously. The No. 2 tube is the second radio amplifier and is the first audio amplifier at the same time. The power stage is reserved entirely for audio power and of course, the detector is used only for its rectifying action. The radio energy thus passes into the 1st, 2nd, and 3rd tubes, is rectified, and the audio energy then passes through the same tubes in the reverse sequence, by going through the 2nd and then the 1st tube. The reversed second sequence is the distinguishing characteristic of inverse duplexing. It is to

be in no way confused with a reflexing scheme which attempts to go back through the tubes in the sequence where the 1st radio tube is also the 1st audio, etc. The two systems and their differences are clearly shown in the schematic sketch of Fig. 2. The numerous advantages of the inverse duplex system over

quality stations, the new UX-171, CX-371 power tube is to be employed, especially when connecting the set to a good cone type speaker. If most of the stations to be heard are a moderate distance away, the UX-112 can be used. It has a slightly higher amplifying factor than the UX-171 and is therefore

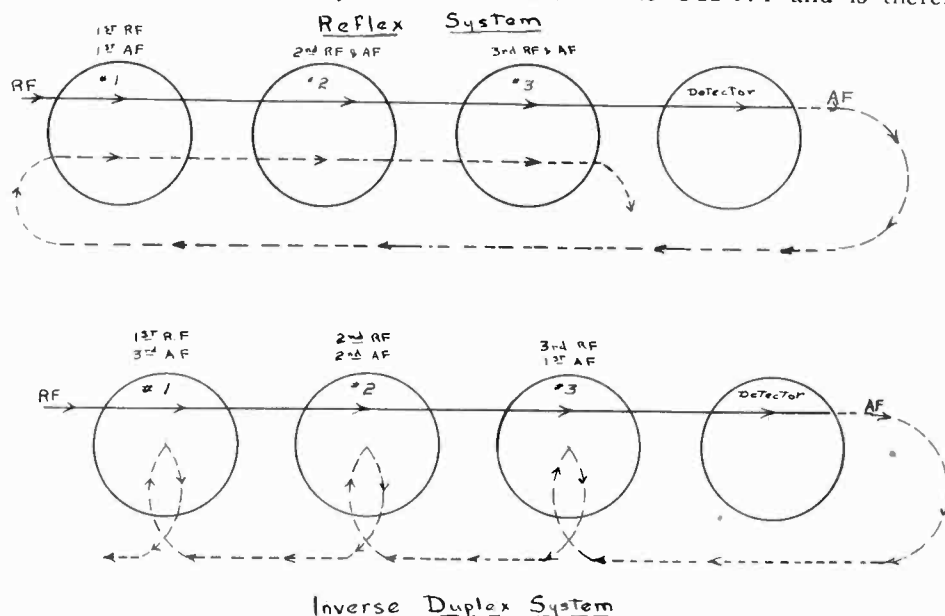

Fig. 2. Comparison of Straight Reflex with Inverse Duplex System.

straight reflexing will be technically discussed and data presented in the form of curves, later in these articles.

The best tubes for the duplex or radio frequency stages are the UX-201A, CX301A type and the new UX-200A, CX-300A tube is to be used for the detector. For best results on nearby good

better on the weaker stations.

The B potential supply for the set should deliver 135 volts, 90 volts, and 22½ volts. The filaments of this model require 6 volts supplied by either a storage battery or trickle charger. The B battery may be either dry cells, storage

(Continued on Page 94)

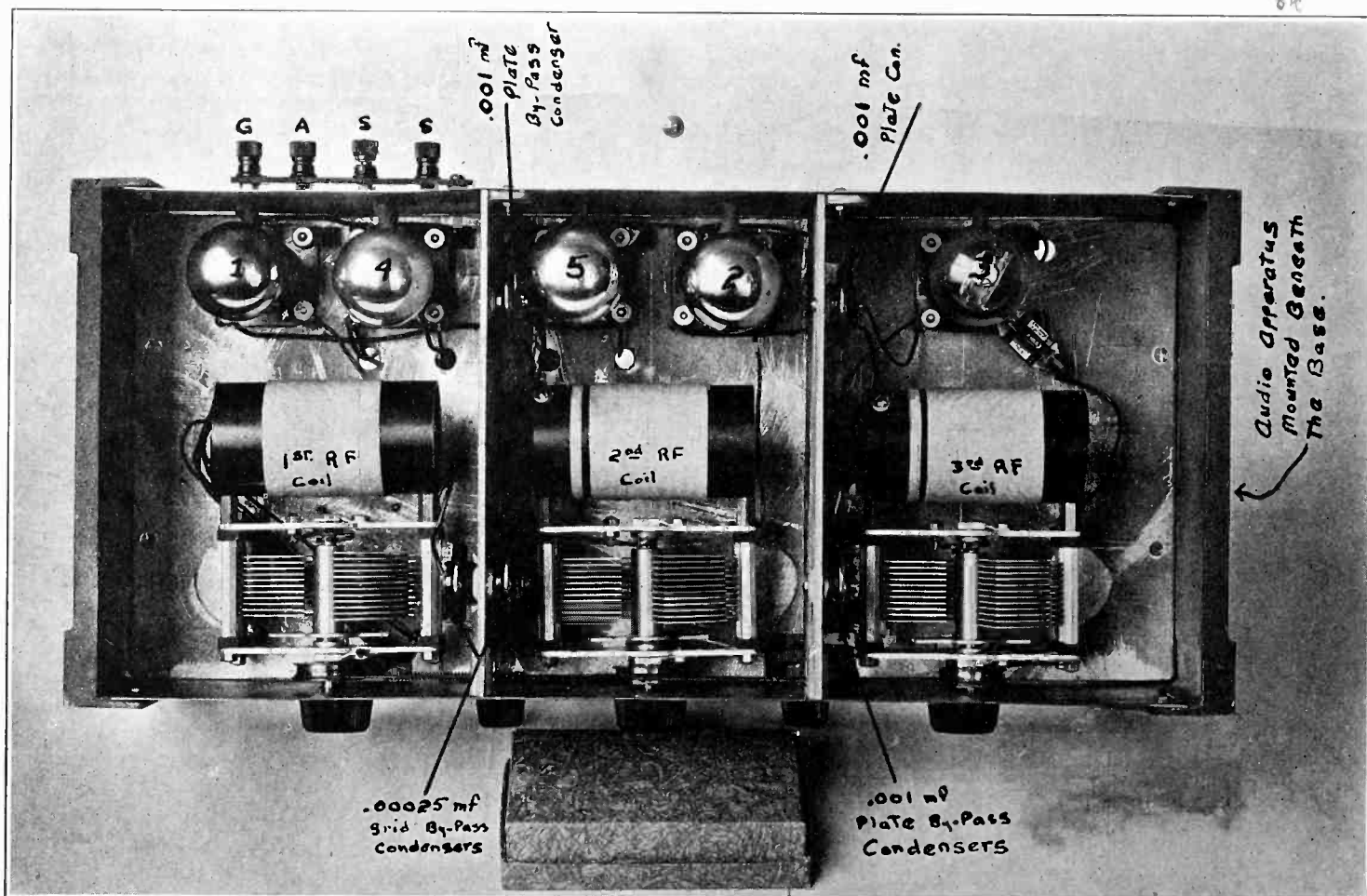

Fig. 3. Completed Inverse Duplex Receiver Using Two Parallel Tubes in Third Audio Stage.

# The Counterphase Power Six

Constructional Details for an Improved Six-Tube Set

By G. M. Best

ONE of the most interesting circuits of the 1925-26 radio season was the Counterphase, which consisted of a three stage tuned r.f. amplifier without elaborate shielding, detector, and two stages of audio, so arranged as to be easy of assembly and wiring. Experience has developed several improvements in the radio and audio frequency ends of the circuit so as to give greater volume and better tone quality, as well as to facilitate tuning.

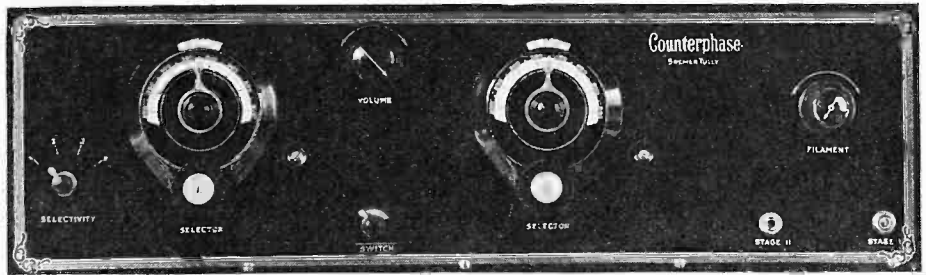

Panel View of Counterphase Power Six.

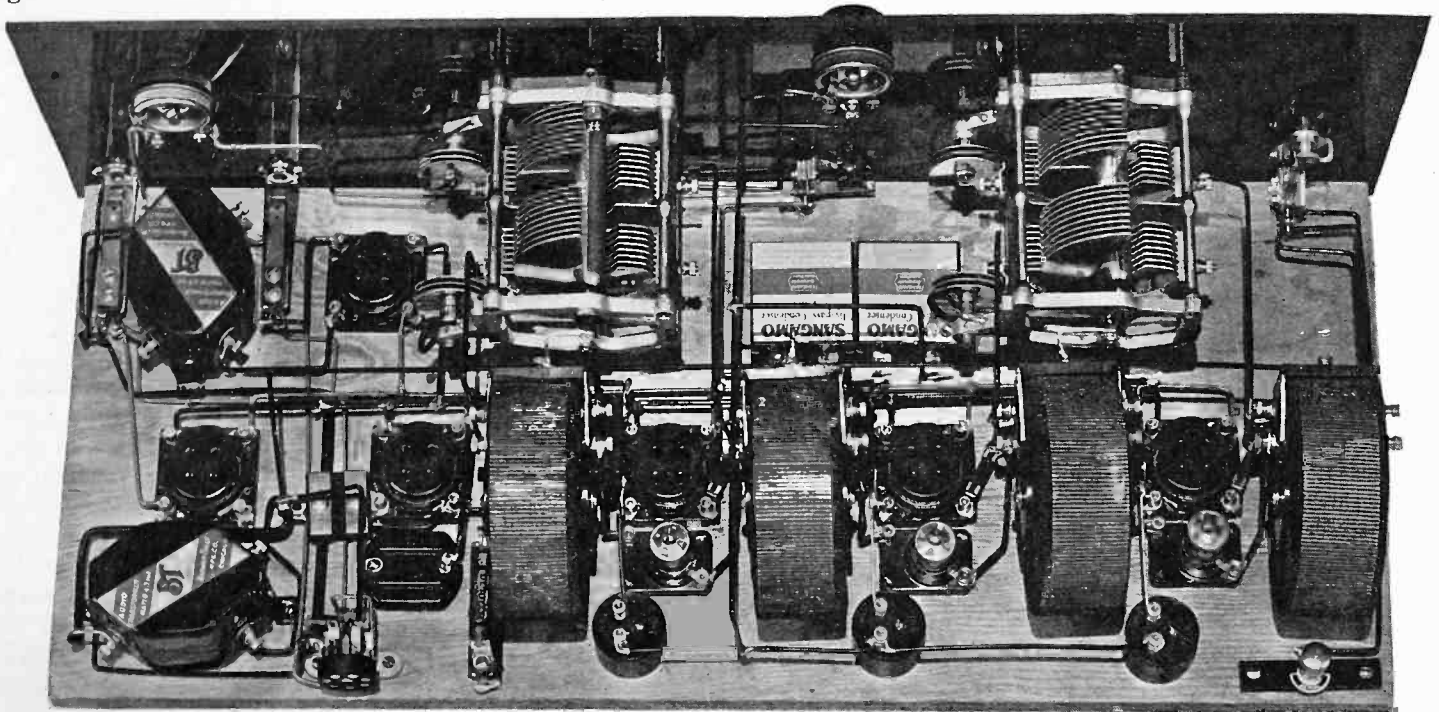

Rear View of Completed Set.

Fig. 1 is the new schematic wiring diagram. The principal change is the supply of plate voltage for the three r.f. amplifier tubes through a system of r.f. chokes, so that the radio frequency component in the plate circuit of each tube is kept out of the B battery circuit, and passes through a bypass condenser and the primary of the r.f. transformer, back to the filament of the tube. This is com-

monly called impedance coupling, and is widely used in audio frequency amplifier circuits.

Fig. 2 shows the arrangement of the choke and bypass condenser for one r.f. stage. The plate current for the tube passes through the r.f. choke, which has a high impedance to r.f. currents but low resistance to direct current. The plate current cannot pass through the primary

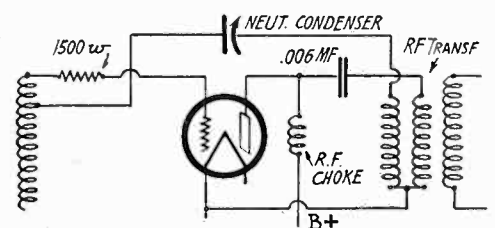

Fig. 2. Method of Coupling R.F. Amplifier

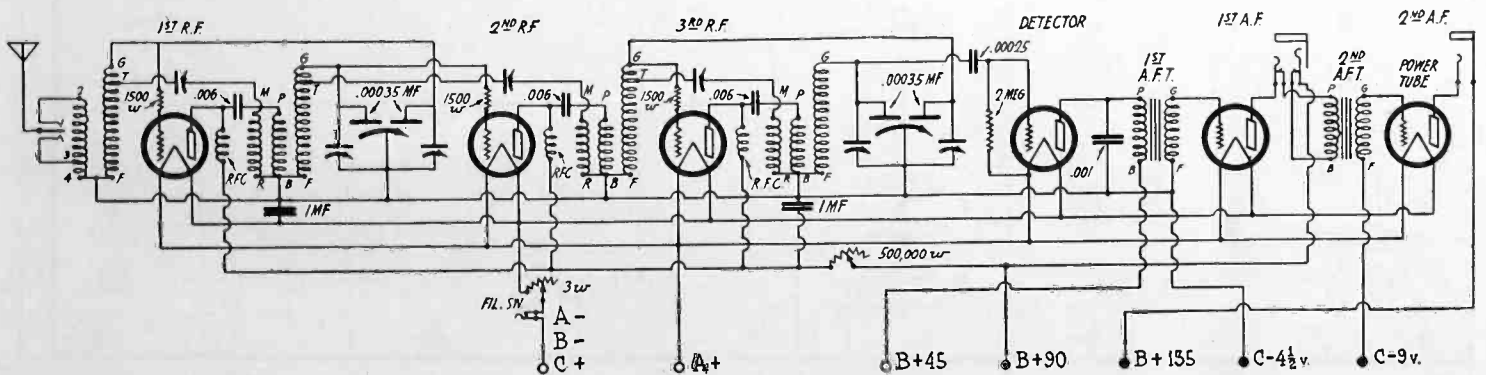

Fig. 1. Schematic Wiring Diagram.



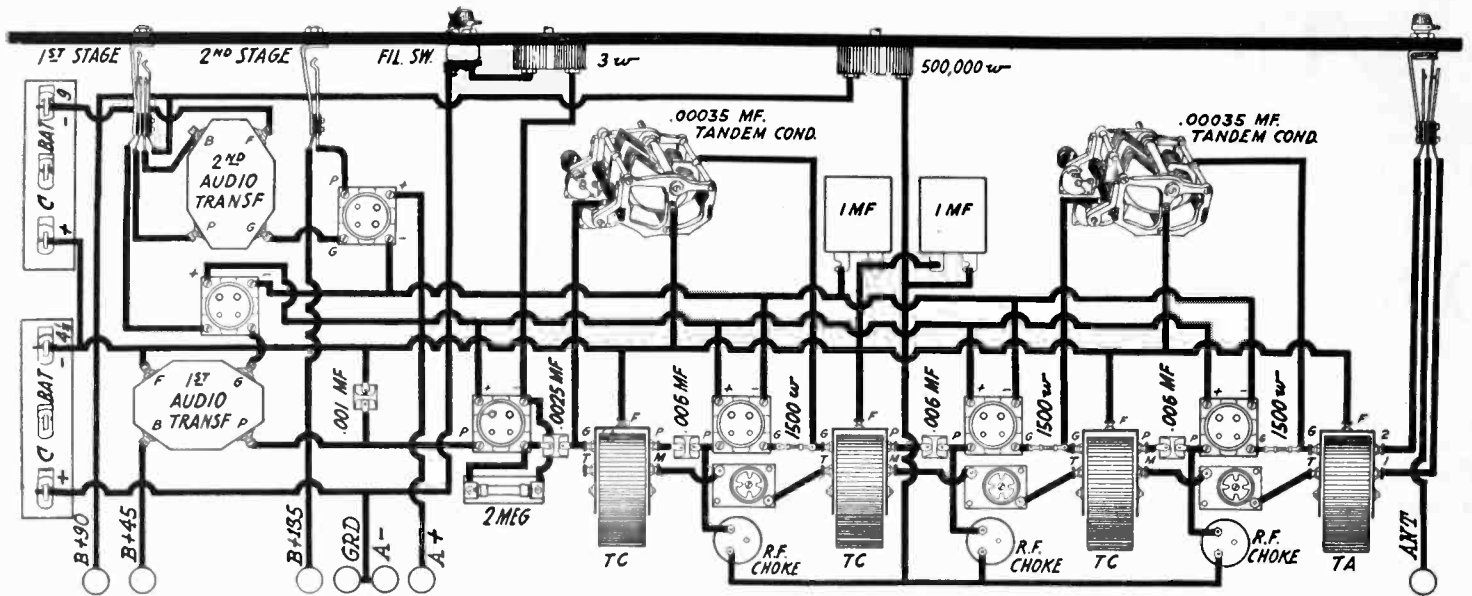

Fig. 3. Pictorial Wiring Diagram of Counterphase Receiver.

of the r.f. transformer, as is customary in most circuits, due to the bypass condenser, which is of large enough capacity to cause practically no impedance to radio frequency, but of course is an open circuit for direct current. This system greatly reduces the tendency of the r.f. stages to oscillate, and with an excellent system of neutralization, employing improved neutralizing condensers, it is easy to adjust the r.f. amplifier so that it will not oscillate, and yet is very sensitive.

The r.f. tubes all employ a C battery, thus reducing the plate current drain of the set, and further stabilizing the r.f. amplifiers. A power tube has been installed in the last stage of audio, with proper B and C batteries, increasing the possible power output over that obtainable with the ordinary A tube. For the benefit of those who are interested in constructing the receiver, a list of parts is given, together with a panel layout and pictorial wiring diagram. Fig. 3 is identical in circuit with Fig. 1, but shows the actual layout of apparatus on the baseboard and panel, and at the same time gives the necessary connections for those who cannot read schematic wiring diagrams. The panel drilling dimensions are given in Fig. 4, or the panel can be obtained already drilled and engraved.

It is best to make all the connections between the various parts on the baseboard first, mounting the panel after they are finished. Use a good grade of No. 14 tinned bus wire, preferably insulated, and solder all connections. A good order to follow in wiring the set is to first wire the positive and negative filament leads complete, to the six sockets. Then complete all connections between the r.f. chokes, transformers, neutralizing condensers and resistances, after which the panel should be fastened to the baseboard. Then connect the filament circuit to the filament rheostat and filament switch, and back to the binding post strip or battery cable terminal. Next connect the 500,000 ohm variable resistor on the panel, to the r.f. circuit, and wire in the two tuning controls. Connect the audio transformers to the panel jacks as designated in the diagram, and bring out flexible leads for the C battery connections. The latter may be placed at the left end of the baseboard, looking at the set from the rear, or they may be placed outside the set, as their circuits are bypassed with condensers and no trouble will result from long C battery leads.

After all connections are made, and the battery circuits tested to make sure

that there are no short circuits, the set is ready for adjustment of the tuning controls. Place all tubes in their sockets and turn on the filament switch, adjusting the filament voltage to 5 volts, if a voltmeter is handy, or if not, cutting in a small amount of resistance in the 3 ohm rheostat. Adjust all neutralizing condensers so that the movable plate is half way down. Tune in a station of moderate power to exact resonance on both dials, using the small trimmer condensers to obtain fine adjustment. Adjust the 500,000 ohm volume control to give the greatest volume without oscillation or squealing in the loudspeaker, which means the point where no whistling will be heard when the dials are rotated back and forth across the signal. Place a small piece of paper over the positive A spring of the third r.f. tube socket, so that the tube filament does not light. The signal will no doubt still be heard, and the neutralizing condenser should now be adjusted back and forth with a small screwdriver, until the signal becomes weaker, or disappears altogether. Now retune the right hand dial for the loudest signal, and again adjust the neutralizing condenser for minimum signal. If it can be tuned out entirely the correct adjust-

(Continued on Page 94)

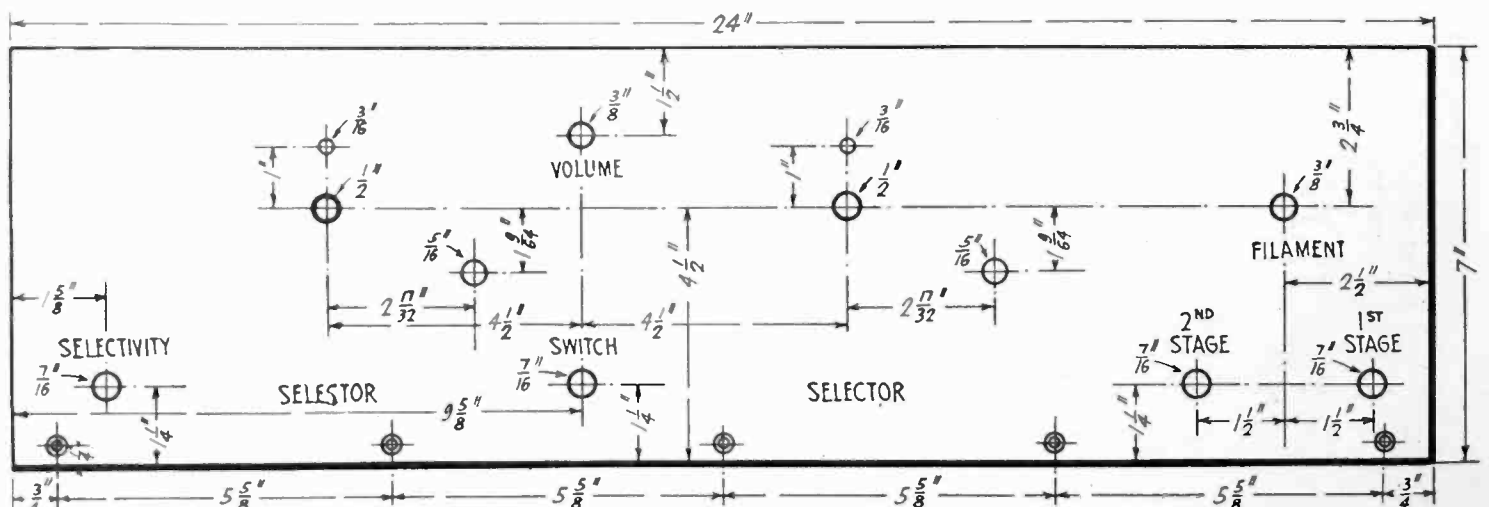
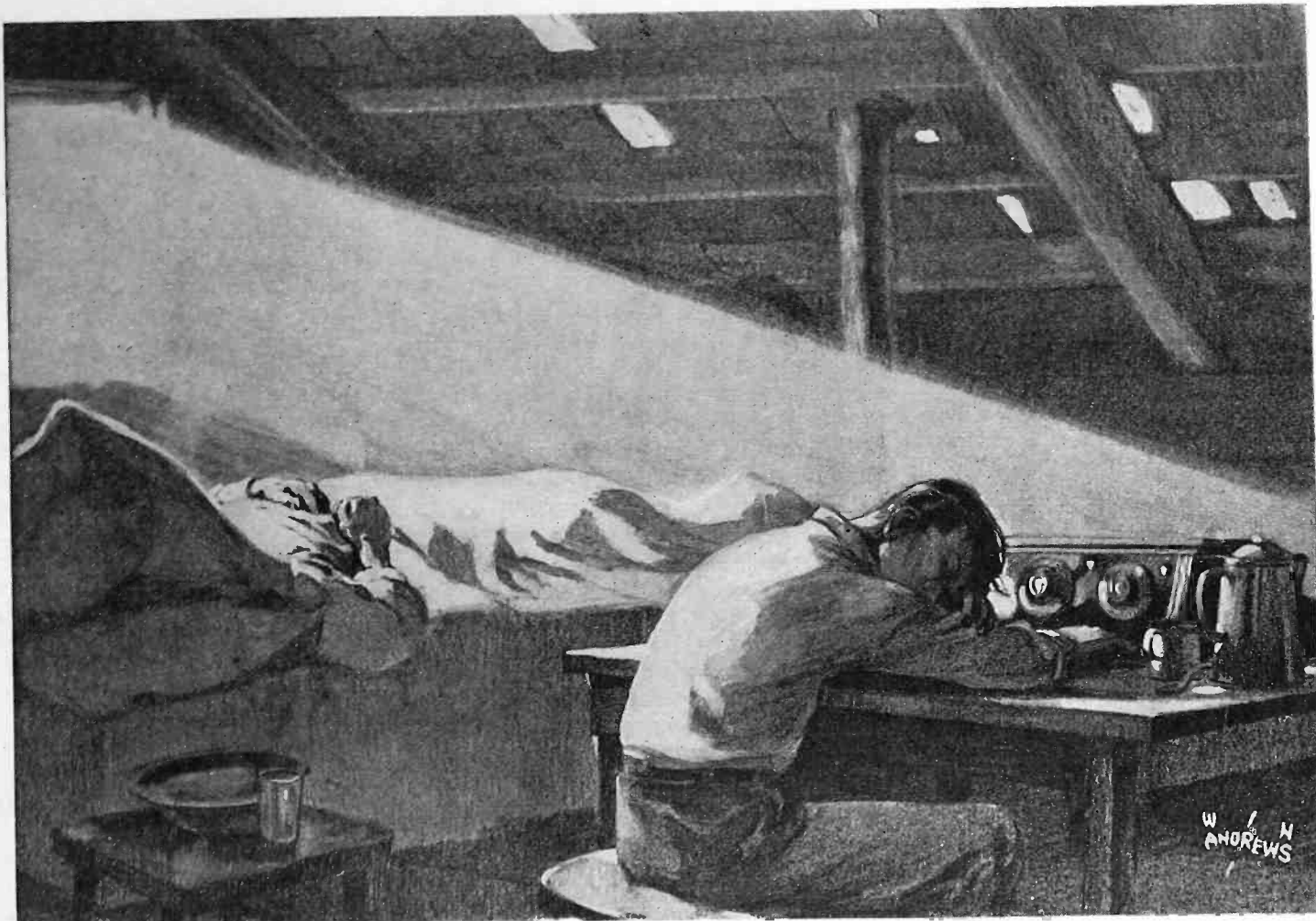

Fig. 4. Panel Layout.



*In the middle of a word he spread his arms on the table and dropped his head on his arm."*

## Direct Action

*By G. W. Weight*

PHILIP McCALL straightened his slim shoulders and, with a quick thrust of long nervous fingers, pushed back a curly red pompadour. His freckled face was flushed, and his brown eyes glowed with enthusiasm.

"Listen to that, Uncle Jake! I've I've got KFI, Los Angeles. No ground either, just this loop aerial."

"Humph!" growled old Jake Mason, a typical desert rat, "I thought, from all the shrieks and groans and howls I heard a few minutes ago, you must ov got tuned in on Hades."

Philip laughed, but he felt a little hurt. He had worked so hard on his old radio set; re-wiring, soldering, installing tubes and transformers, trying this and that "hook-up" to bring into this lonely place, away out on the Colorado desert, the beloved voices of radio land. Now that he had succeeded, he wanted some one to rejoice with him. But crochety old Jake Mason, lover of silence and solitude, did not take kindly to the advent of his nephew and the latter's radio set.

"Desert ain't no place fer company," he grumbled to himself, "An' my kind of grub ain't no ways good fer a person with a delectate stummick. An' the kid's

used to things so tarnation clean around home, he can't leave my things alone the way they be. Gets plumb on my nerves, too, gassin' all the time, er else squawkin' that old radio."

Only at the earnest solicitation of Philip's mother, who was Jake's sister, had the old man extended a grudging hospitality to the lad, whose lungs had been left in bad shape by an attack of pneumonia. For six weeks, now, Philip had shared his uncle's bachelor quarters, and if he got on the old man's nerves, the feeling was mutual.

Having reluctantly dis-connected the maligned radio set, Philip made a valiant attempt to carry on a conversation with his uncle. But old Jake, as usual, doled out his words as if they were dollars.

"Have any luck today, Uncle Jake?"

"Pretty good, lots of color."

"Can't I go with you tomorrow?"

"No!"

After a short silence Philip tried once more.

"Will they ever open the mine again?"

"Maybe."

"If you should pick up the vein that you say pinched out, would some of it belong to the company?"

"No. I'm workin' my own ground."

"What would happen if you didn't do the assessment work on the company's claims?"

"Nothin' unless someone came along and jumped em."

"Can't I help you do it, Uncle Jake? You said when I first came, that it would have to be done soon."

Old Jake laid down the paper he was reading, and glared at his nephew.

"Brick," he said wrathfully, "you jest better tend to yer own business of gettin' well, and let me tend to mine."

Philip didn't know that a guilty conscience prompted that harsh answer. The assessment work should have been finished; but Jake Mason, hopeless victim of gold fever, had neglected the work for which he was paid because, having found signs of gold, he was feverishly digging on his own holdings.

Chagrined and angry, the boy went out on the porch and threw himself down in an old hammock, made of barrel staves.

The old crab is worse than no company, he thought, and this old place is worse than bare desert. I could stand the sand, and the heat, and the silence.



but these spooky old empty shacks give me the heeby-jeebys.

The place, literally a dead town, was unspeakably desolate and ghostly under the desert moon. About two score unpainted frame buildings sprawled along the single street. Some had broken windows and warped doors, some sagging roofs and bulging sides, some completely collapsed, were a mass of wreckage. A four-foot board sidewalk, about every third board missing, the remainder half covered with drifted sand, added its bit to the dreary ensemble. Looming huge in the moonlight, hugging the black rocky side of a hill whose base was literally honeycombed with shafts and tunnels, was the old stamp mill. This mill and the small cottage occupied by Jake Mason, caretaker, were the only buildings which had escaped encroaching ruin.

Philip had never been so poignantly lonely in all his sixteen years. In spite of his best efforts, home memories came crowding in. Way back in Los Angeles the boys would be playing tennis out on the old playground; or perhaps they would be in the good natured jostling crowd around the box office of a popular movie; or maybe someone would be giving a party. Lights! Life! Laughter! Here — ghostly moonlight, deserted shacks and, away out on the mesa, the shrill lament of a lone coyote!

Philip grinned wryly as he listened. "Them thar's my sentiments tew, old chap," he muttered; "You express 'em better than I could myself. Well, got to keep a stiff upper lip. Guess I might as well turn in."

Phil slept on a cot in the living room. The light was out when he went in. "Wouldn't have hurt him to leave it burning. He must be in a sweet humor tonight," grumbled the lad under his breath. As he fumbled on the table for a match his hand struck a hard object which rolled to the floor with a thud. When he had lighted the candle and looked to see what had fallen, he barely suppressed a yell. There on the floor, grinning horribly up at him was a human skull!

"He did that on purpose, the old pirate!" gritted Phil between clenched teeth. "I knew he had that old Indian skull, said he dug it up in one of his tunnels, but it scared me just the same. I don't think much of his brand of humor."

When the boy was ready for bed, and had put out the light, the wonderful moonlight drew him to the window.

"Almost as bright as day," he thought, "I believe I could see to read by this light. What the dickens? I must be seeing things! Did I see him, or didn't I? I don't see what a man would be doing hanging around that old shack. Ought I to wake Uncle Jake and tell him? Just get cussed out if I did, I suppose. I'll tell him in the morning. Omygosh! What a night of alar-ums!

I won't sleep a wink." He was asleep, however, almost as soon as he touched the bed.

A vigorous yank on his big toe awakened him.

"Hey Brick! Brick! Goin' to sleep all day? I've et already. Left a snack fer you out on the stove. An' say, I'll get supper tonight. Them biscuit you made last night would take the old stamp mill to grind them up."

"Brick" yawned and stretched luxuriously. The desert air had begun its work of healing. He felt "keen" this morning. His grouch of the night before had vanished. His heart warmed to the grim old man as he watched him striding stiffly out to his daily battle with the desert for its hidden gold.

Philip was so constituted that he must talk; so as he arranged his breakfast on the little rough board table, which he had covered with a clean flour sack, he talked to himself.

"Poor old duffer! His heart's all right. He's just lived out here among the cactus so long that he has turned into a sort of cactus himself. Mighty decent of him to have me here at all. Yes, sir, it's mighty decent of him; and in lots of ways he's pretty darned good to me." He smiled as he thought of the day his uncle had led him out to a big pile of "tailings" and showed him how to use a dry washer.

"I don't want you taggin' round after me the hull time," Jake stated quite frankly. "I just can't work with so much chinnin' goin' on. This will give you something to do. There's quite a lot of free gold left in this dirt. Someday they'll bring new machinery in here, an' work it over, I reckon."

So Philip had spent much of his time working at the old dump, and was the proud possessor of a small "poke" of yellow gold dust mixed with some flake gold and a few tiny nuggets.

After breakfast he went out to begin his day's labor. But this morning he did not work long. As he rocked the old washer back and forth, he had an uncanny feeling of being watched. A disturbing thought struck him. He had forgotten to tell his uncle about the man he saw, or thought he saw, the night before. Knowing that the caretaker's first duty was to keep trespassers away he felt uneasy. He debated with himself;

"Ought I to go after Uncle Jake and tell him? Tell him what? A vague tale of a shadow in the moonlight? No." He must have something more definite than that before he disturbed the irascible old man. But a sort of sixth sense warned the boy that trouble was afoot. The day dragged slowly as he pattered about the house. He got out an old Colts revolver and strapped it on in true Western style. He had spent some time in target practice. He regretted that he had not spent more. He told himself that he was a fool; that his fears

were groundless. Still it was with a feeling of relief that he saw his uncle coming home, early in the afternoon. But the feeling was short lived, for he soon saw that something was wrong. The old man staggered as he walked, he stumbled and almost fell.

"What's the matter, Uncle Jake?" Phil called as he ran to meet him.

"I've struck it, Brick! I've picked up the vein!" the old man shouted. Then he pitched forward on his face.

Philip's first thought was that his uncle was dead, but he soon found that he had only fainted.

"I'm sure glad that I had that training with the Boy Scouts," he thought, as he got the slight old man on to his back, and carried him into the house, where he applied first aid treatment. The patient soon regained consciousness, but he was weak and shaky, with a blinding headache.

"I got so excited when I uncovered that vein that I dug in too hard fer sich a hot day," he said. "I'll be all right when it gets a little cooler."

But Philip was not so sure. The old man was burning up with fever. He slept uneasily, and muttered crazily to himself, always about the gold. All through the afternoon Phil applied cloths, soaked in cold water from the Mexican olla, to the invalid's head, and gave him the simple remedies he had at hand. Toward evening Jake became quiet, and his sleep seemed more natural. Phil, much relieved, stood at a western window watching the glorious spectacle of a desert sunset. He remained there, completely absorbed, until the marvelous colors had faded and dusk had fallen.

As his mind came back to material things it registered a flare of light in the shack at the end of the street. The old uneasiness, forgotten in the stress of his uncle's illness, returned.

"There's something rotten in Czecho Slovakia," he muttered. "That was the flare of a match. That fellow is still there, and he has no business there. No use to tell Uncle Jake, he couldn't do anything, and it would only worry him."

He finally decided to investigate for himself. It might be a dangerous thing to disturb the intruder; so he slipped cautiously from house to house, hugging the shadows. When he neared his objective, he dropped to his hands and knees, and slowly, silently approached, until he crouched just under the broken window behind which he had seen the light. He could hear voices, one harsh and bullying, the other nasal and whining. He of the harsh voice was doing most of the talking;

"Better lay off that bottle," he growled. "We got to get out o' here by daylight tomorrer mornin' an' you'll need what few brains you've got to drive yer old fliver. You ain't like me. I

(Continued on Page 62)

# The Infradyne Amplifier

An Interesting Account of Its Evolution and of the Reasons for its Peculiar Design Features

By E. M. Sargent

THE heart of the infradyne circuit is the three stage tuned radio frequency amplifier that operates on 86 meters and which is known as the infradyne amplifier. The development of this amplifier involved many months of experimentation and a great deal of research work before success was achieved.

The infradyne circuit consists of two stages of radio frequency amplification at the incoming frequency, a mixer tube, three stage of radio frequency amplification in the infradyne amplifier, a detector and two stages of audio. The two stages of amplification at the incoming frequency are not particularly efficient, because of the fact that this part of the circuit must be varied over the whole waveband and it is almost impossible to make an amplifier which will work efficiently at all wavelengths between 200 and 550 meters. This input amplifier is in the infradyne to increase its selectivity. This throws the main burden of amplification on the infradyne amplifier, and it is therefore important that this be very efficient, being comparable in efficiency to the intermediate amplifier of a super-heterodyne.

When we first started to develop this circuit we did not know at what wavelength it would be necessary to operate the infradyne amplifier. Our first experiment was performed using a neutrodyne adjusted to 200 meters for the intermediate frequency. This worked very well, except that the resulting receiver had a blank spot on the dials around 400 meters, the point at which the oscillator and the incoming wave crossed each other. From this experiment we readily saw that the wavelength of the intermediate amplifier would have to be less than half of the lowest wavelength that we desired to receive. As we wanted the receiving set to be efficient at 200 meters, it meant that the intermediate amplifier would have to operate at a wavelength of less than 100. We therefore next proceeded to reduce the wavelength of the neutrodyne.

The reduction of the neutrodyne's wavelength was accomplished a little at a time. A few turns would be removed from each of the secondary coils and an occasional turn from the primaries and the neutralizing tap changed to a new position before each test was made. In this way the wavelength of the neutrodyne circuit was gradually reduced to 150 meters.

Up to this point the Infradyne circuit as a whole had operated very well,

exhibiting extreme selectivity combined with good sensitivity. In fact, the only drawbacks to the circuit in this form were, first the blank spot on the dials at twice the wavelength of the intermediate, and second the fact that the oscillator was traveling through the broadcast wave band. However, as soon as we dropped below 150 meters the selectivity of the circuit suddenly disappeared and the whole infradyne was no more selective than a good two stage radio frequency set operating on the main wavelength. At first it was thought that this decrease in selectivity might be a natural process which was fundamental in the set because of the fact that changing the broadcast frequency to a higher one, according to the selectivity formula, will naturally broaden it. Investigation proved that this was not the case, as our loss of selectivity was entirely too sudden and too great to be accounted for in this way.

teristics than the circuit through the grid to plate capacity of the tube and the primary of the next coil, the result was two circuits of slightly different wavelength reacting upon each other. The capacity of the tuning condenser was no longer high enough to eliminate the effect of these stray circuits and therefore the tuning of the neutrodyne became much broader as the wavelength was decreased. Continued experiments indicated that this circuit would not be suitable for the extremely short wavelengths at which we wanted to amplify.

Next the circuit shown in Fig. 2 was tried. This is known as the bridge circuit. As the stray tuning circuit through the grid to plate capacity is exactly counterbalanced by the neutralizing capacity it appeared that it would do everything that was desired. A split condenser is required with the bridge circuit in order to tap the center of capacity, but this split can be obtained by two small fixed con-

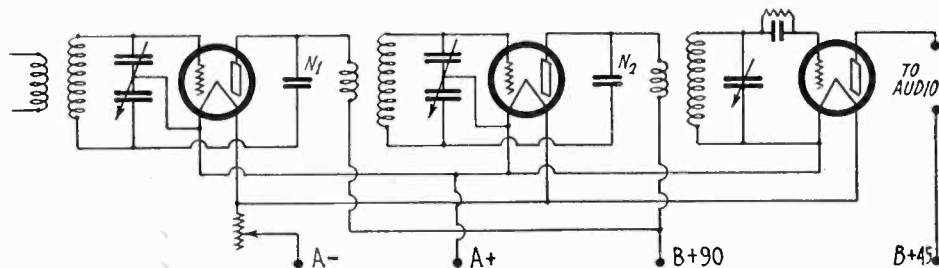

Fig. 1. Hazeltine Neutralizing Circuit.

Fig. 1 shows the circuit diagram of the neutrodyne that was used in this experiment as the intermediate amplifier. As the wavelength of this neutrodyne was dropped below 200 meters it was necessary to maintain a high inductance to capacity ratio in order to get good amplification and by the time the wavelength was reduced to 150 meters, the capacity of the shunt tuning condenser was less than .00008 mfd. The neutralizing circuit through  $N_1$  to the point  $B_1$  on the coil and thence through the bottom part of the coil to  $C_1$  now began to have a very definite effect on the tuning of the neutrodyne. As this neutralizing circuit was of slightly different charac-

ters connected in series and both of these can be tuned by a single variable condenser connected in parallel across the two.

Substituting this bridge circuit for the intermediate amplifier, we were able to drop the wavelength to 90 meters, meantime of course, making the necessary changes in the coils. However, as the wavelength was dropped it became a more and more difficult process to adjust the circuit to neutralization. The tuning condensers had a maximum capacity of not over .00005 mfd. and the condensers used for neutralizing were one third of this capacity. The neutralizing condensers then had a very pro-

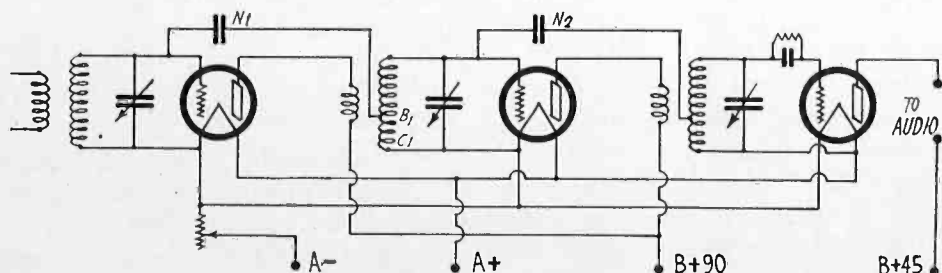

Fig. 2. Bridge Method of Neutralizing.



nounced effect upon the tuning of the circuit and it took the services of a radio expert to tell when these condensers were adjusted at the neutralizing point. Any adjustment of the neutralizing condensers would stop oscillation because if they were not neutralized they would detune the circuit enough to stop it and consequently the resulting amplifier was a seven control affair, which was impractical.

4 in., the amplifier will lock up in uncontrollable oscillation. The fixed condensers must be mounted horizontally, because if they are turned up edgewise the capacity between them will be great enough to by-pass an appreciable part of the high frequency energy. The circuit as a whole must be laid out in such a way that the easiest path for the high frequency current to follow is along the

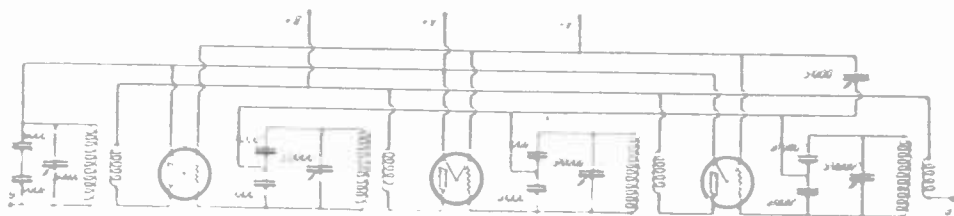

Fig. 3 Circuit Diagram of Infradyne Amplifier Unit

After a great deal of experimenting the circuit shown in Fig. 3. was developed. This is the circuit which is now used in the infradyne amplifier unit. In the strict sense of the word this is not a neutralizing circuit. Instead of neutralization the effect of the tube capacity is eliminated by a radio frequency choke in the plate circuit. This radio frequency choke is also the primary of the next radio frequency transformer. The coupling between the coil and condenser circuit and the input of the tubes is varied through a 0005 mfd condenser. Decreasing this capacity decreases the coupling to the point at which oscillations cease. This method of stopping oscillations is so efficient that a very large primary to secondary coupling in the radio frequency transformers can be used with the result that a good transfer of the signal energy is obtained. The variation of this coupling capacity does not affect the signal strength but merely stops the self oscillation of the circuit. It also has the effect of sharpening the tuning of the circuits as the damping effect of the tube on the tuned circuit is much less with this connection.

An examination of Fig. 3 would lead to the conclusion that the grids of the radio frequency tubes are "open." However, such is not the case because due to unavoidable leakage through the condensers and the tube bases as well as inside the tube itself enough grid leak is present to keep the tubes at a constant grid bias. Measurement of the plate current drawn by the tubes while in operation indicates that the grid bias is about 5 volts which is the point on the characteristic curve at which the tubes amplify best.

As has been stated in previous articles the relative positions of the parts in this amplifier play an important part in its success. This is particularly true of the position of the coils in respect to that of the tubes. If the tubes are placed in the field of the coils even at a distance of 3 to

wires on which it is desired to have it travel.

During the development of the infradyne amplifier 301-A type tubes were used. The '99's were later substituted because it was found that the amplification with either type of tube was the same and the saving in filament current with the '99's made it worth while to use the small tubes. The difference in capacity between the 301-A and the 99 is not enough to make any difference in the amount of amplification that can be obtained.

When the infradyne amplifier is used in the regular ten tube Infradyne circuit the wire from the plate of the mixer tube to the terminal marked "plate" on the amplifier is an 80 meter lead and consequently should be run as short and direct as possible. This lead should be as far away as practicable from other metal objects as otherwise some of the high frequency energy will be by-passed before it enters the amplifier. The importance of running this lead in the right way will be readily understood when it is stated that a piece of shielding 1 in. long placed around this wire and grounded will by-pass the 80 meter input to the amplifier so effectively that even a closely coupled wavemeter cannot be heard through it.

In using electric lamps for voltage control for battery eliminators be sure to use the exact size lamps specified in the instructions and do not substitute other sizes as such lamps are of such high resistance that even a change such as the substitution of a 40 watt lamp where the specifications call for a 50 watt one will throw your potentials hopelessly out of balance, and may destroy the efficient operation of your set.

Unaccountable noises may originate from high resistance ground connections. If you suspect such a thing, try a 50 ft. length of insulated wire as a counterpoise.

## THE RADIO SEASONS

By C. STERLING GLEASON

AND it cometh to pass that once more are gone the days of the summer, and winter draweth near. And our scribe sitteth himself down and pondereth long and deeply, and his musings follow this wise: The year of radio divideth itself into four seasons.

The first of these cometh with the passing of summer and the approach of autumn. The radio man sitteth before his receptor, and listeneth desultorily to what passeth upon the air, and lo! his heart is gladdened and his pulse quickens for the static crasheth less loudly and gone is the constant frying which drowneth the far distant signal. And there remaineth but few of the violent noises which of late so paineth his ear, but instead is heard the live crackling which indicateth that somewhere is life separated not by the impenetrable dead wall of incessant static. And the fan of radiocast heareth a far-off carrier wave which pulsateth and straineth at the bonds of summer; he sitteth patiently in the hope of hearing pronounced the call letters thereof, and trieth connecting once more the long antenna, in the place of the short indoor wire of the summer months. And the ham in his shack taketh the old "one-step" from the shelf where it hath reposed during the long months of summer, and connecteth it to the detector, whereto he hath formerly attached the 'phones because of the loudness of the static. And he beareth as from afar the faint peepings of countless far-off cw's, and longeth mightily for the return of the golden season of great distance. Even at sea doth the commercial op sense the passing of the dog days and curseth less fervently the chance which hath given spark signals the consistency of mush and the semblance of static when received on an oscillating detector.

Now is begun an era of new life. Everywhere is heard the sound of the drilling of panels and the hiss of the soldering iron. Once more the gathering customers bring gladness to the heart of the radio dealer, and the cash register is heard singing its joyful song. The newspaper again printeth schedules of distant stations, and on the news stands appeareth the call-book and the log. The periodical of radio turneth from battery eliminator and static eliminator to circuit tricks and distance dope. The service man droppeth many a gentle hint as to rebuilding and remodeling, and mentioneth casually the wonderful results neighbor Jones across the highway enjoyeth from his rebuilt Dynaplex. The distance map is renewed, and the tube rejuvenated. Once more the president calleth together the radio club, and the clubhouse is full to overflowing, so that the davenport groaneth and the porch is filled with many soap boxes. The wise

(Continued on Page 88)

# The Maze of Radio Patents

An Expert Opinion Concerning Tuned R. F., Grid Leak, Regeneration, Superheterodyne, Tube and Other Patents

By *John Flam, Radio Patent Attorney*

TO the average radio amateur, the patent situation on radio material and systems may seem to be of little interest. Even if he infringes any of the live patents, he realizes he can escape responsibility. What self-respecting and proud hunter of the lords of the jungle would give attention to a mouse?

Yet, the general belief to the contrary notwithstanding, the use or construction by an individual for private use may be an infringement of a patented scheme, provided it is not an experimental use. The immunity enjoyed by such a private user is due to the impracticability of spending time and money to stop him. Furthermore most amateurs have sufficient academic interest in the subject to warrant a brief discourse on radio patents.

Although the Radio Corporation of America controls a large number of patents, yet we find many competing manufacturers who have a sure standing in the field. Especially is this true in the case of broadcast receiver set manufacturers. Undoubtedly some of them infringe important patents; but still others are entirely justified legally in all they are doing. After all, no group or clique, no matter how strong or influential, has a monopoly on brains, inventive skill, and enterprise.

The best example at the moment is seen in the court decision involving the Hazeltine neutrodyne patents. Hazeltine licenses were sued on a patent to Rice owned by the General Electric Co. and controlled by the Radio Corporation, on the ground that what Hazeltine has done was a mere improvement on Rice, and therefore subordinate to him. The court however held otherwise, and decided that Hazeltine's schemes were free of this charge of infringement. It will be interesting to learn the outcome of the appeal taken on this decision.

The "disinterested onlookers" probably feel glad at Hazeltine's victory, whether the decision was technically sound or not, for Hazeltine at least played a large part in popularizing radio frequency amplification. The effect of the decision is simply this—that Hazeltine's licensees can continue to manufacture neutrodynes without molestation from the Rice patent.

Naturally the inquiry is put forth whether radio frequency amplification by itself is free from infringement; in other words, are there not other patents that would prevent the use of radio cascade amplification? In this connection, it

must be borne in mind there are other amplifier patents upon which the Radio Corporation has already brought suit; the most notable being the Alexanderson patent 1,173,079, purporting to cover tuned radio frequency amplification. A decision on this patent by an eastern court is expected shortly.

Although there is considerable doubt about the validity of this patent, it cannot be safely ignored by the manufacturer. The scheme shown in that patent had widespread use, and if held valid in court, would give its owners a whip hand over a majority of set builders. The circuit in this patent shows the familiar tuned grid circuit, applied to each radio frequency amplifier in cascade.

At this stage the reader probably realizes that there are many hazards that a manufacturer of radio sets must overcome. It is foolish indeed to assume that the expiration of such epoch making patents as the original De Forest audion patents, leaves an opening for making practical use of it without getting into hot water. And even if the wise manufacturer makes no tubes but furnishes only the "chassis," he finds numerous circuit arrangements that must be avoided; at least until the corresponding patent expires or is invalidated.

Leaving for the moment the question of amplification, how are the various detection schemes covered? One of the most interesting is the Langmuir grid leak patent 1,282,439, upon which several suits have already been started. It purports to cover broadly the idea of providing a high resistance path in the input circuit of an audion to permit the negative charge from the grid to leak off slowly. Substantially the same scheme is also covered in a De Forest patent, and if the Langmuir patent will be held invalid (as it very likely will be), the De Forest patent must still have to be coped with. In an eastern suit on Langmuir, much pertinent testimony was taken to show that De Forest as well as others, used the grid leak idea before Langmuir's invention date. There is a possibility that grid leaks will be held to be public property; but of course, we must wait for the decision.

The process of litigating patents is a long drawn out one, and it will probably be another few years before the decisions on the scope and validity of all the important ones will be crystallized. In the meanwhile, the manufacturers must size up the probabilities for themselves, and in many instances any of them

may be made to sustain the burden of the litigation if he is to continue in business.

The most unfortunate feature of the whole business is that a mere threat to sue is sufficient to intimidate many of the smaller manufacturers, who have not the means to fight such suits even if they feel that justice is on their side. To many of them, who are inexperienced, a patent looms as a formidable threat. To others, who are wiser, such a threat does not cause a panicky scurrying about, but often induces a wholesome, careful survey of the situation by competent experts. When it is remembered that the Patent Office grants many invalid and baseless patents, the patentee is not necessarily in an impregnable position. Nor is it often the fault of the Patent Office that such patents are granted; for the examiner has no facilities for investigating the prior field except as exemplified in prior patents and publications. Often a device or scheme is public property by long continued public use, of which the examiner knows nothing. This was very likely the situation with respect to the Langmuir grid leak patent mentioned before.

Sometimes the patent situations on a certain scheme takes a complete reversal and performs many peculiar acrobatic feats. Such was the case in regard to the Armstrong patent on regeneration. This patent, issued in 1916, will expire in seven years. It has been held broadly valid in many courts; but in a recent decision, all but five or six of its claims have been held invalid because De Forest, and not Armstrong, was held to be the first inventor.

The story of De Forest's uphill climb to recognition is almost like fiction. A prolific and brilliant inventor, he has time and again failed to profit from his genius due to some seemingly unimportant obstacle. Back in 1912, he experimented with the audion and obtained a beat note by heterodyning, the audion acting as a generator of high frequency oscillations. His circuit was, of course, regenerative.

Armstrong, however, obtained the patent on regeneration, and a few years ago, sued the De Forest company for infringement thereof in New York. Although De Forest attempted to show that he was the prior inventor, both the District Court and the Court of Appeals in New York held that his heterodyning experiments were mere experiments; that he did not himself appreciate their importance; and that he did not know



how to duplicate them. Armstrong was held to be the first inventor, his patent was held valid and infringed, and broad enough to cover the oscillating audion.

Despite this serious setback, De Forest proceeded with his pending applications on regeneration and oscillation. These did not mature into patents until about two years ago, and only after hotly contested interferences with Arnold, Langmuir, Armstrong and Meissner, who each had applications attempting to cover the oscillating audion. In these interferences, the Patent Office repeatedly held against De Forest, and he had to appeal to the Court of Appeals of the District of Columbia, which awarded him priority, the patents issuing thereupon after having been pending in the office for about ten years. In this decision, the court gave due weight to the adverse holding of the New York court, yet it held that the points to be decided were not similar in the two cases; however, since this District of Columbia case decided that the 1912 experiments of De Forest were not abandoned nor valueless, it is apparent that the two decisions were in hopeless conflict.

De Forest then proceeded to have the Armstrong patent held invalid in a Pennsylvania court, on the ground that there was a conflict between Armstrong's and his patents. A few months ago, that court held that many of Armstrong's claims were invalid in view of De Forest; it followed the District of Columbia case in preference to the New York case. Thus we now have this interesting situation—two comparatively recent patents replacing an older one for the same invention, thereby prolonging the patent monopoly. When it is taken into consideration that due to transfer of rights, the Radio Corporation nevertheless obtains control of the De Forest patents so far as they pertain to radio, the only thing De Forest obtained is the personal right for his company to use regeneration as described in his patents. The net result is, then, (1) a change in status of the Armstrong licensees who ostensibly have acquired no rights under De Forest, and who probably cannot obtain any such rights; (2) acquirement of valuable rights to regeneration by De Forest and his company; and (3) a prolongation of the time when regeneration, broadly, can not be practiced by anyone generally, due to the lengthened monopoly secured under De Forest.

Some of the more hopeful manufacturers feel that even the De Forest patents can be invalidated, making regeneration public property. So far there has been no attempt to do this. Undoubtedly also further appeals may be taken by the Armstrong interests; but in view of the tie-up with De Forest through the contracts mentioned, these interests are probably satisfied to let matters stand as they are.

It must also be borne in mind that

De Forest does not cover *all* forms of regeneration; for example, the few claims Armstrong retains cover the idea of having an inductance in the filament lead which is common to both the input and the output circuits, when used in receiving sets. Furthermore, for providing oscillations, Hartley has probably a valid patent on the so-called Hartley circuit, utilizing an oscillating circuit, points of which are in *direct* connection with the electrodes of the tube. This is probably an improvement on De Forest, who shows a grid condenser, not found in Hartley. The theories of operation of the two systems are also patentably distinct. This Hartley patent is owned by American Telephone and Telegraph Co., which granted rights in the radio field to the Radio Corporation. Naturally, neither De Forest nor the public can utilize the Hartley system.

An important circuit well covered by patents is the superheterodyne, the patent on which is most likely valid. It has recently been held that the sale of superheterodyne kits, knowingly sold for constructing a superheterodyne set, is contributory infringement of the patents covering it. Of course, transformers, condensers, and so on can obviously be sold if not individually covered by patents, but not if it is intended that they be used in an infringing manner.

So far, our discussions were confined to radio sets. How does the patent situation stack up with respect to *tubes*, the heart of radio. There are seven or eight large manufacturers of tubes for use in such sets. The most important patent on this is the Langmuir high vacuum tube patent. Almost all sets use "hard" amplifier tubes that have a high vacuum. Therefore, if this tube patent is good, all such tubes made by unlicensed manufacturers are infringements. The expiration of the original De Forest audion patents would under such circumstances help little.

The patent is very ingenuously written to cover tubes that produce substantially pure electronic flow without ionization at definite high voltages. In the early days of the audion, 30 or 40 volts were about as high as could be impressed on the output circuit without producing undesirable ionization; however, it is quite certain that De Forest as well as others tried their best to increase the degree of vacuum. If the Langmuir patent is to fall, it could very likely succumb to an attack based on the contention that it covers merely a result which was long sought after, and not anything that is generically new. In other words, it would be questioned that a valid patent can be granted on a device the possibilities of which were well known, and rendered capable of manufacture by the discovery of more efficient means for evacuation. The degree of vacuum desired was simply not practicably obtainable before. Langmuir produced a device that

differs only in degree from what had already been produced.

The fact that a large number of tube manufacturers are proceeding to make and sell hard tubes in the face of this patent indicates that there is no appreciable acquiescence by the public in its validity. The patent holders will probably find it hard to convince a court that it was properly granted.

There are numerous other patents that bear on tube manufacture. For example, the material used for the filament is covered. Even if a plain tungsten filament be used, such tungsten cannot be efficiently manufactured without infringing the classic Coolidge and Just and Hanaman patents, both of which have been repeatedly held valid in eastern courts, both lower and appellate. Other patents of interest are those involving structure—the manner of holding the various electrodes, the shape and size and material of the electrodes, and the very lead-in wires that connect the electrodes to external circuits.

No mention has been made of the situation regarding the machinery for making the tubes. Of course these are also patented, but can readily be avoided by the use of well-known hand methods; these however involve expensive operations.

There are other comparatively minor patent situations which it is probably worthwhile to discuss summarily. A Hogan patent ostensibly covers the idea of simultaneous tuning of a plurality of circuits, and is of interest in connection with the present vogue of one dial sets. It is probably doubtful whether that patent is any obstacle to the marketing of such sets.

The actual conversion of radio waves into speech, or vice versa, also offers considerable speculation from a patent standpoint. The old time loud-speakers are gradually giving way to more artistic and efficient devices, in which many ingenious patentable ideas are incorporated and protected. It is understood that Baldwin is starting a series of suits against infringers of its unit, which probably will be sustained as of considerable value and as valid. In the future, there will probably be several hotly contested suits involving the newest addition to the loud-speaker art—the piano unit, which utilizes the piano sound board in place of the usual paper cone. So far as is known, no patents have as yet been issued on any such units, but there are undoubtedly several on the way.

This article makes no attempt to discuss the situation regarding commercial radio, such as toll service or ship service. This situation has intricate angles of its own. Tube transmission being largely controlled by the Radio Corporation, it is obviously under no obligation to license others to sell broadcasting or toll transmitting stations, or indeed, to sell any such systems. The Supreme Court has

(Continued on Page 70)

# The "Mindector"

## A Circular Toroid with Minimum Damping

By O. C. Roos

THE true amateur always experiments and calculates in a race after the best. His work on the circular toroid has been almost as fruitful a field of dispute as "low loss" condensers and "Litz" wire. All three have suffered from the disinclination of independent experimenters to take up the problems thoroughly and yet to present them simply after wading through an ocean of analysis.

The circular plate S.L.F. and S.L.W. condenser changes the argument regarding the usual requirements of "low-loss" design: yet no one has yet published the results. "Litz" made from quadruple cotton-covered wire is a far different proposition from ordinary Litz. Take 40 ft. of it and build up a coil, then compare the inductance-resistance ratio at r.f. with usual "Litz" coils. You'll be surprised!

In the same way the toroid has been hailed and abused. The doughnut or circular form and the rectangular form have been pitted against each other. The circular form, with its smaller self-capacitance, was supposed to be the most economical of wire. The idea of compactness in a coil or ratio of inductance to outer diameter was also dragged in and publicity over this item widely invoked. So it has gone, until the real worker has wondered if there was not less fire than smoke,—if the circular toroid is not more critical in design for

either wire-economy  $Ew$  or inductive  $C_i$  than some other shape.

At radio frequencies, wire economy does not necessarily mean coil efficiency, or inductance divided by resistance. This  $L/R$  ratio is not practically proportional to the wire-length in a coil, unless—and this is important—the wire separation is at least twice the wire diameter, and the shortest wavelength is at least 12 times the wirelength in the coil. When the above conditions are to be met we can use No. 26 solid with 6 turns per cm. as wire spacing,  $n$ . Fig. 1 illustrates the layout for two circular toroids of the same outer radius,  $OD_o$ , but with inner radii equal to  $Ob$  and  $Od$ , and with the wire spacing about the inner periphery  $abs$  equal to 6 turns per cm., it is obvious that there will be three times the number of total turns on the toroid of the smaller cross-section, which has one-third the radius of the larger. As the total turns get larger the individual turns become smaller and a maximum length of wire is used when the inner diameter is half the outer, as shown in the upper portion of Fig. 1. But the inductance changes with the inner diameter, so that, length aside, the greatest inductance is obtained when the inner diameter,  $d_i$  is exactly  $4/9$  of the outer,  $d_o$ .

"Wire economy" is always desirable for the manufacturer, but also constitutes true coil-efficiency when low losses are kept in view. The measure for wire economy is  $L/l$ , but this ratio of inductance to length of wire is a mere number. It gives for a certain shape of coil the greatest wire economy. Such a coil as shown in Fig. 2 has a ratio of  $d_i/d_o = .3820$ , giving the most inductance per unit length of winding. In other words, its wire economy  $Ew$  is the greatest possible with a given outer diameter  $d_o$  and "spacing" (turns per unit length of the winding) around the inner periphery of the toroid. Such a toroid may be the most economical (M. E.), but it does not solve the problem of the most electrically efficient coil, that is, one with the minimum damping or ratio of  $R$  to  $L$  at high frequencies.

With 1600 cm. of wire and a wire economy  $Ew$  of .04 m.h. per cm. of wire—an inductance of 64 microhenries is secured. Most M.E. toroids with a spacing,  $n$ , of from 8 to 20 turns per cm. will show this value of  $Ew$ , i.e., .04 microhenries per cm., but this does not give the greatest total inductance; since a greater length of wire might show a better  $Ew$  on an M.E. toroid. The

present solution gives a better coil than the M.E. coil for electrical or tuning efficiency. The "Mindector" coil in Fig.

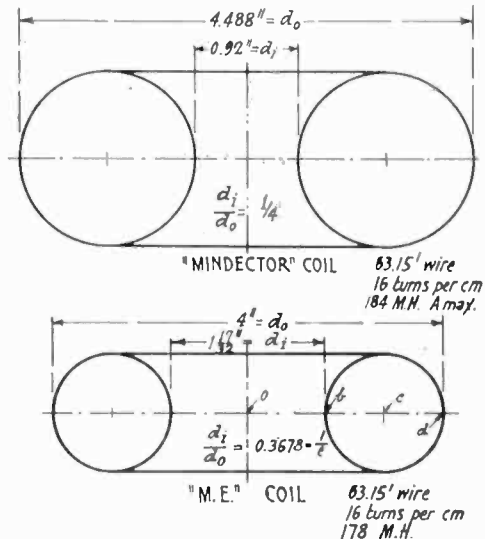

Fig. 2. Comparison of "Most Economical" with "Mindector" Coil.

2 has 3.5% more inductance than the M.E. coil with the same wirelength.

Beware of the man who tells you that the M.E. coil solves the problem of the "coil-of-least-damping." The latter must be designed so that with a given inductance it has the least wire. In other words, with a given length of wire, say 75.5 ft.—a coil of 166 microhenries as a maximum value can be constructed having  $12\frac{3}{4}$  turns of No. 28 per cm. and with external and internal diameters of  $5\frac{7}{16}$  in. and  $1\frac{23}{64}$  in. respectively.

This coil gives the greatest possible inductance with this spacing and length of wire, having 133 turns, and is shown in cross-section in Fig. 3. Such coils are

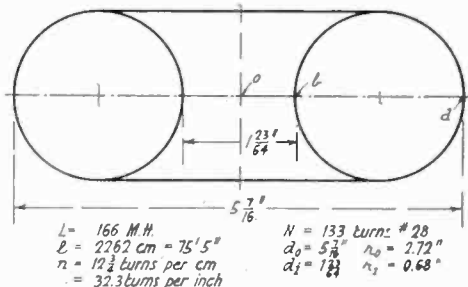
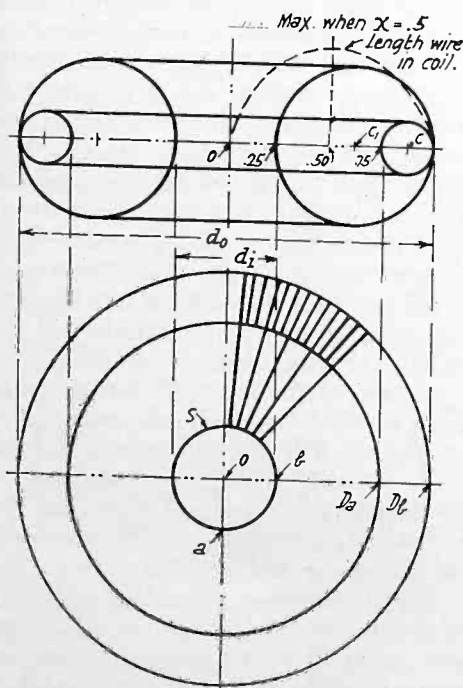

Fig. 3. Mindector Coil for 166 M. H.

not made commercially, so we shall christen it the "Minimum decrement toroid" or "Mindector." All such coils have a fixed ratio of inner diameter  $d_i$  to outer diameter  $d_o$  of .25, or  $d_i = .25 d_o$ . Hence the ratio of the radii  $Ob$  and  $Od$  or  $r_1$  and  $r_2$  respectively in Fig. 3 is .25.

If we want to have less coil bulk, with less inductance and less self-capacitance, we can wind a similar toroid  $\frac{2}{3}$  of this size with the same separation of  $12\frac{3}{4}$  turns per cm. along the inner periphery.



CONSTANCY OF TOROIDAL Wire spacing - "n" (Turns per cm. around "abs")

Fig. 1. Constancy of Toroidal Wire Spacing.



This gives us 89 turns and 33.3 ft. of wire. The toroid coil is now less bulky and yet more efficient than the general commercial types. Fig. 4 shows it with an inductance,  $8/27$  or  $.296$  of its former value,  $49.16$  microhenries,  $d_o = 3\frac{5}{8}$  in. and  $d_i = 2\frac{9}{32}$  in.

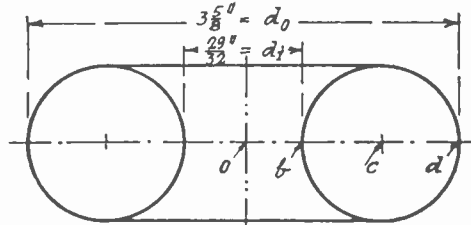

"MINDECTOR" COIL 49.16 M.H.  
Fig. 4. Mindector for 49.16 M.H.

In Fig. 3 we have a 165 microhenry toroidal coil with 133 turns instead of 160 turns; with 75 odd feet instead of 100 ft.; with an average separation between turns of 3 times the wire diameter if No. 26 is used and 4 times if No. 28 is used.

With the system of first winding the toroid as a straight solenoid and then bending the latter, either during or after the operation—the construction is simple. True, such a coil is slightly larger than usual, but we now will soon have commercial variable condensers of from 125 to 500 m. mfd., which measure less than  $\frac{1}{4}$  in. axially and  $2\frac{1}{2}$  in. radially. They

have automatically perfect alignment even under constant use.

Bulk is bad electrostatically in a coil, but cross-coupling from such sources is now controlled by commercially success-

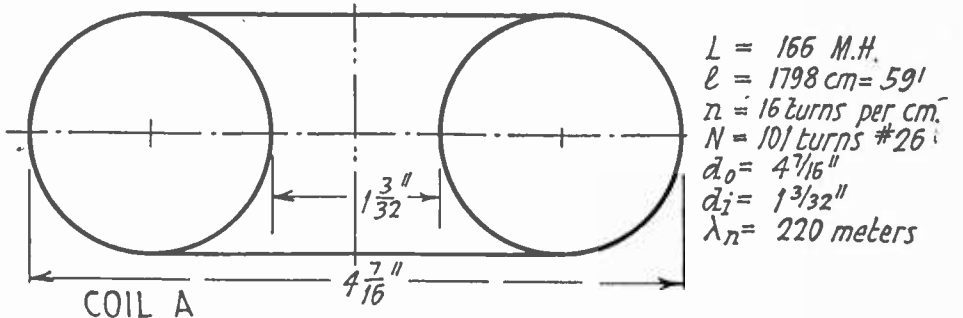

$L = 166 \text{ M.H.}$   
 $\ell = 1798 \text{ cm} = 59'$   
 $n = 16 \text{ turns per cm.}$   
 $N = 101 \text{ turns \#26}$   
 $d_o = 4\frac{7}{16}"$   
 $d_i = 1\frac{3}{32}"$   
 $\lambda_n = 220 \text{ meters}$

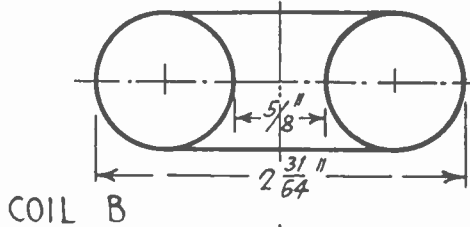

$L = 16.6 \text{ M.H.}$   
 $\ell = 178 \text{ cm}$   
 $n = 5.06 \text{ turns per cm.}$   
 $N = 18 \text{ turns}$   
 $d_o = 2\frac{31}{64}"$   
 $d_i = \frac{5}{8}"$   
 $\lambda_n = 69.56 \text{ meters}$

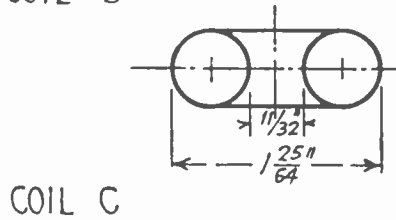

$L = 1.66 \text{ M.H.}$   
 $\ell = 17.8 \text{ cm}$   
 $n = 1.6 \text{ turns per cm.}$   
 $N = 3.2 \text{ turns}$   
 $d_o = 1\frac{25}{64}"$   
 $d_i = \frac{11}{32}"$   
 $\lambda_n = 22 \text{ meters.}$

Fig. 5. Series of Mindector Coils.

ful shielding. The "Mindector" is worthy of the amateur's time and effort. Its winding data and shape are given for No. 26, and smaller wire, in Fig. 5—to get inductance of 166, 16.6, and 1.66 microhenries. This will cover ranges of lowest tuning wave between 220 and 6.9 meters, using variable condensers of 500 and 50 m. mfd.

It must be remembered that the outside wire-spacing on the "Mindector" coil is 4 times as great as that on the inside of the coil, while the latter spacing gives at least an air separation equal to the bare wire diameter. Hence we have very low self capacitance.

To realize a gain of 3.5% in inductance over all other possible toroids with circular cross-sections is not a great practical advance, but at least it points the way to sound design and is a victory in principle. Indirectly it allows better wire spacing and greater tuning range.

The same coil shape may be used for different lengths of wire, provided the separation is also varied proportionally. In other words if we double our wire length we must also double our spacing. The inductance will quadruple and the wavelength will therefore double.

Efficient windings of flat multiple wires, of treble or quadruple cotton, may be used with reduced spacing, for the shorter waves. Flat braid consisting of 20 strands of No. 35 T.C.C. may be wound in parallel, as straight solenoids and then bent into a toroid. The effect of this current sheet in small toroids is to reduce magnetic leakage, which often takes place from the outer periphery of larger toroids. The self-capacitance is reduced and so are the relative eddy current losses. The proper method of using

(Continued on Page 80)

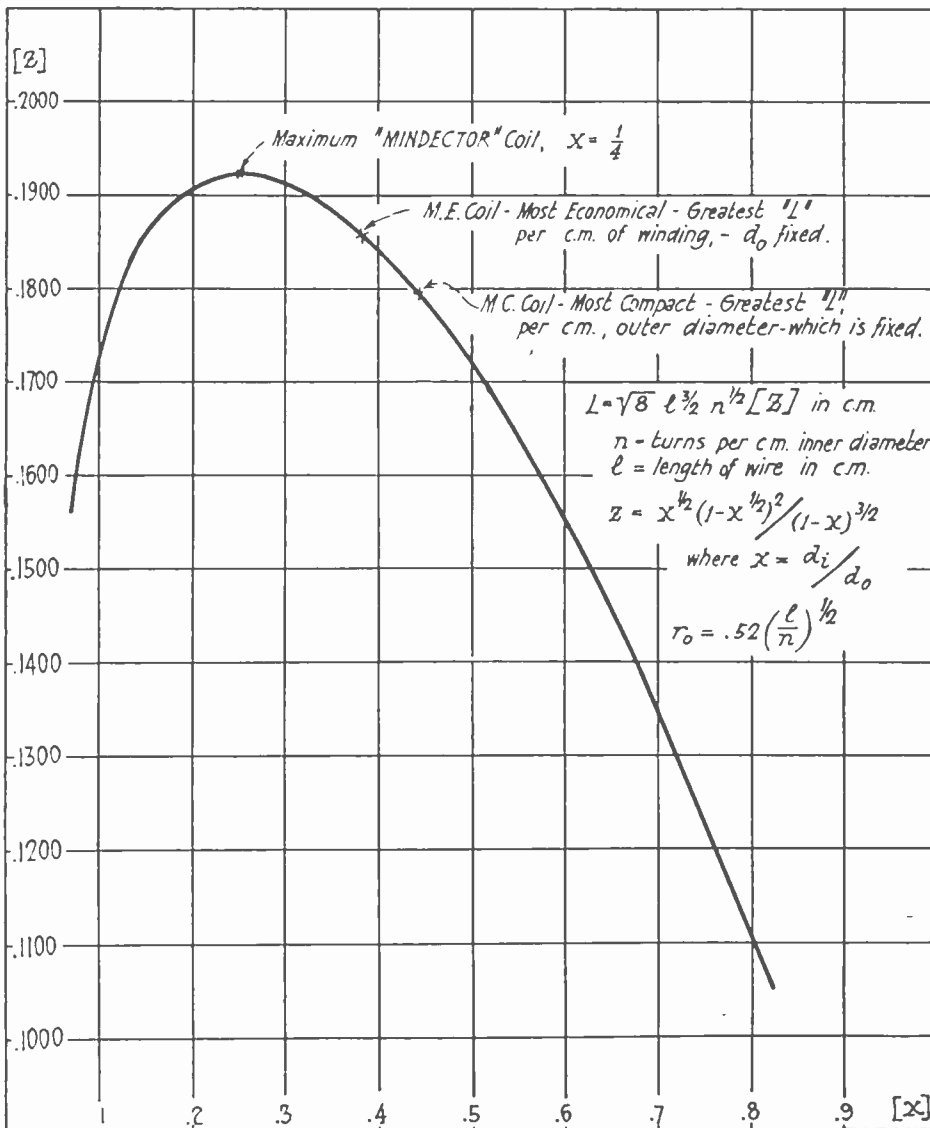

Fig. 7. Circular Toroids of Least Damping for Fixed Length of Wire and Least Spacing.

# More About The Henry-Lyford

By Elmore B. Lyford

THE interest aroused by the constructional details of the Henry-Lyford receiver, as given in October RADIO, justifies a few additional facts which answer some of the questions received. In reply to many inquiries regarding the best aerial to be used with this sensitive receiver we recommend a 70 ft. antenna, including lead-in. If necessary to use a longer one a .0005 mfd. variable condenser inserted in series with the lead-in to the receiver can be adjusted until the desired selectivity is secured. Good reception of local stations can be had with 30 ft. of wire around the moulding of a room.

The selectivity of the receiver is increased if the rotor coil of the antenna coupler is turned so that its windings are not parallel to the windings of the fixed coil within which it rotates. This will slightly reduce the volume in some cases. The tuning will be sharper.

Although the balance condenser can be set so that the receiver will not oscillate at any point of the tuning dials, the audibility of a specific distant station can be increased by adjusting this condenser to just below the point of oscillation.

The settings of the two tuning dials correspond quite closely. After a number of stations have been logged a curve or chart showing the wavelength corresponding to different dial settings should be prepared so that any other station may be easily found. The variable condensers are designed to give the maximum possible separation at all frequencies and there is no undue crowding of stations at any portion of the dial.

In answer to queries as to the use of a power tube other than the UX112 type recommended, a 210 or 171 may be used in the last stage with proper C battery voltage. If more than 135 volts B battery is used on the last tube an output transformer or a combination of a choke coil and condenser should be used so as to prevent the loud speaker coils being burned out by large plate currents.

should have an inductance of from 30 to 50 henries. The condenser should have a capacity of 2 mfd. and must be capable of withstanding the voltage that will be applied to it.

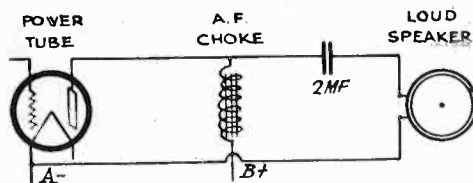

Fig. 2. Connection for Choke Coil and Condenser.

An 0-25 millimeter is recommended in the plate circuit of the last tube. When the receiver is in operation, the plate current should have a steady value. Any fluctuation of the meter indicates overloading of the grid of this tube. A fluctuation of the pointer upward indicates the need of more bias battery, and a fluctuation of the pointer downward indicates the need of more B voltage, or a reduction of bias voltage. The volume control of a Henry-Lyford should never be turned on far enough to cause distortion in this last tube—there will be none before that, if the receiver is working properly.

It will be found that the biasing voltage on the first three tubes of this receiver has a great deal to do with selectivity. The grid circuit returns of the two r.f. tubes and the detector tube are brought out together on the green wire in the battery cable, and it is recommended that 1½ volts bias be used on these tubes for all general purposes. This is the condition of maximum sensitivity, with the detector plate voltage 22½. The selectivity of the receiver may be greatly increased, however, by changing the bias on these three tubes to 4½ volts, and changing the detector plate voltage to 45 to correspond. The plate voltage of the r.f. tubes should remain 90. The receiver will now be found to be slightly less sensitive to distant signals than before, but much more selective. It will be too selective, in fact, for use in the average location, and this higher grid biasing voltage is only suggested as an interesting experiment.

One C battery, such as the Burgess No. 5540, is ample to supply all of the biasing voltages that are needed, but separate batteries may be used if desired. A single No. 950 Eveready unit flashlight cell, with wires soldered to the center terminal and the case, makes a convenient 1½ volt C battery. The center terminal is positive, and should be connected to negative filament. The zinc case of the battery is the negative terminal. Any standard 4½ volt C battery may be used to bias the first audio

tube, and another one in series with it, will supply either 7½ or 9 volts for the bias of a UX 112 tube in the last stage.

The Henry-Lyford receiver will work quite well with only 90 volts of B battery, but will not have quite the volume or quality that it has with 135 volts on the last tube. The 90 volts on the two r.f. tubes and the first audio tube, and the detector plate voltage, all come from the first two 45 volt batteries, and these should be of the heavy duty type. The third 45 volt battery is used to bring the plate voltage of the last tube up to 135 volts, and this battery may be one of the regular type, as there is not so much drain on it as there is on the first two.

Any good B eliminator may be used. If a UX 112 tube is used in the second audio stage, the eliminator should be capable of delivering 135 volts, with a tap at 90 volts, and a tap for the detector voltage. If a UX 171 or other high voltage tube is used in the last stage, the eliminator must be able to supply whatever voltage is needed, in addition to having the 90 and detector taps.

There are two other sets of plug-in coils available for this receiver. One set covers the wave-band from 37 to 125 meters, and the other set covers from 75 to 225 meters. There is a generous overlap, so that there is no wavelength to which the receiver will not tune, between 37 and 550 meters. The behavior and operation of the receiver using these coils is the same as when the broadcast coils are being used.

If the wiring diagrams and instructions are carefully followed in building this model of the Henry-Lyford, no trouble will be experienced in making it work properly right from the start. Mistakes and accidents will happen, though, and a word or two as to the best way of locating them may not be amiss. If the receiver has been all hooked up to the batteries, the tubes light properly, and everything seems to be all right, yet there is no indication of "Life" in the loud speaker, check over all the battery connections, and the antenna and ground, and make sure that the trouble is not there.

If it is pretty certain that there is trouble in the receiver, the first thing to do is to very carefully check over all the wiring of the receiver with the instructions, making sure that every wire is well connected to all that it should be, and not connected to or touching in an exposed place anything that it should not be.

Putting a pair of phones across the P and F posts of the first audio transformer

(Continued on Page 74)

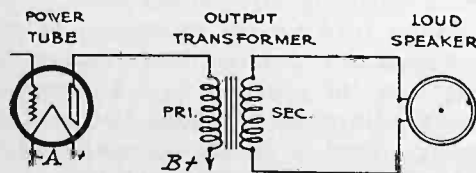

Fig. 1. Method of Connecting Output Transformer.

Fig. 1 shows the method of connecting an output transformer, with the output from the set going to the primary and the output from the secondary going to the speaker.

Fig. 2 shows the connections for a choke coil and condenser. The choke



# An Oscillator That Holds Calibration

Constructional Details for a Dependable Instrument  
Adaptable to Many Uses

By L. W. Hatry

**N**O RADIO laboratory is complete without an oscillator. It is the most useful device that an amateur or experimenter can have. Of its countless uses one of the commonest is for calibrating or logging the dials of an unknown set. It is the driver for actuating any instrument used for the accurate measurement of inductance, capacity, or other constants of a circuit.

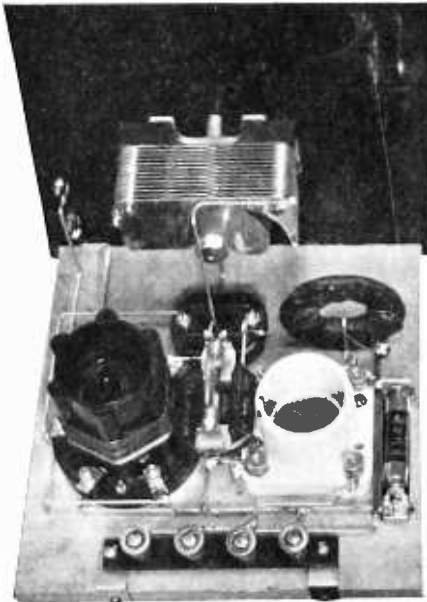

Oscillator as Assembled by Author.

An oscillator consists essentially of vacuum tube and rheostat in circuit with an inductance coil and variable condenser. It generates an oscillating current of a frequency determined by the setting of the variable condenser.

For satisfactory use it should be free from hand capacity effect, its pick-up should be controllable, and its range should extend over the entire radio waveband. It ought to be easily portable, flexible, and above all else should be permanent in calibration. These several specifications are met by the instrument

here illustrated and described. Fig. 1 shows the circuit diagram for use as a transmitter. As an oscillator the key, aerial and ground are not in the circuit.

The several parts may be either home constructed or factory built. The pick-up coils require 10 turns, 15 turns or 20 turns to cover the 50 to 110, 90 to 210, and 190 to 550 meters respectively. It should be wound with No. 30 wire on 2 1/2 in. tubing.

The grid coil requires 8, 17, and 45 turns of No. 26 d.s.c. wire for the several corresponding wavebands and the plate coil 8, 17 and 35 turns respectively, all wound on 2 1/2 in. tubing. The smaller coils should be spaced-wound with shoemaker's thread between turns. All coils should be made rigid with shellac or heavy varnish.

The number of turns required for the longer wavelengths are as follows:

Long Wave Coils about	Pickup	Grid Coil	Plate Coil
8000-20000 meters	100t	2000t	1000t
3500-8500 meters	100t	900t	700t
1500-4000 meters	75t	400t	250t
500-1800 meters	60t	125t	100t

The first three of these coils may be lump-wound with No. 32 s.s.c. cover. The last is wound with No. 30, as de-

scribed for the short wave coils. Fig. 2 shows an excellent method of protecting the coils.

The choke coil can be wound with No. 32 s.s.c. in "slab" fashion with paraffine binder. Together with the bypass condenser it isolates the tube from the B battery.

All of these coils are available in stock, the Silver Marshall 111 A. B. C and E being typical.

The condenser should be a .00035 mfd. variable, preferably of the straight line frequency type. It should be rugged in construction with heavy plates and bearings, with provision to take up the minor wear without altering the plate spacing or position. It should have vernier control and be smooth in operation and the dial should be provided with a permanent hair-line indicator.

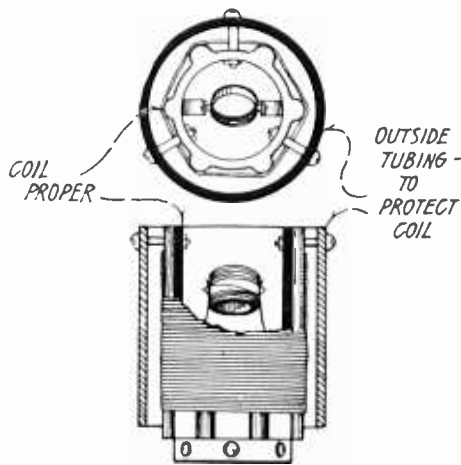
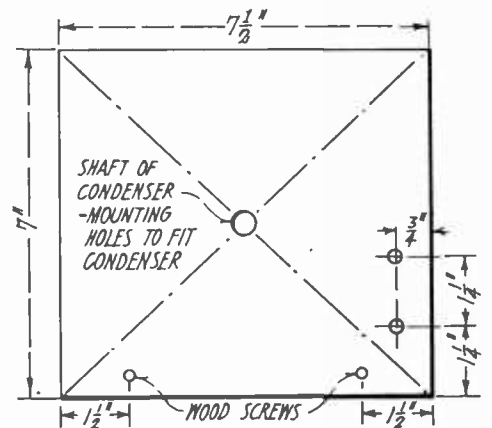

Fig. 2. Method of Coil Protection.



Panel Layout.

Other necessary minor parts are self-evident from the circuit diagram. The grid condenser should not exceed .00005 mfd. in value, as it is necessary to keep the tube capacity low in relation to the circuit capacity, so as to insure permanency of calibration. For the same reason the negative filament line should be clear of anything except the permanent and unchanging wire connections.

When used for the calibration of an unknown new receiver the experimenter first tunes in a station on a known receiver, adjusts the oscillator dial until a strong squeal is heard, disconnects the old set, connects the new, and turns the dials until the same squeal is heard from the oscillator. This locates the point for receiving that station on the unknown receiver. This process can be repeated until enough stations have been logged to enable a curve to be drawn.

Many other uses will suggest themselves to the owner of this handy instrument.

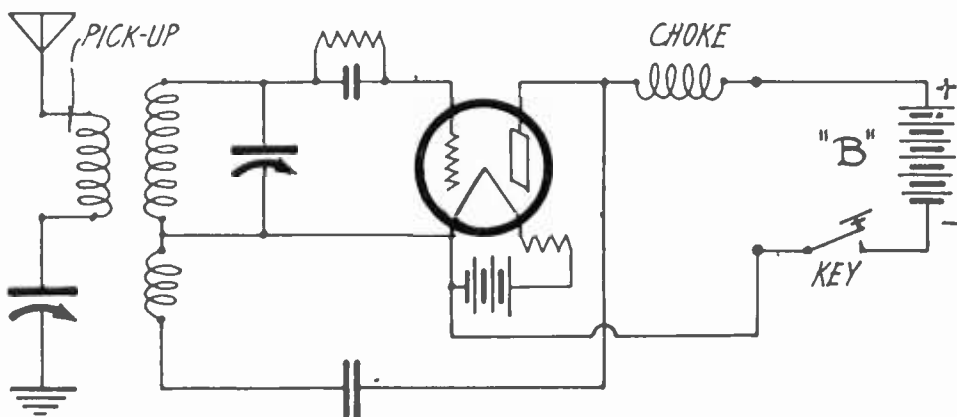

Fig. 1. Oscillator Used as Transmitter.

# An "LCR" Measuring Box

A Convenient Means for Measuring Wavelength, Capacity, Inductance, Coupling Coefficient, or Resistance at Any Frequency

By Sylvan Harris

A SIMPLE and rapid determination of the capacity of condensers, self and mutual inductance of coils, high frequency resistance of tuned circuits, and co-efficient of coupling may be made with this instrument at any desired frequency. The instrument can be easily

Pasted on the side of the box should be a table showing the precision condenser settings which are required to make the circuit resonant to different frequencies. The form of this table is indicated below:

Wavelength	Frequency	Cond. Setting	Oscillation Constant
200 m.	1500 k.c.	158	.0113
250	1200	250	.0176
300	1000	351	.0253
350	858	467	.0345
etc.	etc.	etc.	etc.

tached to the connecting-bars, adjust the precision condenser to resonance and read its capacity. Then remove the unknown condenser, adjust the precision condenser to resonance again and read the capacity again. The difference between these two capacities is equal to the capacity of the condenser to be measured. There are variations of this method which are often useful, which may be found discussed in Circular 74 of

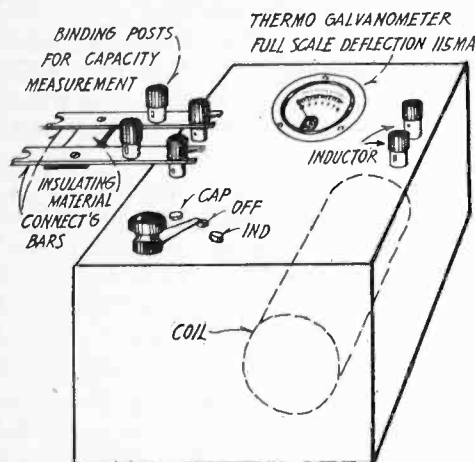

Sketch of "LCR" Measuring Box.

built from the sketch and the circuit diagram of Fig. 1. It is used in connection with an accurately calibrated condenser

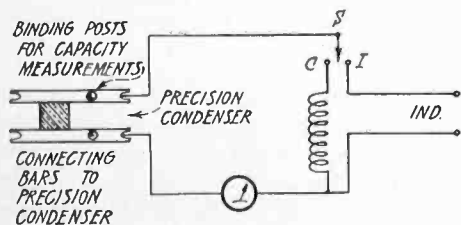

Fig. 1. Circuit Diagram of Box.

housed in a similar box placed along side and joined by connecting bars. These bars should also be equipped with binding posts to which condensers to be measured may be connected. A good oscillator driver, such as is found in almost any radio laboratory, is the only additional equipment necessary.

The LCR box itself consists essentially of an indicating thermogalvanometer, an inductance coil and a switch. A Weston thermogalvanometer having a full scale deflection of 110 milliamperes can be mounted on a bakelite panel fitted to a box large enough to hold a solenoid coil whose inductance is sufficient to cover the range from 1500 to 500 kilocycles with the precision coil connected to it. A two-point switch on the panel facilitates connection either to *C*, so as to put the precision condenser in series with the coil and the thermogalvanometer, or to *I*, so as to measure an unknown inductance. Two binding posts should be mounted on the panel for the latter connection.

The instrument thus constitutes a wavemeter in addition to its other functions. This is especially helpful when plotting curves over a range of frequencies. Suppose we wish to plot a curve of resistance of a tuned circuit over the range used for broadcasting. Before making each measurement, we simply turn the switch to *C*, adjust the precision condenser to the required wavelength or frequency, and then adjust the oscillator to resonance with the instrument, as indicated by the thermogalvanometer. The table of frequencies or wavelengths can be made up to suit one's personal needs.

If we wish to measure the capacity of a condenser, simply switch to *C* and use the substitution method wherein the condenser to be measured is connected to the connecting-bars on the binding-posts. The oscillator may be operated at any frequency, as capacity is independent of frequency, so we do not have to adjust the oscillator, excepting that we must have the precision condenser read higher than the capacity to be measured when resonance is established without the unknown condenser connected. With the oscillator thus set, and the switch on *C*, and with the unknown condenser at-

the Bureau of Standards.

To measure the self-inductance of a coil, connect the coil to the *Ind.* posts. Throw the switch to *C*, making the instrument a wavemeter. Adjust the precision condenser to the setting indicated in the table for the required wavelength or frequency, and note the oscillation constant, *LC*, for that frequency, also given in the table. Adjust the oscillator to resonance, and turn the switch to *I*. Without changing the setting of the oscillator, readjust the precision condenser to resonance, and read its capacity. The oscillation constant divided by this value of the capacity is equal to the inductance of the coil. What could be simpler? A wavemeter and measuring circuit combined, no charts to read, and no calculations to make other than a simple division! (See Fig. 2.)

Now suppose we wish to measure the high frequency resistance of a tuned circuit, such as the precision condenser connected to a certain coil. Connect the coil to the terminals marked *Ind.*, in series with a non-inductive resistance, such as a decade box. This connection is indicated in the diagrams. With the switch at *C* we can again use the instru-

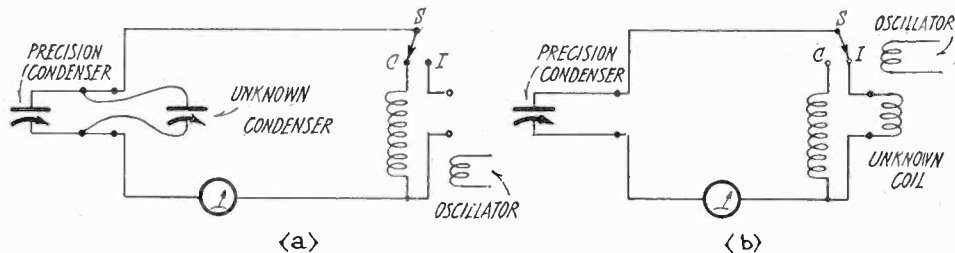

Fig. 2. Connection for Measuring Capacity and Self Inductance.

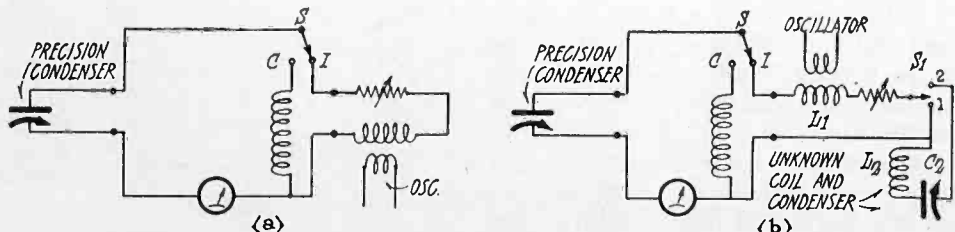

Fig. 3. Connections for Measuring High Frequency Resistance.



ment as a wavemeter, and adjust the oscillator to the required frequency. Then turn the switch to *I*. With the resistance box set at zero, adjust the precision condenser to resonance, and note the reading of the thermogalvanometer. This should be well up on the scale. If it is not, the coil should be placed a little closer to the oscillator, but not so close that reaction occurs. The coil acts as a pick-up coil. (See Fig. 3.)

Next, adjust the resistance box until the thermogalvanometer reads one-quarter the deflection that it read before when the resistance box was set at zero. Then the resistance in the box is equal to the resistance of the coil and precision condenser in series.

Suppose we are not interested in the resistance of this coil in series with the precision condenser, but wish to know what is the resistance of this coil in series with a certain other condenser. The connections are then as indicated in Fig. 3, where  $L_2$  and  $C_2$  are the coil and condenser whose combined resistance we wish to measure.  $L_1$  is any coil which will resonate to the required wavelength with the precision condenser. Turn switch  $S'$  to the point 1, and measure the resistance of  $L_1$  and the precision condenser in the manner explained in the last paragraph. Then set the resistance box at zero again, but do not change the setting of the precision condenser. This condenser is now set so that the reactance of the coil  $L_1$  and the precision condenser is zero, and these act now simply like a pure resistance, having the value  $r_1$ , say, which we just measured. Now without changing anything besides setting the resistance box at zero, turn switch  $S'$  to the point 2. Adjust the condenser  $C_2$  to resonance and use the "quarter-deflection" method again by adjusting the resistance until the meter deflection has been reduced to one-fourth. The resistance in the box is now the resistance of  $L_1$ ,  $L_2$ ,  $C_2$ , and the precision condenser, all in series, and has a value  $r_2$ , say. The resistance of  $L_2$  and  $C_2$  in series is then simply  $r_2 - r_1$ .

So far we have seen how we can measure capacity, self-inductance and resistance at high frequencies with this LCR box. We can go further and measure the mutual inductance of an oscillation transformer by measuring the combined inductance of the primary and secondary connected in series aiding, and again in series opposing, giving values of  $L'_1$  and  $L'_2$ . The mutual inductance is then one-fourth the difference between these two values. What we mean by series aiding and series opposing is that in one case the fields of the two coils are in the same direction, and in the other case in opposite directions. We do not have to worry about it, however, for we can simply connect them in series any old way, and the second time simply reverse one of the coils.

Knowing now how to measure the

self-inductance of the primary and of the secondary, and the mutual inductance between the two, we can easily calculate the coefficient of coupling by means of the formula  $k = M / \sqrt{L_1 L_2}$  where  $L_1$  and  $L_2$  are the self-inductances of the primary and secondary respectively,  $M$  is the mutual inductance, and  $k$  is the coefficient of coupling. This method is not satisfactory, however, for as we can easily see we have to make four different measurements of inductance, and there is great likelihood of serious errors creeping into the measurements.

The following method of making the measurement of coefficient of coupling is exceedingly simple and accurate, and was devised recently by the writer. We will first present the theory of the method.

Whenever a coil is connected to a source of electromotive force, and this coil transfers energy to another coil, as indicated in Fig. 4, the presence of the

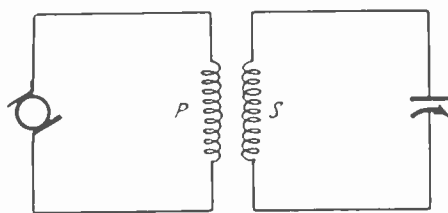

Fig. 4. Theory of Measuring Coupling Coefficient.

second circuit, or secondary, affects the constants of the primary circuit, and vice versa. Without going into the theory, the presence of the primary causes the secondary to act as if it had an inductance  $L'_2$ , which inductance is less than the self-inductance of the secondary coil by itself, and which is given by the formula  $L'_2 = L_2(1 - k^2)$  in which  $L'_2$  is the effective inductance of the secondary, and  $L_2$  its actual inductance. Now this effective inductance combines with the capacity of the condenser to produce resonance, when the condenser is properly adjusted. We can therefore write the usual formula for the frequency of a tuned circuit when in resonance:

$$f = \frac{159.3}{\sqrt{L'_2 C'_2}} \text{ or } C'_2 = \left( \frac{159.3}{f} \right)^2 \frac{1}{L'_2}$$

$$= \left( \frac{159.3}{f} \right)^2 \frac{1}{L_2(1 - k^2)}$$

Now, if we disconnect the primary circuit, and place the source of electromotive force in the secondary circuit, and again adjust the condenser to resonance, the capacity required is

$$C_2 = \left( \frac{159.3}{f} \right)^2 \frac{1}{L_2}$$

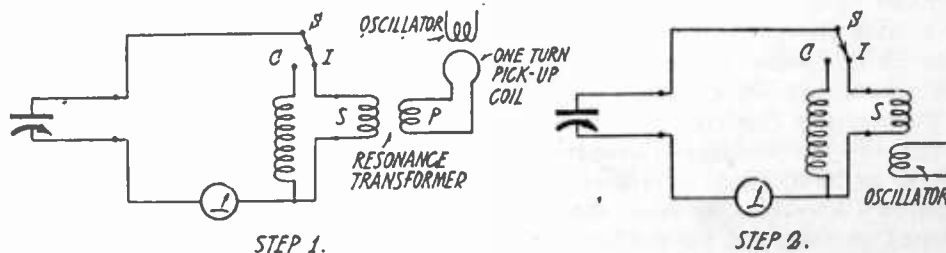

Fig. 5. Connections for Measuring Coefficient of Coupling.

dividing the first value of capacity by the second and solving for  $k$ , we have:

$$k = \sqrt{1 - \frac{C_2}{C'_2}}$$

The method is indicated by the theory. (See Fig. 5.) First set the oscillator to the required frequency. Then with switch  $S$  on the point  $I$  and with the secondary connected to the posts marked *Ind.*, and with primary connected to a single-turn pick-up coil energized by the oscillator, tune the precision condenser to resonance. Note the capacity of  $C'_2$ . Then disconnect the primary circuit entirely, and energize the secondary coil directly. Resonate again and note the capacity  $C_2$  of the precision condenser. Substituting these two values of capacity into the above formula gives the coefficient of coupling of the resonance transformer directly, at the given frequency. What could be simpler? There are only two measurements of capacity to be made, and it is generally admitted that capacity measurements are about the most accurately made in radio practice.

It is hoped that those who construct this instrument will find it to be as helpful and convenient as it has been found to be by the writer. It saves an endless amount of time in making and unmaking set-ups, and the cost involved is hardly worth considering when contrasted with its worth. There are no instruments required to build it which are not already found in the radio laboratory, and the small amount of work required to construct the box is not worth considering.

Even if the voltage across a  $B$  battery seems to be normal, it is no sign that there may not be noise in it. A good test is to substitute a fresh block in the series, and see if the noise will not disappear.

Don't think that because the newer types are rated at higher voltages or greater plate currents than the older ones that they can be abused more.

Keeping a complete replacement of all the tubes in a set may seem an extravagance, but at least one of each type in use should be kept on hand as a spare, so as to avoid the annoyance of non-reception.

A good bypass condenser for radio frequency for transmitting sets may be made up by covering both sides of a sheet of glass with tinfoil to near the edge but so far away that the two surfaces will not touch.

# An Improved "ABC" Power Plant

Including Complete Directions for the Adaptation of the Diamond Of the Air Receiver to Lamp Socket Operation

By G. M. Best

**D**URING the year which has elapsed since the appearance of the first article to be published about a complete ABC eliminator, see December 1925 RADIO, many improvements have been made in the original design and apparatus. Some of them were incorporated in an article in the August 1926 issue of this magazine. Several others are included in the present article, which also describes the changes necessary to adapt the Diamond of the Air 5-tube receiver to lamp socket operation.

The most important improvement is the substitution of a steel base and enclosing box instead of a wooden base-board and cabinet. This not only provides proper precaution against the hazard of fire, but also gives a more durable and compact outfit, as shown in the pictures. Another is the use of mazda lamps as the cheapest form of non-inductive resistance available.

Of the various receiver circuits whose adaptation for use with rectified alternating current has been described previously in these columns, all have employed transformer coupling in the audio stages. A typical set using resistance coupling is



Power Plant Assembly.

the Diamond of the Air. This requires a different arrangement of the B voltage supply which is also applicable to other resistance coupled sets.

Fig. 1 shows the schematic wiring diagram of the receiver and power plant, the dotted line being the dividing line between the two units, which are connected together by means of a flexible battery cable. Before discussing the receiver the revised power plant will be described.

The list of parts required for building the power plant is practically the same as published in August RADIO, except that instead of a bakelite panel and wooden baseboard for mounting the apparatus, a metal plate and can are used. The three variable resistances required are mounted on a small bakelite sub-panel, inside the metal can, where they are accessible. The picture shows clearly the arrangement of apparatus on the metal plate, which is 7 1/4 x 15 3/4 in., of

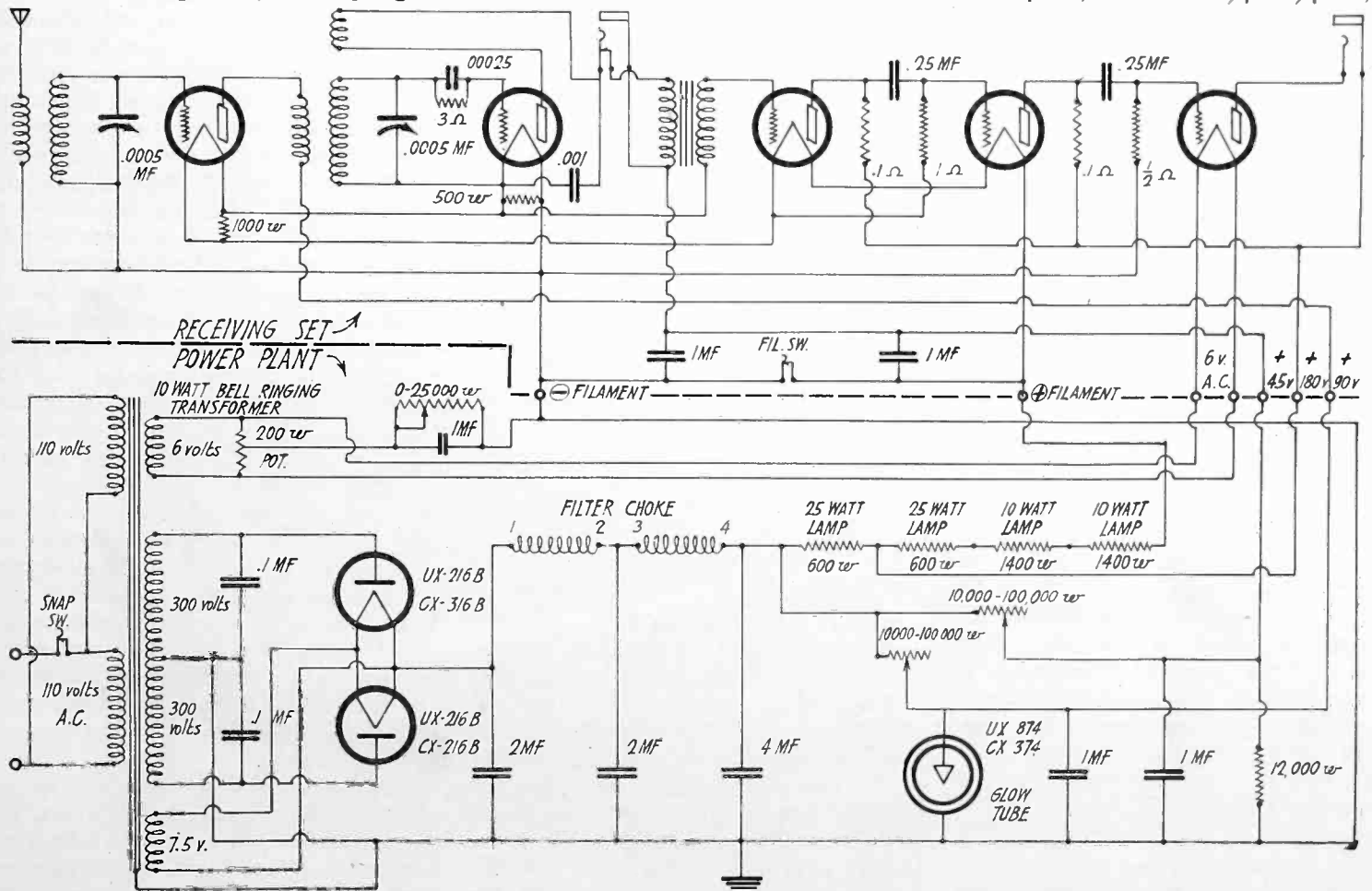

Fig. 1. Schematic Wiring Diagram of Complete A.C. Receiver.



either 16 gauge sheet steel or brass, whichever is more convenient. The metal box is  $7\frac{1}{2} \times 16 \times 6\frac{1}{2}$  in. high, with removable lid, in which ventilating holes are cut or drilled, as well as in the sides. The only piece of apparatus fastened to the can is the main switch, which is mounted at the end of the can nearest the power transformer, and is connected in series with one side of the flexible cord connected to the 110 volt lighting socket.

The power transformer, choke, and condenser bank are all of the same size, and are mounted at one end of the baseplate, as is shown in the picture. The four lamp sockets, glow tube, filament lighting transformer and 200 ohm resistance are mounted in the remaining space on the baseplate, and the three variable resistances are fastened to a strip of  $\frac{3}{16}$  in. bakelite,  $3\frac{1}{4} \times 7$  in., supported from the baseplate by four  $\frac{3}{16}$  in. brass rods  $3\frac{1}{2}$  in. high, drilled and tapped at both ends for 6-32 machine screws.

In the original model, a 25,000 ohm variable resistance was used for providing the *C* voltage for the power tube, but it has been found that the Clarostats used for cutting down the *B* voltage supply to the detector and amplifier tubes are satisfactory to use in this part of the circuit, and hence three variable resistances of identical size can be used. If an especially neat job of wiring is desired, holes may be drilled through the metal baseplate where required, and all wiring passed through these holes, and underneath the plate, so that none will be visible from above. This adds to the safety of the device, and the entire baseplate, with the apparatus intact, can be pulled from the box at any time in case the wiring needs attention.

The theory of operation of the *ABC* eliminator was described in detail in August RADIO, where the function of the mazda lamps used as resistances was included. Successful operation of the '99 tube filaments in series require non-inductive resistances to limit the current in the filament circuit to 60 milliamperes.

Any type of resistance can be used, provided that it carries the current without overheating, and can be adjusted in small steps so as to compensate for changes in line voltage or individual tubes. Several sets of fixed resistances have been placed on the market for use in certain *ABC* eliminators. In all of these the taps are so arranged that the voltage drop across the resistance in the filament circuit is used to provide *B* voltage. This is satisfactory for a specified receiving set having a definite number of tubes with known plate current drain, but is not satisfactory for general use with any type of receiver.

A mazda lamp is not only the cheapest resistance obtainable, but any value of resistance within reasonable limits may also be had by substituting lamps of dif-

LIST OF PARTS USED FOR POWER PLANT	
1	Silver-Marshall Type 330 Power transformer.
1	Silver-Marshall Type 331 Uni-choke.
1	Silver-Marshall Type 332 Condenser bank—4, 2, 2, 1, 1, .1, .1, mfd.
3	Variable resistances—Clarostats.
3	X-base Na-ald sockets.
1	General Radio 200 ohm potentiometer, Model 301.
1	Elect. and mfd. by-pass condenser.
1	Thordarson 10-watt bell ringing transformer.
1	Cutler-Hammer filament switch.
1	Arthur H. Lynch 12,000 ohm resistor.
4	Porcelain lamp sockets for standard mazda lamps.
1	Metal can with steel base plate—Army Sales.
1	Bakelite sub-panel $3\frac{1}{4} \times 7\frac{1}{4}$ in. with $\frac{3}{16}$ in. brass supports—Army Sales.
1	6 ft. section Premier battery cable.
2	UX-216-B, CX-316-B half wave rectifier tubes.
1	UX-874, CX-374 Glow tube.

ferent wattage in the lamp bank, thus adjusting the current to suit the particular set in use.

The *B* voltages are adjusted separately. As they are independent of the filament adjustment, no distortion is introduced into the set due to instantaneous changes in plate current of the power tube, which cause fluctuations in the filament circuit. The voltage regulator, or glow tube, insures a constant voltage supply to the r.f. amplifier tube, no matter how much the line voltage may fluctuate, and prevents sudden changes in volume on distant stations, when the line voltage changes slightly.

Some questions have been asked about the necessity of using two  $7\frac{1}{2}$  watt rectifier tubes, when one tube might do the work equally as well. The load drawn from the rectifier circuit, including the drain of the glow tube, the filament and plate currents of the 99 tubes, and the plate current of the 112 tube, is about 95 milliamperes. With a type 371 power tube, the drain would be 105 milliamperes, and as practically all rectifier tubes when operated alone are rated at not over 85 milliamperes maximum, the extra current drain would be too great for the tube, and its life would be short. If the glow tube were dispensed with, and a type 112 power tube used, the current drain would probably be reduced to 85 milliamperes, but as this amount would be the maximum output of the tube, it would be safer to use two tubes and work at a point well below the maximum, and thus provide a factor of safety as well as longer life for the rectifiers.

AS IS shown in Fig 1, the circuit of the Diamond of the Air receiver has been revised so as to include series filament connection for the r.f. amplifier, detector, and first two audio amplifier tubes, with the proper grid connections to provide *C* bias for the amplifier tubes. The pictures show the panel view and sub-panel layout of apparatus, the general arrangement not differing greatly from that required for parallel filament operation, except in

minor details. The list of parts gives the material needed to construct the receiver, the power plant being a separate item. No panel layout is given, as the panel and bakelite shelf can be obtained already drilled and engraved at most radio stores. The shelf is held in place by a bracket placed at each end of the panel, the audio transformer being mounted underneath the shelf to act as a support to prevent the shelf from sagging.

After assembling the apparatus on the panel and shelf, the wiring will be easy to run, since every part is easy of access, and there are no crowded groups of apparatus. Wire the filament circuit first, then the audio frequency wiring, and run the high frequency wiring last, keeping it away from the other wiring as much as possible. While the filaments are generally turned off by shutting off the power plant, a filament switch comes with the kit of parts usually sold for this receiver, and can be connected as shown in Fig. 1, so that the set can be temporarily shut off and the loud speaker silenced without having to turn off the power plant. This switch will work opposite to its normal position, and will turn the filaments off when it is turned so that the contacts are closed.

While no voltmeter is shown, it is a good plan to have some sort of indicating device for the filament circuit. In the original plan described in August RADIO, a voltmeter was shunted across the filament of the detector tube, and as long as the voltage indicated was approximately 3 volts, the filament circuit was certain to be in correct adjustment.

A milliammeter having a 0-100 milli-ampere scale will do just as well, however, and can also be used to adjust the current in the *B* supply taps. The milliammeter, when placed in the positive filament lead, at the receiving set, should read approximately 58 milliamperes. By reference to the filament circuit in Fig. 1, it will be seen that as each successive tube filament is reached, the filament current will be greater by the addition of the plate current of the preceding tubes, so that the filament current of the detector tube will be 58 milliamperes plus the plate current of the three preceding tubes, which will be around 6 milliamperes. To bypass this excess current around the detector, a 500 ohm resistance or a pair of 1000 ohm resistances in parallel is shunted across the filament terminals, and the placing of a 1000 ohm resistance across the r.f. amplifier filament will by-pass several milliamperes and hence protect that tube from excess current. As the extra filament current in the first audio tube is not sufficient to warrant a protective resistance, none is provided.

To insure sufficient voltage at the plates of the first two audio tubes, the same voltage as for the power tube is applied, with 3 volts negative grid, obtained from the voltage drop across one of the other tubes in the circuit. Connections

for a type CX-112 power tube are shown in Fig. 1, with 180 volts plate and 12 volts negative grid potential. If the type CX-371 power tube is to be used, an output transformer is required, but as there is insufficient room on the subpanel of the Diamond of the Air receiver, the CX-112 is preferable.

To operate the receiver after the power plant and the set are completely wired, first place the four 99 tubes and the 112 power tube in their sockets, with the negative and positive filament terminals from the power plant connections made, but the *B* voltage taps disconnected. The power plant should be turned on, and with the milliammeter in the positive lead, it will be noted that the filament current is about 65 to 70 milliamperes. This proves that the filament circuit is complete, and the *B* voltage taps can now be connected.

Turn the three variable resistances in

#### LIST OF PARTS USED IN RECEIVER

- 1 Bruno No. 99 R. F. Coil.
- 1 Bruno No. 99 Tuning Coil.
- 2 Bruno No. 101 .0005 mfd. S.L.F. Condensers.
- 1 Electrad Single Circuit jack.
- 1 Electrad Double circuit jack.
- 1 Bruno Model D audio transformer.
- 5 Patent UX cushion sockets.
- 1 Drilled socket strip— $2\frac{1}{2} \times 23 \times 3/16$  in.
- 1 Pair Bruno shelf brackets.
- 2 Electrad .25 mfd. fixed condensers.
- 2 Electrad 1 mfd. by-pass condensers.
- 1 Filament switch—optional.
- 1 Electrad .00025 mfd. grid condenser with clips.
- 1 Durham 3 megohm grid leak.
- 2 Durham .1 megohm fixed resistors.
- 1 Durham .5 megohm fixed resistor.
- 1 Durham 1 megohm fixed resistor.
- 4 Grid leak mountings.
- 3 Mydar vernier dials.
- 1 Bakelite or formica panel 7x24 in.
- 1 6 wire battery cable.
- 1 pc. No. 18 twisted pair for power tube filament.
- 3 Tobe 1000 ohm resistances.
- Miscellaneous wire, spaghetti screws, etc.

40 watt lamp, or replace one of the 10 watt size with a 25 watt lamp, in case the current is very much less than 58 milliamperes. After the filament current is finally correct, it will be found necessary to once more adjust the *B* current drain in the various taps, after which no further adjustment should be necessary.

In the Diamond of the Air receiver, volume control is obtained by varying the coupling of the tickler coil in the detector plate circuit. There are of course no filament rheostats, or other variables except the tuning control, and the only adjustment necessary in turning the set on or off is to operate the main 110 volt a.c. switch on the power plant box.

In making up a B battery eliminator, always test out the filter condensers across the high voltage winding of the transformer prior to installing them. A short circuited, or leaky condenser, will manifest itself by popping noises inside the condenser, or even smoke and flame may appear. A good condenser will give a slight hum, at the frequency of the supply line, and will make no other sign.

If an ordinary wave trap, which generally consists of a coil shunted by a variable condenser, is connected to an aerial and ground and placed on top of a receiving set having only a loop antenna, the set will work as well as if it were connected to a regular outside aerial.

Storage batteries will last longer if they are recharged before they go absolutely "flat." It may seem extravagant to charge them once ever so often, whether they seem to need it or not, but this apparent extravagance will be repaid in longer battery life. Even when not in use, a battery should be watered, and given a short charge, preferably at a low rate, once a month.



Panel View of Receiver.

the power plant box until all the resistance is cut in, which means to unscrew the knobs several turns. Now place the milliammeter in the positive 180 volt lead and cut out resistance in the *C* biasing resistance unit by turning in the knob until the plate current is about 16 milliamperes. This means that the power tube is drawing from 12 to 13 milliamperes, and the two resistance coupled '99 tubes are drawing about  $1\frac{1}{2}$  mils each.

Now place the milliammeter in the 90 volt *B* lead and cut out resistance in the 90 volt tap until the current is about  $2\frac{1}{2}$  or 3 milliamperes. At this point it will be noted that the glow tube has operated and shows a pink color around the elements inside the bulb. As soon as the

glow tube begins to draw current, the 90 volt resistance knob can be turned in a considerable amount without affecting the current drain in the 90 volt lead to the set, showing that the glow tube is functioning properly. The final adjustment is the 45 volt *B* voltage tap, in which the milliammeter should be placed, and the current adjusted to approximately  $1\frac{1}{2}$  milliamperes.

Now place the milliammeter in the positive filament lead, and the filament current should be about 58 milliamperes. If it is greater than this amount, replace one of the 25 watt mazda lamps in the power plant, with a 10 watt lamp. If the current is less than 58 milliamperes, replace one of the 25 watt lamps with a

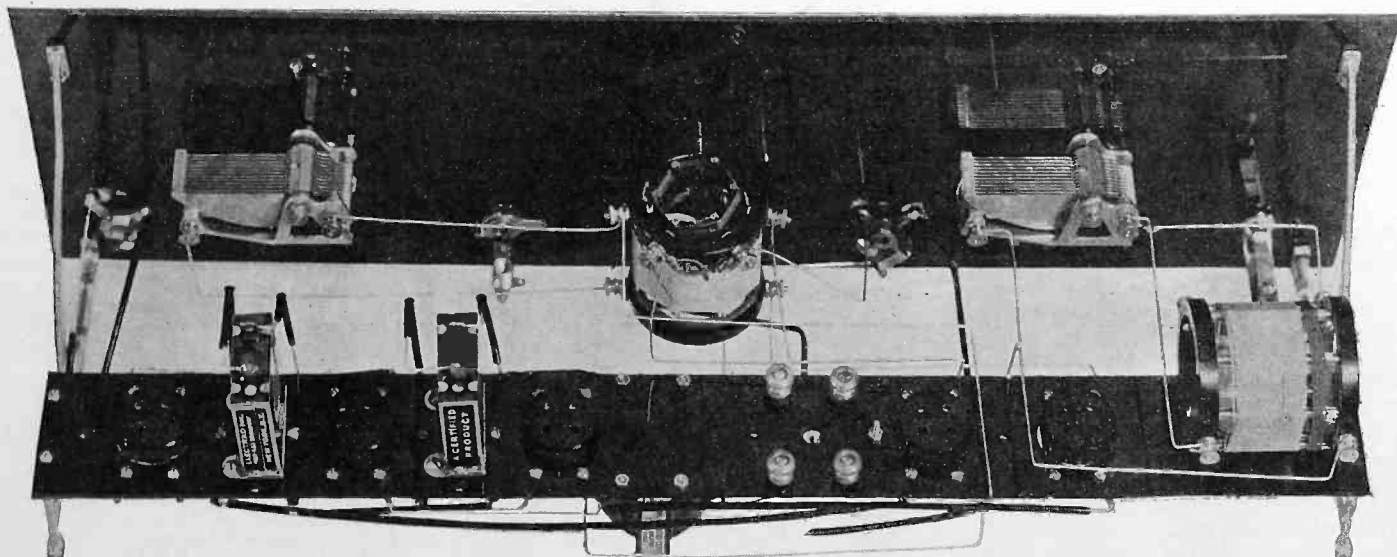

Rear View of Receiver, Giving Details of Shelf Mounting.





# QUERIES *and* REPLIES



Questions of general interest are published in this department. Questions should be brief, typewritten, or in ink, written on one side of the paper, and should state whether the answer is to be published or personally acknowledged. Where personal answer is desired, a fee of 25c per question, including diagrams, should be sent. If questions require special work, or diagrams, particularly those of factory-built receivers, an extra charge will be made, and correspondents will be notified of the amount of this charge before answer is made.

I have several VT-2 Western Electric tubes which I believe could be used in a "B" eliminator. Can you suggest an appropriate circuit in which one of these tubes could be used to supply plate voltage for a 6 tube set?—H. S., Sacramento, Calif.

A good circuit for the VT-2 tube is shown in Fig. 1. As the tube is capable of

a shunt variable resistance across the primary of the second intermediate amplifier tube. This resistance may be a 50,000 ohm Centralab or Royalty resistance, arranged for panel mounting. All three plug-in coils, including the oscillator coil, must be changed when receiving on wavebands below the present broadcast band. Three sets of coils are available, one set

I wish to use an antenna in connection with my Radiola Super, which is of a model about 2½ years old. Have tried several antenna connections, but they are not selective. How may this be done?—J. C. S., Elgin, Ill.

While you could build an antenna tuner with antenna circuit separate from the secondary, and tuned by means of a variable condenser and loading coil, a stage of tuned r.f. amplification would be a better means of providing selectivity, added sensitivity, and freedom from radiation of energy into the antenna, to the great joy of your neighbors. In Fig. 2 is shown a suggested circuit for an antenna tuner, r.f. amplifier, and coupling transformer, requiring only one control, and no critical adjustments. Such an amplifier was described in June RADIO, but for your particular set, a few changes must be made. The output transformer, which in this case is a Silver-Marshall Type 110-A, is designed so that the secondary is tuned with a .00035 mfd. variable condenser, to cover the broadcast band. As the condenser shunted across the loop in your set is about .0008 mfd., it would probably tune the 110-A coil through a range of from 250 to 800 meters, and you would be unable to tune in the lower wavelength stations. Hence only one whole section of the stator winding should be used, with 6 additional turns from the other stator winding, the remaining turns being removed. It is best to unsolder the wire leading to terminal 3 of the transformer, and remove turns from the coil until only 6 are left, soldering the end of the 6 turn coil to terminal 3. Connect the terminals 3 and 6 of the coil to the binding posts in the set which are marked for "external loop" connection, and the loop condenser will thus be shunted across the coil. The filament and plate voltages for the r.f. tube may be obtained from the same set of A and B batteries supplying the main set.

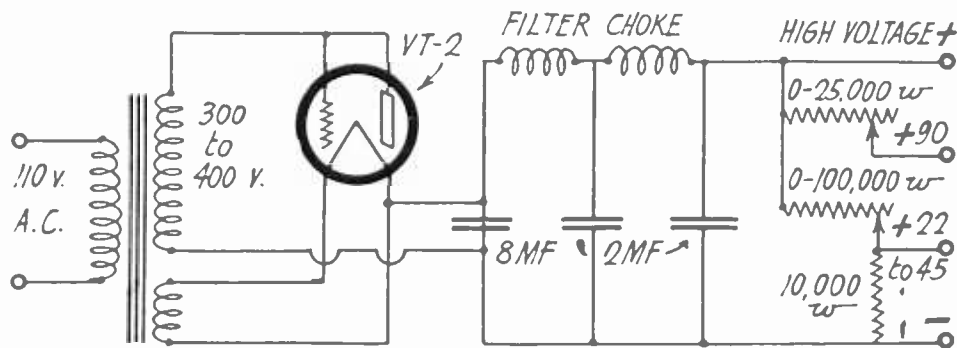

Fig. 1. VT-2 Tube in B Eliminator Circuit.

operating at a plate voltage of 350 to 450 volts, you can supply sufficient voltage, using it as a rectifier, to operate a type 310 power tube, as well as a number of tubes of lower voltage requirements. One of the power transformers designed for use with either the CX-316-B rectifier tubes, or the heavy duty Raytheon rectifier can be used, provided that the transformer has a filament winding of at least 6 volts. If no filament winding is furnished with the transformer, a small bell ringing transformer having a 6 volt secondary can be used, with the primary connected in parallel with the plate transformer primary. The filter circuit is the same as for any of the B eliminator circuits now in use, and the voltage reducing resistances are connected in the customary manner, as is shown in the diagram. The grid and plate of the tube are connected together, at the socket terminals.

being intended for the band from 50 to 125 meters, another for the band from 100 to 300 meters, and a third for the band from 200 to 550 meters. The r.f. chokes can be purchased ready made. The choke in the plate circuit of the r.f. amplifier tube should be a Silver-Marshall short wave choke, and the other chokes may all be large sized chokes such as the Samson, Silver-Marshall or the Bremer-Tully. The intermediate transformers may be any standard make, and when using A tubes in the intermediate amplifier, transformers specifically designed for such tubes should be used. Many transformers are designed for the '99 tubes, and when used with the A tubes, are tuned to a much lower frequency than that specified, so that the filter will not be peaked at the same frequency as the intermediates, and a double hump will be observed at each setting of the oscillator dial.

Have read with interest the article by Armstrong on the modified Best superheterodyne in October RADIO. What changes are necessary to use 201-A tubes with 112 power tube? Do all three plug-in coils have to be changed when it is desired to receive on the lower wavelengths? Can the r.f. chokes mentioned be purchased ready made? Also the intermediate and filter transformers?—H. L. R., Jamaica, N. Y.

If the large tubes are to be used, it would be better to dispense with the filament rheostat and voltmeter, and use Amperites. The volume control could be changed from a filament rheostat in the first two intermediate amplifier tubes, to

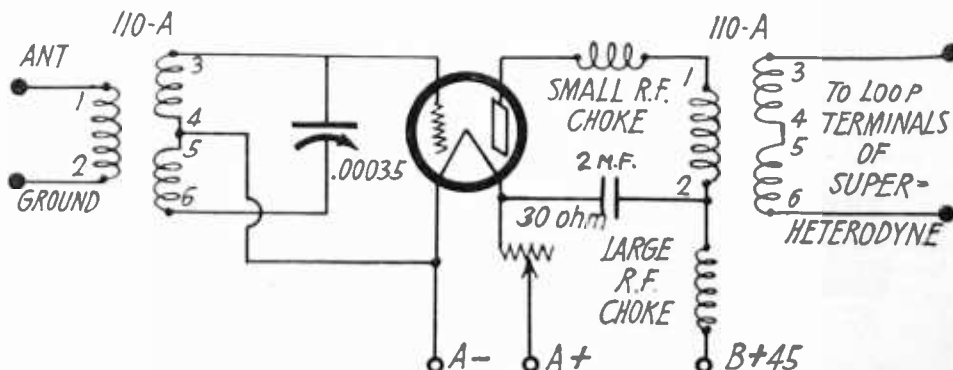

Fig. 2. Antenna Tuner With R.F. Amplifier for Radiola Superheterodyne.



R. O. KOCH, *Great Lakes Correspondent*

# The COMMERCIAL BRASSPOUNDER

## A Department for the Operator at Sea and Ashore



Edited by P. S. LUCAS

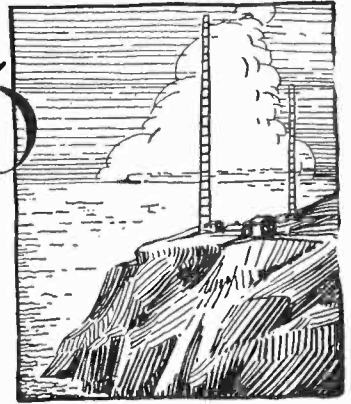

C. W. RADOS, *Boston Correspondent*

### WE NEED YARNS

Well, we're still here. In spite of the fact that some of the enthusiasm over the Commercial Brasspounder at its beginning was accompanied by a slight degree of pessimism, we have kept the ball rolling and are hoping to continue to do so.

By *we* I mean, not the department editorial staff, but the group of operators, numbering about a dozen, who have assisted in the success of this department with their contributions. They are the ones to whom the greater part of the credit belongs. So if you've enjoyed an article printed here drop the writer a line to let him know you appreciated it. Appreciation is all he gets—he certainly deserves plenty of that.

There have been many others who have helped the good work along indirectly with encouraging letters and suggestions. These we have tried to answer, but can't seem to keep quite up to the surface. We do appreciate them, nevertheless, and wish to say that if it were not for these letters to prove that the department is popular, we should probably not be given the space. So keep at it, fellows.

One dozen contributors seems like a mighty small group to fill more than two pages a month for eight months, doesn't it? Well, it is a small group. The only reason similar attempts to establish a commercial operator's department in other radio periodicals have failed is that the men for whom it was intended have failed to support it.

Here's part of a letter from W. L. Jepson, who has an article in this issue: "There's a wealth of experience and information back of the quiet exterior of the average operator who, speaking from my own experience, is afflicted with what might be humorously termed 'chronic indolitis.'"

"It's a fine thing to use a camera and notebook habitually while engaged in wearing out white tickets. My great regret is that I didn't. After you've quit the biz, the past, however flat it is while being lived, is seen through the colored glasses of romantic fancy and the lure of radio intrigues you from every written page and dog-eared snapshot if you have them.

"This department needs such matter so that the operator-readers may enjoy personal reminiscences in the light of your story of some ship or shore station."

It surely does! And as far as the camera and notebook are concerned, many are the regrets of old-timers who have nothing to refresh their memories or stir up reminiscences of a pleasant day spent in a strange port.

Not long ago we called for skeds. Well, we certainly got them. As far as the North Pacific, Oriental, Intercoastal and European runs are concerned, I don't believe there is a more complete set of time, weather and press schedules printed, than those in your files of RADIO. And we're going to keep them complete and right up-to-date. (The South American, Mediterranean and African runs have been rather neglected, but we are expecting some of you fellows around there to take a hint and come across.)

We asked for station write-ups. Received a couple. Technical articles; and you came through with some real stuff. But when it comes to personal experiences you're all afraid your yarns won't hold water. Well, what of it? The District Attorney won't see 'em.

Now, I want a bunch of you to elect yourselves reporters for this dangerous sheet. The next time you drop in on the gang at a familiar static-room, take along some paper and a couple of well oiled pencils and take notes on some of the yarns that are being passed back and forth, there. Then send 'em in.

This being taken care of, we shall turn the matter over to the postman.

In the August issue of RADIO, under the heading: "Help Wanted—Male," we introduced the question: Shall we abandon the column entitled "Who's Who and Where," so that we may use the space for time, weather and press schedules, technical articles, etc.? And we asked you to drop us a line telling us what you thought of the idea. Although the response wasn't what we had hoped for in volume (each saying: "Let George do it") there were about twenty-five votes cast, six of which were in favor of abandoning Who's Who. All the rest felt that it would be best to keep the column, but hold it down in case we were crowded out by more important material.

Although it sometimes seems that we are not going to be able to publish all the articles we receive, we soon catch up, and even get ahead; so it's just as well you decided the thing as you did.

From our observation it would appear that the Who's Who column is the most popular section of the department, as it is the first thing that all the operators we have seen,

turn to. It isn't lasting, though; that is, the items in Who's Who, although interesting today, are not especially valuable to us in our duties as an operator.

Having decided to keep the column, we wish to extend the invitation to all of you to send in any items you would like to see listed. If it's your own name, and you want to be real proud of it, let it head a little article or story of some sort. What say?

### EXPOSURE No. II

*(Being the inside dope on the life of H. D. Watson, whose fist is well known all over the Pacific Coast, signing "HD" at KOK.)*

H. D. Watson

After tacking his high school diploma on the wall with a couple of ten-penny nails, "HD," or "Wat," as Mr. Watson is known to his friends, started out on the career of a railroad man, taking a job in his home town of Boone, Iowa, with the interurban railway. His first duty with this company was that of soldering copper bonds onto the rail. Carrying a double burner torch along with him as he traversed the ties between Fort Dodge and Des Moines, he soldered these bonds onto every rail for this whole distance of 120 miles. At Des Moines, getting tired of "walking the tracks," he left his native state and joined the navy as an apprentice electrician.

HD graduated from this apprenticeship a year later (1910), and was made electrician second class with a special recommendation for radio duty. This recommendation, in those days, took the place of what is now a regular radio operator's classification, as radio communication was too new a field to afford the complete attention of any one man. With this recommendation HD took the assignment as chief radio operator of the U.S.S. *Yorktown*, a little gunboat belonging to Old Admiral Evans' White Navy, and cruised



H. D. Watson



# Great Circle Distances

By Harold Larson SS "West Cajoot"

down the coast from San Francisco to Callao, stopping in at every port. He had his first operating experience on that trip, and with the weather condition, static, etc., as they are down that way, it was an experience that he will never forget, and one which "broke him in right," as the saying goes. The ship was equipped with one of the most modern transmitters of the time, being supplied by a 120 cycle m.g., which in those days was a rarity, indeed. It was quite a stunt at that age of the radio game, to work NPK from the Gulf of Lower California, and when they heard him from off Esmeraldas, Ecuador, with a crystal, they were pretty well "set up" over the feat.

Having established himself on this trip as a reliable radio man, HD was taken off the *Yorktown* in April, 1911, and sent on the Alaska Radio Expedition in the capacity of construction engineer. This expedition built NPS, Kodiak, NPR, Dutch Harbor, and NPO, St. Paul Island. At NPR they installed the first 500 cycle transmitter on the coast, and probably gave every operator in that section a thrill as they first began plowing up the ether with that high frequency note.

Thence, as we said, to NPQ (to be). Upon arriving at the Pribiloff Islands, they had the interesting experience of seeing the seals come in. (The writer didn't find out where the seals had been.) First came the bachelors or those of the tender age of three years; then the bulls, each picking out a nice, comfortable location for a home, settling down in it, and waiting for the female element of the colony. The females didn't put in their appearance until about a week afterward, making sure, we suppose, that they would find all things comfortable upon their arrival. Then, gathering around the bulls at the ratio of about a dozen or so to one (a la Solomon), they also settled down.

But enough of the seals. The expedition, after leaving NPQ, journeyed down along the coast, repaired the station at Cordova, and dropped HD off at Sitka in October, a chief operator of NPB. Pounding brass, hunting deer and grouse and trying his luck as a fisherman occupied his time at Sitka until the middle of 1912, when he was transferred to NPC Bremerton, Washington. In April, 1913, he was transferred to the submarine fleet for a short time, thence to the Destroyer *Perry* as chief electrician, radio. This concludes Wat's Navy experience, and starts him out as a commercial brasspounder, free lance, so to speak.

Waving a white ticket in the face of the Alaska Packers manager, he was assigned to KHT, a spark station on the Naknek River, Bristol Bay, Alaska. (Easterners, reading this, will probably get the idea that Alaska constitutes about seventy-five per cent of the Pacific Coast.) Here he stayed during the summer, scrapping the mosquitoes, as is the wont of those who venture to Alaska during the summer. At the end of the season he returned to San Francisco and lined up with the Federal Telegraph Co., understudying at KFS in order to get his hand in on the arcs. Leaving the beach, Wat went to sea again as operator on the *S.S. Argyle*, upon which he stayed until being transferred to the *S.S. Harvard*. He was on the *Harvard* in 1917, when the country seemed to be getting pretty thickly in the war, so he enlisted in the Naval Reserve as chief electrician, radio. With his experience in back of him, he was soon made a warrant officer, and was put in charge of the watch at the Naval radio station at San Francisco.

The war over, Wat got out of the Navy, and went back to the Federal Telegraph, who sent him down to Los Angeles to aid in the installation of their new marine station, KOK. He is still there, as equipment supervisor and chief operator, having charge of all installation and repair work that comes into Los Angeles.

For those who are interested in working out problems for the sake of the mathematical calculation, and for those who want an accurate method of figuring transmission and reception distances, this article will be well worth reading and studying. A table of logarithms is necessary for these computations, but may be had for a small price at almost any bookstore.

The average seagoing operator who wants to know the distance between his ship and another ship or a short station either figures sixty miles to a degree or steps off the distance on a chart, both methods giving only rough approximations. If more accurate results are desired, it is usually necessary to ask one of the deck officers to figure it out. Even when one so accommodating can be found, it is a long, tedious problem by the ordinary Great Circle Sailing method, which involves the figuring of the various courses and so forth, the actual distance being the very last thing to be found.

By means of spherical trigonometry the distance between two positions may be found directly as follows:

1. Add the logarithmic sines of the two latitudes. Find the number corresponding to this logarithm.

2. Add the logarithmic cosines of the two latitudes and the logarithmic cosine of the difference of longitude. Find the number corresponding to this logarithm.

3. Add the two numbers obtained in 1 and 2. In the table of Natural Cosines find the angle corresponding to this sum. This angle expressed in minutes will be the distance between the two positions in nautical miles.

Example: A ship in lat. 34° 43' N., long. 178° 50' W., works KFS, whose position is lat. 37° 50' N., long. 122° 30' W. The distance is found as follows:

$$\begin{array}{r} 1. \quad L \sin 34^\circ 42' \quad 9.7553 \\ \quad \quad L \sin 37^\circ 50' \quad 9.7877 \\ \hline \end{array}$$

$$\quad \quad \quad = 9.5430$$

$$\begin{array}{r} 2. \quad \quad \quad = \log \text{ of } .3491 \\ \quad \quad \quad 178^\circ 50' \\ \quad \quad \quad 122^\circ 30' \\ \hline \end{array}$$

$$\text{Diff. of Long.} = 56^\circ 20'$$

$$L \cos 34^\circ 42' \quad 9.9149$$

$$L \cos 37^\circ 50' \quad 9.8975$$

$$L \cos 56^\circ 20' \quad 9.7438$$

$$\quad \quad \quad 9.5562$$

$$= \log \text{ of } .3599$$

$$\begin{array}{r} 3. \quad \quad \quad .3491 \\ \quad \quad \quad .3599 \\ \hline \end{array}$$

$$\quad \quad \quad .7090$$

$$= \text{Nat. Cos. of } 44^\circ 51'$$

$$\text{Then } 44^\circ 51'$$

$$\text{times } 60$$

$$= 2691 \text{ Miles}$$

When one position is north of the equator and the other south, the latitude of the position south of the equator is considered a negative angle and the following rules apply:

$$\sin (-a) = -\sin a$$

$$\cos (-a) = \cos a$$

When the difference of longitude is more than ninety degrees:

$$\cos (90^\circ + a) = -\sin a$$

When the distance is more than 5,400 miles (90° expressed in minutes):

$$-\cos a = \cos (180^\circ - a)$$

Example: To find the distances between the positions lat. 18° 35' N., long. 120° 25' E. lat. 37° 45' N., long. 122° 41' W.

$$1. \quad L \sin 18^\circ 35' \quad 9.50336$$

$$L \sin 37^\circ 45' \quad 9.78691$$

$$\quad \quad \quad 9.29027$$

$$= \log \text{ of } .19511$$

$$\begin{array}{r} 2. \quad \text{Diff. of Long.} = 116^\circ 54' \\ \quad \cos (90^\circ + a) = -\sin a \\ \quad \cos (90^\circ + 26^\circ 54') = -\sin 26^\circ 54' \\ \quad \quad L \cos 116^\circ 54' = L \sin 26^\circ 54' \\ \quad \quad \quad = 9.65555 \end{array}$$

$$L \cos 116^\circ 54' \quad 9.65555 \text{ log of } - \text{ number}$$

$$L \cos 18^\circ 35' \quad 9.97674 \text{ log of } + \text{ number}$$

$$L \cos 37^\circ 45' \quad 9.89801 \text{ log of } + \text{ number}$$

$$\quad \quad \quad 9.53030 \text{ log of } - \text{ number}$$

$$= \log \text{ of } -.33908$$

$$3. \quad \quad \quad -.33908$$

$$\quad \quad \quad \text{add } +.19511$$

$$\quad \quad \quad = .14397$$

$$.14397 = \text{Nat. Cos. of } 81^\circ 43'$$

$$\text{But } -\cos a = \cos (180^\circ - a)$$

$$-.14397 = \cos (180^\circ - 81^\circ 43')$$

$$= 98^\circ 17'$$

$$98^\circ 17'$$

$$\times 60$$

$$= 5897 \text{ Miles}$$

## CORRECTIONS IN EAST COAST SCHEDULES

In September we ran a list of skeds covering the Atlantic Coast and Gulf of Mexico. Some errors have been called to our attention, since that time, by T. C. Hahn of WCG, New York, so hoping that we have not caused anyone any unnecessary listening, we are submitting the following corrections:

WSA, WSH and WCG will send Sandy Hook weather report on request. These reports are received at 8:15 a. m. EST and 4:15 p. m. EST.

Storm warnings and hurricanes are sent QST as soon as received from the weather bureau. Also sent to vessels on request from either WSA, WSH or WCG.

Press dispatches are transmitted at 10:47 p. m. EST from both stations at WSA and WSH, remote controlled from WCG. WSA on 630 and WSH on 2478 meters. WCG does not send press, but will send weather reports on request.

During baseball season, the scores are transmitted from WSA, WSH and WCG around 8:10 p. m. EST.

## WHO'S WHO AND WHERE

Karl Zint, ex-KDNS, WON, etc., left on the fifteenth of October for a nice long cruise on Zane Grey's yacht, *Fisherman*. The trip is to last a year and a half, taking in every fishing ground in the world. More power to you, Karl. Come and see us if you ever get back to the U. S.

Francis E. Beaulieu took the *Calawaii* to Hawaii last trip, relieving I. W. Pinkerton, who is taking a job ashore.

Gaspar, ex-*Admiral Dewey*, is now second on the *Calawaii*.

The millionaire banker, Captain G. Allen Hancock, has just finished the reconditioning of the Mexican ship *Oaxaca*, installing on her a Federal chopper spark as her radio equipment, with an iron mike, Sperry repeating compass, and Kolster radio compass as part of her wheelhouse equipment. She has been built for cargo carrying, but her quarters are such that she may be used for a yacht. Opr. Maurice Kennedy will take her out for her maiden (?) voyage.

Keith Levy, after recovering his stolen automobile, took the *Santa Maria* to Buenos Aires. The farther the better, says Keith.

# With the Amateur Operators

## THE LOS ANGELES RADIO CLUB

THE Los Angeles Radio Club has been reorganized by eight Los Angeles "hams," who rented and furnished a clubroom. They "own" the club, but they share its privileges with other fellow "hams" for a reasonable initiation and membership fee. There are no regular meetings, but if the club is honored by a good speaker, or if there is important business to transact, an assembly of the membership is called. The wives or "friends" of the members furnish refreshments, and everyone has a good time. (No, no! It's perfectly legal and all that.) The clubroom is open to members and visitors

tion in theory and code and there is room for fifteen students at the tables at the same time. Code practice is given every Monday and Friday nights with the aid of two "P.R.S." tape transmitters and a large omnigraph. Every Wednesday, there is a class in practical transmission and reception under a competent instructor. It is surprising to watch the rapid growth of this class of BCLs and others who are beginning to appreciate "real radio."

Back of the instruction corner is the laboratory containing tools and instruments for club members to carry on experiments on a small scale or for making apparatus for their own use. (It looked to us as if the lab.

noises. The appearance of the station would satisfy the taste of the most discriminating operator. All apparatus was either built or donated by the membership. At present, a 50 watt transmitter is used with "S-Tube" plate supply. An auxiliary set is nearly ready for use. A Grebe CR-6 is used for long wave work in receiving, and a conventional "lo-loss" fills all needs in the amateur bands. A broadcast transmitter is on its way and the club intends to broadcast some spicy programs. Snappy entertainment, educational talks on radio, code practice; all of these will go out on 108 meters. Watch for some surprises, too! The call letters of the amateur station are 6CWG.

To set off the appearance of the station, a large silver cup stands on top of the "Grebe." This cup was won by a wily delegation from the club to the National Convention of the A.R.R.L. at Chicago in August, 1925, for having the most "men eniles" at the convention. This beautiful cup is now used to catch all voltage drop, but it is still empty.

Just a few more words. We almost forgot the most important part. The eight men who reorganized the club are as follows: Jay Peters, 6BEV, President; C. F. Wright, Secretary-Treasurer; Ed Gilbert, 6AIC, Publicity Manager and Chief Torero; M. E. McCreery, 6LJ, Editor of Publications; Harry Leighton, 6CFT, Superintendent of Instruction and in charge of station; Melvin S. Wood, 6AVJ, Official Printer; Don Kirk, Instructor; William H. Hardy, 6CMS, Club Physician. And . . . omyes! Among the honorary members and members at large are Col. J. F. Dillon, Supervisor of Radio, 6th District; Miss Flora Turner, 6BXA, and Miss Harriet A. Ellsworth, 7SI, popular radio "hamettes" of the Pacific Coast. Officer Harry Farrant of the Los Angeles Police Department, Motorcycle Squad, is another member of the club. He goes after all the boys with heavy feet and handles a mean throttle, trigger, and key, but he shoots "square." His call, when not siren ICW, is 6BG.

A typical meeting was that recently held to give an audience of over 100 members to Col. J. F. Dillon, Supervisor of Radio, and to give a demonstration of talking pictures, using the De Forest Method of speech reproduction.

Colonel Dillon related several instances of dealing with people who made severe interference and how differences and antagonistic attitudes were overcome by good will and sensible reasoning. Col. Dillon went on to say: "There is no law that can be formulated that can so regulate radio energy as to prevent interference. There are several enterprises now operating that give rise to the production of interference. We have only been broadcasting for six years, and it must be admitted that the interference problem has been cleared up a great deal. The co-operation of all concerned with radio is a great thing. Quiet hours and other methods of procedure originated in California, and I want to say that most of the advances in science originated here also. (Applause.) Although there is necessity for the regulation of radio interests, this regulation cannot be done by law alone. It is necessary that there be concerted co-operation, not individually but collectively. This is where the club comes in."

6TQ, Kenneth A. Cantin, A. R. R. L. communications manager at Honolulu, died there on Oct. 27th, 1926. His death will be a great shock throughout the world, as he has communicated with amateurs in almost every country. Heartfelt sympathy is extended to his family.

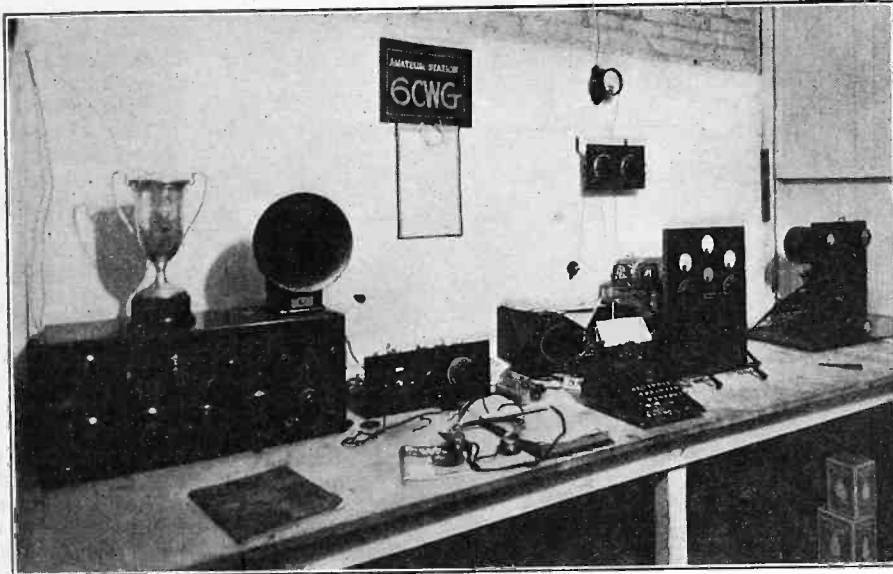

Operating Room.

from noon until midnight. All members are required to strictly adhere to an excellent set of rules which are particularly suited to a club of this kind.

The clubroom is at 2808½ South Main Street where there is plenty of (s)parking space, very little noise, a minimum of QRN, and in a location within easy reach of all. The room is attractively furnished and they have a library in which may be found the latest magazines and publications on radio. A corner is devoted to instruc-

tion might play a prominent part in their real initiation hi jinx that they have for new members!) Across from the laboratory are bunks, accommodating six men, for those who want to "pound brass" all night or for the convenience of out-of-town members. In another corner of the room is the "commissary," where soft drinks, candy, and tobacco may be had. All the modern conveniences of home plus!

The club station is inclosed by a glass partition, shutting out practically all room

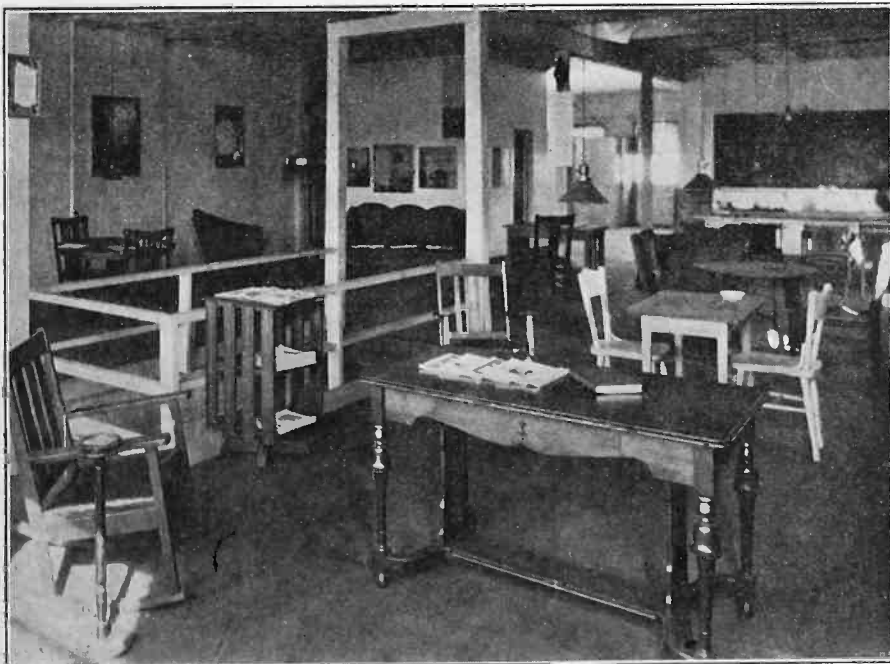

Club Room of Los Angeles Radio Club.



## R.F. TRANSMISSION LINES

By FRANK C. JONES

The purpose of a radio frequency transmission line, otherwise known as an energy coupler or antenna feeder, is to connect an efficiently located antenna and counterpoise to a conveniently located distant transmitter. Properly located, its losses may be less than those of the ordinary short lead-in arrangement. It may be of either the voltage feed or of the current feed type, according as it conducts small current at high voltage or large current at low voltage.

The results of a series of recent tests of the relative efficiencies of these two types on 41 meters are shown in the accompanying tables. The antenna was an inverted L with 31 ft. aerial 9 ft. from a 30 ft. counterpoise, each being a single No. 14 wire. The nodal point of voltage fell within the coupling coil, which was made of 3 turns on a 3 in. diameter. The resistance of the antenna, including the coupling coil, was 15 ohms. Antenna current was read with a hot wire ammeter placed close to the coil, thus giving maximum current in the antenna for most of the tests.

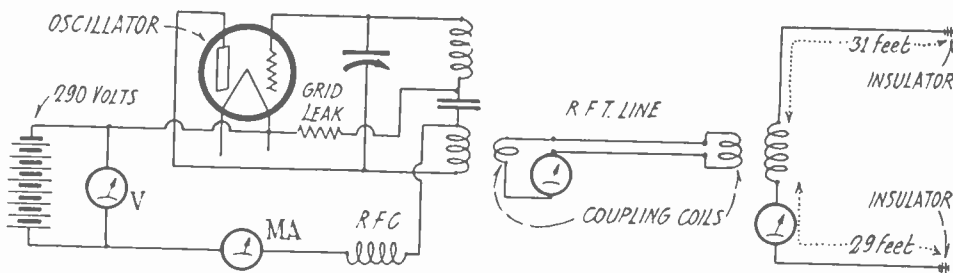

Fig. 1. Current Feed Arrangement.

Fig. 1 shows the current feed arrangement. Plate current for the low-powered oscillator was supplied from 290 volts of B battery. Tests were primarily made to show the effects of wire spacing and size. It may be noted that the efficiency of the system was increased over 400 per cent by decreasing the spacing of the wires in the RFT system. The results with twisted wire are most startling. Obviously larger wire gave better results. It was noted that the current in the RFT line was a minimum and the plate current a maximum when the oscillator was tuned to the wavelength of the antenna. When the oscillator was tuned slightly to either side of the antenna wavelength, the current increased greatly in the RFT line, and when detuned far enough the current dropped off to nearly zero.

The wiring of the voltage type of feeder is shown in Fig. 2, the feeder being tapped on

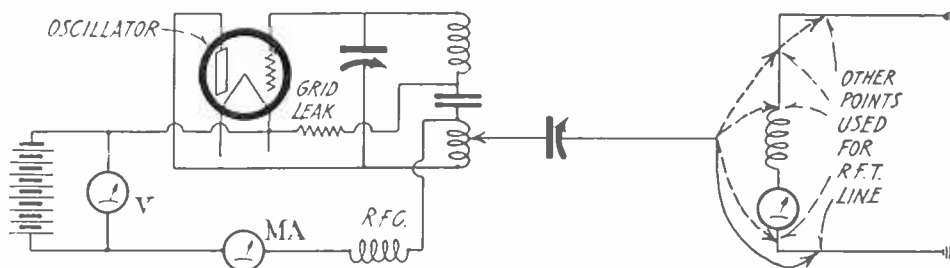

Fig. 2. Voltage Feed Arrangement

to different points along the aerial or counterpoise. It was found that the natural wavelength of the antenna was increased considerably when the RFT feeder was moved out further along either the aerial or counterpoise. In every case the plate current was considerably greater for the same antenna current except when the feeder was out quite far along the aerial or counterpoise and then the antenna fundamental went way up. The fundamental could be lowered by taking the coil out of the center of the antenna, in which case the ammeter reading in the antenna could not be used as a comparative reading.

It was rather difficult to compare the two systems of RFT lines, but the general conclusion drawn was that the current feeder type was more efficient and desirable than the voltage type. The voltage feeder has the great disadvantages of power loss if near anything, while the current feeder type can be run along the house under window sills, or nearly any place, with practically no additional introduced losses. Another thing is that the voltage feeder is really part of the antenna, in that it actually radiates power, which is undesirable, and it has a very decided effect on the fundamental of the antenna. On the other hand, it does not require any coil in the center of the antenna, which acts as a loading coil.

The reason for the great increase in efficiency of the current feeder type of RFT line when the two wires are twisted together may be due to a better power factor in the line itself. Another experiment was tried in which the line was made up of three different sizes of wire in the twisted portion. The losses in this line, probably from reflection losses due to unequal impedances, were considerably

greater than in a line made of all one size of wire.

Coupling the antenna coil directly to the oscillator gave the results listed in the table and simply shows that the losses in the RFT lines were not very large, which is a large point in favor of their use in order to get the antenna clear of nearby objects. Great height in an antenna is unnecessary, if it is located in the clear with nothing near it, but such reasoning doesn't apply in cities or wooded areas when a "clearance height" should be allowed for and some form of "Hertzian" antenna used especially for the short wave below 50 meters.

In designing a "Hertzian" antenna, it may be either vertical or horizontal with the counterpoise extending straight out from the aerial part. A simple rule for use in the 40 meter band is to make it half the wavelength, in actual length minus a certain amount for

the inductance located at the center. A coil of about 3 turns will increase the fundamental about 4 meters, so for a 40 meter antenna and a 3 turn coupling coil, the length, excluding the coil, should be about 16 meters, or about 52½ feet.

### Current Feeder RFT Line

$\lambda=41$  meters.

Antenna current	.....0.60	amperes
Plate current	.....38	mils.
RFT line—11' of No. 19 ga. twisted pair.		
Antenna current	.....0.51	amperes
Plate current	.....32	mils.

RFT line—4' of No. 24 wire spaced 4 to 8 inches.

Antenna current	.....0.59½	amperes
Plate current	.....35½	mils.

RFT line—4' of No. 24 wire twisted together.

Antenna current	.....0.20	amperes
Plate current	.....29½	mils.

RFT line—25' of No. 26 wire spaced 6 inches.

Antenna current	.....0.47½	amperes
Plate current	.....32	mils.

RFT line—25' of No. 26 wire twisted together.

Antenna current	.....0.42	amperes
Plate current	.....29½	mils.

RFT line—25' of No. 26 wire twisted together.

Antenna current	.....0.59	amperes
Plate current	.....36½	mils.

RFT line—25' of No. 26 wire twisted together. (Closer coupling.)

Antenna current	.....0.59½	amperes
Plate current	.....37½	mils.

RFT line—7' of No. 28 wire twisted.

Antenna current	.....0.55	amperes
Plate current	.....34½	mils.

RFT line—7' of No. 14 wire twisted.

Antenna current	.....0.40	amperes
Plate current	.....32	mils.

RFT line—8' of No. 19 wire twisted.

Antenna current	.....0.48	amperes
Plate current	.....33½	mils.

RFT line—7' of No. 28 wire twisted.

Antenna current	.....0.49	amperes
Plate current	.....33½	mils.

RFT line—7' of No. 14 wire twisted.

### Voltage Feeder RFT Line

Antenna current	.....0.54½	amperes
Plate current	.....36½	mils.

RFT feeder 5' above antenna coil (point of connection to antenna).

Antenna current	.....0.20	amperes
Plate current	.....36½	mils.

RFT feeder at top side of antenna coil ( $\lambda=43½$  meters).

Antenna current	.....0.59½	amperes
Plate current	.....37½	mils.

RFT feeder 10' above antenna coil ( $\lambda=44½$  meters).

Antenna current	.....0.52	amperes
Plate current	.....40½	mils.

RFT feeder 10' above antenna coil ( $\lambda=45$  meters, osc. slightly detuned).

Antenna current	.....0.21	amperes
Plate current	.....43	mils.

RFT feeder 5' from coil on counterpoise side ( $\lambda=43½$  meters).

Antenna current	.....0.61	amperes
Plate current	.....40½	mils.

RFT feeder 9' from coil on cterpse. side ( $\lambda=44$  meters).

Antenna current	.....0.54	amperes
Plate current	.....41	mils.

RFT feeder 9' from coil on ctrpse. side ( $\lambda=40½$  meters and 2 turns in coil).

Antenna current	.....0.56	amperes
Plate current	.....41	mils.

RFT feeder 9' from coil (only 1 turn in coil and  $\lambda=42$  meters).

Antenna current	.....0.56½	amperes
Plate current	.....41½	mils.

RFT feeder 9' from coil to 1 turn ( $\lambda=41½$  meters).

### Antenna Coupled Directly to Oscillator

Antenna current	.....0.60	amperes
Plate current	.....38	mils.

Antenna current	.....0.51½	amperes
Plate current	.....33½	mils.

Antenna current	.....0.47½	amperes
Plate current	.....32	mils.

Antenna current	.....0.59	amperes
Plate current	.....36	mils.

Antenna current	.....0.41	amperes
Plate current	.....31	mils.

Antenna current	.....0.20	amperes
Plate current	.....29	mils.

## 100 WATT MASTER OSCILLATOR AT 6NO

6NO, owned and operated by Chas. H. Cross, 735 Hilgirt Circle, Oakland, Calif., uses one 50 watt 203A as oscillator and two

similar tubes in parallel as amplifiers. With 130 m. a. on the plate of the oscillator and 300 m. a. on the plates of the amplifier, 7½ volts filament, the radiation is 6 amps. on 38 meters. Coils are silver-plated, 4 in. in diameter; 3 in. coupling is used.

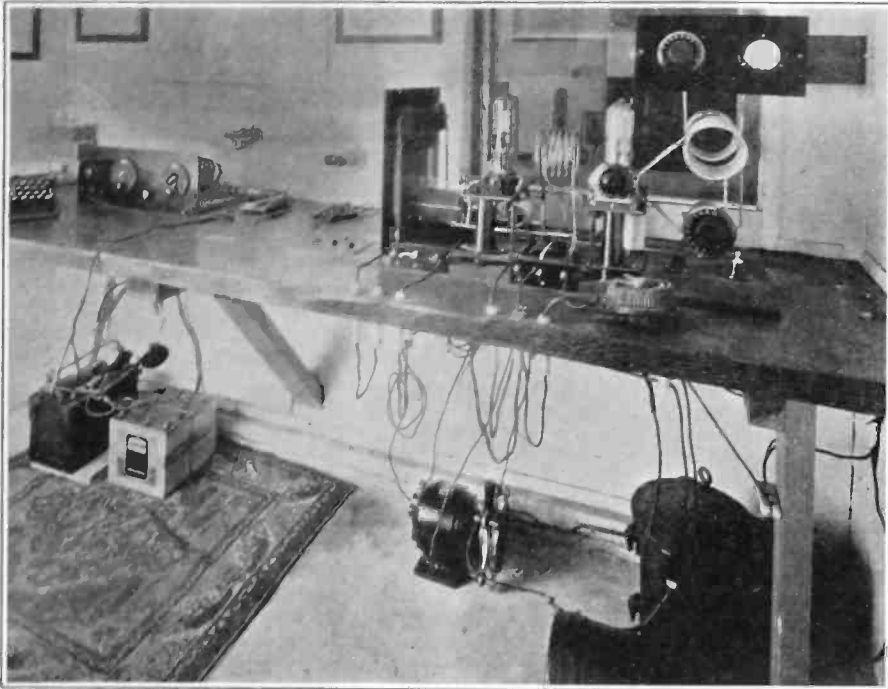

Radio Station 6NO.

similar tubes in parallel as amplifiers. With 130 m. a. on the plate of the oscillator and 300 m. a. on the plates of the amplifier, 7½ volts filament, the radiation is 6 amps. on 38 meters. Coils are silver-plated, 4 in. in diameter; 3 in. coupling is used.

the tuning condenser a double click will be heard in the phones as you pass over the point at which the antenna circuit and the secondary circuit are in resonance.

Gradually loosen the coupling between these circuits and repeat this procedure until

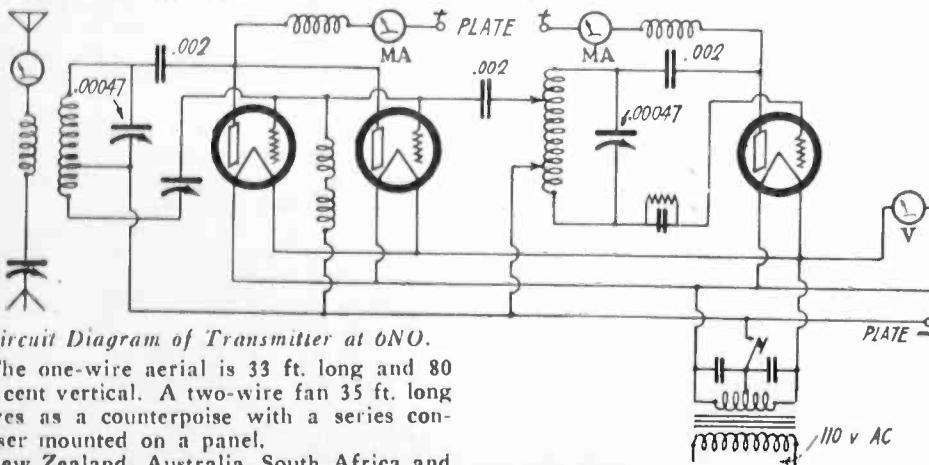

Circuit Diagram of Transmitter at 6NO.

The one-wire aerial is 33 ft. long and 80 per cent vertical. A two-wire fan 35 ft. long serves as a counterpoise with a series condenser mounted on a panel.

New Zealand, Australia, South Africa and South America were worked during July. Traffic schedules are to be maintained during the winter months.

## MEASUREMENT OF ANTENNA FUNDAMENTAL

By A. P. PRICK

With a properly designed antenna system it is possible for the amateur to construct a transmitter which can be operated on the 40, 80 or 150-200 meter wavebands at will. For such double or triple duty the antenna must be constructed for a certain pre-determined wavelength of about 130 meters. With a loading coil in series it can then be tuned to any point in the 150-200 meter band by means of a condenser. With a 4 or 5 turn pick-up coil and a series antenna condenser it can be operated on 80 meters. Then by tuning the oscillator to 40 meters and the antenna circuit to its third harmonic the entire set can be efficiently operated on 40 meters.

The important part of this process is the determination of the antenna fundamental. This can be readily measured by the click method with a calibrated oscillatory receiver or an uncalibrated receiver and wave-meter.

the two clicks merge into one. The reading of the calibrated receiver dial is the fundamental wavelength of your antenna circuit.

If your receiver is not calibrated first find the point of resonance and place a wavemeter coil close to the receiver secondary. Then, not touching the secondary tuning dial, slowly turn the wavemeter control dial until the click locates the point where the wavemeter and receiver are in resonance. Finally read the wavelength on the wavemeter scale.

If the fundamental is too high or too low, change the physical construction of your antenna and counterpoise until it approximates 130 meters.

For transmission on 40 meters hook your pick-up coil in series with the aerial, the series condenser, and the counterpoise. Set your oscillatory receiving set at 40 meters, either by means of its own calibrated scale or by check with the wavemeter. Then couple the pick-up coil to the secondary tuning coil of the receiver, and slowly turn the dial of the series antenna condenser until a click is again heard, whereupon it will be found that the antenna circuit is tuned to the third harmonic of the oscillatory receiver. You will

find this harmonic tuning very sharp and the click quite faint. You may possibly have to use quite close coupling in order to get results, but do not carry this coupling too far, as the effect on the secondary tuning circuit of the receiver by the antenna circuit will throw the measurement off.

It is obvious that the above described method of checking antenna wavelengths will be applicable to various phases of transmission. This work also goes to show how valuable a calibrated oscillatory receiver is to the amateur interested in transmission. By all means have a good receiver in your possession and calibrate it by means of an accurate wavemeter. You will never regret the time and trouble spent in this direction.

## CALLS HEARD



By DAPY, 3337 Oak Park Ave., Berwyn, Ill. (40 and 80 meters)

1aei, 1aer, (1aid), 1akz, 1amd, 1ami, (1awe), 1azd, (1bca), (1bhp), 1bwi, 1byx, 1ecz, 1clb, 1ctp, 1lh, 1mp, 2aar, 2afo, 2akv, 2ali, 2apv, 2axy, 2byg, 2cin, 2crb, 2cuq, (2cvj), 2cxl, 2czz, 2ds, (2em), 2ev, 2nf, 2qi, 2rs, 2va, 3afw, 3ahj, 3buv, 3bvt, 3cjh, 3ld, 3mp, 3oq, 3ql, 3xl, 4bu, 4cz, 4dd, 4ft, 4fu, 4fw, 4go, 4iz, 4jk, 4kj, 4lb, 4li, 4mv, 4oa, 4oq, 4pf, 4qb, 4ql, 4rm, 4si, 4wa, 4wj, 5aab, 5adt, 5afb, (5afs), 5agl, 5ajp, 5akk, 5amb, 5anc, (5apg), (5api), 5aqf, 5ax, 5ce, 5de, 5dq, 5dv, 5ek, 5hz, 5mz, 5pk, 5ql, (5qq), 5qy, 5qz, 5tt, 5uk, 5vl, 5yd, 6aaf, 6adv, 6agd, 6agu, 6ahp, 6amm, 6aod, 6bau, 6bcn, 6bjt, 6bmw, 6bol, 6bxd, 6bzn, 6bzy, 6cae, 6cqw, 6cuw, 6daa, 6ud, 6zat, 7aab, 7anu, 7cs, 7kq, 7pu, 7vl. Australian: A-2BB, A-2BK, A-2YI, A-5BG. Canadian: (C-3HP). Miscellaneous: AA7, AGB, AQ8, FW, GDVB, GLQ, KEL, NAR, NBA, NRRG, VOQ, WIZ, WNP, WVC, WVY, ZDA XC51.

By RXY, M.S. "City of San Francisco"

While at different Central American ports, from Oct. 4th to 25th.

1azd, 1xy, (1fl), 1aac, (1gno), 1ahv, 1bhg, 1cjc, 1zs, 1ajx, 1blf, 1ic, 1ly, (1amd), IR0, (1xg), 1as, (2uo), 2xa, 2anx, (2ayj), 2bqa, 2tp, (2dy), 3bms, 3ee, 3gp, (3hg), 3ba, 4oa, 4rb, 4el, (4km), (4nh), (4rm), 4ak, 4er, 4jr, 4k, 4xe, 4mw, 4iz, 4ee, (4ni), 4qb, 4ft, 5aab, 5acl, 5eb, 5ql, 5ajs, (5ax), 5lr, 5ls, 5aur, 5ado, 5alo, 5alq, 5agl, 5aql, 5amn, 5avl, 5ash, 5hy, 5tt, 5zal, 5aao, 5ada, 5arf, 5ae, 5ev, (5jf), 5uk, 5am, 5kc, 5ame, 5jd, 5oa, 6awa, (6cbj), 6dp, 6jn, 6kb, 6qua, 6bzq, 6bdo, 6bil, 6bux, 6bqg, 6cnc, 6rv, 6rv, 6cky, (6ctx), (6cyh), 6cyw, 6hj, (6zat), 6abc, 6chx, (6cin), 6or, 6gd, 6awq, 6cex, 6ea, 6abg, 6aks, 6bxl, (6bzf), 6cmi, 6cng, 6ih, 6mu, 6aaf, 6ag, 6api, 6akv, 6aon, 6aqa, 6bba, 6bbn, 6blz, 6bt, 6bnn, 6bnw, 6bvd, 6cdf, 6cfx, 6chr, 6cax, 6ckt, 6cky, 6clj, 6cqa, 6cww, 6cub, 6dck, (6cmg), 6eb, 6ep, 6hu, 6lx, 6ud, 6to, 6zao, 7tv, 7abb, 7aek, 8cbr, 8ccs, 8eq, 8qb, 8ben, 8bff, 8cpq, 8dbb, 8vu, (8ajm), 8bbe, 8cau, 8el, 8cjm, 8cb, 8df, 8dsy, 8sx, 8boy, 8bh, 8gk, 9aeb, 9aq, 9bzv, 9cet, 9cye, 9cyp, 9dbh, 9eev, 9ejl, 9ek, 9rf, 9za, 9bay, 9bbf, 9bbn, (9bht), 9bqo, 9bvp, 9cve, 9dpu, 9ub, 9aaq, 9agd, 9ara, 9bow, 9cgn, 9cyw, 9sl, 9ada, (9beq), 9eku, 9dmz, 9dte, 9egh, 9auw, 9cyb, 9drd, 9duh, 9elc, 9kg, 9aln, 9ell, (9aek). Miscellaneous: (ardi), arcx, (a-2yi), a-5bg, a-3yx, (a-2sh), aa7, ab1, ab2, abg, m5n, (m-jh), mlj, f9c, ev8, hu-fx1, (hu-6buc), ft, fw, abc, (ch-4aq), bn-sk2, (gh-lfg), fmh, hik, gky, gb-4cm, joc, lpj, (nem), xdm1, kjoe, r-2cb, wnu, (wvy)?, wax, z-ae, z-4aa, z-3ar, z-2xa, (z-2gc), z-2br, o-a3e, wvx, wvr, (bb3), xda. Pls qsl to radio operators m.s. City of San Francisco, care Panama Mail S.S. Co., San Francisco, Calif.

By 9UB-9FD, Box 347, La Salle, Ill.

Australia: 2bk, 2lk, 2tm, 2kg, 2yl, 2sa, 3bd, 3cs, 4kb, 3ij, 3jr, 3wm, 3ef, 6js, 7kx, 7cs, 7pf. New Zealand: 1ao, 1ax, 2ac, 2bx, 2xa, 2ae, 4aa, 4ac, 4ak, 4am. Mexico: jh, 1n, 1j, 1k, 1aa, 9a. Italy: lau, 1or. Brazil: law, 1ia, 1ip, 1ac, 2ab. Chile: 2ld, 9c. Argentina: cb8, ar1. Hawaii: 6buc, 6def, 6bd1, 6db1, 6axw, fx1. Uruguay: jcp, 1br, 1cd, 2ak. Cuba: 2lc. Canada: 3el, 3bl, 3jl, 3ht, 3nl, 4dy, 4bz, 4zb, 9ag, 5cr. England: 2lz. France: 8hm. Spain: ear13, ear15, ear21. (Continued on Page 60)



# FROM THE RADIO MANUFACTURERS

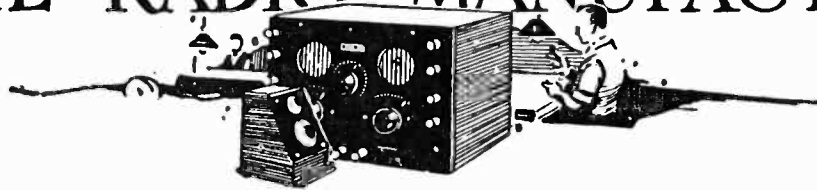

The Chaslyn SOS hydrometer employs three colored balls instead of the usual graduated float to indicate the specific gravity of the electrolyte in a storage bat-



tery. If all the balls swim the battery is full charged. If they sink it is discharged. Intermediate conditions are indicated by one or two of the balls sinking or swimming.

The Greene-Brown "B" supply unit employs as the rectifier a new gaseous conduction tube which is claimed to have low resistance between electrodes, high

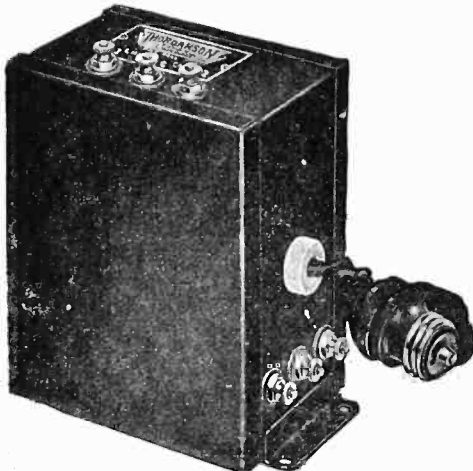

current capacity, and great rectification efficiency. This tube is manufactured to special specifications to match the characteristics of the filter circuit used. It delivers 60 milliamperes at 136 volts.

The new Daven compensator is a mid-gest split stator condenser or "trimmer" used to balance the capacity in two radio frequency circuits which are tuned by

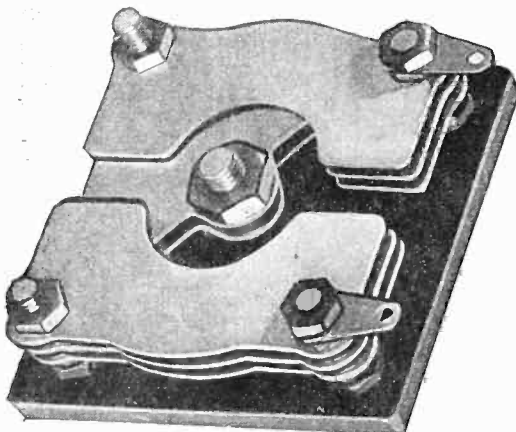

tandem condensers. It is so connected that as the capacity of one of the tandem units is slightly reduced that of the other is slightly increased, thus balancing the two. Where a third tuning condenser is used, the Daven balance may be used in the first r.f. circuit to balance the capacity added to the second and third by the compensator.

The Thordarson power compact is a combined B eliminator and power amplifier. It is made in two types: R-171 for use with a Raytheon tube as a rectifier



and a UX-171 tube as a power amplifier and R-210 for use with a UX-216B rectifying tube and a UX-210 amplifier. Associated parts in both types include a step-up transformer, two chokes, and two condensers.

The Eby shielded dial is designed for one hole mounting. Being shielded, there is no change in the setting of a station when the band is removed. It is made of

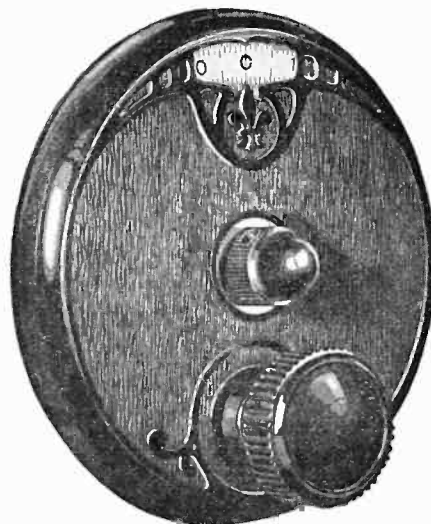

black bakelite in clockwise and counter clockwise types, with hairline indicator. It has no gears nor back-lash and is of non-microphonic construction.

F. J. Marco, 9ZA, is directing the short-wave transmitting and receiving department of the Barawik Co. of Chicago, who are taking an especial interest in the development of short wave equipment.

## NEW RADIO CATALOGS

"Power Supply for Radio Sets" is the subject of an unusually simple and clear discussion on the lamp socket operation of radio sets. It incorporates much of the laboratory experience of the Acme Apparatus Co. of Cambridge, Mass. Circuit diagrams and parts specifications are given for A, B, and C eliminators, which are also available in factory-built models.

The new eighth edition of "The Manual of Daven Amplification," from the Daven Radio Corp. of Newark, N. J., is a popular treatise on resistance coupled audio amplifiers. Illustrations are given of its application to all types of receivers except those employing the reflex principle. Practical suggestions are given for obviating any trouble that may arise. This pamphlet is priced at 25 cents a copy.

"Audio Frequency Amplification" is the subject of an attractive 40 page booklet from the Samson Electric Co. of Canton, Mass. It discusses various types of audio amplifiers, together with the causes of distortion, and presents some interesting facts regarding transformer amplification. The text is well illustrated with high grade circuit diagrams.

Audio amplification with impedance coupling by using Ford double unit is illustrated and described in a circular from the Ford Radio & Mica Corporation of New York City.

Among items listed in a forthcoming catalog from the All-American Radio Corporation of Chicago are their new model shielded audio transformer with either 3 to 1 or 5 to 1 ratio and their input and output push-pull transformer. They also illustrate and describe the Lorel reproducer, involving a combination of a cone speaker with a sounding board and chamber.

The General Instrument Corporation of New York City are distributing literature on their battery "Ga-Jit," an ingenious device for testing a wet battery's condition by means of its discharge voltage, thus obviating the use of a hydrometer.

New and Improved Freshman Masterpiece Models for 1927 are shown in a catalog and instruction book from Chas. Freshman, Inc., of New York and Chicago. These include models varying in price from \$57.50 for a sample 5 tube set to \$119.50 for more elaborate models with built-in cone type loud speaker. Other items illustrated include the Freshman Master B eliminator, ABC power supply storage battery, power amplifier, and master speaker.

The Westinghouse Electric and Manufacturing Company catalog on Rectigon battery chargers is complete with descriptions of the various types and their applications. The catalogue is divided into sections that describe the operation and construction of radio and private garage rectigon outfits, home and garage outfits, radio B battery charging attachments, telephone rectigon outfits, the 6-ampere 75 volt rectigon outfit, and the 12 ampere 75 volt rectigon outfit. This publication, catalogue 284, is well illustrated with halftones of the various types.

# Still the undisputed leader

*Rauland-Lyric*  
AUDIO TRANSFORMER



If you love music, and want your radio set to reproduce tones *faultlessly*, there is one audio transformer you can absolutely depend on—the famous Rauland-Lyric.

Voices and instruments alike are amplified with amazing realness by the Rauland-Lyric; with faithful amplification of those “overtones” essential to full, natural reproduction. The amplification curve of the Rauland-Lyric illustrates its outstanding superiority in tone purity.

The Rauland-Lyric is the undisputed leader in its field. It is invariably chosen by set builders who want the utmost in perfect tone quality.

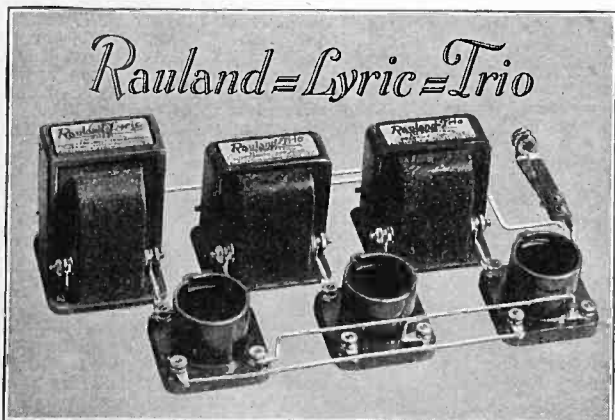

Write for “Modern Audio Amplification”,  
a free book, describing this fine unit.

## A new high mark in three-stage audio amplifiers

Your receiver's tone quality depends in large measure on correct audio amplification. The famous Rauland-Lyric Transformer may now be combined with two Rauland-Trios (impedance units) to form the Rauland-Lyric-Trio — the highest known perfection in three-stage audio amplification. Rauland-Trio is a compact, well-made unit — containing in one shell — inductance, resistance, and capacity in correctly balanced relation.

## New 1927 Radio Key Book

You'll enjoy reading it—48 pages of interesting, up-to-the-minute facts about radio, simply told. Also full construction details of all leading types of circuits. Send 10 cents (coin or stamps) to cover postage and mailing cost.

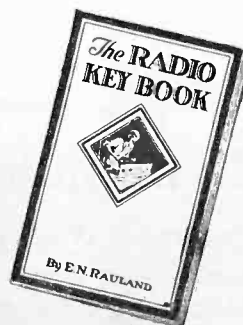

ALL-AMERICAN RADIO CORPORATION

4215 Belmont Avenue, Chicago, Illinois

OWNING AND OPERATING STATION WENR 266 METERS

Tell them that you saw it in RADIO



**YOU CAN BUILD THE NEW SHIELDED HI-Q\***



**The Hammarlund-Roberts Board of Engineers**

The Hammarlund-Roberts Hi-Q Receiver is the joint creation of ten of America's leading engineers.

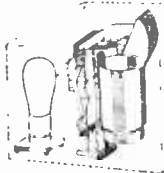

**Automatic Variable Coupling**

A wonderful new feature which gives maximum and equal amplification and selectivity over entire tuning range.



**"How to Build It" Book**

Simple ABC language. Every detail described, numbered and diagrammed so that you can easily understand it.

Price 25c.



**The Hi-Q Foundation Set**

Includes drilled and engraved panel and sub panel and all the essentials required to start building.

Price \$10.50



**\$6<sup>05</sup>**

**Over 57,000 Built at Home  
You Can Do It Too**

**I**F you want radio's greatest value look into this New Shielded Hi-Q Receiver—designed by ten leading American engineers. Even a greater instrument than the famous Hammarlund-Roberts which has been built by over 57,000 novices. Incorporates every modern feature. Highest quality parts are PERFECTLY MATCHED. Five tubes equal eight. A new feature eliminates distortion and produces the sensitivity of expensive many-tubed "Supers." And on all stations, tone has that velvet-smooth, crystal-clear quality you have always hoped for.

Ask your dealer for the "How to Build" book and learn how you can build one of the world's finest radios—at a saving of \$50 to \$100 over sets of anything like similar efficiency.



**HAMMARLUND-ROBERTS**  
1182-F BROADWAY, NEW YORK

*\*High ratio of reactance to resistance  
High ratio—Great Selectivity—Loud Signals*

**RADIO DX HOUNDS**

Get "Broadcast Weekly" to keep posted on operating schedules and wavelength of U. S. Stations.

Send 10c for Copy.

**BROADCAST WEEKLY**  
433 Pacific Building,  
San Francisco, Cal.

**FIVE TUBE RADIO**



**\$25<sup>00</sup>**  
**AGENTS WANTED  
BIG COMMISSION**

Demonstrating agent wanted; every county. Exclusive to right man. Sell what public wants—five tube, long distance, loud speaker radio with single dial control. Price within reach of all, \$25.00 retail; liberal discount to agents. Sell in spare time—evenings. No selling or radio experience necessary. Territory going fast. 100 page P-d'n Book FREE. Write today—don't delay. C. D. FISCHER, 122 W. Austin Ave., Chicago

**CALLS HEARD**

(Continued from Page 51)

ear22. Miscellaneous: kfuh, kegk, kurf, kflf, bam, nidk, nidr, niss, nba, nau, nem, fbio, wvy, wvz, wpe, wzt, wnp, kgbb, aw5, eg5, aot, rxy, kfhw.

**By 17MF-ABM, Harold DeVoe, 1310 West Main St., Medford, Ore.**

Alaska: 7bh, 7bw. Australia: 2bb, 2bk, 2cg, 2cs, 2lk, 2no, 2yi, 3ef, 3em, 3en, 3ls, 3my, 3yx, 4cm, 5bg, (5wh), (7cw), 7dx, (7la). Borneo (North): sk1, sk2. Brazilian: law. Canadian: 3jw, (4af), (4dq), 4hh, (5aj), (5ar), (5bf), (5hk). Chilean: 2ar, 2ld. Hawaiian: 6ams, 6asr, 6dbl, 6dcu, (6dea), 6xk, fl-1, (fx-1). Japanese: 1ts, 3aa, joc, Mexican: 1j, 9a. New Zealand: 1ao, 1ax, 2ac, 2ae, 2bg, 2bp, 2bx, 2gc, (2xa), 3al, 3aj, 3ak, (3ar), 4aa, 4ac, 4am, 4av. Philippines: 1au, 1dr, 1hr, wucb. South Africa: a6a. Straits Settlements: 2se. Uruguay: 1cd, 2ak. Miscellaneous: ahi, (bb-3), dx-8, fb-2, fw, kel, lpi, naw, npc, npg, npm, npn, wiz, wnp, wvc, xc51, 2xaf, 8flo, 7mf is on 40.5 meters with a UV-203-A, all reports appreciated and answered promptly. Will be away to college, but all cards will be answered during vacations. Best 73's and cu on the air.

**By G2ACI, 22 Hurst Grove, Bedford, Eng.**

March—U.S.A.: 1ae, 1awe, 1ajf, 1apz, 1blb, 1rd, 1ww, 1yv, 1vy, 1sw, 1wl, 1bz, 2cvj, 2cjj, 2atc, 2ev, 2ng, 3cjn, 3ck, 4ca, 5lz, 6al, 6dl, 8tk, 8kc, 8xe. Canada: 2pn. New Zealand: 4au, 6hu. Australia: 3ki, (Tel), 2pf. Various: gfc, lpz, wiz, buz, cy7, zhc, gbm, gha, gfp, tmu, xk, zss2, ek, uev, gsag, jzo, m8ric, falcd.

May—U.S.A.: 1nv, 1lf, 1sz, 1xf, 1bzp, 1ckp, 1aao, 2dx, 2agx, 5za, 8dan, 9aab. Brazil: 1ad, 1ar, 1ap, 1be, 1af, 1pt, 2ab, 2ws, snl. Australia: 1aa, 3bq, 3lw. New Zealand: 4aa. Various: sgc, lgm, kel, agk, agb, bxc.

June—U.S.A.: 1amd, 1cmx, 1mv, 1ch, 1car, 1ba, 1xms, 2aha, 2gk, (Tel), 2ff, 2rv, 2xaf, 3bva, 6fc, 7hc. Canada: 1ar. Brazil: 1ap, 1aw, 1af, 1ar, 1ay, 1ao, 1aq, 1al, 1ak, 3aa, 6qb. Chile: 2ld. Argentine: ha2, hd3, cb8. Various: crj, etc3.

July—U.S.A.: 1axx, 1ade, 1ble, 1bk, 1cc, 1mv, 1as, 1dh, 1ad, 1fl, 1cnp, 1ayl, 1alr, 1ahx, 1fl, 2aj, 2amj, 2cjd, 2shg, 2cyq, 2ar, 2bdn, 2gv, 2bs, 2cip, 2xaf (Tel), 3cmz, 3cjn, 3ld, 4ar, 4lk, 4br, 5ave, 6eus, 6dt, 8pbp. Brazil: 1ay, 1ao, 1ar, 1ad, 2ae, 2cg. Argentine: ar1, bal, cb8, db2, de3. Uruguay: 1cd. Porto Rico: 5ja. Chile: 2ld, 2ar. Various: oxx, anf, wnp, nkf, gdvb, agc, agb, obm, crj, nks, oxx, oax, sgc. Hav. plenty of crds. hr. OM's and always QSL.

**By 6ASD, G. M. Green, 6346 Drexel Ave., Los Angeles, Calif.**

U.S.A.: 1aci, 1akm, (1amu), 1apd, 1awe, 1azd, 1bbr, 1bhs, 1bif, 1bz, 1cab, (1ccz), 1cjc, (1ckk), 1cmp, 1cmx, 1dl, 1fl, 1kk, 1py, 1vz, 1xv, 2aib, 2aln, 2apd, 2apv, 2aqk, 2aqw, 2arm, 2avr, 2bkr, 2amj, 2blm, 2bot, 2bsc, 2cty, 2cuq, 2exl, (2dy), 2kg, 2nz, 2rm, 2sq, (2sy), 2tp, 2uo, 2wc, 3afv, 3ajt, 3aly, 3bqj, 3bva, 3cb, (3cdk), 3cjn, (3ee), 3fc, 3kr, 3nk, (3ql), 3zo, 4bt, (4cm), 4cu, (4do), 4fl, 4fu, 4gt, 4hl, (4jk), 4js, 4lb, 4li, 4lt, 4nh, 4oa, 4pz, 4qb, 4rm, 4ry, 4si, 8ada, (8ago), (8amb), 8asb, 8atv, (8axk), 8baf, 8bay, 8bbe, 8bbx, (8bct), 8bf, 8biq, 8bpl, 8bqc, z-3yi, z-4aa, z-4am, z-4av. Miscellaneous: aa7, ab1, agb, and, aq8, bb3, bxy, lp1, naj, nao, npa, npk, npm, npn, npu, vkp, voq, wnp, wvr, wvy, wvz.

**By 7PH-7ABV, Leo Sands, 2119 McDougall Ave., Everett, Wash.**

a3hl, z2ac, c4ag, tuk, rrp, rdw, kft, nkf, ndf, wiz, wwd, npo, reb8, u2gy, au7bh, bam, tuthht (gra?), ktt, kfgf, npl, fl, poz, gdvb, f8ds. Will QSL to above on receipt of card.

**By J. Federico Mejia, sr-FMH, 14a Avenida Norte No. 21, San Salvador, Rep. of Salvador, C. A.**

U. S. Calls: 1ajm, 1awe, 1bhs, 1ccz, 2amq, 2apv, 2au, 2aw, 2awq, 2ayj, 2ck, 2ih, 2cxl, 2nz, 2fx, 2sc, 2sj, 2uo, 3aig, 3ade, 3asw, 3blz, 3jf, 3kw, 3xg, 3yp, 4bk, 4gl, 4it, 4iz, 4qb, 4qbv, 4sl, 4tkb, 4wb, 4wj, 5aab, 5ash, 5at, 5dh, 5fa, 5gz, 5uk, 5ux, 5ik, 5zg, 5zu, 6ahh, 6asa, 6edu, 6chl, 6ct, 6ul, 6cuw, 8aay, 8az, 8bdc, 8boy, 8bzt, 8bfv, 8ccs, 8cro, 8chx, 8cuZ, 8dbb, 8dmz, 8dne, 8ex, 8nn, 8sz, 9acx, 9atq, 9auv, 9bff, 9buj, 9bvp, 9cet, 9cw, 9cyw, 9dez, 9dkg, 9dpw, 9dte, 9dvt, 9eea, 9ei, 9ekn, 9elb, 9elt, 9ft, 9if, 9iun, 9mn, 9qab. Miscellaneous: fw, lcc, glq, npg, npl, nem, nxf, ur, wiz. Crd. for crd. OM; send for urs. QRK sr-FMH on 78 meters?

**By 6RO, 284 4th St., San Francisco (40 meters only)**

1alr, 2sz, 2uo, 3wj, 3zo, 4dd, 4ft, 5ado, 5aio, 5apo, 5arn, 5ash, 5et, 5lg, 5tt, 5uk, hu, 6dbl, 6dcf, 6dea, 6amb, 8eq, 8ew, 8sf, 9ahq, 9baa, 9bpx, 9bqo, 9bwo, 9cp, 9dlj, 9dkm, 9dpj, 9dvl, 9eea, 9la, 9zk, m9a, jh, jaa, xc5l. Unknown: aqe, zbj.



Eveready's exclusive Layerbilt  
construction *makes this*  
*the most economical of "B" batteries*

IMPROVEMENT on top of improvement has been the history of Eveready Radio Batteries. Here, in the radically different Eveready Layerbilt, is the "B" battery which tops them all. The ability of this battery to give you unrivaled service and economy is due to its unique internal design. Instead of the usual assembly of round cells, it is built of flat layers of current-producing materials pressed firmly together. This construction makes use of the spaces now wasted between the round-type cells and avoids the usual

soldered wire connections. Eveready Layerbilt is every inch a battery. This exclusive Eveready Battery development packs more active chemicals in a given space and enables them to produce more current and give longer life.

This HEAVY-DUTY EVEREADY LAYERBILT BATTERY gives twice the service of the

**EVEREADY**  
**Radio Batteries**  
*-they last longer*

smaller Light-Duty batteries and greatly reduces your "B" battery operating cost.

Use Eveready Layerbilts on any set, and get not only this extra service, but also—the greatest "B" power operating economy—the utmost in "B" power dependability—D. C. (direct current) in its purest form, so necessary for pure tone quality. There is an Eveready dealer nearby.

*Manufactured and guaranteed by*  
NATIONAL CARBON CO., Inc.  
New York San Francisco  
Canadian National Carbon Co., Limited  
Toronto, Ontario





**DIRECT ACTION**  
(Continued from Page 38)

never got more liquor aboard yit than I could carry."

"Ah! quit yer beefin! You don't seem to realize what I've let you in on, just because I need yer old buzz wagon. Didn't know myself jest how d—good it was. When I heard down there to Mesquite how this old guy was so busy with his own minin' that he was like to slop over on the assessment work, I lowed we might maybe get a chance to jump some claims; an' here we blow in jest when he's hit the vein. Talk about luck! We're the frog's chin whiskers!"

"Huh? What if he has got it staked?"

"Nah. He ain't filed on it. This is a bran new hole. Suppose I hain't seen the gold. You heard what he said, didn't you? An' that ole billy goat knows his onions. We'll get some samples as soon as it is light, an' high tail it fer the land office."

The boy had heard enough. Silently he worked his way back to his uncle's house. What would he do? What could he do?

While not a coward, Philip had never been especially daring, and at this time his physical condition was far below par. He felt his courage slipping. For a moment he was tempted to do nothing; let things take their course. No one could blame him. No one would even know that he had heard. But he came from a long line of fighters. He had too much good stuff in him to stand by, cowering, while these birds of prey robbed his old uncle of his "strike"—the quest of a lifetime. Something *must* be done, and it was up to him to do it.

Several hours later Philip, with a little wooden box beside him, crouched again just outside the broken window. The moon had dropped behind the barren hills; a velvet darkness enveloped the vast desert and the little forsaken town. The dead stillness of the night was in itself sinister, almost terrifying. The boy's body was tense, his heart hammered painfully. He placed a peculiar round object, which was connected to the box by long wires, on the window sill. With a shaking hand he pressed a button and turned a dial on the little box. From much exasperating experience Phil knew just how far to turn that little dial.

The silence was broken by a shrill blood-curdling shriek. It was followed by another, and yet another.

The men in the shack scrambled to their feet in a frenzy of fear. Framed in the window, a baleful red light gleaming from its ghastly eye sockets, was a hideous death's head! The frightful sounds which had roused them came again.

"Two minds with but a single thought," two substantial bodies with but a single means of exit, caused a bad  
(Continued on Page 64)

## Send your good wishes —and a Tungar, too

If he enjoys the radio—surprise him with a G-E Tungar. It will keep batteries fully charged; help him to obtain better reception. Through the years, its helpfulness will be a constant reminder of your greetings.

Five ampere, two ampere, or Trickle Charger—your dealer will show you the correct type for any service. They are all made by General Electric—they all can be permanently installed, and they all say "good-by battery charging problem."

P. S. Treat yourself to one, too.

East of the Rockies  
2 ampere Tungar, \$18  
5 ampere Tungar, \$28  
Trickle Charger, \$12  
(60 cycles—110 volts)  
Merchandise Department  
General Electric Company  
Bridgeport, Connecticut

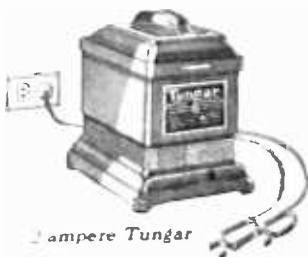

Two ampere—charges all 2, 4 or 6 volt "A," and 24 to 96 volt "B" batteries in series—and auto batteries, too.

Trickle—charges 4 or 6

volt radio "A" storage batteries, four charging rates up to one-half ampere.

Five ampere—same range as two ampere but charges faster

# Tungar

REG. U.S. PAT. OFF.

**BATTERY CHARGER**

Tungar—a registered trademark—is found only on the genuine. Look for it on the name plate.



# GENERAL ELECTRIC

## Bradleystat

PERFECT FILAMENT CONTROL

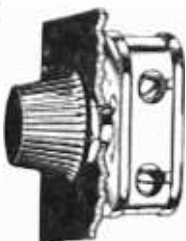

Provides complete noiseless filament control for all radio tubes without change of connections. Metal parts are nickel plated. One hole mounting. Self contained switch opens battery circuit when desired.

**Allen-Bradley Co.**  
Electric Controlling Apparatus

279 Greenfield Avenue Milwaukee, Wis.

## INFRADYNE

has revolutionized radio reception. It is the ultimate in radio. New Full Size Blue Prints, prepared by E. M. Sargent, One Dollar.

MAILED POSTPAID

## L. C. RAYMENT

1200 Franklin St., Oakland, Cal.

**CROSLLEY RADIO**  
All prices slightly higher west of Rocky Mts.

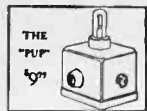

**THE "PUP" \$27**  
This little double-circuit 1-tube set has made long distance records.



**THE "4-29" \$29**  
4 tubes. Amazing efficiency. Crescendon equipped!



**THE "PORTABLE" \$33**  
The 4-29 in portable form.



**THE "5-38" \$38**  
Five tubes, tuned radio frequency. Two stages non-oscillating radio frequency amplification, Crescendon, two stages audio frequency amplification.



**THE "5-50" \$50**  
6 tubes, 1-dial control acuminators, Crescendon, power tube adaptability.



**"RFL-73" \$65**  
5 tubes. True-cascade amplification; non-oscillating and non-radiating.



**THE "5-75" CONSOLE \$75**  
In a mahogany console. 5-tube 5-50 receiver, Crosley Musicone speaker, ample compartment for batteries.



**"RFL-90" CONSOLE \$90**  
Double drum station selector. Mahogany console finished in two tones. Crosley Musicone built-in. Ample space for all batteries and accessories. Power tube adaptability. Comparable in appearance to the highest priced radios, and in performance it has few equals.

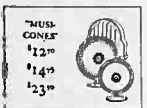

**"MUS CONES" \$125, \$145, \$155**  
12-inch size, \$12.50. Super Musicone, \$14.75. Musicone Deluxe, \$23.50. Also beautiful Musicone console with room for batteries and accessories, as below.



**Crosley Features**

**"CRESCENDON"**

When, on ordinary radios, ears must strain to catch a station miles away, a turn of the Crescendon on Crosley radios instantly swells reception to room-fill-

ing volume. An exclusive Crosley feature. **ALL-METAL SHIELDED CHASSIS**



This truly great radio achievement, found in several Crosley sets,

furnishes a substantial frame for mounting elements, produces excellent alignment of condensers, shields the units from each other, prevents interstage, improves the stability of the circuit, increases selectivity and saves costs by standardizing this phase of manufacture.

**THE SINGLE-DIAL STATION SELECTOR**

Nothing in radio equals the joy or the convenience of single dial control. Crosley single drum control enables you to find the stations sought without log book or "tuning"

**"THE ACUMINATORS"**

Crosley Acuminators permit tuning in—loud and clear—weak stations passed over and entirely missed by ordinary single dial radios. In tuning high powered and local stations they are not used.

**USE OF POWER TUBE**

Power tube adaptability marks the Crosley "5-50", "5-75" and "RFL" sets. This feature typifies Crosley provision for best radio reception at moderate cost. This feature is in keeping with all that is most progressive

**President**

For Catalogue write Dept. 19



**QUALITY AND BEAUTY IN CABINETS AND CONSOLES**

**HEAD PHONES \$3.00**



**Highly Selective R.F.L. models**

Manufactured under Radio Frequency Laboratory License

Crosley R. F. L. sets represent the highest known development in radio receivers. They will not howl, squeal or re-radiate while tuning—no matter how inexperienced the operator may be.

They are sensitive to a degree rarely attained in tuned radio frequency circuits, cutting out nearby stations with an ease and simplicity that makes them ideal for use in congested broadcasting areas.

Persons technically initiated will instantly understand the perfection of Crosley R. F. L. sets when they realize that true cascade amplification, in addition to absolute balance, is accomplished through the use of Wheatstone bridges in each stage of radio frequency.

To this technical perfection Powel Crosley, Jr. has applied his mass production methods, with the result that nowhere else will the radio buyer find equipment that even approaches Crosley values.

The use of parts in million quantity lots, the simplification of mechanical processes and assembly, and the ownership of wood-working factories which produce exquisite mahogany cabinets at an almost unbelievable low cost, are the means employed by Crosley to make possible the highest type of radio reception at the lowest possible price.

That the public is appreciative of the excellence of Crosley R.F.L. radio sets, as well as the opportunity to enjoy them at small cost, is daily indicated by the tremendous volume of Crosley sales.

**Table Model R.F.L. - 75**

Beautiful two-tone mahogany cabinet—High ratio vernier controlled condensers affording sharp tuning—Recessed dials behind windows—Rich metal trimmings—Power tube adaptability. Appearance and efficiency of this set are out of all proportion to its low cost—the result of Crosley mass production.

**\$65**

**6-Tube Console Model R.F.L. - 90**

Double drum station selector. Mahogany console finished in two tones. Crosley Musicone built-in. Ample space for all batteries and accessories. Power tube adaptability. Comparable in appearance to the highest priced radios, and in performance it has few equals.

**\$90**

**THE CROSLLEY RADIO CORPORATION, CINCINNATI—POWEL CROSLLEY, Jr.,**

Crosley manufactures radio receiving sets, which are licensed under Armstrong U. S. Patent No. 1,113,149 or under patent applications of Radio Frequency Laboratories, Inc., and other patents issued and pending. Owning and operating station WLW, first remote control super-power station in America. All prices without accessories.



# A·B·C Light Socket Power

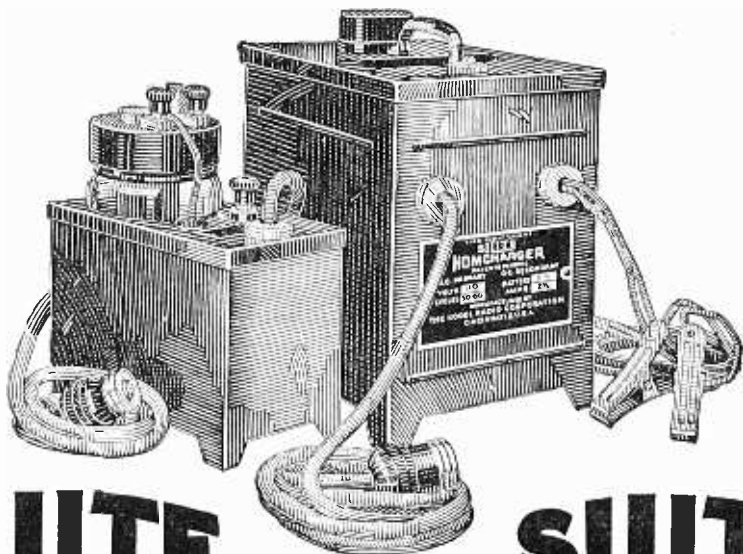

## SILITE

**TRICKLE CHARGER**

## SILITE

**HOMCHARGER**

Your battery troubles are over, at last. Now all radio power is in your light socket.

For continuous unflinching "A" current, connect either the Silite Homcharger or the Silite Trickle Charger to your present storage battery. Absolutely noiseless, without bulbs, moving parts, or adjustments, Silite Trickle Charger makes a power unit of your battery—keeps it always at top efficiency. Left permanently on charge, Silite Trickle converts light socket current into radio power and stores it in your battery ready for use at any time—you simply forget about battery charging forever. For exceptionally large sets where a high charging rate is necessary, the Silite Homcharger is recommended. Either model may be used while the set is operating.

<b>SILITE TRICKLE CHARGER</b>	<b>SILITE HOMCHARGER</b>
.6 ampere charging rate.	2½-3 ampere charging rate.
Complete.....\$10.00	Complete.....\$19.50

## Kodel A&B Transifiers

Kodel A and B Transifiers actually deliver all A, B, and C current direct from the light socket—smooth, constant, never-falling power that operates your set always at its greatest efficiency. Vastly different from and superior to the ordinary power unit, Kodel Transifiers consume current only while the set is operating—maintenance cost is less than one-half cent for every hour you use your set. Any radio dealer can show you Silite Battery Chargers and Kodel Transifiers.



<b>MODEL 10 "A" TRANSIFIER</b>	
Supplies 2, 4, or 6-volts "A" current direct from the light socket. For sets using up to 10 tubes.....	\$42.50
<b>MODEL 10 "B" TRANSIFIER</b>	
22½ to 150 volts "B" current; 4 to 10 volts "C" current for any size set. Operates power tubes.....	\$42.50
<b>MODEL 61 "B" TRANSIFIER</b>	
22½ to 90 volts noiseless "B" power for sets up to 6 tubes.....	\$28.50
(Bulbs extra)	

["Behind the Scenes in a Broadcasting Station" an interesting 24-page booklet, will be mailed free on request, together with literature describing Silite Chargers and Kodel Transifiers.]

**The Kodel Radio Corporation, 514 E. Pearl St., Cincinnati, O.**  
Owners and Operators of Broadcasting Station WKRC

Pacific Sales Office  
BERTRAM SMITH, 400 San Fernando Bldg., Los Angeles, Calif.

Battery Chargers  
Power Units

**KODEL** Radio Receivers  
Loud Speakers

POWER SPECIALISTS SINCE 1912

## DIRECT ACTION

(Continued from Page 62)

mixup at the door of the shack; but even so, in thirty seconds, flat, the two men were outside, and traveling in great leaps and bounds toward the hidden Ford.

They stumbled over rocks, they fell on coarse gravel, scraping the skin from hands and knees; they plowed, unheeding through a thorny thicket of cacti, spurred on by unearthly moans and diabolical howls that came, they would have sworn, from some avenging shade, or evil spirit right behind them. The apparition and the sounds were enough to raise the hair of a sober man; and the two crooks, who had imbibed pretty freely of post-Volstead stuff, were thrown into a state of blind, unreasoning terror.

Philip heard the wheezing of a Ford engine crowded to the last notch. He saw a red tail light heaving about as if on a ship in a storm. With a total disregard for the whereabouts of the rutted winding road, the men were headed straight across the desert, in a bee line for Mesquite City.

"Well," said "Brick" as he gathered up his radio set and the old Indian skull, "even re-generation howls are useful sometimes. I guess that will hold 'em for a while, until Uncle Jake is on his feet again anyway."

But, after a trying night for both, Philip was forced to admit that his uncle's condition was worse, much worse.

The old man's skin was burning hot to the touch, his eyes had an unnatural brightness, rapid, pounding heartbeats shook his frail old body, and always, in delirium, he was digging for gold! gold!

Poor Philip became panicky. What was to be done? He could not leave his uncle, to go for aid; he might die there alone; he might even wander out into the desert. No that was not to be thought of. Neither could he bear to think of another night alone with the sick old man, in this God forsaken place, with the grim Reaper, perhaps, drawing very near.

He must do something. His dazed mind circled round and round the problem finding no solution. Yet in the back of his brain, constantly recurring, was the thought that, somehow, radio was the answer. Yet how could it be? He had no means of broadcasting.

In the clear atmosphere of the early morning, the little town of Mesquite, ten miles to the westward, was plainly visible. The night operator in the railway station there was a radio fan. He had a good receiving set. If only there were some way of reaching him. Philip forced himself to sit down and consider the situation calmly. There was some way a powerful regenerative set, such as his, could be made to broadcast dots and dashes. He remembered reading about it at home. He had wanted to try it out, but in deference to the listeners in

(Continued on Page 66)

# An Amazing New World

## OF RADIO Is Now Yours!

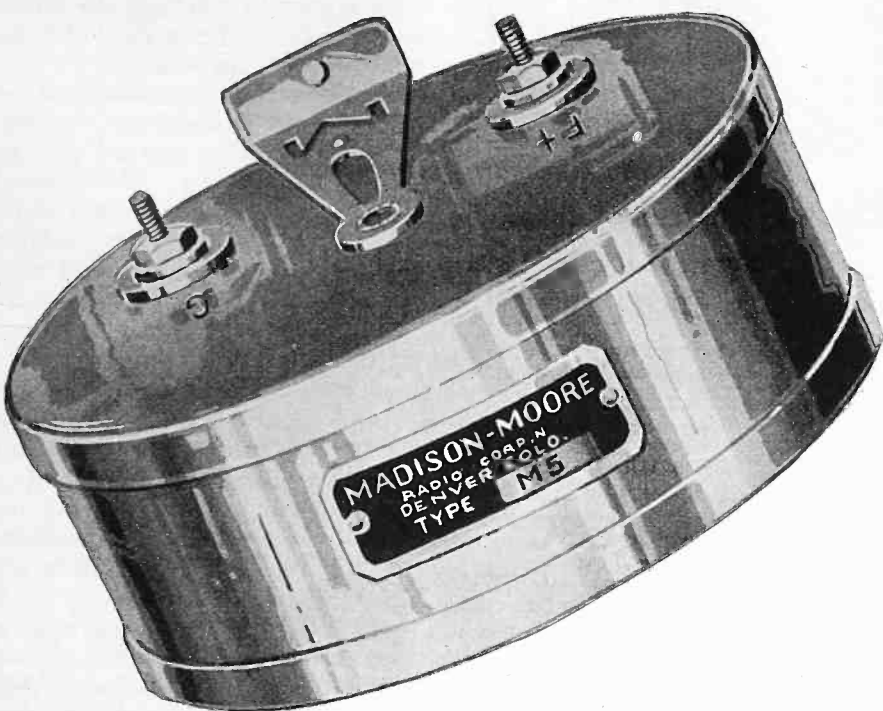

Distance, Quality, Volume, Selectivity --- a new conception of these essentials awaits you with the use of **MADISON - MOORE TRANSFORMERS**

Stations from afar, which even the finest receiving sets have failed to record, come in easily with this instrument. Your dials become the magic key to a new and untouched realm of sound and melody.

Tone is vastly improved and beautified, the most delicate shadings being faithfully reproduced.

Selectivity, always a problem, is no longer difficult. MADISON-MOORE Transformers make every night a radio certainty, for they bring in DX like locals.

Stations which the listener never before brought in, come with loud speaker volume with the use of only a two-foot loop. Quality is immensely improved on all reception.

Every MADISON-MOORE Unit is subjected to most exhaustive laboratory tests before it is approved for use. Every instrument is precision made and is as nearly perfect, electrically and mechanically, as skill and fine apparatus can make it. Radio Engineers and authorities accord it highest praise.

**ONLY WHEN YOU INSTALL MADISON-MOORE TRANSFORMERS WILL YOU ENJOY THE UTMOST FROM YOUR SET—WHETHER YOU HAVE THE FINEST YOU CAN BUY OR HAVE BUILT IT YOURSELF.**

*[ If your dealer cannot supply you, write us ]*

MADISON-MOORE RADIO CORPORATION  
2524 Federal Boulevard  
Denver, Colorado - U. S. A.



READ THE GUARANTEE

# MADISON~MOORE

*The Finest RADIO APPARATUS in the World!*

Tell them that you saw it in RADIO



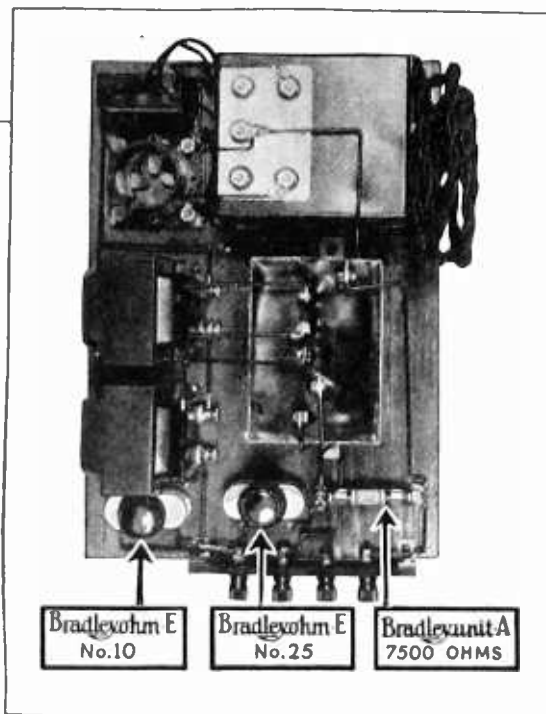

## What a whale of a difference a few Bradleyohms make — in a B-Eliminator!



### Bradleyohm-E

For B-eliminator service requiring wide voltage control, Bradleyohm E is essential. It is an oversize Bradleyohm with sufficient capacity to handle all normal B-eliminator requirements. Be sure to ask for Bradleyohm E in the checkered carton. Your dealer can get them for you.



### Bradleyunit-A

This solid, molded, fixed resistor has no glass or hermetic sealing in its construction. It is a solid unit with silver plated end caps that are not affected by temperature, moisture and age. By all means, use Bradleyunit-A when you need a fixed resistor.

MAGAZINES and newspapers have been publishing circuits and instructions for assembling B-eliminators. Many types of kits have been used, but the outstanding feature has been the almost unanimous recommendation to use Bradleyohm-E for plate voltage control and Bradleyunit-A for the fixed resistor.

The leading manufacturers of B-eliminators have long since adopted Allen-Bradley variable and fixed resistors as standard equipment for their B-eliminators. In fact, the Bradleyohm-E has become almost as universally used in Raytheon tube B-eliminators as the Raytheon tube itself. The scientifically-treated graphite discs in these remarkable units have never been equaled for silent, stepless plate voltage control so essential for the satisfactory operation of a radio set with a B-eliminator.

When you build your B-eliminator, always insist that Bradleyohm-E and Bradleyunit-A are included with kit. You then will be assured of perfect voltage control. Send for folder "How to Build a B-eliminator" describing seven popular hookups.

ALLEN-BRADLEY CO.

279 Greenfield Ave. :: Milwaukee, Wis.

Use  
**Allen-Bradley**  
Perfect Radio Devices

### DIRECT ACTION

(Continued from Page 64)

in his neighborhood, had refrained. Slowly, bit by bit, the method came back to him.

The first thing to do was to build the regeneration up to its maximum point. Next disconnect the regeneration wire from the antenna coil. Then close and open the circuit by touching the wire to its binding post on the antenna coil, thus transmitting dots and dashes.

Philip knew the code, as do all first class Boy Scouts, and he was overjoyed to find that the scheme worked even better than he had hoped. Of course he could not tell just how far the signals carried, but in the clear air, with no interference, surely they would carry ten miles.

So all through the creeping hours of the morning, he alternately ministered to his uncle and sent out his eager calls for help. The relentless desert sun climbed high in the heavens. Noon came with its fierce, stifling heat to sap the vitality of both invalid and nurse. The old man became more quiet from sheer weakness, and the boy re-doubled his efforts with his improvised transmitter.

The little town was hidden, now, behind a curtain of shimmering, dancing heat waves. How Philip hated them. Somehow, he had always hated them. Now he feared that they would interfere with the transmission of his signals. Still he continued to send them out; there was nothing else to do.

The long afternoon, a repetition of the morning except that it was hotter, dragged slowly by. The sun sank huge and red in a riot of color. Twilight brought blessed surcease from heat, but no answer to Phillip's desperate calls for aid.

He wondered if they failed to carry far enough, or if no one happened to be listening in. Well it didn't matter; the result was the same.

It seemed that eons of time had passed since his uncle came staggering home from his work. Was it only yesterday? For thirty-six hours Philip had not slept, he had scarcely eaten. Every nerve in his body cried out for rest. He felt dizzy, nauseated. In the middle of a word, he spread his arms on the table, and dropped his head on his arms. He was utterly spent. He had done his best; but he was beaten.

To that mysterious *something* which shapes human destinies, co-incidence, fate, luck (its names are legion), to this thing alone can be attributed the fact that Bill Benson, night operator at Mesquite, "tuned in" at seven o'clock instead of, say, seven-five, on a certain evening in June. Dinner over he turned his attention to his radio set, while his wife took up her sewing, and his two small boys played about the living room.

Bill sat at ease, turning this dial and that to get the best possible adjustment.

(Continued on Page 68)

# What Really Comes Through Your Transformer?

We know what you want to get out of your set. Everyone wants it. It is clear, pure-toned reception—and you don't want to miss a note from the muffled base of the kettledrum or the profound booming of the baseviol to the shrill "sky-high" tones of the fife and piccolo.

So much depends on your circuit, so much on your speaker—but even more on your transformers. To render sweet music and to get the full range of orchestral or instrumental performance, the transformer must faithfully reproduce all frequencies.

## The FERRANTI TRANSFORMER Meets Every Condition of Good Audio Reception

It takes two and a half miles of wire for the coils of the A.F. 3 and one and a half for the A.F. 4 plus the many refinements which the genius of Dr. Ferranti has made possible, to create transformers whose amplification curve is almost perfect—almost a straight line. By installing Ferrantis you can modernize your old set or perfect your new one. Ferranti will give you an uncensored message from the sending station.

If you want to make the best of the power tube feeding the loud speaker, use Ferranti.

Ask your dealer for a Ferranti. Don't be satisfied until you have installed one. If he does not carry Ferranti Transformers, write us and we shall tell you where you can get one. No better transformer is available at any price.

For the best available transformer results—Ferranti Audio Frequency Transformer A.F. 3—ratio  $3\frac{1}{2}$  to 1—\$12.

For a transformer far superior to the average, use Ferranti A. F. 4—ratio  $3\frac{1}{2}$  to 1—\$8.50.

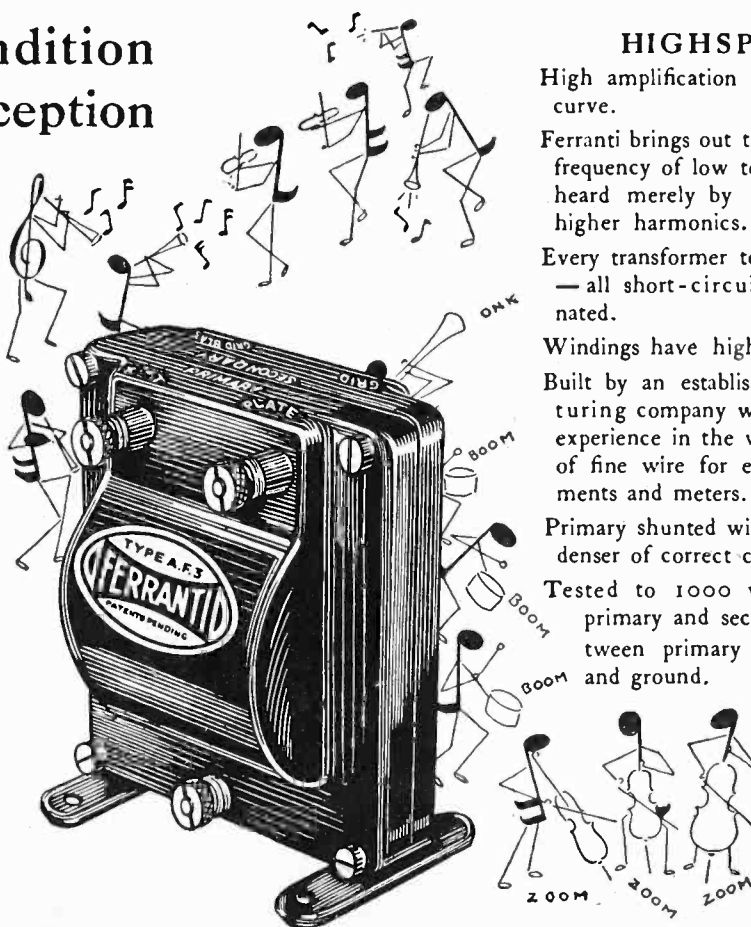

### HIGHSPOTS

High amplification ratio with flat curve.

Ferranti brings out the fundamental frequency of low tones—none are heard merely by inference from higher harmonics.

Every transformer tested ten times—all short-circuit turns eliminated.

Windings have high impedance.

Built by an established manufacturing company with forty years' experience in the winding of coils of fine wire for electrical instruments and meters.

Primary shunted with built-in condenser of correct capacity

Tested to 1000 volts between primary and secondary and between primary and secondary and ground.

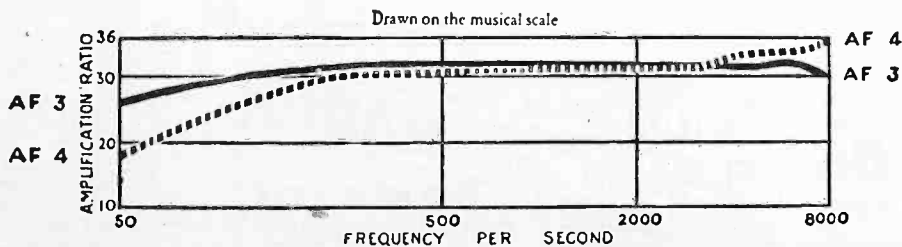

This graph is drawn on a musical scale—the only accurate way of showing the full value of each tone which your set receives. Note that the evenness and fullness of amplification in both the Ferranti A. F. 3 and the A. F. 4 extends throughout the range of the organ, cello and the human voice.

Pacific Wholesale Radio Co.,  
1310 South San Pedro St.,  
Los Angeles, Calif.

FERRANTI, INC.,  
130 West 42nd Street  
New York, N. Y.

Pacific Wholesale Radio Co.,  
127 12th St., Oakland, Calif.

The Electric Corporation  
1050 Santee St., Los Angeles, Calif.



# AERO COIL

## SUPER-SENSITIVE INDUCTANCE UNITS

*The most important factors in perfect set performance!*

Aero Coils are the perfect supersensitive inductance units. Due to their special patented construction, high frequency resistance is reduced to a minimum. Hence Aero Coils are capable of greater volume, and are sensitive to all the radio frequencies, thereby correcting the real cause of distortion, impossible to correct with other types of coils. But more! No dope is used. So if you are interested in better performance from any set, be sure to build with Aero Coils.

### Aero Tuned Radio Frequency Kit



Price, \$12.00

The Aero Coil Tuned Radio Frequency Kit illustrated above will positively improve the performance of any receiver. Patented Aero Coil construction eliminates radio frequency losses and brings tremendous improvement to volume, tone and selectivity. Kit consists of three matched units. The antenna coupler has variable primary. Uses .00035 condenser. Eight-page color circuit, layout and instruction sheet for building the supersensitive 5-tube Aero-Dyne receiver packed with each kit. Extra copies, 75c each.

### Aero Interchangeable Short Wave Kit

Completely interchangeable. Adopted by experts and amateurs. Range, 15 to 130 meters. Includes three coils and base mounting, covering U. S. bands, 20, 40 and 80 meters. You can increase the range of this short wave tuner by securing Coils No. 4 and 5. Combined range of 15 to 550 meters. Both interchangeable coils fit same base supplied with short wave kit and use the same condensers. Coil No. 4 price, \$4.00; Coil No. 5 price, \$4.00.

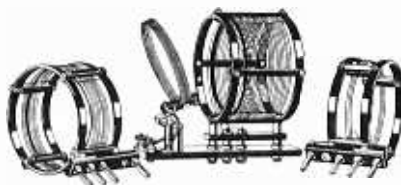

Price, \$12.50

### Aero Interchangeable Coils No. 4 and No. 5



Increase range of your short wave tuner by securing Coil No. 4 and Coil No. 5, combined range 125 to 550 meters. Both interchangeable coils fit the same Aero base supplied with the short wave kit, and use the same condensers.

Coil No. 4—Range 125 to 250 meters.....\$4.00  
Coil No. 5—Range 235 to 550 meters.....\$4.00



### Other Supersensitive Aero Inductance Coils

There is an Aero Coil for every inductance requirement. In addition to those described above we make the following coils: Aero 3 Circuit Tuner, \$6.50. Aero Radio Frequency Regenerative Kit, \$10.00. Aero Low-Loss Antenna Coupler, \$4.50. Aero Oscillator (for Superheterodynes), \$5.50. Aero Wave Trap Unit, \$4.00.

You can get any or all of these coils from your nearest dealer. See him TODAY

### AERO PRODUCTS, Inc.

DEPT. 103, 1772 WILSON AVENUE, CHICAGO, ILL.

(Pacific Coast Representatives)

### HENGER-SELTZER

1111 WALL ST., LOS ANGELES, CALIF.—377 BRANNAN ST., SAN FRANCISCO, CALIF.

### DIRECT ACTION

(Continued from Page 66)

Suddenly he jerked erect. His trained ear (he had been a wireless operator on one of Uncle Sam's warships in the World War) had caught the fateful dots and dashes of the SOS! He quickly disconnected the loud speaker and adjusted the head phones.

"Keep those kids quiet!" he flung over his shoulder to his wife.

After a short interval of silence the call came again, queer and scratchy, but quite audible in the head phones. Then slowly, jerkily, a message in Continental code followed:

"Send doctor to Sunflower mine. Hurry."

Tense, impatient, the listener waited for more particulars. "SOS" he heard once more. "Send doctor to Sun—" The halting letters came slowly, more slowly; stopped.

"You don't suppose it's a fake? Someone playing a prank?" hazarded Dr. James, when Bill had rushed to him with the message he had snatched out of the air.

"No sir, I don't. That fellow was in deadly earnest. I'll stake my life on that," declared Bill.

"Well, I'll start right out there," decided the good old physician, and I'll take a nurse with me. They probably need a nurse as much as they do a doctor."

In less than an hour, Dr. James and a nurse entered Jake Mason's little cottage. Philip still slept as though drugged.

"The boy is all right, said the doctor after a cursory examination, but the old man needs all the help we can give him."

Philip knew nothing of their presence until the doctor had finished his work and was ready to go. Then he was roused, not without difficulty.

"I have done all I can for your uncle and I am going," said the doctor. "I think he'll be all right now. The nurse will stay here, and you go to bed and get a good sleep."

"But, doctor, I am afraid those crooks will come back and jump the claim."

"What's that? What claim? The medical man eyed the boy curiously. "Has his mind become deranged under the strain," he wondered.

Philip outlined briefly what had happened.

"U-huh," grunted Dr. James; "Those birds have been hanging 'round Mesquite for quite a while. I thought they were suspicious characters. Well they can't do anything until tomorrow when the land office opens. I'll put the sheriff on, and he'll lock them up. That will take care of them until you can fix up some monuments and file on your uncle's claim. Mason should have done that in the first place, but I suppose he pulled so many blanks that he got careless. We will get some one to do the assessment

(Continued on Page 70)

## Bradley Leak

THE PERFECT GRID LEAK

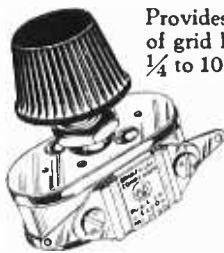

Provides a noiseless range of grid leak resistance from 1/4 to 10 megohms. Assures most effective grid leak resistance value for all tubes. Small grid condenser (0.00025) is separate. Metal parts nickel plated. One hole mounting.

Allen-Bradley Co.

Electric Controlling Apparatus  
279 Greenfield Avenue Milwaukee, Wis.

American RADIO Now—  
50% DISCOUNT ON RADIO!  
BIG NEW 1927 CATALOG-FREE

Dealers, Agents, Set Builders—get our big 1927 Catalog—225 nationally advertised lines. Lowest prices in America! Largest, most complete stock. Radio's latest developments. It's FREE—send for your copy now. AMERICAN AUTO & RADIO MFG. CO., Inc. 1425 McGee Street, Kansas City, Mo.

LOG YOUR STATIONS

10c For a Copy of the Radio Log Book. 16 Pages.

"RADIO," San Francisco

Tell them that you saw it in RADIO

# So That Your Enjoyment Might Be Uninterrupted

Today you can be as sure of your B-power supply as you are of your electric lights. No longer need you worry whether your B batteries will run out at the most crucial moment of some national sporting event. No longer need you hesitate to invite the neighbors over to hear the opera for fear that your B-power unit will fail for lack of proper attention.

Raytheon has made possible absolutely reliable B-power that requires no attention. For years Raytheon Engineers studied the application of light socket power to the operation of radio in the home. Eventually the Raytheon rectifying tube was produced, giving an abundance of power, long life (no filament) and complete elimination of all service.

At this point the leading makers of radio equipment took up the task of incorporating the Raytheon rectifier in a complete B-power unit, ready for installation in the home. This has been accomplished with great success by the organizations represented on these pages.

Their units, all tested and approved by the Raytheon Laboratories, represent a wide variety of styles and prices. Your dealer will be glad to recommend one best suited for your set. The fact that it is Raytheon-equipped means that un failing B-power is yours at the touch of a switch.

Raytheon is the heart of reliable radio power.

## Raytheon Manufacturing Co.

CAMBRIDGE, MASS.



Organizations Manufacturing B-Power Units  
**RAYTHEON-EQUIPPED**

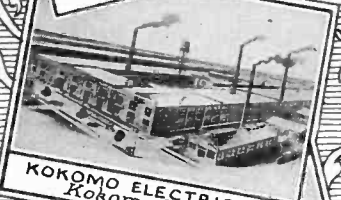
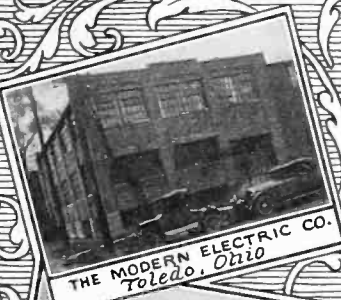



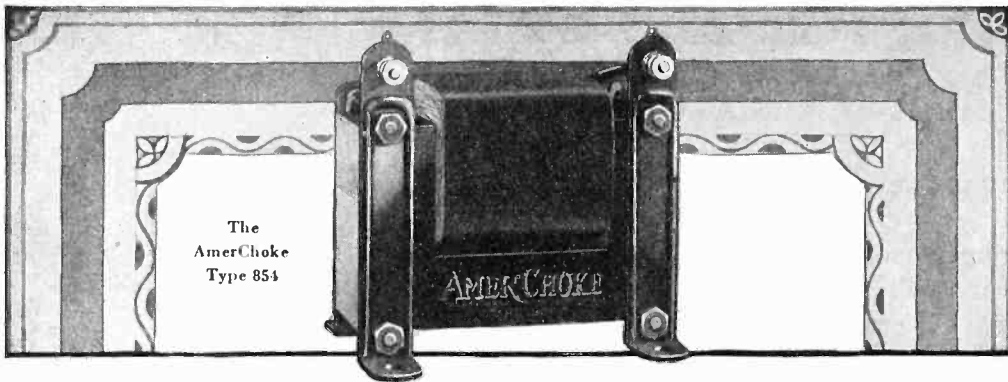

# AMERTRAN RADIO PRODUCTS

## A Reliable Choke for Filter Circuits

The AmerChoke Type 854 is a choke coil or impedance designed primarily for use in filter circuits. As an output impedance with a fixed condenser it forms an ideal filter for the loudspeaker, insuring tone quality equal to the average output transformer. And it *will* be more economical. For filter circuits in "B" Eliminators, the AmerChoke will give perfect results due to its scientific design and generous proportions.

To obtain even, quiet current supply use the AmerChoke and the AmerTran Transformer (described at the left) in the construction of your power amplifier.

### AMERICAN TRANSFORMER COMPANY

178 Emmett Street, Newark, N. J.

*"Transformer Builders for Over Twenty-five Years"*

Pacific Coast Office:

RIALTO BUILDING, SAN FRANCISCO

**The AmerTran Power Transformer Type PF-52**  
Type PF-52 is intended for use in the best power supply developments.

**Other AmerTran Products:**  
AmerTran Resistor Type 400.  
AmerTran Heater Transformer Type H-28 (for A. C. Tubes).



AMERTRAN TYPES AF-7 AND AF-6—These popular and efficient audio transformers are made in two types—AF-7 (ratio 3½:1)—AF-6 (5:1).

*We shall be very glad to send you upon request a copy of our booklet, "Improving the Audio Amplifier."*

**The AmerTran De Luxe Audio Transformer**  
This new transformer sets an entirely new standard of audio amplification.

## DIRECT ACTION

(Continued from Page 68)

work on the company's claims too. Without waiting for Philip's fervent thanks, the kindly old man hurried away.

It was more than a week before old Jake, leaning on his nephew's arm, was able to hobble out to his "strike."

"Brick," he said, huskily; "I'm plumb ashamed of myself. I was just pizen onery. Doc. says that I come mighty nigh goin' on my last prospect trip; and you and that little old radio box I was so spiteful about—you saved my life, and my gold too."

"I won't forget it, Brick"; his dim old eyes were swimming with unaccustomed tears; "I'll buy you the best danged radio for Christmas they is made; and half of whatever I get out of this hole is yours."

## THE MAZE OF RADIO PATENTS

(Continued from Page 42)

repeatedly held that a patentee can refuse to commercialize his invention and to grant licenses to others, and therefore there seems to be no legal way in which this transmission monopoly can be broken. Of course, it is possible that others may have acquired some rights under the transmission patents, as for example, De Forest and his company; but for the present, the Radio Corporation seems to have no solidly founded rival in the commercial field of tube transmission.

Much agitation is in progress to change our patent laws to make it compulsory for a patentee who does not supply equipment under his patents to grant licenses; but in the opinion of the writer there is little likelihood of such legislation being passed in the near future. The wisdom of such legislation is also questioned by many of the most eminent of the legal fraternity.

Of course, after all, transmission can be obtained in other ways, as by arc or spark sets; and in many instances such sets give entirely satisfactory service. In this connection, it is perhaps proper to attempt to peep into the future. Is there no likelihood that the tube as an instrumentality in reception and transmission will be superseded by something better? The production of "cold electrons" has attracted the attention of many minds; this would obviate the need of a heated filament.

Such a scheme, however, would be generically the same as in the present vacuum tube—the control of flow being accomplished by a control electrode such as a grid. In considering what kind of a substitute could take the place of this device, it is advisable to point out the attributes that make it so admirably suited for the functions demanded of it. This discussion is of interest in connection with patents, for it may point a way to the production of a device free from

(Continued on Page 72)

## DX FANS

Get Weekly Station Schedules.

Corrected Every Seven Days.

YOU NEED IT

10 Cents Per Copy

BROADCAST WEEKLY

Pacific Building San Francisco

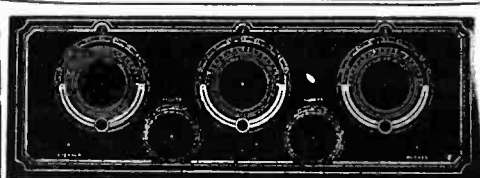

RADIO PANELS cut, drilled and engraved to order. Meter-holes cut, etc. Best Bakelite, good work, reasonable prices. Wholesale and retail. Mail-orders solicited. Prompt service.

*Expert radio service and repairing.  
Storage batteries repaired and recharged.  
Tubes reactivated.*

Volney G. Mathison & Co.

660 TWELFTH STREET OAKLAND, CALIF.



**YAXLEY**  
APPROVED RADIO PRODUCTS

**Automatic  
Power Control**



**H**ERE is a gift of gifts for your radio friends—the latest radio convenience that every set owner will want. The Yaxley Automatic Power Control does all the extra switching for you. It takes care of your B eliminator or trickle charger or both. When you turn your set on, the trickle charger is off, the B eliminator is on. When you turn the set off, the Power Control is standing guard for you. It works automatically and without fail to turn off the B eliminator and turn on the trickle charger.

No. 444, Series Type—for use with sets with tubes having a current draw equal to or greater than 6 UV-199 type tubes. Each \$5.00

No. 445, Multiple Type—for use with any set, but especially for sets having tubes with a current draw lower than that of 6 UV-199 type tubes. Each \$6.00

At your dealer's. If he cannot supply you, send his name with your order to

California Representative

Henger-Seltzer Co.

Los Angeles San Francisco  
1111 Wall Street 377 Brannan Street

Northwest Representative

D. H. Burcham

1553 E. Everett St., Portland, Oregon

Yaxley Manufacturing Co.

Dept. A, 9 So. Clinton St., Chicago, Ill.



**KARAS EQUAMATIC MANUAL**  
Price 10c.

Build the Karas Equamatic 5-Tube Radio Sensation—the most selective receiver ever designed. Mail 10c today for 16-page Manual of wiring diagrams and complete instructions for building this remarkable receiver. Address:

**KARAS ELECTRIC COMPANY**

1049 Association Building Chicago, Ill.

**STORAD**

Radio Power Supply  
has REMOTE CONTROL

Write for information.

**THE STORAD MFG. CO.**

2429 Detroit Ave., Cleveland, Ohio.

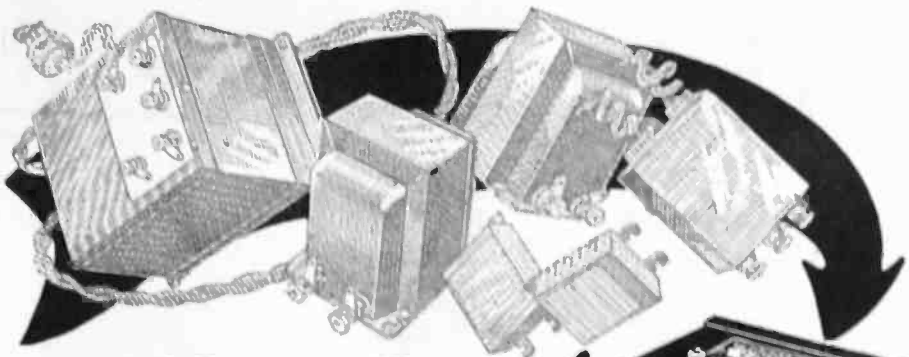

*All in One!*

**THORDARSON  
POWER  
COMPACT**

<b>TYPE R-171</b> For Raytheon BH rectifier and power amplifier UX171. Includes 2 buffer condensers. \$15.00	<b>TYPE R-210</b> For UX216-B rectifier and power tube UX 210. No condensers included. \$20.00
---	---

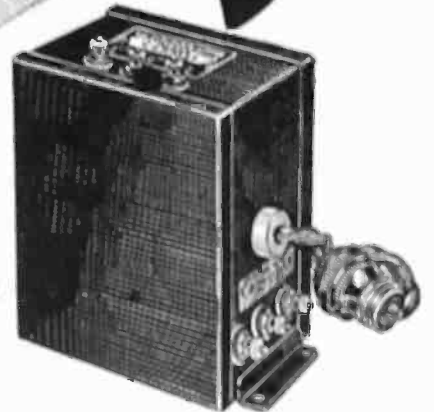

**The Complete Foundation Unit  
for  
power amplification and B-supply**

**Simplified Assembly.** Only 14 leads are necessary to complete the Raytheon assembly. All terminals are carefully located for the greatest ease of connection.

**Compactness.** The only additional apparatus required to build the B-supply are the condenser block (Raytheon Type), a Raytheon tube BH, and the resistance units.

**High Efficiency.** The power supply of either Power Compact furnishes the proper current for maximum efficiency of the rectifiers used; the chokes are of sufficient capacity to carry the maximum output. Conservatively rated; will not heat up in continuous service.

**High Voltage Output.** The R-171 Power Compact assembly will deliver a maximum plate voltage of 300 v. at 30 MA., or 275 v. at 40 MA.

Write for instruction booklets SD-49 and SD-50. — If your dealer cannot supply, order direct from factory.

**THORDARSON ELECTRIC MANUFACTURING CO.**

*Transformer Specialists Since 1895*

**WORLD'S OLDEST AND LARGEST EXCLUSIVE TRANSFORMER MAKERS**

*Hyron and Kingsbury Streets — Chicago, Ill. U.S.A. 3116-A*

A power supply transformer  
Two filter chokes  
Two buffer condensers  
A power filament supply  
**ALL IN ONE CASE**

The R-210 type assembly will deliver 400 volts to the plate of the power tube, and, in addition, will supply a constant 90 volts to the receiver at any current drain up to 40 MA.

**Silent In Operation.** There is no traceable hum, either mechanical in the compact itself, or electrical through the loudspeaker.

**Complete Supply For Power Amplification.** The Power Compact provides for complete A-B-C supply for the power stage. Makes it possible to use power amplification, even on sets designed for dry battery operation.

**Electrically Centered Filament Supply.** The power tube filament supply is tapped at the electrical center for grid return. The center tap is taken from the common lead of two perfectly balanced windings—completely obliterating the A. C. hum. (An exclusive Thordarson Feature.)

To keep posted on  
**INFRADYNE**  
suggestions and  
improvements

Why not subscribe now to  
"RADIO" for 12 months at the  
price of \$2.50.

**AUDIO FREE  
AMPLIFICATION**

The four types thoroughly explained in a fully illustrated booklet 9x12". This book will be sent to you absolutely FREE if you will send me six cents in stamps to cover cost of handling and postage.

**W. McMANN**

64 Church St., Dept. R. New York City

"RADIO"—\$2.50  
Mailed to Your Home for One Year.



# Valley Electric

## MAZE OF RADIO PATENTS

(Continued from Page 70)

all patent restrictions. Even the change from a hot filament to a cold source of electrons may be sufficient to escape many of the patents herein mentioned, for some of them allude to a vessel having "hot and cold electrodes."

The features that makes the tube so eminently successful is its immediate response to the influence brought to bear upon it—its inertialess quality. Variations in the flow of electrons are accomplished immediately. Another feature, about as important, is the accuracy with which the variations in flow follow the controlling actions, which makes it possible to reproduce speech or music so faithfully. What medium, other than an electronic flow, could produce these functions? Such a medium must be without material mass and capable of accurate control. It is possible that a magnetic field or an electrostatic field, or light waves, can be substituted for the seemingly final and perfect electron stream. These are of course only wild flights of the imagination; yet if it should arouse latent possibilities by attracting the interest of inventive genius, this article will be more than fully justified.

An inventor after all is one who recognizes the value of a nugget which was kicked about by others less discerning. Certainly there is every reason to believe that radio development is no different from any other field—all are changing, and evolution will continue to alter our seemingly permanent instrumentalities "until time shall be no more." The important radio patents are being "fire tested"; those that will withstand the intensive attacks will take their place in the science of radio as worthy mentors and deserving of respect. Those that will be held spurious will free the unjust fetters from the industry.

In drilling a panel it is sometimes better to work from the back so as to preserve the front finish. This complicates the drilling with templates designed to punch or mark through from the front. But by sponging the paper with oil, it may be made translucent, and then punched from the reverse side just as easily as if you were working on the right side. A template can be saved for use by using a needle point for punching.

A darning needle may be soldered into a small brass handle to serve as a scribe for light work. Being cheap, it can be thrown away when dull.

By pasting a sheet of paper at the corners and center of a highly polished panel, it can be worked without scratching. The paper may be subsequently torn off, the paste spot removed with a damp cloth and the panel polished with a soft rag.

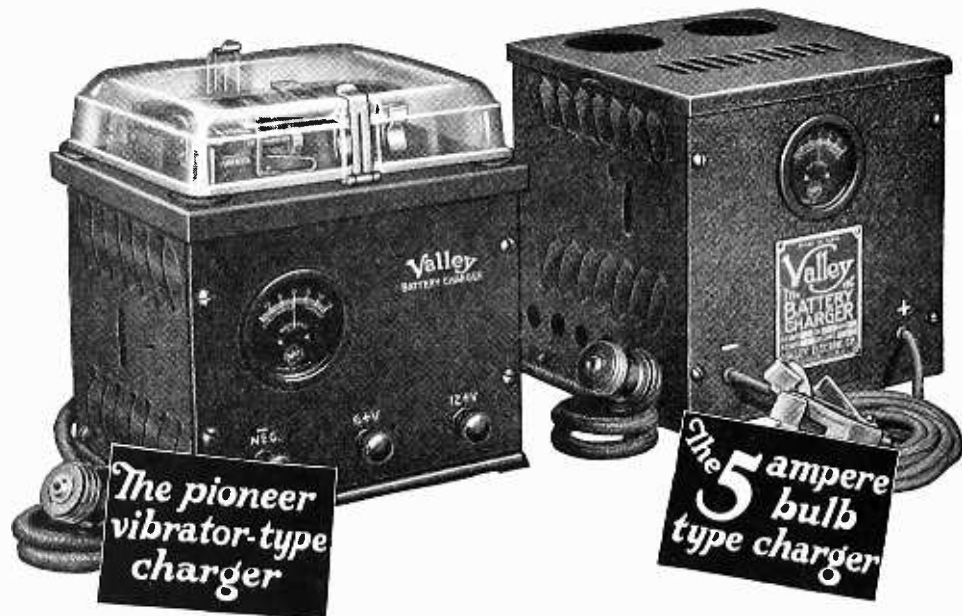

## Use either one for a dependable source of "A" battery current

You can get the famous Valley Battery Charger in both vibrator and bulb types. Use either one for a dependable source of A battery current.

**The Vibrator Type:** This is the pioneer of radio battery chargers. Nearly a quarter of a million of this type of Valley Charger has gone into service all over the world.

Charges 6-volt batteries at 6 amperes, 12-volt batteries at 3 amperes, Quiet. Efficient. Cannot harm the battery.

Mounted in black case with bakelite panel and glass top. Pleasing in appearance and will harmonize with finest radio receiver. Complete with cord and plug, and leads and clips.

**The Twin Bulb Type:** The twin bulb design of this Valley Charger overcomes the only objection to the bulb type charger, i. e., the slow charging rate.

Using both bulbs, you have a 5-ampere charger. Using only one bulb, you have a 2½-ampere charger. Thus the charging rate and the purchase of one bulb or two are entirely optional.

Absolutely noiseless. Built in handsome black grained metal case. Complete with cord and plug, and leads and clips.

### Other Valley Radio Units

The two small cuts below show the Valley B Power Unit and the Valley Radio Receiver.

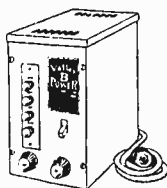

The B Power Unit supplies plate voltage from the house circuit. For sets of 12 tubes or less. May be used with a power tube or unit. Fitted with the Raytheon Tube only—"for reliable reception."

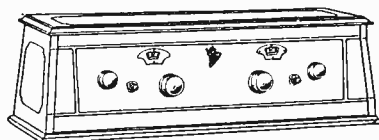

The Valleytone is a 5-tube, tuned radio frequency receiver. Two-dial control. Wired so that use of power tube is optional.

VALLEY ELECTRIC CO. · RADIO DIVISION · ST. LOUIS, MO.

District Offices: Boston, Chicago, Cleveland, Indianapolis, Kansas City, Minneapolis, New York, Philadelphia, San Francisco

# AMSCO METALOID

## GRID GATES & RESISTORS

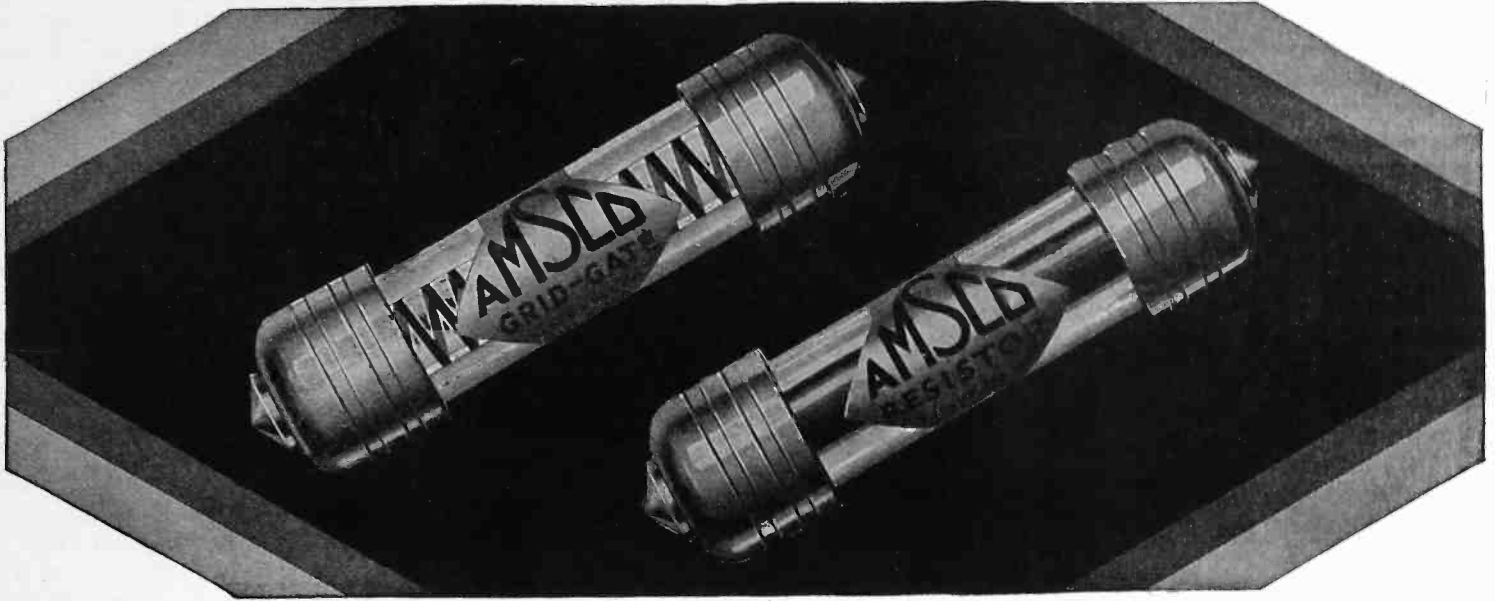

### SILENT ACCURATE PERMANENT

THE secret of AMSCO excellence is in the changeless AMSCO METALOID resistance element. It is COLLOIDAL—smooth, stable, never varying with age, moisture or usage—superceding crystalline forms, with their jagged, noisy pathway to the current.

The element is fused into glass, and contact made by a welded joint, spun to the exterior cap. The large element, many times the size of inferior metallic resistors, will dissipate two watts of power with a 500 per cent margin of safe overload.

AMSCO Metaloid Grid Gates and Resistors are standard specification for fine Radio Receivers, and Battery Eliminators requiring high watt dissipation.

AMSCO Accuracy is guaranteed within five per cent of rated value—Silent operation guaranteed without qualification. Insist upon AMSCO.

Write for Zeh Bouck's monograph on R. C. Amplification. Also leaflets describing AMSCO Allocating Condensers, single, siamese, and three-gang—allocating by frequencies, wavelengths or capacity variations.

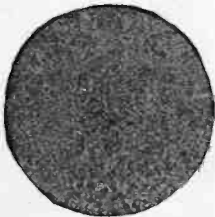

Microphotogram of Colloidal AMSCO metaloid element. "Smooth, unbroken and silent."

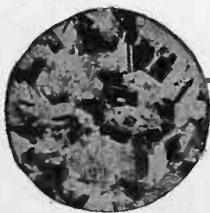

Microphotogram of typical crystalline metallic element. "Jagged and noisy."

AMSCO PRODUCTS, INC.

Broome and Lafayette Streets

New York City



Tell them that you saw it in RADIO



**THE HENRY-LYFORD**

(Continued from Page 45)

will tell if the first three tubes are working properly or not. If there is no indication of "Life" in the phones when they are connected there, the trouble is ahead of that point, but if the receiver is working up to that point, the trouble is somewhere in the audio amplifier. If it appears to be in the r.f. part, make sure that the untuned r.f. transformer is not reversed end for end, and that a good contact is being made with the lugs at each of its terminals. Wherever the trouble appears to be, examine the tube sockets, and see that all four prongs of the tube are making contact.

Outside of faulty wiring and poor connections, these are the only two points in the receiver where there is a chance for trouble to develop, and trouble due to either of these causes is easy to remedy. If ordinary care is taken in the wiring, however, there will be no trouble, and the receiver will start off "with the gun," working perfectly.

Like automobiles, radio receivers are individual, and require a little practice to get the best out of them. With familiarity with the "workings" of the Henry-Lyford will come more and more ease in tuning distance, and in logging new stations, but the thrill of hearing perfect quality will never be any greater than the first time you hear the receiver working.

**CORRECTION ON WNU SKED**

WNU sked on 3331 meter for PX to KUS at 11:30 a.m. and p.m. E.S.T. have been discontinued and are now sent out at 6:30 a.m. E.S.T. only. KSE sends local WX at 9 a.m. P.S.T.—R. Maddox, operator S.S. Panaman.

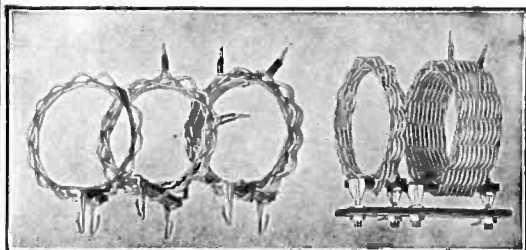

**Brought Out the First Low Wave Coils**

Rel Loose Basket Weave Coils are equipped with plug-in mountings—quick efficient coil changing—five interchangeable units in each outfit. Triple cotton covered paraffined wire—Chocolate color—won't soil—for any low wave circuit—covers 10-110 meters. Inexpensive—Rugged—Efficient.

Price \$4.50, including mounting. At Your Dealer's or Order Direct Write for the new Rel 30-page catalogue on transmission. Includes hookups, data, antennae, power supply and much other valuable information. Send 25 cents in stamps.

**RADIO ENGINEERING LABORATORIES**  
29 THAMES ST. NEW YORK, N. Y.

**FMC DOUBLE IMPEDANCE AUDIO UNITS**

Of the three systems of audio amplification, transformer, resistance and impedance, **IMPEDANCE-COUPLED** is admitted by all radio experts to be the best.

Sold by All Dealers.

FREE—"The Story of Amplification." Write for a Copy.

**Ford Radio & Mica Corp.,**  
111 Bleecker St., New York City

**-FORD-**

**"B" ELIMINATOR**

Operates any set from an alternating current light socket, furnishing a continuous and uniform supply of plate voltage without noise or hum. Ask your dealer for a demonstration.

Distributed by  
E. P. Denham, Seattle, Wash.  
Gray Sales Co., Philadelphia, Pa.  
S. B. Darmstadter, Chicago, Ill.  
James C. Pope, Jr., Minneapolis, Minn.  
Industrial Sales Co., San Francisco

**FORD RADIO & MICA CORPORATION**  
111 Bleecker St., New York City

**Turn Dial-get stations everywhere:-30 Days Free!**



**MIRACO RADIO GETS 'EM COAST TO COAST**

Beautiful Hand-rubbed Solid Walnut Cabinet

**ONE DIAL CONTROL**  
Only One Dial to turn for all programs.

**28 in. Long**

**SPECIAL WHOLESALE PRICES**  
to user-agents who show the set to friends.

**DEALERS WRITE!**

**SEND COUPON FOR AMAZING SPECIAL OFFER!**

**NOTE:** This offer is made to prospective buyers by famous big Radio Corporation, one of America's oldest reliable manufacturers of fine sets—seventh successful year. Many satisfied users in every state. Postal or coupon brings testimony of near-by users and proof Miraco's outperform sets costing up to 4 times as much. Very easy to operate

**BEAUTIFUL-BIG-POWERFUL Ultra Selective MIRACO Unit 5**

Users report Miraco Radios get programs Coast to Coast, also Canada, Cuba and Mexico, loud and clear on speaker; outperform \$100 to \$200 sets. Unless trial proves it, MOST SELECTIVE, CLEAREST TONED and MOST POWERFUL DISTANCE-GETTER among beautiful big 6-tube sets, don't buy it. Every Miraco comes completely assembled, rigidly tested and fully guaranteed.

**Our Factory Prices Save You Up to 1/2!**

**SEND NO MONEY!** Save or make money on sets, speakers, tubes, batteries—write for AMAZING OFFER. Ultra-5 (not illus.) is marvelous value in a big Guaranteed 6-tube, 3-dial set: **Retail List \$49-75**

**COAST TO COAST RECEPTION**  
verified by Miraco users

Reports from users everywhere leave little for us to add. These are only a few of the many in our files and which we receive daily. Send coupon for plenty of additional proof, testimony of nearby users and of additional

**"UNITUNE" SEPARATES CHICAGO LOCALS.** Chicago, With 4 stations broadcasting less than a mile away, one after another I cantune and keep separated as high as 15 Chicago stations on your "Unitune-6". Even during the summer I frequently get stations clear and loud on speaker as far away as Colo., New Jersey, New Orleans and many others. With the single dial I switch from one to another station in an instant. The selectivity is amazing, the set is a beauty and the tone is perfect. **W. H. Schneller, COAST TO COAST.**

**OMAHA, NEBRASKA.** Miraco is a wonder for distance, volume, tone. We have 5 local broadcast stations here and she goes right thru and brings them from coast to coast. No trouble at all. **H. N. Eller.**

**BEATS OTHERS FOR SELECTIVITY.** Cleveland, O. Have been up against some pretty good radio men with other sets and this receiver has them guessing. In selectivity, volume and range it has outdone several. We were able to cut out WTAM (powerful local station in points, to bring in other stations. **W. C. Pike.**

**HONOLULU TO LONDON FROM IOWA.** Anthon, Iowa. Here are some of the stations we picked up on the Miraco 6 Sunday Jan. 24 between 10 and 11 P. M.: 2LO London, KVO Honolulu, Hawaii; WKAQ San Juan, P. R. and a station in Ireland; could not get call letter. **John Kuban,**

**NEW YORK LOGS 163 STATIONS.** Buffalo, N. Y. I received 2LO London, 11:05 on Monday night but there was so much interference it was not very plain. I also logged 163 stations in U.S. and Canada. Satisfied user of Miraco, Norman W. Ives.

**NEBRASKA HEARS PORTO RICO ON SPEAKER.** Spencer, Nebraska, Using the Miraco, we have often heard Mexico City, Porto Rico, Miami, Florida, Ottawa, Canada and Vancouver, B. C. Canada and all along the Pacific Coast. All the above stations on the speaker. Have also heard Lima, Peru, South America, H. J. Schmidt.

**ONE VOLUME, DISTANCE, TONE, VOLUME, DISTANCE.** Ebling, Kans. We like our Miraco fine especially because of its volume, tone and its freedom from howling. Although I do not try much for distance we received programs from Oakland, Cal.; Los Angeles, New York, Miami and Havana. In my opinion it's the best ever. **Mrs. E. A. Regier.**

**MIRACO EQUALS \$240 SET.** Onaka, S. D. Miraco works fine. Selective and plenty of volume. Stations logged include Winnipeg, Canada; PWX, Havana, Cuba; and GYL, Mexico City, Mexico. Have heard quite a few sets, one costing as much as \$240, but can't see where it comes from.

**NO HOWLS... SUPERIOR TO COSTLY SETS.** Modoc, Ind. We certainly enjoy our Miraco-6. Results equal to any radio I ever heard and

far superior to most radios costing a great deal more. All stations come in loud and clear on the loud speaker. **James Tullis, Duncansville, Pa.** I don't think there is a better receiving set made than a Miraco-5. Stations received—all on the loud speaker—include KFI, Los Angeles, California—distance, 2,250 miles. I got this on loud-speaker plain, when others couldn't get it with 6 and 8 tube sets. Also have heard Can., Colo., Fla., Cuba, Neb. and many other states. **S. D. Fowkes.**

**CALIFORNIA HEARS PENNA. ON THE SPEAKER.** San Rafael, Calif. I have purchased three of your sets and will give you an idea of what the Miraco-5 which I got here. I have logged 88 stations, Mexico City on the South to CFON, Calgary, Canada, on the North, with Honolulu to the West and E. Pitts., Pa., to the East. All on loud speaker, clear and loud. **Roy L. Sharer.**

**MIDWEST RADIO CORPORATION, Pioneer Builders of Sets**  
414 P. Miraco Bldg., Cincinnati, Ohio  
**WITHOUT OBLIGATION, send free literature, AMAZING SPECIAL OFFERS, testimony of users, etc.**

NAME: \_\_\_\_\_  
ADDRESS: \_\_\_\_\_

# ELECTRAD

## New Model

The Experienced say  
**“ROYALTY”** when in need of  
**Variable High Resistance!**

*Dissipates Three Watts*

*Licensed by Technidyne Corporation under U. S. Patent 1593685, July 27, 1926.*

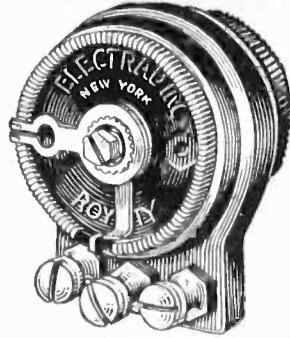

From these 11 types you can select the range of resistance exactly adapted to your set. Note these important features of superiority:

- 1—Resistance element is not exposed to any mechanical operation.
- 2—Electrical contact is made positive by metallic arm on wire-wound strip.
- 3—The same resistance is always obtained at the same point.
- 4—Resistance value is under control in process of manufacture and does not change in use.
- 5—Entire range of resistance is covered with less than a single turn of the knob.
- 6—There is no mechanical binding and shaft is turned smoothly over entire range.

Ask your dealer for the genuine ELECTRAD Royalty High Resistances and insure satisfactory results.

### A Range for Every Purpose

Type A—1/10 to 7 megohms.  
 Type B—1500 to 100,000 ohms.  
 Type C—500 to 50,000 ohms.  
 Type D—10,000 to 700,000 ohms  
 (Detector control for B  
 Eliminator).  
 Type E—Compensator, 500,000  
 ohms. Potentiometer.  
 Type F—0 to 2,000 ohms.  
 Type G—0 to 10,000 ohms.  
 Type H—0 to 25,000 ohms.  
 Type J—0 to 200,000 ohms.  
 Type K—0 to 5,000 ohms.  
 Type L—0 to 500,000 ohms.  
 Type E—\$2.00. All other types,  
 \$1.50.

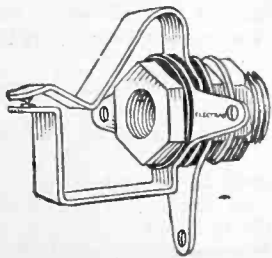

## ELECTRAD CERTIFIED JACKS

You have never seen the equal of the new Electrad Certified Single Circuit Jacks, both open and closed. Requires less than 1" behind panel. Positive acting springs of phosphor bronze. Sterling silver contact points. Insulation of hard rubber. Tinned soldering lugs, so placed that good connections can easily be made. Any good radio store has these jacks or can easily get them for you. Certified and guaranteed electrically and mechanically. U. S. Prices Open 25c, Closed 35c. Canada prices, open 35c, closed 50c.

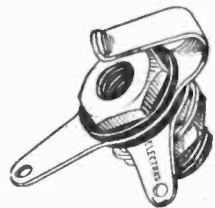

## ELECTRAD CERTIFIED SWITCHES

*Hear Them Click!*

No doubt whether you are on or off when you equip your set with the Electrad Certified Switch. You hear it click. Requires less than 1" behind panel. Solid brass construction. Tinned soldering lugs so placed to make easy connections. Neatly designed. Genuine Bakelite knob. Adds to the appearance of your set. Certified and guaranteed electrically and mechanically. Price U. S. 40c, Canada 60c.

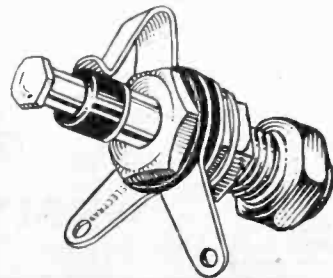

For perfect control of tone and volume use the Electrad 500,000 ohm compensator. For free hook-up write 428 Broadway, N. Y. City.



# ELECTRAD Inc.

Tell them that you saw it in RADIO





# Diamond of the Air



A Direct From Lighting Circuit, Licensed Regenerative Receiver

Nothing to Make, Just Solder Connections

## COMPLETE ABC ELIMINATOR for the DIAMOND OF THE AIR

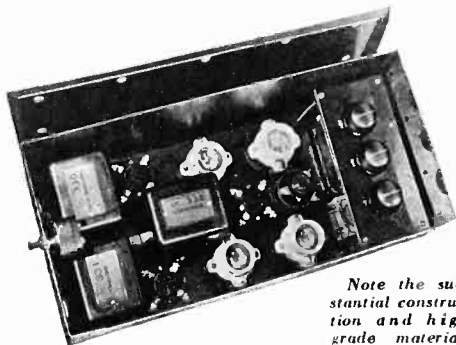

Note the substantial construction and high grade materials used.

A complete A, B and C battery eliminator, identically like the one described by Gerald M. Best in the December issue of RADIO, for the Diamond of the Air receiver, or any other radio set having the filaments wired in series, for use with type 99 tubes. This power plant will operate a receiver having as many as ten tubes, including the type 371 power tube.

### Delivers More Current Than Any Other Eliminator Now In Use

This eliminator will give as high as 120 milliamperes at 200 volts, so that it will deliver sufficient current to supply 60 milliamperes for the filaments of the 99 tubes, 45 milliamperes for the plate circuit supply, and from 10 to 15 milliamperes for the voltage regulator tube. No other ABC eliminator will take care of the 371 power amplifier tube as well as supply the filament and plate voltages for the 99 tubes, without being badly overloaded.

### Can Be Used As a "B" Eliminator Alone If Desired

It can be used as a "B" battery eliminator for any type of set, and as an ABC battery eliminator when the set has the filaments wired in series. The kit of parts is completely assembled on a metal base-plate, mounted in a fireproof metal box, handsomely finished in Duco enamel. Only the best parts available are used, including the Silver-Marshall transformer, choke and condensers. Only the necessary wiring and rectifier tubes are needed to place it in operation. No assembly, drilling or other inconvenience necessary, as we assemble it for you.

**\$39<sup>50</sup>**

Completely Assembled-- Ready to Wire

### USE THIS ORDER BLANK

ARMY SALES CO.,  
1650 Jackson Street,  
San Francisco, California.  
Herewith enclosed \$39.50, for which send one complete Power Plant to the following address:  
Name.....  
Address.....  
City.....  
State.....

## ARMY SALES CO.

1650 Jackson Street

San Francisco, Calif.

## Diamond of the Air!

Once more leading radio authorities specify  
**ELECTRAD** products.  
N. Y. C.

**ELECTRAD**

## PACENT CUSHION TYPE BAKELITE SOCKETS

Used in "The Diamond of the Air" Kit  
Ask your dealer or write us direct about these and other Pacent Radio Essentials

PACENT ELECTRIC COMPANY, INC.  
91 7TH AVENUE, N. Y. C.

## NOW FOR THE CABINET!

Of course you will want our 7"x24"x1 1/2" IVEYLINE. Mahogany finish rubbed \$4.00. Solid Walnut \$5.25 f.o.b. Hickory, cash with order. Free catalogue.

The Southern Toy Company  
HICKORY, N. C.

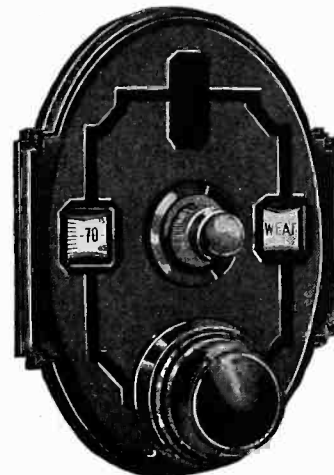

## ACCURATUNE Recording Dial

Its simplicity and efficiency has overwhelmed the real radio fans. Its positive friction grip insures absolute smooth action. Graduated from 0 to 100 or reverse.

Sold in three ways.  
Recording Dial.....\$2.00  
(Ratio 10 to 1)  
With Micrometer Control, 2.75  
(Coarse Ratio—and 200 to 1)  
Illuminated extra......50  
Sent Direct if Your Dealer Cannot Supply You.

## Mydar Radio Company

19 Campbell St. Newark, N. J.  
"Pioneer Mfgs. of Micrometer Dials"

Black Insuline, 7"x24", drilled and engraved for "DIAMOND OF THE AIR." List Price.....\$4.25  
Black Insuline, 7"x30" or 7"x28", drilled and engraved for "INFRA-DYNE." List Price.....\$5.50  
Also panels for all other popular circuits; sub-panels, mounting brackets, etc.  
Write today for Catalog 12  
INSULATING CO., OF AMERICA  
(Incorporated)  
59 WARREN STREET, NEW YORK CITY



Perfect Filament Control in the "DIAMOND of the AIR" is assured by

**AMPERITE**  
REG. U.S. PAT. OFF.  
The "SELF-ADJUSTING" Rheostat



# THE NEW IMPROVED DIAMOND OF THE AIR KIT

The only licensed Kit that is fairly priced at \$37.50 and distributed by us direct to you to save the difference. Every fan knows the DIAMOND OF THE AIR, 100,000 fans have praised this wonderful Kit. All complete with blue print ready to wire—your pliers and screwdriver, all you need.

ORDER YOURS NOW.

The  
**DIAMOND**  
Gives You  
Clarity,  
Quality,  
Selectivity

Works  
on a Loop

Outside Aerial  
Indoor Antenna



Assembled by the Clapp-Eastham Co. Licensed under ARMSTRONG PATENT No. 1,113,149 exclusively for BRUNO RADIO CORP.

Complete Kit of Parts, with Blueprint, Ready to Wire, as Specified by GERALD M. BEST

DIRECT  
TO YOU

**\$37.50**

SEND FOR  
NEW  
BOOKLET

KIT VIEW OF THE DIAMOND OF THE AIR



A NEW TUNING UNIT  
THAT SIMPLIFIES AND  
BEAUTIFIES ANY SET

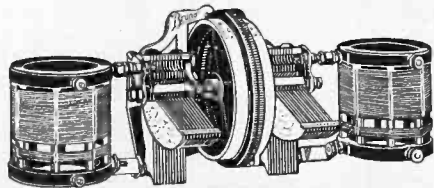

UNITUNE  
Model RF

## BRUNO

Adjustable  
Brackets

They are of die-cast aluminum and form a substantial support between the panel and the socket strip. By the use of "BRUNO" brackets, wiring is made simple, as all parts are readily accessible with this construction. Price, Bruno Bracket for straight panel, \$1.00 per pair.

Price, Adjustable Bracket for Sloping Panel, \$1.25 per pair.

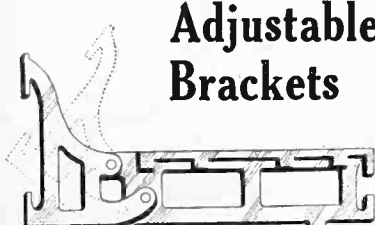

**UNITUNE Model 2C**  
This basic instrument consists of two bakelite shaft Bruno straight line frequency condensers (.0005 mfd. unless otherwise specified), mounted on an aluminum frame; a bronze panel plate and two drums, with scale. The condensers are insulated from each other.

Price \$11.00

**UNITUNE Model CC**  
Consists of one .0005 mfd. bakelite shaft, straight line frequency condenser and a three circuit tuner on one frame, with regular Bruno drum control.

Price \$12.00

**UNITUNE Model CF**  
Consists of 2C unit with one fixed RF coupler and special three winding coil, with fixed primary and tickler, for use in capacity feedback regenerative circuits.

Price \$19.00

Consists of the basic condenser frame, Model 2C, and two Bruno LOW LOSS RF transformers. This combination provides two radio frequency stages and covers a wavelength of 200 to 550 meters. Complete assembled.

Price \$17.00

**UNITUNE Model TK**  
This model is similar to Model RF except that the right hand condenser holds a standard BRUNO THREE-CIRCUIT TUNER. It is adaptable to a variety of circuits. Complete assembled.

Price \$20.00

**UNITUNE Model BD**  
Consists of two condensers and two specially wound coils designed for use in the BROWNING-DRAKE circuit.

Price \$21.00

MAIL ORDERS PROMPTLY FILLED

Frame,  
Panel-plate  
and Drums  
\$3.50



"BRUNO  
99"

—3-circuit Tuner, wound on Quartzite glass and specified in the Diamond of the Air and other popular circuits.

\$5.50

"BRUNO  
99"

Matched R.F. Coil for the 99 Tuner. Used in the Diamond of the Air and other popular circuits.

\$3.00

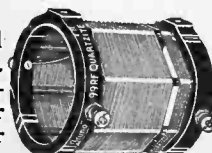

**B. C. L. RADIO SERVICE CO., Inc., 221-R Fulton St., NEW YORK CITY**

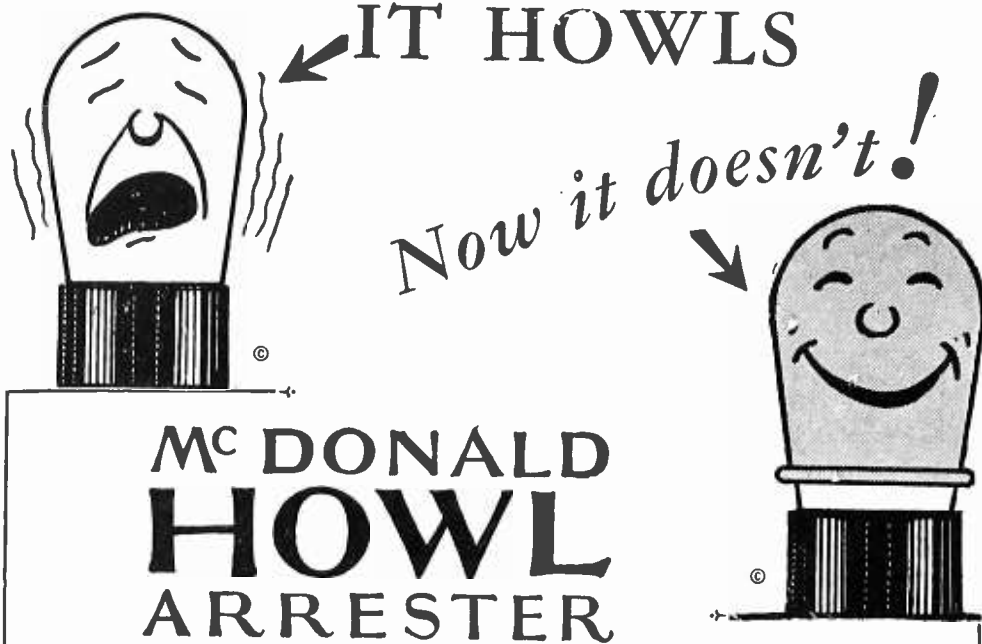

# Mc DONALD HOWL ARRESTER

TRADE MARK

*"It Stops that Howl!"*

Slip one of these live rubber jackets over each trouble-making tube . . . and the Howl stops.

Remember the name! You can get it for every size tube. It sells for 75c each. Just ask your dealer, or write.

Sole Selling Agents for the U. S. A.

SPARTAN ELECTRIC CORPORATION  
350 West 34th Street, New York City

Manufactured in the U. S. A., by the  
SCIENTIFIC PRODUCTS CANADA, LTD.

*"It Stops that Howl!"*

# NEW



**Dependable  
Products**  
—for the 1927 Season

Muter Products  
Are Distributed to the  
Western Jobbers by  
**A. S. Lindstrom Co.**  
SEATTLE—PORTLAND  
SAN FRANCISCO—LOS ANGELES  
SALT LAKE

**Leslie F. Muter Co.**  
76th and Greenwood Avenue  
Chicago, U. S. A.

**Knife Throw  
Switches**

Moulded Bakelite base—Spring  
brass contact—Moulded insulator  
handles.



Single Pole, Double Throw  
Base 2 1/2" x 1 1/2"  
Stock No. 2018 . . . . . 7c list



Double Pole, Double Throw  
Base 2 1/2" x 1 1/2"  
Stock No. 2020 . . . . . \$1.00 list



Triple Pole, Double Throw  
Base 2 1/2" x 1 1/2"  
Stock No. 2020 . . . . . \$1.50 list



Five Pole, Double Throw  
Base 2 1/2" x 1 1/2"  
Stock No. 2020 . . . . . \$2.50 list



Antenna Pin  
Black moulded Bakelite 2 1/2" long.  
Stock No. 2020 . . . . . 50c list



Resistance Amplifiers  
Completely wired, ready for installation. Individually  
packed, with instructions.  
Stock No. 1410 (1 stage) . . . . . \$4.00 list  
Stock No. 1400 (3 stage) . . . . . \$9.00 list



Standard  
Complete Aerial Kit  
Contains all necessary parts to erect. Attractive  
lively individual markings.  
Stock No. 220 . . . . . \$3.50 list



Audio Frequency  
Transformers  
Highly efficient—popular price—  
fully shielded in an expanded  
metal case.  
Stock No. 1500 . . . . . \$2.25 list  
3 1/2 to 1 ratio . . . . . \$2.25 list  
Stock No. 1550 . . . . . \$2.50 list  
8 to 1 ratio . . . . . \$2.50 list



Variable High Resistance  
Controls oscillation and regulates  
quality and volume. Highly machined  
plated metal shell with moulded  
Bakelite base.  
Range 0 to 700,000 Ohms.  
Stock No. 2100 . . . . . \$1.25 list  
Range 0 to 500,000 Ohms.  
Stock No. 2150 . . . . . \$1.25 list



Interference and Static  
Eliminator  
Moulded Bakelite case with enamel  
and spraying wires.  
Stock No. 1000 . . . . . \$1.50 list



Variable Condensers  
Moulded Bakelite case  
Bakelite condenser . . . . . \$1.00 list  
Stock No. 1900 . . . . . \$1.00 list  
Variable grid condenser 80013 to  
2005 H . . . . . \$1.00 list  
Stock No. 1950 . . . . . \$1.00 list



Fixed Condensers  
Highly polished metal end plates with adjust-  
able underlying legs. Bakelite plates—also in-  
sulation—brass shrouds—give maximum re-  
sults.  
Used by leading set builders.  
All popular sizes—from 30u to 85u list.

ULTRA-VIOLET SPECTRUM	
3380 (A)	Flint glass ceases to transmit
3050	Harmful effects on living tissue begins
3000	Limit of solar spectrum found by Miethe and Lehman
2915.	
2800	
2790	Light crown glass ceases to transmit.
2500	Dangerous to the eyes. Abiotic effects increase rapidly from here with shorter waves
2220	Ordinary clear quartz begins to absorb
2020	Miller's photographic limit.
1850	Stoke's limit of phosphorescence
1800	Ozone producing power begins.
1700	Shortest wave length transmitted by mercury lamp of clear glass.
1450	Rock salt ceases to transmit.
1350	Limit of transparency crystal quartz 2 m.m. thick
1230	Ionization of air begins
1000	Limit of transmission of superfine fluorite
500	Saunders' limit in spectra of Calcium in 1914. Also Schuman derived from hydrogen spectrum
450	Observed in spectrum of helium at 2 to 3 m.m. pressure by Lyman in 1917.
372.2	Observed by Richardson and Bazzone in the spectrum of helium.
144.3	Observed by Milliken in the spectra of aluminum, magnesium and sodium 1921.
130.0	
SLIGHTLY EXPLORED REGION	
56.25 (A)	Explored by bureau of Standards, 1922.
28.125	Characteristic properties of X-rays.
14.06	
X RAYS AND GAMMA RAYS	
12.35 (A)	Longest X-rays from zinc observed by Freeman
1.66	X-rays from nickel
.976	
.619	X-rays from palladium.
.614	
.580	
.488	
.475	X-rays from rhodium
.445	
.122	Shortest measured X-rays, 1917
.114	
.071	Gamma rays
.02	Below this are the newly discovered cosmic rays, the shortest waves known.
and shorter	

(Continued on Page 80)

Tell them that you saw it in RADIO



**STATEMENT OF OWNERSHIP, MANAGEMENT, CIRCULATION, ETC., REQUIRED BY THE ACT OF CONGRESS OF AUGUST 24, 1912.**

"RADIO," published monthly at San Francisco, Calif., for October 1, 1926.

State of California, County of San Francisco, ss.

Before me, a Notary Public in and for the State and county aforesaid, personally appeared H. W. Dickow, who, having been duly sworn according to law, deposes and says that he is the Business Manager of "RADIO," and that the following is, to the best of his knowledge and belief, a true statement of the ownership, management, etc., of the aforesaid publication for the date shown in the above caption, required by the Act of August 24, 1912, embodied in section 443, Postal Laws and Regulations, printed on the reverse of this form, to-wit:

1. That the names and addresses of the publisher, editor, managing editor, and business managers are:

Publisher, Pacific Radio Publishing Co., Pacific Bldg., San Francisco; Editor, Arthur H. Halloran, Berkeley, Calif.; Managing Editor, None; Business Manager, H. W. Dickow, Pacific Bldg., San Francisco.

2. That the owner is:

Pacific Radio Publishing Co., Pacific Bldg., San Francisco; Arthur H. Halloran, Berkeley, Calif.; H. W. Dickow, Pacific Bldg., San Francisco; H. L. Halloran, Berkeley, Calif.

3. That the known bondholders, mortgagees, and other security holders owning or holding 1 per cent or more of total amount of bonds, mortgages, or other securities are: None.

4. That the two paragraphs next above, giving the names of the owners, stockholders, and security holders, if any, contain not only the list of stockholders and security holders as they appear upon the books of the company but also, in cases where the stockholder or security holder appears upon the books of the company as trustee or in any other fiduciary relation, the name of the person or corporation for whom such trustee is acting, is given; also that the said two paragraphs contain statements embracing affiant's full knowledge and belief as to the circumstances and conditions under which stockholders and security holders who do not appear upon the books of the company as trustees, hold stock and securities in a capacity other than that of a bona fide owner and this affiant has no reason to believe that any other person, association, or corporation has any interest direct or indirect in the said stock, bonds, or other securities than as so stated by him.

H. W. DICKOW,  
Business Manager.

Sworn to and subscribed before me this 22nd day of September, 1926.

(SEAL) JOHN L. MURPHY,

Notary Public in and for the City and County of San Francisco, State of California. My commission expires May 20, 1929.

# LYNCH METALLIZED

## FIXED RESISTORS

ARE WARRANTED—

Absolutely Noiseless

Permanently Accurate

Dependable!

Write us!

ARTHUR H. LYNCH, Inc.

Manufacturers of Radio Devices

Fisk Bldg., Broadway & 57th Street  
New York, N.Y.



# The Abox Filter

Real "A" elimination at last. Filters current direct from charger to set. Employs an entirely new type condenser. The first device of its kind ever offered to the public.



**\$19.50**

East of Rockies

## Gives "A" Current from Light Socket —Contains No Batteries!

THE Abox Filter is in no sense a Battery.

It is a filter circuit consisting of a choke coil and two of the new Andrews electrolytic condensers which operate on a new principle and permit enormous capacity with small space, cost and weight.

The Abox Filter handles as much as five amperes and renders the current absolutely smooth and suitable for proper operation of the tubes.

It is only half the size and less than half the weight of a storage battery. Used with a suitable

charger the Abox Filter provides a complete "A" eliminator drawing power from the light socket. Can be installed by anyone in a few moments.

It is never charged or discharged and supplies no power of its own. It is always ready for immediate use, even after long periods of idleness. There is nothing to wear out. It does not deteriorate either in use or lying idle, and will last for many years.

For an explanation of this remarkable development write for folder, describing in detail its construction and use.

THE ABOX COMPANY - 215 N. Michigan Ave. - CHICAGO

## Just Out!

SARGENT'S OFFICIAL  
INFRADYNE MANUAL

**25 cents**

Per Copy Postpaid

A Complete Manual.

For Sale By

Pacific Radio Pub. Co.  
Pacific Building San Francisco

### SET BUILDERS

IF you are interested in saving money send for the

#### BUILDERS' KIT and PRICE GUIDE

When we say "Save Money" we mean—well,—for example:

Cockaday's New LC-27, for only.....	\$69.75
Improved Browning-Drake .....	54.77
Henry Lyford .....	57.52
Sargent's Infradyne .....	89.50
Raytheon B. Supply.....	36.72

Exact parts as used and may be purchased separately at ham prices. Get the guide before buying elsewhere. Many other items of receiving and transmitting parts.

Reimler .00035 var. condenser (List \$5.00) \$4.13;  
Hammarlund Midline Dual Condenser (List \$7.50), \$5.97; Single (\$4.65), \$3.95; Aero Low Wave Tuner Kit (\$12.50), \$9.87.

Sent Prepaid East of the Rockies. West Thereof Add 8c Each Pound. 25% Deposit On All C. O. D. Orders.

M. B. S. SALES CO., Dept. G., Boston, Mass

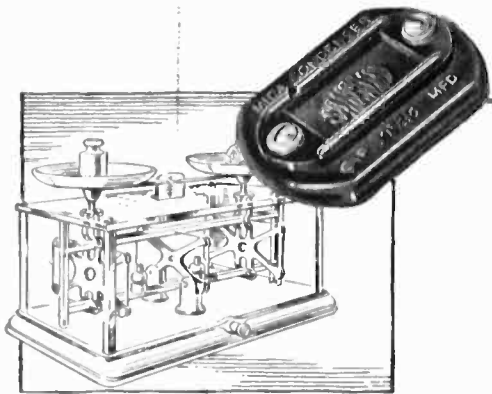

"Weights out right capacity as accurately as the apothecary weighs out a precious drug."

A. C. L.

TECHNICAL men were quick to appreciate Sangamo condensers in intermediate capacities. One engineer, well known to readers of radio publications—Austin C. Lescarboua—sends us the following characteristic comment, which is published with his consent:

"In my laboratory we develop new circuits and variations of old circuits, publishing the results in radio magazines. Needless to say, we are using and specifying Sangamo condensers throughout. In my opinion there is no other fixed condenser that can compare with the Sangamo in accuracy, permanent capacity value, neatness and handiness.

"The Sangamo condenser weighs out just the right capacity as the apothecary weighs out a precious drug."

## SANGAMO

### Mica Condensers

are made in 34 sizes, ranging from 0.00004 mfd. to 0.012 mfd. Sangamo Wound Condensers are ready in capacities from 1/10 mfd. to 4 mfd.; Series A guaranteed for continuous operation at 250 volts AC, 400 volts DC; Series B guaranteed at 500 volts AC, 1000 volts DC; also 12 and 14 mfd. blocks.



Sangamo Electric Company

6332-10

Springfield, Illinois

RADIO DIVISION, 50 Church Street, New York

SALES OFFICES—PRINCIPAL CITIES



### MURRAY UNIT REALLY ENDS TROUBLE

For constant Radio "A" power; can be operated while set is in use. Simply connect to light socket. No adjustment; no wires to change; no low batteries. Equipped with hydrometer in cap for gravity test and 2-amp. G. E. Tungar bulb. Delivered ready to use.

Agents Murray Distributor  
Wanted! 4837 N. Robey St., A, CHICAGO

**\$2950**  
LIST

### FREE CATALOG

"Gets em—Coast to Coast"  
Reports of hundreds of users.  
A startling new kind of radio.  
Dealers and Agents wanted.

5 Tube  
Prmco Radio  
**\$42.**<sup>list</sup>  
5 days trial

PORTS MFG. CO. Dept. R. 1. FRESNO, CALIF.

## ACME ENAMELED ANTENNA



Best outdoor antenna you can buy. 7 strands of enameled copper wire; maximum surface for reception. Prevents corrosion and consequent weak signals.

### The Original Celatsite

—a tinned, copper bus bar wire with non-inflammable "spaghetti" covering, for hook-ups. 5 colors; 30-inch lengths. We also offer the highest grade of "spaghetti" tubing for Nos. 10 to 18 wires. 5 colors; 30-inch lengths.

### Flexible Celatsite



Flexible, stranded wire for point-to-point and sub-panel wiring. Non-inflammable "spaghetti" covering. In black, yellow, green, red and brown; a color for each circuit. Put up in 25-foot coils.

### Celatsite Battery Cable

—a silk-covered cable of vari-colored Flexible Celatsite wires, for connecting batteries to set. Prevents "blowing" of tubes; gives your set an orderly appearance.

Send for folder

THE ACME WIRE CO., DEPT. R  
NEW HAVEN, CONN.

## ACME WIRE MAKES BETTER RADIO

Oh boy  
KESTER  
Rosin Core  
Radio SOLDER  
Sure is Safe and Simple

Approved by  
Radio Engineers  
A Genuine Solder  
CHICAGO SOLDER COMPANY  
4254 Wrigleywood Ave., Chicago, U.S.A.

Real Sensation of the Year  
**CHELSEA**  
TRUPHONIC SIX—\$60.00

Write us.  
Chelsea Radio Co.  
Chelsea, Mass.

## ETHERIAL WAVES

(Continued from Page 78)

APPROXIMATE SUMMARY

	Octaves
Wavelengths used in radio.....	9
Hertzian (very short radio).....	14
Infra-red, or dark heat waves.....	11
Visible light.....	1
Ultra-violet.....	5
Long X-rays, X-rays, and Gamma rays.....	11

Total.....51

EXPLANATION OF UNITS OF LENGTH INVOLVED

10 Angstrom (A) = 1 m.mic'n = 10 <sup>7</sup> c.m.
1000 Millimicrons (μμ) = 1 micron = 10 <sup>6</sup> c.m.
1000 Microns (μ) = 1 m.meter = 10 <sup>9</sup> c.m.
10 Millimeters (m.m.) = 1 centimeter
100 Centimeters (c.m.) = 1 meter

## THE "MINDECTOR"

(Continued from Page 44)

flat Litz multi-strand wire is shown in Fig. 6. In the first place the braid is not woven, but consists of from 12 to 20 T.C.C. wires of No. 40 to 34 held together by a zig-zag binder-thread. Such braid can be obtained from textile webbing companies, if the wire is supplied



Fig. 6. Flat Braid Litz.

for \$2.50 a gross yard up, according to the quantity. A gross yard means 432 linear feet of braid and the number of parallel strands does not much change the "braiding" cost. I use wire of 60 strands of No. 35 in parallel and the braiding cost is not much different from that for 30 strands.

These braids are put on doubly or trebly, according to the number of turns used. They cover 50 to 80% of the toroid's surface and keep the magnetic field within the ring, yet without undue eddy current losses and with practically negligible skin effect. They are practically "all-air" toroids. In Fig. 7 curves are given covering the series of Mindector coils shown in Fig. 5 and also covering a series of coils with constant  $l$  and constant  $n$ , or turns per centimeter of inner periphery, as the inner diameter  $d_1$  changes.

## "WHO'S WHO AND WHERE"

W. E. Chadwick, ex-Calawaii, took the S.S. Yorba Linda to Toulon, France. From there KDNS is to go to the East Coast and continue to run out of Eastern ports.

The S.S. Coalinga is now being ably handled by H. R. Packwood, who spent several years on the Liebre.

It is rumored that the change of control of the G. P. tankers to the Standard Transportation Co is not so popular a move among the crews. The G. P. tankers certainly had a fine reputation among sea-going men, and were the aspirations of many a good operator. No more, no more.

J. G. Alverson, Radio Engineer extraordinary, moved his ore-locating apparatus to Silver City, New Mexico. Maybe he's after some NAA galena now.

# Better Reception

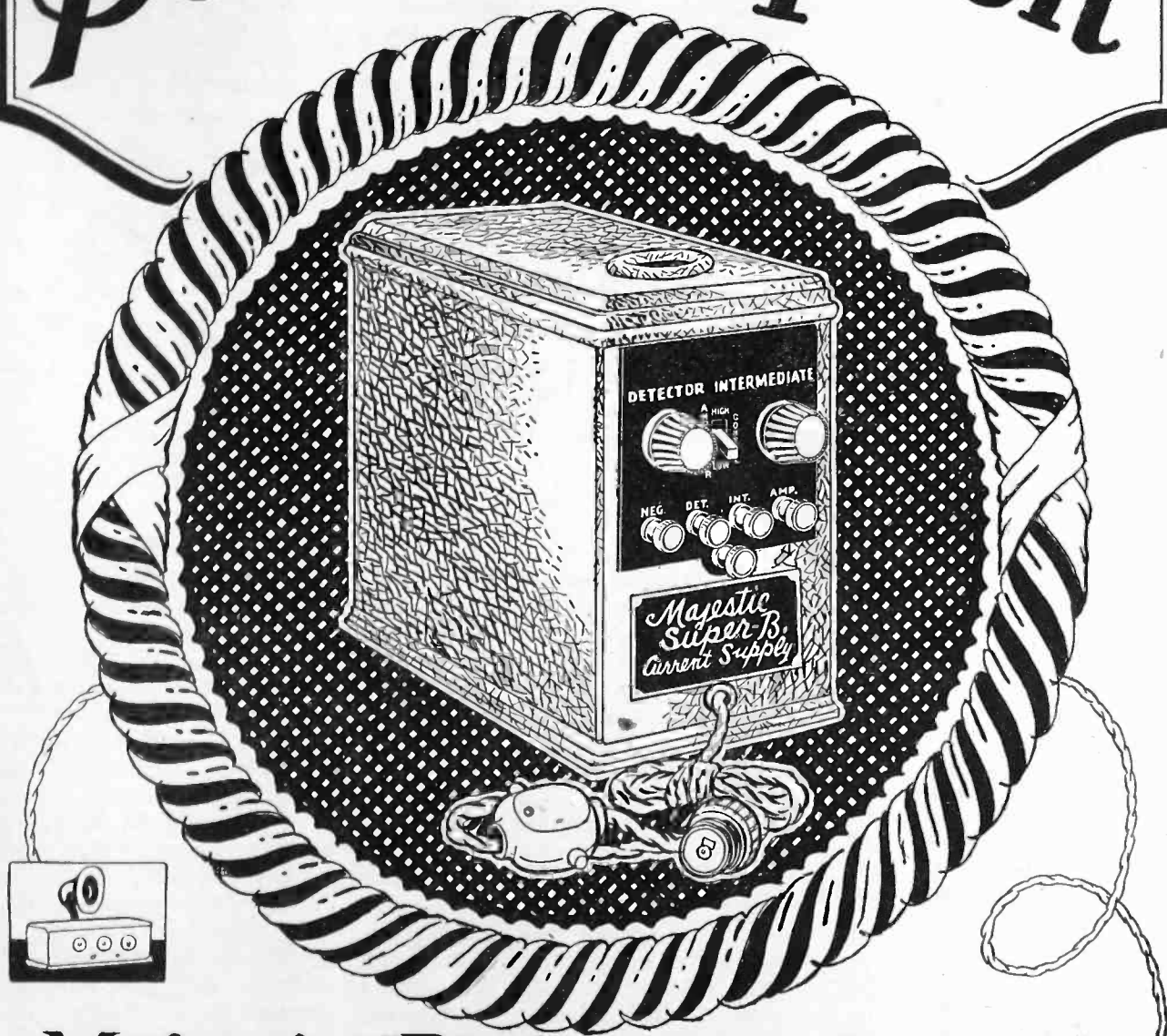

## Majestic "B" Current Supply

delivers pure direct current—from your light socket

### Majestic Standard-B

Capacity seven tubes or six plus 1 power tube. 45 milliamperes at 135 volts

**\$32.50**

*West of Rocky Mts., \$35.00*

### Majestic Super-B

Capacity one to twelve tubes, including the use of power tubes. 45 mils **\$35.00** at 150 volts.

*West of Rocky Mts., \$37.50* [AS ILLUSTRATED]

### Majestic Master-B

For Radiola 25, 28, 30 and Super heterodynes. Operates power tubes. 60 mils at 150 volts.

**\$42.50**

*West of Rocky Mts., \$45.00*

### No Hum—Superior to Any Source of Power

The voltage can always be accurately adjusted to meet the varying conditions of every city and on any set.

Economical—cost a fraction of a cent per hour. No acid or liquids; Uses Raytheon Tube; No filament to burn out.

See your dealer today. Insist on a demonstration on YOUR set immediately

(Can be purchased on deferred payments)

GRIGSBY - GRUNOW - HINDS - CO. 4580 ARMITAGE AVE, CHICAGO-ILL.

Tell them that you saw it in RADIO



# Precision

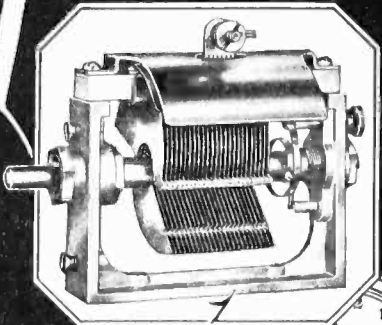

*built like a watch*



## PRECISION

of detail, both electrically AND mechanically, is what places so far ahead of the field the

## Samson Uniform Frequency Condensers

Electrically this condenser has mathematically proportioned plates so that ALL stations are uniformly spaced. The dielectric is small and well removed from the field. The plates are small and close together, avoiding losses due to fringing effects and large plate area, and are plated for high surface conductivity.

Mechanically this condenser is the smallest made. It is built on a rugged frame capable of mounting in all positions with or without single-hole mounting. The rotor is of heavy construction, having cone bearings on either end and should wear indefinitely without adjustment. A shield is incorporated with the condenser to protect against injury and dust.

The Samson Uniform Frequency Condenser is furnished in five sizes: Prices—500 mmf., \$7.50; 350 mmf., \$7.25; 250 mmf., \$7.00; 125 mmf., \$7.00; 75 mmf., \$7.00.

Our book—"Audio Amplification"—already accepted as a manual of audio design by many radio engineers—contains much original information of greatest practical value to those interested in bettering the quality of their reproduction. Sent upon receipt of 25c.

**SAMSON ELECTRIC COMPANY**



MAIN OFFICE:  
CANTON, MASS.

Manufacturers  
Since 1882

## MARINE RADIO

(Continued from Page 30)

quires 2 k.w. at 200 volts, supplied by a d.c. motor generator. This is fed to the arc converter, which changes it to high frequency alternating current to be fed to the antenna circuit through a suitable keying device. The arc electrodes are of copper tubing, water-cooled, as is also the copper chamber in which they are suspended. Below this chamber are the field magnets, the magnetic circuit being completed by an iron cover over the case and chamber. Hydrocarbon vapor is supplied by alcohol which drips slowly from a magnetically controlled feed cup. This feeds alcohol when transmitting

"shunt" circuit, which is provided with a variable artificial resistor to absorb the energy, and simulate operating conditions. When the key is closed, this circuit is disconnected, and the arc connected to the antenna, through suitable loading inductances. The contacts on the relay "follow" part way, as the key is manipulated, so that for a moment both antenna and shunt circuits are connected together, and then as the contacts move over, the shunt circuit disconnects, leaving the antenna free to oscillate. This arrangement is necessary to transfer the load from one circuit to the other without removing the load from the arc, as the latter will go out if the load is

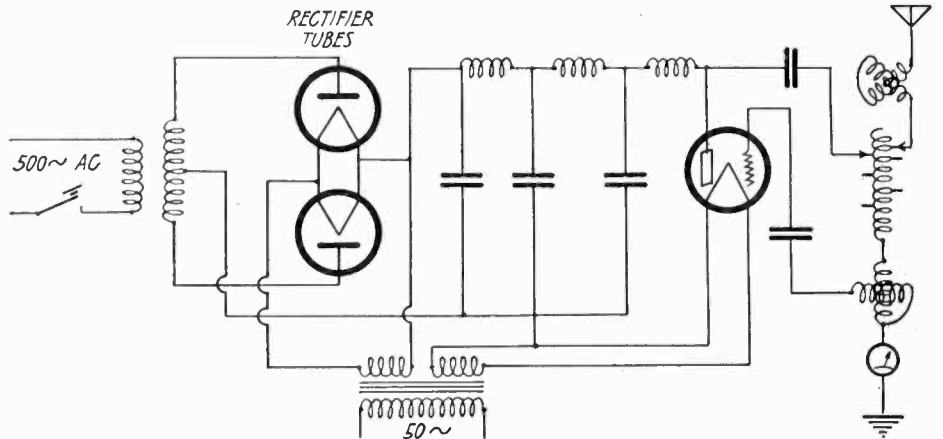

Fig. 3. Telefunken System.

and shuts it off when receiving.

The circuit essentials are shown in Fig. 4. A combined overload circuit breaker and starting switch in the positive lead from the d.c. supply first throws the current on to the arc with a 20 ohm resistance in series. A second control switch, which is also an overload circuit breaker, cuts this resistance out of the circuit and allows the arc to draw full power. The series arc fields in the positive lead also serve as r.f. chokes. The negative terminal of the supply line, which is the ground side of the arc, is permanently grounded. A radio frequency ammeter measures the antenna current, a small inductive shunt giving a path for the d.c., should the antenna become grounded and throw the whole load across the antenna circuit.

The "back shunt" keying system is controlled by a relay key operated from the 110 volt line. When the key is in the "open" position, as shown, the arc burns continuously, and the radio frequency goes into a tuned closed or

entirely removed. A small resistor is connected between the antenna and relay contacts, which is of such a value that no oscillations take place when the key is "open," but this reduces the sparking, and wear on the contacts.

The 3/4 k.w. Federal spark transmitter uses the usual ship's supply power of 110 volts d.c. as its source of current.

A motor-driven interrupter gives a periodic reversal of flux in the core of a transformer whose low voltage output is stepped up for charging the condenser. The condenser discharges through a spark gap and inductance. The inductance serves a dual purpose as the primary of the transformer and as a coupler for the closed and open circuits of the secondary, which is connected through suitable loading to the antenna and ground system. The synchronous spark gap is mounted on a shaft in front of the panel and behind the interrupter. An adjustable rocker arm permits the two stationary low tension electrodes to be rotated until they are in synchronism.

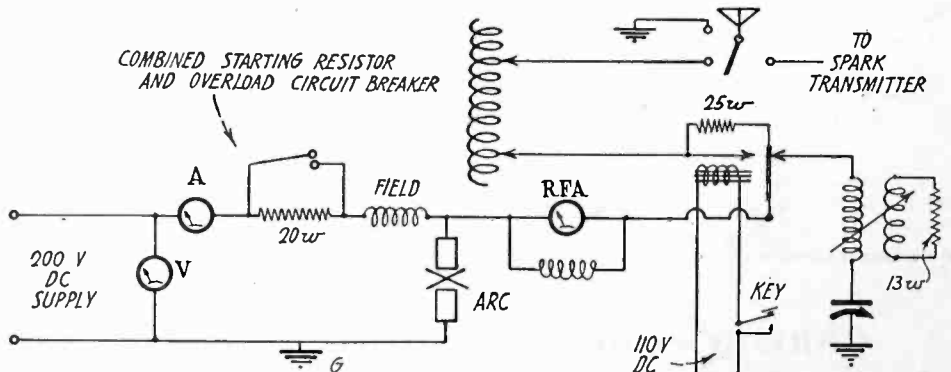

Fig. 4. Federal 2 k.w. Arc Set.

Tell them that you saw it in RADIO



25c at Daven Dealers, 30c by Mail

Even if you can't drive a nail straight you can build

## the finest set you ever heard

THE set that radio fandom is talking about—and building—in tremendous quantities, can now be built by anyone.

No matter if you have never built even a one-tube set before—no matter if you have never had a screw-driver in your hands before—you can, with the book, "How to Make a Daven Bass Note Circuit," equal the job of an expert.

Every conceivable question is answered. Every part is shown in life size drawings. Every connection is numbered—and with the "A B C" wiring chart no one could possibly make a mistake.

The Daven Bass Note Set in its new two dial layout is even better than ever before—the new Daven Balancer and Compensator make tuning sharper and easier than ever before.

Get the Book today—it will be one of the best radio investments you ever made. The Daven Bass Note Set will open your eyes—and your ears! Your Bass Note Set will be the talk of your neighborhood—everyone will want to copy it. Secure your copy now, as the first edition is going rapidly, and you might have to wait for another printing.

# DAVEN

## Bass Note Circuit for Complete Radio Reception

New 8th Edition Daven Manual

This valuable book explaining Daven Amplification, has been just newly revised. It will tell you in full detail how to apply Daven Amplification to YOUR set. 25c at dealers, 30c by mail.



"The Sine of Merit"  
DAVEN RADIO CORPORATION  
TRADE MARK "Resistor Specialists" REGISTERED  
222 SUMMIT ST., NEWARK, N. J.  
FREE CATALOG ON REQUEST



## Bridge great distances

The new PRIESS "9" NINE brings in remote stations with astounding quality—even when the locals are at the height of their broadcasting

Deep, sonorous bass notes as well as the faintest sounds of a violin—there are no "squeaks" or "howls"—no background noises. Instead a tone quality to marvel at.

Because of its matchless selectivity the Priess Nine is ideally suited for use in cities and other congested broadcasting districts—it goes through the locals as though they were not there.

Fourteen years of RADIO experience are back of every Priess set. A home demonstration involves no obligation and is a guarantee of your satisfaction. Write for names of dealers.

Priess  
TRADE MARK

## STRAIGHT 9 NINE



"Outstanding radio performance and value on the market today—without exception"

PRIESS RADIO CORPORATION  
687 Broadway, New York

Authorized Priess Dealers show this sign in their windows



Console \$335

### The one set for city use

Enclosed panel operated loop and built-in loud speaker. A splendid piece of furniture in addition to its radio perfection. NINE TUBES give tremendous power. Single dial control and direct reading wave length. No outside aerial. No lightning hazard. Priess known quality and value.

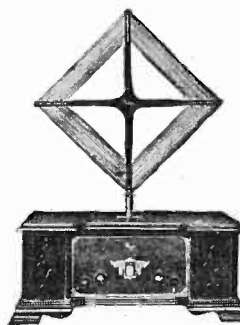

Table model \$195

## See Jay Power Unit



Here to Stay!

### This Battery Never Runs Down!

A combination alkaline element battery and trickle charger all in one. Price, shipped dry with solution, \$16.00. Tube extra, \$1.00. 100 volt with chemical charger \$12.00, 140 volt \$17.00.

Write for our illustrated 32 page booklets  
Send No Money—Pay Expressman

SEE JAY BATTERY COMPANY  
919 Brook Avenue New York City

FOLLOW THE  
: : INFRADYNE : :  
Subscribe now to  
"RADIO"—\$2.50 Per Year

## Potter Condensers

Potter condensers, American made of highest quality materials to full capacity, build the best Socket Power Devices, Power Amplifiers, Impedance Amplifiers. And they are best for Filter Uses, Rectifiers, By Pass, and Blocking D.C. All types and sizes.

POTTER MANUFACTURING CO.  
North Chicago, Illinois

Tell them that you saw it in RADIO

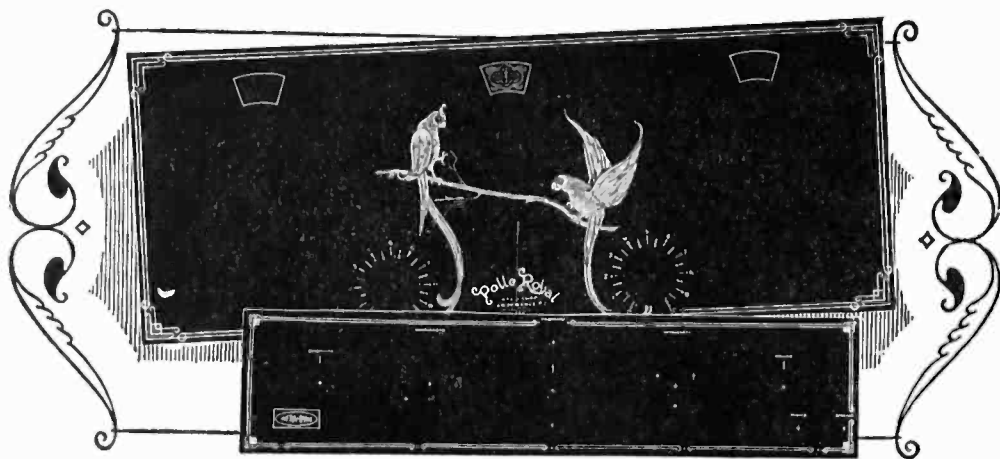

## INVERSE DUPLEX

(Continued from Page 34)

*B*, or a *B* eliminator. The *C* batteries are divided into two units—one of  $4\frac{1}{2}$  volts which supplies the UX-201A duplex stages, and the other section varies in voltage depending on the type of power tube used. If the UX-112 tube is used, the 2nd unit of *C* potential should be  $4\frac{1}{2}$  volts like the 1st unit, making a total of 9 volts. If the UX-171 tube is used, the 2nd section should be  $22\frac{1}{2}$  volts, making a total of 27 volts on the grid of the UX-171,—the correct value when using 135 volts on the plate.

The 135 volt tap supplies not only the last power stage but is used also for the plate potential for the resistance coupled stage. This works out ideally as 70 volts actually reach the plate of the No. 2 tube through the 24,000 ohms when connected to the 135 volt tap. The No. 2 tube is thus a very efficient radio amplifier, receiving the plate volts necessary for best r.f. results. This 70 volts plate potential also enables this tube to perform as an excellent resistance coupled audio stage. By means of the 24,000 ohms and the 135 volt tap, this No. 2 tube delivers much more energy than the ordinary resistance stage.

The 90 volt battery tap supplies only the plate potential for the No. 1 tube, which reaches the plate at 90 volts due to the low resistance in the primary of the 6 to 1 audio transformer. The  $22\frac{1}{2}$  volt tap feeds the detector as usual, through the primary of the 2 to 1 audio transformer. The lower value of  $22\frac{1}{2}$  instead of 45 volts, has been chosen for several reasons. The detector is somewhat more sensitive at the lower value and certainly more quiet. The 45 volts gives a little more volume on local but with three audio stages, this is not needed. Furthermore, the  $22\frac{1}{2}$  volt tap can usually be taken off from the common *B* battery. The 45 volt detector tap usually howls if taken off the common *B*. As the main *B* battery becomes old, the common detector tap may cause battery whistle necessitating a small separate  $22\frac{1}{2}$  unit, which is certainly more convenient and cheaper than a separate 45 volt unit.

A discussion of shielding is in order next, as its advantages and disadvantages must be understood before a complete discussion of the r.f. and a.f. circuits is possible. It has been found that shielding is of little or no advantage unless it is complete. Apparently, the main advantage gained, is that of electro-static shielding,—preventing stray static fields from causing feedbacks. Separating the set into three subdivided metal compartments as indicated by dotted lines in Fig. 1, and shown in Fig. 3, is necessary in addition to surrounding the set completely. The shielding walls between stages also act to prevent magnetic coupling as it is easier to mount all the coils

(Continued on Page 86)

## Bremer Tully Power Six Panel

Formica has prepared a panel decorated in gold on gloss black Formica and fully drilled for the Bremer-Tully Power Six Kits. There is a new Formica Panel for the H. F. L. Nine in Line Superheterodyne, and a Victoreen Universal one dial control.

Other Formica Kit Panels are Infradyne, 7x28 and 7x30; Karas Equamatic front and sub panel; Aerodyne; St. James; Browning Drake National; Bremer Tully Counterphase; Victoreen two dial Superheterodyne; Madison Moore Superheterodyne; Camfield Duoformer.

THE FORMICA INSULATION COMPANY

4616 SPRING GROVE AVENUE

CINCINNATI, OHIO

Hear the FORMICA  
Orchestra Tuesday  
9 to 10  
over WLW

**FORMICA**  
Made from Anhydrous Bakelite Resins  
SHEETS TUBES RODS

Formica has a Complete Service on Insulating Material for Radio Manufacturers.

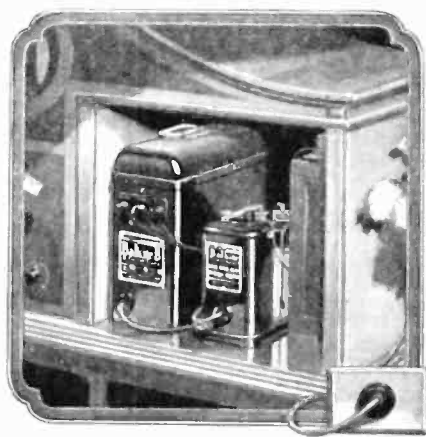

The new Balkite "B" at \$27<sup>50</sup> and the Balkite Trickle Charger at \$10<sup>50</sup> convert your radio set into a light socket receiver

ASK YOUR RADIO DEALER

FANSTEEL PRODUCTS COMPANY, Inc., North Chicago, Ill.

LET G. M. BEST ANSWER YOUR QUESTIONS

Subscribe to "RADIO" for 1 year (\$2.50) and get 10 coupons—entitling you to 10 answers to radio questions.

"RADIO"

Pacific Building

San Francisco



QUALITY **ONGAN** PRODUCTS

**Approved Parts for  
Eliminators Power Amplifiers**

Dongan has perfected transformers and chokes of several types which are used widely with UX, RCA and Raytheon Tubes for both Eliminator and Power Amplifiers.

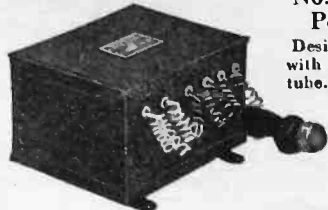

**No. 2568 ABC  
Power Unit**

Designed for use with Raytheon BH tube. Eliminates all batteries. Built into sturdy good-looking black metal case.

List \$17.50

**POWER AMPLIFIERS FOR  
HOME USE**

Use Dongan No. 2567 transformer half wave with UX216 B-tube used in conjunction with UX Power Amplifier tube No. 210.

List \$10.00

Dongan transformers available for all standard types of power Amplifier tubes.

**MANUFACTURERS**

For a reliable source of supply on the latest designs Dongan offers quantity production on all approved types. For special requirements our engineering department is at your service.

**FANS**

Order these and other Dongan parts from your dealer or send to the factory for complete information on constructing eliminator and power amplifier units.

**Dongan Electric Mfg. Co.**

2981-3001 Franklin St. Detroit, Mich.

TRANSFORMERS of MERIT for FIFTEEN YEARS



Dubilier  
Ducon  
Price \$1.50

**Aerials have  
gone out of  
style**

In the old days, when radio was new, the "fan" was known by crazy festoons of wire that decorated his house-top or yard. These were the old-fashioned aerials, and no one has forgotten all the grief they caused.

Modern radio may use the hidden loop, or the short indoor aerial. But there is a better way. The DUBILIER DUCON enables you to use the complete wiring system of your house without risk, and with better results than most outdoor aerials give.

You simply screw a DUBILIER DUCON into any lamp socket, and connect it with the antenna binding post of your set. You will find that it increases selectivity--especially in crowded neighborhoods, and will reduce "static" in the summertime.

Try a DUBILIER DUCON on your set tonight. They are sold by all good dealers on five days 'trial for \$1.50.

**Dubilier**  
CONDENSER AND RADIO CORPORATION

**SAIL AWAY  
AS A  
RADIO  
OPERATOR**



**T**RAVEL to foreign shores as a radio operator and draw good pay while you see the world.

Radio operating is fascinating work. Excellent quarters and board, the ranking of a ship's officer, and shore leave in foreign ports are among the privileges accorded to the "op". The prominent radio positions held by our 8,000 graduates show the wonderful opportunities for advancement.

**RIA conducted by RCA**

Radio Institute of America instruction is not surpassed anywhere. The Institute is conducted by RCA and, in addition to enjoying every advantage of the world's greatest radio organization, it has seventeen years' experience back of it.

**Study at home**

A few months of study at home will qualify you to pass the U. S. Government Commercial Amateur or Broadcast License Examination and start on a successful radio career.

Send in the coupon. It will bring you a booklet filled with interesting information on license requirements and opportunities in the radio field. It outlines our courses in detail.

Radio Institute conducts a special technicians' course for radio dealers, jobbers and service men. Write for information.

Send this in

Radio Institute of America  
322 Broadway, New York City

Please send me your free booklet.

- I am interested in the radio course which prepares for the Govt. Commercial, Broadcast or Amateur License.
- I am interested in the technicians' course for jobbers, dealers and service men.

Name \_\_\_\_\_

Address \_\_\_\_\_

**Radio Institute of America**  
322 Broadway New York City

**Why  
your set  
needs  
AMPERITE**

Because clear reception and long tube life necessitate that delicate and self-adjustable control which only AMPERITE can give.

**Eliminates hand rheostats.  
Simplifies set-wiring.**

Accepted as the only perfect filament control in every popular construction set.

Price \$1.10 Complete

FREE--Write for "The Radiall Book," containing the latest popular hook-ups and construction data, to Dept. k.-12

**Radiall Company**  
50 FRANKLIN ST., NEW YORK

**AMPERITE**  
REG. U.S. PAT. OFF.

**The "SELF-ADJUSTING" Rheostat**

Tell them that you saw it in RADIO



Do you hear *All* of the Orchestra—or *only part*?

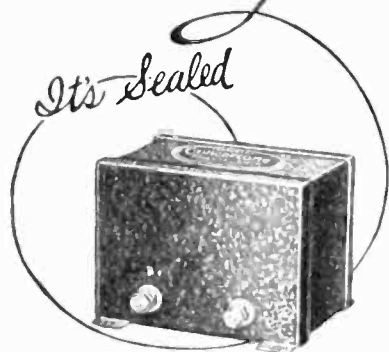

WHEN famous orchestras broadcast, do you clearly hear all the musicians? Or—through inability of your transformers to amplify low and high notes as evenly as middle tones—are you really only listening to a few of the instruments? Put Jefferson "Concertones" in your set and enjoy the whole orchestra!

Specified in latest circuits because they do not lose, distort or "blast" any audible notes from the lowest (30 cycles) to the highest (10,000 cycles). Ideal for safe, continuous use with power tubes. At your dealer's, \$6 each.

JEFFERSON ELECTRIC MFG. CO.  
Largest manufacturers of small transformers  
502 So. Green St., Chicago, Ill.

# Jefferson

## Concertone Transformers

### "B" BATTERY ELIMINATOR

Only \$7.95

**MONEY-BACK GUARANTEE**  
No more worry with "B" Batteries! Hook up a Roll-O "B" Battery Eliminator and forget battery troubles forever. This wonderful new invention means better reception, sharper tuning. Gives you more real pleasure from your set.

Completely Equipped—No "Extras" to Buy  
Operates perfectly on direct or alternating current, giving up to 90 volts current, and using the full wave of the power supply. Simple directions enclosed—anyone can plug it in to any kind of set up to six tubes. Constant voltage gives set more power. Costs no more than set of good "B" Batteries. Solidly built in beautifully finished metal case, with genuine Bakelite top.

**SEND YOUR ORDER NOW**  
Don't blame your set because run down "B" Batteries won't let it work right. Order your Eliminator NOW. Write name and address on a piece of paper, pin a dollar bill to it, and mail it TODAY. Pay postman balance (\$8.95 plus a few cents postage) when he delivers your Eliminator. Use it ten days. If not more than satisfied, return it and get your money back. Roll-O Trickle Charger, for either "A" or "B" Batteries, only \$3.95 (plus few cents postage). Send \$1.00 with order—balance C. O. D. Satisfaction guaranteed or money refunded.  
THE ROLL-O RADIO CO.  
Dept. Q-6 Third and Sycamore, Cincinnati O.

FOR XMAS!

Send "RADIO" for one year

\$2.50

"RADIO"—San Francisco

### INVERSE DUPLEX

(Continued from Page 84)

in one straight line. The magnetic coupling is not the serious thing, though, as it is small compared with the capacity coupling.

The shielding also has a big advantage from an audio standpoint. The grid of the detector tube is practically "floating" as regards audio potentials, it being separated from the filament by a very high impedance grid condenser and resistance. Floating grids are exceedingly sensitive to audio voltages in adjacent circuits. Detectors usually pick up a lot of 60 cycle hum from electric light wires in the house. With the set shielded, this is impossible.

Shielding in an inverse duplex has an additional advantage in the audio circuit. As soon as we incorporated tuned radio frequency trouble was encountered, as the tuning condensers literally hung on the grids of the audio transformers. These large masses of metal on the audio grids act as a source of audio capacity feedback from grid to grid, tending to produce audio whistling. Furthermore, as the operator tuned the middle tuning condenser, bringing his hand near it, he was in reality, touching the grid of the 1st audio tube. This caused a hum as he placed his hand on this tuning control. Shielding all of these units prevents the difficulties mentioned.

Care must be taken, however, not to mount the r.f. apparatus, especially the tuning coils, nearer than 1 in. from the metal shielding. Any closer mounting will reduce the r.f. efficiency and broaden the tuning. It was originally thought that copper was essential but almost any metal may be used, as the advantage gained is not so much an absorption of the magnetic fields as a grounding of the capacity fields. Aluminum has been found to be desirable because of its light weight and freedom from corrosion.

The next article in the series will discuss in detail the design of the r.f. circuit, and the phase angles of the audio circuit.

Storage batteries may be kept indefinitely if they are given a long slow charge, the electrolyte dumped out, distilled water put in, and another slow charge given them, after which they should again be dumped, and distilled water added to the usual height of the acid. When placed in service, dump the water, and add acid of proper gravity, and give a couple of cycles of charge and discharge at the normal rate.

Nitro-cellulose lacquer makes a fine paint for coils requiring distinctive colors and where high insulation value must be had.

In winding coils by hand, a few wire paper clips will often be handy in holding the wire from unwinding when your hands get cramped.

**FREE!**  
This 84 PAGE RADIO BOOK  
SAVE 1/3 to 1/2

**The World's Largest Exclusive Radio Mail Order House**  
will send you—FREE—this wonder catalog of radio bargains containing over 2000 items of everything in RADIO, including all the latest Sets, Kits, and Parts, at rockbottom prices that Save you 1/3 to 1/2.

**5-TUBE SETS AS LOW AS \$24.90**  
**LATEST 1927 MODELS**  
Table and Console models with built-in loud speakers. Beautiful, genuine mahogany and walnut cabinets. All sets at amazingly low prices.

**SEND FOR BOOK TODAY**  
We cannot begin to tell all about this wonderful Radio Book. Simply send letter or postal, and this bargain radio catalog will come to you absolutely free. Write Today.

**RANDOLPH RADIO CORP.**  
180 N. Union Ave., Dept. 94 Chicago, Ill.

# MODERN "B" Compact

*"What a difference it makes!"*

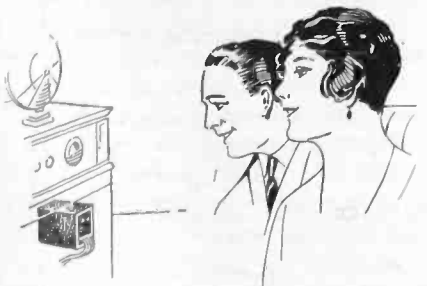

**Y**OU will be astonished to find what greatly improved reception you will get from your present set when you try a Modern "B" Compact.

It furnishes quiet, uniform current that eliminates many battery noises often mistaken for static, connects to your light socket and does away with "B" Batteries.

Ideal for sets up to six tubes including power tube. Has three B+ taps and two variable voltage controls. Complete with Raytheon tube.

**\$30.00**      **\$32.00**

(East of the Rockies)      (West of the Rockies)

If your dealer can't supply you write us direct

The Modern Electric Mfg. Co.  
Toledo, Ohio

MODERN "B" POWER UNIT  
FOR SETS LARGER THAN SIX TUBES  
\$50.00 East of the Rockies

*Constant as Niagara  
Silent as the Sphinx*

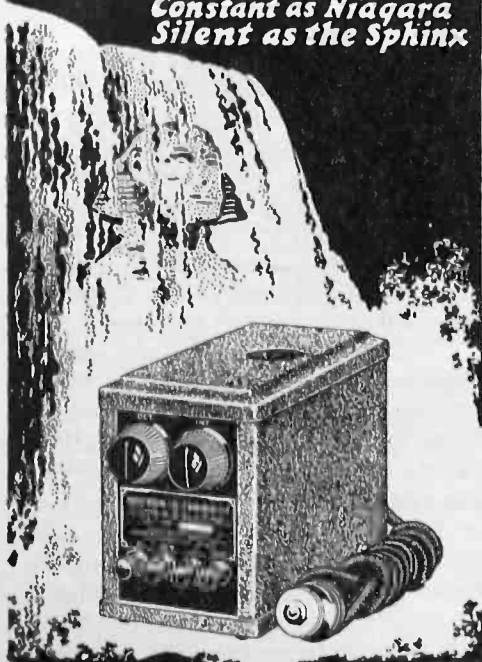

PRECISION  
ARBORPHONE  
PRODUCTS

## ARBORPHONE

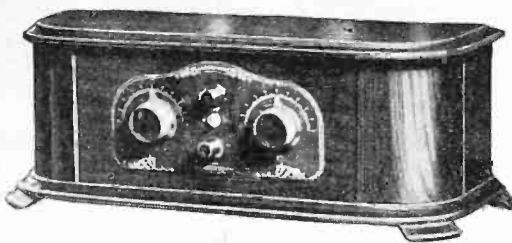

**A** HAPPY blending of Radio's latest advancements with ultra-precision construction methods makes Arborphone the outstanding receiver of the year.

**T**HE strikingly beautiful Arborphone cabinet assures an ever-active market to the franchised Arborphone dealer. Write or wire for information in your territory.

**\$60**



**\$105**

Includes Receiver  
Table and Built-in  
Loud Speaker.

PRECISION PRODUCTS COMPANY

335 South Main Street

Ann Arbor, Michigan

National Factory Representatives  
**SANFORD BROS.**  
30 W. Walton Place  
CHICAGO ILL.

# Hoyt

## PHONE-PLUG MILLIAMMETER

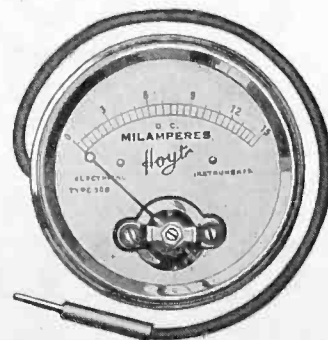

This precision, moving coil instrument is made to plug into the loud speaker lead on your set and enables you to adjust your C-battery bias on the power tube for perfect reproduction. Instantly attached. A necessary accessory if you desire the utmost in quality. Price \$8.50.

### BURTON - ROGERS COMPANY

Boston, Mass.

Sales Department for Hoyt Electrical Instrument Co.



## THE RADIO SEASONS

(Continued from Page 40)

one reneweth his subscription to the great periodical, and putteth on charge the weak battery. The cabinet and set is dusteth, even unto the wiring and the plates of the condenser, and the old grid leak is replaced. It is a time of joy for all for doth not he who hath only a modest blooper rejoice equally with him who owneth a great superheterodyne at the dawn of the new year, when the distance to come knoweth no bounds save the limits of his imagination?

But deepeneth the autumn, and winter is come, bringing gladness to the heart of him who loveth the Hertzian art; even he who hath not tasted the full richness thereof findeth much pleasure and diversion in the increase of his logbook, or his score at radio golf. The fisherman consigneth to mothballs his rod and his tackle, to fish in the vast etheric streams; the huntsman putteth behind him his weapon, for what explosive baggeth the game of the hound of dx? and what line entangleth the wary denizen of the etheric pools?

Now he who loveth the great out-of-doors grieveth not when the storm rageth without and snow barreth the traveller; for seated by the warmth of his own fireplace, he voyageth with incredible swiftness to every clime, and basketh in the warm breeze of the south, though the thermometer beside the door registereth ten below zero. What magic carpet of olden day compareth with his own etheric Pegasus, which requireth no secret charm, but circleth the earth at the touch of a hand?

Even the brasspounder in the newer day campeth not atop the oil stove, nor groweth numb with attic or cellar frigidity; he putteth instead a few drops of the anti-freeze potion into the jars of his rectifier, and attacheth the device of remote control unto the noise-maker; ensconced beside the parlor fire no sound of chattering teeth is heard, but only the soft click of the quick vibroplex. The family no longer raiseth the roof in angry protest, as in days of yore, when the deafening rotary ostracized the ardent ham, for the electrons of the fire-bottle make no sound, nor doth the evening light blink at the drain of the kilowatt "coffin." Many of the fathers of the land, moreover, their offspring in distant college, themselves sit coaxing the last microwatt of energy from a small and feeble '99, for in the long cold evenings even the Heavyside layer freezeth unto such a slippery consistency that the power of a fly glideth in penetrating waves to far climes, and while the radiation meter quivereth not, one's call may be rattling foreign diaphragms. The poor man envieth no longer the rich, when the tiny whisper may outdistance the mighty blast as of a thousand trumpets; and the glory thereof lieth more-

(Continued on Page 90)



**Don't Neglect  
this Vital  
Point  
of  
Contact!**

**A** FEW spare moments, a screw driver, and you have sure, perfect connection between your aerial and lead-in wire. No noise, no soldering, no loss of "distance" due to swinging aerial or corrosion. Tip-Top cannot work loose.

*Jobbers and Dealers, write us!*

**JAMES F. DOOLAN**  
MANUFACTURING CORPORATION  
36-42 West 47th St., New York



## CeCo Type "H" The New Hard Detector

Will give improved reproduction and avoid the usual rushing and hissing sounds of the "soft" detectors.

Using a higher plate voltage than previous types, it will handle powerful signals with less overloading. Average mutual conductance 940. Voltage Amplification factor 14.4.

Price \$2.50

**CECO**

*A Type for Every Radio Need*

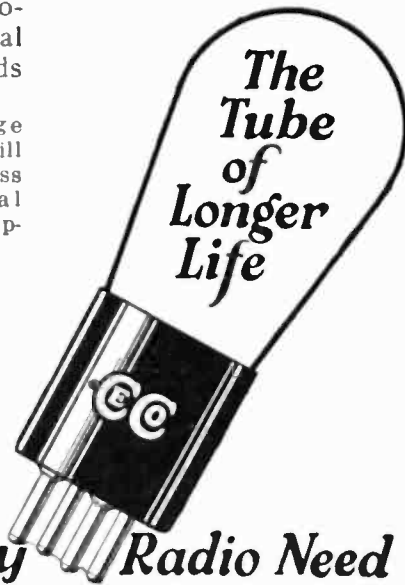

## CARTER Parts

*as usual---are specified in*

## HENRY-LYFORD Circuit

**as in all other really popular circuits**

*In Canada:*  
Carter Radio Co.,  
Limited, Toronto



*Any dealer can  
supply*



**It's Surprising**  
 what a big difference  
 a little thing makes  
**SEE**  
**THAT**  
**SCREW**



A screw-driver  
 adjusts an X-L  
 in crowded  
 places.

**X-L  
 VARIO  
 DENSER**

Results in easier tuning, more distance,  
 volume and clarity—greater stability.  
 Indorsed by leading radio authorities.

MODEL "N"—A slight turn obtains correct tube  
 oscillation on all tuned radio frequency circuits.  
 Neutrodyne, Roberts two tube, Browning-Drake,  
 McMurdo Silver's Knockout, etc., capacity range  
 1.8 to 20 micro-micro farads. Price.....\$1.00

MODEL "G"—With grid clips obtains the proper  
 grid capacity on Cockaday circuits, filter and  
 intermediate frequency tuning in heterodyne and  
 positive grid bias in all sets.

Model G is made in three  
 variable capacities:  
 G-1-.0002 to .0001 MF.  
 G-5-.0001 to .0005 MF.  
 G-10-.0003 to .001 MF.

Price Each With Grid Leak Clips, \$1.50

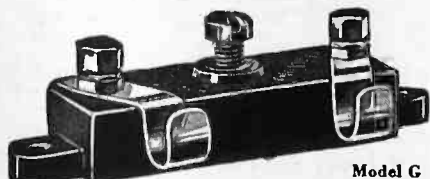

Model G

X-L PUSH POST—Push it down  
 with your thumb, insert wire,  
 remove pressure and wire is  
 firmly held. Releases instantly.  
 Price 15c.

PUSH POST PANEL perman-  
 ently marked in white on black  
 insulating panel. In box includ-  
 ing soldering lugs, raising bush-  
 ings and screws for mounting,  
 etc. Price \$1.50.

Write for details

X-L RADIO LABORATORIES  
 2428 LINCOLN AVENUE, CHICAGO, ILL.

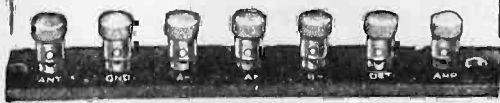

**ELIMINATE ALL BATTERIES**

Run ANY set. ANY number of ANY type  
 tubes from 110 volt A.C. No hum. Easily  
 done with NEW TYPE ELIMINATOR  
 quickly made for few dollars from STAND-  
 ARD parts. No liquids. No salts. NO  
 TRICKLE CHARGER! No battery of any  
 kind. Gives perfect "A" and "B" current  
 in any quantity. Nothing like it. Dollar  
 bill brings detailed blue prints and in-  
 structions that assure perfect results. J.  
 M. MULLEN, Consulting Eng., Lab. C., 6549  
 N. Washitena Ave., Chicago.

**CONE UNIT**

For any cone up to 4-foot size. Gives  
 wonderful tone at any volume. Sold  
 on rigid money-back guarantee.  
 C.O.D. or Prepaid, \$7.50.

**Tunbar Radio Co.**

26 Cortland Street, New York, N. Y.

**AERIAL  
 WIRE**

ENAMELED  
 TINNED COPPER  
 BARE COPPER  
 SOLID  
 STRANDED  
 BRAIDED

**COILS**

MAGNET WINDINGS  
 FOR LOUD SPEAKERS  
 TRANSFORMER AND  
 CHOKE WINDINGS  
 FOR BATTERY  
 CHARGERS  
 AND ELIMINATORS  
 COILS FOR AUDIO  
 TRANSFORMERS

**MAGNET  
 WIRE**

ENAMELED  
 COTTON COVERED  
 SILK COVERED  
 SINGLE OR DOUBLE  
 WHITE OR COLORED



**Dudlo Manufacturing Corporation**

FORT WAYNE, IND.

A. S. LINDSTROM CO.—Western Representative

274 Brannan Street  
 San Francisco

324 N. San Pedro Street  
 Los Angeles

95 Connecticut Street  
 Seattle

146½ N. 10th Street  
 Portland

221 South West Temple  
 Salt Lake City

**The Superunit  
 Phonograph Reproducer**

(Not a loud speaker)



Orthophonic Records on Your  
 Old Victrola—No Static  
 No Interference

The "Superunit" Phonograph Re-  
 producer consists of an electric gener-  
 ator which is used in place of the  
 regular reproducer on the phono-  
 graph. When a record is played, the  
 needle in the reproducer is caused to  
 vibrate, and while no sound is pro-  
 duced, the "Superunit" Reproducer  
 generates an electric current which  
 is an exact replica of the sound  
 waves.

The "Superunit" Phonograph Re-  
 producer is not a carbon microphone.  
 It is capable of reproducing all the  
 audio frequencies, and this may be  
 easily proved by listening to a rec-  
 ord with a pair of head phones con-  
 nected to the Reproducer cord.

The "Superunit" Phonograph Re-  
 producer is hung in such a manner  
 that only a small portion of the  
 weight is supported by the needle.  
 This prevents undue wear of the  
 records.

The "Superunit" Phonograph Re-  
 producer is furnished complete with  
 volume control, mounting screws,  
 attachment cord and instructions.

PRICE, \$16.50

**Hanscom Radio Devices**

Woonsocket, R. I., U. S. A.

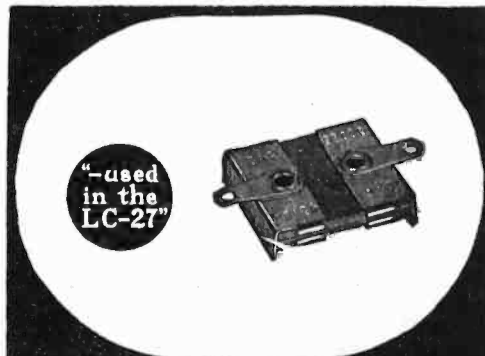

**AEROVOX**  
 "Built Better"

**FIXED  
 CONDENSERS**

are Specified in

LC-27	by L. M. Cockaday
Diamond of the Air	" Herman Bernard
To be announced soon(?)	" John Rider
Raytheon "B" Eliminator	" Raytheon Mfg. Co.
Ultradyn	" R. E. Lacault
To be announced soon(?)	" R. E. Lacault

AEROVOX fixed condensers have been approved  
 by M. I. T. and Yale Universities.

**AEROVOX WIRELESS CORP.**

489-491-493 Broome Street  
 New York

**An Appropriate Xmas Gift**

Send "RADIO" to a friend for one year. \$2.50. It's an all year 'round gift.  
 Treat yourself to a subscription also. Send Xmas orders now.

"RADIO"—Pacific Building, San Francisco

You may have wondered why a Radio Set using the NATIONAL BROWNING-DRAKE TRANSFORMERS performs so exceptionally well.



There are

**2**

reasons for this

1. SLOT-wound Primary
2. SPACE-wound Secondary.

These are the 2 reasons why the

## National Browning-Drake Transformers

are so sensitive and selective. They were developed mathematically by Glenn H. Browning and F. H. Drake after a year of research at Harvard University and are made under Glenn H. Browning's supervision.



The NATIONAL TUNING-UNITS comprise these fine coils and the NATIONAL "Equicycle" condensers (plates developed by Prof. R. F. Field of Harvard University, and Carl A. Hellman of Washington, D. C.)—and the unexcelled NATIONAL VELVET VERNIER DIALS, Type A, Type B, or Type C, the ILLUMINATED DIAL.

Price B D-1 B, \$10.25 B D-2 B, \$13.75  
Inductance Coil and Transformer separate, \$8.50

NATIONAL Radio set essentials may be easily assembled into a modern receiving set—sensitive, selective, easy to operate and easy to listen to. Send for Bulletin 116-R.

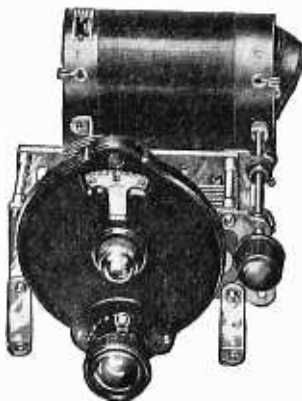

BE SURE YOU GET THE GENUINE

# NATIONAL

RADIO PRODUCTS

NATIONAL CO., INC., Engineers and Manufacturers—W. A. Ready, Pres., Cambridge, Mass.

## RADIO DEALERS

Get the new 1926-27  
Van-Ashe Catalogue---

Shows all the newest parts, circuits and kits—  
all the hard-to-get items that set-builders demand. 12-hour shipments—extra-good discounts. Mail the Coupon.

**Dan-Ashe Radio Co.**

212 North 10th ST. ST. LOUIS, MO.

Name \_\_\_\_\_  
Address \_\_\_\_\_

## RADIO LISTENER'S RED-BOOK

enables you to definitely locate each station on your dials and to reduce the squeals and howls of "hit-or-miss" tuning. It is

### A GUIDE TO BETTER RADIO RECEPTION

Two-page, two-color broadcasting station map gives distance, direction and time divisions. Two-page "Radio Doctor" tells how you can determine and remedy the common troubles of radio sets, batteries, tubes, etc. Complete information regarding each station including new licenses and latest changes listed and cross-indexed three ways.

If not sold by your radio or news dealer, copies mailed post-paid for 25c each, stamps or coin.

**ANDREWS RADIO DIRECTORY AND LOG-BOOK**  
Fl. Wayne, Ind., P.O. Box 158 B

### SAVE MONEY

By Subscribing to "RADIO."

One year \$2.50. Nothing is more appropriate as a Christmas Gift to a friend. Send him "RADIO" for one year.

## THE RADIO SEASONS

(Continued from Page 88)

over less in the card of acknowledgement upon the wall than in the smallness of the milliammeter reading. Yea, verily, is the new day happier for the brass-pounder; no longer do all revile him and persecute him; for when ice and sleet layeth on the ground all telegraph lines, wreaking havoc with all intercourse, then doth the amateur hie himself to radio shack, and unpack the stored B batteries; with his emergency transmitter he sendeth out the sacred call; from all around his fellows answer him, and behold! a network of communication overtops the wintry barrier. Day and night he cheerfully sticketh at his post, that the need of the public be fulfilled, and when the day of trouble passeth, he liveth long in the gratitude of those whom he hath served, and is much loved and revered.

In the radio shack at sea, the operator dozeth comfortably, or, feet upon table, feasteth upon dime novel or magazine of adventure, heeding not the fury of the storm upon the face of the waters. What if the graven tablet upon the old ether-buster describeth the range thereof as but a scant hundred of miles; for but last night, with the grace of all the gods of dx, hath he not cleared traffic with both coasts of the great pond?

As summer bringeth its multitude of tales of fishing prowess, so doth the first snow open the great season of boasting. But whereas the fisherman is of necessity constrained to some semblance of the truth by the very nature of his catch, for the minnow or his creel may not approach the proportions of a whale, the angler for dx knoweth no such limit of his braggings. When weak and unintelligible is the faint carrier wave, the language thereof must necessarily be foreign, else why passeth it his understanding? and he loggeth it as Buenos Ayres. But when one complimenteth him thereupon he disclaimeth all glory, and subtly letteth it be inferred that had not the static been rampant, or the B battery not weak he would indeed have shown the meaning of the word "dx" to the marvelling world. And when he meeteth others of his kind, he heartily agreeth that receiving conditions are rotten, for last winter hath he not logged Pittsburgh nightly? Still, he believeth that, were the tubes new and the battery strong, again might he perform these miracles, and even greater. And he raiseth his voice long and loud, but down in his heart each crediteth not the tall tales of his neighbor, but prideth himself only upon his own mighty works.

For him who toileth in the great marts of trade the winter is the golden time of realization. He who designeth the great masterpieces of radio craftsmanship reapeth his full measure of satisfaction from the eager public, and the manufacturer thereof is buried under a glorious ava-

(Continued on Page 92)





WORKRITE MODEL 16  
Six tube neutrodyne.  
Two dial control, 3 Way  
Switch, Walnut Cabinet.  
Price \$80.00

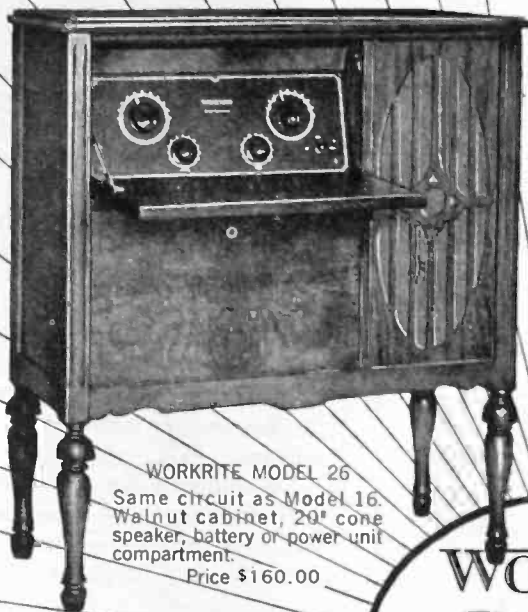

WORKRITE MODEL 26  
Same circuit as Model 16.  
Walnut cabinet, 20" cone  
speaker, battery or power unit  
compartment.  
Price \$160.00

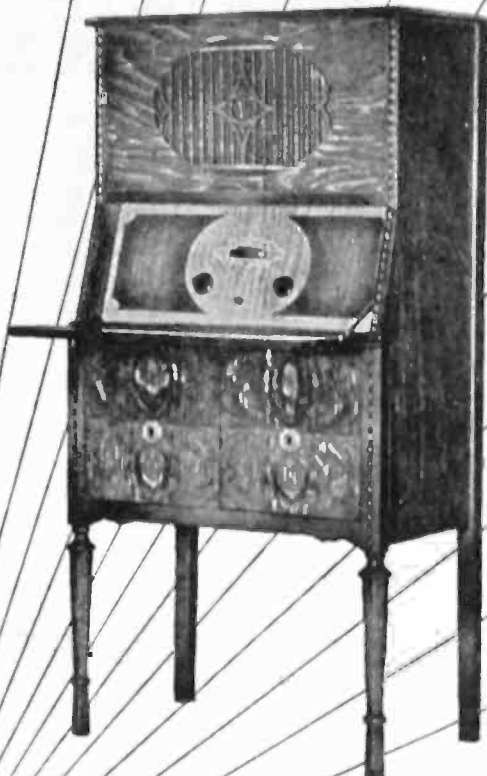

WORKRITE MODEL 36  
Six tube neutrodyne. Two in-  
one dial control, 3 Way Switch  
24" cone speaker, wired for  
power units from lighting  
socket, or batteries. Beautiful  
two tone walnut cabinet.  
Price \$210.00

**WORKRITE**  
**Radios**  
**WORKRITE**

*Performance that pleases —  
reliability that assures profits!*

**Wired for Light  
Socket Power Units**

**Console Models  
have Built-in Cone  
Speakers**

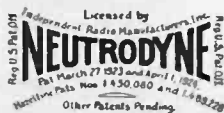

**Dealers**

There is still some exclusive territory available for the distribution of WorkRite Radios. Write today.

When you buy a radio you want a perfected set—one that has been tested time and again until it is as reliable as engineering and mechanical skill can make it. That's the kind of set you can get when you buy a WorkRite Super Neutrodyne Radio.

Seventeen years of manufacturing experience, five of them in radios, are back of WorkRites. High grade materials and competent workmanship assure a reliable standardized set. Each set goes through five different tests before it leaves the factory.

You must see and hear these wonderful WorkRite Radios before you can judge them adequately.

Visit a franchised WorkRite Dealer today.

**The WorkRite Manufacturing Co.**

1837 East 30th St., Cleveland, Ohio.

**WORKRITE**  
SUPER NEUTRODYNE RADIOS

# PERRYMAN P RADIO TUBES

"Distance without Distortion"

## TWINS!

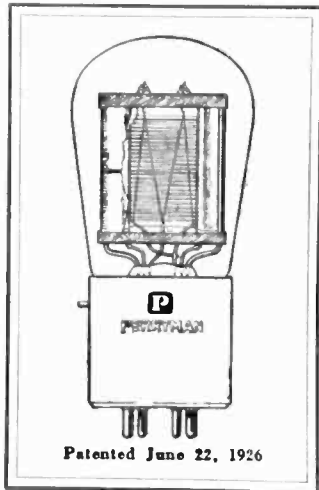

Above is the clear glass demonstrating tube showing the patented Perryman Bridge which holds the elements in place at the distance of greatest efficiency. Ordinary jars or jolts do not affect Perryman Tubes.

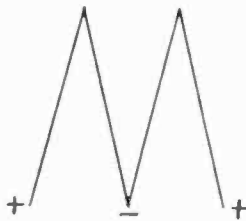

Notice the double filament which distributes the electron emission over the full area of the plate, giving greater capacity without overloading. You get natural tone for the life of the tube and the life of the tube is exceptionally long. The double filament doubles the life of Perryman Tubes.

**I**DENTICAL twins are often so alike that their mothers can't tell them apart. The methods of making Perryman tubes are so scientifically accurate, due to the use of the patented Perryman bridge, that similar tubes are exactly alike in their operating characteristics. If you have grown a little bit tired of shifting tubes from socket to socket trying for the best result, a set of Perryman tubes will be a real relief. Perryman tubes have thoroughly standardized operating habits.

See the Perryman clear glass demonstrating tube at your dealer's. Look at the rigid reinforcements which keep its elements parallel at the point of greatest efficiency.

See the patented double filament. Then listen to a set equipped with Perryman Tubes. That's all we ask.

*The Perryman line consists of detectors, amplifier-detectors, power-amplifiers, super-power amplifiers, full wave and half wave rectifiers listing from \$2.00 to \$9.00. These tubes are made in all types of bases for both storage and dry battery operation.*



The PERRYMAN ELECTRIC CO., Inc.  
33 West 60th Street New York City

Pacific Coast Representative:  
ATLANTIC-PACIFIC AGENCIES CORP., 383 Broadway St., San Francisco



### THE RADIO SEASONS

(Continued from Page 90)

lanche of orders. From the mighty baron of trade to the factory agent in his tiny cubicle, from the great jobber to the humblest retailer, each rejoiceth as he dippeth in the swelling stream of riches. Yet even as the gentle rain from heaven, which falleth alike upon the just and the unjust, so doth the sun of prosperity shine upon the legitimate merchant and the fly-by-nighter. The overflowing horn of plenty spilleth many choice fruits upon the undeserving; for while the worthy commercant garnereth the rich sheaves, the gyp and the cut-throat reapeth also in the plentiful fields. In the columns of the public prints appear side by side tidings of the sale of Punkatrons for sixty-nine mites at Cheet-ham's and of Genutrons for two shekels at Fairdeal's, for he who searcheth after that which is cheap must be served as well as he who knoweth the economy of quality. Yet why should the one of good repute wax wroth at this little speck in garnered fruit? for well he knoweth that during the lean months of the summer only the house builded upon the solid rock of integrity can stand, and the house upon the shifting sand of cut-rate must fall.

So spinneth the busy wheel of time, until the month of blustering winds passeth into April showers. The operator upon the face of the waters first senseth the waning of the season of dx. During the long watches of the night he feeleth the stirrings and rumblings of the static demons; he first perceiveth the little cloud, no bigger than a man's hand, upon the bright horizon of winter. The rumbling swelleth, the cloud spreadeth, the sky is overcast; now the whole ether boileth and seetheth; slowly droppeth the sediment of the turmoil, building a barrier to the feeble signal; the weak carrier wriggleth and is lost in the troubled ether. Now the fan of broadcast heareth a new crackling like unto that of old batteries; he twisteth and twirleth the dials, but yet doth the noise persist; he trieth new combinations, but it availeth him nothing; slowly dwindleth the entry of the logbook. He wondereth regarding the static eliminator so marvelously advertised; he unwrappeth his fishing rod and tackle, and oileth the shotgun; one by one his tribe slippeth away to seashore or mountain-top, till at last deserted is the temple of radio golf. At last even the ham heareth the approach of summer; he groweth ill at ease, and moveth restlessly to and fro in his narrow spectrum; until beneath his window a bird caroleth. He teareth from his calloused ears the faithful Baldies, and hieth himself out into the sunshine. Into the ancient flivver he tosseth the mosquito netting and the sunburn ointment, and is gone at once into the wilderness. In the season of summer doth the tired ether replenish itself. When exhausted is the harvest of dx, the wise radio man

## Amateurs -- Attention!

We will have the Fall Issue of the Citizens' Radio Amateur Call Book off the press late in September. This will be a brand new book—containing the best list of American, Canadian, English and the whole world's listing of amateur stations—right up to date. It will also contain the A. R. R. L. list of official relay stations. This and succeeding issues will be on sale at most stores catering to "Hams." If unable to get one, send 75 cents, United States stamps or coin. If you send check, add 5 cents for exchange. Get your order in early. Last issue was way oversold. Will be mailed postpaid as soon as it is off the press.

### CITIZENS RADIO CALL BOOK

508 SOUTH DEARBORN ST., CHICAGO, ILL.

tilleth not his accustomed fields, but instead alloweth them to lie fallow, to bring forth in the fall a new crop. Thus deserted is the land where formerly millions were heard, and where but lately innumerable cw's peeped, now remain but a few. The faithful brasspounder still keepeth watch over the routes of traffic, but he striveth more for the total of msgs handled than for the thrill of surpassing dx. The night-hawk frolicketh no more, save for the entertainment of his neighbors; the hoarse announcer alloweth his tongue to slip carelessly over the syllables of his erstwhile carefully enunciated call. The dealer retrencheth, and moveth mayhap into the smaller apartment; his space in the newspaper he no longer filleth with loud boastings of his "Remotodyne," but speaketh instead of quality and clearness of speech, and dwelleth upon the B eliminator built into the cabinet of his "Localdyne." The periodical of radio revampeth all old gags for the suppression of static, and its cover displayeth a bathing girl wearing antenna, headphones and set. The engineer in his laboratory alone worketh faithfully during the months of the summer, for now must he profit by the experience of winter, and incorporate the wisdom he hath gained in the model of next year. Thus he laboreth, though his heart yearneth for the cool breezes of the seashore; but when his appointed task is done, he too hasteneth forth into the land of vacation.

**TONER**  
QUALITY  
BEYOND BELIEF  
WITH  
**POWERIZER**

REF.

**Combined "B" Eliminator and Power Amplifier**

POWERIZED radio reception is so true—so faithful, that the radio entertainers are literally transported into your own home. Such remarkable reception up to this time has been offered only in the most expensive new Super-Power sets. Now YOU can have it by merely attaching a Powerizer to your present set, at the cost of a "B" eliminator alone. Ask the nearest Powerizer dealer to demonstrate it TODAY.

**RADIO RECEPTOR CO.**  
106 Seventh Ave. New York

Price  
**\$49.50**



**No Circuit Since the Birth of Radio**

is as nearly perfect, by actual test and comparison with every quality set now on the market, as the new

**HENRY-LYFORD**

**RECEIVER**

Were a manufacturer to build this set, with labor, overhead and selling costs, which of necessity must be added to material, it would easily come within the \$300 class.

**It's the Outstanding Circuit of the Year**

HENRY-LYFORD has been approved and endorsed by magazines and newspapers from California to New York, including Radio News, RADIO, Popular Radio, Radio Mechanics, Radio Age, Radio Review and Citizens Call Book. Read about it in this issue of RADIO.

**HENRY-LYFORD**  
is a plug-in coil receiver with a deliberately **Unbalanced Circuit**

**TUNE IN FROM 37 TO 550 METERS**

You can get even the very short waves with the Henry-Lyford Receiver. Supplied with plug-in coils, you are protected against the most radical change in broadcast wavelengths. Hear the North Pole Expeditions, prominent amateurs, powerful foreign stations, and experimental programs that the ordinary receiver can never get.

**Complete List of Parts**

- 1 Bakelite panel, 7x24, drilled and engraved.
- 1 Bakelite sub-panel, drilled, with 5 Benjamin sockets mounted.
- 2 Precise 350 mmfd. variable condensers, type 845.
- 1 Precise 55 mmfd. variable condenser, type 940.
- 1 Centralab modulator, type 500 M.
- 1 Carter "Imp." filament switch.
- 1 Carter No. 102a jack.
- 1 Carter No. 103 jack.
- 1 University antenna coupling transformer, type B-1.
- 1 University radio frequency transformer, type B-2.
- 1 University tuned radio frequency transformer, type B-3.
- 2 Thordarson Audio Transformers, type R-200.
- 5 Tube Deutschmann 1 mfd. fixed condenser.
- 1 Micamold .002 mfd. permanent condenser.
- 1 Micamold .001 mfd. permanent condenser.
- 3 Amperites, type 112.
- 10 Coil mounting jacks.
- 1 pair of Benjamin brackets, type 8629.
- 1 sub-panel supporting post.
- 2 Eby binding posts marked Ant., Gnd.
- 2 4-in. Kurz Kasch dials, 100 to 1.
- 1 8-wire battery cable.
- 1 coil of Belden hook-up wire.
- 1 complete set of hardware.
- Complete set of parts..... **\$69.50**

If your dealer cannot supply you order direct from us.

University Radio Corp.

Gentlemen:

Please send me booklet describing in detail full particulars of the new HENRY-LYFORD Receiver.

Name.....

Address.....

City & State.....

Dealers and Jobbers Supplied—Write Now.

**University Radio Mfg. Corp.**  
50 Park Place, New York, N. Y.

**HALCO**  
**MAIL ORDER SERVICE**  
For Radio Transmitting Equipment

**EDWAN B. DALLIN** of Couft Laboratory, Harvard College, has developed a Short-Wave Super-Regenerative Receiver which is startling in its performance,—simple and inexpensive to construct, and free from difficulties of operation. Not only code, but VOICE regularly received from the continent. Halco has been appointed sole representative and has a complete kit for this wonderful receiver. Write us for particulars and prices. We sell all standard makes of equipment for hams by mail.

**Halco Mail Order Service**  
132 Hanover St., Boston, Mass.

**Yale GROUND HOG**  
The Perfect Ground  
**DOUBLES POWER AND DISTANCE**

Marvelous newly-invented ground gives incredibly improved reception. Doubles power and distance users say. Reduces leakage. Stops jangling even in mid-summer. Results never before equalled. Satisfaction guaranteed or money back at once. Approved by Highest Radio authorities after exhaustive tests. Proven absolutely essential to clear, powerful distance reception. Draws and holds moisture indefinitely. Highly sensitive to radio energy. **SEND NO MONEY**—To introduce we offer to those who act at once, regular \$5.00 size for only \$2.00. Send name today and pay \$2.00 plus 17c postage on delivery. Or send only \$2.00 with order and save postage. **FREE**—Full description of Ground Hog and details of amazing special offer on request—write today.

**YALE SPECIALTY SUPPLY COMPANY**

139 W 5TH ST., KANSAS CITY

**Build It Yourself**  
Parts Complete \$14.15  
Including Unit



In one evening and for 1/5 retail cost you can build the finest 3 foot Cone Speaker. Marvellous tone quality; every instrument in an entire symphony orchestra is clear, musical and distinct, even the very lowest. And the cost for ALL the parts—2 sheets Alhambra FON-O-TEX, Penn Back Rings, Unit Mountings, special Ambroid Cement and genuine

**Penn Speaker UNIT**

designed especially for 3 foot Cone Speaker —is but \$14.15.

PENN Cone Speaker Unit is adjustable to the audio output of any set. Unit alone, \$9.50.

If your dealer cannot or will not get the parts for you, we will ship on receipt of price. Pamphlet, "How to Build a 3 foot Cone Speaker for \$14.15," sent for 10c., stamps or coin.

**PENN RADIO SALES CO.**  
104 Fifth Ave. Suite 000 New York City  
Exclusive Selling Agents for G. R. Penn Mfg. Co., New York



## COUNTERPHASE POWER SIX

(Continued from Page 36)

ment of the condenser has been obtained.

Now remove the piece of paper from the filament spring and repeat the operation with the second r.f. tube. Be sure to retune both tuning dials before making the final adjustment of the neutralizing condenser, and make sure that the signals remain weak or entirely disappear over a band of one or more turns of the neutralizing condenser before finishing the adjustments.

Replace the filament connection, and repeat the performance with the first r.f. tube, being very careful in adjusting the

**UNIVERSAL**  
Covers every  
**Resistor**  
requirement

noiselss  
one hole  
mount

current  
carrying  
capacity  
**20  
watts**

wherever a  
variable  
resistance  
is  
specified

From  
practically  
0 to  
**500,000  
ohms**

**CLAROSTAT \$2.25**

**I**N practically every well known B eliminator you will find

# CLAROSTAT

functioning effectively as a voltage control. Wherever a variable resistance is specified, play safe—use a Clarostat.

*If you are building a set or eliminator, write for a copy of*

**"THE GATEWAY TO BETTER RADIO,"** a comprehensive manual of 32 pages dealing with the application of the Clarostat in all phases of radio reception, amplification, transmission and battery elimination. It includes complete directions on how to make the good radio receiver better, together with diagrams and descriptions of the latest radio receiving circuits. Complete constructional data is available in this manual on the various types of battery eliminators. This practical radio manual is sold at the low price of 25c to defray printing costs. At your local radio dealer or remit the price in stamps or coin to Dept. R.P.

**American Mechanical Laboratories  
INCORPORATED**  
285-287 No. 6th St., Brooklyn, N. Y.



neutralizing condenser, as the band of silence in this stage is very small, and may be passed over. As soon as the position of reduced volume is heard, replace the tube, and note whether the amplifier can be made to oscillate when 500,000 ohm resistance is entirely cut out of the circuit, with the tuning controls set around 350 meters. If the receiver has been carefully wired, it may be possible to secure slight oscillation at this wavelength, but this is desirable for greatest sensitivity. If no oscillations occur, turn the volume control on full, and rotate the neutralizing condenser of the third r.f. tube by half turns until oscillations occur at 350 meters, and the position of greatest sensitivity is thus obtained.

### LIST OF PARTS

- 1 Bremer-Tully Type TA Torostyle transformer.
- 3 Bremer-Tully Type TC Torostyle Transformers.
- 2 Bremer-Tully Type LD-17 Twin condensers.
- 3 1500 ohm non-inductive resistances.
- 1 500,000 ohm variable resistance.
- 3 Bremer-Tully r. f. chokes.
- 3 Bremer-Tully neutralizing condensers.
- 1 .001 mfd. fixed condenser.
- 1 .00025 mfd. fixed condenser.
- 3 .006 mfd. fixed condensers.
- 2 Audio transformers.
- 2 Vernier dials.
- 2 1 mfd. by-pass condensers.
- 1 2 megohm grid leak—Durham.
- 6 Bremer-Tully cushioned sockets.
- 1 Double circuit jack.
- 1 Single circuit jack.
- 1 Filament switch.
- 1 3 ohm rheostat.
- 6 binding posts or battery cable.
- 2 4½ volt C batteries.
- 1 Micarta panel, 7x24x3/16 in.
- 1 Baseboard 9¾x23½x½ in.

In tuning the set, it will be found necessary to adjust the small trimmer condensers which are mounted on the side of the main tuning condensers. The variation in capacity between circuits is bound to occur, due to differences in wiring capacity as well as the constants of the coils and tuning condensers, so that in order to bring the circuits into exact resonance, small vernier condensers are required. The usual procedure in adjusting the trimmers is to tune in a station to maximum volume on both dials, and then adjust the rear trimmer of each condenser group until the volume is at a maximum. If the volume becomes too great, reduce it by cutting in a part of the 500,000 ohm resistance. After the rear trimmers have once been adjusted, they need not again be touched, and the front trimmers can then be set for maximum volume. Try to get the greatest volume with the front trimmer near its central position, and for fine tuning the trimmer may then be turned either way without going beyond the range of the condenser. If this point of maximum volume does not come with the front trimmer near the central position, change the rear trimmer slightly and try again

Addenda by John C. Tully, Pres.  
Bremer-Tully Mfg. Co.

One feature about radio design which

should be better understood is that it involves a continuous compromise between conflicting factors. One factor cannot be changed without affecting another. The ideal radio set has selectivity, volume, distance-getting ability, tone quality and simplicity in tuning. Omit selectivity and all the other good qualities avail but little. Without tone quality your receiver may be interesting but not a pleasure. Put on more than two tuning dials and you are behind the times.

The thing to do, then, is to design a set with all of the good qualities, each in the maximum degree,—and if it is one for the home-builder it should also be easy to construct and balance. Now any particular one of these essentials is easy to secure,—if you don't insist on the others at the same time also. It's quite easy for example to design a set so selective that head-phones must be used to locate even local stations. Such set might delight the extremist but would have no value for the general public. Furthermore, when selectivity is pushed beyond a certain point "side-bands" are cut off, over-tones lost and the tone is distorted, flat and dull.

Similarly, increasing volume affects tone quality and selectivity, and increasing distance means that greater selectivity is required or the set will pull in more stations than it can separate under present conditions where all parts of the scale are overcrowded with stations operating too close together and some of them in addition much too careless in infringing on each other's territory.

The B-T Power-Six is new only in so far as its adaptation to latest conditions and its employment of latest developments is concerned. Basically it employs the same patented counterphase circuit that has proved its excellence during the past two years.

The easiest set to design and build is one that covers from about 250 meters up, has three tuning dials and will pick up nearby stations, with occasional results from high-power stations at greater distances. The first feeling of satisfaction with such set soon fades as the user begins to realize its shortcomings.

The Power-Six circuit admits of very simple tuning for those who want simplicity. When their knowledge increases they will find at hand the means for satisfying their desires. These provisions in previous models have brought unlimited praise and we predict even greater success for the improvements now available. In our many years of effort we have tried and discarded hundreds of novel ideas in parts and circuits. We believe the Power-Six offers a combination that will give the greatest satisfaction to the home-builder whose greatest pleasure is in building a receiver that will provide lasting satisfaction.

Tell them that you saw it in RADIO

# RADIOADS

A Classified Advertising Section Read by Better Buyers.

The rate per word is eight cents net. Remittance must accompany all advertisements. Include name and address when mentioning words.

Ads for the January Issue Must Reach Us by December Fifth

HOFF'S Radio Trouble Finder explains what to do when radio gets out of order. Contains list broadcasting stations. Postpaid \$1.00 per copy. Information free. Hockmively, Box 373, San Pedro, Calif.

CHOKES for Filter or Speaker Circuit: 5oh., 60ma. \$2.10; Audio Transformers, \$1.00; 275v Transformer from 110, \$2.10. Use two for Raytheon tube. All postpaid. Write for lists of parts. RADIO PARTS SALE CO., Box 24, Orange, N. J.

OLD NUMBERS WANTED. The New York Public Library, 475 Fifth Avenue, New York City, wants to acquire by gift or purchase, Nos. 1 to 5 of Vol. 1, Nos. 8 and 10 of Vol. 2, and Nos. 4 and 5 of Vol. 3 of "RADIO." Any reader willing to dispose of them is invited to write to the library.

GENERAL ELECTRIC 24/1500 volt 233 ampere dynamometers, \$38.00 with shaft extension for either battery or belt drive, Government cost \$92.50. Several hundred in use. Navy SE 1012 receivers range 50-1000 meters new \$45.00. Photos. Henry Kienale, 501 East 84th Street, New York.

SRAGOING OPERATORS—Blueprint of two kilowatt spark converted to ICW and commercial radio traffic manual—only book of its kind in world. Both for one dollar. Howard S. Pyle, 1922 Transportation Building, Chicago. (TC)

MORO CRYSTAL. Guaranteed sensitive. Price, 50 cents. William Ebel, 3448 Hartford S.W., St. Louis, Mo.

DO YOU GET TIRED of buying "B" batteries? A lifetime Edison will solve your troubles. Good, live, large size elements connected with pure nickel wire, electrically welded, 7c pair. All parts for sale. Sample cell and dope sheet, 10c. Paul Mills, Woodburn, Oregon.

TYPE 201A RADIO TUBES, tested, guaranteed, \$1.00 Grayson Radio, 929 Broadway, New York.

MAKE \$100 weekly in spare time. Sell what the public wants—long distance radio receiving sets. Two sales weekly pays \$100 profit. No big investment, no canvassing. Sharpe of Colorado made \$955 in one month. Representatives wanted at once. This plan is sweeping the country—Write today before your county is gone. OZARKA, Inc., 431 N. LaSalle Ave. B, Chicago.

CRYSTAL SETS with crystal complete, 50c, stamps or money order. Nathan Bros., 2036 Polk St., San Francisco, Calif.

RADIO TROUBLES OVER. Hoff's trouble finder locates, explains Remedy, 103 radio ailments. Particular free. Smith, 516 Main, St. John, N. S.

WILL SKILL Rhombic "B" eliminator with new tube for \$15; cost \$25. Crooley 3 tube set, \$12; cost \$25. F. MERK, Rockbridge, Illinois.

## RADIO from Factory to YOU

Get our list price on Parts also Knocked Down 1 and 3 Tube Sets Compare List Price with others then Deduct 20 to 50 per Cent Your Price A. C. HAYDEN CO., Brockton, Mass.

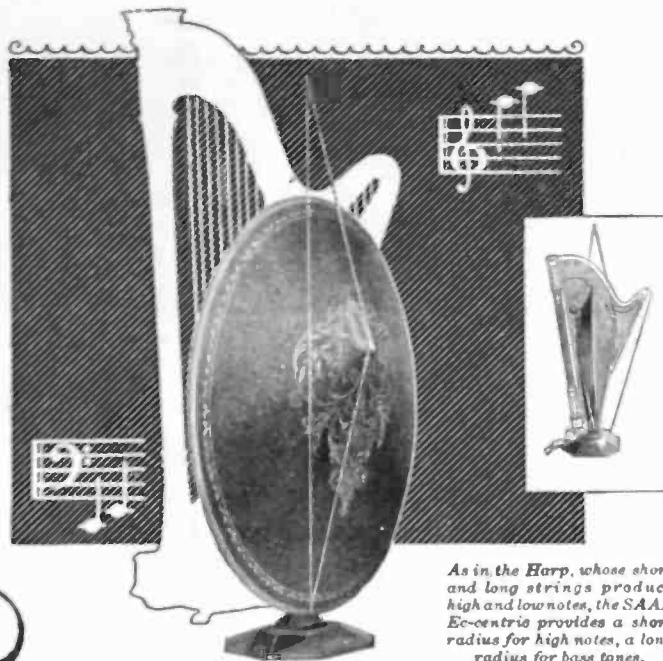

As in the Harp, whose short and long strings produce high and low notes, the SAAL Ec-centric provides a short radius for high notes, a long radius for bass tones.

# Ec-centric

— the new scientific SAAL EC-CENTRIC CONE whose balanced tone color is the sensation in radio today.

Your receiving set may be getting all of the best that's on the air—but are you getting it? You cannot know the capabilities of your radio set, in volume, clarity, beauty of tone till you give it the advantage of the Saal Ec-centric.

On the principle of the harp, whose short strings produce the high treble notes, whose long strings give forth the deep bass tones, the Saal Ec-centric, with its "center" actually off-center, provides a short vibrating radius for the high notes, a long radius for the rich low tones.

These exact relative proportions of vibrating area, definitely fixed by scientific principles, are now provided for the first time in the Saal Ec-centric Cone. All rumble or "barrel tone" is eliminated. True balanced tone from soprano, flute and violin to pipe organ or 'cello. A demonstration will convince you.

Hear the Saal Ec-centric at your dealer's, or write us to direct you where it can be heard.

The Saal Ec-centric comes in two models: 20-inch, \$25; 14-inch Junior, \$15. Slightly more west of Rockies.

H. G. SAAL COMPANY, 1800 Montrose Ave. Chicago, U. S. A.

WORLD FAMOUS MAKERS OF HORNS · CONES · PEDESTALS

# SAAL



The SAAL Pedestal is an ornament to the most beautiful surroundings. Its pure wooden tone chamber, three feet in length, gives exceptionally clear mellow reception. Price, \$39



The famous SAAL Soft Speaker, the outstanding speaker of its type. Is giving satisfaction regardless of the set or equipment used. Standard with radio engineers. Price, \$29.50

Tell them that you saw it in RADIO



# I Will Train You At Home To Fill a Big Pay Radio Job



"I give you all this apparatus so you can learn quickly at home the *Practical Way*"

J.E.S.  
FREE OF EXTRA COST

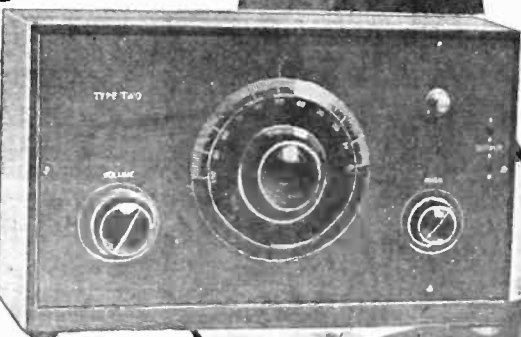

If you're earning a penny less than \$50 a week, clip coupon now. Send for AMAZING FREE BOOK, "Rich Rewards in Radio." Why go along at \$25 or \$35 or \$45 a week, when you could earn \$50 to \$250 in the same six days, as a Radio Expert? Hundreds of N. R. I. trained men are doing it—why can't you?

## Earn \$50 to \$250 a Week—RADIO EXPERTS IN BIG DEMAND

Radio needs trained men. Get into this new live-wire profession of quick success. It's the trained man, the Radio Expert, who gets the big jobs of this profession—paying \$75, \$100, \$200 a week and up. Every day N. R. I. trained men are taking good places in the Radio field—men just like you—their only advantage is TRAINING: You can prepare just as they did, by new practical methods. Our tested clear training makes it easy for you. Big Free Book contains all the proof.

## You Learn Quickly In Spare Time

So sure am I that I can train you successfully for a better future in this new Big-Pay profession, that I guarantee your training with a money-back bond. Lack of experience or education won't hold you back—common schooling all you need to start. You can stay home, hold your job, and learn quickly and pleasantly in your spare time. My practical, helpful methods enable you to start RIGHT AWAY toward one of the bigger Radio jobs paying \$50 to \$250 a week. No delay, no losing time from work—no scrimping or scraping to get your training.



**Operates WMAQ**  
"Accepted a position with the Chicago Daily News Station WMAQ. MY INCOME PRACTICALLY DOUBLED, thanks to you. I handle all consultation, also do operating. Your course taught me not only the theoretical but also the practical knowledge that makes my work easy for me." Keith Kimball, Station WMAQ, Chicago, Ill.

## You Get All of This

All instruments shown here and others sent to all my students free of extra cost under short time special offer. Clip coupon now—find out all about this big unequalled offer while you still have time to take advantage of it. This training is intensely practical—these instruments help you do the practical work. You learn workmanship and get added confidence in your ability.



### World Famous Training That "Pays for Itself"

My Radio course World-Famous as the training that "pays for itself." Make more money QUICK when you take up this practical course. Work on millions of antennae, receiving sets, offers you big chance to make spare time cash while you're learning. I'll show you how—teach you the latest "dope," furnish you with business cards, show you how to get the business and make it pay. My students don't wait a year to increase their income—they report QUICK INCREASES as a result of this course—often two or three weeks after starting.

Howard Luce, Friedens, Pa. made \$320 in 7 weeks during spare time. D. H. Sult Newport, Ark., writes, "While taking the course I earned in spare time work about \$900." Earl Wright, Omaha, reports making \$400 in a short time while taking course—working at Radio in spare time! Sylvester Senso, Kaukauna, Wis., made \$500. These records not unusual—these men a few of hundreds.

### Your Satisfaction Guaranteed

We who know the results this practical tested training gets—the increased earnings it has brought to men everywhere—stand behind it all the way with a signed guarantee bond that we give you when you enroll. On completion if you're not entirely satisfied in every way, you get back every cent you've paid us. No strings to this offer—you yourself are the only judge. Get started today! It's your big chance for one of the bigger Radio jobs—mail coupon NOW for my Big FREE BOOK and proof! No obligation.

## Get This FREE BOOK

Most amazing book on Radio ever written—full of facts and pictures—tells all about the great new Radio field, how we prepare you and help you start. You can do what others have done—GET THIS BOOK. Send coupon today—no obligation.

J. E. SMITH, President  
NATIONAL RADIO INSTITUTE  
Dept. PV9, Washington, D. C.

### \$70 In One Day For T. M. Wilcox

"I am in business for myself and RECENTLY MADE \$70 in ONE DAY. I was an electrician of rich experience, occupying a splendid position as telephone superintendent when I enrolled with you believing it would open up greater opportunities—have not been disappointed. Estimate Radio will be worth tens of thousands of dollars to me in next few years." T. M. Wilcox, Belle Island, Newfoundland.

## EMPLOYMENT SERVICE TO ALL GRADUATES

Originators of Radio Home-Study Training



**MAIL THIS COUPON TODAY**  
J. E. SMITH, President  
NATIONAL RADIO INSTITUTE  
Dept. PV9, Washington, D. C.  
Dear Mr. Smith—Without obligating me in any way, send me your free book, "Rich Rewards in Radio," and all information about your practical, home-study Radio Course.

Name..... Age.....  
Street Address.....  
Town..... State.....



# A Brief Study of AUDIO AMPLIFICATION



**Type 285**

## Audio Transformers

Under average conditions two stages of audio amplification are necessary to produce the desired loudspeaker volume.

Usually a combination of 1 to 2.7 and 1 to 6 ratio transformers proves most satisfactory, with the high ratio preferably in the last stage.

The new General Radio Type 285-D transformer has a ratio of 1 to 2.7 and has been designed specifically for use in the first stage of audio amplification following the new type 200A detector tube. Because of its high input impedance, it produces very noticeably better tone quality than is possible with other transformers having a lower input impedance.

This transformer is particularly adapted, therefore, to use in the first stage of audio amplification and gives excellent results in the second stage as well.

		Price
Type 285	1 to 6	\$6.00
Type 285-D	1 to 2.7	6.00
Type 285-L	1 to 2	6.00

**I**N THE design of any amplifying device for use at audio frequencies, it should be kept in mind that the curve of voltage amplification against frequency should approximate as closely as possible a horizontal line, if true tone quality is to be preserved in the process of intensifying the audible notes.

Since the purpose of amplification is to effect a considerable increase in volume, the curve representing the character of amplification should be as high as possible as well as a straight line running in a horizontal direction.

While it is a comparatively simple task to design a transformer to have a high and even amplification curve over any narrow frequency band, it is considerably more difficult to maintain the same degree of amplification at very low and very high frequencies as in the middle of the range.

In order that a transformer may function efficiently at low frequencies, its input impedance must be high—several times the plate impedance of the tube at 100 cycles. This is accomplished in the General Radio Type 285 transformers by means of a core of large cross-section of high permeability steel and a primary coil of many turns. Proper coil design, avoiding excessive coil capacity and magnetic leakage prevents loss of notes above the middle register.

Careful laboratory measurements of all General Radio Type 285 Audio Transformers show a high and comparatively flat curve over practically the entire section of the audio range covered by the human voice and musical instruments.

It will be remembered by radio experimenters whose interest in the science dates back to the early days of broadcasting, that in 1917 the General Radio Company brought out the first closed core transformer to be sold commercially. This instrument was the type 166. It established a new and higher standard of audio frequency transformer design. Since that time the subject of amplification has been exhaustively studied in the laboratories of the General Radio Company with the result that transformer design has been constantly improved and today the General Radio Company is universally recognized as an outstanding manufacturer of quality transformers.

Ask your dealer or write for Catalog 925 containing full descriptions of all General Radio Parts.

**GENERAL RADIO CO., Cambridge, Mass.**



**Type 369**

## Coupling Impedance

While the greater amplification that is obtained by a transformer coupled amplifier has much in its favor, slightly better quality can sometimes be obtained by the use of impedance coupling, if one is willing to dispense with the greater amplification per stage of transformer coupled amplification.

The impedance method of coupling is considerably more efficient than the use of resistances because it allows a much larger proportion of the plate voltage to be impressed on the plate of the amplifier tube.

By using a choke of sufficiently high inductance a quality of reproduction may be obtained, which can not be distinguished from that obtained by the use of resistances and a larger amplification per stage produced.

Type 369 Coupling Impedance—Price \$5.00 each

# GENERAL RADIO

## PARTS AND ACCESSORIES





look  
inside  
that Christmas Radio Set

**T**HE equipment is as important as the set. The distance reach of a set depends a great deal on the tube in the detector socket. The over-all performance of a set depends very much on the tubes in every socket. The volume and tone quality you will get are dependent upon the tube in the last audio stage. In every point, the tubes are as important as the set. And everyone who realizes this insists on genuine RCA Radiotrons.

The research laboratories of RCA, General Electric and Westinghouse have developed Radiotrons to new accomplishment, year by year. And the manufacturing skill of these same companies keeps RCA Radiotrons far in the lead in accurate making.

*Be sure, when you buy a Christmas radio set, that you are getting genuine RCA Radiotrons with it. You can tell by the RCA mark inside the glass at the top. Or take out the tube, and look at its base.*



**Extra! Extra!  
Gift Ideas  
for Radio fans**

A "spare" Radiotron—genuine RCA Radiotron, of course—of the type he uses.

A *power* Radiotron UX-112, UX-171 or UX-210 for bigger volume and finer tone.

A special *detector* Radiotron UX-200-A for storage battery sets—for longer distance reach.

Ask any dealer all about these Radiotrons—he'll tell you which to get. But be sure it's a genuine RCA Radiotron, if it's to be worthy of gift giving.

RADIO CORPORATION  
OF AMERICA  
New York Chicago  
San Francisco

# RCA Radiotron

MADE BY THE MAKERS OF THE RADIOLA