

JULY 1923

25 Cents

RADIO



“This is a
RADIO
SUMMER”

In this issue--

*Special
Summertime
Radio
Features*

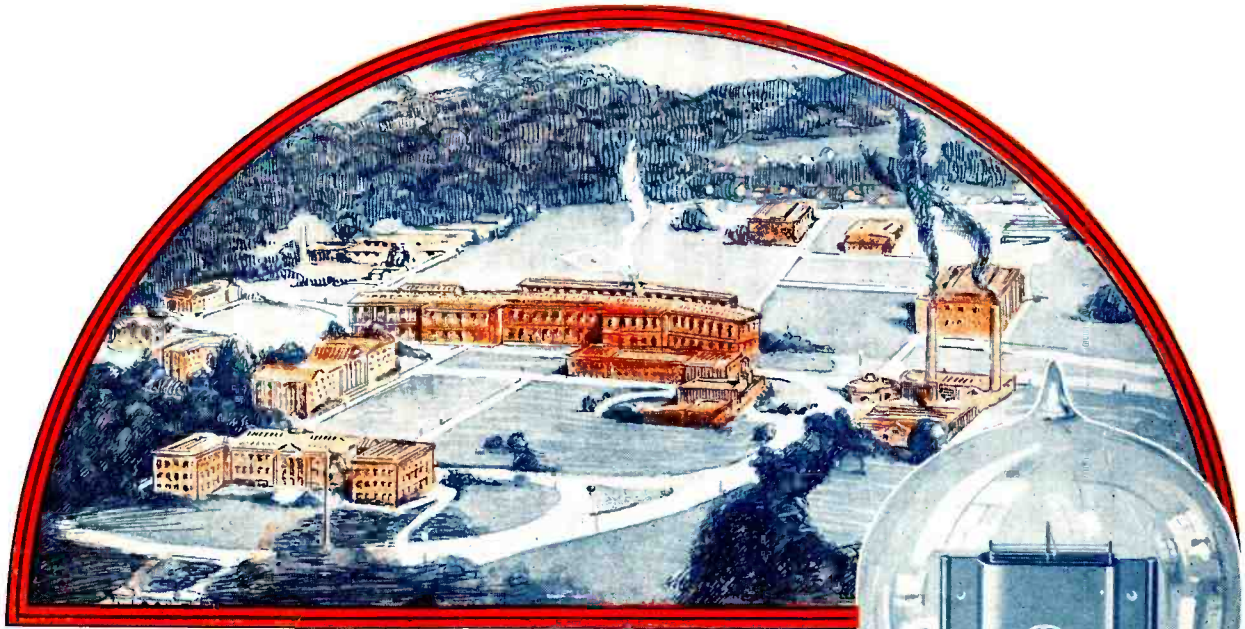

One of the World's Largest Manufacturers with unlimited resources Builds Cunningham Tubes

FORTY-THREE years ago the carbon filament electric lamp, at that time considered the finest development in the electrical art, came into general use.

The important and ever-growing demand resulted in the building and expansion of mighty factories, and the improvement of factory methods, until today the tungsten filament gas-filled lamp yields eight times the candle power for the same electric input.

In recent years these same highly skilled manufacturers have been devoting a part of their factories, and applying their engineering talent gained through years of experience, to the production of vacuum tubes.

The new Cunningham type C-301-A, Amplifier and Detector represents a combination of these years of manufacturing experience, and the engineering ability contributed by that great scientific organization, the Research Laboratory of the General Electric Company.

The low filament current of only one-fourth of an ampere and the extremely high mutual conductance of 700 micro-mhos, make the C-301-A the most efficient vacuum tube ever built for amateur and entertainment use in radio.

Patent Notice: *Cunningham tubes are covered by patents dated 11-7-05, 1-15-07, 2-18-08, and others issued and pending. Licensed for amateur, experimental and entertainment use in radio communication. Any other use will be an infringement.*



*A Specially
Designed Tube
For Every
Radio Use*

A. J. Cunningham Inc.

Home Office:
248 First Street
San Francisco, Calif.

Eastern representative:
Chicago, Illinois

RADIO

Established 1917 as Pacific Radio News

Volume V for JULY, 1923 Number 7

CONTENTS for JULY, 1923

Radiatorial Comment	9
Broadcasting And Its Future	10
By PROF. C. M. JANSKY	
A Peanut Tube Single Circuit Set	11
By D. B. MCGOWN	
An Adjustable Selective Receiver	13
By SAMUEL G. McMEEN	
Technique of DX Reception	14
By CARL DREHER	
A Cheap, Selective Crystal Outfit	15
By LAWRENCE B. EMMONS	
High Frequency Resistance	16
By L. R. FELDER	
How To Make A 48-Volt B Storage Battery	18
By C. R. EVANS	
The Lighthouse Dry Battery Receiver	19
By S. R. WINTERS	
Far Into The Night	20
By JACK BRONT	
The House That Jack Built	20
By PAUL FRANKLIN JIMSON	
Jimson The Great	21
By EARL ENNIS	
Single or Three Circuit	23
By A. P. KING	
Filtering Sink Rectifiers	24
By DR. A. E. BANKS	
A Portable "Super" For Broadcast Receiving	25
By L. W. CURTIS	
Easily Made Capacities	26
By CARLOS S. MUNDT	
Radio Frequency Measurements With A Wheatstone Bridge.....	27
By BERNARD STEINMETZ	
An Old Dog Learns A New Trick	30
By S. P. WRIGHT	
A Better Receiving Set For The Expert	31
By ARTHUR L. MUNZIG (Six Zee Jay)	
Building A Wooden Antenna Tower	32
By W. G. GROSS	
Reduction of Resistance By Use Of A Counterpoise	33
By MAURICE BUCHBINDER	
Queries and Replies on C. W. Practice	35
By G. M. BEST	
News of the Broadcasters	37
With The Amateur Operators	39
Letters To The Editor	38
Calls Heard	41
New Apparatus and Supplies	42

RADIO is Published Monthly by the Pacific Radio Publishing Co., Inc., Pacific Building, San Francisco, Calif.

ARTHUR H. HALLORAN	Editor
LAWRENCE MOTT	Associate Editor
LOUIS TREVISIO	Art Editor
GERALD M. BEST	Technical Adviser
O. SCHUWENDT	Engineering Draughtsman
H. W. DICKOW	Advertising Manager

Branch Offices: 17 West 42nd St., New York City, Telephone Longacre 8248; 157E. Ontario St., Chicago; 761 Spitzer Bldg., Toledo, Ohio; 52 Irving Street, Boston, Telephone Copley 5107-R; 1102 Republic Bldg., Kansas City, Mo.; Suite 511, 456 So. Spring St., Los Angeles, Cal., Telephone 12050; 2218 Third W., Seattle, Wash., Telephone Elliot 1903.

European Representatives: Compagnie Universelle De Representation wt de Commerce. Rue des Fortifications, 69, Anvers, Belgium.

Advertising Forms Close on the First of the Month Preceding Date of Issue.

Issued Monthly, 25c a copy. Subscription price \$2.50 per year in the U. S., \$3.00 per year elsewhere. Instructions for change of address should be sent to the publisher two weeks before the date they are to go into effect. Both old and new addresses must always be given.

Entered as second-class matter at the Post Office at San Francisco, Calif., under the Act of March 3, 1879.

Copyright 1923, by the Pacific Radio Publishing Co., Inc.

Forecast of Contributions for August Issue

A Simplified Reinartz set employing but two controls is illustrated and described by M. B. Sleeper. The details are complete enough to enable any amateur to secure as good results as does the author.

Bernard Steinmetz discusses resonance phenomena and the distribution of energy in simple language. Its practical application in eliminating interference is pointed out.

"The Toth Circuit" by Bert T. Bonaventure is a well-deserved "dig" at the multiplicity of new miracle circuits that are being announced. This is a fine satire.

Samuel G. McMeen describes the construction of an exclusive broadcast receiver (exclusive because selection of the broadcast band of wavelengths only).

An idea for stirring up interest and enthusiasm at the first fall meeting of the radio club is cleverly told by S. P. Wright in his account of radio tag. It is well worth playing.

Edward T. Jones, whose experience as a radio supervisor and as a radio editor has given him a broad understanding of the subject, gives a practical story on the effects of fading.

The transmitting amateur will be interested in "The Effects of Poor Insulation and Leakage" by A. Reisner. Guarding against the losses, he explains, will increase the range of any set.

As an introduction to the method to be used in building a receiving set, Florian J. Fox tells of the preliminary factors to be considered in general design. He also gives specific directions for making a two-stage a.f. amplifier.

The further adventures of Jimson the Great will be detailed by Earl Ennis, who introduces this character in this issue. He learns how to operate a radio set, but the knowledge does not seem to give him the power that his ignorance first brought him. "Jimson's Coup" will make you laugh. In the humorous fiction line also "Scratchi" takes a fling at the Hoot Owls.

In accordance with the policy of showing the industrial applications of radio principles to non-radio uses space is devoted to an article by L. R. Felder on a d.c. circuit breaker. The radio engineering of today is the electrical engineering of tomorrow.

Jesse Marsten, whose articles on the simplified theory of radio have been a feature of recent issues, presents a practical article on an exceptional single circuit, non-regenerative tube set for broadcast reception.

Why relatively broad tuning of a receiving set gives less sound distortion than a more selective receiver is admirably told by A. Machson in an article on "The Principles of Radio Telephony." In the same article is an exceptionally clear explanation of what is meant by modulation. Jerome Snyder, in "Selectivity and Its Applications to Reception" also discusses these factors.

Arthur Munzig (Six Zee Jay) describes a portable receiver for DX Code, employing the house wiring as an aerial and a.c. current for filament lighting.

“Allow the ear to hear
what it likes,
the eye to see
what it likes.”

Kuan-Yi-Wu.

The Grebe Receiver

delights both
ear and eye,
For the ear enjoys
the eye good music,
beautiful
craftsmanship.



GREBE RADIO

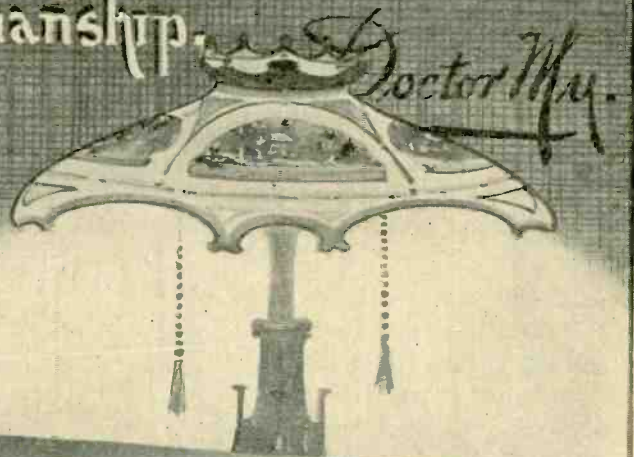

Doctor Mu.

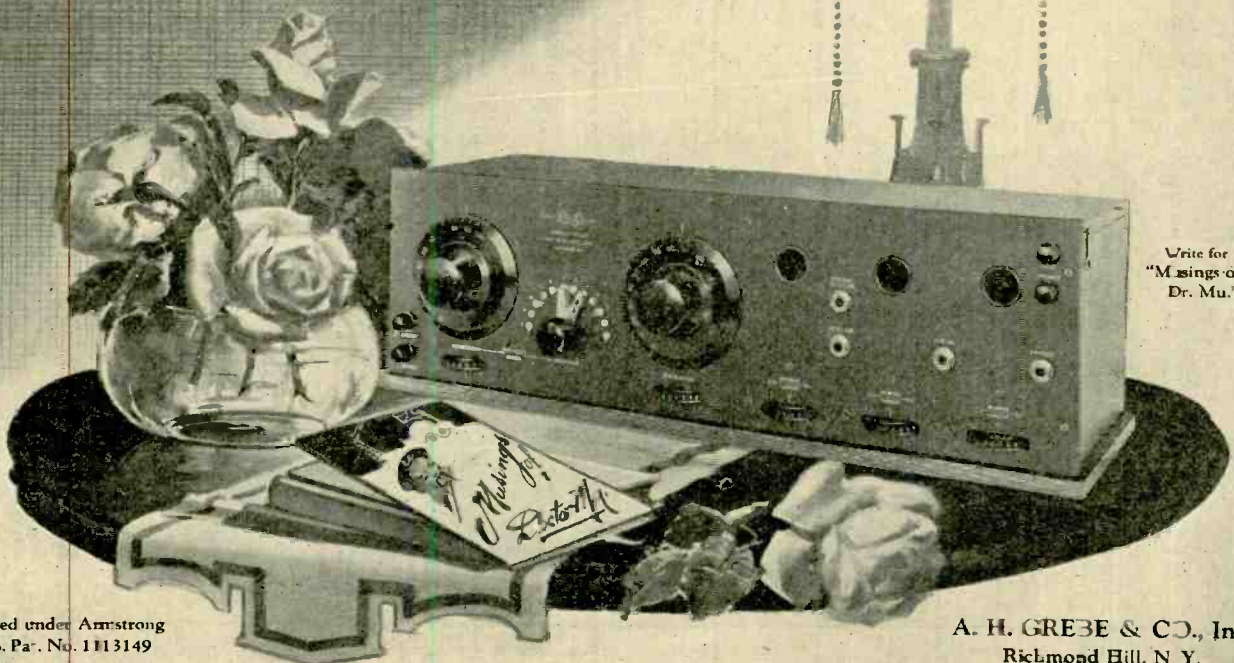

Write for
“Masings o
Dr. Mu.”

Licensed under Armstrong
U. S. Pat. No. 1113149

A. H. GREBE & CO., Inc.
Richmond Hill, N. Y.

Using the MAGNAVOX

IT is the Magnavox owner who gets the utmost service from Radio.

While the Radio enthusiast constantly strives to better his receiving equipment, Magnavox Reproducers and Power Amplifiers are units which no other apparatus can replace.

The only correct principles of sound reproduction and amplification are embodied in Magnavox construction.

Magnavox Reproducers and Power Amplifiers can be used with any receiving set of good quality. Without Magnavox, no receiving set is complete.

Magnavox R2 Reproducer and 2 stage Power Amplifier (as illustrated)
\$115.00

R2 Magnavox Reproducer with 18-inch curvex horn: the utmost in amplifying power; requires only .6 of an ampere for the field \$60.00

R3 Magnavox Reproducer with 14-inch curvex horn: ideal for homes, offices, etc. . . . \$35.00

Model C Magnavox Power Amplifier insures getting the largest possible power input for your Magnavox Reproducer.

AC-2-C, 2-stage, \$55.00
AC-3-C, 3-stage, \$75.00



*Helping to Keep the
"Stay-at-Homes" happy.*



RADIO has banished that dull, lonely evening idea once and for all—the "stay-at-home" nowadays can choose his own brand of entertainment from a number of programs practically every hour.

But a Radio set is only as good as its reproducer—make sure you have the Magnavox (electro-dynamic) Reproducer Supreme.

Magnavox products can be had of good dealers everywhere. Send for copy of unusual booklet.

The Magnavox Co., Oakland, California
New York: 370 Seventh Avenue

MAGNAVOX
Radio
The Reproducer Supreme

JUST OUT!

The Latest Edition of **CITIZEN'S RADIO CALL BOOK**

180 Pages. Only 50 Cents Per Copy

CITIZENS

RADIO CALL BOOK

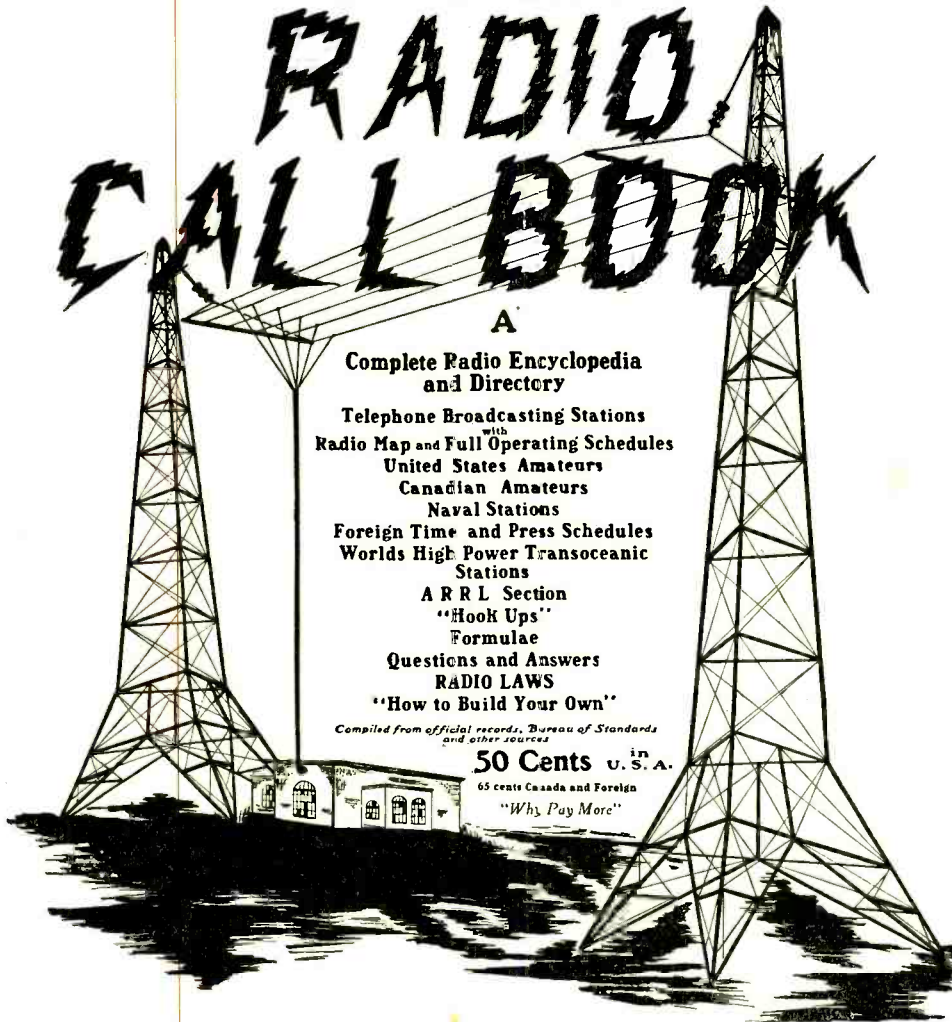

A
Complete Radio Encyclopedia and Directory
Telephone Broadcasting Stations
Radio Map and Full Operating Schedules
United States Amateurs
Canadian Amateurs
Naval Stations
Foreign Time and Press Schedules
Worlds High Power Transoceanic Stations
A R R L Section
"Hook Ups"
Formulae
Questions and Answers
RADIO LAWS
"How to Build Your Own"

Compiled from official records, Bureau of Standards and other sources

50 Cents U.S.A.

65 cents Canada and Foreign

"Why Pay More"

CONTENTS

The Nine Amateur Districts, Special Amateur and Experimental Stations. All practical wireless circuits. Schematic diagrams of these and a glossary or description of the working of the circuits. There are also full page graphic illustrations and photographs of the Flewelling circuit, the Reinartz and Armstrong double regenerative circuits.

A complete list of all Telephone Broadcasting Stations with their full operating schedules. These are also listed alphabetically by States. A complete 4 page American Radio Relay League section, containing a letter to the Citizen-Radio, by Mr. Kenneth B. Warner. A double page A. R. R. L. divisional map. A page giving the personnel of the Executive and Operation Divisions throughout the country.

A complete list of all Canadian Amateurs and Canadian Telephone Broadcasting Stations with their schedules.

A double page Radiophone Map of the United States, with all stations marked on the map, drawn to scale.

A double page map of the world, with all high powered stations marked. A Complete Schedule over 24 hours' time (Greenwich) of all high power stations, time they send, system they employ, wave length and character of the matter they send.

A Complete Federal Market Broadcasting schedule, by state, town and information on matter they broadcast.

International Continental Code and Conventional "Q" Signals.

Trap Circuits.

Up-to-date Radio laws, Amateur and Commercial.

Hook Ups.

Formulae for the Amateur and Experimenter. A wonderful Question and Answer Department, very complete.

The Circuit section contains both Receiving and Transmitting diagrams. The Transmitting end of this covers the best of the Amateur hook-ups on short wave transmission, C. W., I.C.W., and Voice.

The book contains 176 pages and cover printed in two colors.

Amateurs---Broadcast Listeners---you need this wonderful radio book. Send 50c. for your copy today. Supply almost exhausted!

DEALERS: Write for Trade Prices

CITIZENS RADIO SERVICE BUREAU,
 Dept. R, 416 South Dearborn St.,
 Chicago, Ills.

Herewith is 50 cents for which you will immediately send me the latest CITIZENS RADIO CALL BOOK.

Name.....

Address.....



A Good Head Set

Should be a part of your radio equipment

Clear reception with plenty of volume is necessary to satisfactorily listen to distant stations.

Kellogg head sets should not be classed as ordinary radio receivers. Today Kellogg stands foremost in the manufacture of a high-grade head set that actually surprises listeners in comparative tests.

Maximum volume, unusual clearness, extreme lightness in weight, are a few of the many outstanding advantages. The head band is unusually light, though durably built. The receivers are easily adjusted to fit the head, and can be detached from the holders when desired.

The magnets are of special tested steel and hardened by our own special method which controls the heat and time electrically and mechanically, eliminating any possible variation as when manually controlled.

The magnet windings are of great accuracy, the mountings, end plates, wire, insulation, etc. are of the highest grade and of the best material suited for the purpose.

Our twenty-five years experience in building receivers for telephone work has proven invaluable in turning out a real radio receiver of merit.

Hundreds of voluntary testimonial letters tell us of the superiority of Kellogg head sets in actual comparative tests, barring none.

Listen-in tonight with a pair of Kellogg receivers and get a new thrill from your radio set. Kellogg radio products are all in a class by themselves from a quality, service and appearance standpoint. With Kellogg radio equipment, USE Is The Test.

KELLOGG SWITCHBOARD & SUPPLY COMPANY
CHICAGO

COLUMBUS

KANSAS CITY

SAN FRANCISCO

PORTLAND

Kellogg apparatus exclusively is used in building The Symphony Receiver

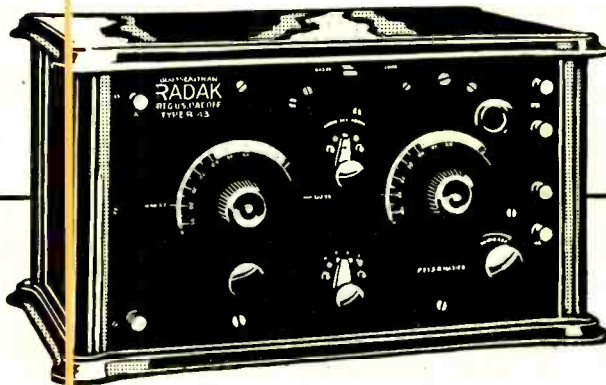

Radak

Is Insulated with Formica

THE Radak radio equipment manufactured by Clapp-Eastham of Cambridge, Mass., and sold everywhere is made with Formica panels and other Formica insulating parts.

This well-known line has genuine prestige in the radio industry. It is sold and known everywhere — and its endorsement of Formica is a matter of moment to every dealer and amateur.

The judgment of Clapp-Eastham Engineers in selecting Formica is supported by practically all the leading independent radio concerns, who likewise use it.

Formica is the best looking, the most uniform, the most efficient laminated phenolic material for radio uses.

DEALERS: The Formica Insulation Company supports you with responsive and helpful service and the most aggressive advertising and sales campaign in the industry. Formica dealers can supply you promptly with panels in all standard sizes. They can also supply special sizes when you want them.

THE FORMICA INSULATION COMPANY

4616 Spring Grove Ave.
Cincinnati, Ohio

SALES OFFICES

50 Church Street... New York, N. Y.
422 First Avenue... Pittsburgh, Pa.
1042 Granite Bldg., Rochester, N. Y.
415 Ohio Building... Toledo, Ohio

1210 Arch Street... Philadelphia, Pa.
1819 Lyndale Ave., S. Minneapolis, Minn.
Sheldon Building... San Francisco, Cal.
Whitney Central Bldg... New Orleans, La.

414 Finance Bldg... Cleveland, Ohio
9 South Clinton Street... Chicago, Ill.
313 Title Building... Baltimore, Md.
47 King Street... Toronto, Ontario

FORMICA

Made from Anhydrous Redmanol Resins
SHEETS TUBES RODS

Tell them that you saw it in RADIO

Get Long Range with RCA radio- frequency transformers



Model UV-1714
\$6.50

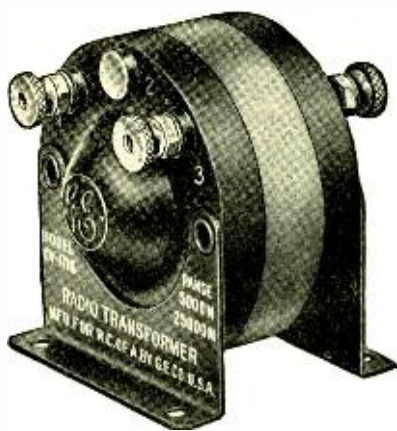

Model UV-1716
\$8.50

—To make a small inside loop reach as far as an outside antenna.

—To increase tremendously the range of an outdoor aerial without distortion.

To amplify singly or in cascade; complete shielding prevents interaction of fields.

—To cover a broad band of wave lengths and pick up stations of every class.

*Particularly Adapted for Use
with RCA Radiotron Tubes*

Insist on RCA audio and radio-frequency transformers at your dealer.



*This symbol of quality
is your protection.*

Radio Corporation of America

Sales Dept. Suite 2069
233 Broadway
New York

District Sales Offices
10 So. LaSalle Street Chicago, Illinois
433 California Street San Francisco, California

Radiotorial Comment

IN applications of science, as in all the other activities of life, each worker begins with what has been furnished by those who have gone before. Nothing is originated entire, however novel the thing may seem. Closely scrutinized, every invention is an improvement and not a thing wholly new. There is nothing to regret in this, for all we have a right to ask is constant improvement, and one day we shall arrive at a state of affairs better worth having, though they are rather good as they are.

As we listen to radio broadcasting we sometimes experience a momentary thrill of gratitude to those pioneers who have made possible one more agency of luxury and ease, and it is just as well to grasp those moments as they pass, before the new art achieves the commonplace acceptance we accord to all the other marvels that come before it. Let us occasionally call the roll of the "blazers of the way," the "seekers of the priceless fleece, the Truth," who have worked in darkness and in silence, mostly, and often in the midst of a hostile world.

The fame of Isaac Newton rests principally on his finding of the laws of gravitation, but even his own great work thereon could not have been done with the systems of mathematics that he found ready to his hand. Before his work could be brought to completion he had to invent a mathematics of variables, which the world of thinkers had lacked since the world began. While Newton made no explorations of the realm of radio, he did furnish one of the intellectual tools for the work of Maxwell, who first showed the possibility of creating and using longer waves than those of light and set the minds of men in the groove leading to the radio we know and use today.

So accumulates the debt one generation owes to all that have gone before.

SAMUEL G. MCMEEEN.

THE group of the Nation's Fathers—meaning Congress—is on the longest vacation that it has known in many years. As a result, much legislation was "ditched" in the last frenzied moment! And among other bills that were left out in the cold was the badly-needed White-Kellogg radio measure. No one seems to know particularly WHY! Rumors of certain "political activities" are rife—etc. All of these to no end—however!

The fact remains that nothing was accomplished, and this forced the Secretary of Commerce, with the advice of the Commissioner of Navigation, and other radio authorities, to devise such temporary ways and means as would best alleviate a condition of the air that was fast becoming an infernal chaos.

A certain official, high in Government Service, but whose name I am asked not to publish—writes in part—as follows:

I have read your letter and fully appreciate the interest that you have taken in this service. You understand, of course, that it is too late to help us during the present session of Congress. At the same time an article by you will

no doubt cause interest in the service and make it clear to the public the handicap under which we are endeavoring to operate, and will create a friendly interest in the service which will be helpful later on. The men throughout the country who come in direct contact with our Inspection Force, know the truth as you do, but the great mass now using radio have but little realization of the scope of the work our small force is expected to perform, and the limited funds at our disposal. Had the Radio Bill passed, there would probably have been an opportunity to get an increased appropriation because of the increased duties involved in the new law. But the failure of the Bill removes this opportunity. Undoubtedly a bill similar to the last will be introduced in the next Congress and I hope that the PUBLIC INTEREST—the capitals are ours)—"will be so manifest that it may have an early consideration."

The point that we wish to make is that a very great deal of the present confusion and chaos would be eliminated were there a much larger staff of inspectors and assistants! To obtain them more funds are needed—of course! And we also urge *better salaries* for the Government employees in the Radio Service! It cannot be expected that highly competent men—and only such would be worth the having!—could be induced to serve at the present scale of salaries! (We do not mean to cast aspersions at the very fine body of patriotic men, now serving—be it understood). But when it is considered that such firms as The Radio Corporation of America, *et al.*, pay double and treble that which the Government offers—it will easily be seen why capable men do not race—*madly*—in search of a Radio Inspector's billet! Furthermore: at far greater salaries, men that are employed by private business enterprise have far less actual work *and* far less responsibilities!

It is to be hoped that the next Radio Bill to be introduced will carry *ample* license fees—on a graduated scale—beginning with the broadcasting stations—down to receivers, the fees on the latter to be added to the cost of the apparatus, by the manufacturers, and then turned in to the Government, with their other taxes. It is ridiculous for the vast body-aggregate of the nation's radio enthusiasts to incessantly growl about air conditions, interference, and so forth—*ad nauseam*—and yet apathetically do nothing to better the situation!

When Congress re-convenes why not show a *very real* spirit of interestedness in the Radio Bill that will then be introduced? Why not push it? Why not inform your Senators and Congressmen that you want effective radio legislation?

The American radio public may rest assured that in the persons of the Secretary of Commerce, and the Commissioner of Navigation it has two eminently capable officials, whose one aim is to clarify the air conditions, and to give satisfaction to all! In the meantime let radio operators heed the temporary arrangements—as to wavelengths, etc—that have been instituted—to the end that a semblance, at least, of order may maintain. —MAJOR LAWRENCE MOTT.

Broadcasting and Its Future

By Prof. C. M. Jansky

While one man's guess may be as good as another's with regard to the future of broadcasting, yet the opinion of a recognized authority like Prof. Jansky carries great weight. As professor of electrical engineering at the University of Wisconsin and as a member of the National Radio Conference, he has the facts upon which to base his analysis. His opinion, as here expressed, is of great interest and value.

WHEN the wave of radio popularity was at its peak many agencies struggled to be first in the field to broadcast, and some of these now feel like the man who caught the bull by the tail—they cannot let go. With these the question of importance is whether to broadcast or not to broadcast. That such a contingency confronted many who thoughtlessly, or from a purely commercial instinct, entered upon this expensive pastime, was evident to anyone who gave some consideration to the possibilities of radio and its probable greatest field of usefulness to humanity. Radio broadcasting is merely another means of communication which must ultimately find its place among the existing systems. This place will perhaps be better understood if the changes in communicating systems be briefly considered.

The message concerning the victory on the plains of Marathon was carried to Athens by a fleet runner. Likewise, Caesar transmitted his laconic dispatch, "I came, I saw, I conquered" by messenger. Perhaps, "We have met the enemy and they are ours" was conveyed to Washington by courier. The message announcing Lee's surrender to Grant was transmitted by telegraph, while the signing of the Armistice in the late world war was made known the world over by radio. Thus from 490 B.C. to 1900 A.D., or for 24 centuries, messages originating at one source were conveyed either by messenger or wire and delivered to some other particular place, and not until the last five or ten years has it been possible to have a message or signal originating at one place be spread, or be broadcasted, in all directions and be detected at almost any place on a hemisphere.

Many improvements have been made in the means of communication from the time the first beacon fires were lighted to signal the presence or movement of either friend or foe. New means of communication were devised, but the one common attribute of all efficient systems, until now, was the directed or directional characteristic. That is, communication over distances exceeding the range of the human voice was always conveyed along predetermined channels and received at designated or selected stations only. The feature that distinguishes radio communication from all other systems is dispersion, scattering, or broadcasting of the message. Instead of directing the message along a pre-

determined and definite channel to a predetermined station, the message is cast into space, scattered in every direction, and may be detected by any suitably-equipped station. It is this distinguishing feature of radio communication that, in my judgment, will ultimately determine its place among communicating systems. No one need fear that means of communication used in the past are going to be displaced by radio. These will continue to serve, but a new agency of human intercourse has suddenly come into use and its ultimate contribution to human welfare is still a matter of prophecy. Right here let me remark that the agencies which have contributed most to the advancement of civilization are those of communication. The invention of the alphabet, the greatest invention of the human mind, was nothing more than an agency for the preservation or recording of thought and later communicating it to others, thus linking the past with the present and the present with the future and making continuous progress possible.

As man's means of communication improved, his mental horizon expanded and civilization advanced. Radio makes possible still further advancement as it too widens man's mental vision bringing him into immediate contact, not with the past, but with the remote present thus opening a new world to his ken. Man, in regions remote from his fellow beings and in regions remote from civilizing and educational forces, is by means of radio brought within the compass of these forces and thus becomes an active and participating member of the human family. The activities and doings of others become of more intimate concern to him as well as his do to them. Avenues of information and education are opened up so that matters of immediate and vital import are made accessible to those hitherto denied them. The source of the usefulness of radio communication is, therefore, not in its similarity to other means but to its difference, and this difference is well characterized by the term broadcasting.

The problem of broadcasting contains three elements that will undoubtedly shape its future development. The first of these is the expense associated with the installation and operation of a broadcasting station.

Many stations have been installed for the same reason that manufacturers of cigars, fabrics, etc., are attempting to

copyright the name of old King Tut, i.e., advertising. The value of broadcasting for such purposes has only a temporary value and this value is hardly commensurate with the expense of installation and operation. Manufacturers of radio apparatus, of course, receive compensation for the large and continuous outlay through the stimulation that broadcasting gives to the sale of radio apparatus. These manufacturing companies are in a sense obligated to supply the demand for broadcasting, which they have created and stimulated. But the appetite they have thus created grows with what it feeds upon, continuously demanding something new and more stimulating. Thus is introduced the second element which is even more profoundly affecting broadcasting, namely, suitable material to be broadcasted.

Many broadcasting stations started out at a pace which was certain to leave them gasping within a short time. This is confessed by Mr. William H. Easton who recently said, "after a manager has staged three or four different events every night for a year or so, he finds that he is milling around in a circle. His programs have become monotonous even in their extreme variety, and real novelties are almost unattainable." If the large company represented by Mr. Easton is already experiencing difficulty in meeting the demands of the public, what must be the experiences of the smaller concerns, whose sole object in broadcasting is advertising. This difficulty to find suitable material for broadcasting when coupled with the stand of lyceum bureaus and other booking agencies prohibiting the broadcasting of performances by their artists will soon limit the musical programs to reproductions by a phonograph with which broadcasting started. This, of course, will not hold any radio audiences. Even this will be precarious if the plans of publishers and distributors of copyrighted music are carried into effect. They propose to collect a royalty from every broadcasting station that uses any of their material, and their representatives even went so far as to ask the Department of Commerce to act as their collection agency by refusing a license to any broadcasting station which had not paid the royalty demanded. There are many other things that may be broadcasted besides music. But no matter what the program, to continually hold

Continued on page 50

A Peanut Tube Single Circuit Set

By D. B. McGown

Here are the directions for making a satisfactory portable set which can be carried where wires do not go, far from the madding crowd. It comprises tuner, detector, and one-step amplifier.

THE WD-11 vacuum tube is admirably adapted for use in a receiving set of ordinary construction and design, provided the proper steps are taken to alter the filament circuit to that required for the tube. The set described herein was designed for the purpose of installation at a location remote from any source of electric current, and all

to any radio stations which might interfere, or if he lives along the sea-coast, or in any other place where there is liable to be interference from nearby spark sets. This set will not tune such

apparatus out, and it cannot, generally, be made to do so. If the user lives fifty miles, or more from a source of interference, he will not be troubled with much extraneous interference, save from

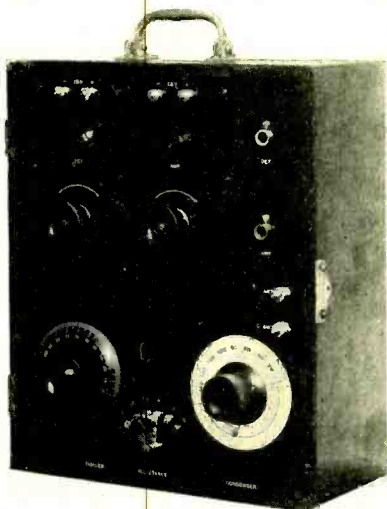

Fig. 3. Front View of Completed Set

the "juice" available had to be carried there inside of batteries. Storage batteries were bulky and heavy, and required frequent charging, so it was decided to use the smaller tubes.

The set is a common "single circuit" affair, and as the place of use was remote from all local interference, this circuit was considered to be selective enough for the purpose, which proved to be correct in actual use. The reader is advised not to attempt the use of a set of this type if he lives in close proximity

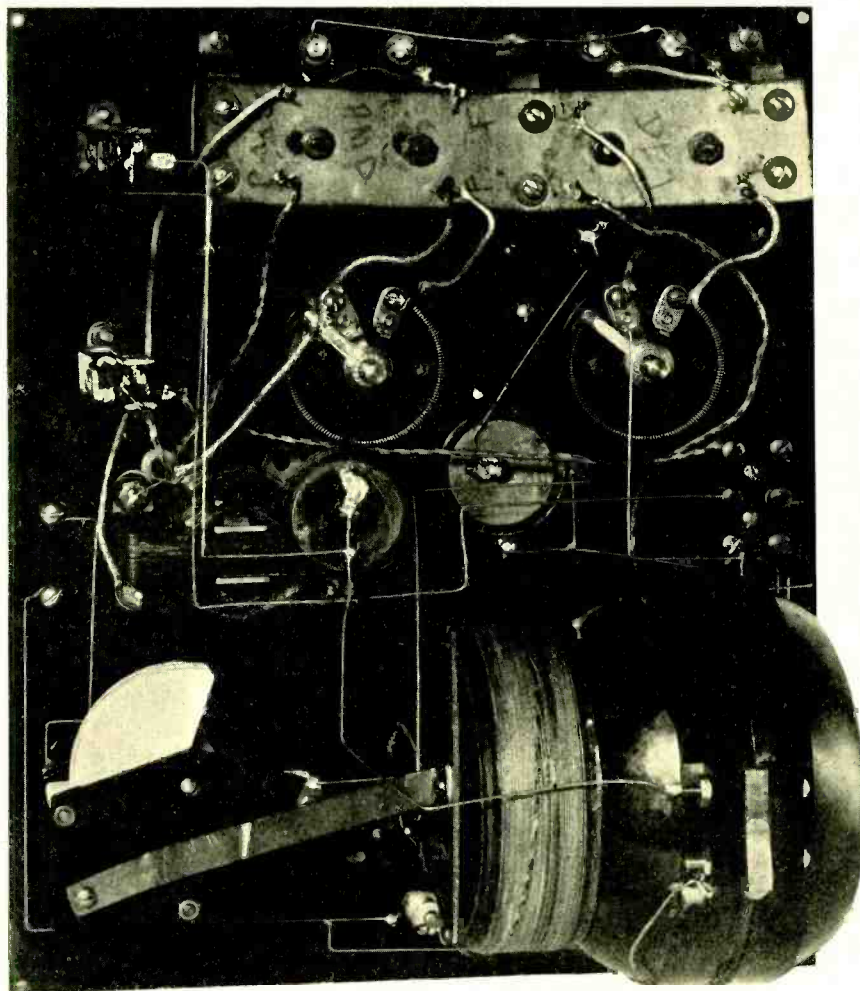

Fig. 4. Rear View of Completed Set

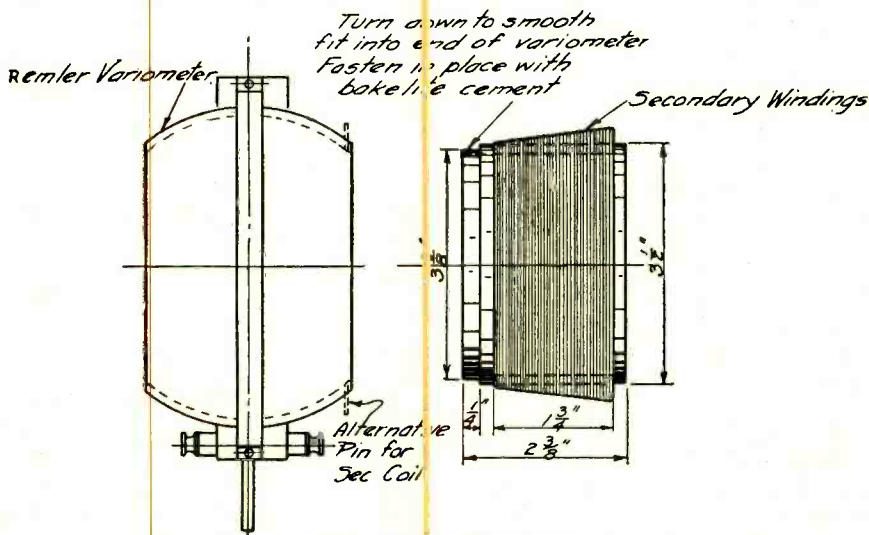

Fig. 1. Modified Variometer

ship stations on 450 meters (soon to be reduced).

The circuit used in this set is the so-called "CR-5" circuit, after the type brought out by the Grebe people. Here we have a Remler variometer, with a small cylindrical loading coil fastened to the end (Fig. 1). This coil is wound with 25 turns, double banked, from the variometer end and 60 more turns, double banked, from tap 25.

The stator of the variometer is disconnected from the rotor, and wire unwound from one side, until only 15 turns are left (only advisable if the writer wishes to get down to 200 meters, or below), and the other half of the stator is left as it is wound by the maker, which will be about 32 turns. The end of this is connected to

the start of the 25 turns, and leads are led off to the switch, in all cases, as shown in the diagram, Fig. 2. Two blank switch points and a double-lever switch are provided, so that the unused coils can be shorted out, to remove their "dead-end" effect by detuning them. Care should be taken to wind and connect the cylindrical coil so that it will form a continuation of the variometer stator, as this is absolutely necessary, or the two windings will oppose each other, and practically nullify themselves. If inconvenient to bank wind the cylindrical coil, the same number of turns, layer wound can be used, with almost the same results. The writer made this coil of bakelite tubing, and the winding was of No. 24 D.C.C. wire, held in place with collodion.

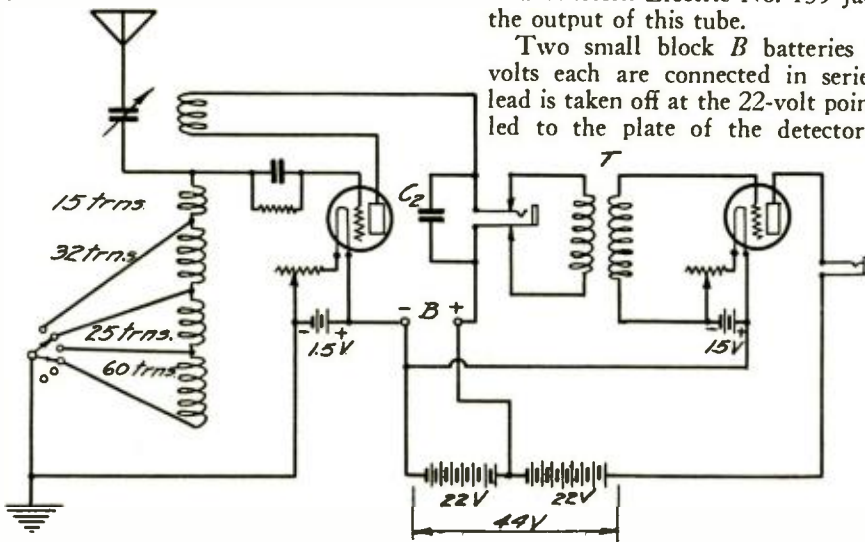

Fig. 2. Circuit Diagram

The grid condenser, C_1 , is an ordinary .00025 mfd. mica condenser, and is shunted by a 2 megohm grid-leak, L , Fig. 2. The plate of the tube is connected directly to the rotor of the variometer, which acts as a "tickler" coil, and feeds-back between the grid and plate circuit so the tube will oscillate, provided the coupling is set at the proper point. From the plate, through the tickler, the current goes to the detector output jack, which is shunted by condenser C_2 , which is of approximately .004 mfd. capacity, and which serves as a by-pass for the radio-frequency flowing in this particular circuit. Care should be taken in obtaining a large enough condenser, as if it is too small the set will not oscillate, or if it does, it will oscillate very feebly, and erratically. This particular is a point often lost sight of in construction of an oscillating set, and many sets refuse to oscillate, to the disgust of their builder, just because they have insufficient capacity across the high impedance of the telephone or output circuit.

The author used a Western Electric No. 160 jack for the detector output. When the plug is inserted the primary of the transformer T is disconnected entirely from the circuit. When the

plug is removed, this transformer is again connected, with its primary across the output of the tube. This transformer may be of any standard make, although some special types now on the market are said to be designed especially for the WD-11 tubes, and might be best to use. The author used a standard "Westrad" transformer for this purpose.

The secondary circuit of the input transformer is connected to the grid and filament posts of the tube, as indicated in Fig. 2. The rheostat should be connected as shown, as this will permit the impressing of some negative potential on the grid, due to the drop in voltage across the resistance. The plate circuit of the amplifier tube is connected to a Western Electric No. 159 jack, for the output of this tube.

Two small block B batteries of 22 volts each are connected in series. A lead is taken off at the 22-volt point, and led to the plate of the detector tube,

while the full 45 volts is impressed on the amplifier bulb. Connection blocks are provided for the terminals. The B batteries are carried inside the case.

The WD-11 tubes, being designed to operate on low voltage filament supply, are lighted from ordinary dry-cell batteries, and it is advisable to use separate batteries for each tube, as shown in Fig. 2. If at hand, single-cell storage batteries may be used, and it will be found that these will give more reliable service than the dry cells, if the set is to be used very much, as dry cells are adapted only for intermittent operation. On the other hand, flash-light batteries may be used if it is desired to make the set more portable, and each cell of this type will last several hours, and may be thrown away when exhausted without serious loss.

Ordinary rheostats were used to control the filament current, of approximately 6 ohms resistance. The WD-11 tubes are said to be designed for 1.5 volts, but the addition of a rheostat allows the current to be cut down, and the tube's life lengthened very considerably thereby, as when new batteries are connected in circuit they will supply more current than is needed for the optimum operation of the tubes.

Tube sockets were used, of common commercial design, and both were mounted on a strip of soft rubber packing. This prevents any shocks or jars from reaching the tubes, and aids in preventing breakage, but what is more important, it precludes entirely the possibility of "microphonic" noise, i.e. internal noise in the tube, due to the jarring of the elements when the whole tube structure is subjected to shocks and jolts. This rubber strip is held to the rear of the panel by brass supports, the sockets being mounted in the rear of the panel, the tubes being inserted therein through holes drilled in the panel.

Standard head-telephones were used. The writer happened to have a pair of Baldwins on hand. Any other sensitive receivers would serve as well.

As shown and designed, only a single stage of audio frequency amplification was used, as it was desired only to receive the signals through a head-set. If a loud-speaker is to be used, it would be necessary to use another stage of amplification, to get sufficient volume to operate a loud-talker up to an efficient point. If loud signals are desired, it would be much better to use the single stage of audio frequency amplification, as shown, and then use a standard type of amplifier, and loud-speaker, such as are being offered by several makers, and which are especially designed for this class of service.

Almost any antenna will serve for this set, if it is not too large. A large antenna is a regular static and interference collector, and will bring in more extraneous noise than signals, in many cases. A single wire, of any size strong enough to hold up over the span will answer, and may be of any convenient length up to 75 or 100 ft. long. A greater length will be less useful than a shorter one, and a total length of only 35 or 40 ft. will often serve as well as a longer one. The ground is connected to the conventional water-pipe, in most cases, but if none is available, a simple counterpoise may be used. This may consist of a single wire, either suspended on porcelain knobs on stakes a few inches above the earth, or a length of rubber-covered insulated wire of the same length, may be stretched out right below the antenna, the open end being covered with tape for insulation. In very dry country quite good results may be obtained if two wires of equal length are laid along the ground in a straight line, the receiving set being connected to the two ends at the middle. In any case, it should be borne in mind that a small antenna is preferable to a large one, if any selectivity at all is to be obtained, although, as previously stated, this type of set is not, and does not pretend to be very selective.

An Adjustably Selective Receiver

By Samuel G. McMeen

Selectivity and simplicity in combination are unusual. But when a man of Mr. McMeen's standing says that this tuner of his gives it you can depend upon its being so. Furthermore it is efficient. So what more can you want?

EVERY radio worker, from the transmitting amateur to the novice broadcast listener, feels something of the urge to cover distance, and to add items to his log of stations heard. The comparison of the results in miles and relative audibility has an entertaining quality of the order of a long drive at golf or a long hard shot at a rapidly receding duck.

This entertainment, however, has its difficulties, in the frequent encountering of stations right on the wavelength of a station sought, and the singling out of the station one is pursuing is not the easiest task. Any expedient, therefore, that will help to exclude what is not wanted and that offers means of varying all the coupling dimensions, has its usefulness in such a phase of the art.

Interfering stations can be avoided to a considerable degree by increasing the separation between the primary and secondary windings of a three-coil receiver, and the sensitiveness of the set to weak signals can be increased by decreasing that separation. For these reasons it is desirable to experiment with combinations of parts that permits of those variations. Such ability exists in the three-coil combination possible with honeycomb coils in the three unit mounting. In this form, however, the inductive relation between the tickler and the secondary coil is not as intimate as in the form in which the former rotates within the latter, as shown in the accompanying sketch. Such a rig can be conveniently assembled from a variocoupler type of variable inductance. The variocoupler needs more turns than are usually found in such devices as sold in the market, but the market type can be rewound with little labor, or the whole device can be made in a little time.

To cover the range of wavelengths from 200 to and including 800 meters there should be 80 turns on the secondary coil, which is the stator of the variocoupler, and these turns should be tapped at the 20th, 40th and 60th. These three taps, with the 80th turn, are taken to switch points for the convenient selection of the portions. It is to be noted that the dead turns, when fewer than the whole 80 are in use, will be at the bottom of the coil as it is shown in the sketch, and that the turns that are always active are those that are closest to the honeycomb coil. This is intentional and essential. The honeycomb coil, in other words, shall be placed on the side of the secondary that leads directly to the grid of the tube.

The rotor winding is of 50 turns, and, like the stator winding, may well be of No. 26 wire, or even of No. 28, if the space requires that small a diameter to accommodate the number of turns. The winding of the rotor is connected in series with the plate, the telephones and the B battery. The latter shall be of the voltage required by the particular tube used, though it will be in the neighborhood of 22 volts, most likely.

The honeycomb coil will be of 25, 35 or 50 turns, depending on the wavelength. For 200 meters, 25 turns; for 360 and 400 meters, 35 turns; for everything higher, 50 turns. For most purposes, therefore, the 25 and 35 turn coils will be all that are needed.

trically close, preferably attached directly to that post, which in most cases is feasible. The reason for this necessity is that the energy which reaches the grid is exquisitely feeble, unless stages of amplification precede the detector, and at the frequencies of 800,000 to 1,500,000 cycles per second the opportunity of loss through capacitance between the grid lead and other conductors is ample to make the losses apparent in operation.

The simplicity of this arrangement should not be allowed to mislead anyone to think that it is not efficient. It is on the contrary a most useful type, and is capable of long distance reception and the highest selectivity. By varying

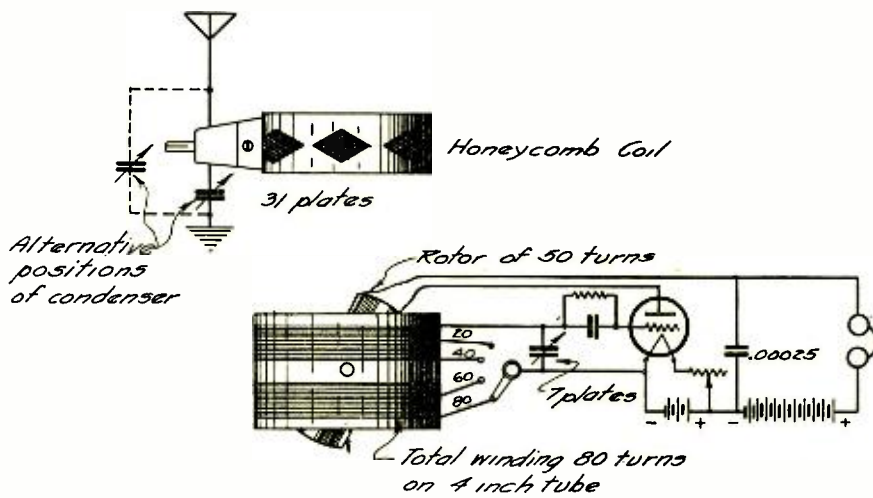

Hookup for Adjustably Selective Receiver

The condensers are two; that for the primary circuit is of 31 plates and that for the secondary is of 7 plates. The primary condenser is in series with its coil and the secondary is in parallel with its. If a stage of radio frequency amplification is to be installed ahead of the set at any time, then the primary condenser must be changed to be in parallel with its winding, but this is easily done when the need arises. The type of radio frequency amplification referred to as requiring this change is that which we described in the March issue of RADIO. The alternative connection in such a case is that shown in dotted lines, and with its use the condenser shown in solid lines is to be omitted, and the wire containing it made continuous.

The grid condenser may well be of .00025 capacity, and the grid leak two megohms. As in all other types of receivers, the grid condenser should be located as close to the grid post of the tube socket as possible—that is, elec-

the distance between the honeycomb coil and the secondary winding stations that are operating on *nominally* the same wavelength have been separated with it, an accomplishment that will be found to be beyond many receivers of greater cost and complication.

What has been described is of course only one variant of the general class of regenerative circuits to which it belongs. The reader will see a number of possible similar arrangements of parts carrying out the principle. It is feasible to use a variometer with a honeycomb coil, placing the latter at the side of the variometer so that the turns of the stator will be parallel with those of the honeycomb coil. The only drawback to full range in this case is in the absence of taps on the stator of the variometer. This can be compensated for in some degree by the choice of the secondary condenser, choosing one that has a maximum capacitance great enough to reach the desired wavelength. In this form it

Technique of D. X. Reception

By Carl Dreher

Herein are given helpful hints and remedies for eliminating extraneous noises that interfere with d.x. work. Suggestions are also given whereby the careful operator may secure greater distance than the careless one. The conclusion is that it is the operator rather than the instrument that determines the range of a receiving set.

IT is not the object of this article to describe any particular set suitable for long range reception, nor to recommend any of the various types of sets, such as regenerative receivers with audio frequency amplification, or radio frequency amplifiers, or the superheterodyne, which are found in use. Every type of receiving set, in the hands of some experimenters, seems to give extraordinary results, while other individuals, using identical apparatus, get only mediocre effects. The difference, apparently, is in the handling of the set, and sometimes in external factors such as locality. Obviously if one is going in for the delicate business of distance reception the first requisite is a decently designed set, but the discussion here will be confined to the factor of skill in operation, together with certain less controllable factors which the DX man is forced to take into account.

Freedom from Interference

Nothing is more conducive to unusual records in reception than a quiet receiving field, to use a term adapted from optics. Just as when one wants to inspect a small object under the microscope it is necessary to place it on a perfectly clean glass slide, so, in radio, when one goes after a very weak signal, the first step to success is to bar all other sounds as far as possible. This seems obvious, but how many really quiet receivers does one encounter? One of the most common faults is bulb hiss. Often superior results may be secured by changing around the tubes when several are used. The amplification may not be increased, but if some of the hiss and underlying rustle is eliminated, that much is gained. Or, there may be a gassy tube in the amplifier. Tubes now run fairly uniform, as compared to the days when a new bulb might pick up anything from Cape Race to Demerara, or stop short at Seagate. Still, now and then one is apt to hit on a noisy one, and the best thing to do, if the effect is at all pronounced, is to take it out and leave it out. Varying grid bias, lowering the grid leak resistance, or changing the plate voltage, often is of service. It is surprising how few amateurs pay attention to this important detail, which is under each individual's control, unlike external forms of interference such as static and code signals.

Induction from nearby motors or a.c. feed lines may be an important factor in curtailing the range of a receiver. The usual remedy, in the case of a.c. hum,

is to swing the antenna at right angles to the line, whenever possible, thus doing away with the magnetic linking of the line and the antenna. However, in many cases the trouble is caused by electrostatic coupling between the room wiring and the plate circuit of the last tube, via the listener's body and the telephones. In such instances a considerable degree of relief is obtained by grounding the listener's body, or the metal framework of the telephones, or both, thus changing these surfaces from an intermediate condenser plate between the set and the house wiring, into a grounded shield between these points.

In one case I found that the exposed transformer coils of an a.f. amplifier were picking up induction directly from the house wiring. The coupling was magnetic in this instance and the difficulty was removed very simply by turning the receiver into a position where the exposed coil was at right angles to the field. In another case lighting a desk lamp with a long length of cord brought in the hum. The thing to do in all such instances is to experiment until the source of the disturbing field is located and the remedy is then usually obvious.

Motors with sparking brushes are a frequent cause of rattling and whirring noises in sensitive receivers. When the trouble can be localized and the motor is accessible, relief may often be secured by the use of 4-6 mfd. capacity across the terminals—and of course trimming the brushes is also very much in order and sometimes does away with the racket without further measures. But here the experimenter is apt to run up against the same kind of individual as the lightning-shy landlord. I call to mind the operator of an ash conveyer who refused to touch his motor because he said that all motors spark at the brushes when they run, and would have nothing to do with condensers because he was sure that they would draw extra current from the line.

Among other sources of interference with DX reception we may mention static. No effective and simple remedy is known at the present time. When in the form of isolated crashes with clear intervals, it does not interfere so much with the DX fiends, who are satisfied if they get the distant station's call.

When it comes to serious interference from telegraph stations, the only remedy, in some instances, is to wait until spark transmitters are barred by law or the pressure of public opinion. It is impossible to tune out a spark coil transmitter next door, and it is very hard, to say the least, to hear distant broadcasting stations if one happens to be located in the shadow of a powerful commercial spark station, even though the latter is sharply tuned and complying with the law in every respect. If this is the case, however, a wave trap may often be used to good effect. This is simply a tuned circuit coupled to the antenna through a step-down radio frequency transformer. A design employing spiderweb coils is shown in Fig. 1. By tuning the condenser and varying the trap coupling 200 meter spark stations may be eliminated with no effect on the 360 meter broadcasters.

In getting through the local broadcasters a small, low antenna is of great advantage. For some months a futile controversy raged on this point in one of the radio newspaper supplements, some listeners maintaining that it was possible to receive DX through the local stations, and others refuting them from experience. It was simply a case of receivers 6-10 miles from the locals, and using antennas with low effective height, in the first case; and in the other instance people either very near the locals, or using comparatively high aerials, or both. If one is very close, say within two miles, the problem is of course more difficult, but in any case the low antenna is advantageous. The theory on this point was first published

Continued on page 54

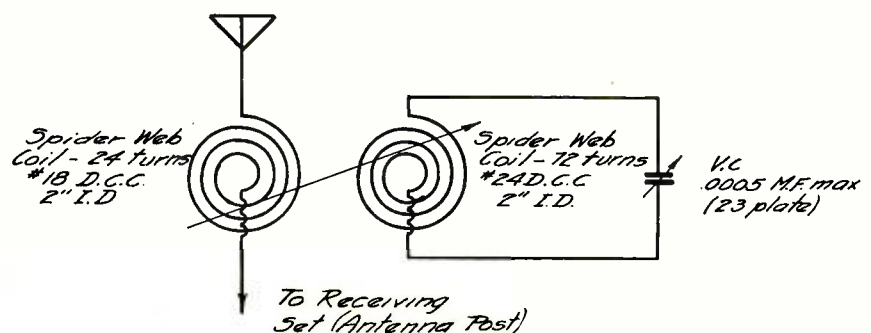

A Cheap Selective Crystal Outfit

By Lawrence B. Emmons

To secure selectivity in a crystal receiver the author has successfully used a variometer made up from spiderweb coils. How this is done is told in such a manner that anyone can duplicate this set from material around the house.

FEW of us realize the number of people anxious to make a start in radio but held back either by the confusing array of expensive sets and material offered, or the unjoyful experience of some friend, purchaser of a cheap crystal outfit of the type guaranteed not only to bring in one concert, but several all at the same time and well mixed like Chinese foods. They want something simple, cheap, easily constructed, yet efficient, and above all, in these days of numerous broadcasting stations, selective.

A review of the numerous crystal sets offered on the market and the various hook-ups published in the magazines

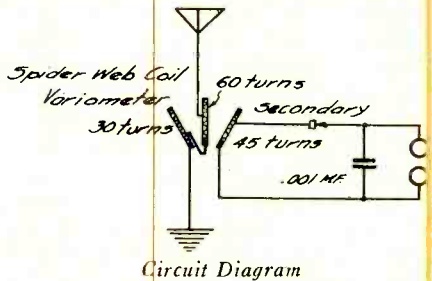

Circuit Diagram

convinced me that the combination would be hard to find. The single tapped coil or variometer type of tuner lacked selectivity, and the two-circuit types usually required variable condensers costing several dollars apiece and were thus out of the question. Through M. McMeen and his articles in RADIO, I had become interested in spiderweb coils and had found them not only attractive to the eye, but easily made and most efficient, so turned to them for a solution of the problem. Two of these little coils connected in series and moved toward or away from each other act as a very good variometer, and I soon found that a third spiderweb used as a secondary and inductively coupled to the variometer coils in the primary, as per circuit diagram, made as efficient and selective a tuner as could be desired. The little outfit shown in the picture was constructed on this principle.

It is not only rather unique in appearance but was easily made of simple materials with tools found in most any home. The absence of switches, dials, bakelite and variable condensers tend to make it inexpensive, yet I did not try to reach rock bottom in that respect. The average beginner does not desire novelties in the shape of pocket sets, or tuners constructed of cardboard boxes and paper clips but will gladly spend a few extra cents for something attractive and dependable in performance. I have purposely avoided too many details, be-

lieving that those interested in making things usually like to follow their available materials or own taste as to minor dimensions, finish, etc., and with the aid of the circuit diagram and photo, will have no difficulty in building the set.

Materials needed are a crystal detector, preferably of the glass enclosed type, four binding posts, a .001 mfd. phone condenser, $\frac{1}{4}$ lb. of No. 26 or 28 magnet wire, some good stiff cardboard (heavy pressboard is just the thing if obtainable) and odds and ends consisting of wood, screws, etc., usually to be found around the house. The above need not cost much over a dollar, though the small extra amount required for a really good crystal detector will be more than repaid by the added satisfaction it will give in maintaining its adjustment and sensitiveness.

Any smooth board about 6 by 8 in. will serve as a base. The four binding posts are mounted near one end two at either side to act as aerial, ground and phone connections. The detector and phone condenser are screwed to the base between the two pair of posts. All this should occupy not more than two or three inches at one end of the baseboard. Crosswise of the base and directly in front of the detector is fastened an upright piece of wood about 2 in. high, 2 in. long and $\frac{1}{2}$ or $\frac{3}{4}$ in. thick and to the top of this are screwed two narrow strips of wood each about 4 in. long to serve as pivoted swinging arms

for supporting the two movable coils. Three strips should be spaced about an inch apart and should pivot readily toward and away from each other. Washers under each screw head and between the strips and the upright to which they are fastened will aid materially.

The coil forms are made with shears from cardboard discs 4 in. in diameter with nine evenly-spaced $\frac{1}{8}$ -in. radial slots. For the secondary (or nearest coil in the photo) these slots extend to a depth of 1 in. and the wire is woven in and out around the disc to about forty-five turns and generous leads left at both the center and edge. These are fastened by passing the wire through pin holes in the cardboard. The completed coil is fastened by a small screw through its center to the nearest one of the swinging arms and the leads run to one terminal of the detector and to one of the phone binding posts respectively. The other terminal of the detector is connected to the other phone post and the condenser connected between the two so as to shunt the phones.

The disc for the center or stationary coil is slotted to a depth of $1\frac{1}{4}$ in. wound with about sixty turns of wire and one lead carried to the aerial binding post. The finished coil is slipped in a sawcut in a small strip of wood which is glued to the base so as to hold the coil vertical and at right angles to the upright piece. Slots for the third coil are

Continued on page 64

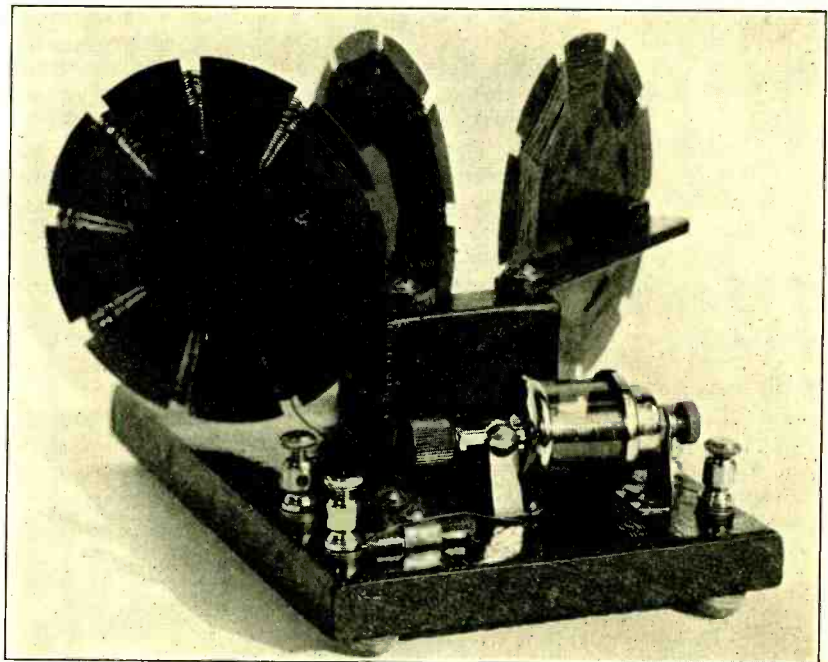

Complete Crystal Set with Spiderweb Coils.

High Frequency Resistance

By L. R. Felder

This is a simple explanation of the high resistance offered to high frequency current due to the skin effect of a conductor. The theory is specifically applied in considering practical means for reducing such radio frequency resistances to a minimum.

RESISTANCE in any electrical or radio circuit is productive of losses and wasteful of energy. All the energy which is consumed by resistance is converted into heat, and unless heat is desired, as in the case of electrical heaters or flat-irons, this energy is a total loss. In radio sets of any description, receiving or transmitting, resistance means a loss. The best engineering practice in design work is therefore a problem of decreasing resistance losses as much as possible, and thereby increasing the efficiency of the set.

This problem of resistance reduction is more important in radio than in other branches of electrical work because the resistance of a wire or coil is much greater at radio frequencies than it is for direct current or the commercial frequencies of alternating current. Furthermore the higher the radio frequency the greater is the resistance. The cause for this lies in a peculiar action of radio frequency currents termed "*skin effect*," as a result of which the high frequency currents flow only on the outer layer of any conductor.

An electrical conductor offers minimum resistance to a direct current, which is really an alternating current with zero frequency. With direct current the resistance depends upon three factors: material, the length, and the active area or cross section of the conductor. When a direct current flows through a wire it distributes itself uniformly over the cross section, that is, the same current flows through each unit area of the conductor. In other words, the current density for direct currents is uniform. Thus Fig. 1 represents the cross section of an electrical conductor which is divided up into small units of area. The uniform shading of these unit areas shows that the same current flows through one as the other. A unit area of conductor at the center carries no more nor no less current than a unit area at the edge. A direct current is able to distribute itself uniformly over the cross section of a conductor because it never changes its direction of flow through the conductor. Hence the current has sufficient time to penetrate from the outside of the conductor to the inside, resulting in the current distributing itself uniformly over the cross-section. Since the direct current does distribute itself uniformly all of the cross-section is used. Hence the resistance to direct current must be a minimum since the entire cross-section of wire is used effectively for carrying current.

An alternating current changes its

direction of flow through the wire at regular intervals. Thus if we consider the case of the alternating current generally used to light the lamps in our houses, namely 60 cycle current, this current, changes its direction of flow 60 times a second. For 1/120th of a second it flows in one direction along the wire, for the next 1/120th of a second it flows in the opposite direction and so on. Since the current flows through the wire in a given direction for a limited period it has only a limited time in which to spread over the area of the wire, for when this limited time has expired the current immediately reverses its direction of flow and has to begin all over again to diffuse over the wire. Now the speed of electricity is finite although it is extremely great. But it is possible, in fact it is actually the case, that the time which the current has to flow in a given direction before it reverses may be too small in which to diffuse itself over the entire cross-section of the wire. Thus consider the case of a 300 meter radio current. At this wave length the frequency of the currents is *one million* cycles per second which means that the current flows in one direction for the extremely short period of one two millionth of a second! In one two millionth of a second the current must travel from the outside of the conductor to the inside and distribute itself uniformly. What actually happens may be pictured by Fig. 2 which represents the cross-section of the conductor through which an alternating current is passing. Let us say that the frequency of this alternating current is 100,000 cycles per second. This means that the current can flow in one direction only 1/200,000th of a second before reversing its direction. In this short period the current may only have had time to penetrate through the thin outer ring designated by the shaded area before it begins to reverse its direction. When the direction of flow reverses it must begin again to penetrate from the outside to the inside of the conductor. Thus we see that for alternating current it is impossible for the current to distribute itself uniformly over the entire cross-section of the conductor since it has not enough time in which to do so. In other words the entire cross-section of the conductor is not utilized when alternating currents flow through it. Hence the resistance of the wire must be greater for alternating current than for direct current. Obviously the greater the frequency of the current the less time it has in which to penetrate

into the conductor, hence the smaller will be the cross-section of the conductor through which it flows. Thus the higher the frequency of the current the greater the resistance of the conductor.

In high frequency work the current, then, simply flows through an outer shell of the conductor, or through the skin of the conductor. From this we derive the expression "*skin effect*," indicating that the current flows through the outer skin of the wire.

In the above explanation it was assumed that the current flowed on the outer surface of the wire and penetrated inside. In order to thoroughly understand why the current flows on the outer surface of the wire rather than on the inner surface of the wire we must consider what happens from the inductance point of view when high frequency current flows through a wire.

An electrical conductor may be considered to be made up of a large number of fine filaments, Fig. 3. The total current which flows through this wire is distributed among these filaments, each filament carrying a certain current. When a current flows through a wire the wire is surrounded by magnetic lines of force as in Fig. 4. The greater the number of lines of force which surround a wire the greater is the inductance of the wire. Not only is the wire surrounded by lines of force on the outside but there are lines of force inside the wire also. That is the current through each of the filamentary wires produces its lines of force as in Fig. 5. As a result, since the lines of force due to the outside filaments also surround the inside filaments it will be seen that the inside filaments are linked by a greater number of lines of force than are the outside filaments. Hence the inductance of the elementary filaments inside the wire will be greater than the inductance of the outside filaments.

The larger the inductance of a wire the greater will its reactance be to the flow of alternating current. Since the elementary filaments inside the wire have greater inductances than those on the outside their reactances will also be greater. As a result, for the same potential difference applied to the wire less current will flow through the inside filaments than through the outside. It is for this reason that in alternating current work the currents traverse the outer portion of the wire rather than the inner portion as explained before.

Thus far we have seen that due to the inductive effect of the wire there is a tendency for the radio frequency cur-

rents to flow on the outside surface of the wire. This in effect reduces the active area of the conductor thus increasing its resistance. Now actually there may be a very small percentage of the current flowing through the inner portion of the wire. Hence it might be stated that the entire conductor is utilized. But it is not being utilized to its fullest extent.

For those amateurs who desire conclusive proof the following will complete the demonstration. If a given current produces more heat in one wire than in another then the resistance of



FIG. 1



FIG. 2



FIG. 4



FIG. 3

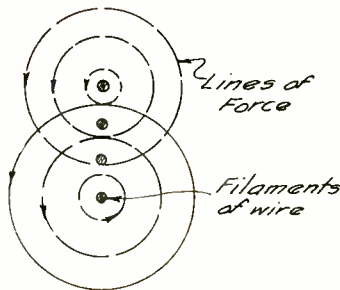

FIG. 5

the first is greater than that of the second. Likewise if a given current produces in the same wire more heat in one case than in another then its resistance in the first case is greater than that in the second. In the case of direct current the distribution of current is uniform, while in the case of radio frequency current the distribution is non-uniform. Let us consider the heat generated by the same current in both cases.

Fig. 1 represents the cross-section of a wire divided into a number of areas of unit cross-section. Since the current is direct the density is uniform, and each unit area carries the same current. Call this current I . If R is the resistance of each unit area of the wire then the amount of heat generated in each unit area is given by

$$h = I^2 R$$

If we assume that the wire is divided into n equal divisions the total amount of heat developed by the current I will be n times that developed in one division, or

$$\text{Total Heat} = H = n \times I^2 R \quad (1)$$

Suppose that this same current I is so distributed over the cross-section of the wire that only half of the divisions carry current. Consequently each division that does carry current must carry as much as before, since the total current is the same as before. Hence each of the $n/2$ divisions will carry $2I$ amperes, while the other $n/2$ divisions will carry no

current. This is equivalent to a non-uniform distribution of current as in radio frequency work. The heat developed in each division of the wire will now be given by

$$h = (2I)^2 \times R = 4I^2 \times R$$

Since only $1/2n$ divisions are carrying current the total amount of heat developed will be given by $1/2n$ times that in one division or

$$\text{Total Heat} = H = \frac{1}{2n} \times 4 \times I^2 \times R = \frac{2 \times n \times I^2 \times R}{2} \quad (2)$$

It is thus seen that when the current is

non-uniformly distributed over the cross-section of the wire the heat generated is twice that developed when the distribution is uniform, from equations (1) and (2). Hence the resistance of the total wire for non-uniform distribution of current in the above case is twice that for uniform distribution. It may be shown in a similar way that no matter what the particular distribution of current is, if it is non-uniform, it will result in the wire having a greater resistance than it has for uniform distribution. Now radio frequency currents are distributed non-uniformly over a conducting area, hence the resistance of a wire to radio frequency current will be greater than its resistance to direct current.

This increase in resistance at high frequency is extremely great at times, and one of the problems of all radio design work is the reduction of high frequency resistance to a minimum. We will now consider the principal means which radio designers employ to reduce this "skin effect" as much as possible.

1. The use of copper tubing. Since in high frequency work the inside of a solid wire is inactive and all the current flows on the outer skin, it would be most efficient if a conductor could be devised which would be all skin and have no solid interior. The first type of wire which suggests itself is hollow copper tubing. This construction eliminates the useless solid section, leaving just the outside surface along which the current flows.

2. The use of flat copper strip. A flat copper strip approximates very closely a plane surface having very little solid section. The thinner the strip the less solid section there is and the more surface there is. Thus the current flows through the outer surface or skin, which really constitutes the entire wire, there being very little or no interior section. By this means of construction the conducting wire only has active area, thus reducing resistance at high frequencies.

3. The use of "litzendraht cable." Where round solid wire is used, the thinner the wire the more surface it has, hence the less resistance it will have at high frequencies. However, thin wire may not have the current carrying capacity necessary and so some other means must be devised for constructing low resistance wire. We cannot increase the diameter of the wire, since the skin effect will increase, thus increasing the resistance. If a large number of thin strands of wire insulated from one another are interwoven a cable will be formed which is found to have a reduced skin effect and hence lower resistance. If these separate strands are braided so that each strand comes to the surface as frequently as every other strand the skin effect, and hence the high frequency resistance, is found to be reduced to a minimum. This type of wire is called "litzendraht" and is used in the best types of radio equipment.

It was stated above that the thinner the wire the less will be the skin effect and hence the lower the increase in resistance at high frequencies. It is also found that for wire having high specific resistances the skin effect at high frequencies is negligible if the diameter of the wire is low. These facts are utilized in the construction of resistance standards. If a material such as manganin, or constantin is used and the diameter of the wire is very small, it is found that the high frequency resistance and d.c. resistance coincide. Thus it is possible to use these materials when resistance standards are required. The resistances are measured for direct currents very accurately and are used in high frequency calculations.

There are two other important factors which influence to a marked extent the resistance of coils and circuits in radio frequency work. In the first place there is the distributed capacity of coils. Every coil has some distributed capacity through which leakage currents flow. This results in an extraction of energy and is therefore equivalent to an increase in the resistance of the coil. The poorer the dielectric of the coil the greater is the loss in it and hence the greater will be the resistance of the coil. As a result, considerable work is being done in coil design to reduce distributed capacity since this will also result in reduced resistance. Various types of coils

Continued on page 78

ploys one dry battery tube and is housed in a pine cabinet with a seasoned oak panel covered with tinfoil which is grounded. The complete outfit, including dry batteries, weighs about 12 pounds and costs about \$20.

After the panel has been drilled and the cabinet boards cut to size they are covered with two coats of shellac, including the panel holes. The tinfoil is secured to the panel while the shellac is still wet and soft and is cut away at points where parts are attached so as to avoid electrical connection with the panel. The finished cabinet may be stained.

The antenna is about 150 ft. of bare copper wire suspended by insulators and its lead is connected to the inside of coil *b*. The ground should be a water pipe or a mass of metal buried in moist ground.

In assembling the set care must be exercised to assemble the coils so that the windings of each pair are in the same direction, i.e. if the windings of coil *a* turn in a clockwise direction from inside to outside so must the windings in coil *b*. Connect the outside wire of *b* to inside wire of *a*; outside wire of *a* to outside wire of *c*; inside of *c* to fixed plate of condensers, plate terminal on detector socket to inside wire of *e*; outside wire of *e* to inside wire of *d*; out-wire of *d* to phones, etc. All other connections are shown in the diagram. In case results are not obtained on the first hook-up try changing the leads on the various coils until the proper arrangement is secured.

Coil *a* and *b* are tuning coils to be used in connection with the condenser. Greater selectivity is obtained with the coils well open. Coils *c*, *d*, and *e* control the regeneration so that no vernier is required on the filament rheostat.

HOW TO MAKE A 48-VOLT B STORAGE BATTERY

Continued from page 18

about 5 records. As it takes about a week for the records to dissolve, the mixture should be kept in an air tight jar to prevent the alcohol from evaporating. A little varnish added to the mixture will give a gloss to the paint.



FAR INTO THE NIGHT

By JACK BRONT

There was no mistake about it. Worth removed the phones from his ears and listened again. The sound within the house ceased. Utter penetrating silence again clothed the house.

The single shaded lamp glowed down on the panels and knobs. Worth sat tense and listened again, in sheer terror. There it was again! A light and subtle creaking—a halted advance, then silence settled down again like a pall.

He gazed at the clock in the receiver panel. The hands pointed to twenty seconds to midnight. A faint breathing was now audible. His keen ears detected that.

One second to twelve and the door knob started turning slowly, moved thru half a revolution and the door started to swing open!

It was wide open now. Worth gasped and clutched at the chair. There dull in the threshold stood a white figure!

He gasped again as the form moved toward him in silence. The features were now perfectly plain.

"My Lord! You!"

"Yes" said the form, "I have come for what I asked of you."

"No, No!" said Worth in a hoarse voice filled with apprehension. "No, I cannot!"

"You shall," said the form, "or I will—"

"It is here! It is here!" mumbled Worth as he sank into the chair. There was no escape now. The tone of the voice had been unmistakable.

With despairing hands Worth fumbled with a screw and drew it out. He held an object out to the white figure.

Greedy hands clutched at the object. Under the glow of the lamp it showed out in full relief. It was one side of Worth's only set of double phones, and his kid brother in pajamas drew it to his ear.

"Has 6XAD come in yet?" he asked in a whisper.

Worth had promised to let him listen in for DX calls.

THE RADIO HOUSE THAT JACK BUILT

By PAUL FRANKLIN JOHNSON

This is the house that Jack built.

This is the pole that was nailed to the house that Jack built.

This is the wire that hung from the pole that was nailed to the house that Jack built.

This is the set at the end of the wire that hung from the pole that was nailed to the house that Jack built.

This is the horn that was part of the set at the end of the wire that hung from the pole that was nailed to the house that Jack built.

This is the waltz at two in the morn

that came from the mouth of the radio horn that was part of the set at the end of the wire that hung from the pole that was nailed to the house that Jack built.

This is the maiden all forlorn that heard the waltz at two in the morn that came from the mouth of the radio horn that was part of the set at the end of the wire that hung from the pole that was nailed to the house that Jack built.

This is the youth so full of scorn that danced with the maiden all forlorn that heard the waltz at two in the morn that came from the mouth of the radio horn that was part of the set at the end of the wire that hung from the pole that was nailed to the house that Jack built.

This is the dad unshaven, unshorn, that accosted the youth so full of scorn that danced with the maiden all forlorn that heard the waltz at two in the morn that came from the mouth of the radio horn that was part of the set at the end of the wire that hung from the pole that was nailed to the house that Jack built.

This is the boot that covered the corn of the irate dad unshaven, unshorn that accosted the youth so full of scorn that danced with the maiden all forlorn that heard the waltz at two in the morn that came from the mouth of the radio horn that was part of the set at the end of the wire that hung from the pole that was nailed to the house that Jack built.

These are the trousers all tattered and torn by the hefty boot that covered the corn of the irate dad unshaven, unshorn that accosted the youth so full of scorn that danced with the maiden all forlorn that heard the waltz at two in the morn that came from the mouth of the radio horn that was part of the set at the end of the wire that hung from the pole that was nailed to the house that Jack built.

This is the result of so much scorn as to dance to the music of a radio horn at the unseemly hour of two.

"RADIO"

Written by Grace Isabel Colbron for the opening of Broadcast Central, the new station at Aeolian Hall, New York.

Flinging free from the guardian wires, into the blue alone,

The human voice goes soaring forth, the simple spoken tone,

Bridging the breadth of the sea's expanse the mountains' cloud-capt height, Over the fertile prairies broad, the fores fragrant night.

Calling across from land to land the grings of friendships go,

With the intimate touch of the spoken its warm and human glow.

Before this Wonder the distance shrinks a listening world draws close,

Its petty envies and hates forgot as the of Brotherhood grows.

Before this Wonder the past gleams pale, the future with promise bright,

For the spoken word on the Radio her New Dawn's light.

best result solder the connections. It is not necessary to connect these taps to switch points unless a greater wave-

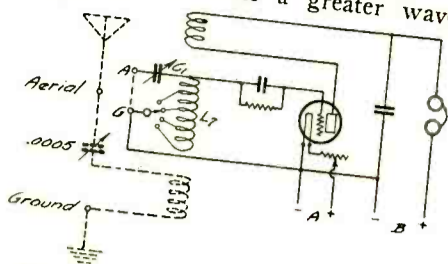

Fig. 4. Conversion of "CR5" to Three-Circuit Tuner.

L=60 turns on 4" tube, tapped at 40th, 50th and 60th turns, placed in inductive relation to L₂ coupling with 1 or 2 in. between coils. Dotted lines indicate additions.

length range than from 190 to 500 meter is desired. This coil is placed in inductive relation with the stationary winding of the coupler and placed 1 or 2 in. from the winding as shown in Fig. 5. This setting is not critical and the exact position had best be deter-

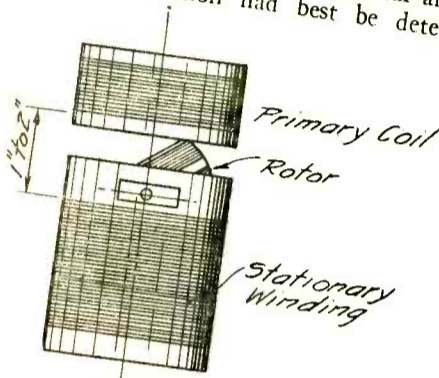

Fig. 5. Coil Placing

mined by experiment. This three circuit is just as efficient as if it had been built this way originally.

Those who are interested in building a good conventional three-circuit receiver which will give good results with a high degree of selectivity and extreme sensitiveness are referred to Fig. 6. The constants are given. This has been almost identical with...

After the right... The coupling will... The oscillator coils for maximum amplification... can be set... 1/2 in. to 3/4 in.

ments should be carried out with alternating currents. Now in the explanation of the fundamental theory direct current was used from a battery, hence we could use a delicate voltmeter as a balancing instrument. However, if alternating currents are used instead of direct we will have to employ another device instead of the voltmeter to tell us when a balance has been secured, that is when there is no flow of current from point C to point D of the Wheatstone

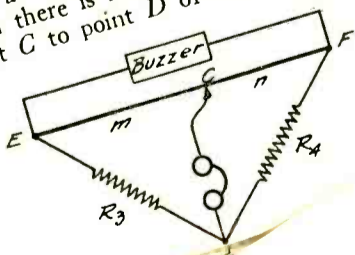

bar usually comes tinned, which is undesirable for the following reasons: It is a recognized fact that radio frequency currents flow on an outside path of the conductor, better known as the "skin effect." Now, if the conductor is covered with tin, the currents will travel thru it, which is a very poor conductor, it presents an objectionable resistance, but present

17 ft. The inside of the tower is cross-guyed at every cross brace with No. 8 wire. The cross-guying on the inside should be taken that all wires are tuned up tight, in the same manner that an aeroplane fuselage is guyed. The guying is done last, with the tower lying level, as the tower will hold the shape it is lying in when guyed.

gon RA-10. Those who are skeptical as to whether the three-circuit receiver is superior or not to the single-circuit receiver in sensitiveness and long distance reception will find by investigation that practically all long distance records are in the hands of operators with three-circuit receivers.

FILTERING SINK RECTIFIERS

By DR. A. E. BANKS, 6ZB

The demand for high voltage d.c. is on the increase since the advent of CW. Of course a motor generator of liberal wattage is a wonderful thing but such apparatus is not available to the majority of amateurs. Most of us have turned to some form of rectified a.c. The writer was unable to obtain a mercury arc rectifier so has had no experience with one, but it would seem that theoretically this type should be ideal. A properly designed chemical rectifier is a most efficient type of apparatus and

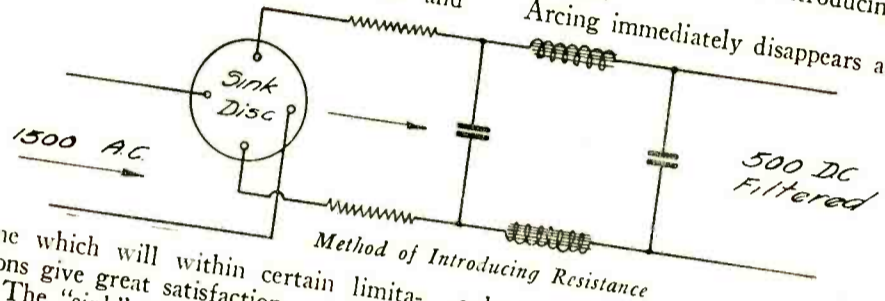

roduction with a "sink" rectifier on account of "fireworks" at the brushes. Let us see what happens. The rectifier is so arranged that the break occurs at zero voltage. Now when chokes and condensers are introduced as in a filter, we find that the condensers discharge in such a manner that the zero point is nullified and arcing follows. The transmitting tubes have high resistance at the distal end of the line. There is no resistance where the rectifier insulating segment breaks, the arcing therefore occurs at this point. It has been found that by introducing a resistance equal to, or a little greater than the total resistance of the transmitting tubes, on the rectifier side of the filter, and thereafter raising the potential of the rectifier d.c. to compensate for this, a filter works splendidly. The accompanying diagram explains the manner of introducing the resistance.

Arcing immediately disappears and it only remains for the experimenter to have a properly designed filter to get obliteration of pulsed d.c. lines. High resistance introduction by the writer in series with the

zener and telephones. The actual circuit connections are shown in Fig. 5. We have two D. P. D. T. switches: one is for switching on either the buzzer or d.c. battery for source of current; the other is for switching on either telephones or voltmeter for the corresponding balance indicator. The battery and voltmeter are used to secure a direct current resistance balance while the buzzer and telephones are used for the alternating current balance. The ratio of the two resistances is which enables us to secure a ratio of 10 to 1.

a 25-ft. pole and double block, in the following manner:
1. Lay the tower in position for raising.
2. Dig four holes 4 ft. apart and put in base supports.
3. Move the base of the tower up and between the first two base supports

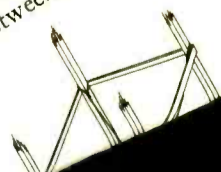

rents to flow on the outside surface of the wire. This in effect reduces the active area of the conductor thus increasing its resistance. Now actually there may be a very small percentage of the current flowing through the inner portion of the wire. Hence it might be stated that the entire conductor is utilized. But it is not being utilized to its fullest extent.

For those amateurs who desire conclusive proof the following will complete the demonstration. If a given current produces more heat in one wire than in another then the resistance of

current. This is equivalent to a non-uniform distribution of current as in radio frequency work. The heat developed in each division of the wire will now be given by

$$h=(2I)^2 \times R=4I^2 \times R$$

Since only $\frac{1}{2}n$ divisions are carrying current the total amount of heat developed will be given by $\frac{1}{2}n$ times that in one division or

$$\text{Total Heat} = H = \frac{1}{2}n \times 4 \times I^2 \times R = 2 \times n \times I^2 \times R \quad (2)$$

It is thus seen that when the current is

2. The use of flat copper strip. A flat copper strip approximates very closely a plane surface having very little solid section. The thinner the strip the less solid section there is and the more surface there is. Thus the current flows through the outer surface or skin, which really constitutes the entire wire, there being very little or no interior section. By this means of construction the conducting wire only has active area, thus reducing resistance at high frequencies.

3. The use of "litzendraht cable." Where round solid wire is used, the thinner the wire the more surface it has, hence the less resistance it will have at high frequencies. However, thin wire may not have the current carrying capacity necessary and so some other means must be devised for constructing low resistance wire. We cannot increase the diameter of the wire, since the skin effect will increase, thus increasing the resistance. If a large number of thin strands of wire insulated from one another are interwoven a cable will be formed which is found to have a reduced skin effect and hence lower resistance. If these separate strands are braided so that each strand comes to the surface as frequently as every other strand the skin effect, and hence the high frequency resistance, is found to be reduced to a minimum. This type of wire is called "litzendraht" and is used in the best types of radio equipment.

It was stated above that the thinner the wire the less will be the skin effect and hence the lower the increase in resistance at high frequencies. It is also found that for wire having high specific resistances the skin effect at high frequencies is negligible if the diameter of the wire is low. These facts are utilized in the construction of resistance standards. If a material such as manganin, or constantin is used and the diameter of the wire is very small, it is found that the high frequency resistance and d.c. resistance coincide. Thus it is possible to use these materials when resistance standards are required. The resistances are measured for direct currents very accurately and are used in high frequency calculations.

There are two other important factors which influence to a marked extent the resistance of coils and circuits in radio frequency work. In the first place there is the distributed capacity of coils. Every coil has some distributed capacity through which leakage currents flow. This results in an extraction of energy and is therefore equivalent to an increase in the resistance of the coil. The poorer the dielectric of the coil the greater is the loss in it and hence the greater will be the resistance of the coil. As a result, considerable work is being done in coil design to reduce distributed capacity since this will also result in reduced resistance. Various types of coils

Continued on page 78



FIG. 1



FIG. 2



FIG. 3



FIG. 4

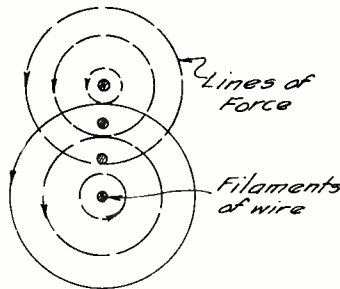

FIG. 5

the first is greater than that of the second. Likewise if a given current produces in the same wire more heat in one case than in another then its resistance in the first case is greater than that in the second. In the case of direct current the distribution of current is uniform, while in the case of radio frequency current the distribution is non-uniform. Let us consider the heat generated by the same current in both cases.

Fig. 1 represents the cross-section of a wire divided into a number of areas of unit cross-section. Since the current is direct the density is uniform, and each unit area carries the same current. Call this current I . If R is the resistance of each unit area of the wire then the amount of heat generated in each unit area is given by

$$h=I^2 R$$

If we assume that the wire is divided into n equal divisions the total amount of heat developed by the current I will be n times that developed in one division, or

$$\text{Total Heat} = H = n \times I^2 R \quad (1)$$

Suppose that this same current I is so distributed over the cross-section of the wire that only half of the divisions carry current. Consequently each division that does carry current must carry twice as much as before, since the total current is the same as before. Hence $\frac{n}{2}$ divisions will carry $2I$ amperes, while the other $\frac{1}{2}n$ divisions will carry no

non-uniformly distributed over the cross-section of the wire the heat generated is twice that developed when the distribution is uniform, from equations (1) and (2). Hence the resistance of the total wire for non-uniform distribution of current in the above case is twice that for uniform distribution. It may be shown in a similar way that no matter what the particular distribution of current is, if it is non-uniform, it will result in the wire having a greater resistance than it has for uniform distribution. Now radio frequency currents are distributed non-uniformly over a conducting area, hence the resistance of a wire to radio frequency current will be greater than its resistance to direct current.

This increase in resistance at high frequency is extremely great at times, and one of the problems of all radio design work is the reduction of high frequency resistance to a minimum. We will now consider the principal means which radio designers employ to reduce this "skin effect" as much as possible.

1. The use of copper tubing. Since in high frequency work the inside of a solid wire is inactive and all the current flows on the outer skin, it would be most efficient if a conductor could be devised which would be all skin and have no solid interior. The first type of wire which suggests itself is hollow copper tubing. This construction eliminates the useless solid section, leaving just the outside surface along which the current flows.

How to Make a 48-Volt B Storage Battery

By C. R. Evans

THE amateur who uses upwards of 100 volts on his plates is faced with a real problem in regard to B batteries. Not only is a considerable initial outlay necessary, but they must be replaced in a few months if dry batteries are used, as run down or partially run down dry cells produce a most annoying crackling in the receivers, which, by the way, many beginners charge to static.

The batteries described here may be constructed at a cost under that which would be paid for dry batteries and best of all they may be recharged with any type charger when the voltage drop becomes noticeable.

The materials necessary to construct a 48 volt unit, are listed below at the prices I paid. The battery plates, wood separators and the acid may be obtained at any battery shop and your druggist can supply you with the test tubes.

2 pieces sugar pine board, 13"x6"x1"	.10
2 pieces sugar pine board, 7"x6"x1"	.05
3 positive battery plates, at 21c.....	.63
3 negative battery plates, at 21c.....	.63
4 wood separators, at 5c.....	.20
24 glass test tubes at 5c.....	1.20
1 quart sulphuric acid, 1300 sp. gr.	.25
5 ft. No. 14 tinned copper wire.....	.05

\$3.11

You will also need a small quantity of battery wax and 3 Fahrenstock clips. The wax may be obtained from the tops of old dry cells or discarded B batteries. The clips can come from the same source.

The first step is to drill 24 one-inch holes in each of the larger boards, making three rows of holes, 8 holes to the row (Fig. 1) and leaving a 1/2-inch space between each hole. Make a tube rack by screwing the two short boards on the ends of the longer ones, placing one of the long boards about 3 inches below the other. (Fig. 2). Upon dropping a test tube in each hole it will be found that the rim on the top of each tube holds it in place.

The next job is to cut each of the battery plates into eight strips 9/16 in. wide by 5 3/4 in. long. Be sure to cut the strips across the plates—NOT up and down—as the former method allows each of the small strips to contain a number of unbroken cross sections. Use a thin saw with fine teeth if possible, as a coarse saw may break off small chunks of the active plate material. When finished you should have 24 small positive (brown) and 24 negative (grey) plates. The plates should now be prepared for soldering, by filing or sandpapering one end of each until it is bright.

Cut 21 pieces of the tinned wire 1 1/4 in. long, also 2 pieces 2 in. long. Connect up 21 pairs of plates by soldering one end of one of the short pieces of wire to the brightened end of a positive plate and the other end of the wire to a negative plate (Fig. 1a). Connect 2 more pair with the longer wire as shown in (Fig. 1b) with their faces parallel

and in line with one another. Solder a Fahrenstock clip to each remaining negative and positive plate (Fig. 1c). Also solder a clip to the wire connecting one of the pairs of plates Fig. 1d. Use as little acid or paste as possible when soldering. Cut the wood separators into strips 3/4-in. wide and drop a strip into each test tube.

Melt the battery wax until it is of the consistency of syrup and dip the tops of each of the pairs of plates with its connecting wire, into the melted wax to a depth of about 3/4-in. Be sure the wax is hot, otherwise too much of it will adhere to the wire and plates. CAUTION: Dip quickly; if left in the wax too long the heat may loosen the solder. It will be necessary to paint the wax on the single plates with clips attached also on the pair of plates that have the clip soldered thereto.

Starting at the left hand tube nearest to you, place the negative plate with clip attached, in the tube. In the same tube place the positive plate of one of the pairs, allowing the negative plate of this pair to drop into the adjoining tube on the right. Continue in this manner until the end of the row is reached when it will be found necessary to use one of the pairs connected by the longer wire. Work to the left on the second row, placing the pair of plates with clip attached, between the 11th and 12th tube from the starting point. This gives you your 22 volt tap for detector tube. If 18 volts are desired, place this pair of plates in the 9th and 10th tubes. Be sure plates in each tube are separated by the strip of wood separator, also be sure you have a negative and a positive plate in each tube. Mark the tube where you first started *N* and the last tube *P*.

Fill the tubes to within 3/4 in. of the top with the sulphuric acid and charge at a 1/4 ampere rate for 10 hours. It is a good plan to discharge the battery rather rapidly after the first charging and recharge before using.

As evaporation is rather rapid, I make it a practice to inspect the battery each week and fill tubes to their proper level with distilled water. These batteries will work satisfactorily for 90 days or more without recharging but to make sure I charge for three hours on the first of each month.

As near as I can determine, these batteries have a capacity of about 2 ampere hours. My voltmeter shows about 54 volts from the 24 cells when fully charged.

An excellent acid resisting paint that will also help prevent leakage between cells can be made by dissolving old phonograph records in denatured alcohol. A pint of alcohol will dissolve

Continued on page 20

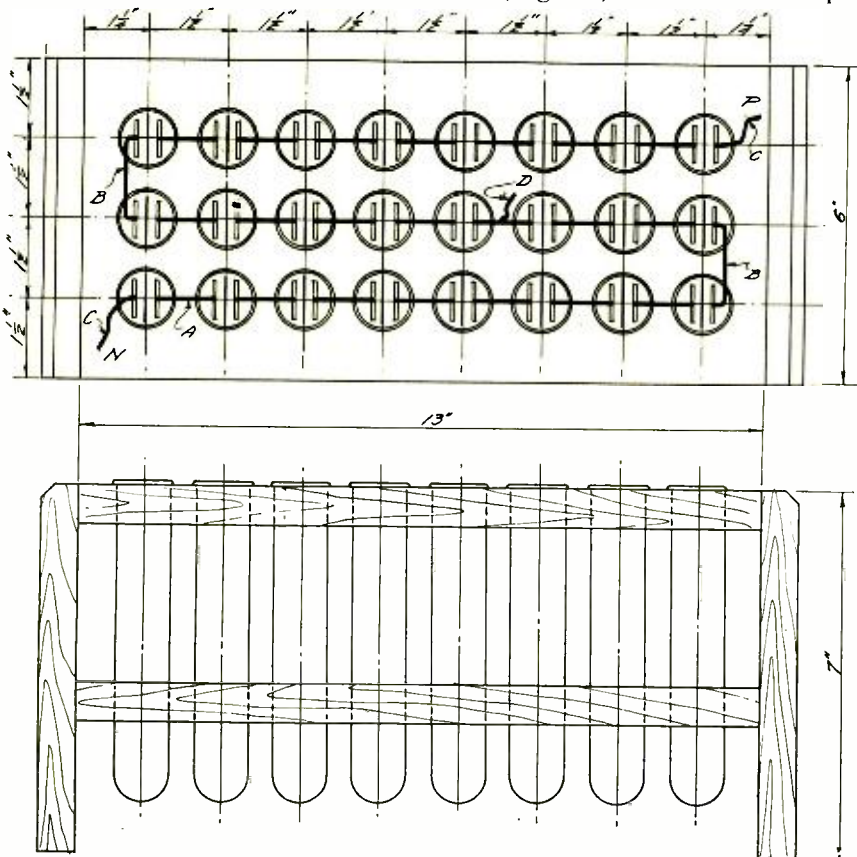

The Lighthouse Dry Battery Receiver

By S. R. Winters

In view of the popularity of radio receivers independent of a storage battery this description of a set which can be made at home should be of interest and value. It is as adaptable for the home as to lighthouse use.

THERE are approximately 500 keepers of lighthouses in the United States and outlying provinces. Their duties are to keep watch along the treacherous waters of our 44,000 miles of coast line and to see that these beacons of light "are trimmed and burning," figuratively, as guides to navigators. A lighthouse may be located ashore at the entrance to a harbor or perched on a rock in the midst of water, miles from land. The guardians of these towers of light, however, may remain on duty for months and even years without taking a leave of absence. Surely, the existence of a lighthouse keeper must be lonely and at times he must despair of the monotony of life.

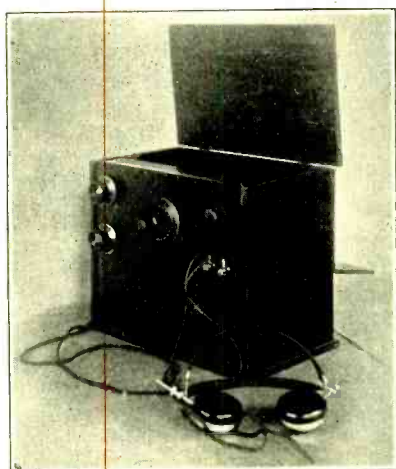

Front View of "Lighthouse" Set

Now, thanks to the radio telephone, the ancient lighthouse, which formerly suggested desolation, may be converted into a forum for the reception of information and entertainment. The keeper of a lighthouse can maintain his residence on a rock in the Pacific Ocean, and without going ashore, receive instructions how to keep fit physically, recipes for cooking his meals, be entertained by grand opera in the evening, and on Sunday, figuratively, worship "at the church around the corner" in a big city. This mental picture is faithful to real conditions, even though the broadcasting services received by individual keepers of lighthouses will vary in different localities.

The Bureau of Lighthouses of the United States Department of Commerce, appreciating the advantages of the radio telephone as a means of dispelling the loneliness of its beacons to navigation, is lending a hand in making it easier for these guardians of life

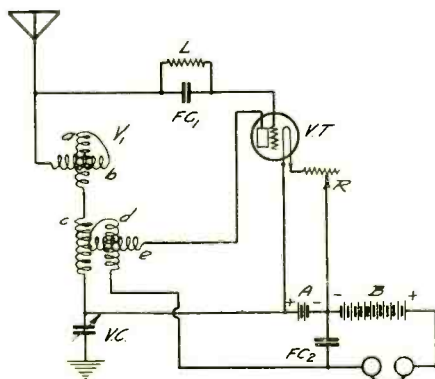

Fig. 1. Circuit Diagram for "Lighthouse" Set.

- V_1 —variometer consisting of 2 spiderweb coils in series; a is fixed and has 40 turns; b is movable and has 50 turns.
- V_2 —variometer consisting of a 50-turn moveable coil c and of two fixed 30-turn moveable coils, d , the inner, and e , the outer, wound on the same spiderweb frame. No. 26 wire is used for winding.
- FC_1 —23-plate condenser with vernier.
- FC_2 —.0005 mfd. grid condenser.
- L —grid leak, made by pencil mark on heavy paper.
- VT —detector tube, WD-11 or other dry battery tube.
- FC_3 —.0025 mfd. phone condenser.
- R —filament rheostat.
- A —1½-volt dry cell.
- B —22-volt dry cell.

and property on the seas to acquire a wireless receiving set. This Government bureau has no funds for equipping lighthouses with radio-telephone apparatus, but its engineering division is going the limit in rendering the five hundred keepers of lighthouses the opportunity to acquire wireless outfits at a minimum

expenditure of funds. Consequently, A. W. Tupper, assistant engineer of the engineering construction division of the Bureau of Lighthouses, has devised and built a model of a radio-telephone receiving set that is adaptable to service in lighthouses.

As illustrated herewith, this set em-

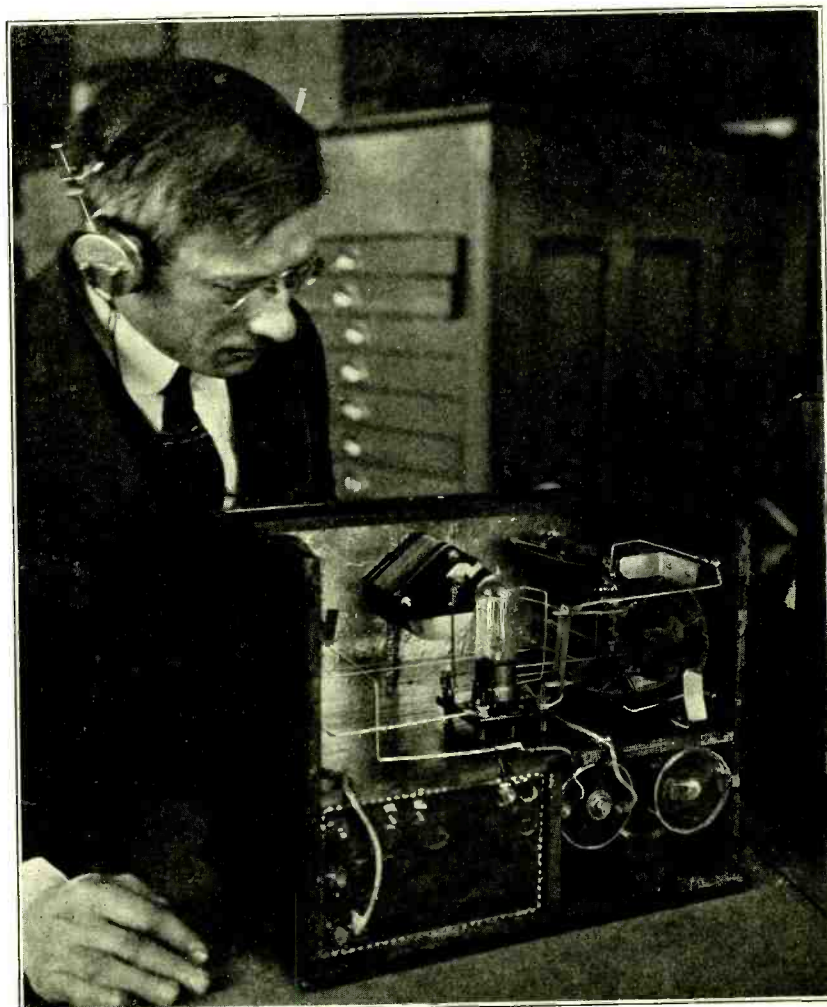

A. W. Tupper, Assistant Engineer Bureau of Lighthouses, with Receiving Set.

loys one dry battery tube and is housed in a pine cabinet with a seasoned oak panel covered with tinfoil which is grounded. The complete outfit, including dry batteries, weighs about 12 pounds and costs about \$20.

After the panel has been drilled and the cabinet boards cut to size they are covered with two coats of shellac, including the panel holes. The tinfoil is secured to the panel while the shellac is still wet and soft and is cut away at points where parts are attached so as to avoid electrical connection with the panel. The finished cabinet may be stained.

The antenna is about 150 ft. of bare copper wire suspended by insulators and its lead is connected to the inside of coil *b*. The ground should be a water pipe or a mass of metal buried in moist ground.

In assembling the set care must be exercised to assemble the coils so that the windings of each pair are in the same direction, i.e. if the windings of coil *a* turn in a clockwise direction from inside to outside so must the windings in coil *b*. Connect the outside wire of *b* to inside wire of *a*; outside wire of *a* to outside wire of *c*; inside of *c* to fixed plate of condensers, plate terminal on detector socket to inside wire of *e*; outside wire of *e* to inside wire of *d*; outside wire of *d* to phones, etc. All other connections are shown in the diagram. In case results are not obtained on the first hook-up try changing the leads on the various coils until the proper arrangement is secured.

Coil *a* and *b* are tuning coils to be used in connection with the condenser. Greater selectivity is obtained with the coils well open. Coils *c*, *d*, and *e* control the regeneration so that no vernier is required on the filament rheostat.

HOW TO MAKE A 48-VOLT B STORAGE BATTERY

Continued from page 18

about 5 records. As it takes about a week for the records to dissolve, the mixture should be kept in an air tight jar to prevent the alcohol from evaporating. A little varnish added to the mixture will give a gloss to the paint.



FAR INTO THE NIGHT

By JACK BRONT

There was no mistake about it. Worth removed the phones from his ears and listened again. The sound within the house ceased. Utter penetrating silence again clothed the house.

The single shaded lamp glowed down on the panels and knobs. Worth sat tense and listened again, in sheer terror. There it was again! A light and subtle creaking—a halted advance, then silence settled down again like a pall.

He gazed at the clock in the receiver panel. The hands pointed to twenty seconds to midnight. A faint breathing was now audible. His keen ears detected that.

One second to twelve and the door knob started turning slowly, moved thru half a revolution and the door started to swing open!

It was wide open now. Worth gasped and clutched at the chair. There dull in the threshold stood a white figure!

He gasped again as the form moved toward him in silence. The features were now perfectly plain.

"My Lord! You!"

"Yes" said the form, "I have come for what I asked of you."

"No, No!" said Worth in a hoarse voice filled with apprehension. "No, I cannot!"

"You shall," said the form, "or I will—"

"It is here! It is here!" mumbled Worth as he sank into the chair. There was no escape now. The tone of the voice had been unmistakable.

With despairing hands Worth fumbled with a screw and drew it out. He held an object out to the white figure.

Greedy hands clutched at the object. Under the glow of the lamp it showed out in full relief. It was one side of Worth's only set of double phones, and his kid brother in pajamas drew it to his ear.

"Has 6XAD come in yet?" he asked in a whisper.

Worth had promised to let him listen in for DX calls.

THE RADIO HOUSE THAT JACK BUILT

By PAUL FRANKLIN JOHNSON

This is the house that Jack built.

This is the pole that was nailed to the house that Jack built.

This is the wire that hung from the pole that was nailed to the house that Jack built.

This is the set at the end of the wire that hung from the pole that was nailed to the house that Jack built.

This is the horn that was part of the set at the end of the wire that hung from the pole that was nailed to the house that Jack built.

This is the waltz at two in the morn

that came from the mouth of the radio horn that was part of the set at the end of the wire that hung from the pole that was nailed to the house that Jack built.

This is the maiden all forlorn that heard the waltz at two in the morn that came from the mouth of the radio horn that was part of the set at the end of the wire that hung from the pole that was nailed to the house that Jack built.

This is the youth so full of scorn that danced with the maiden all forlorn that heard the waltz at two in the morn that came from the mouth of the radio horn that was part of the set at the end of the wire that hung from the pole that was nailed to the house that Jack built.

This is the dad unshaven, unshorn, that accosted the youth so full of scorn that danced with the maiden all forlorn that heard the waltz at two in the morn that came from the mouth of the radio horn that was part of the set at the end of the wire that hung from the pole that was nailed to the house that Jack built.

This is the boot that covered the corn of the irate dad unshaven, unshorn that accosted the youth so full of scorn that danced with the maiden all forlorn that heard the waltz at two in the morn that came from the mouth of the radio horn that was part of the set at the end of the wire that hung from the pole that was nailed to the house that Jack built.

These are the trousers all tattered and torn by the hefty boot that covered the corn of the irate dad unshaven, unshorn that accosted the youth so full of scorn that danced with the maiden all forlorn that heard the waltz at two in the morn that came from the mouth of the radio horn that was part of the set at the end of the the wire that hung from the pole that was nailed to the house that Jack built.

This is the result of so much scorn as to dance to the music of a radio horn at the unseemly hour of two.

"RADIO"

Written by Grace Isabel Colbron for the opening of Broadcast Central, the new station at Aeolian Hall, New York.

Flinging free from the guardian wires, into the blue alone,

The human voice goes soaring forth, the simple spoken tone,

Bridging the breadth of the sea's expanse, the mountains' cloud-capt height,

Over the fertile prairies broad, the forest's fragrant night.

Calling across from land to land the greetings of friendships go,

With the intimate touch of the spoken word, its warm and human glow.

Before this Wonder the distance shrinks and a listening world draws close,

Its petty envies and hates forgot as the sense of Brotherhood grows.

Before this Wonder the past gleams pale, but the future with promise bright,

For the spoken word on the Radio heralds a New Dawn's light.

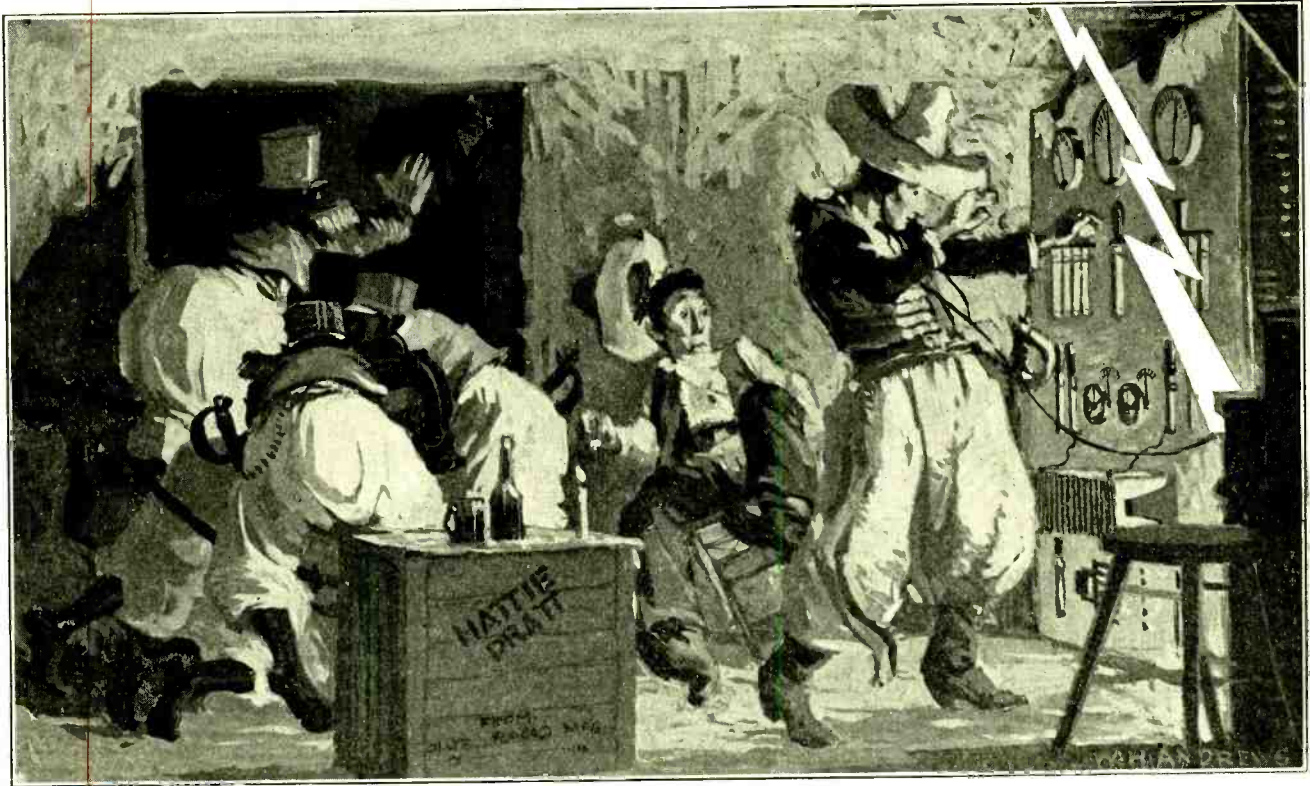

Jimson The Great

By Earl Ennis

This yarn is in answer to the call for humorous radio stories. A couple of ex-cow-punchers exiled in a Central American republic use a radio set to quell a revolution. In it is at least a chuckle a minute.

THE day the *Hattie Pratt* runs ashore on Puente Reef, Jimson and me walks down to the beach and looks her over.

"Her belly's full of barley," says Jimson. "She's gonna swell up and bust. We got to get busy."

"Doin' what?" asks I.

We was down south of the tropics at the time, buildin' an alleged railroad for a jerkwater republic. Loot extra.

"Savin' the portholes for a doughnut works," says Jimson, real sarcastic like.

"Oh," says I. "I thought maybe you was aimin' to go fishin' with the anchor."

Jimson don't pay no attention to me. He's studyin' the wreck.

"Salvage!" says he, "and nothin' hinderin' but destiny!"

Nobody knows what Jimson's gonna do next and at them words I gets a sort of gone feelin' inside, and contains myself with vigor.

"Lissen," I says. "Before it's too late—be reasonable."

"I'm aimin' to get a few cases of Scotch off yon craft," he goes on, seein' I aint much impressed.

"When does we begin?" I asks with enthusiasm.

"The sooner the better," says Jimson. "The crew's dead drunk down at Maw Polini's cantina. Me and you and some track bozos is goin' to promul-

gate a spell while they's paralyzed. What they don't savvey aint goin' cut their fingers," he says.

Jimson's a funny coot. When he thinks of a thing, he does it. Comes 5 o'clock we has a dozen cases of Black and White hid away in the shack which we calls home. Also we has the *Hattie Pratt's* radio set, the which I finds out afterward was Jimson's real reason for goin' aboard, parked in one end of the room.

"I savvey the whiskey," says I, as we sits around the bunkhouse, feelin' some amiable. "But I don't get the purpose of them radio instruments."

Jimson grins. He's been to Vassar or some college and can speak right educated when he wants.

"You," says he, "aint got no imagination. Give me a sewin' machine on a cannibal isle," says he, "an' I'll be king in twenty-four hours. This here radio is gonna make us rich and famous. The secret of trade and politics is to get somethin' the rest aint got and work it. With this radio set down here, me and you can be as exclusive as a couple of skunks in a oak tree. All we got to do is put brains with it, the which I can supply easy, and the thing's done."

I was too full of Scotch and comfort to argue. Furthermore I don't take his remarks serious until the next day when I sees Jimson palaverin' with a

couple of chocolate colored hombres in mysterious manner.

"Hum," thinks I, "I should have choked him whilst he slept. It would of been cheaper in the end."

I goes back to the bunkhouse and takes a look at the radio stuff, tryin' to figger in my own mind what he's planin'.

He comes in and catches me at it.

"What do you think of it?" he asks.

"Well," says I, "not knowin' anything about radio, I'd say it was plumb elegant."

Jimson chuckles.

"You aint got nothin' on me," he says. "But I aims to do some all-fired fast learnin'. A week from now, ask me anything and I reckon I can tell you."

That's Jimson all over. Born a cow-punch in a long-horn country he grows up with the idea the only way to do a thing is to just nachully go ahead and do it. He'd a flew a plane to Europe onct on the strength of bein' able to ride anything in the Hot-Hoss country if I hadn't of stopped him.

"What do you aim to do with it, now you've swiped it?" I asks.

Jimson cocks an eye at the junk.

"I ought to be able to elect m'self secr'tary of the navy," says he. "I've always thought as how I'd look kinda nifty in a snappin' turtle suit and a trick hat. The only thing that's a

drawback," he says, "is the fact, that there aint no navy. But on second thoughts, that aint so worse, because I wouldn't have no worries."

As I aint got nothin' with which to talk back I keeps a loquacious silence, and me and Jimson cleans out the shack and installs the radio in one end. Jimson snuck a photograph off the wall in the radio cabin of the *Hattie Pratt* and goin' by this and our own ideas which was not worth much net, we makes a fair job of it."

"That's as good as anybody could of done south of the tropic of cancer and other diseases," says Jimson standin' back and lookin' proud.

"There's lots of knobs and things, for a fack," I says. "Only will it work?"

Jimson gives me a pityin' look.

"The way you talks," he says. "A person'd think you was born down in this here God forsaken country. You ask the same kind of fool questions," he says.

"Excuse me," says I, "but when I sees a pianny I nachully asks does it play." I could be some rancid myself when I wanted.

"Lissen ol' horned toad," says Jimson. "The less you know, the better you get along. This thing calls for imagination, the which you aint got none of. If it aint strainin' your .25 caliber intellect, I'd like to work it out without suggestion."

"Go to it," says I, "only don't forget it's usual I who gets your bail when you finishes your fancy thinkin'."

I was touchin' upon a tender subject, intentional and for purposes of insult. Jimson retards his spark immejit, and we gets along better.

"We got to have some wires up in the air to catch this here radio," says Jimson.

"Is radio and wireless the same thing?" I asks.

"Tis among friends," says Jimson.

"Then what's the wires for?" I asks.

Jimson looks at me kinda sad-like.

"You sure are defunct on imagination," says he. "Didn't Joe McGee says 'What's in a name?' The answer is—nothin'. What if there is wires? Can't we do a wireless business just the same? Migosh aint you ever heard of oil stocks?"

That sets me back considerable.

While I sits by, aidin' and abettin' grand larceny and other crimes, Jimson cuts down a couple of blocks of wire from the government telegraph line passin' the shack, which he hangs from a tree to our one flagpole. When we gets through, it looks real handsome. Thinks I: old man Macaroni would be mighty proud if he could see us now, standin' in front of his little pet, with a glass of Scotch in our hands, and not a blamed thing comin' in.

"There's no hurry about it workin',"

says Jimson. "The air's always full of radio with plenty for all, and malice towards each," he says.

That was all for that time. The next day Jimson lays off the railroad buildin' and hoofs it in town to call on His Excellency El Presidente.

At noon, followin' the customs of the country, I lays me down under a tree and has a siesta, which is done on the back with the cady over the nose. I was awaked by a lot of cayuses tarry-diddlin' down the road.

"Huh," says I, "cavalry in red pants takin' a littel pasear. Probable Shriners of the rellum," says I, "doin' a little stuff for the home town boys."

But I notices my track bozos gets some excited and begins chatterin' high power tamale, so I opines that maybe a circus is comin'. I picks me out a good seat on a donkey engine and gets ready to give the spangle ladies a look-see. Just about the time I thinks I sees a camel, I finds it aint a camel at all but ol' Jimson, settin' back in a Spirit of '76 carryall, all togged out in Mex decorations, and lookin' real haughty, with about a dozen tough lookin' hombres with cow-goads ridin' alongside.

"Pinched again," says I to myself. "The blamed ijit! An' bluffin' it out good old Yank style. I wonder what he done this time. Probable kidnapped the governor's daughter and is maybe en rooay to gettin' life." I sighs heavy, thinkin' of the bribes I has got to dig up pronto to beat justice on the draw.

The parade pulls up outside the shack. A bimbo gets down off the seat, and just as I gets a good bead on him with my .45, he ushes Jimson out with a bow, like he was a crate of eggs on Saturday night in Alaska.

"Gracias," says Jimson, like he was born purple with fine linen.

"Huh!" thinks I. "They got some polite cops down heres anyway."

Before I gets any more ijeas on the subject, all the red pants hombres salutes. Then they does a right about face, and retires in good order, leavin' me and Jimson alone with the scenery.

"Greetings, onion," says Jimson. "Didn't I tell you?"

I tumbles. The fancy hack was El Presidente's private wheelbarrow. The catsup boys was the palace guard, the toughest bunch of pogo sticks in captivity.

"Sufferin' cats," I ejaculates. "You didn't make it?"

Jimson gives a couple of flicks.

"Me and El spent quite a pleasant afternoon," he says, very off-hand and bon mot. "He's a nice ol' party," he says. "An' he's got one swell bartender."

He stretches a couple and then I lamps the fact he's got a sword tied on him, right where it'll do him the least good.

"Would you mind tellin' me, General

Pershing," I remarks, "How you come by the bread knife?"

"Oh, that?" says Jimson, pretendin' to notice it for the first time. "I'm a minister," he says.

"Oh, are you," I retorts. "Baptist or Holy Roller?" I asks. "Or, maybe you aint insectarian?" I adds.

"I'm Minister of Radio Communications Hot Air and Watts," says he, struttin' about. "El Presidente did it with his little pen."

I sits down sort of heavy, so's I can stand the shock better.

"When did this here happen?" I demands.

"About five minnits after 11 a. m. to be kerrect," he says. "El kind of took a fancy to me. He's got imagination, El has. He seen his opportunity and he grabbed it. There aint much money in it, but there's a hell of a lot of honor."

I slips him a Napa soda look.

"I suppose I'm to keep on railroadin' the whites you cavorts right prominent with a safety razor on," says I.

"No," says Jimson. "I never forgets a pal. I got you a new job too. You're chief of the bureau of Aerograms and Amperes, whatever they is. Your salary is only 50,000 pesos less than mine—when you gets it."

By this time I was kinda dizzy.

"Have we got any duties, as it were," says I, "or does we just sleep around as per usual."

Jimson fixes me with reckless eye.

"We're gonna be right busy," he says. "We got to save a whole nation," he says, "the which aint no small job for two men."

"Oh," says I. "You're gonna save a nation, are we? Aint that real nice! Was you aimin' to pay the national debt, maybe, or teach 'em how to home brew?" I asks.

"It's revolution," says Jimson, impressive-like. "It's the red flag of terriblism wavin' in a sea of blood," he says.

"When does all this here ruin and debauchery aim to begin?" says I, calm and cool on the exit but none too cheerful and Merry Christmas in the gizzard.

"As soon's I give the word," says Jimson. "As I tells El this a.m., I am probable the best informed hombre on revolutions in the country. What Bill Burns is to America I am to this unhallowed hole of iniquity. I hear everything. I know everything. I am all over the honorable place. I got an ear that never sleeps and an eye that's sharper than a serpent's tooth. There aint nothin' gets by me anytime, anywhere, any place."

"Lissen," says I, "I wish you'd pull them sentiments out in the open. I aint hankerin' to get hit by lightnin' because some bow-legged cow-punch figgers on settin' up competition with the Almighty."

Continued on page 66

Single or Three Circuit

By A. P. King

This article tells how to convert a single circuit CR-5 receiver into a three circuit tuner without changing the wiring of the CR-5. It also gives the hook-up for a three circuit receiver.

THE trend of the present moment is toward the simplification of receiving sets. This is a natural tendency and dream of many a radio engineer to simplify the three-circuit receiver without lessening its efficiency. Up to the present time this has not been accomplished.

It is the purpose of this article to state the advantages and disadvantages of the single and three-circuit tuners and to show how a single circuit CR-5 may be changed into three-circuit tuner without changing the wiring of the CR-5.

To the reader, usually the following important questions arise: (1) What are the advantages of a single circuit tuner to be used for receiving broadcasting or continuous waves? What will it do that the three-circuit receiver cannot do? This includes that class of receivers known as "CR-5", Colpitts circuit used for receiving, Reinartz and many other similar circuits having only two controls.

(2) What can the three-circuit receiver do that the simplified tuners cannot do?

(3) Should I sacrifice the efficiency of my tuner as well as its freedom from interference by using a single-circuit tuner?

The three-circuit tuner is the ideal type of receiver for all round use. It is more flexible and will ultimately give the operator greater satisfaction, particularly for long distance reception. The three-circuit tuner is so termed because it has three tuned circuits: the primary or antenna circuit, the secondary or grid circuit and the tertiary or plate circuit. Figs. 1 and 2 illustrate these graphically.

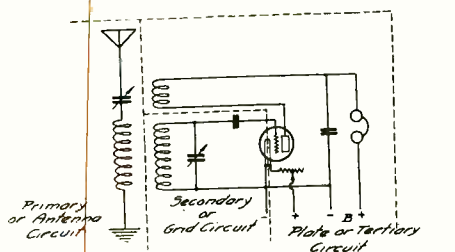

Fig. 1. Three-Circuit Condenser Tuned Set

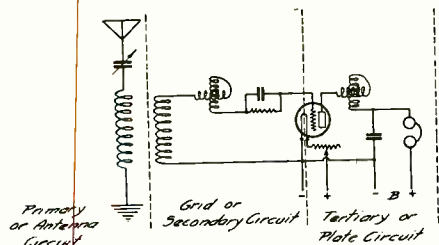

Fig. 2. Three-Circuit Variometer Tuned Set

In this type of tuner greater selectivity is obtained due to the fact that the secondary is distinct from the primary and is tuned. By selectivity we mean that a receiver will respond to one wavelength without responding to other wavelengths than that to which it is tuned. The resistance of the antenna circuit does not affect the resistance of the grid circuit and thereby the decrement is lowered and the selectivity is increased. The more selective a set is, the freer it is from interference from waves other than that to which it is tuned. In a three-circuit tuner we have complete control over each circuit. The antenna circuit is tuned resonance and we absorb a certain amount of energy or signal. By tuning the secondary to resonance with the primary, most of this energy is absorbed by the secondary. Any variation of the grid potential by this incoming wave produces a corresponding greater plate current variation, then by regeneration or repeating the plate energy back to the grid the incoming signal is increased many times. Also the resistance of the secondary approaches zero in a regenerative circuit, thereby increasing the selectivity of the set.

Single Circuit Receivers

Single circuit or simplified tuners do not possess the fine tuning qualities that the three circuit receivers possess. In the latter it is possible to tune each circuit to resonance, thus getting the greatest efficiency and signal strength. In Fig. 3 one of the best known single circuit receivers is shown. This is usually termed the "CR-5". It will be noted that all three circuits are present in a single circuit tuner but they are not all tuned and the antenna tuning coil is coupled conductively or "direct" to the grid or secondary circuit and the grid circuit is not tuned. We have only two circuits to tune, the primary and the tickler, which controls the regeneration.

Let us analyze the action of a single circuit receiver. The incoming wave impinges upon the antenna, and this circuit, which is of quite high resistance and decrement, is susceptible to waves other than that to which it is tuned. The secondary is untuned and aperiodic. Therefore it is dependent upon the antenna circuit for its selectivity, but the latter is not selective, due to the high decrement of this circuit, and renders the grid susceptible to stations on different wavelengths at the same time. Of course there are only two controls or dials on the average single circuit in

place of the three or four in the three-circuit tuner and the single-circuit receiver is simpler in operation. The operator will get better results right at the start with a CR-5 than with the three-circuit receivers, but the latter will give superior results in two or three weeks without interference from other stations.

Some people think they cannot operate a three-circuit tuner. True, it takes longer to learn how to operate a three-circuit than to operate a single circuit, but if the prospective operator is possessed with moderate patience he or she can soon master the three-circuit, which enables distance reception through local stations and the elimination of interference. You can learn to operate a single-circuit receiver in two or three hours. You can learn to drive a Ford in two or three hours, but it will take several days to master the operation of a Pierce Arrow. Which would you rather operate?

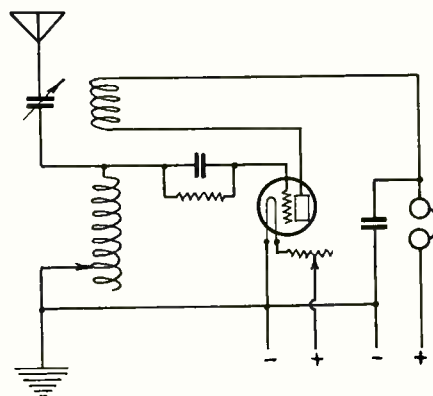

Fig. 3. Single-Circuit "CR5" Receiver

If you have a single-circuit CR-5 as illustrated in Fig. 3 you can change it into a three-circuit set without changing the wiring of your present CR-5. All the parts necessary for making the change are:

1—23 plate .0005 condenser (variable).

1—coil 4" diameter 60 turns No. 22 SCC tapped at the 40th, 50th and 60th turns.

The circuit arrangement is shown in Fig. 4, the position of the coil in Fig. 5. Remove the aerial and ground wires from your CR-5 and connect the two binding posts to which the aerial and ground were connected with a piece of wire. Do not change any other wires on the set. Now connect the aerial and ground with the condenser and coil as shown in Fig. 5. The tap at the 40th and 50th turn is so that an antenna of varying characteristics may be employed. After the tap is found which gives the

best result solder the connections. It is not necessary to connect these taps to switch points unless a greater wave-

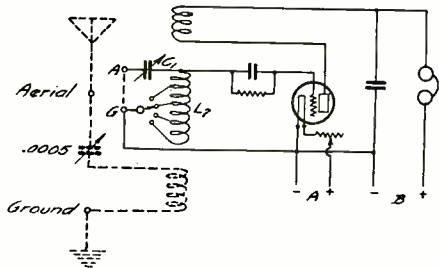

Fig. 4. Conversion of "CR5" to Three-Circuit Tuner.

$L=60$ turns on 4" tube, tapped at 40th, 50th and 60th turns, placed in inductive relation to L_2 coupling with 1 or 2 in. between coils. Dotted lines indicate additions.

length range than from 190 to 500 meter is desired. This coil is placed in inductive relation with the stationary winding of the coupler and placed 1 or 2 in. from the winding as shown in Fig. 5. This setting is not critical and the exact position had best be deter-

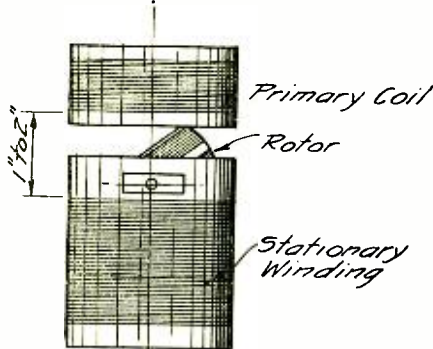

Fig. 5. Coil Placing

mined by experiment. This three circuit is just as efficient as if it had been built this way originally.

Those who are interested in building a good conventional three-circuit receiver which will give good results with a high degree of selectivity and extreme sensitiveness are referred to Fig. 6. The constants are given. This hook-up is almost identical with the famous Para-

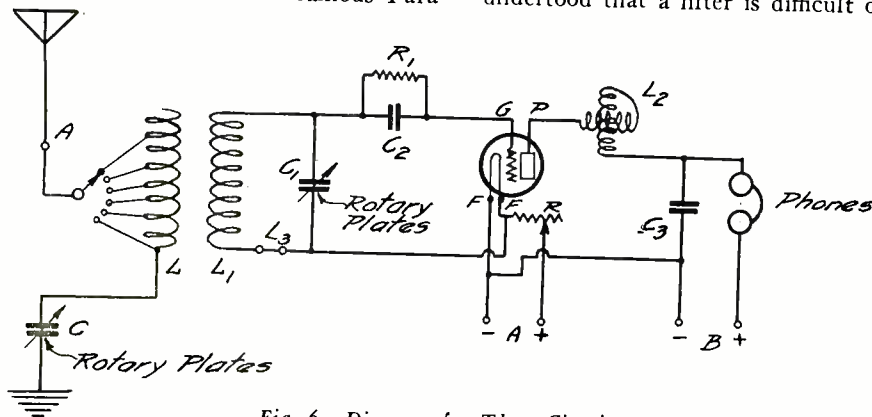

Fig. 6. Diagram for Three-Circuit Tuner

$L=60-80$ turns of No. 22 on 4" tube tapped every 10 turns.
 $L_1=50-60$ turns of No. 26 on $3\frac{1}{2}$ " rotor, not tapped.
 L and L_1 are the windings of a vario-coupler, L_3 is where the secondary load may be inserted.
 L_2 =short wave variometer.

gon RA-10. Those who are skeptical as to whether the three-circuit receiver is superior or not to the single-circuit receiver in sensitiveness and long distance reception will find by investigation that practically all long distance records are in the hands of operators with three-circuit receivers.

FILTERING SINK RECTIFIERS

By DR. A. E. BANKS, 6ZB

The demand for high voltage d.c. is on the increase since the advent of C.W. Of course a motor generator of liberal wattage is a wonderful thing but such apparatus is not available to the majority of amateurs. Most of us have turned to some form of rectified a.c. The writer was unable to obtain a mercury arc rectifier so has had no experience with one, but it would seem that theoretically this type should be ideal. A properly designed chemical rectifier is a most efficient type of apparatus and

roduction with a "sink" rectifier on account of "fireworks" at the brushes.

Let us see what happens. The rectifier is so arranged that the break occurs at zero voltage. Now when chokes and condensers are introduced as in a filter, we find that the condensers discharge in such a manner that the zero point is nullified and arcing follows. The transmitting tubes have high resistance at the distal end of the line. There is no resistance where the rectifier insulating segment breaks, the arcing therefore occurs at this point. It has been found that by introducing a resistance equal to, or a little greater than the total resistance of the transmitting tubes, on the rectifier side of the filter, and thereafter raising the potential of the rectifier d.c. to compensate for this, a filter works splendidly. The accompanying diagram explains the manner of introducing the resistance.

Arcing immediately disappears and it

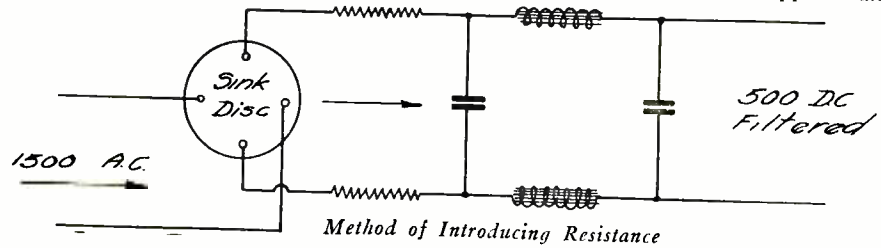

one which will within certain limitations give great satisfaction.

The "sink" rectifier has much to its credit. A number of Western amateurs have been using this type of rectification for months with satisfaction. The writer acquired one a few weeks ago and considerable opportunity for experiment developed immediately. In the first place "sink" rectifiers have become noted for their arcing at the brushes whenever attempts were made to dispense with the 60 cycle component from the transmitted signal. Several schemes have been tried but a regulation filter was not accepted, in fact it is generally understood that a filter is difficult of in-

only remains for the experimenter to have a properly designed filter in order to get obliteration of pulsations from his d.c. lines. High resistances suitable for introduction were not obtainable and the writer used two-watt carbon lamps in series, four on each side of the line. It would be preferable to have some more concentrated device and we are on the lookout for something which will pass sufficient current and at the same time have the desired resistance in the units.

It is hoped that this information will prove of interest to those amateurs who have so far failed in any attempt to introduce chokes and condensers in an effort to filter the output of their sinks. The credit for this method of procedure is due to Mr. Roy K. Freeman, to whom the writer appealed for help in working out a feasible plan.

Several amateurs have remarked that the resistances introduced in the "anti spark" circuit for Sink filters is not practical because of power waste. Attention is invited to the fact that with the use of Kenotron tubes there is a considerable drop, in fact it is hard to imagine how one can get something for nothing. The resistances may be balanced with a minimum of wastage and the improvement in operation will be more than compensated for.

If one desires to compute the expense of this additional resistance in the power supply it is believed that not more than two or three "bootlegs" per annum would cover the operating expense.

$C=.0005$ variable condenser (23 plate).
 $C_1=.0005$ variable condenser (23 plate).
 $C_2=.00025$ for Cunningham; .0005 for WD-11 tubes.
 $C_3=.0005$.
 $R=6$ ohm rheostat.
 $R_1=1\frac{1}{2}$ megohm for Cunningham, 1 megohm for WD-11.

A Portable "Super" for Broadcast Receiving

By L. W. Curtis

For simplicity and lightness of construction this portable "super" is well adapted for use with a loop in an automobile. It probably will be found to possess the usual skill in operation required by sets of this character.

SUPER-regeneration has received so much publicity recently that it is perhaps only natural that the extravagant claims made for it should be so generally believed. Some of the things that the super will do are really wonderful, but it has also very definite limitations. For local reception with little or no antenna the super will produce greater volume than any other circuit using the same number of tubes.

Its inherent defects, though, prevent its use with any satisfaction on weak signals. When it is operating properly it simply amplifies so much that local static and other disturbances will drown out anything but a strong signal.

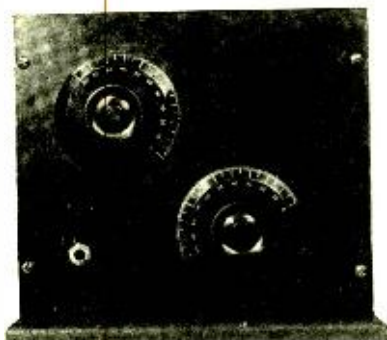

Panel for Portable Super

On local stuff the ordinary two-tube super will give about the same results as a good regenerator and one stage of audio amplification. But for anything over fifty miles the super is hopelessly outclassed.

The one-tube super, if constructed properly, will give practically the same results as the two-tube set and is the only one that has any noticeable advantages over the simple regenerator. With my one-tube super I have heard stations up to 800 miles, but the static is so bad that the results are usually unsatisfactory.

For nearby stations I can get almost as loud signals without using either antenna or ground but I would suggest that the experimenter use one of the two until he has the circuit operating properly. What I use most of the time is the grounded side of the electric light circuit. A loop in series with the C battery will give practically the same results as the ground.

Doubtless many have noticed the similarity between my hook-up and that originally given by Armstrong. The only real difference between the two is in the production of the variation frequency. While experimenting one night with the super hooked up in the conventional way I reversed the leads

to one of the large honeycombs and the set immediately picked up. Experimenting further, I found that with the coils connected in the reverse of the way they ordinarily are a weak oscillation was produced that gave much better results.

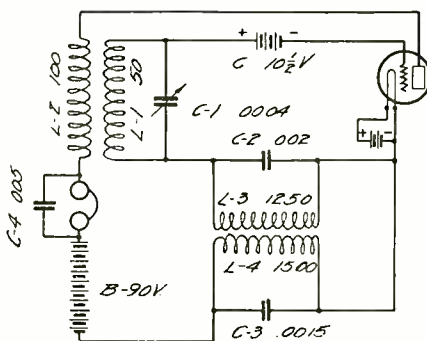

Hook-up for Portable Super

What I mean by "the reverse" is this: If the coils are hooked up and capacitively coupled it will be found that the tube will not oscillate unless the coils are connected in one particular way. If the leads to one of the coils are changed the oscillations will stop. However, if tight inductive coupling is substituted for capacitive and the correct constants used a comparatively weak oscillation will be produced. This oscillation is easily killed by a small amount of capacitive coupling so to be sure that you have the coils connected right, shunt a fixed condenser (anything over .0005) across the coils. That is, from the negative of the B to the lower end of the vario-coupler primary. If it doesn't oscillate it is connected up right. If it does, reverse the connections to one of the coils.

The value of the grid battery is very critical. It will vary from 9 to 12 volts if 90 volts are used on the plate.

L₁ is the primary of a vario-coupler; fifty turns on a 4-in. tube, tapped every ten turns. L₂ is the secondary, wound with 100 turns of No. 28 wire. With a VT2 or the new C-301A tubes, use only 30 of the primary turns. The C-301 tube doesn't oscillate as readily so requires a little closer coupling, about 40 turns. The C-301A works especially well in the "super." It oscillates as easily as the VT2 and of course is more economical. A filament rheostat is not essential with this circuit. If you have one keep it turned on all the way.

I haven't had a chance to try honeycomb coils instead of the vario-coupler but I don't see why they wouldn't work just as well. I would suggest 35 turns for the grid and 100 for the plate. If the vario-coupler is used it is very important that the unused turns be

shorted out. This can be easily done by connecting one end of the primary to the switch lever.

This hook-up will work with less than 90 volts on the plate, but of course will not amplify as much. If more than 90 volts are used it makes the operation more critical.

The variable condenser across the primary of the vario-coupler is a Varidon .0004. Anything up to .001 will work just as well. The fixed condenser across the 1250 turn coil is a .002 Dubilier. The condenser across the 1500 turn coil should be varied from .001 to .003 until best results are secured. I am using .0015.

When the set is assembled, separate the honeycomb coils several inches, set the variable condenser at minimum capacity and advance the tickler until a click is heard in the phones. If the high frequency oscillations do not start, reverse the leads to the tickler. With the tube oscillating at a radio frequency, couple the honeycombs tightly. Shunt a condenser across the honeycombs to see if they are connected correctly. If they are connected correctly and are coupled tightly together a roar should be heard in the phones as the tickler is advanced.

If the low frequency oscillations stop when the tickler is advanced, add more C battery. With the variation frequency working, connect the antenna to the grid, set the tickler at maximum, the variable condenser at minimum and vary both until signals are heard. After a station is tuned in vary the coupling between the oscillator coils for maximum amplification. The coupling will vary from 1/8 to 3/4 in. After the right position is found it can be set. I have mine fixed at 1/4 in.

If a loop is used it should be connected in series with the C battery. If a ground or antenna is used it should be connected to the grid or C battery. Until the operator is familiar with the circuit it might help to put a variable condenser in series with the antenna or ground. The hardest part of constructing the super is getting the variation frequency working properly. The actual tuning is easy.

10-METER RADIO TRANSMISSION

Paper No. 469, Part of Vol. 19, published by the Bureau of Standards, April 11th, deals with "Directive Radio Transmission On A Wavelength of 10 Meters." The contents of this paper are of unusual interest. 16 illustrations. It is edited by Francis W. Dunmore, Associate Physicist, and Francis H. Engel, Assistant Physicist of the Bureau of Standards. Copies can be purchased for 10c from the Superintendent of Documents, Government Printing Office, Washington, D. C.

Easily Made Capacities

By Carlos S. Mundt

This text with accompanying graph facilitates the computation of home-made condensers for radio purposes. It takes the place of some formidable mathematics and should be helpful to many an experimenter.

QUITE often the experimenter wishes certain values of capacity when experimenting with a new hook-up. He is somewhat taken aback on looking at the formulae, though he has the materials to make up a set of such capacities. It is the purpose of this article to show, by simple graphical analysis of the formulae involved, how to do the mathematical end of it with a minimum of figuring.

It has been found experimentally that capacity

- (1) increases with increase in plate area;
- (2) increases when plates are closer together;
- (3) changes with the dielectric substance.

Hence, from a consideration of (1) and (2), we see that it would pay to use large area and small plate spacing up to certain practical limits. This is why manufacturers are able to put out capacities of amazingly small sizes for their capacity value.

The third characteristic possibly requires some further explanation. It has been found by experiment that a given condenser using air as dielectric material will give a certain capacity value; but if a slab of paraffin be inserted between the plates the value will increase to a certain multiple of the original; further, if mica be inserted instead of paraffin a value will be noted as still a different multiple of the original (air) value. In short, every dielectric substance (paper, mica, rub-

ber, glass, etc.) shows a certain multiple of the original value. This is called the "dielectric constant" or "specific inductive capacity," usually designated by *K*. Values of this constant with air taken as standard are tabulated briefly here for various common substances and certain ones will be noted in the graphical treatment which follows:

Air	1.00	Paraffin	2.1
Mica (India		Paper	2.0
Ruby)	5.8	Shellac	3.1
Mica (Canadian Amber)	3.0		

For a condenser composed of two parallel metal plates of the same size and shape, separated by a uniform dielectric, we have

$$C = 0.0885 \frac{K S}{t}$$

Where *C* is the capacity in mmfds—
K is the dielectric constant;
S is the surface of one side of one plate in square centimeters;
t is the thickness in centimeters of the dielectric used.

Analysis of this formula shows that small values of *t* with large values of *K* and *S* will give the largest possible values of *C*.

Using the above formula, graphs have been drawn for several commonly required values of *K* and different thicknesses of dielectric substance, restricting ourselves, however, to reasonable values for *S* so as to keep the condenser small in size. It is to be noted

that the surfaces may take any rectangular shape; i.e., 10 sq. cm. may be made up as 5x2 cm. or 10x1 cm. or 2½x4 cm., thus allowing the maker to use whichever shape suits his wishes. If you are not certain of the thickness of the dielectric then obtain a measurement by micrometer calipers, such as are often found in the physics laboratory and are supplied by nearly all laboratory supply houses. If no calipers are available you may judge the thickness roughly by comparison with certain known B. & S. standard wire gauges—a less accurate method, but one which is sufficiently so for our purposes. These are tabulated as follows:

B. & S. No.	<i>t</i> in cm. (diameter)
12	0.20
18	0.10
20	0.08
24	0.05
26	0.04
29	0.03
32	0.02
38	0.01
40	0.008

Note that capacities in parallel give a capacity which is equal to the sum of the separate values. Hence, making a set of four or five will give many other values by combining in this manner.

An example of the use of the graph: Let us ask what plate surface will be required to make a condenser of cap.=.00025, the dielectric being Canadian Amber Mica (*K*=3) of thickness .02 cm. Now .00025 mfd. is changed to mmfd. by multiplying by 1,000,000 and pointing off five places, yielding 250 mmfd. Taking the horizontal axis for *C*, which is labeled *K*=3, go out to the right until reaching 250 (almost two squares to right of the 225 mark). Now follow up until intersecting the .02 line as graphed. From this intersection follow over to the left along the horizontal until you strike the *S* (vertical) axis, where the value is read, turning out about 9.5 sq. cm.

Another example: Required the capacity of a condenser in which *S*=12 sq. cm., *K*=6 (India Ruby Mica), *t*=.01 cm. Follow up the *S* (vertical) axis to 12, then out horizontally until the intersection with the .01 graph is found; thence vertically downward until the *C* scale for *K*=6 is reached, where the value is read as 650 mmfd. (approximately). This is changed to mfd. by dividing by 1,000,000, yielding .00065 mfd.

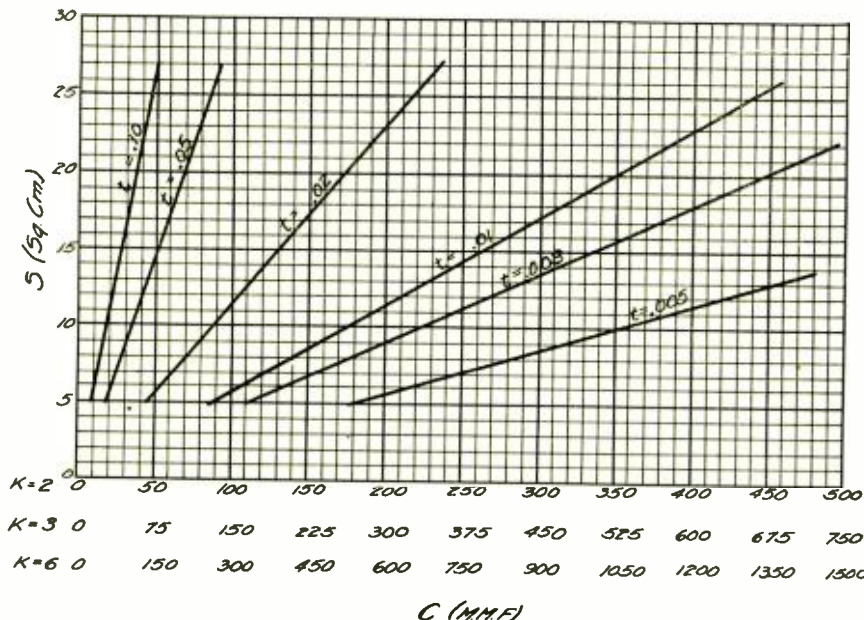

Graph for Figuring Capacities

Radio Frequency Measurements With a Wheatstone Bridge

By Bernard Steinmetz

There is much pleasure and information to be gained from radio measurements. Even with the simple apparatus here described the experimenter can learn the constants of rheostats, inductance coils and condensers. While different from the usual run of radio articles, this should prove of interest to many readers.

THE radio amateur frequently has occasion to make measurements of his coils and condensers but is often unable to do so because of lack of measuring apparatus. He very seldom has measuring apparatus around his station because of the feeling that measuring apparatus must be elaborate and expensive. This feeling is entirely wrong and it will be the object of this article, therefore, to show how a very simple and inexpensive measuring equipment may be set up by every amateur and how it is utilized in various radio measurements.

The radio measuring equipment here to be considered is an application of the Wheatstone bridge to radio work. Its theory will be given here briefly for the benefit of those radio fans that are not familiar with it. Fig. 1 represents a network of four resistances, R_1 , R_2 , R_3 and R_4 , connected as shown. Across two terminals C and D is connected a very sensitive instrument such as a galvanometer or delicate voltmeter. A battery B is connected between the other two terminals, E and F . Now current from the battery has two paths to flow through: (1) From battery B to E through R_1 to C through R_2 to F and back to the battery; and (2) From battery B to E through R_3 to D through R_4 to F and back to the battery. Thus the same current flows through R_1 and R_2 . Let us call this current i_1 . Also the same current which flows through R_3 flows through R_4 . Let us call this current i_2 .

The voltmeter across points C and D will indicate whether any current flows from C to D . If the voltmeter registers there is such a flow of current. If it does not register there is no flow of current between C and D , which means that points C and D are at the same potential. Now whether or not there is a flow of current between points C and D depends entirely upon the value of the various resistances and by adjusting them we can get a set of values for them which will result in no current flowing from C to D . In other words, by adjusting the values of the different resistances in this bridge, we can bring points C and D to the same electric potential.

Let us suppose that such an adjustment has been made. The voltmeter V will therefore not be deflected. The currents through the different resistances are shown in Fig. 1. Since point C is

at the same potential as point D , it follows that the voltage drop from E to C must be the same as the voltage drop from E to D . But these voltages are given by $R_1 i_1$ and $R_3 i_2$ respectively. Therefore

$$R_1 i_1 = R_3 i_2 \quad (1)$$

In the same way the voltage drop between F and C must be equal to the

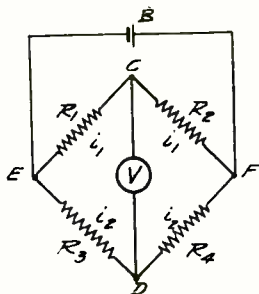

Fig. 1. Principle of Wheatstone Bridge

voltage drop between F and D . Therefore

$$R_2 i_1 = R_4 i_2 \quad (2)$$

If we divide equation (1) by equation (2) we get the following results:

$$\frac{R_1}{R_2} = \frac{R_3}{R_4}$$

Therefore

$$R_3 = R_4 \times \frac{R_1}{R_2} \quad (3)$$

In other words, by adjusting the resistances R_1 and R_2 we can secure a balance and so determine the value of one resistance, say R_3 , in terms of the other.

The important point to observe here is that it is not important to know the absolute values of R_1 and R_2 . What we have to know is the ratio between R_1 and R_2 . Knowing this ratio, all we need to know is one resistance, R_4 , and we are then able to determine or measure any unknown resistance, R_3 .

Suppose then, that in place of the resistances R_1 and R_2 we connect a uniform resistance wire l as in Fig. 2, with a sliding contact from the voltmeter running along the length of the resistance wire, called a "slide wire." It will be observed by comparing Figs. 1 and 2 that these two networks are identical, except that in place of a resistance R_1 we have a portion of a resistance wire, namely m in Fig. 2, and in place of R_2 we have another portion of a resistance wire, namely n . However m

is a resistance and so is n . The proportioning of the resistance of m and n is easily made by means of the sliding contact which alters the length of wire in m and n , and thus alters the resistance.

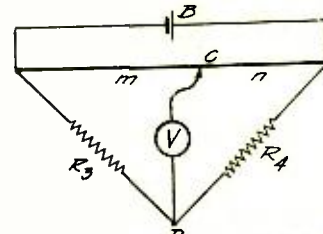

Fig. 2. Wheatstone Bridge with Slide Wire

Thus by simply sliding this contact along the wire l we can make an easy adjustment of the resistances m and n which will result in a balance, that is no current through V . In this case from equation (3) we have the following:

$$R_3 = R_4 \times \frac{\text{Resistance of wire } m}{\text{Resistance of wire } n}$$

But if the entire wire l is uniform the resistance of m is directly proportional to the length of m , and the same thing holds true of n . Thus the above immediately becomes

$$R_3 = R_4 \times \frac{\text{length of } m}{\text{length of } n} = R_4 \times \frac{m}{n}$$

In other words all we require for such a measuring apparatus is a wire of uniform diameter along which a sliding contact can be made, one standard resistance R_4 , and an indicating device. If the wire is laid along the length of a ruler between E and F , say along a meter stick having 100 divisions, then no matter where the sliding contact is we can tell at a glance what m and n are. Suppose that the slider is moved along the wire and that a balance is secured at 43, counting from E , Fig. 2. Then m is 43 and n is 100 minus 43 or 57. Thus knowing what R_4 is, and what the ratio of m to n is, we can immediately tell what the unknown resistance R_3 is.

This is called the Wheatstone "slide wire" bridge and the above is its theory as far as measurement of plain resistances goes. The same principle may be utilized in the measurement of inductances and capacities as employed in radio work. Let us take each case up separately.

In the first place inductances and capacities as used in radio are used with alternating currents. Hence measure-

ments should be carried out with alternating currents. Now in the explanation of the fundamental theory direct current was used from a battery, hence we could use a delicate voltmeter as a balancing instrument. However, if alternating currents are used instead of direct we will have to employ another device instead of the voltmeter to tell us when a balance has been secured, that is when there is no flow of current from point C to point D of the Wheatstone

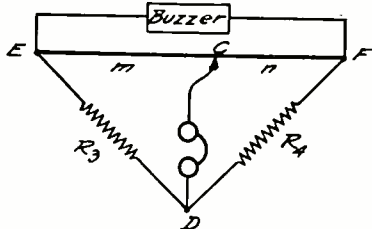

Fig. 3. Telephones As Balance Indicator

bridge. Fig. 3 illustrates what is used. Suppose that source of voltage B is not a battery but a buzzer which gives an alternating current through the various arms of the bridge. If this alternating current flows through a pair of telephones a sound will be heard. If none of the alternating current flows through the telephones no sound is heard. We could then use these telephones as our balance indicator instead of the voltmeter, as in Fig. 3. The Wheatstone bridge is then balanced by varying the arms of the bridge m and n by means of the sliding contact until no sound is heard in the telephones, or until a minimum sound is heard. This is the condition of balance. A minimum sound is stated, rather than no sound, because it may be impossible to secure a zero sound balance on account of induction and stray capacity effects. Knowing this we may now consider the case of measuring the inductance of a coil by means of a bridge.

Inductance Measurement

The use of the bridge in inductance measurements is shown in Fig. 4, where m and n are the slide wire arms of the bridge, X is an unknown coil whose in-

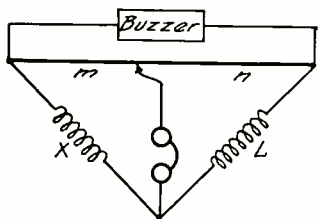

Fig. 4. Inductance Measurement

ductance is to be measured, and L is a known inductance. The theory of this measurement shows, as in the case of the resistance measurement, that when the slider is moved until a balance is secured, no sound or a minimum sound in the phones, then the following relation is true:

$$\frac{X}{L} = \frac{m}{n}, \text{ therefore } X = L \times \frac{m}{n}$$

Thus if a single standard inductance and slide wire bridge, with phones and buzzer, are available inductances may be measured easily. This relationship is true as it stands provided the unknown inductance is of the same order of magnitude as the standard. Thus it would be obvious that inaccuracies would arise if the standard inductance was about 0.1 millihenry, while the unknown inductance were 10 millihenrys. For then the ratio of m to n would be too great to secure a balance. Best and most accurate results are obtained when the ratio of m to n is in the neighborhood of 1 or 2, for then a sharp balance is secured.

For those amateurs who are interested in accurate, precision measurements with a bridge the following notes will be of great interest. The above formula for the inductance is sufficiently accurate for all practical purposes. However, it neglects a very important factor, namely the resistance of the inductance coils. If there is a great discrepancy between the resistances of the two coils it is quite possible that a sharp balance will not be obtained. Balancing a Wheatstone bridge is somewhat analogous to tuning a radio frequency circuit. Resistance in a radio circuit results in extremely broad tuning. Balancing a Wheatstone bridge is equivalent to reducing the resistance, and thus enables sharp balance or tuning. If the resistances of the coils are not balanced, then, even if a balance is secured for the inductances, a sharp balance will not be secured, and hence the accuracy of the measurement will be destroyed. For it is clear from the foregoing that the accuracy of measurement in a Wheatstone bridge depends upon the sharpness of the balance.

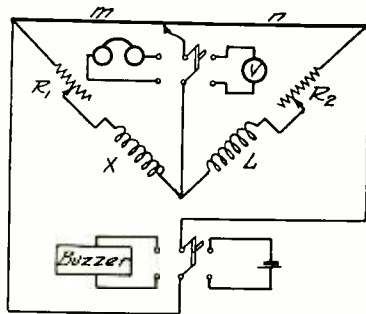

Fig. 5. Accurate Measurement of Civil Inductance and Resistance

Since all inductance coils have some resistance a more correct illustration of the state of affairs in the bridge is as shown in Fig. 5, where each coil has its corresponding resistance. For precision measurements it is necessary to strike a balance for the resistances of the coils and for their inductances. The resistance balance is secured by means of a voltmeter indicator and a battery for the source of supply, while the inductance balance is secured by means of the buz-

zer and telephones. The actual circuit connections are shown in Fig. 5. We have two D. P. D. T. switches: one is for switching on either the buzzer or d.c. battery for source of current; the other is for switching on either telephones or voltmeter for the corresponding balance indicator. The battery and voltmeter are used to secure a direct current resistance balance, while the buzzer and telephones are used for the alternating current inductance balance. In series with each of the inductances is placed a variable resistance which enables balancing the inductance arms for resistance.

The method used for this accurate test is as follows: First a balance is secured for alternating current. The D. P. D. T. switches are both thrown so that the buzzer and telephones are used. The sliding contact on the wire is varied until a balance is secured. The switches are now thrown so that battery and voltmeter are in circuit. With the sliding contact fixed at the position previously obtained vary resistances R1 and R2 until the voltmeter indicates a balance by zero reflection. Now switch over to the buzzer and phones and vary sliding contact until balance is obtained as indicated by minimum sound in phones. Again switch to battery and voltmeter and keeping sliding contact fixed in the new position previously found vary R1 and R2 until balance is secured. Alternate this way until a very sharp direct and alternating current is obtained. Then note the values of m and n and apply the above formula:

$$X = L \times \frac{m}{n}$$

It will be noted that the important adjustment of the sliding contact was not disturbed in balancing the resistances, since this was done by means of the resistances R1 and R2. This is so arranged since the important adjustment of the slider determines the inductance measurement. The above formula is absolutely correct and based upon both types of balance thus obtained.

Capacity Measurement

Unknown capacities may be measured in a similar manner by the Wheatstone slide wire bridge, there being required but one known capacity. The circuit for this measurement is shown in Fig. 6, in which Cx is the unknown capacity, Cn is the known capacity and m and n are the lengths of the two arms of the slide wire when they have been adjusted for a balance, that is for a minimum sound in the telephones. When such a balance has been obtained it may be shown by a mathematical analysis that the unknown capacity is given by the following formula:

$$C_x = C_n \times \frac{n}{m}$$

Thus if a variable air condenser is calibrated and used as a standard a very large range of capacities may be measured very simply. Thus the slider is set at the midpoint of the length of the wire, making m equal to n . The vari-

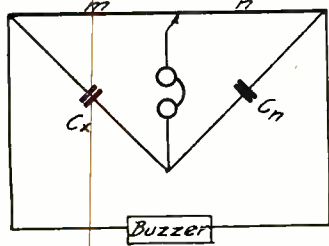

Fig. 6. Measurement of Capacity

able air standard is then varied until a balance is secured. Then whatever the variable air condenser reads will be the capacity of the unknown condenser, since m and n are equal.

In the measurement of capacities the question of the effective resistance of the condenser enters exactly as in the measurement of inductance. In the case of air condensers this question does not occur since the resistance of an air condenser is almost zero. However, where different dielectrics are employed there may be considerable difference in their resistances and it will be impossible to secure a silent point in the phones. However, in the usual case it is possible to secure a fair balance point. Due to the insulating qualities of the condensers it is not possible to balance the bridge for direct currents, as with inductances. However, as stated above, it is generally found that a good balance is secured, giving quite fair accuracy in measurement.

In all these measurements employing a buzzer to supply the alternating current to the bridge it is advisable to take the precaution of setting the buzzer at some distance from the bridge or muffling its sound in some way. If too close to the observer and the sound is not muffled it is very difficult for the observer to tell whether the note in his telephones is due to current flowing through them, or whether it is direct noise from the buzzer. The writer has found that setting the buzzer in a box and surrounding the buzzer with absorbent cotton will generally muffle the direct buzzer noise excellently. If at the same time it is kept a few feet from the bridge the observer will have no difficulty due to buzzer noise.

In the construction of the bridge all that is required is a meter rule which is divided into 100 centimeter divisions, and a uniform resistance wire having a length of 100 centimeters. The wire may be any of the standard brands, such as nichrome, German silver, manganin, etc., and its gauge may well be No. 20 or No. 22 B&S. Uniformity of cross-section is an extremely important pre-

requisite, since the resistances of the two arms of the slide wire are proportional to their lengths only if their cross sections are equal. Be careful, therefore, to secure uniform wire. The wire is stretched along the length of the meter rule and fastened down at the two ends, 0 and 100, either by means of heavy metal blocks, or by means of two heavy binding posts. These two binding posts should have at least two connection points each so that connections from the other parts of the circuits may be made to them. If necessary two binding posts should be used at each end. The connections of the wire terminals to the end blocks or binding posts should be positive connections, as poor connections mean added resistance, and any added resistance to the bridge means that the balance is spoiled and accuracy is lost. All wire connections from other parts of the bridge circuit as the external resistances and condensers should also, therefore, be tight and positive. For a slider a flexible wire, such as rubber-covered lamp cord, may be soldered to one end of a thin brass rod, the other end being ground down to a knife edge. This edge is run along the wire, pressed tightly against it, thus securing good contact. Having these items, all that is required is the buzzer, battery (dry cells), phones, and condenser and inductance standards.

The buzzer, phones, dry cells are generally found around any amateur station. A variable condenser is always available also, and this can be calibrated and used as a standard. For inductances, the amateur may use the different honeycomb coils, or build some on glass tubes, and make standards out of them. The only extra cost, therefore, is the cost of the meter stick and resistance wire, which comes to practically nothing. The use to which this bridge can be put will repay any amateur for the trouble in putting it together, and it will give him something else to do besides receive and send. Measuring radio constants is an art in itself and should be learned by all amateurs. This bridge will give him his start.

How to Adapt Your Tube Rectifier to Charge Storage B Batteries By 7KS

Supplementing Mr. Stuart A. Henrick's (2BJG) article on making a Tube Rectifier in February, 1923, for those who have made up one of these rectifiers, and who are using storage B batteries, the following may be of interest.

I have been using my rectifier for charging storage B batteries for some time past, with very good results, and by switching arrangement shown can change circuit to charge either A or B batteries.

The regular tungar circuit, for A

battery, and also the circuit when charging storage B batteries are shown herewith.

I have not seen this arrangement published before, and thought probably some of the amateurs, as well as the

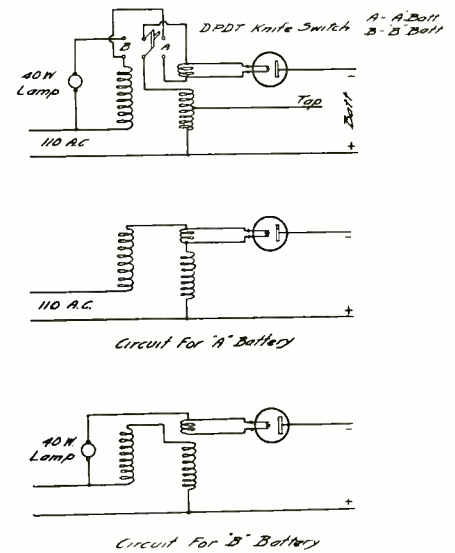

B C Ls, would have use for same. Would be pleased to answer any questions regarding same. I might also state it works FB for forming plates for a chemical rectifier, for C. W. transmitters.

Audio - Frequency Amplifier Unit for Simple Radio Receiving Set

Very simple radio receiving outfits are described in a series of circulars issued by the Bureau of Standards of the Department of Commerce, and published at the request of the States Relation Service of the Department of Agriculture. The circulars are fully illustrated.

The first two, which are Bureau of Standards Circulars Nos. 120 and 121 describe receiving sets using crystal detectors. Circular 120 describes the receiving antenna and ground connection also.

Circular No. 133 describes an electron tube detector unit which can be substituted for the crystal detector in either of the two sets previously described.

Circular No. 137 describes telephone shunt and series antenna condensers and a loading coil for use with the simple receiving sets.

The fifth circular of this series is Circular No. 141. It describes an audio frequency amplifier unit of such proportions that in external appearance it matches the electron tube detector unit. One or two of these amplifier units may be used with the equipment previously described to amplify the signals detected by the electron tube detector unit, or the detector unit may be omitted and one or two amplifier units used with the crystal detector. In either case the addition of the amplifier units results in a considerable increase of the volume of the received signal and increases the receiving range somewhat.

Copies of these circulars may be obtained from the Superintendent of Documents, Government Printing Office, Washington, D. C. The price of Circular 141 is 10 cents. The others are 5 cents each.

An Old Dog Learns a New Trick

(A "Spark's McAllister" Story)

By Sewell Peaslee Wright

This time Wildcat has made a real discovery, something useful as well as ornamental. Here is a "kink" so good that it is a wonder some one did not think of it before. To find it out you have only to read the story.

"SPIDER-WEBS" pronounced Sparks McAllister didactically, "are the gnat's eyebrows for radio work, especially for short-wave stuff. Spider-webs and basket-weaves," he amended.

"Guess you're right," admitted Wildcat, blowing a fragrant cloud of cigarette smoke towards the ceiling. "I'm using them in half a dozen forms, I guess; Reinartz, single circuit, and a lot of trick radio freaks and reflex hook-ups that I've been trying out."

"Jever try them as the movable coil of a variocoupler?" asked Sparks, interestedly. "I used to have a lot of trouble getting a doggone tube that would revolve inside of the main inductance, until I hit on the idea of using a spider-web for the revolving coil. 'Course, if I'd had a regular variometer rotor, that would have been all right, but they're never handy when you want 'em."

Wildcat flicked the ashes from his cigarette with an air of superior wisdom—if you don't think ashes can be flicked from a cigarette in this fashion, just watch any eighteen-year-old do his stuff. You'll be surprised.

"Yeah," he drawled, "that's old stuff. What I'd like to ask you is, what do you use on your coils to keep them in place?"

"Collodion is the best think I know of," admitted Sparks. "It's pretty good, if you learn how to apply it quickly and evenly, but it isn't very strong, at that. Better than shellac, tho, as it has practically no effect on the value of the coil."

"What would you say, my child, if I should tell you that I knew of a substance that makes a spider-web as rigid as a sheet of tin, without having any effect on the inductance or distributed capacity, and yet which is obtainable in any drug store at very, very low prices?"

"I'd say," retorted Sparks, "that you were either an awful liar, or a discoverer of something mighty good!"

Wildcat turned around and opened a drawer in his operating table. He fished around in the interior for several minutes during which time the smoke from his cigarette nearly choked him, much to the amusement of Sparks, who puffed calmly away on his fearsome old briar, his head enveloped in a cloud of smoke that would have asphyxiated any ordinary mortal. Finally Wildcat found what he was looking for.

"Cast your eagle eye over that, son," he crowed. "Ever see a spider-web as solid as that? Drop it edge-wise on the

floor—throw it down, for that matter—and see if you can hurt it."

He tossed the coil to Sparks, who took him at his word, and slammed it sharply to the floor. The thin coil of wire struck edge-wise, bounced, and rolled over on its side—uninjured.

Sparks leaned forward and picked up the coil. It looked like an ordinary spider-web, except that it was covered with a thin glaze, exactly as tho the coil had been dipped into molten glass, and dried. It was perfectly rigid, almost as solid as tho every wire was soldered in place.

"By George, sonny, I'll give you credit!" congratulated Sparks. "This is sure a new one on me! What is it?"

Wildcat grinned so broadly that for a moment it looked as tho his mouth was about to engulf his entire countenance, or at least, sever it into two sections. Praise from Sparks McAllister was praise indeed.

"Don't you wish you knew?" he countered, unable to resist the temptation to gloat.

"Um-m-m-m-m!" remarked Sparks calmly, puffing away as tho uninterested in anything but polluting the atmosphere. "Was there anything new at the last meeting? The Mrs. wasn't feeling very well, so I couldn't get down, and—"

Wildcat could contain his secret no longer.

"It's water-glass!" he exploded. "Just the plain, ordinary egg-preserving variety of water-glass. Electrical engineer from the East told a friend of mine about it, and he told me—You just dip the coil in the water-glass, or paint it on with a clean brush, and then bake the coil for about twenty or thirty minutes in a 'medium oven,' as the cook books say—isn't that simple, what?"

Sparks laughed at the success of his little ruse and the enthusiasm of his young friend.

"Sounds like a real discovery, all right," he admitted. "It sure is worth a trial."

"I'll say it is!" exclaimed Wildcat. "Just fix up some spider-webs wound with green silk covered wire, and see if it doesn't make one of the prettiest jobs you ever saw. The green glistens thru the clear coating just as tho it were covered with crystal—that's right, laugh, you hyena! Just because your sets always look like something the cat brought in and couldn't eat is no sign

that nobody takes a little pride in a nice-looking set!"

"I graduated from the pretty brass and nickel plated stage back in the days when the more knobs, dials, screws, switches, straps, bolts, nuts, gadgets and thing-a-ma-bobs we could crowd onto our panels the happier we were. 'Giving the set a commercial look,' we used to call it!" He laughed reminiscently. "Those were the good old days! Ten kilowatts if you could get the transformer, and all wave lengths in the world to work on. Talk to commercial operators or anybody else, and if they jammed you, you could jam right back. Everybody made their own calls; initials or any fancy combination with a 'swing' to it that might take their fancy. A hundred miles at night was DX work —"

"Dry up! Come down to date!" interrupted Wildcat. "Why dwell in the past, when you've got supers and reflexes and radio frequency and all that sort of dope to monkey with in the glorious present?"

"For the same reason, sonny, that you and a few other birds are roaring away with a much-ado-about-nothing spark set when with my little, quiet, economical ten watts I can sneak in where your wave has never penetrated. Why, just the night before last, when you fellows were all down to the meeting, I worked—"

"Again?" wailed Wildcat dejectedly. "Let me tell it—I know it all by heart!"

Sparks preserved a dignified silence.

"Water-glass as a coil varnish," he meditated. "First they used it to preserve eggs with, now they use it to preserve radio coils. How the world do move!"

BOOK REVIEW

RADIO OPERATOR'S HANDBOOK, published by the International Correspondence Schools, Scranton, Pa., is a 570-page pocket-size book containing more than the ordinary amount of practical radio information. It is illustrated with many diagrams and sketches. It describes, in a very simple manner, the various types of radio equipment in use today. General Conversion Factors, wire tables, weights and measures, decimal equivalents, list of radio transmitting stations, radio compass data, six pages of white space for memoranda and many useful formulae make this Handbook one of the most complete radio books on the market. It is heavily bound in cloth. The retail price is one dollar per copy.

A Better Receiving Set for the Expert

By Six Zee Jay

Following up his article on the use of a coupled plate and grid circuit in a single circuit receiver as published in March RADIO, the author here applies it to a three circuit regenerative receiver. A subsequent article will tell of its application to radio frequency amplification, the Gibbons circuit, tickler feed back, and Armstrong's single tube super-regenerative circuit.

MOST regenerative receiving sets, made by the experimenter, never seem to just come up to the standard of a reliable factory built receiver. Unless the experimenter has built at least a half a dozen receivers he will not discover the mechanical and electrical ingenuities that the manufacturers guard so zealously. The average radio experimenter cannot find out these constructional "kinks" due to a slim pocketbook, but fortunately there are a few that have made more or less exhaustive researches along this line, and who are able to enlighten those less informed thru the columns of radio periodicals.

The writer has built numerous receiving sets with varying results and has experimented with many circuits. In his opinion, the best of those for short wavelengths is that here described. It is a three-circuit regenerative receiver, with selective characteristics far above the standard two-variometer and tickler circuits. Moreover, the increased signal strength over the conventional circuits, make it well worth while.

The parts needed are listed below:

- 1 Wooden form variometer (wound with No. 22 D. C. C. copper wire.)
- 1 3½ in. bakelite or fiber tube 6 in. long.
- 1 Vario-coupler parts with tube 5 in. long. ½ lb. No. 22 D. C. C. copper wire.
- 1 23 plate variable condenser.
- 2 Switches (levers and knobs for contact points).
- 16 Primary contact points.
- 6 Secondary-load contact points.
- 1 VT socket (with wiping contacts).
- 1 Grid condenser.
- 1 Rheostat.
- 2 4 in. dials.
- 1 3 in. dial.
- 8 Binding posts.
- 1 6"x21"x3/16" bakelite or other panel.
- 1 Soft pine base 6"x20"x1".
- 1 Battery connection panel 1"x6"x3/16".

The variocoupler primary is wound with 100 turns of No. 22 D. C. C. copper wire, bringing taps out at the following turns: 5th, 9th, 12th, 15th, 19th, 24th, 28th, 32nd, 42nd, 47th, 53rd, 58th, 68th, 78th, 88th and 100th—the end of winding. This gives a close enough variation of the antenna circuit on the shorter waves and fairly good on longer waves. Usually, a variable condenser is connected in series with the ground for the short-waves and in shunt for the longer, so even if it was merely tapped at every tenth turn, the results would be approximately the same. However, a variation of about five turns has been found by the writer to give better results, be-

cause it is quite often found necessary to use large values of capacity and a small amount of inductance and vice versa, to obtain maximum results.

The rotor ball should have a winding space of about ¼ in. on each side. If

reader was cautioned to wind the inductance in the same direction as the variometer windings. However, either way will function, because in this case we have currents in the grid-antenna circuit rotating in both directions.

The circuit connections are shown in Fig. 1. Circuit students will immedi-

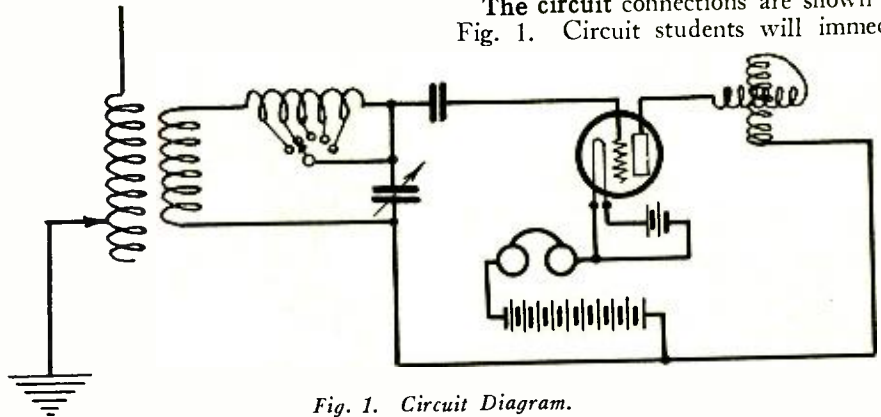

Fig. 1. Circuit Diagram.

it hasn't, wind the ball with smaller wire—No. 24 or 26. Otherwise, wind with No. 22 D. C. C. copper wire.

The variometer secondary lead unit employs a coupling of the grid and plate circuits to obtain further selectivity over three circuit methods and increased regenerative amplification.

A tube 3½ in. in diameter and 6 in. long is wound with 70 turns of No. 22 D. C. C. copper wire, bringing out taps at the 20th, 30th, 40th, 50th, 60th and 70th turn. Leave a space of about ½ in. from the right hand end of the tube, before winding, so that two small sheet-brass angles can be fastened to hold the inductance to the variometer. Using two wood screws, fasten the inductance to the left side of the variometer.

The windings of the inductance and variometer are in opposite directions. This is necessary due to the inherent flow of current in the grid and plate circuits. With the single coil circuit, described in the March RADIO, the

atly recognize this as the famous Paragon circuit, with a few improvements. This circuit has been accepted as one of the most efficient and stable for regenerative amplification. But to couple the grid and plate circuits is not generally known.

Inter-connections of all parts are made with No. 16 hard-drawn bare copper wire. Too large connecting wire (and if covered with cambric sleeving or rubber tubing) will increase the distributed capacity between the relative leads. Very little tubing need be used and then only in places where the utmost insulation is imperative—such as to cover leads from the inductances to the contact points. As has been pointed out by various writers, from time to time, do not run leads parallel and avoid lengthy leads by not making square corners, consistent with general practice.

Bus-bar connections are not recommended because of their comparatively large surface area, thus contributing to the capacity between leads—acting as miniature condensers. Furthermore, bus-

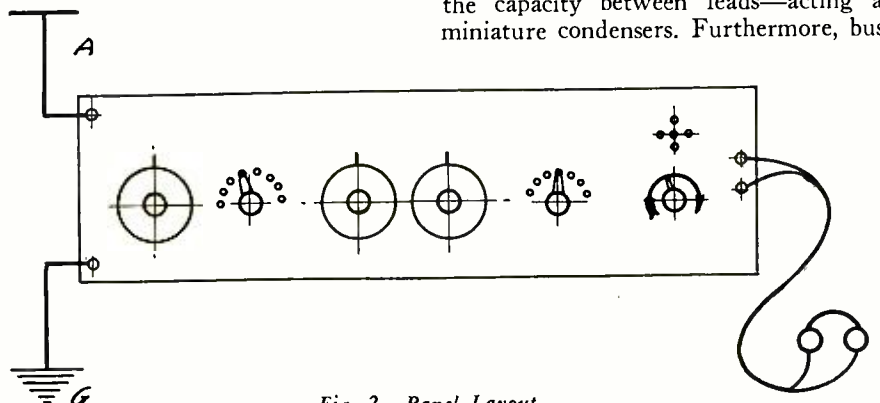

Fig. 2. Panel Layout.

bar usually comes tinned, which is undesirable for the following reasons: It is a recognized fact that radio frequency currents flow on an outside path of the conductor, better known as the "skin effect." Now, if the conductor is covered with tin, the currents will travel thru it, and, as tin is a very poor conductor, it will offer an objectionable resistance, maybe not noticeable to us, but present tho, nevertheless. Silver-plated bus-bar, however, is entirely different and is recommended if it can be had, but should not have a surface area larger than a No. 14 copper wire.

The panel layout is illustrated in Fig. 2. Starting from the extreme left end, the controls are as follows: Antenna inductance control switch; coupling control; variable condenser control; variometer control; secondary load control switch and tube rheostat control. (A rheostat with a micrometer adjustment is almost necessary with present-day critical tubes, so should be included in the set for best results).

A small bakelite panel approximately 1 in. by 6 in. by 3/16 in. is used to mount the binding posts for the batteries and is fastened to the wood base in the rear—thus eliminating the inconvenience of running wires to the front of panel, which will materially add to the appearance of the set.

Quite often one makes numerous mistakes in marking and drilling the panel, thus wasting material, money and patience. However, if proper tools are used for laying out the panel, this waste can all be dispensed with and a much neater panel will result. The work will be such that the experimenter will be satisfied and proud of his handiwork. For this delicate work, the writer uses the following tools: Yankee hand-drill (with about a dozen different sized drills), a pair of calipers, a steel rule, a small sharp-pointed punch; a small, light hammer and a steel square. When the panel is accurately marked with the proper tools, it is so much easier to drill correctly.

BUILDING A WOODEN ANTENNA TOWER

By W. G. GROSS

THIS antenna tower can be built by anyone who can measure and use a hammer and saw. It is rigid, strong, light and easy to erect. The cost for a 75- or 100-ft. tower is considerably less than a pipe or steel tower. My own tower was made with clear spruce, which is easy to work, strong, light and can be obtained anywhere.

The design is for a four-legged tower, 75 ft. high and tapering from a 4-ft. cross-section at the base to 1 ft. at the top. The four corner pieces are 2x2, while all the cross braces are 1x2. Cross bracing is placed every 5 ft. for the lower 30 ft, every 4 ft. for the center 28 ft. and every 3 ft. at the top

17 ft. The inside of the tower is cross-guyed at every cross brace with No. 8 wire. The cross-guying on the inside is the backbone of this tower and care should be taken that all wires are tuned up tight, in the same manner that an aeroplane fuselage is guyed. The guying is done last, with the tower lying level, as the tower will hold the shape it is lying in when guyed.

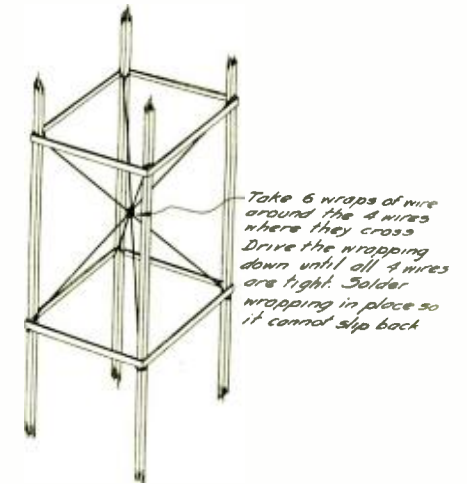
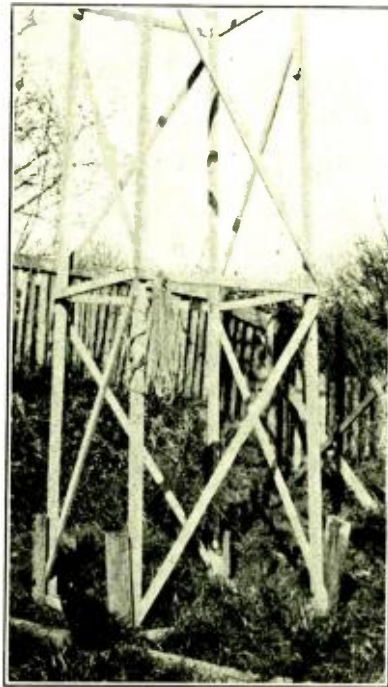

FIG. 2

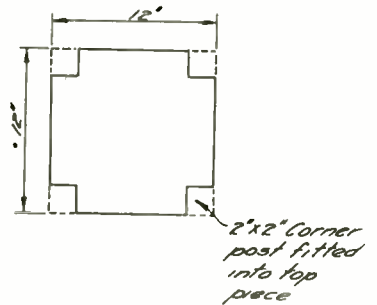

FIG. 3

A simple way of tuning up the guy wires is shown in Fig. 1. The splices in the 2x2's were made every 16 or 18 ft., with no two splices coming opposite each other. A simple form of splice is shown in Fig. 2. A 2-in. block 12 in. square is at the top with the four cornerpieces fitted into it as in Fig. 3.

Cleats are provided for climbing. Only four guy wires are required and these should not be smaller than No. 2 stranded cable. The guy wires are installed 15 ft. from the top. All guy wires, pulley and antenna cable should be in place before raising the tower, but if any changes are to be made after the tower is set up, one can climb to the top of this tower with perfect safety.

The tower is raised in one piece with

as in Fig. 4 and drill a 1/2-in. hole through the base supports and the 2x2's of the tower. Now put a 1/2-in. bolt through the 2x2's and the base support. This will prevent the tower from raising up at the base when you start to raise it and also act as a hinge, keeping the tower straight and in line while raising.

Continued on page 79

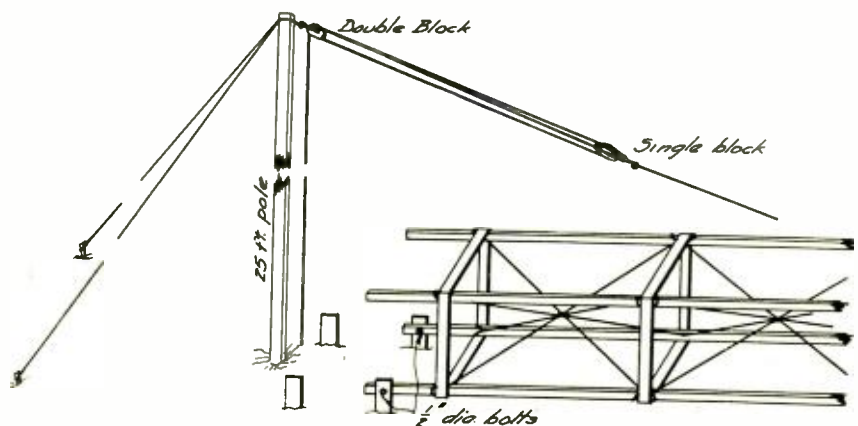

Reduction of Resistance by Use of a Counterpoise

By Maurice Buchbinder

After briefly reviewing the theory of antenna resistance the author shows how and why this may be reduced by using a counterpoise. The theory is illustrated by practical applications so that thereby the amateur may intelligently design his own counterpoise.

THE resistance of any antenna, whether for receiving or transmitting is due to three distinct factors. First and most important is radiation resistance. This, in a transmitting antenna, represents the energy sent out usefully into space. It is the factor which multiplied by the mean square of the antenna current gives the power radiated: In the receiving antenna radiation resistance is also of prime importance because when a receiving system is working most efficiently the energy used to produce sound signals tends to equal the energy re-radiated. Hence if we hope to obtain great signal strength we must expect a correspondingly large amount of re-radiation.

The other two factors are dielectric or ground loss, and ohmic loss. These are dead losses on the circuit. It is the object of good antenna design to reduce them to a minimum: In the course of this article it is shown how the use of a counterpoise greatly decreases dielectric and ohmic loss, at the same time keeping radiation substantially constant.

By dielectric loss is meant the power dissipated on account of the fact that the dielectric, e. g. the space between antenna and ground, contains substances of poor dielectric qualities, such as vegetation, dry earth, structures and the like. The effect is as though there were interposed between the plates of an air condenser some substance possessing a considerable amount of dielectric inertia, as well as leakage to conduction currents. The losses from this source increase directly with wavelength. This is in harmony with the laws governing dielectric loss in any condenser.

By ohmic loss is meant the power dissipated in the conducting wires and earth by currents. Excluding the skin effect at very short wavelengths this is substantially constant for any given arrangement of ground. The skin effect, by effectually reducing the cross section thru which these currents must pass, quickly raise the ohmic resistance as the frequency goes up and the wavelength goes down.

It is well, in order to gauge the relative values and importance of the three factors and to see the influence which change in wavelength, antenna height and other factors exert upon them, to formularize, or put them into mathematical language.

The radiation resistance is given theoretically by the relation

$$R_r = \frac{1600h^2}{\lambda^2}$$

where h is the effective height in meters.
 λ is the wavelength in meters.
 R_r is the radiation resistance in ohms.

The term effective height is the true geometric height of the antenna above ground (or above the plane which may be considered ground) multiplied by a

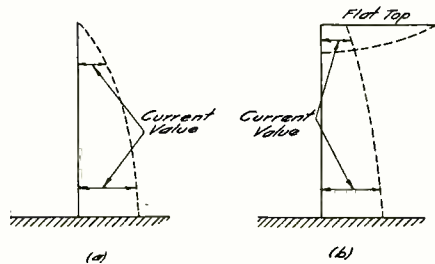

Fig. 1. Effect of Flat Top on Current Distribution

correction factor called the form factor. The need for such a correction may be understood readily as follows: If the antenna current were the same thruout the height of the antenna there would be no need for a correction. But it is easy to see that this current is maximum at the ground and drops down to zero at the very end of the antenna flat top, being used up of course in charging the capacity of the antenna. The average value of this current thruout the height of the antenna would be a more logical value to use. This is indeed the form factor. The use of an extensive flat top pulls the form factor towards unity. In Fig. 1 the effect of a flat top is illustrated.

(a) Shows a simple vertical antenna without flat top. The dotted line shows the current distribution along its height.

(b) Shows a vertical antenna of equal height as (a), plus the flat top. The dotted line again shows current distribution. This time the average value of the current along the vertical part is seen to be considerably higher than before. The flat top has raised it.

Now the effective height of a system will be substantially the same if it is a ground system or a counterpoise system, provided the counterpoise is not lifted too high above the ground and is adequate in size. This is because the counterpoise merely acts as another plate of the condenser of which the upper one is the antenna, being a complete substitute in this respect for the ground. It follows that any advantages coming from the use of a counterpoise must be in a reduction of ground and ohmic loss. That these advantages are in some cases very great has been proved many times in practice, and later in the article there

are comparative curves for resistance using ground and counterpoise for the same antenna. The indications for the need of a counterpoise in transmitting are when the ground is particularly dry and sandy or when the arrangement of the antenna is such that the ground lead would be excessively long and tortuous. In two cases of shore stations familiar to the writer these adverse conditions were present and counterpoise installations were very fruitful of results. In one case the soil was practically pure quartz and silica and in the other the station was located on top of a big six-story concrete factory building. These two conditions find their parallel in the experiences of amateurs in radiophone or CW work. If they live in the big cities their antennas are likely to be lifted from over house tops, making the ground lead unnecessarily long. If they live inland in the country they may find ground water not easily accessible. For these two typical cases the logical solution would be, of course, the counterpoise. Counterpoise for reception is useful in hastily erected camping outfits. It has been the writer's experience that a single insulated counterpoise wire beneath a single wire antenna makes an extremely good combination for receiving.

The formula for dielectric loss is

$$R_d = k\lambda$$

where R_d is the dielectric loss in ohms.
 k is some fixed constant.
 λ is the wavelength.

The formula for ohmic loss is $R_o = c$, c being some fixed amount for any given arrangement except as before stated for very short wavelengths.

Adding the factors together then, the total antenna resistance

$$R_A = 1600 \frac{h^2}{\lambda^2} + k\lambda + c$$

By this relation we can predict the form of any resistance curve for various wavelengths. The first factor will make it rise at low wavelengths, the second factor will make it steadily mount as the wavelength goes up, the third factor will be merely an added fixed amount to each wavelength. Thus there will be some point of minimum resistance. Our resistance curves follow out this general form quite well.

A conception of the value of a counterpoise may be obtained from a consideration of the data of measurements taken at WSC at Nantucket Island, Mass. It is about 200 ft. from the beach and far enough away to render a

metallic, sea-water ground impossible. Consequently the first system built consisted in the usual arrangement of buried copper conductors. The towers are two in number, steel pipe variety, 100 ft. high, each with metal guys broken by insulators every 30 ft. The antenna is 180 ft. long with a 12 ft. spread and a 100 ft. lead in. Fig. 2 shows the an-

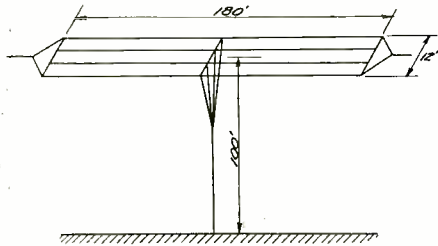

Fig. 2. Antenna Arrangement at W.S.C.

tenna arrangement. The natural wavelength of this antenna system is 353 meters. It is practically the same with ground or counterpoise. The counterpoise is located immediately beneath the antenna. It consists of 10 wires, 12½ ft. apart supported on 15 ft. poles. The arrangement is shown in Fig. 3.

It is seen that the area of the counterpoise is considerably larger than that

energy taken from it by leading out a small coil for coupling.

The current is coupled into a circuit including the antenna, a loading coil, a sensitive milliammeter, and ground. The oscillator is tuned to exact resonance with this antenna circuit as indicated by greatest deflection of the milliammeter. The coupling between oscillator and antenna circuit is next adjusted so as to give a definite reading on the meter at a high portion of its scale. Then the antenna and counterpoise are disconnected and in their places a standard air condenser and calibrated radio frequency variable resistance inserted.

This operation is performed by merely throwing a double pole double throw switch. The standard condenser is now adjusted to resonance and the variable resistance adjusted so as to give in the milliammeter the same reading as before. Then we know that the substituted resistance equals the antenna resistance.

Such is the theory of the method. In practice several precautions need to be observed in order to get accurate and verifiable results. They are briefly as follows:

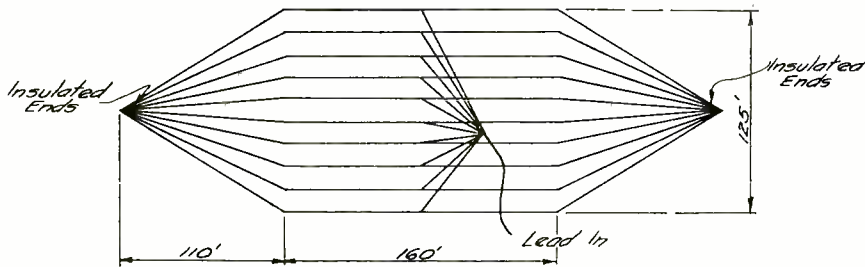

Fig. 3. Counterpoise at W.S.C.

of the antenna. In this case the ratio of counterpoise area to antenna area is approximately 17 to 1. This large ratio is necessary in order to get the full benefit of the use of counterpoise. By increasing the counterpoise spread we increase its isolated capacity and thus make its potential approach zero no matter to what voltage the antenna is being charged. Thus the counterpoise acts as an electrostatic shield protecting structures beneath it from induction of stray currents which cause the dielectric loss before mentioned.

While used as a 600 meter shore to ship radio telegraph station, the constants of the antenna of the station just described are such as to be suitable for a typical 400 meter broadcasting station and any conclusions we may draw from it will be equally valid for the radio telephone station.

Measurement of the Antenna Resistance

The antenna resistance at any wavelength may be determined with fair accuracy by the so-called substitution method. In this method a C.W. oscillator is used as the source of e.m.f. at the required wavelength. This oscillator must be electrostatically shielded and

(a) The oscillator must be electrostatically screened and grounded. Small mesh copper is satisfactory to completely enclose the box containing the oscillator with all its batteries, etc., leaving merely the instrument handles to project thru.

(b) The coupling coil from the oscillator should be connected with twisted lamp cord and run in grounded Belden braid. This coil should be small, with two or three turns, and so located in the oscillator circuit that its potential remains practically zero. Otherwise we should have electrostatic as well as electromagnetic coupling, and since the former would be different when the antenna was in circuit from what it is with the standard condenser in circuit, the results would be quite unreliable. To test the accuracy of results the coupling coil leads are reversed and re-measurements taken. Any error due to electrostatic coupling is thereby detected.

These measurements are made thru-out a wide range of wavelengths. A series is run using antenna to counterpoise and one using antenna to ground.

Discussion of the Data

Fig. 4 graphically shows a series of resistance determinations made at W.S.C. station, the higher curve being that for antenna to ground, the lower for antenna to counterpoise. Both curves show very well our theoretical evaluation of the components in the total resistance. At short wavelengths the radiation resistance is large, making the total resistance correspondingly large.

Continued on page 79

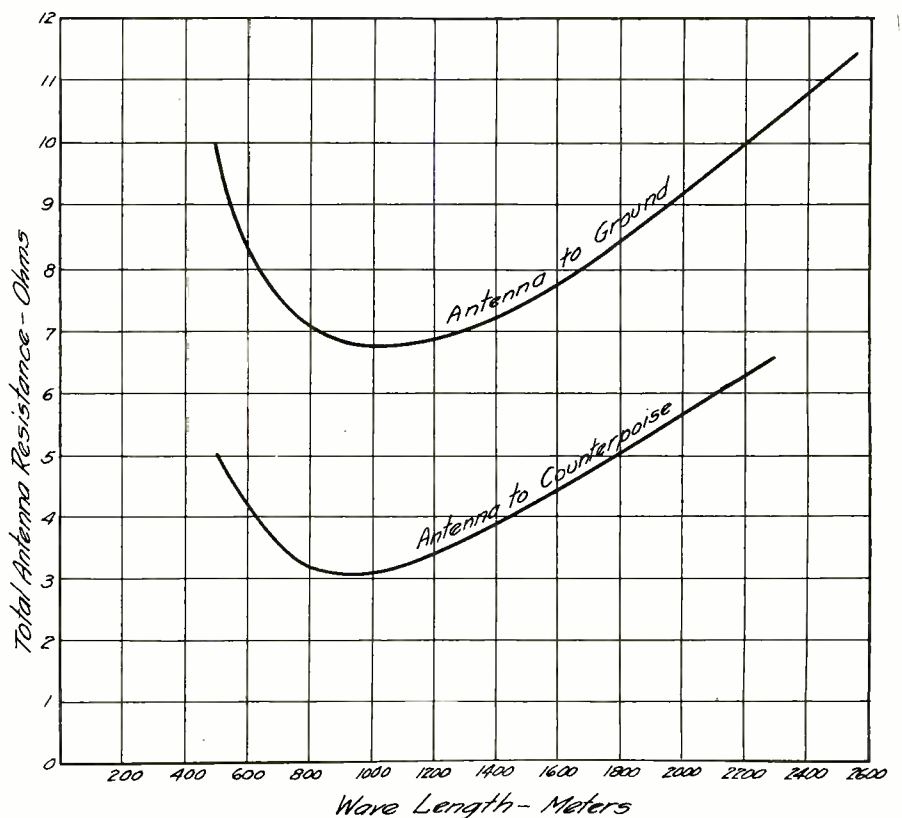

Fig. 4. Variation of Antenna Resistance with Wavelength.

QUERIES & REPLIES

ON C.W. PRACTICE

BY
Gerald M. Best
TECHNICAL ADVISOR



Questions submitted for answer in this department should be typewritten or in ink, written on one side of the paper. All answers of general interest will be published. Readers are invited to use this service without charge, except that 25c per question should be forwarded when personal answer by mail is wanted.

Is the UV-199 tube an amplifier or detector? What is its amplification constant? What special transformer shall I use with C-302 tubes as power amplifiers, as you told me in May RADIO?

M. E. R., Winchester, Mas.

The UV-199 is both a detector and an amplifier. It works best as a detector with 25 volts on the plate, and the grid return connected to the positive side of the filament. As an amplifier, it will operate on plate voltages up to 90, provided that the proper negative grid potential is maintained. For 45 volts plate, a 3 volt C battery should be used, and for 90 volts plate, a 4.5 volt C battery is necessary. The amplification constant of the UV-199 is from 7 to 8. Special transformers for use with power tubes are made by the Magnavox Company, Oakland, Calif.

Please publish a circuit for a one-stage radio frequency amplifier, detector and two stages of audio frequency, using an anti-capacity switch to connect either a honeycomb coil unit or a vario-coupler, as the tuned circuit.

C. M. C., Stanford U., Calif.

Such a circuit is shown in Fig. 1. This circuit is intended to be used with the .25 ampere tubes now in general use.

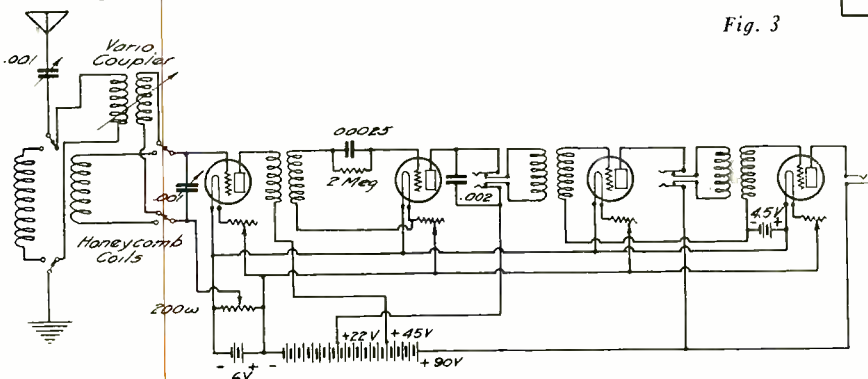

Fig. 1

Please publish a circuit using a Ford spark coil as the source of plate voltage, for a one-tube transmitting set. Where can I connect a dry cell so as to strengthen the signals in my crystal receiver?

W. J., Middleton, Idaho.

A circuit for a Ford Spark coil plate supply is shown in Fig. 2. If your crystal is galena, which I presume is the case, you do not need a battery for proper operation.

Please give me a diagram of a 10 watt radiophone and C. W. transmitter.

N. D., Germantown, N. Y.

The circuit for such a combination is shown in Fig. 2.

Kindly publish a circuit for two five-watt tubes, for short wave transmission, with chemical rectifier, and 1000 volt transformer. What resistance and current-carrying capacity should a rheostat have, for two 5-watt tubes?

H. H. K., Montclair, N. J.

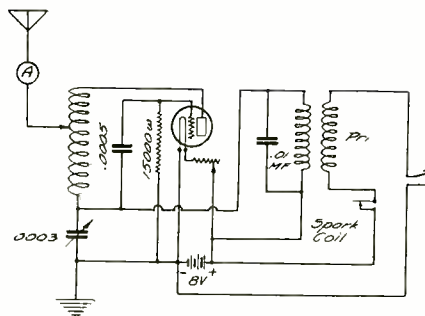

Fig. 2

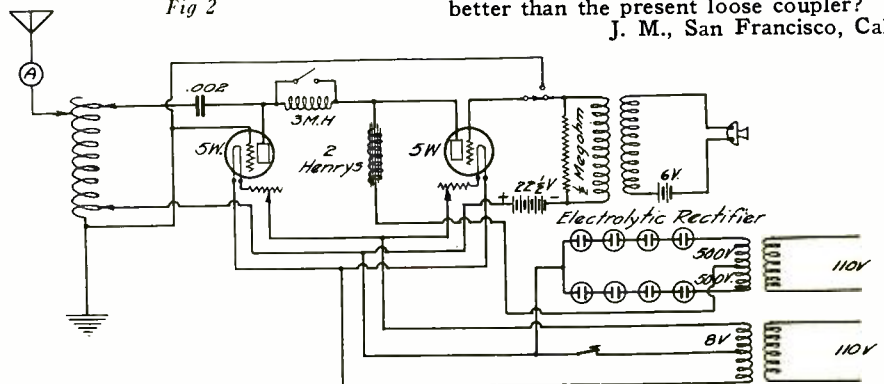

Fig. 3

The circuit you wish is shown in Fig. 3. A rheostat for two 5-watt tubes should be able to carry 5 amperes without excessive heating, and should have a resistance of at least one ohm.

How many wires should a counterpoise have, for 200 meter transmission? My counterpoise is 60 ft. long, and 20 ft. wide, with wires spaced 6 in. apart.

P. K., Grass Valley, Calif.

Authorities seem to differ on the subject of the number of wires in the counterpoise. It certainly should not be any longer than your antenna, but I do not see any reason why your present counterpoise will not serve very well. Read the May issue of QST for some very good information on antenna systems.

In connection with S. G. McMeen's radio frequency amplifier in March RADIO, (1) What size of wire and of tube should be used in the antenna in-

ductance? (2) What size of tube should be used for the primary and secondary? (3) How should the antenna inductance, the primary, secondary, and tickler be wound so that the set will function on wavelengths from 360 to 800 meters?

C. E. M., Hampton Falls, N. H.

1. Four-inch tube and No. 18 wire, 35 turns. 2. Four-inch. 3. The winding data given in the article (March issue) will be satisfactory at all wavelengths from about 150 to 800. The condensers give the required latitude of adjustment.

What is wrong with my WD-11 tube circuit, and would a variocoupler work better than the present loose coupler?

J. M., San Francisco, Cal.

Nothing appears to be wrong with your circuit, except that you should have a fixed condenser of .002 mfd. bridged across your telephone receivers. A variocoupler will probably give you a better and more convenient method of adjusting the coupling.

Please publish a circuit similar to the one described in March RADIO, page 11, but for C. W. telegraph only, using one WD-11 tube. Are choke coils necessary in this circuit? Is a WD-12 an amplifier, and is it better than the WD-11?

D. E. F., Butte City, Cal.

The circuit desired is shown in Fig. 4. Choke coils are not necessary in this circuit. A WD-11 tube would surely be ruined if 120 volts plate potential were applied, and I would suggest the use of a C-301-A tube as the oscillator. A WD-12 tube is the same as the WD-11, except for the base, which is of the standard four prong bayonet lock type in the WD-12, and special in the WD-11.

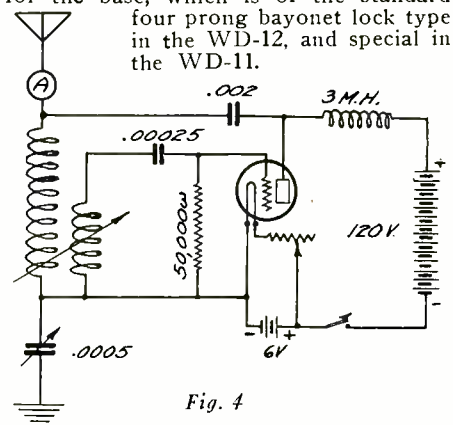

Fig. 4

I would like to obtain some information on the tuned ground circuit used in C. W. transmission.

W. L. M., Yosemite, Cal.

A very good description of the method by which the ground and counterpoise are used simultaneously in a C. W. transmitter is shown in C. W. catalogue published by the Radio Corporation. Briefly, it consists of properly combining the counterpoise and ground with a resulting extremely low radiation resistance in the entire antenna system, and the custom is to connect the ground in the usual way, the counterpoise being connected to the helix by means of a clip, so that the counterpoise connection may be placed

at different points on the helix with respect to ground, until the correct combination is found.

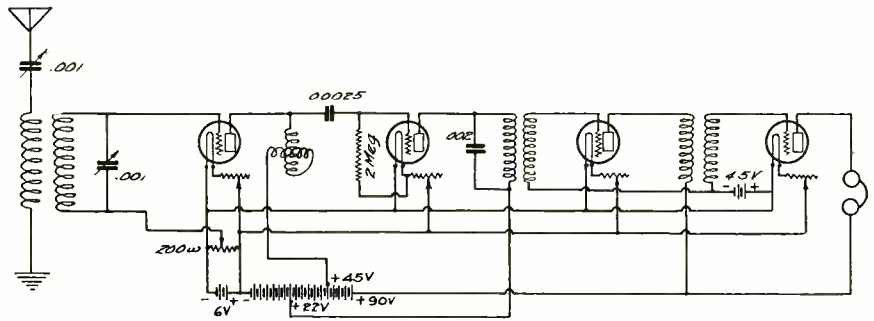

Fig. 5

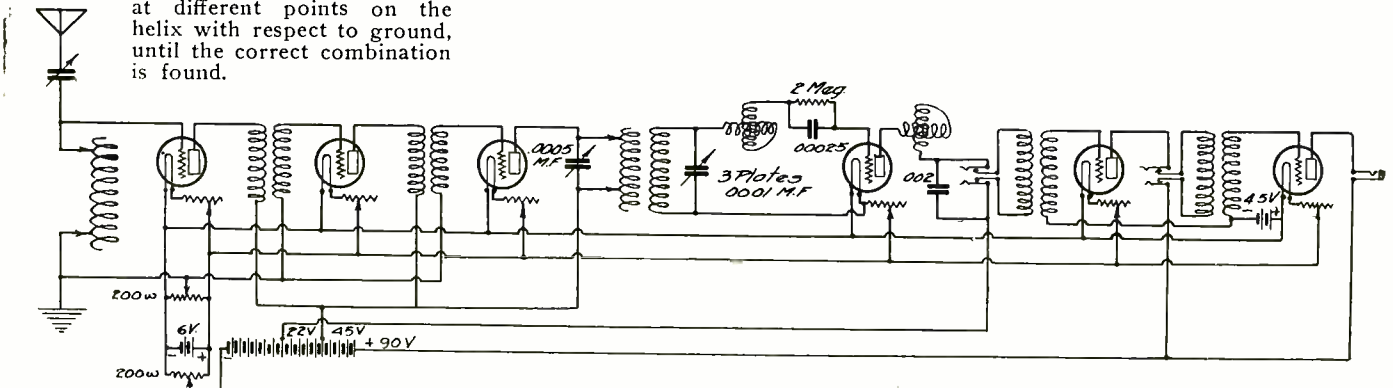

Fig. 7

I wish to add two steps of radio frequency amplification to my present circuit. Will you kindly show how to do this.

L. C. P., Creve Coeur, Mo.

A complete circuit diagram, with suggested changes to your present set to improve the quality of speech amplification is shown in Fig. 7.

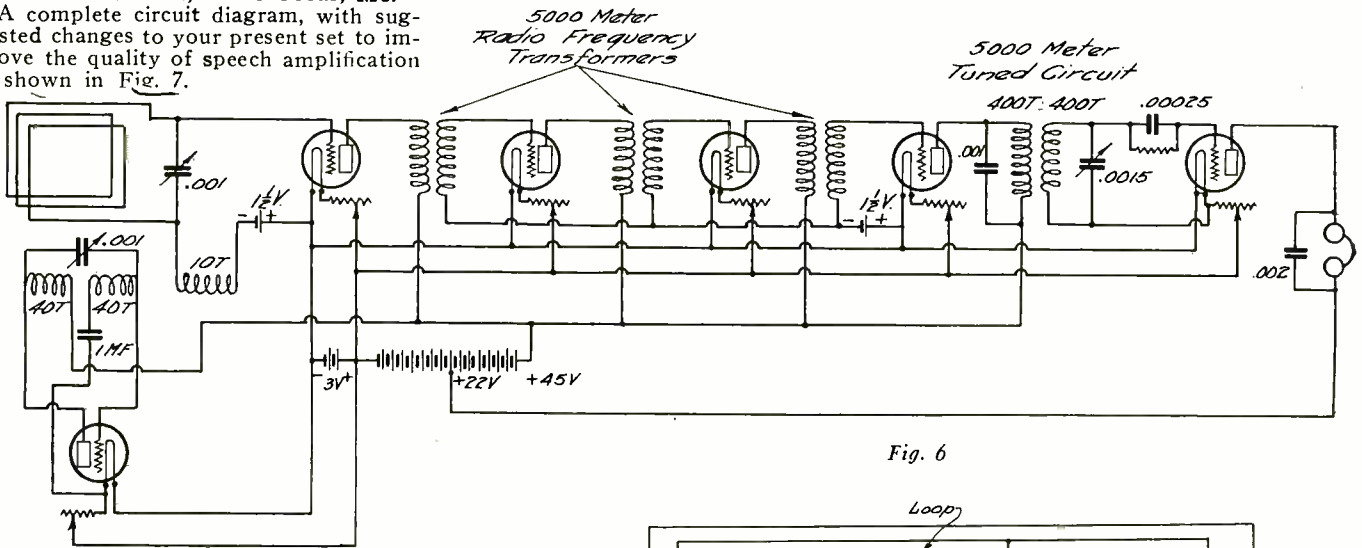

Fig. 6

Please publish a circuit using one stage of radio frequency, detector and two stages of audio frequency without jacks or switches.

W. B., Santa Ana, Calif.

The circuit in Fig. 1 shows a transformer coupled radio frequency amplifier, but with jacks. Fig. 5 shows a tuned radio frequency amplifier, and audio frequency stages without jacks, as requested.

Please publish a circuit for an Armstrong Super-Heterodyne receiver, using peanut tubes, and loop antenna. Would such a circuit be better than several stages of radio and audio frequency amplification?

J. D. C., San Jose, Calif.

This circuit is shown in Fig. 6. If properly constructed, and all parts thoroughly shielded, it should give you better results than practically any other circuit yet developed. Great care should be shown in placing the heterodyne oscillator and first detector in separate shielded compartments, as should the three stage intermediate frequency amplifier.

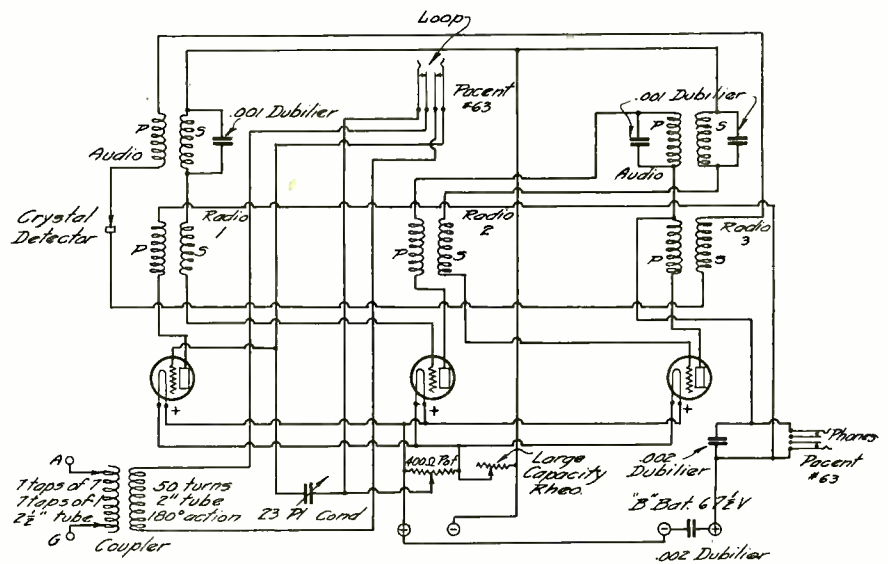

Use all amplifier tubes
Corrected De Forest Reflex Circuit

NEWS OF THE BROADCASTERS

POWERFUL G. E. STATION FOR OAKLAND, CAL.

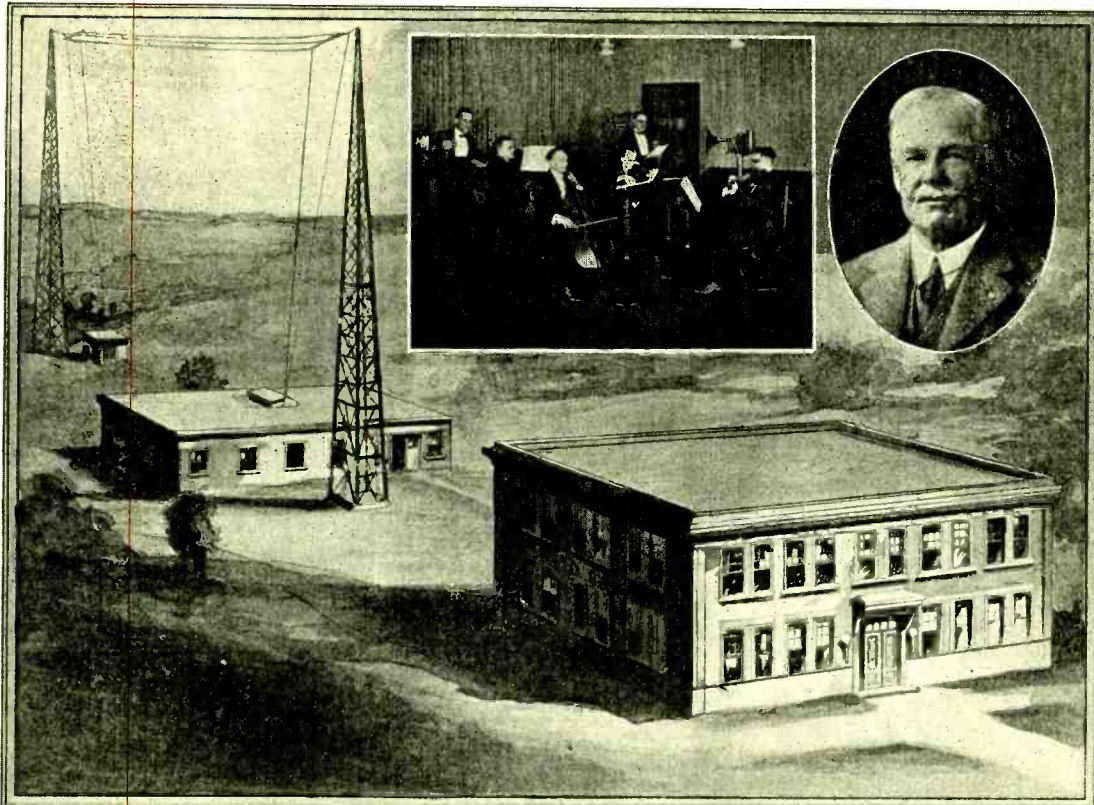

Wash drawing of new broadcast station, showing studio and office building, the power station in the rear and the antenna; insert in center shows how the studio will look, and insert to right is portrait of Dr. Thomas Addison, Pacific Coast Manager of the General Electric Company, who will supervise the operation of the station.

FAITH in the permanence of radio broadcasting is demonstrated by the announcement of the General Electric Company that the first plant to be constructed exclusively for popular broadcasting will be constructed in Oakland, California, to house the large Pacific Coast station of that company.

Work will be started this month on a two-story studio building, the antenna towers and the power house. Workmen are already assembling the radio equipment. It is expected that the new station will be in the air within six months.

Martin P. Rice, director of broadcasting for the General Electric Company, will direct the operating policy of the station, and Dr. Thomas Addison, manager of the company's interests on the Pacific Coast for the past thirty years, will have supervision of the plant.

The station will be located on East 14th Street, Oakland, adjacent to the new General Electric Company factory building. The site was selected after a thorough inspection of available properties in San Francisco and vicinity. The Oakland plot was chosen because of its technical advantages, the availability of musical talent and the proximity of the site to San Francisco, the great commercial center of the Pacific Coast.

The plans provide for a two-story brick structure. On the first floor will be the office of the studio manager, a general correspondence room, a reception room for artists and quarters for motor-generator sets and storage batteries. There will be two studios on the second floor, the main studio large enough to accommodate large bodies of musicians such as a band or symphony orchestra, and a smaller studio from which solo numbers and addresses may be broadcasted. The use of two studios will make possible continuous broadcasting. Research is now being carried on to determine the reverberating qualities of the ideal studio in order that the proper amount of dampening may be se-

cured in the Oakland studio to assure maximum musical quality. The radio control room will be on the second floor.

One thousand feet back of studio building will be the power house and antenna system. The antenna will be multiple-tuned and strung between two steel towers, each 150 feet high and placed 260 feet apart. Beneath the antenna proper will be the counterpoise consisting of a network of wires, fourteen feet above the ground, covering an area of 150 by 300 feet. In addition to the power house which will be one story high, 71 by 32 feet, there will be a small building for the tuning apparatus and the end of the multiple-tuned antenna.

The transmitting set will be similar to that which is now heard almost nightly from WGY, Schenectady, N. Y., and the many developments which have brought this station a reputation for exceptional transmission quality will be part of the Pacific Coast station equipment. The apparatus is now being manufactured in the Schenectady works of the General Electric Company and tested at WGY.

The Pacific Coast station will be operated at 1000 watts, but the equipment will be designed in excess of that power for pur-

Continued on page 71

Station SPE, Rio de Janeiro, Heard 8000 Miles

To be heard 8,000 miles is the remarkable record of the radio broadcasting station SPE erected by the International Western Electric Company at the Brazilian Centennial Exposition at Rio de Janeiro. Its voice was heard by a government radio station in Honolulu. This is the long distance record for a 500 watt radio transmitter. A radius of 8,000 miles drawn around New York City would take in all the land on the globe with the exception of Australia, New Zealand and a few small islands in the Pacific Ocean.

This station was installed shortly after the opening of the Brazilian Exposition at Praia Vermelha, a suburb of Rio de Janeiro, where the National Telegraphs, the Bureau of Communications had established an official section of the exposition for radio exhibits. The apparatus used was the standard 500 watt radio transmitter; the same as that at WEA, WOC, WSB and others in the United States and PWX and WKAQ in Cuba and Porto Rico, respectively.

The antenna, which contributes considerably to the exceptional efficiency of this transmitter, is of a very unusual type. It is

Continued on page 79

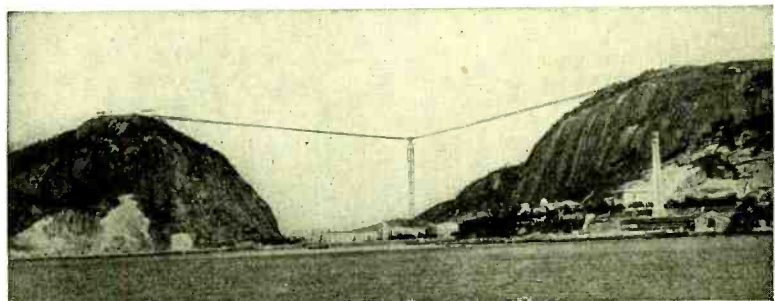

Aerial at SPE

LETTERS TO THE EDITOR

RELATIVITY OF RECEPTION

Sir: One of the most confusing things about radio for the newcomer, is the number of contradictory claims made for different hook-ups. As easily ninety-nine per cent., of the new radio bugs, are such simply to hear broadcasting, I suggest that standard be set for measuring the capacities of receiving sets. An official antenna would have to be chosen, and then when anyone made claims for a certain hook-up he would not be seriously considered unless willing to test his set on said antenna.

For myself I have been trying to find out the best, or at least one of the best, hook-ups to use for receiving broadcasting over as great a distance as possible, and as this implies coming into contact with a large number of sending stations, the set must be quite selective. I want to use a loud speaker also. Now if anyone will tell me which circuit is best a one, two or three, I'll be obliged.

Referring to the first paragraph above; I have a peanut set. At Los Gatos it brought in Los Angeles on a Trutone horn quite loud and clear, but in San Francisco on a 125 foot antenna put up correctly, properly grounded, etc., I can only get Los Angeles thru the head phones. I get Salt Lake regularly but poorly. Also get Portland, and Sacramento. At Los Gatos the same set got the above stations, also Seattle, Vancouver, Great Falls, Davenport, Fort Worth. Consequently the claims made for different hook-ups mean nothing at all unless tested from the same antenna, over a reasonable length of time. Now why not have RADIO choose such a testing place, and have the hook-up bugs flock to it. We might possibly learn something.

Yours,
T. BUCKLEY.

San Francisco, Calif.

A NOVEL CIRCUIT

Sir: Like a great many other fans, when it comes to hookups, I look a great many of 'em over, and try not a few of 'em. Particularly have the hookups which have appeared in RADIO been given a fair trial along with others. Convinced as I am that locality of the receiver and the strength of the transmitting station has more to do with some of the wonderful reception we hear about through the use of certain peculiar hookups, yet I want to pass along some "dope" which is somewhat of a freak, but nevertheless is based on a standard hookup and one other which has become quite popular here.

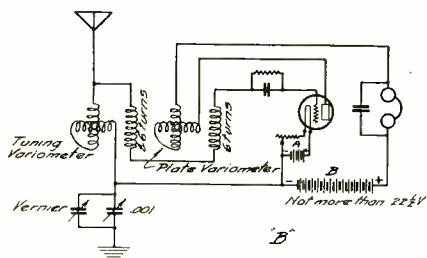

Two variometers are inductively related in much the same manner as the "Sleeper" circuit set, in which one gets the best results when there is no oscillation. On either side of the plate variometer there is a piece of 3½-in. tubing 1 in. wide, on which is wound six turns of wire ⅛ in. away from the side of the variometer, the turns being made in the same direction as those on the stator of the variometer. The accompanying sketches show that this circuit continues on to the grid.

The .001 gives sharp tuning, which

changes of course with the position of the rotor of the tuning variometer, and the vernier of course helps out on the DX. Furthermore, lessening the capacity of the variable condenser by turning out the rotary plates will result in louder signals when the tuning

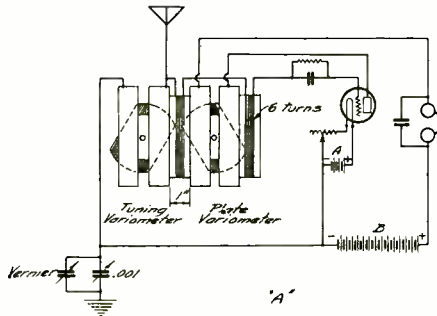

variometer is adjusted to suit. There is a limit to this of course. With local broadcasting and a short indoor aerial, say 15 ft. to 25 ft., it works perfectly. With 50 to 75 ft. outside I have had no difficulty at all in copying WOC and KSD (middle west) or one WD11 tube. There is also a corresponding decrease in the amount of current used on the filament.

I used good variometers, a good variable grid leak, a good vernier rheostat, and a good condenser, and got good results. Just to add a little to the gaiety of nations it's worth trying. If you find it to be what I think it is, perhaps some of your readers who are still in the "fan" class would like to take a fall out of it. Yours very truly,

JAMES McCARTNEY,
8020 Frankford Ave., Philadelphia.

Sir: After reading 6XAD-6ZW's effort on page 36 of June RADIO, I feel disposed to administer a few antidotes.

Of course the transmission and reception of the human voice by radio is not perfect and distance certainly should not tend to lend enchantment, *but*—why blame the artists?

Some of the propagandists might be eliminated, *but*—hardly 99-9/10%.

Perhaps announcers might be persuaded to limit discussion on themselves and distance of transmission, *but*—would the amateur cooperate by refraining from filling the columns of ADIO with "Calls Heard," etc?

Admittedly many listeners are disgusted with certain parts of a broadcast program, *but* is that sufficient reason for withholding these portions from the ones who enjoy them?

It cannot be said that a variety of languages are interesting to any individual listener, but all people do not understand the English tongue and there are many sets sold in adjacent countries and to foreign-speaking people in this country.

And, last but not least, if the announcer is ushering in a public official, "veteran" or other obnoxious individual who will perhaps not prove entertaining to all, do not turn out the tubes and light a cigarette, but do like anyone would do who really wants to listen, and tune in some other station with a more congenial program.

To return to 6XAD's first "if"—if 6XAD and myself could "see (hear ourselves as others see (hear) us," neither of us would, in all probability, have written what we did at all, but would have sent our criticism direct to the offending stations, where it would do most good.

H. MANCHESTER.

Atwater, Calif.,
May 25, 1923.

A. R. R. L. RECOMMENDATIONS ON AMATEUR TRANSMISSION

Representatives of the American Radio Relay League, in accordance with the opportunity given them by the Department of Commerce to suggest a possible subdivision of the 150 to 220 meter amateur wave band, have submitted their recommendations. These call for the segregation of all modulated services (spark, 1CW, 'phone, ACCW) within the limits of 176 and 200 meters; pure CW 150 to 200 meters; special license stations with pure CW, 150 to 220 meters; all stations to be permitted to operate on any wave within the band to which that type is eligible. It was recommended that special licenses be issued only to holders of a new type of extra-first grade amateur operator's license to be established, requiring two years' amateur experience and a code speed of twenty words. It should be noted that the present law prevents the assignment of waves above 200 meters except under special license, and only to applicants of experience and ability.

This recommendation, if adopted, will result in bands reserved for CW exclusively at either end of the amateur allocation. It should be noted that in general no changes will be necessary in the adjustments of the average transmitter to comply with this proposal. No changes in power limits were recommended. The idea of an elaborately subdivided amateur band, as tentatively announced by some of the supervisors, has been abandoned. No decision has been received from the department at this writing.

CW has been tentatively defined as a continuous oscillation telegraph system in which the power supply is substantially direct current as obtained from a generator, a battery, or a rectifier plus an adequate filter. It was felt that a more ambitious definition would be impracticable of enforcement.

The telephony conference made no recommendation respecting amateur quiet hours. The ARRL board, however, has been on record as advocating voluntary quiet hours from 7:30 to 10 P. M., local time. In the belief that better amateur conditions would exist if the plan were observed uniformly, the department on April 6 authorized supervisors of radio (inspectors) to note on licenses "This station is not licensed to transmit between the hours of 7:30 and 10:30 P. M. daily, local standard time." Although discretionary with the supervisor, some of the supervisors began recalling licenses to be so indorsed, whereupon the league sent a representative to Washington to protest. As a result, instructions were telegraphed the supervisors to apply the notation only to new licenses, pending consideration of the matter by the A. R. R. L. board. At its meeting on April 27 the board reiterated its recommendation of voluntary quiet hours, as before, but opposing enforced quiet hours in the conviction that they would be destructive of co-operation with the department. Recommendations to this effect have been made to the department and we now await their advice.

The radiotelephony conference regarded the waves below 150 meters as reserved and recommended an amateur assignment having 150 meters as its lower limit. The league feels that no restrictions should be imposed which will prevent experimental investigation of this field, and regards its members as better able to develop these waves than any other interest. Strong representations accordingly have been made to the department to permit the continued non-exclusive use of the waves below 150 meters on all amateur licenses.

WITH THE AMATEUR OPERATORS

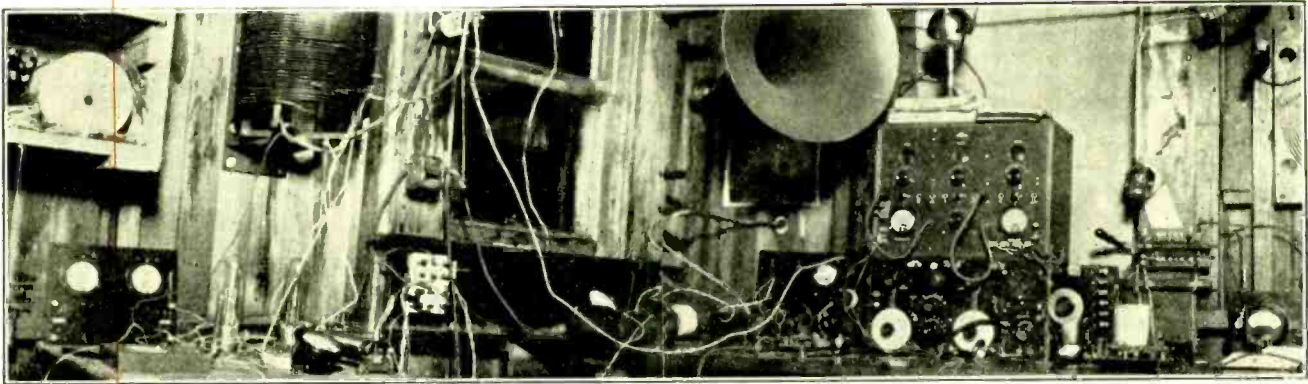

RADIO STATION 6ZE

Station 6ZE is owned and operated by Mr. D. B. McGown, U. S. Radio Inspector, Department of Commerce, at 1247 Forty-seventh Avenue, San Francisco, and is within a stone's throw of the Pacific Ocean. The larger picture shows the general appearance of the station's interior in a small, specially built radio-house, which is devoted to this exclusive service.

Starting at the left, we see the 100-watt tube set, which is connected with the reversed feedback circuit. This set is mounted on a separate table. A smaller set of 10 watts capacity is shown on the main operating desk, immediately next to the receiver. The latter is a specially built regenerative affair, the output of which is led to the three-stage audio frequency amplifier directly above the receiving set; waves between 50 and 1000

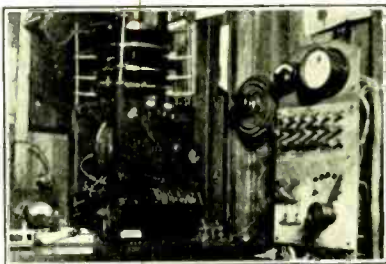

meters can be received on this apparatus. A Navy type SB 1420 receiver is also used for longer wavelengths, but is not shown in the photo. It is arranged to connect with the same amplifier as the short wave set. A loud speaker is attached to the output of the three-stage amplifier, although head receivers are used in most cases.

In the smaller photograph, we see the spark transmitter, which is a 500-cycle 1/2 kw. quenched spark set, equipped with a wave changer, and adjusted to 200, 300, 375 and 600 meters, any one of which can be obtained by a simple manipulation of the wave-change switch.

The power panel is shown to the right of the spark transmitter, and controls the various machines used. The motor generators are located in a separate building, and all wiring is run underground to the radio station, through armored cable, with the sheath carefully grounded. A 500-cycle 1/2 kw. motor generator is used for the spark transmitter, and a 1000-volt d.c. machine is used for vacuum tube supply, both for the large and small equipments. The 500-cycle supply is also available for use on either tube set, giving half wave, 500-cycle I.C.W., and in the case of necessity, 60 cycles can be used on the plates of the tubes, as well.

The normal radiation on the spark equipment is about 5 amperes, on both 200 and 375 meters, with an exceptionally low decrement

—averaging 0.07 on 200 meters. On normal operation, on d.c. supply, the 100-watt tube set puts about 4.25 amperes into the antenna, and on 500 cycles about 4.5 amperes. A maximum of about 7 amperes has been obtained, on tests, on 200 meters. Keying of the tube sets is accomplished by breaking the grid leak on d.c., and by breaking the transformer primary for 500 and 60 cycles.

Special transformers are used for filament lighting, in each case. The 10-watt set, with 100 volts d.c. on the plates, is used for local work, and radiates about 0.2 amperes. As this plate supply is pure direct current from a battery, it is exceptionally sharp, and no interference is caused to anyone, even if located within a very short distance from the station. The smaller tube set is adjusted to 200 meters only; the 100-watt set is arranged so transmission can be accomplished on 200, 300, 375 or 600 meters. The antenna system is composed of a 4-wire T type, flat top. The flat top portion is exactly 50 ft. long and 52 ft. high, with 9 ft. cross-arms attached to the poles, which serve in place of spreaders. Separate halliards are provided for each wire in the antenna, and any one can be lowered, and removed, without disturbing the others. Porcelain insulators are installed at the end of each wire.

For receiving, a conductive ground is used, which is made up of a large number of grounded pipes and strips. The transmitting set is connected to a counterpoise, suspended 8 ft. above the earth, directly under the antenna. This counterpoise is made up of ten 50-ft. wires, separated 2 ft. apart.

The natural period of this antenna (to counterpoise) is 160 meters, with an effective capacity of .00065 mfd. There are no data available as to the effective resistance. Reports covering the signals from this station, on either tube, or spark, or both, have been received from practically the whole Pacific Coast, and practically continuous communication was carried out with 6ZAC, while the latter was operating at Wailuka, T. H.

WITH THE AMATEUR OPERATORS

The call 6CES has been assigned to W. C. Thompson of No. 679 East Fourth street, LaVerne, California, who was formerly Radio 6ZH of Richfield, Utah. Please QSL if sigs are heard and will do the same. Transmitter is 15 watts, rectified ac.

6ATZ is now located at 522 Grand avenue, Oakland, Calif., and is operated by F. W. Morse, Jr., and G. S. Evans. Anyone hearing our 10 watt C. W.. 1 C. W. sigs pse qsl crd.

6XAS and 6BLV have moved from 1707 Camden Court, South Pasadena, Calif., to 1209 Cremshaw Blvd., Los Angeles.

A HAM OUTING

By PRESTON SHAFTEEN

Rotten roads, a ramshackle Ford of the vintage of 1912 or earlier, three CW fiends and a portable receiver are the how and wherefore of this tale. The funny thing about it is that it is all true. We had long been desirous of getting out in the open and wherefore of this tale. The funny thing about it is that it is all true. We had long been desirous of getting out in the open and roughing it. Being DX fiends we dragged along a little heap to pull in a few stns??? while we were out in the woods. We sure were tired the first night and as we had covered about 30 miles over country roads to the north of Sausalito after leaving the highway at a little past Manzanita. Fearless suggested we take that road as it looked the smoothest thing around the country except the smile on Hezekiah's face when he lams a keen dame in Sausalito and wanted to get out and walk. We held him back. Women is to Hez what 110 is to the filament of a 5 watter. Simply a calamity.

The Ford is getting sore feet and it's getting dark when I think it about time to cast our freight for the night. We finds a good place by the side of a little stream and Hez appoints himself as the official cook. I had not ever tasted his cooking and so when we sat down to eat what he called graveyard stew I had some misgivings. The first mouthful I took went out faster than it went in. And Acki simply bent over the creek and did what every self-respecting person does when he gets seasick. "Oh," says Hez, "I forgot to tell you. The potatoes and the kerosene got mixed up and I didn't think you would mind tho." When we finished with him he quit as cook, being slightly bunged up.

We opens a can of tamales after boiling it in the fire for 15 minutes and when Acki plunges the can opener into the hot tin there's an eruption of goo and tamale in liquid form that makes Vesuvius feel sick for shame. I feels we done something wrong as canned stuff never did that when mother opens it so we give up the tamale idea. It's dark now and the fire is about the only light we has. Hez says he'll drag out the heap and got something on the loop. I wish I'd get something on the stomach but it's so dark that I can't find the Ford so I lays down by the fire on a blanket and watches Hez fool with the lil heap. The set consisted of 1 variable, a honeycomb choke circuit copied from RADIO and a WD 11 and a dry sell. The sell part was that it only lasted about a week at the rate we used it.

On the loop Hez strains his milk listening for CW hams. All at once he gives a heave and yells, "Shh Hh keep still. 9DTM signing off qsahr, nm nw 73s." Well I know that lil heap pretty well but 9DTM in the middle of the woods on a one tube set on an empty stomach is too much and I grabs the

cans and strains my liver and holds my breath and sure enough theres the old familiar chirp and then 6ZH breaks in and tears off about 5 msgs to 5ZA. I couldn't get 5ZA come back tho. Well we took turns listening in and the following is the list of calls heard in one hour on that ramshackle outfit lost in the woods on an empty stomach.

6APL, 5ZAE, 6ZD, 6BSQ, 7ADP, 7AK, 7GE, 7OE, 7ABX, 6IK, 6JN, 6AOX, 6TY, 6CC, 6BUA, 5XB, 9WCC, 9DTE, 9US, 9UU, 9BRE, 9CUI, 9CAO, and a bunch of six stns fm around the bay that's handling traffic on CW.

It's getting late so we calls the party and turns in. The ground was hard so I waited till the rest got asleep then I hocked the seat cushions from the Ford after falling over about all the rocks and gulleys in Marin county I makes a mattress of these and falls asleep.

The next morning after Hez wakes us all up at 5:30 by pouring coal oil in my mouth and then sticks a piece of wood in Acki's mouth and yells in his ear. Acki jumps and the wood pokes the back of his tongue thru his throat and he almost chokes for we gets it out. Hez says he will make some pancakes. I has a misgiving again and says never mind, that it's my turn to cook and I mixes a nice batter and had the pancake all nice and brown ready to flip when Hez begs so hard to let him flip it that I takes heart and hands him the pan. I forgot to tell him the darn thing had a collapsible handle and therefore when he flips the batter the whole mess flies up and distributes itself all over his face.

When it comes to ruining meals that guy takes the cake. Well we ate finally and packs up and gets going again with the Ford hitting on all 4 like good old Havana. Well we tops a high ridge and stops and looks over the country below. We finds a sign that says, Longlys Garage, Bolinas, 7 miles. Well I remembers that about the biggest radio station in the world is at Bolinas so we hits it up and down we goes to the flat country around a small bay. We drives along the bay shore till we gets to a small town and we turns to the right and follows the road till we almost drops off suddenly on to a keen beach.

Hez goes off to explore. He sneaks back in a minute and says, "Sssh come here." We follows him and goes out onto a sort of a casino esplanade and he points down on the beach and WOW, there's about 5 of the keenest looking girls about 18 years old all in keen suits that mostly aint. Hez says he's gone to buy a lot and build heer if this is the population but the girls give him a cold stare and turn the other way and go on with their card game. They was playing cards on a big towel. Well we gets our suits on in a little house that is one of many bathing houses and we goes down onto the beach and lays down. There's an awful mob of aristocratic looking men and women playing indoor ball on the beach and then the girls went in swimming. They was hardly in the water when a chap in a green silk suit tears down from a hill nearby and dives into the water and starts out as if he was heading to San Francisco. When he gets out a quarter of a mile or so he turns over on his back and takes a rest then he swims in again.

The girls had come out and when this bird climbs out of the water he is surrounded by the whole mob of them. This drives Hez mad, and he says he's going over and get introduced. I says it aint his type of girls and to keep away but Hez hikes over and I sees him talk to the chap in the green suit and then to my surprise they leaves the girls and hikes up the hill together and disappears into a keen looking home on the top of the hill.

We repairs to our clothes and at 5 o'clock Hez returns. "Boys, I'm the luckiest chap

on this earth. I've got a permit to visit KET and KPH the big stations." Well it seems that the guy in the suit was our old CW pal on the air—6AOR and he's got us passes to see the joint. Well we sleeps at 6AORs joint all night. Hez says he cant get used to having a servant wait on him and said the guy grabbed his plate before he had time to take his knife and fork off so he could eat dessert with them. That's a dirty trick I'll say but the dessert was a shivery stuff in a high glass bowl that one had to be an expert to eat out of. Hez groans when it's brought on and thinks of home where he can eat with his fingers and AOR gets his custard down and digested while we were trying to coax ours to stay on the spoon. Well the next day we drives out to KET in the big car that AOR sports and we goes all thru the joint. I'll say there's neat work there in the wiring and I wish I had half the copper wire that was laying around the ground.

Well 6AOR sees our lil portable heap and insists we hook it on his aerial and stay another night and suffers torture every meal cause if we didn't make one mistake and grab the wrong salad fork or eat the cocoa with our saucers. Well, I never could eat and enjoy it the way some guys do.

That night we listens in again. We had a one wire aerial 70 feet long running east and west and absorbing all the 300 amperes from the Alexanderson alternaters at KET and the qrm from the fone set on 2200 meters we being only 2 miles from it. Then kph the old spark did its dirty work and we had some did to copy thru. The calls heard were, 4ag, 4ea, 4ep, 4fg, 4ik, 4me, 5za, 5po, 5kc, 5mb, 5me, 5ta, 5zaz, 8oi, 8om, 8tt, 8ll, 8sm, 8vq, 9ajh, 9aku, 9apw, 9et, 9ox, 9ei, 9aqr, 9amh, 9ark, 9ug, 9aps, 9bjy, 9bry, 9cfy, 9cip, 9cxv, 9cxp, and a raft of sixes that we all hear every night on the air. Well 6AOR says that's pretty good for our hookup but that we ought to see the heap work he had in Berkeley and that it was a keen hookup. Well we drew this hookup and it was the same one that came out in February RADIO and was patterned after his. Well we sure laughed a lot I'll say and all agreed that it sure was some hookup and that we didn't need any more tubes than just one and we left for the trip back to San Francisco in a keen mood to rave radio to every one and so here I am. Only don't forget to always take some one who can really cook.

RADIO STATION 8BRL OF CRAFTON, PA.

Radio 8BRL, located at 35 Haldane St., Crafton, Pittsburgh, Pa., is owned and operated by Herbert W. Haberl (HW) and Allan L. Machesney (RU) and has been heard in 46 states, East and West coasts of Canada, Mexico, Cuba, and on the Atlantic and Pacific Oceans. It is a combined spark and C W station although C W is most always used.

The antennae at 8BRL is a 6 wire cage, 65 ft. high and 70 ft. long with a cage lead in. The counterpoise, being 8 ft. from the ground, is a 13 wire fan, 75 ft. long and 80 ft. wide at the open end, a cage lead in also being used here. For receiving, a single wire 45 ft. high and 100 ft. long is used.

The receiver used is a CR-8 with 1 stage radio and 2 stages of audiofrequency amplification. A new Reinartz tuner is also being installed.

There are four transmitters used at 8BRL, two being spark and two being C W.

Transmitter No. 1 is a 1 kw. spark set using Amrad quenched gaps and oil condensers. The transformer is a pre-war Thordarson. Radiation on this set is 6.7 amperes. Transmitter No. 2 is a ½ kw. 500 cycle Telefunken spark set with either rotary or quenched gaps. Radiation on this set is 3.2

amperes. Both of these sets are on 203 meters. Transmitter No. 3 is a 50-watt A. C. C. W. or sink rectifier set using a 2200 volt pole transformer for the plate supply. Radiation on this set is 3.2 amperes on a.c. and 3.6 amperes on sink rectifier. Trans-

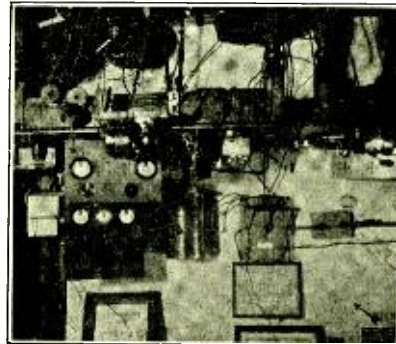

Operating Room at 8BRL.

mitter No. 4, the smallest and best set, is 20 watts C W, chopper, buzzer, or phone and has been heard on the Pacific Coast consistently for nearly a year and a half. The plate supply for this set is furnished by a 500 volt motor generator set under the table. The filter system for this set consists of 6 mfs. across the generator and 2 audio chokes on each lead and 3 radio chokes on the plate lead. This eliminates all commutator hum as it cannot even be detected by the receiving set. This set radiates 2.9 amperes on C W., 2.7 amperes on chopper, 2.5 amperes on buzzer, and 1.7 amperes on voice. The voice has been heard as far as Cheyenne, Wyoming, a distance of about 1300 miles from Pittsburgh.

We admit that the wiring around the table could be neater but that is only one factor when you are after DX. The Hartley circuit is used on both C W sets with Heising's system of modulation on the phone set.

This is an official relay station and would appreciate a QRK on the signals of this station. All cards will be answered.

CORRECTION NOTICE

The advertisement of R. Mitchell Co., page 52, June issue of RADIO, describes the new No. 195 Amplifier Unit and the No. 211 Detector Unit. The illustration of these new units was omitted from the advertising copy in error and the cut of another manufacturer was inserted in its place. The correct illustration of the units will be found in this issue on page 47.

TRANSFORMER DESIGN CORRECTION

Attention is called to an error in the Transformer Design Diagram on Page No. 33 for the June issue of RADIO.

In the lower right hand corner of the page, figure No. 2, the number of layers for the ten-volt Secondary is given as 21. This should read, "10-Volt Secondary 2 layers No. 14 DCC Wire 10 turns per layer, etc."

6 X A D --- 6 Z W IS HEARD IN NEW ZEALAND ON LESS THAN 4 AMPS. RADIATION

REPORTS OF 6XAD-6ZW, AVALON, CATALINA ISLAND, CALIF.

By MAJOR LAWRENCE MOTT

On May 20th I received a cable from J. S. Spackman, Auckland, New Zealand: "signals heard."

A series of tests have been arranged for between Mr. Maclurcan, of Sydney, Australia,—whose report of receiving me on May 7th appeared in RADIO—Mr. Spackman and me. Certain pre-arranged signals and hours are carefully followed, in order that these tests—that will last all summer—may not be in the nature of the usual "hit-or-miss" methods that are generally followed on such tests, and that—scientifically—mean nothing! To my mind the end to be attained is NOT the mere fact of "getting across" the thousands of miles on GREAT power—one, or two—or more!—250-watt tubes, with a radiation of anything from 8 amperes—UP to all that an over-loaded tube will stand! Rather do I think that it is a far greater satisfaction to reach unto the far-flung places of the earth on as LOW power as possible!

To this end I began my series of tests with 2-WE tubes, of 50-watts each—and with my input power cut down one-half! On full power—220 meters—ICW throughout—I obtain 6.1 in the antenna, without the least strain on anything. At the time that I was heard in both Australia and New Zealand I was putting exactly 3.9 amperes on the air—and not a fraction more!!

This, then, gives the lie direct to the priests of high power, and proves, conclusively, that, given a carefully-built transmitter, given adequate antenna and ground systems, nearly 8000 miles can easily be bridged with less than 4 amperes' radiation! It may be remembered that during the '21-'22 radio season I effectually worked 3ALN (Washington, D. C.), 8BUM, 8BSS (Syracuse, N. Y.), and many other 8's between Catalina Island and New York State, on but 4-WE-5 watt tubes, and a radiation of but 2.3! Whence, then, the cry for GREAT power???

My DX—since the last issue: 1aeq, 1cna, 1gv, 1boq, 2ced, 2cmd, 2awm, 3bwt, 3apv, 3bqf, 3asv, 3ahk, 3apz, 3aqa, 3bhv, 4dg, 4fv (Can.), 5aib, (5go), 5jf, 5im, 5vo, (5xak), 6's too numerous, (7ks), (7adg), 7aaj, 8cpv, 1ohn Schiedler, Millvale, Pa., 8cvt, 8qd, 8sf, 8bdv, (8cpx, Watertown, N. Y.), 8cid, 8pd, 8hoy, 8acm, 9dmw, 9aix, (9zt), 9ep, 9aus, 9ho, 9hdn, 9dff, 9cns, (9dgc), 9blt, 9ctv, 9azx, 9ckp, 9app, (9ang), (9dte), (9azg), 9doe, (9dis).

The bracketed stations have been worked. The others have been good enough to report hearing me. Considering that QRN is vile on the majority of nights, I think that all these gentlemen are to be congratulated on the excellence of their receiving. As I wrote in RADIO, for June, 6XAD-6ZW is but seldom on the air—until October.

By 6BQL, 575 21st Ave., S. F., Calif.

Can.—3gk, 3ni, 4fn, 4cl, 4cn, 4hh, 5ak, 5ax, 5cn, 5ct, 5ei, 5go, (5hr), 6sb, 9bp, 9bx. U. S.—5be, 5nk, 5px, 5rh, 5vo, 5ado, 5aec, (6ea), 6eb, 6ec, (6eo), 6iv, (6ku), (6mh), 6ol, 6rm, (6yc), 6zh, 6zp, 6z, 6za, 6xb, 6aa, 6ahp, 6ahu, (6aih), 6alk, 6alu, 6aqp, 6awr, 6avv, 6awx, 6bae, 6bah, (6beh), 6bec, 6bip, (6bki), (6bod), 6boe, 6bqc, 6bqd, 6bqs, (6brf), (6bri), 6brj, 6bsg, 6bud, (6bun), 6buo, (6bvg), 6caj,

CALLS HEARD



Readers are invited to send in lists of calls heard from stations distant 250 miles or more from their own station

6cbi, 6cfq, 6cgg, 6ckz, 7ak, 7ba, (7bj), 7cu, 7dc, 7dp, 7em, 7gc, 7gp, 7hf, 7io, (7iw), 7jw, 7ks, 7ln, 7my, 7ng, 7nk, 7nn, 7np, 7pf, 7pj, 7qw, 7qf, 7ri, (7sf), 7sn, 7ti, 7to, 7tq, 7ve, 7vf, 7wa, 7wm, 7wx, 7zf, (7zn), (7zl), 7zr, 7zu, 7abb, 7abh, 7abs, 7acm, 7acx, 7adg, 7adp, 7aea, 7aff, 7afn, 7afo, 7ahi, 8cf, 8yv, 8aih, 8aqa, 8chq, 9bg, 9pp, 9uh, 9xm, 9zt, 9aah, 9abc, 9abx, 9abu, 9alg, 9aog, 9apf, 9avu, 9avz, 9ayu, 9bkj, 9bjt, 9bri, 9brk, 9bsg, 9bto, 9bun, (9bxm), 9bxq, 9cby, 9cjj, 9cmk, 9cvo, 9cwi, 9dge, 9dgv, 9dsg, 9dte, 9dvj, 9dwn, 9dzw, 9eea, 9ekf, 9ekx.

By 6BWM, R. D. No. 3, Box 76, Santa Ana, Calif.

4ba, 5fv, 5nd, 5za, 5and, 6cc, 6fy, 6gl, 6nx, 6ny, 6tq, 6vk, 6zz, 6iu, 6su, 6acm, 6ada, 6ajd, 6akl, 6aoc, 6ajj, 6awt, 6bak, 6bap, 6bau, 6bbo, 6bbr, 6bce, 6bdf, 6bec, 6bfm, 6bc, 6bjp, 6blm, 6bou, 6bps, 6bqn, 6brm, 6bru, 6bsd, 6bub, 6bum, 6bup, 6bvc, 6bvo, 6bwk, 6cay, 6cbu, 6cdm, 6cdq, 6ceb, 6ced, 6ege, 6cjb, 7ge, 7ot, 7aiw, 8ab, 8yd, 8awp, 9ap, 9dn, 9fu, 9wu, 9zn, 9ajp, 9bji, 9bra.

The list of calls heard as appeared in May RADIO from 6BWN were from 6BWU and the call 6BWN was printed by mistake.

By 8AKI, W. K. Aughenbaugh, 1432 12th Ave., Altoona, Pa.

1bie, 1cru, 1awj, 2ho, 2agb, 2aia, 2axe, 2chx, 2cpa, 2cqi, 2crp, 3hs, 3nc, 3wr, 3atg, 3avk, 3avy, 3brl, 3btl, 3bvp, 3czz, 4dn, 4dw, 4na, 5gg, 5jk, 8's too numerous, 9dk, 9aon, 9cdh, 9cnv, 9deb, 9dwa. All C. W. or I. C. W.

By 6BE, 138 Va. Place, Fort Worth, Tex.

Can.—(3co), 3ko, 3ni, (4hh), 5ct. U. S.—1bes, 1bop, 1boq, 1car, 1cmk, (2agb), (2czz), (3ab), (3auv), (3hs), 3blf, 3bmn, 3xm, 3zo, 4eb, 4cc, (4fb), 4lk, 4my, 4ya, 6cu, 6ea, (6eb), (6jd), (6ka), 6ql, 6rm, 6ti, (6ash), qra?, 6alv, (6avr), 6awt, 6awx, 6beo, 6bic, 6bhk, 6bjc, (6bjj), (6blv), 6bqw, (6brf), 6bri, 6brj, 6bvg, (6bvs), (6bun), 6buu, (6caj), (6cbg), 6cbu, 6xad, 6zh, 6zg, 6zz, 7ba, 7bj, (7dh), 7hm, (7lr), 7pf, 7sc, (7sf), (7wx), 7zu. WL ans. all cards.

By 6EB, Los Angeles

5px, 5xb, 5zh, 5ado, 5aec, 5zav, 6ak, 6bm, 6bu, (6dr), 6fy, 6gf, 6gr, 6hv, 6ku, 6lv, 6nx, 6ti, 6vk, 6vm, 6yc, (6aaj), 6acm, 6ahu, 6ajf, 6alv, 6aop, 6ape, 6arb, 6arc, 6arf, 6avf, 6awt, 6beh, 6bgd, (6bgy), (6bhk), 6bhl, 6big, 6bih, 6bkc, (6bly), 6bnt, (6bnu), 6bob, 6bon, 6bou, 6bqb, 6bq, 6bua, 6bum, 6buy, 6cay, 6cbu, 6cbw, 6cdg, 6ceb, 6cec, 6cee, 6cgg, 6chl, 6ciw, 6ckh, 6ckr, 7ba, 7bj, 7je, 7kr, 7ny, 7oh, 7pf, 7qt, 7sc, (7sf), 7to, 7tq, 7wl, 7wm, (7adg), 7afe, (7aff), 7ahi, 9anf, 9ayu, 9baw, (9bjk), 9bun, 9bxq, 9caa, 9cav, 9cby, 9ctg, 9dau, 9dah, 9dvi, 9eea, 9zt. Can. 4fn, (5go) wk'd on 5 watts), bh2. Anyone listed above who would like a printed card, please write me and qrk?

By 6BQR, 953 West 7th St., Los Angeles, Calif.

All CW: 4ea, 4fs, 5adb, 5ado, 5aky, 5go, 5ma, 5mn, 5px, 5qi, 5rd, 5ui, 5xd, 5xaj, 5za, 5zh, 5zak, 5zav, 6aat, 6atq, 6ak, 6awt, (6abx), 6atu, 6av, 6ate, 6agh, 6akl, 6arf, 6akt, 6alx, (6aoi), 6afh, 6asv, 6ang, 6abk, 6ati, 6abs, 6acz, (6aak), 6auy, 6asj, (6arb), 6avv, 6auu, (6anb), (6ape), 6acm, 6atv, 6alv, 6amz, 6ahp, 6hin, 6huv, 6bci, 6bcd, 6baf, 6bum, (6biy), 6bsj, 6bnw, 6ber, 6bbh, 6bmd, (6bel), 6bmy, 6bnt, 6bow, 6bql, (6bm), (6buv), 6bon, (6brv), 6bfg, 6bua, (6bih), 6bgy, (6bhr), 6bay, 6bhk, 6bge, 6bpl, (6bnu), 6bou, 6bfl, (6bu), 6bez, 6bff, 6blm, (6beh), 6boo, 6bhv, 6boe, (6cc), 6cp, 6caj, 6can, 6cay, 6cej, 6chl, 6caw, 6cim, 6ceb, 6dr, 6et, 6fy, 6fh, 6gf, 6gr, 6gx, 6gy, 6hv, 6hp, (6ii), 6lu, 6lv, 6nh, 6nx, 6ok, 6rm, 6sz, 6tc, 6ti, 6um, 6uy, 6vm, 6vf, (6wz), 6xj, 6xr, (6xad), 6yc, 6za, 6zb, (6zx), 6zf, 6zm, 6zt, 6zq, (6zh), (6zz), (6zo), 7af, 7ak, 7aw, 7abs, 7aea, (7aem), 7afw, 7aic, 7abh, 7ahw, 7anf, 7acx, (7bj), 7ba, 7dr, 7dy, 7zk, 7hj, 7hm, 7io, 7ic, 7jd, 7iw, (7ks), 7lu, 7lr, 7ln, 7mc, 7me, 7mf, 7na, 7ny, (7ot), 7oh, 7om, 7pf, 7qt, 7r, (7iq), 7th, 7to, 7tg, 7ve, 7vf, 7wm, 7ya, 7zn, 7zl, 7zu, 7zm, 7zo, 7zb, 7zv, 8asc, 8aik, 8axn, 8bx, 8bk, 8bdu, 8bxx, 8cf, 8er, 8fu, 8mz, 8qk, 8xr qra?, 8zz, 9auw, 9amb, 9ayu, 9aul, 9aw, 9awm, 9asf, 9arz, 9avu, 9ahh, 9apf, 9abu, 9aiy, 9bun, (9bji), 9bey, 9bxq, 9bzi, 9bm, 9bxz, 9bsg, 9bjk, 9bxm, 9bri, 9cns, 9cgy, 9cde,

9ccv, 9ckp, 9cmk, 9caw, 9czz, 9cvc, 9cwi, 9dtm, 9dfb, 9dte, 9dgv, 9dlm, 9dvi, 9dio, 9dsm, 9djb, 9dky, 9eea, 9eac, 9ekh, 9fv, 9ii, 9kp, 9lz, 9pi, 9rc, 9xaq, 9xac, 9xay, 9yw, 9yaj, 9zaf, 9zab. Canadian: 4fn, 5cn, 9ac, 9bx. Wud appreciate qsl from any dx station bring 6bqr's CW. All crds ansd.

By 6AHU, R. W. Goodale, Anaheim, Calif.

(Not L. E. Gardner, Sanger, Calif., as listed) CW, Can. (fn), (4hh), (5cn), (5go). CW. (5za), (5adb), 5kp, (5px), 5nz, 5bm, 5zak, 5xb, 5mn, 5aec, 5zab, 5xaj, (6bri), 6's too numerous, (7na), (7om), (7jg), 7sc, 7eq, (7vf), 7abb, (7zn), 7ve, (7aea), 7lw, (7afw), 7wk, 7vu, 7lu, 7sj, 7tn, (7tq), (7wx), 7afe, 7zl (7js), 7adg, (7ln), (7ks), (7jw), 7ak, (7lr), (7wm), 7tg, 7ws, 7gc, 7my, (7bj), 7wf, 7kj, 7abh, (7sf), 7gp, 7dp, 7ahw, (7hs), 7ri, 7io, (7adc), (7pj), (7pb), (7je), (7pf), (7ba), 7agu, 7em, 7abs, 7fg, (7it), (7to), 7mc, (7ro), 7agi, 7afn, 7qn, 7qt, (7hi), (7zu), 7kf, 7afo, 7adp, 7mf, 7nl, 7br, 7hm, 7gp, 7ey, 8atp, (9bri), 9cwa, 9dgv, (9caa), 9gk, (9amb), (9bjk), 9cvo, 9cgy, 9bxa, 9ayu, 9bxq, 9ac, 9dvi, 9bji, 9avu, 9au, 9avk, 9bvo, 9azg, 9eca, (9apf), 9bxm, 9zt, 9acy, 9ckm, 9aah, 9bhd, 9cjj, 9aul, (9bun), 9cwc, 9dvw, (9aap), bt3.

By 9AAP, Milwaukee, Wis.

CW. law, (1gv), 1sn, (1azl), (1awz), (1brq), (1bwj), 1cni, (2om), (2hw), (2fp), (2ann), (2ccd), (3ii), (3jj), (3fq), (3wf), 3xm, (3zo), (3aa), (3hd), (3apr), (3cfl), (3acr), (3bgt), (4ag), (4cy), (4el), (4mb), (4my), (4ek), (5iv), (5xa), (5zb), 5aec, (5agj), (5ahr), 5zaba, (6gg), 6iv, 6jd, 6ka, 6ze, (6zg), (6ti), (6ahu), 6xad-zw, 6awt, 6bvf, 6xxa, (7ln), (7nf), (7sc), 7wx, (7zu), (7zv), (7abb), (8es), (8ri), (8vl), (8te), (8xe daltze), (8yv), (8aeg), (8agv), (8alg), (8alf), (8avd), (8azo), (8bch), (8bde), (8bdo), (8bdy), (8byu), (8cdd), (8cny), (8cxp), (8dgp), (8cgo), (8yae), 9s all wk'd. 9ci, 9ep, 9ig, 9mf, 9of, 9ox, 9sv, 9uh, 9ur, 9uu, 9xm, 9yb, 9ahh, 9aix, 9aj, 9amt, 9apw, 9aog, 9ape, 9aps, 9arc, 9arg, 9asf, 9atn, 9aua, 9aul, 9awk-fone, 9aza, 9bav, 9bcb, 9bch, 9bhe, 9brk, 9boo, 9btt, 9bwq, 9ccn, 9cka, 9cln, 9cxt, 9cyy, 9daw, 9dbl, 9dbm, 9dcb, 9ddu, 9dvw, 9dgi, 9dgv, 9dkq, 9duq, 9ear, 9ead, 9ebh, 9ebi, 9eky, 9ehi. Canadian: (5go), (3in), (3ni), (3oj), (4bv), 4cn, (4er), 9bx. Geographical conditions here prevent us from hearing 6's and 7's. 100 watts hr.

By Sam Spittle, Astoria, Ore.

C. W.—be3, qra?, 6ar, 6ai, 6av, 6arb, 6auu, 6bbc, 6bge, 6bjy, 6bic, 6buu, 6bv, 6cn, 6can, 6cgd, 6cdz, 6bu, 6ckl, 6fy, 6pl, 6vm, 7acn, 7agf, 7akq, 7aiy, 7hm, 7io, 7nt, 7om, 7pv, 7tq, 7wa, 7zu. Canadians: 4cn, 4cl, 4fn, 5ej, 9bx (cw & fone).

By 6BQL, 575 21st Ave., San Francisco, Calif.

Can.—4cn, 4hh, 5ej, (5go). U. S.—3yo, 5kc, 5za, 6cu, 6ea, 6hv, 6ka, (6rm), 6yc, 6zb, (6zr), 6zz, (6zal), 6aag, 6aak, 6acs, (6acz), (6ahq), (6ajr), (6alk), (6anb), 6apv, (6avr), 6bbc, 6bbh, 6beg, (6beo), 6beh, 6bic, (6bjj), 6boe, (6bod), (6bqb), 6bqd, (6bge), 6bqc, (6bmn), (6bih), (6buo), 6bve, 6bvg, (6bwb), (6bwd), 6bwl, 6cch, 6ccj, (6cfq), 6cgv, (6egd), 6cim, (6che), 6cmr, (6cng), (6cjj), (7af), 7ak, (7bj), 7br, 7fh, 7dh, (7gp), 7hm, (7iw), 7ks, 7nl, 7oh, (7ri), 7sc, (7to), 7tt, 7tq, 7wm, (7ws), (7za), 7zf, 7zu, 7zn, (7adg), 7aea, (7aff), 7afo, 7ahc, 8jy, 8cmi, 9dw, 9qf, 9zt, 9aap, 9ahu, 9apf, 9apw, 9asf, 9aul, 9avz, 9cvo, 9dez, 9dwn. Wud appreciate a qsl on my new 5-watter. qrk?

By 9DSW, Fairmont, Minn.

All C. W.: law, laxi, 1gl, 1gv, 1ii, 1il, 1iv, 1jt, 1mc, 1mv, 1go, 1qp, 1sq, 1sw, 1vr, 1wi, 1xu, 1xz, 1yj, 1yk, (1adn), 1ajx, 1aqm, 1ban, 1bas, 1bes, 1bp, 1ba, 1bkq, 1bku, 1bms, 1btr, 1bv, 1bwj, 1cab, 1cac, 1cc, 1co, 1cja, 1civ, (1emp), 1enf, 1eni, 2af, 2ca, 2cc, 2cm, 2co, 2el, 2fp, 2zf, 2gk, 2hg, 2hj, 2ir, 2jz, 2em, 2lo, 2mb, 2nz, 2oh, 2pv, 2px, 2qr, 2re, 2rf, 2sm, 2ud, 2wb, 2xi, 2xq, 2xu, 2ax, 2abq, 2acd, 2afb, 2afc, 2afw, 2ajf, 2ajh, 2ajw, 2ajj, (2anm), 2api, 2aro, 2awf, 2awl, 2az, 2bfe, 2bgt, 2bjo, 2blp, (2bls), 2bmr, 2bnz, 2bof, 2bhu, 2bqt, 2brb, 2brc, 2bri, 2brg, 2buc, (2bzw), (2ced), 2cfx, 2ctg, 2ek, 2ekl, 2ekn, 2elr, 2cnk, 2cuz, 2cur, 2cvc, 2evj, 2cwo, 2cxl, 3as, (3ba), 3bn, 3bz, 3ca, 3cm, 3fk, 3fq, 3hd, 3hh, 3hs, 3iu, 3iz, 3ji, 3jj, 3jy, 3ko, 3me, 3mo, 3nb, 3nf, 3od, 3oe, 3pq, 3pz, 3qe, 3qv, 3rf, 3si, 3sk, 3sx, 3tj, 3tl, 3ta, 3uz, 3za, 3xm, 3xn, 3yo, 3yk (spk), 3wf, 3zo, 3zp, 3zs, 3acq, 3acy, (3adx), 3aib, 3ajj, 3akr, 3ami, (3apr), (3aqr), 3aro, (3arp), 3ava, 3bav, 3bfu, 3bhl, 3bhm, 3biy, 3bjj, 3bkl, 3blf, 3blg, 3hno, 3bof, 3bob, 3bqx, 3bsp, 3btl, 3buq, 3bvc, 3bva, 3cbm, 3cbz, 3ccu, 3cel, (3xal), 4acy, (4ag), 4bi, 4br, 4bq, 4cd, 4cg, 4co, 4db, 4dc, 4do, (4eb), 4el, 4fb, 4eh, 4fg, 4fj, 4fq, 4fs, 4ft, 4gz, 4hs, (4hw), 4hz, 4id, 4iv, 4jj, 4jk, 4w, 4kc, 4kl, (4km), 4ki, (4lj), 4li, 4mb, 4me, 4nn, 4nv, 4od, 4oi, 4pd, 4qc, 4xn, 4ya, 4zc, (5ae), (5bm), 5br, 5cy, 5da, (5do), (5eb), 5ed, (5ek), (5el), 5er, 5fo, 5fv, (5ga), (5gj), (5gg), 5hb, (5ho), 5hh, 5ik, 5im, (5iq), 5ix, 5iz, 5jb, (5jn), (5jw), (5ke), 5kc, (5kk), (5kp), 5ku, (5ll), (5lu), (5ml), (5mb), (5nk), 5ou, (5nn), 5pb, 5pf, (5po), (5px), 5qm, (5qs), (5qi), 5rh, (5rn), (5sf), (5sm), (5ta), (5tc), 5tj, 5tp, 5tt, (5ud), 5uj, 5uk, 5un, (5uo), 5up, 5we, 5xa, 5xb, 5xk, 5xr, 5xv, (5yg), (5za), 5zb, 5zg, 5zy, (5zp), (5aab), 5aag.

NEW APPARATUS & SUPPLIES FROM THE RADIO MANUFACTURERS



The Cutler-Hammer 30 Ohm Radio-Rheostat

When purchasing material for a new radio receiving set, or when buying one already completed, it is well to give some consideration to the kind of vacuum tubes which are to be used in the new set.

The standard detector or amplifier tube requires a six-volt storage battery and has a current consumption of about 1 ampere. This combination requires the use of a standard four to six ohm rheostat.

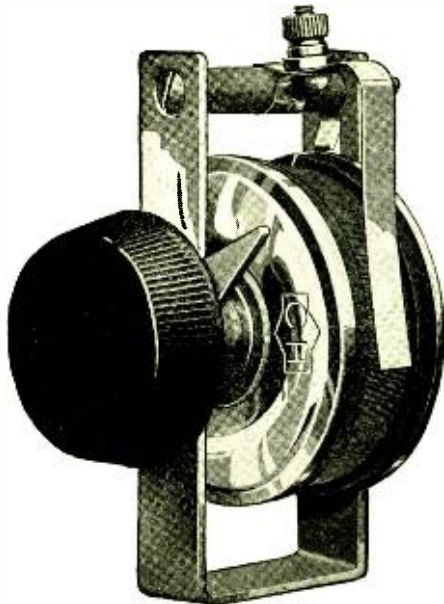

New C-H 30 ohm Radio-Rheostat

With the coming out of the new receiving tubes, however, operating efficiently on one-quarter of an ampere, it becomes necessary to use a rheostat of much lighter resistance to control the new tubes.

With a six-volt battery, it is necessary to insert a rheostat of approximately 30 ohm resistance in the circuit when using the new 201-A or 301-A receiving tube. These tubes will function with a 4 to 6 ohm rheostat in use, but continued usage of such high current will materially shorten the life of the tube, and the benefits of low current consumption and efficient operation will be lost.

When it is understood that four of the new tubes use the same amount of energy as one of the old, the advisability of the use of a proper rheostat at once becomes apparent. The Cutler-Hammer Mfg. Co. is building 30 ohm rheostats which are particularly adapted to the use of the new one-quarter ampere tubes.

The new 30 ohm rheostat is variable over its entire range of from 0 to 30 ohms, and is easy and convenient to mount and connect. The contact finger rides smoothly over the resistance and the rheostat is noiseless in operation. They are thoroughly packed in individual cartons with a mounting template enclosed, and instructions are plainly printed on each box. These rheostats are of the re-

volving drum type which have proven so successful in radio work in the past.

The new one-quarter ampere receiving tubes are very efficient in operation and extremely economical of current.

Some of the benefits which accrue from the use of the new tubes are increased volume of incoming signals or music, less current consumption from the storage battery and the decided advantage of not having to charge the storage battery so frequently.

The 201-A one-quarter ampere tube is listed as both detector and amplifier, but these tubes find their greatest field in amplifying circuits. They are especially adapted to audio frequency amplification. It is best to have a rheostat of 30 ohms resist-

NEW CLAPP-EASTHAM RECEIVER

The Clapp-Eastham Company of Cambridge, Mass., manufacturers of Radak radio equipment, have brought out a new receiver incorporating many unusual features. This Type C-3 Receiver is housed in a very attractive walnut cabinet. All binding posts have been removed from the front, and connections are made through the back of the cabinet. All tuning controls are equipped with a single-knob vernier. The vernier has no back-lash or lost motion, and has a ratio of 5 to 1. A new vernier rheostat is used on the detector, which is a single-knob vernier, and is very simple to operate.



Clapp-Eastham Type C-3 Receiver

ance on the set so that the tubes may be interchangeable, that is, several types of tubes may be used. The rheostat has enough resistance to compensate for any difference in voltage, using the standard six-volt storage battery.

The Cutler-Hammer 30 ohm rheostat will do all that the 6 ohm rheostat will do and besides has the additional ohmic capacity to handle the new tubes.

The Allen-Bradley Co., 288 Greenfield Avenue, Milwaukee, Wisconsin, have recently placed upon the market a new model of the well-known Bradleystat which can be used with all detector and amplifier tubes. The new model, known as the Universal Bradleystat with three terminals, provides extremely wide range of control in three ranges obtainable by using the proper pair of terminal connections. By means of the new Universal Bradleystat radio enthusiasts and radio manufacturers can use one rheostat for all tubes and enjoy the same wide range of stepless, noiseless control which the older Bradleystat models provided for a limited number of tubes. The use of scientifically-treated discs enables the Allen-Bradley Co. to guarantee the Universal Bradleystat to give perfect filament control for all tubes.

All tube bases, rheostats and telephone jacks are in line, making a symmetrical appearance.

The set is regenerative, licensed under the Armstrong Patent, and probably the most interesting feature of the set is its rugged construction. In place of the wire commonly used, a 3/8 x 1/16-inch brass buss bar is used throughout for connections. This makes a very attractive proposition, and certainly eliminates the trouble from soldered joints, etc.

The makers say, "This set is built like Brooklyn Bridge—to last forever," and one look at the interior convinces the average person that this is so. In addition to tuning to the usual broadcast wavelengths, this set tunes to 3000 meters.

Herbert H. Frost, Inc., 154 West Lake Street, Chicago, has opened a New York City office at 30 Church St., under the direction of Mr. M. Frank Burns as District Sales Manager. Mr. Burns was formerly with the Westinghouse Electric & Manufacturing Company of East Pittsburgh, Pa. The opening of Herbert H. Frost's New York office is one of the moves toward general expansion of its organization through district sales offices by this company, and will be followed by the opening of similar offices in San Francisco and other cities.

Be a Radio Operator

Earn Big Money

See the World

Without Expense



An Operator on One of Our Ocean Liners

Learn at home to fill a REAL position in the world's fastest growing industry! Thousands of big pay jobs waiting for trained men. Read what one big newspaper says about this crying demand for radio operators.

A Great American Newspaper Says This About Radio:

(This article appeared in the San Francisco Call and Post, May 21, 1923.)

SHORTAGE OF RADIO MEN THREATENS SHIPPING

By Al. S. Peterson

A shortage of radio operators threatens the world's shipping.

Unless the American boy can be lured from the simplicity of the radio telephony and persuaded to learn practical wireless telegraphy, the operator shortage will soon become so serious that it may be impossible to secure enough men to provide radio needs of shipping, according to C. H. Blake, marine manager for the Federal Telegraph Company. He added:

"The situation is not critical at present, but it will be soon. All of the surplus supply of experienced radio operators has been put to work. We just managed to get enough to supply the demand from the canary fleet and stations this year.

"It will now be necessary for the wireless companies to secure some sort of co-operation from the shipping men and the public if men are to be trained for the work that is demanded by law for certain classes of ships.

"The situation confronting the world's shipping can only be attributed to the lure of the broadcasting. Those vitally interested are arranging to get together for the purpose of planning some method to meet the situation that threatens.

"We believe there should be some feasible method that can be depended upon to attract young men to take up the study of radio telegraphy, which offers an opportunity for travel, health and splendid compensation."

How often you've dreamed of travel—of being able to talk from experience of the gayness of Paris, the splendor of a Mediterranean sunset, the quaintness of a Chilean village, the poverty of Oriental settlements, the antiquity of Egyptian landmarks—these and a thousand other interesting scenes you've read about or seen in movies.

Now you can see the world—not as a hurried tourist who sees little and feels nothing, but with comfort and quietness, and earning splendid money all the while. You can be equally at home on a London tram or in a Venetian gondola; you can be as familiar with the native characteristics of the Chinese coolie as the Spanish peasant; you can in truth be a real citizen of the world, enjoying experiences rarely granted to men.

A Splendid Education The Life of an Officer

You will find that travel affords a splendid education. In your travels about the world you will learn much. You will meet the world's greatest variety of peoples. On board ship you will come into contact with the wealthy traveling public and the prosperous, active business class. In port you will be free to roam around and to explore all the interesting points both in the seaport towns and the surrounding country.

You travel in real style. On board ship you enjoy all the privileges of an officer. Your work is most fascinating. Messages to all corners of the world pass through your fingers. You occupy a position of great responsibility, a position which gives you a fine chance to make valuable connections in case you ever want to give up the sea and settle down.

Radio operators are in big demand on land as well as sea. In case you want to give up the sea, you have a wonderful opportunity of step-

ping into a splendid land position—operator at a land station or any one of hundreds of the more important big paying positions in radio. The splendid training you receive in qualifying as an operator will bring big money to you no matter where you decide to settle.

Send for New Booklet

Learn more about this world's fastest growing industry. Send for new illustrated booklet "Your Opportunity in Radio" which describes in detail the glorious opportunities in this field. Radio calls you from land and sea, and offers you more money than you could possibly earn in other fields.

Write now for this interesting booklet which tells you how you can become an operator or qualify for any other of the better positions in radio. It will be sent to you without cost. Mail coupon for it NOW.

National Radio Institute
Dept. 10-6 WASHINGTON, D. C.

NATIONAL RADIO INSTITUTE
Radio Headquarters
Dept. 10-6, Washington, D. C.

Please send me your catalog "Your Opportunity in Radio" describing your Home Study Course which will qualify me to become a Radio-trician.

Name

Address

City State

Tell them that you saw it in RADIO

CHARGE YOUR RADIO BATTERY at HOME for a NICKEL



PATENTED ARMATURE
The HOMCHARGER'S only moving and wearing part, replaceable after thousands of hours' use for \$1.00. Tungsten contacts now used exclusively. Will not stick, corrode or wear excessively.

Enjoyable concerts and maximum receiving range are obtained only when your battery is fully charged.

THE HOMCHARGER

charges your "A" or "B" battery OVER NIGHT for a nickel without removing it from your living room. Operates silently—charging rate governed automatically. No muss—no trouble—no dirt—requires no watching.

The HOMCHARGER is the ONLY battery charger combining all of these necessary features. SELF-POLARIZING—FIVE to EIGHT-AMPERE charging rate—UNDERWRITERS' APPROVAL—beautifully finished in mahogany and old gold—UNIQUELY LIFEDLY GUARANTEED. Over 100,000 now in use.

The minute you buy a radio set you need a Homcharger—get it then. All good radio and electrical dealers sell it complete with ammeter, etc., for \$18.50. \$25.00 in Canada.

Write for FREE circular showing why the HOMCHARGER is the BEST battery charger at any price.

MOTORISTS — THE HOMCHARGER will also charge your AUTO Battery.

Western Distributor
BERTRAM SMITH
405 San Fernando Bldg., Los Angeles, Cal.
THE AUTOMATIC ELECTRICAL DEVICES CO.
117 West Third St.
Cincinnati, Ohio

Largest Manufacturers of Vibrating Rectifiers in the World.

AMRAD TO SELL RADIO BY PARTIAL PAYMENTS

A definite plan for selling Amrad Radio Products on partial payments is announced to the entire radio trade by the American Radio and Research Corporation. Selling radio on time is something distinctly new in the radio industry.

According to the details of the plan now ready for the trade and announced by H. J. Power, Vice President and General Manager, the small dealer is able to sell radio on partial payments without increasing his capital.

THE AUDIOMETER

An interesting application of a vacuum tube circuit to other than radio purposes is the audiometer, which, as its name implies, is a device for measuring the amount of sound heard by a person.

normal ears there has now been established a standard for the normal hearing. This is shown in Fig. 2. The lower line is established by finding the lowest intensity at which the tones can just be heard, the tones being spaced an

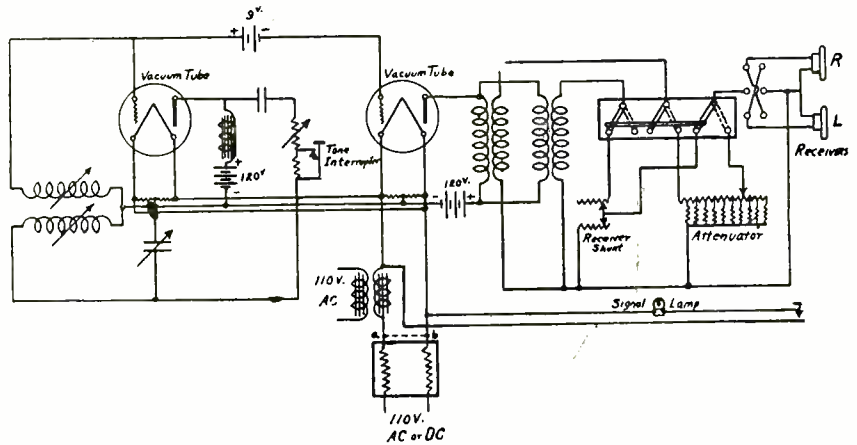

Fig. 1. Audiometer Hookup.

This interesting instrument has been developed in the research laboratories of the Western Electric Co. As may be noted from the accompanying circuit diagram the vacuum tube may be caused to generate an oscillating electrical current of any desired frequency. This electrical vibration is transferred into

octave apart. The upper line shows the maximum intensity at which these tones can be heard without hurting the ears. The area between these two lines shows the area of normal hearing. It will be noted that the tones near the middle of the scale when their intensity or loudness is considerably less than that

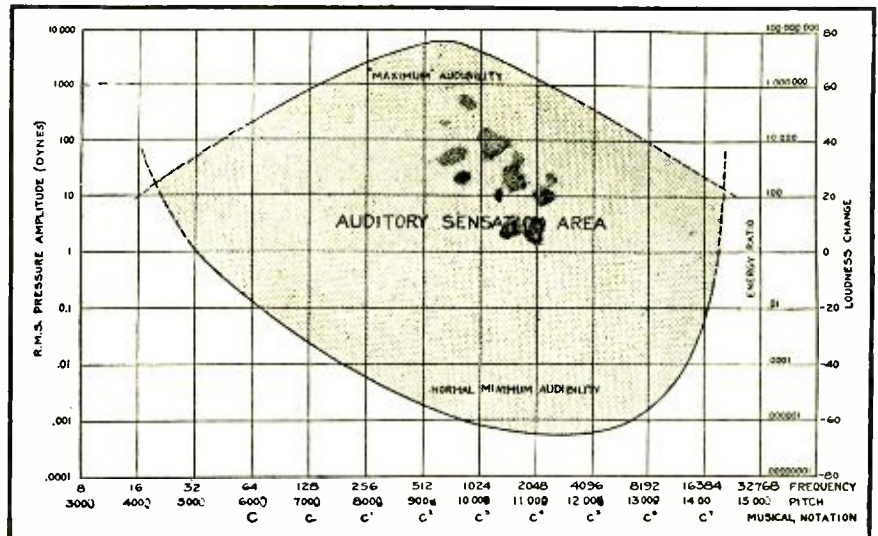

Fig. 2. Chart of Normal Hearing.

sound vibration by means of a telephone receiver. Between the receiver and the oscillator, a wire network called an attenuator is interposed which makes it possible to regulate the volume of sound. The theory of the thermal receiver, used to calibrate the audiometer, has been worked out so that it is possible to calculate its acoustic output from the electrical energy it is absorbing. In this way it is possible to calculate the pressure produced in the outer ear canal when a tone is being perceived.

Its use is to determine the number of pure tones audible to a person. Then by measuring the hearing of a number of

of the higher or lower notes at either end.

With such a chart as a standard the percentage of deafness of a person with poor hearing can be obtained by plating a similar chart. It is also possible to determine just what tones cannot be heard and thus give a doctor a clue to what causes the deafness and possibly restore the hearing.

C. Thompson (6UQ) of San Francisco is now in Mazatlan, Mexico, installing the former 50-watt KDN Fairmont Hotel broadcasting equipment for a Mexican concern.

Tell them that you saw it in RADIO

PERFECT
FILAMENT
CONTROL
FOR
ALL
TUBES

Ask for the Universal Bradleystat With 3 Terminals



A Perplexing Problem Solved!

TRY any tube in your radio set! It makes no difference what tube is used, the new universal Bradleystat with three terminals will give perfect filament control. A very simple change of connections and a remarkable range of control make this possible for the first time in radio history. Like former Bradleystat models, the new universal Bradleystat with three terminals is covered by the same iron-clad guarantee of perfect performance, noiseless control and quicker tuning that sold hundreds of thousands of Bradleystats during the past year.

Be prepared to try any new tube by replacing your present rheostats with the new universal Bradleystat. It is the last word in flexible and perfect control. It is backed by twenty years' experience with graphite disc rheostats. *Beware of imitations.* Avoid the use of inferior carbon powder rheostats. The name "Bradleystat" is embossed on container for your protection.

Mail the coupon below for full information about the latest and most remarkable development in filament control. CLIP THE COUPON, NOW!

ALLEN-BRADLEY CO. • 288 Greenfield Ave. • MILWAUKEE, WIS.

I am pleased to hear that the universal Bradleystat with three terminals has solved the perplexing problem of finding one rheostat for all tubes. This is good news. Please send me full information and explain how it is done.

Tell them that you saw it in RADIO

- C-300
- C-301
- C-301A
- WD-11
- WD-12
- UV-200
- UV-201
- UV-201-A
- UV-199

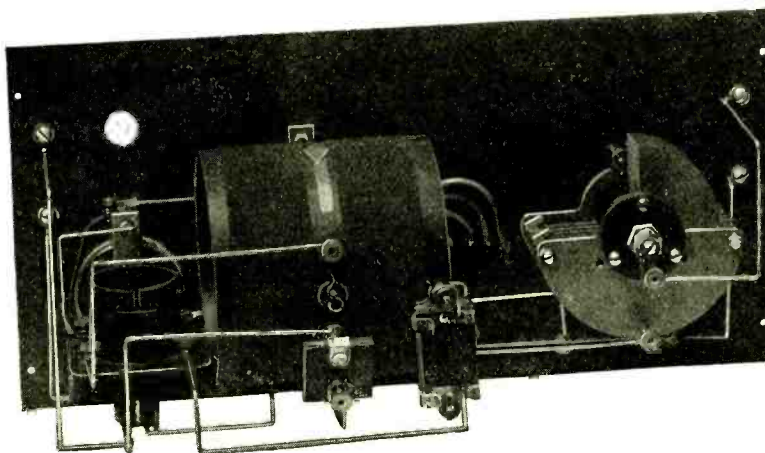

TYPE AD SET KNOCK DOWN.....\$28.00
 Range 1000 Miles Fitted for Std. or WD 11 Tube
 (Price does not include cabinet)

SE-AR-DE TYPE AD RECEIVER is supplied in knock down form only. Genuine Bakelite panel, 6⁵/₈x14, drilled and engraved, is packed in a substantial wooden box with all of the parts, including wire, spaghetti, etc. One of these sets brought in KHJ, Los Angeles, Cal., from South Acworth, New Hampshire.

R. MITCHELL CO. : 255 Atlantic Avenue
 Boston, Massachusetts

For 47 years Manufacturers of Scientific and other equipment
 Look for trade mark on every piece

Jobbers and Dealers write for discounts

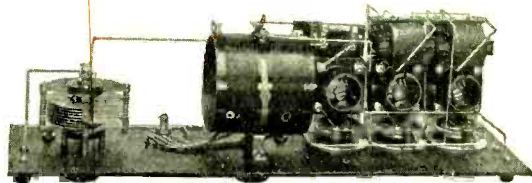

TYPE AD2 SHORT WAVE RECEIVER \$49.00
150 to 630 Meters—Knock Down Form only

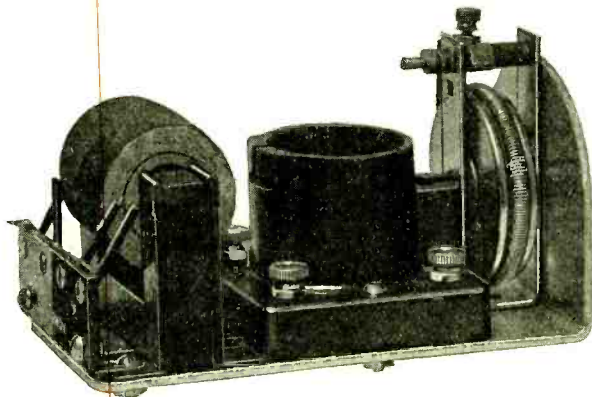

No. 198 Amplifying Unit \$7.50
No. 211 Detector Unit \$2.40
No. 206 Detector Unit (30 ohm) \$3.00

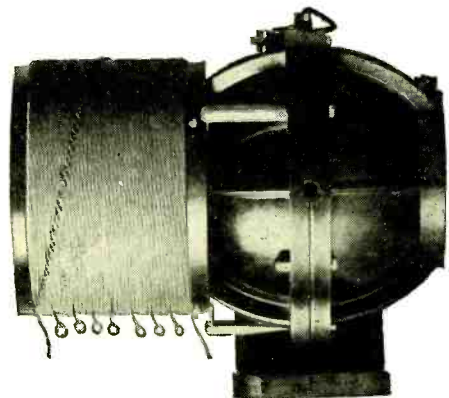

No. 165 \$13.00
SE-AR-DE Radiometer with
B. W. Inductance

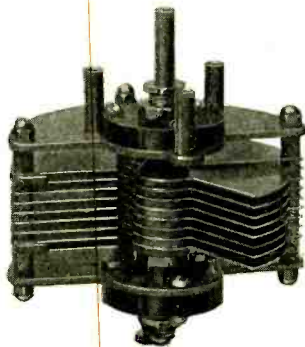

No. 185 Variable Condenser
\$4.25
Cap. .00035 m. f. 17 plates



No. 193
Vernier
Adjuster
\$0.35



No. 164 Knob and Dial
\$0.75
Molded Bakelite

R. MITCHELL CO. :

255 Atlantic Avenue
Boston, Massachusetts

For 47 years Manufacturers of Scientific and other equipment
Look for trade mark on every piece
Jobbers and Dealers write for discounts

ATWATER KENT

RECEIVING SETS AND PARTS



If you are now working with a one-tube set, the 2-stage amplifier shown here will give you the necessary volume of sound to make a loud speaker possible.

It is a compact unit—transformers are sealed in the base so that no dampness can affect the working quality of the instrument. To demonstrate the damp-proof qualities, one of these instruments was soaked in a tub of water for several hours, then put into a circuit and tested for reception with perfect results.

Send for an illustrated folder showing all parts and complete sets.

ATWATER KENT MANUFACTURING COMPANY
4947 STENTON AVE. Radio Dept. PHILADELPHIA, PA.

ADJUSTABLY SELECTIVE RECEIVER

Continued from page 13

is of course necessary to separate the windings of the variometer; they are normally connected together in series; for this use the rotor must be free from any connection with the stator, as it must be in the plate circuit, while the stator becomes the secondary.

Similarly, if one has merely the urge to see what the device can do and will be satisfied with less than the full range from 200 to 800 meters, the shorter portion of that range can be had with any of the market types of variocouplers. These have the required taps already provided, and will give, with the condensers described and pictured, a workable outfit for the amateur transmitting band, and this with absolutely no broadcasting interference.

A further convenience lies in the type of honeycomb coils that has taps and a switch incorporated in the coil mounting. With one of these of proper tapping, the necessity of changing the honeycomb coil is obviated and the device is complete with one such coil instead of three or more of the ordinary type.

The rotor shown in the sketch suggests, correctly, that the type in the practice of the writer was one turned from wood, with a transverse curvature on the face. This form most closely fits the stator, and is to be preferred for just that reason. The difference in results, however, between this form and a cylindrical rotor is not great, while to some workers the difference between using a turned rotor and a piece of pasteboard tubing may mean all the difference between trying the arrangement and not trying it at all. In such cases we urge the use of the tubing, which suggests the further mention, as to this and other types of receiving sets, that the use of silicate of soda markedly extends the usefulness of pasteboard for the radio experimenter. Using it as an adhesive one can roll up perfectly satisfactory cylinders. Examine a commercially made oats box and copy the practice of using several layers and spirally wrapping to avoid overlapping joints. The thickness is under control in this method, so that the resulting tube can be as stiff as you may wish. If your taste runs to artistic results, cover the tube with dull finished black paper, using silicate of soda to attach it, paint it inside and on the ends with the color known as "flat black," and the result will gratify you. It will be at least the equal of a bakelite tube in operation and sightliness.

The best way to carry out the ends of the rotor winding is to use tubing for the shaft and drill into the bore of it within the open space of the rotor and carry the two wires out through the shaft to the rear end.

The Best Headset



At Your DEALERS
\$5.00

Highest Audibility
Perfect Matching
Greatest Volume

Why Strain Your Ears?

"T-B-H" Head Sets reproduce clearly and naturally. No "Fuzz" or "Tinny" tone. Extremely sensitive.

Aluminum cases—6 Foot cord—Weight 12 oz.
Type 6-A 17500 Turns (2200 ohms) Hard Rubber caps.....\$7.00
Junior 16000 Turns (2000 ohms) Composition caps.....\$5.00
If your dealer does not carry them : Dealers and Jobbers
he will order them for you. Write For Discounts

The **T-B-H** Corporation
Dansville, New York, U. S. A.

DISTRIBUTORS:
The Eastern Specialty Co., Philadelphia, Pa. (Metropolitan District & South Atlantic States.)
Donaldson Radio & Service Station, Kansas City, Mo. (Southwestern States.)
Marie A. Alvarez, Havana, Cuba. (Cuba)

Try **REYNOLDS RADIO Service**

9ZAF

from **DENVER**

KLZ

The exclusive distributors of

KENNEDY EQUIPMENT

IN THIS TERRITORY

If you have a **KENNEDY Receiver** you have the best in Radio
REYNOLDS RADIO CO., Inc., 1534 Glenarm St., Denver, Colo.

Largest distributors of Radio Apparatus in the West

? Did YOU receive our 68-page Catalogue ?



Frost-Fones are made with the precision of fine watchmaking. Every part of a pair of these famous fones is built within such close limits of accuracy that absolute uniformity of tone is assured. They could not be made better if they cost twice as much.

FROST-FONES

“LIKE postage stamps, used everywhere” is the best proof of Frost-Fone quality. Many hundreds of thousands have been sold to fans who know what a head fone should be and who insist upon nothing less than highest quality and utmost value for their money. You too, will find in Frost-Fones your ideal for clearest, sweetest radio reception. Your dealer has them — see him today.

No. 162
2000 Ohm Set
\$5⁰⁰

No. 163
3000 Ohm Set
\$6⁰⁰

HERBERT H. FROST, Inc.
154 WEST LAKE STREET
CHICAGO
30 Church Street, New York

FROST-RADIO TUNING COIL

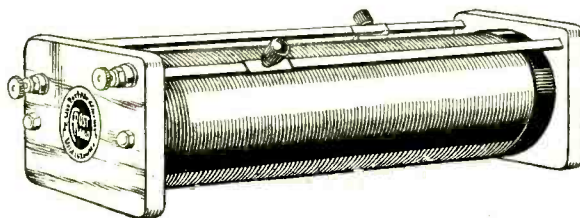

EVERY owner of a radio receiving set should have a Frost-Radio Tuning Coil as a piece of auxiliary apparatus. No trouble to tune to a hair on the new wave lengths with this selective “single turn” quality coil. For those who have no set as yet, the Frost-Radio Tuning Coil combined with a pair of Frost Fones and a crystal detector make an ideal beginner’s outfit. Has 1000 meter range. Beautifully made. Guaranteed by the name of the maker.

No. 410 FROST-RADIO \$3⁰⁰
Tuning Coil

FOR the more experienced amateur, or for the beginner who wants a more elaborate tuner we recommend a Frost-Radio Receiving Transformer. Has 200-4000 meter range, with wonderfully selective slider. Silk-wire-wound. Mahogany finished hardwood base and frame. Formica secondary coil head. Nickel plated brass metal parts, hand buffed. A value without an equal in the entire radio field.

No. 400
Frost-Radio
Receiving
Transformer
\$8⁵⁰

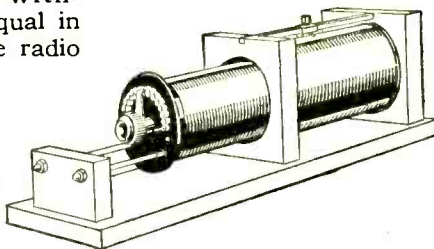



The Trinity Loud Speaker

TYPE "A1"
\$25.00
21-in. Fiber Horn

The only device of its kind in the Radio field



Type "B" \$12.50

Study the illustration carefully and you will understand why it produces full, clear, natural tones with perfect reproduction of all vocal and instrumental music. May be used with phonograph. No storage battery required.

The Trinity Loud Speaker is an instrument that combines the best qualities of a phonograph reproduce^r in combination with electro magnetic principles best fitted for radio amplification. Absolutely perfect reproduction of all music and speech without distortion. The volume may be regulated from that required for a room in your home to a tremendous output that can be heard hundreds of feet out of doors by simply increasing "B" battery voltage. No storage batteries required. The instrument is of a heavy duty type and is guaranteed fully by the manufacturers.

Ask your dealer for demonstration—if he cannot we can.

TRINITY RADIO CORP.

168A Dartmouth St.
BOSTON, MASS.

BROADCASTING AND ITS FUTURE

Continued from page 10

an audience, the matter broadcasted must have a permanent value and not compete with other agencies that can and do produce the same program more efficiently. No matter how efficient the broadcasting station, the reception of broadcasted music cannot satisfactorily compete with the personally attended concert, and seldom with a first class phonograph. Inevitably then, as soon as the novelty wears off the continued uses of radio must rest upon a more stable foundation than amusement by jazz, concerts, plays, athletic contests and sports.

The third element that is shaping the destiny of radio broadcasting is its control and the ownership of broadcasting stations. The uncontrolled operation of broadcasting stations cannot continue much longer without creating an aversion to all things broadcasted. Some order must be introduced in the confusion that at present exists. This control will inevitably shape or mould the type of broadcasting in the future. As Congress failed to enact into law the bills proposed by the first radio conference, Secretary Hoover, recognizing the imperative necessity of bringing some semblance of order out of the chaotic condition now existing, convened the second radio conference. This conference in its recommendations recognizes the paramountcy of the public interest in radio broadcasting and recommends a limitation and rigid governmental control of broadcasting stations to prevent the jeopardizing of this public interest.

This control of broadcasting stations is at present only regulatory, but when the limited facilities available for broadcasting, the uneconomic and uncertain basis of this method of disseminating entertainment, the conflicting local interests, together with the characteristic element of radio communication, are considered, not merely regulatory control, but agency of operation assumes importance.

As already suggested the future of radio broadcasting must rest on some service to the public which has a paramount value and which no other agency is supplying in as efficient a manner. This element of value is involved in the possibility of simultaneous reception of signals at a large number of widely separated points to which timely and useful information of all sorts from centers of activity seldom penetrates, and at regions and districts to which such intelligence does ultimately penetrate but where delivery is usually delayed until the value of such information is lost. Plainly then the element of permanent value in radio broadcasting is to rural and outlying districts and not to urban communities. Radio broadcasting pos-

Continued on page 52

WITHIN THE REACH OF ALL THE WELL KNOWN—

Jacobs' Concert Receiver

Made From the Very Best Standard Parts—Assembled by Skilled Workmen

ASSEMBLED, READY FOR USE
\$15
TAKING NEW ENGLAND BY STORM

Satisfactory in every way for long distant concert reception. Remember Every Set is Backed by a Guarantee of Absolute Satisfaction or Money Refunded.

The Radio Sensation of the Year

Receives These Stations Regularly from Boston, Mass.:

WHA—Madison, Wis.	WOC—Davenport, Iowa.	WCX—Detroit, Mich.
WHAF—Pittsburg, Pa.	WOR—Newark, N. J.	NOF—Anacostia, D. C.
WHAS—Louisville, Ky.	WQAG—Abilene, Tex.	WGAF—Tulsa, Okla.
WIP—Philadelphia, Pa.	WRAU—Amarillo, Tex.	WGAS—Chicago, Ill.
WJAC—Univ. Pl., Neb.	KDKA—Pittsburg, Pa.	WGM—Atlanta, Ga.
WJZ—Newark, N. J.	KSD—St. Louis, Mo.	WGY—Schenectady, N. Y.
WHB—Kansas City, Mo.	WBAZ—Richmond, Va.	

Dealers and Jobbers write for Discounts

Dealers and Jobbers: Write for discounts

The RADIO SPECIALTY CO.

Of New England

25 Huntington Ave., Boston, Mass.

NOVO "B" BATTERIES

with insulated binding posts and 7' Copper Wire Connectors

Pacific Coast Representatives

MARSHALL & CO.

Union League Bldg., Los Angeles, Calif.

GUARANTEED REPAIRS

Broken and Burned-Out VACUUM TUBES

W.D.-11 not accepted for repair

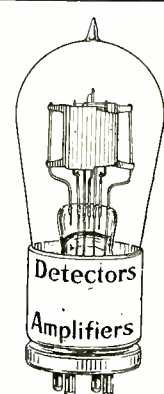

Your dealer should know, but if he does not, send direct to

HARVARD RADIO LABORATORIES

Boston 9, Mass.

Tubes returned Parcel Post C.O.D.

Tell them that you saw it in RADIO



SIGNAL
Radio
Talks, No. 6

SIGNAL

Facts from the Factory

DON'T let exaggerated stories of summer "static" dampen your enthusiasm for Radio at this season. On most summer nights—especially in dry weather—receiving is as good as at any other time of the year. *But you must have quality apparatus*—like SIGNAL for instance.

Most of the interference attributed to static and other air disturbances is due to apparatus incorrectly, ignorantly, or carelessly manufactured. You *never*—at any season of the year—can get satisfaction with such apparatus.

But with SIGNAL Radio sets or parts it's different. Every SIGNAL item is made in a factory that has grown up with "wireless." Utmost precision marks even the smallest detail of manufacture. With SIGNAL, service is inbuilt; SIGNAL has stood the test of time.

Say SIGNAL, when you're buying radio equipment, and you'll "listen in" with satisfaction the whole year through.

SIGNAL Electric
Mfg. Co

Factory and General Offices:
1913 Broadway, Menominee, Mich.

Atlanta
Boston
Chicago
Cleveland

Minneapolis
Montreal
New York
Philadelphia

Pittsburgh
San Francisco
St. Louis
Toronto

You'll find our local address in your Telephone Directory

**SIGNAL Vernier
Rheostat**

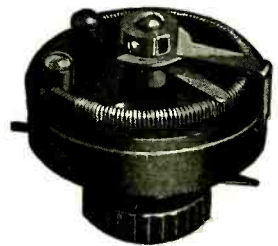

A simple coupling between the main contact and the vernier contact, carries the main contact by vernier to point nearest proper tuning. From here a fine adjustment is obtained by revolving the knob in the opposite direction. Furnished both with or without knob and pointer, so dial to match others of set may be used.

(2423A)

Information Coupon

Signal Electric Mfg. Co.,
1913 Broadway,
Menominee, Mich.

Please send catalog and bulletins giving complete information about SIGNAL Radio equipment to name and address written below—without obligation, of course.

Continued from page 50

esses possibilities of service to people in remote regions which no existing agency fulfills. It is in this field that broadcasting must ultimately function.

Urban communities are today served by other means of communication more effectively than they can be served by radio, but no agency of communication possesses the potentiality of service to

rural communities that is inherent in radio.

Grand opera, entertainment, lectures, and other cultural agencies are of importance to dwellers in the cities, but only the smaller cities are now denied their benefits. The dwellers in the great rural regions, however, have practically no opportunity, with the exception of an infrequent visit to a large city, to benefit by any of these enlightening and civilizing influences. It, therefore, becomes a matter of national importance to conserve this unique means of extending to these remote regions cultural values which are at present forbidden to them. Will private broadcasting stations continue this service without some financial return?

It is interesting to note that our state universities were the first to sense the possibilities of radio broadcasting in this direction. The University of Wisconsin, the University of North Dakota, the Agricultural College of Kansas, and probably others maintained weather forecast and market service by radio before the world war. After the war many other educational institutions established radio broadcasting stations in connection with their instructional work in radio communication. Today several are maintaining a daily schedule of instructional and informational lectures while others are seeking legislative appropriations for establishing such service.

The fact then that radio is unique, in that by means of it economic, educational, and climatic information having a wide public appeal may be disseminated, and by virtue of the fact that the public must ultimately, in some way or other, finance such projects, seems to indicate that broadcasting will become a public or governmental agency. It will be an agency par excellence for eliminating the effects of geographic differences, and for the creation of greater national and even international harmony. It will provide increased facilities for widespread dissemination of educational matter thus aiding in advancing the average of intellectual attainments.

By the increased distribution of the finer products of the musical art it will stimulate popular appreciation of and increase the sensitiveness to the less materialistic aspects of living. By increasing familiarity with phenomena of science it will necessarily tend to produce a much needed keenness of perception and power of logical reasoning. In the words of W. T. Harris, one time United States Commissioner of Education, it opens another window of the human soul to cultural values well-nigh immeasurable.



LIFELIKE Re-PRODUCTION

ALMOST as though from the throat of the artist in the distant studio floats the vibrant tones of the song, actually Re-PRODUCED, created anew, faultlessly duplicated through the marvelous musical-radio instrument—the Atlas Amplitone. Does not blast or distort.

Adjustable double diaphragm fits the Amplitone to your set and the individual receiving conditions.

Made like a fine musical instrument by the joint study and skill of acoustic and radio engineers. In every respect, worthy of your confidence.

Atlas AMPLITONE

LOUD SPEAKER

With connecting cord and full instructions

\$25

**Insist Upon the
Atlas Amplitone**

Only the Atlas Amplitone can Re-PRODUCE. If your dealer has none, ask him to order for you.

and including a list of broadcasting stations, directions for improving reception, and the proper use of a loud speaker, and other valuable information from a widely known expert sent upon request.



Atlas Amplitone Unit

The Atlas Amplitone, minus the horn and base, can be purchased separately for use with your own horn or for attachment to any phonograph (except the Brunswick) with \$13.50 phonograph attachment.

Unit without attachment, \$12.50

Send for Atlas Amplitone Book

This fully illustrated book describing this greatly advanced loud speaker

RADIO
DIVISION

MULTIPLE ELECTRIC PRODUCTS CO., Inc.

1 Orange Street Newark, N. J.

RADIO INSTITUTE OF AMERICA

TRAINING IN ALL COMMERCIAL BRANCHES OF RADIO

If you cannot attend the Radio Institute of America in person the same instruction can come to you through our recently inaugurated "HOME STUDY COURSE"—Investigate.



Detailed information free on request.

Conducted by

THE RADIO CORPORATION OF AMERICA

331 Call Bldg.
98 Worth St.

Phone Douglas 3030
Phone Franklin 1144

San Francisco, Calif.
New York City

Tell them that you saw it in RADIO

You can get **MURDOCK** Receivers

AND OTHER MURDOCK RADIO APPARATUS

--- Why bother with any other kind?

\$5.00

2000 Ohms
No. 56
Double

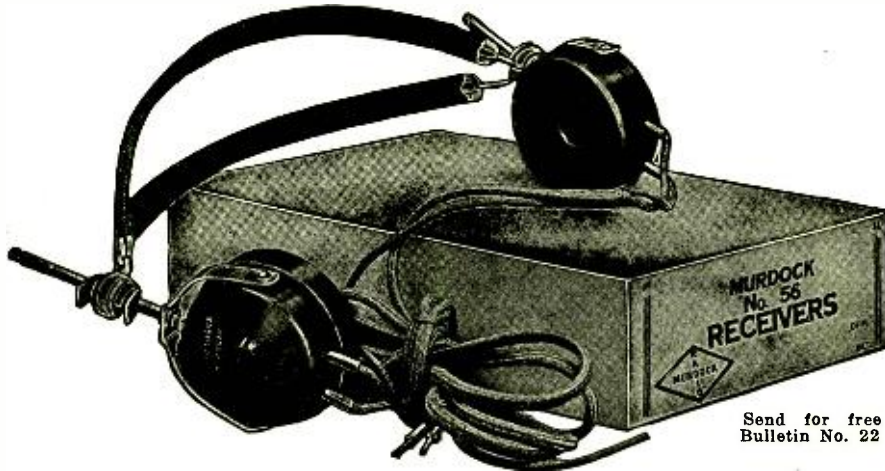

\$5.50

3000 Ohms
No. 56
Double

Send for free
Bulletin No. 22

If your dealer is not supplied send remittance direct to us and your order will be promptly filled.

MURDOCK MADE 800,000 TELEPHONE RECEIVERS BEFORE GOING INTO THE RADIO BUSINESS AND HAS MADE THE BEST RADIO RECEIVERS FOR 14 YEARS

We carry a complete stock in our Pacific Coast warehouses. Write for dealer discounts.

KEELER WHITE COMPANY

Pacific Coast Agents—WM. J. MURDOCK CO.—Since 1905

Polson Bldg., 71 Columbia St.,
SEATTLE, WASH.

509 Mission Street, SAN FRANCISCO

211 So. San Pedro Street,
LOS ANGELES

Get a
Lefax
Radio
Hand-
book
Free

Subscribe to
"RADIO"
for 18
months
(\$3.75)
and we will
send you
the \$3.50
Lefax Book
Free!

"RADIO"
San Francisco

The choice of foremost
Engineers
for over 17 years.



Sold by
all dealers

BRACH
VACUUM
RADIO PROTECTOR

Approved by the National
Board of Fire Underwriters
Ask YOUR Insurance Agent

L. S. BRACH MFG. CO.,
Newark, New Jersey

SOLDERALL
Metal in Paste Form



Handy Tubes
Every Electrical
Connection Needs
Solderall for Perfect Reception.
The Only Convenient Metal Solder

SAVE MONEY!
Turn to Page 80

In Any or All Stages
of audio frequency amplification

The AMERTRAN



Price \$7
Ask your electrical
dealer, or sent car-
riage charges collect.
(Wt. 1 lb.)

can and should be used. It is made in
only one type and one ratio. Its flat-
top amplification curve precludes the
possibility of distortion on the part of
the transformer when used in any or
all stages. It will give the same clear-
toned distortionless amplification with
all tubes which are approximately
alike in A. C. Impedance and Amplifi-
cation Factor, such as

UV-201 WD-11 WD-12 UV-201-A
C-301 UV-199 C-299 C-301-A

Its amplification in one stage
is 38.6; two stages 1490.

American Transformer Company

Designers and builders of radio
transformers for over 20 years.

174 Emmet St.

Newark, N. J.

Pacific Coast Office, Rialto Bldg., San Francisco

Not an adaptation of old methods of current control but distinctly designed to utilize the great tuning possibilities of the vacuum tube itself.

The Filament Control

of Infinite Adjustment

FIL-KO-STAT

enables you to hear stations you've never heard before—

1000-eee-eee eee eee eee



Your receiving set is probably bringing in stations you never hear! You just get that faint mouse-like whistle. But you can't bring in the music because your rheostat does not properly control your filament action.

Then again, you hear stations that sound as though they were down a deep well. They come in weak and indistinct. Your tuning apparatus gets the wave length, but your wire rheostat or other so-called filament control can't do the rest of the job which is to adjust the electronic flow in the vacuum tube to meet the conditions under which the station is operating.

With the Fil-Ko-Stat you bring in the weak stations strong and clear.

The Fil-Ko-Stat permits you to select other stations on similar wave lengths, tune one in and the other out with a slight turn of the knob without otherwise changing any of the tuning units.

The Fil-Ko-Stat cuts out "frying." It is non-microphonic and operates silently.

The Fil-Ko-Stat regulates filament heat and gives absolute control of electronic flow, permitting the finest tuning possible. Its fine adjustment starts where the tube begins to function.

The Fil-Ko-Stat's perfect and gradual increase of filament heat insures longer life to your tubes.

The Fil-Ko-Stat is the only instrument which permits that accurate control of "A" battery current necessary in using UV 199's and other dry cell tubes.

Say "FIL-KO-STAT" to your dealer today

If he has none in stock send his name and your remittance direct to

RADIO STORES CORPORATION

Sole International Distributors

Dept. R. 7, 218-222 West 34th Street, New York

PRICE Post Paid

\$ **2**

Fitted with Fahnestock Clips Patented

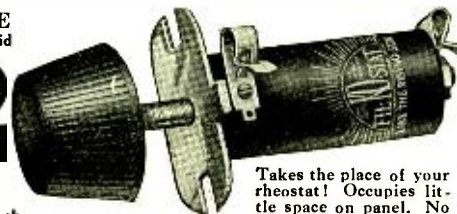

Takes the place of your rheostat! Occupies little space on panel. No redrilling necessary.

Manufactured by



by the maker that it will be replaced if broken within one year.

GUARANTEED

TECNIQUE OF D. X. RECEPTION

Continued from page 14

by Mr. Frank Conrad, Assistant Chief Engineer of the Westinghouse Company in the Proceedings of the Institute of Radio Engineers, X, 6, Dec. 1922. Although the low antenna picks up less signal energy regeneration may be used to compensate for this in considerable part, and the results on the whole are much better than with a high antenna. This also holds for 200 meter reception. On Long Island I have picked up strong signals from Fourth District stations on a wire six feet above ground, with negligible QRM from the Second District stations about 100 miles away.

Regeneration

Regeneration consists in repeating back the signals from the plate of a tube to reinforce the oscillations in the grid circuit. When carried too far the receiving set acts as a small but often very disturbing C. W. transmitter. There has been a great deal of agitation on the proper use of regeneration and its advantages and drawbacks. Much of the discussion has been more in the way of heat than illumination.

The unfortunate fact seems to be that everybody seems to consider it legitimate to let his own receiver oscillate vigorously at times, but objects to the other fellows doing it. If we discuss regeneration, however, not as a matter of radio morals, but simply as to what is most expedient at the present stage, experience shows two things: (1) That it is helpful to use oscillation in picking up distant broadcasting stations by beating with the carrier wave; and (2) That after the station is located maximum intelligibility is secured by cutting down on the regeneration to a point where the beat note goes out, speech is not distorted, and the receiver is not a source of interference to other people on the air.

On this basis one may use regeneration to the point of oscillation in sweeping through the wavelength range of the receiver. To advise people never to let their receivers oscillate is a counsel of perfection; it may be highly commendable, but few people pay any attention to it in practical reception. It may be considered fair, under present conditions, to use a limited amount of regenerative oscillation for "heterodyne searching" as above, but to refrain from the continuous use of this mode of reception, both from motives of decency, and because it is of no earthly use. The first impulse, when one hears a distant broadcasting station, is to get it in as loud as possible. This is accomplished by local oscillation and zero-beating with the distant transmitter. Sometimes one gets fairly good music by this means, since the sounds of most instru-

Continued on page 56

By Test the Best

Laboratory tests prove the Fil-Ko-Stat to have a fine adjustment area (which means ability to control filament heat and electronic flow) eighteen times greater than that of the wire rheostat and several times that of the next best filament control.

For All Tubes

The Fil-Ko-Stat is regulated at the factory to the ideal "off" point for all tubes, obviating the necessity of tampering with any screws or adjustments. And the "off" position is definite. When filament extinguishes the "A" Battery is positively disconnected.

No Discs to Break

Nothing to chip. Resistance element so finely divided further division is impossible.



NOBODY WANTS TO WEAR HEAD PHONES DURING HOT STUFFY WEATHER

A small efficient Loud Speaker ruggedly built will be welcome in any camp outfit. The AUDIOPHONE Jr. is just the thing.

Light in weight and easily assembled or dismantled without tools. Doesn't require any battery. The tone quality is exceptional and enough volume to entertain the whole camp party.

See it at your dealers or write direct.

Bristol Audiophone
made in two sizes—

AUDIOPHONE SR.

Diameter of horn,
15-inches.

Weight, 10-pounds.

Price, \$32.50.

AUDIOPHONE JR.

Diameter of horn,
11-inches.

Weight, 7-pounds.

Price, \$22.50.

Bulletin 3006-W de-
scribes them.

THE BRISTOL CO.

Waterbury, Conn.

Boston

Detroit

New York

Chicago

Philadelphia

St. Louis

Pittsburgh

San Francisco

Just Consider

—the essential features
necessary to make an
audio frequency trans-
former a good one—

1. High Amplification.
2. Minimum Distortion.
3. Low Interstage Linkage.
4. Convenient Mounting.
5. Compactness.

Cotoco transformers make
these ideal features facts.
And the finish will surely
please you.

"Built First to Last"

\$5.00

At Your Dealer's

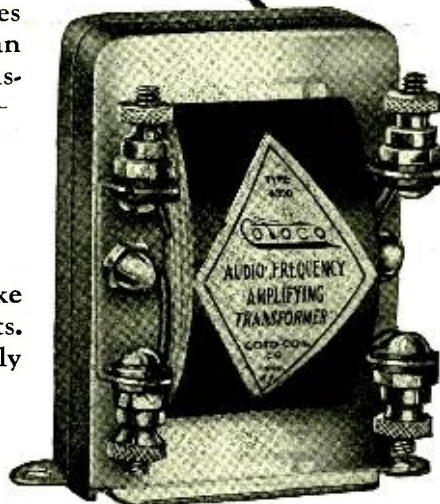

Pacific Coast Branch
329 Union League Bldg.
Los Angeles

COTO-COIL CO. PROVIDENCE

RADIO "BUGS" Get Into Business For Yourself

Why not turn your hobby into money? You can easily make \$15.00 a day, or as much more as you like, by our wonderful plan of selling Radio direct to the millions of people just waiting for our better parts or sets. We furnish everything you need at lowest factory prices and tell you how to build a profitable business of your own.

Knott products are up to the minute. Knott plans are unique and unbeatable. Radio is just beginning to come into its own. Are you? Want to make more money? Want to be your own boss? Write TODAY for FREE instructions How to Sell Real Radio.

E. R. KNOTT MACHINE CO.

1-H. Ellery St.

S. Boston 27, MASS.

MARLE TRANSFORMERS



Audio and
Radio
Frequency

—
Superior
Quality
Reasonably
Priced

Ask Your Dealer!

Manufactured by
MARLE ENGINEERING CO.
Orange, N. J.

Continued from page 54

ments are considerably less complex than the human voice, but when the crucial moment comes and the announcer gives the call letters and location of the distant station, it is only luck if one succeeds in deciphering the resulting hash of words. By far the better course is to tune accurately to the station, get maximum regeneration consistent with clarity, and no more, and then, if the signal is still too weak to read, wait for it to build up outside. If he is in a fading spell just at the time of signing, you are out of luck, but you have done your best and at the same time not made an unmitigated nuisance of yourself in the ether.

Incidentally the popular notion that coupled receivers, as distinguished from single-circuits, do not oscillate into the antenna, is erroneous. They can and they do. The proposal to bar single-circuit receivers is therefore no solution at all.

Psychological and Physiological Factors

The art of deciphering faint telegraph signals or speech is partly a matter of ear-training. Loud signals have a temporarily injurious effect by making the ear insensitive to succeeding weak sounds. Anything which fatigues the ear is to be avoided. Thus any noise such as a continuous hum or machine rattle is a handicap not only because it may drown out distant stations, but because unconsciously the listener is annoyed by it and the edge is taken off his ability to make the considerable nervous effort usually necessary in getting the sign of a very distant station. Good hearing and a suitable temperament for this sort of work are of course inherent advantages which some people have.

By the same reasoning, ease in operation is of great importance, although often neglected. The energy expended in tinkering with the receiver is at least partly subtracted from the energy available for effective listening. Receiver shielding is desirable because it makes adjustment easier by eliminating the effects of body capacity, and the use of vernier attachments is almost imperative. Trying to set a 43-plate (0.001 mfd.) variable condenser to optimum position for a 360 meter station, with a small antenna, is as bad as adjusting a surveyor's transit on a below-zero day.

Among physiological factors is the matter of breathing. At the instant of trying to hear an almost inaudible call one should hold one's breath, not only to obviate the slight noise in the respiratory passages, but because an appreciable gain in ear sensitivity may be secured in this way. Details like this spell the difference between success and failure in DX work. A comfortable posture at the receiving set is also helpful.

Continued on page 58.

Tell them that you saw it in RADIO

The Symphony



The ability to select your entertainment from the various programs that are being broadcast, and the clarity with which long distance stations can be heard depend entirely on the quality of the receiving set.

The Symphony is an unusually good receiver. By turning a single knob under proper conditions, it is possible to tune in stations, one by one, to the total exclusion of all others.

This improved circuit, in the vernacular of the technical expert, is an improvement over the single circuit by means of a variometer, and affords unusually selective reception.

So efficient is the Symphony that its volume, at any stage, surpasses many sets,

and is equal to many other receivers using additional stages of amplification.

Every piece of apparatus that goes into the Symphony is the best that can be produced, and each unit is correctly mounted in proper relation to each other part, factors that play an important part in your satisfaction of radio.

The placing of a Symphony in your home is a permanent investment that will win your instant approval, and occupy a prominent place among your most cherished possessions.

The Symphony Receivers are made in two types—detector, and two or three stages of audio frequency amplification.

If your dealer cannot furnish information on the Symphony, wire, or write for illustrated catalog, giving us his name.

JONES RADIO COMPANY

Lytton Building, Chicago

The Symphony is manufactured under the U. S. Patent No. 1113149, Armstrong Regenerative Circuit

All parts used in the Symphony are built and guaranteed by the Kellogg Switchboard & Supply Company, manufacturers for twenty-five years of complete telephone equipment

ATTENTION!

Radio Fans

For a limited time we offer you Radio Supplies that are exceptional values. You cannot secure better from any source.

COMBINATION No. 1

- 2 Variometers
- 1 Variocoupler
- 3 Dials, 3"
- 1 Vernier Rheostat
- 1 Inductance Switch

All for **\$11.00**

COMBINATION No. 2

- 1 Mahogany Variometer
- 1 Condenser, 11 Plate
- 2 Dials, 3"
- 1 Vernier Rheostat

All for **\$6.25**

EXTRA PARTS

- Filament Rheostat,
Plain **65¢**
- Bakelite Rheostat,
vernier **\$1.15**
- All Wave Coupler . . **\$5.00**
- Dials, 2-in. **20¢**
- Dials, 3-in. **25¢**
- Amp. Unit, 1 stage. . **\$6.00**
- Moulded Variometer. **\$3.75**

- Midget Vernier
Condenser **\$1.00**
- Mahogany Variometer **\$3.25**
- Grid Leak and Cond. **15¢**
- Inductance Switch . . **25¢**
- Condenser, 11 plate. **\$1.50**
- R. F. Transformer . . **\$2.50**
- A. F. Transformer . . **\$3.00**

Send us your order; same will be shipped immediately, Parcel Post prepaid.

ROSS RADIO SERVICE

Mail Order Service Only

693 Mission Street, San Francisco, Cal.

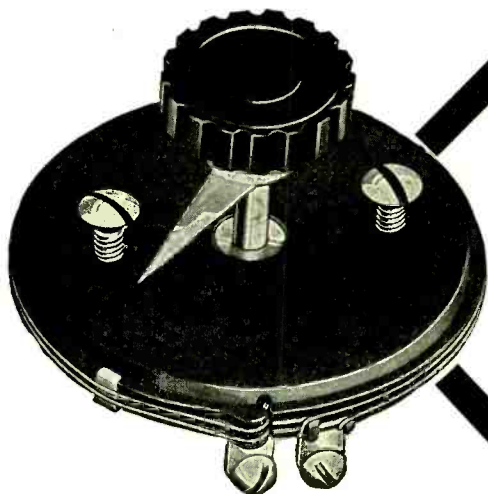

JEWELL VERNIER RHEOSTAT

The Jewell vernier rheostat is extremely simple and substantial in construction, employing a new principle of contact which we have patented. Made of the highest grade bakelite and using the best resistance wire obtainable. Very fine adjustments are obtained by a single turn of the knob. Ask your dealer or write to us for special circular.

Price \$1.00

Jewell Electrical Instrument Co.

1650 WALNUT ST. - CHICAGO

Continued from page 56

The Transmitting End

The fundamental item which determines the reliable sending radius of any radio station is the meter-amperes product, the effective height of the antenna, that is, multiplied by the current put into the antenna by the set. Secondary factors, such as complete modulation, but not over-modulation, and careful avoidance of distortion in the microphones and other parts of the set, rank next in importance. Thus powerful broadcasting stations like WGY, WJZ, and KDKA are most apt to make transmitting records.

There is one practice which some broadcasting stations make part of their routine that is rather unfair to some of the listeners competing for long distance honors. That is the use of the oscillator as a telegraph transmitter in signing off. By this means the range of the station is greatly extended, for the telegraph carries much farther than speech or music. Occasionally listeners whose receivers were oscillating at the time, but who were hearing the broadcasted material only as an indecipherable murmur, or not getting it at all, pick up the concluding telegraph sign and on that basis make a claim of having heard the station. This is stealing a march on the listeners who make their identification by received speech, and is unfair in that it is not telephone reception at all. The one good feature is that it puts a premium on knowing the code, at least for very low speeds; but in any case the great majority of broadcast listeners will never learn the code, for the same reason that the bulk of the people who use cameras never think of doing their own printing or developing.

Amateur telegraph radio is another matter and here a reform in the opposite direction might be recommended. Many operators make a practice of sending a few score "CQ's" and then signing once or twice. It would be better to curtail the "CQ" part and add a few more signatures. Also, at the end of a message, it is good practice to send one's call once or twice, so that a chance listener may be able to log it. To end up simply with a "K," as so many operators do, is to neglect the opportunity to be acknowledged by some listener at perhaps a phenomenal distance.

Meaning of "Range"

The meaning of the term "range" is so badly defined, as yet, in broadcasting practice, that the following suggestions may clarify the situation a trifle. For a given form of receiver the range of a transmitting station might be considered in say four gradations, as follows: (a) Consistent reception under practically all conditions and over practically 24 hours of the day. This would be the case of the powerful transoceanic tele-

Continued on page 60



VARIOMETER

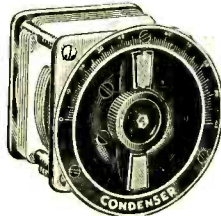

CONDENSER

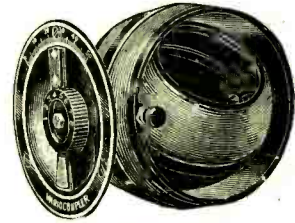

VARIOCOUPLER

THROUGH the use of Eisemann units and panels the assembly of a receiving set entails less than half the labor customarily involved.

The panels illustrated below are completely drilled and ready for use. The units are simply bolted to the panels—the only tool required being a small screw driver. The panels are of aluminum, which acts as a body capacity shield, and have a crystal black finish.



DETECTOR UNIT

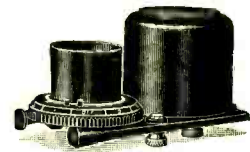

AUDIO AMPLIFIER UNIT

Variometers, variocouplers and condensers, with their matched recessed dials, fit interchangeably into the large circular openings. The rheostat wheels surrounding the sockets on detector and amplifier units extend through the rectangular holes in lower half of panels.



T-1



A-2

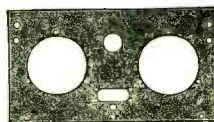

TD-2

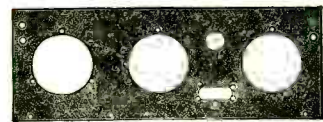

TD-3

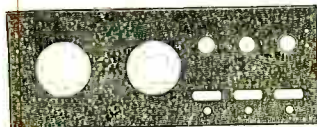

TD-2A

METAL
PANELS

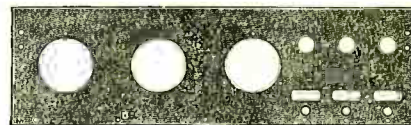

TD-3A

Descriptive literature on request.

EISEMANN MAGNETO CORPORATION

William N. Shaw, *President*
BROOKLYN, N. Y.

DETROIT

CHICAGO

SAN FRANCISCO

How to Get the Most Out of a Single Tube

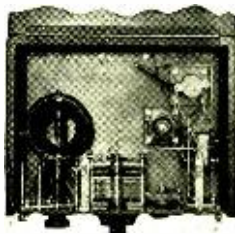

Duo-Reflex simplicity assures neat, compact, cabinet installation. Detailed blue prints are on sale by dealers at 25c per set



Erala radio frequency transformers maintain unequaled amplification over a waveband of 200 to 900 meters. AB 1, 2, 3, \$4. Reflex, \$5



Erala bezels, in bright nickel or dull enamel, improve any receiving cabinet 100%. Made in 1" and 1 1/2" sizes to fit any 3/8" to 1/4" panel. 20c



Absolute accuracy in Erala fixed condensers eliminates a major source of trouble in apparatus construction. Eleven sizes. 35c to \$1 each

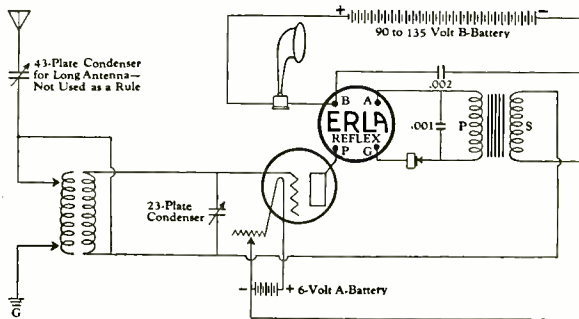

Use Duo-Reflex Hook-Up and Erala Transformers

You will never know the full range and power of a single tube until you have operated Duo-Reflex, the most powerful single-tube circuit ever built. Under conditions at all favorable, a wide compass of stations is brought in through a loud speaker, and headphones extend the range from coast to coast.

Equally improved is the tuning, so sharp and selective as to eliminate interference almost at will. Modulation, likewise, is flawless, with complete absence of static and parasitic noises.

Due to low current consumption, Duo-Reflex is operated successfully on dry cells. This, combined with light weight, makes it readily portable.

Especially designed for Duo-Reflex, and the major essential of its power, is the Erala radio frequency reflex transformer. Synchronizing perfectly the reflected radio and audio frequency impulses, it provides unequaled magnification without distortion.

A complete description of Duo-Reflex, together with directions for its construction, is given in Erala Bulletin No. 13, obtainable gratis from leading radio dealers. Or write us direct, giving your dealer's name.

Manufactured by
Electrical Research Laboratories Dept. H
2515 Michigan Ave., Chicago

Coast Representative
Globe Commercial Co.
709 Mission Street
San Francisco

ERLA

Delicate Soldering

Both the manufacturers' and amateurs' problems on all fine work is readily solved by the instrument constructed for this particular purpose.

THE POST SOLDERING IRON

Platinum Heating Unit—Interchangeable Tips—Universal Current

(Large & Small)

\$6

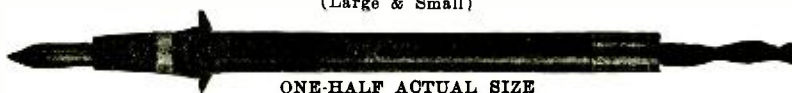

ONE-HALF ACTUAL SIZE

Awarded Certificate of Excellency, N. Y. Evening Mail Radio Institute

From your Dealer, or write

POST ELECTRIC COMPANY (Fifth Division), 30 E. 42nd St., New York

Continued from page 58

graph stations operating commercial radio circuits over which continuous communication is imperative. (b) Limited reliable service during only a portion of each day, and barring very unfavorable natural conditions. As an example we might cite the radio-telegraph circuit now being inaugurated between Holland and the Dutch East Indies. This is such a long throw—some 9000 miles—and the static conditions at the southern end are normally so bad, that it is not expected to communicate more than about three hours a day, when the entire intervening area is under cover of night, and when the tropical static is not too violent. This arrangement covers the traffic requirements in this instance. (c) Frequent freaking—meaning unreliable but nevertheless not uncommon reception. At the present stage, with existing broadcasting energy and interference conditions, most telephone reception, other than local stations or those within a few hundred miles, would come under this head. If one cannot be sure of hearing a given station at any time that he is going, this would be the proper classification, no matter how often the station was heard. (d) Phenomenal freaking—the condition of hearing a station once in a blue moon, when all the elements conspire for success. The bulk of broadcast reception over 1000 miles is in this class.

Similarly a receiving station could define its range with respect to given transmitting stations along the lines of such a scheme of classification. A broadcast fan might then remark, "My new r.f. set has a Class C range for WOC," or, "I get WGY consistently after dark, but never in the day time—that's a good B-range, don't you think so?" and so on. This would constitute a first step toward a more scientific conception of ranges and claims made for given sets and stations.

Of course the determining factor in the last two gradations defined above is the phenomenon known as fading. There is reason to believe that at a distance of some hundreds of miles above the earth there is a conducting layer, named the Heaviside layer after the great British mathematical physicist, which forms, with the earth, a sort of whispering gallery for radio signals. The wave travels on its way, bouncing off the walls of the gallery with many echoes, unpredictable interferences, and chance reinforcing; and for that or for similar reasons the familiar variation of signal strength at a distance is observed, especially at night, when natural conditions are most unsettled. Thus we have the fading and building up of signals.

In the present popular sense of the word the range is taken as the maximum reception record of the set in question,

Continued on page 62



Dayton Radio Products

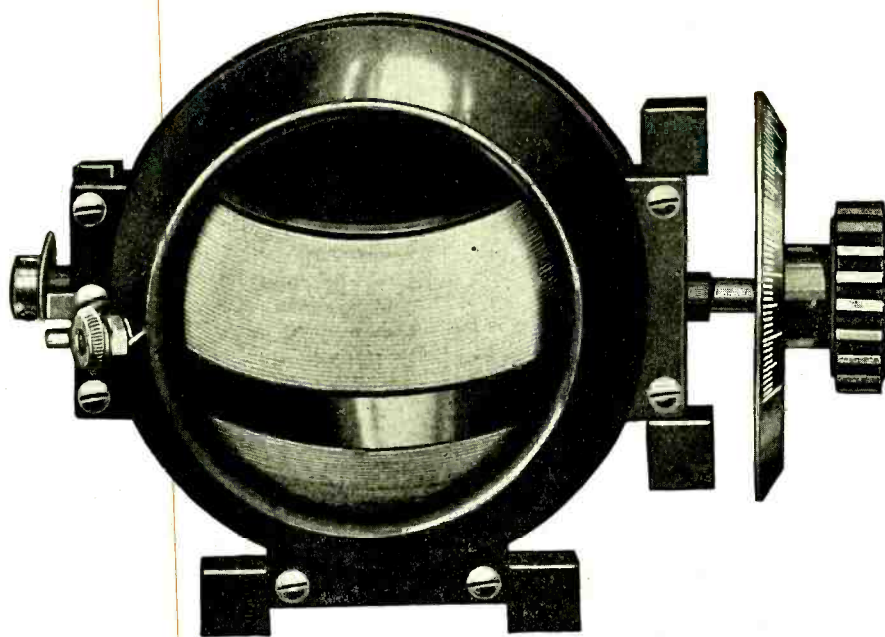
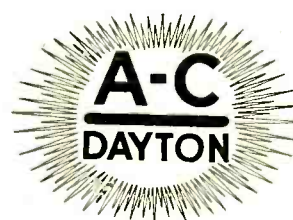

TYPE A VARIOMETER
List Price, \$6.75

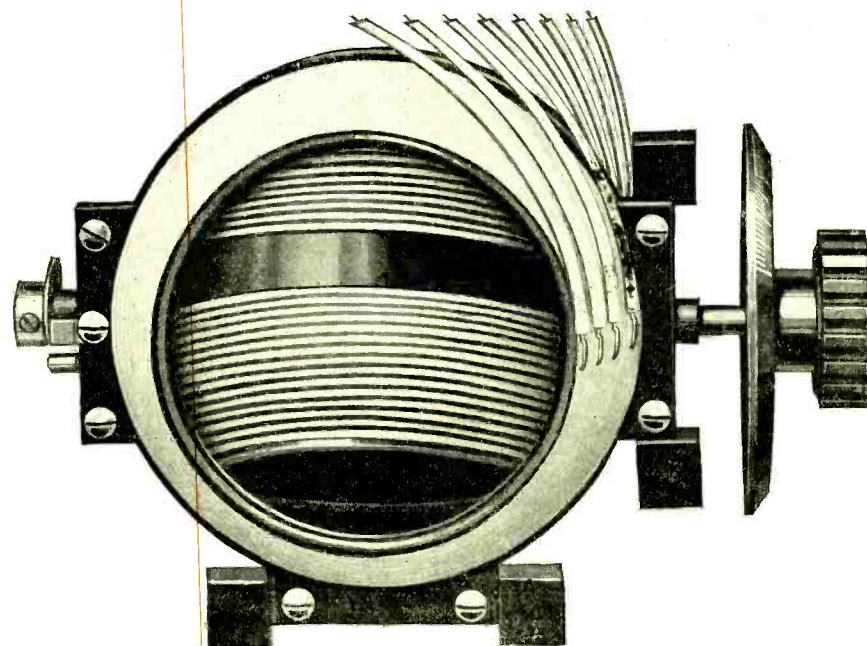

TYPE A VARIOCOUPLER
List Price, \$7.00

Nine Reasons Why You Should Use A-C Moulded Bakelite Variometers and Variocouplers

1. Correct electrical design and correct wave length range for broadcasting and short wave reception.
2. Completely insulated. No inactive metal in the field of the instruments.
3. Pigtailed connections to the rotor, eliminating all contact troubles.
4. Small in size. Permits the construction of a small receiving set.
5. Attractive appearance. Green double cotton covered wire is used, which is treated with a special transparent insulating compound.
6. Supports are insulated. This allows mounting direct on metal or shielded panels without grounding variometer.
7. A ledge or collar is provided for mounting a 3" diameter coil if desired, making a long range variometer or coupler.
8. Variocouplers have 17 taps, 9 of which have leads attached, making soldering unnecessary in the construction of a set.
9. Genuine Brown Bakelite is used throughout for insulation, giving the highest degree of insulation and durability.

Complete Illustrated Catalog Mailed on Receipt of 6c for Mailing.

THE A-C ELECTRICAL MANUFACTURING CO.

DAYTON, OHIO, U. S. A.

Makers of Electrical Devices for over 20 Years

Tell them that you saw it in RADIO

Introducing the "SR 25"

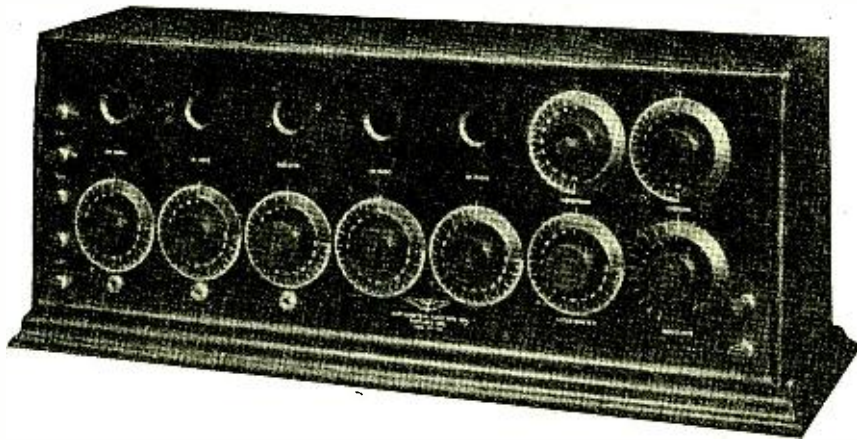

WE INVITE YOUR ENQUIRIES

Hallock and Watson Radio Service

192 Park Street

"KGG"

Portland, Ore.

This "UNITED" Audio Frequency Amplifying Transformer

is a little "gem" of radio engineering—magnetically shielded, Ratio 5 to 1—a wonder-worker in producing loud, clear-toned signals, from any distance. At your dealer's \$4.50.



"United" Variable Condensers have a new vernier dial assembly, original with us, that makes fine tuning a joy.



- | | | | |
|---------------|--------|--------------|--------|
| 43 plate..... | \$6.50 | 5 plate..... | \$5.00 |
| 23 plate..... | 6.00 | 3 plate..... | 4.75 |
| 11 plate..... | 5.50 | Postpaid. | |

Vernier alone; can be attached to any \$2.50 plate condenser by drilling one hole..

Show this ad to your dealer and ask him to supply your needs at the above prices. If he cannot do so, remit to us direct, under our money-back guarantee and give us name and address of dealer you wish to favor.

UNITED MFG. & DISTRIBUTING CO.

9705 COTTAGE GROVE AVENUE,

New York Office:
50 Church St.
New York, N. Y.

CHICAGO,
ILL.

San Francisco Office:
709 Mission St.
San Francisco, Cal.

Continued from page 60

in most cases. This recalls the complaint of a golf professional, who remarked that when a club member once went around in eighty, say, after that he always protested that he was off form whenever he exceeded that figure—even if he never got down to it again. In reality the player's average—his reliable figure—might be around one hundred, and from the professional's viewpoint he had no right to offer the standard excuse unless he went over the latter value. Similarly in radio a phenomenal record in reception is properly speaking, nothing more than something to shoot at thereafter.

Uncontrollable Factors

Fading, static interference, QRM from spark sets, and other items which have been discussed may thus be classified, at any given time and for any given problem of reception, as uncontrollable. Of course a deferred control is possible, and on this the progress of the art depends: Static interference may be effectively conquered by greater radiation and technical improvements at the transmitter; legislation is doing away with some evils, such as the sardine-packing of the broadcasters in the narrow 360-400 meter band. But at any set time, it is obvious, luck plays a great part in DX work—and that is part of its fascination. As one sweeps up over the wavelength range of the receiver, one may be missing a transmitter down below who happens to be audible at that minute, and perhaps will never come in again at that place; or one may be running into a lucky encounter with a station at the other end of the country. One must gamble, but in the long run rational methods and a good technique win out over hit-and-miss procedures.

Semi-controllable Factors

Of elements theoretically controllable but which in practice are usually fixed by other considerations, the most important is locality. Occasionally, as in the case of camp receiving sets, the site may be picked. It is well to bear in mind, then, the superior reception conditions near bodies of water. Early in the history of the art it was found that in reception of signals on moving vehicles, such as trains, the signal strength increased near lakes and rivers; it was, as Dr. DeForest has said, as if the waves hung over the water like a mist. Obstructions, such as hills and forests, particularly when the trees are in foliage, have a weakening effect. This is very pronounced in the case of structures of conducting material. From these considerations it follows that the seashore is a better receiving location than inland mountainous territory, and rural locations are in general better than

Continued on page 64

FREE VACUUM TUBE RADIO SET

The Set you always Wanted, FREE
A real RADIO SET—Listen in on Concerts, Lectures, Singing, etc. Can receive 75 to 100 miles and more.

RUSH

your name and address and we will tell you HOW you can get a VACUUM TUBE RADIO SET

ABSOLUTELY FREE

Don't delay. Write today for FREE RADIO PLAN
Home Supply Co.
Dept. 878
181 Duane St. New York



LEARN RADIO

Here's your opportunity. Radio needs you. Win success in this fascinating field. Trained men in demand at highest salaries. Learn at home, in your spare time.

Be a Radio Expert

I will train you, quickly and easily, to design, construct, install, operate, repair, maintain, and sell all forms of Radio apparatus. My new methods are the most successful in existence. Learn to earn

\$1,800 to \$10,000 a Year

FREE Wonderful, home-construction, tube receiving set, of latest design. Write for "Radio Facts" free. Engineer Mohaupt.
American Electrical Association
Dept. 298 4513 Ravenswood Ave., Chicago

Tell them that you saw it in RADIO

A Midget Vernier and Other Chelten Radio Products

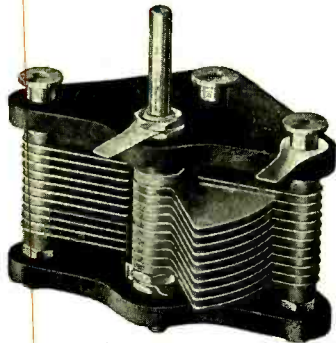

Chelten Variable Condenser
21 Plate
Cat. No. 810

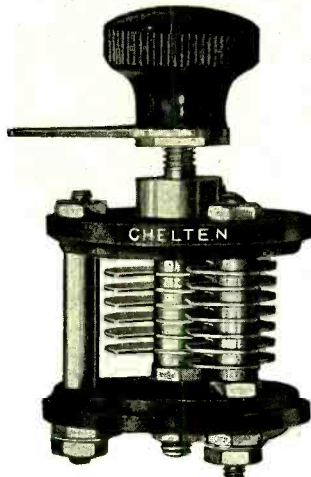

Chelten Midget Vernier
Cat. No. 850

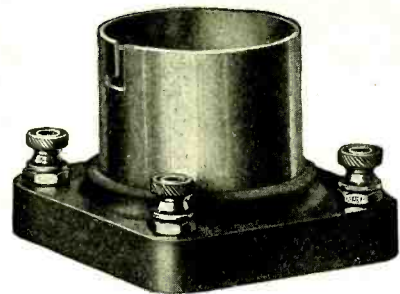

Chelten Tube Socket
Cat. No. 740

The "Chelten Midget Vernier" is a really remarkable little instrument. Though small in size its seven stationary and six rotar plates permit sharper tuning than is usually possible with other Verniers. Those who are satisfied with nothing but the best are usually the ones who are securing the most satisfactory results from their Radio Equipment.

The Chelten line of Radio Products is noted for its high quality. Every part is made to micrometer measurement and only the best of materials obtainable are used. Insist on CHELTEN. We manufacture a complete line of Condensers, Sockets, Rheostats, Plugs, Jacks, Grid Leaks, Crystal Detectors, and Bakelite Dials and Knobs.

Since 1910 Manufacturers of High Grade Electrical Specialties



Chelten Hexagonal
Plug
Cat. No. 746

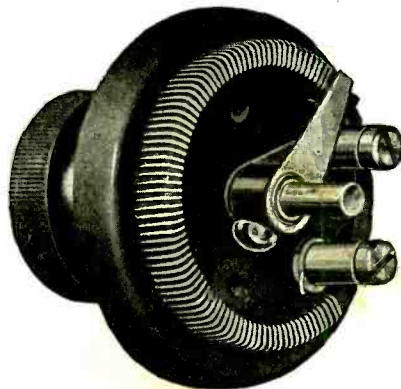

Chelten Filament Rheostat
Cat. No. 720

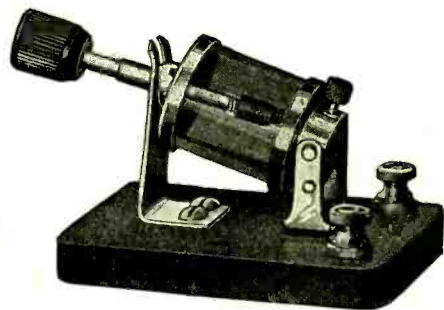

Chelten Crystal Detector
Cat. No. 750

THE CHELTEN ELECTRIC COMPANY
4863 STENTON AVENUE, PHILADELPHIA, PA.

Continued from page 62

urban. The ideal place is a ship. For a land station, according to Mr. Paul Godley, the beach gives better results on signals coming over the water than points even a short distance inland. And

of course geographical locality is important; if one had to receive an English broadcasting station in the United States at some given time, for example, the logical locality would be Maine rather than New York, for Maine is

some 400 miles nearer Europe, giving a considerably better signal, and at the same time static is markedly weaker than in more southerly latitudes.

Urban experiments with portable receivers have demonstrated that at some points along the same street signals are consistently weaker than at others. At street intersections the intensity tends to rise, owing to the approximation to an open space. Overheard wires, as one would expect, absorb energy and cut down the range. Some spots in the larger cities are comparatively dead because of the effect of obstructions. As yet no instances have become public, but it would not be surprising if some day a prospective tenant, before signing the lease, should demand a guarantee that the house is not in a dead spot for radio signals!

USE A.C.H. SHARP TUNER DIALS

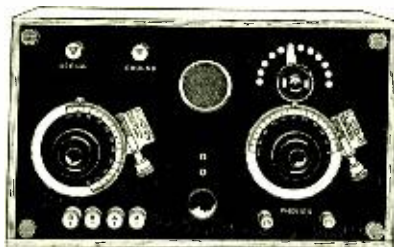
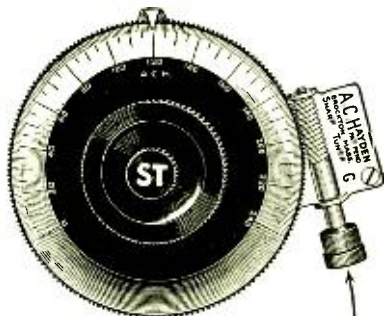

Why the A.C.H. is different

- 3 in. DIAL (156-f0-1)
- 4 in. DIAL (215-f0-1)

Positive movement, no friction to slip, and no back lash in the spiral machine cut worm gear. (NOT MOULDED.)

Your Choice of

Rough tuning with dial or one thousandth of an inch in either direction with the Sharp Tuner Knob. Both controlled by center knob ST. Eliminates a vernier condenser. Locks instrument automatically. Dial grounded, reducing body capacity.

Money Back Guarantee

Price A.C.H. 3" Dial complete.....\$2.50
 Price A.C.H. 4" Dial complete..... 5.00
 Regular fitting 5/16" hole, 1/4" and 3/16".
 Bushings, 5c. each extra. 10c. for all.
 Free Plan with mail orders on request.

A.C.H. DETECTOR SET

Not wired—Price \$20.00

Including 2 3-in. A.C.H. Dials

Three ways to purchase:

1. Send money-order or check for \$20.00, we will send same prepaid.
2. Send any amount and when we receive a total of \$20.00 we will send same prepaid. Make last payment when you want your set.
3. Send for list of parts and when you purchase all assemble entire set.
 Total cost.....\$20.00

A. C. Hayden Radio & Research Co.

Brockton, Mass., U. S. A.
 Mail Orders sent prepaid in U. S. A.

BRECO RADIO APPARATUS

Bring Best Results—They are Dependable

Listed below are a few BRECO specialties. Owing to our increased facilities, we are able to reduce the prices on some of our manufactured products.

Variometers	\$7.00	Crystal Detectors	\$1.75
Variocouplers	5.00	Inductance Switches complete	
Variable Condensers, 43 plate....	4.50	with 7 points and 2 stops.....	.50
Dials, 3 in. Moulded.....	.50	Switch Points03
Rheostats75	A. F. Transformers.....	5.00
Binding Posts, N. P. or Insulated Knob.....	.08		
Mahogany cabinets, various sizes.....	\$5.00 up		
Bakelite sheets	per lb., \$2.00		
Straight Circuit Tuner with Detector.....	\$35.00		
Detector and Two Stage Amplifier.....	\$50.00		
Straight Circuit Tuner with Detector and Three Stage Amplifier.....	\$115.00		

Write for Catalogue

If your dealer cannot fill your requirements on BRECO apparatus, your order mailed to us will receive prompt attention.

BRONX RADIO EQUIPMENT COMPANY

Bronx, N. Y. C. "Manufacturers of Quality" 687 Courtlandt Ave.

RADIO MAILING LISTS

12,422 Radio Dealers, U.S. by States	Per M. \$7.50
	Per list \$15.00
1,614 Radio Mfrs. U.S. by States	15.00
1,760 Radio Supply Jobbers, U.S. by States	4.00
260 Radio Stations	4.00
257 Mfrs. complete Radio Sets	1.50
67 Radio Battery Manufacturers	

Ready to send on receipt of remittance
 Trade Circular Addressing Co.
 166 W. Adams St., Chicago

MONTROSE CONDENSERS

11 Plate Vernier.....	\$2.20
23 Plate Vernier.....	2.55
43 Plate Vernier.....	3.35
3 Plate Condenser.....	.75
11 Plate Condenser.....	1.20
23 Plate Condenser.....	1.55
43 Plate Condenser.....	2.00
.00025 mfd. Bal. Vernier	2.70
.0005 mfd. Bal. Vernier	3.30
.001 mfd. Bal. Vernier	4.00

MONTROSE MFG. CO.
 1200 Bedford Ave. Brooklyn, N. Y.

Tell them that you saw it in RADIO

SELECTIVE CRYSTAL OUTFIT

Continued from page 14

3/4 in. deep and it is wound with thirty turns and screwed to the remaining swinging arm. One lead is carried to the ground binding post and the other connected to the free lead from the center coil. It can be seen that these two coils being connected in series will act as a variometer in the aerial-ground circuit and tuning can be accomplished by altering their proximity to each other. It is most important that the turns on each of these variometer coils run in opposite directions. This can best be checked up by carefully tracing the course of the winding and if found circling in the same direction on both, reversing the connections of one coil.

The number of turns specified was found to be best for a 50-ft. aerial. A longer one will require less inductance in the variometer, that is more wire on the thirty-turn or less on the sixty-turn coil.

To operate, connect ground, aerial and phones to their binding posts, place both movable coils close to the center stationary one and adjust the cat-whisker of the detector on the crystal till signals are heard, then move the swinging coil of the variometer until they become loudest. If interference is found between stations move the secondary coil an inch or two away and it will be found possible to tune in either station (provided they are not on exactly the same wavelength) by adjusting the movable variometer coil.

As mentioned before, the beauty of this little set is its selectivity. The writer, living about ten miles from each of two class B stations, broadcasting on much the same schedules, has no difficulty in bringing in either one loud and clear without the slightest interference, and recommends the circuit to anyone desiring an efficient yet cheap and easily constructed crystal outfit.

Which One Do You Want?

USE A WORKRITE

Super Vernier Rheostat and the WorkRite Tuner Team

and you can tune in on the station you want even with your local station in operation

50,000 Adjustment Vernier Rheostat

Here is an instrument that is the last word in Rheostats. 50,000 adjustments for \$1.00. The drum is moulded and can not shrink. No danger of the wires loosening. Easy to mount on panel. Pushing the knob way in turns off filament. Turning the knob gives the very finest adjustment. Often a turn of 1/32-inch will clear up a station or separate two stations. The regular Rheostat has 6 ohms resistance. A WorkRite Super Vernier Rheostat on your Detector Tubes will double the efficiency of your set. Try it and see. Put a WorkRite Rheostat on each of your tubes and get perfect adjustments.

WorkRite New Super Vernier Rheostat **\$1.00**

(With 15 ohms resistance, \$1.10)
(With 30 ohms resistance \$1.25)

WorkRite 25 Ohm Resistance Cartridge for use with any 5 ohm Rheostat for controlling UV 199 Tubes.....40c

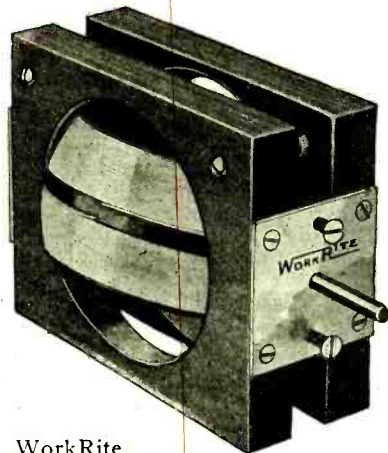
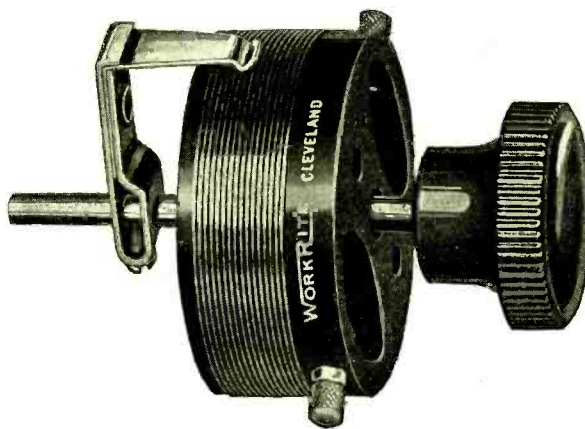

WorkRite Super Variometer

WorkRite Tuner Team

Tunes Out Local Stations and Gets the Station You Want

Two WorkRite Variometers and one WorkRite Variocoupler make up the Famous WorkRite Tuner Team about which the whole country is talking. No difficulty to separate stations and bring in the one you want clear and loud. The coupler is made from moulded Bakelite and wound with green silk. The Variometer is made from polished Mahogany; has a range of 200 to 760 meters. Make up a set with WorkRite parts and see what a real set is like.

WorkRite Super Variometer, each **\$3.50**
WorkRite 180° Super Variocoupler, each



WorkRite 180° Super Variocoupler



WorkRite Hydrometer

Double the life of your battery by giving it proper care. Fill and test it regularly with a WorkRite Hydrometer. Never let it get below 1150. Full instructions for testing and care of battery with each "WorkRite." Get one now.

Price75c

OTHER WORKRITE RADIO PRODUCTS

WORKRITE E-Z-TUNE DIAL
Has a knurled flange on outer edge giving firm grasp for fine tuning. Price..... **75c**

WORKRITE CONCERTOLAS
Loud Speakers complete with phone unit and cord.
WorkRite Concertola, Junior. Price **\$12.00**
WorkRite Concertola, Senior. Price **\$24.00**

WORKRITE SWITCH SET
Complete switch set in one unit. Parts made to work together. Use block for template in drilling plate. Price..... **50c**

WORKRITE HEAD SET
Extremely sensitive and free from distortion. Compare it with any on the market. New Price **\$6.00**

"Workrite Radio Parts WorkRite"

The WorkRite Manufacturing Co.

5516 Euclid Avenue

Cleveland, Ohio

(Branch Office, 536 Lake Shore Drive, Chicago)

The Receiver famous thru Performance Telmaco



Type B-R Receiver

fully meets the requirements of the discriminating purchaser because of the following features:

EFFICIENCY OF OPERATION: Securing volume, distance (1500 miles with single tube is not unusual), selectivity: broadcasting stations one-half mile distant are tuned out by a slight turn of condenser dial.

EASE OF OPERATION enabling the novice to secure satisfactory results.

HIGHEST QUALITY OF WORKMANSHIP AND MATERIALS.

\$25.00 PRICE within the reach of everybody. Manufactured exclusively for us by

Tri-City Radio Electric Supply Co., licensed under Armstrong U. S. Patent No. 1113149, Oct. 6, 1914.

Telmaco BA 2-Stage Amplifier for the Above \$20.00

Our New Radio Guide Book Sent at Your Request

Our new 64-page Catalog No. TCR contains twenty of the most popular radio circuits printed in blue. These include the Hazeltine Neutrodyne, Grimes Inverted, Colpitts, Flewelling, Reinartz, Diode Electrad, Heterodyne, Super-Regenerative and many others. Each article used in circuit is attractively pictured instead of appearing in straight schematic form. Besides containing blue prints, the best in radio is also illustrated and described. Catalog sent postpaid for ten c. Each Circuit worth double. Send for your copy today

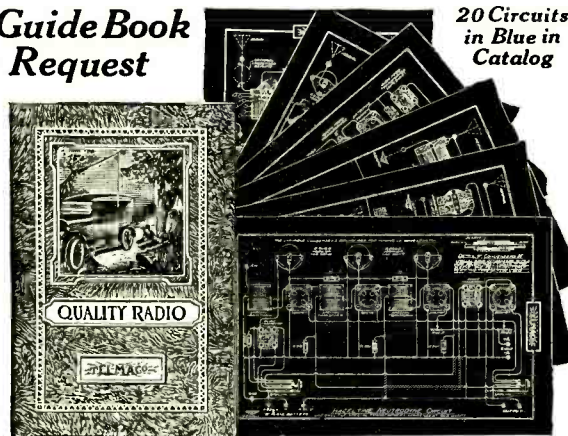

20 Circuits
in Blue in
Catalog

JOBBERS We have an attractive proposition for a few more bona-fide Jobbers

DEALERS If your Jobber cannot supply you order direct

TELMACO
Quality Radio Exclusively

Radio Division
TELEPHONE MAINTENANCE CO.
20 So. Wells St., Dept. 00, Chicago, Ill.

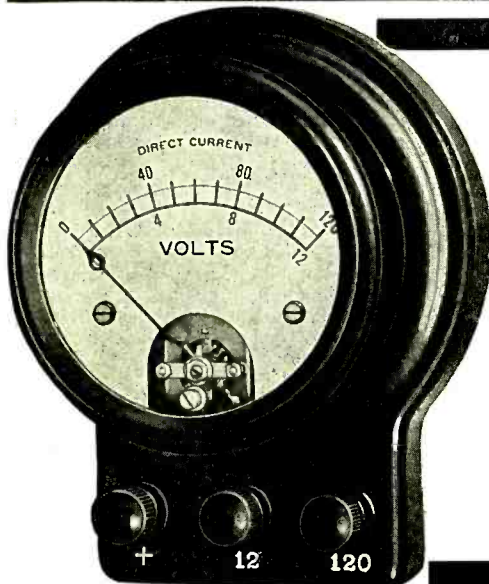

A-B BATTERY TESTER

The Jewell A-B Battery tester fills a need for a low priced but accurate portable instrument for checking battery voltages. Double readings 0-12-120 volts is the range usually supplied, which takes care of the "A" battery under all conditions and the "B" battery up to the highest commonly used for receiving.

Price \$10.00

We were the first to supply a complete line of miniature radio instruments of uniform size. Ask your dealer or write to us for complete radio circular.

**JEWELL ELECTRICAL
INSTRUMENT CO.**
1650 WALNUT ST. CHICAGO

JIMSON THE GREAT

Continued from page 22

"Rats," says Jimson. "Me and the Almighty is workin' together on this thing," he says. "Anyway, I was referin' to radio."

"Meanin' just what?" says I.

Jimson sits down on a sack and explains.

"When me and El was palaverin' this a. m.," he declares, "I breaks it to him sort of gentle-like how much good he could have done hisself a long time ago, had he took to radio. I doesn't go into technicals, principal because I doesn't know any. But I gets over the ijea in a lump. When I sees him pickin' up his ears, I drops my ace on the table and takes the pot."

"The which was?"

"That a couple of ex-Arizona cow-punches with nothin' on their hands but a bum railroad, has just inherited a radio set from a sick uncle, the like of which there aint in the tropics nowheres. Before I gets through I convinces him them same hombres is in a good and noble position to kinda keep an eye on revolutions and such things pervided they was treated right and proper by the said government."

I begins to grin, as I gets the cuteness of the ijea.

"I says to him," Jimson goes on, "as how if it was worth our whites, we might sit in, casual-like, and see what some of the dynamite boys was doin' right now. An' I might even tell him, in confidence o' course, what they was aimin' to do. I says. Well—El's sure got an imagination. He gets up and pumps my hand and orders up some more Scotch the which we drinks. Then he calls in a bon-bon in eye-glasses and tells him I'm a chest protector, or somethin' of the kind. The bon-bon bows and scribbles on a paper, and I'm a minister. Then I makes my palaver about you, and you've got a job. Then we has a few more, and I comes home in style. All nice, easy and purty, with me and you ridin' high, wide and hand-some!"

Well—I was sure flumdusted—complete and entire, and I says so.

"How do you aim to get the dope?" I asts.

"By lissenin' to the revolutionists' radios," says he.

"Hub," asts I, "are they usin' any?"

"That," says Jimson, "is where the catch comes in. I aint got the least ijea, m'self. Neither has El. You see—uneasy sits the seat that wears a crown. El figgers them revolutionists has got everything. Says I: 'Their radio is one of your big dangers,' I says. 'Si,' says he, 'of a certainty,' he says. I says: 'Our radio is better than theirs,' I says. 'Bueno,' says El. 'You have save the nation' he says. Well—after

Continued on page 68

HERE!



Buy Only a Non-Selective Transformer

Good quality demands equal amplification for all frequencies within the voice range. The 3.7 to 1 ratio of the Type 231A amplifying Transformer gives maximum amplification without distortion, in multi-stage as well as in single-stage amplifiers.

High ratio amplifying Transformers are selective—and selective transformers have a resonant peak that causes serious distortion.

The General Radio Co.'s type 231A Transformer is suitable for use with UV-201A, 201, 199, WD-11, 12 and tubes of similar plate impedance. \$5.00.

At your dealers, or direct from us; Two educational folders, "Quality Amplification," and "Quality Condensers." Ask your dealer or write us. Send for free Radio Bulletin 914-C.

GENERAL RADIO CO.

Manufacturers of
Radio and Electrical Laboratory Apparatus
Cambridge Massachusetts

RT-A 2

The Audio Frequency Transformer that gives you perfect Tone Quality and High Amplification without distortion. Moisture-proof—it is ideal for the seashore.



Letters received every day state that RT-A2 passes every test and fulfills the most critical requirements of experts and amateurs.

Use RT-A2 transformers at once and enjoy better radio reception.

Price \$6.50 at all good dealers.

RASLA SALES CORPORATION

National Distributors
DEPT. C, 10 E. 43rd ST. NEW YORK CITY

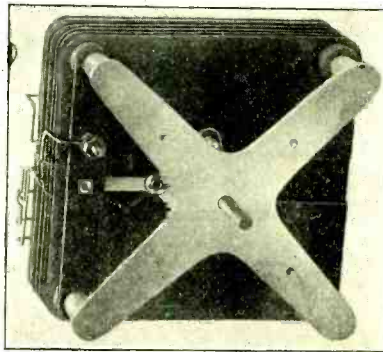

VARIO TRANSFORMERS

Make this receiver easy to build and operate. One unit for tuning, coupling and amplifying replaces the old style vario-coupler, RF transformer and tuning condenser.

Write for FREE booklet by LESTER L. JONES, formerly Expert Radio Aid, United States Navy

DANZIGER-JONES, Inc.
145 Prince Street New York, N. Y.

The
BEST

RECEIVING
SYSTEM is the

ACMEDYNE

It Builds Up, without distortion, the signal you want. Drops Out All Noises and Interference.

TYPE TC4 RANGE
180M. to 600M. \$8.50
List Price.....

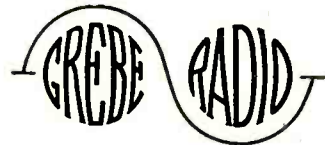
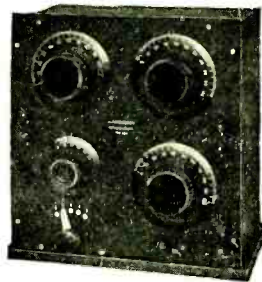

RADIOLA EQUIPMENT
AND RADIO CORPORATION
PARTS.

When You Want It Quickly

mail your order with check or money-order to us. Our mail order department is exceptionally well organized to give you immediate delivery; and our location insures better mail service than ordinary. Any standard, advertised radio part is in our stock—and we pay the postage. Try us.

COAST RADIO COMPANY, INC.
EL MONTE, CALIF.

KUY 6XAX 6IM

Loud Speaker in Your Auto No cumbersome aerial required

The Ideal portable set weighs only ten pounds, including detector and two-stage amplifier with all batteries. Carry it like a camera. Just the set for the auto, camp, or home. Absolutely guaranteed as efficient as any detector and two-stage set made, and at a cost of slightly more than some detector sets.

Get our complete instructive catalogue
Steinmetz Wireless Mfg. Co.
5704 Penn Ave. Pittsburgh, Penna.

BROADCAST PROGRAM

A weekly magazine devoted to Western Broadcasting.

5c per copy.
26 issues for \$1.00.

BROADCAST PROGRAM

449 Pacific Bldg.
San Francisco, Cal.

★ ★ RADIOADS ★ ★

A CLASSIFIED ADVERTISING SECTION READ BY BETTER BUYERS

The rate per word is five cents, net. Remittance must accompany all advertisements.
Include name and address when counting words.

ADS FOR THE AUGUST ISSUE MUST REACH US BY JULY FIRST

EDISON ELEMENTS for STORAGE "B" Batteries. I handle only first grade, full capacity plates. Six to ten cents per pair, postpaid, depending solely upon quantity ordered. A. J. Hanks, 608 Montgomery St., Jersey City, N. J. (6 T. Exp. Oct.)

RADIO WORLD, THE GREAT NATIONAL WEEKLY—published every seven days with all the latest news, developments and pictures of the radio field. 15c a copy. \$6.00 a year (52 numbers), \$3.00 six months, \$1.50 three months. Special to radio readers. Send \$1.00 and we will send you the next eight issues of RADIO WORLD. Pub. Office, 1493 Broadway, New York. (tc)

Vacuum Tube Hospital
We repair and guarantee them.
Agents, Dealers, and Customers Wanted.
George H. Porell Co., Inc.
West Somerville, Mass.

RADIO GENERATORS—500 Volt, 100 Watt, \$23.50. High Speed Motors, Federal Phones, \$5.50. Battery Charges, \$12.50. Motor Specialties Co., Crafton, Pittsburgh, Pa. (tc)

C. W. and RADIO PHONISTS—Our new converters will satisfy your need for a more efficient and durable direct current plate supply. No armatures to burn out. Output from seven hundred to two thousand volts at .4 amperes. Synchronous Motors, Transformers and other parts sold separate. Write immediately. Kimley Equipment Mfg. Co., 290 Winslow Ave., Buffalo, N. Y. (tc)

WANTED—Radio Engineer to travel extensively. Must be capable of highest type of sales service work in demonstrating and introducing line of patented radio equipment for well known manufacturer of thirty years standing. Write, stating experience, education, age and salary desired. Box 333, "RADIO", San Francisco.

RADIO FANS—Make your own "A" and "B" batteries. Our catalog tells you how. All kinds of radio apparatus and materials. Stamp for catalog. PACIFIC SCREW CO., Dept. W, 645 N. E. 53rd St., Portland, Oregon.

ARC & SPARK SYSTEMS
Send for Descriptive Circular QRD.
Interesting and Instructive.
Pacific Radio School 433 Call Bldg., San Francisco

BUILD YOUR SETS WITH QUALITY PARTS and get sure results. Radio Parts Co., Box 56, Unellen, N. J. (Gt-exp. Nov.)

LIGHTNING STRANGE BATTERY COMPOUND. Charges discharged batteries instantly. Eliminates old method entirely. Gallon free to agents. Lightning Co., St. Paul, Minn.

FOR SALE: Acme 75 watt plate and filament Transformer, slightly used, \$10.00. R. G. Wascher, Seaside Oregon.

SINGLE TUBE REFLEX—Are you having trouble with your reflex circuits? My circuits WORK! Any of the following mailed for 25c: Single tube Neutrodyne-Reflex (WMAQ heard with this circuit loud every night); Improved Single Tube Reflex (absolutely does not oscillate! The only circuit from which satisfactory results can be had! Works with any reliable radio frequency transformer. You can have it for only two-bits); Tuned Radio Frequency Reflex; or any known circuit. Just tell me what you want. Enclose a self-addressed stamped envelope and 25c for each circuit. SIX ZEE JAY, 1017 Tribune Street, Redlands, Calif.

FOR SALE: Set of Goodman spider-webb coils mounted. 43 and 23 plate variable condensers, Cooper 80 amp. storage battery, Dorgan Audio Transformer, U. V. 200 and U. V. 201 tubes. \$24.00. C. Snider, 50 Rogers St., Atlanta, Ga.

MAGNAVOX TYPE R3. Latest nationally advertised models in original sealed factory cartons. List \$35. Special introductory offer \$25. Radio Central, Dept. P, Abilene, Kansas.

Dictograph phones \$6.00; R. 3 Magnavox \$28.00, General Radio, Audio Frequency Transformer \$4.25; Three VT-1 \$6.00; Three VT-2 \$7.00; Cunningham Detectors \$4.00; Cunningham Amplifiers \$5.20; C-301A \$6.00; WD-11 dry cell tubes \$5.50. All new. Other goods at low prices. Audion sets on monthly payments. Ship C. O. D. subject to examination. Lariel Jenkins, Box 701, Honolulu, Hawaii.

FOR SALE: Complete set. Two storage batteries. Kennedy two stage with Magnavox and Detector \$90.00. Theodore Roth, Box 214, Winters, Calif.

FOR SALE: Two Step Regn set in cabinet with tubes, receivers and batteries \$85.00. Write Jas. G. Wilson, General Delivery Box 34, Benson Station, Omaha, Nebr.

FOR SALE: Copies of "PROCEEDINGS of the Institute of Radio Engineers," dated Feb. 1916 to Dec. 1921. Extra copies of Feb., April, June, Oct. and Dec., 1919, also. All \$1.00 each. Prepaid. Lyndon F. Seefred, 343 So. Fremont Ave., Los Angeles, Calif.

CALLS HEARD POSTAL CARDS for DX reports. Station call letters in color. Printed on Government or plain postals. \$0.80 hundred up. "Used Everywhere—Go Everywhere." Write for samples. Radio Print Shop, Box 582, Kokomo, Indiana.

MUST SELL: New 4 tube universal-wave-length ABC unit receiving set, \$68. Also used and new tubes and phones. Write for list and prices. Victor Vogel, Glenrock, Wyoming.

Young married man experienced in commercial radio operating, automatic telephone inspection, and maintenance of electrical equipment, two years' college engineering; desires employment with opportunities. Box 99, Radio, San Francisco.

Continued from page 66

he puts it that way, I aint the hombre that throws down a whole nation."

"And you figgers on livin' awhile longer?" I asks.

"If I does, I got to eat pronto," says Jimson.

The which we done.

The next mornin' me and Jimson tests out Handsome Henry, the radio.

"Just in case," says Jimson. And I makes it unanimous.

There was juice runnin' into the shack from a power line and we turns over the generator a couple. Nothin' happens. Then Jimson wiggles a telegraph key that goes with the junk. Right away a spark busts loose with a racket they must have heard in Pekin.

"Holy mackerel," says Jimson. "There aint nothin' private about radio is there?"

"Nothin' except where its gone after its started," says I, not worryin' a lot about that. "Aint we gonna do no receivin'?" I asks.

"Yes," says Jimson. "But we got to have a battery," he says, "to light them lamps on the set. There was one on the boat but I forgot it," he says.

"Let's go get it, then," I says.

Jimson takes a look at the *Hattie Pratt*, which was breakin' up nice and easy.

"Can't," he replies, "unless we got a strainer. There aint nothin' comin' ashore now but rivets."

While we're thinkin' things over, along comes a bozo in a Ford.

"Ha," says Jimson. "The Gods is with us."

He hails the hombre and old rusty face jerks his levers, and goes dead in the road.

"Dos pesos," says Jimson, holdin' up two fingers.

"Tres pesos," says the bozo, right back, raisin' the ante on general principles. "What for?" he asks.

"That little black box you got on the runnin' board," says Jimson.

The bozo stares. He hadn't never noticed it before.

"Tres pesos," says he, kinda uncertain like.

"All right," says Jimson. "Make it snappy."

The bozo gets down and pries the box loose, breakin' a few wires and such which didn't mean nothin' to him. Jimson hands over the three pesos and walks off with rusty's only battery as purty as anything, leavin' the car standin' dead in the road. We hears the bozo tryin' to get it started for about half an hour. Then we sees him pushin' it up the road by foot.

"An' you thinks we're gonna have troubles in a country full of mavericks like that?" says Jimson. "Say, for two more pesos he'd of give me his engine."

Continued on page 70

Turn It Into Cash

Only
5
Cents
a
Word

Sell the spare radio supplies that you have on hand. Use the "RADIO-ADS." Get quick and profitable results. "Exchange" Radioads also accepted.

What have you for sale or exchange?

MAIL YOUR "RADIOAD" TODAY

More Reasons Why

CROSLEY
 Better - Cost Less
 Radio Products
 are
so Much Better

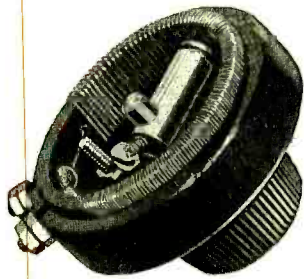

The new Crosley Duostat universal duo-wound rheostat for all makes of tubes is sold separately from Crosley radio sets if desired, complete as shown in the illustration above. Price—85c.

By perfecting the new Crosley Duostat universal filament control rheostat, the Crosley Manufacturing Company has made giant strides in bringing within reach of all, the true reproduction of signals from the air. This rheostat, (patent pending) properly controls all makes of tubes, including the new "A" and 199 and makes Crosley instruments even more efficient than ever before because of the:

1. Efficient, smooth, uniform control of all tubes duo-wound to low and high resistance 10 to 20 ohms.
2. Plunger type contact actuated by a special spring, insuring uniform pressure at all times.
3. Spring washers producing uniform tension.
4. Positive rugged stop at zero resistance or "on" position.
5. Circuit interrupted at "off" position.
6. Resistance material having zero temperature co-efficient.
7. Windings protected by a black moulded shell of high heat insulating material.
8. Electrical connections substantial in construction.
9. Design of parts to prevent warping.
10. Extremely low operating temperature with all tubes.

The outstanding performance of all Crosley instruments is due to the effective co-operation of the new filament control rheostat with the other parts.

For Sale at Best Dealers Everywhere

Write for Free Catalog

CROSLEY MANUFACTURING CO.
 719 Alfred Street Cincinnati, Ohio



New York Office, C. B. Cooper, 1503 Tribune Bldg., 154 Nassau St.

Boston Office, B. H. Smith, 929 Blue Hill Ave., Dorchester.

Chicago Office, 1311 Steger Bldg., 28 E. Jackson Blvd., E. A. Stemm, Mgr.

Philadelphia Office, J. H. Lyte, 65 North 63rd St.

St. Louis Office, Rob't W. Bennett Co., 1326 Syndicate Trust Bldg.

Crosley Radio Receivers have a universal appeal. The Model X pictured here is the last word in efficiency. It sells at \$55 in spite of its new features and advanced manufacturing cost.



7411

NEW RADIO DRY CELL "A" Battery for WD-11 Tubes

The Dry Cells in this 1½ volt NEW Eveready "A" Battery were developed especially for use with WD-11 Vacuum Tubes. They last longer than Dry Cells made for other purposes. Longer Service Hours Means Economy. Made in three sizes—7111 one cell, 7211 two cells, 7411 four cells.

FOR BETTER RESULTS USE

EVEREADY RADIO BATTERIES

—they last longer

Made on the Pacific Coast—fresh and full of pep

National Carbon Company, Inc.

599 Eighth Street

San Francisco, Calif.

"GRANOLITE"

Universal Loud Speaker Radio Horns

The All-Wood, perfect reproducing horn you have been looking for.

"GRANOLITE" Universal Radio horns are positively superior to all others, because we have embodied in their construction perfect acoustic qualities, careful workmanship, high grade, carefully selected materials, strength and beauty of design. The base construction and equipment is universal, permitting the installation and use of any of the standard and well known loudspeakers and receivers.

"GRANOLITE" is hydraulically treated wood, which after being put through our secret processes is developed into a new material which we have named "GRANOLITE", because it represents a combination of the lightness of weight and basic tonal qualities of native wood with the tensile strength of granite.

"GRANOLITE" Loud Speaker Horns are made from granolited wood and are guaranteed to give satisfaction. They will not warp, crack, chip, or peel. The bell is accurately shaped and the exceptionally clear acoustic properties are the result of months of careful and exhaustive tests, which have enabled us to place a horn on the market, embodying everything that is required to give a clear, perfect reproduction of sound exactly as received and thus eliminating the various troubles and objections encountered in connection with the use of fiber and metal horns.

"GRANOLITE" horns are made in three sizes: No. 1. A small one, 15" high, with 8" bell for crystal receivers; No. 2. A medium size, 19" high with 9½" bell for private use in the home, and a large size, our No. 3, which is 25" high with a 14" bell for concert halls, moving picture houses, theaters, etc.

Granolite horns are finished in either dull or bright black lacquer, dark brown, bronze, ivory or verdi-green. When ordering be sure to specify finish desired. Our standard finish is dull black, which will be supplied unless otherwise specified.

LIST PRICES

- No. 1 Horn 15 inches high.....\$ 8.00
- No. 2 Horn 19 inches high..... 10.00
- No. 3 Horn 25 inches high..... 12.00

Above prices apply to horn and base only. If horn is wanted complete with receiver add \$6.00.

Granolite horns are manufactured solely by

GRANOLITE ART PRODUCTS CO.

222-224 4th Street



"Granolite"

Made in three sizes:
No. 1 with 7 1/2 inch bell; height, 15 inches.
No. 2 with 9 1/2 inch bell; height, 19 inches.
No. 3 with 14 inch bell; height, 25 inches.

Continued from page 68

"Well," says I, "he'd a had less to push," says I.

Jimson drags the battery inside the shack and he hooks her up as per directions. Jimson turns on them lights. I aint never heard nowhere, more sadder wails ever come out of a box.

"Sufferin' polecats," says I. "Has we got to live with that?"

"Oh," says Jimson. "That aint so bad. You'd ought to be married awhile," he says, with feelin'.

This was on a Friday. Come Sunday, which was muy caliente as far as heat goes, things begins to happen right pronto. Me and Jimson is layin' under a tree wonderin' why the flies in the country is too lazy to get up off their backs, when up comes a ragged bozo lookin' kinda excited.

"Huh," says Jimson. "Yon comes my intelligence department."

"Senor," pants the wreck, "beega fight she's beegin, pronto. Two, mebbe tree hoondred soldados . . ."

"Where?" snaps Jimson.

"Fuente del Rey," says the wreck.

"Gun?" asks Jimson.

"Si—mucho."

"Cannons?"

"Si—dos."

"Weno," says Jimson. "Vemoose and learn me some more."

He chucks him a couple of pesos and the intelligence department fades up the road on the run.

"At last," says I to myself. "There's somethin' stirrin' in this blamed country."

Jimson writes a message on a piece of paper, the which he gives to one of our track bozos.

"El Presidente — palacio!" snaps Jimson.

The bozo comes to life like his tailor was dead and hotfoots it down the same road took by the intelligence department.

Jimson goes in and ties on his sword, so's it'll hang down where he can step on it when runnin'.

"From now on I'm official," he says.

"You look it," says I. Furthermore," I says, "you're that bowlegged you resembles the uncle of a snappin' turtle."

Jimson gives me a haughty look, some like a llama, but doesn't say nothin' in the way of repartee.

There might have been words between us only a red pant comes gallopin' up from the palace and explains that he's official likewise, and is aimin' to sit around and run errands for us—El's orders.

"Heaven help us," says I, "everything in this blamed country is official but officials. Does this buzzard aim to eat offen us?"

"He presents a complication," says Jimson, thoughtful like, "but I reckon we can manage to worry along."

Continued on page 72

PRE-INVENTORY RADIO SALE

	Regular Price	Sale Price
Federal detector and one-step.....	\$ 52.00	\$ 30.00
Federal two-step amplifiers.....	58.00	35.00
Clapp Eastham wave meter.....	27.00	15.00
Clapp Eastham detector and one-step.....	35.00	20.00
Turney spider web inductances.....	5.85	3.00
Radio instrument DX receivers.....		40% Off
General Electric crystal receivers with headset.....	18.00	12.00
Crystal receiver with headset and buzzer practice set with battery.....	17.00	10.00
John Firth detector control cabinet.....	10.50	8.00
Acmefone receivers with detector and two-step amplifier and loud speaker.....	80.00	50.00
King Amplitones.....	12.00	8.00
Paragon Transmitters (C. W. Voice and I. C. W.)	72.00	50.00
Meyers tubes with sockets.....	5.90	4.50
Paragon tuner, detector and two-step.....	140.00	110.00
Hall relay—automatic code receiver.....	160.00	40.00
Dials—		
4-inch Tuska, 1/4 and 3-16.....	1.65	.60
4-inch Paragon, 1/4.....	1.75	.60
3-inch Paragon, 1/4.....	1.00	.60
2-1/4 inch Paragon, 1/4.....	.90	.60
2 3/4-inch Composition.....	1.00	.60
General Apparatus, 1/4.....	1.25	.60
Bausch & Lomb Precision Binoculars, six-power....	50.00	40.00

PAUL FRANKLIN JOHNSON

560 East Colorado Street, Pasadena, California

"EVERYTHING WORTH WHILE IN RADIO"

POWERFUL G. E. STATION

Continued from page 37

poses of conducting tests. In operating high-powered equipment below normal rating in broadcasting, tubes and rectifiers are not subject to occasional overloads and, as a result, superior quality and greater reliability of transmission are obtained.

Six motor-generator sets will be placed in the power house and these will supply filament and plate current for the oscillator, modulator and kenetron rectifier tubes.

Every part of the equipment in the power house and in the control room will be in duplicate, assuring uninterrupted service. If one outfit or part of an outfit breaks down during the operation period another part will be ready to be brought into the circuit.

There will be six tubes in the kenetron rectifier assembly, one metal plate oscillator tube and one metal plate modulator tube. The control room in the studio building will have three stages of speech amplification made up of two 5-watt tubes and four 50-watt tubes. A fourth stage of speech amplification will be installed in the power house.

It is probable that an auxiliary studio, connected with the transmitting equipment of the station by telephone lines, will be located in San Francisco.

By means of what is known as "remote control," the facilities of a radio broadcasting station may now be brought to banquet hall, theater or church and the audience, theretofore limited to the seating capacity of hall or church, is multiplied many times. The church is connected to the transmitting equipment by telephone lines and control of broadcast material is maintained in the church by operators.

The Pacific Coast station of the General Electric Company will utilize "remote control" to broadcast church services and musical entertainments from San Francisco and Oakland. The Pacific Telegraph & Telephone Company has offered to provide land wire connection for this type of service.



CRYSTAL RECTIFIER
MULTIPOINT (Patent Pending)

A Synthetic CRYSTAL DETECTOR, sensitive over its entire surface.

Eliminates all detector troubles. Extraordinary clearness and volume. Endorsed by Radio experts and press for both: REFLEX CIRCUITS and CRYSTAL SETS. Sold in Sealed Packages only.

Price Postpaid, Mounted Sensitiveness Guaranteed **50c**

RUSONITE CATWHISKER
14 Karat Gold Multipoint contact. Super-sensitive **25c**
Order from your dealer or direct from us.

RUSONITE PRODUCTS

15 Park Row, New York Dept. "K."

"B" BATTERIES

AN
EVEREADY
PRODUCT

13V. Batteries, tapped.....\$5.00
22 1/2 V. Batteries, Navy Type..... 3.00
22 1/2 V. Batteries, Commercial Type..... 2.00

Latter two types especially adapted to Cunningham and Radiotron Tubes. Postage Prepaid Anywhere in U. S.

ETS-HOKIN & GALVIN
Wireless Engineers

10 Mission Street San Francisco

"EURACO PRODUCTS"

(Guaranteed)

Compact — Interchangeable — Accurate
Most Efficient



Price 60 cents per Unit
Mfgs. of

MICA CONDENSERS, GRID LEAKS, MOUNTINGS

Interesting Proposition for Dealers

European Radio Company

1342 East 22nd Street Brooklyn, N. Y.

RADIO TUBE EXCHANGE



SAVE 50%

We Repair All Makes of Tubes

WD11—VT1

UV201A—VT2

Dry Cell Filament Put in Any Tube.

RADIO TUBE EXCHANGE

453 Washington St., Boston Mass.

Continued from page 70

MU-RAD RECEIVERS SUPREME



The reception of far distant stations, heralded by owners of ordinary sets as a rare achievement, is the common experience of those who own MU-RAD Receivers. Only a 2-foot loop aerial required. Sensitivity finer than anything you have ever known. Faithful reproduction. Selects with amazing ease and sharpness. Yet these highly perfected sets are very simply operated. Guaranteed to receive 1000 miles, minimum. The maximum record is broken every week. Send for literature.

The New
Star in
the Radio
World



MU-RAD LABORATORIES, INC.

806 FIFTH AVE. ASBURY PARK, NEW JERSEY

"ALL WAVE" COUPLER

CAPITOL PHONO-LIER TYPE

Free with 4 subscriptions to "RADIO."

This coupler sells for \$9.00. You get it free with \$10.00 worth of subscriptions

THIS OFFER GOOD DURING JUNE ONLY

He leads me aside.

"Yuh got to go down the road apiece," says he, "and flag the intelligence department when it returns. Get his dope and bring it to me. I got to make a bluff of gettin' it over the radio," he says, "for El's private use. The main thing is to keep red pants from findin' out how I'm gettin' my stuff or me and you won't be workin' at no royal job."

Well, I tumbles immejit. So I hies me off to wheres I can lamp the road from under a tree. Jimson takes red pants inside and stakes him to a seat where he can hear li'l' ol' radio-telegrafico wailin' away like it was havin' its sins burned out in a Baptist hell. Herms aint none too enthusiastic about the whole works and keeps as clost to the door as the law allows.

Me—I loafs around under the tree, smokin' severial cigarettes and thinkin' what a couple of prize ijits we is to get tangled up with politics in a country where we don't know no police judges.

Comes half an hour, and I sees the intelligence department headin' my way. The way he's travellin' I figgers he's doin' his hundred in about eight flat.

"Whoa!" says I, when he comes abreast. "Como la speed?"

"Mucha guerra," says he, pointin' toward the North Pole, from which I gathers war has broke at last.

"Spill it," says I in my best pongo. "Habla the works and come clean," I says.

He does. I lissens and gathers what I can. When he's done I sees the fun has begun in plumb earnest.

"Go back and git some more," I orders, slipping him a few pesos. He salutes and percolates rapid.

Me—I hurries back to the shack, loaded with info. Jimson sees me comin' and steps outside.

"There's five hundred battlin' babies," says I, "headed for the palace along Santa Rita road. They figgers on smackin' the palace at dawn, accordin' to yore pantless intelligence department. They got a cannon and ammunition, the which they've been stealin' right regular from the royal arsenal, and they figgers on butcherin' El at the throttle."

"Ah ha," says Jimson, doin' some fast figgerin'. "They'll be at Carimar creek at 4 a.m.," he says.

"Interestin' if true," I retorts. "They'll also be at the palace for breakfast if nothin' interferes," says I.

"We've got to stop 'em at Carimar creek," says Jimson, thoughtful like, trippin' over his bread-knife.

"Oh, sure," says I. "Just like that. Shall we do it alone, or would we better take a couple of 10-year-old boys along to help out? Five hundred sore

Continued on page 74

Chelsea Condensers

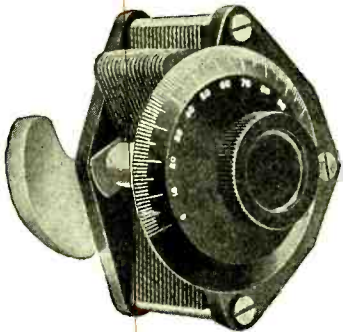

No. 1

PRICES:

No. 1 Table.....	.001	\$5.00
No. 2 Table.....	.0005	4.50
No. 3 Panel.....	.001	4.75
No. 3a Panel without dial..		4.35
No. 4 Panel.....	.0005	4.25
No. 4a Panel without dial..		3.85
No. 5 Panel.....	.00025	3.75
No. 5a Panel without dial..		3.35
No. 6 Panel vernier.....		2.90
No. 6a Panel without dial..		2.50
No. 7 Table with vernier....		6.75
No. 8 Panel with vernier....		6.50

Genuine Bakelite Construction

The best and most complete line of condensers in existence.

Write for our catalog No. 7

Chelsea Radio Co.
152 Fifth Street
CHELSEA, MASS.

CARTER AUTOMATIC RHEOSTAT

The Latest! The Best!

Eliminates first and second stage jacks. Decidedly simplifies amplification. Clock-spring pivot connection insures consistently reliable operation.

No. 3, 6-ohm, for U. V. 200 tubes, \$2.25 ea.
No. 3-C, 20-ohm, for U. V. 201 tubes, \$2.50 ea.
No. 3-D, 30-ohm, for U. V. 199 tube, \$2.50 ea.

Write for Bulletin on Distinctive Carter Products

Carter Radio Co. 209 S. State St., Chicago

CURKOIDS

The Supreme Inductance. Greater Signal Strength. Greater Distance of Reception Without Distortion.

Rieger Research Corporation
112 WEST 44th ST., NEW YORK, N. Y.

"ALL-AMERICAN" Amplifying Transformers

(RADIO AND AUDIO FREQUENCY)

Again Prove Their Superiority in "NEUTRODYNE" and "REFLEX" Circuits

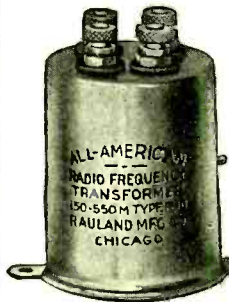

The use of "All-American" radio (Type R-10) and audio frequency (Type R-13, Ratio 10 to 1) amplifying transformers make possible the wonderful success of the single tube Reflex Circuit.

"All-American" radio frequency transformers (Type R-10) having a non-magnetic core can be tuned, making them the most efficient radio frequency transformers for the Neutrodyne Circuit.

- R-10 Radio Frequency (150-550 meters) \$4.50**
- R-12 Audio Frequency (Ratio 3 to 1) 4.50**
- R-21 Audio Frequency (Ratio 5 to 1) 4.75**
- R-13 Audio Frequency (Ratio 10 to 1) 4.75**

Ask your dealer for FREE "All-American" Hand Book of Radio Hookups. If he cannot supply you, send two cent stamp for postage and name of your dealer.



RAULAND MFG. Co.
200 No. Jefferson St., Chicago, Ill.



Large Carbon and Copper Contacts that cannot BURN or STICK. Sturdy Vibrator gives Dependable Service.

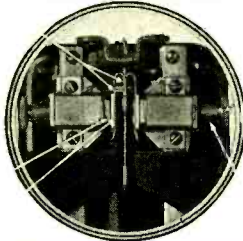

Adjustment Held Permanent. Easily Adjusted.

It will quickly and easily keep your RADIO "A" and "B", and Auto Storage Batteries in active service. Seven types, attractively priced, to fill your needs. What are they? Present users, write for details of the new F-F "B" Battery Charging Attachment.

F-F Battery Chargers are sold by the better dealers. If yours cannot supply you, mention his name and send us remittance with express or postal charges on 9 lbs. for quick shipment.

Bulletin No. 32 Sent on Request

The FRANCE MFG. CO.

10433 Berea Road, Cleveland, Ohio

Pioneer Manufacturers of Patented Battery Chargers

A Good Name---Ten Years Old

Non-fusible carbon contactors that cannot BURN or STICK, permit a high charging current not satisfactorily obtained by other methods.

This is only one of the many features embodied in F-F Chargers; only one point of superiority that has helped to establish their ten year old reputation as "the one dependable charger." You buy genuine satisfaction with the

F-F BATTERY CHARGER

\$15.00

F. O. B. Cleveland

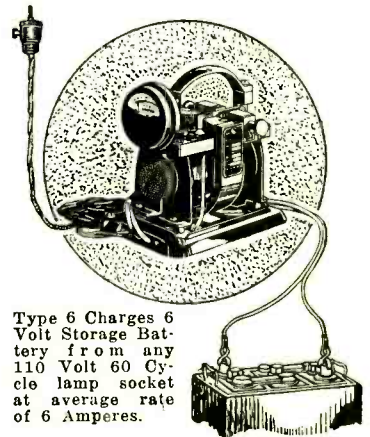

Type 6 Charges 6 Volt Storage Battery from any 110 Volt 60 Cycle lamp socket at average rate of 6 Amperes.

Western Representative:
EMMETT F. ANNIS

327 Dooly Bldg., Salt Lake City, Utah
67 2nd St., San Francisco, Calif.

"Read'em" Binding Posts

With knobs that won't come off

Anyone can "read 'em." Irremovable knobs. All popular styles—Antenna, Ground, Phones, A and B Battery plus and minus—abbreviations of different names engraved on knobs. Radio users—ask your dealer for "Read 'em." Dealers—write for our proposition on this big seller. Write Dept. B for liberal profit proposition.

The Marshall-Gerken Co.
Manufacturers
Toledo Ohio

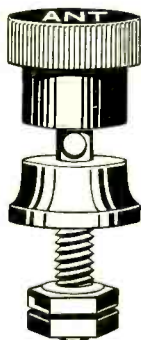

"A-B-C of Radio"

An illustrated non-technical radio book

25c Per Copy

"RADIO"
Pacific Building
San Francisco

Tell them that you saw it in RADIO

RHAMSTINE [★]

Victophone

and your phonograph make a
Perfect Loud-Speaker

This reasonably priced unit makes it possible for you to secure great volume when attached to a horn or the tone-arm of your phonograph.

Critical adjustment of the poles is easily made, giving you the desired fullness and sweetness of the low or high notes.

Compare it with others—even those selling at double the price—and the Victophone will be your choice. Order yours now.



Price **\$7.50**

complete with
cord

Manufactured by

J. THOS. RHAMSTINE [★]

2162 E. LARNED ST.

DETROIT, MICH.

*Maker of Radio Products

Continued from page 72

hombres aint nothin' to stand off a-tall," I says.

Jimson gives me a fried egg look.

"You got the savvy and grasp of a dead asparagus," he says. "You must have been a lot of help to yore folks. I'll attend to this myself," he says.

He goes into the shack and drags out some boxes. Then he sends a track bozo for a cayuse and a wagon. Not havin' anything to do, I kicks my heels and checks over a couple of sins just to see how I stood in case we don't stop them battlin' boys at the creek like Jimson says. When the bozo gets back with a sick-lookin' mule and a rickety buckboard, Jimson loads the cases aboard with some other junk, the which looks plumb familiar.

"Goin' to build another railroad?" I asks.

"No," says Jimson. "I'm aimin' to make rain," he says. "Only it aint gonna rain nothin' nobody ever saw before."

When he's all set, he writes out a message for El and sends off the paralyzed messenger who aint used to things movin' quite so fast and has been standin' around lookin' dumb. The messenger spurts out like his grandfather has just died and left him a still.

"You should have been minister of speed and ideas," says I. "You're ruinin' the country by hurryin' the low-gear middle class," I says.

Jimson gives me a mean look.

"If langwidge was cannon," says he, "you'd a won the Civil War for Alexander," he says.

Then he climbs aboard his chariot and giddaps his barley motor.

"Sit tight," he says. "I'll be back 'round midnight. Keep them lamps howlin' in case somebody shows up from the palace, because we got to act official right along, now," he says.

With which illuminatin' words he drives off, leavin' me to a bum conscience and a lot of loco scenery.

Comes seven o'clock, I has nothin' to do but watch the sun go down, the which is the principal industry of the country. The hot-foot bozo drifts in with the news that the palace is all het up, with El all over the place givin' orders, but dependin' a whole lot on me and Jimson. I chuckles. Thinks I, El must have got a square look at the army. But I don't say nothin', because there's places for humor, like there is for hooch and other amusements.

"When in doubt, sleep," says I. Which I does, with one ear on the road, so to speak.

At half past midnight, Jimson comes back. I greets him with a lantern, and sees to my surprise the said mule was all lathered up, from which I opines he's been a long ways.

"Yore dope was right," says Jimson,



means Radio Insurance



Multiple Point
Inductance
Switch



Compensating
Condenser

SATISFACTION is assured—every particle of risk is eliminated by our money-back guarantee, when you buy Amsco Products. Everything we make—from the wonderful Melco-Supreme Radio-Frequency Receiver (150-750 meter wave length), to the smallest binding post—is scientifically correct, mechanically perfect and built for durability.

Write for booklets 1001 and 1002
illustrating and describing our entire
line of quality apparatus.

Amsco Products, Inc.

Fairbanks Building
Broome & Lafayette Sts.
New York



Tube Socket



Vernier-Coil
Mounting

Successors to Mortimer Radio Corp. and Advance Metal Stamping Co.



**D. X.
Special
3000**

Ohm Phones
List Price
\$3.25

Very sensitive
for D.X. work.
Good discount
to Dealers.
Send for sam-
ple.

THE RADIO SHOP OF NEWARK, INC.
Dept. D.X. 76 Springfield Ave., Newark, N. J.



**WE REPAIR
WD-11, \$3.50**

and OTHER
VACUUM TUBES

Excepting
VT-I and VT-II

MAIL ORDERS Solicited and
Promptly Attended To

H & H RADIO CO.

512 Clinton Avenue NEWARK, N. J.

Tell them that you saw it in RADIO

chucklin'. "The boys hits Carimar creek at 4 a. m.," he says.

"Well, what's it to me?" I asks, gettin' sore, for the way things stood I was as plumb ignorant as a college professor, of what was goin' on around me.

"A whole lot," says Jimson. "Aint you patriotic? Don't you know the date?"

I figgers a minit.

"July 4," says I.

"Righto," says Jimson. "A noble moment of history," he says, "that cut the corns off of Cornwallis," he says. "The Fourth of July and the Battle of Carimar Creek,—both noble happenings. I aint had so much fun since I put gin in the Methodist punch."

"From which I takes it yore aimin' to celebrate," I remarks.

"You said it," says Jimson. "And El and the bunch is goin' to help. El," he goes on, "and the boys are goin' to drop in about 3.30 a. m., to help out. Don't tell 'em nothin'. Just act mysterious. Let me do the palaverin'."

A little after 3 o'clock I was awaked by a lot of jinglin' and Jimson kickin' me in the stomach, the which always did keep me from sleepin'.

"Get up for the love of Mike," he says, "and act official."

"What's comin' off?" I asks.

"El's here," says Jimson. "And he's brang all the high power boys with him."

He has. I never seen so many Knights of Pythias in one spot except onct at a convention back in U. S. Every bozo had a sword and shoulder tassels, and there was more bowin' and scrapin' and kissin'. I tries to act plumb dignified, but there was so many of 'em had the bends they got me doin' it.

"Enter gents," says Jimson. "The great battle of freedom is about to come off."

I looks 'em over, and they was a hell of an army's all I got to say. They looks like the Prisoner of Zenda back stage, only more so. They'd of gone good in Tucson in a tent, with a couple of zebras and a ephelunt on the side. Thinks I to myself, if we only had some pink lemonade now. But Jimson goes one better. He opens a case of Scotch from the *Hattie Pratt*.

"Libertad!" says Jimson raisin' his tea-cup.

"Libertad," says El, sociable like, takin' his from the bottle.

"El Presidente," says Jimson.

"El Presidente!" roars back the knights.

"Libertador!" says El, holdin' out his bottle toward Jimson.

"Viva!" squawks the grand opera boys.

"Give 'em the ax!" I yells, gettin' into the party.

They looks at me polite, then decides my intentions is right, and they hands me "salute" right back.

"Gents," says Jimson. "The forces of revolution is marchin' against the forces of government. Right must triumph," he says, "the which is the government which made me what I is today. In gratitude for the same I devote the great cause of radio," he says, "to savin' the nation." He raises his cup. "El radiotelegrafico" says he.

"El radiotelegrafico!" yodles the free thinkers, clatterin' their swords.

"At 4 o'clock," says Jimson, "five thousand desperate rebels will try to cross Carimar Creek," he says, "to attack the palace of our noble El Presidente."

"Five thousand?" says El, gettin' dough colored. "But, senior—our army is but two thousand. I have place them where you direct, but against such a force of rebels — caramba. We are helpless!"

"Bunk," says Jimson. "Two thousand is plenty. For that matter, none is too many," he says. "Fear not—radiotelegrafico will protect you. See!"

He goes to the switch-board and turns on the generator, the which begins to make a fuss. El and the boys all crowd around.

"See!" says Jimson, "when I touch this key—pouf! There are no rebels!"

He makes a motion and all the staff boys backs away like they'd just as soon be somewhere's else. Jimson looks at his watch.

"Hum," says he. "Two minnits to four. Tis time the battle starts."

He sits down at the instrument and puts the cans on his head. When he turns on the lamps and the blamed thing starts howlin' the whole bunch gets mighty nervous.

"Silence," shouts Jimson above the racket of them lamps. "Not a sound whilst I find out what them rebels is doin'."

He harks a few while El and the boys stands around with their eyes popin' out of their heads.

"Ah," says Jimson, jumpin' to his

Build Your Own HAZELTINE NEUTRODYNE with FREED-EISEMANN Licensed Essential Parts



Complete wiring diagram, instructions, etc. sent in special container with patented essential parts. Three NEUTROFORMER COILS

mounted on variable condensers, and DOUBLE NEUTRODON (as illustrated), sent for \$21.50. Ask your dealer to show you these parts, as well as complete assembled five-tube Neutrodyne Set in mahogany cabinet, Model NR-5, \$150.

Or send 25c for Neutrodyne Constructor which shows "How to Make the Neutrodyne"

FREED-EISEMANN RADIO CORPORATION
Dept. D
255 FOURTH AVENUE NEW YORK
Licensed by I. R. M. Inc. Under Hazeltine Pats.
Tell them that you saw it in RADIO



NA-ALD
Special Socket
No. 499



NA-ALD
De Luxe No. 400

It's the contact that counts

The Na-ald Special Socket No. 499 is a sturdy little socket with a dependable contact for the G. E. No. 199 dry-cell tube. It has special slot construction, and is moulded of genuine Bakelite. The heat from soldering connections will not affect Na-ald sockets.

Price 50c

The dual-wipe contact strips of the Na-ald De Luxe socket avoid the trouble experienced with the socket of conventional design. Because of thorough cure and high dielectric properties Na-ald sockets keep plate to grit losses at a minimum (of particular importance in Flewelling Circuit or in Radio Frequency.)

Price 75c

Na-ald Adaptor for No. 199 tube, \$1.00

Booklet with diagram of Hazeltine's Neutrodyne Circuit and Other selected circuits, packed with each Na-ald product or sent in exchange for cover taken from any Na-ald carton.

Alden Manufacturing Co.

Manufacturers of Sockets for Every Tube and Requirement
Dept. H 52 Willow St. Springfield, Mass.



Wave Trap

TRADE MARK
PATENT APPLIED FOR

The Missing Link in RADIO

Stops Interference!

The "WAVE TRAP" will eliminate interfering broadcasting stations and enable you to listen to your favorite station.

It will work on any set, greatly increase its selectivity and clearness, and eliminate code and spark stations.

It is mounted on a Formica panel in a handsome mahogany finished cabinet 6x5x6. It is a high grade instrument throughout and a valuable addition to the operation and appearance of any set. It comes to you complete and there are no extras to buy. It is installed in a minute by changing only one outside connection. Use the "WAVE TRAP" for real results.

John A. Burrichter, 207 E. Ohio St., Indianapolis, Ind., says:

My set is about ten blocks from one of the local stations and when they started broadcasting, it meant that ended everything for the evening. After your Wave Trap was installed, they were tuned out completely.

Had expected with the approach of warm weather to take down my set until next fall, but while other local "Listeners In" are almost entirely cut off by STATIC, I am enjoying the programs just as much as in the cold months.

Have covered distances that heretofore have been impossible and really consider the Wave Trap the greatest invention since radio.

Use the "FERBEND WAVE TRAP" for real results.

THE ORIGINAL WAVE FILTER

850 Ferbend Electric Co.
CHICAGO
17 E. SOUTH WATER ST.

**a Chi-Rad
Special!**



for W.D. 11 tubes—

Standard, threaded rubber, Willard's, specially adapted for use with W.D. 11 tubes. Supply current at 2 volts to one W.D. 11 tube for 210 hours on a single charge. Rechargeable. Brand new, size 4x5½ x7 inches—Chi-Rad guaranteed.

2-Volt Willard Charged...\$7.50

2-Volt Willard Dry..... 6.50

These same Willards can be adapted to deliver 8 volts for pure D.C. for C.W. Transmitters. Better than a generator because no filter is necessary. Much less expensive.

In lots of 40 (320 volts) \$160.00
(Better prices on larger quantities)

Specify dry or charged when ordering.

Chicago Radio Apparatus Co.
415 S. Dearborn St., Chicago, Ill.



**STATIC
and Inter-
ference is
Reduced
to a
Minimum**
—
**Better
Reception
with the**

NASSAU

LOOP TUNER

TRADE MARK

Pat. Pend.
Price \$35.00
Jobbers and Dealers
write for
Proposition

Eliminates Aerial and Ground.
**The Secret is in the Patented Winding
1500 MILES ON LOUD SPEAKER**

With 2 stages radio and
2 stages audio frequency
amplification.

Write for Circular "R"

Manufactured by

NASSAU RADIO CO. Inc.
60 Court St., Brooklyn, N. Y.

**RADIO MAPS
of U. S.**

**35c Postpaid
"RADIO"
Pacific Bldg.
San Francisco**

feet sudden like. "They have give the command to forward. General Mendoza is in the lead. Five thousand men are crossing the Calimar Creek bridge this minnit," he says.

El gives a groan.

"Santa Maria," he says. "All is lost."

"No," says Jimson. "All is won!"

And with them words he shuts the key of the transmittin' set. A long blue spark cracks in that shack like a couple of shot-guns goin' off all to onct. I gives a jump myself, not lookin' for it. As for El and the boys, they just natchully lets out one yell of plumb terror and all of 'em tries to get through the door at the same time. I never seen such fightin' and clawin' and yellin' from a gang of hombres. When they finds themselves outdoors, they was for streakin' it for the palace, El in the lead. But Jimson halts 'em.

"Wait!" says he. "In the name of freedom!"

They comes back.

"Santa Cristo!" says El. "What have happen!"

"As Minister of Kilowatts," says Jimson, usin' a bass voice, "I have dispatch the death-dealing power of a radio volt to Carimar Creek bridge. It is even now on its way. Listen! We stands silent. I could feel the hair on the back of my neck kinda stand up, and I reckon El's was doin' the same. One, two, three minutes. Then away off, across the roof of the palace we sees a big red flash. A minnit more, and there comes a dull boom!"

"Done!" says Jimson, shootin' both hands over his head. "The foes of freedom have perished! Five thousand of 'em, destroyed on Carimar Bridge by the power of radio!"

Migosh, but it was sure dramatic! El stands kinda paralyzed.

"Perish," he whispers. "Five thou-
..."

Well, sir, the grand opera boys goes all to pieces. Some of 'em cries, and others breaks into language. A couple of 'em with a crime or two on their consciences begins prayin'. El staggers around kinda dazed. Then he falls on Jimson and begins to hug him like he was the prodigal calf come home to be fattened.

"Labrador!" says he. "If you have tell me of the truth you are of the country the savior," he says.

"Well," says Jimson, breakin' a clinch, "if you got any doubts you kin send a courier to find out."

Which El done, the whiles we has a few hundred drinks apiece on freedom, liberty and other dames we all knows.

By and by, or maybe sooner—near dawn it was—the courier rides back with the news that "el radiotelegrafico" has blown Carimar bridge to smithereens, and from what was left of some red pants hangin' in a tree, General

Tell them that you saw it in RADIO

Mendoza and his boys has left for parts unknown muy pronto. The courier was too plumb excited to notice how many was killed but he gathers enough to let El know the revolution was over for fair.

Well, right there I got to hand it to El for bein' a kind-hearted old slob, for he ups and bust into tears. The staff, seein' weeps was fashionable, cuts loose and begins to carry on likewise, the which I never seen no wetter gatherin' anywheres.

"Hey," says Jimson, pattin' El on the back, "it's all right, amigo. As I tells you before, the first hundred shocks is the toughest. All we done was our duty and anyhow its the Fourth of July," he says, "and we was puttin' on some of the party on our own."

El quits weepin' after a bit and wants Jimson and me to come up to the palacio so's he can hand us the mint or the navy or somethin' appropriate. But Jimson opines as how some sleep would do us a heap more good first. So El wipes his eyes on his sleeve, and sniffs a couple of times. Then him and the knights kisses us all around like we was rich relatives and they all goes off to arrange a celebration in our honor.

"We aint hell on parties," says Jimson, "but we'll come."

They all clatters off at them words, lookin' plumb grateful. When they was out of sight, I turns to Jimson and by the dawn's early light I gives him a wall eye.

"Of all the low-down, ornery flim-flammers I ever met up with," I says, "you're the most plumb useless, no 'count . . ."

"Shut up," says Jimson. "That aint no way to talk to a man what's just won a war."

"War, my eye," I replies. "What was that explosion, anyways?"

"That," says Jimson, yawnin', "was about fifty sticks of blastin' powder and an alarm clock what got friendly under Carimar bridge," he says.

"Was that there clock set for 4 a. m.?" I asks, beginnin' to see light.

"Kerrect," says he. "And you got to hand it to me for timin' things purty near right."

"You," says he, "aint got no imaginafor you them revolutes didn't git acrost that bridge too soon," I says. "I'd never took no chances like that."

Jimson kinda yawns.

"You," says he, "aint got no imagina-
tion."

And with them words he clumb into bed and goes to sleep without another sound except such as the human face can make when wide open and unwatched.

And that was that.

At 4 o'clock that afternoon we gets sent for from the palace. So we washes up and Jimson ties on his sword and we goes down to the slaughter, same bein'

the feed in our honor, etc., El sent the family bus for us and we goes ridin' into town like we was conquerin' heroes, with grand opera boys on all sides and the air full of shouts and good feelin'.

I aint never been treated royal and it sure was a strain. Dames we hadn't never met before climbs into the go-cart and kisses us like we was Dick Hobson back from sinkin' the Merrimack. Grown bozos kept chuckin' flowers and paper dinguses at us. One secret revolute hits me on the neck with an artichoke and I would have got out and lammed him, only I didn't know who it was, and anyhow there was a couple of dames clawin' at me at the time. When we gets to the palace, there was El out on the front porch with the Pythian boys and all six of the army. They gives us the past noble raspberry for fair, the which we couldn't have been better treated if we was bootleggers.

I aint so clear about the rest of it. I remembers there is a banquet and a lot of drinkin', and El makes a speech with Jimson tellin' me in lumps what he's sayin', owin' to a brunette who kept feedin' me champagne with a fire hose. I didn't get much of it except we is considered the grand cheese and the city is ours.

After awhile Jimson gets up and without no authority from Washington, D. C., presents "el radiotelegrafico" to the republic in the name of George Washington and William Jennings Bryan, with our compliments. Ev-rybody cheers and acts dizzy, but not speakin' English they aint gettin' much of it. But they follows the national custom when in doubt drink. And that's all I remembers, except tryin' to sell the Grand Canyon to an hombre in a funny hat for a sword which I finally took off him when he was unconscious. What I mean is, El and the boys kinda faded out.

THE followin' mornin' broke rotten and sickish, the which was due to bein' aboard a flossy lookin' steamer goin' somewheres. Jimson and me comes to lying against the wheelhouse with a taste like a dead shirt. A maverick in a uniform was lookin' down at us kinda grinnin' but he was United States so I speaks up and asks where we is.

"Aboard the steamer Maloney, bound for New York," says he.

"Sufferin' mackeral," says I. "How'd we get here?"

"You was brang aboard in style," says he. "Nearly the whole republic was down to see you off," he says.

"Have we got tickets?" I asks, hatin' the stearge some plenty.

"Straight through," says he. "Comps of the republic," he says. "They says you was to have the best on board because you just got a radio from the President of the United States to come home and save the country from a re-

"ESCO" BATTERY CHARGERS

To meet an insistent demand for

**Rugged, Reliable
Neverfailing
Motor-Generators**

For charging Batteries used in wireless operation, we have developed a complete line of many sizes. With or without panel boards. "ESCO" quality thruout. You KNOW what THAT means.

Ask for Bulletin 242

**ELECTRIC
SPECIALTY
COMPANY**

**215 South Street
STAMFORD
Conn., U. S. A.**

Pioneers in developing
Quality Wireless Apparatus

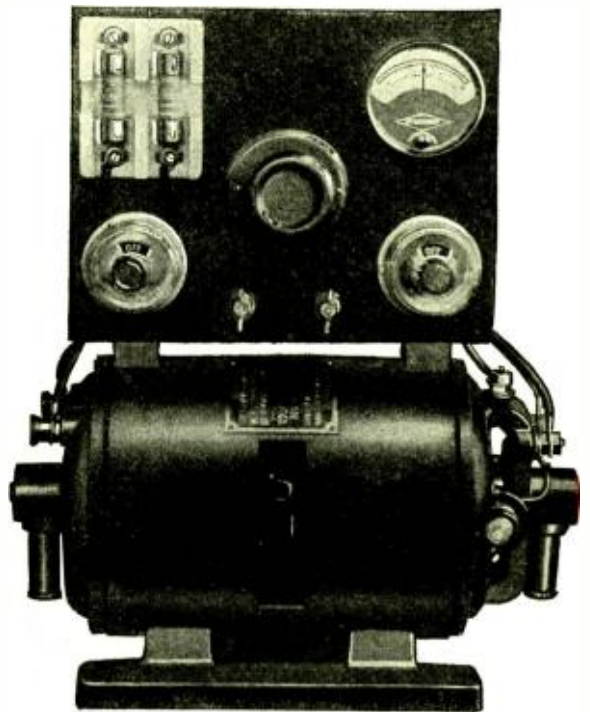

Summer Static Overcome

"Good-bye Aerial"



ANTENELLA

No aerial or antenna needed

All outside wiring, aerial, lightning arresters, switches and other inconveniences so inductive to static are eliminated. Merely plug Antenella in any light socket and you can enjoy all Radio pleasures in any room in your home, apartment or hotel. No current consumed.

**New Improved
ANTENELLA**

NOW ONLY \$1.25
formerly \$2.00

At your dealers—otherwise send purchase price and you will be supplied postpaid.

Chas. Freshman Co. Inc.
Radio Condenser Products

106 Seventh Avenue New York



KICO Storage "B" Batteries Give Long Service at Low Cost

Alkaline type, will not sulphate or buckle. Not harmed by short-circuiting, overcharging, or standing idle. Panel switches afford single cell variations. Easily recharged from any 110-volt A. C. line by means of small home rectifier. One charge lasts three to six months in detector plate circuit.

		Plain Panels	
Prices without rectifier	16 cell 22 volt	\$5.50	
	24 cell 32 volt	\$7.25	\$11.75
	36 cell 48 volt	\$9.50	\$14.00
	50 cell 68 volt	\$12.50	\$17.00
	78 cell 100 volt	\$17.50	\$22.50
	108 cell 145 volt	\$23.50	\$28.50
	Unmounted rectifier	\$1.00	
	Mounted rectifier	\$2.50	

SATISFACTION GUARANTEED

Money is refunded if user is not satisfied after 30 day trial. Write for full information on "A" and "B" Batteries.

KIMLEY ELECTRIC CO., Inc.
2669 Main St. Buffalo, N. Y.

The
Welsh

PEANUT W. T. 501, \$2.00

Detector
Tube

Can be used in any tube set or to convert any crystal set into tube set. Used on 3 dry cells or one 6-V "A" battery. Write for booklet.

RADIO RESEARCH GUILD
40 Clinton St., Newark, N. J.

BIG RADIO MAP FREE!

A wonderful two-color radio map 27 in. x 34 in., showing location of all radio broadcasting stations—Navy and Army stations—Canadian stations, etc.

Free with
one subscription to
"RADIO"

This map is divided into four divisions of time—Pacific, Mountain, Central and Eastern time.

Limited Supply of these
Maps on hand.

Use the Coupon—
Mail it Now.

RADIO, Pacific Bldg.,
San Francisco, Cal.

I enclose \$2.50. Send
"RADIO" for 1 year and the
big free radio map.

Name

Address

THE GOTTSCHALK TRADE MARK Loud Speaker that gained such rapid popularity Not merely a head-phone instrument



The Latest Development to produce a loud speaker that surpasses anything on the market at any price

Powerful Volume Producing
Mica Diaphragm Element

Employed In An Entirely New Manner

Assures Maximum Clarity With Total Elimination of Distortion

Fatert Pending

Will Positively Not Rattle

No Metallic Ring—Beautifully Finished
Moderately Priced

Greater Volume with Less Energy

Supersensitive for Long Distance Reception

The Price:

\$22.00

Dealers—Write at once
for trade proposition.

GOTTSCHALK ELECTRIC
& MANUFACTURING CO.
992 Howard St., San Francisco

Big Money for YOU in RADIO

Earn \$50 to \$250 a Week
Spare Time or Full Time Positions

Amazing expansion of radio has opened up thousands of wonderful positions. Thousands of men needed as radio mechanics, salesmen, inspectors, draftsmen, broadcasting operators, ship operators, executives, etc. Qualify for one of these finest positions in radio or earn big money in spare time erecting, building, selling, repairing radio sets.

Easy To Learn At Home

You can easily and quickly become a Certified Radio-trician at home in spare time through the help of National Radio Institute, the Oldest and Largest Radio School in the World. Radio experts help you. Instruments supplied with course.

Write For New Book
"Your Opportunities in Radio"

Learn more about the amazing opportunities in this world's fastest growing industry, and how YOU can easily qualify for a big pay spare time or full time position. Mail post card or letter NOW.

NATIONAL RADIO INSTITUTE
Dept. 10-G Washington, D. C.

Tell them that you saw it in RADIO

volution which was bein' started by the G. A. R." he says.

"Is that all?" I asks kinda weak.

"Almost," says the uniform guy. "I got a couple of sacks down in the safe that your friends sent along with you," he says. "They say there's about a million pesos in 'em which they leaves out of gratitude for somethin' you done."

Jimson looks kinda dazed and him and me gets up.

"I don't understand," he says.

"You aint got no imagination," I says. "That's what's the matter with you."

The uniform guy cuts in.

"If you gent's'll come with me," he says, "I'll show you where you bunk."

We follers him along the deck like a couple of loco cows headin' for water. We meets up with a door with a brass plate on it. A youngish guy was standin' there doin' nothin' in particular.

"What's this?" asks Jimson, thinkin' maybe it was a bar.

"It's the wireless," says the young feller. "Come in and I'll show you how it works," he says.

Jimson stares at him a minnit. Then he kinda laughs.

"Reckon I will," he says. "I've always wanted to know how one of them things works," he says.

HIGH FREQUENCY RESISTANCE

Continued from page 17

are being produced, such as honeycomb, Giblin-Remler, or spiral wound, all of which result in some reduction of the distributed capacity, and hence the resistance of the coil.

Secondly, there is the question of the proximity of other circuits. In ordinary direct current work the presence of nearby circuits has no effect on the resistance. In radio frequency work, due to induction effects which are so predominant in radio, considerable energy is transferred from one circuit to another. Thus if a circuit is tuned to another it will extract a large proportion of the energy from it, and this is equivalent to adding a resistance to the first circuit which resistance consumes as much energy as the neighboring circuit extracts. In other words, neighboring circuits in radio result in a rise in the resistance of other circuits due to withdrawing energy from them by induction and the better these circuits are tuned to each other the greater will be this rise in resistance. In radio work it is therefore important to see that no absorbing circuits are present unless they are placed there by design.

This covers the causes for increase in high frequency resistance of coils and circuits. It will be noted by the novice that there are many factors which influence resistance at high frequency and that therefore no pains should be spared in reducing these to a minimum.

The Most Efficient Compact Inductance Ever Used in Radio

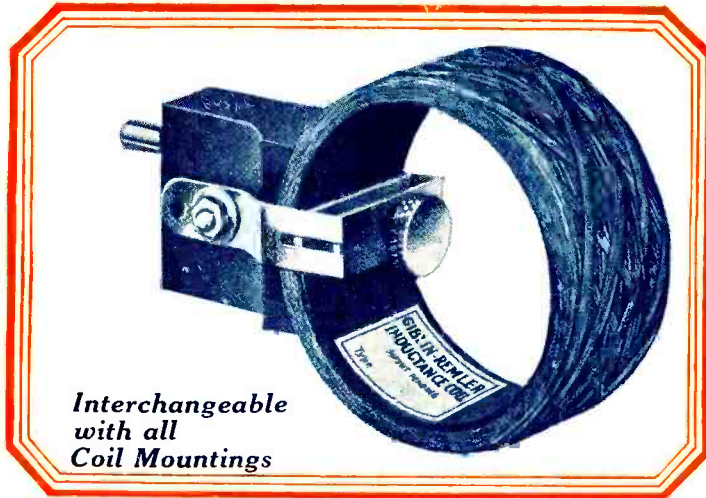

Use GIBLIN-REMLER Coils for receiving over the entire range of broadcast wave lengths---

228-546 METERS

THERE are two reasons why GIBLIN-REMLER Coils constitute the very best system of broadcast reception under the new assignment of wave lengths for broadcasting stations ranging from 248 to 546 meters. First: The coil is so designed as to have maximum inductance, minimum distributed capacity, and minimum high-frequency resistance for a given number of turns. These are the three features most essential to obtain maximum signal strength and maximum selectivity.

Type and Number of Turns, Mounted	Price, Mounted	Type and Number of Turns, Unmounted	Price, Unmounted	Inductance in Milli-henrys at 1000 cycles Accuracy 1/2%	Natural Wave Length in Meters, Accuracy 1/2%	Distributed Capacity, in micro-micro-farads, Accuracy 1%	Wave Length Range in Meters using Condenser of .001 max. and .00004 mfd. min.				High Frequency Resistance in Ohms at Wave Length shown.	
							Min.	Mas.	200	500		1000
RG 20M	1.50	RG 20U	.70	.030	39	14.3	63	334			1.1	
RG 25M	1.50	RG 25U	.70	.041	47	15.2	75	389			1.5	
RG 35M	1.50	RG 35U	.70	.083	87	25.4	128	550			2.5	
RG 50M	1.60	RG 50U	.80	.169	114	21.6	185	785			3.5	
RG 75M	1.65	RG 75U	.85	.377	163	19.8	266	1170			4.4	
RG 100M	1.70	RG 100U	.90	.666	217	19.9	358	1550			6.2	
									1000	2000	5000	10000
RG 150M	1.75	RG 150U	.95	1.503	281	14.8	512	2320	69.8	23.8	7.1	
RG 200M	1.80	RG 200U	1.00	2.68	374	14.7	690	3110		50.6	12.5	
RG 250M	1.90	RG 250U	1.10	4.20	424	12.1	860	3880		87.5	19.9	
RG 300M	2.00	RG 300U	1.20	6.11	494	11.2	1030	4680		141	29.3	13.8
RG 400M	2.10	RG 400U	1.30	11.04	618	9.7	1380	6300			54.6	22.3
RG 500M	2.30	RG 500U	1.50	17.50	747	9.0	1730	7900			93.1	34.9
									2000	5000	10000	20000
RG 600M	2.40	RG 600U	1.60	29.2	1024	10.1	2260	10250		111	43.8	
RG 750M	2.65	RG 750U	1.85	39.0	1249	11.3	2660	11850			64	
RG1000M	3.40	RG1000U	2.50	71.6	1620	10.3	3570	16000			123	
RG1250M	3.80	RG1250U	2.90	108.0	1930	9.7	4380	19700				
RG1500M	4.40	RG1500U	3.50	159.8	2300	9.3	5300	23800				

These tests have been made by Robert F. Field of Cruft High Tension Electrical Laboratory, Harvard University, Cambridge, Mass.

REMLER RADIO MANUFACTURING COMPANY

Factory and Home Office 248 First Street, San Francisco, Cal.

Eastern Sales Office, Chicago, Ill.

"WRIGHT" IS RIGHT IN RADIO



The Sign of Standardized Radio Equipment

The H. Earle Wright Company again forges ahead in its mission of Radio Standardization. The Universal Rheostat and the Standard Socket Adapter are added to the line of Wright Radio Products. They were designed to conform with the standard of efficiency by one of the leading Radio engineers of America.

Two New Standardized Radio Necessities



Standard Socket Adapters
Price at your dealers anywhere \$1.

WRP Standard Socket Adapter

To be used with either C-299 or UV-199 Tubes

This standard socket adapter is necessary to adapt the new C-299 or UV-199 tubes to the standard tube socket.

It is scientifically designed with the following advantages:

Lowest internal capacity: Contact springs do not overlap and are sufficiently separated to reduce capacity to the minimum.

The best phosphor bronze obtainable is used in the contact springs to make them sturdy and keep their elasticity.

No soldering used in the construction to become corroded and spoil your signals.

No nuts or screw connections used in the assembly of contacts to become loosened and give trouble. A special means is used to bind these elements securely and permanently.

It is designed accurately to fit both tube and socket snugly—no play to allow the tube to wobble; no prongs to become disengaged with contact springs.

Pure bakelite is used thruout for insulation, and contact springs are so located as to give the maximum leak resistance between tube elements.

Knurled and overlapping edge makes it convenient to remove the adapter from socket easily.

Has all the good points of other adapters, besides correcting their faulty points. In fact it is without a peer.

For better efficiency, economy of space, and more consistent results, use the new C-299 or UV-199 tubes, and be sure to adapt them with WRP Standard Socket Adapters.

WRP Universal Rheostat

The WRP Universal Rheostat is without doubt the Acme of standardization. The base is made of moulded bakelite, and is strong and durable. Small binding posts are provided for connections which also serve as a lock for the resistance elements. No trouble to change resistance elements—merely remove two thumb screws, take the old resistance off and replace the new one.

Not necessary to purchase a whole new rheostat when it is desired to use a new type tube, merely obtain a new element and exchange with the old one.

This saves you much expense and time.

The rheostat base comes complete, without resistance element or knob, ready to mount on your panel. The desired knob and resistance element can be purchased separately. The resistance elements come in 3, 10, 20, 30, 200, 300, 400 ohm values. This combination to select from will give you any combination for rheostat or potentiometer you may desire.

Another important feature of the WRP Universal Rheostat is its half round construction. This makes it possible to mount the sub-panel directly under or above the rheostat and helps to form a support for the sub-panel; also it allows the use of a 180 degree dial or a knob and pointer with 180 degree etched brass scale.

It will pay you to change your old rheostats for a WRP Universal new and be standardized for all tubes.

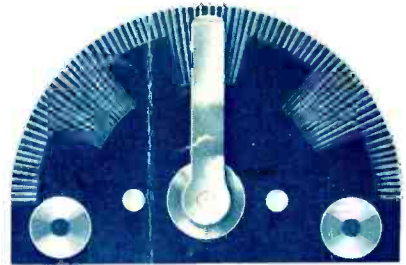

Universal Rheostat

Price at your dealers anywhere

WRP Universal Rheostat	\$0.75
WRP 3 ohm resistance element25
" 10 " " " " " " " " " " " "25
" 20 " " " " " " " " " " " "35
" 30 " " " " " " " " " " " "35
" 200 " " " " " " " " " " " "50
" 300 " " " " " " " " " " " "50
" 400 " " " " " " " " " " " "50

Radio Dealers all over the country are finding big demand for these Standardized units. Write today for our attractive sales proposition.

THE H. EARLE WRIGHT COMPANY

MANUFACTURERS and DISTRIBUTORS
"The Home of Radio Center"

914 South Flower Street
LOS ANGELES

131-133 Eighth Street
SAN FRANCISCO

IF IT'S FROM WRIGHT'S IT WILL FIT YOUR SET