

MAY 1923

25 CENTS

# RADIO



See Page 13—  
“The D. X. Bringer-In”

Page 16—

“Practical Hints for Radiophone Reception”

Page 25—

“Getting the Most Out of a Dry Cell Tube”





*Cunningham*

**the standard tube for all makes of receiving sets**

**Mutual Conductance**

**The Correct Rating for Vacuum Tubes**

Gas Engines are rated by their horsepower—Electric Generators are rated by their watt or kilowatt output—Mazda Lamps are rated by their candle-power. All of these factors actually express the efficiency of the article for the purpose intended.

In the past vacuum tubes have been known merely as Detectors and Amplifiers. These terms indicated only the use for which the tube was designed, but in no way expressed its efficiency for either of these purposes. Though little known to the general public, there is a factor—**MUTUAL CONDUCTANCE**—which adequately and accurately expresses the efficiency of vacuum tubes. The new Cunningham C-301-A has the *highest value of mutual conductance ever obtained in a receiving tube*, and it is this factor that is responsible for its *superior operation* as an Amplifier.

Write for Bulletin 1-R explaining the uses and advantages of the term Mutual Conductance as the correct rating for Vacuum Tubes

**Cunningham C-301 A Improved Amplifier Now \$6.50**

Filament Current  $\frac{1}{4}$  Amp. Mutual Conductance—600 micromhos at 100 volts plate and 6 volts neg. grid potential

For the assistance of the public, in obtaining true musical quality and actual reproduction in broadcast reception, this company will, from time to time, issue Service Bulletins explaining in a clear and simple manner the most important technical features that must be observed in the selection and operation of radio apparatus.

Cunningham Service Bulletin No. 1 explains the use of the fact of mutual conductance as the standard rating for vacuum tubes. The information it contains should be thoroughly known to every owner of a radio set who is interested in obtaining maximum efficiency with a given number of vacuum tubes. This bulletin will be mailed to you, free of charge, upon request.



The trade mark GE is the guarantee of these quality tubes. Each tube is built to most rigid specifications.

**Patent Notice:** Cunningham tubes are covered by patents dated 11-7-05, 1-15-07, 2-18-08, and others issued and pending. Licensed for amateur, experimental and entertainment use in radio communication. Any other use will be an infringement.

*E. J. Cunningham*

Home Office:  
248 First Street  
San Francisco, Calif.

Eastern Representative:  
154 West Lake Street  
Chicago, Illinois



*The New*  
**Burgess Radio Atlas**  
**Of the World**

Through the air comes a signal! Who's calling? Where is he located? Can you mentally put your finger on the spot? The new Burgess Radio Atlas lists every broadcasting station in the world and contains three big double page maps, 14x20 inches in size, showing—(1) The United States (2) Canada. (3) The World.

**10c Brings It**

Send us ten cents and your dealer's name and we will send you this big 16-page atlas containing the three big maps showing by red dots the location of all towns with broadcasting stations. Contains two lists of all stations, alphabetically and by towns, together with wave length and names of owners. Maps show time divisions and radio districts. All new coun-

tries correctly shown and named. Single page map shows U. S. Army and Navy Stations, also Relay System of Radio Stations. Many other descriptive facts and data too numerous to mention.

Every radio operator needs one of these Burgess complete Atlases. First edition is limited. Send your order today and don't fail to mention your dealer's name.

**BURGESS BATTERY COMPANY**

Dept. 63

Madison, Wis.

In Canada: BURGESS BATTERIES, Ltd.  
 Winnipeg, Toronto, Montreal

**"ASK ANY RADIO ENGINEER"**

**BURGESS**  
**RADIO BATTERIES**

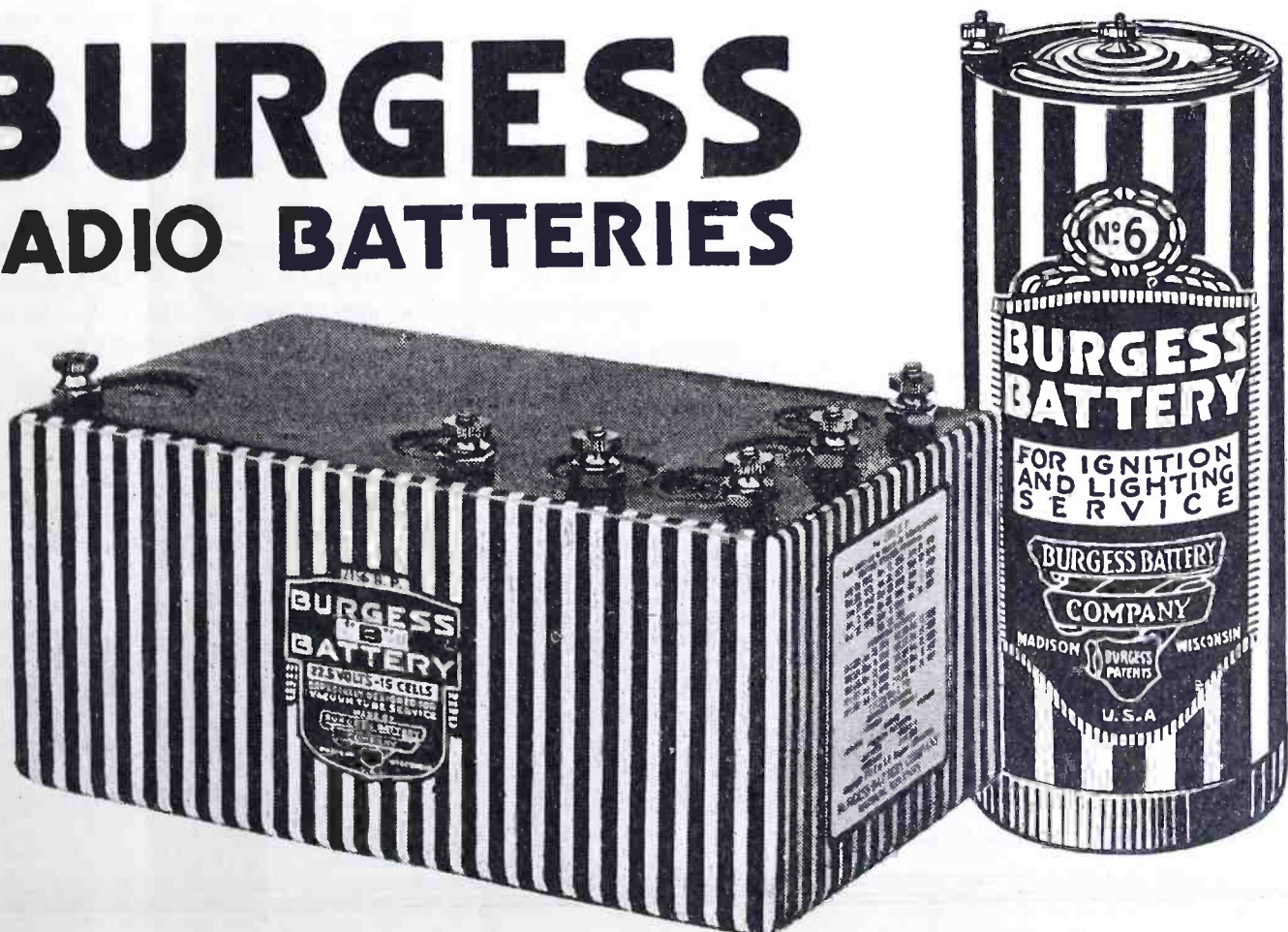

Tell them that you saw it in RADIO



# RADIO

Established 1917 as Pacific Radio News

Volume V

for MAY, 1923

Number 5

## CONTENTS for MAY, 1923

Radiatorial Comment .....	9
Experience With A 50-Watt A. C. Radiophone.....	10
<i>By R. C. DENNY</i>	
The D. X. Bringer-In.....	13
<i>By STUART A. HENDRICK</i>	
Practical Hints for Radiophone Reception.....	16
<i>By ELLERY W. STONE</i>	
Radio Transmission Circuits.....	17
<i>By SAMUEL G. MCMEEN</i>	
The Use of Choke Coils In Radio.....	19
<i>By A. MACHSON</i>	
Memorizing the Continental Code.....	20
<i>By N. A. ROLLAH</i>	
Sparks Springs His New Wave Trap.....	21
<i>By S. P. WRIGHT</i>	
Hamplicatus Horribulus .....	22
<i>By H. A. HIGHSTONE</i>	
The Radio Mystery of Mt. Diablo.....	23
<i>By PAUL OARD</i>	
Needed Radio Inventions.....	24
<i>By RAYMOND F. YATES</i>	
Getting the Most Out Of A Dry Cell Tube.....	25
<i>By ARTHUR GORDON</i>	
Reflex Circuits .....	27
<i>By ARTHUR HOBART</i>	
Radio—A Liberal Education.....	28
<i>By E. F. W. ALEXANDERSON</i>	
Modulation Systems In Radio Telephoning.....	29
<i>By L. R. FELDER</i>	
"Blooping!" .....	30
<i>By EARL ENNIS</i>	
A Mechanical Rectifier for C. W. Transmitters.....	31
<i>By J. W. KIDD</i>	
A "Different" Circuit.....	32
<i>By BERT HORTON</i>	
A New Message Blank Holder.....	32
<i>By C. A. REBERGER</i>	
Report of Washington Radio Conference.....	33
Letters to the Editor.....	34
News of the Broadcasters.....	35
Digest of Recent Radio Patents.....	36
Queries and Replies on C. W. Practice.....	37
<i>By GERALD M. BEST</i>	
With the Amateur Operators.....	39
Calls Heard .....	41
New Apparatus and Supplies.....	42

RADIO is Published Monthly by the Pacific Radio Publishing Co., Inc.,  
Pacific Building, San Francisco, Calif.

ARTHUR H. HALLORAN	Editor
LAWRENCE MOTT	Associate Editor
LOUIS TREVISIO	Art Editor
GERALD M. BEST	Technical Adviser
O. SCHUWENDT	Engineering Draughtsman
H. W. DICKOW	Advertising Manager

Branch Offices: 17 West 42nd St., New York City, Telephone Longacre 8248; 157E. Ontario St., Chicago; 761 Spitzer Bldg., Toledo, Ohio; 52 Irving Street, Boston, Telephone Copley 5107-R; 1102 Republic Bldg., Kansas City, Mo.; Suite 511, 456 So. Spring St., Los Angeles, Cal., Telephone 12050; 2218 Third W., Seattle, Wash., Telephone Elliot 1903.

European Representatives: Compagnie Universelle De Representation wt de Commerce. Rue des Fortifications, 69, Anvers, Belgium.

Advertising Forms Close on the First of the Month Preceding Date of Issue.

Issued Monthly, 25c a copy. Subscription price \$2.50 per year in the U. S., \$3.00 per year elsewhere. Instructions for change of address should be sent to the publisher two weeks before the date they are to go into effect. Both old and new addresses must always be given.

Entered as second-class matter at the Post Office at San Francisco, Calif., under the Act of March 3, 1879.

Copyright 1923, by the Pacific Radio Publishing Co., Inc.

## Forecast of Contributions for June Issue

Joseph W. Geoff, 4 PG, discusses audio frequency and double regeneration, giving several tried and true hookups.

✽

Carle Dreher, in the course of an answer as to what the broadcast fans want, gives some excellent suggestions for aerial installations on apartment houses.

✽

Those considering the construction of a transmitting set may well wait for Jerome Snyder's article on "C. W. and Radiophone Transmitters for Beginners."

✽

Because of his ability to present technical matters in understandable form our readers will be interested in Jesse Marsten's complete resumé of "The Properties of Radio Condensers."

✽

Raymond F. Yates presents some good advice on "How To Buy Radio Apparatus," wherein he points out some of the defects to be avoided.

✽

The transmitting amateur will also be interested in an article on a cheap but efficient ICW transmitter constructed by Everett H. Gibbs, 1AAC.

✽

A timely article by Paul McGinnis gives some valuable hints about equipping a pleasure boat with radio. Seasonable, likewise, are S. P. Wright's humorous account of a radio vacation wherein radio in the rural regions receiveth recognition.

✽

From the wealth of his experience Lieutenant Jennings B. Dow contributes the results of some Navy tests on "Litz."

✽

The fiction feature will be another sea story by Major Lawrence Mott, "A Very Useful Receiver." Of course there is lots of radio in it.

✽

From a descriptive standpoint C. A. Reberger writes about some new and interesting stations in the Philippine Islands, illustrating his remarks with some good pictures.

✽

Samuel G. McMeen, whose radio articles are helping many of our readers, is one of the big telephone engineers of the country. His article on "Radio's Gift To the Wire Lines" tells of the applications of the vacuum tube to the improvement of telephone transmission.

✽

To make room for some last minute developments two articles which were promised for May were omitted and will appear in the June issue. That by Florian J. Fox gives detailed directions for the construction of a regenerative single-circuit tuner with three stages of amplification. Also 6 Zee Jay's article on the construction of a portable receiver without aerial will appear then.





“The wise man,” said Confucius,  
 “does not esteem a person  
 more highly, because of what  
 he says. —”

The wise radioist is not  
 misled by extravagant claims,  
 he knows that only a

**Grebe Receiver**  
 can come up to his  
 expectations.

*Doctor Mu.*

**A. H. GREBE & CO., Inc.**  
 Richmond Hill, N. Y.

Western Branch  
 451 East 3rd Street, Los Angeles, Cal.

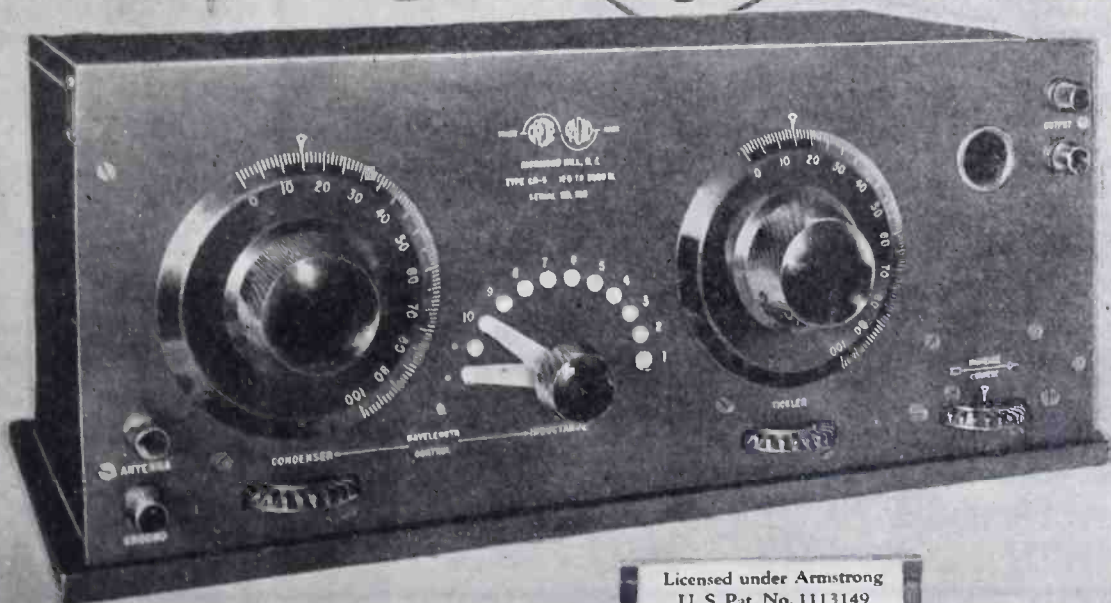

Write for  
 “Musings of  
 Dr. Mu.”

Licensed under Armstrong  
 U. S. Pat. No. 1113149



# TUNE-IN ON THE NATIONAL

WAVE LENGTH AND SAVE MONEY ON YOUR PURCHASES

Lowest Prices on Standard Radio Goods in the U. S. A.

**FREE** A HYDROMETER (Battery Tester) with **FREE**  
each purchase of \$1.00 or over

HAVE YOU ENTERED OUR ADVERTISING PRIZE CONTEST?

## FIRST PRIZE

\$250.00 Radio Set Free—Six Tube Radio-Audio Frequency Set

## SECOND PRIZE

\$150.00 Radio Set Free—Four Tube Set, Detector and 3 stages Amplification

## THIRD PRIZE

\$100.00 Radio Set Free—Three Tube Set, Detector and 2 stages Amplification

To advertise our business we will give the above prizes to the three persons sending us a list of five or more names of Radio fans and who compose the best slogan or phrase of words we can use for our advertising matter. We are interested in sending our catalogue and price lists to Radio fans.

If you are interested in Radio and in its future possibilities don't overlook this opportunity to get acquainted with us, secure low prices on your purchases and an opportunity to win one of the above prizes free of charge.

In the event of two or more persons submitting the slogan judged the best, second best, or third best, each will receive the full amount of the prize tied for. All entries must be received by us not later than March 31, 1923.

## Our Peanut Tube Does the Work of WD-11

For Detector and Amplifying uses. Can be used on 1½ volt dry cells or regular 6 volt A Batteries. Fits standard V.T. socket. Uses about 1/10 ampere, on two 1½ volt dry batteries. Price of tube, \$2.50, includes adapter.

1½ VOLT TUBE (not WD-11, but for same use). For detector and amplifying uses. Used on 2 Dry Cell batteries (1½ volt).....\$5.00

## THIS WEEK'S SPECIALS

1,000 HEADSETS, \$6.00 Value .....\$2.99 each

Biggest Radio Bargain Ever Offered—Order Promptly

200 CRYSTAL SETS, \$12.50 Value .....\$6.50 each

Includes Receiving Set and All Antenna Equipment (no phones)

### VACUUM TUBES

U. S. Navy (Plotron) used as a detector, amplifier and transmitting tube, all in one, type V. T. 14.....	List \$8.00, now \$4.00
U. V. 200 Detector.....	4.25
U. V. 201 Amplifier.....	5.25
U. V. 201-A Amplifier.....	8.50
WD-11 1½ Volt.....	6.50
Cunningham Detector.....	4.25
Cunningham Amplifier.....	5.25
Myers Audion High-Mu.....	4.50

Vacuum Tubes Repaired. Broken and burned out tubes repaired. Mail them parcel post insured. Price, \$2.75 each, cash with your order. Tubes returned by Parcel Post, prepaid. We guarantee them to burn equal to new tubes.

BUS BAR WIRE—6 two-foot lengths .....\$0.25

DX TRANSFORMERS, \$9.00 Value, Special ..... 6.50

### HEADSETS

2200 Ohm, equals best \$8.00 phones on market, now..	\$4.50
Brandes—2000 Ohm.....	5.50

### VERNIER CONDENSERS

11 Plate.....	List \$4.00, now \$3.00
23 Plate.....	" 5.00, " 4.00
43 Plate.....	" 6.50, " 5.00
Freshman Grid Leak and Condenser for Flewelling Circuit.....	" 1.00, " .75

### TRANSFORMERS

Thordasen.....	List \$4.50, now \$3.00
Atwater Kent.....	" 5.00, " 3.75
Acme.....	" 5.00, " 3.75
WD-11.....	" 5.00, " 3.75

Dictograph.....	\$5.80
Federal.....	5.30

**HOW TO ORDER** All goods forwarded by Parcel Post. Send Money Order with order, and include the following rates with same for postage:

On Purchases \$1.00 to \$5.00, 6 Cents Postage  
On Purchases \$5.00 to \$10.00, 15 Cents Postage

On Purchases \$10.00 to \$20.00, 20 Cents Postage  
On Purchases \$25.00 to \$50.00, 35 Cents Postage

Space being limited, we are obliged to omit other money-saving items. Write for quotations or ask for our latest Price Sheet Catalogue.

## National Radio Products Corporation

Mail Order Dept.,

509 FIFTH AVENUE

NEW YORK





# Federal

## Is A Large User of Formica

THE Federal Telephone and Telegraph Company of Buffalo is a large factor in the radio industry and has an excellent reputation for the quality of its product.

It is a very extensive user of Formica insulation not only in the complete sets which it produces but in the radio parts, variometers, variocouplers, head sets of which it is a large manufacturer.

A list of users of Formica reads like a directory of the leading independent radio manufacturers. So many of the best informed radio men in America cannot be mistaken in their opinion that Formica is most uniform, the best looking, and the most efficient radio insulation.

Dealers and amateurs can safely follow these great concerns in selling or using Formica.

## The Formica Insulation Company

4616 Spring Grove Ave.  
Cincinnati, O.

### Sales Offices:

50 Church St., New York, N. Y.  
422 First Ave., Pittsburgh, Pa.  
1042 Granite Bldg., Rochester, N.Y.  
415 Ohio Bldg., Toledo, Ohio

1210 Arch St., Philadelphia, Pa.  
1819 Lyndale Ave., S. Minneapolis,  
Minn.  
Sheldon Bldg., San Francisco, Calif.  
Whitney Central Bldg., New Orleans

414 Finance Bldg., Cleveland, O.  
9 S. Clinton St., Chicago, Ill.  
313 Title Bldg., Baltimore, Md.  
47 King St., Toronto, Ontario.

# FORMICA

Made from Anhydrous Redmanol Resins  
SHEETS TUBES RODS

Tell them that you saw it in RADIO





## One of these panels fits *your* set

**Y**ESTERDAY you would have had to wait while the size was cut from sheet stock.

Today you can get the panel you need immediately. Celoron Radio Panels come in standard sizes, one of which will be right for any set you may build.

The days of waiting for your panel to be cut are gone. Each Celoron panel is already cut and wrapped ready for you to take home and begin working at once. Full instructions for working and finishing are on the glassine paper around every panel.

The sizes have been selected only after careful study of present day needs of set-builders. Your dealer should be able to supply you with any of the following sizes:

- |                           |                             |
|---------------------------|-----------------------------|
| 1.—6 x 7 x $\frac{1}{8}$  | 4.—7 x 18 x $\frac{3}{16}$  |
| 2.—7 x 9 x $\frac{1}{8}$  | 5.—9 x 14 x $\frac{3}{16}$  |
| 3.—7 x 12 x $\frac{1}{8}$ | 6.—7 x 21 x $\frac{3}{16}$  |
|                           | 7.—12 x 14 x $\frac{3}{16}$ |

Also comes in sheets and can be cut in special sizes when desired.

Condensite Celoron, the material used for these panels, has high insulating qualities, high dielectric strength, and low dielectric losses. It is a laminated phenolic condensation product used by many of the leading manufacturers of radio equipment. It is easily machined and can be sawed, drilled, turned, or milled.

### Send for free booklet

We have prepared an attractive booklet, "Tuning in on a New World," which tells more about Celoron and gives lists of leading broadcasting stations in the United States and Canada, symbols used in reading radio diagrams, and several highly efficient radio hook-ups. This booklet will be of use to every radio fan and will be sent to you free of charge upon your request. Write today.

## Diamond State Fibre Company

BRIDGEPORT (near Philadelphia) PENNSYLVANIA

BRANCH FACTORIES AND WAREHOUSES

BOSTON CHICAGO SAN FRANCISCO

Offices in Principal Cities

In Canada: Diamond State Fibre Company of Canada, Limited, 245 Carlaw Avenue, Toronto

**To radio dealers:**

Celoron Radio Panels cut in standard sizes offer an exceptional opportunity for quick sales and substantial profit. Write for special dealer price list showing standard assortments.

# CONDENSITE CELORON STANDARD RADIO PANEL

Tell them that you saw it in RADIO



# SPANNING THE CONTINENT

with

# Victory Grantone

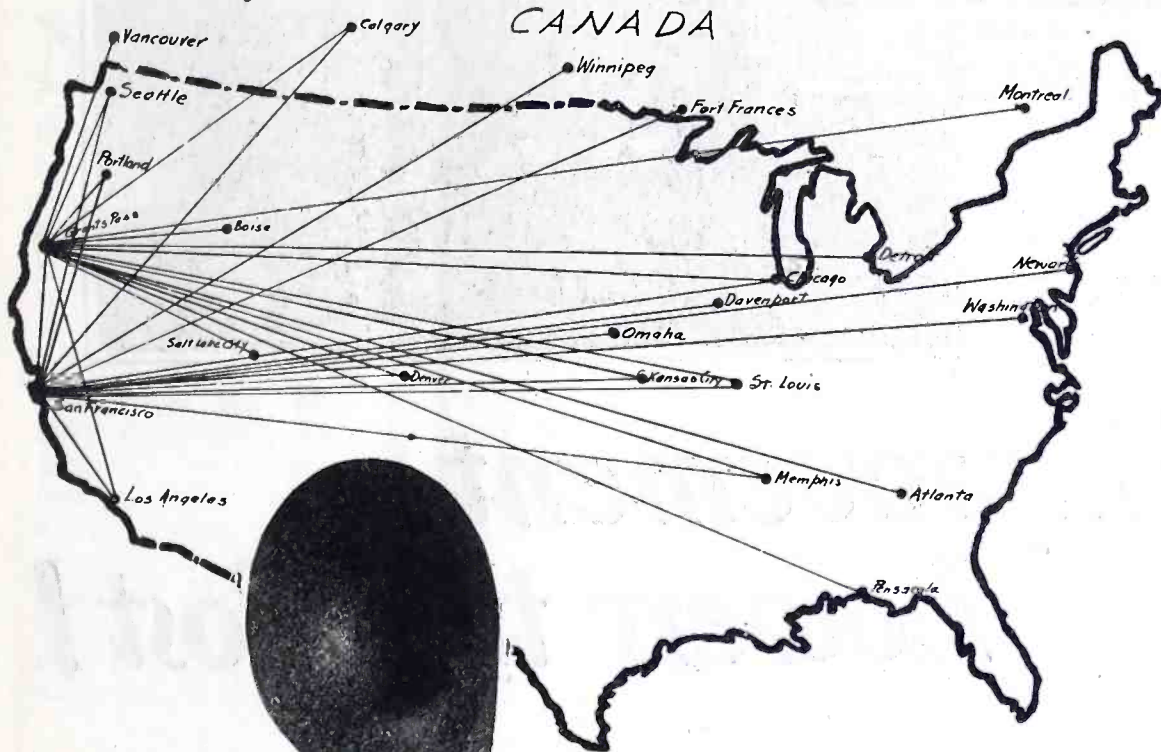

One of the Many Unsolicited Testimonials That Have Been Received from Enthusiastic Owners of "Victory Grantone" Receiving Sets.

Grants Pass, Oregon, February 18, 1923.

Victory Radio-Electric Company, 559-561 Howard Street, San Francisco, California.

Gentlemen: On January 29, 1923, we installed one of your No. 550 Victory-Grantone Loud Speaking Radio Sets and have had wonderful results in getting distant stations as clear as local and Coast stations. We have kept a record of all stations received and have written them thanking them for their entertainment. I will put down the stations we received, by which you can see we are actually getting excellent results: KFDB, KPO, KDN, KFBK, KFI, KHJ, KGC, KJS, KMJ, KJX, KVL from California; WOC—Davenport, Iowa; KGG, KGN, KGW, KZAY from Oregon; KFAN from Idaho; KZN, KDYL from Utah; KAO, KLZ from Colorado; Electric City, Montana (did not catch his call); WSB—Atlanta, Ga.; WPO—Memphis, Tenn.; WWJ—Detroit, Mich.; Kansas City Star—Kansas City, Mo.; KSD—St. Louis, Mo.; WOC—Rock Island, Ill.; KYW—Chicago, Ill.; WGAN—Pensacola, Fla.; a station in South Carolina; and one in New York; KMC, KLV, KGY, KNT of Washington; CFCN, CFAC of Calgary; CFCF—Montreal, Canada; and Vancouver, B. C.

Yours, very truly,  
(Signed) K. M. LADEWIG,  
R. No. 3, Box 74, Grants Pass, Oregon.

## PORTABILITY

An outstanding feature of Victory-Grantone No. 550 Radio Receiving Set. Makes an ideal outfit to take along on trips, motoring and vacations. Even when visiting or going to parties or entertainments, this set can be conveniently carried and always depended upon.

For short distance reception a piece of insulated wire placed on the floor or a light socket aerial will serve to give excellent results.

Complete weight only twenty-two pounds.

Victory Grantone

RADIO RECEIVER No. 550

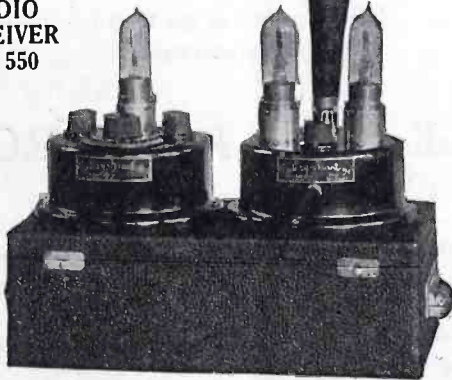

This is truly the most compact, neatest and totally self-contained loud speaking radio receiver yet developed. Embodies everything necessary for its operation. No unsightly loose batteries, wires, parts, etc., but everything is in a complete unit which may be readily carried from place to place and ready for instant operation.

The detector and tuning unit is simple, sharp, very selective and extremely sensitive. It is encased in a housing which shields it from all body capacity and other external influences, thereby giving maximum receiving efficiency.

The Amplifying Loud Speaker contains besides two stages of audio frequency amplification a super-sensitive loud speaking element with heavy mica diaphragm adjusted to give a true natural tone, which can be controlled from a soft audible sound to a mighty volume. A Victory Selector Jack with automatic filament control gives one or two stages of amplification.

Operates only on two dry cells without storage battery.  
Price without Tubes and Batteries ..... \$65.00  
Price complete with three 1½ Volt Tubes, two V B Batteries and two dry cells ..... \$95.00



Victory Grantone

AMPLIFIER and LOUD SPEAKER

This unit has no equal in the entire radio industry.

Enables everybody now to fully enjoy radio entertainment without nuisance of taking turns with head receivers. Operates with equally remarkable efficiency from the simplest kind of crystal set to the most elaborate vacuum tube detector.

Contains besides two stages of audio frequency amplification a super-sensitive loud speaking element with heavy mica diaphragm adjusted to give a true natural mellow tone, which can be controlled from a soft, audible sound to a mighty volume.

Horn is of durable wood fibre composition designed on best acoustic principles.

A Victory Selector Jack with automatic filament control gives one or two stages of amplification.

No. 525 operates with two dry cells, using 1½ V. tubes.

No. 535 operates with storage battery, using standard 6 V. tubes.

Price of either unit \$37.50 without tubes

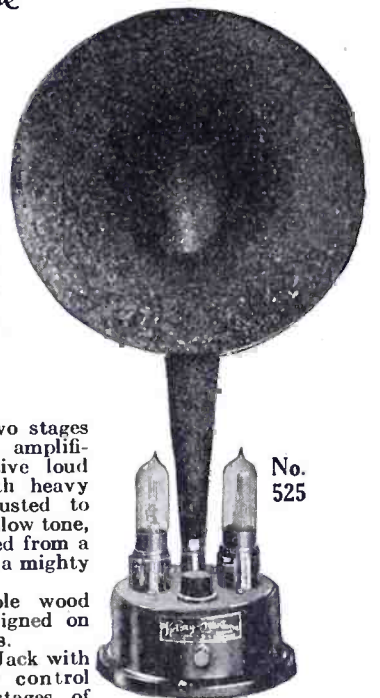

FREE

Mail this coupon today and we will send you our latest catalog of VICTORY GRANTONE APPARATUS.

Name.....  
Address.....

DEALERS: Write for our trade proposition  
**VICTORY RADIO-ELECTRO CO.**  
559-561 HOWARD ST. SAN FRANCISCO



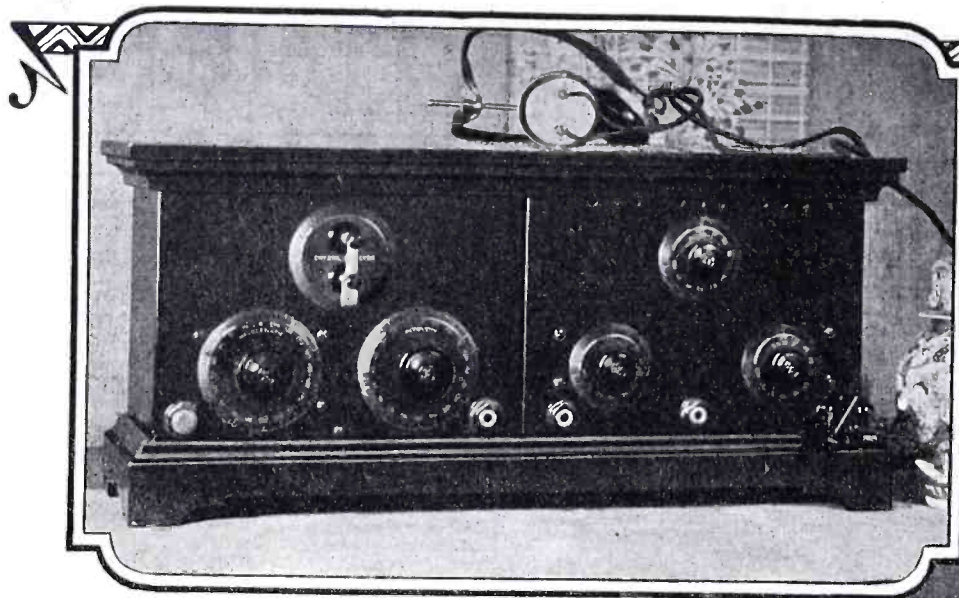

## Radiola V

Radiola V is built for a life time—solidly—ruggedly. In principle and performance, it is the same as Radiola RC—detector with two stages of audio amplification. With the same long distance reach. And the same keen sensitiveness. A pleasing and unobtrusive piece of furniture in its neatly finished casing. Dependable always—and simple enough for anyone to operate.

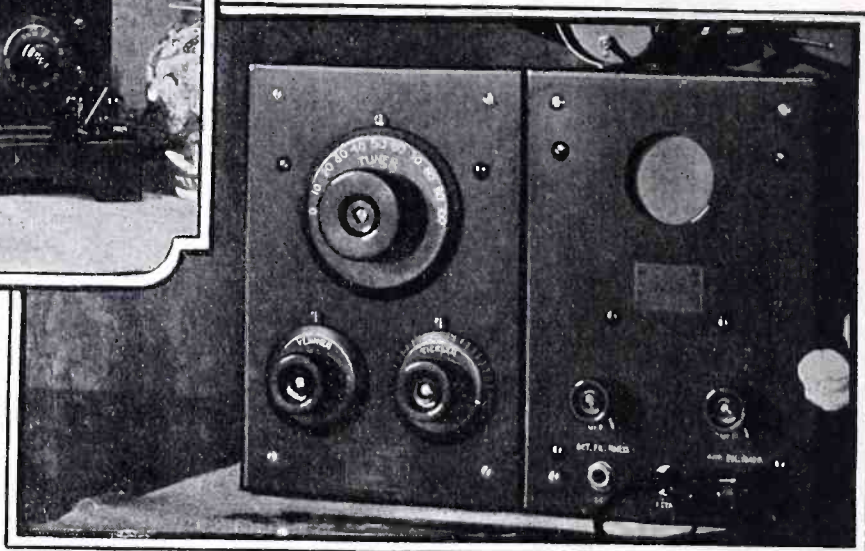

## Radiola RC

Radiola RC is one of the nation's most popular long distance receivers. Compact—efficient—with a sensitive detector, and two stages of amplification, for louder, clearer reception of distance. Finely made—and attractively finished—of solid mahogany.

# A New Improvement Lowers the Cost!

## Dry Cells Replace Storage Batteries

A new vacuum tube has made it possible. Radiola V and Radiola RC have been topping them all in popularity for dependability and long range—receiving over thrilling distances—up to 1,500 miles and more. Now both are converted to dry battery operation. This means greatly lowered cost—does away with bulky storage batteries—gives the far-away farmer the same good service it gives the city man.

No more need for expensive storage battery and charger. A big saving! And a saving made greater by the new offer—a combination offer of receiver and accessories—complete at a price remarkably low.

*"There's a Radiola for every purse"*

at the nearest Radio or Electrical Store

# Radiola

REG. U.S. PAT. OFF.

## Radio Corporation of America

Sales Department  
233 Broadway  
New York

District Sales Offices  
10 So. LaSalle Street  
Chicago, Illinois

433 California Street  
San Francisco, California



This symbol of quality  
is your protection

## Radiola V or Radiola RC Complete \$142.50

*The New Way:* Complete for dry battery operation, including three WD-12 Radiotron vacuum tubes; head telephones; "A" battery consisting of three dry cells; "B" battery consisting of three 22½ volt units. \$142.50.

*The Old Way:* The price of Radiola V or Radiola RC when equipped for storage battery operation, formerly came to \$207.50.

### Send for this Free Booklet

If you can't have a \$350 Radiola—want something bigger than a \$25 Radiola—write for the booklet. Plenty of in-between sets. The booklet tells all about 'em.

RADIO CORPORATION OF AMERICA  
Dept. 2069 233 Broadway, New York  
Please send me your free Radio Booklet.

Name \_\_\_\_\_

Street Address \_\_\_\_\_

City \_\_\_\_\_

R. F. D. \_\_\_\_\_

State \_\_\_\_\_



## Radiotorial Comment

**N**OTWITHSTANDING repeated statements from Washington that advertising via radio is not approved, there is considerable current comment as to the possibility of using the educational power of broadcasting to direct the buying habits of the people. To prostitute the wonderful powers of this new agency to such base ends is to kill it. Just as the high class moving picture houses have been forced by public opinion to discontinue the use of advertising slides, so would any big broadcasting station be obliged to discontinue any attempt to use radio for direct advertising. The people would not listen.

As it is, they chafe under the indirect advertising incidental to announcing the name of the station or the performers. To try to interlard musical programs with announcements of sales will cause the listener to shut off his set. The nuisance of interpolating advertising slides between the parts of a movie displayed in waiting rooms would be magnified tenfold if some clever ad writer could induce a baritone to sing "Twas three o'clock in the morning as I slept on my rest-easy mattress" or "On the road to Mandalay use Blinkem's glareless light."

**T**HROUGH the recommendations of the Second Radio Conference Secretary Hoover can cut the Gordian Knot and silence the babel in the air incident to interference between broadcasting stations and between broadcasting stations and amateurs. In the absence of any direct legislation by the last Congress there is nothing to prevent the enforcement of these recommendations which are the result of agreement among the several interests involved.

Examination of the wave allocations, as printed elsewhere in this issue, shows that the amateur has been given the band between 150 and 222 meters, spark stations being confined between 176 and 200 meters. Class B broadcasters, the present Class A stations of low power, are assigned the band from 222 to 286 meters, and Class A, the new designation of 500 watt or larger stations, are allocated the band from 288 to 545 meters. Provision is made for fifty of the latter stations, each to be assigned a wavelength which will not interfere with nearby stations.

It will be some weeks before this new allocations can take effect, as they must first be approved by Secretary Hoover. Taken all in all they offer a sensible solution of present troubles. It is devoutly to be hoped that they may soon.

**R**ADIO, like other sports, has a hazard. This danger comes not from radio itself but from nearby electric power lines with which an antenna may come in accidental contact. Twelve fatal accidents have recently been reported to the accident prevention committee of the National Electric Light Association.

These accidents have been caused by direct or indirect contact with electric light and power wires while the victims were installing their aerials. They are due to ignorance of

the danger involved. They may be obviated by a few simple precautions.

First, never attach an aerial to a pole or tower to which other wires, except guys, are attached. They may be in contact with high voltage wires accidental contact with which might cause fires or even death. Secondly, never string an aerial over or under any other wires. Thirdly, always attach the aerial to a substantial support so located that if either the support or aerial breaks it cannot come in contact with other wires. And last, but not least, do not use kite aerials in any place when there is a possibility of contact with a power wire.

While on the subject of "dents" it is well to warn the amateur not to climb insecure supports while erecting aerials. Many boys have had serious falls from not observing ordinary care in this respect.

**W**ITH so many taxes to be paid we'd hesitate suggesting another were it not for the fact that it is so sadly needed. The suggestion has come from so many sources that there is no question as to its justice and necessity. The idea is a special radio tax to be paid by the manufacturer of receiving sets and parts.

The need is twofold, first, to build up a fund to provide for more and better paid radio inspectors and, secondly, to make provision for the time when it will be necessary to pay for broadcast programs. While the appropriation for the work of the radio inspector comes from the Federal budget for the Department of Commerce, the duties have increased in direct ratio with the recent popularity of radio. As a consequence the present small force of inspectors is unable to do all that it is called upon to do. It therefore seems eminently proper that some additional form of revenue be provided.

The best argument as to the need for assisting the broadcast stations in their program is contained in the question: "How would you like it if your favorite broadcaster suddenly shut down for all time?" The present incentive of publicity warrants the continuance of some of the great stations maintained by newspapers. The sale of radio apparatus justifies others. A fine public spirit maintains others. But aside from this there is nothing to offset the heavy expense of running a station.

As one correspondent aptly writes, "radio is on much the same financial plane as a tentless circus or a theater without walls or roof." It would be as much to expect free moving pictures as free radio broadcasting.

An alternative means for raising the necessary revenue, a license on receiving sets, has been adopted in England. But in view of the difficulties incident to the compulsory use of such a license, the sales tax seems the simplest.

Such a tax would, of course, be passed on to the purchaser, the person who enjoys the broadcast entertainment. Those who do not own sets would be exempt, as is equitable, thus doing away with the injustice of a general tax.

But whatever the answer may be, the problem will soon be upon us. Now is the time to think out plans for its solution.



# Experience With a 50-Watt A. C. Radiophone

By R. C. Denny

*This excellent account of a commercial application of a radiophone for emergency communication contains much valuable information for the amateur. It includes a discussion of the comparative advantages of space and line radio. The author is operating engineer with the San Joaquin Light & Power Corporation.*

**C**OGNIZANT of the need for an emergency means of communication to carry on system dispatching when the telephone lines were disabled, the San Joaquin Light & Power Corporation of Fresno, California, in the fall of 1921 undertook the development of a practical radiophone. The chief requirement was consistent operation day or night over a maximum radius of 135 miles from the dispatcher's office at Fresno in a south-westerly direction. The distance requirements in other directions were approximately half as great, but as these shorter distances were over a mountainous country into deep canyons these requirements were quite severe.

The fact that transmission was desired in all directions from the operating center of the system rather eliminated the wired wireless or carrier current system with its limitations. Moreover the failure of communication is usually incidental or secondary to failures of the transmission lines, which would render the carrier system useless in case either telephone lines or transmission lines were

used for the purpose, and just at the time it was most needed.

Obviously then, to be practical under the most adverse conditions, emergency communication must be entirely separate and independent of the lines. Manifestly it is only adverse conditions constituting emergencies, that really justify any system of radio, as fully 95% of the time the line telephone system functions properly and is entirely adequate. Therefore, in view of the notorious inefficiency of radio transmission, it would seem the height of ineconomy to use any form of radio where the telephone would suffice, except, of course, for emergencies.

Particularly is this true in the case where radio is applied to systems where telephone lines already exist and where they are strung beneath the transmission lines. It is admittedly a fact that on new projects where long transmission lines are to be built, that the carrier current phone system may be used for routine work, over the transmission conductors in lieu of building separate telephone lines and a saving thus effected, providing the initial cost of the carrier current apparatus is kept down within reason. However, unless the transmission lines are provided in duplicate it is rather doubtful if the carrier system would suffice in the case of line failures where one or several spans were down, tangled up and grounded.

Thus it is very dubious whether the

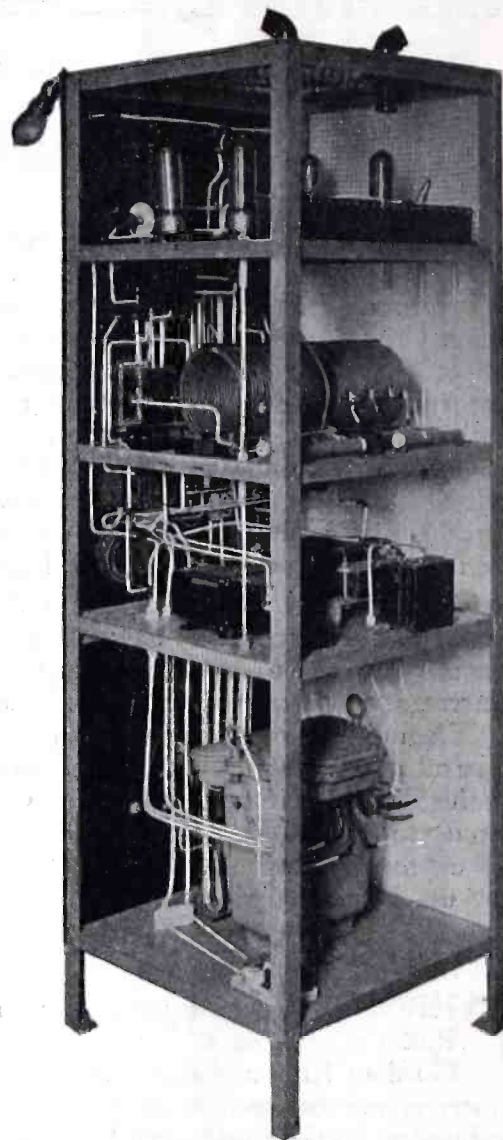

*Rear and interior view of 50-watt a. c. operated radiophone. On top are power tubes and rectifiers; on next shelf are oscillatory circuits and apparatus; on third shelf is filter and choke system; at bottom is power supply.*

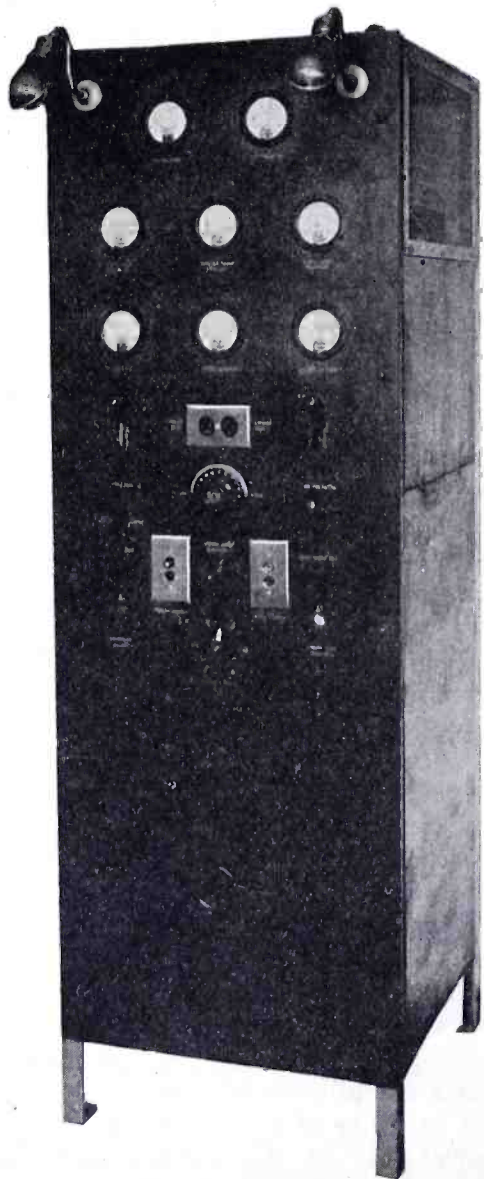

*Front view of 50-watt Radiophone*

*Distance Records, to date 2-23-23 of the San Joaquin Lt & Pr. Corp's Radiophone*

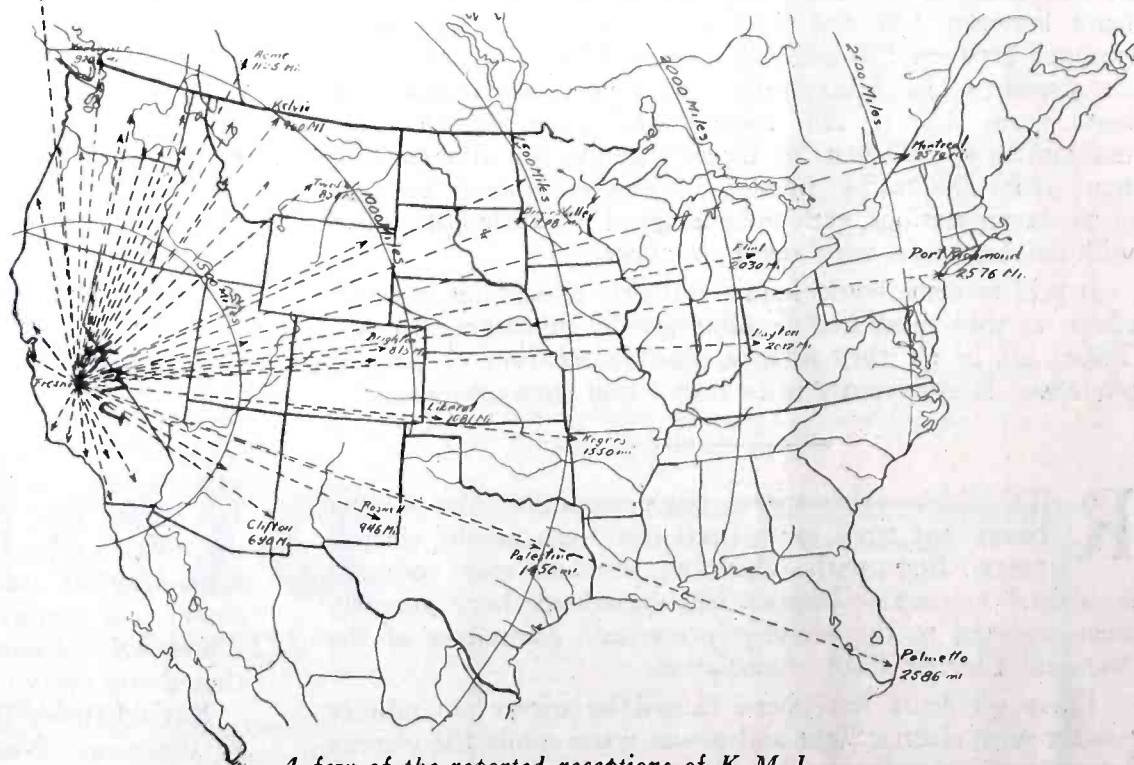

*A few of the reported receptions of K M J*



carrier current system will be of any great value in emergencies. At any rate it rather becomes apparent that each of the two systems of communication has its own field; the radiophone, where an extensive interconnected transmission network of one, two or three voltages is to be talked over in any or all directions, and the carrier current scheme for talking over especially long and important transmission lines where communication is desired only at the terminals thereof. In fact, several companies are adapting the carrier current system to certain more important stretches of their transmission system because of the Government radio regulations, which are rather inclined to handicap the use of the radiophone, even for emergency operation. Whether it will prove entirely successful with them in emergencies is yet to be demonstrated.

Another requirement to be met in the development of a practical radiophone

for emergency use, was that it should not cost one whit more than was commensurable with successful and consistent operation. Another was that it should be simple in operation and adjustments and of low maintenance expense. With these and the distance requirements in mind the writer set about the development of such a radio telephone set. At that time, and with only the experiences of two other radio telephone installations to be judged from it was decided that a set of 50 watts output rating, if that output be properly modulated, would meet the distance requirements. Advice from several of the large manufacturers that at least 250 watts would be required, and that 1000 watts was recommended, did not affect the original decision.

From the outset it was decided to eliminate the one item of greatest expense formerly used in such sets, that being the

motor generator set for the production of high voltage direct current. Experiments with an electrolytic rectifier proved conclusively that alternating current could be used, if the resultant pulsating direct current should be sufficiently filtered or smoothed out to minimize if not eliminate the fundamental hum. It was soon demonstrated though, that the chemical device for rectification was inadequate for constant use on currents even as low as 300 milliamperes at 1000 volts due to overheating. Besides being very inefficient it was cumbersome and mussy which rather precluded its use in a compact and finished set. Having served the very useful purpose of demonstrating the possibilities of rectified a. c. it was discarded in favor of vacuum tube rectifiers.

It was also very desirable to use alternating current for heating the filaments of the various vacuum tubes to be used in the set. Besides being more economical than using storage batteries and much simpler than low voltage generators, it actually results in a longer filament life, as the emission is more even from all parts of the filament. In actual service it was found very feasible to use a. c. for this purpose if certain precautions were taken, that is to bring out the center tap of the transformer winding for connection with the negative high voltage lead which forms the negative or common connection for the entire set. One microfarad telephone condensers should be bridged across from this center tap to each end of the winding, these to serve as a low impedance path or bypass for the high frequency currents from the oscillator tube. Ordinary potential transformers were rebuilt or remodeled for the purposes of filament heating and high voltage for the rectifier. But these too proved to be inadequate due to overheating when used continuously. However, they served their purpose, permitting the experimentation being carried on while properly designed apparatus of adequate capacity was being developed by radio manufacturers.

One thing that became apparent in the early stages of the experiments was that of the necessity for low antenna resistance. An aerial and ground system that had been perfectly satisfactory for the spark system of radio telegraphy, employing spark frequencies on the order of 1000 per second would not serve at all for the high frequencies of the radio phone carrier wave which was something over 833,000 cycles at the particular wave length at which the experiments were carried on. Accordingly a counter capacity antenna or counterpoise was designed having the same physical dimensions as the antenna and erected directly beneath the antenna and parallel to it at a distance of 40 feet, this being influenced by local conditions. Every precaution was taken to keep the ohmic re-

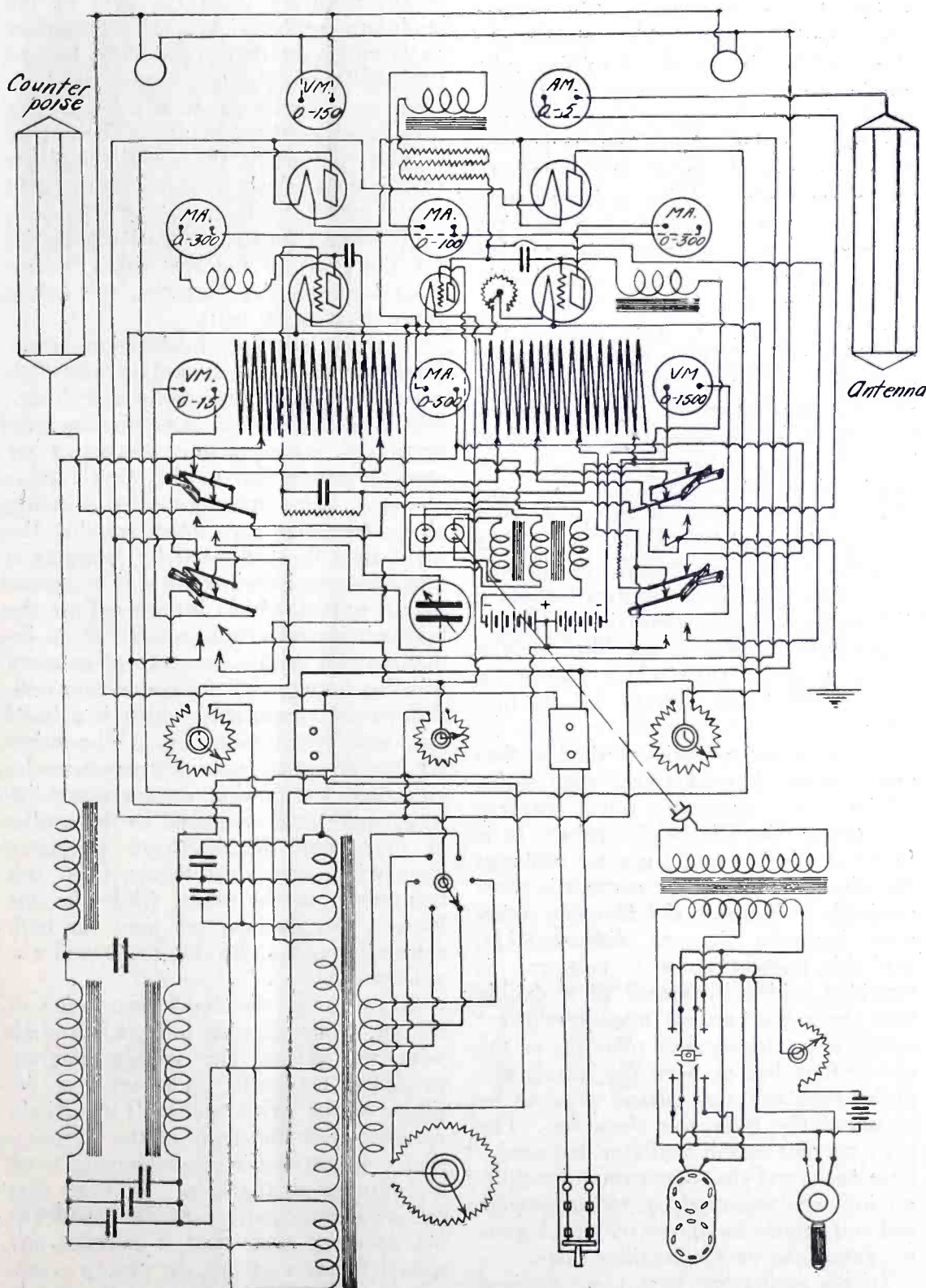

Wiring Diagram of 50-Watt A. C. Operated Radiophone



sistance as low as possible, stranded copper conductors being used, heavy leads employed and all joints soldered. A marked increase in radiation was the result, practically  $3\frac{1}{2}$  times the former current. It was found possible to further increase the radiation by connecting the ground lead to a certain point on the inductance coil, so that with the combination of counterpoise and ground connection, the radiation was four times that obtained with ground alone.

In order to bring in reports from all directions on the operations, during the experimental development of the radiophone it was necessary to do a certain amount of broadcasting. Another and fully as important reason for broadcasting was that of stimulating an interest in radio among the power house and substation employees about the system. It was considered that such interest was vitally important to the successful future operation of an emergency radiophone service. This was done under an experimental license until a ruling of the Department of Commerce necessitated taking out a special broadcasting license for the purpose. It was thus that broadcasting station KMJ came into existence, but with the idea of a broadcasting station secondary to the development of the set for use in emergency communication.

After many months of delay occasioned by the inability to get satisfactory tubes and apparatus, hardly any of which were more than out of the experimental stage and on a production basis, a complete set of standard parts was evolved. A satisfactory filter system had in this time been developed, utilizing the primary winding of a 1 kw, 2300 volt distribution transformer as a choke, the two coils each in series with one side of the rectified high voltage supply. Three one microfarad condensers insulated for 1750 volts were shunted across this circuit on the power side and one on the radio side. A special but standard transformer of 750 watts rating was used for the one source of power. This transformer has one primary winding with taps for operation on from 102.5 to 115 volts, and three secondary windings, two of which give 10.5 volts for filament heating and one of 3000 volts for the rectifier tubes. Each of these secondary windings has its center tap brought out, which connection is absolutely essential. It was found in actual practice that this transformer, which is of the dry type, when operating continuously at just full load for an hour at a time became dangerously hot. For this reason it was necessary to rearrange the terminal connections, soldering on long leads and sawing out sections of the end shells preparing the transformer for operation under oil. It was put into a 1 kw distribution transformer case, submerged in oil and the operation since has been entirely satisfactory. Owing to the primary voltage sometimes going above the trans-

former voltage rating, a 40 ohm rheostat is provided in the primary circuit.

Power for the set is supplied from the 115 volt lighting circuit of 60 cycles frequency. Entering the set through a fused knife switch it passes through a flush type lock switch to the main power bus and thence to the bracket lamps and a. c. voltmeter. This meter indicates which voltage tap to work on, so the tap selector switch is moved to the proper point and with the primary resistance all in the flush push switch is snapped on. The primary resistance is then cut out gradually and the set brought up to normal operation.

Power tubes of 50 watts output rating are used, one as an oscillator and the other as the modulator. The constant current system of modulation is used in connection with a 5 watt speech amplifier. A special reactor of 300 milliamperes capacity is used in the main positive lead to the plates. The power tubes require at least 1000 volts on the plates while the speech amplifier tube requires 350. A resistance of 15,000 ohms, having a continuous carrying capacity of at least 50 milliamperes, was found necessary to reduce the voltage to the proper value. This resistance was composed of three standard 5000 ohm resistors. A d. c. voltmeter is provided which, by means of a double pole double throw switch, may be thrown on power tube plate circuit or upon that of the amplifier tube. The rectifier tubes have an output rating of 150 watts each and the two carry a load of 300 milliamperes at 1300 volts without undue heating. Two standard rheostats of 15 amperes continuous carrying capacity are provided, one for each set of tubes that operate in multiple. An additional rheostat is provided for the modulator tube which sometimes requires a slightly different adjustment than the oscillator. A separate rheostat is provided for the speech amplifier tube which requires a considerably lower voltage for its filament.

The constant potential method of filament control is used rather than maintaining the constant rated current throughout the life of the tube. It is found that this method greatly prolongs the life of a tube, as the current is automatically reduced as the filament resistance increases due to disintegration. For this purpose an a. c. voltmeter is provided which by means of a double pole three way switch may be thrown upon either the rectifier tube bus or the power tube bus or onto the speech amplifier tube and the voltage adjusted by means of the respective rheostats. The plate current of the oscillator and modulator tubes and the speech amplifier tubes are indicated separately by milliammeters and collectively by one meter which gives the total load on the rectifier tubes.

In the oscillatory circuit are utilized two standard inductance coils of 25

turns each, two fixed capacity 3000 volt mica condensers of .002 mfd. each, one variable mercury mica condenser of .0012 mfd. insulated for 4000 volts, and one 5000 ohm resistor which is used as a grid leak on the oscillator tube. One of the inductances is to be used as a loading coil for long wave work, while the variable condenser is for short wave work, either of which may be introduced into the counterpoise lead by the proper operation of a double pole double throw switch. Another double pole double throw switch is provided to either connect the antenna and counterpoise to the active inductance or to ground them both. Small choke coils of 1 henry reactance at audio frequencies are inserted in the grid circuit of the modulator tube and the plate circuit of the speech amplifier to prevent the dissipation of the audio frequency impulses and practically forcing the effect of the speech amplifier upon the grid of the modulator tube. A radio frequency choke coil is inserted in the plate lead of the oscillator tube to prevent the high frequency output of that tube getting back into the other circuits. The output or plate circuit of the speech amplifier tube is capacitively coupled to the grid of the modulator by means of a  $\frac{1}{2}$  mfd. 1750 volt condenser. Negative potential for the grids of the two tubes is supplied by small dry batteries, the values approximating 30 volts.

A three winding modulation transformer is used, the secondary of which connects with the grid of the speech amplifier tube. The primary winding connects with a receptacle on the panel for external connection to the speech input circuit. The tertiary or third winding also connects to a receptacle so that the input may be monitored by plugging a telephone receiver in on it. The microphone system which is external to the transmitting set proper consists of an induction coil with center tap of primary winding brought out for connection with differential transmitter which is a hand set used for announcing. The other transmitter is an especially sensitive device used for picking up vocal and instrumental music rendered in the studio. A four point double throw telephone key switch serves to throw from one transmitter to the other, while the one battery and rheostat are used for both transmitters, the rheostat to control the volume.

So much for the detail description of the set, which may be followed through with the aid of the wiring diagram presented herewith. The set was designed by the writer and built up switchboard style in the shops of the Corporation as illustrated in accompanying front and interior photographs. The fact that the set is principally used for broadcasting does not mean that it contains any special features except the pickup transmitter which does not materially add to

*Continued on page 50*



# The D. X. Bringer-In

By Stuart A. Hendrick, 2BJG

*The author has received so many requests for complete constructional details of the set briefly described in April, 1922, RADIO, that he has written this description of his remarkable regenerative three-circuit tuner and two-stage amplifier. If you are about to build a new receiver or reconstruct your old one this is just the information you need.*

UPON hearing of the merits of the "DX Bringer-In" designed by 2XK, Mr. L. M. Cockaday, I had an opportunity to personally listen in on his outfit. As I found that it had no body-capacity effects and no taps or switches on the coils and that it was extremely sharp in tuning and capable of being loaded up to a wavelength of 25,000 meters, I resolved that I should waste no time until I had a receiver of this type in my station. After building the set I realized that I had a wonderful receiver, better than any set I had ever

The primary circuit is untuned and will respond to a broad band of wavelengths without touching the primary condenser.

The secondary circuit is tuned by a variable condenser and is extremely selective and sharp. It is coupled to the primary circuit rather tightly and for this reason the wavelength may be calibrated directly upon the secondary scale. This calibration will be correct to within a few percent on almost any antenna with which the set may be used.

The set has no taps or switches and

Another interesting thing about this set is that it may be loaded to any wavelength by inserting honeycomb or similar coils in the primary, secondary and plate circuits by means of plugs or jacks. The places marked with an X, in the hookup, show where the set is to be loaded. These loading coils are out of the set when you do not desire to receive the longer waves so this cuts out the dead-end losses usually present in "all wave receivers." Without these long wave coils the set is, inherently, the best type for short waves and is remarkably sensitive and sharp, in fact so sharp that a vernier on the secondary condenser is almost a necessity.

In regard to results I will say that they will be, perhaps, better than you will expect. On the detector tube I have heard fifty-one broadcasting stations, some of them over 1500 miles distant and I have heard amateur stations from almost every state in the Union. What more could be desired of a set on the detector tube alone?

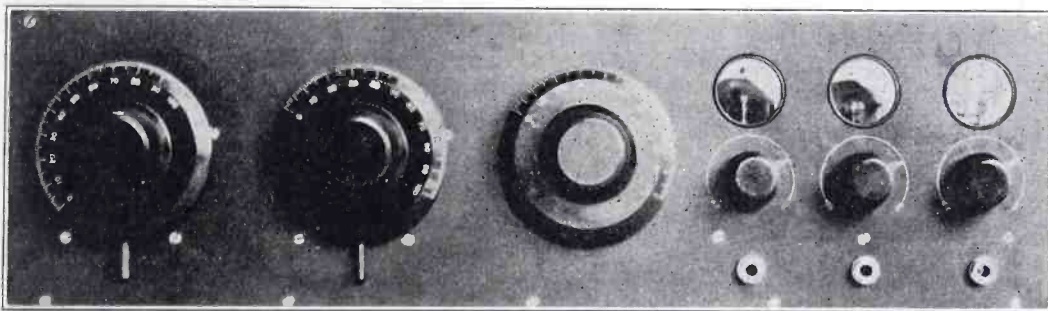

Panel for D. X. Bringer-In

owned or listened-in on; distant stations came pouring in and the ease with which I could tune out interference and control the regeneration was a revelation to me.

How many times have you given up trying to get that far-off station because when you removed your hand from the dial he faded out. That will not happen in this set if you follow directions in hooking it up and it will not be necessary to shield the back of the panel either. This is made possible by placing the moving parts, which are toward the front of the panel, at ground potential. Therefore the movable plates of both the primary and secondary condensers are grounded together with the stator of the plate variometer. How this is done will be seen by referring to the circuit diagram, Fig. 1.

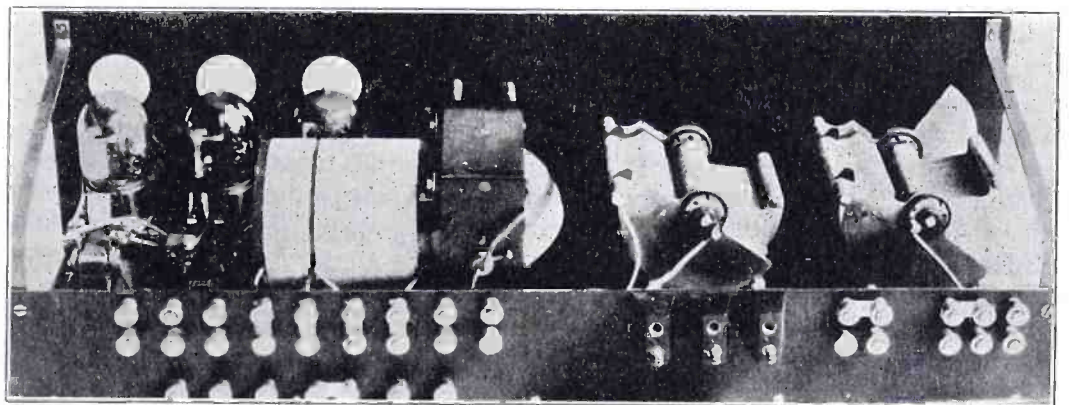

Looking down on set from rear.

has only one wavelength control, the secondary condenser.

The primary condenser acts as a vernier and is a great help in tuning because the secondary condenser tunes exceptionally sharp.

The regenerative control actually controls the feedback and over the entire scale, too.

The remainder of this article will deal with the construction of the set and a two-stage amplifier to be used in conjunction with it. Wiring diagrams for the amplifier will be given so that it may be hooked up with the filament control jacks or with the ordinary kind.

The wavelength range of the set, without being loaded, will be between 175 and 580 meters if a .001 mfd. condenser is used in the primary circuit and a .0005 mfd. condenser in the secondary circuit. If a .0015 mfd. variable condenser is put in the primary circuit and a .001 mfd. condenser in the secondary circuit the wavelength will be increased to about 800 meters and will tune much sharper.

Fig. 4 shows the panel layout and spacing for the holes to mount the various parts. The panel should measure 7 in. x 24 in. and should be either 1/4-in. or 3/16-in. thick. It should be, preferably, of bakelite or formica. It should

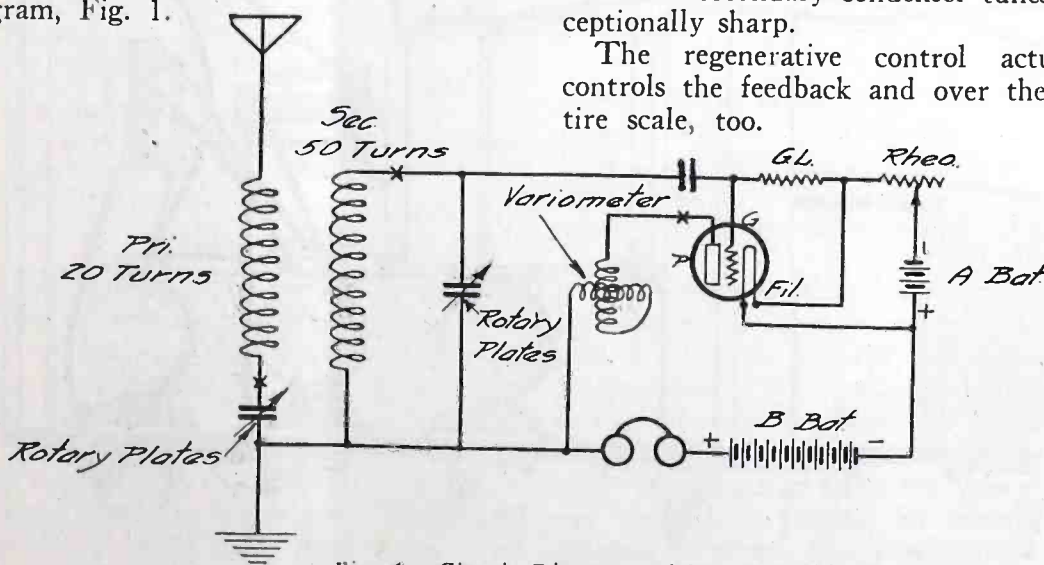

Fig. 1. Circuit Diagram without Amplifiers.



be grained lengthwise, after all the holes are drilled, with a piece of fine emery cloth wrapped around a block of wood. After it is grained it should be rubbed down with machine oil and a soft cloth. This will give the panel a beautiful finish which is to be desired if the set is to have a good appearance when finished.

The rheostat and socket holes are given for the Fada brand and if others are used they will have to be changed accordingly. Only center holes are laid out for the condensers and the variometer because the rest of the holes for mounting these parts will vary with the make of instrument selected for use with the set.

strument is fitted on the panel for a trial. It should then be removed and the next one put on and removed until all the parts have been fitted and tried.

Then the panel is grained and fastened to the wooden base board, as shown in Figs. 3 and 5, by means of five flister head wood screws, shown in Fig. 4.

After this is done the terminal panel, 3½ in. x 24 in., should be grained and drilled for binding posts and coil plugs (if the set is to be loaded.)

This should then be mounted upon the back of the base board and the two panels are then braced by means of the special brass brackets, two of which should be made according to Figs. 3 and 5. These

upon the panel the rheostats should be mounted and the pointers should be lined up with the contact arms and made tight. Make a careful job of this, because if the pointers come loose after the set has been in operation a while much trouble will be experienced in tightening the parts again. The socket is then put into place and fastened tight, after which the condensers are mounted in their respective positions. Last but not least is the variometer and special coil which should be made as follows: On a 3½-in. diameter tube of bakelite 4 in. long wind 20 turns of No. 18 D. C. C. wire, leaving ¼ inch on the end of the tube. A small hole should be drilled at the start and finish of the two windings and the wire inserted in these holes to keep it in place. After the 20 turns have been put on, a winding of 50 turns, for the secondary, is started ⅛ in. away from it. A 5/16 in. space should be left on the end of the tube which will be sufficient space for fastening the small brass brackets for holding it to the variometer. Brackets for holding the coil and the variometer away from the panel should now be made and then the variometer should be fastened to the panel in its proper place. If the shaft on the variometer is not long enough an extension of some sort will have to be made. One-half pound of the No. 18 wire will be sufficient to wind the coils.

The set will now be ready to be wired if instructions have been carried out as described above. The wiring should be done very carefully if good results are to be expected. Fig. 6 shows the wiring diagram of the set with two stages of audio frequency amplification and filament control jacks. Fig. 1 gives a hook-up of the set with the detector only.

The wiring should be of No. 20 bare copper wire encased in varnished cambric tubing (spaghetti) and the connections should be as short as possible to get the greatest efficiency and prevent howling in the amplifier part of the circuit. Do not use bus-bar wiring even if you happen to know somebody who gives it away for the asking.

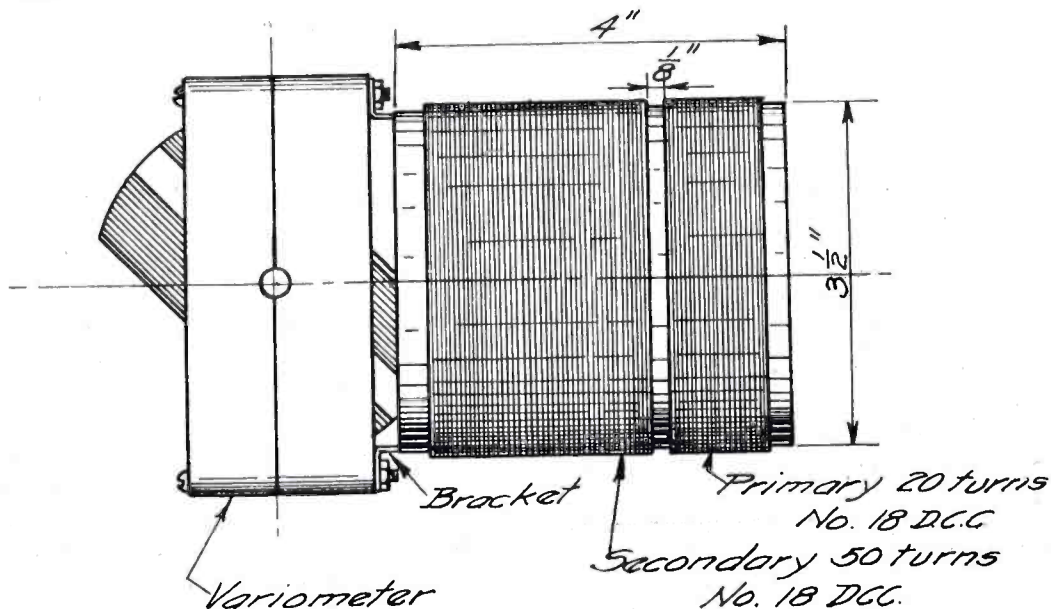

Fig. 2.

The arrows or pointers for the rheostats and the peep-holes for the bulbs can best be done by someone who has the machines for this purpose, but if this part of the job must be done by the builder, himself, he can engrave a pointer with a sharp pair of dividers and the peep-holes can be made into a number of smaller ones instead of the one large one.

Holes for each instrument should be laid out by means of a template and drilled with the proper size twist drill and those intended for flat head screws should be countersunk. Then the in-

struments should be screwed into place and will keep the panel from warping. The two amplifying transformers are to be fastened down to the wood base by means of wood screws. They should be mounted at right angles to each other in order to avoid the squeaks and howls usually present in the home-built amplifier.

When these panels have been set up and braced with the brass brackets the parts should be put on and fastened in their proper places in the following order. First the jacks should be mounted upside down for convenience in wiring the set. After these are fastened

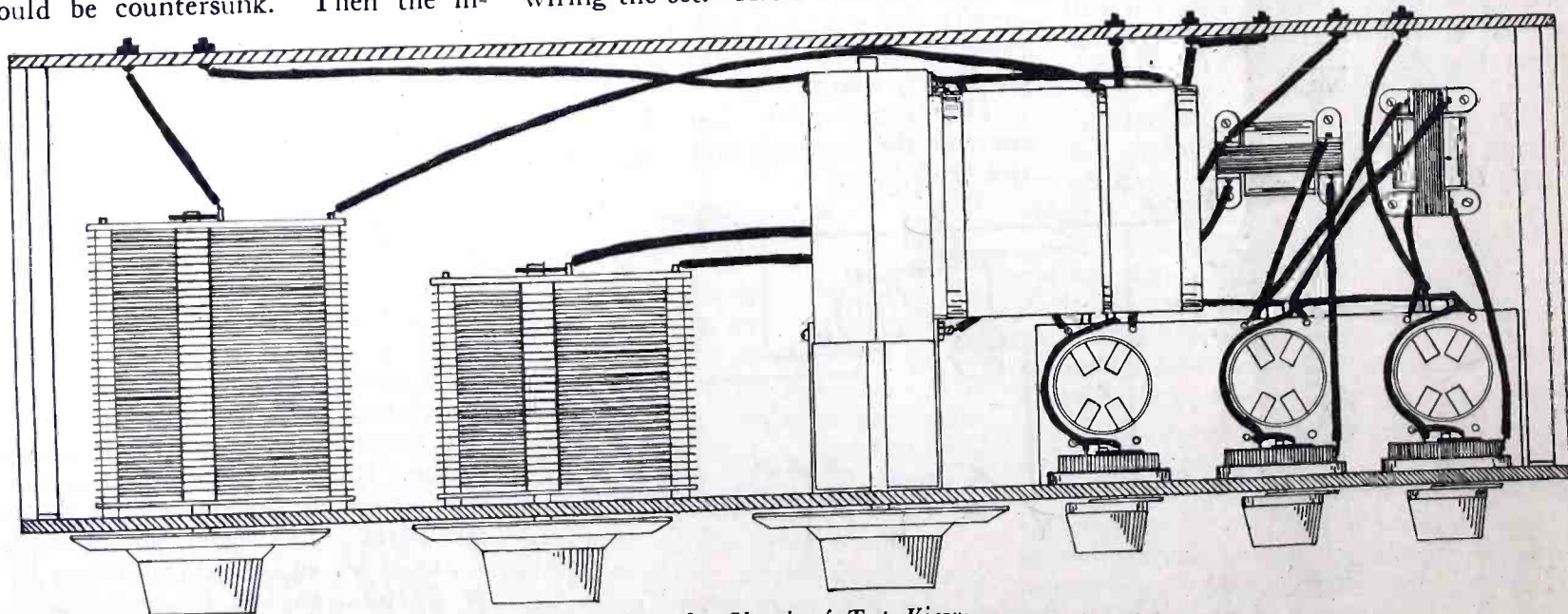

Fig. 3. Sketch of Top View:



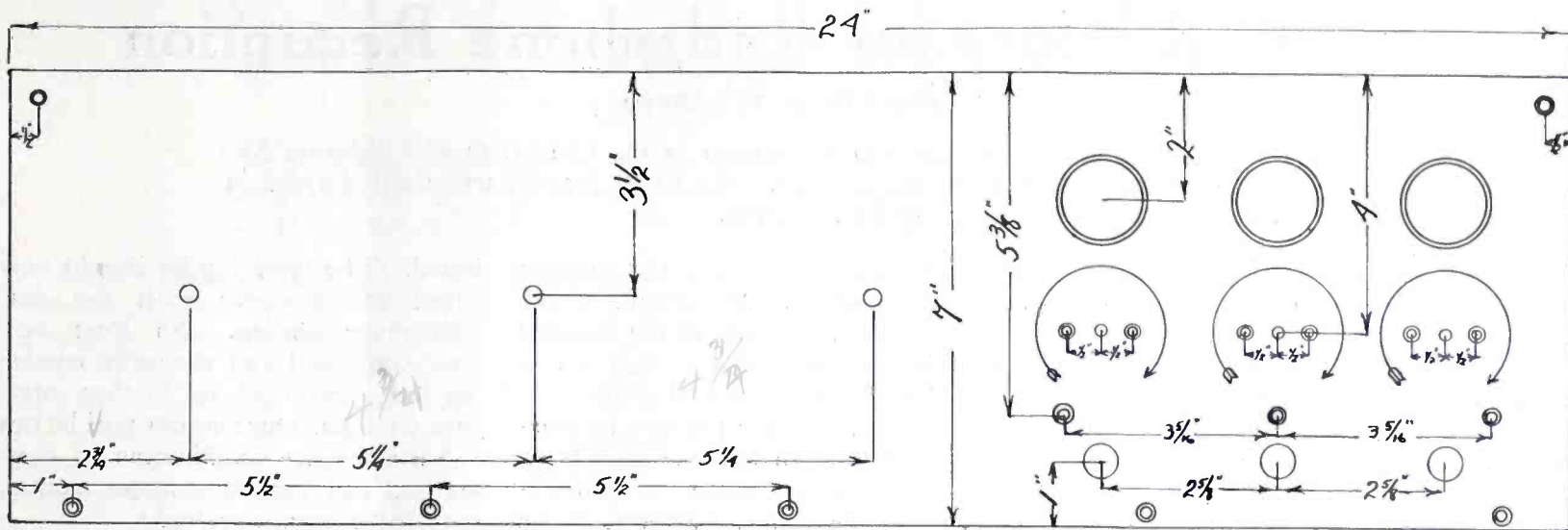

Fig. 4. Panel Layout.

The rotary plates of the primary variable condenser should be connected to the ground binding post. The stationary plates of the secondary condenser should go to the grid through the grid condenser which should be an .00025 or .0003 mfd. mica condenser.

If the variometer control is not critical and does not regenerate properly the lead to it should be reversed to make it work properly. The grid leak should be 1 1/2

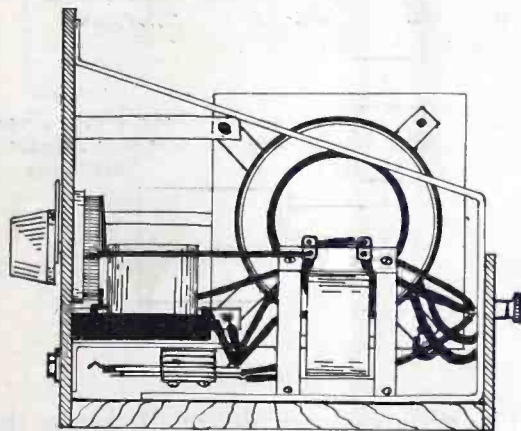

Fig. 5. Sketch of Side View.

or 2 megohms and should be connected from the grid to the filament.

LIST OF PARTS

- |                       |                         |
|-----------------------|-------------------------|
| 1 Variometer.         | 3 Jacks.                |
| 1 Variable Condenser. | 2 Amplifying Trans-     |
| 1 Variable Condenser  | formers.                |
| with Vernier.         | 7 Binding Posts.        |
| 1 Panel 24 in.x7 in.  | 2 Brass Panel Braces.   |
| 1 Terminal Panel      | 1/2-lb. No. 18 D. C. C. |
| 24 in.x3 in.          | Wire.                   |
| 3 4-in. Knobs and     | 4 Brackets for Tube.    |
| Dials.                | 2 Brackets for Vari-    |
| 1 Baseboard 24 in.    | ometer.                 |
| x7 in.                | 1 Grid Condenser        |
| 1 Bakelite Tube       | .0003 mfd.              |
| 3 1/2 in.x4 in.       | 1 Grid Leak, 2 Meg-     |
| 1 Triple Socket.      | ohm.                    |
| 3 Rheostats.          |                         |

Tuning the Set

The primary condenser should be set about three quarters of the way in or 75 degrees on the dial, after the set has been hooked up and the batteries connected.

The variometer should be set at 15 or 20 degrees and then the secondary condenser should be turned until the desired signal is heard after which the variometer is turned to obtain maximum re-

generation. If the secondary condenser tunes very sharp the primary condenser should then be tuned to get the signals at the most intensity.

To get the longer waves the set should be loaded by opening the primary, secondary, and plate circuits in the places marked X in the circuit diagram, Fig. 1. The position of these coils in relation to one another will have to be changed by experiment until the proper polarity is found, that is, the connections to the coils may have to be reversed if no signals are heard when they are first plugged into the set. Coil mounting plugs may be put in these places and left there, but they should be shorted by a

two stage may be used separately if desired but this method complicates the wiring and is not desired in the set for everyday use.

The writer is now experimenting on this circuit with the idea of making a one tube super-regenerative set out of it. So far results have been very satisfactory, signals are heard all over the house using one- A-P amplifier tube with 60 volts on the plate with no antenna, ground or loop. With the antenna, Chicago, WDAP, was heard all around the operating room here in New York City. This will be written up in due time when it is made to work better than at the present time.

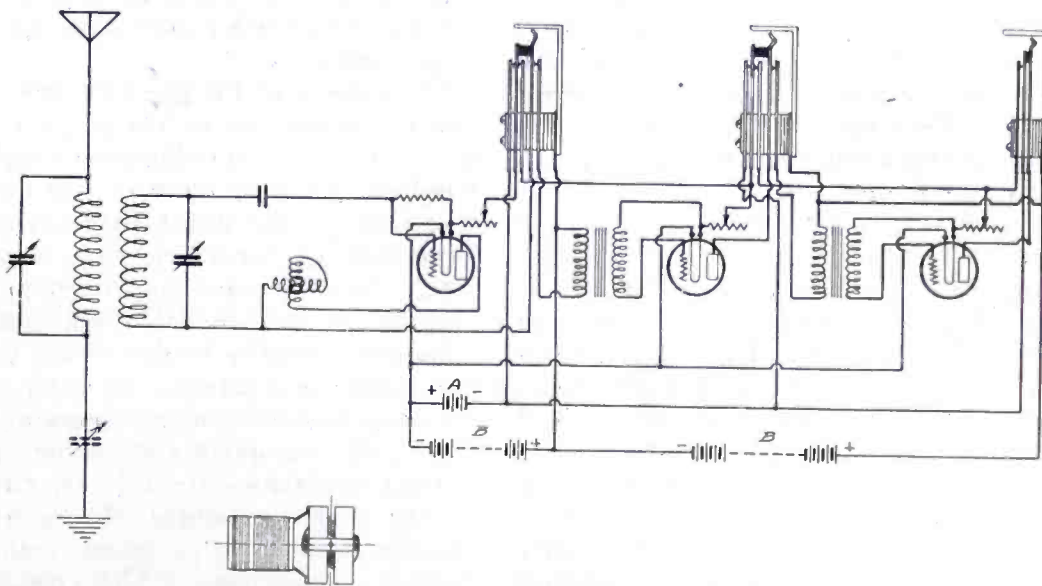

Fig. 6. Circuit Diagram with Amplifiers.

jumper or a blank plug with a strap connected across it when the set is not loaded. Closed circuit jacks and plugs could also be used or ordinary binding posts with straps across them when not in use.

The pictures show the outfit constructed by the author and will give an idea of what the set will look like when it is finished. The rows of binding posts and jumpers in the back of this set are for the purpose of disconnecting any piece of apparatus from the rest of the set when it is needed for some other purpose. Thus, the condensers, coil, variometer, detector and two stage or the

With the foregoing description anyone ought to be able to construct one of these exceptionally sensitive receivers and then they will know the difference between this DX receiver and the conventional three circuit tuner.

THE SUPERIORITY OF C. W.

Out of a total of 121,592 messages handled by members of the A. R. R. L. in February, 108,713 or 89 per cent. were continuous wave and 12,879 or 11 per cent. were spark. The report also broke all previous records in the number of messages handled in any one month.



# Practical Hints for Radiphone Reception

By Ellery W. Stone

*This constitutes the fifteenth and last assignment in the University of California Extension Division course in Elementary Radio. It will be found particularly helpful to the novice interested in improving his reception.*

ONE of the most important factors for efficient radio reception is the design of the proper antenna. This varies somewhat with the type of receiving set with which it is to be used. For example, with crystal detector reception, where the energy heard in the telephone receivers is only that actually received and is not supplied by some local source such as a *B* battery, the antenna or aerial should be fairly large. This is necessary in order to pick up a maximum amount of energy. On the other hand, with highly regenerative tube receivers or those employing radio-frequency amplification, only a small antenna (even a loop) need be used.

It should be clearly understood that when the sensitiveness of the receiver will permit, it is far more satisfactory to employ a small antenna than a large one. This is because a small antenna is less responsive than a large one to static or atmospheric interference and the tuning is sharper. The last tends to reduce the interference from stations which you do not desire to hear.

Thus, if radio-frequency is to be used, particularly if three or more stages are available, a loop antenna may profitably be employed. As has already been explained in a previous assignment, the effect of the loop is to reduce static and interference from other stations through its directive qualities.

However, as we have also seen, the use of a loop cuts down the receiving range that would be obtained with the same receiving equipment connected to an outdoor antenna. If, with radio-frequency amplification, still greater receiving range is desired than can be obtained with the loop, an outdoor antenna may be successfully used providing it is not too large. For this reason, a single wire antenna not more than fifty to eighty feet in length should be used. Greater length or a greater number of wires will not noticeably increase the receiving range and it will increase station and static interference.

The same type of antenna should be used with sets which are highly regenerative. This feature which may be found in many new types of receiving sets makes it possible to employ them with small, single wire antennas. The physical advantages attendant upon the erection of such small antennas are of course obvious.

With the average crystal or tube set, however, probably the best type of antenna is a single wire, not more than 150 feet in length. The lead-in in every case should be as short as possible, and

all connections or splices in the antenna should be soldered. If antenna joints are not soldered, exposure to the weather will cause corrosion and a high resistance at such connections will result.

Quite often, it is the practice of amateurs to say that an antenna is 150 ft. when in reality it consists of two 75-ft. wires. The latter, however, is by no means the equivalent of the former. When the receiving set calls for an antenna 150 ft. in length, equivalent results will *not* be obtained by a two wire antenna 75 ft. long, and still less satisfactory would be a three-wire antenna 50 ft. long.

For radio reception, therefore, always use a single wire antenna. The length should not be more than 150 ft. for the average crystal or tube set, and not more than 50 to 80 ft. with a highly regenerative or radio-frequency set.

A suitable connection to earth may be secured by fastening a wire to a convenient water pipe. This may be a drain pipe, any pipe connected to the house plumbing, or a steam or hot water radiator. The ground wire, like the lead-in, should be as short as possible and should be soldered to the pipe to which it is connected.

On account of the great efficiency and ease of adjustment of the single circuit type of receiver for radiophone reception, there are probably more of this type in operation in this country than any other. Occasionally, however, in congested areas, there is some interference from amateur or commercial spark stations. This may partially be due to the use of too large an antenna. In such cases, increased selectivity or sharpness of tuning—with consequent elimination of unwanted stations—can easily be effected by the simple expedient of inserting a variable condenser in series with the ground connection. The condenser should be set at a fairly low value of capacity, and the tuning device on the receiver—either variometer, vario-coupler, or variable condenser—should be tuned to resonance with the wave of the desired station in the usual manner. Tuning on the series variable condenser will now be found to be much sharper.

If an amateur spark transmitting station should be located in the immediate vicinity of your receiver and you have found it impossible to tune out his signals, a small honeycomb coil—of 35 or 50 turns—may be shunted across the variable condenser mentioned in the last paragraph. The series variable condenser should now be tuned until a point is found where the offender is no longer

heard. The receiving set should now be tuned to resonance with the desired radiophone station. So long as the honeycomb coil and the series condenser are left unchanged, no further interference from amateur stations will be heard.

Such a series combination of condenser and coil for the purpose mentioned is called a *frequency trap*.

If interference from commercial spark stations operating on 600 meters is also encountered, still another frequency trap may be used in series with the receiver and the first trap. For 600 meters, this should consist of a small variable condenser and a 100 turn honeycomb coil.

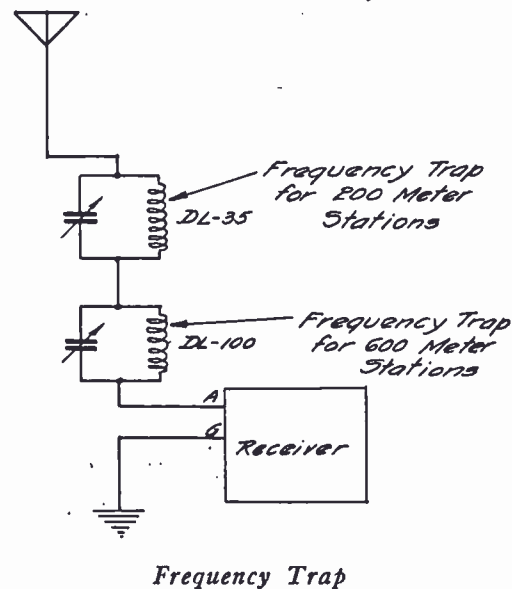

Frequency Trap

The accompanying figure illustrates the circuit for their use.

Remember that regeneration is employed to secure amplification within the detector tube itself. It is generally controlled by revolving a tickler coil inductively coupled to the grid-circuit inductance (in a single circuit receiver this will be the antenna inductance) or by revolving the rotor of a variometer for the purpose of tuning the plate circuit. Amplification by regeneration is increased as we increase the amount of energy returned from the plate circuit to the grid circuit. If the tickler coupling is made too close, the circuits will begin to oscillate and the music or speech will be distorted and a shrill note or "howl" will be heard in the telephone receivers. The oscillations may be stopped by slightly lowering the filament brilliancy of the detector tube or by turning back the tickler coil knob until the distortion ceases.

In receiving weak signals, best results are obtained by increasing the regeneration until a shrill note is heard on either side of the point of resonance (where the music is heard the loudest). The closer you "straddle" the resonant point with

*Continued on page 54*



# Radio Transmission Circuits

By Samuel G. McMeen

*This is a qualitative account of the four standard transmitting circuits of special interest and value to the amateur who is thinking of installing a sending set. It includes some helpful ideas on transmitting from a loop aerial.*

NO radio amateur's experience is complete until he has utilized transmitting as well as receiving equipment. Listening to broad-casting stations is good amusement, and in some quarters there is observable a marked improvement in the quality of such transmission, but the radio art has so much more scope than that of mere listening that it is a pity not to go further. Learn the International code and transmit as well as listen. Make the most of things as they are.

We are gathering together in this writing several forms of transmitting circuits, in the hope that they may be useful as reference data for those who

pletely suppressed. The improvement in that regard is due to the inventive ability of Mr. A. H. Babcock.

The letters and figures in the several transmitting circuit sketches have meanings as follows:

- A, Ammeter.
- a, b and c, connections to correspondingly lettered points of Hartley, Meissner and British airplane circuits.
- 1, Condenser, .001 mf.
- 2, condenser, .00125 mf.
- 3 and 4, Condenser, .002 mf.
- 5 and 6, Condenser, 1/2 mf.
- 7 and 8, High frequency inductance; 100 turns No. 30 wire on 2 1/2-inch tube.

For wavelengths below 400 meters, covering all amateur needs, the inductances may well have 45 turns each if the diameter be not less than 4 in. In the Colpitts and Hartley circuits there are no tuning inductances except that connected to the aerial. In the Hartley

In the Colpitts circuit there are two condensers associated with the primary inductance. The variable one in the ground lead should be .001 microfarad capacitance; the fixed one in the grid lead should be .00125 microfarad. The grid leak is a fixed resistance of 5000 ohms. Such a device can be had of resistance wire wound on a porcelain tube, capable of withstanding more energy than if made like a receiving-set graphite grid leak. A similar tube-wound grid leak is suitable for the British airplane circuit.

In the tube portion of the circuits it will be noted that all the elements fall into symmetrical relation. There are two tubes, two pairs of condensers, two radio-frequency chokes, and two halves of the transformer secondary winding. The transformer has three windings. The primary is connected to the house circuit of a 50 or 60 cycle alternating current system; the secondary gives the high voltage required for the plate circuits—this being from 500 to 1000 volts—and the tertiary winding supplies filament current for the tubes. If the tertiary voltage be about 6 volts the filament rheostats may be of the type used for receiving tubes, if the installation is using small energy, say five watts, but in any case the filament current should be that recommended by the makers for the particular type of tubes used. One filament rheostat controls the current to both filaments.

The transmitting key lies in the exact central line of the whole symmetrical arrangement, and is so related to the energy-giving elements that there is entire absence of sparking at its contacts. The standard Morse key so long used on land lines is thus suitable for this circuit, with its advantages of light-

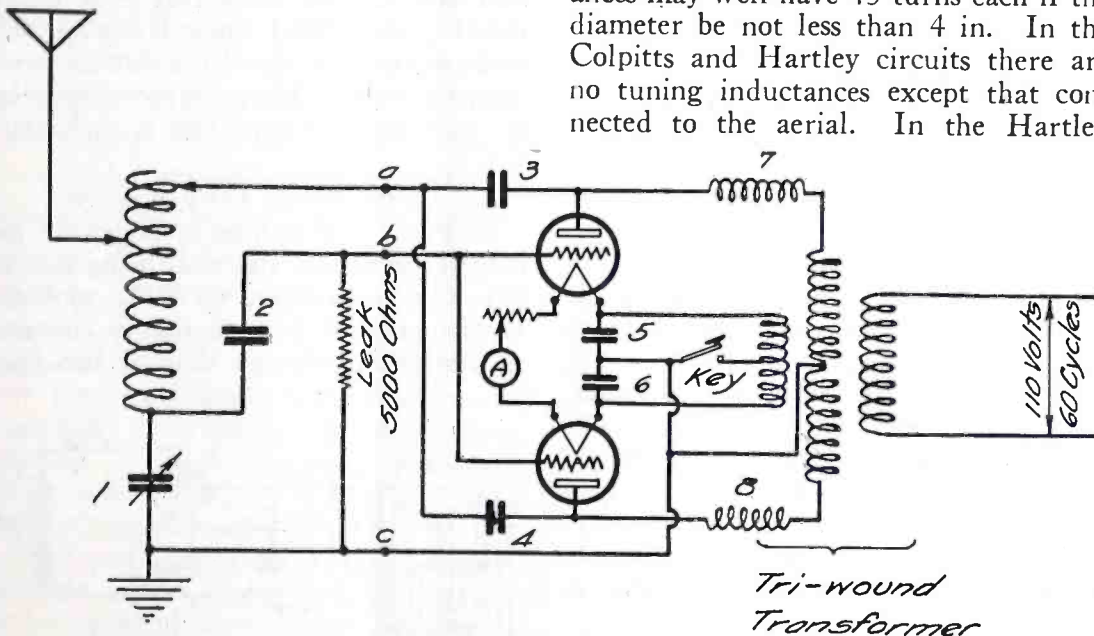

Fig. 1. Colpitts Transmitting Circuit with Self-Rectifying Tube Generator using both half-waves of A. C. supply.

are making ventures in these lines. In Fig. 1 is shown the Colpitts circuit, associated with a valuable type of self rectifying tube generator circuit using both half-waves of alternating current supply. This tube circuit is unique in the arrangement of the key portion of the circuit, the relations being such that sparking at the key contacts is com-

circuit there are primary and secondary inductances, tunable by relative motion. In the British airplane circuit there are two inductances, not variable by motion but by shunted capacitance. In all four of the circuits there is opportunity for adjustment of wavelength by taps.

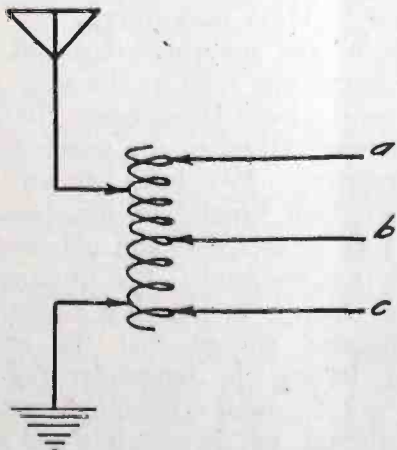

Fig. 2. Hartley Transmitting Circuit.

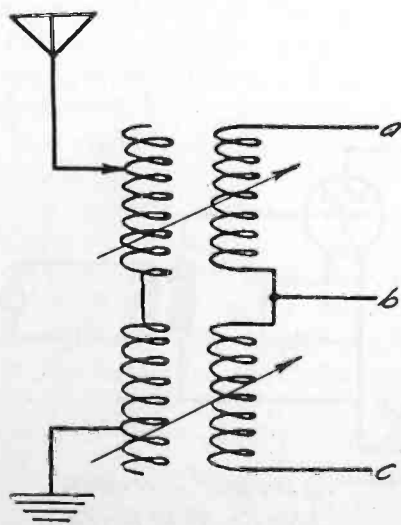

Fig. 3. Meissner Transmitting Circuit.

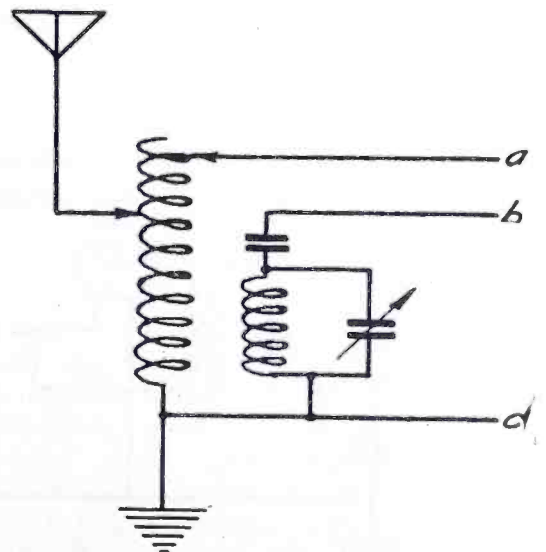

Fig. 4. British Airplane Transmitting Circuit



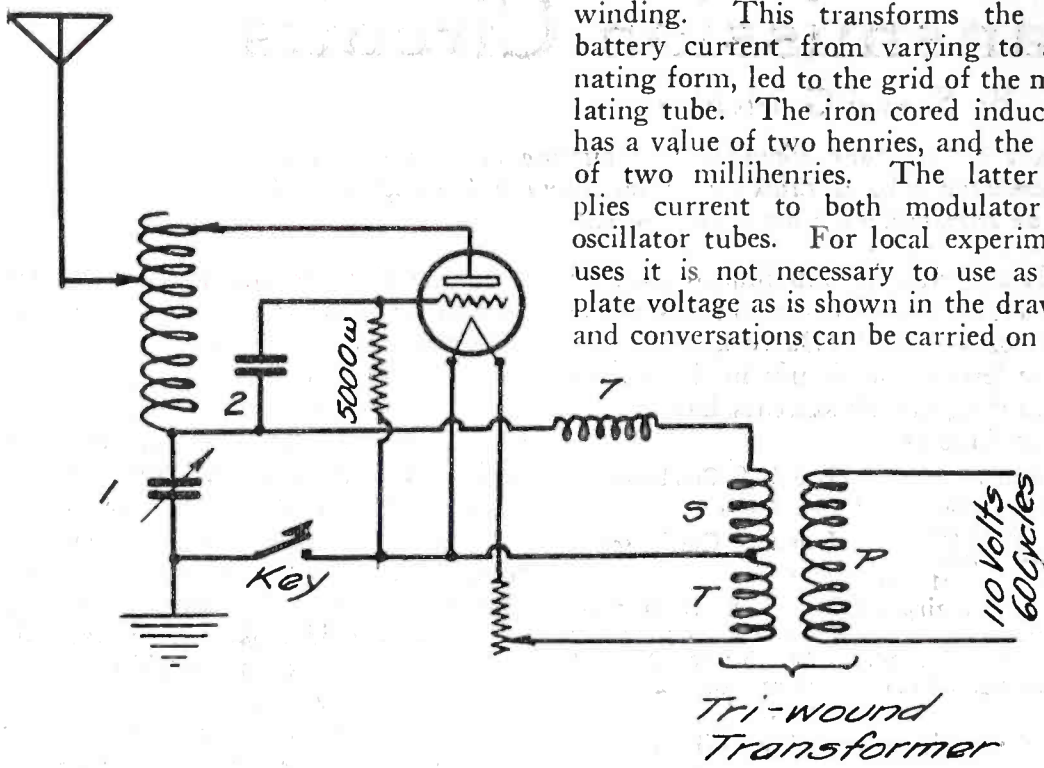

Fig. 5. Colpitts Transmitting Circuit with half-wave single tube generator.

weight lever and a minimum of platinum in the contacts.

This circuit can be split so as to use but one tube and one half of each cycle of the supply current. In this case the arrangement becomes that of Fig. 5, wherein the Colpitts tuning portion remains as in the two-tube type, but the key and transformer and plate connections are somewhat different.

It was with the Hartley circuit, associated with the full-wave tube circuit, that the first amateur both-ways communication was established between California and the Hawaiian Islands. The communicants in that accomplishment were Messrs. Babcock and Dow.

No group of transmitting circuits should omit the premier of radiophone circuits so far as modulation is concerned. It is the Heising, and is shown in Fig. 6. It will be noted that the tuning portion is the same as the Colpitts. It is in the use of a modulating tube that its virtue lies. The telephone transmitter is associated with a modulation transformer, which in experimental work may be merely a local battery induction coil with the transmitter in the low resistance

winding. This transforms the local battery current from varying to alternating form, led to the grid of the modulating tube. The iron cored inductance has a value of two henries, and the other of two millihenries. The latter supplies current to both modulator and oscillator tubes. For local experimental uses it is not necessary to use as high plate voltage as is shown in the drawing, and conversations can be carried on for a

mile or so with one of the 100 volt dry-cell blocks of the market.

A good many novices in radio research miss entertainment because of supposing that special tube equipment is required for transmission, and so do not make a beginning. As a matter of fact, all tubes—detectors, amplifiers, modulators and oscillators—are fundamentally alike. They differ in name because of the duties for which they are specialized in the making. But any tube will transmit, every tube will oscillate, all tubes will modulate and most tubes will detect. Use what you have, and very often you will do surprisingly well. For the purpose of proving principles short distance transmission is often as informative as any other.

Loop aerials have long been used for receiving, and have achieved some popularity and some useful applications because of their ability to receive in a definite plane while suppressing or rejecting signals from other directions. It is because of the power of discrimination on part of a loop that it is used in the radio direction finder or radio compass. In such use, the strongest signals are heard

when the loop is edgewise-on toward the sending station, and the signals are inaudible when the loop is set broadside-on toward that station. This accomplishes directional receiving, and by its use ships can take bearings on two or more known sending stations and determine their positions with a working degree of accuracy. Similarly two shore stations can listen to signals received on loops from a ship and by a simple calculation learn and tell the ship where it is.

But less application has been made of the power of a loop to transmit. Actions in the natural world are so generally reversible that it would be matter of surprise if a loop could receive and not transmit. Yet it is not unusual to read in the radio press that a loop can not be used as a transmitting aerial.

Transmitting loops were used behind the Allied lines in France during the war. They have the same valuable property as receiving loops, in that they are directional. But in the case of transmission one has the advantage that directional powers tend toward secrecy and make economical use of the already overcrowded ether. Here are some notes on one experimental adventure in such practice.

Transmitting With a Loop

In Fig. 7 is shown an arrangement for loop transmission, the plan being due to Mr. Oliver Wright, (6 GD) of California. It will be seen that it contains no inductance except that of the loop

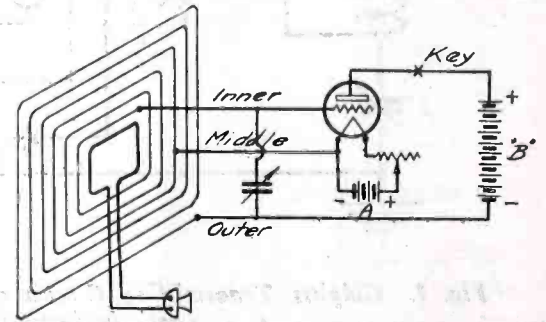

Fig. 7. Transmitting from middle-tapped loop with one-turn absorption loop for modulation.

itself, this containing five turns in a plane on a frame such that the side of the square is three and a half feet. The turns are spaced two inches apart. The connections to the tube portion of the set are; Outer turn of loop to negative B source; inner turn to grid, and middle turn to negative side of filament. The condenser is .0005 microfarad.

Inside of the innermost turn of the loop proper is one turn of the same size of wire as the loop, (in our test No. 24) its ends being taken to the terminals of a microphone. We have shown this absorption loop heavier in the drawing for the sake of clearness and not because heavy wire is essential. The function of this inner loop is to absorb a portion of the generated energy that the set is emitting, letting the remainder radiate. This is not the most economical method of modulation, but is certainly the simplest.

Continued on page 62

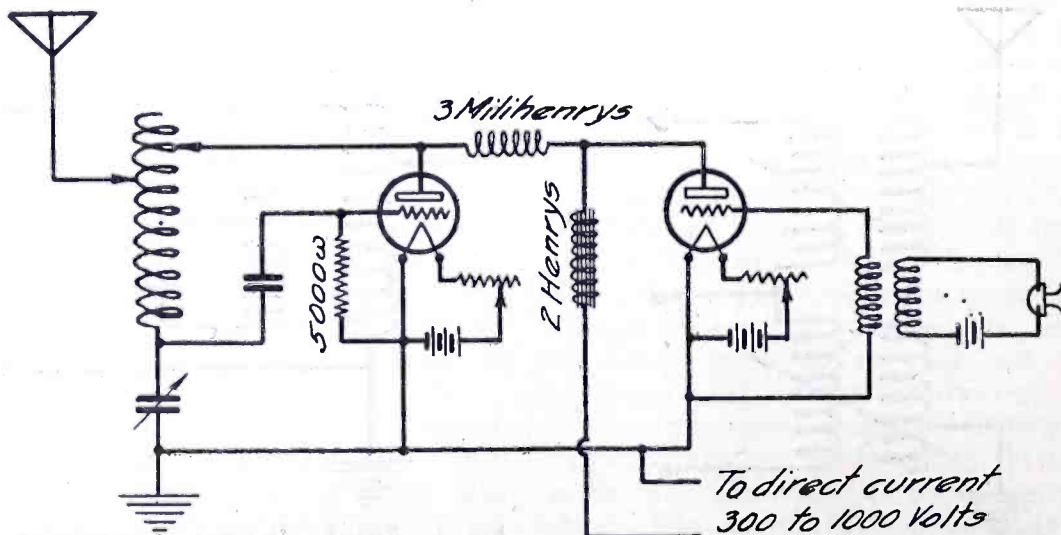

Fig. 6. Heising Modulation Circuit.



# The Use of Choke Coils in Radio

By A. Machson

*Half the fun in radio is to know why a given piece of apparatus works as it does. Here the author has expurgated enough mathematics from the theory of choke coils to make clear to the average amateur the manner in which choke coils operate and behave. It concludes with a practical suggestion for elimination of interference and commutator hum.*

THE two commonest and most important factors in a radio circuit are the inductance coil and condenser. These may be called the primary factors, as all radio circuits must contain them in one form or another. It may therefore be instructive to consider some of the uses of these factors, and in this article we will consider the use of inductance as a choke coil.

The main function of an inductance coil, when used as a choke coil, is to protect apparatus behind it from high voltages or to limit the current flowing in an inductive circuit. When it is desired to limit the current a current choke coil is used; when protection is desired from high voltages a voltage choke coil is used. The current choke is more common in low frequency work, as in the primary circuit of resonance transformers, whereas the voltage choke is more frequently found in radio circuits. In low frequency work the choke consists practically always of an inductance, whereas in high frequency work the choke may be an inductance coil or a radio frequency circuit. In low frequency work the action of the choke coil depends primarily on the inductive reactance presented by the coil, whereas in high frequency work the action of the choke, whether coil or circuit, depends both on the inductance of the coil and the distributed or concentrated capacity associated with the choke.

That the use of choke coils or circuits is a very important factor in radio will be evident from an examination of modern radio circuits. Choke coils and choke circuits—the so-called “frequency traps,” are sprinkled all over, in one place to protect apparatus from high voltages, in other places to build up high voltages, and in still other places to stop the flow of leakage or other currents. Diagrams of such circuits showing the special uses of chokes will be shown and discussed later.

The necessity for using chokes arises very frequently in experimental and research work, until the circuits or designs are so perfected that the chokes may be dispensed with. It is therefore important to understand exactly how a choke coil or circuit functions and why it does so. Actually how does a choke coil choke?

To the average amateur an inductance coil acts as a choke coil because it has a

high inductance and offers a high reactance to the current at the given frequency. But in actual practice it is found that in some cases high inductances are very poor chokes and that frequently a small inductance properly built is a very good and efficient choke coil. That the amateur's idea as given above does not explain the choking action of an inductance is also proved by the fact that a coil which may be a good choke at 300 meters is a poor one at 1300 meters.

Let us consider the problem thoroughly. The most effective choking circuit, if it could be built, is a simple, capacity-free, high inductance coil. For in this case the inductance would indeed have a high pure inductive reactance, and this would always be made large enough for whatever choking purposes it was required. But although considerable progress is being made in the design and construction of coils, coils still have distributed capacity. There is not yet a capacity-free coil.

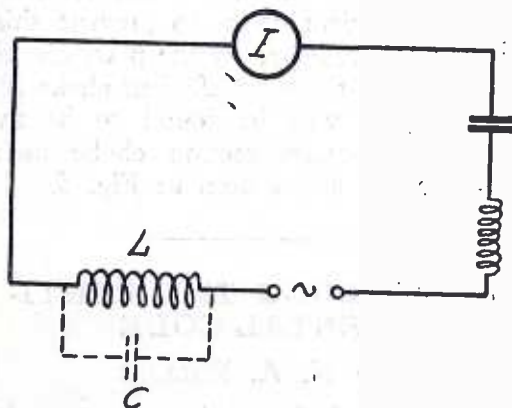

Fig. 1. Choke Coil Circuit.

Consequently let us consider a choke coil of inductance  $L$  which has a distributed capacity  $C$  and assume it to be connected in a circuit as in Fig. 1.  $I$  is an instrument, let us say, which is to be protected or from which current is to be excluded, and for electrical reasons may not be shunted by a protective condenser. The choke coil cannot be considered a pure inductive reactance, because there is a capacity reactance in parallel with it due to the distributed capacity of coil, neutralizing the inductive reactance. Now it is not difficult to conceive that many cases may arise, where, in spite of the fact that the inductance is high, the distributed capacity may be sufficiently great to by-pass the current to be choked, and thus ruin the instrument which was to be protected. On the other hand the choke coil may be so designed that the distributed capacity assists the

inductance and makes the coil an efficient choke coil.

An inductance therefore, when used as a choke, must be considered in conjunction with its distributed capacity. Every turn has a capacity to every other turn. These small distributed capacities add up to an equivalent total capacity  $C$  which is the distributed capacity of the coil as a whole. This capacity is generally considered to be in parallel with the inductance, as in Fig. 2. Consequently the coil has a natural period of

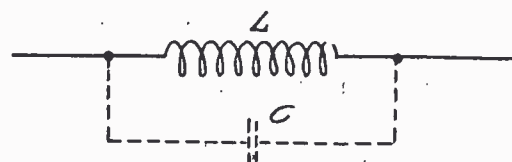

Fig. 2. Distributed Capacity in Choke Coil.

its own which is according to the usual formula

$$T = 2\pi\sqrt{LC}$$

By mathematical analysis the total impedance of such a combination may be found and at the natural frequency of the coil itself analysis shows this impedance to be given by the equation

$$Z = \frac{L}{RC}$$

in which  $Z$  is the impedance of the coil at its natural frequency,  $L$  its inductance,  $C$  its capacity, and  $R$  its resistance. Suppose this inductance is efficiently designed so that its resistance is negligible, that is  $R$  equals zero, then the impedance of this coil turn out to be

$$Z = \frac{L}{C \times 0} = \infty = \text{infinity.}$$

That is when  $R$  is zero the coil has an infinite impedance. However  $R$  is never zero, but the coil can be designed so that its resistance is very small, and in this case while the impedance does not become infinite it does become extremely great since  $R$  is very small.

This result shows that if  $R$ , the resistance of the coil, is negligible, the coil will have an infinite impedance to currents of its own frequency and will therefore absolutely choke currents of that frequency. If  $R$  is very small then the impedance will nevertheless be very great and will still be able to effectively choke currents of its frequency. Consequently to have an inductance coil act properly and efficiently as a choke it must be



designed so that its natural frequency will be equal or nearly equal to the frequency at which it is to be used. This shows that a coil acts as a choke, not so much because it has a high inductance, but because it acts as a tuned circuit whose impedance is very great at the frequency to which it tunes.

The above discussion and analysis is the basis of the so-called "frequency trap," which is nothing but a closed circuit of inductance and capacity tuned to the frequency of the current which is to be choked out of a line, see Fig 3. This arrangement of capacity and inductance

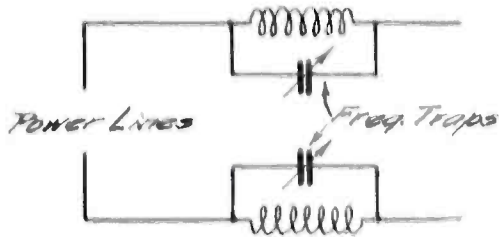

Fig. 3. Frequency Trap.

to tune to the given frequency is being satisfactorily used on such circuits as power lines, telephone lines, etc., but in radio sets becomes a little unwieldly, especially where experimental work is done, and in small sets where the number of elements is required to be a minimum and space is at a premium. Hence if possible it is far more desirable to develop and build small choke coils which in themselves, without the aid of external capacity, will act as efficient chokes. The results of the analysis given above show that if coils can be designed to have sufficient distributed capacity to tune with the inductance the object will be attained.

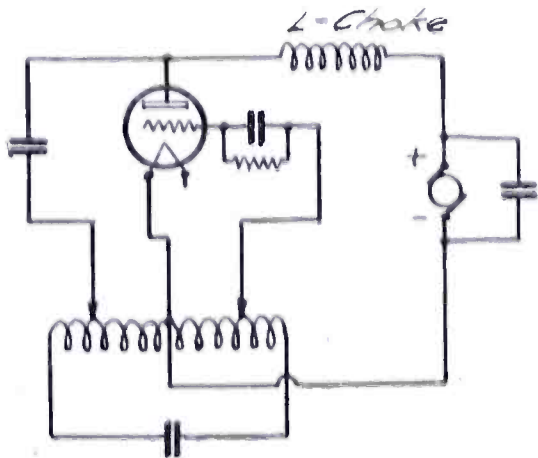

Fig. 4. Shunt Circuit.

The most satisfactory kind of coil for this purpose is the multi-layer square section coil. These have been designed and built for a large number of frequencies and have proved very efficient. It is not necessary to build a coil for each frequency, as it will be found by amateurs that a given coil tuned to a certain frequency will act as a very efficient choke over a fairly wide range of frequencies on either side of its natural period. Thus a 3 milli-henry choke coil was found to

give very good choking action over a range of wavelengths from 400 to 600 meters, while a 15 milli-henry coil which tuned to about 1700 meters, was found to be very satisfactory between 1500 and 2000 meters. These coils may be wound with various sized wires to accommodate different currents, but for average small power sets No. 22 wire was found to be satisfactory. As one practical illustration of the use of these choke coils consider the oscillatory circuit of Fig. 4. This is a well known and widely used valve circuit for the generation of continuous waves, called the shunt circuit. The condenser across the generator is for the purpose of eliminating the commutator hum. In the circuit it is absolutely essential that an efficient choke be placed in the plate circuit of the valve. For the generator is practically shunted across the plate circuit of the tube and would act as a short circuit to the radio frequency

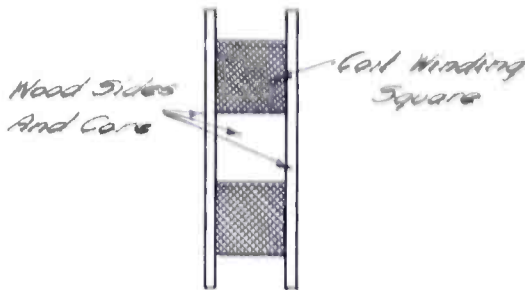

Fig. 5. Multi-Layer Square Section Choke.

voltage across the valve unless there were an efficient choke to prevent this. This is accomplished by the plate circuit choke *L* and the most efficient choke for this purpose will be found to be the multi-layer square section choke mentioned above and shown in Fig. 5.

### MEMORIZING THE CONTINENTAL CODE

By N. A. ROLLAH

**M**OST of the various systems designed to facilitate memorizing the continental code depend upon visual rather than oral impressions. But as the practical use of the code is in hearing rather than in seeing, all of these methods ultimately require that what was learned by sight be converted into sound. Consequently it is better in the long run to learn by ear rather than by eye. But as everyone cannot go to a school where the "dit dah" is taught, some easy system combining both sight and sound in a logical arrangement is helpful to the home student.

The twenty-six letters of the alphabet are represented in the code by different combinations of dots and dashes. Thus *e* is dot, *a* dot dash, *t* dash, etc. As everyone knows the order of the letters in the alphabet it is easier to memorize the code in the same order rather than to memorize some other more logical arrangement of the dot-dash combinations.

The scheme adopted in the "Memo-code" devised by the author is to represent a dash by a syllable containing the letter *o*, and a dot by a syllable containing either *a*, *e*, *i*, or *u*; these syllables making up words. These words have been so chosen as to make sense or non-sense when arranged in alphabetical order.

The Memo Code		
Allow	broken-hearted	
co-respondents	domestic	ease,
Fancyworking	godmothers	
habilitate	idle	Jim O'Connor's
knockabout	laborsaving	maters,
Noisy	orthodox	philosophers
quote-orators	recondite,	Sensitive
tools	undertook	ventilator
window-cards	(x)	officio
yokefellows of	Zoroaster	

Only a brief word is necessary regarding a few of the letters. *J* is represented by the two words "Jim O'Connor," *Q* by "quote orators" and *Y* by "yokefellows of." The *X* is silent in "(e)x-officio."

As regards punctuation marks, three *i*'s make a period, three *a*'s a comma, *k r* a semi-colon, *k k* a parenthesis, *du* a hyphen, *m i m* an exclamation and *os* a colon. Reference to the code will show the simple arrangement for numerals, although two-letter combinations can also be used if desired.

It is possible to memorize these twenty-six words in a very few minutes. Then by going over them in your mind substituting "dahs" for *a*'s and "dits" for the other vowels you at once know the right combination for any letter. By repeating them aloud you can easily recognize the identifying "awing" of combinations for each letter. Thus "dit dah dah dit" is recognized as "philosopher" and associated with *p*, "dit dah dit dit" as "laborsaving" meaning *l* etc. Proof is in the trying! It's easy.

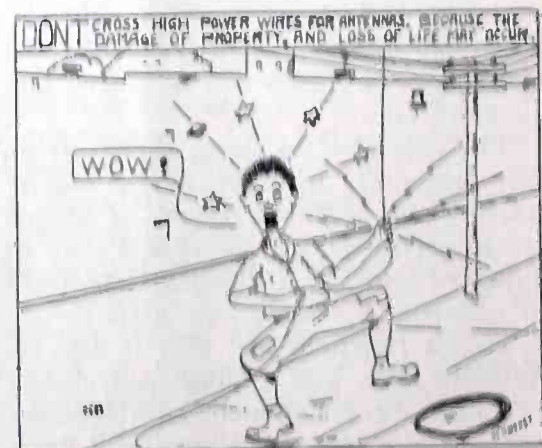



# Sparks Springs His New Wave Trap

By Sewell Peaslee Wright

"I WANTA see," said Wildcat, as soon as he was comfortably seated in the broken-down old morris chair that was a familiar land-mark in "Sparks" radio room, "I wanta see this wonderful wave-trap you've got, that you was telling about so proudly the other night."

"Me too!" chimed in "Bozo," another ham, about the same age as Wildcat. "If you've got a wave trap that comes even somewhere near being practical for ham use, I'll say you're g-o-o-d good! With a capital "G," he added generously.

Sparks carelessly removed a glue-pot, three old newspapers, some dozen cigarette-butts, two files, a screwdriver and an egg-beater drill from the operating table, tossing them into a corner to be

wavelengths, and while the interference isn't as bad on the higher waves, you frequently run across it."

His listeners nodded in confirmation, and he continued.

"In this wave-trap, the inductance is a honeycomb coil, or whatever kind of concentrated inductance of that type that you may have laying around. When you want to switch the range of your wave-trap, you just yank out the coil that's in it, and shove in the one that will work on the wave that's interfering with you. You fellows know the general hook-up of a wave-trap, don't you?"

"An inductance and a condenser in parallel, and the whole works in series with the antenna lead, isn't it?" said Wildcat. Sparks nodded.

darned things work—and if they do work."

"Oh, they work pretty well, unless the QRM is *very* close to you," replied Sparks. "Tune 'em carefully and they clear up the atmosphere to a surprising extent; sure do! Tuning them is easy, once you get used to it; it's just learning how to put reverse English on tuning IN a station—the wave-trap tunes them OUT."

"Yeah, I know, but HOW?" queried Wildcat.

"On this type, you just plug in the trap and plug in the right coil—a little experience will show you which is the right one—and then you vary your condenser until the interfering signals are weakened. Tune slow and easy, and you'll find a valley where the signals will disappear entirely. The strength of the signals you're after will not be noticeably affected unless the station you're listening for is almost exactly on the wave of the interfering station; in which case you should whistle 'Home, Sweet Home' three times before saying anything out loud—for the sake of any ladies who might be within a block or two."

"What d'ye mean, a 'valley'?" asked Bozo entirely disregarding Sparks' attempt at humor.

"A 'valley' is a low point between two peaks, my lad," explained Sparks patiently. "The sound will have a peak audibility at one point on the condenser scale, and turning one way will cause the interfering signals to grow weaker, till, as I said, they finally become inaudible. Keep turning in the same direction, and they'll start getting loud again. The point where they disappear is the very lowest point of the 'valley'."

"I gotcha," nodded Bozo, "something like tuning a two-variometer set, only backwards." This somewhat complicated simile was accepted, and Sparks continued.

"Never mind what happens to the station you want to listen when you're cutting out the interference; it may fluctuate a lot—probably will—but you want to keep your ear on the baby you're trying to get rid of—understand?"

The two young hams nodded in unison.

"Guess I'll build me one, and see how the dog-gone thing works," said Wildcat. "Won't cost me a cent, and if it'll cut down some of the horrible QRM I've been 'enjoying', I'll sure say it's a good job well done!"

Sparks waved his hand broadly.

"Hop to it, youngster," he advised, "you'll find it time well spent."

"Yeah," said Bozo. "You and me both!"

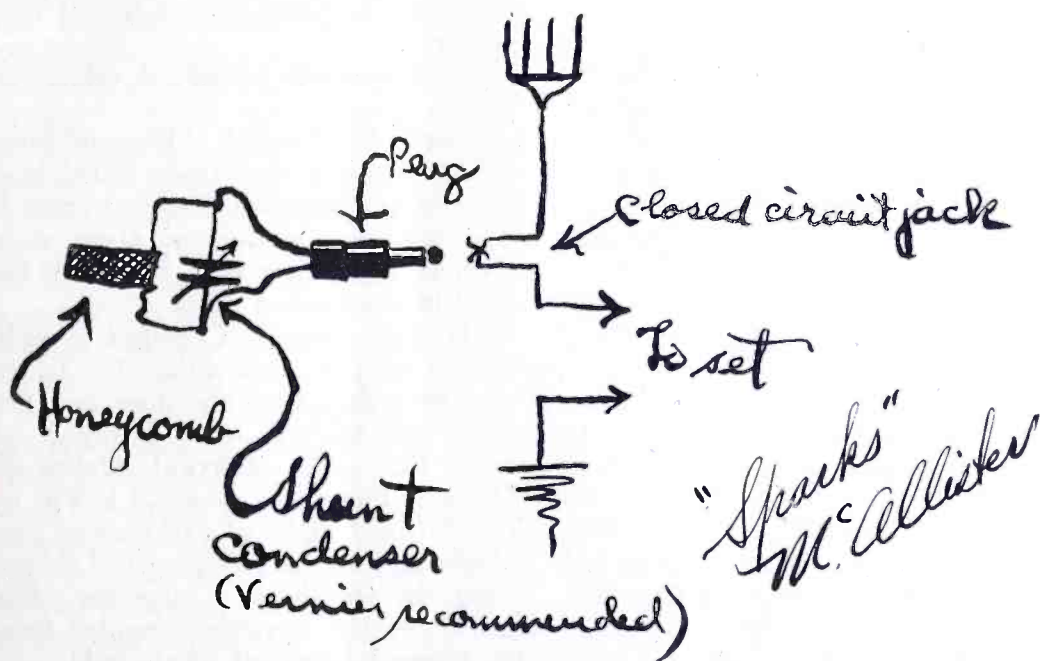

taken care of later; "later" being an indefinite period of time, which never arrived. That corner was a veritable mine of tools, parts, raw material and everything else that a ham would want in his "hell box."

The operating table cleared up sufficiently, Sparks carefully filled and lit his pipe: Sparks was always either filling, smoking or emptying that pipe.

"Want to see a reg'lar wave-trap, do you?" he queried, between puffs. "Well, I've got the best one I've seen or heard of; tho it's a long ways from perfect, yet!" He reached over and pulled forth a small panel about six by six, on which was arranged a small condenser and a single honeycomb coil mounting. A short length of flexible cord that was connected somewhere in back of the panel terminated in a telephone plug.

"This," said Sparks, "is the aforementioned trap. It has several advantages over the old styles, as it is far more flexible, has a much greater range, and my system of putting it into the circuit is better, I think. You see, most of us fellows work over a wide range of

"That's one way of putting it," he admitted. "Anyway, here's the way mine is hooked up." Sparks extracted a sheet of paper from a drawer in the operating table, and a stubby pencil from his north east vest pocket.

"Here's your aerial" he said, drawing to illustrate his comments, "and here is your honeycomb coil. This is the variable condenser—a small one, or one with a vernier is best. Didn't have a vernier handy when I made this, or I'd have used it. Think it would improve it."

"This is a flexible lead with an ordinary plug on the end. It fits into a closed circuit jack in my receiving panel, so that when the plug is in the jack, the wave trap is in series with the aerial lead, and when it is pulled out, the aerial goes straight thru, and I can take this hoodinkus and use the various parts of it for something else. Haven't got half enough V. C.s around here to work with anyway, and I need this one every once in a while."

"Gee," said Wildcat, "you have got some pretty good ideas there—for you. What I'd like to know is just how the



# Hamplificatus Horribulus

By H. A. Highstone

*Here is a funny story with a moral for those dissatisfied with their two-step. Even in its exaggerations it is true to life.*

**D**ID you ever hear of Hamplificatus? No, neither did I, until a few months ago while perusing an obscure little radio magazine I came upon an article bearing that heading, wherein the author explained the average amateur's insatiable desire to increase the volume and range of signals in his receiving set. He ascribed the cause to some heretofore unknown microbe which he claimed to have isolated after long research. A portion of the article I reproduce herewith.

"— known as Hamplificatus. The disease derives its name from the two Latin words 'hammus', literally, a radio amateur and amplificatæ, meaning a radio amplifier; the whole, in effect, a radio amateur with a never-satisfied obsession for amplifying radio signals. The disease had been observed in two phases, Hamplificatus Pacæ, mild, comparatively harmless, and very common, and Hamplificatus Horribulus, a most violent and malignant form, having no known cure except the total exhaustion of the patient's resources." Ah, poor Bill, that was what ailed him—Hamplificatus Horribulus. However, he's cured now, but it wasn't the failure of his bank account that did it, the cause was an ordinary——, but it is best to begin at the beginning.

Bill is a forest ranger in the National Park where he earns his daily bacon by caring for fifty thousand acres of forest-covered mountains which have a most annoying habit of catching fire during the dry season. Since he first left Terryville three years ago to take up his present position, we have maintained a steady correspondence, Bill's epistles being mostly made up of data concerning his receiving set, for he is a

"ham" from way back, and saw to it that his duties did not interfere with his hobby. It was about a year ago when one of his letters first made mention of amplifiers; his first "one step" began it, and succeeding letters over a period of three months indicated that he had acquired next a two step, then a four, and finally last spring I received a missive in which he querulously berated the six step amplifier he now possessed. He continued further, inquiring whether or not I had any "dope" on radio-frequency amplification, and if I thought, say three stages, of this type would enable him to do some real distance work? Then his correspondence abruptly ceased, and I heard no more from him. Summer came; August was passing, and becoming uneasy I decided to look him up and see what was wrong.

And so one crisp day last September I stopped to breathe my horse at the top of a hill up in the high Sierras, and inquired of a ragged gentleman guarding a flock of sheep if he knew aught of one Bill Harken, a ranger. The herder, evidently of Scandinavian origin, stared at me with a strange expression.

"Yas," he replied. "He is ofer on ta——." His features suddenly contorted with terror as a fearful long drawn howl came bellowing over the mountains and fell off into a horrible wailing. With my hair standing on end I turned in my saddle to interrogate the man, but he was nowhere to be seen. After a moment a quavering voice came from the brush.

"Follow ta noise," it said. "He iss——."

"Whooroom!" A low rumbling filled the air, and an insanely modulated voice cackled through the trees unintelligibly. The noise ceased abruptly and I spurred

my horse down the rutted trail while the echoes were still playing back and forth among the hills. Five miles further on I came upon a little one room cabin which I recognized from a photo my friend had once sent me.

As my horse clumped up to the cabin in the falling dusk, the door swung open and the overalled form of Bill framed itself in the doorway. After five minutes of eager conversation I interrupted to inquire the meaning of the horrible outcries which so startled the shepherd and myself. Bill beamed.

"My set!" he told me, "I was just trying out the twenty-ninth step." Slowly I slid out of my saddle and caught at the horse to save myself from falling.

"Twenty-ninth what?" I asked him faintly.

"Step," he repeated. "Deaf or something? — step, sometimes called stage of radio amplification," he continued in a peevish voice, noting my glassy stare. "What's the matter with it?" he at last asked in exasperated tones.

"It ain't done!" I gasped weakly. "There ain't no such animal!" In answer he jerked open the door and motioned me within——. Today it all seems like some electrical nightmare. The only impression which is left to me is a confused maze of variometers, condensers and meters gleaming and shining along the length of a huge log table. Metal covered mysteries crowded bakelite covered boxes off of the table in a great overflow upon the wall, while a dozen large fixed-variable condensers were actually attached to the low ceiling. And wires! east, west, south, north, they ran, forward and backward, crawling

*Continued on page 64*

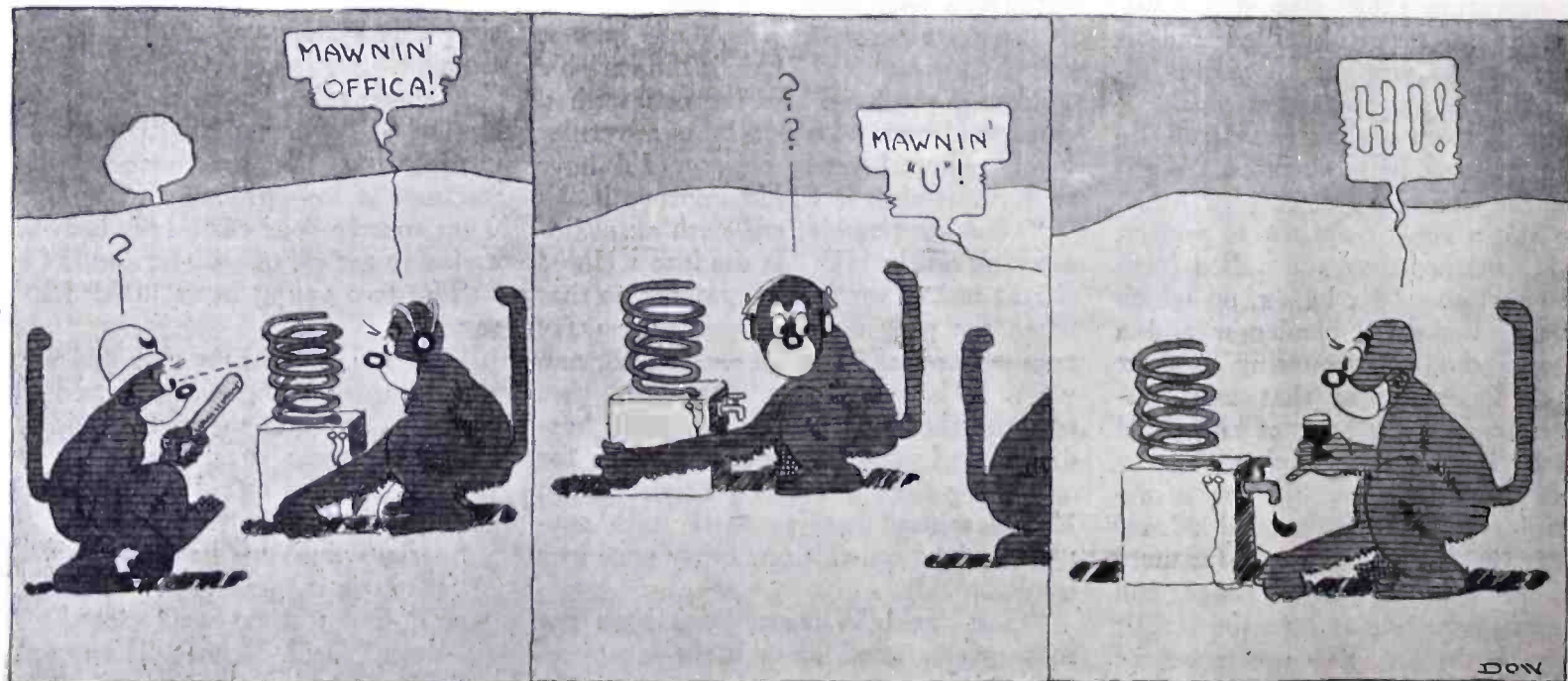



# The Radio Mystery of Mt. Diablo

By Paul Oard

*This is a war story, where Yankee wits outmatched German wits. Heart-gripping, soul-stirring action runs through it. It includes a splendid tribute to the part played by the American radio amateur in the World War.*

TWO men were seated at the radio equipment in Major Cutting's quarters at the Presidio of San Francisco. One of them, a captain, removed the receivers that were tightly strapped to his ears, with an impatient gesture, and bringing both receivers and one fist down on the table before him with an angry crash spoke vigorously.

"Major, I'm just about ready to quit. This matter looked easy enough at the first, but I'll be frank with you in saying that I feel as though I am at the end of my rope. Of all perplexing problems, this one is the limit."

The major smiled at the irate captain. Removing his own headset slowly, he studied the carpet a short while before replying. Those who knew him were never deceived by this apparent slowness. Underneath a placid enough exterior lay a mind that acted with suddenness and precision in an emergency. He spoke.

"Well, captain, I admit that it is enough to try the patience of a saint, and you are far from being one. But, my boy, when I picked you as the man who would work through this, I had made up my mind that you were the one who would do it. You have been under strain for the past week that I can well appreciate, and I am going to suggest that a short rest is much in order. Now, I want you to run up to my country home near Mt. Diablo for the next few days. Put in your time running around that section on some of my blooded stock that is so badly in need of exercising, and you will come back feeling ready to lick your weight in fresh young wildcats. My car is outside. When you are ready to come back, telephone me and I will see that somebody goes up after you. And in the meantime, just forget that there is a war on. You'll be the better for the real work on hand if you do. Now, no more, get out of here. And don't come back until you are fed up on ranch life."

IT now becomes necessary to go back a way in order that the story show proper sequence. In telling of the Nicholson safety screen, I do not break faith, for it can not be long now before this most remarkable radio mechanism will be familiar to all radio men. The war is over,

and it follows that the device will of necessity be turned toward more peaceful aims than it was first used in. At the time, had you asked the average radio man about the Nicholson safety screen, you would have been met with a blank look. Had you spoken to one of those—the very few—who could rightfully affix the term "radio engineer" to his name, you would have been rewarded with a quick searching glance, and a

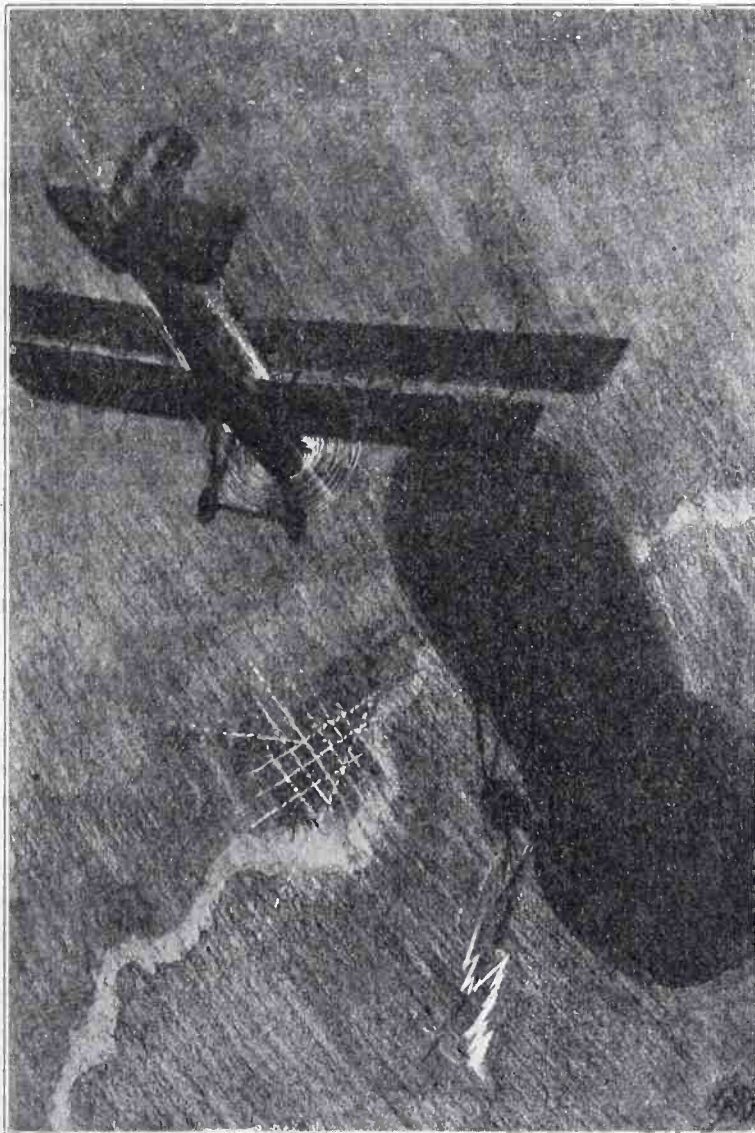

"A dark object loomed before the nose of the plane."

more or less non-committal answer, depending a good deal upon you standing in regard to a number of matters. But the need of secrecy is now of secondary importance, though at the time, lives depended upon it.

Most of us, who play or work with radio, know of the fine little game of wits that was played by the allied forces and those who made up the enemy side, in the radio part of the war. Oftimes it settled down to a clash between rival stations, the operator with the most perseverance eventually jamming the enemy station. With the entrance of America into the conflict, came the American

amateur, who through his early training, added another thorn to the side of the harrassed Hun. I sometimes wonder if a rather unappreciative citizenry will ever realize the true value of the American amateur in the war. I hope so.

Then came the Nicholson safety screen. Were I to mention Nicholson by his true name, you would recognize him as one whose name has been inseparably linked with radio from its early infancy. Nicholson, confident that a means could be built up whereby a method of radio control that would effectually jam enemy stations, while at the same time permitting allied stations to operate without difficulty, set to work with the untiring energy that characterized him in all his radio research. The screen was the result of his labors.

Through its use, allied operators worked with ease, in spite of determined efforts of enemy operators to jam their signals. Not only did it permit them to transact their business with the calm certainty of less troublesome days, but through a reverse device it could be directed against enemy controls, to effectually jam them, even when operating at considerable distances.

With the introduction of the screen, things went along merrily for a while. Then one morning allied operators awoke to the painful realization that the secret of the screen was in enemy hands. They found themselves checkmated at several points of control, and while not altogether as effectual as their own method, there was no doubt that the enemy had a working knowledge of the device. The Nicholson screen, used only in long distance communication, and at points remote from the possibility of enemy capture, had been a sealed device, the actual mechanism of which was not known even to the operators in charge. The fact that the enemy did not have full control of their apparatus pointed out that there were still facts with which they were not familiar. It was established that wherever the leak had come from, it was not from the European side. Nicholson had perfected his safety screen in his laboratories in San Francisco. Like others of mechanical and

*Continued on page 70*



# Needed Radio Inventions

By Raymond F. Yates, I. R. E., Member of Radio Club of America and American Physical Society

THESE comes a time in every man's life when he is moved by the inventive urge. In fact, we invent every day. When we speak, we invent sentences to express our thoughts. And surely hardly a day goes by in which we do not invent or improvise some new method in our business or our work. The creative instinct is fundamental in our makeup. A child playing with blocks on the floor is direct proof of this. Invention is the intelligent use of imagination.

Originality is a passion with most Americans. We can truthfully say that America has been the cradle of radio development as far as broadcasting is concerned. We shall continue to set the pace. And not a few of the new contributions to the art will be made by our novices and fans. Indeed this is already true. During the past year several hundred patents have been applied for by men who know very little about the art. We must understand that it is not always the engineer or the scientist who sees the improvement first. Some of them are so close to the problems that they cannot see them or at least their solutions. It is the old story of not seeing the forest for the trees. There are many of our technicians so steeped in the technicalities of their art that their imagination is atrophied. A lively, practical imaginative faculty tempered with a little knowledge has a very good chance of developing worthwhile ideas. It is to men with imagination of this type that the writer is addressing this article.

One need not search long or hard for radio problems to solve. Radio broadcasting is a wonderful thing, but not nearly so wonderful as it is going to be after the problems outlined in this article are solved. They are not imagined improvements but recognized problems that all engineers agree upon.

There can be no possible doubt that radio frequency will one day replace the ordinary type of regenerative circuit. The regenerative receiver is developing into a profound nuisance in congested areas. It is a disturber of the radio peace, sending out, as it does, a howling wave of its own. The fellow next door who is trying to tune cannot complain if he picks up this howl since it is purely a game of put and take.

The solution of this problem is radio frequency. The handwriting is on the wall in large crimson letters. In England a law has been passed preventing the use of the regenerative outfit.

But radio frequency outfits have their shortcomings also. There are certain fundamental problems which must be solved. Most of these problems center around the radio frequency amplifying transformer. We need transformers that

can be tuned, so they will respond to a fairly wide range of wavelengths. This is what would appear to be a simple problem, yet the writer is in a position to know that there is a considerable financial reward awaiting the person who can solve it.

Equally important is the problem of the variable grid leak. Of course it would be easy to produce a sliding contact on a piece of carbon smeared cardboard, and there are some leaks in the market embodying this principle. But this is a crude arrangement which is unable to stand up under service. A few hundred trips of the contact across the resistance element ruins it. Then too, we must always keep in mind the fact that the resistance element must be positively non-microphonic. A device the least bit microphonic would only contribute to the volume of disturbing noises in the circuit. This problem is really a mechanical one and it would probably be better solved by a mechanical genius than by a radio genius.

We all know that a jack is a condenser. Its peculiar construction makes it so. It is a variable condenser too, since its capacity will depend upon whether the plug is in or out. Here is another mechanical problem as well as an electrical one. We want jacks that have no capacity. Not just a little, nothing less than none will do.

Among the more practical problems that await solution we find the filament rheostat. We have many nice rheostats on the market to be sure, and most of them are well worth the money we pay for them. However, the very nature of the construction of the rheostat means comparatively crude adjustment through coarse current regulation. The best we can do is to adjust the rheostat to a space of one turn of wire. If we could take the same amount of wire and arrange it in a small coil wound in the form of a spiral we could get much better current regulation and closer adjustment of our vacuum tubes. Here again is a strictly mechanical problem applying to the radio field.

The loud speaker is the next on the list. In mentioning the loud speaker the writer does not wish to be misunderstood. He is not condemning the speakers upon the market, but simply citing a problem in connection with them which is recognized by every engineer. In the loud speaker we depend upon a vibrating diaphragm for the reproduction of sound. Back in the physics class at high school we learned that every body had a "period" of its own—that is, a body of certain dimensions will respond best to one particular frequency. We cannot depend upon one body of a given di-

mension to give perfect reproduction over a long band of frequencies. However, this is what we ask the diaphragm in the loud speaker to do. We call upon it to do the impossible.

Can a loud speaker be made that will not depend upon the movement of metal masses for the reproduction of sound? Some years ago a Dutch physicist invented what he called a "Thermaphone." The thermaphone was made up of a very small wire sealed in a glass tube. The tube was small enough to be inserted in the ear. Voice carrying currents passing through the tube would have a heating effect upon the wire and this heating effect of course fluctuated with the current. When the wire was heated the air in contact with it contracted and expanded in sympathy with the current passing through it. The result was that sound was reproduced without a diaphragm. Cannot this principle in some way be employed in radio loud speakers?

Under certain circumstances an ordinary fixed condenser can be made to reproduce speech. Perhaps something might be worked out of this hint.

There is the problem of the cheap crystal amplifier. We must look upon the crystal as the one perfect detector and rectifier. It bows to the vacuum tube only when it comes to amplification. If we could amplify with crystals, reproduction would be absolutely perfect as far detection was concerned.

If we had a simple method of sharp tuning, radio development would be put ahead ten years. This is not an exaggeration. Sharp tuning would solve many of our radio commercial problems from the standpoint of broadcasting at least. Sharp tuning means minimum interference. It also means that we can have more broadcasting stations working on different wavelengths. For instance, if we had a receiver that would distinguish between the stations of 360 and 365 meters we could have more stations in a given area. At the present time some of us have difficulty in separating the 360 and 400 meter stations. This problem of sharp tuning not only relates to receiving sets but to transmitters as well. We want some tuning device for our broadcasting stations so that their wavelength will not vary from day to day as it now does. What our transmitters need is some device that will act like a steam engine governor to keep them on one wavelength.

If there is a radio heaven, it is the heaven of sharp tuning. Our amateurs could then have all the fun they wanted in transmitting and they could use heavier power than they are using now.

*Continued on page 84*



# Getting the Most Out of a Dry-Cell Tube

By Arther Gordon

*Here are explicit instructions for building and operating a single circuit regenerative receiver with a dry-cell tube. Notwithstanding the simplicity of the construction with honeycomb coils it may be depended upon to give good results.*

A SET that is designed primarily for the radio novice and yet which has proven itself capable of truly remarkable D X reception, is the single circuit regenerative outfit described in this article. There are several original points in its construction, and the entire set is the result of several months intense experimentation with dry-cell tubes. It is the belief of the author that no other circuit is better adapted to the new  $1\frac{1}{2}$  volt detectors than the one shown here.

The instruments comprised are one variable condenser, one grid-leak condenser, one vario-coupler, one rheostat, one tube socket (for dry-cell tubes) and the tube, which may be either a WD 11 or a De Forest  $1\frac{1}{2}$  volt tube. With the latter, the regular sized tube socket may be used. If the former, a special socket, of which there are several types on the market, will be necessary.

With this simple lineup of instruments wonderful results have been obtained. While being tested in Waukegan, Michigan, the set brought in KHJ, Los Angeles, and WBZ, Springfield, Massachusetts, and all stations in between. In Fall River, Mass., the set has brought in WOC, Davenport, Iowa, with no trouble. The reception is clear and without distortion. The set is easy to operate, since it has no multiple taps on the tuner, and only

two main tuning dials, one for the 43-plate variable condenser in the antenna circuit and the other for the movable coil of the vario-coupler.

Amateurs following the design of this set are not taking any chances. The results are guaranteed, provided, of course, that a reasonable amount of care is taken in assembling the various recommended parts. The ability of any circuit to tune sharply and over a wide range depends to a large extent on the care and scientific precision with which it is built and assembled.

The panel is 7 in. by 14 in. It is screwed to a wooden baseboard  $\frac{3}{4}$  in. thick and 5 in. wide. Dimensions for drilling the holes in the panel will be found in Fig. 1, which is also the assembly view of the set, showing how the various instruments are lined up in relations to one another.

There are eight binding posts on the face of the panel, and their use is indicated in Fig. 2. Two 3-in. dials are used for the condenser and vario-coupler, while the appearance of the rheostat will depend largely upon the type used. In this case a scale was mounted as shown. The terminal markings were engraved upon the panel with a sharp steel point, and then filled in with white ink. A cabinet may be made later, but at first it is better to have only the panel and the baseboard.

The honeycomb tuner or vario-coupler employs two honeycomb coils, the movable one of 50 and the stationary one of 75 turns. The movable coil is the antenna inductance, while the larger coil is the feedback inductance. Having this feedback inductance stationary is a departure, but the results justify the change.

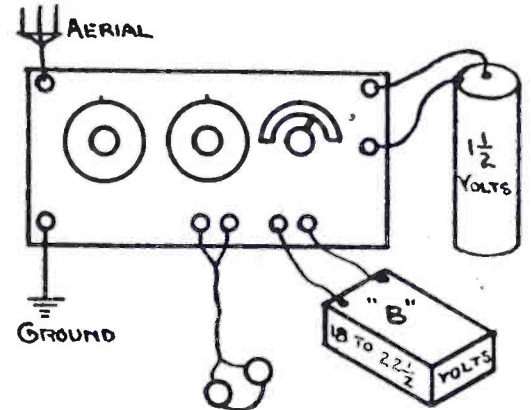

Fig. 2. Sketch Showing Functions of Eight Binding Posts.

The honeycomb coils may be bought or made. In making them, the amateur should pay particular attention to getting the number of turns just right. If too much wire is put on the primary coil, the initial wavelength will be greater than the wavelength of broadcast stations, and no music or speech will be heard. If too few turns are made, the efficiency of the set will suffer.

In winding honeycomb coils, take a cardboard tube  $2\frac{1}{2}$  in. in diameter and, with a pencil, mark off two sections, each 1 in. wide. Leave plenty of room between these sections so that you can wind both coils on the same tube before cutting them to size. Continue the pencil lines around the circumference of the tube and then stick

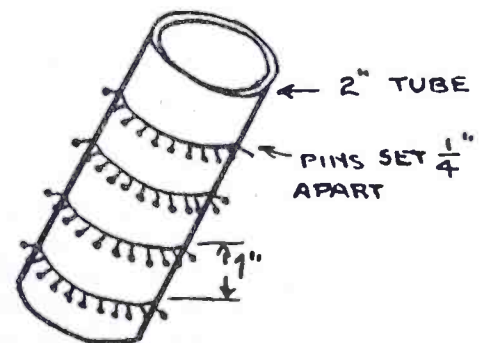

Fig. 3. Appearance of Tube Before Winding Honeycomb Coil.

in pins  $\frac{1}{4}$  in. apart. You will have something like Fig. 3. Now begin the winding.

Using No. 22 S. C. C., copper wire, start any place along one edge of the tube and wind diagonally across it to a pin-head on the other edge half way around the tube. At this point, make

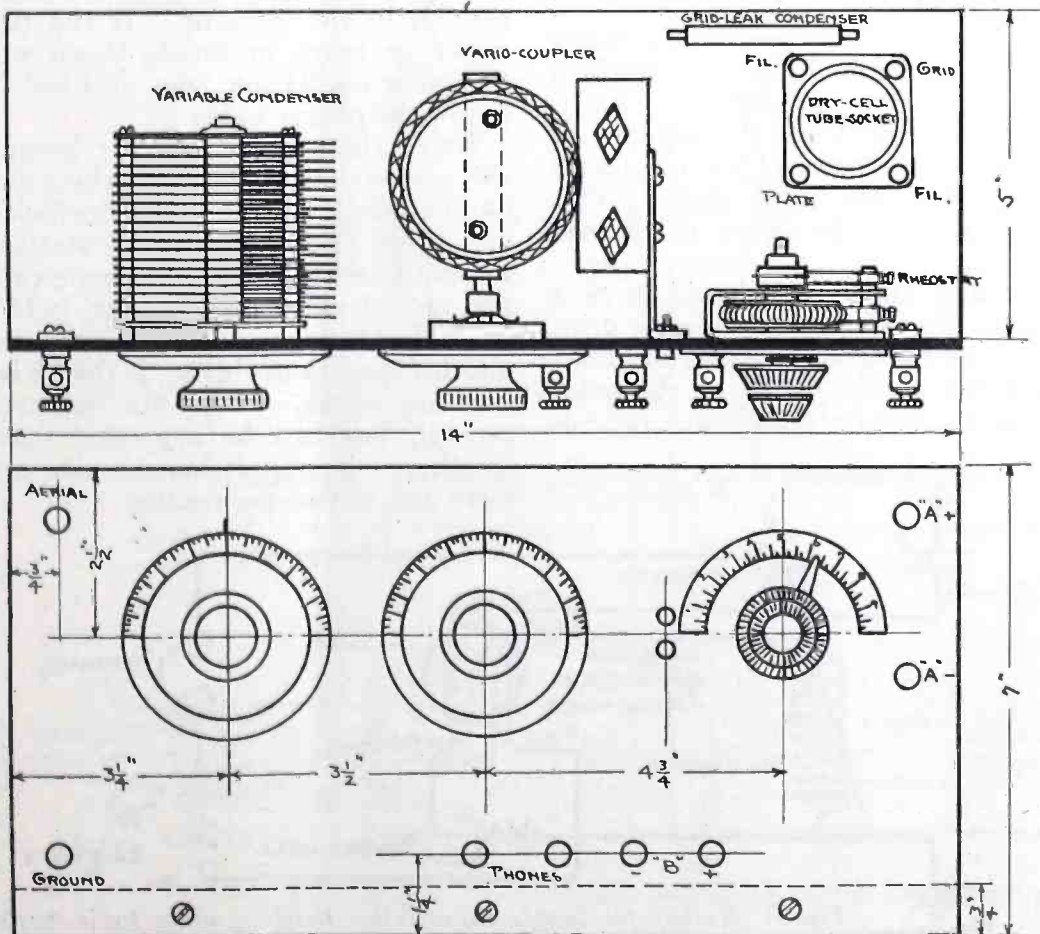

Fig. 1. Top View and Panel of Regenerative Set using Dry Cell Tube.



an angle and complete the turn, ending at the pinhead just beyond the starting point. Call this one turn. The second turn is made the same as the first, advancing one pin each turn, until the required number of turns are made. Since each succeeding turn "binds" the one which has preceded it, all the pins but two may be taken out when the coil is finished. These two are obviously the one which hold the last turn. When the coil is soaked in paraffine and is hard, even these two pins may be withdrawn.

thick. Six or seven layers of the excelsior in which the tubes come packed make good padding for the socket. The reason for putting a shock-absorber on the tube receptacle is not because the tube is delicate but whenever the cabinet is jarred, or the panel tapped with the finger or a pencil, the unprotected dry-cell tube gives out a loud microphone sound, which proves very annoying. The padding prevents this annoyance.

The plate voltage is determined only by experiment. It is never the

tube but for every particular tube as well. It is up to the amateur to discover the value needed for his own tube by experimentation.

No phone condenser is used.

Assembly of the various instruments is shown in Fig. 1. Wire carefully and accurately, using the single circuit regenerative hook-up given in Fig. 5. Solder all connections. Connect the batteries to their binding posts as shown in Fig. 2. Connect the aerial, the ground and the phones. Then the set is ready for operation.

Turn the rheostat until a sandy noise like the beginning of a phonograph record warns you that regeneration has set in. If no such sound is heard, do one or more of the following things:

1. Reverse the leads to the stationary coil. The turns in both coils must go in the same direction before the set will regenerate.

2. Reverse the leads to the B battery.
3. Reverse the leads to the A battery.

Regeneration secured, turn the dials until a shrill whistle is heard. This whistle is the carrier wave of a 'phone transmitting station. Carefully adjust the variable condenser and the vario-coupler until this whistle disappears and in its place is a distorted and swollen something that sounds as though it might be a voice, a song or an orchestra, as the case may be.

Now cut down the filament voltage with the rheostat and you will notice that as the proper voltage is neared, the music clears itself out, and the attendant noises disappear. When this happens, close adjustment of the other two dials will complete the tuning to perfection.

If you hear a continuous hum in your head-pieces, there is a broken connection in the hook-up. If the tube clicks, or roars, or breaks down with excessive oscillation, the grid-leak is not of the proper value.

Don't think for a moment because this set is small and has only three dials on the panel, that it is also inefficient and good only for local stations. Fifteen hundred miles on a single tube, and on a dry-cell tube at that, is DX work that is not to be laughed at. And another quality of this set is that it is a sure-fire outfit. It is not temperamental, but can be depended upon, weather only permitting, to give uniform and unvarying results.

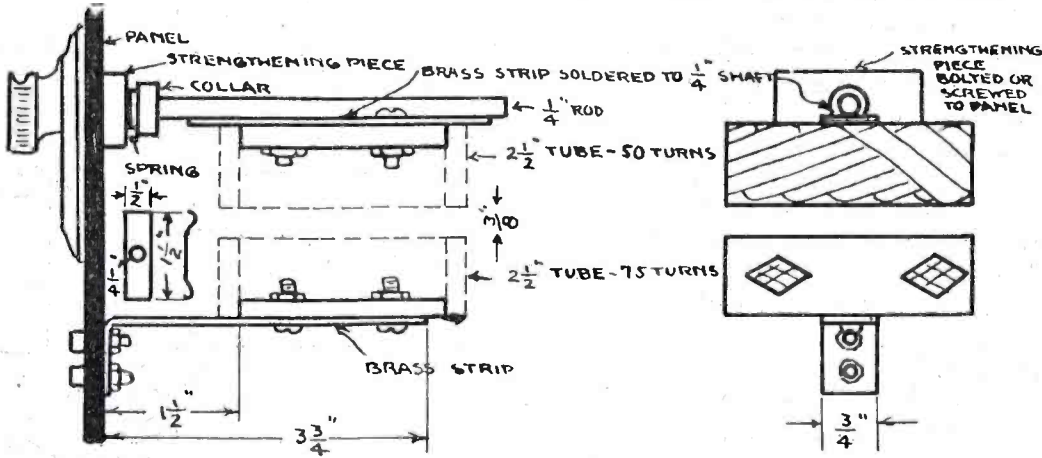

Fig. 4. Honeycomb Tuner details, showing method of mounting.

The fixed coil is mounted on the panel by a piece of heavy brass, cut as per the dimensions in Fig. 4. The movable coil is mounted so that it is in the same plane as the fixed coil. The assembly view shows the movable coil at right angles to the fixed coil. In this position the self-inductance is at a minimum. When the two coils are placed parallel to one another, as in Fig. 4, the self-inductance is at a maximum.

In mounting the movable coil on the panel, it is necessary to give the 1/4 in. brass rod bearing surface. This is done by a strengthening piece of fiber or wood bolted, or screwed, to the panel. A shoulder—soldered on to the brass rod—fits against this strengthening piece with a small piece of spring brass between, the shape of which is shown in a small insert sketch in Fig. 4. This arrangement is ideal, and permits of complete rotation of the coil. However, other ways may suggest themselves to ingenious amateurs.

The rheostat to control the current lighting the filament should be vernier of the highest grade. When the filament is getting just enough voltage, no more and no less, the reception of signals is truly remarkable—the music is clear, undistorted, and minus the scratches and undertone whistles so frequently the rule in vacuum tube reception. When too much voltage is supplied to the W D II filament, the signals begin to get noisy and distorted.

The tube socket will have to be of a special make for a W D II tube. The De Forest dry-cell tube, however, fits the ordinary six-volt tube socket. In fastening the socket to the base, put it on a cushion of felt about 3/4 in.

same for any two sets, even although constructed in the same manner. Some users of the dry-cell tube say that the plate should have not less than 40 volts, while others assert that they have never used more than 18 1/2 volts. From 15 to 22 1/2 volts is about the proper range of "B" battery voltage to have on tap. Each station received with a W D II tube has an individual requirement in the way of plate voltage, and strangely enough, the DX work comes in on the lower voltages.

The condenser for tuning the antenna circuit is a 43-plate variable. It is placed in series with the antenna as shown in the hook-up. It is shielded from the panel to prevent body capacity. The wire from the antenna is fastened to the rotor of the condenser instead of to the fixed plates. This also minimizes the effect of outside capacity.

The grid condenser should have a capacity of .00025 mfd. while the grid-leak should have a resistance of about 2 megohms. The value of the grid-leak varies, not only for every type of

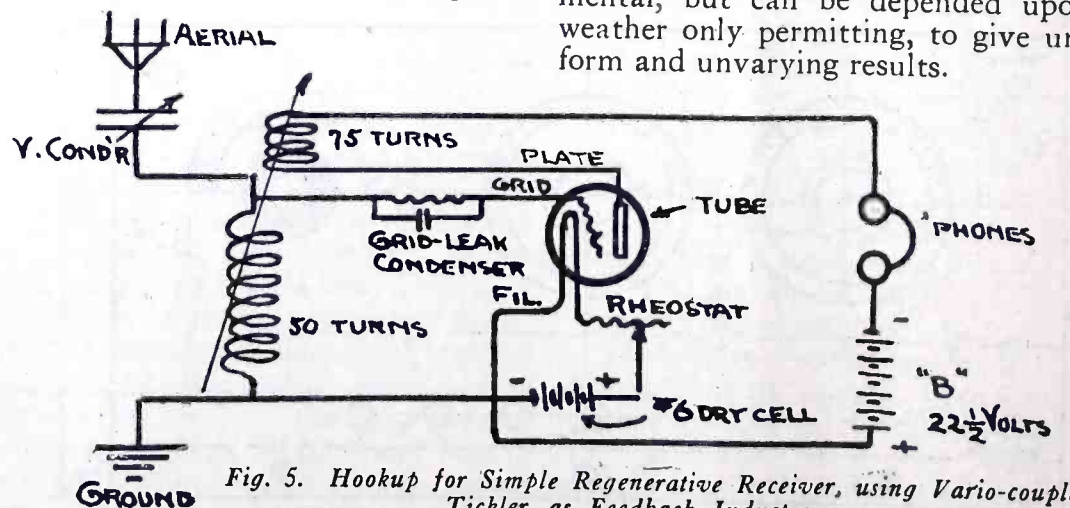

Fig. 5. Hookup for Simple Regenerative Receiver, using Vario-coupler Tickler as Feedback Inductance.



# Reflex Circuits

By Arthur Hobart

*Most of the descriptive articles published in these columns are of sets that have been tried out so often that results can be guaranteed. But the adventuresome experimenter wants to try out new hookups. These suggestions are offered for trial.*

**F**OR the amateur who enjoys trying out new hookups considerable interest will be found in the "reflex" circuits in which one tube is made to function as both a radio and an audio frequency amplifier. Most of these circuits are adaptation of the circuit originally proposed by M. Latour, a French engineer and mathematician. The most successful employ a crystal detector.

One practical circuit is that used in the De Forest D7 Reflex receiver as shown in Fig. 1. By means of three tubes and crystal this hookup gives three stages of radio and two stages of audio frequency amplification. Connections are shown for either an outside aerial and ground or a loop aerial. Especially good results have been obtained by using C301 A tubes.

A good hookup for the beginner is the one-tube set devised by William Priess of Boston as shown in Fig. 2. This calls for a variocoupler with .001 mfd. vernier condenser in series with the stator and .0005 mfd. vernier condenser in parallel with the rotor; one audio frequency and one radio frequency transformer; crystal, tube and socket; 200 ohm potentiometer; one rheostat, 3 .002 mfd. mica condensers, one tube, 2 45 volt B batteries, 1 A battery and phones.

To operate, after adjusting the cat-whisker until a sensitive point is found on the crystal, the tube is lighted by

*Continued on page 28*

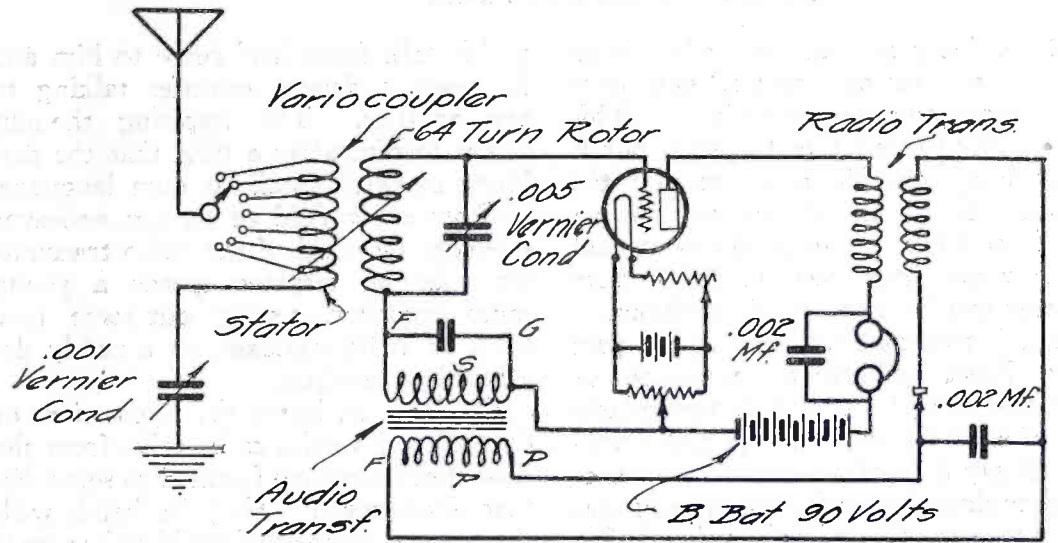

Fig. 2. Circuit Diagram for One Tube Reflex Circuit.

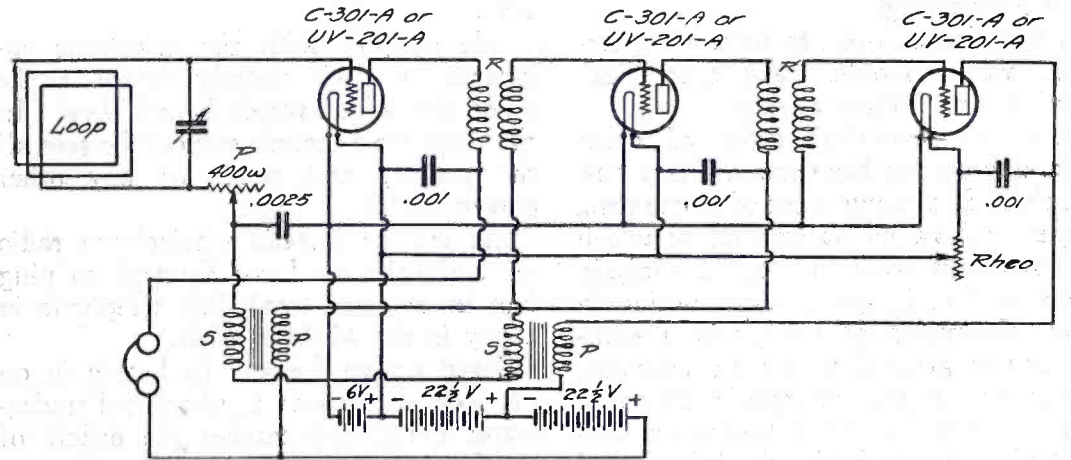
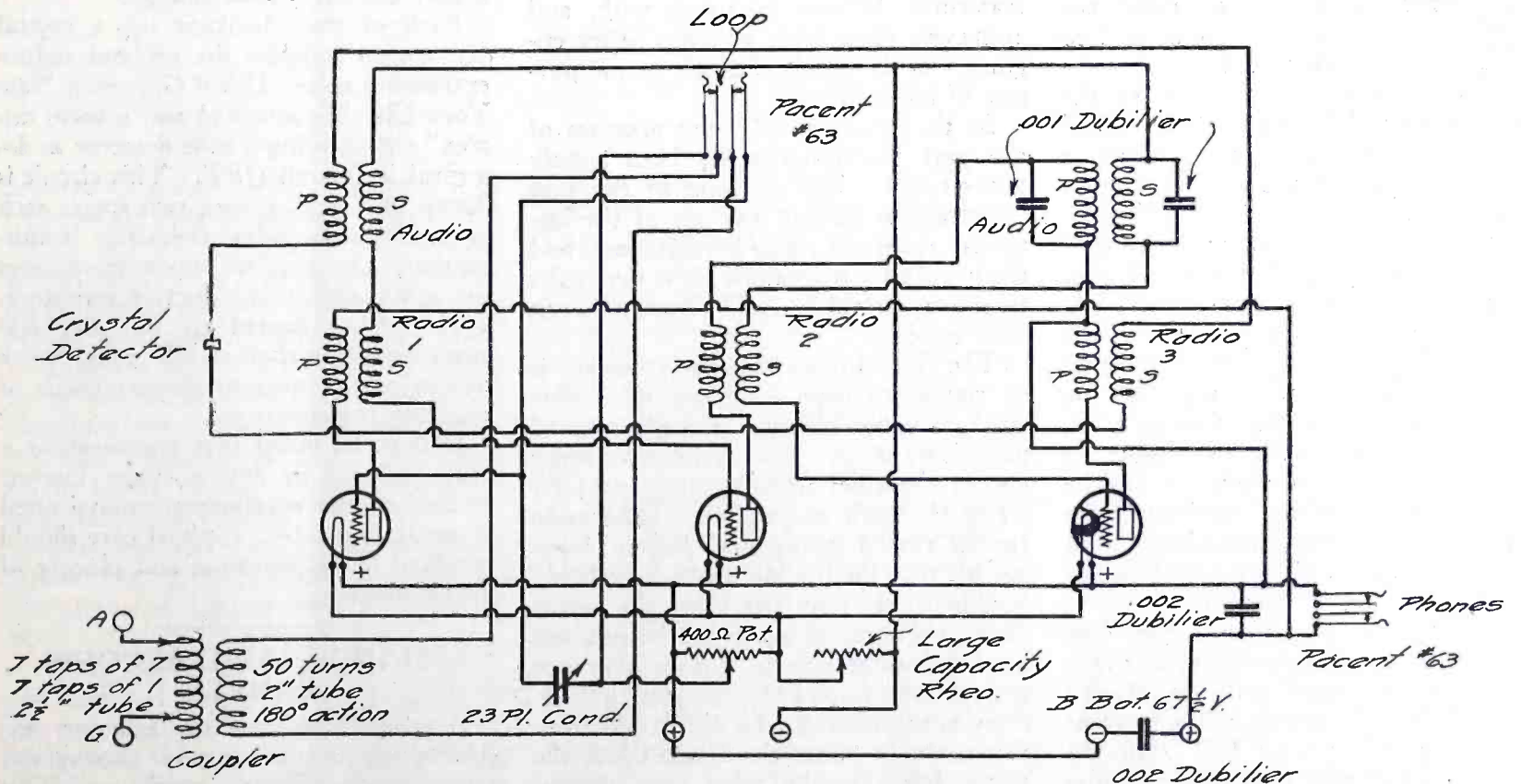

Fig. 3. Three Tube Reverse Duplex Circuit.

Loop: 20 turns on 1 1/2 in. frame. Tuning condenser .0005 mfd. R radio frequency transformers, SP audio frequency transformers, P 400 ohm potentiometer.



*Use all amplifier tubes*

Fig. 1. Circuit Diagram of De Forest D-7 Reflex Receiver.



# Radio---A Liberal Education

By E. F. W. Alexanderson, Chief Engineer, Radio Corporation of America

*The question sometimes arises in a home as to whether the boy is wasting his time while playing with radio. Here is an answer from an eminent engineer who thinks that radio is very much worth while.*

**A**N eminent specialist on administration told me once that all executives should have engineering training. This has not been possible in the past, but it is becoming possible now, because the scientific education of our engineering schools and institutions produces trained minds which have been found to have superior qualifications in all positions.

If it is true that engineering is a part of a liberal education, alongside of mathematics and Latin, it is particularly true of electrical engineering, and I venture to say that of all branches of electrical engineering, radio engineering has the greatest educational value. To prove this thesis I should like to point out some of the interesting aspects of radio engineering.

A technical subject, to have an educational value, should have theoretical, practical, and human aspects.

From a theoretical point of view, radio engineering has extraordinary possibilities. It presents a set of phenomena of the most varied nature, all of which are capable of exact and logical analysis. Wave motion in space, wave motion in wires, absorption of energy in a semi-conducting ground under an antenna; oscillating circuits, electronic discharge in vacuum under the influence of electric and magnetic fields; the behavior of iron in a high frequency magnetic field, etc., almost ad infinitum.

The practical aspects of radio engineering are no less numerous, and so well known that they need not be mentioned specifically. In relation to the experimenter and educator, the practical aspect of the technique has, however, a greater significance than in any other branch of engineering. Other theoretical experimenters must work under artificial conditions in a laboratory, whereas the radio experimenter is in touch with the ultimate realities. He has the whole world for his laboratory, and therein he may choose at will what assistance he desires for his various experiments.

He may mingle with his fellows in the vagaries of short-wave work, and he may reach out over the continent some night with his own transmitter, even spanning the Atlantic when all conditions happen to be in his favor.

He may prefer to gather in the "free speech" that, so appropriately, is available in this country of ours, and, by enlarging the tiny incoming words to giant size, he can fill a huge hall with the whispers of someone hundreds of miles away. He may listen to the ships dotting the ocean, or he may choose the longer wavelengths till the giant voices

which talk from land come to him and he hears a dozen countries talking to one another. The inspiring thought comes to him after a time that the majority of them speak his own language.

Over every field of human endeavor stretches the field of the radio transmitter. In an airplane speeds a young radio engineer, testing out some new form of radio compass, or a newly developed transmitter.

On land, he learns the fascinations of the railroad world, as he talks from the Twentieth Century Limited to some distant signal tower. He joins hands with the entertainers of the world as he speeds their joyousness, through the medium of the broadcasting station, to lonely homes afar.

He mingles with the telephone engineers, in their orderly mazes, as he sends the wired words by wireless. In the huge transoceanic stations he sees all the solidity and order of any other power station.

At sea, he installs a telephone radio set and calls up Land Central to plug him in to some local desk telephone in a city in the Middle West.

Even under the sea, he listens in on the loop antenna of a submerged underwater craft, and catches the orders of the flagship above.

The radio engineer is one of the most broadminded of the entire engineering fraternity, because he meets with, and exchanges ideas with so many other engineers of divergent callings, in the pursuit of his daily task.

In the amateur field, the progress of the past few months has been simply phenomenal. The opening of the first broadcasting station was one of the historical events of radio development, and the popularity it attained grew overnight to enormous values. The reason is not hard to seek.

The chief joy of amateur receiving is of course to copy someone, to receive an intelligible message, the pleasure of participation in communication being one of the chief urges driving mankind along the path of progress. The same feeling that a young man has on copying his first intelligible message probably is akin to the joy that filled the breast of the primeval savage when he received his first smoke signals, but to everyone present who knows the telegraphic code there are thousands who don't, and from the ranks of those thousands came the many who bought what are termed "broadcasting receivers" during the past few months.

The possibilities of this wholesale dis-

tribution of news-without-a-time-interval are myriad, even greater than were the possibilities of the daily press in its inception. Here we are independent of train service, of airplanes, of the rural free delivery wagon; theoretically, every person in the United States can be personally spoken to by our President at one and the same time.

We have here great possibilities of advertising—of propaganda—and may it be wisely used—of the nationalization of the opera and the stage. If wisely used, this radio broadcasting can be made into a tool to unite this great country of ours even more closely than it is united today, for the news will know no time limit. A speech by the President of the United States will be heard in San Francisco before it reaches the ears of the more remote of his personal audience in Washington. An appeal to the people can be made a matter of moments and not of months, or days. Radio broadcasting faces a stupendous future.

## REFLEX CIRCUITS

*Continued from page 27*

tuning the rheostat till a high note is heard in the phones. Then turn the potentiometer until this noise is eliminated. Next tune in with the primary condenser until music is heard, readjusting the varicoupler and secondary condenser until it is loud enough.

Each of these hookups use a crystal detector to stabilize the set and reduce extraneous noise. David Grimes of New York City has invented an "inverse duplex" circuit using a tube detector as described in March *QST*. This circuit is shown in Fig. 3, giving two stages each of radio and audio frequency amplification. It requires mica condensers and a 400 ohm non-inductive resistance. It is better adapted to 360 and 400 meter reception than to 200 meter work because of the inherent characteristics of available transformers.

It is to be noted that regeneration is not employed in any of these circuits because of the paralyzing action caused by oscillating tubes. Special care should be taken in the selection and placing of the condensers.

## PHONOGRAPH RECORD PANELS

A good "Kink" for the amateur constructor is to use an old phonograph record as a panel for a crystal set. This is an excellent insulator, costs little or nothing and can easily be mounted in a hat box, tin pan or chafing dish base.



# Modulation Systems in Radio Telephony

By L. R. Felder

*This article presents a simple, descriptive summary of the several modulation systems that have proven practical for amateur use. The author's recommendations will be found helpful to the constructor of a radio telephone set.*

**T**HE type of modulation system largely depends upon the generator employed to produce the radio frequency oscillations. Thus a system suitable for a vacuum tube generator might be unsuitable for an arc generator.

In general, modulation system may be classified as to how the modulation is accomplished, whether by varying the output or the wavelength of the radio frequency oscillator. The former is the more practical, as the latter produces interference due to the fact that the radiated energy is distributed over a wide band of wavelengths.

Modulation system dependent upon variation in output may be further classified as *absorption* or *non-absorption* methods, according as the modulator does or does not absorb energy from the oscillator.

Wavelength modulation is usually accomplished with the condenser microphone.

This consists of the usual mouthpiece and diaphragm, the latter being attached to a series of plates which are movable

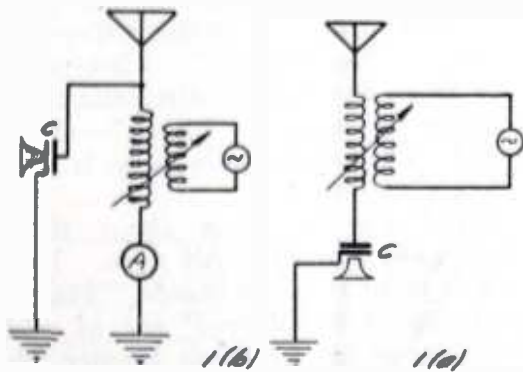

Fig. 1. Connections for Condenser Microphone.

relative to a fixed series of plates. The microphone may be connected as in Fig. 1 (a) or (b). When the microphone is spoken into, the voice waves move the diaphragm and hence also the movable plates, thus altering the capacity of  $C$ . The motion of the plates is proportional to the amplitude of the speech waves, and therefore the capacity and wavelength are also proportional to the amplitude of the speech waves. In this way speech modulation is effected. However, the method has the great disadvantage of broad tuning and interference and is therefore not used in amateur transmitters.

With regard to variation of output, the first and simplest method is the use of the standard carbon microphone in series with the antenna, as shown in Fig. 2 (a). Other methods of connection shown in Fig. 2 (b), (c), (d), reduce ultimately to circuit in Fig. 2 (a), and have the same effect as the direct micro-

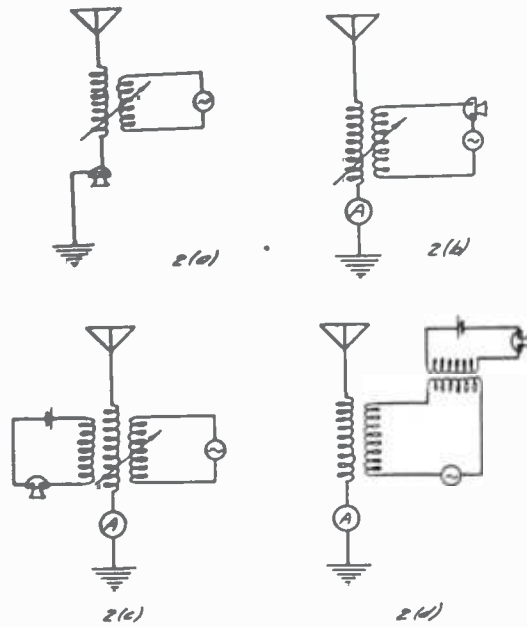

Fig. 2. Connections for Carbon Microphone in Series.

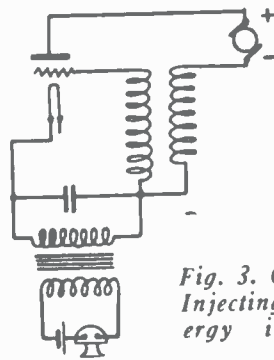

Fig. 3. Connection for Injecting Speech Energy into Oscillator Grid.

phone-in-antenna system, since the microphone can be transferred into the antenna by the usual transformer relations.

The manner in which modulation is here accomplished is quite well known, namely, speaking into the microphone alters its resistance and hence the output. This variation of the output is proportional to the speech variations. Since the microphone consumes a certain amount of energy due to its resistance this system is properly an absorption system. It may be used with any kind of radio frequency generator. The maximum modulation effect is produced when the maximum microphone resistance (or its equivalent if placed in a coupled circuit) equals the antenna resistance.

Since the microphone is a low power device and the manner in which it is here used requires the passage of the r. f. current through it, it is best used on low power sets. As soon as it is used on high powers in the manner described difficulties arise, such as packing of carbon microphone due to overheating, distortion of speech, etc. Consequently it becomes necessary to employ, for higher powers, microphones in parallel or spe-

cially cooled microphones in order that the heavy currents can be accommodated. This is a difficult problem, and very inconvenient. Consequently where powers of any appreciable magnitude are involved this method should be avoided. It is quite satisfactory for sets of about 5 watts output at the most.

Since the use of the microphone in controlling radio frequency directly is limited to such low powers it is necessary to employ other means of control for greater powers. The vacuum tube possesses properties which make it readily suitable for such control, and a series of modulation methods utilizing these properties have been developed. These will now be considered.

The first and simplest method is applicable only to vacuum tube oscillators, and consists in injecting the speech energy into the oscillator grid, as shown in Fig. 3. The speech voltages in the

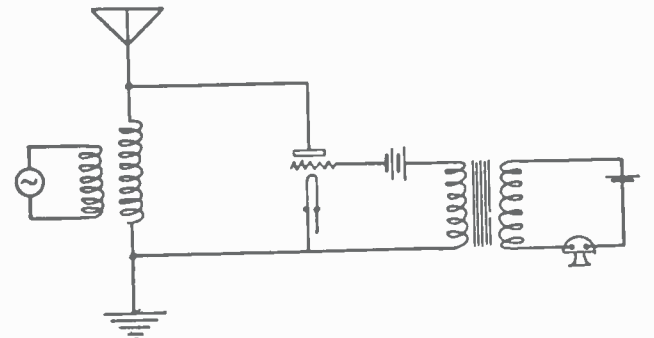

Fig. 4. Absorption System with Vacuum Tube.

microphone circuit are stepped up in the secondary of the induction coil and applied to the grid of the oscillator. The average potential of the grid is thus varied and therefore the plate current is controlled by the speech, and hence also the output. When the microphone is not spoken into the grid it is at its average potential and the oscillator supplies normal average output. When the microphone is spoken into the grid voltage swings above and below this mean potential and thus increases and decreases the oscillator output. Thus this system may be considered a non-absorption system if the rises and falls neutralize each other. This method is very satisfactory on low powers as far as articulation and percentage modulation go. For high powers, although it is possible to secure complete modulation, there is considerable distortion of speech and instability of oscillations. This method is admirably suited to amateur sets up to about 20 watts output.

An absorption system of modulation employing vacuum tubes, which may be used with any type of radio frequency generator is the one in Fig. 4. The



principle of this system is the use of a resistance in parallel with a portion of the oscillating circuit, which resistance can be varied by speech. Here the variable resistance is the internal resistance of a vacuum tube which is connected across the antenna loading coil and ground. The grid is kept normally at a very high negative potential thus preventing any flow of plate current, and the output in the antenna is normal oscillator output. When the microphone is spoken into the audio voltages vary the mean grid potential, and as it becomes more and more positive the valve resistance becomes less and withdraws energy from the antenna circuit. Thus energy from the antenna is absorbed by the modulation valve in proportion to the decrease in the negative grid potential produced by the speech voltages. In this way modulation of the r. f. output is effected. This system is adapted to the higher powers and may be used with any of the systems of undamped oscillation generators.

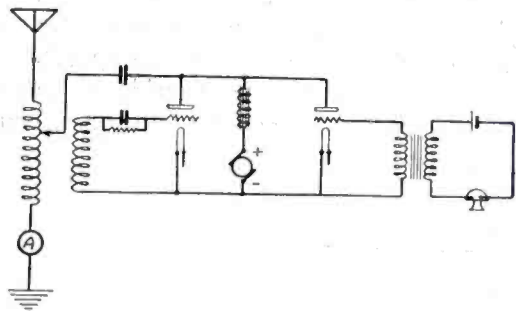

Fig. 5. Constant Current Modulation System.

The most popular and widely used system of modulation employing vacuum tubes is the system called "constant current modulation," the circuit of which is shown in Fig. 5. It is one of the most effective and efficient systems and is capable of being used for any power of the oscillator. It is used solely in conjunction with vacuum tube oscillators.

The manner in which modulation is effected in this system will be readily understood from the following explanation. As will be seen from the diagram in Fig. 5, there is one oscillating tube and one modulating tube. The modulating tube develops large audio frequency voltages which modulate the radio frequency output in the following manner. Upon speaking into the microphone, the average grid potential is varied by the speech voltages generated in the secondary of the telephone induction coil. These variations in grid potential affect in a similar manner the plate current of the modulator valve, with the result that an alternating audio frequency voltage is developed across the iron core inductance  $L$  in the modulator plate circuit. This audio frequency voltage is proportional to the speech voltage and, since the modulator tube is in parallel with the oscillator tube, combines with the voltage on the plate of the oscillator tube. Therefore on the posi-

tive wave of the audio voltage the oscillator plate voltage increases, and hence also the output. On the negative wave of the audio voltage the oscillator plate voltage decreases, and hence also the output. In this way modulation is effected. Since the modulator not only effects a decrease in the oscillator output but also

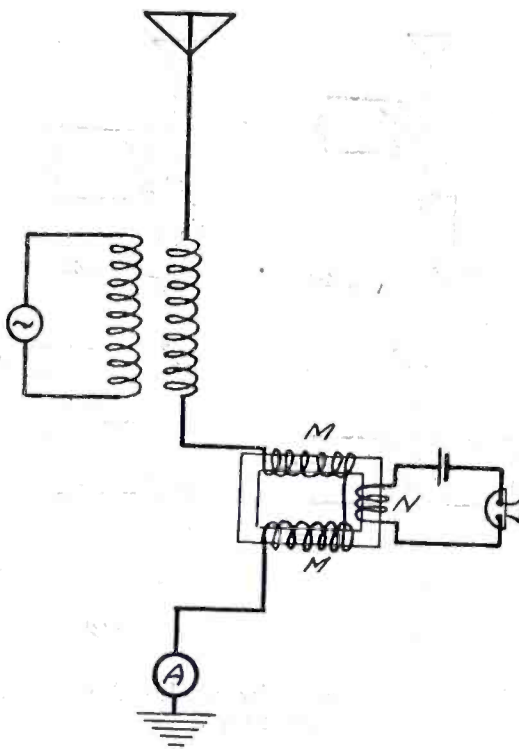

Fig. 6. Magnetic Modulation System.

supplies a corresponding increase the system is a non-absorption system. Of all the modulation methods employing vacuum tubes this one will be found to be superior to the others, giving better control and better articulation. This system is the most frequently used in commercial practice.

The above methods employing vacuum tubes in modulation cover the most important and the most practicable in that group. We will now consider another group of methods employing a different principle, namely magnetic modulation. This system may be used with any type of radio frequency generator and is adapted to any power. It has been used in commercial practice with r. f. alternators and has therefore handled powers over 50 kw.

Fig. 6 represents a simple circuit in which magnetic modulation is employed.  $A$  represents any radio frequency oscillator coupled to the antenna.  $MM$  represents two coils wound around an iron core, the coils being wound in opposite directions so that the resulting radio frequency induction in  $N$  is zero.  $N$  represents the direct current magnetizing coil, in which circuit the microphone is connected. When the microphone is not spoken into the direct current through coil  $N$  magnetizes the iron to a definite extent, and due to the radio frequency current through  $MM$  the iron losses have a definite magnitude. These iron losses are therefore equivalent to the losses in a given resistance in the antenna. When the microphone is spoken into, the current through the magnetiz-

ing coil  $N$  varies with the variation in speech intensity, and therefore the magnetization of the iron core varies also. Hence the losses in the iron vary, which is equivalent to varying the effective resistance of the iron core and thus varying the antenna output as the speech is impressed on the microphone. This system is an absorption system since the iron losses are equivalent to an absorption of energy from the oscillator.

### "BLOOPING!"

By EARL ENNIS

DAY by day, in every way, the air is getting "bloopier" and "bloopier!" If there is a motto which should be learned, it is: "Bloop not, lest ye be blooped!" And thereby hangs an oscillation.

The "blooper," in the words of the cynic, is "one who bleeps." To "bleep," one turns up the lamp of one's receiving set until it glows like a lighthouse off the coast of England and starts hunting for a distant radiophone. The action is accompanied by a violent wiggling of the tickler. The result, for everyone else in the neighborhood, is a series of wild whoops and yells. These are "bloops." When the neighbor quits, he has been "blooped."

Any evening, for instance. Listen in. "Bloop! Bloop! Bloop!" In all directions. Duets, trios, sextettes and whole choruses of them. Sometimes they vary a bit. "Yeow-bloop!" Caterwauls, back fence dissonances, chromatic colics, banshee yodelings. "Bloops"—all of them! The whole radio game is being "blooped" to death.

What can be done about them? Change the circuits? All right. Let's. It will be of common benefit. Many a good concert is "blooped" out of existence because an ambitious listener who took the sky for a limit, tried to hear a man playing a cornet behind a fence in Stavanger, Norway, while the rest of the world was tuning for Salt Lake.

England has put the crusher on "blooping" at the very outset of the game. Government regulations there provide that receiving sets must not oscillate, radiate or irritate. In the shadow of Buckingham Palace they are leading a peaceful and "bloopless" life while we in America are rushing toward national insanity.

Alas the "blooper" who plucks the strings of the night and twangs an ode to misery on his damnable "bloopischord!"

Synonyms: "Two minute rest"; "Two minute intermission"; "Two minute listening period"; "Two minutes off the air"; "Two minutes recess"; "Close down for two minutes"; "Close down for the customary two minutes"; "Close down for the usual period"; "Close down in compliance with government regulation."



# A Mechanical Rectifier for C. W. Transmitters

By J. W. Kidd

*Detailed directions are herein given for constructing a synchronous motor rectifier from a discarded induction motor. Its efficiency of operation may be judged from the fact that radio station 8KG, operated by the author, has been reported from 41 states and Honolulu.*

PROBABLY one of the most discouraging pieces of apparatus used in C. W. transmitters depending on a.c. for the source of supply is the rectifier. After having tried several different types of electrolytic rectifiers, with the usual success and disappointments, usually the later, I hit upon a scheme to rectify a.c. into pulsating d.c. mechanically.

An alternating current cycle represents the gradual rise from zero to maximum positive, to zero, to maximum negative, to zero. This is graphically illustrated by the heavy line *A* in Fig. 1. Since there are two changes of polarity, i.e., positive and negative to a complete cycle, the frequency is double the cycles or in the case of 60 cycle current, 120, and the interval of time required to complete any one of these rises and falls of polarity is 1/120 second, to complete a cycle 1/60

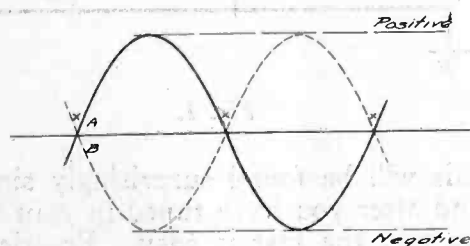

FIG 1

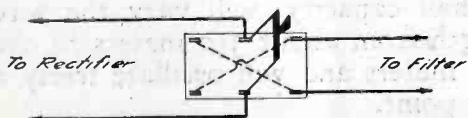

FIG 2

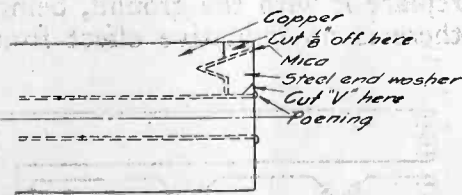
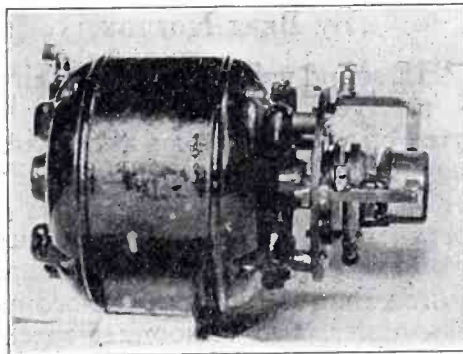

FIG 3

second. Therefore it follows that there are 60 times in each second when the polarity is in the positive half cycle, 60 times in negative half cycle and 120 times when the current flow is at zero.

In a two wire, single phase, alternating current system, when wire *A* is in the positive half cycle, wire *B* is in the negative half cycle, and vice versa; also when the current in *A* is at zero the current in *B* is also at zero. Since to have a direct current, one wire must be positive and the other negative, it is the purpose of a rectifier to permit only the positive charges occurring on wires *A* and *B* to pass on to wire *D* and the negative to wire *C*. There are several different methods of accom-



Completed Rectifier

plishing this but the method in which we are most concerned is the mechanical.

If it were possible to operate a double pole, double throw switch, connected as reversing switch. (Fig. 2) synchronously, i.e., so that the throwing of the switch would be in step with the frequency and at the point *X* on the sine curve (Fig. 1) would not the resulting current in the center posts of this switch be a pulsating d.c.? At commercial frequencies, it would be impossible to operate the switch, but a synchronous motor will solve our difficulty.

For those who do not have a synchronous motor, the item appearing in April 1921 issue of *QST* gives detailed instructions for changing a squirrel cage induction motor so that it will run at synchronous speed. It is often possible to obtain a second hand, induction motor from an electric washing machine dealer at considerable saving. It is preferable that the motor should have a four pole winding, which will run at from 1750 to 1850 r.p.m. and when changed to a synchronous motor the speed at exactly 60 cycles will be 1800 r.p.m.

Should your motor, after changing, indicate a speed, above or below 1800 r.p.m. do not be alarmed for even though the power company tells you that the frequency is 60 cycles, there is likely to be a 5% variation above or below, consequently a variation in speed.

The reversing switch is constructed from a commutator which can usually be obtained from an auto electric shop. It is best, tho not necessary, to procure a commutator with a number of bars that is a multiple of 4 i.e., 16-20-24-28. Since it is necessary to take this commutator apart it is best to secure one that may be dismembered by unloosening a lock-nut or a series of screws. This later type is hard to obtain; the usual type being one that is assembled on a tube and the ends of the tube poened over the end washers.

This type can be taken apart by chucking in a lathe and cutting away the poening; in order to have room to again poen when reassembled cut a V in the washer under the poening and just to the tube Fig. 3.

In reassembling the commutator, assemble one quarter of the total number of bars without mica between them, i.e., in the case of a 24 bar commutator, 6 bars. Then assemble 6 pieces of mica, then 6 bars, 6 mica and so on until the assembly is complete; upon completion the assembly will be a four bar commutator with mica insulator about 3/16 in. thick between each of the four bars.

When facing the commutator, cut about 1/8 in. off the ends of the copper bars, being careful to cut only down to the mica. This will make the face of the commutator 1/4 in. narrower and is done for the purpose of preventing a flashover to the end washer of the commutator. In order to strengthen the exposed mica, paint with a thin coat of shellac and while wet hold over a flame and burn in; repeat this process until the entire space left by cutting the bars away is completely filled with burned shellac.

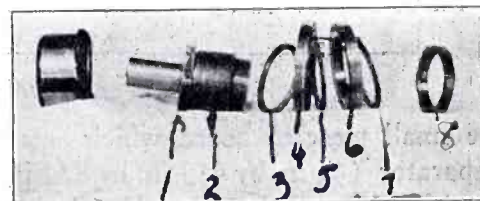

Collector Ring Assembly

The collector ring assembly is so clearly illustrated by the picture that a description is hardly necessary. No. 1 is an iron tube 1 3/4 in. long, threaded on one end to take a locknut; No. 2 is a fibre or hard rubber tube 7/8 in. long; No.'s 3-5-7 are fibre spacing washers and 4-6 brass collector rings; No. 8 is the locknut to hold the assembly together. The collector rings described were secured from a Gyro ceiling fan made by The Adams Bagnall Co., Cleveland, Ohio.

It may be possible to secure the assembly from them much cheaper than to have it made.

The collector ring and commutator are now assembled on a suitable bushing. The size of the motor shift, together with the bore on the commutator and collector rings, will govern the dimensions of this bushing so that no dimensions can be given that will apply in all cases. Bar 1 and 3 of the commutator are connected and sol-

*Continued on page 87*



## A NEAT MESSAGE BLANK HOLDER FOR YOUR STATION

By C. A. REBERGER

THOSE who are fussy about the appearance of their stations are bound to be interested in a neat looking holder for message blanks, which can be made in a few hours. It will eliminate having a number of blanks laying haphazardly around the operating table, and floor, and the time that is devoted to its construction, will never be considered wasted.

The holder should preferably be of oak,  $\frac{3}{8}$  in. in thickness and should have a good grain. White pine is cheaper and easier to work. As will be seen from the accompanying drawing, the holder has two "apartments," one for "received" messages and the other for "relay" messages, or any kind of message blank the builder may care to put in it.

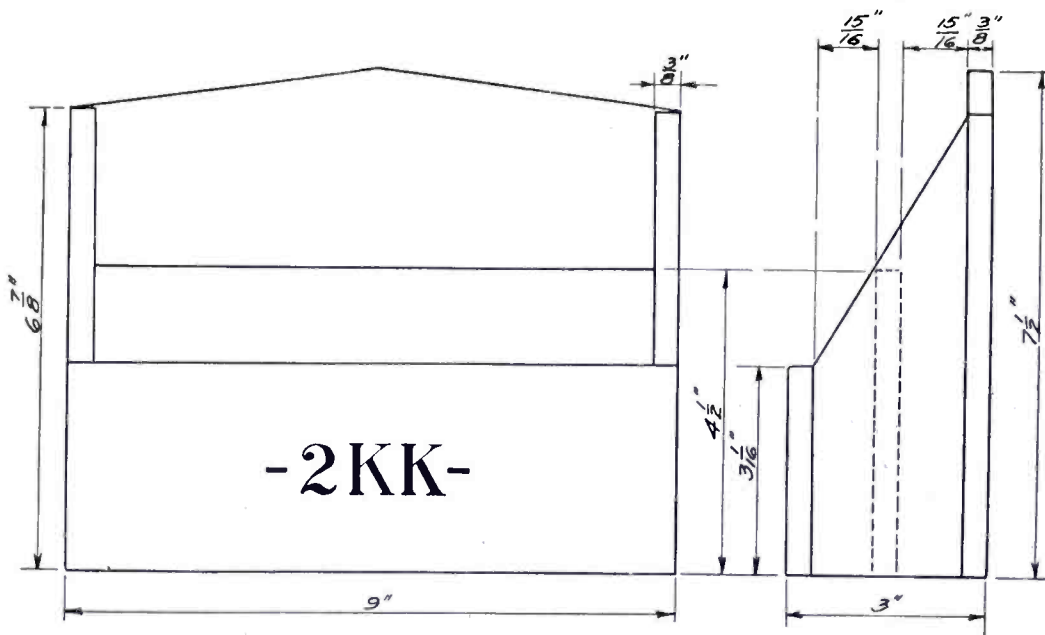

Constructional Details for Message Blank Holder.

The small piece of board which acts as a separator ( $3\frac{7}{8}$  in. by  $4\frac{1}{2}$  in. by  $8\frac{3}{4}$  in.) can either be nailed to the side pieces or grooved in. The latter is preferred, for a better looking job results and does away with the necessity of having nails showing from the outside. There are to be made two side pieces, 3 in. by  $3\frac{1}{16}$  in. by  $6\frac{7}{8}$  in. From the drawing it will be seen how these two pieces are cut and mounted. The front piece is 9 in. by  $3\frac{1}{16}$  in. in size, while the back board measures 9 in. by  $7\frac{1}{2}$  in. It will be noted that the highest peak of this board measures  $7\frac{1}{2}$  in. while the sides are only  $6\frac{7}{8}$  in. This is due to the design of this board, that is—the way it is cut so as to make a nice appearance when the holder is completed. Care should be exercised to see that the nails used are not too large, otherwise they may split the boards. By consulting the drawing we will be able to ascertain how the middle piece is mounted and how far it is spaced from the front and back boards. It will also be seen that a hole is drilled in the back board. This allows the message holder to be screwed to the wall, table or desk.

If it is desired, the builder may easily print his call signals on the front of the holder, which would tend to give it a much better appearance and at the same time, make the station look "classier."

## A "DIFFERENT" CIRCUIT

By BERT HORTON

THE sound volume of a single circuit receiver, combined with the high degree of selectivity of a three circuit tuner is the main feature of the set to be described. It will well repay the experimenter for the few minutes' work of assembling. Nothing more is required than is found in the ordinary variocoupler, two variometer regenerative receiver, and in comparison, in my own case, at least, the results

Especial attention is called to the fact that the variocoupler connections is the reverse of standard practice when the stator is the primary and the rotor the secondary. In this hook-up the rotor is the primary and the stator the secondary. The rotor should be wound with heavier wire than the stator.

In tuning, cut in as much inductance as possible in the primary of the coupler with the variable condenser within 15 or 20 degrees of zero. The secondary (tickler) coil should be coupled fairly close and  $V_1$  set at zero with  $V_2$  at maximum. Rotate the dial of  $V_1$  slowly until the familiar carrier wave whistle is heard and clear it up by loosening the coupling of the tickler and perhaps varying the grid leak resistance.  $V_2$  is used as a vernier, producing a relatively small change in regeneration. With the set before you,

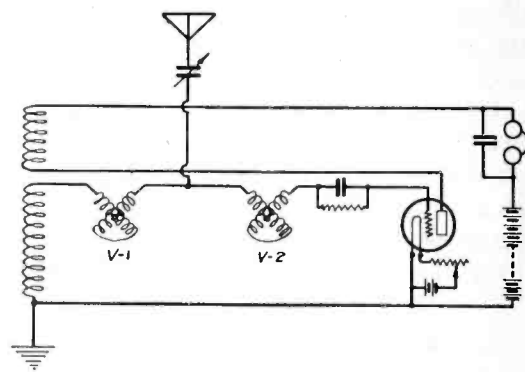

Fig. 1.

this will be found surprisingly simple and after you have tuned in your first station, the rest is easy. Practically all tuning is done with  $V_1$  and on my own set, with the series condenser set at half capacity, will vary the wave length from about 350 meters to over 600 meters and will oscillate freely at any point.

However, the big kick comes in Fig. 2. Remove the antenna lead and replace it with the ground, being sure there is no inductive effect from the

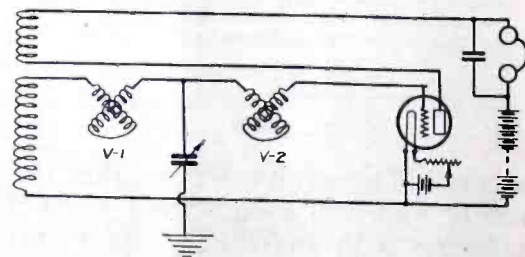

Fig. 2.

aerial lead-in. Feed up your tube a bit and go to it. Owing to the absence of the antenna, re-tuning will be necessary, but you will find that stations two and three hundred miles distant are still audibly working at the same old stand. Tuning, will, of course, be considerably sharpened and care must be taken not to miss them, but they're there; and as for local stuff—well, try it for yourself and maybe "you'll be surprised."

attained were highly gratifying. Little difficulty will be experienced in bringing in phone stations within a large radius, even thru local interference on the same approximate wave length. For instance, KPO, a few miles from me, can be practically eliminated and KHJ, in Los Angeles, or KGW, in Portland, tuned in loud enough, on one step amplification, to be heard forty feet from a home-made loud speaker. All of these are 500 watt stations, operating on 400 meters.

As will be seen from the diagram, Fig. 1,  $V_1$ , and  $V_2$  are two variometers in series with the grid and primary coil of the vario-coupler, with the antenna lead taken from *between* the variometers. This is important. The variable condenser in series with the primary circuit is of .001 mfd. capacity, while it may be necessary to use from .003 to .005 mfd. capacity across the phones. The grid condenser is .00025 mfd. and the variable grid leak, 2 megohms, is rather critical. A honeycomb coil, DL50, inserted between the plate and tickler will strengthen the signals but this is not essential and is not shown in the diagram.



## Recommendations of National Radio Conference

The second National Radio Conference recommendations to the Secretary of Commerce mark a new era for the radio public. It recommended that the interference experienced by broadcasters and listeners be relieved by the opening up of a new wide band of waves by the Government and a new assignment of individual wave lengths to broadcasting stations. This is made possible by the opening up of what was previously government reserved waves and the shifting of certain ship waves out of the broadcasting wave bands. The Department of Commerce, acting under its present authority, will be able to establish and enforce the new regulations, and thus bring order in the radio world.

Previously all broadcasting was concentrated on three wavelengths, 360, 400 and 485 meters. Now a new field extending from 222 meters to 545 meters can be created for the purpose. Within that field stations can be assigned individual wavelengths and divided into two classes. The higher power Class "B" stations can use the wavelengths between 288 meters and 545 meters, while lower powered stations can use the waves from 222 to 286.

This will enable the higher power stations distributed in 50 localities and comprehensively covering the United States, to be within the reach of every listener. Suitable wavelengths are provided in the recommendations for the more than 500 existing lower power stations.

The report urges that the field of amateur activity be extended by allotting a band extending from 150 meters to 222 meters in place of the waves up to 200 meters now used. The band from 200 to 222 meters can be reserved for high grade continuous wave telegraph transmitting stations operating under special license. Technical and training school licenses can also occupy this band. The report confines spark amateur radio telegraph stations to the band 175 meters to 200 meters.

It also includes the provision that ships using 450 meter waves keep silent between 7 and 11 p. m. and, as soon as possible, readjust their equipment for transmission on wavelengths above 600 meters.

Provision is made in the recommendations for a new field of ship telephone service, enabling persons on shore to talk to those

aboard ship. This can be carried out on waves far above broadcasting waves, so that no interference can result.

The reading of telegrams or letters by broadcasting stations should be permitted says the report so long as the signer is not addressed in person and so long as the text matter is of general interest.

Another recommendation is that simultaneous rebroadcasting be permitted as a service only on a broadcasting wavelength, and with the authorization of the original broadcaster and of the Department of Commerce.

The new regulations recommended are based on a plan submitted by the radio inspectors of the Department of Commerce, and include elements from other plans submitted by the Radio Section of the Associated Manufacturers of Electrical Supplies, The National Radio Chamber of Commerce, the Institute of Radio Engineers and the American Newspaper broadcasting stations and several other groups.

It is the unanimous opinion of the conference that the Secretary of Commerce in licensing stations has the authority under the present law to regulate hours and wavelengths of operation of stations, and to revoke or withhold licenses of stations when such action is necessary to prevent interference detrimental to the public good.

The Committee also urged that the fullest co-operation be given by those who operate broadcasting stations and by the public with the Department of Commerce in the co-operative adjustment of local broadcasting problems in order to realize the fullest possibilities of the recommendations outlined.

The following is the membership of the Radio Conference:

Maj. Gen. George O. Squier, War Department.

Com. D. C. Bingham, U. S. N., Navy Department.

W. A. Wheeler, Department of Agriculture.

John W. Sutherin, Post Office Department.

F. P. Guthrie, United States Shipping Board.

Edwin H. Armstrong, Columbia University, New York.

Dr. Alfred N. Goldsmith, Secretary, Institute of Radio Engineers.

Prof. L. A. Hazeltine, Stevens Institute of Technology.

John V. L. Hogan, Consulting Radio Engineer, New York.

C. B. Cooper, C. B. Cooper Company, New York.

Hiram Percy Maxim, President, American Radio Relay League.

Prof. C. M. Jansky, University of Minnesota.

A. H. Griswold, American Telegraph and Telephone Company.

Leo. Fitzpatrick, Radio Editor, Kansas City Star.

D. B. Carson, Department of Commerce, Bureau of Navigation.

W. D. Terrell, Department of Commerce, Bureau of Navigation.

J. H. Dellinger, Department of Commerce, Bureau of Standards.

L. E. Whittemore, Department of Commerce, Bureau of Standards.

L. J. Heath, Treasury Department.

## Recommended Wave Allocation

Reserved—Below 150 meters (except Government C. W. on 130 and 143), 286 to 288, 952 to 1053 (except radio beacons on 1000.)

Government—C. W., exclusive, 130 and 143; C. W., non-exclusive, 674; C. W., I. C. W., and spark, exclusive, 952, 1304 to 1579, and 2500 to 3158, C. W. and I. C. W., non-exclusive, 1091 and 1200.

Amateur—C. W., I. C. W., and phone, exclusive, 150 to 176; C. W., I. C. W., phone and spark, exclusive, 176 to 200.

Special amateur and technical training schools, C. W., exclusive, 200 to 222.

Aircraft—C. W., I. C. W. and phone, non-exclusive, 222 to 231.

Class A broadcasting—Phone, non-exclusive, 222 to 286.

Class B broadcasting—Phone, exclusive, 288 to 545. (See Note 2.)

Marine—C. W., I. C. W., spark, non-exclusive, 300 (see Note 3); exclusive, 450 (see Note 4); phone, exclusive, 800 to 952, 1053 to 1277.

Marine and Aircraft—C. W., I. C. W. and spark, exclusive, 545 to 600; C. W. and

*Continued on page 88*



Members of Second National Radio Conference at Washington, D. C.



# LETTERS TO THE EDITOR

## Gibbons Hookup With Variometer

Editor Radio: It seems that the favorite occupation of several radio amateurs has been to make improvements on the simple single honeycomb hookup submitted to RADIO some months ago by Mr. Gibbons.

A good improvement on the hookup for short wave work is to use a variometer instead of the honeycomb. This improves flexibility a good deal, causes the set to regenerate over a greater range, and increases the signal

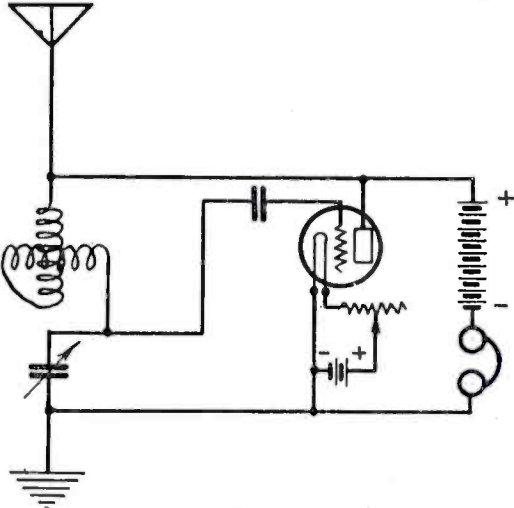

strength greatly. The set is as sensitive and selective as any other single circuit receiver and more so than most others. Capacity effects can be almost entirely eliminated by connecting the rotor of the condenser to the ground side.

I have tried all of the improvements submitted by other amateurs and this one works more sensitively and with greater simplicity than any of them.

HERMAN O. WERNER,  
Berkeley, Calif. Radio 6ASI.

## More Details About Improving Gibbons Circuit

So many dx chaps have written to ask about my improvements on the Gibbons circuit as published in February RADIO that I will answer them here. The variometer is an old wooden type from the Radio shop, the condenser was from the Wireless shop.

Since last publication I have found that the 43 plate condenser works best in the aerial lead and a small vernier condenser in the leads to ground.

Mr. Fite of the Maxwell Electric Co., holds that the coil mounted on the side is not in inductive relation to the variometer and acts only as a choke. Many subsequent experiments confirm this fact.

The Gibbons circuit is an old De Forest hookup. To function well on 200 meters or below the antenna must be short. You must get its natural period down low. The 6 wire 35 ft. cage aerial at 6AOR used in conjunction with my 5 watt transmitter works well.

SIDNEY GLASSON,  
Berkeley, Calif. 6AOR.

## NEWS FROM THE SEVENTH DISTRICT

By R. WASHEY

Executive Assistant Division Manager N. W. Division A. A. R. L.

Due to its adoption by the Executive Council, the Revised Pacific Plan is in force throughout the entire 7th district and seems to be serving its purpose admirably, with the possible exception of a few BCL's who seem to think that the amateurs' hours should be from 5:59 to 6:01 a. m. on the 29th of February. A substantial increase in relay traffic is noted throughout the entire Division.

A general trend toward CW is also noted, only about 4% of the traffic going on spark.

In Montana the spring QRN is being felt and has made slight inroads on the message traffic. In this state several freak operating conditions are found. Perhaps the queerest is that stations who work a much longer distance with ease are utterly unable to work other Montana stations. During the past month it was attempted to get a daylight route over the state and the various stations were requested to be on every Sunday afternoon from 3:00 p. m. on and call other Montana stations. The results were absolutely nil. At station 7ZL, it was found impossible to raise other Montana stations in daylight, while coast stations and those in Kansas were worked with ease. Montana is now 100% CW, with the exception of one station, 7EX, who has both spark and CW.

In Idaho things are livening up quite a bit and several new stations are reported on the air. Old 7JD, from Weiser, is up at Moscow installing the old spark and a new ten watt CW set. 7ZM, the old standby, will be back on soon with 100 watts. Nampa has three active stations and is qso all directions. 7CG and 7LN are handling the bulk of the traffic. 7LN has worked 8BEO in Watertown, N. Y., and is heard throughout the east. 7HJ and 7ZN continue to hold down their end of the traffic line. The stations in Boise are making some wonderful records, all being heard in the east consistently and 7ZN being heard a distance of 4700 miles.

In Oregon a re-organization of the A. R. R. L. Operating Department is being undertaken. The bulk of the traffic is going through 7NA and 7LR. 7NA turned in a report of 318 messages this month. Who sez the old N. W. is dead? 7LR had the bad luck to have his fifty watter "go west" and had to resort to the spark to clear his hook. He now reports that he is putting in 100 watts and that the spark set will be heard no more as the OT is in the counterpoise and the rest of it in other places where it will help the CW radiation.

In Washington conditions are steadily improving, the traffic handled going up about 50% this month. From the Grays Harbor district comes the report that 7NN and 7SC are installing higher powered sets and expect to increase their QSO. As SC has worked 2FP direct he will have to go some to increase his range. Guess he must be after French 8AB next. 7GP at Olympia is down on 180 meters and reports qrm nil on that wave. He says that it is hard to work any one there tho as no one seems to want to listen that low. In Vancouver 7BJ is handling the bulk of the traffic, assisted by 7AIC and 7AJV. BJ has joined the Owls and is putting up a new antenna so that he can radiate a few more watts. In Tacoma 7WX and 7BA are holding down the graveyard shift while 7WM and 7AFO are on in the evening. In this way there is always some one on in Tacoma and traffic is kept on the jump. In Everett 7ABB and 7EQ are the two mainstays who are doing very good work. Stations around Everett are doing exceptionally good work with eastern stations. 7HI in Auburn has installed 100 watts CW. Seattle is working hard to rid itself of the stigma of its reputation, recently acquired, of having no stations on the air. 7JG is handling the bulk here and 7ADP, 7DU, and 7KF are also keeping the hook clear.

Perhaps the most important event in the Northwest Division this month is appointment of Mr. Royal V. Howard, better known as 7LR, to the office of Division Publicity Manager. Mr. Howard is well suited to this position and with a little more publicity on the side of the amateur things in this neck of the woods are sure going to hum.

## Tualatin Radio Association

The last meeting of the Tualatin Radio Association of Hillsboro, Oregon, was by far the most interesting held since the organization of the club in December, 1921. There was code practice from 7:30 to 8:00, and those not interested in code practice read the latest Radio magazines.

At 8 o'clock the meeting was called to order. The club decided to buy parts for an experimental receiving set, ranging from 175 to 25,000 meters. The meeting adjourned at 9:15, and from then until 10 radio questions were answered and diagrams were drawn on a new blackboard. Anybody interested in radio is cordially invited to attend our meetings, which are held every Tuesday evening. Those wishing to procure amateur license are invited to the meetings, and we will be glad to help you to obtain them.

## Second District Radio Council

At a recent meeting of the Executive Radio Council of the Second district, a radio fan living in Brooklyn requested the Council to take in hand a licensed amateur whom he believed was transmitting unlawfully and causing interference with the reception of broadcasting. The licensed amateur, as well as the broadcast fan, were requested to be present at this meeting of the Council, and both were in attendance.

The man who had complained was first requested to tell his story, and was then questioned by a disinterested amateur, and then by a disinterested manufacturer's representative. The licensed amateur was then put through the same process, the chairman acting as a judge in the matter. It developed that the licensed amateur was operating on 197 meters with a 5-watt transmitter.

The broadcast listener, on the other hand, was using a receiving set of inferior design, and did not understand its operation. After careful consideration it was suggested that the Radio Club of Brooklyn take hold of the matter and show the broadcast listener how to operate his set. Representatives of this club will call upon the listener, bringing with them a receiving set of approved design, and will show him exactly what can be done with a set of this kind, and it is hoped that this fan will find an end to his troubles.

The Council, by undertaking work of this kind, will greatly relieve the congestion existing in the radio inspector's office, and incidentally will be able to settle in a friendly manner—many arguments that might possibly lead to serious consequences. It has been decided further that any complaints of this nature should be taken up by the local radio clubs and settled in that way, if possible. If, on the other hand, the club cannot settle the matter, then it will be up to the Executive Radio Council. If they cannot do it, then it will be passed on to the radio inspector.

## THE NEW HAVEN RADIO ASSOCIATION

The New Haven Radio Association, at 19 Elm St., New Haven, Connecticut, is progressing rapidly. The club is affiliated with the American Radio Relay League and has done much to promote interest in radio.

Recently a novel form of code practice was instituted, by which a local C. W. station transmits code at various speeds in order that the beginner as well as the advanced amateur may derive benefit.

It has been planned to hold a convention, on April 14, in the Commercial High School. Correspondence from other clubs is desired and all such correspondence should be addressed to Paul Boyce, care of the New Haven Radio Association, New Haven, Conn.



# NEWS OF THE BROADCASTERS

## BRITISH BROADCAST TROUBLES

There is a great and growing dissatisfaction among British buyers of wireless sets with the service of broadcasting now being given. It was supposed that the first and temporary arrangements would soon be efficiently improved to satisfy subscribers. But the volume of complaints is said to be increasing rapidly, and unless the defect is remedied the whole boom may suffer a severe setback.

The buyer of a cheap crystal receiving set is limited in range to the one broadcasting station's program, and even the buyer of a two-valve set cannot expect much more, while the purchasers of more expensive sets running up to £60 or £70 have a wider range of stations, but are severely limited as to the hours in which listening-in programs are available.

To speak plainly, does the man who spends a good round sum on wireless get enough for his money when he is only able to listen to a "bed-time story" between 5 and 6 p. m., and about three hours of a concert supplied by an "orchestra" consisting of some half a dozen instruments, and a few singers and instrumentalists of sometimes only average ability? The broadcasting of Covent Garden opera recently gave listeners in a taste of possibilities.

The arrangement under which broadcasting is carried out is generally known. The makers of the sets add to their selling price a proportionate sum, which is handed over to the Broadcasting Company to be spent in the provision of adequate broadcasting. We have recently been told that some 60,000 licenses, for listening-in have been applied for, of which about 10,000 are experimental licenses. The ordinary license holder by the purchase of their sets, pay anything from a few shillings up to several pounds, and the experimenters 10s to the postoffice, of which half goes to the Broadcasting Company.

The average ordinary payment is probably not less than £2, which would give a sum of about £102,000 to the Broadcasting Company. We do not know what the installation of each broadcasting station equipment costs, but cannot suppose it more than £4,000, and at most the first eight stations could hardly cost £50,000, which leaves more than a similar sum to be spent out of what has been received to date; while, as we know, the sale of sets and revenue of the Broadcasting Company is continuing and increasing each month.

The intricate questions of unlicensed wireless receiver and home-made radio sets were also the subject of a recent conference between representatives of the Postmaster-General and the British Broadcasting Company.

The difficulty has arisen because thousands of prospective listeners-in are keenly enjoying making their own gear. When it is made however, they cannot obtain broadcasting licenses because these are granted only for sets made and stamped by the British Broadcasting Company.

Hence the radio pirate who calmly uses his own set and gets all the fun possible out of broadcasting without contributing to its cost. This situation means that: The post-office loses control over wireless installations. Irregular valve circuits are used, which create "howling" and make listening-in impossible for other people. The Broadcasting Company loses its royalties.

Among the suggestions which found favor at the conference was one which proposed

that home-made sets should be licensed, providing they were of approved design and that that their owners paid the Broadcasting Company's royalty. Thus the company would receive 5s. of the 10s. license fee and royalties ranging between 7s. 6d. for a crystal set and £2-15s. for a four-valve set.

In fairness to the company it should be pointed out that broadcasting is an expensive business. The first small experimental station cost many thousand of pounds to fix up and run, and there are now six big stations, with two more being established. For each of these stations there are substations to test and report on the broadcasting, while special cables have to be laid to thea-

communicates with points in Europe was connected by land wires to an instrument at the ringside where an announcer was stationed. Immediately upon getting the returns they were telephoned to the Broad Street operator, who transcribed them into dots and dashes, then flashing them to Argentine by radio on a long wavelength. The operator there reversed the operation by retranscribing the telegraph characters into a word picture which was broadcast on a short wavelength for the benefit of listeners within range of the local station.

Reports from Argentine state that the demonstration was highly successful and enthusiastically received.

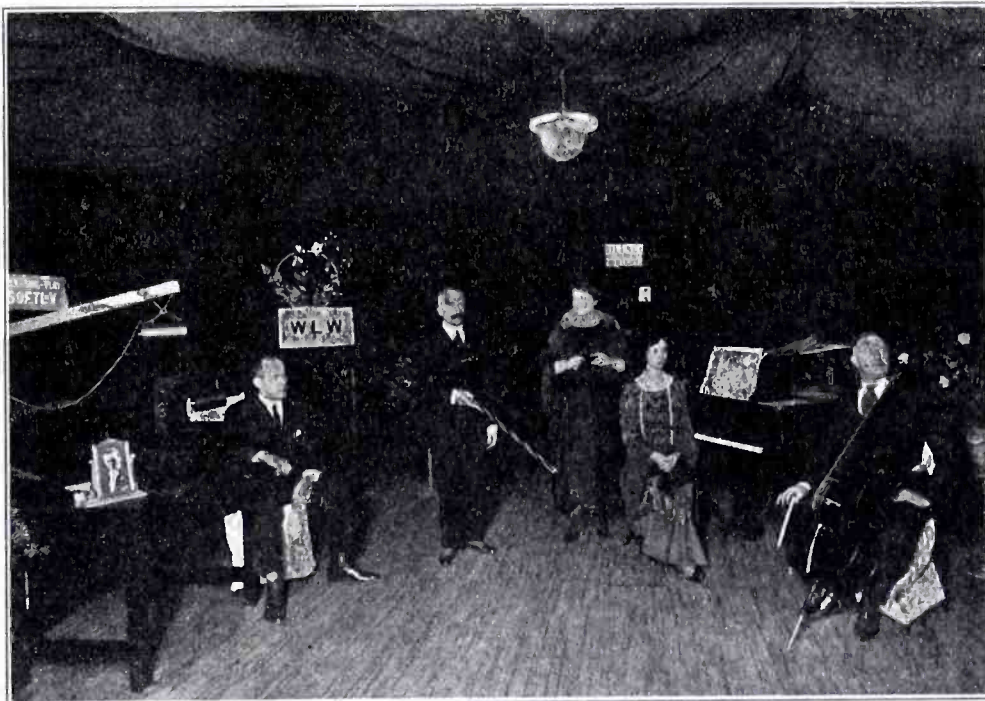

Studio at WLW, operated by Crossley Mfg. Co., Cincinnati, Ohio.

tres and buildings in order to broadcast opera, plays, speeches, etc. In addition, artists have to be paid, authors' copyrights and fees met, and a big staff employed to arrange programs.

In the event of no steps being taken to deal with "radio pirates," it is obvious that the Broadcasting Company will be tempted to go easy in the development of the radio, which would penalize those who have fulfilled their part of the broadcasting bargain by obtaining licenses as well as the license dodgers.

## Firpo-Brennan Bout Transmitted Direct to Argentine by Radio

For the first time in history, Argentine was joined with New York by radio when the high power station, Radio Central at Rocky Point, Long Island, transmitted a complete description of the Firpo-Brennan bout on Monday evening, round by round, direct from the ringside at Madison Square Garden, which was received but an instant later in the homes of hundreds of South Americans within hearing distance of the local broadcast station there.

No previous attempt had been made to intentionally furnish South America with a radio service, especially of a character which involves a definite schedule as in the case of the recent demonstration where minutes were as precious as hours to the anxious listeners located over 6,000 miles from the scene.

The station of the Radio Corporation of America in Long Island which ordinarily

## WHY NOT?

"Miss Reba Rawba will sing a soprano solo, accompanied by her sister Miss Rawba Reba Ruba on the Sears-Roebuck...."

\* \* \*

"Mr. Shoosh will play nine instruments at once, including an asthma accompaniment and a left-handed solo on the Montgomery-Ward"

\* \* \*

"The Yawman-Erbe used in tonight's concert was painted especially for this station by Yon Yonson, expert varnisher of Columbus avenue, prices reasonable; will call for work."

\* \* \*

"The next number will be 'La Mayonaise' from 'El Salad' with organ obligation. Viscount Kam-Chatka at the Boerick-Runyon."

\* \* \*

"The piano used tonight was loaned by Herman-Mud and Co., the switches by Jones, microphones by Westinghouse, waves by Hertz, current by the P. G. & E., services by Hank Smith, operator, over our own antenna."



# DIGEST OF RECENT RADIO PATENTS

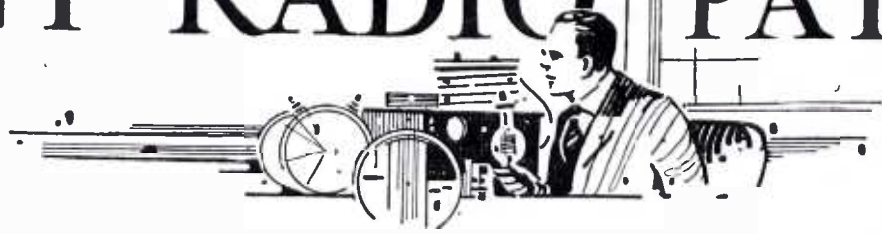

Prepared by White, Prost & Evans, Patent Attorneys, San Francisco, who have been particularly active in the radio field for many years, and from whom may be obtained further information regarding any of the patents listed below.

H. Morris-Airey, et al, Pat. No. 1,447,481: March 6, 1923. Thermionic Valve.

In lead ins to electrodes of vacuum tubes, heating at the junction point of the electrode and the leading in wire may cause the junction to be destroyed. In order to overcome this, an arrangement is described in which the leading in wire A has a larger diameter than at the sealing portion x. More power can therefore be utilized in the tube.

L. Espenschied, Pat. No. 1,447,204: March 6, 1923. Plural Modulation and Demodulation Circuits.

A scheme for sending a plurality of signals simultaneously from a single antenna and receiving them in a single antenna is described. For this purpose, successive and simultaneous modulation and demodulation are utilized. In the example illustrated, a tube oscillator G generating 5000 cycles, has its output distorted to supply harmonics for the various modulating frequencies of 10,000 and 15,000 cycles or more, as well as for the carrier frequency of 500,000 cycles. The modulator tubes M<sub>1</sub>, M<sub>2</sub> and M<sub>3</sub> are respectively affected by signals in lines TL<sub>1</sub>, TL<sub>2</sub> and TL<sub>3</sub>; and are also supplied with the low

modulating frequencies as indicated. These frequencies after being modulated by the signals, are transmitted to the main modulator M through filters TF<sub>1</sub>, TF<sub>2</sub> and TF<sub>3</sub>. These filters suppress one of the side bands of modulation, and therefore less power is needed for transmitting a given signal strength. The main modulator M is of the Carson duplex type, and is supplied with the carrier frequency of 500,000. At the receiving station the transmitting arrangements are reversed, the carrier frequency being first suppressed, and afterwards, through 3 separate channels the intermediate frequencies are suppressed. Due to the fact that a common source is used for all frequencies at both the receiving and transmitting stations, the various frequencies are easily kept in the proper relation to each other.

L. Espenschied, et al., Pat. No. 1,447,773: March 6, 1923. Radiotransmission Control System.

A scheme is described for maintaining the intensity of signaling uniform at the receiving station, and thus compensate automatically for varying conditions of the ether, etc. For this purpose the degree of amplification of

amplifier A is varied by varying the amount of resistance in its input circuit. This variation in resistance is accomplished by a small reversible pilot motor 26 which is controlled by the variation in current flowing in the output side of the detector D. Thus when this variation is small, corresponding to weak signals, the motor 26 is operated by relays R<sub>1</sub> and R<sub>2</sub> to reduce resistance 12 and thus increase amplification. For too strong signals the reverse action takes place. In order to apprise an attendant of the fact that the switch arm 13 is in its extreme position, a signaling circuit 28 is associated therewith, and causes a lamp 30 to light for either extreme position.

J. H. Hammond, Jr., Pat. No. 1,447,779: March 6, 1923. System of Ether Wave Control.

A signaling device, such as bell 23, is so arranged at a receiving station that it is operative only when modulated constant wave signals are received, or groups of waves of any sort. For this purpose the diaphragm 15 is provided in the detector circuit, which of course has too high inertia to be affected

Continued on page 44

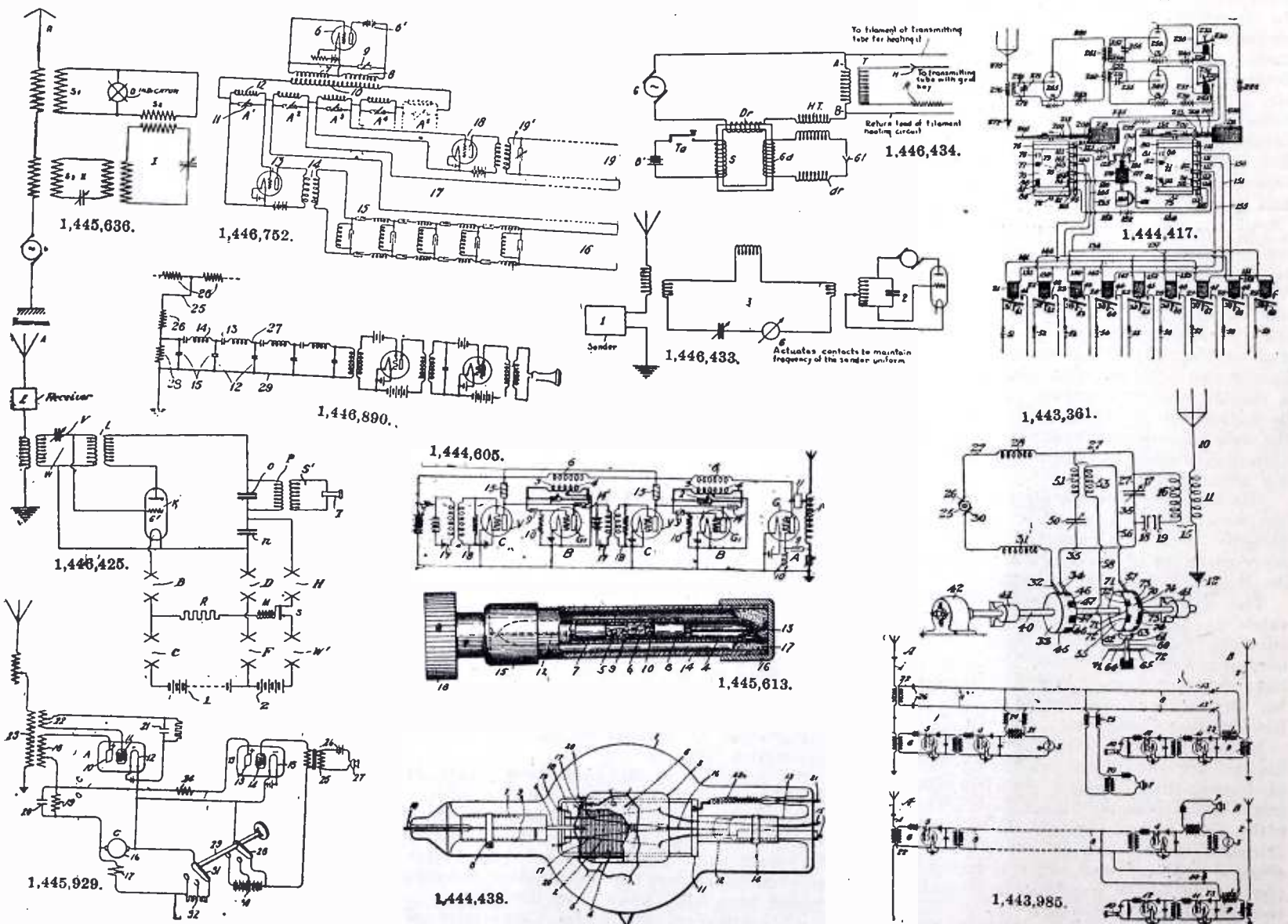



# QUERIES & REPLIES

## ON C.W. PRACTICE

BY  
**Gerald M. Best**  
 TECHNICAL ADVISOR



Questions submitted for answer in this department should be typewritten or in ink, written on one side of the paper. All answers of general interest will be published. Readers are invited to use this service without charge, except that 25 cents per question should be forwarded when personal answer by mail is wanted.

Please publish a complete diagram of the De Forest Reflex receiver.

B. C. S., Calexico, Calif.

The De Forest Reflex circuit is shown in Fig. 1.

If you mean a loop 25 or 30 ft. square, mounted on a roof, I would say that you would probably get very good results with it, using it as a loop, with a ground connection tied to one side of the loop.

transformers? Would I get better results using two tubes in parallel? Which of these three tubes is the best amplifier: C-301-A, C-302 or VT-2?

M. E. R., Winchester, Mass.

C-302 tubes will make good amplifiers, but you would surely burn out the primary windings of your amplifying transformers. You would either have to obtain special transformers capable of carrying the plate current of the C-302 tubes, or use a resistance coupled circuit. Two tubes in parallel would increase the power output, but not the amplification. It is against the policy of this department to answer your last question.

I have a 2 stage amplifier, and when I remove the plug from the output jack on the set, I can hear the concert by putting my ear to the amplifier tubes. What is the cause of this?

L. N., San Francisco, Calif.

The phenomena you have observed is

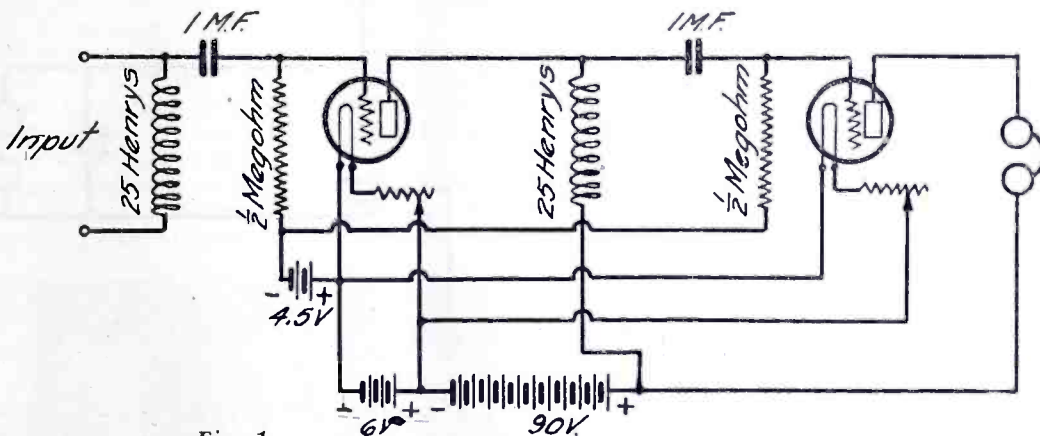

Fig. 1.

In March RADIO, the D. X. R-A-F receiver on Page 13 has a vernier condenser listed in the material column. Where is this used?

F. D. S., Sparta, Tenn.

The most useful place for such a condenser would be in parallel with the antenna condenser, for fine adjustment on the tuning.

Please tell me the best regenerative circuit for a detector and one stage amplifier, using a variocoupler, 43 and 11 plate condensers, and grid condenser. Also the length of antenna I should have.

B. L., San Francisco, Calif.

A circuit for the apparatus you mention is shown in Fig. 2. An antenna 100 ft. long, and as high as you can conveniently raise it should do very nicely for concert work.

Please advise if an outside aerial built in the form of an ordinary inside loop, mounted 25 or 30 ft. high, and connected as ordinary outside aerial would operate successfully with a one tube set. Would this be as efficient as an inverted L or T type aerial, with equal amount of wire?

J. L. T., Houston, Texas.

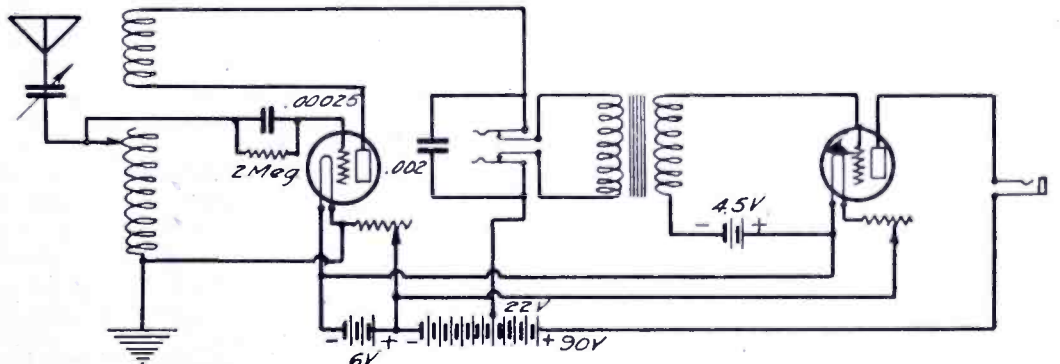

Fig. 2.

It would be highly directional, and unless you had some means of turning it, or destroying the directional effect, you would have difficulty in hearing stations except in a narrow band at right angles to the loop. The whole combination would probably not be as good as an inverted L or T antenna.

Can I use a C302 five watt tube as an amplifier with 350 volts on the plate, using Radio Corporation amplifying

probably due to a loose grid or filament in one of the tubes, as such a condition will often cause the elements to vibrate when strong signals are being received. It might also be due to a loose core in one of the amplifying transformers.

Please inform me how I can improve my set without adding amplifiers.

L. C., Aurora, Ill.

You can greatly improve your set by adding a grid leak, and phone condenser, and tying the grid lead to the positive side of the filament, as shown in Fig. 3, which is your circuit corrected as above.

What is the most efficient crystal circuit? One using a variocoupler, variable condenser, etc., was suggested, being most selective. Can regeneration be used? A friend told me that to make a loud talker for a crystal set, one should place a phone over a magnet, getting the poles to correspond.

F. L., Los Angeles, Calif.

A crystal circuit using a variocoupler, with series primary and parallel secondary condensers, should be very efficient. You cannot use regeneration with a crystal set, it being necessary to employ vacuum tubes in some form or other for that purpose. You will probably not get very satisfactory results from using any form of a loud speaker

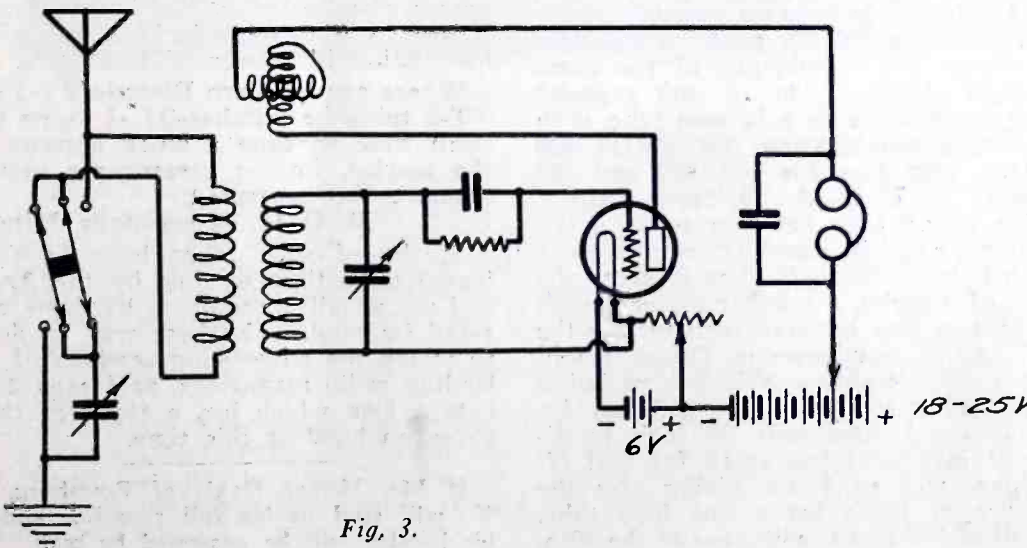

Fig. 3.



with a crystal set. At least one vacuum tube amplifier would be necessary for satisfactory results.

Does it shorten the life of a C-302 tube to apply the full 7.5 volts to the filament instantaneously, or should the rheostat be used to ease the current on and off the tube every time it is turned on or off? When making an inductance for a C. W. transmitter is the pancake type as efficient as one wound on a bakelite tube? If so, how many turns should be placed on each pancake, if a grid coil is to be used, this to be used in tuning to 200 meters with an average amateur antenna. What is the best flux to use for efficient electrical connections?

A. E. W. Watsonville, Calif.

It makes no difference whether you turn the filament on or off gradually, or abruptly, provided that you do not apply the plate voltage until the tube has had an opportunity to warm the elements. The pancake inductance should be every bit as efficient as one wound on a tube. About 25 turns on each pancake would give you plenty of latitude for tuning at any low wavelength.

In tuning my C. W. set, which of the taps are critical? How can I make a 3 millihenry choke? Should the plate get hot when I use 400 volts? Should not a grid condenser and leak be used in the Hartley circuit? What is the advantage of the mid tap on the filament winding?

J. W. M., San Francisco, Calif.  
The filament tap is the most critical in the Hartley circuit. You can wind a 3 millihenry choke with 200 turns of No. 26 or No. 28 wire on a cardboard tube 3 inches in diameter. The plate of a 5 watt tube will become hot when 400 volts is applied. In the Hartley circuit, no grid condenser or leak is necessary. The mid tap on the filament winding is to reduce the A. C. noise to a minimum, as the filament circuit is unbalanced unless the plate voltage is applied to the center of the transformer.

Would greatly appreciate a list of all books published regarding the Armstrong Super-Regenerative circuits.

P. B. C., Glen Ellyn, Ill.

Descriptive articles on this circuit have appeared several times in every radio magazine in the country. The Lefax Company includes a chapter on this circuit in their radio handbook. I do not know of any books devoted to this circuit, or containing any detailed references to the Super-Regenerative circuit, at this time.

I am using a three circuit tuner consisting of two variometers and a variocoupler. I can get 400 meter stations perfectly, but I can barely hear the 360 meter stations. Please tell me how I can remedy this.

H. K., Lawrence, Mass.  
Probably your antenna is too long, or high. Try placing a small air condenser in series with the antenna, and if this does not bring in the 360 meter stations, make your antenna not longer than 100 ft., and you will be able to tune to 200 meters with your present equipment.

What is the difference between the various types of Baldwin receivers, such as the C, E, F and G? I am told that C is for short waves, E and F for medium and type G for long waves.

C. S. L., Santa Barbara, Calif.

The only difference in the various types is the amount of power that they will handle without rattling of the diaphragm, and also as to their size. The Type C is generally used for loud speaker work, or where a large amount of power is being handled. The type of receivers used has nothing whatever to do with the

wavelength, the receivers being used for audio frequencies only.

How can I make a vacuum tube detector set out of 2 variable condensers and a variocoupler? Would I have to buy a variometer? Could it be made without a storage battery?

R. S., San Mateo, Calif.

Fig. 2 will show you such a circuit. It is not necessary to buy a variometer unless you wish to make the circuit a regenerative one. If you use a peanut tube, or dry cell tube, as it is sometimes called, you will only require a single 1½ volt dry cell, and no storage battery will be necessary.

Please publish a circuit for a wave trap, for use in eliminating interference.

F. C., Cincinnati, Ohio.

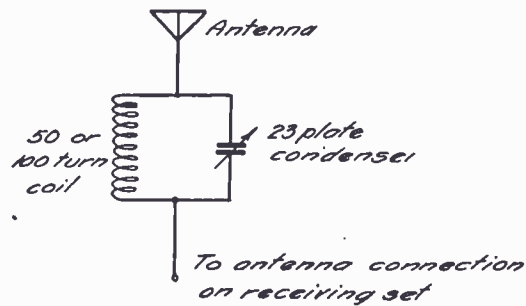

Fig. 5.

This circuit is shown in Fig. 5, and the apparatus should be connected between the antenna, and the set itself for best results.

I am building a C. W. transformer according to the article in the February, 1922, RADIO, entitled, "The ease of C. W. Transformer design," by A. H. Babcock. I am using black sheet iron for core, and wish to know if this is correct for use with coils as wound per above article. Is a choke coil necessary on both sides of the rectifier, in the filter circuit?

G. K., Springfield, Mass.

The iron you are intending to use will be O. K. with Mr. Babcock's formulae. A choke coil is necessary only in one side of the high voltage line, provided that you have a fairly large capacity, say 6 to 10 m. f., on each side of the coil. Otherwise, you should use two coils, and at least 4 m. f. on each side of the coils.

How may the Armstrong "flivver" circuit described in February RADIO, be increased in wavelength range?

P. L., Los Angeles, Calif.

The most satisfactory wave would be to add a loading coil or 25 turns, in the loop or antenna circuit, to increase the wavelength range an additional 100 meters.

What is distributed capacity? With a fixed value of inductance, would a variable condenser of .001 m. f. be sufficient to change the wavelength of the combination through 150 to 300 meters? How many turns on a ¼ inch tube, with the above combination, for 150 to 600 meters, with taps for 300, 400 and 500 meters?

E. M. A., Modesto, Calif.

The capacitance between turns in an inductance coil is generally referred to as "distributed capacity," since it gives the effect of bridging a number of very small condensers, one between each turn in the coil. An air condenser of .001 m. f. will give a considerable wavelength variation when connected in series with an inductance. A tube only ¼ inch in diameter is almost too small for real efficiency, and so I am giving you the number of turns for a one inch tube. A coil of 175 turns, with taps at the 40th,

80th and 130th turns will give you to proper wavelength variation.

I am making a one tube super-regenerative circuit. Will you give me the hookup please. I have a loop antenna 18 inches square, 16 turns. Do you think it will be good for 360-400 meters?

W. N., San Francisco, Calif.

In February RADIO, you will find an article by Mr. Greaves, describing in detail the circuit you want, for a single tube super-regenerator to tune up to 400 meters. It should work well with your loop antenna.

Please tell me why signals come in louder on my crystal set when I hold my fingers on the radiocite crystal?

W. D., Richmond, Calif.

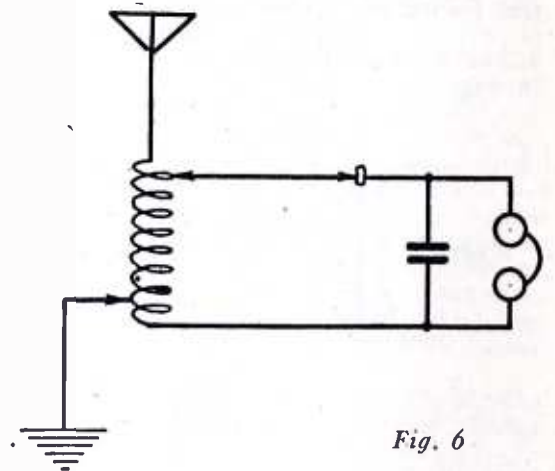

Fig. 6

If your circuit shows your set exactly as you have it, the trouble lies in the fact that you have no condenser bridged across the telephone receivers. A corrected circuit is shown in Fig. 6.

For a 5 watt phone set, which is best; magnetic modulator, loop, or the use of a turn or two of the transmitting inductance.

T. A. C., Campbell, Calif.

If you use a good microphone, like the Western Electric 323-W, the magnetic modulator should give you the best results, since it was designed to take care of one tube.

Occasionally on certain nights no one in town can get any results, as there is a peculiar noise to be heard in the phones, sounding like a trip hammer, or motor generator. It is so loud that you can get nothing else. Please tell me what is the cause of this.

F. B., Cabool, Mo.

The principal causes of such noises is from power lines, or power apparatus. If there is a power line in your town, with a voltage of 5000 or more, the trouble may be due to a leaky insulator, which causes a static discharge, transmitting a disturbing noise on all wavelengths. If there is a large motor, particularly of the d. c. type, in your town, it may be the cause. A large ice machine power plant often is the cause of such noises, as the motor in that sort of an installation is usually of large size.

Where can Western Electric VT-1 and VT-2 tubes be purchased? I know that from time to time a stock appears on the market, but at present the market seems to be exhausted.

M. G. C., Minneapolis, Minn.

Stocks of such tubes have been released from time to time by the Army, and are usually bought up by firms who retail by mail. The best way to do is to watch the advertising sections of the leading radio magazines, as I cannot locate a firm which has a stock of these tubes on hand at this time.

If Mr. Homer Davis of Frensburg, N. Y., will send us his full postoffice address his inquiry will be answered by mail.



# WITH THE AMATEUR OPERATORS

## FEBRUARY-MARCH DX AT 6XAD

By MAJOR LAWRENCE MOTT  
Signal—ORC—USA

With the coming of the summer weather my DX efforts—until October—are about over, and I would call attention to the fact that after April 25th I shall not be on the air during my regular hours. On "good" nights the station may be heard—if fishing is not too alluring!

Thanks to the great courtesy of the Commissioner of Navigation, and of Lt.-Col. Dillon, radio inspector of the 6th district. I have been granted a special amateur license—in addition to my experimental one, so that this station will henceforward be known as either 6ZW—for message and relay work—or 6XAD for experimental effort with other stations of similar classification.

I would deeply thank the very many operators, all over the nation, for their courtesy to me during the passed radio season, and I desire to assure them that I have greatly appreciated their cards, letters and telegrams—having to do with my signals. It has been a joy, indeed, to make so many new friends throughout the United States!

Herewith the final DX—until autumn:  
A verbatim card from R. Slade, Esq., "Belfield House," Waimataitai, Timoru, New Zealand, dated Feb. 13th:

"I have heard your station on the following dates Nov. 9th, calling 8BUM, at 8:09 P. M., New Zealand mean time, and at 8:25 the same night, calling 5XAD. On Jan. 31st, at 9:07 P. M., our time, calling 6KA.

Ere this is in print I shall have begun a series of tests with both Australian and New Zealand operators, that have been arranged for by cables and letters. The tests will last for six weeks, and I shall use the following transmitters: 1. 250-watt, with a 250-watt Western Electric tube. 2. 250-watt, with a Radio Corporation tube. 3. 500-watt, with a British (Mullard) tube. 4. 100-watt, with 2 Western Electric 50-watt tubes, and, 5. 100-watt, with 2 Radio Corporation 50's. I rather expect some most interesting results, in the comparison of effectiveness, and so forth. Results will appear in RADIO at some future date.

Lieutenant L. E. Raesch, of East Orange, N. J., who has been at sea in South American waters, writes under date of March 2nd:

" . . . I picked you up on the following occasions, all California time and

dates Oct. 19th, 11:12 P. M., 6XAD calling 9AL. Oct. 22nd, 1:17 A. M., 6XAD working 9AON; and at 11:48 P. M., same date, 6XAD calling 9GK. On Oct. 31st, at 11:17 P. M., 6XAD calling 9YAJ. The last time that I heard you we were 5700 nautical miles from you; or, well over 6000 miles' distant. Your signals carried very well, indeed. Your wave was about 230 meters."

This report corresponds with my Log, and my courteous informant heard Transmitter No. 4 with 2 WE 50's radiation 6.1, on 240 meters ICW throughout.

Radio 9BJT in Streator, Ill., informs me that he heard 6XAD during early March "without aerial or ground, and signals QSA four inches from fones."

The latest list up to March 23rd: (1CMK) 1RV, 1CJK, 1CTH, 1CPN, 1CNA and a report from Mr. A. Hubbard, of Waterton, Mass., that he heard 6XAD, QSA.

2AHB (heard 6XAD using electric light wires as antenna) (2HJ).

2BJA, 2CVR, 2AWH, 2CBG, 2GK, 2ASK, (2AYV) 2BZV, 2BGI, 2XL, 2BNK, 2MU, (2EL).

3BGN, 3BQZ, (3BVA) W. Downs, Washington, D. C., (3TA-CAN) 3BGG,

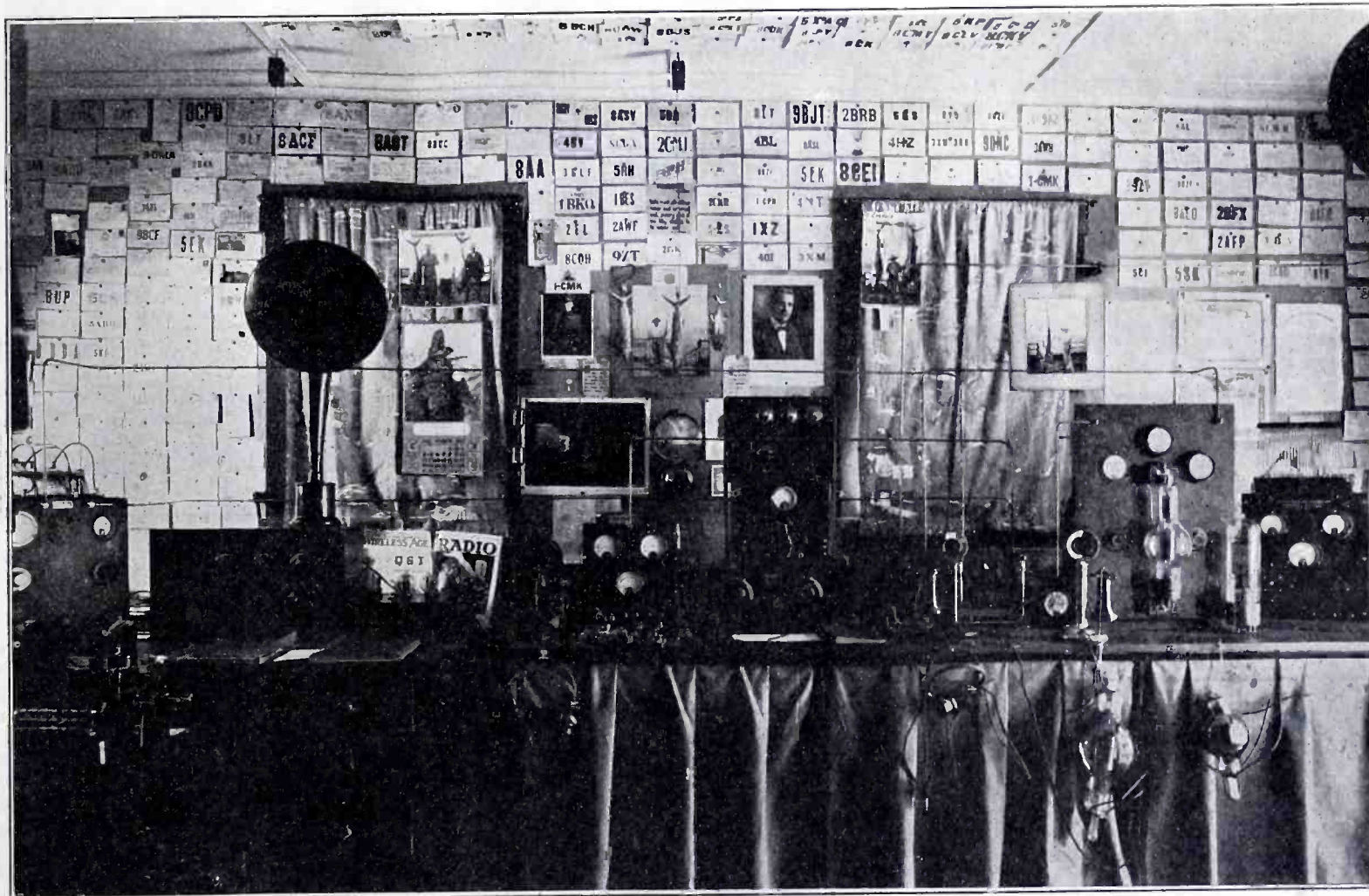

The New 6ZW-6XAD Station Operated by Major Lawrence Mott

### DESCRIPTION OF 6XAD-6ZW

From right to left: 200-watt combination fone & tel. set, with 4-50 watt GE tubes, and 1-WE-5 watt as a speech-amplifier.

The big set, so adapted as to use a GE-250 watt—a WE-250 watt—a Mullard (British) 250 watt, or a Mullard 500 watt. The latter two are shown, hanging below panel, and the WE-250 is on table, at right. The GE-250 was in circuit at time of photograph taking.

Meter—110V-AC—to show, at all times, amount of V. from power house.

Specially designed 4-way switch for throwing in to action any one of the 4 transmitters. One motion changes aerial, ground, (Switch designed by Stuart Dalton, 6KY, whose invaluable assistance and advice was used in making over station).

Antenna switch.

Grebe-CR-5, with special WE-2-step amplifier above, using WE tubes, and above that a WE-7A amplifier, that is used in a certain way to obtain great amplification when desired.

100-watt transmitter, using either WE or GE-50 watt tubes. Rad: 6.1-AC throughout. Effective DX: Australia, New Zealand, ALL States, ALL Districts, and ALL Canadian Districts worked during season '22-'23.

WE amplifier 7A-No. 2, for use in broadcast receiving, also so connected as to be used in amplifying long-wave signals from the Grebe-CR-7 (new-type), on which stands the WE horn.

At extreme left is another transmitter using either 4-WE-5 watt, 4-GE-5 watt, or 1-50 watt tube.

Western Electric and Baldwin fones used. Four 180-hour EXIDE Batteries to light filaments. 25 tubes in circuits.



The Foster Radio Company, Wilkes-Barre, Pa., 3BHA.

4FV, CAN, 4IK, 5GF, 51M, 5QL. 6's too numerous. 7's also.

(8YAE) (8XAP) (8KH) (8CUU) (8DV) (8BOZ) (8ADG) (8ADH) (8CLV) (8CLU) 8BYO, H. Hoch, Webster Grove, Mo., J. M. Hodge, West Lafayette, Ind., 8BJS, 8AFL, 8BYH, 8BF, 8CXP, 8CPY, 8IJ, 8BUT, 8BOE (heard 6XAD without ground) 8CF, 8CPX, 8BWV.

(9UZ) (9EGY) (9BED) (9APS) (EEA) (9DYN) (9DTE) (9ASE) (9NZ) (9DAX) (9CTV) (9AAV) 9CJC, 9BJT, 9WA (aerial grounded) 9AOQ, 9BDZ, 9CKP, 9BLT, 9CTV, 9CDE, 9EFA.

On February 7th my good friend Mr. H. H. Carman, 2EL of Freeport, Long Island, N. Y., with whom I hold chat *any* night when QRN is not too obstreperous—sent his voice in to 6XAD to such good effect that it was plainly distinguishable. The time was 1 A. M. at Catalina Island, and the night a rarely fine one for DX effort. 2EL was only using 100 watts, and I believe this feat to be THE record-breaker—*par excellence*—of radio effort! I am putting in a 200-watt fone set for next autumn, and fully expect to communicate with 2EL by word of mouth as easily as we have been in effective communication all winter by telegraph.

Late reports have also been received from 4KL, 8APH, (8CAA) (8PD) (8BRL) (8ADG) (9CBA) (9CNV) 9CUI, 9DMW, (9BRK) 3AHK, 4IV, 5VO, 1CNA, 9CKP, 9DFE, (9AAV) 8BUT, 8AFL, 5IM, 8IJ, 8BVH, 8BF, 3BGG, Can. 4FV, 3BGN, 7ACX, (Can. 3TA) 2MU, 8BIS, B. Aitchison, Washington, D. C.

### RADIO STATION 8AB

The frequency of DX reports of 8AB on the Pacific Coast adds to the interest in this station at Port Huron, Mich. As may be seen from the illustration, the transmitting set consists of two 100 watt tubes. Filament current is supplied by a 12 volt battery and plate current by a 100 volt motor generator set.

The receiving set consists of a Grebe tuner, Federal detector and three stage amplifier, using Federal and Baldwin phones. The antenna system is a 6 wire cage 56 ft. high and 140 ft. long with a 6 wire counterpoise.

A few of the DX records include:

C. W.: 5CT, Duncan, B. C.; 6ZOC, Wailuku, T. H.; 6ACM, Palo Alto, Calif.; 7PN, Seattle, Wash.; 93XT, Giltnee, Neb.; 4DY, Winnipeg, Man.; 5ADL, Baten Rouge, La.:

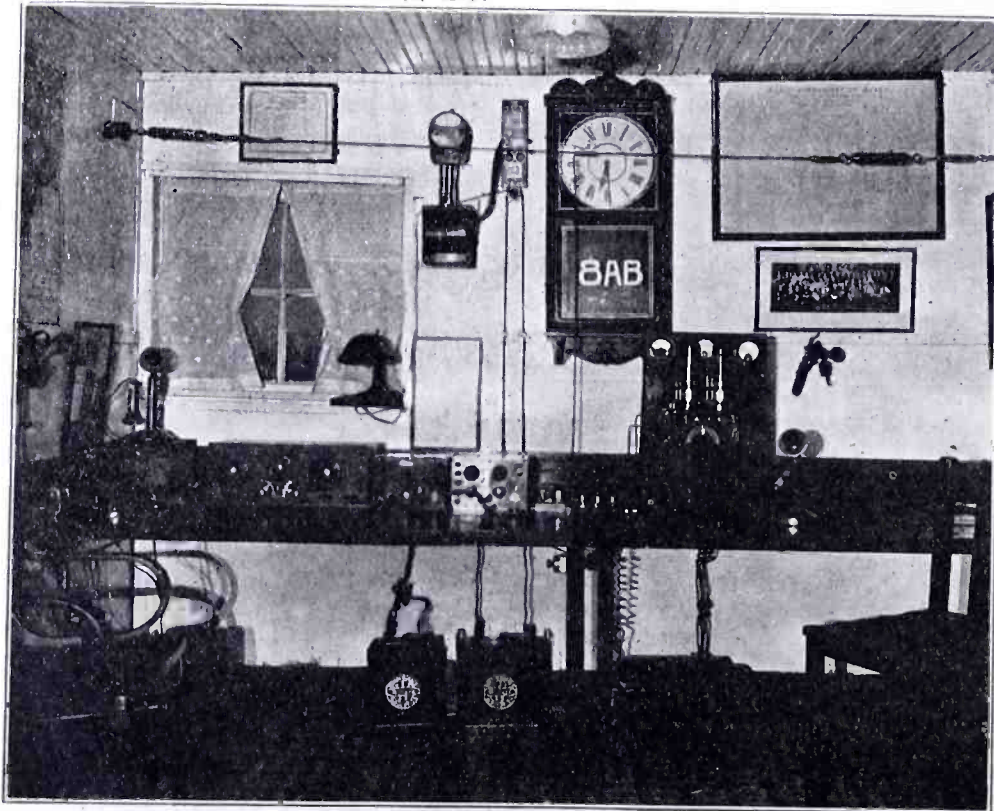

Radio Station 8AB.

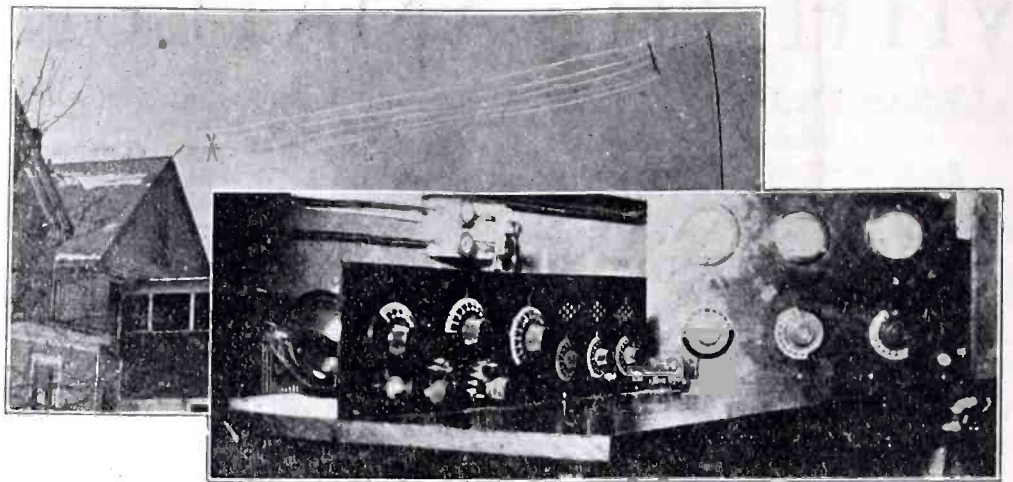

Radio Station 8CMY, operated by Edwin Schoenhen, Elyria, Ohio, who has worked 6XAD

7ABB, Everett, Wash.; 5DI, Fort Worth, Texas; 6ZY, Honolulu, Hawaii; 6KA, Los Angeles, Calif.; 7TT, Portland, Oregon; phone, 5XAJ, Texas.

This station is owned by Charles R. Thompson, Roy C. Gartung and J. Irving Bell. Albert Cassin is assistant operator.

### RADIO STATION 9AVC

ROBERT M. STEPHENS

My station, as shown in the accompanying picture, is located at the Y. M. C. A. of Hastings, Nebraska. The antenna is supported by one 60 ft. wood mast, in a vacant

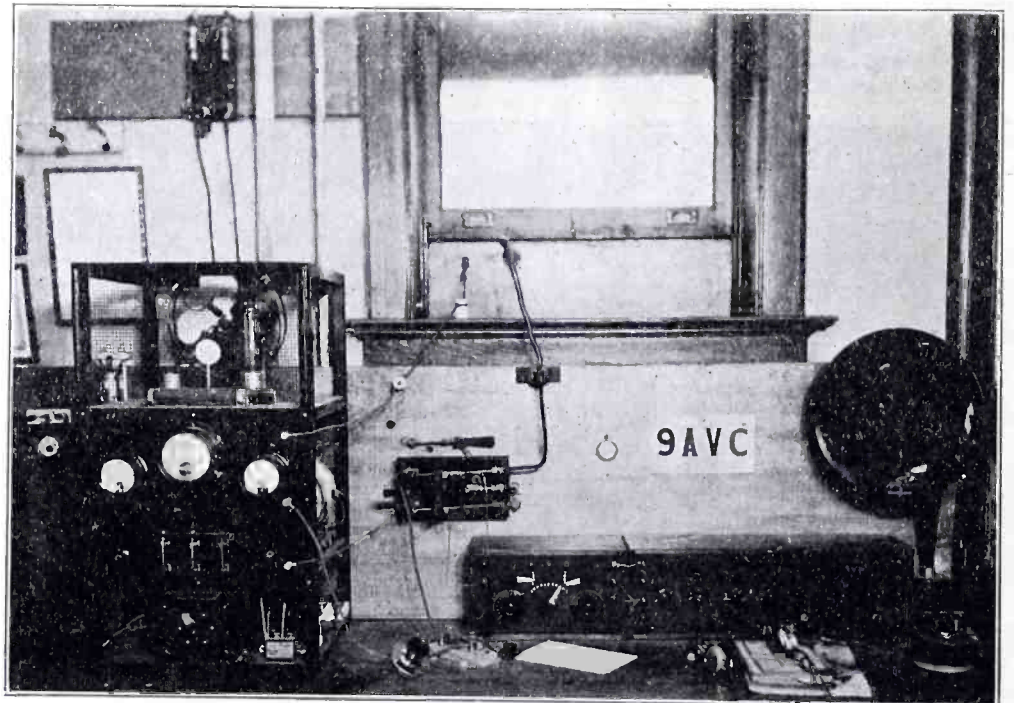

Radio Station 9AVC.

space behind another building and the other mast is a 25 ft. pole on the roof of the "Y." The antenna is a six wire cage, inverted L type. The lead-in is a six wire cage 9 in. in diameter. The counterpoise is a six wire flat top on 20 ft. spreaders, directly under and only 30 ft. below the antenna. The transmitting wavelength is exactly 196 meters.

The transmitter uses one 50 watt Radiotron in a straight Hartley circuit. The radiation at present is 5 thermo-couple amperes on straight C. W. and 2 on voice, moving up to 3.5 when the voice is impressed on the circuit. I also have a chopper, not shown in the picture, which is used for calling and handling traffic thru QRM and QRN. The voltage on the plate circuit is about 11, and is obtained with a 36 jar chemical rectifier in which a borax solution is used. I am seriously thinking of using ammonium phosphate because of the greater efficiency and less trouble in the care of such a rectifier. The rectifier is mounted directly under the transmitter. The filter circuit, which I take to be about as near perfect as possible, judging from the reports received complimenting the smooth note, is 3-1 mfd. filter condensers in parallel and a R C A filter reactor.

All controls are within easy reach of the operator, and are as simple as could be made. The receiving set is homemade, using Rein-

Continued on page 53



# CALLS HEARD



Readers are invited to send in lists of calls heard from stations distant 250 miles or more from their own station

### By 8ATN, 166 Grand Ave., East Highland Park, Mich.

1aw, 1fd, 1ru, 1sn, 1adn, 1bom, 1bwj, 1bys, 1cak, 1cbr, 1ckp, 1cmp, 1cit, (2el), (2pv), (2ry), 2aau, 2auu, 2auv, (2azy), (2bbb), (2bkl), 2bpx, (2cqz), (2cpk), (2cvu), (3ca), (3ha), (3nb), (3yo), (3zo), (3adq), (3auv), (3bji), 4bi, (4el), (4ik), (4kl), 4jn, 4js, 4ya, 4yd, (5ga), (5ix), 5js, (5ke), (5kw), 5mo, (5nn), (5ok), (5or), (5ov) (5px), 5pv, (5px), (5qi), 5sf, 5sk, 5so, 5sp, (5ta), (5u), 5uk, 5xa, 5za, 5zg, (5zp), (5aa), (5aec), 5aib, 5ams, 5anx, 5axj, (5zas), 5zav, 5ea, 6if, 6ka, 6ti, 6zh, 6abs, 6anb, 6avr, 6bjj, 6bun, 6bva, 6ad, 7zo, 7ya, 7ca, 7afs, 7aic, 9aa, 9dk, (9fb), 9lh, (9vk), (9yb), (9za), 9zt, (9acp), (9aeq), (9aog), (9aqz), (9ar), (9ase), (9ato), (9atn), (9aus), 9awf, (9bed), (9bke), (9bkk), (9bkl), (9bkj), (9bjc), (9buk), (9uz), (9bc), 9cac, 9edb, (9egk), 9eka, (9cm), (9emk), (9eki), (9cin), (9csn), (9cuc), (9dbf), 9dbl, (9dmj), (9dsd), (9dsw), (9dta), (9ebj), 9ekf. Anyone hearing my C. W. pse. qsl.

### By 6OV, C. Schomaker, 199 Douglass St., San Francisco.

5za, 5zh, 6bf, 6cc, 6cu, 6ea, 6eb, 6en, (6fh), 6ft, 6gx, 6ka, 6ku, 6pi, 6rr, 6sg, 6za, 6zb, 6zf, 6zg, 6zm, 6zac, 6xad, 6xaq, 6xab, 6abx, 6aek, 6agp, 6ahp, 6ahq, 6aio, 6aiy, 6ajh, 6alu, 6aaz, 6apw, 6apa, 6atc, 6atg, 6atq, 6aqq, 6bes, 6boe, 6bjp, 6bjq, 6awx, (7om) (7tq) 7nf, 7aic.

### By Roland Smith, 113 Ulandi St., Hilo, Hawaii.

All Stations Over 2000 Miles.

C. W.: 1ze, 1azw, 1sn, 2brb, 2nz, 2zk, 2ccd, 2co, 2el, 2ayv, 2sif, 2afp, 2bd, 2fp, 2kf, 2xq, 3cc, 3yo, 3af, 3ot, 3any, 3xn, 3bp, 3bij, 3buc, 3bj, 3aro, 3gk, 3awl, 3ahk, 3co, 4eh, 4cy, 4bv, 4cg, 4eb, 4ga, 4sf, 4xad, 5bbc, 5acf, 5za, 5xd, 5fv, 5px, 5ti, 5ir, 5nk, 5ke, 5vc, 5ix, 5mt, 5hz, 5ft, 5nn, 5aar, 5va, 5gr, 5jl, 5zak, 5zg, 5po, 5cn, 5ado, 5ov, 5aec, 5ml, 5abb, 5tr, 5zb, 5hz, 5yo, 5ako, 5zas, 5je, 5aml, 5xt, 5zh, 5tc, 5bm, 5uj, 5aar, 5sm, 5vo, 5ji, 5xab, 5iq, 5zav, 6akl, 6ko, 6zz, 6avr, 6abx, 6zi, 6bji, 6bcr, 6ak, 6bun, 6zaa, 6asq, 6zo, 6cc, 6zal, 6zx, 6ar, 6alu, 6fh, 6brg, 6zn, 6abx, 6pi, 6zg, 6arb, 6bcg, 6arf, 6zhd, 6zi, 6asy, 6bqd, 6if, 6aeh, 6bjj, 6bqc, 6bvw, 6ahx, 6bod, 6aat, 6ebi, 6brf, 6ka, 6bnv, 6apw, 6bi, 6vm, 6zr, 6bqb, 6xas, 6alv, 6g, 6bko, 6ff, 6auh, 6bak, 6bqf, 6xb, 6bqz, 6en, 6bjj, 6auu, 6zq, 6akl, 6bh, 6brs, 6xx, 6biq, 6ea, 6anh, 6bic, 6bu, 6xx, 6su, 6bgh, 6bcj, 6tc, 6awt, 6ti, 6ek, 6hdf, 6bis, 6zb, 6zm, 6bua, 6aor, 6ajf, 6eb, 6xwi, 6ef, 6aul, 6ajd, 6aai, 6ff, 6ze, 6rr, 6awa, 6ju, 6nak, 6apv, 6bzl, 6fy, 6bcl, 6xaw, 6avv, 6bru, 6ku, 6buy, 6mvr, 6anc, 6lv, 6bbv, 6bug, 6cu, 6bon, 6bh, 6bvg, 6biq, 6anb, 6avr, 6bur, 6bip, 6aix, 6aiy, 6aty, 6bru, 6haw, 7zm, 7xig, 7sc, 7tq, 7zo, 7aiy, 7wm, 7xd, 7zu, 7xi, 7kj, 7kz, 7yg, 7nf, 7sj, 7mf, 7nn, 7lr, 7pf, 7sj, 7aw, 7pf, 7bj, 7mf, 7zf, 7ab, 7ab, 7in, 8xe, 8yd, 8bk, 8btv, 8asv, 8amm, 8ib, 8bke, 8ue, 8zaf, 8pd, 8ui, 8bey, 8axc, 8eou, 8bdo, 8bfm, 8brc, 8bnj, 8qk, 8xe, 8beo, 8cur, 8xau, 8ii, 8bxx, 8bfx, 8aim, 8ecd, 8bfq, 8byo, 8bch, 8ak, 8cf, 8bsy, 8adg, 8vq, 8uf, 8zr, 8ate, 8caa, 8aaf, 9zaf, 9akb, 9bji, 9awn, 9dky, 9zm, 9zac, 9ays, 9wei, 9cns, 9ck, 9apw, 9cmk, 9dsd, 9bey, 9pi, 9zx, 9uh, 9bz, 9gk, 9anq, 9aps, 9aap, 9yw, 9acs, 9asu, 9ac, 9bik, 9ni, 9av, 9afk, 9ami, 9bm, 9bbf, 9yaj, 9afk, 9ei, 9bp, 9arz, 9anf, 9aul, 9dyn, 9bri, 9mo, 9gk, 9bhz, 9dgv, 9bef, 9aza, 9dz, 9kwe, 9bzz, 9cny, 9cac, 9cfi, 9bqv, 9btt, 9bsz, 9zt, 9yaj, 9bjv, 9abv, 9qf, 9aws, 9axu, 9anq, 9kp, 9ctg, 9fm, 9avz, 9bri, 9vm, 9cns, 9ccv, 9abv, 9asf, 9fs, 9cfy, 9ccv, 9ekh, 9aog, 9bzl, 9bed, 9bhi, 9bkk, 9cdr, 9cwr, 9ehn, 9bxm, 9yu, 9bxt, 9avz, 9ami, 9alh, 9bxz, 9acd, 9abu

Spark: 6aqu, 6bju, 6ald, 6aic, 5nk, 7kj, 6aoa, 6mq, 9aso, 9pho wbp, 9kjh, 9kdn, 9kdy, 9klx, 9kwg, 9kfi, 9kog, 9kuo, 9kdp, 9kwh, 9kze, 9kfb, 9dn, 9wgy, 9kzn, 9kuy, 9kvq, 9klx, 9cfac, 9kx, 9kre, 9kkg, 9klz, 9whb, 9cfc, 9kdm, 9waf, 9kfo, 9kyj, 9woai, 9whaz, C. W. rbzzg, nof, nrts. All stations please qsl by crd.

### By A. J. Blue, 65 Kensington Ave., Northampton, Mass.

Spark: 1cni, 1ary, 1amd, 2bjf, 2ns, 3gx, 3ei, 4gn, 5tu, 5xa, 5brl, 5by, 5ku, 9abm, 9aid, 9dlx, 9dxt. C. W.: 1gv, 1ze, 1adn, 1any, 1aqt, 1aww, 1ayd, 1azl, 1bas, 1bdt, 1bfg, 1bkr, 1bla, 1bsd, 1cak, 1cbj, 1cho, 1cik, 1ckp, 1cmk, 1cnf, 2ann, 2nz, 2tb, 3abw, 3afb, 3aga, 3ans, 3apt, 3aqr, 3arm, 4bx, 4gc, 4ea, 4kl, 5xa, 5xd, 5zas, 5zb, 5zav, 6cc, 6ka, 6avr, 6bcn, 6xad, 6zy, 7hm, 7sc, 7wx, 8bzk, 8bnh, 8bxa, 8bxt, 8cgu, 8ckm, 8xae, 9avc, 9bch, 9bdb, 9bsg, 9cmj, 9ddy, 9zaa. Canadian 2ei, 2hg, 3gk, 3nb, 9bh, 9od.

### By 9CIP, 480 Grand Ave., St. Paul, Minn.

All C.W.: 1xm, 1abb, 1bq, 1cik, 2ig, 2ke, 2ayn, 2brm, 2brb, 2cbw, 2cjr, 3cg, 3hs, 3qv, 3su, 3yo, 3atb, 3bjy, 3caq, 4ai, 4bi, 4bg, 4cg, 4dc, 4ea, 4el, 4jk, 4jl, (4km), 5ga, 5gi, 5ho, 5jg, (5kr), (5ok), 5pv, 5qi, 5sr, (5ss), (5tm), (5uk), 5we, 5xv, 5zh, (5ahd), 5aib, (5xab), 5zaa, 6ea, 6eb (6ft), 6if, 6jn, 6ti, 6z, 6abx, 6arb, (6avr), 6biq, (6bqa), 6bsq, 6cgv, (7lu), 7pf, 7sc, 8dg, 8hj, 8ib, 8am, 8agi, 8avv, (8arr), 8bin, (8bnz), (8boe), 8bog,

8epx, 8cve, (8dae), (9ce), (9pq), (9uh), (9vm), (9anf), (9ano), (9arj), (9aus), (9boz), (9bto), (9bun), (9cin), (9cki), (9cao), (9cof), (9ctz), (9dvw), (9ebn).

### By 6AND, James Kennedy, Peepeekee, Hawaii.

5kr, 5lv, 5xt, 5cy, 5kp, 6dak, 5bi, 5ek, 5ec, 5ok, 5qak, 5xao, 5xaw, 5xb, 5xk, 5xt, 5xy, 5zac, 5zak, 5zat, 6zh, 6cay, 6bm, 6big, 6bkk, 6buu, 6jx, 6bog, 6bug, 6bic, 6bun, 6zb, 6zix, 6cc, 6cej, 6tq, 6bua, 6aay, 6arb, 6zz, 6ajf, 6bjg, 6awx, 6awt, 6asg, 6bmo, 6cu, 6ao, 6cgwex6if, 6buf, 6awh, 7bj, 7zf, 7pf, 7aw, 7nf, 7sc, 7abb, 7zu, 7lu, 7ks, 8yd, 8cy, 8co, 8xd, 8ue, 8xe, 8bda, 8dx, 9ami, 9bzi, 9apw, 9ccv, 9bkk, 9cvt, 9wvr, 9bxq, 9adg, 9dpd, 9uv, 9dim, 9cwr, 9dgc, 9cfy, 9ve, 9bx, 9zaf.

### By 6CAN, J. W. Clark, Calistoga, California, Bx. 122.

3aro, 4al, 4ec, 4pi, 5ae, 5ga, 5gi, 5cn, (can), 5si, 5mo, 5za, 5xd, 5akt, 5ado, 5dx, 5aec, 5xa, 5zaa?, 6aea, 6afh, 6aji, 6arv, 6ax, 6ant, 6cav, 6cay, 6ajy, 6bak, 6aoi, 6bhv, 6ka, 6bru, 6awe, 6acm, 6bjq, 6bds, 6bmn, 6buo, 6bur, 6bic, 6zf, 6zu, 6zh, 6zt, 6ced, 6bjy, 6bun, 6ef, 6xx, 6bip, 6tn, 6ceq, 6qm, 6bka, 6cec, 6bsv, 6bge, 6bqr, 6ak, 7zf, 7na, 7mc, 7aff, 7cg, 7nn, 7om, 7sf, 7zu, 7nf, 7xk, 7wn, 7ny, 7aii, 7ln, 7sc, 7oc, 7vf, 7eq, 7azf, 7pf, 7wf, 7adf, 7ads, 7ey, 7ri, 8co, 8xr, 8ow, 8bec, 8dak, 9adu, 9bqm, 9cas, 9dqm, 9af, 9bji, 9ami, 9pi, 9aat, 9cnx, 9asf, 9cm, 9kaf, 9xn, 9amb, 9zx, 9tk, 9xa, 9arl, 9xu, 9cgv, 9ccy, 9yd, 9bjk, 9ym, 9ox, 9bx, 9bri, 9abu, 9bun, 9aog, 9bzi, 9bte, 9cwr, 9bur, 9bim, 9ckm, 9ani, 9csn, 9eea, 9bkk, 9aze.

10 watts A. C. w at 6 can. Would appreciate reports from any one hearing my sigs. W1 Qsl to any above as to tone, etc.

### By C. E. Cornwell, Osage, Iowa.

1gv, 1my?, 1rv, 1aok, 1apc, (qra?), 1bes, 1bro, 2gi, 2lt, 2sg, 2wc, 2xz, 2zp, 2ari, 2aro, 2asi, 2ayv, 2aw, 2bgh, 2bmr, 2ecd, 3bv, 3ca, 3fj, 3gz, 3ji, 3km, 3mf, 3oh, 3ot, 3pz, 3ti, 3uh, 3wf, 3xm, 3afb, 3aln, 3aro, 3bob, 3bsu, 3bvc, 4bi, 4bx, 4by, 4cd, 4ea, 4eb, 4eh, 4ft, 4fk, 4gz, 4hw, 4jc, 4jk, 4jl, 4kc, 4kl, 4mb, 4nv, 4oh, 4pd?, 4ya, 4yd, Too many 5's, 6bjg, (qra?), 6vm, 6za, 6zh, 6zz, 7pf, 7zu, 7zv, Too many 8's and 9's. Specials: ad7, nof. Canadian: 3bp, 3bv, 3dh, 3fo, 3gb, 3gk, 3jl, 3ni, 4bv, 9bj, 9bx.

### By 8CF (C. H. Katzenberger) at 711 North University Ave., Ann Arbor, Mich.

(6bh), 6bo, 6cc, (6cp), 6cu, 6ea, 6eb, 6gf, 6gr, 6hp, 6jd, (6jn), 6ka, 6ki, 6lu, 6om, 6pi, 6rm, (6ti), (6abx), 6amk, 6anb, 6arb, (6awt), 6bod, 6bqo, 6bun, 6xl, 6xi, (6xad), 6xav, 6zf, 6zh, (6zi), 6zo, 6zx, 6zz. 7bh, 7fp, 7ln, (7lr), 7lu, 7nf, (7pf), 7qk, 7sc, (7abb), 7zu, 7zv. All districts worked in one night.

### By 5AIA, Ferris L. Dietz, 719 Ryan St., Lake Charles, La.

On Galena Detector, no Amplification. 6fi, 5fp, 5gq, 5jd, 5kn, 5qt, 5rz, 5tu, 5ud, 5vy, 5xac, 5xa, 5xad, 5xv, 5zc, 5zh, 9adq, 9akq, 9asl, 9aof, 9aza, 9bwn, 9czl, 9dww, 9mc, 9xv. Anyone hearing 5aia's 5-watt spark-tube set please qsl.

### By 6VF, San Francisco, California.

be3, 5hz, 5jt, 5nk, 5rh, 5xt, 5za, 5ado, 5xab, 5zav, 7(7ak), 7ey, (7hd), 7hj, (7hm), (7ij), 7ke, 7kf, 7ln, 7lr, 7lv, (7mc), 7na, 7ny, 7m, (7vf), (7sc), (7sn), (7sy), 7tn, 7to, 7tq, 7tt, 7zf, 7zl, 7zv, 7abb, 7aea, 7aft, 7afw, 7agi, 7agv, 7ajv, 7amg, 8bk, 8bx, 8kg, 8yn, 8zo, 8zw, 8zz, 8aaf, 8alv, 8apw, 8asv, 8bch, 8bda, 8aef, 8bxx, 8byo, 8cur, 8crb, 9bx, 9yb, 9zt, 9amu, 9arz, 9atx, 9auw, 9avz, 9ayv, 9ekh, 9bji, 9bjk, 9bly, 9bri, 9brk, 9bxa, 9bxm, 9bxt, 9cfy, 9cpa, 9cwr, 9dax, 9dgv, 9dlm, 9dsd, 9dvi, 9dxy. Canadian (5ej). Any one hearing my ten-watts, please qsl.

### By 6EB, 343 So. Fremont Ave., Los Angeles, Cal.

Can. 4bv—U. S.—5cy, 5di, (5el), 5ke, 5kk, (5kp), 5px, 5sk, 5ta, 5we, (5za), 5zh, 5adb, 5ado, 5aec, 5xaj, 5zak, 5zas, (5zav), (6aa), 6ao, 6ex? or 6tx? (punk fist), (6fh), 6gf, (6hp), 6ii, (6jn), (6ku), (6lu), 6nx, 6ti, 6zh, 6zt, (6zz), 6ael, 6ahu, 6akt, 6alx, (6ann), 6aqw, 6arb, (6arv), 6aty, (6awt), 6bel, (6beh), 6bfq, 6bka, 6bki, (6bly), 6bmy, (6bnt), 6bob, (6boe), 6bon, 6bru, 6bsd, (6caj), (6cee), (6cec), (6cfq), (7ba), 7dh, 7dp, 7ge, (7gp), 7hf, 7hu, (7na), 7nf, 7qt, (7sc), 7tg, 7vf, 7wm, (7wx), 7zf, 7zu, 7zv, (7abb), 7adg, 7adr, (7afn), 7afo, 8hj, 8qk, 8bch, 8bey, 8bed, 8byo, 8bxx, 9fv, 9qf, (9ql), 9uh, 9xj, 9zt, (9abu), 9aey, (9amb)—daylite, 9aog, 9aps, 9arv, 9arz, 9aul, 9avu, 9ayu, 9bed, 9bki, 9bkk, 9bkkp, 9bre, (9bri), (9bxa), (9bxm), 9caa, (9ccv), 9cip, (9cny), (9cny), 9ckp, 9cks, 9dge, 9dhl, 9dkg, 9dky, 9eea, nof. Have some new cards printed and if any one listed above who wishes to have one, please write me and qsr?.

### By 8CMY, Elyria, Ohio.

1ap, 1aw, 1bm, 1cn, 1cy, 1df, 1dw, 1fb, 1fd, 1gv, 1hk, 1ii, (1il), 1ki, 1mc, 1ow, 1qp, 1rd, 1sn, 1uj, 1vc, 1wc, 1xu, 1xz, 1abb, 1adl, 1adp, 1af, (1agh), 1ain, 1ajp, 1alz, 1anr, 1aoj, 1aot, 1ary, 1asi, 1ati, 1atj, 1avb, 1awe, 1ban, 1bdi, 1bel, 1bes, 1bet, 1bfe, 1bgw, 1bhr, 1bjj, 1bka, 1bkr, (1boq), 1bqd, 1bqk, 1bsp, 1bsz, 1bvh, 1bvr, 1bwj, (1cab), 1caj, 1cak, 1cdo, 1cdr, 1cgr, 1cit, 1cja, 1cjd, (1cjh), 1clz, 1cmk, 1cmp, (1cnf), 1cpi, 1cpo, 1cre, 1cru, 1crw, 1csw, 1eve, 2da, 2el, 2fp, 2gk, 2gv, 2hj, 2ne, 2om, 2pz, 2rm, 2rz, 2wr, 2afp, 2ajf, 2amf, 2auz, 2awf, 2axf, 2axk, 2ayv, (2azy), 2bay, 2bfh, 2bkk, 2bls, 2bmk, 2bml, 2bmr, 2bqb, 2bqz, 2brb, 2buu,

2cbg, 2cbw, 2ccd, 2cei, 2cfb, 2cgt, 2chu, 2chz, 2cim, 2clr, 2clt, 2cms, 2cmv, 2col, 2cor, 2cqi, 2cqz, 2ctd, (2cvu), 3ab, 3ak, 3as, 3ay, 3bj, 3bz, 3cc, 3cm, 3de, 3fp, 3fq, 3fs, 3hc, 3hj, 3hk, 3ig, 3ii, 3il, 3iw, 3jg, 3jj, 3lk, 3lp, 3mk, 3mo, 3of, 3oj, 3ot, 3ph, 3pz, 3qb, 3rf, 3sk, 3su, 3ta, 3ti, 3vw, 3wf, 3xm, 3xo, (3yo), 3zo, 3zw, (3zz), 3acr, 3acy, 3adb, 3adt, 3afb, 3afw, 3agb, 3ahr, 3ajj, 3ajl, 3aln, 3alu, 3amw, 3apr, 3apt, 3aqg, 3arm, 3aro, 3asi, 3asp, 3asy, 3atb, 3awa, 3awv, 3ayg, 3bei, 3bfu, 3bfg, 3bho, 3bif, 3bij, 3bit, 3biy, 3bji, 3bjy, 3blf, 3blp, 3bof, 3bss, 3btk, 3bup, 3bur, 3buy, 3bva, 3bvc, (3bvl), 3bvy, 3bwb, 4ai, 4bd, 4bg, 4bk, 4bq, 4bw, 4bx, 4cg, 4db, 4dx, 4ea, 4eb, 4ep, 4et, (4ft), 4gh, (4gz), 4hk, 4hw, (4hz), 4jk, 4kc, (4lj), 4mb, 4nv, 4od, 4oi, 4oh, 4tb, (4ya), 4yd, 5bw, 5da, 5dn, 5dq, 5ek, 5fv, 5ho, 5ik, 5ix, 5jb, 5js, 5kc, 5mb, 5ml, 5ns, 5nz, 5pv, (5qi), 5sp, 5sm, 5ta, 5uk, 5up, 5vj, 5xa, (5xk), 5xv, 5za, 5zb, 5zk, 5zp, 5zas, 5abh, 5acq, 5aec, 5agi, 5zas, 5zav, 5zaz, 5zax, 6abx, 6zf, 6zu, 6zz, 6bjx, (6xad), 7bh, 7hm, 7sc, 7zu, 9aj, 9bp, 9cm, 9cr, 9da, 9du, 9dv, (9ei), 9eq, 9ex, 9hk, 9ig, 9ii, 9io, 9il, (9lj), 9lz, (9of), (9or), 9pe, (9pf), 9ps, 9qf, 9uc, 9uu, 9vv, 9vz, 9wc, 9xt, 9yf, 9yj, 9yu, 9zt, 9aap, 9aau, 9aaw, 9abu, 9abv, 9aey, (9afk), 9ahh, 9ajh, 9aky, (9ami), 9amq, 9amu, (9aog), 9apw, 9aqz, 9arg, 9arj, (9ase), 9atn, 9ato, 9aua, 9avc, 9avu, 9awf, 9axa, 9aza, 9bcb, 9bch, 9bed, (9bfg), 9bgb, (9bgh), (9bhd), 9bji, 9biv, 9bjt, 9bjv, 9bkj, 9bkk, 9bkw, 9blw, 9blz, (9bop), 9bre, 9bri, (9bst), 9bst, 9btl, 9btt, 9buo, 9bvy, (9bvz), 9bwn, 9bwr, 9bxj, 9bye, 9byx, 9bze, 9bz, 9bz, 9cao, 9cbs, 9cbt, 9ccv, 9eda, 9edu, 9cee, 9cen, 9cgd, 9cgk, 9cgy, 9che, 9ci, 9cin, 9cja, 9cjc, 9cjm, 9ckv, 9ckw, 9clk, 9clq, 9clz, 9cmv, 9col, 9cpa, 9cpc, 9ern, 9csn, 9cte, 9ctg, 9ctv, 9ctw, 9cui, 9cvi, 9cvs, 9cwp, 9cwr, 9cwy, 9cym, 9cyw, 9czf, 9czy, 9daj, 9daw, 9dbv, 9dca, 9deg, 9der, 9dfq, 9dgg, 9dgv, 9dhh, 9djb, 9dka, 9dky, 9dmf, 9dmj, 9dnd, 9dqu, 9dri, 9dsd, 9dsm, 9dti, 9dts, 9dvl, 9dvw, 9dvw, 9dvw, 9dxc, 9dxn, 9dyv, 9dzg, 9ear, 9ebh, 9edb, 9ede, 9eey, (9efc), 9ehn, 9eht, 9ehw, 9ehz, 9eil, 9ekf, 9xac, 9xaq, 9zaa, 9zaf, 9zat. Can.—2am, 2an, 2cq, (3ad), 3bp, (3bv), 3co, (3dh), (3fa), 3gn, 3il, (3ji), 3jl, 3ko, 3xn, 3yh, 3zl, 4dk, 9cd, 9us.

### By 6AVR, Fullerton, Cal.

3aro, 4co, 4ft, 4hw, 4ya, 4zc, 5ek, 5kc, 5ns, 5sp, 5ta, 5uo, 5aar, 5abh, (5ado), (5aec), 5aib, 5xb, (5za), 5zh, 5zaa, 5zak, (5zat), 5zas, 7ab, 7ak, (7bj), 7cg, 7dh, 7dp, (7hj), (7iy), 7jw, 7ke, 7lr, (7ln), 7lu, 7mc, 7nf, 7ny, (7om), 7pf, (7sc), 7sy, (7vf), (7wx), 7abb, 7aea, 7afo, (7aft), 7afw, 7ahw, 7aic, (7aif), (7ajq) qsl, 7ajv, (7zn), 7zu, 7zv, 8qv, 8azv, 8bch, 8bdo, 8byo, 8cei, 8cpd, 8yv, 8zo, 9dv, 9fh, 9pg, 9ps, (9uh), 9aap, 9abu, 9afk, 9aiy, (9amb), 9aog, 9apw, 9arz, 9abu, 9bds, 9bis, 9bte, 9btt, 9buo, 9bxx, 9bxm, 9bzi, 9cac, 9ccv, (9cip), 9cjj, 9cny, 9cpa, (9cpv), 9cte, 9ctg, (9cuc), 9cwr, 9bca, 9dhi, 9dky, 9dsd, (9dte), 9dva, 9dvw, 9cea, 9ekh, 9yb, 9zt. Can.: 9bp, 9bv, 9bx. Any one hearing my C. W. sigs. qsl.

### By 6BH, K. V. Dilts, 760 East California St., Pasadena, Calif.

C. W.: 2fp, 3bp, 3fi, 4bi, 4eb, 4hh, 4ya, 5aw, (5be), 5di, 5ek, 5fo, 5fv, 5gi, 5hb, 5ir, (5ix), 5ke, 5lo, 5nk, (5nn), (5ns), 5nz, 5px, (5qi), (5st), 5sk, (5ss), 5ud, 5uj, 5uk, 5un, 5uo, (5vo), 5aah, (5adb), (5ado), 5xb, 5xd—voice, 5xu, 5yq, (5za), 5zj, 5zo, 5zx, 5zak, 5zam, 5zas, 6ah, (6ak), 6bm, (6bu), (6cc), 6cz, 6dd, 6dt, 6ex, (6fh), (6fy), 6gr, (6gx), (6jn), 6ku, (6lu), (6lv), 6nh, 6nx, 6oh, 6oo, 6ot, (6rd), (6re), 6rm, (6su), (6ti), (6uq), 6uw, (6vf), 6vk, (6vm), (6aa), 6aan, 6abx, (6acm), 6aeh, 6ajf, (6ajr), 6akl, (6alv), (6alx), (6anb), (6anh), (6anp), (6aqf), 6arb, (6arf), (6asj), (6atq), (6atu), 6aul, (6aun), (6auy), (6avv), (6awt), (6bbh), 6bed, (6beh), 6bfy, (6bgd), (6bih), (6biq), (6bjy), (6bmd), (6bmn), (6bmy), (6bnu), (6boe), (6bpl), (6bqf), (6bql), (6bsa), (6bsq), (6bua), 6bum, (6buy), (6caj), (6cay), (6chl), 6xd, 6xw, (6za), 6ze, 6zf, (6zh), (6zm), 6zq, 6zy, (6zz), 6xaf, 6xao, 6zac, 6zaf, 6zam, 7ab, 7ad, 7ak, 7ba, (7bj), 7bp, 7ed, (7eq), 7ga, (7ge), (7hj), 7hm, 7jw, 7ke, 7ln, 7lr, (7mc), (7mf), 7na, 7nf, 7om, 7qt, (7sc), 7to, (7tq), 7tx, (7wx), 7abb, (7aem), (7aff), 7afw, 7aiu, 7alu, 7bag, qra?, (7zn), 7zu, (7zv), 8ab, (8cf), 8ib, 8kp, 8qk, 8vq, 8afd, 8agd, 8aio, 8aog, 8apw, 8aqv, 8bch, 8bda, 8bdo, 8bdu, 8bef, 8bfm, 8bke, 8bwa, 8bxh, 8bxx, 8byo, 8bzy, 8caa, 8cgv, 8ckv, 8crb, 8yb, 8yd, 8zw, 8zy, 8zz, 8xae, 9bf, 9bm, 9bx, 9dp, 9ei, (9fv), 9gk, 9gm, 9kp, (9lw), 9nx, 9ox, 9pi, 9ps, 9ql, 9rc, 9uh, 9uu, 9wd, 9abu, 9abv, 9aeg, (9aey), 9aix, 9ajh, 9ajp, 9aku, (9amb), 9ani, 9anq, 9ans, 9aog, 9apw, 9arv, 9ari, 9arz, 9asf, 9atn, 9aul, 9ave, 9awm, 9ayu, 9bed, 9bfb, 9bhd, 9bik, 9bil, 9bji, 9bjk, 9bor, 9bsg, 9bvm, 9bvy, 9bxa, (9bxh), 9bxm, 9bxq, 9byc, 9bzi, 9bzz, 9cac, 9cba, 9cek, 9ccv, 9ccy, (9cde), (9cfy), 9cip, 9cjj, 9ckp, 9clw, 9cns, 9cpi, 9cpu, 9cpc, 9cte, 9ctv, 9dfb, 9dgv, 9dhi, 9dio, (9dky), (9dpd), (9dsd), 9dsm, (9dta), 9dte, 9dtm, 9dva, 9dvw, 9dvm, 9dxc, qra?, 9zt, 9xaq, 9yaj, 9zaf. Spark: (6gf), 6kc, 6kd, 6qr, (6hnp), (6aoa), (6apl), 6auu, 6bbe, 6bju, 6bke, 7ya. Can. C. W.: 5cn, (5go), 9bp.

The qra of 6bh is Pasadena and not Los Angeles as given in the call books, so that is why some who sent me cards received no qsl.

Continued on page 44



# NEW APPARATUS & SUPPLIES FROM THE RADIO MANUFACTURERS

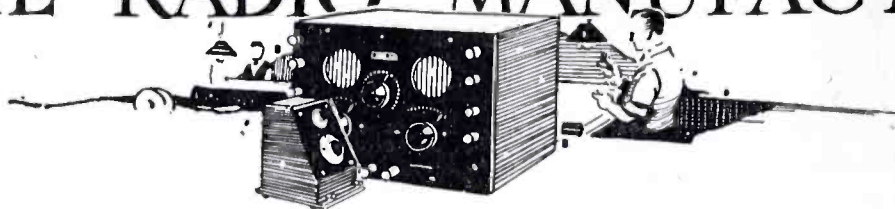

## THE FILKOSTAT

In the Filkostat, a new filament control just perfected by S. R. Hipple, there is presented an instrument designed to utilize the great tuning possibilities of the vacuum tube, by permitting perfect regulation of filament heat. Since the heat emitted varies as the square of the current, fine current regulation becomes necessary. The fine adjustment of the Filkostat starts slightly before the tube begins to function. Between 1800 degrees—dull red glow—and 2050 degrees—white heat—the Filkostat control is so fine that increases of temperature are in fractions of a degree, with corresponding variations of electronic flow from the filament to the plate, are obtainable.

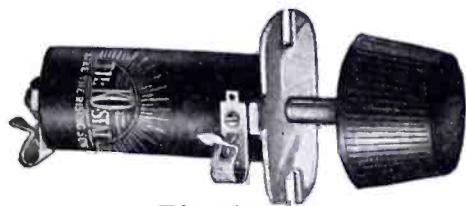

The Filkostat

The Filkostat has a definite off. It is so designed that the filament extinguishes abruptly, indicating that the *A* battery supply is completely disconnected. At Full On the resistance is practically zero.

The Filkostat consists of a hollow cylinder containing the special finely divided resistance material placed between two large adjustable contacts controlled by turning the knob. The resistance remains constant at any position, eliminating current variations after it is once set.

The Filkostat is manufactured by the DX Instrument Company of Harrisburg, Pa. The entire international distribution is in the hands of Radio Stores Corp. of New York.

## THE FOUR WAY RADIO PLUG

A new convenience for the operator of a receiving set is provided in the four way radio plug made by the Four Way Co. of Springfield, Mass. This is a single plug switch that connects two double head sets or one double head set and a loud speaker through on jack, thus taking the place of two plugs and one jack. By a simple rotation of the switch it is possible to connect either set of phones singly or both sets in series or in parallel.

For example it is thus possible to tune in with the headset and then throw on the loud speaker without removing the phone plug, the headset meanwhile being either in or out of circuit as preferred.

## WESTINGHOUSE NEW TRANSMITTER

A new radio transmitter invented by Dr. Phillips Thomas, research engineer of the Westinghouse Electric & Manufacturing Company, makes possible the broadcasting of music and other sounds exactly as produced. It has been used at the Westinghouse broadcasting station KDKA within the past few months, which explains the clarity and strength of this station's signals.

The basis of Dr. Thomas's invention is the elimination of the diaphragm now used in all

transmitters in practical service. This diaphragm consists of a thin disk of metal or other substance and operates by being vibrated by the sound waves which strike it. But because of its inherent inertia, no material diaphragm is capable of vibrating in perfect sympathy with the entire range of audible sounds. If it can transmit low notes successfully, it will fail on high notes; and vice versa. The ordinary diaphragm is designed with reference to the middle register, and it therefore does not transmit extremely high and extremely low notes satisfactorily. The piano is a case in point. The radio audience hears the highest notes as a series of clicks and the very bass notes as a roar.

In the Thomas transmitter, a minute electrical discharge takes the place of the mechanical disk. This discharge flows between

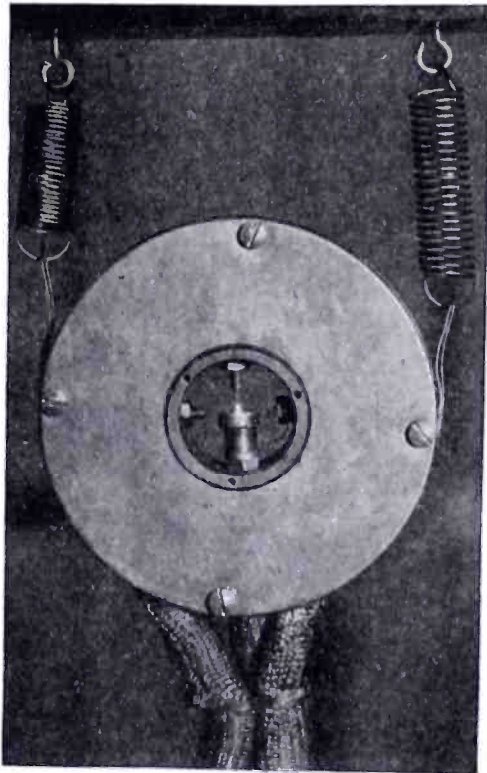

Close up view of the glow discharge transmitter.

two points, separated by a very small fraction of an inch. It is affected by sound waves, just like the diaphragm, but being non-material and having no perceptible inertia, it responds equally well to all vibrations. Hence music broadcasted by means of it is transmitted in all its original purity.

In appearance, the Thomas transmitter resembles a large watch, with the front and back covered by wire gauze. On looking into it, a point of light can be seen, caused by the flow of the electric energy against one of the terminals. From this fact, it is called the glow discharge transmitter.

## ERRATA NOTICE

The circuit shown on page 13 of March RADIO is in error and will be redrawn for publication in the May number. As shown it will short circuit the *B* battery.

In the last paragraph of 6ZJ's article on p. 28 of April RADIO "500 micro farads" should be "500 micro-micro farads."

## THE DICTOGRAND RADIO LOUD SPEAKER

The Dictograph Products Corporation, of New York City, has placed on the market the new Dictogrand radio loud speaker which is mounted in a mahogany finished hardwood cabinet. An adjusting dial in the front of the cabinet increases or decreases the air gap or distance between the pole shoes and an especially made alloy diaphragm. The adjusting mechanism operates through a shaft,



Dictogrand Loud Speaker

pinion and gear. Changing the air gap varies the pull of the magnet upon the diaphragm, thus enabling the loud speaker to be tuned up in complete harmony and resonance with the receiving set.

The unit is an entirely new and novel arrangement consisting of laminated pole shoes with special Dictograph coils wound with No. 44 magnet wire. All harsh, jarring sounds, noises and overtones have been overcome in the Dictogrand. It creates the illusion that the artists are in the very room with the listener.

The diaphragm is of special composition, restricted solely to Dictograph Loud Speaker production. The entire unit is subjected to a rigid inspection and test both during sub-assembly and final completion and is guaranteed against all mechanical and electrical defects for a period of one year.

The horn is of spun copper handsomely finished in mahogany. The tone-arm is a die casting especially designed for resonance and lack of vibration. Each loud speaker is equipped with five feet of flexible silk cord with standard terminals.

The Dictogrand Radio Loud Speaker is designed to operate on any vacuum tube receiving set, using two stages of amplification, but good results are often secured on sets employing but one stage of amplification, dependent upon the type set used and the distance from the broadcasting station. This loud speaker requires no external batteries.

Continued on page 90







# CHARGE YOUR RADIO BATTERY at HOME for a NICKEL

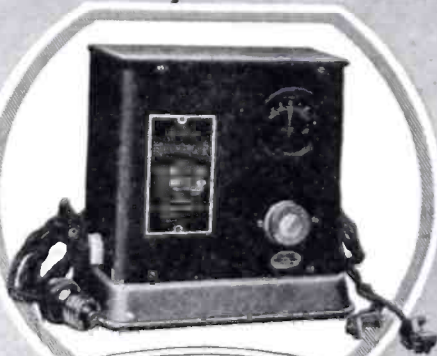

**PATENTED ARMATURE**  
The HOMCHARGER'S only moving and wearing part, replaceable after thousands of hours' use for \$1.00. Tungsten contacts now used exclusively. Will not stick, corrode or wear excessively.

Enjoyable concerts and maximum receiving range are obtained only when your battery is fully charged.

## THE HOMCHARGER

charges your "A" or "B" battery OVER NIGHT for a nickel without removing it from your living room. Operates silently—charging rate governed automatically. No muss—no trouble—no dirt—requires no watching.

The HOMCHARGER is the ONLY battery charger combining all of these necessary features. SELF-POLARIZING—FIVE to EIGHT-AMPERE charging rate—UNDERWRITERS' APPROVAL—beautifully finished in mahogany and old gold—UNQUALIFIEDLY GUARANTEED. Over 100,000 now in use.

The minute you buy a radio set you need a Homcharger—get it then. All good radio and electrical dealers sell it complete with ammeter, etc., for \$18.50. \$25.00 in Canada.

Write for FREE circular showing why the HOMCHARGER is the BEST battery charger at any price.

**MOTORISTS — THE HOMCHARGER** will also charge your AUTO Battery.

Western Distributor  
**BERTRAM SMITH**  
516 San Fernando Bldg., Los Angeles, Cal.  
**THE AUTOMATIC ELECTRICAL DEVICES CO.**  
117 West Third St.  
Cincinnati, Ohio

Largest Manufacturers of Vibrating Rectifiers in the World

# BROADCAST PROGRAM

A weekly magazine devoted to Western Broadcasting.

5c per copy.  
26 issues for \$1.00.

**BROADCAST PROGRAM**  
449 Pacific Bldg.  
San Francisco, Cal.

## CALLS HEARD

Continued on page 41

By 6BQL, 575 21st Ave., San Francisco, Calif.

Can.—4bv, 4hh, 5ae, 5bq, (5cn), 9ae, 9bx, U. S.—nof, 4eh, 5ek, 5ft, 5fv, 5ir, 5kc, 5my, 5qm, 5tj, 5za, 5xd, 5xv, 5aby, 5aec, (5zak), 5zav, (6bh), 6cu, (6ea), 6eb, 6ek, 6en, 6ft, 6gd, 6gh, 6if, 6ka, 6ku, 6om, (6rm), 6za, 6zb, (6zh), (6zo), 6zt, 6zz, 6xx, 6aa, 6ada, 6aeh, 6agp, 6ahq, (6akl), 6alu, 6amn, 6anh, 6apw, 6atq, 6avd, 6bbh, (6beq), 6bfp, 6bgh, 6bjj, (6bjq), 6bjy, 6bjt, 6bmd, 6bnv, 6bob, 6bod, 6boe, 6bow, 6bqb, 6bqc, (6bqd), 6bqe, 6bqf, (6bqw), 6bqz, 6brf, 6br, 6bum, (6bun), 6byw, 6xad, (6xas), (6zac), 6zal, 7ba, 7bj, 7bk, 7dp, 7ex, 7fd, (7hj), 7hm, 7kr, 7lr, 7lu, 7lw, 7mf, 7mp, 7nf, 7na, 7nn, 7oe, 7ot, 7pf, 7qe, 7qf, 7sc, 7th, 7to, (7tq), 7wm, 7yg, 7zk, 7zu, 7abb, (7adf), 7adp, 7aem, 7aff, 8bk, 8by, 8fu, 8ib, 8jj, 8axb, 8axc, 8axd, 8ach, 8bvr, 8bxx, 8bzy, 8cfo, 8cfx, 8zy, 9bm, 9bp, 9er, 9fm, 9kp, 9ps, 9rc, 9rm, 9zn, 9zt, 9afk, 9aiv, 9aog, 9aou, 9amb, 9ami, 9anq, 9apw, 9asf, 9aul, 9avc, 9avz, 9awm, 9ayu, 9bed, 9bho, 9bik, 9bji, 9bvy, 9bjy, 9bkg, 9bly, 9bsg, 9bxa, 9bxk, 9bxq, 9byc, 9bzi, 9ccv, 9cyl, 9dio, 9dky, 9dqm, 9yaj, 9xac.

By 9CKM, 623 Sandusky Ave., Kansas City, Kansas.

low, 1aab, 1ajx, 1qaf, 1yk, 2af, 2ayv, 2bmr, 2 can, 2cjr, 2epo, 3as, 3ca, 3jj, 3pl, 3rf, 3tr, 3aef, 3aro, 3arz, 3bwt, 3xm, 3xal, 3zp, 4bi, 4by, 4cg, 4du, 4eh, 4hw, 5bw, 5di, 5oq, (5ek), 5gn, 5ho, (5ym), 5ix, 5js, 5jt, 5kc, 5mo, 5nv, 5nz, 5pi, 5pv, (5px), (5qi), 5rh, 5rn, (5sm), (5ta), (5tc), 5tj, 5uk, 5uo, 5us, 5aam, 5aby, 5acq, 5agg, (5ahj), 5aib, 5xa, 5xb, 5xt, 5xaj, 5za, 5zav, 5zaw, 6tt, 6anh, 6boe, 6xad, 6xaw, 6raf, (6zz), 6zao, 7dh, 7ln, 7lu, 8aa, 8az, 8cf, 8cp, 8eb, 8fe, 8ib, 8jj, 8kj, 8mg, 8pd, 8pj, 8sm, 8ss, 8ue, 8uk, 8vq, 8wv, (8wx), 8aaf, 8aak, 8aea, 8aeg, 8ago, 8aim, 8alt, (8anb), 8apt, 8aqc, 8aqf, 8atn, 8atx, 8axt, 8azd, 8bdu, 8beo, 8bge, 8bke, 8brt, 8bry, 8bsy, 8bwa, 8bxh, 8byn, 8byo, 8byt, 8caa, 8ccv, 8cdd, 8cei, (8chb), 8ciz, 8ckv, 8cnn, 8coh, 8coz, 8cpd, 8ctn, 8cwe, 8cxf, (8cxw), 8eyt, 8cyu, 8dag, 8dak, 8dat, 8xap, 8yb, (8yv), 8zd, 8zf, 8zw, 9cm, (9cr), 9ep, 9io, (9lz), 9mf, (9of), (9or), 9qf, (9uh), 9ul, (9ur), (9vm), 9uz, (9abu), 9acd, (9anf), 9aps, (9apw), 9aqa, 9asn, 9aza, 9azn, 9bji, (9bkj), (9bri), (9brk), 9bst, (9bwn), (9bxc), (9bxh), 9bxm, 9cfb, 9cfy, (9cfz), (9cdg), 9ekp, (9clq), (9coc), (9cpr), 9cte, 9ctf, 9ctv, (9cvo), (9czf), (9dhs), 9dkk, 9dkq, (9dqm), (9dqu), 9dwl, (9dyy), (9ehn), (9eib), (9ekf), 9yb, (9zt).

Can.—3jl, 3ni, 4cn, (9bx), 9lw.

By 7RO, Portland, Oregon.

All O. W.: 5nk, 5ir, 5za, 5qi, 6aa, 6aag, 6abx, 6ajd, 6anb, 6anh, 6apw, 6arb, 6arv, 6avv, 6awd, 6bcj, 6bel, 6bie, (6biq), 6bm, 6bnv, 6bod, 6bon, 6bqb, 6brs, 6bru, 6bsj, 6btz, 6bu, 6bum, 6un, (6buy), (6can), 6cej, 6ef, 6ek, 6fh, 6fy, 6ju, 6ka, (6ku), 6qm, 6rm, 6rr, 6su, 6ti, 6uw, 6xad, 6xao, 6xx, 6za, 6zao, 6ze, 6zh, 6zz, (7adp), 7afw, 7ge, 7hj, (7ke), 7kv, 7lr, 7lu, 7pf, (7tq), 7zv, 8axc, 8azd, 8bxx, 8er, 8ib, 8uc, 8vq, 8zy, 9ajp, 9ami, 9ani, 9anq, 9aou, 9arz, 9asf, 9avz, 9awm, 9ayu, 9aza, 9bds, 9bji, 9bly, 9bm, 9bxm, 9edu, 9cns, 9edu, 9cwr, 9dsm, 9dtm, 9edb, 9gk, 9pi, 9rc, 9yaj, 9yf.

Can.—4dh, (5cn), (5ct), 5ej, 5go, 9bx. All of above heard on 1 tube. Anyone who hears my 5-watter pse qsl card to 439 East 10th St. North, Portland, Oregon.

By 8RY, Burton, Ohio

4cy, 5bw, 5gr, 5ix, 5nn, 5ns, 5px, 5za, 5zac, 5zak, 5zb, 6ka, 6rm, 6zz, 7sc, 7zu, 9ayu. Pse. qsl on 10 watt self-rec. C. W. hr.

By 6EC, Anaheim, California

Can.—3xn, 4bv, 4hh, 5cn. U. S.—4eh, 5aec, 5ir, 5za, 5xd, 5xad, 5cn, 5xaj, 5zak, 5aar, 5xab, 7ad, 7ba, 7bj, 7na, 7sc, 7ty, 7zo, 7zu, 7zv, 7zx, 7abb, 7aic, 7afw, 8ml, 8aap, 8alt, 8asc, 8bgj, 8azf, 8bry, 8zaf, 8caa, 8pb, 8gk, 9km, 9rc, 9ox, 9yw, 9zg, 9aau, 9afd, 9aiy, 9ajh, 9aps, 9bak, 9bdr, 9bji, 9bxq, 9bun, 9cvo, 9cyl, 9dfb, 9dtm, 9xag, 9xaq, 9yaj. Would appreciate reports from distant stations hearing my 5-watt C. W. Have a 20-watt set under construction.

By 6AUB.

C. W.: 1bes, 2ds, 2zs, 3hg, 3hj, 3ot, 3aro, 3blf, 4oi, 4va, 5ek, 5gr, 5ia, 5jl, 5jt, 5nk, 5ns, 5ss, 5ta, 5uj, 5vo, 5aah, 5aar, 5adb, 5ado, 5aec, 5xv, 5xad, 5xaj, 5za, 5zb, 5zak, 5zat, 6aa, 6ak, 6bh, 6bu, 6cc, 6cn, 6cp, 6cs, 6cu, 6dt, 6du, 6dy, 6ea, 6eb, 6ec, 6ef, 6ek, 6en, 6fh, 6ft, 6fy, 6gd, 6gr, 6gx, 6ik, 6iv, 6jn, 6ka, 6lu, 6lv, 6my, 6nx, 6oh, 6ok, 6om, 6pi, 6re, 6rm, 6rr, 6su, 6ti, 6uw, 6vf, 6aag, 6aaj, 6aak, 6abx, 6acm, 6ah, 6ahp, 6ahr, 6aib, 6ajd, 6ajf, 6alu, 6alv, 6ame, 6amn, 6anb, 6ang, 6aoi, 6aop, 6aor, 6apv, 6apw, 6aqc, 6arb, 6arf, 6asu, 6atu, 6auu, 6avn, 6avr, 6awf, 6awt, 6bbc, 6bbv, 6bcj, 6bcl, 6bdf, 6bdw, 6bea, 6bfy, 6bgd, 6bgh, 6bgs, 6bhw, 6bic, 6bih, 6bip, 6biq, 6bjc, 6bjj, 6bjk, 6bjv, 6bko, 6bmn, 6bnu, 6boe, 6boo, 6bow, 6bpl, 6bqc, 6bqd, 6bqe, 6bqg, 6bql, 6bqr, 6brf, 6brg, 6bru, 6bua, 6bum, 6bun, 6bv, 6bvq, 6bvs, 6bvw, 6bwp, 6caj, 6can, 6cbf, 6cbi, 6cbn, 6ceb, 6xk, 6xr, 6xad, 6xah, 6xas, 6ze, 6zi, 6zo, 6zt, 6zx, 6zz, 7bj, 7du, 7dp, 7ey, 7fg, 7gk, 7hj, 7jm, 7kr, 7lc, 7lr, 7lu, 7mc, 7mf, 7na, 7nc, 7nf, 7ny, 7om, 7qt, 7rn, 7sc, 7sy, 7tg, 7vf, 7abb, 7adm, 7aem, 7afs, 7afw, 7ahw, 7xc, 7zn, 7zu, 8bk, 8cf, 8fu, 8kg, 8uk, 8alf, 8bch,

8beo, 8brm, 8brh, 8bxx, 8byo, 8cur, 8xe, 8yd, 8zd, 8zw, 9bp, 9ep, 9dl, 9kp, 9la, 9ox, 9pa, 9abv, 9aey, 9afk, 9amb, 9ans, 9asf, 9avc, 9avs, 9ayu, 9bbf, 9bed, 9bhd, 9bik, 9biz, 9bjj, 9bjk, 9bly, 9bri, 9brk, 9bxa, 9bxm, 9bxt, 9bz, 9bzz, 9caa, 9ccv, 9cde, 9edu, 9cyl, 9cyl, 9cns, 9cuc, 9dhi, 9dio, 9dky, 9dlm, 9dpl, 9dam, 9dtm, 9dxn, 9tge, 9xac, 9at. Canadians: 3bp, 3bv, 3gk, 4bv, 5cn, 9bx. Specials: ad7 and nof.

By Roland Smith, 113 Ululani St., Hilo, Hawaii.

C. W.: 1ze, 1azw, 1sn, 2awl, 2afp, 2ayv, 2brb, 2bed, 2ecd, 2co, 2el, 2kf, 2fp, 2alf, 3aay, 3aro, 3bp, 3buc, 3bij, 3bj, 3gk, 3xn, 3yo, 4bv, 4cg, 4cy, 4eb, 4eh, 5acf, 5aar, 5ado, 5abb, 5xd, 5fv, 5px, 5tj, 5ir, 5nk, 5kc, 5xv, 5ix, 5za, 5mt, 5hz, 5ft, 5nn, 5va, 5zak, 5jl, 5zg, 5po, 5ov, 5gr, 5xaj, 5ml, 5tr, 5zb, 5xb, 6akl, 6ko, 6z, 6avv, 6abx, 6zi, 6bjy, 6ber, 6ak, 6bun, 6zaa, 6asq, 6ao, 6cc, 6zal, 6ar, 6alu, 6fh, 6lr, 6zn, 6pi, 6zg, 6arb, 6bcr, 6arf, 6zh, 6bmd, 6asy, 6bqd, 6if, 6bjq, 6bvw, 6ber, 6bqc, 6bod, 6aat, 6ebi, 6ka, 6aly, 6bnv, 6apw, 6ebi, 6avr, 6vm, 6ar, 6bqb, 6xas, 6xy, 6bko, 6ff, 6bak, 6ank, 6xtn, 6ti, 6en, 6bjj, 6auu, 6zq, 6ku, 6za, 6bh, 6xk, 6ea, 6lf, 6bu, 6su, 6bic, 6bgh, 6bcj, 6tc, 6awt, 6bc, 6bdf, 6bis, 6zb, 6zm, 6bua, 6bnh, 6ajf, 6xwi, 6eb, 7sc, 7xi, 7kiz, 7yg, 7nf, 7aj, 7wx, 7mf, 7nn, 7tn, 7ta, 7zu, 8btv, 8pd, 8axc, 8asv, 8aio, 8bey, 8amm, 8ni, 8cuu, 8ib, 8bk, 8bre, 8bke, 8ne, 8zaf, 8bdo, 8xan, 8bfm, 8bxx, 8bnj, 8bfz, 8beo, 8aim, 8cur, 8cdd, 8yd, 8bfq, 8byo, 8xe, 8bch, 9anq, 9aps, 9fm, 9aap, 9yw, 9acs, 9fx, 9asn, 9ac, 9xaq, 9bek, 9bey, 9zn, 9av, 9ecf, 9ofk, 9bji, 9awm, 9ami, 9asf, 9bff, 9bur, 9bzi, 9yaj, 9bji, 9afk, 9ei, 9bp, 9arz, 9anf, 9anl, 9dky, 9ns, 9asf, 9bri, 9mo, 9gk, 9bnz, 9dgv, 9oxn, 9bef, 9bz, 9aza, 9dz, 9kwl, 9ps, 9bzz, 9cyl, 9cyl, 9bqw, 9xac, 9asf, 9btt, 9cyl, 9zt, 9bjv, 9abv, 9aws, 9anq, 9anz, 9ctg, 9bx, 9asf, 9cr, 9ani, 9vm, 9lri, 9czf, 9lxt, 9ccv, 9aey, 9abv, nof, 6xam. Brd.: kog, kwh, kpo, wpa, knz, kfaf, kvo, kdyn, khj, wbp, kfbd, woi, wgy, kfc, kdpt, knz, kvq, kix, cfac, ofcn, kdym, wdaf, whai, whaz.

By TIM, Wilbur, Wash.

Can.: 3ce, 3co, 4bv, 5on, 5ct, 5bo, 9bd, 9bx, 9bg, 5aw, 5aj, 5hk, 5ir, 5q, 5qs, 5sf, 5wo, 5zav, 5za, 6aa, 6ab, 6ak, 6am, 6aw, 6bd, 6bu, 6cc, 6cf, 6cp, 6cv, 6ea, 6eb, 6en, 6eo, 6ex, 6fh, 6fy, 6gf, 6gr, 6gx, 6hj, 6ka, 6ki, 6ku, 6lu, 6lv, 6oh, 6om, 6od, 6pi, 6pn, 6qm, 6qy, 6rd, 6re, 6rm, 6rn, 6su, 6tc, 6ti, 6to, 6uw, 6vf, 6vm, 6vx, 6wk, 6xf, 6za, 6zc, 6zf, 6zh, 6z, 6z, 6aat, 6abx, (6acr), 6afh, 6afp, 6afw, 6ahq, 6akt, 6aoq, 6aor, 6aqw, 6ar, 6arf, 6asj, 6atc, 6atq, 6auu, 6avd, 6avf, 6avn, 6avr, 6avy, 6awt, 6bor, 6bip, 6biq, 6bjr, 6bjj, 6bkk, 6bmn, 6bob, 6boe, 6boj, 6bq, 6bqz, 6brf, 6brs, 6bsq, 6btb, 6bua, 6bu, 6bum, 6bun, 6buw, 6bvw, 6cmm, 6cjl, 6xad, 6zaf, 6zas, 7ab, 7bb, 7bp, 7bz, 7cz, 7dp, 7dx, 7ep, 7eq, (7ex), 7if, 7fg, (7ge), 7go, 7hm, 7hj, 7ia, 7iv, 7iw, 7js, (7ke), 7kj, (7la), 7lr, 7lu, 7mc, (7mf), 7mo, (7na), (7nn), 7ny, (7oj), 7om, 7ot, (7pf), 7ps, 7qr, (7qt), 7rn, 7sc, 7sy, 7z, 7g, (7th), (7tq), 7to, 7tt, 7ve, 7vi, (7vx), 7wq, 7wg, 7ya, 7zb, 7zn, 7zo, 7zs, 7zu, (7abb), 7aad, (7add), 7acx, 7adm, 7ado, 7aea, 7aem, (7afh), 7afs, 7afw, 7agc, 7aic, 7aid, 7aiv, 7ari, 8bk, 8cp, 8apy, 8ain, 8bey, 8bfm, 8bnj, 8bvt, 8bvt, 8okm, 8dta, 9gk, 9amb, 9awm, 9avl, 9ays, 9bcf, 9bjk, 9bzi, 9cns, 9ctr, 9bed, 9doz, 9bik, 9dtm, 9dyg, 9dky, 9zaf. (Any one hearing my 10 watt straight C. W., pls qsl.)

By 6ZT, P. O. Box 772, Salt Lake City.

5aec, 5ado, 5gj, 5jl, 5px, 5tj, 5vm, 5xd, 5za, 5zak, 6aa, 6aag, 6abx, 6ael, 6ahp, 6akl, 6alx, 6anb, 6anh, 6aoi, 6aqq, 6arb, 6ark, 6arv, 6atg, 6auy, 6avn, 6avr, 6avv, 6awt, 6bbh, 6bcj, 6bdw, 6bgh, 6bh, 6bkh, 6bio, 6bip, 6biq, 6bjc, 6bjj, 6bjk, 6bjy, 6bko, 6bks, 6bmd, 6bmn, 6bnh, 6bnv, 6bob, 6bpi, 6bpc, 6bqe, 6bqf, 6bql, 6brf, 6brs, 6bru, 6bu, 6bun, 6bur, 6buw, 6bvg, 6bvs, 6bv, 6bwe, 6caj, 6cbd, 6cbi, 6cc, 6ccj, 6ceb, 6cn, 6cu, 6ea, 6eb, 6ef, 6ek, 6en, 6fh, 6gf, 6gx, 6iv, 6jn, 6lu, 6lv, 6nh, 6nx, 6oh, 6ok, 6pi, 6rr, 6su, 6tc, 6ti, 6uw, 6vf, 6vm, 6xas, 6xax, 6xx, 6xr, 6xw, 6zb, 6zg, 6zh, 6zi, 6zn, 6zo, 6zz, 7abb, 7aem, 7afw, 7bk, 7bj, 7ex, 7ge, 7hj, 7ln, 7lu, 7mf, 7na, 7nf, 7sc, 7vf, 7wm, 7zl, 9abu, 9abv, 9aey, 9aig, 9amb, 9ami, 9aog, 9apw, 9avc, 9avs, 9avz, 9axu, 9bbf, 9bcf, 9bji, 9bjk, 9bri, 9bsq, 9bvo, 9bvy, 9bxa, 9bxm, 9bxq, 9bxt, 9bxy, 9bzi, 9bzz, 9ccv, 9cyl, 9cns, 9ctg, 9dah, 9dhi, 9djm, 9dky, 9dlm, 9dpl, 9dpl, 9ekh, 9fm, 9fv, 9kp, 9pn, 9ps, 9un, 9ve. Canada: 4bv, 4hh, 5cn, 9bx.

By 6BWN, Sebastopol, Calif., P. O. Box E.

All C. W.: 4jk, 5za, 5zas, 6's too numerous. 7bj, 7bk, 7bu, 7cg, 7du, 7ge, 7hj, 7ht, 7ke, 7ln, 7lr, 7mf, 7na, 7nf, 7ny, 7oh, 7om, 7qt, 7qw, 7rs, 7sc, 7sy, 7to, 7tq, 7tt, 7vf, 7vv, 7zf, 7zn, 7zu, 7zv, 7abf, 7abx, 7ado, 7aem, 7af, 7afw, 7aic, 8fu, 8yn, 8zz, 8anb, 8baa, 8bbf, 8byo, 8cei, 9lz, 9pn, 9za, 9abu, 9arz, 9avo, 9ayu, 9bed, 9bji, 9bjv, 9bkm, 9bri, 9bun, 9bzi, 9ccv, 9cns, 9cny, 9dwk, 9ekh, 9xaq. Can.: 5cn, 5ct, 9bx, qra'?

At 6ZE 1247 Fortyeventh Ave., San Francisco, Calif.

5ek, 5qe, 5qy, 5sk, 5xb, 5xd, 5zav, 6's too numerous. 7bj, 7bk, 7ce, 7hj, 7kj, 7im, 7nn, 7ny, 7ng, 7pf, 7sc, 7ud, 7ri, 7wg, 7afk, 7aft, 7ya, 7yg, 7zk, 7zu, 7zv, 8bk, 8cf, 8qk, 8zy, 8xae, 9fm, 9yw, 9xaq, 9zac, 9zaf, 9aa, 9aks, 9asf, 9asn, 9awm, 9awt, 9bfm, 9bed, 9bey, 9bds, 9bsg, 9bji, 9cns, 9dte. Canadian: 4bq, 4bv, 5cn, 5fn, 9ac.

By 6CBL, B. H. Denney, 1411 Central Ave., Glendale, Calif.

All C. W.: 4km, 4oi, 5ado, 5ady, 5ki, 5xd, 5za, 6aa, 6abk, 6abx, 6acm, 6ael, 6afh, 6alf, Ai (voice)—6ajf, 6aji, 6amg, 6anb, 6ang, 6aoi, 6ar, 6arb, 6as, 6as, 6ata, 6atu, 6auu, 6avy, 6bas, 6bel, 6bdf, 6beh, 6bhv, 6bic, 6bip, 6biq, 6bjc, 6bjj, 6bjk, 6bjm, 6bnr, 6bnt, 6bob, 6boe, 6bpl, 6bru, 6bu, 6buk, 6bum, 6caj, 6can, 6cc, 6cd, 6fv, 6go, 6ic, 6ik, 6oh, 6ow, 6rk, 6su, 6rm, 6tc, 6ti, 6va, 6vm, 6zaa, 6zac, 6zo, 6zt, 6z, 7aem, 7afa, 7afs, 7fv, 7gk, 7gu, 7ke, 7lr, 7mf, 7na, 7nf, 7xt, 7zu, 7zv, 8abe, 9an, 9amb, 9asf, 9bf, 9bji, 9bk, 9bm, 9bxm, 9cyl, 9cwr, 9ddg, 9dgv, 9dtm.

Heard on detector only. If you want reports on sigs. pse. qsl.

Tell them that you saw it in RADIO



CALLS HEARD

By 6ARB, 3029 Acton St., Berkeley, Calif.

C. W.: (4eb), (4km), (4ya), (5jl), (5qi), (5sf), (5za), (5zax), (6du), (6rm), (6su), (6uw), (6xk), (6ag), (6ajd), (6anp), (6atq), (6apv), (6atq), (6avv), (6bgg), (6bic), (6bip), (6biq), (6bjj), (6bjy), (6bpl), (6bqe), (6bqw), (6bru), (6bsq), (6bun), (6bvg), (6bwx), (6cbi), (6cbg), (6cbw), (6xas), (7ba), (7bj), (7ge), (7hj), (7kf), (7na), (7ny), (7om), (7ri), (7sc), (7vx), (7wm), (7wx), (7zn), (7adf), (7adg), (7afs), (7agi), (7ahw), (7ajv), (8jj), (8bfq), (8bwa), (8caa), (9qf), (9abu), (9apw), (9ave), (9axu), (9bkk), (9bxm), (9cgk), (9dge), (9dhs), (9dsd), (9dta), (Can. 5go).

C. W.: 2fp, 4kt, 5ek, 5fv, 5hz, 5ix, 5jt, 5ke, 5nk, 5sk, 5xv, 5zh, 5aat, 5aac, 5xaj, 5zak, 5zas, 5zav, 6ea, 6eb, 6ek, 6bki, 6bko, 6boe, 6brv, 6bur, 6bwf, 6cai, 7ad, 7ak, 7ey, 7hf, 7oe, 7pf, 7qe, 7qn, 7sy, 7to, 7tt, 7tq, 7vf, 7wq, 7zu, 7abb, 7acx, 7adm, 7aff, 7aic, 7aii, 7aif, 7aiy, 7bk, 7cf, 7fu, 7gj, 7sm, 7ue, 7vq, 7yd, 7zy, 7asc, 7asv, 7ayu, 7azb, 7azq, 7bch, 7bex, 7bda, 7bdc, 7bxx, 7cql, 7crb, 7crn, 7dp, 7ds, 7ei, 7fm, 7kp, 7uc, 7ve, 7zn, 7zt, 7aep, 7aey, 7ami, 7ans, 7apr, 7arz, 7atn, 7aua, 7avu, 7ayv, 7bbf, 7bed, 7bcf, 7bil, 7bjl, 7bkl, 7bks, 7blg, 7bly, 7bri, 7bq, 7bv, 7bxa, 7bxx, 7bzi, 7ccv, 7cfy, 7cpi, 7cjc, 7dah, 7dgv, 7dky, 7dlm, 7dsw, 7dtdm, 7dud, 7dyn, 7dxm, 7ekh, 7xac, 7xay, nof. Can.: 5cn, 5ct, 5ej, 5hp, 9bx.

6arb—50-watter heard in Alaska, Mexico, Hawaii, Japan, New Zealand; qrk my cw? All correspondence answered.

By 9BKJ, 500 Lake Ave., White Bear Lake, Minn.

1agh, 1akb, (1awe), (1ban), (1bas), (1bes), 1bka, 1bkq, 1boq, (1brq), (1bsz), (1bwj), 1cab, 1cjh, 1ckp, (1cmk), 1cmp, 1cve, 1gv, 1li, 1mc, 1rd, 1sd, 1xm, 2aab, 2ajf, (2anm), 2ano, (2awf), 2awl, 2ayv, 2bbb, 2bml, 2bmr, 2bms, 2bq, 2brb, 2bun, (2ebc), 2ecd, (2ecc), 2cei, (2cjr), 2ekk, 2ekn, 2clu, 2cm, 2enk, 2epa, 2epk, 2eqz, 2dd, 2el, 2fp, 2gk, (2hj), (2hw), (2ig), (2le), 2mx, 2ne, (2pv), (2rz), 2xz, 3aa, 3ab, 3abw, 3ady, 3ajh, 3apr, 3aqr, (3aro), 3bec, 3bfq, 3bj, 3bsb, 3bt, 3buc, (3bv), 3de, 3em, 3fm, 3hg, (3hj), (3ji), (3mb), 3ni, 3ot, 3pz, (dalite), (3rf), 3su, 3vw, 3xm, 3yo, 3zo, 3zs, 4bi, 4bq, (dalite), 4cg, (dalite), (4co), 4do, 4eb, (4hw), 4zh, (4ik), 4ir, 4jh, 4kl, (4lj), 4lw, 4mj, 4ya, 4yd, 5aar, 5abh, 5ade, 5aac, 5aib, 5be, 5bm, 5bp, 5bw, 5ci, 5ca, 5ey, 5di, 5dn, 5ek, 5er, 5fv, 5gr, 5ho, 5ik, 5iq, 5ix, 5jd, (5pk), 5jr, (5js), 5kf, 5kk, 5kn, (5kp), 5lf, 5ml, 5mo, 5nk, (5nn), 5nv, 5nz, 5ok, (5ov), 5pb, 5pe, (5pv), 5px, 5pz, (5qi), 5qs, 5rh, 5sf, (5sk), 5ss, (5ta), 5tc, 5ti, 5uk, (5uo, dalite), 5va, 5vy, 5xa, 5xb, 5xk, 5xv, 5za, 5zat, 5zas, 5zav, (5zaz), 5zb, 5zax, 5zax, 5zav, 5zi, 5zj, 5zk, 5zl, 5zm, 5zn, 5zo, 5zp, 5zq, 5zr, 5zs, 5zt, 5zu, 5zv, 5zw, 5zx, 5zy, 6aa, 6ab, 6ac, 6ad, 6ae, 6af, 6ag, 6ah, 6ai, 6aj, 6ak, 6al, 6am, 6an, 6ao, 6ap, 6aq, 6ar, 6as, 6at, 6au, 6av, 6aw, 6ax, 6ay, 6az, 6ba, 6bb, 6bc, 6bd, 6be, 6bf, 6bg, 6bh, 6bi, 6bj, 6bk, 6bl, 6bm, 6bn, 6bo, 6bp, 6bq, 6br, 6bs, 6bt, 6bu, 6bv, 6bw, 6bx, 6by, 6bz, 6ca, 6cb, 6cc, 6cd, 6ce, 6cf, 6cg, 6ch, 6ci, 6cj, 6ck, 6cl, 6cm, 6cn, 6co, 6cp, 6cq, 6cr, 6cs, 6ct, 6cu, 6cv, 6cw, 6cx, 6cy, 6cz, 6da, 6db, 6dc, 6dd, 6de, 6df, 6dg, 6dh, 6di, 6dj, 6dk, 6dl, 6dm, 6dn, 6do, 6dp, 6dq, 6dr, 6ds, 6dt, 6du, 6dv, 6dw, 6dx, 6dy, 6dz, 6ea, 6eb, 6ec, 6ed, 6ee, 6ef, 6eg, 6eh, 6ei, 6ej, 6ek, 6el, 6em, 6en, 6eo, 6ep, 6eq, 6er, 6es, 6et, 6eu, 6ev, 6ew, 6ex, 6ey, 6ez, 6fa, 6fb, 6fc, 6fd, 6fe, 6ff, 6fg, 6fh, 6fi, 6fj, 6fk, 6fl, 6fm, 6fn, 6fo, 6fp, 6fq, 6fr, 6fs, 6ft, 6fu, 6fv, 6fw, 6fx, 6fy, 6fz, 6ga, 6gb, 6gc, 6gd, 6ge, 6gf, 6gg, 6gh, 6gi, 6gj, 6gk, 6gl, 6gm, 6gn, 6go, 6gp, 6gq, 6gr, 6gs, 6gt, 6gu, 6gv, 6gw, 6gx, 6gy, 6gz, 6ha, 6hb, 6hc, 6hd, 6he, 6hf, 6hg, 6hh, 6hi, 6hj, 6hk, 6hl, 6hm, 6hn, 6ho, 6hp, 6hq, 6hr, 6hs, 6ht, 6hu, 6hv, 6hw, 6hx, 6hy, 6hz, 6ia, 6ib, 6ic, 6id, 6ie, 6if, 6ig, 6ih, 6ii, 6ij, 6ik, 6il, 6im, 6in, 6io, 6ip, 6iq, 6ir, 6is, 6it, 6iu, 6iv, 6iw, 6ix, 6iy, 6iz, 6ja, 6jb, 6jc, 6jd, 6je, 6jf, 6jg, 6jh, 6ji, 6jk, 6jl, 6jm, 6jn, 6jo, 6jp, 6jq, 6jr, 6js, 6jt, 6ju, 6jv, 6jw, 6jx, 6jy, 6jz, 6ka, 6kb, 6kc, 6kd, 6ke, 6kf, 6kg, 6kh, 6ki, 6kj, 6kl, 6km, 6kn, 6ko, 6kp, 6kq, 6kr, 6ks, 6kt, 6ku, 6kv, 6kw, 6kx, 6ky, 6kz, 6la, 6lb, 6lc, 6ld, 6le, 6lf, 6lg, 6lh, 6li, 6lj, 6lk, 6ll, 6lm, 6ln, 6lo, 6lp, 6lq, 6lr, 6ls, 6lt, 6lu, 6lv, 6lw, 6lx, 6ly, 6lz, 6ma, 6mb, 6mc, 6md, 6me, 6mf, 6mg, 6mh, 6mi, 6mj, 6mk, 6ml, 6mn, 6mo, 6mp, 6mq, 6mr, 6ms, 6mt, 6mu, 6mv, 6mw, 6mx, 6my, 6mz, 6na, 6nb, 6nc, 6nd, 6ne, 6nf, 6ng, 6nh, 6ni, 6nj, 6nk, 6nl, 6nm, 6no, 6np, 6nq, 6nr, 6ns, 6nt, 6nu, 6nv, 6nw, 6nx, 6ny, 6nz, 6oa, 6ob, 6oc, 6od, 6oe, 6of, 6og, 6oh, 6oi, 6oj, 6ok, 6ol, 6om, 6on, 6oo, 6op, 6oq, 6or, 6os, 6ot, 6ou, 6ov, 6ow, 6ox, 6oy, 6oz, 6pa, 6pb, 6pc, 6pd, 6pe, 6pf, 6pg, 6ph, 6pi, 6pj, 6pk, 6pl, 6pm, 6pn, 6po, 6pp, 6pq, 6pr, 6ps, 6pt, 6pu, 6pv, 6pw, 6px, 6py, 6pz, 6qa, 6qb, 6qc, 6qd, 6qe, 6qf, 6qg, 6qh, 6qi, 6qj, 6qk, 6ql, 6qm, 6qn, 6qo, 6qp, 6qq, 6qr, 6qs, 6qt, 6qu, 6qv, 6qw, 6qx, 6qy, 6qz, 6ra, 6rb, 6rc, 6rd, 6re, 6rf, 6rg, 6rh, 6ri, 6rj, 6rk, 6rl, 6rm, 6rn, 6ro, 6rp, 6rq, 6rr, 6rs, 6rt, 6ru, 6rv, 6rw, 6rx, 6ry, 6rz, 6sa, 6sb, 6sc, 6sd, 6se, 6sf, 6sg, 6sh, 6si, 6sj, 6sk, 6sl, 6sm, 6sn, 6so, 6sp, 6sq, 6sr, 6ss, 6st, 6su, 6sv, 6sw, 6sx, 6sy, 6sz, 6ta, 6tb, 6tc, 6td, 6te, 6tf, 6tg, 6th, 6ti, 6tj, 6tk, 6tl, 6tm, 6tn, 6to, 6tp, 6tq, 6tr, 6ts, 6tt, 6tu, 6tv, 6tw, 6tx, 6ty, 6tz, 6ua, 6ub, 6uc, 6ud, 6ue, 6uf, 6ug, 6uh, 6ui, 6uj, 6uk, 6ul, 6um, 6un, 6uo, 6up, 6uq, 6ur, 6us, 6ut, 6uu, 6uv, 6uw, 6ux, 6uy, 6uz, 6va, 6vb, 6vc, 6vd, 6ve, 6vf, 6vg, 6vh, 6vi, 6vj, 6vk, 6vl, 6vm, 6vn, 6vo, 6vp, 6vq, 6vr, 6vs, 6vt, 6vu, 6vv, 6vw, 6vx, 6vy, 6vz, 6wa, 6wb, 6wc, 6wd, 6we, 6wf, 6wg, 6wh, 6wi, 6wj, 6wk, 6wl, 6wm, 6wn, 6wo, 6wp, 6wq, 6wr, 6ws, 6wt, 6wu, 6wv, 6ww, 6wx, 6wy, 6wz, 6xa, 6xb, 6xc, 6xd, 6xe, 6xf, 6xg, 6xh, 6xi, 6xj, 6xk, 6xl, 6xm, 6xn, 6xo, 6xp, 6xq, 6xr, 6xs, 6xt, 6xu, 6xv, 6xw, 6xy, 6xz, 6ya, 6yb, 6yc, 6yd, 6ye, 6yf, 6yg, 6yh, 6yi, 6yj, 6yk, 6yl, 6ym, 6yn, 6yo, 6yp, 6yq, 6yr, 6ys, 6yt, 6yu, 6yv, 6yw, 6yx, 6yz, 6za, 6zb, 6zc, 6zd, 6ze, 6zf, 6zg, 6zh, 6zi, 6zj, 6zk, 6zl, 6zm, 6zn, 6zo, 6zp, 6zq, 6zr, 6zs, 6zt, 6zu, 6zv, 6zw, 6zx, 6zy, 6zz.

By 6CIS, Box 144, Yosemite Valley, Calif.

All C. W.'s.: 1cmp, 5xaj, 5bd, 6aar, 6bvf, 6bm, 6beh, 6bn, 6bmx, 6bru, 6bfl, 6aa, 7acn, 7ajv, 7abh, 7aiy, 7ayc, 8hyk, (Phone) khj, kgg, kzn, kfaf, kfae, kfi, kpo, woc, kyw, whap, kfcb, wjaz, wdaf, kgn, cfn, wwi, kgy, kdyw, wlag.

By 6ZT, Box 772, Salt Lake City.

Canadian: 4bv, 4hh, 9bx, Ad7, 2xq, 5aah, 5ado, 5aec, 5ahd, 5cy, 5di, 5ix, 5va, 5xaj, 5za, 5zav, 5zax, 5zh, 6aa, 6aak, 6abx, 6ahu, 6ajd, 6ajr, 6amn, 6anh, 6aio, 6apw, 6aqw, 6asj, 6auu, 6avr, 6avv, 6bbv, 6bc, 6bes, 6bh, 6bic, 6bip, 6bj, 6bjj, 6bjq, 6bjr, 6bjy, 6bko, 6bm, 6bpb, 6bpi, 6bqd, 6bqg, 6bru, 6bsq, 6btz, 6bua, 6bum, 6bun, 6bur, 6buy, 6bv, 6bv, 6bw, 6bwe, 6cbd, 6cc, 6ceb, 6cek, 6ef, 6ek, 6fh, 6fy, 6iv, 6jn, 6ku, 6om, 6rr, 6su, 6uw, 6vf, 6vm, 6xad, 6xas, 6xk, 6za, 6ze, 6zh, 6zn, 6zx, 6zz, 7abb, 7adp, 7afw, 7aie, 7ba, 7bj, 7dl, 7ge, 7hj, 7im, 7iy, 7ks, 7ln, 7lr, 7lu, 7na, 7nf, 7ot, 7pf, 7qt, 7sc, 7wm, 7zf, 7zn, 7zo, 7zu, 7zv, 9abv, 9adf, 9aec, 9aeq, 9aey, 9aiy, 9amb, 9ami, 9aog, 9avc, 9avu, 9ayv, 9bcf, 9bhd, 9bji, 9bjk, 9bkk, 9bri, 9bsq, 9bto, 9btt, 9bvy, 9bwj, 9bxm, 9bxt, 9bxy, 9bzc, 9bzi, 9ccs, 9ccv, 9cdr, 9cns, 9dgv, 9dtm, 9dxm. Canadian: 4bv, 5ax, 5ct, 5ej, 5go, 9bx. Anyone hearing my 5-watt c. w. pse qsl.

At 6AMX, 2716 Pacific Ave., San Francisco, Calif.

5za, 5zat, 7ad, 7ak, 7bj, 7eb, 7er, 7hj, 7hm, 7iy, 7kf, 7mc, 7mf, 7na, 7nf, 7nl, 7om, 7qt, 7ri, 7rn, 7sc, 7tg, 7tq, 7vf, 7wm, 7zf, 7acx, 7adp, 7aes, 7afo, 7aif, 7agi, 7aim, 8ij, 8uc, 8afd, 8xae, 9bs, 9ox, 9pi, 9cf, 9wc, 9zt, 9aio, 9apw, 9avu, 9avz, 9bji, 9bvy, 9bzi, 9cac, 9cbb, 9ccv, 9cdr, 9cns, 9dgv, 9dtm, 9dxm. Canadian: 4bv, 5ax, 5ct, 5ej, 5go, 9bx. Anyone hearing my 5-watt c. w. pse qsl.

By 9BXT, Giltner, Nebr.

C. W.: 1mc, 1qp, 1qr, 1rv, 1sn, 1wc, 1xu, 1abb, 1ajp, 1ajx, 1alz, 1apc, 1azl, 1ban, 1bkq, 1boe, 1cak, 1ckp, 1cmk, 2el, 2fp, 2gk, 2hj, 2kf, 2nz, 2rm, 2rz, 2ali, 2bmr, 2bqh, 2lrb, 2ecd, 2cgt, 2cqq, 2cl, 3fq, 3hg, 3hs, 3ij, 3km, 3pz, 3su, 3wf, 3xm, 3ajj, 3aln, 3alt, 3aro, 3bji, 3bfl, 3bv, 3cqz, 4ag, 4bk, 4bq, 4bx, 4co, 4cy, 4db, 4do, 4eb, 4eh, 4el, 4fa, 4fg, 4ft, 4gz, 4hw, 4hz, 4ik, 4jh, 4kl, 4yu, 4lo, 4mb, 4od, 4oi, 4ya, 4yd, 4ze, 4zn, 5bp, 5bw, 5de, 5di, 5ek, 5en, 5fv, 5ih, 5ho, 5iq, 5jb, 5jl, 5jn, 5js, 5ke, 5ki, 5kk, 5kw, 5mo, 5nn, 5ns, 5nv, 5nz, 5ov, 5pb, 5px, 5qi, 5rn, 5sp, 5sr, 5ss, 5ta, 5tc, 5ti, 5uk, 5uo, 5us, 5xb, 5aag, 5aam, 5aaq, 5aar,

5amb, 5aby, 5adb, 5ade, 5adf, 5ado, 5aec, 5afq, 5agn, 5ahd, 5aib, 5ajc, 5xac, 5xaj, 5zae, 5zaf, 5zak, 5zaw, 6ea, 6ix, 6ku, 6ol, 6ti, 6wm, 6xk, 6zh, 6zn, 6zt, 6anh, 6aqp, 6aqw, 6asj, 6auu, 6awt, 6awx, 6bbv, 6bcj, 6bel, 6bjq, 6boe, 6bqg, 6bqw, 6bsq, 6buv, 6bvf, 6bvg, 6caj, 6cec, 6xad, 7bj, 7hm, 7ln, 7lu, 7nf, 7ot, 7sc, 7we, 7zf, 7zn, 7zv, 7abb, 7ado, 7afo, 7aiy, 8aa, 8ag, 8cf, 8eo, 8fc, 8gz, 8hc, 8hn, 8ij, 8kh, 8ki, 8on, 8pi, 8rj, 8rr, 8tx, 8uf, 8vq, 8wx, 8wy, 8xe, 8yk, 8yy, 8zd, 8zn, 8zo, 8adg, 8adz, 8afd, 8aig, 8aim, 8amp, 8anb, 8aol, 8apv, 8aqc, 8aqv, 8asv, 8atc, 8atn, 8awz, 8axn, 8azg, 8bda, 8bdv, 8bek, 8ben, 8bec, 8bfb, 8bfg, 8bfz, 8bgl, 8bjs, 8bnz, 8brq, 8bry, 8bxa, 8bxh, 8bxx, 8byo, 8caa, 8cab, 8cbe, 8cdz, 8cfo, 8cgl, 8chb, 8cik, 8cjc, 8cjr, 8ckv, 8cl, 8con, 8cow, 8cpb, 8cpz, 8cpc, 8ert, 8cuo, 8cvx, 8cxf, 8ewx, 8eyt, 8eyz, 8eze, 8dag, 8dai, 8dat, 8zae, 8zax, 8zay, 8zaz, 8zbc, 8zbd, 8zbe, 8zbf, 8zbg, 8zch, 8zcl, 8zcm, 8zcn, 8zco, 8zcp, 8zcr, 8zcs, 8zct, 8zcu, 8zcv, 8zcw, 8zcx, 8zcy, 8zcz, 8zda, 8zdb, 8zdc, 8zde, 8zdf, 8zdg, 8zdh, 8zdi, 8zdl, 8zdm, 8zdn, 8zdo, 8zdp, 8zdq, 8zdr, 8zds, 8zdt, 8zdu, 8zdv, 8zdw, 8zdx, 8zdy, 8zdz, 8zea, 8zeb, 8zec, 8zed, 8zef, 8zeg, 8zeh, 8zei, 8zej, 8zek, 8zcl, 8zcm, 8zcn, 8zco, 8zcp, 8zcr, 8zcs, 8zct, 8zcu, 8zcv, 8zcw, 8zcx, 8zcy, 8zcz, 8zda, 8zdb, 8zdc, 8zde, 8zdf, 8zdg, 8zdh, 8zdi, 8zdl, 8zdm, 8zdn, 8zdo, 8zdp, 8zdq, 8zdr, 8zds, 8zdt, 8zdu, 8zdv, 8zdw, 8zdx, 8zdy, 8zdz, 8zea, 8zeb, 8zec, 8zed, 8zef, 8zeg, 8zeh, 8zei, 8zej, 8zek, 8zcl, 8zcm, 8zcn, 8zco, 8zcp, 8zcr, 8zcs, 8zct, 8zcu, 8zcv, 8zcw, 8zcx, 8zcy, 8zcz, 8zda, 8zdb, 8zdc, 8zde, 8zdf, 8zdg, 8zdh, 8zdi, 8zdl, 8zdm, 8zdn, 8zdo, 8zdp, 8zdq, 8zdr, 8zds, 8zdt, 8zdu, 8zdv, 8zdw, 8zdx, 8zdy, 8zdz, 8zea, 8zeb, 8zec, 8zed, 8zef, 8zeg, 8zeh, 8zei, 8zej, 8zek, 8zcl, 8zcm, 8zcn, 8zco, 8zcp, 8zcr, 8zcs, 8zct, 8zcu, 8zcv, 8zcw, 8zcx, 8zcy, 8zcz, 8zda, 8zdb, 8zdc, 8zde, 8zdf, 8zdg, 8zdh, 8zdi, 8zdl, 8zdm, 8zdn, 8zdo, 8zdp, 8zdq, 8zdr, 8zds, 8zdt, 8zdu, 8zdv, 8zdw, 8zdx, 8zdy, 8zdz, 8zea, 8zeb, 8zec, 8zed, 8zef, 8zeg, 8zeh, 8zei, 8zej, 8zek, 8zcl, 8zcm, 8zcn, 8zco, 8zcp, 8zcr, 8zcs, 8zct, 8zcu, 8zcv, 8zcw, 8zcx, 8zcy, 8zcz, 8zda, 8zdb, 8zdc, 8zde, 8zdf, 8zdg, 8zdh, 8zdi, 8zdl, 8zdm, 8zdn, 8zdo, 8zdp, 8zdq, 8zdr, 8zds, 8zdt, 8zdu, 8zdv, 8zdw, 8zdx, 8zdy, 8zdz, 8zea, 8zeb, 8zec, 8zed, 8zef, 8zeg, 8zeh, 8zei, 8zej, 8zek, 8zcl, 8zcm, 8zcn, 8zco, 8zcp, 8zcr, 8zcs, 8zct, 8zcu, 8zcv, 8zcw, 8zcx, 8zcy, 8zcz, 8zda, 8zdb, 8zdc, 8zde, 8zdf, 8zdg, 8zdh, 8zdi, 8zdl, 8zdm, 8zdn, 8zdo, 8zdp, 8zdq, 8zdr, 8zds, 8zdt, 8zdu, 8zdv, 8zdw, 8zdx, 8zdy, 8zdz, 8zea, 8zeb, 8zec, 8zed, 8zef, 8zeg, 8zeh, 8zei, 8zej, 8zek, 8zcl, 8zcm, 8zcn, 8zco, 8zcp, 8zcr, 8zcs, 8zct, 8zcu, 8zcv, 8zcw, 8zcx, 8zcy, 8zcz, 8zda, 8zdb, 8zdc, 8zde, 8zdf, 8zdg, 8zdh, 8zdi, 8zdl, 8zdm, 8zdn, 8zdo, 8zdp, 8zdq, 8zdr, 8zds, 8zdt, 8zdu, 8zdv, 8zdw, 8zdx, 8zdy, 8zdz, 8zea, 8zeb, 8zec, 8zed, 8zef, 8zeg, 8zeh, 8zei, 8zej, 8zek, 8zcl, 8zcm, 8zcn, 8zco, 8zcp, 8zcr, 8zcs, 8zct, 8zcu, 8zcv, 8zcw, 8zcx, 8zcy, 8zcz, 8zda, 8zdb, 8zdc, 8zde, 8zdf, 8zdg, 8zdh, 8zdi, 8zdl, 8zdm, 8zdn, 8zdo, 8zdp, 8zdq, 8zdr, 8zds, 8zdt, 8zdu, 8zdv, 8zdw, 8zdx, 8zdy, 8zdz, 8zea, 8zeb, 8zec, 8zed, 8zef, 8zeg, 8zeh, 8zei, 8zej, 8zek, 8zcl, 8zcm, 8zcn, 8zco, 8zcp, 8zcr, 8zcs, 8zct, 8zcu, 8zcv, 8zcw, 8zcx, 8zcy, 8zcz, 8zda, 8zdb, 8zdc, 8zde, 8zdf, 8zdg, 8zdh, 8zdi, 8zdl, 8zdm, 8zdn, 8zdo, 8zdp, 8zdq, 8zdr, 8zds, 8zdt, 8zdu, 8zdv, 8zdw, 8zdx, 8zdy, 8zdz, 8zea, 8zeb, 8zec, 8zed, 8zef, 8zeg, 8zeh, 8zei, 8zej, 8zek, 8zcl, 8zcm, 8zcn, 8zco, 8zcp, 8zcr, 8zcs, 8zct, 8zcu, 8zcv, 8zcw, 8zcx, 8zcy, 8zcz, 8zda, 8zdb, 8zdc, 8zde, 8zdf, 8zdg, 8zdh, 8zdi, 8zdl, 8zdm, 8zdn, 8zdo, 8zdp, 8zdq, 8zdr, 8zds, 8zdt, 8zdu, 8zdv, 8zdw, 8zdx, 8zdy, 8zdz, 8zea, 8zeb, 8zec, 8zed, 8zef, 8zeg, 8zeh, 8zei, 8zej, 8zek, 8zcl, 8zcm, 8zcn, 8zco, 8zcp, 8zcr, 8zcs, 8zct, 8zcu, 8zcv, 8zcw, 8zcx, 8zcy, 8zcz, 8zda, 8zdb, 8zdc, 8zde, 8zdf, 8zdg, 8zdh, 8zdi, 8zdl, 8zdm, 8zdn, 8zdo, 8zdp, 8zdq, 8zdr, 8zds, 8zdt, 8zdu, 8zdv, 8zdw, 8zdx, 8zdy, 8zdz, 8zea, 8zeb, 8zec, 8zed, 8zef, 8zeg, 8zeh, 8zei, 8zej, 8zek, 8zcl, 8zcm, 8zcn, 8zco, 8zcp, 8zcr, 8zcs, 8zct, 8zcu, 8zcv, 8zcw, 8zcx, 8zcy, 8zcz, 8zda, 8zdb, 8zdc, 8zde, 8zdf, 8zdg, 8zdh, 8zdi, 8zdl, 8zdm, 8zdn, 8zdo, 8zdp, 8zdq, 8zdr, 8zds, 8zdt, 8zdu, 8zdv, 8zdw, 8zdx, 8zdy, 8zdz, 8zea, 8zeb, 8zec, 8zed, 8zef, 8zeg, 8zeh, 8zei, 8zej, 8zek, 8zcl, 8zcm, 8zcn, 8zco, 8zcp, 8zcr, 8zcs, 8zct, 8zcu, 8zcv, 8zcw, 8zcx, 8zcy, 8zcz, 8zda, 8zdb, 8zdc, 8zde, 8zdf, 8zdg, 8zdh, 8zdi, 8zdl, 8zdm, 8zdn, 8zdo, 8zdp, 8zdq, 8zdr, 8zds, 8zdt, 8zdu, 8zdv, 8zdw, 8zdx, 8zdy, 8zdz, 8zea, 8zeb, 8zec, 8zed, 8zef, 8zeg, 8zeh, 8zei, 8zej, 8zek, 8zcl, 8zcm, 8zcn, 8zco, 8zcp, 8zcr, 8zcs, 8zct, 8zcu, 8zcv, 8zcw, 8zcx, 8zcy, 8zcz, 8zda, 8zdb, 8zdc, 8zde, 8zdf, 8zdg, 8zdh, 8zdi, 8zdl, 8zdm, 8zdn, 8zdo, 8zdp, 8zdq, 8zdr, 8zds, 8zdt, 8zdu, 8zdv, 8zdw, 8zdx, 8zdy, 8zdz, 8zea, 8zeb, 8zec, 8zed, 8zef, 8zeg, 8zeh, 8zei, 8zej, 8zek, 8zcl, 8zcm, 8zcn, 8zco, 8zcp, 8zcr, 8zcs, 8zct, 8zcu, 8zcv, 8zcw, 8zcx, 8zcy, 8zcz, 8zda, 8zdb, 8zdc, 8zde, 8zdf, 8zdg, 8zdh, 8zdi, 8zdl, 8zdm, 8zdn, 8zdo, 8zdp, 8zdq, 8zdr, 8zds, 8zdt, 8zdu, 8zdv, 8zdw, 8zdx, 8zdy, 8zdz, 8zea, 8zeb, 8zec, 8zed, 8zef, 8zeg, 8zeh, 8zei, 8zej, 8zek, 8zcl, 8zcm, 8zcn, 8zco, 8zcp, 8zcr, 8zcs, 8zct, 8zcu, 8zcv, 8zcw, 8zcx, 8zcy, 8zcz, 8zda, 8zdb, 8zdc, 8zde, 8zdf, 8zdg, 8zdh, 8zdi, 8zdl, 8zdm, 8zdn, 8zdo, 8zdp, 8zdq, 8zdr, 8zds, 8zdt, 8zdu, 8zdv, 8zdw, 8zdx, 8zdy, 8zdz, 8zea, 8zeb, 8zec, 8zed, 8zef, 8zeg, 8zeh, 8zei, 8zej, 8zek, 8zcl, 8zcm, 8zcn, 8zco, 8zcp, 8zcr, 8zcs, 8zct, 8zcu, 8zcv, 8zcw, 8zcx, 8zcy, 8zcz, 8zda, 8zdb, 8zdc, 8zde, 8zdf, 8zdg, 8zdh, 8zdi, 8zdl, 8zdm, 8zdn, 8zdo, 8zdp, 8zdq, 8zdr, 8zds, 8zdt, 8zdu, 8zdv, 8zdw, 8zdx, 8zdy, 8zdz, 8zea, 8zeb, 8zec, 8zed, 8zef, 8zeg, 8zeh, 8zei, 8zej, 8zek, 8zcl, 8zcm, 8zcn, 8zco, 8zcp, 8zcr, 8zcs, 8zct, 8zcu, 8zcv, 8zcw, 8zcx, 8zcy, 8zcz, 8zda, 8zdb, 8zdc, 8zde, 8zdf, 8zdg, 8zdh, 8zdi, 8zdl, 8zdm, 8zdn, 8zdo, 8zdp, 8zdq, 8zdr, 8zds, 8zdt, 8zdu, 8zdv, 8zdw, 8zdx, 8zdy, 8zdz, 8zea, 8zeb, 8zec, 8zed, 8zef, 8zeg, 8zeh, 8zei, 8zej, 8zek, 8zcl, 8zcm, 8zcn, 8zco, 8zcp, 8zcr, 8zcs, 8zct, 8zcu, 8zcv, 8zcw, 8zcx, 8zcy, 8zcz, 8zda, 8zdb, 8zdc, 8zde, 8zdf, 8zdg, 8zdh, 8zdi, 8zdl, 8zdm, 8zdn, 8zdo, 8zdp, 8zdq, 8zdr, 8zds, 8zdt, 8zdu, 8zdv, 8zdw, 8zdx, 8zdy, 8zdz, 8zea, 8zeb, 8zec, 8zed, 8zef, 8zeg, 8zeh, 8zei, 8zej, 8zek, 8zcl, 8zcm, 8zcn, 8zco, 8zcp, 8zcr, 8zcs, 8zct, 8zcu, 8zcv, 8zcw, 8zcx, 8zcy, 8zcz, 8zda, 8zdb, 8zdc, 8zde, 8zdf, 8zdg, 8zdh, 8zdi, 8zdl, 8zdm, 8zdn, 8zdo, 8zdp, 8zdq, 8zdr, 8zds, 8zdt, 8zdu, 8zdv, 8zdw, 8zdx, 8zdy, 8zdz, 8zea, 8zeb, 8zec, 8zed, 8zef, 8zeg, 8zeh, 8zei, 8zej, 8zek, 8zcl, 8zcm, 8zcn, 8zco, 8zcp, 8zcr, 8zcs, 8zct, 8zcu, 8zcv, 8zcw, 8zcx, 8zcy, 8zcz, 8zda, 8zdb, 8zdc, 8zde, 8zdf, 8zdg, 8zdh, 8zdi, 8zdl, 8zdm, 8zdn, 8zdo, 8zdp, 8zdq, 8zdr, 8zds, 8zdt, 8zdu, 8zdv, 8zdw, 8zdx, 8zdy, 8zdz, 8zea, 8zeb, 8zec, 8zed, 8zef, 8zeg, 8zeh, 8zei, 8zej, 8zek, 8zcl, 8zcm,



For  
**BETTER  
RESULTS**

use

**EVEREADY**

"A" and "B"

**BATTERIES**

with your  
radio set

Westinghouse  
WD-11 Vacuum  
Tubes operate  
best when used  
in connection  
with

**Columbia**

**Dry  
Batteries**

—they last longer

Manufactured on the  
Pacific Coast—

fresh and full of pep

**NATIONAL CARBON  
COMPANY, Inc.**

599 Eighth St.

San Francisco,

Calif.

### CALLS HEARD

By 6BQL, 575 21st Ave., San Francisco, Calif.

Can.: 3ta, 4bv, 4cn, 4fn, 4hh, 5ak, 5ax, 5cn, 5ct, 5ej, (5go), 9bp, 9bx.  
U. S.: 1bop, 2fp, 3zo, 4co, 4oi, (4ya), 5bm, 5ek, 5kw, 5nk, 5nz, 5px, 5qi, 5rh, 5uk, (5vo), 5ado, 5aib, 5xb, 5xad, 5za, 5zg, 5zh, 5zak, 5zav, 6bh, (6ea), 6eb, 6ef, 6iv, 6jd, (6ku), 6mh, 6ol, 6rr, 6xk, 6za, 6zb, 6zh, 6zr, 6zt, 6zz, 6aag, (6aak), 6ahq, 6ajr, 6akd, 6amn, 6anh, (6aoi), 6apw, 6aqw, 6arv, 6arw, 6avr, 6avv, (6awx), 6xah, 6zao, 6bah, 6bak, 6baw, 6bbv, 6beg, 6beq, 6bfp, 6bgc, 6bhv, (6bic), (6bip), 6bjc, 6bjj, (bjq), (6bjy), 6bod, 6boe, 6bqc, 6bqd, 6bqg, 6bqv, (6bqw), 6brf, 6bum, 6bun, (6bvg), 6bvf, 6bwe, 6bwx, 6caj, 6cbi, 6cbw, (6cfq), 6cdg, 6cgw, 6xad, 6xas, 7ak, 7bj, 7ba, 7dh, (7eg), 7ge, 7hj, 7jg, 7jw, 7ke, 7ks, 7lr, 7lw, 7mf, 7mc, (7na), 7nf, 7om, 7pf, 7qi, 7qn, 7ri, 7rn, (7sc), 7tg, 7tt, (7vf), 7wa, 7we, 7wm, 7ws, 7za, 7zf, 7zn, 7zv, 7abb, 7aca, 7acx, 7adg, (7aea), 7aff, 7afh, 7afo, 7afw, 7aif, 7aic, 7aie, 7aig, 7agi, 7agj, 7agk, 7agl, 7agm, 7agp, 7agq, 7agr, 7ags, 7agt, 7agu, 7agv, 7agw, 7agx, 7agy, 7az, 7ba, 7bb, 7bc, 7bd, 7be, 7bf, 7bg, 7bh, 7bi, 7bj, 7bk, 7bl, 7bm, 7bn, 7bo, 7bp, 7bq, 7br, 7bs, 7bt, 7bu, 7bv, 7bw, 7bx, 7by, 7bz, 7ca, 7cb, 7cc, 7cd, 7ce, 7cf, 7cg, 7ch, 7ci, 7cj, 7ck, 7cl, 7cm, 7cn, 7co, 7cp, 7cq, 7cr, 7cs, 7ct, 7cu, 7cv, 7cw, 7cx, 7cy, 7cz, 7da, 7db, 7dc, 7dd, 7de, 7df, 7dg, 7dh, 7di, 7dj, 7dk, 7dl, 7dm, 7dn, 7do, 7dp, 7dq, 7dr, 7ds, 7dt, 7du, 7dv, 7dw, 7dx, 7dy, 7dz, 7ea, 7eb, 7ec, 7ed, 7ee, 7ef, 7eg, 7eh, 7ei, 7ej, 7ek, 7el, 7em, 7en, 7eo, 7ep, 7eq, 7er, 7es, 7et, 7eu, 7ev, 7ew, 7ex, 7ey, 7ez, 7fa, 7fb, 7fc, 7fd, 7fe, 7ff, 7fg, 7fh, 7fi, 7fj, 7fk, 7fl, 7fm, 7fn, 7fo, 7fp, 7fq, 7fr, 7fs, 7ft, 7fu, 7fv, 7fw, 7fx, 7fy, 7fz, 7ga, 7gb, 7gc, 7gd, 7ge, 7gf, 7gg, 7gh, 7gi, 7gj, 7gk, 7gl, 7gm, 7gn, 7go, 7gp, 7gq, 7gr, 7gs, 7gt, 7gu, 7gv, 7gw, 7gx, 7gy, 7gz, 7ha, 7hb, 7hc, 7hd, 7he, 7hf, 7hg, 7hh, 7hi, 7hj, 7hk, 7hl, 7hm, 7hn, 7ho, 7hp, 7hq, 7hr, 7hs, 7ht, 7hu, 7hv, 7hw, 7hx, 7hy, 7hz, 7ia, 7ib, 7ic, 7id, 7ie, 7if, 7ig, 7ih, 7ii, 7ij, 7ik, 7il, 7im, 7in, 7io, 7ip, 7iq, 7ir, 7is, 7it, 7iu, 7iv, 7iw, 7ix, 7iy, 7iz, 7ja, 7jb, 7jc, 7jd, 7je, 7jf, 7jg, 7jh, 7ji, 7jk, 7jl, 7jm, 7jn, 7jo, 7jp, 7jq, 7jr, 7js, 7jt, 7ju, 7jv, 7jw, 7jx, 7jy, 7jz, 7ka, 7kb, 7kc, 7kd, 7ke, 7kf, 7kg, 7kh, 7ki, 7kj, 7kl, 7km, 7kn, 7ko, 7kp, 7kq, 7kr, 7ks, 7kt, 7ku, 7kv, 7kw, 7kx, 7ky, 7kz, 7la, 7lb, 7lc, 7ld, 7le, 7lf, 7lg, 7lh, 7li, 7lj, 7lk, 7ll, 7lm, 7ln, 7lo, 7lp, 7lq, 7lr, 7ls, 7lt, 7lu, 7lv, 7lw, 7lx, 7ly, 7lz, 7ma, 7mb, 7mc, 7md, 7me, 7mf, 7mg, 7mh, 7mi, 7mj, 7mk, 7ml, 7mn, 7mo, 7mp, 7mq, 7mr, 7ms, 7mt, 7mu, 7mv, 7mw, 7mx, 7my, 7mz, 7na, 7nb, 7nc, 7nd, 7ne, 7nf, 7ng, 7nh, 7ni, 7nj, 7nk, 7nl, 7nm, 7nn, 7no, 7np, 7nq, 7nr, 7ns, 7nt, 7nu, 7nv, 7nw, 7nx, 7ny, 7nz, 7oa, 7ob, 7oc, 7od, 7oe, 7of, 7og, 7oh, 7oi, 7oj, 7ok, 7ol, 7om, 7on, 7oo, 7op, 7oq, 7or, 7os, 7ot, 7ou, 7ov, 7ow, 7ox, 7oy, 7oz, 7pa, 7pb, 7pc, 7pd, 7pe, 7pf, 7pg, 7ph, 7pi, 7pj, 7pk, 7pl, 7pm, 7pn, 7po, 7pp, 7pq, 7pr, 7ps, 7pt, 7pu, 7pv, 7pw, 7px, 7py, 7pz, 7qa, 7qb, 7qc, 7qd, 7qe, 7qf, 7qg, 7qh, 7qi, 7qj, 7qk, 7ql, 7qm, 7qn, 7qo, 7qp, 7qq, 7qr, 7qs, 7qt, 7qu, 7qv, 7qw, 7qx, 7qy, 7qz, 7ra, 7rb, 7rc, 7rd, 7re, 7rf, 7rg, 7rh, 7ri, 7rj, 7rk, 7rl, 7rm, 7rn, 7ro, 7rp, 7rq, 7rr, 7rs, 7rt, 7ru, 7rv, 7rw, 7rx, 7ry, 7rz, 7sa, 7sb, 7sc, 7sd, 7se, 7sf, 7sg, 7sh, 7si, 7sj, 7sk, 7sl, 7sm, 7sn, 7so, 7sp, 7sq, 7sr, 7ss, 7st, 7su, 7sv, 7sw, 7sx, 7sy, 7sz, 7ta, 7tb, 7tc, 7td, 7te, 7tf, 7tg, 7th, 7ti, 7tj, 7tk, 7tl, 7tm, 7tn, 7to, 7tp, 7tq, 7tr, 7ts, 7tt, 7tu, 7tv, 7tw, 7tx, 7ty, 7tz, 7ua, 7ub, 7uc, 7ud, 7ue, 7uf, 7ug, 7uh, 7ui, 7uj, 7uk, 7ul, 7um, 7un, 7uo, 7up, 7uq, 7ur, 7us, 7ut, 7uu, 7uv, 7uw, 7ux, 7uy, 7uz, 7va, 7vb, 7vc, 7vd, 7ve, 7vf, 7vg, 7vh, 7vi, 7vj, 7vk, 7vl, 7vm, 7vn, 7vo, 7vp, 7vq, 7vr, 7vs, 7vt, 7vu, 7vv, 7vw, 7vx, 7vy, 7vz, 7wa, 7wb, 7wc, 7wd, 7we, 7wf, 7wg, 7wh, 7wi, 7wj, 7wk, 7wl, 7wm, 7wn, 7wo, 7wp, 7wq, 7wr, 7ws, 7wt, 7wu, 7wv, 7ww, 7wx, 7wy, 7wz, 7xa, 7xb, 7xc, 7xd, 7xe, 7xf, 7xg, 7xh, 7xi, 7xj, 7xk, 7xl, 7xm, 7xn, 7xo, 7xp, 7xq, 7xr, 7xs, 7xt, 7xu, 7xv, 7xw, 7xx, 7xy, 7xz, 7ya, 7yb, 7yc, 7yd, 7ye, 7yf, 7yg, 7yh, 7yi, 7yj, 7yk, 7yl, 7ym, 7yn, 7yo, 7yp, 7yq, 7yr, 7ys, 7yt, 7yu, 7yv, 7yw, 7yx, 7yy, 7yz, 7za, 7zb, 7zc, 7zd, 7ze, 7zf, 7zg, 7zh, 7zi, 7zj, 7zk, 7zl, 7zm, 7zn, 7zo, 7zp, 7zq, 7zr, 7zs, 7zt, 7zu, 7zv, 7zw, 7zx, 7zy, 7zz.

By 6BEQ, Route 1, Box 76 A, Puente, Calif.

1xm, 2xq, 3hr, 3jj, 3xo, 3apr, 3aro, 4bh, 4bi, 4eb, 4el, 4eh, 4oi, 4hw, 4fs, 4mc, 4nv, 4qu, 4sb, 4jz, 4yd, 4xo, 4xi, 5be, 5cc, 5cy, 5ek, 5el, 5ho, 5ix, 5mb, 5mo, 5nk, 5ok, 5ov, 5pb, 5rh, 5js, 5jz, 5lj, 5sf, 5sk, 5ui, 5un, 5uk, 5va, 5vo, 5xd, 5xv, 5zh, 5xad, 5xaj, 5aah, 5aby, 5ado, 5aec, 5ahb, 5amf, (6lu), (6apl), (6alx), 6ath, (6bly), (6bmy), (6bos), (6buy), (6cee), 7ak, 7br, (7dc), (7dh), 7dp, 7eq, (7ge), 7hi, 7ks, 7lg, (7na), 7nf, 7ri, (7to), (7tq), 7tt, 7ut, (7acx), (7aea), 7aey, 7afw, 7anf, 7zl, 7zu, 8by, 8cq, 8cf, 8er, 8hn, 8ij, 8jj, 8ld, 8lh, 8qk, 8aaf, 8ago, 8alt, 8aqv, 8asv, 8bog, 8bda, 8bdo, 8bvr, 8bxh, 8bxx, 8byo, 8xad, 8cei, 8chb, 8cih, 8cqh, 8crb, 8cyu, 8bag, 8xe, 8yn, 9cr, 9ew, (9fv), 9fh, 9fu, 9nr, 9of, 9ox, 9qk, 9rc, 9ur, 9uh, 9wi, 9aap, 9aec, 9ahh, 9aix, 9ami, 9adn, 9ape, 9apw, 9ams, 9asf, 9avc, (9avu), 9awf, 9ayu, 9avz, 9aza, 9bak, 9bcf, 9bds, 9bed, 9bey, 9bfe, 9bgh, 9bjk, 9bkj, 9bkk, 9bpv, 9bsg, 9bxc, 9bxm, 9bzz, (9bun), (9caa), 9cao, 9cba, 9cev, 9cgy, 9cmd, 9cnv, 9crq, 9ccs, 9cvg, 9cvo, 9dah, 9dca, 9dex, 9dfb, 9dfk, 9dge, 9dky, 9dkk, 9dsd, 9dsm, 9dte, 9dyn, 9dyd, 9dxc, 9edb, 9egy, 9ekv, 9eil, 9ekx, (9eca), 9fse. Can.: 9bx, 4co, 4bv. Anyone hearing my 10 watt CW pse qsl.

By 6QM, Geo E. Conner, Lewiston, Calif.

4uj, qra?, 5io, 5md, 5nk, 5ta, 5za, 5zh, 5aec, 6's too many, 7's too many, 8ue, 8uj, 8sj, 8zo, 8aoi, 9av, 9bx, 9ea, 9ec, 9gf, 9gk, 9hi, 9io, 9it, 9lf, 9ps, 9uc, 9uh, 9vm, 9adf, 9agt, 9ami, 9apw, 9arp, 9arz, 9asf, 9avc, 9bbf, 9bii, 9bri, 9bss, 9bvy, 9bxm, 9bxt, 9ccv, 9ccy, 9cfu, 9cfy, 9cga, 9cns, 9ctg, 9ctn, 9djm, 9dlm, 9dlo, 9dps, 9drf, 9dyt. Can.: 5ak, (5ct), 5ej, (5go). Spark: 8bm. Am on 100 watt cw dx. Cards welcome.

By 6BQV, 3101 Grand Ave., Los Angeles, Calif.

2fp, 3ni, 5cn (Can.), 5di, 5hz, 5jz, 5kc, 5ke, 5po, 5tc, 5vu, 5xd, 5za, 5zg, 5zh, 5ado, 5adb, 5aec, 5xaj, 5zak, 5zav, 7dp, 7bj, 7ey, 7ln, 7lw, 7na, 7nf, 7pf, 7sc, 7tq, 7vf, 7wm, 7zf, 7zn, 7zu, 7abb, 7aea, 8avu, 8cvy, 9pf, 9uh, 9zt, 9afk, 9amb, 9avu, 9avv, 9ayu, 9bji, 9bjk, 9bsg, 9bit, 9bun, 9bxm, 9cba, 9cfy, 9cki, 9cvo, 9dgv, 9dhi, 9dhs, 9dok, 9dtm, 9dvi, 9eea, 9ekh. Anyone hearing my ICW pse qsl crd.

By 9DJA, Robert C. Valentine, Jr., 303 Jerome St., Marshalltown, Iowa

1adl, 1bes, 1bwj, 1qp, 2awf, 2bmr, 3acy, 3as, 3bhm, 3bpp, 3hl, 3iw, 3pz, 3rf, 3zo, 4bq, 4bx, 4eb, 4gw, 4od, 5adq, 5bm, 5ix, 5kc, 5ud, 6arb, 6bbv, 6xad, 6zz, 7apw, 7lu, 7zo, 7zv, 8aim, 8anb, 8asv, 8awz, 8bep, 8boz, 8byo, 8cgg, 8jj, 8vq, 9abv, 9ae, 9ami, 9amu, 9arz, 9aog, 9aoj, 9aso, and cw, 9haj, 9hau, 9bdr, 9bji, 9bxj, 9bzi, 9cao, 9cfk, 9bgh, 9cho, 9clq, 9cns, 9oio, 9onc, 9dsm, and cw, 9dpw, 9dtm, and cw, 9dvc, 9dwb, cw, 9ead, 9eak, 9efs, 9ejj, 9fp, 9ho, and cw, 9mc, and cw, 9ox, 9uu. Can.: 3dh, 3oy, 3nb, 9al.

By 6AMK, Glen Una, Los Gatos, Calif.

All Spark. 5tu, 5ug, 5afa, (6gt), 6hh, 6lk, (6od), (6qr), (6tf), (6up), 6ahp, (6aic), 6alg, 6alu, (6anp), (6ars), (6awg), (6awx), (6baj), (6bak), (6bbe), (6bee), (6bjg), (6bjq), 6bju, 6bny, (6bqt), (6bvd), 6cej, (7kj), 7agi, 9bri? Canadian (5dx). All hearing 6amk pse qsl dx 2500 miles Canada, and Alaska; 12 states.

By 9CLQ, 919-42nd St., Des Moines, Iowa, 1 tube

6asp, 6awt, 6apw, 6arb, 6beg, 6bjq, 6boe, 6bik, 6bvg, 6bwp, 6hq, 6bum, 6bvw, 6cc, 6cu, 6caj, 6cbu, 6cgw, 6jx, 6ka, 6rm, 6ya, 6zh, 6zi, 6zn, 6zt, 7abb, 7afw, 7hm, (7lu), (7na), 7pf, 7rn?, (accw), 7wm, 7ve, 7zf, 7zn, 7zv. All 6's and 7's hearing 9clq's 100-50 watt cw set pse qsl crd. All repts appreciated and acknowledged tnx.

Continued on page 48

Tell them that you saw it in RADIO

# Standard Radio Supplies

We offer no cut prices or "junk" merchandise — but we do guarantee you full value for your money, prompt and courteous service, and experienced advice — the result of 15 years in the radio field.

**Send Us  
Your  
Mail  
Orders**

Everything in stock that's  
standard in radio—

Grebe Apparatus—every  
model always in stock.

Cunningham Tubes—all  
Types.

WD-11 Tubes, Detector and  
Amplifier.

Westinghouse Radio Receiv-  
ing Apparatus.

Frost Fones and other  
accessories.

Magnavox.

All Radio Corporation of  
America Receivers.

Remler Radio Mfg. Co.—full  
line of parts.

Baldwin Phones—all models.  
Tungar and Homcharger

Rectifiers.

Atwater-Kent Radio Parts.

Bradleystat.

Fada Parts.

Western Electric Loud Speak-  
ers and Amplifiers.

Eveready Batteries.

And Others too Numerous  
to Mention!

**Coast Radio Company  
Incorporated**

EL MONTE, CALIF.



# JUST OUT!

The Latest Edition of **CITIZEN'S RADIO CALL BOOK**

192 Pages. Only 50 Cents Per Copy

## CITIZENS

# RADIO CALL BOOK

A

**Complete Radio Encyclopedia and Directory**  
**Telephone Broadcasting Stations**  
**Radio Map and Full Operating Schedules**  
**United States Amateurs**  
**Canadian Amateurs**  
**Naval Stations**  
**Foreign Time and Press Schedules**  
**Worlds High Power Transoceanic Stations**  
**A R R L Section**  
**"Hook Ups"**  
**Formulae**  
**Questions and Answers**  
**RADIO LAWS**  
**"How to Build Your Own"**

*Compiled from official records, Bureau of Standards and other sources*

**50 Cents** in U. S. A.  
 65 cents Canada and Foreign  
 "Why Pay More"

## CONTENTS

The Nine Amateur Districts, Special Amateur and Experimental Stations. All practical wireless circuits. Schematic diagrams of these and a glossary or description of the working of the circuits. There are also full page graphic illustrations and photographs of the Flewelling circuit, the Reinartz and Armstrong double regenerative circuits.

A complete list of all Telephone Broadcasting Stations with their full operating schedules. These are also listed alphabetically by States. A complete 4 page American Radio Relay League section, containing a letter to the Citizen-Radio, by Mr. Kenneth B. Warner. A double page A. R. R. L. divisional map. A page giving the personnel of the Executive and Operation Divisions throughout the country.

A complete list of all Canadian Amateurs and Canadian Telephone Broadcasting Stations with their schedules.

A double page Radiophone Map of the United States, with all stations marked on the map, drawn to scale.

A double page map of the world, with all high powered stations marked. A Complete Schedule over 24 hours' time (Greenwich) of all high power stations, time they send, system they employ, wave length and character of the matter they send.

A Complete Federal Market Broadcasting schedule, by state, town and information on matter they broadcast.

International Continental Code and Conventional "Q" Signals.

Trap Circuits.

Up-to-date [Radio] laws, Amateur and Commercial.

Hook Ups.

Formulae for the Amateur and Experimenter. A wonderful Question and Answer Department, very complete.

The Circuit section contains both Receiving and Transmitting diagrams. The Transmitting end of this covers the best of the Amateur hook-ups on short wave transmission, C. W., I.C.W., and Voice.

The book contains 192 pages and cover printed in two colors.

**This Call Book is Distributed in the West by Pacific Radio Publishing Co., Inc., Pacific Bldg., San Francisco.**

**DEALERS: Write for Trade Prices**

"RADIO," Pacific Bldg., San Francisco.

Herewith is 50 cents for which you will immediately send me the latest **CITIZENS RADIO CALL BOOK**. Please include 10c for mailing charges.

Name .....

Address .....

Tell them that you saw it in RADIO



# 1800 MILE REFLEX

CIRCUIT and INSTRUCTIONS

50c Immediate Delivery 50c

One Step "Radio," Detector and  
One Step "Audio" on  
ONE TUBE!

DEALERS:  
Write for Special Proposition

## E. M. SARGENT CO.

"An Exclusive Radio Supply House"

1200 FRANKLIN ST., OAKLAND, CALIF.

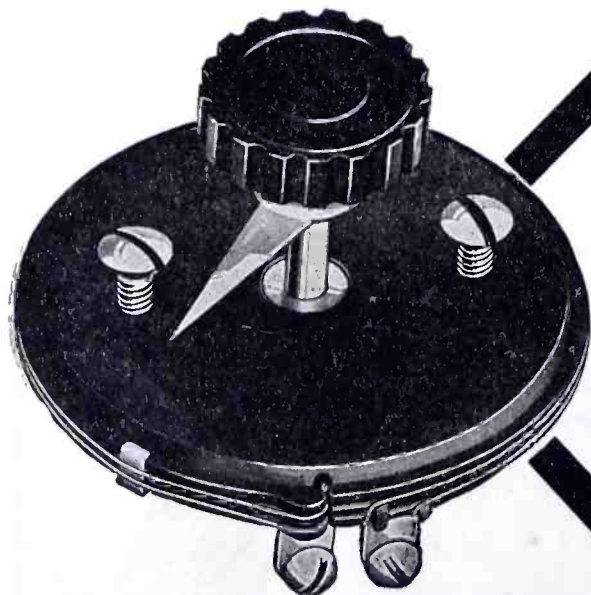

### JEWELL VERNIER RHEOSTAT

The Jewell vernier rheostat is extremely simple and substantial in construction, employing a new principle of contact which we have patented. Made of the highest grade bakelite and using the best resistance wire obtainable. Very fine adjustments are obtained by a single turn of the knob. Ask your dealer or write to us for special circular.

Price \$1.00

Jewell Electrical Instrument Co.  
1650 WALNUT ST. - CHICAGO

Tell them that you saw it in RADIO

### CALLS HEARD

FOZ, U.S.S. Canopus, At Sea Between Cuba and Haiti

All districts and Canada heard on one tube single circuit receiver—one wire antenna 120 feet long. Operator B. Overstreet, U. S. S. Canopus, c/o Postmaster, New York City.

- (E. S. T.)  
Time
- 0107 -----9bj, va
  - 0108 cq de 4ft ar k
  - 0109 cq de 5nb 5nb k
  - 0111 cq de ad7 msg ar k
  - 0112 -- -- 9ctg msg fr u ar k
  - 0113 5xa de 4ft-No. 3-r-73-va-gn
  - 0120 cq de 9bed ar
  - 0122 9aus de 5xa msg
  - 0123 cq fm can 9bj ar k
  - 0124 5agj de 8atx ar k
  - 0125 4ft de 1sn-qtc? ar k
  - 0128 cq de 2rm ar
  - 0129 cq de 8dak----
  - 0130 9aog de 9bds ar
  - 0131 cq de 9btt----
  - 0143 1xu de 4em ar
  - 0145 Sado de 7zv va (doubtful as to whether it was Sada or Sado wkg 7zv)
  - 0147 7zv de 5ado-r-gn-va-va
  - 0149 5agj de 8ahr bt guess nil qru hr om hw ar k
  - 0150 ----5cs is Little Rock om tnx---(qss)
  - 0151 5rn de 9bds ar k
  - 0153 9bds de 9bhi--as---as
  - 0200 1cni de 1ban-k
  - 0201 9dq de 8atx ar k
  - 0202 1cni de 1ban-k
  - 0204 3bnf de 1mk-nil hr so 73 va
  - 0205 1?? de 4ag-k
  - 0206 cq de 8ahr-k
  - 0207 qra? 9bj bt pse send crd hw is weather there cold as can be down hr below zero bt is qra 9bj ok bt 8bj aa 9dri-k
  - 0210 cq de 8apw----
  - 0212 ---de 8pj bt qsa qss qta pse -k
  - 0223 cq de 3bnu ar
  - 0224 6zh de 8apw ar
  - 0225 8pj de 2ddl -ar
  - 0226 2ddl de 8pj hr nr 2---qss
  - 0227 --- de 3zz gm hr nr 1----
  - 0228 9dri de 9bkk ar k
  - 0229 2zo de 2xq nr 1 r-qtc? nil gm 2zo de 2xq va gm
  - 0230 9bxm de 3bva qra? k
  - 0231 9bhi de 2aoi-gm qtc? k
  - 0232 -----8ajx ar k
  - 0233 cq de 6zh-k
  - 0234 -- de 3fs ar k
  - 0235 cq de 9bhi ar k
  - 0236 9bxm de 3bva (wkg)
  - 0237 1sn de 2xq ar
  - 0238 bkl de 9amb ar
  - 0239 9dri de 9bkd qru nil qtc?-k
  - 0244 cq de 6boe va (vy qsa fr one tube and dx --no doubt as to call)
  - 0246 6zh de 5?? bt pse tri-k
  - 0247 cq de 8ay?----
  - 0248 -----5zas ar k
  - 0249 2zq de 3zo ar
  - 0250 cq de 3zo ar k
  - 0257 2xq de ???---(qss)
  - 0258 9abu de 8apw ar
  - 0259 9bxm de 9bed hw?-k
  - 0300 2xq de 9aav-----
  - 0301 ----msg 6anb to 9axx did you get my crd btsg 6anb hw 6zh
  - 0302 6 boe de 8egu ar k
  - 0303 9dri de 2blk-k
  - 0304 cq de 9cvo ar k
  - 0309 6boe de 3bva and 5sf—Guess Nuff dx tonite.

Continued on page 82

**Investigate!**  
**WESTERN-RADIO DEALERS SERVICE**  
Wholesale RADIO Only  
637 So. Hope Street, LOS ANGELES  
565 Howard Street, SAN FRANCISCO

### RECHARGEABLE "B" STORAGE BATTERIES

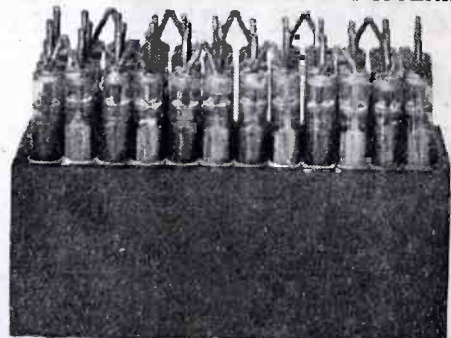

25 Volts \$5.00 50 Volts \$9.00 100 Volts \$17.00  
Dealers: Write for Discount.  
**DURKEE-THOMAS PRODUCTS CO.**  
1228 Folsom Street San Francisco, Calif.



# A MAGNAVOX Power Amplifier *for your* Magnavox Reproducer

MAGNAVOX products are made for people who judge Radio equipment as expertly as the engineer judges a locomotive or a musician a violin.

To answer such requirements, the Magnavox Power Amplifier was developed for use with the Magnavox Radio, the Reproducer Supreme.

Under present conditions, the combination of Magnavox Reproducer and Power Amplifier represents the last refinement in Radio reception — a demonstration at your dealer's is the convincing proof.

## R2 Magnavox Radio (With 18-inch horn)

This instrument is intended for those who wish the utmost in amplifying power; for clubs, hotels, dance halls, large audiences, etc. It requires only .6 of an ampere for the field.

Price \$60.00

## R3 Magnavox Radio (With 14-inch horn) *As illustrated*

The ideal instrument for use in homes, offices, amateur stations, etc. Same in principle and construction as Type R-2.

Price \$35.00

## Model C Magnavox Power Amplifier *As illustrated*

For use with the Magnavox Radio and insures getting the largest possible power input.

2-stage, \$55.00

3-stage, \$75.00

Magnavox Reproducers and Power Amplifiers can be used with any receiving set of good quality. Without Magnavox, no receiving set is complete.

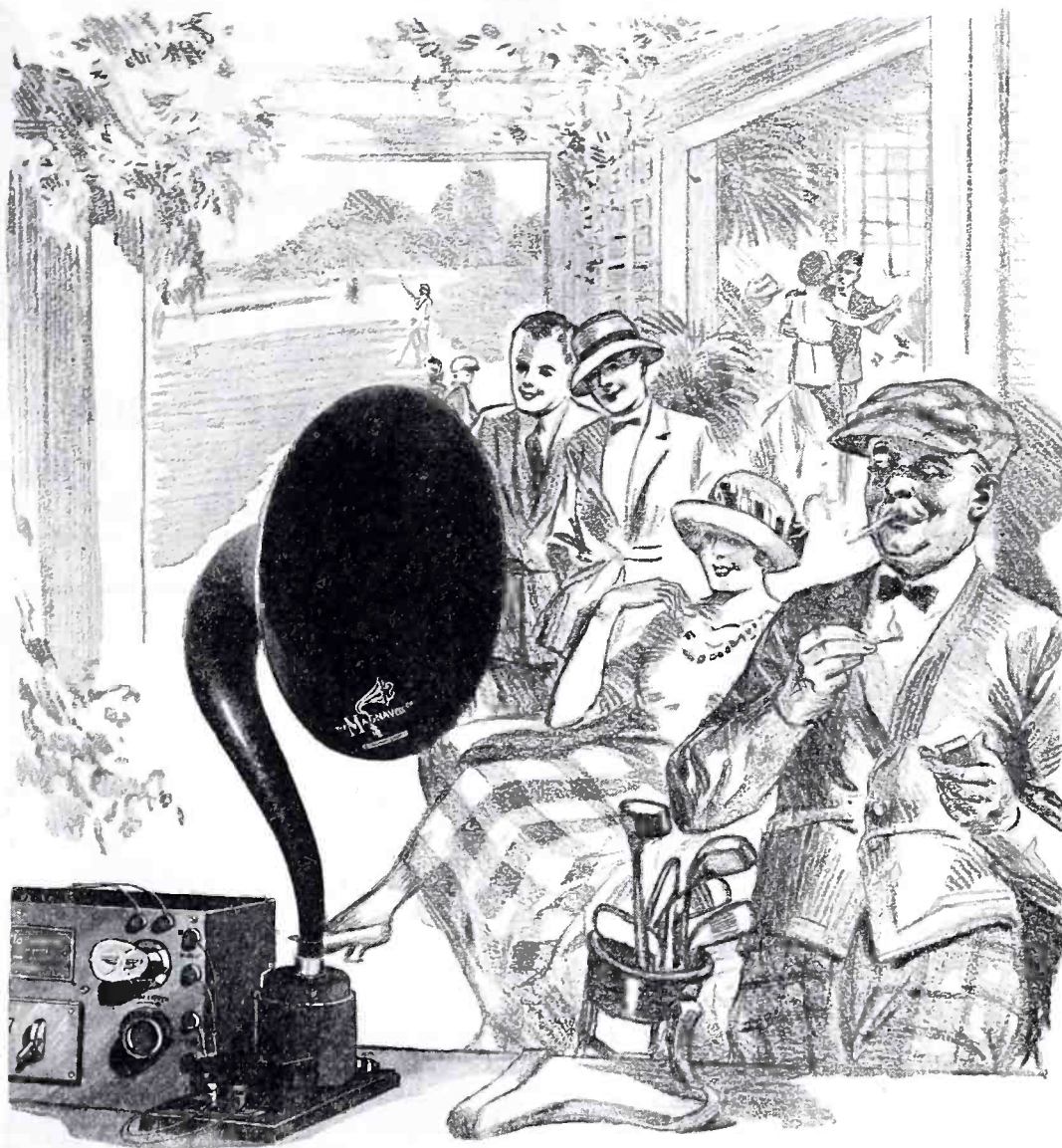

# On the Veranda of the Country Club

WHERE Radio apparatus, like a professional entertainer, must meet the test of satisfying really discriminating people, Magnavox is certain to be installed.

The first requisites—tone clearness, pitch and quality—are fulfilled by the Magnavox Reproducer; the addition of a Magnavox Power Amplifier supplies the other requisite, volume.

*Magnavox Products can be had from good dealers everywhere. Our interesting new booklet will be sent on request.*

The Magnavox Co., Oakland, California  
New York: 370 Seventh Avenue



# MAGNAVOX Radio The Reproducer Supreme

Tell them that you saw it in RADIO



SOLD  
THROUGH  
JOBBER  
DEALER

# K & C RADIO

KUALITY  
CERVICE

**KILBOURNE & CLARK MFG. CO., SEATTLE, WASH.**

SAN FRANCISCO BRANCH: 591 MISSION ST.  
PHONE SUTTER 40



## Thrills !!!

**T**HRILLS never end when you have a Tuska Popular—the regenerative receiving set that experts recommend. Signals clear and sharp come in night after night from far-away stations. And for nearby programs, plenty of volume without distortion. Every part Tuska-made; known for 12 years as fine radio instruments.

THE C. D. TUSKA CO., Hartford, Conn.

**Tuska Popular No. 225**  
Regenerative Receiving Set,  
Tuska receiver, detector and  
2-stage amplifier, licensed  
under Armstrong U. S. Patent  
No. 1,113,149. Catalog No.  
12-A, showing Popular and  
other sets, on request.

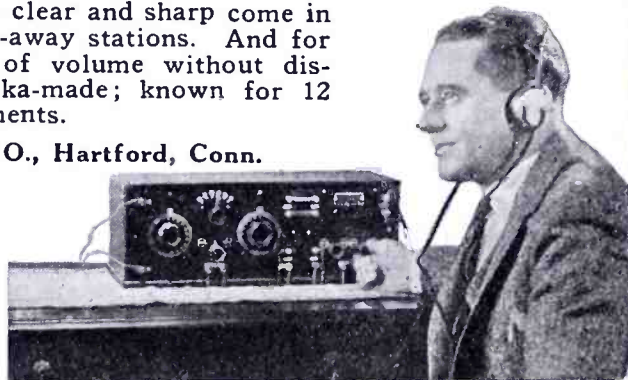

# TUSKA RADIO

### 50-WATT RADIOPHONE

*Continued from page 12*

the cost of the set. In fact, built of standard parts as it is, there is no reason why it can not be duplicated by any of the power companies having even meager shop facilities, at a total cost of \$750.00. It may be built even for less but hardly in such compact shape. It would be ill advised, however, to reduce the cost by eliminating any of the meters, as they are very essential to the proper adjustment of various circuits. Needless to say, the set may be used for carrier wave transmission just as well as for radio, with certain additional apparatus for transferring the output to the lines.

Operating at normal power input rating, on a 4-wire flat top T type antenna 75 ft. high and 175 ft. long and a counterpoise of similar dimensions, this set has a normal radiation of 4 amperes at 360 meters, which is indicated by a radio frequency ammeter of the thermo-couple type. Modulation, effected by speaking or whistling into the transmitter, produces from two-tenths to one ampere variation in the radiation. This is known as the percentage modulation and it is upon this that the voice range of the set depends to a large extent. It is possible to get a higher percentage modulation but hardly without distortion. To briefly summarize the results obtained with this set: of the total number of reports on overland reception of speech and music from same, 2% were over 2500 miles from Fresno, 1½% between 2500 and 2000 miles, 2% between 2000 and 1500 miles, 7% between 1500 and 1000 miles, 51% between 1000 and 500 miles and 37% within 500 miles. Practically every report pronounced modulation excellent and volume good. One person at a distance of 700 miles reported hearing ten consecutive concerts which rather proves the operation consistent. On several occasions conversations have been carried on by voice with Portland, Oregon, a distance of 650 miles, and on one occasion with Denver, Colorado, at 865 miles, the latter con-

*Continued on page 52*

## HERE—AT LAST

The Wonder of the Radio World

### Jacobs' Circuit Receiving Set

The dream of all radio fans has materialized—the goal for which radio engineers have striven for years has at last been reached.

**Tunes Up To 900 Meters**

**No Crystal      No Tubes      No Batteries**

**No Expense to Operate**

**The First Cost is the Last Cost**

Simplicity of operation—clearness of reception—purity of tone, are all incorporated in this remarkable Jacobs' Circuit Receiving Set.

**Every Set Guaranteed to Give Absolute Satisfaction**

## \$8.50

**Jobbers and Dealers Write for Discounts**

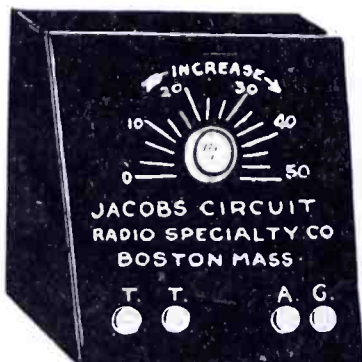

Mail and Phone Orders Filled—Phone B. B. 2636

## RADIO SPECIALTY CO.

25 Huntington Ave.,

Boston, Mass. Room 608

Tell them that you saw it in RADIO



# Try the Bradleystat on Your Radio Set, to-night

*A New Thrill Awaits You!*

*Pull in those distant stations that  
you lose with Wire Rheostats*

Does your receiving range enable you to pick up concerts over great distances? If not, try the Bradleystat.

Read this interesting letter from Chas. H. M. White of Massachusetts Institute of Technology at Cambridge, Massachusetts:

*"I have tried the Bradleystat on my radio set. The improvement is really remarkable and beyond all my expectations. Previously I only picked up local stations and WJZ, but on my first trial with the Bradleystat I heard KYW (Chicago), WOC (Davenport) and many other stations."*

Get the Bradleystat, today, from your nearest radio dealer and get more enjoyment from your radio set. Insist on the genuine Bradleystat.

**Allen-Bradley Co.**  
Electric Controlling Apparatus

288 Greenfield Avenue • Milwaukee, Wisconsin  
Member of the National Radio Chamber of Commerce



Retail Price  
**\$1.85**  
P. P. 10c extra

**Other Radio Products**  
The Bradleyometer, a perfect potentiometer and the Bradley-adaptor for the WD-11 tubes are two new radio products equal in quality to the Bradleystat.

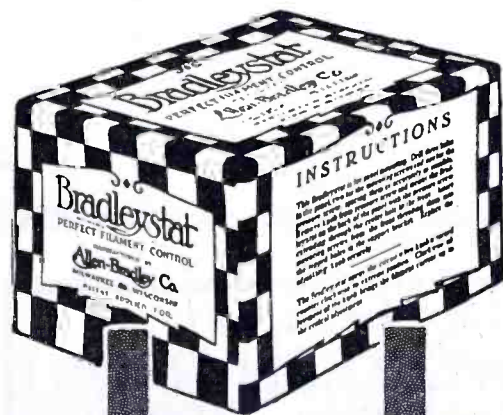

# Bradleystat

REGISTERED U. S. PAT. OFF.

## PERFECT FILAMENT CONTROL

Tell them that you saw it in RADIO



Continued from page 50



For more than eight years, among men who know and use Radio Apparatus of the better sort, the name—General Radio Company—had been accepted as a guarantee of all that goes to make up satisfaction and as synonymous with the advances in theory and practice which accompany all true Radio progress. If you are interested in Radio Apparatus in which price is subordinated to satisfaction, send for Bulletin 914 "C". It is an educational pamphlet for the amateur who wants better equipment.

## GENERAL RADIO CO.

Manufacturers of Radio and Electrical Laboratory Apparatus

Cambridge 39 :: :: Massachusetts

General Radio Types 300A and B Amplifier Unit—A compact unit, wired ready for external connection. Type 300-A for WD-11 Tubes

**\$7.50**

Type 300-B with Standard Socket

**\$8.00**

General Radio Type 214 Theostat—For the new UV201-A 20 Ohms: For the newer UV199 Tubes, 50 Ohms: For the Standard Tube, 7 Ohms:

**\$2.25**

General Radio Type 231-A Transformer—Gives maximum amplification possible without distortion—

**\$5.00**

*Investigate!*  
**WESTERN-RADIO DEALERS SERVICE**  
 Wholesale RADIO Only  
 637 So. Hope Street, 565 Howard Street  
 LOS ANGELES SAN FRANCISCO

**EMPIRE RADIO CORP.**  
 Send 10c for new and complete catalog  
 Dealers and Jobbers write for our discounts  
**EMPIRE RADIO CORPORATION**  
 271 W. 125th Street, New York City

**Just Out** New Citizens' Radio Call Books. See Page 47  
 Only 50c—"RADIO"—San Francisco, California

versation being overheard in its entirety by a novice in Dayton, Ohio, 2012 miles from Fresno. The remarkable thing about this record was that the novice used only a simple regenerative detector set without any amplification. These records were practically all made at 360 meters operation and subject to interference from a multitude of other stations broadcasting at the same or very nearly the same wavelength. Therefore, it is obvious that operating at much higher wavelengths, which would be the case in emergency operation as limited commercial stations, there would be practically no interference, which would allow of very consistent results.

These records might seem to indicate that much more power than necessary was being used to cover the power system in question. Possibly so, but the next size smaller power tube has an output rating of only 5 watts which is ostensibly not enough. Operating tubes in multiple to increase the output rating of a set is not particularly satisfactory without a complication of controls and meters which immediately runs into an expense. For such reasons it was considered inadvisable to experiment with less than a 50-watt tube; also it was felt that for operation through the summer months such capacity was not any great excess.

While it was not the intention that problems of reception should be within the scope of this article, the writer desires to remark that in his opinion the success of duplex operation of the radio telephone is going to hinge pretty much on the receiving end; but after all this is largely a matter of training the operating personnel. Broadcasting is having just that effect, not merely the Corporation's efforts but broadcasting in general is serving to acquaint the power man with receiving sets, getting him accustomed to the more or less delicate adjustments of the instruments. Numerous receiving tests made about the San Joaquin system have well demonstrated the success of ordinary receiving sets employing one or two stages of audio frequency amplification, connected with outdoor antennae; however, before duplex operation of the radiophone can be any complete success, it will be necessary to resort to loop reception and radio frequency amplification. This will permit stations transmitting at one wavelength and while transmitting, receiving at another wavelength without interference from their own transmitter. This is the next problem to be attacked, now that much has been learned about radio frequency amplification. A complete receiving set including loud speaking device should not cost over \$250.00 making a total investment of perhaps \$2000.00 for a complete two way radio station.

Tell them that you saw it in RADIO



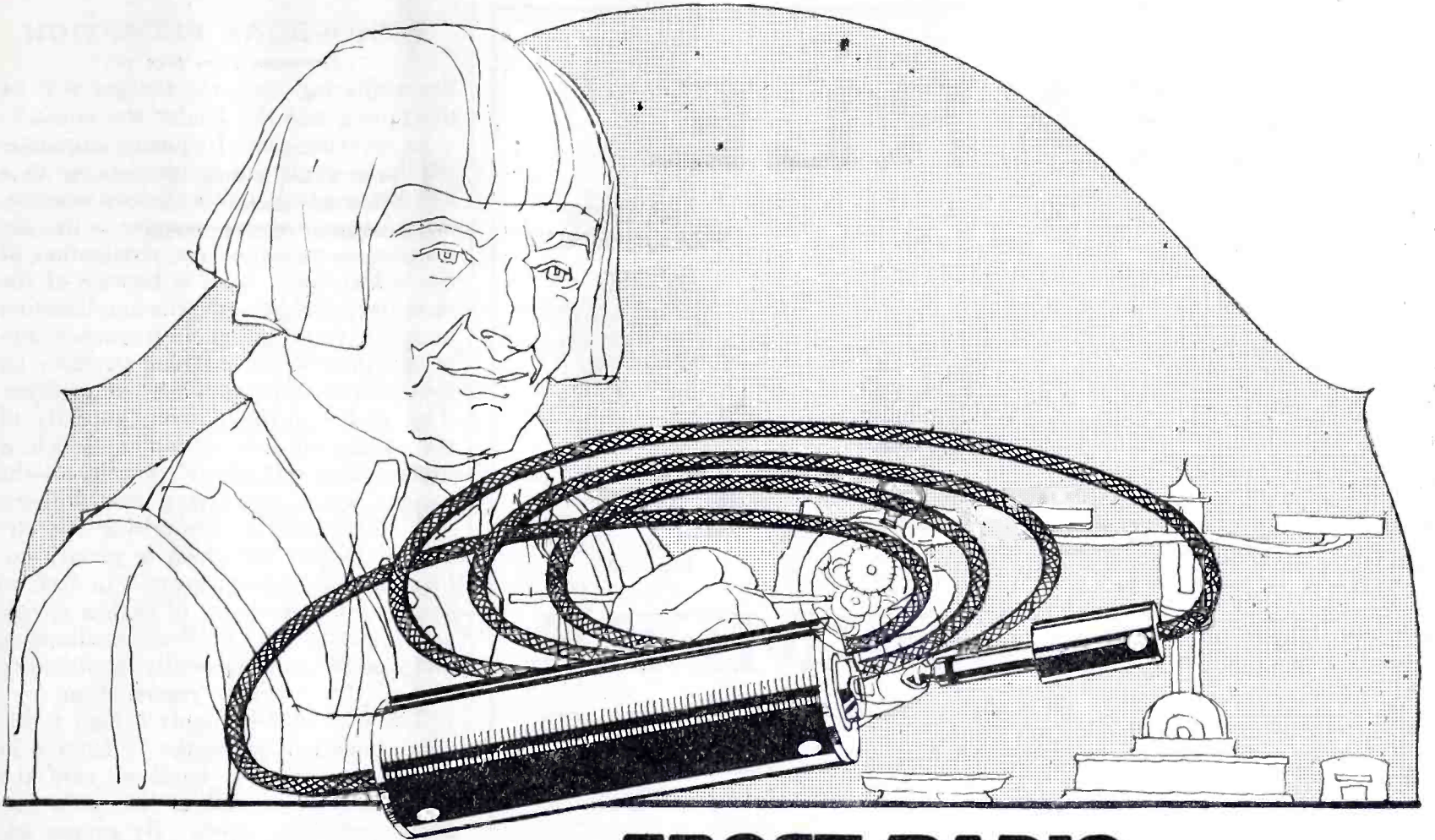

Sold in these stock lengths:

- |                              |                        |
|------------------------------|------------------------|
| <i>Tinsel Copper</i>         | <i>Stranded Copper</i> |
| No. 300—10 ft. cord—No. 310  |                        |
| No. 301—20 ft. cord—No. 311  |                        |
| No. 302—30 ft. cord—No. 312  |                        |
| No. 303—40 ft. cord—No. 313  |                        |
| No. 304—50 ft. cord—No. 314  |                        |
| No. 305—100 ft. cord—No. 315 |                        |

No. 325—Mounted Jack only.  
List, \$1.75

## FROST-RADIO

### Extension Cord—Precision Quality

IF every owner of a radio receiving set knew of the superb quality of the Frost Radio Extension Cord, and its convenience, we could not begin to supply the demand. Thousands of owners have already equipped their sets with this handy loud speaker extension.

### A wonderfully convenient accessory for your set

With this Extension Cord the speaker may be placed in one room, the receiving set in another. No unsightly wires strung along hallways, but a fine mercerized or telephone twin pair cord from set to loud speaker.

Note that Frost Radio Extension Cord comes equipped with Frost Cord Tip Plug, and hard rubber housing containing Frost Jack. Made in two styles: Nos. 300 to 305 in tinsel copper cordage and mercerized braid. Nos. 310 to 315 in stranded copper conductor with twin pair cord.

Go to your dealer today and ask to be shown this handy Extension Cord. The low prices on any length will surprise you. Take time to examine the workmanship and finish of this piece of Frost Radio Apparatus. You will agree with us that it is real value and high quality.

### A superb tuning coil for a small price

Everyone who has seen a Frost Radio Tuning Coil has been amazed that so much value could be offered for only \$3.00. Silk wire wound on seamless tube. Hardwood ends, mahogany finish. Triple nickel plated and hand buffed metal parts. 1000 meter range.

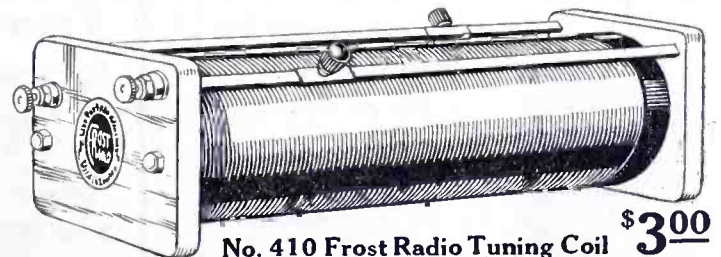

No. 410 Frost Radio Tuning Coil \$3<sup>00</sup>



**FROST FONES**

No. 162  
2000 Ohm Set  
**\$5<sup>00</sup>**

No. 163  
3000 Ohm Set  
**\$6<sup>00</sup>**



**HERBERT H. FROST, Inc.**  
154 WEST LAKE STREET, CHICAGO, ILLINOIS.

Tell them that you saw it in RADIO



# MARLE

AUDIO  
FREQUENCY

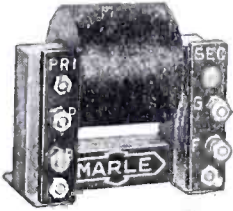

TYPE A4  
RATIO 3 3/4 TO 1  
LIST PRICE \$3.75  
BLACK TERMINAL  
BOARD

RADIO  
FREQUENCY

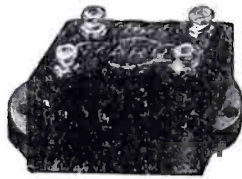

TYPE R1  
LIST PRICE, \$4.00

AUDIO  
FREQUENCY

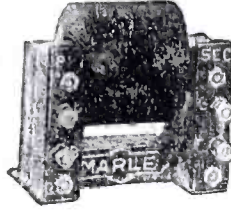

TYPE A6  
RATIO 5 TO 1  
LIST PRICE, \$4.25  
RED TERMINAL  
BOARD

## TRANSFORMERS

SUPERIOR QUALITY TRANSFORMERS USED AND  
RECOMMENDED BY LEADING REPUTABLE  
MANUFACTURERS OF RADIO APPARATUS

MANUFACTURED BY

MARLE ENGINEERING CO., Orange, N. J.

## Delicate Soldering

Both the manufacturers' and amateurs' problems on all fine work is readily solved by the instrument constructed for this particular purpose.

THE POST SOLDERING IRON

Platinum Heating Unit—Interchangeable Tips—Universal Current  
(Large & Small)

\$6

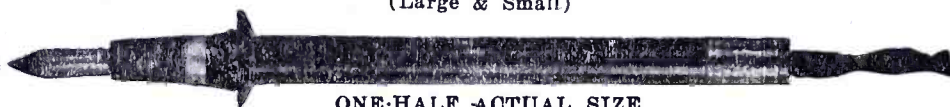

ONE-HALF ACTUAL SIZE

Awarded Certificate of Excellency, N. Y. Evening Mail Radio Institute  
From your Dealer, or write

POST ELECTRIC COMPANY (Fifth Division), 30 E. 42nd St., New York

## THE Q. T. DRY CELL SET

A Popular Priced Set  
for Every Home

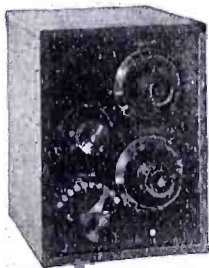

SPECIFICATIONS—

Mahogany-stained oak cabinet, engraved Radion panel, Ajax socket-rheostat, 21 plate variable condenser, 180° Bakelite variocoupler, no external binding posts, bus-bar wiring, all connections securely soldered. Nickered plated brass parts.

List Price, \$17.00

Complete with phones, "A" & "B" batteries and tube, \$27.50.

If your dealer can not furnish this set order direct from manufacturer.

THE Q. T. LIGHT CO.

East Orange Dept. C-1 N. J.

## Whatever Your Question



Be it the pronunciation of *Bolsheviki* or *scviet*, the spelling of a puzzling word — the meaning of *blightly*, *fourth arm*, etc., this Supreme Authority —

WEBSTER'S

NEW INTERNATIONAL DICTIONARY

contains an accurate, final answer. 400,000 Words, 2700 Pages. 6000 Illustrations. Regular and India-Paper Editions.

G. & C. Merriam Co., Springfield, Mass.

Write for specimen pages, prices, etc., and FREE Pocket Maps if you name this publication.

*Investigate!*  
**WESTERN-RADIO  
DEALERS SERVICE**  
Wholesale RADIO Only  
637 So. Hope Street, 565 Howard Street  
LOS ANGELES SAN FRANCISCO

## RADIOPHONE RECEPTION

Continued from page 16

the oscillating note, the sharper will be the tuning and the louder the music.

In applying radio-frequency amplification to a single circuit receiver or to a detector-amplifier unit with loop antenna, many experimenters wonder why the manufacturers advise the elimination of the tickler coil. This is because of the fact that in addition to the amplification obtained from the radio-frequency amplifier, there is also a strong tendency on the part of this amplifier to oscillate. This is due to the inherent capacity of the radio-frequency amplifier, which is itself due to the mutual capacity of the various wires, amplifying transformers, and other elements comprising the circuit, the effect of which is greatly enhanced at radio frequencies. In fact, so strong is the tendency of such a circuit automatically to produce oscillations, that a *stabilizer* is generally furnished to control this inherent regeneration.

The stabilizer is simply a high resistance connected across the *A* battery in such a way that it tends to vary the potential on the grids of the radio frequency amplifier tubes. By proper adjustment of the stabilizer, it is possible to keep the radio frequency amplifier circuit just below the oscillating point. With this adjustment, all the advantages of radio frequency amplification as well as amplification through regeneration are obtained.

We have had occasion, in the assignment on radio-frequency amplification, to consider the deleterious effects of "tube noises" in the detector tube. In the reception of high power broadcasting stations within 25 miles from your receiver, it is often possible to obtain sufficient volume with a crystal detector to permit of its amplification with two or more steps of audio-frequency amplification. In many cases, a loud speaker may even be operated in conjunction with such a combination. The result is to secure music reproduction of great purity.

For most efficient results, detector tubes should be operated just below the "hissing" point. This may be found by proper adjustment of the detector tube rheostat. When additional tubes are thrown onto the storage battery, the potential across the terminals of the detector tube is of course reduced, and a slight change in the detector tube rheostat must be made to restore it to its original operating adjustment. This is particularly noticeable in throwing on the current for a power amplifier.

The proper *B* battery potential for the detector tube must be found by trial. All standard detector tubes, Radiotron UV 200 and Cunningham C 300, require from 18 to 23 volts for the plate potential. The quickest way to determine the correct voltage is to connect

Continued on page 56

Tell them that you saw it in RADIO



## THE RADIO SET OF THE FUTURE

IT cannot be foretold what combination of units will be used, or the circuits that may be employed in the Receiver of tomorrow. It is obvious, however, that today's conventional set will soon be considered crude and antiquated.

Little prescience is required to realize that the panel of insulating material, with its shielded background, is doomed to obsolescence. The use of a great mass of expensive insulating material to provide for "live shafts" was merely a temporary expedient. Progressive practice has eliminated the electrical difficulties connected with live shafts and also obviated the necessity for massive insulation.

Carrying primary leads to the panel, and the drilling of numerous holes for a switch, will cease because of the waste such labor entails. To make the tap-switch an integral part of the instrument is the expedient thing to do.

Knobs add nothing to the appearance of a panel, and will in time become a relic of bygone days. The concave dial and bar control, giving ease of adjustment without cramping the hand, is far more sensible and attractive.

### EISEMANN PARTS AND PANELS

Permit changing circuits and re-location of parts on panel—  
—all units being interchangeable.

Make unnecessary the use of shielding—metal panel itself  
accomplishing this purpose.

Eliminate mounting of tap-switches and soldering of  
primary leads.

Give the many advantages of concave dials—a natural  
position of the hand in tuning, added attractiveness in appearance and ease in packing for transportation.

*Write for descriptive literature and discounts*

### EISEMANN MAGNETO CORPORATION

William N. Shaw, President

BROOKLYN, N. Y.

DETROIT

CHICAGO



**EISEMANN**

Tell them that you saw it in RADIO



Continued from page 54

the positive lead from the plate to the 23-volt tap on the *B* battery. The negative lead should be connected to the negative post of the battery. The detector tube rheostat should be adjusted for the loudest signals. Now move the negative lead to the 1.5-volt tap. This will reduce the total *B* battery potential to the detector to 21.5 volts. Readjust the filament rheostat. The signals will probably be a little louder. Now move the negative lead to the 3-volt tap, and readjust the rheostat. If the signals are weaker, replace the lead at the 1.5-volt tap, but if louder, try it at the 4.5-volt tap. The correct position is usually at the 1.5-volt tap.

The correct *B* battery potential for amplifier tubes is not at all critical. Generally speaking, the last tap on a 43-volt battery should be used. However, if a Western Electric 10-D (without power amplifier), Magnavox, or Master-Baldwin Claraphone loud speaker is to be used, it is usually better to employ 86 to 120 volts in order to obtain sufficient plate current to produce the proper volume in the loud speaker.

From 108 to 120 volts should be used on the plates of the tubes in the power amplifier of the Western Electric 10-A loud speaker. Although three tubes are used in this power amplifier, it is in reality a two-stage amplifier—two of the tubes being used in the second stage, in what is known as a "push-pull" circuit.

Storage batteries should be charged on an average of about once per week, according to usage. A vacuum tube type of battery charger such as the General Electric Tungar rectifier is superior to a vibrator type. With the former, there are no moving parts. With the latter, sparking contacts give rise to trouble. After charging a battery, always wait at least five minutes, preferably fifteen, until the voltage of the battery has dropped a little to its normal potential. If the tube circuit is closed directly after completing the charge there is danger of burning it out, since the potential of a battery at the instant of completing the charge may be at least 50% higher than its rated voltage.

In operating dry battery tubes, (peanut tubes), such as the WD-11, C-301A, UV-199 tubes, be sure to see that not more than the required potential is applied to the filament. In the case of the WD-11, this is 1.5 volts—the output of a single No. 6 dry cell. By connecting two or three of these dry cells in *parallel*, the life of the batteries will be lengthened and the voltage output will be more constant while the tube is in operation.

The WD-11 tube functions as a detector on 22.5 volts and as an amplifier on 43 volts. The opinion is prevalent among amateurs that two styles of WD-11 tubes are manufactured. This

Continued on page 58



**MU-RAD RECEIVERS**  
**SUPREME**

LIKE THE POWERFUL TELESCOPE that makes us neighbors to the stars, MU-RAD Receivers annihilate distance with delightful ease. Honolulu is as near to St. Louis by MU-RAD reception as New York.

So marvelously sensitive that it requires only a 2-foot loop aerial. Distinct reproduction with hair breadth selectivity, and yet easy for even a novice to operate. Conservatively guaranteed for 1000 miles.

*Write for literature*

*The New*  
**Star in**  
*the* **Radio**  
**World**



**MU-RAD LABORATORIES, INC.**  
806 FIFTH AVE. ASBURY PARK, NEW JERSEY

Try **REYNOLDS RADIO Service**

9ZAF

from **DENVER**

KLZ

The exclusive distributors of

**KENNEDY EQUIPMENT**

IN THIS TERRITORY

If you have a **KENNEDY Receiver** you have the best in Radio  
**REYNOLDS RADIO CO., Inc., 1534 Glenarm St., Denver, Colo.**

Largest distributors of Radio Apparatus in the West

? Did YOU receive our 68-page Catalogue ?

Tell them that you saw it in RADIO





**RADIO**

**PRODUCTS**

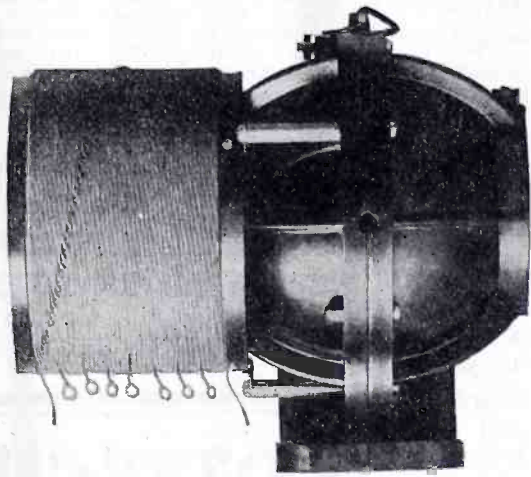

Catalogue No. 165.....\$13.00  
SE-AR-DE RADIOMETER WITH  
B. W. INDUCTANCE

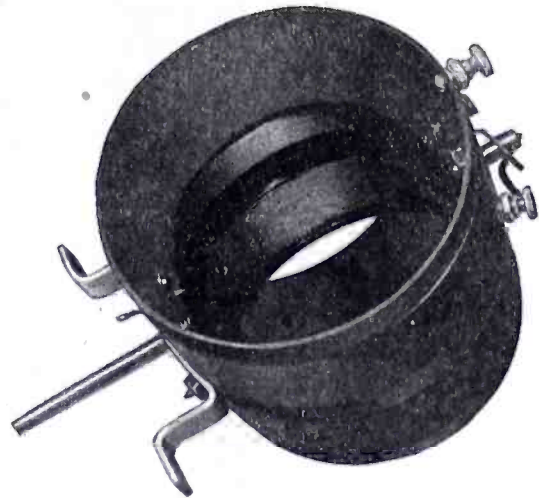

Catalogue No. 166.....\$5.50  
SE-AR-DE VARIO COUPLER  
(Center Rotor Type)



Catalogue No. 163...\$1.00  
SE - AR - DE VACUUM  
TUBE SOCKET for stand-  
ard and W.E. VT2 without  
change.

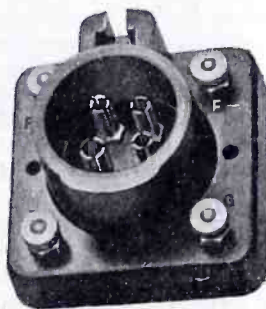

Catalogue No. 199,  
\$1.00  
SE-AR-DE Socket  
for WD11 Tube,  
positive contacts.

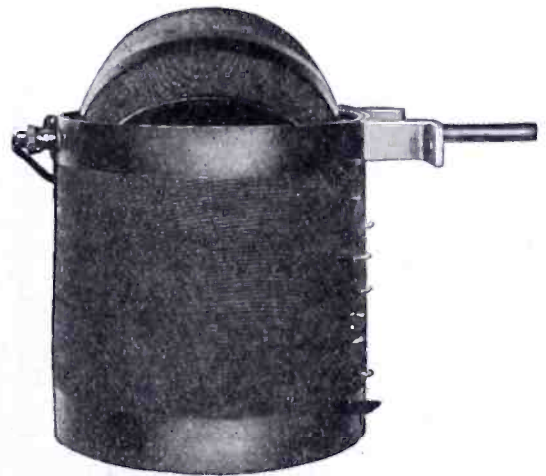

Catalogue No. 167.....\$5.50  
SE-AR-DE VARIO COUPLER  
(Bracket Type)

**R. MITCHELL & CO.**

**255 Atlantic Ave.**

**Boston, Mass.**

*For 47 years Manufacturers of Scientific and other equipment  
Look for trade mark on every piece*

**Jobbers and Dealers write for discounts**

Tell them that you saw it in RADIO



# SOMETHING

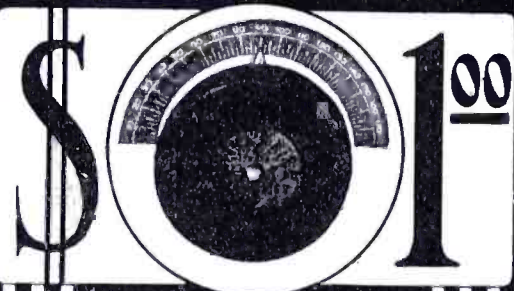

# NEW

## SELECTIVITY AT LAST!

The UNIVERNIER obtains selective tuning through vernier action. It is an attractive bakelite knob substituted for the ordinary knob on the shafts of Variometers, Vario-couplers, Variable Condensers, Potentiometers, and Rheostats and may be installed in a few minutes.

### THE UNIVERNIER

obtains a ratio of 12 to 1 by means of a self contained mechanism which is so constructed that rotation of the knob is 12 times that of the instrument shaft. Pressure towards the panel permits coarse adjustment.

Finely graduated, 360° silver plated dial. . . . .25  
(Made for use with the UNIVERNIER)—

COMPLETE. . . . . \$1.25

SEND NO MONEY—Mail us your order today for one or any number you need to equip your set—and pay the postman for each when delivered:

Made in two sizes  
No. 251 for  $\frac{1}{4}$  inch shafts  
No. 188 for  $\frac{3}{16}$  inch shafts

Dealers and Jobbers Write for Discounts

WALBERT MANUFACTURING COMPANY  
927 Wrightwood Ave. Chicago, Ill.

# UNIVERNIER

## TURN TO PAGE 47

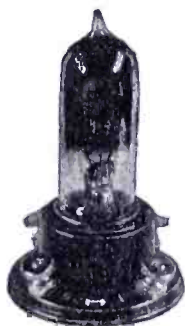

Na-ald Special  
Socket No. 499

### It's the contact that counts

The dual-wipe contact strips of the Na-ald DeLuxe socket avoid the trouble experienced with the socket of conventional design. Because of thorough cure and high dielectric properties this socket keeps plate to grit losses at a minimum (of particular importance in Flewelling Circuit or in Radio Frequency).

Price 75c

The Na-ald Special Socket No. 499 is a sturdy little socket for the G. E. No. 199 dry-cell tube. It has special slot construction, and is moulded of genuine Bakelite. The heat from soldering connections will not affect these sockets.

Price 75c

After May 20, 50c



Na-ald DeLuxe No. 400

Booklet with wiring design and instructions for Hazeltine's Neutrodyne circuit, together with other selected circuits, packed with each Na-ald product or sent in exchange for cover taken from any Na-ald carton.

ALDEN MFG. CO.

formerly

ALDEN-NAPIER CO.

Dept. H 52 Willow St.  
Springfield, Mass.

# NA-ALD

RADIO PRODUCTS

Continued from page 56

is incorrect. Only one style is supplied and this will function as both detector and amplifier according to the B battery potential applied to it.

The UV-199 and C-301A tubes require 4.5 volts but since their current consumption is very low, they may be operated from three No. 6 cells in series. For longer battery life, two or more series strings of three cells each may be connected in parallel as in the case of the single cells for the WD-11. The B battery potential is approximately the same as for the WD-11. The filaments of both styles of tubes operate at little more than red heat.

In assembling tube circuits, remember that the proper amplifying transformer and the correct grid leak must be used to eliminate distortion. For all Cunningham and Radio Corporation tubes, the detector condenser should be about 0.00025 mf. and the detector grid leak should be about 2.0 megohms. The UV-712 transformer may be used for audio-frequency amplification and the UV-1714 for radio-frequency, their impedances having the correct values for the tubes in question. Across the secondaries of the UV-712 audio-frequency transformers, always connect grid leaks of 0.4 megohm resistance. Distortionless and efficient amplification can be obtained only by using tubes, transformers, and grid leaks which were designed to be used together. Generally speaking, this applies to all receiving equipment.

## RADIO STATION 9AVC

Continued from page 40

artz tuner, with 3 steps radio, detector, and 2 steps audio frequency available. For average work, only detector and one step AF are used. The headset is a Connecticut and the loud speaker is a Magnavox.

With this set in two months of operation, all districts, with the exception of the second, have been worked, and several reports have come from the second district. To date 38 states have been worked, 4 Canadian districts worked, and reports received from Santiago, Cuba, Alaska, and from 6ZY at Honolulu, T. H., approximately 3500 miles from Hastings. The best DX on fone is 800 miles, 8 states and 3 districts, with a corresponding record for daylight transmission.

I would also like to thank those who have been so kind as to write me reports and to send me cards concerning the reception of my signals. Practically all have reported me loud, steady and F. B. as to pure D. C. tone. I would also like to state that all correspondence is answered by letter or by card.

Because of the growth in their business, Chas. Freshman Co. Inc., manufacturers of Antennas, Micons and Variable Resistance Leaks, found their quarters at 97 Beekman St., New York, totally inadequate to meet the prevailing demand for their products. They have, therefore, taken much larger quarters in a modern, up-to-date building at 106 Seventh Ave., on the corner of 17th Street, and are now doing business on an even larger scale. Production has been increased manifold and everything possible is being done to assure a maximum of service to all customers.

Tell them that you saw it in RADIO

# Wave Trap

TRADE MARK  
PATENT APPLIED FOR

The Missing  
Link  
in RADIO



## Stops Interference!

The "WAVE TRAP" will eliminate interfering broadcasting stations and enable you to listen to your favorite station.

It will work on any set, greatly increase its selectivity and clearness, and eliminate code and spark stations.

It is mounted on a Formica panel in a handsome mahogany finished cabinet 6x5x6: It is a high grade instrument throughout and a valuable addition to the operation and appearance of any set. It comes to you complete and there are no extras to buy. It is installed in a minute by changing only one outside connection.

Use the "WAVE TRAP" for real results.

850 Berhend Electric Co.  
CHARGES PREPAID  
17 E. South Water St.  
CHICAGO

# THE GOTTSCHALK

TRADE MARK

## Loud Speaker that gained such rapid popularity

Not merely a head-phone instrument



The Latest Development to produce a loud speaker that surpasses anything on the market at any price

Powerful Volume  
Producing  
Mica Diaphragm  
Element

Employed In An  
Entirely New Manner

Assures Maximum  
Clarity With Total  
Elimination of  
Distortion

Patent Pending

Will Positively Not Rattle

No Metallic Ring—Beautifully Finished  
Moderately Priced

Greater Volume with Less Energy

Supersensitive for Long Distance  
Reception

The Price:

# \$22.00

Dealers—Write at once  
for trade proposition.

GOTTSCHALK ELECTRIC  
& MANUFACTURING CO.  
992 Howard St., San Francisco



# Read this again!!

## Filkostat Proven Best Filament Control

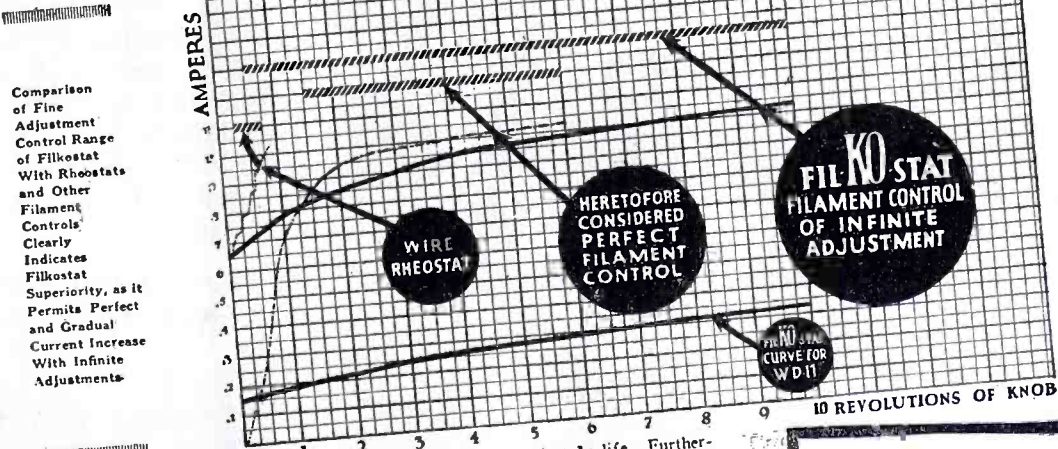

Comparison of Fine Adjustment Control Range of Filkostat With Rheostats and Other Filament Controls Clearly Indicates Filkostat Superiority, as it Permits Perfect and Gradual Current Increase With Infinite Adjustments.

**PERFECT TUBE CONTROL**  
The Filkostat permits perfect regulation of filament heat. Since the heat emitted varies as the square of the current, fine current regulation becomes extremely necessary to accomplish. This governs the flow of electrons. Proper control of the electronic flow in the tube permits the very finest tuning conceivable. The fine adjustment of the Filkostat starts slightly before the tube begins to function. With other filament controls, what minute adjustment there is, starts when the filament is almost at maximum heat. Between 1800 degrees—

considerable increase in tube life. Furthermore the extreme degree of fineness in increase and decrease of electronic flow by infinitesimal variations, makes the Filkostat control ideal.  
The perfection of design including ample internal contact is the cause of this new instrument being non-microphonic, absolutely silent, and free from all noises.

**IDEAL FOR W.D.I.'S AND DX WORK.**  
The lower curve on the graph above is eloquent testimony as to the Filkostat's adaptability to any dry cell tube. These tubes using only a fraction of an ampere demand an instrument that is so finely adjusted that this fractional current can be perfectly regulated. This the Filkostat accomplishes.

**OTHER FILKOSTAT FEATURES**  
The Filkostat has a definite off. It is so designed that the filament extinguishes abruptly indicating that the A battery supply is completely disconnected.

At Full On the Filkostat resistance is practically zero.  
The Filkostat consists of a hollow cylinder containing the special resistance material placed between two large adjustable contacts controlled by turning the knob.

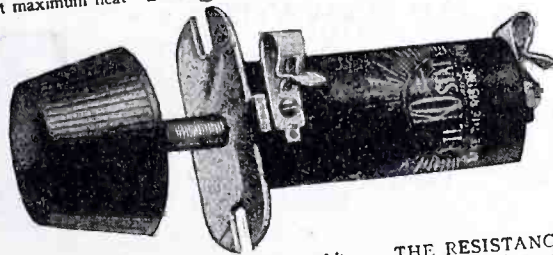

The Filkostat is to all purposes "fool proof". It is compact in form, takes very little space on the panel and so mountable that it can replace any other control without re-drilling.

dull red glow—and 2050 degrees—white heat—the Filkostat control is so fine that increases of temperature of fractions of a degree, with corresponding variations of electronic flow from the filament to the plate, are obtainable.

**LONGER TUBE LIFE; NO NOISES**  
The initial inrush of current prevents the crystallization of the filament which so many experts claim occurs when the current is fed too slowly at first as is done in other terms of filament controls. This means

**THE RESISTANCE ELEMENT** is so finely divided that no further division is possible. There are no disks to break or chip.

**THE RESISTANCE** remains CONSTANT at any position eliminating current variation once set. Such variations are not apparent to the person tuning excepting in "fading out" of stations and noises. But in the laboratory, where such a test as that shown on the above graph can be made by anyone, this feature and all the other points of superiority of the Filkostat are immediately apparent.

The filament control of infinite adjustment

# FIL-KO-STAT

CURRENT INCREASE PERFECT AND GRADUAL  
**LIKE THE RISING SUN**

## \$200

—and here's why you need it!!

- Designed For Vacuum Tube**  
adjustment and not just an old method adapted to &
- NOT a Rheostat**  
—but a REAL Filament Control.
- Infinitesimal Control**—of filament heat and therefore of electronic flow.
- Very Finest Tuning for DX**  
is realized with Fil-Ko-Stat.
- Controls Fractional Currents**  
—making it ideal for use with any dry cell tube.
- Fine Adjustment Starts**  
—where tube commences to function increasing the AREA OF FINE ADJUSTMENT CONTROL.
- Definite Off**—  
an important feature indicating complete 'A' Battery disconnection.
- Resistance Practically Zero**  
at "full on" there is practically no resistance in circuit.
- No Disks To Break or Chip**  
Resistance Element is so finely divided further division impossible.
- Absolutely Silent**  
The Fil-Ko-Stat is non-microphonic and operates free of all noises.
- Fahnestock Clips**  
and solder contacts on connection posts.
- Adjustable Mounting**  
—no re-drilling of panel necessary

**GUARANTEED**

The FIL-KO-STAT is to all purposes "fool proof". Each instrument is packed with the maker's guarantee that it will be replaced if broken within one year.

Replace Old Style Current Controls with the NEW FIL-KO-STAT a real Filament Control ON SALE AT RADIO DEALERS EVERYWHERE

Manufactured By **DX INSTRUMENT CO.** Harrisburg PA  
If your dealer has none in stock yet send \$2.00 and his name direct to  
SOLE INTERNATIONAL DISTRIBUTORS  
**RADIO STORES CORPORATION**  
Dept. R 218-222 West 34th Street, New York

Tell them that you saw it in RADIO



# ATWATER KENT

Receiving Sets and Parts

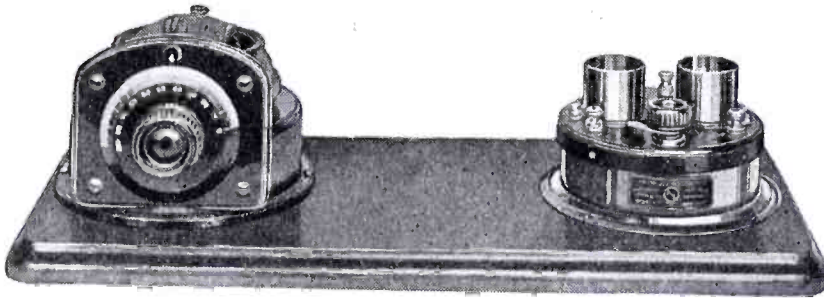

The two instruments at the left comprise an excellent and complete receiving set. The Coupled Circuit Tuner and Detector 1-stage Amplifier on the mahogany mounting board present a beautiful appearance.

A similar set is furnished with a detector 2-stage amplifier.

The Coupled Circuit Tuner and Detector Unit only, comprise a complete receiving set. Later, if desired, the 2-stage Amplifier can be added for two stages of audio frequency amplification, as shown at the right.

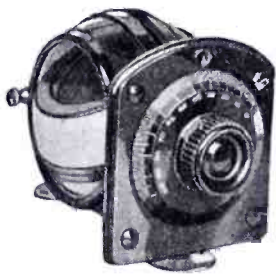
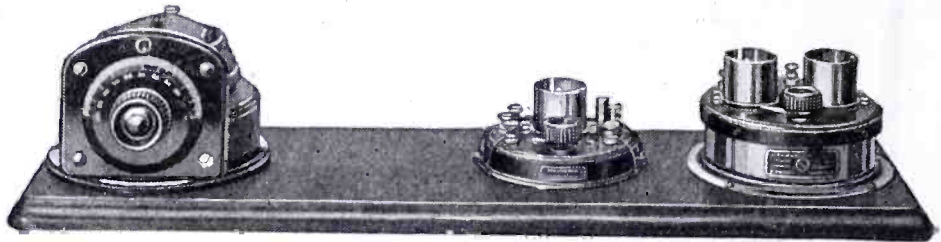

Mounted Variometer

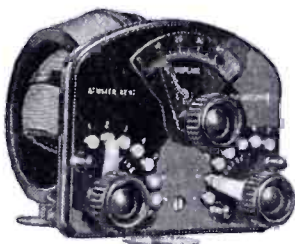

Mounted Variocoupler

TAKE the world with you this summer wherever you go. On your automobile and yachting trips, to your camp, or your cottage at the shore or in the mountains. An ATWATER KENT radio set will bring you music, reports, time signals, baseball scores—the world's news.

*Atwater Kent products sell on appearance.*

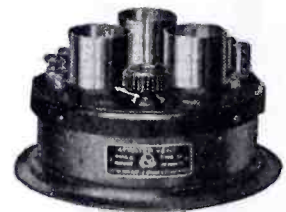

Detector 2-stage Amplifier

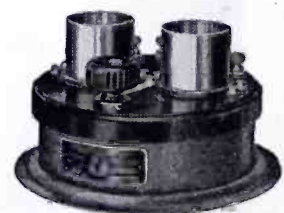

Detector 1-stage Amplifier  
A similar unit is furnished in a 2-stage Amplifier

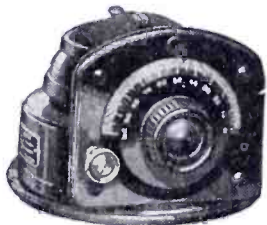

Type 11 Tuner



Standard Tube Detector Unit



1/2-Volt Tube Detector Unit



1-stage Amplifier

ATWATER KENT MANUFACTURING COMPANY, PHILADELPHIA  
4947 STENTON AVE.

Tell them that you saw it in RADIO



# ATWATER KENT

## Receiving Sets and Parts

This receiving set includes the Type 11 Tuner, 1 stage of transformer coupled radio frequency amplification, Potentiometer, Detector and 2 stages of audio frequency amplification. A similar set is furnished with a detector unit instead of the detector 2-stage amplifier.

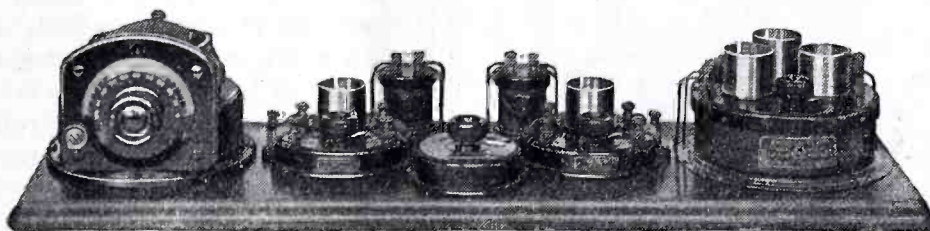
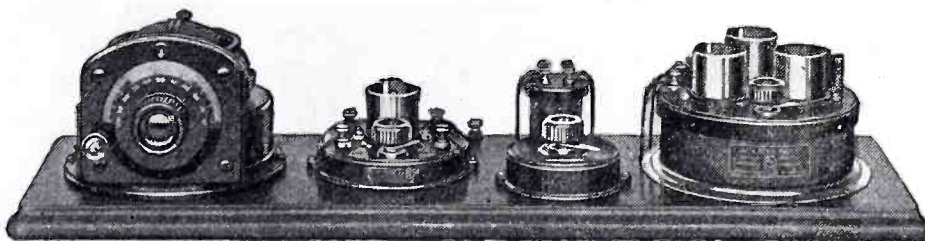

This set includes all the parts shown in set at top of this page, with an additional stage of transformer coupled radio frequency amplification.

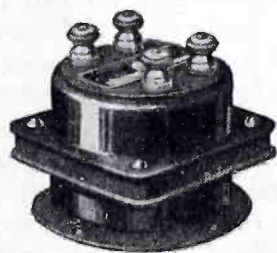

A.F. Transformer



A. F. Transformer Type L



R. F. Transformer

ATWATER KENT sets and parts are ideal for summer use due to their compact and rugged construction and the fact that they are moisture-proof. They are made mostly of condensite with all metal parts thoroughly water-proofed. You will find ATWATER KENT radio equipment ideal for summer use.

*They stay sold on quality of performance.*

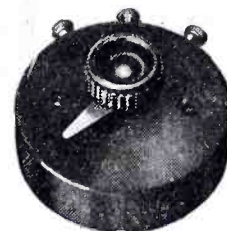

Panel Potentiometer



Table Potentiometer



Standard Tube Socket



1/2-Volt Tube Socket

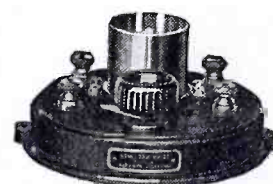

Standard Vac. Tube Unit

ATWATER KENT MANUFACTURING COMPANY, PHILADELPHIA  
4947 STENTON AVE.

Tell them that you saw it in RADIO



**RADIO TRANSMISSION  
CIRCUITS**

*Continued from page 18*

To change from voice to key transmission one opens the microphone circuit

and uses the key. The key must be closed when voice transmission occurs.

With 300 volts on the plate circuit this arrangement spoke seven miles. How much further it may have been

heard we do not know. It was reported as full and robust speech at the distance mentioned. We have been told since that test of such transmission up to 300 miles, but have not participated in those tests, though we have no doubt of the validity of the reports. Short distances are readily covered with 100 volts from dry cells in blocks.

It is interesting to explore the region surrounding the main loop with a wave-meter while transmission is going on. With certain positions of the meter there will be found blanks in its operation, where a minimum or absence of energy exists. Plotting these results will be an assistance to visualizing what is going on.

As in receiving, the loop transmits in the direction of its plane, and least or not at all in the directions at right angles thereto. Of course this means that if the loop stands north and south it can be heard both north and south. In this regard the plan is not wholly directional as to a single line of propagation, as is the case in Signor Marconi's revived directional method utilizing reflection of short waves. Nevertheless there is considerable gain over complete broadcasting.

Either the Heising or the last-described transmitting set can be modified readily to apply them to General Squier's system of wire-directed radio, and as we have said before in these columns we recommend that amateurs do some research in that field. One of the reasons for this recommendation is the real commercial value of the system, which so far has been confined to a somewhat limited field. There are as many possibilities there as any one imagination can envisage. The applications that have been made have been wholly successful, the only drawback being that the cost of the apparatus has been rather large compared with the savings in wires. This is about what happens in the early application of any new phase of the communication art, is not to be wondered at, and certainly will be reduced or eliminated by further development. No reason exists why much of this development should not come from the amateur field. It is from that source that we have wire-directed radio itself, as we believe General Squier would so classify himself at the time of his original work upon it.

A license from the government is necessary before one transmits. There are seven grades of such licenses, four commercial and three amateur, considering the grade of experiment and instruction to be an amateur grade. In all the grades a knowledge of the International code is required, to the degree necessary to enable the operator to recognize distress and "keep out" signals. Your nearest Radio Inspector can give you the data necessary for making application for license.

**"ESCO" BATTERY CHARGERS**

*To meet an insistent demand for*

**Rugged, Reliable  
Neverfailing  
Motor-Generators**

For charging Batteries used in wireless operation, we have developed a complete line of many sizes. With or without panel boards. "ESCO" quality thruout. You KNOW what THAT means.

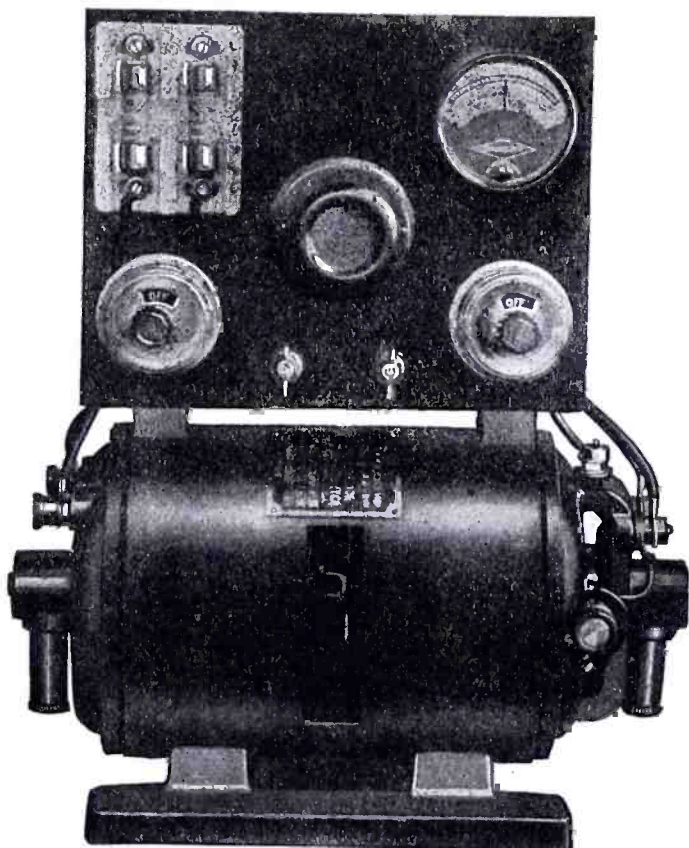

*Ask for Bulletin 242*

**ELECTRIC  
SPECIALTY  
COMPANY**

**215 South Street  
STAMFORD  
Conn., U. S. A.**

*Pioneers in developing  
Quality Wireless Apparatus*

**Your Dealer Probably Has  
"ALL-AMERICAN"  
Amplifying Transformers  
Radio and Audio Frequency**

If he has thus far missed these highly important aids to clear strong radio reception, tell him you will buy

**"ALL-AMERICAN OR NOTHING"**

They cost no more; and your set is entitled to the best the art has produced.

Our Radio Frequency Transformers should be used to amplify the radio frequency impulses before they reach the detector tube and the audio frequency Transformer, to strengthen the detected signals.

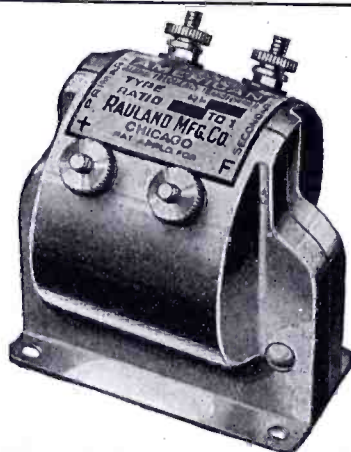

The combination of the two forms the ideal long-distance radio reception hookup for either headphone or loudspeaker reproduction.

**"ALL-AMERICAN" AMPLIFYING TRANSFORMERS**

- R-10 Radio Frequency (150-550 meters)... \$4.50
- R-12 Audio Frequency (Ratio 3 to 1)..... 4.50
- R-13 Audio Frequency (Ratio 10 to 1)..... 4.75
- R-21 Audio Frequency (Ratio 5 to 1)..... 4.75

Ask your Dealers first, before you write. If none of them can supply you, send order to us with name and address of Dealer you wish to favor, and transformers will be sent you postpaid at the prices named.

**FREE HAND BOOK  
OF HOOKUPS**

25 up-to-date Diagrams of Successful Circuits sent 2c stamp.



**RAULAND MFG. Co.**  
200 N. Jefferson St., Chicago, Ill.



Tell them that you saw it in RADIO



# The Receiver of Tomorrow



## The Symphony

Tomorrow in Radio means a wider and more useful as well as more entertaining broadcasting. Therefore, to the purchasers of receiving sets, the design, the material, the workmanship, the circuit and the assembly, all play an important part in the quality of reception, and distance heard.

The placing of a Symphony in your home is a permanent investment that will win your instant approval, and occupy a prominent place among your most cherished possessions.

The clear reception and unusual volume are the results of the high grade units, the fine workmanship, the most

efficient circuit, and the correct assembly. The improved circuit used in the Symphony combined with the accuracy of its construction, has increased the selectivity to a marked degree.

The range of the Symphony Receiver is unlimited. Recently, in Chicago, Havana, Cuba, was tuned in not only on a head set but heard plainly on a loud speaker.

The Symphony Receivers are made in two types — Three and Two stages of audio frequency amplification.

If your dealer cannot furnish information on the Symphony, write for illustrated catalog, giving us his name.

### JONES RADIO COMPANY

Lytton Building, Chicago

The Symphony is manufactured under the U. S. Patent No. 1113149, Armstrong Regenerative Circuit

*All parts used in the Symphony are built and guaranteed by the Kellogg Switchboard & Supply Company for twenty-five years manufacturers of complete telephone equipment*

Tell them that you saw it in RADIO





### Is your battery always fully charged and fit?

Is it always toned up for best results, whenever friends happen in—throughout every concert? Keep it at full strength and prolong its life—the simple, easy, inexpensive Tungar way. Tungar—the go-between from house-lighting circuit to storage battery—attaches wherever there is a lamp or convenience outlet. You don't have to move the battery. Just connect Tungar, and leave it—any time, day or night.

Tungar is *certain, clean, quiet*. No moving parts to get out of order or make noise. Good for the auto battery too—the *same* Tungar. See one at any good electrical store, or write for literature. Address Section Rd5.

Merchandise Department  
General Electric Company  
Bridgeport, Connecticut

*Tungar Battery Charger. Operates on Alternating Current.*  
2 Ampere Outfits—\$18.00  
5 Ampere Outfits—\$28.00  
(Prices east of the Rockies.)  
Special attachment for charging 12 or 24 cell "B" Storage Battery—\$3.00—fits either size Tungar.

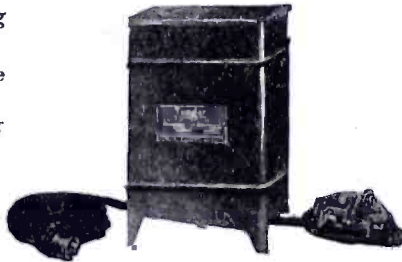

Charge 'em at Home, with

# Tungar

## BATTERY CHARGER

A GENERAL ELECTRIC PRODUCT

35 A—961D

The most satisfactory book for beginners that has yet appeared.—Public Ledger.



**RADIO SIMPLIFIED**  
By KENDALL & KOEHLER  
Radio Instructors

**WHAT TO BUY  
HOW TO BUILD  
HOW TO OPERATE**

A clear explanation of Radio in simple language with complete directions for assembling and installing home radio equipment. Will aid you in getting the best results from your set. 96 Illustrations including picture diagrams showing hook-ups, etc. Cloth, 250 pages, \$1.00. On sale at Booksellers or mailed on receipt of price THE JOHN C. WINSTON CO., 35 Winston Building, Philadelphia, Pa

## LEARN RADIO

Here's your opportunity. Radio needs you. Win success in this fascinating field. Trained men in demand at highest salaries. Learn at home, in your spare time.

### Be a Radio Expert

I will train you, quickly and easily, to design, construct, install, operate, repair, maintain, and sell all forms of Radio apparatus. My new methods are the most successful in existence. Learn to earn

**\$1,800 to \$10,000 a Year**

**FREE** Wonderful, home-construction, tube receiving set, of latest design. Write for "Radio Facts" free. Engineer Mohaupt.

**American Electrical Association**  
Dept. 294 4513 Ravenswood Ave., Chicago

Tell them that you saw it in RADIO

### HAMPLIFICATUS HORRIBULUS

Continued from page 22

about that insane mass of apparatus in a manner which would have defied Edison to trace them out. Twenty-nine steps—it looked like a hundred. I lay back in a chair and goggled like a bullfrog while my friend prepared supper.

"The shepherders around here won't come within a mile of the place nowadays," he told me as we arose from the table. "They get off the road when they see me coming and hide in the brush till I get past, they're that scared." Piling the dirty dishes outside the door for the cleansing tongues of the porcupines, whom it seemed abounded in that locality, Bill started up his set. Now that seems rather a simple statement, but the best part of an hour went by before all the tone-traps and static-eliminators and what-not were working to suit him. Then, throwing in the lightning switch, he turned on the loud speaker and the most terrific bedlam of sound I have ever listened to immediately burst forth from this instrument. Big as it was, with a body the size of a twenty pound lard pail, it rocked and vibrated on its base in an alarming manner, and the whole cabin shook with its clamorings. Writing upon a piece of paper from my notebook I inquired the reason for the two rubber tubes which lead from the apparatus to a hole in the roof.

"Water jacket!" yelled Bill at the top of his voice, placing his lips against my ear, "Keeps the movable coil from burning up.—It always.—" A sky-rending buzz which eclipsed all other noises cut off the rest of his speech. He pulled out a switch which silenced the instrument, and through the open window I could hear the echoes roaring back across the canyon.

"Teyuga auto stage," he explained, his voice sounding curiously feeble in the cessation of the uproar, "Over on the other side of El Solo Divide." I made a motion which he misinterpreted. "Nix—" he enjoined, backing away, "I know its nineteen miles, but poison me for a porcupine if that isn't his ignition. Listen, and you can tell when he shifts gears at the top." He slowly rotated several knobs, his eyes upon a group of meters.

"That blowing sound you heard in the horn was the aerial swaying in the wind," he replied to my question, "Cuts the earth's magnetic field—like a dynamo, you know. Have to tighten it up tomorrow—oh yes, I mean the aerial." He went on with a list of apparently endless causes of local interference, of which I remember but little. Prowling wildcats, it seemed, anywhere within several miles of the place when rubbing themselves against the branches of trees, as is their custom, developed no small

Continued on page 66



# It's Only a Step for You Now to a Big Paying Radio Position

**S**URELY you have noticed how wireless is spreading over every part of the world. Every day you learn of some new field that is utilizing it—some new firm organized to push it forward. But do you realize that YOU can easily qualify for the wonderful opportunities that are opening? Do you know that you can quickly build up a complete knowledge of Wireless—and be ready any time you wish to for a fine Wireless position, either on land or on sea? Through our special method of home-study instruction a short period of your spare time can be turned into preparation for a worthwhile future in the fastest-growing field in America today—Wireless. No one is in a better position than you to cash in big on the wireless expansion that is sweeping over the world. You have the whole foundation, all ready to build upon. Our new easy method of instruction makes the rest pure fun—but fun that pays big.

Commercial Wireless expansion is sweeping over the world like wildfire! Big opportunities are open—and every day get more numerous and attractive. You are in a fine position to cash in big on this growing field. Right at home in spare time you can easily build upon your present knowledge and quickly qualify. The coupon below will bring you an interesting free booklet—telling about the splendid opportunities open, and how you can share them. Mail coupon for booklet today!

## New Method Makes It Easy to Qualify

Without obligation to yourself we would like to tell you more fully about the future wireless offers you. We would like to tell you about our Institute, which is officially recognized by the U. S. Government. The National Radio Institute was the original and is today the oldest and largest school in America teaching wireless by mail. The Government allows our graduates five to ten points credit when taking First Class Government License examinations. We have graduates in almost every part of the world who have quickly qualified through our special new method.



Both on sea and on land a fine future awaits the man who is qualified in wireless. No matter whether you wish to visit every nook and corner of the world or whether you prefer a land station, wireless awaits you.

This method not only includes a comprehensive course of instruction written exclusively for us by some of America's greatest wireless experts (members of our own staff) but also includes, Free, a wonderful new invention patented and controlled only by us. This device, called

the Natrometer, teaches you in half the usual time how to send and receive with speed and accuracy. This Natrometer (which can be purchased separately) is superior to any other device of its kind. Without aerials or any outside device it sends you any one of 600 different messages at a speed which you can vary from 3 to 30 words per minute. It is portable; also very attractive in appearance. It is

noiseless; and it sends in a natural manner, not like a mechanical device. You get the messages thru its phones at whatever speed you wish. And this is **only one** of the features which our new method brings you. Others are listed below. Read them and you will realize why our students quickly qualify and why they step into the fine wireless positions that are waiting!

## 10 Points That Make This School the Best

1. New Easy Method of Instruction.
2. Wonderful Natrometer and 3 Other Instruments to Give You Practical Instructions at Home.
3. Government Credit and Recognition.
4. Our Location in Washington—Passing New Official Developments on to You.
5. Personal, Individual Attention of Great Experts.
6. Our Service in Obtaining You Employment.
7. Free Training in Wireless Telephony.
8. Unlimited Consultation and Advisory Service.
9. Free Post-Graduate Course in Our Washington Residence School If You Wish.
10. Low Tuition Cost and Easy Terms of Payment.

Mail coupon today for our free illustrated booklet, "How to Learn Radio at Home." Without cost or obligation, we want to tell you more about this field, its big opportunities both on land and on sea, and just how our new method quickly qualifies you. No agent will call upon you. We just want to send you the facts. Mail coupon at once! National Radio Institute, Dept. 10-E, Washington, D. C.

**Men—Boys 16 or Over Should Mail Coupon Immediately**

NATIONAL RADIO INSTITUTE, Dept. 10-E,  
1345 Pennsylvania Ave., N. W., Washington, D. C.  
Please send me your free book "How to Learn Radio at Home," with full particulars about the opportunities in Radio, and how you will quickly train me in my spare time at home to become a certified Radiotrician. Also, tell me how your free employment service will help me to a position and particulars of your special short-time offer.

Name.....Age.....  
Address.....  
City.....State.....

Tell them that you saw it in RADIO



## Critical tuning with the Dubilier Ducon

The Dubilier Ducon is the only device of its kind passed by the Laboratories of the National Board of Fire Underwriters. Several hundred thousand radio "listeners in" in America and Europe use it to do away with the cumbersome antenna and its lightning arresters and switches.

With the Dubilier Ducon in a lamp socket, the tuning is so sharp that the slightest movement of the knobs is sufficient to suppress one of two stations on nearby wave lengths.

Hence the Dubilier Ducon not only makes it easy to enjoy radio by doing away with the antenna but gives to the simplest set a selectivity in tuning attainable only in the most expensive and elaborately equipped apparatus.

DUBILIER CONDENSER AND RADIO CORP.  
48-50 West Fourth St., N. Y.

#### Branch Offices

St. Louis, Mo., Syndicate Trust Bldg. Washington, D. C., Munsey Bldg.  
Atlanta, Ga., Forsyth Building. Chicago, Ill., 33 So. Clinton St.  
Los Angeles, Cal., 329 Union  
League Bldg.

Huntington, W. Va., 1028 Fourth Avenue.

Distributed in Canada by  
Canadian General Electric Company, Ltd., Toronto

England: Dubilier Condenser Co., Ltd., London

Germany: The Telefunken Co., Berlin

France: C. Capart Paris

Retail price \$1.50. At all good dealers.  
The Dubilier Ducon is used throughout the world.

## RADIO INSTITUTE OF AMERICA

### TRAINING IN ALL COMMERCIAL BRANCHES OF RADIO

If you cannot attend the Radio Institute of America in person the same instruction can come to you through our recently inaugurated "HOME STUDY COURSE"—Investigate.



Detailed information free on request.

Conducted by

THE RADIO CORPORATION OF AMERICA

331 Call Bldg.  
98 Worth St.

Phone Douglas 3030  
Phone Franklin 1144

San Francisco, Calif.  
New York City

Tell them that you saw it in RADIO

Continued from page 64

amount of static-like interference, due to the electricity generated by the fur of these animals. The telephone line along the Teyuga road also caused him considerable trouble, developing cross talk in dry weather. Presently he closed the lightning switch and the horn resumed its monstrous bellowing. With difficulty I began reading a code message only to be baffled by an unintelligible discourse in *Italian*. Bill pointed out a chart on the wall, and arising I read:

"1DU—Genoa, Italy—10 watts—C. W. & I. C. W.—105 meters." A long array of like information followed beneath. Number 38 read "BBJ3—2391 Avenida de Mayo—Buenos Ayres—Ford Spark Coil—100-450 meters." Below it: "MB2—Pestorovitsky, Siberia—250 watts—spark—340 meters." Down a long sheet of wrapping ran the list of calls, the numbers going up to four hundred and seventy-three, if I remember correctly. Shortly after the Italian signed off MB2 broke in.

"QST QST MB2 MB2—Xeremsky murdevitch hamsky protequelevt—Havgavitch—MB2."

"Weather report" shrieked Bill, twisting several knobs.

"Wham!" The loud speaker leaped a foot in the air and fell to the floor in a tangle of connecting wires, its roaring silenced. A cloud of smoke poured from the horn and a frying sound was audible from the interior. Growling savagely Bill hurriedly disconnected the instrument and replaced it with another which he pulled from beneath the table.

"One of those hams down in ——" He mentioned a small town in the valley, a good hundred and fifty miles distant. It seemed that every time he happened to get on the wavelength of any amateur within the aforementioned distance his loud speaker immediately burned out. Bill waved a hand toward a large box in the corner.

"Replacement coils," he informed me, as he threw in the lightning switch. A shrill high-pitched note, not unlike that of a buzzer beat upon my ear-drums deafeningly.

"Five watt I. C. W. station at Big Trek on the Hoogly River in South Africa," howled my friend as the station signed its call letters. "Trader runs it; he's lowered his wavelength, I see." he added, peering at the chart.

ABRUPTLY I found myself in a hot, smoke-filled darkness. I was lying in a constrained position, and so far as I could judge, standing upon my head. Wheels and streamers of fire revolved about me in dizzy circles and my head ached intolerably. Could I have shuffled off this mortal coil? The heat and smoke which were impressing themselves upon my senses caused me to hope fervently that I had not. Moving my feet

Continued on page 68



# “WorkRite” SUPER VARIOMETER

## \$3.50

### USE THE WORKRITE TUNER TEAM

When you want to get a certain station and tune out all others you will find the Work-Rite Tuner Team consisting of Two Work-Rite Super Variometers and One WorkRite 180° Super Variocoupler is just the apparatus you need.

The WorkRite Super Variometer is exceptionally well made from polished mahogany. Has just the right number of turns and air space to tune extremely sharp.

The WorkRite 180° Super Variocoupler has a range from 180 to 800 meters. Both secondary and primary are made from moulded Bakelite and are wound with green silk wire. It has 12 taps.

The prices on these instruments have been reduced from \$6.00 since last spring.

**WorkRite Super Variometer each \$3.50**  
“180° Super Variocoupler “

WorkRite 180° Super  
Variocoupler

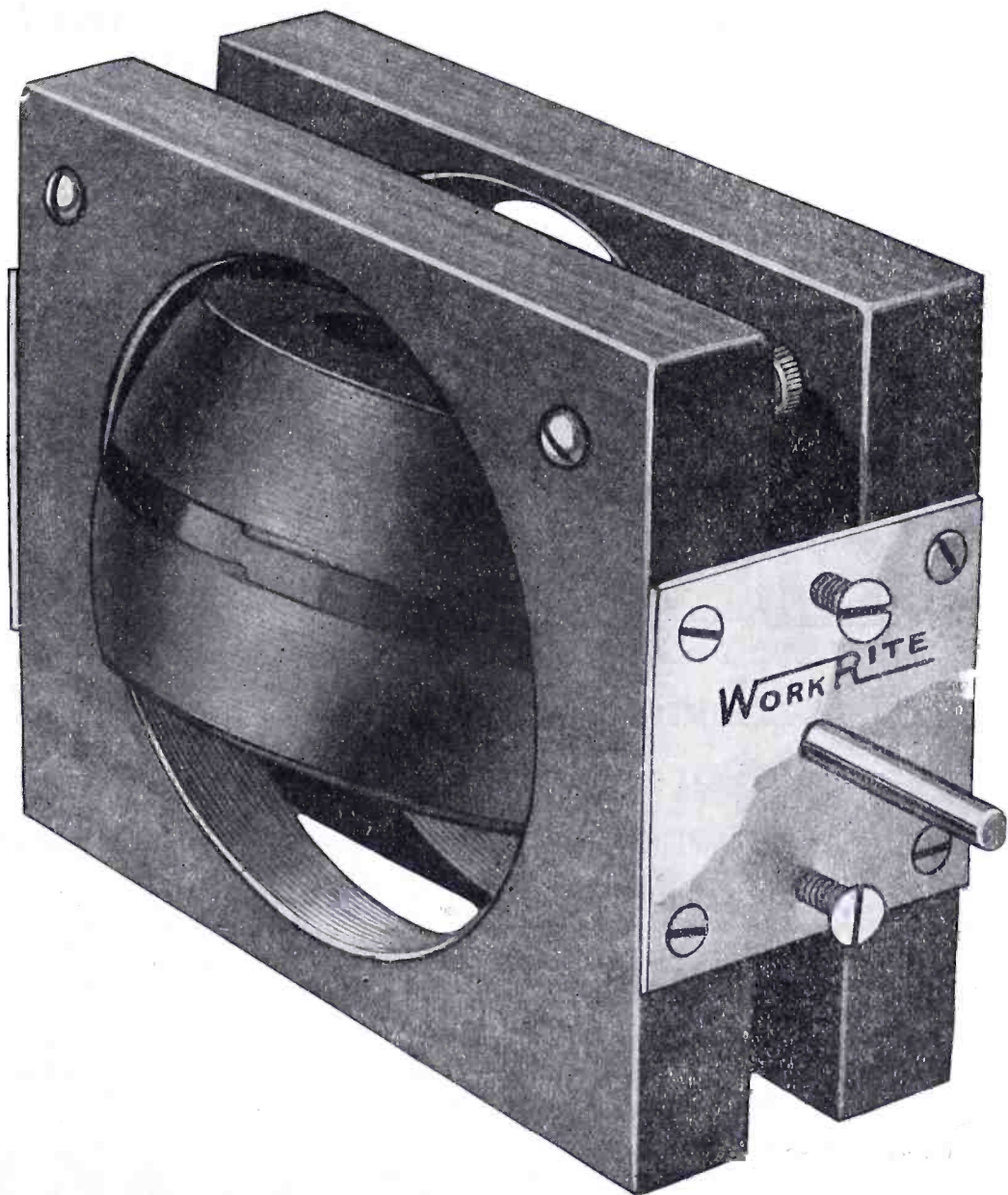
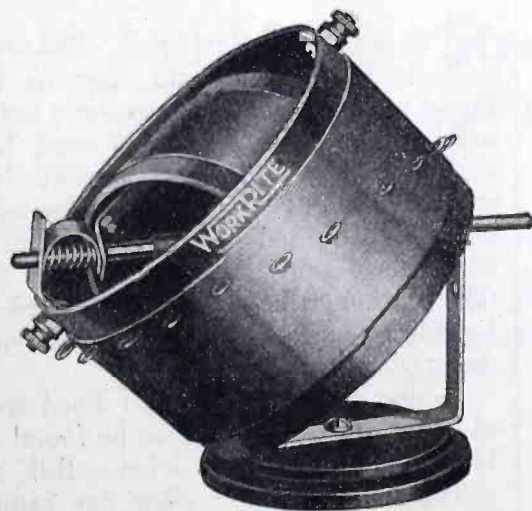

### “WorkRite Radio Parts Workrite”

The name WorkRite is a guarantee of quality and reliability. Insist on WorkRite Radio Parts from your dealer or if he does not have them send your order to us, and you will receive them by mail prepaid. Here is a partial list of WorkRite Products:

*WorkRite Concertolas, WorkRite Super Vernier Rheostat, WorkRite E-Z-Tune Dial, WorkRite Concert Headset, WorkRite Hydrometers.*

**THE WORKRITE MANUFACTURING CO.**  
5510 Euclid Ave., Cleveland, Ohio

*Pacific Coast Representative: B. Kruger, 423 Douglas Bldg., Los Angeles, Calif.*

Tell them that you saw it in RADIO



# Operate a Loud Speaker on One Tube

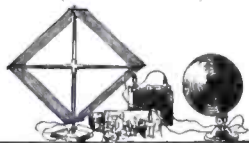

Erla radio frequency transformers are at the forefront of radio progress, assuring best results. Price: Types AB1, 2, 3, \$4; Reflex, \$5

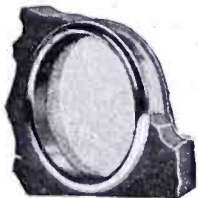

Erla bezels are finished in bright nickel or dull black enamel. Telescoping rim fits any  $\frac{1}{8}$ " to  $\frac{1}{4}$ " panel. Made in 1" and  $1\frac{1}{2}$ " sizes. Price, 20c



Erla fixed condensers offer material improvement over present standards, adhering most closely to their rating. Eleven sizes, 35c to \$1 each

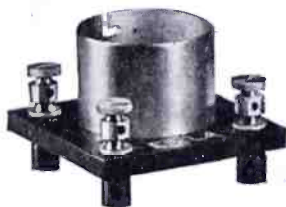

Erla sockets stand alone in quality of workmanship and beauty of finish. All parts triply nicked. Polished Radion base. Price each, \$1

## Erla Radio Transformers Make This Possible

The entire family listens to broadcasting, with the new Erla Duo-Reflex circuit, the most powerful single-tube circuit ever built. Through a loud speaker, ample tone volume is provided, except for the most distant stations. And, for local reception, a loop aerial is effectively employed.

The cost of this circuit is so modest as to make it available to every American home. Also it is so simple to construct and operate as to present no difficulties for even the most inexperienced individual.

Tuning is extremely sharp and selective, undesired stations being eliminated almost at will. Remarkable as well is the purity and clarity of tone, achieved through perfect modulation, plus the effective damping of parasitic noises.

The heart of this and other guaranteed Erla circuits is the Erla radio frequency transformer. Overcoming the high capacitance of domestic vacuum tubes in unique degree, and with lowest inherent capacitance, it provides unequalled magnification without distortion.

Our bulletin No. 13, giving diagrams and instructions for building the Duo-Reflex circuit may be obtained gratis from leading radio dealers. Or write us direct.

Manufactured by  
Electrical Research Laboratories Dept. H  
2515 Michigan Ave., Chicago

Coast Representative  
Globe Commercial Co.  
709 Mission Street  
San Francisco

# ERLA

## VARIOMETER

FREE with 2 subscriptions to "RADIO."  
Work-Rite Type (\$3.50)

PLEASE SEND 12c FOR MAILING CHARGES

"RADIO", Pacific Bldg., San Francisco, Cal.

Tell them that you saw it in RADIO

Continued from page 66

cautiously they disentangled themselves from some obstruction and I fell over onto an even keel and lay there on my back staring through the bursted roof of the cabin up to the stars. Sitting up I gazed about me. A cloud of smoke filled the air the odor of burnt rubber and fused copper mingling with the acrid smell of burning wood. In the feeble glimmer of a miraculously undamaged lantern I was watching a piece of glowing brass melt down a bakelite panel when a sensation of heat caused me to suddenly arise. Dully I stared at the smoking wreck of the loud speaker upon which I had been reclining, then bracing myself I wobbled out into the center of the cabin from which vantage point I discovered the form of my friend Bill jammed beneath the cookstove. Muffled profanity emanating from beneath this last object indicated that he was still in the land of the living. His legs waved violently as he vainly attempted to extricate himself but unheeding, I continued to stare at the scene of destruction. Broken glass and splintered wood littered the floor, shattered panels and apparatus were strewn about the room as if by the explosion of blasting powder. Half of the table was swinging gently from the lead-in running across the ceiling under the impetus of the night breeze which blew gently in through the shattered roof. Gone was that marvelous receiver, only a few splintered remnants remained. The face of my shepherd of the preceding afternoon appeared, peering cautiously through the ruined doorway. Not observing Bill, he advanced inside.

"I har big explosion fifteen minutes ago," he explained. "And I guess it iss har, yas?"

"Yas," I told him savagely, sucking at my burned fingers, "It was haar!" The herder gazed vacantly about the room.

"You was tawing dynamite maybe?" he hazarded, "Or didt you overloadt ta still?" Then with a yell of pure terror he dashed through the entrance and disappeared as Bill, after overturning the stove, appeared at my elbow, soot-covered and hideous.

NO, it wasn't a total loss. Bill wrote me later and said that he had found a pair of side-cutting pliers underneath the floor, and about a week later a high wind blew the box of spare loud speaker coils out of the top of a big sugar pine. He hunted high and low but he has still to find the other half of that table, although he recently recovered the lightning switch three hundred yards down the creek.

It was an ordinary plain Ford spark coil that did the damage, as he found out later. Two "hams" whom Bill fervently hopes to meet some day camped

Continued on page 70



# ANNOUNCEMENT

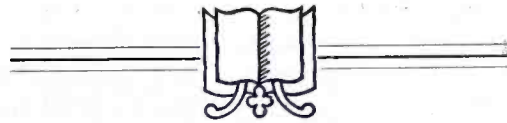

WARNER BROS., largest radio supply house in the West, announce the opening of their third radio store, 428 Market Street, San Francisco

To celebrate this big event we further announce a great radio sale.

*Only the highest grade standard radio equipment and parts sold by us. Our sale prices will astonish you. Visit any of our stores today, or write at once for our radio price lists.*

## WARNER BROS.

THREE STORES

350 Market Street San Francisco 428 Market Street  
Oakland—Twenty-second and Telegraph Avenue

If you are unable to call for a copy of our big radio bulletin, be sure to mail this coupon now Send  it to any of our three stores.

SEND ME YOUR BIG RADIO PRICE LIST AT ONCE.

Name.....

.....

Address.....

.....

Tell them that you saw it in RADIO



## 24 Hour Service

No order too small—  
no Dealer too far away.  
We ship everywhere.

**COMPLETE STOCK** Radio Standard Sets and Parts.  
**LARGEST COMPLETE STOCK** of Standard Supplies in Middle West. Write for 64-Page Catalog No. D 10.  
**DEALERS:** Greater Discounts, Better Profits

**American Radio Mfg. Co.**

Dept. N

107 E. 13th St. Kansas City, Mo.

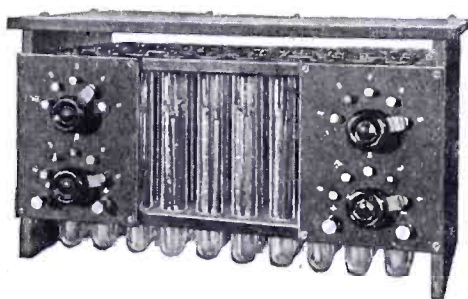

## KICO Radio Storage "B" Batteries for EFFICIENT Receiving

1. KICO "B" batteries allow single cell variations by means of switches mounted on panels. (The first in the market with this feature.)
2. Alkaline type.
3. Rechargeable from your 110-volt A. C. line in connection with the rectifier supplied.
4. One charge lasts from three to six months in the detector plate circuit.
5. Neat, efficient and compact.
6. Unlimited life.
7. Your money back if unsatisfied within a 90-day trial.

	(Plain)	(With Panels)
16 cell 22 volt.....	\$8.50	\$12.00
24 cell 32 volt.....	8.00	14.00
36 cell 48 volt.....	10.00	17.00
50 cell 68 volt.....	12.00	21.00
78 cell 100 volt.....	16.00	26.00
108 cell 145 volt.....	21.00	26.00

"A" and "B" Battery Literature gladly furnished

## KIMLEY ELECTRIC COMPANY

1359 FILLMORE AVENUE BUFFALO, N. Y.

*Investigate!*  
**WESTERN-RADIO DEALERS SERVICE**  
Wholesale RADIO Only  
637 So. Hope Street, LOS ANGELES  
565 Howard Street, SAN FRANCISCO

### HYGRADE SPECIALS

200 ft. 7 Strand No. 22 Copper Aerial Wire.....	\$1.25
Morse Eureka Test Clips, per dozen.....	.50
Skinderviken Transmitter Buttons.....	.95
No. 763 Eveready 22½ Volt Variable B. Battery.....	1.25
No. 766 Eveready 22½ Volt Variable B. Battery.....	2.25
No. 767 Eveready 45 Volt Variable B. Battery.....	4.25
2000 Ohm Murdock No. 56 Head Sets.....	4.49
3000 Ohm Murdock No. 56 Head Sets.....	4.98
Federal or Brandes 2200 Ohm Head Sets.....	6.50
Dictograph 3000 Ohm Head Sets.....	6.98
Fada or Framingham Rheostats.....	.65
Acme Amplifying Transformers (new type).....	4.25
Acme R. F. Transformers, Types R.2-R.3-R.4.....	4.25
6 Volt Marko Storage Batteries.....	8.95

All orders must include Parcel Post charges

**HYGRADE ELECTRICAL NOVELTY CO.**

41 West 125th Street New York, N. Y.

Continued from page 68

half a mile down the creek that night and put up a temporary aerial. Hooking up the spark coil to two dry cells they had attempted to "raise" someone, which they immediately did. They raised that set of Bill's all over the landscape. Bill writes me that there are pieces of apparatus sprinkled over the scenery for half a mile around, and the creek bed assays twenty pounds of copper to the ton. But the shepherders still live in mortal terror of my friend. One of them summoned up courage about a month after the accident to ask him what he was doing that night. Bill told him he had been amplifying himself and within a week three of them quit their jobs and disappeared. He hasn't seen them since.

## RADIO MYSTERY

Continued from page 23

electrical genius, he was the guiding mind in its perfection, leaving the matter of detail to trained experts, who worked out in painstaking minuteness the necessary data for the construction of the device.

The laboratory force under Nicholson was a picked one. Still it is a matter of record that some men have their price. That the leak had come from one of Nicholson's own men, carefully as they had been selected, was apparent.

During the war, the Imperial German Government, through its secret service, or what ever you may care to call the corps of highly trained spies that flung its tentacles across the whole world, could secure information in a marvelously quick manner. It is no secret that information went out of the United States during the conflict through a dozen different methods. And radio was one of these methods.

Shortly before it was apparent that the Nicholson Safety Screen method of control was known, radio stations in several parts of the world began to pick up mysterious, intermittent signals. The signals were badly chopped up, of a high whining note, with a lower note superimposed upon the higher. It was not long, of course, before the approximate origin of the signals was traced by the radio compass. Repeated bearings fixed the signals as coming from the approximate vicinity of San Francisco. But in this vicinity all bearings failed. The radio compass registered all directions equally. No definite bearing was obtainable. From points around San Francisco, the signals were deafening. At distances of more than a hundred miles, bearings were fairly sharp, but at closer ranges only the approximate location could be determined.

Investigators connected the signals with the leak concerning the Nicholson safety screen. There was reasonable belief that one of the Nicholson force had

revealed the secret to German agents, and that through means of the whistling, intermittent signals, information relative to its working had been conveyed to those interested. The fact that the enemy did not as yet have as perfect control as did the allied forces made this supposition reasonable enough, for to convey a fully adequate description of the screen via radio only, without any written descriptive matter, was practically an impossibility. Also, the short periods that signals from the unknown station were transmitted, with their unexpected and irregular times of transmission, made it all the more difficult for cipher and code experts to attempt to decode them, as well as for

Continued on page 72

## ABOLISH STORAGE BATTERIES

The BRU No. 5 receptacle in your circuit will accomplish this.

**NO TROUBLE CHARGING**

**NO TROUBLE HANDLING**

Replace dirty storage battery with neat 1½ volt dry cell. Use BRU No. 5.

Fit your circuit with BRU No. 5



BRU No. 5 Pat. Pend.

Moulded Bakelite Socket.....75c each

**Bruno Radio Corp., New York**  
152 West 14th St.

*Investigate!*  
**WESTERN-RADIO DEALERS SERVICE**  
Wholesale RADIO Only  
637 So. Hope Street, LOS ANGELES  
565 Howard Street, SAN FRANCISCO

**"COPPERWELD"**  
THE IDEAL RADIO ANTENNA

**COPPERWELD IS 50% STRONGER**  
than Copper, can be strung taut, stays up when other wires stretch and break, and gives 100% electrical efficiency.

**COPPER CLAD STEEL COMPANY**  
BRADDOCK P. O. RANKIN, PA.  
Directions for Antenna construction on reverse side of carton

**BUY IT IN CARTONS**

Tell them that you saw it in RADIO



**SIGNAL**  
Radio  
Talks, No. 4



*Facts from the Factory*

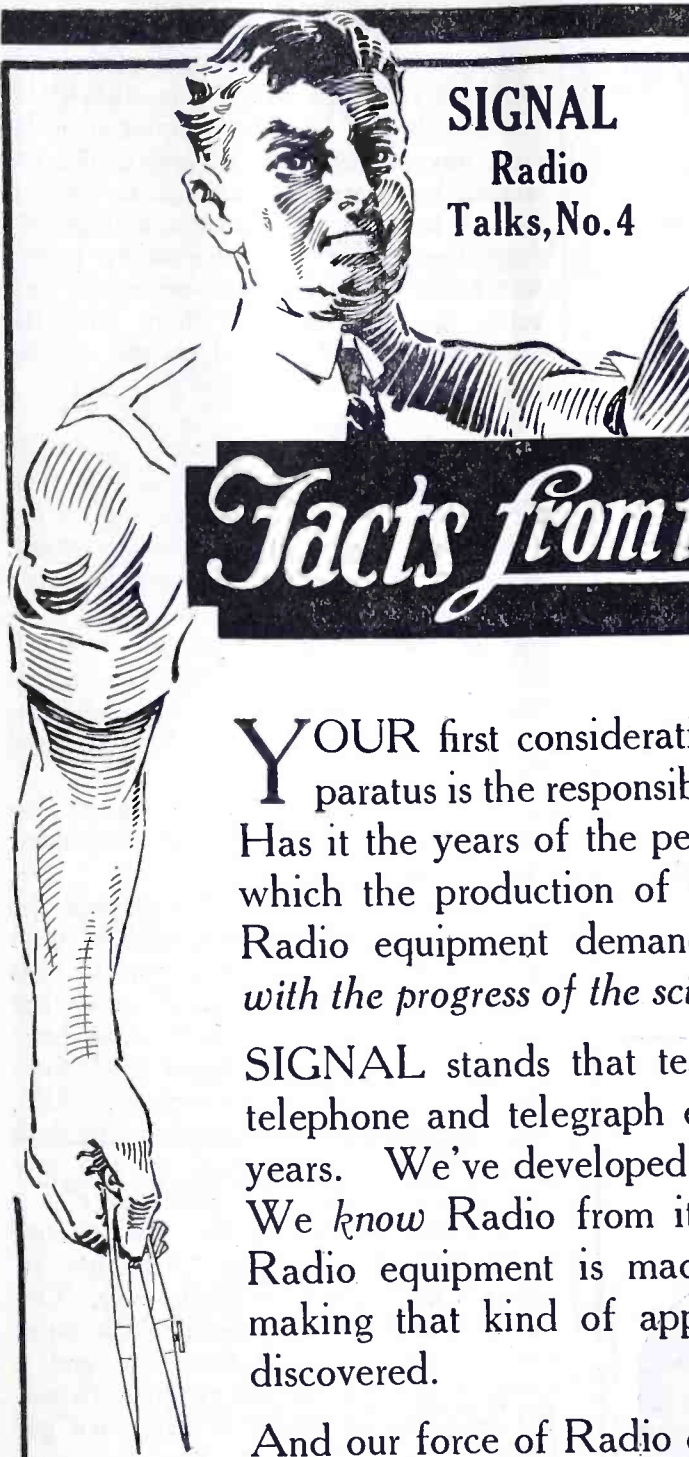

**Y**OUR first consideration in buying Radio apparatus is the responsibility of the manufacturer. Has it the years of the peculiar kind of experience which the production of efficient and dependable Radio equipment demands? *Does it keep pace with the progress of the science of Radio?*

SIGNAL stands that test. We've been making telephone and telegraph equipment over thirty-five years. We've developed as "wireless" developed. We know Radio from its beginning. SIGNAL Radio equipment is made by men who've been making that kind of apparatus ever since it was discovered.

And our force of Radio engineers is constantly engaged in research work which insures that every SIGNAL Item represents the latest development in Radio.

For sale by dealers everywhere. Insist on SIGNAL—it's *your* protection.

**SIGNAL Vernier Rheostat**

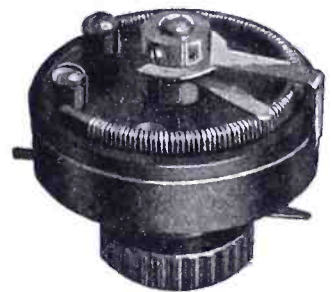

You'll surely approve of this SIGNAL Vernier Rheostat. It has the fine appearance and will give the exceptional service which characterizes every SIGNAL item. It's the first successful vernier using a single knob for control. Fine adjustment easily obtained. Furnished with or without knob and pointer, so dial to match others of set may be used.

The coupon below will bring you valuable and practical information—if you send it in right away.

**SIGNAL Electric Mfg. Co.**

Factory and General Offices:  
1913 Broadway, Menominee, Mich.

Atlanta  
Boston  
Chicago  
Cleveland

Minneapolis  
Montreal  
New York  
Pittsburgh

San Francisco  
St. Louis  
Toronto

*You'll find our local address in your Telephone Directory*

(2243)

**Information Coupon**

Signal Electric Mfg. Co.,  
1913 Broadway,  
Menominee, Mich.

Please send catalog and bulletins giving complete information about SIGNAL Radio equipment to name and address written below.

\_\_\_\_\_  
\_\_\_\_\_  
\_\_\_\_\_







**In Any or All Stages**  
of audio frequency amplification

*The AMERTRAN*



Price \$7

Ask your electrical dealer, or sent carriage charges collect. (Wt. 1 lb.)

can and should be used. It is made in only one type and one ratio. Its flat-top amplification curve precludes the possibility of distortion on the part of the transformer when used in any or all stages. It will give the same clear-toned distortionless amplification with all tubes which are approximately alike in A. C. Impedance and Amplification Factor, such as

- |        |       |          |
|--------|-------|----------|
| UV-201 | WD-11 | UV-201-A |
| C-301  |       | C-301-A  |

Its amplification in one stage is 38.6; two stages 1490.

**American Transformer Company**

*Designers and builders of radio transformers for over 20 years.*

174 Emmet St.

Newark, N. J.

*Pacific Coast Office, Rialto Bldg., San Francisco*

**DICTOGRAPH**  
**Radio HEADSET**

*The Best Headset in the World*  
at ANY Price

Made by the makers of the world standard Dictograph Products—the marvelous "Acousticon" for the Deaf, the famous Detector Dictograph, the Dictograph System of Interior Telephones and Dictograph Radio Loud Speaker for the Home.

**The First Choice of Experts**

La Porte, Ind.

"I have been experimenting with Radio for the past year; in my experience have tried out 14 different headsets, including the—which I purchased for \$16.50. I at last have found the ideal phone where tone quality excels, and harshness is eliminated, and I cannot express myself in words as to the wonderful results I have obtained."

J. T. BACHMAN

Go to your dealer's today and listen-in with this supreme instrument. Note the difference. Buy two or three Dictograph Headsets and let the rest of the family enjoy your set.

Always insist on Dictograph Products. They are Fully Guaranteed.

DEALERS: Sell goods you *know* your customers will be proud of. Order through your jobber or write direct for names of authorized distributors.

**DICTOGRAPH PRODUCTS CORPORATION**

220 W. 42 St., New York City

*Branches in All Principal Cities*



Type R-1, 3,000 ohms. For all types of crystal and vacuum tube receiving sets.

**MAIL ORDER RADIO SUPPLY SERVICE**

*A Real Opportunity to Save Money*

**ARE YOU USING "ROSS SERVICE?"**

Our tremendous buying power enables us to give you the benefit of very low prices on first quality, standard make merchandise. We have thousands of Radio fans on our list who are reaping the benefits of our

prices. Why not you?

We issue a monthly bulletin showing prices, etc., which is yours for the asking, and will be mailed to you regularly.

Clip and mail coupon at once.

**ROSS RADIO SERVICE**

**693 MISSION STREET**  
**SAN FRANCISCO, CALIF.**

Ross Radio Service,  
693 Mission St.,  
San Francisco, Calif.

Kindly enter my name on your mailing list for your Monthly Bulletin.

\_\_\_\_\_  
\_\_\_\_\_  
\_\_\_\_\_





3-Step Radio Frequency  
Amplifier Detector Set

Price Without  
Accessories \$110.00

## Its Marvelous Sensitivity is Amazing the Entire Radio World

The WARE AD2 Receiver operates with any properly made loop intended for broadcasting wave lengths.

It receives local stations in any location, including steel buildings. In unshielded locations during fall, winter and spring, it brings in programs from 1000 to 3000 miles on small indoor loop.

It eliminates interference (static,

induction and interfering radio stations) to an extent that will prove a revelation.

It reproduces the broadcasted programs with absolutely perfect tone quality.

It requires no other knowledge to hook up and operate than is contained in the printed instructions which come with each set.

Designed to be used with UV201A Vacuum Tubes.  
Ask your dealer or send direct for descriptive folder.

*Distributors and dealers write for proposition.*

# WARE RADIO CORP'N

160-162 DUANE ST.



NEW YORK, N.Y.

**Investigate!**  
**WESTERN-RADIO**  
**DEALERS SERVICE**  
Wholesale RADIO Only  
637 So. Hope Street, 565 Howard Street  
LOS ANGELES SAN FRANCISCO

### A RECOGNIZED RADIO ENGINEER

who has been associated with the radio industry for the past ten years, is a college man, a business executive trained as an electrical engineer, has owned, edited and managed a national radio monthly, designed and constructed amateur and commercial radio equipment, holds a first-grade commercial radio operator's license, is a competent sales and research engineer, with a thorough knowledge of advertising and correspondence, desires a worthy position with a reliable firm. Available immediately. Address: N. E. Wunderlich, 4533 No. Sawyers Ave., Chicago, Ill.

**WIS WIN**

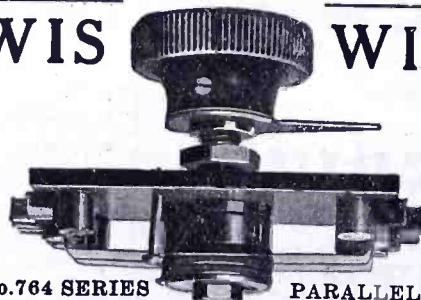

No. 764 SERIES PARALLEL

Concealed type, mounted on formica base

No. 754 visible type, switch alone, 65c

Our sheet of diagrams showing the many uses of this popular switch, sent free upon request.

**WILLIS SWITCH & INSTRUMENT CO.**  
8 Kingsbury St., Jamestown, N. Y.

Tell them that you saw it in RADIO

*Continued from page 72*

them, the major noted the lights of towns and villages. He spoke into the transmitter that was wired into his helmet.

"Where to?"

"Mount Diablo," replied the captain.

Through the darkness the dim bulk of the South Peak of Mount Diablo soon loomed. Once more the plane pointed her nose to the stars and climbed. Her motor faltered, coughed, then again resumed its steady roar. Peering over the side, the major made out the lights of valley towns. He shrugged his shoulders again, and gave himself over to some unpleasant reflections concerning the altitude at which they were flying. He had never been keen on air work.

Again the plane came to level keel. She had passed over the South Peak, and was now swinging in a wide circle around the North Peak, and some two thousand feet above it. Her nose dropped.

"Look."

It was the captain speaking. He had removed one hand from the controls, and was pointing. The major followed his motion.

At first he saw nothing. Then, two flickering bands of light, hardly visible, reaching into the sky, it seemed, flickering, coming and going in rhythmic order. Involuntarily his lips framed the word.

"Code."

The captain nodded. A dark object loomed before the nose of the plane. With a startled exclamation the captain threw his controls hard over, and like a living thing the plane leaped to one side, grazing a shadowy mass. Up she shot again, this time with her nose pointing homeward. Through the night the lights of Oakland and Alameda passed beneath them, then a long descending spiral, and she swiftly glided through the path of the landing flares to a stop in front of her hangar.

The major climbed out with alacrity. As I have said before, he was not fond of flying.

"I'll get into my story at once," said the captain as he and the major seated themselves in the major's room. "I was delivered safe and sound at your country home, and as per your request when I left, sent the car back by Thomas, telling him I would phone you when I wanted him to come up again for me. Well, you know I went out of here feeling pretty mean, so after I had had dinner, I asked your foreman to give me a good riding horse with plenty of ginger in him, so that I could get some of it out of my system.

"After I had mounted, I spent about ten minutes in quieting my mount down, and picking out a path that didn't look like it had much travel on it, started out. Your place is almost under the

*Continued on page 76*



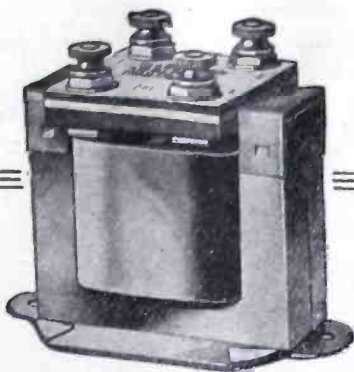

**On the First Step**

*Thordarson  
6 to 1 Ratio  
A. F. Transformer*

The ideal two step amplifier has a Thordarson 6 to 1 ratio transformer on the first step.

This is a new product — recently perfected and is distinguished from our 3½ to 1 ratio transformer by the red lettering on the top plate. It gives unusually high amplification without distortion, the core having twice the cross-section of the ordinary transformer.

Remarkably low priced to retail at \$5.00. Good discounts.

**Couple up these two for Highest Amplification**

We should be able to make better radio transformers for less. And we do!

We have specialized in transformers for the last twenty-five years. That means we know how to make them right! We have the men and the manufacturing facilities to produce them in quantity. That means we can make them economically!

Together they mean the best audio frequency amplifying transformer that can be made, at the lowest possible cost.

Hook up to Thordarson Transformers and see what perfect amplification really means. If you are a dealer, demonstrate to your customers what a perfect combination two Thordarson Transformers make for a two step amplifier—

These transformers can be used with excellent results on low voltage tubes.

And such a demonstration will certainly make sales if results are what your customers are after.

*Get a supply of Thordarson Transformers from your jobber now*

**THORDARSON**  
**ELECTRIC MANUFACTURING CO.**  
500 W. Huron St., Chicago, Ill.

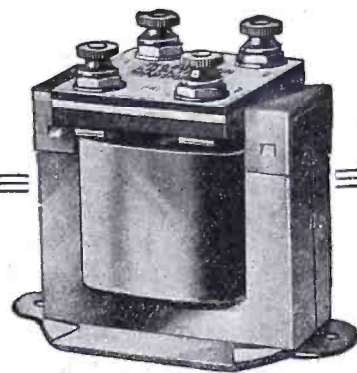

**On the Second Step**

*Thordarson  
3½ to 1 Ratio  
A. F. Transformer*

For best results and perfect reproduction of signals, the 3½ to 1 ratio transformer should be used on the second step. Used together in this way, these two transformers give exceptionally loud signals, yet in perfect modulation.

The Thordarson 3½ to 1 ratio transformer is distinguished by the black lettered top plate.

All silk insulated wire used throughout. Unequaled value at \$4.50 list—also with good discounts.

**You can get MURDOCK Receivers**

AND OTHER MURDOCK RADIO APPARATUS

**--- Why bother with any other kind?**

**\$5.00**

2000 Ohms  
No. 56  
Double

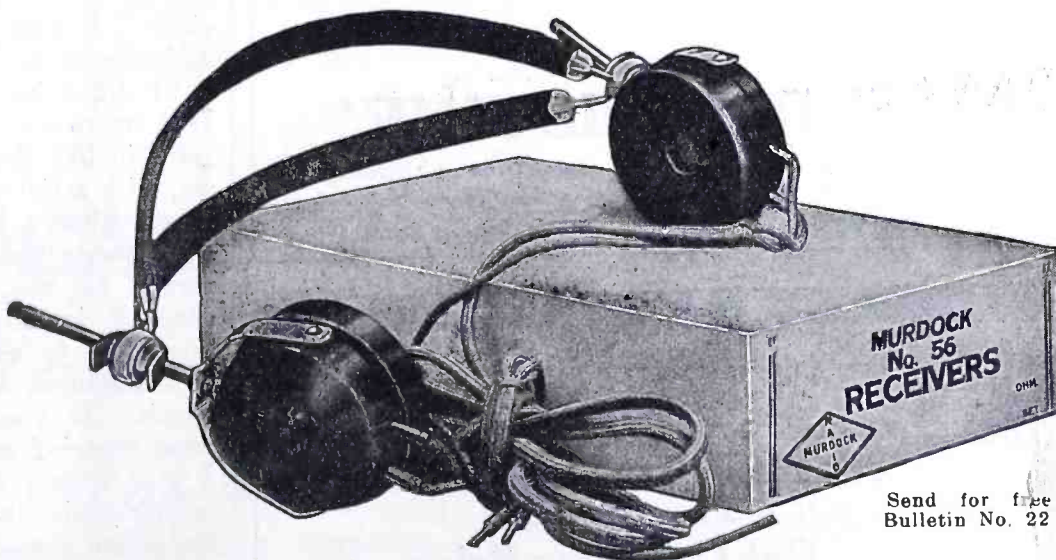

**\$5.50**

3000 Ohms  
No. 56  
Double

Send for free Bulletin No. 22

If your dealer is not supplied send remittance direct to us and your order will be promptly filled.

MURDOCK MADE 800,000 TELEPHONE RECEIVERS BEFORE GOING INTO THE RADIO BUSINESS AND HAS MADE THE BEST RADIO RECEIVERS FOR 14 YEARS

We carry a complete stock in our Pacific Coast warehouses. Write for dealer discounts.

**KEELER WHITE COMPANY**

*Pacific Coast Agents—WM. J. MURDOCK CO.—Since 1905*

509 Mission Street, SAN FRANCISCO

211 So. San Pedro Street, LOS ANGELES

Polson Bldg., 71 Columbia St., SEATTLE, WASH.

Tell them that you saw it in RADIO



# RHAMSTINE\*

## Victophone

### A NEW LOUD-SPEAKER



Price  
**\$7.50**

Complete with  
Phone Cord

Remove the reproducer from your Victrola and put on the Rhamstine\* Victophone, adjust the pole regulator until the tone and volume are just right—and see if it does not fully meet your needs for a perfect loud-speaker.

The Victophone is a correctly designed loud-speaking receiver—it requires no battery to operate it. It can be used with any type of horn but it is especially designed to be attached to the tone-arm of various phonographs.

It possesses these superior qualities:

1. Adjustable poles.
2. A venturi opening in the cap correctly designed to increase volume.
3. Rubber gasket between the tone-arm flange and the cap to reduce metallic vibrations.

The Victophone is nickel-plated and highly polished. It bears the name Rhamstine,\* assuring you of satisfaction in your purchase.

Order yours today. Dealers write for discount.

Manufactured by

## J. THOMAS RHAMSTINE\*

2162 E. Larned Street

\*Maker of Radio Products

Detroit, Michigan

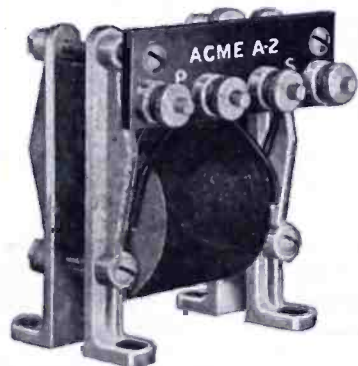

Acme A. F. Transformer...\$5.00

### ONE HOUR RADIO SERVICE

All Orders Shipped One Hour  
From Receipt

Get Our New Price  
Bulletin Today!

### COMPLETE LINE

## PORTS RADIO MANUFACTURING CO.

3305 Belmont Ave.

QST RADIO SHOP

FRESNO, CALIF.

Tell them that you saw it in RADIO

Continued from page 74

shadow of the North Peak, and I figured on riding in that direction. Well, after a while, I rode by a farm house off the main road, and in looking over it casually, was surprised to note a small aerial suspended between the barn and the house. Now, remembering that all amateur stations are supposed to be dismantled by government order, I rode in to investigate. The fellow who came to the door didn't speak English well—I guess he was a Portuguese or a Spaniard, and upon my pointing to the aerial, he let out a whoop, and a little tad came running. The kid spoke English well enough. Said that he had a "wireless" on the end of the aerial, but that he didn't pick up much, except one station, and that he couldn't make out what it said because he didn't understand the code. He didn't know anything about the dismantling order, as his people were foreigners, and took no English newspapers. Then, the aerial was so insignificant, and the location so out of the way, that it would not be noticed at all, ordinarily.

"I went inside to look at the outfit, after telling him that it should be taken down at once, to which he agreed readily enough. All he had was a cheap 75 ohm receiver and a silicon detector, without even a tuner. The kid was pretty proud of it at that, and to humor him I put the receiver to my ear, and tickled the catwhisker on the detector. I didn't want to hurt the kid's feelings by laughing at him, because I remembered that my first outfit was exactly the same as his, and I thought it some outfit.

"Well, you could have knocked me cold when whistling in for a million, came the signals from that blankety blank station that we have been concentrating on. Nothing weak about them either. I broke the antenna connection, and they came in just the same.

"I did a lot of thinking in the next few moments. The signals wouldn't come in like that on an untuned crystal set, with aerial cut out, unless they were pretty close. I figured that the best thing to do was to come back here and report to you, and then lay out a plan of investigation. So I told the youngster to dismantle his outfit, and then mounted and started back for the ranch. It was dark by now, and I wasn't paying much attention to where I was going, and turned off on the wrong road. It was an old unused trail, and when I noticed where I was going, I started to turn back. I had been so busy thinking about those signals that I had let my mount go almost up to the base of the North Peak. When I turned, a rabbit jumped out in front of my horse, and he just stood on his hind legs and the first thing I knew I was lying flat on my back and that bag of TNT was going down the road with the

Continued on page 78



# Lefax Radio Handbook—

Distributed in the West by Pacific Radio Pub. Co., Inc.

**L**EFAX Radio Handbook is the one Book on Radio that keeps abreast of developments. As quickly as the authors learn new facts about the subject, the information is passed on to you. It comes all printed in loose-leaf form, all pages numbered and properly classified. Lefax is the only Book on Radio that doesn't, cannot grow old.

Note the little rings in the center of the book. Those rings are hinged. They are instantly opened—by a slight finger pressure—to receive the perforated pages. Once an ordinary book is bound, it cannot be changed—but Lefax can. You buy Radio information *complete* when you buy Lefax. We furnish, free for a year, pages containing additional information. You need Lefax Radio Handbook.

RADIO HANDBOOK

**The Whole Story About Radio**

Told by the two Chiefs of the Radio Department of the U. S. Bureau of Standards.

Dr. Dellinger, and Mr. Whittemore, the authors of the Lefax Radio Handbook are the only authorities who have access to all the facts about Radio as well as all the New Developments. They have not only written the most complete story about Radio obtainable, but will also write up all the new developments for the **YEAR'S FREE SERVICE** (to be continued after that at a small cost)

LEFAX

**A COPY FREE with one subscription to "RADIO" for 18 months.**

**A**DDITIONAL loose leaf pages are mailed to you as they are issued — free of charge for one year. Automatically keeps itself up to date. Every radio experimenter needs this book. Send for your copy today. Immediate deliveries.

**The One Best Book on RADIO**



**LEFAX Never Grows Old**

**\$ 3 50**

**DEALERS:** We are Western Distributors for this Book. Write for trade discounts!

**Take Your Choice---Use Either Coupon**

**FREE LEFAX BOOK**

"RADIO"—Pacific Bldg., San Francisco. Herewith is \$3.75. Send me a free copy of LEFAX and "RADIO" for 18 months.

Name .....

Address .....

**"RADIO" Pacific Building, San Francisco.**

Herewith is \$3.50. Send one Lefax Radio Handbook to:

Name .....

Address .....

Tell them that you saw it in RADIO



**USE YOUR PHONOGRAPH**



**E. S. X. Radio Phonograph Attachment**

THE NEW E. S. X. is the first and only ATTACHMENT that can be used with one or two receivers. There are Thousands of E. S. X. Attachments in use and every one gives satisfaction. It is needless to say that the PHONOGRAPH tone chamber is superior to a horn. Send \$2.00 and mention make of Phonograph to ESSEX WIRELESS SPECIALTY CO., 32 New St., Newark, N. J.

**USE YOUR PHONOGRAPH**

*Continued from page 76*

throttle wide open. I struck my head on a stone and lay there stunned for a few seconds, too dizzy to get up.

"I was lying with my head pointing toward Mount Diablo's north peak, and on my back, as I was, my eyes were focused on a point about half way up the peak. I noticed those same flickering bands of light that you saw tonight. At first I thought I was literally 'seeing stars' because the two bands were intermittent in character, and they seemed to stab right up into the sky, but it wasn't long that I noticed that they were flickering for all the world as though they were in code. Then I came too in a hurry. I was too weak to do any investigating, so I got myself back to the ranch as fast as I could. I started back for here this morning after I had persuaded your foreman to lend me the wreck he calls an automobile, thinking I could make better time than by waiting for Thomas to come up after me. I broke down, and that is why I got in so late tonight. I would have called you on the telephone, but I wanted you to see those two bands of light yourself, so that you would be convinced.

"Now, here is my theory. Up on the North Peak of Mount Diablo, in one of those caves a high powered transmitting station is secreted. The antenna is carried aloft by means of a captive balloon. That is what we grazed tonight in the plane. In my experimental days I used to fly kites for the purposes of carrying up receiving aerials, and the same idea applied to a balloon is not difficult of execution. In all probability the balloon is of oiled silk, and in the daytime is almost transparent. It could be sent up in the daytime without fear of detection, as hardly anyone ever goes up on the North Peak, and a lookout posted at a vantage point could give the alarm in time, if there seemed to be any danger of an occasional hunter coming too close. At that, most of their work has been done at night, as you are well aware, and there is very little danger of detection then.

"Those two flickering bands of light are caused by an overloaded antenna. When I was a commercial operator on the Orient run, our ship antenna emitted a strong corona that was clearly visible at night. I got quite a kick assuring passengers that the corona was the wireless message jumping off the aerial, and a good many fell for it. The aerial wire used is of necessity light, in order to allow of its being carried up by the balloon, and as they are using very high power, the corona would be very noticeable to one near there."

"Well, by Jove," said the major, as the captain paused, out of breath from his eager recital. "My boy, I think that you have made out a case. But how do you account for the fact that with

*Continued on page 80*

**Announcement to Our Numerous Friends!**

Beginning May 1, 1923 the

**MORTIMER RADIO CORPORATION**

and the

**ADVANCE METAL STAMPING CO.**

both of New York City will consolidate and be known in the future as

**AMSCO PRODUCTS, INC.**

The "Melco Supreme" Radio-Frequency Receiver will continue to be marketed under its own name and a complete line of high-grade parts will be available at good dealers under the AmSCO brand.

Our new home in the

**Fairbanks Building**

Broome & Lafayette Sts. New York City

is up-to-date in every respect and will enable us to give even better service than has heretofore been possible. A postcard will bring you our literature—describing both sets and parts.

*Thank You!*

**DEAD TUBES**

????

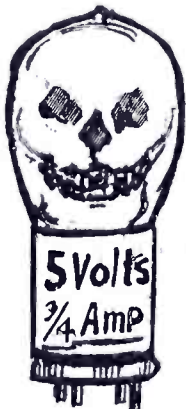

Broken or burned-out tubes have a 50c value when you purchase

**Guaranteed**

**\$3.00**

**Detector Amplifier**

**W. H. BRYANT**

99 Bedford St., Boston

Dealers' Discounts

We Also Repair Tubes We Buy Old Tubes

**HONEY COMB COILS**

L- 50)  
L- 75, 40c each  
L-100)

**W. H. BRYANT**

99 Bedford St., Boston, Mass.

**"Read'em" Binding Posts**

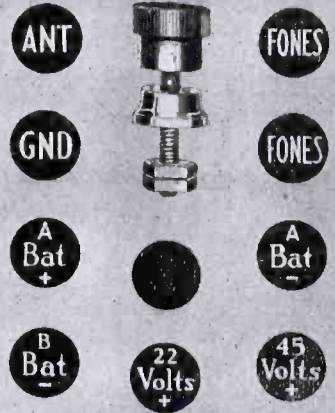

The Marshall-Gerken Co. Toledo, O.

Irremovable Knobs

With "Read 'em" Binding Posts you know exactly what you are doing in making a hook-up. Abbreviations of the different names are engraved on the face of each post. Knobs are irremovable. Anyone can "read 'em." One always knows which post is which.

"Read 'em" Binding Posts are popular all over the world. You can buy them anywhere. Price 15c.

**Other Marshall-Gerken Products**

S12 Bakelite Socket	\$1.00
CDS Bakelite Dial	.90
R90 Bakelite Rheostat, 3 ohms	1.10
R91 Bakelite Rheostat, 16 ohms	1.10
R92 Bakelite, 300 ohms	1.50
9-B Double Binding Posts	.12

If your dealer cannot supply you, write us direct. Please address Department B.

Dealers—Write for Proposition

**The Marshall-Gerken Co.**  
Manufacturers  
Toledo

<b>RADIO MAILING LISTS</b>	Per M.
12,422 Radio Dealers, U.S. by States	\$7.50
1,614 Radio Mfrs. U.S. by States	\$15.00
1,760 Radio Supply Jobbers, U.S. by States	15.00
260 Radio Stations	4.00
257 Mfrs. complete Radio Sets	4.00
67 Radio Battery Manufacturers	1.50
Ready to send on receipt of remittance	
Trade Circular Addressing Co.	
166 W. Adams St., Chicago	

*Investigate!*  
**WESTERN-RADIO DEALERS SERVICE**  
Wholesale RADIO only  
637 SO. HOPE ST. LOS ANGELES  
1200 FRANKLIN OAKLAND

Tell them that you saw it in RADIO





**KING QUALITY**  
"Universal" Adapter.  
R-10 designed  
to fit all tubes  
and valves.



**KING QUALITY**  
Rheostat. R-630  
Resistance valve  
6.5 ohms. Special  
Brass Panel Bush-  
ing insures smooth  
operation. Genuine  
Bakelite Base and  
Knob.

**KING QUALITY**  
ALL THE NAME IMPLIES  
**RADIO APPARATUS**

QUALITY—so outstanding in appearance, in design, in workmanship, in serviceability—that none dare deny its superiority.

Such a line as KING QUALITY any dealer may be proud to display and offer his customers as the Best on the market.

Increased sales and profits are the result of tying up with the KING QUALITY line. Write today to

**RADIO APPARATUS DIVISION**  
King Sewing Machine Co., Buffalo, N. Y.  
*We maintain our own Bakelite Plant*



**KING QUALITY**  
Vernier Rheostat.  
R-631 provides mi-  
crometer adjust-  
ment resistance.  
Superior construc-  
tion assures perfect  
control.





## This Offer Is Still Open!

You can subscribe to "QST" and "RADIO" for a full year at the special low rate of \$2.70.

### Save \$1.80

Get both of these leaders for a little more than the cost of one.

RADIO, Pacific Bldg., S. F., Cal.

Send me "QST" and "RADIO" for one full year. I enclose \$2.70.

Name .....

Address .....

*"The Peak of Perfection"*

# Dialkill

**PARTS**

SINCE 1914

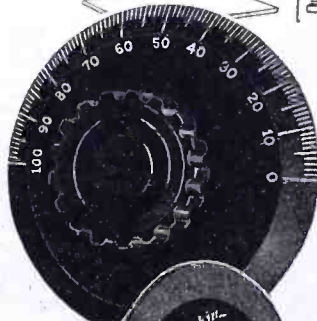
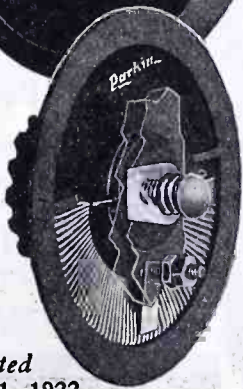
Patented  
Aug. 1, 1922

## Dial-Type Rheostat

*"The Peak of Perfection"*

GUARANTEED to improve both the appearance and operation of any set. Improves appearance because it matches and harmonizes with the other dials on the panel. Improves operation because it assures constant signal strength and prevents resistance overheating. Resistance element recessed in the back of the dial *outside the cabinet*, also giving more cabinet space. Sold through dealers, or direct if cash accompanies order. Money back if not satisfied. Price—

### \$1.50

Mail this coupon  
FREE catalog

Parkin Mfg. Co.,  
San Rafael, California  
Gentlemen: Please mail me copy of  
PARKIN Catalog. Name and ad-  
dress of myself and of the dealer  
I favor, are:

MY NAME.....

STREET .....

ADDRESS .....

DEALER .....

STREET .....

ADDRESS .....

Tell them that you saw it in RADIO



### Convert Your Crystal Set Into Tube Set at Small Cost

You can now enjoy wider range, greater volume of sound and purer tone and do away with feeling around for a sensitive spot, if you make a Tube Set out of your Crystal Set by adding the Peanut Tube W. T. 501 and a few other inexpensive accessories. Full directions packed with every W. T. 501.

### Welsh PEANUT Detector Tube W. T. 501

can be used on three dry cells or one regular 6-V "A" battery. Consumes less than half as much current as ordinary tubes, consequently does not use up batteries as fast.

Nickel-plated socket, moulded base, double-spring contacts, 40c extra. Adaptor for Standard V. T. Socket, 75c extra.

If not at your dealer's, send us his name and address with money order and we'll see that you are supplied. Include 10c extra for registration.

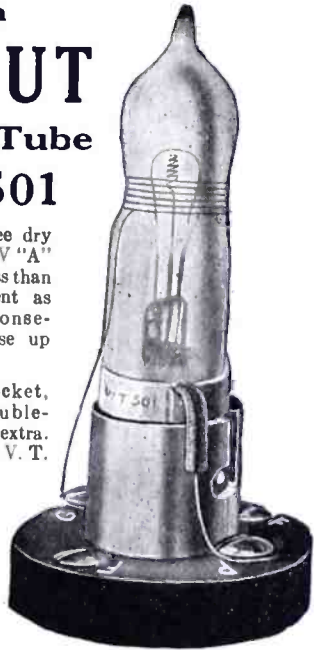

**RADIO RESEARCH GUILD**  
40 Clinton Street  
Newark, N. J. **\$200** Immediate Delivery

### Chelsea Condensers

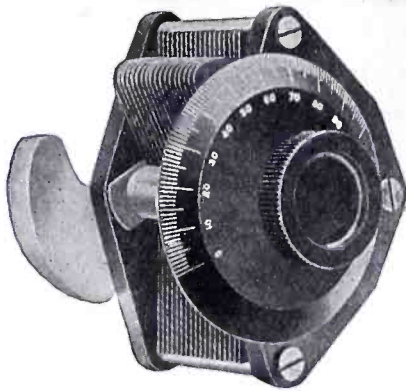

No. 1

#### PRICES:

No. 1 Table.....	.001	\$5.00
No. 2 Table.....	.0005	4.50
No. 3 Panel.....	.001	4.75
No. 3a Panel without dial..		4.35
No. 4 Panel.....	.0005	4.25
No. 4a Panel without dial..		3.85
No. 5 Panel.....	.00025	3.75
No. 5a Panel without dial..		3.35
No. 6 Panel vernier.....		2.90
No. 6a Panel without dial..		2.50
No. 7 Table with vernier....		6.75
No. 8 Panel with vernier....		6.50

#### Genuine Bakelite Construction

The best and most complete line of condensers in existence.

Write for our catalog No. 7

**Chelsea Radio Co.**  
152 Fifth Street  
CHELSEA, MASS.

Continued from page 78

the station located so close to San Francisco, we have been unable to fix a compass bearing on it? Can you explain that?"

"I think I can," replied the captain. "Understand, this is but a theory, and it may seem a far fetched one at that, but it has a reasonable foundation. You are no doubt familiar with what commercial operators in the radio service call "dead spots". For instance, at a point eighty miles south of San Francisco, it is almost impossible to get a message through to San Francisco from ships plying along the coast, while the same ship may go on to San Diego, and have no trouble transmitting from there. Similarly, I understand that such a dead spot exists between Honolulu and San Francisco. It has been general custom to blame this condition on to heavily mineralized deposits in such particular regions, or to atmospheric conditions in some cases. There are a number of other instances which I might quote.

"Now, based on this, though somewhat apart in actual practice, I believe mineralized deposits in the Coast Range mountains, and particularly in Mount Diablo, have formed in effect, a radio echo. So tremendous has been the power generated at this station, that just as a sound wave may be deflected from a wall, some of this energy has been deflected by these mineralized deposits to be flung out in all directions. This deflection is localized to a certain extent, enough to make compass bearings of no avail at close range, yet weakening further away so as to permit bearings to be made approximately."

The major reflected a few moments, then nodded. "You are right," he said. "Now, I guess the next thing in order is to get a squad of men out by truck and see if they can't surprise the station. I have some news that may be of interest to you—we have under observance one of the force employed by Nicholson. He has been securing leaves of absence to visit his mother, and we have just ascertained this afternoon that he has no mother. It was our intention to arrest him upon return and question him. There is a possibility that he may have gone to the station today, as he secured a leave of absence last night. Now, you had better turn in and get some sleep. I know that territory pretty thoroughly, and I will go up with my men to guide them."

"Not much," replied the captain. "I will sit in on this little matter too. That station has caused me enough worry to date—I'd like to see the finish of this. Count me in."

IT now behooves me to bring my story to a close. The squad of picked men, headed by the major and the captain, advancing carefully up the side of the

**SIXTH DISTRICT AMATEUR CALLS** appear in "Broadcast Program"—\$1.00 for 6 months.

**Investigate!**  
**WESTERN-RADIO DEALERS SERVICE**  
Wholesale RADIO Only  
637 So. Hope Street, LOS ANGELES  
565 Howard Street, SAN FRANCISCO

**Sidbenel** "B" Batteries that last five years.  
Send For This Catalog  
Sidbenel Radio Equipment Mfg. Co., Inc.  
25 Mount Eden Ave. New York, N. Y.



### A-B BATTERY TESTER

The Jewell A-B Battery tester fills a need for a low priced but accurate portable instrument for checking battery voltages. Double readings 0-12-120 volts is the range usually supplied, which takes care of the "A" battery under all conditions and the "B" battery up to the highest commonly used for receiving.

Price \$10.00

We were the first to supply a complete line of miniature radio instruments of uniform size. Ask your dealer or write to us for complete radio circular.

**JEWELL ELECTRICAL INSTRUMENT CO.**  
1650 WALNUT ST. CHICAGO

Tell them that you saw it in RADIO



North Peak, were still some hundreds of feet below the point where they believed the hidden station to be located, when the peak was shaken by a terrific explosion. Scattered bits of flesh, broken pieces of machinery, torn bits of fabric, parts of a hoisting winch, apparently used to play out and pull in the balloon, were all that was left to tell the tale. A belt buckle that was identified as belonging to the man under suspicion at the Nicholson laboratories was also found.

Time fuses have failed before, and they may have failed in this instance. Whether the circling airplane gave the alarm that night, or whether it was felt that the station had served its usefulness, and a decision resulted to dynamite the cave I don't know. At any rate, the hole caused by the blast may be still observed in the side of the peak, by those who care to make the rather difficult climb.

In closing, I might add that with the ceasing of hostilities, a certain youngster who believed that a silicon detector and a 75 ohm receiver was quite the proper thing in radio, received about as slick a radio receiving equipment as could be collected. Whether it was the gift of the captain, the major, or both, I don't know.

So ends the story of the radio mystery of Mount Diablo, California's beloved mountain of the Devil.

**RADIO CONFERENCE**

*Continued from page 33*

I. C. W., exclusive ( see Note 3); C. W., I. C. W. and spark, exclusive, 600 to 800, Radio Beacons—C. W., I. C. W. and spark, exclusive, 1000.

University, college and experimental, C. W. and I. C. W., exclusive, 1277 to 1304.

Marine and point-to-point, non-government, C. W., I. C. W. and spark, exclusive, 1579.

**Notes**

NOTE 1. Not more than six CW amateur stations to be licensed to use wavelengths below 286 meters for communication across natural barriers.

NOTE 2. A class A broadcasting station is a station of sufficient power to serve an extensive territory. Fifty territorial wave frequencies approximately 5 meters apart are to be assigned by Department of Commerce to local areas throughout the United States without duplication. The ten such areas within each of five national zones are to have wave frequencies separated by approximately 25 meters.

NOTE 3. The 300 and 600 meter waves are for calling and distress purposes, with a minimum traffic.

NOTE 4. Mobile service on the 450 meter wave is to be stopped between 7 and 11 p. m. local standard time, and to be transferred in so far and as soon as practicable, to wavelengths between 600 and 800 meters.

**Recommendations Approved**

Subsequent to the issuance of the foregoing recommendations the Department of Commerce issued a statement wherein it was said that "the Department fully accepts the recommendations of the Conference, but there are a number of difficulties in placing the plan abruptly into action: First, the hardship that it may cause to various stations to

**Just Consider**

—the essential features necessary to make an audio frequency transformer a good one—

1. High Amplification.
2. Minimum Distortion.
3. Low Interstage Linkage.
4. Convenient Mounting.
5. Compactness.

Cotoco transformers make these ideal features facts. And the finish will surely please you.

"Built First to Last"  
\$5.00  
At Your Dealer's

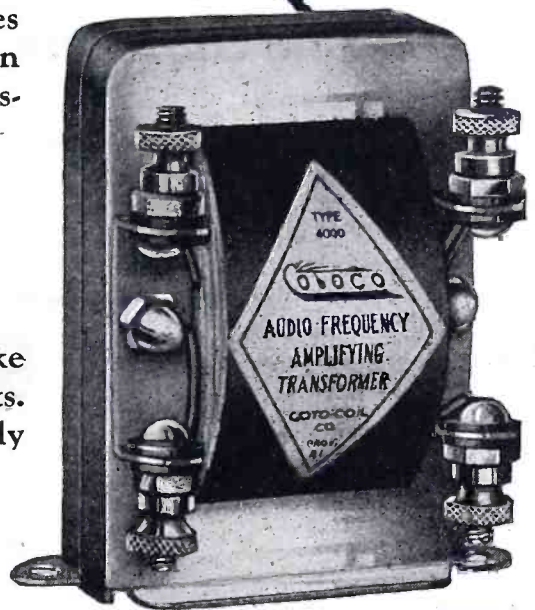

**COTO-COIL CO. PROVIDENCE**

Pacific Coast Branch, 329 Union League Bldg., Los Angeles



**HIGH EFFICIENCY HEAD SETS**

- Army and Navy Type:  
2500 ohm, per pair..... \$10.00  
3200 ohm, per pair..... \$12.00
- Swedish-American Type:  
2200 ohm, per pair..... \$8.00
- Victor Type:  
Double pole, single coil, per pair ..... \$6.00

*American Electric*

COMPANY  
CHICAGO, U. S. A.  
For 30 Years Makers of Good Telephones

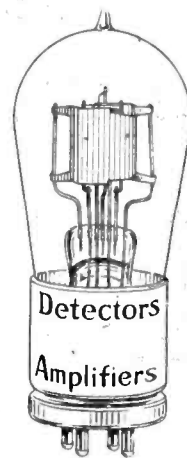

**GUARANTEED REPAIRS**

Broken and Burned-Out  
**VACUUM TUBES**

W.D.-11 not accepted for repair

Your dealer should know, but if he does not, send direct to

**HARVARD RADIO LABORATORIES**  
Boston 9, Mass.

Tubes returned Parcel Post C.O.D.

*Investigate!*  
**WESTERN-RADIO DEALERS SERVICE**  
Wholesale RADIO Only  
637 So. Hope Street, 565 Howard Street  
LOS ANGELES SAN FRANCISCO

**CARTER "HOLD-TITE" JACKS**  
1 to 5 springs; price 70c to \$1.10  
New design; heavy phosphor-bronze springs; no spacer washers required. Write for Bulletin on these Jacks, the well-known "TU-WAY" Plugs and other Carter products. All-Pac. Radio Sup. Co., San Francisco, Coast Dist. CARTER RADIO CO., 209 S. State St., Chicago

**"KING SR." VARIOMETER**  
For 150 to 600 Wave Length  
Better than moulded and each packed with guarantee from manufacturer  
Ask your dealer or write us—  
**AREMCOE MFG. CO.**  
303 4th Avenue :: :: New York City

**STOP THAT NOISE!**  
SAVES YOUR TUBES  
**AMPERITE**  
AUTOMATIC FILAMENT CURRENT ADJUSTER  
EXPELS ALL TUBE TROUBLES  
FROM YOUR DEALER OR  
**RADIALL COMPANY**  
99 WARREN STREET NEW YORK \$1.10 MOUNTING

Tell them that you saw it in RADIO



# CURKOIDS

## The Supreme Inductance

Greatest inductance per length of wire  
with  
Lowest resistance  
Least distributed capacity  
in combination with  
Curkoid Triple or Dual Parallel Couplers  
produce  
Greater signal strength  
Distortionless tone  
and  
Bring in signals from greater distances

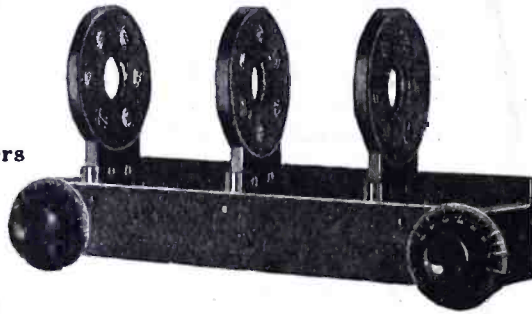

Patents applied for

**RIEGER RESEARCH CORPORATION**  
112 West 44th St. New York City

## The New R T-8 Radio Frequency Transformers

on the market March 1st, 1923, are specially designed by the *Radio Service Laboratories* for maximum efficiency when used with any low filament current consumption and low voltage tubes on the market.

For Audio Frequency the new RT-A2 will give you 100% Tone Quality and High Amplification without distortion. For best results on both tone and distance, use *Radio Service Laboratories* Radio Frequency R T-8 (for all stages) in the black case, retail price \$6.00, and Audio Frequency R T-A2, in brown case, retail price \$6.50.

For sale at all reliable electrical or Radio Stores. If your dealer cannot supply you, order direct. Order by type number, accept no substitute, and remember that all *Radio Service Laboratories* Transformers are individually triple tested and unconditionally guaranteed.



Send ten cents for new booklet on Radio Frequency with schematic diagrams—a most valuable and helpful publication for radio amateurs and expert.

## RASLA SALES CORPORATION

National Distributor  
Dept. C 10 East 43rd Street New York City

## NOVO "B" BATTERIES

with insulated binding posts  
and 7" Copper Wire Connectors

Pacific Coast Representatives

**MARSHALL & CO.**  
Union League Bldg., Los Angeles, Calif.

## Cut Rate Radio

STANDARD APPARATUS ONLY

Write for 54 Page Catalog of Bargains!

Baldwin Type "O" Phones	\$10.25
Brandes Superior Phones	\$6.45
Radiotron UV200 Detector Tubes	\$4.25
Acme Audio Transformers	\$4.45
43 Plate Condensers	\$1.95
23 Plate Condensers	\$1.80
Federal Phones	\$8.35

Everything for Radio at less.  
Immediate Delivery.

**Federal Radio Electric Co.**  
Dept. N  
1233 Grand Ave., Kansas City, Mo.

move arbitrarily to new wavelengths; second, the difficulties introduced by the ship to shore communication which are now working to some extent on 300 meters and also on 450 meters.

"In order to make progress in this direction of developing the area from 600 to 800 for ship communication, it is proposed that all ships and all shore stations used for ship communications shall cease using 450 meters between the hours of 7 and 11 p. m., but may use 700 meters at this or any other time. The 300 meters wavelength now assigned under the International Convention is very little used and will be used for inland broadcasting, and it is not expected that the ships will avail themselves of the International Agreement in this particular, as it has not proved of practical advantage except to a limited extent.

"For internal broadcasting the Department proposes to cooperate with the various stations with a view to developing a systematic assignment of wavelengths to the various stations within the broad confines of the recommendations of the Conference. In order to carry this out without hardship the following classification of stations will be made:

"Class A stations—that is, stations equipped to use power not exceeding 500 watts. In this class it is proposed that the radio inspectors, in cooperation with the station owners, shall assign distinctive wavelengths to each station so far as is possible in the area from 222 to 300 meters. No station will be required to change from 360 unless it so desires.

"Class B stations—that is, stations equipped to use from 500 to 1000 watts. In this class it is proposed to similarly offer to license these stations on special wavelengths from 300 to 345 and from 375 to 545 meters, having regard to the maintenance of some ship work on 450 meters as outlined above and again no station will be required to change from 360 unless it so desires.

"Class C stations—comprising all stations now licensed for 360 meters. In this class no new licenses will be issued for stations on 360 meters until the plan is entirely realized. Stations which do not wish to move under the general plan may remain at 360 meters, but they will necessarily be subject to some interference at best. It is thought that by the above plan the stations can be gradually brought into accord without hardships.

"Under the plan amateurs are given the whole area from 150 to 220, instead of being fixed upon 200 with special licenses at 375. The special licenses hitherto issued for amateurs at 375 will now be issued at 220. Certain special cases will be taken care of otherwise. It is proposed, in cooperation with the amateur associations, to develop an assignment of wave bands in classifications so as to somewhat relieve the present interference among amateurs. It will be remembered that the number of wave bands which can be used among the short wave area assigned to the amateurs is greater in proportion than among the longer wavelengths, and these arrangements expand the area hitherto assigned to amateurs."

Important among the resolutions adopted by the Conference were the following:

"That the Department of Commerce be requested to insist upon the suppression of harmonic and other parasitic radiation from all radio stations, as for example, by requiring the installation, if necessary, of coupled circuit transmitters at the earliest feasible date."

"That spark transmitting apparatus be replaced as rapidly as practicable by apparatus which will produce a minimum of interference."

"That the amateur organizations of the United States study the time requirements of the broadcasting of religious services on Sun-

Continued on page 84

Tell them that you saw it in RADIO





**CROSLEY** "WLW BROADCASTING STATION"  
 BETTER COST LESS  
**RADIO**  
 PRODUCTS  
**CROSLEY MFG., CO.**  
 CINCINNATI, O.

**THE HEIGHT OF EFFICIENCY**  
**CROSLEY MODEL X PRICE \$55**

Clearly, distinctly, as though given in the same room, messages from W. L. W. Broadcasting Station, Crosley Mfg. Co., Cincinnati are heard in all parts of America if a Crosley Model X—a four-tube radio frequency set—is used. This remarkable instrument, very easy to tune, simple and beautiful in construction, has repeatedly brought in messages over 4,900 miles away. Other Crosley Models, like the Model VIII, three-tube set—price \$48, and the Model VI, two-tube set—price \$28, have given exceptional results to thousands of satisfied users everywhere.

Write For Catalog Showing Complete Crosley Line.  
 For Sale By Best Dealers Everywhere.

Besides a complete assortment of receivers, Crosley manufactures parts for replacement or home construction. Jobbers and Dealers Will be Interested in the Crosley Proposition.

**CROSLEY MANUFACTURING COMPANY**  
 519 ALFRED STREET CINCINNATI, OHIO

New York Office, C. B. Cooper, 1803 Tribune Bldg., 154 Nassau St.  
 Boston Office, B. H. Smith, 929 Blue Hill Ave., Dorchester  
 Chicago Office, 1311 Steger Bldg., 28 E. Jackson Blvd., R. A. Stemm, Mgr.

**Remarkable  
 Regenerative  
 Receivers**

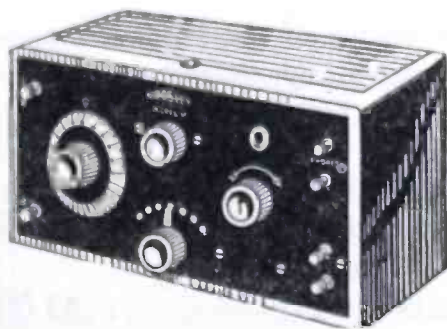

**Ace Model V**  
**\$ 20**

Formerly known as  
 Crosley Model VC

This one tube receiver is astounding the radio world with its wonderful achievements. Stations more than 1000 miles away are being regularly copied on this set. In comparison to its price, there is no receiver on the market today to equal it in performance. Because of its size and price the ACE Model V is a great summer seller.

Licensed under Armstrong U. S. Patent No. 1,113,149.

Live Jobbers and Dealers are eagerly taking advantage of the sales this instrument and the rest of the Precision instruments and parts bring them.

Free Catalog on Request

**THE PRECISION EQUIPMENT CO.**

*Powel Crosley Jr. President*

519 GILBERT AVE.

CINCINNATI, OHIO

Tell them that you saw it in RADIO



# Don't Waste Money

*Time and Patience on cheap, improperly designed radio parts. Insist on getting New York Coil Company's products, which insure entire satisfaction. Honestly priced, scientifically constructed and engineered to deliver the maximum results.*

**JOBBERs AND DEALERs** get our complete literature and worthwhile discounts.

**Standard 90 Degree Variocoupler, Bakelite tube, highly efficient, pigtail connections, price \$3.50.**

Our Combination Mounted Variocoupler for table or back panel mounting has all taps connected and soldered, nothing else like it. Price, \$8.00.

**180 DEGREE VARIOCOUPLER,** most efficient Coupler in existence. Bakelite tubing, silk wire, two bearing support, pigtail connections, very selective tuning, exceptional value at \$4.50.

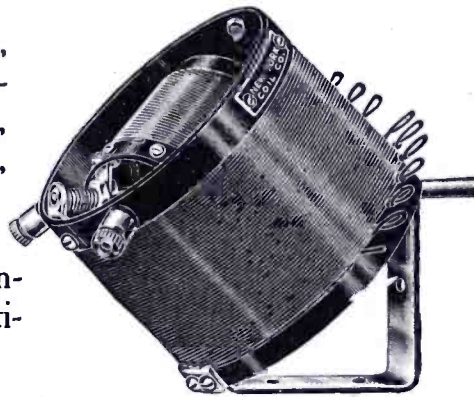

Our Variometers are full size precision instruments. They are not of the "competitive" type. Price \$4.00.

Our Audio Frequency Transformers are the choice of the leading manufacturers and radio engineers. Guaranteed to give high magnification, less distortion and better all around efficiency. No howling. Price \$4.00.

**NEW YORK COIL COMPANY'S** Variable Condensers are the standard by which others are judged, containing such features as all metal framework, adjustable bearings and positive electrical contact:

- |               |        |               |        |
|---------------|--------|---------------|--------|
| 11 Plate..... | \$1.50 | 43 Plate..... | \$3.00 |
| 23 Plate..... | 2.00   | 3 Plate.....  | 1.25   |

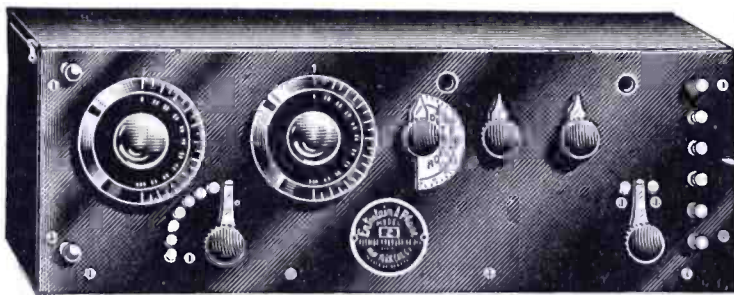

**NEW YORK ENTERTAIN-APHONE RECEIVING SET No. 2**—Complete with detector and two stages of amplification, all in one cabinet. Contains a non-regenerative two circuit hook-up with two stages audio amplification. Results are simply a revelation. It must be operated and heard to be appreciated. Workmanship and design and material of exceptional character throughout. Of unusual interest to the jobber. Price \$50.00, fully guaranteed. DW-11 1½ volt battery lamps may be used if desired.

**NEW YORK COIL COMPANY, Inc.**  
338 Pearl Street New York City, N. Y.

*Continued from page 82*

day and by mutual arrangement with the broadcasters determine upon silent periods which will make possible the reception of such religious services in any given locality."

"That where a line-radio installation produces interference with the reception of signals from beyond the state such line-radio station shall require a license from the Department of Commerce."

"That the subject of interference caused by the devices not used for radio communication purposes and which are not subject to the present radio law be referred to the projected Sectional Committee of the American Engineering Standards Committee and that in the meantime the members of the conference offer to the Department of Commerce their cooperation in the solution of such immediate problems as may be of a character in which their aid could be of value."

"That, in the judgment of the Second National Radio Conference, the prevention of 'wilful or malicious interference,' as provided for by Section 5 of the Act of August 13, 1912, and the minimization of interference, as provided for by Article 8 of the International Convention, require that the Department of Commerce shall, in its discretion, withhold or rescind station licenses to transmit on specified wave frequencies, at certain times, and on definite powers, and with certain types of transmitters and when, in the judgment of the Department of Commerce such interference would result or does result; and that it is the clear and manifest intent of Section 1 through 4, and Regulations 10, 12 and 18 of Section 4 of the said Act to give the Department of Commerce such authority to withhold or rescind licenses where such interference will result or does result; and that the Second National Radio Conference believes that a decision by the Courts validating the above views will be greatly in the public interest; and that the Second National Radio Conference expresses its willingness to advise and assist the Department of Commerce in the support of the above resolutions in the event of litigation."

## NEEDED RADIO INVENTIONS

*Continued from page 24*

Short wave transmission is also looming up on the horizon of the future. Experimental transmission has been carried on using a wavelength of only one meter. The frequency runs very high. Here is an unexplored field which holds out some very promising things. Indeed, the use of 1 meter in broadcasting would bring about sharp tuning. The further we get down the wavelength scale the sharper the tuning becomes. Using one meter we would have to tune to a hair's breadth of accuracy. The same would be true of ten meters. Here is a problem that quite naturally needs considerable engineering talent to bring about its solution.

Although the vacuum tube is one of the most sensitive electrical devices known to science it is still a comparatively crude device. At least it is crude when we consider how imperfectly it meets our needs. Fundamentally it is a rectifier of alternating current. Why then could we not develop a tube that will not only rectify the radio currents that pass through it, but also rectify the alternating current of commercial frequency so that we can use this current on

Tell them that you saw it in RADIO



the plate of the same tube? Then why cannot the construction of a tube be changed in such a way that it will have an absolutely invariable impedance?

When we think of radio problems, we always think of the matter of static elimination. It is difficult to realize the importance of this problem. Out at Rocky Point, Long Island, we see the towers of a tremendous radio plant poking their noses almost into the clouds. We see aerials that run for a distance of three miles, ground wires 400 miles long and high frequency generators producing ten times the amount of power that would be necessary if static did not exist. This great radio plant and all others of a similar nature can be looked upon as colossal monuments built up out of pure respect for static. As the amateurs have demonstrated, we do not need 200 kilowatts of energy to lay a message down in England, but we do need it when we have static and reliable communication to consider. In trans-oceanic communication there is so much static at times that engineers have found it necessary to absolutely "push" the messages through by putting a tremendous amount of energy behind them.

The particular radio plant at Rocky Point to which we refer, cost several million dollars to build. The interest at 6% on the money invested would probably reach a figure as high as \$150,000 a year. This is for one station. And all because of this static nuisance. Think too of the trouble it causes the radio fans. If there was ever an invention of the devil it is the static pest.

A careful study of the situation demonstrates to us the importance of this static problem, and what its solution would mean in a financial way to an inventor. Isn't there some way that we can take out these static noises? Isn't there some sort of a filtering process that will hold back these disagreeable murmurings that reach us from the clouds?

Hertz did more than discover radio waves. He discovered the principle of photo-electricity. He found that electrically charged bodies could be discharged by exposing them to ultra-violet light. Out of this simple discovery science of photo-electricity grew. Today we have such things as photo-electric cells, and not a few scientists have tried to apply these cells to radio reception. Some success has been had, but there is still a problem to be solved. The photo-electric cell is tremendously sensitive and it can be made to rectify feeble currents. If we had a photo-electric cell it would last us a long, long time.

While on the subject of radio problems, it would be unwise to overlook the matter of radio power transmission. We transmit radio power everyday. The broadcasting stations allow electrical energy to pour over the face of the earth.

Continued on page 86

**THIS IS THE SWITCH**  
**that does the trick**  
**Turn it 'till you hear it click**  
**FOUR WAY COMPANY. SPRINGFIELD, MASS. U.S.A.**

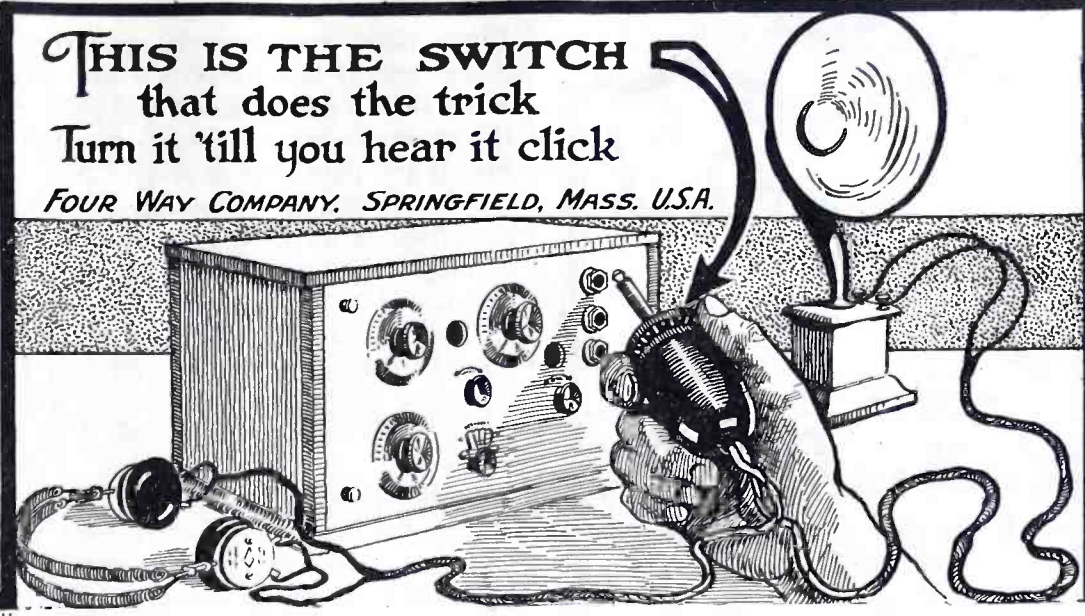

**TURN 1: Head Set**  
**TURN 2: Loud Speaker**  
**TURN 3: Both in Series**  
**TURN 4: Both in Parallel**

*The latest and greatest improvement in Radio!*

A switch plug which makes it possible to tune in through head set and switch in loud speaker by turning dial. Two head sets can be readily attached, or one head set and loud speaker. Both can be used at the same time or either one alone.

**\$1.50**

**FOUR WAY COMPANY**  
 Dept. E Springfield, Mass.

# RADIO DISTANCES

## To Estimate Them Quickly, Accurately—

Use Cram's Detailed Radio Map covering the United States and Canada. Just one hundred miles to the inch. Map plate 30x20 inches, on sheet 34x28 inches. Latest call numbers at sides and bottom. Used by Radio Experts. Radio Districts and headquarters and time divisions. New edition now ready. Ideal for the purpose.

POSTPAID

Pocket Form.....	\$0.35
Wall Style Wooden Rollers....	1.50
On Heavy Board for Tacks....	6.75

*Special quantity prices to trade  
and advertisers*

## THE GEORGE F. CRAM CO.

111 N. Market Street  
 Department R. M. CHICAGO, ILL.

Tell them that you saw it in RADIO



Continued from page 85

Every radio receiver picks up a tiny bit of this energy and converts it into sound. If we have a pail of water and pour it on the street, the water flows in every direction if the pavement is level. No large amount of water is flowing in any one direction. If we were to pour this water through a pipe we would concentrate its effect, and so it would be with electrical energy from a broadcasting station if we were to shoot it out in one straight line. Then we might be able to receive a large part of the energy and to put it to useful work.

Radio power—considerable amounts of it—has been transmitted over short distances. In fact, in a recent experiment made by one of the large electrical companies a toy motor was made to run by radio transmitted current.

We all know that the present method of broadcasting is economically unsound. A manufacturer selling a broadcast receiver is more or less obligated to supply entertainment with it. On the other hand a phonograph manufacturer makes most of his money from the records which he sells for the instrument. Eastman once said he would give his kodaks away if people would use his film.

But what has this to do with technical radio problems. Just this much: If some wise radio man would invent a scrambler and unmixer of waves, the broadcasting station owners could charge for the services they give, and receivers instead of being sold could be licensed. Simultaneous transmission could be made on several wavelengths and the particular receivers would be able to piece these waves together in such a way as to make possible intelligent reproduction. This would solve a mean commercial problem.

Let us not forget the automatic radio control of distant mechanisms. Here is a fruitful field for research and investigation. Soon the world will be running by radio and the writer is firm in the belief that the commercial future of automatic radio control will pale the broadcasting field into insignificance.

We have often seen the telautographs working in railroad stations and hotels. The telautograph allows us to write over an electric wire. Why cannot some genius radioize this contrivance? Incidentally that brings up the problem of the transmission of photographs. There is a niche waiting in the commercial world to be filled by those who think.

"How To Make Radio Receiving Apparatus" is the subject of a helpful 28-page bulletin being freely distributed by the Federal Telephone & Telegraph Co., of Buffalo, N. Y. After a brief foreword illustrating and describing each standard part of a set, illustrated descriptions are given of the construction of a crystal detector, talc detector and various stages of audio and radio frequency amplification.

Tell them that you saw it in RADIO

STANDARD EQUIPMENT

PRICES?

Can U Beat 'Em?

Every item is guaranteed highest grade and perfect or money refunded.

	Regular	Our Price
Magnavox, R-3.....	\$45.00	\$34.50
WD-11 Peanut Tube—Socket Free .....		6.50
Cunningham Detector Tubes.....		5.00
Cunningham Amplifier Tubes.....		6.50
With each Cunningham tube purchased we will give free 1 bakelite base, metal neck socket and 1 high grade rheostat.		
Baldwin Phones .....	\$12.00	\$ 9.25
Western Electric Aviation Type Army Phones with Headbands Guaranteed New Stock. A Remarkable Value at the price of.....		8.00
11 Plate Variable Condensers.....	3.00	1.45
23 Plate Variable Condensers.....	3.50	1.50
43 Plate Variable Condensers.....	4.50	1.75
Large Size "Tapped" "B" Battery 22½ Volt.....	3.00	1.75
Large Size Tapped "B" Battery 45 Volts.....	5.00	3.00
All-American A. F. Transformers Shielded 10 to 1.....	4.75	3.35
All-American A. F. Transformers Shielded 5 to 1.....	4.75	3.35
All-American A. F. Transformers Shielded 3 to 1.....	4.50	3.25
Erla Radio Frequency Transformers .....	4.00	2.95
Carter Radio Jacks—Open Circuit Jack .....	.70	.50
Closed Circuit Jack.....	.80	.60
Double Circuit Jack.....	.90	.70
Filament Control 4 Spring.....	1.00	.80
Filament Control 6 Spring.....	1.10	.90
High Grade Filament Rheostats .....	.75	.45
Moulded Variometers .....	5.50	3.75
Moulded Variocouplers 180 Degree .....	4.50	3.25
Freshman, Micon, etc.....	30% off list	
Switch Lever—Tapered Knob.....	.40	.17
Switch Points.....	Special at Per Dz.	.10
Switch Stops.....	Special at Per Dz.	.24
Guaranteed Radiocite Mtd.....	.30	.20
Guaranteed Million Point Mtd.....	.30	.20
3" Bakelite Dial .....	.75	.45
Tone Tested Mtd. Galena.....	.30	.20
Grewol Crystal Detector .....	2.00	1.65
Federal No. 226W. Transformers .....	7.00	5.25
Triple Honey Comb Coil Mounting .....	5.00	3.50

SPECIAL SPECIAL SPECIAL SPECIAL  
TUSKA STANDARD LICENSED REGENERATIVE RECEIVER AND TWO STAGE AMPLIFIER COMPLETE WITH—3 Cunningham Tubes—6 Volt 100 Ampere "A" Battery—2 Large Size "B" Batteries—3000 Ohm Headset—Aerial Equipment—and Arkay Loud Speaker—In Short, Nothing Else To Buy—At The Very Special Price of. \$100.00

Send Your Order In Today!  
Shipments made within 24 hours. Please remit by Express or Postal Money Order. Include postage at your zone rate or shipment will be made by Express.

INDEPENDENT  
Radio Supply Co.  
3239 Ogden Ave.  
Chicago, Ill.

Just Out

4th Edition \$1.00

AMATEUR RADIO CALLBOOK



Over 20,000 Call Letters and Map-size 2x3ft

Indispensable to every radio owner. Contains up-to-date list of over 20,000 Amateur, Commercial, Army, Navy, Transoceanic High Powered, and Broadcasting Stations in the United States and Canada; International Morse Code and Convention Signals; the construction and operation of the Reinartz Tuner Detector, and one-stage Amplifier; also an abundance of other useful information.

Included with the book is a splendid two-color map of the United States and Canada, 2x3 ft., showing radio district boundaries, standard time lines, geographical location of broadcasting stations, etc.

Buy the Book with the Blue Cover

The greatest dollar value on the radio market. At your dealer's or direct by mail. Use check or money order. Do not send stamps.

Radio Directory and Pub. Co.,  
45-0 Vesey St., New York City  
Send me a copy of the Amateur Radio Call Book and Map, Fourth Edition, for which I enclose \$1.00.

Name .....

Street .....

Town .....

AMATEUR  
RADIO CALL BOOK



**MECHANICAL RECTIFIER**

*Continued from page 31*

dered to one of the collector rings, bars 2 and 4 are similarly connected to the other collector ring.

The assembly is now ready to mount on the shaft of the motor. In securing this assembly to the motor shaft—if the mica insulation on the commutator is lined up with the center line of the slots that were cut in the rotor, the reversing will take place at nearly the zero portion of the sine curve. In fact this setting is so nearly right that it will require a very little shifting of the brushes to adjust the switch, this holds true though only if one of the brushes on the commutator is parallel and the other at right angles to the base of the motor.

The construction of suitable brush holders is a matter that will vary with the different types of motors used and can best be worked out in each individual case. Three holes were drilled and tapped in the end casting of the motor, each being the same distance from the shaft of the motor. To these were fastened a formica ring 4½ in. outside diameter; 2 in. inside diameter and ⅜ in. thick. Slots about 1½ in. long were cut in the formica at the three supporting screws. These slots are cut so that the brushes which this ring supports can be shifted partly around the commutator.

As before stated, in placing the holders for the brushes intended to ride on the commutator, one brush should be so placed that its length will be parallel with the base of the motor. The other brush must be at right angles. Copper gauze was found to be the best material for these brushes and for best results should be ⅛ in. square. The brushes can also be made of carbon. However the grade of carbon used here caused a deposit on the commutator and unless it was cleaned quite frequently it would arc over. This will not happen with copper gauze brushes. The brushes on the collector ring can be of carbon and can ride on the rings at any convenient position. A binding post should be provided on each of the four brush arms.

In putting the machine into service connect the two leads from the transformer to the two brushes riding on commutator. Connect the two binding posts on the collector rings to filter or transmitter. As this rectifier is not self polarizing it will be necessary to connect a polarity reversing switch, Fig. 2, in the output circuit of the rectifier.

The brushes should now be adjusted so that there is a minimum of sparking; when properly adjusted, the sparking at the brushes is about the same as is usually found on small vacuum cleaner motors.

When adjusted for a minimum

amount of arcing, final setting can be determined by the radiation meter. Often a shift of 1/16 in. will send the ammeter up or down 1/10 amp.

It would be well before applying full voltage to the set to look over the insulation, filter condensers, etc. While the insulation and filter condensers probably held up with the electrolytic and other rectifiers, the voltage efficiency of the mechanical rectifier was about 99%; or with 500 volt supply an electrolytic rectifier will give 400 volts to the set. The rectifier here described will give about 495 volts.

The commutator described has been tested under operating conditions with voltage up to 1500. For those desiring to handle larger voltage, I would suggest that instead of making reversing switch from a commutator, that they have moulded a four segment wheel, similar to R.C.A. tone wheel.

**Original Nathaniel Baldwin HEADSETS**

Type C Complete Special Price **\$11.75**

**FREE** with each pair of phones—a \$5.00 Shelton Loud Speaker.

Phones can be used as head set or on speaker. Both for less than the regular price of the Baldwins. Cash with order or C. O. D.

**WALTER SCOTT**

10 St. Lukes Place, Montclair, N. J.



**How to build the Reinartz Receiver**

is told, complete with illustrations and diagrams, in the latest addition to the "Chi-Rad" Handbook-Catalog.

Out Handbook also includes:

1. Technical discussions of standard radio apparatus and equipment.
2. Radio definitions, wireless codes, wire tables, definitions, etc.

Pin this ad to your letter and mail it together with a dime for your copy of the Handbook.

Send for it, today!

**Chicago Radio Apparatus Co.**

415 S. Dearborn St., Chicago



*Investigate!*  
**WESTERN-RADIO DEALERS SERVICE**  
Wholesale RADIO Only  
637 So. Hope Street, LOS ANGELES  
565 Howard Street, SAN FRANCISCO

Tell them that you saw it in RADIO

**FLERON VERNIER ADJUSTER**

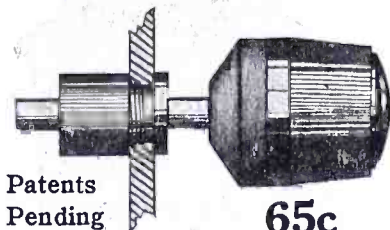

Patents Pending

**65c**

An absolute necessity for close sharp tuning. One should be with every tuning dial on your set.

Easily mounted by drilling only one 5/16" hole. Normal position of Vernier is away from the dial. A slight pressure causes beveled soft rubber of Vernier to make contact with bevel of dial. Vernier is then turned for accurate tuning.

**FLERON PORCELAIN INSULATORS**



No deterioration in the weather with Fleron Porcelain Insulators. These insulators are made with a heavy Black Glaze without kiln marks or white spots. Each one packed in a separate Carton. FIVE SIZES.

- No. 0—1⅛x3 long ..... \$0.20
- No. 1—1⅝x4 long ..... .30
- No. 2—2⅛x3¾ (Ball) ..... .35
- No. 3—1⅝x5 long ..... .40
- No. 4—1⅝x8 long ..... .60

**M. M. FLERON & SON**

INCORPORATED

Manufacturers

TRENTON, N. J.

U. S. A.

**LOUD SPEAKER**

for any

**CRYSTAL SET**

By using the STEINMETZ amplifier you can fill the whole room with music and can increase your range up to 1000 miles. \$8.50, remit by check or money order.

Specials for limited time only

- Radiotron UV200 Detector tube ..... \$3.75
- Amplifier tubes ..... 4.75
- 1½ volt dry cell tubes ..... 4.75
- Sockets for standard tubes, 50c; sockets for 1½ volt dry cell tubes, 50c; standard 2000 ohm phones, \$3.90; 3000 ohm, \$4.90; SUPERIOR crystal sets, \$3.90; Eveready 22½ volt "B" Batteries, \$1.50; Rheostats, 50c; Vac. tube detector sets, \$5.50; Amplifier sets, \$8.50.

This add must accompany order. Complete instructive catalog, 5c.

At your dealer's or

STEINMETZ WIRELESS MFG. CO.  
6704 Penn. Ave., Pittsburgh, Pa.



## New "United" Vernier Dial Assembly

More Power and Far Greater Selectivity



Large capacity, due to the large area of the mica-insulated copper vernier plates.

Great Fineness of tuning, due to the delicate screw thread adjustment of Vernier.

Short-circuiting rendered practically impossible. Note that the opposing circuits are located in the Knob and Dial—a new and better way.

This new United Vernier Dial Assembly can be attached to any plate condenser, it being necessary to drill one hole

Price, Postpaid — \$2.50

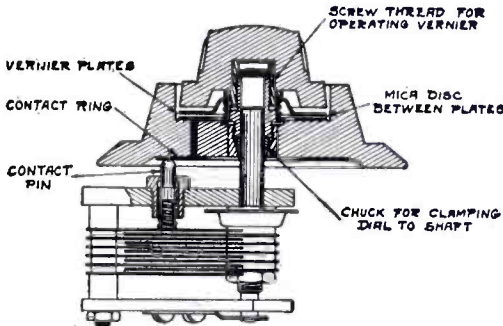

### United Variable Condensers With New Type Vernier Dial Assembly

43 plate \$6.50	23 plate \$6.00	11 plate \$5.50
5 plate \$5.00	3 plate \$4.75	

"UNITED" AMPLIFYING TRANSFORMER. Audio Frequency, magnetically shielded. Fine piece of precision workmanship. Ratio 5-1. Each \$4.50

All United Products are sold under a positive money-back guarantee. When you remit or write for circular, give us the name and address of your favorite Radio dealer.

### United Mfg. and Distributing Co.

536 Lake Shore Drive, Chicago, Ill.

NEW YORK OFFICE

50 Church St., New York, N. Y.

SAN FRANCISCO OFFICE

709 Mission St., San Francisco, Cal.

## \$5.25

Guaranteed 1½ Volt Tube  
Operates on Dry Cell

Detectors and Amplifiers, Best Made

\$5.00 Guaranteed Detector Tubes (6 Volt).....\$2.95

\$6.50 Guaranteed Amplifier Tubes (6 Volt)..... 3.45

Sent post paid anywhere, upon receipt of price

Price list free (containing 100 bargains)

Broadway Electrical Novelty House

Mall Order Department R. O.  
134 Third Ave., New York, N. Y.

## RECENT RADIO PATENTS

Continued from page 36

by the radio waves directly, but may be operated when modulated waves are received. When this occurs, a local circuit including relay 19 is alternately made and broken by the diaphragm, and signal 23, controlled by the local circuit, is accordingly operated.

R. A. Heising, Pat. No. 1,445,278: February 13, 1923. Thermionic Vacuum Tube.

A scheme is described for equalizing the temperature of a plurality of filaments 14, 15, 16, 17 in thermionic tubes 10, 11, 12, 13. The course C supplies filaments 14 and 15 in series, as well as 16 and 17 in series. The output circuits are in parallel, all of them connecting to a coil of transformer 9. Due to this parallel arrangement, filaments 14 and 16 would carry the space current for tubes 11 and 17 respectively, and would be heated more than the other filaments. To overcome this, shunt resistances 18 and 19 are provided. Furthermore resistances 20 to 25 are also provided for safeguarding against excessive temperatures in the remaining filaments should any one burn out.

M. Latour, Pat. No. 1,447,793: March 6, 1923. Radio Receiving System.

When receiving is accomplished with the aid of a heterodyning voltage applied at the receiving station, it is found that there is a limit to the intensity of the signal as this voltage is increased. This is due to the creation of a permanent magnetization in the telephone receivers by the signals themselves. In order to overcome this and increase the sensitivity, it is suggested to reduce the usual permanent magnetization usually applied to the telephone, so that this magnetization added to that due to heterodyning, will be just sufficient to produce the most sensitive state. To increase the sensitivity still more, it is suggested to use two rectifying detectors oppositely connected to the receiving circuit so that both half waves may be utilized.

G. H. Stevenson, Pat. No. 1,448,575: March 13, 1923. Wave Meter and Similar Electrical Device.

A scheme is described for the more accurate calibration of a wave meter circuit, including a fixed inductance 1, a variable condenser 2 calibrated to read either wavelength or frequency, a detector 3, and phone 7. Such a circuit sometimes utilizes a buzzer arrangement 8 for impressing on this circuit wave trains carrying waves of the frequency at which the circuit is resonant. In order to control the connection and disconnection of the buzzer, a switch K is provided. The blades 11 and 12 of this switch when open form a small condenser which interferes with the proper calibration of the circuit. In order to compensate for this effect, auxiliary insulated blades 13 are provided which have the same capacity effect on the circuit when the switch K is closed, as that of the blades 11 and 12 when the switch is open.

W. F. Gehrig, Pat. No. 1,449,148: March 20, 1923. Detector for Wireless Telephone Outfits.

A crystal detector is described, in which a universal adjustment of the cat whisker 22 is effected by the aid of a ball and socket joint. This joint includes two hemispherical cups 18 and 19, frictionally held in a stationary spring clip 16. The rod 21 carrying the exploring electrode is slidable through the ball formed by the cups. After the sensitive spot is found, it is maintained thereon by the frictional forces produced by the spring clips.

M. S. Strock, Pat. No. 1,449,253: March 20, 1923. Unidirectional Receiving System.

In order to produce unidirectional effects in a receiving system, a rotatable loop circuit. A is employed, which is inductively coupled by the aid of coil 3 to a uniform

absorbing system B. An amplifier-detector is used, in which the input electrodes 4 and 7 are respectively connected to the two circuits. The phase of energy interchange between the two circuits depends upon the relative position of the coil, and it is found that potential variations are correspondingly produced on the input circuit.

W. Schaffer, Pat. No. 1,446,433: February 20, 1923. Circuit Arrangement for Indicating the Deviation of a Sender from a Desired Frequency.

In order to indicate and correct deviations of frequency of a sender 1 in a transmission system, an auxiliary sender such as tube arrangement 2 is utilized, which is set to oscillate at the required frequency. This tube 2 is coupled to the oscillatory circuit by an intermediate circuit 3 in which the indicator 6 is located. Deviations of sender frequency may then be recognized by the variation in current flow in circuit 3.

W. Schaffer and Fritz Kruschinsky, Pat. No. 1,446,434: February 20, 1923. Circuit Arrangement for Use In the Transmission of Signals.

This patent describes a scheme whereby the electrical characteristics of a high frequency generator circuit are maintained substantially constant. The generator G may be used to supply both the plate voltage as well as the heating current for one or more transmitter tubes. A coil Dr in series with the generator performs the circuit regulation and for this purpose it is wound over core which is already magnetized by a direct pulsating current derived from the generator circuit, as by the aid of transformer HT and rectifier G1. The greater the current flow in the generator G caused by a greater load on main transformer T, the less the reactance Dr becomes, and the effect of a decreasing potential of G due to increased load may be exactly neutralized. Further intermittent magnetization of the core may be provided by a key Ta or a microphone in order to secure signaling.

A. Leib, Pat. No. 1,446,425: February 20, 1923. Wave Meter With Cathode Tube.

In order to measure the wavelengths of radiations received by the antenna A, a tunable measuring circuit W is utilized, to which is also connected as oscillating tube K. The wave is determined by tuning to maximum response in the phone T, and in order to secure audible indications an interrupter or buzzer M is arranged to split up the radio waves into audio frequency groups. The connections to and from the batteries 1 and 2 for the tube are effected by the aid of switches B, C, D, F, H and W<sup>1</sup>.

A. Meissner, Pat. No. 1,445,636: February 20, 1923. Method of and Means for Indicating the Frequency Alterations of an Alternating Current.

In order to ensure that the proper frequency is transmitted by antenna A, an indicator D is utilized, in which the indication is zero only when the desired frequency is transmitted. To secure this result, the indicator derives energy through two paths from the antenna, including couplings S<sub>1</sub> and S<sub>2</sub>, which are so tuned that for the desired frequency the currents are exactly in phase opposition as they flow through the indicator. For any other frequency there is no exact phase opposition, and the indicator moves from its zero position.

W. R. G. Baker, Pat. No. 1,445,929: February 20, 1923. Electrical Apparatus.

An oscillator tube A and a modulator tube B have their plate circuits connected to a common source of potential, C. The tube B also flows through the common inductor 19 so as to affect variations in the oscillations. In order to vary the range of such an arrangement,

Tell them that you saw it in RADIO

*Investigate!*  
**WESTERN-RADIO**  
**DEALERS SERVICE**  
Wholesale RADIO Only  
637 So. Hope Street, 565 Howard Street  
LOS ANGELES, SAN FRANCISCO



it is desirable to vary the potential of source C as well as that applied between the grid and filament of tube B. To accomplish this in a most satisfactory manner, a common shaft 29 is used to operate both switches 28 and 31 for simultaneously varying the excitation of the generator C and the number of active cells in battery 30.

B. W. Kendall, Pat. No. 1,446,752: February 27, 1923. Generator and the Generation of Multiple Frequencies.

In order to obtain higher frequency harmonics by the aid of an oscillating thermionic device 6, the variation of voltage impressed on the grid thereof is made greater than that required to obtain the saturation current through it. The result is a distorted e. m. f. in the output circuit, and the harmonics may be segregated out by the aid of tone trap circuits and filter circuits.

L. Espenschied, Pat. No. 1,446,890: February 27, 1923. Radio Receiving Apparatus.

A scheme for eliminating the effect of energy received in the form of impulses, upon a receiving system is described. Such an arrangement is especially useful for reducing "static". In order to accomplish this result, a Campbell wave filter 12-13-14-15 is closely coupled to the receiving antenna and is so adjusted that it utilizes the shock excitation energy over a broad wave band, which band may include the wave of the frequency at which it is desired to receive. The detector circuit is connected to the filter through an amplifier of the audion type and is very accurately tuned to the desired frequency. Due to the filter coupled to the antenna, the disturbing impulsive excitations become spread out over the whole band of frequencies, and is not concentrated only on the frequency to which the receiving circuit is to respond. Thus only that small portion of the disturbing energy is present in the detector circuit which has a frequency in the filter near that of the signaling frequency.

Am.-Plus Storage Battery Company has established a new plant at 425 West Superior Street, Chicago, to replace the one destroyed by fire on Jan. 24th.

## ANNOUNCING TWO NEW TUBES 1 1/2 VOLTS

Voltage ..... 1 1/10-1 1/2  
Fil. Amp. .... .25  
Plate Volt. .... 20-75  
Base..... Large Standard Size

Guaranteed Unsurpassable Quality

On SAMPLE ORDERS WE OFFER  
CONSUMERS AND DEALERS

### Introductory Price

WRC 22 Amplifier 5.50 List 6.50  
Detector

WRC 20 Detector 5.00 List 6.00

Cash with order. Shipment  
made same day order received.

Dealers and Jobbers Write for Prices

Conway Electrical Laboratories

Sales Div., Box 22

125 E. 34th St. New York City

# The Receiver that Satisfies Telmaco



## Type B-R Receiver

fully meets the requirements of the discriminating purchaser because of the following features:

**EFFICIENCY OF OPERATION:** Securing volume, distance (1500 miles with single tube is not unusual), selectivity. Broadcasting stations one-half mile distant are tuned out by a slight turn of condenser dial.

**EASE OF OPERATION** enabling the novice to secure satisfactory results.

**HIGHEST QUALITY OF WORKMANSHIP AND MATERIALS.**

**PRICE** within the reach of everybody.

Manufactured exclusively for us by the Tri-City Radio Electric Supply Co., licensed under Armstrong U. S. Patent No. 1113149, October 6th, 1914.

## Specifications:

**Panel**—Formica, grained and machine engraved. **Vario-Coupler**—Telmaco special silk wound with loading inductance. **Condenser**—Special 13-plate with Bakelite ends. **Rheostat**—Single knob control. **Socket**—Highly nickeled shell, Bakelite base. **Dials**—are polished, presenting pleasing contrast with dull panel. **Telmaco Adjustable Vernier Handle**—secures extremely fine tuning and entirely eliminates body capacity effects. **Workmanship**—manufactured according to Telmaco's rigid specifications. This Guarantees Your Satisfaction. Either 6 volt or 1 1/2 volt tube may be used.

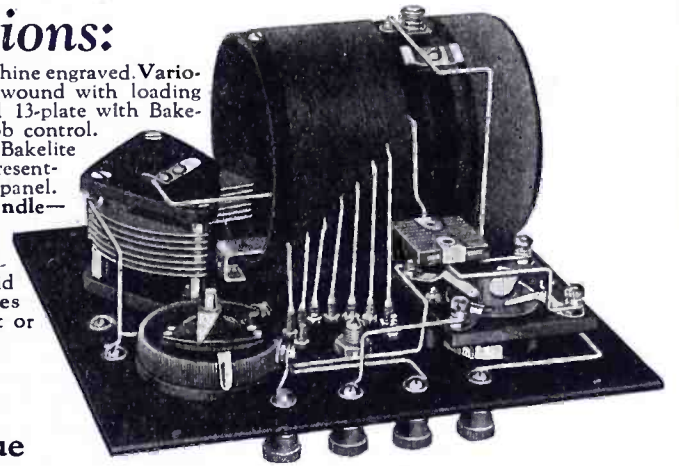

Price \$25

The ultimate in value



Quality Radio Exclusively

Bona Fide Jobbers

If our salesmen have not reached you with our proposition, write or wire for it today

## TELMACO Type B-A Two Stage A. F. Amplifier

Matches the above in size and construction. The greatest Amplifier value on the market. Price \$20.00.

RADIO DIVISION

TELEPHONE MAINTENANCE CO.  
20 S. Wells Street, Dept. A Chicago, Illinois

## "B" BATTERIES AN EVEREADY PRODUCT

43V. Batteries, tapped..... \$5.00  
22 1/2 V. Batteries, Navy Type..... 3.00  
22 1/2 V. Batteries, Commercial Type..... 2.00

Latter two types especially adapted to  
Cunningham and Radiotron Tubes.  
Postage Prepaid Anywhere in U. S.

ETS-HOKIN & GALVIN

Wireless Engineers

10 Mission Street

San Francisco

## "EURACO PRODUCTS"

(Guaranteed)

Compact — Interchangeable — Accurate  
Most Efficient



Price 60 cents per Unit  
Mfgs. of

MICA CONDENSERS, GRID LEAKS,  
MOUNTINGS

Interesting Proposition for Dealers

European Radio Company

1342 East 22nd Street

Brooklyn, N. Y.

Tell them that you saw it in RADIO



# ★ ★ RADIOADS ★ ★

A CLASSIFIED ADVERTISING SECTION READ BY BETTER BUYERS

The rate per word is five cents, net. Remittance must accompany all advertisements. Include name and address when counting words.

ADS FOR THE JUNE ISSUE MUST REACH US BY MAY FIRST

**THE RADIO BROADCASTING CLUB.** The only club of its kind in the world. Keep up with the art. Up-to-date radio news, programs, and articles in our free Journal to members. Radio apparatus and parts sold to members at a big discount. Dues only \$1.00 a year. Join now. Write to RADIO BROADCASTING CLUB, Room 52 Ryland Bldg., San Jose, Calif.

**FOR SALE OR EXCHANGE**—Colin B. Kennedy, Universal receiver, old type all letters answered. Hyman 1708 W. 23d St., Los Angeles.

**Electric Soldering Irons.** Price \$1.50 post paid. Richmond Radio Shop, 421 Macdonald Ave., Richmond, Calif.

**Automatic Regenerative Receiver.** 1000 to 1500 miles on one tube, one control, 150 to 25,000 meters. No rheostat, storage battery, variocoupler, variometer, 3 coil mounting, variable inductance, taps or radio frequency. Complete information and hookup \$1. No checks. Nothing to guess about. Build and save 50% or more and get better results. Radio Experimental Laboratory, Box 194-D, Berkeley, Calif.

I will pay \$1.00 each in radio goods for the following Nos. of PACIFIC RADIO NEWS. Vol. I, Nos. 1, 4, 6, 7, and 9; Vol. II, No. 1, and Vol. IV, No. 4 of RADIO. PAUL FRANKLIN JOHNSON, 560 E. Colorado St., Pasadena, Calif.

**Receiving sets good for 1000 miles.** Price including everything with gum wood cabinet \$32.00. Not a crystal set. Richmond Radio Shop, 421 Macdonald Ave., Richmond, Calif.

**Condensite Dials,** three inch 35c each, three for \$1.00, postpaid. State size of shaft when ordering. Richmond Radio Shop, 421 Macdonald Ave., Richmond, Calif.

**MUST SELL Regenerative Receiver,** mahogany finished cabinet. Contains detector and three stages amplification with tubes, Dictograph phones, Baldwin loud speaker, "A" and "B" storage batteries, Westinghouse charger, and Aerial. A \$200 outfit complete for \$100. W. H. Clifton, Van Wert, Ohio.

**LOOK—\$240 set \$115,** long and short wave regenerative receiver, detector, two stage amplifier, also tubes, B batteries, storage battery, phones. Wm. Del Monte, 860 Union St., San Francisco, Cal.

**EDISON ELEMENTS for STORAGE "B" Batteries.** I handle only first grade, full capacity plates. Six to ten cents per pair, postpaid, depending solely upon quantity ordered. A. J. Hanks, 608 Montgomery St., Jersey City, N. J. (6 T. Exp. Oct.)

**Western Electric set complete in original crates,** includes transmitter, receiver, loud speaker, amplifier, dynamotors, switchboards, fones, etc., as described Page 15 April RADIO. Sell at once for \$240.00. J. Lafore, Narberth, Pa.

**FOR SALE:** Best looking W. C.W., I.C.W. or 10 W. Phone Transmitter made. Six meters R.C.A. Material cost \$300.00 to build. Also CR-9 RECEIVER; all cheap. Picture sent. Hyman Fink, 1708 W. 23rd St., Los Angeles, Cal.

**LIGHTNING**—Electrolyte startles the world. Charges discharged batteries instantly. Eliminates the old method. Gallon free to agents. Lightning Co., St. Paul, Minn.

**RADIO WORLD, THE GREAT NATIONAL WEEKLY**—published every seven days with all the latest news, developments and pictures of the radio field. 15c a copy. \$6.00 a year (52 numbers), \$3.00 six months, \$1.50 three months. Special to radio readers. Send \$1.00 and we will send you the next eight issues of RADIO WORLD. Pub. Office, 1493 Broadway, New York. (tc)

**Vacuum Tube Hospital**  
We repair and guarantee them.  
Agents, Dealers, and Customers Wanted.  
George H. Porell Co., Inc.  
West Somerville, Mass.

**RADIO GENERATORS—500 Volt, 100 Watt,** \$23.50. High Speed Motors, Federal Phones, \$5.50. Battery Charges, \$12.50. Motor Specialties Co., Crafton, Pittsburgh, Pa. (tc)

**C. W. and RADIO PHONISTS**—Our new converters will satisfy your need for a more efficient and durable direct current plate supply. No armatures to burn out. Output from seven hundred to two thousand volts at .4 amperes. Synchronous Motors, Transformers and other parts sold separate. Write immediately. Kimley Equipment Mfg. Co., 290 Winslow Ave., Buffalo, N. Y. (tc)

**WANTED**—Radio Engineer to travel extensively. Must be capable of highest type of sales service work in demonstrating and introducing line of patented radio equipment for well known manufacturer of thirty years standing. Write, stating experience, education, age and salary desired. Box 333, "RADIO", San Francisco.

**RADIO FANS**—Make your own "A" and "B" batteries. Our catalog tells you how. All kinds of radio apparatus and materials. Stamp for catalog. PACIFIC SCREW CO., Dept. W, 645 N. E. 53rd St., Portland, Oregon.

## BUSINESS OPPORTUNITIES

**BIG MONEY IN RADIO.** Thousands of men needed in fastest growing industry. Best positions go to men holding Government License in Radio. Easy to qualify for this at home in spare time. Write for Free Book on radio. Describes bigger opportunities in Radio; tells how you can easily qualify for them. Address, National Radio Institute, Dept. M-9, 1345 Pennsylvania Ave., N. W. Washington, D. C.

## NEW APPARATUS

Continued from page 42

### Latest F-F Rectifier Charges "B" Storage Batteries Only

Charging B storage batteries of 22 and 100 volts from alternating current can be easily, economically and cleanly done with the Type TB mechanical rectifier, recently added to the line of F-F Battery Boosters, made and marketed by The France Manufacturing Company, Cleveland, Ohio.

The manufacturer states: "We developed this low-priced equipment to overcome the uncertainties of electrolytic rectifiers with their attendant mussiness, short life and great voltage loss. Type BB is always ready for instant use. It has no parts to get out of order or to deteriorate."

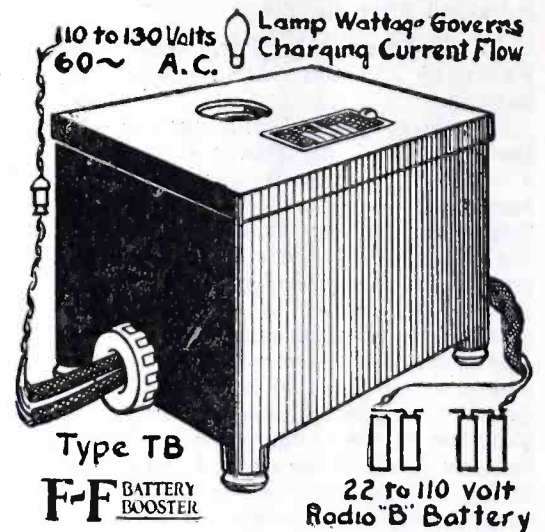

Any group of lead or Edison cells equivalent to 22 or 100 volts can be charged in series at the same time. The current rate is regulated by tungsten lamp screwed into socket shown on rectifier. Usually a 60-watt lamp meets the requirement.

A B storage battery is charged by first disconnecting it from the receiving set. Clips supplied on ends of battery cords coming from rectifier are snapped on battery terminals—positive to positive, negative to negative—no chance for reversed currents. The extension cord is then plugged into any convenient a. c. lamp socket.

### SOCKET CHANGES FOR DRY BATTERY TUBES

A great many of us have wondered why it was that the Radio Corporation, with its exclusive control over the manufacturer of vacuum tubes, have seen fit to change the types and sizes of their bases.

This question was put to one of their representatives recently, who made the following explanation:

"There have been no changes made in tube design without a real reason for changing.

"The size of the W. D. 11 tube lends itself to a smaller base. The variation in the size of the prongs and peculiar location insure the tube being placed in the socket with the proper connections and prevent its being burned out by being placed in a socket of sets using a 6-volt battery.

"The same reason for changing the size of the base also applies to the new G.E. 199 tube that works from two dry cells.

"However, the most interesting change for added efficiency is in the changing of the plate and grid terminals. In the regular 6-volt tube No. 200, 201 and 201-A, the plates and grid terminals are side by side. In the Westinghouse W. D. 11 tube and General Electric Company's No. 199 tube, the plates and grid terminals or prongs are opposite each other. This elimination of capacity between these two terminals adds a great deal to the efficiency of these tubes. To get

## Use a Leich Non-Tune Rectifier For Charging Your Radio Storage Battery



The Leich NON-TUNE Rectifier has a charging rate of 2 amperes when connected to a six volt storage battery.

This rate is sufficient for home use where three to four watt tubes are operated.

Before many months one to one and one-half watt tubes (1 1/4 amp.) will be common practice.

Here the Leich NON-TUNE Rectifier is in a class by itself, highly efficient; at full load it consumes less current than a 40-watt lamp; reliable, and with a charging rate to assure long life to the battery.

**NON-TUNE FEATURE,** gives this charger flexibility in its operation, allowing for considerable voltage and frequency variation of the power circuit.

**A PATENTED RELAY LOCK** keeps the battery circuit open when the power current fails.

**LEADING RAILROAD COMPANIES** have used Non-Tune Rectifiers for years for charging batteries in their signal service because Non-Tune can be depended upon to function properly at all times.

Try a NON-TUNE. Ask your dealer or write for Bulletin No. 101B.

# LEICH ELECTRIC CO.

Manufacturers Genoa, Illinois

NON-TUNE RECTIFIERS—LEICH COMFORTABLE HEADPHONES

Tell them that you saw it in RADIO





A high-grade Headset of standard aluminum construction, at a price that appeals to the average purchaser of radio apparatus.

# CLARION

RADIO HEADSET

## \$5.00

The Clarion Headset is guaranteed to give perfect satisfaction or purchase price will be refunded.

Circular 21-A, mailed free on request, is of interest to Jobbers, Dealers and those desiring a high grade headset at moderate cost.

**Radio Supply Company**  
Hornell, N. Y.

the full benefit of this efficiency, it is advisable to use sockets designed especially for this tube. Some manufacturers have simply made over the mould for their regular sockets, necessitating making the changing of connections underneath. To do this they must run close to each other and this restores the capacity effect to a serious degree. This same objection is also found in all adapters, as it is necessary for the connection to cross over and run in close proximity to each other."

The Na-ald socket designed and sold by the Alden Mfg. Company, formerly the Alden-Napier Company, Springfield, Mass., is designed especially for this tube, avoiding the fault just mentioned, and combining a contact of exceptional merit. The Na-ald contact has a wiping action so made that it will take care of all variation in tube prongs and at the same time exert a pressure that holds the tube firmly in the socket. The conventional socket design, however, has only a pressing contact of small area against the ends of the tube terminals, although the Electrical Engineer in designing a snap switch or any other electrical contacting device, would insist on a wiping contact. A dual wiping contact is also provided in the Na-ald No. 400 De Luxe socket for No. 200, 201, 201-A tubes.

### Brandes Develop Improved Cord Terminal

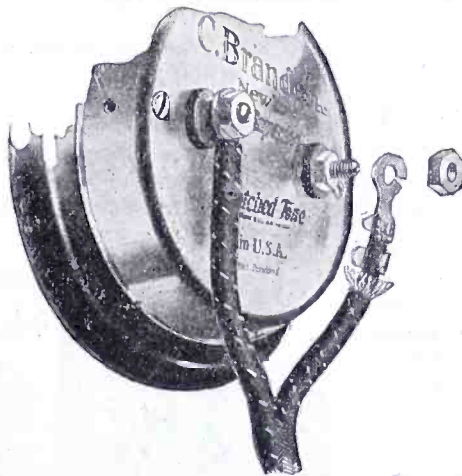

The new cord for Brandes' matched tone headsets is a decided improvement over the old way of terminating the cord at the receiver end and attaching it to the binding post. It is provided with a lock terminal that prevents it from twisting backward and forward under the lock nut. The same piece of metal that holds the tinsel braid and forms the contact for the lead wires, goes around the binding post much the same as the ordinary lock washer, and thus prevents possibility of the terminal slipping out of the binding post while the headset is in use. It also removes all strain from the tinsel conducting cord and keeps the braid from slipping back and thus exposing the tinsel. All Brandes headset cords have a red interwoven tracer, showing the positive terminal.

### NEW RADIO CATALOGS

"Getting Acquainted With Radio Receivers" is the subject of a helpful booklet written by Paul Godley and published by Adams-Morgan Co., of Upper Montclair, N. J. It gives the most complete directions for the installation and operation of Paragon receivers. Its price is 25 cents, except to owners of Paragon sets. As an instruction booklet it will be of value to any owner of a regenerative variometer set.

Dayton Radio Products are attractively illustrated and described in a booklet from The A. C. Electrical Mfg. Co., of Dayton, Ohio. It includes a handy dictionary of commonly used radio terms and a number of suggested hookups.

Tell them that you saw it in RADIO

## A "Radio Wonder" \$1.25

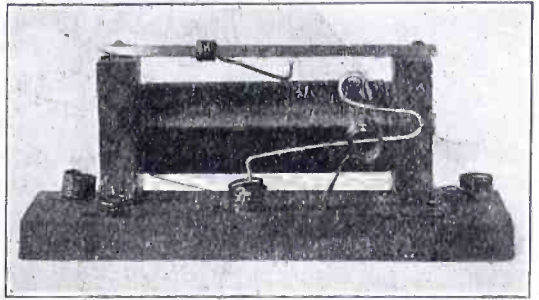

This splendid little set will receive radio concerts from any station within thirty miles, and will give just as satisfactory results as the larger and more expensive machines. Each outfit is equipped with an extra-sensitive piece of Standard mineral and is complete—ready for use—when you receive it. Full directions sent with each set.

Results are simply a revelation, so why be without one. Order yours at once and include ten cents with your money order to cover postage.

Dealer Inquiries Invited

**GERING SPECIALTIES CO.**  
274 Halsey Street  
Newark, N. J.

## CRYSTALS

Unconditionally  
GUARANTEED

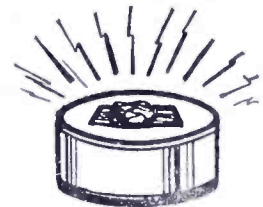

Crystals are unconditionally guaranteed to give satisfaction—we tie no strings to our offer, they must be right.

**Standard Mineral Company**  
216 Market St. Newark, N. J.

*Investigate!*  
**WESTERN-RADIO DEALERS SERVICE**  
Wholesale RADIO Only  
637 So. Hope Street, LOS ANGELES 565 Howard Street, SAN FRANCISCO

### VARIABLE CONDENSERS

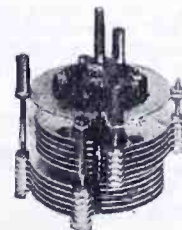

8-Plate Vernier . . . . \$0.75  
23-Plate .0005 Mfd. . . 1.75  
43-Plate .001 Mfd. . . 2.25  
24-Plate Bal. Cond. . . 3.75  
44-Plate Bal. Cond. . . 4.75  
Add 10c for postage.

Aluminum Plates, accurate spacing. Shaft runs in bearings. Money back if you are not satisfied.

**MONTROSE MFG. CO.**  
1200 Bedford Ave.,  
Brooklyn, N. Y.

*This is the Switch*  
that does the trick.  
Turn it till you hear it click

**Four Way Switch Plug**

ASK TO SEE IT

MANUFACTURED BY  
**THE FOUR WAY COMPANY**  
Springfield, Mass. U.S.A.

PRICE \$1.50 PRICE \$1.50



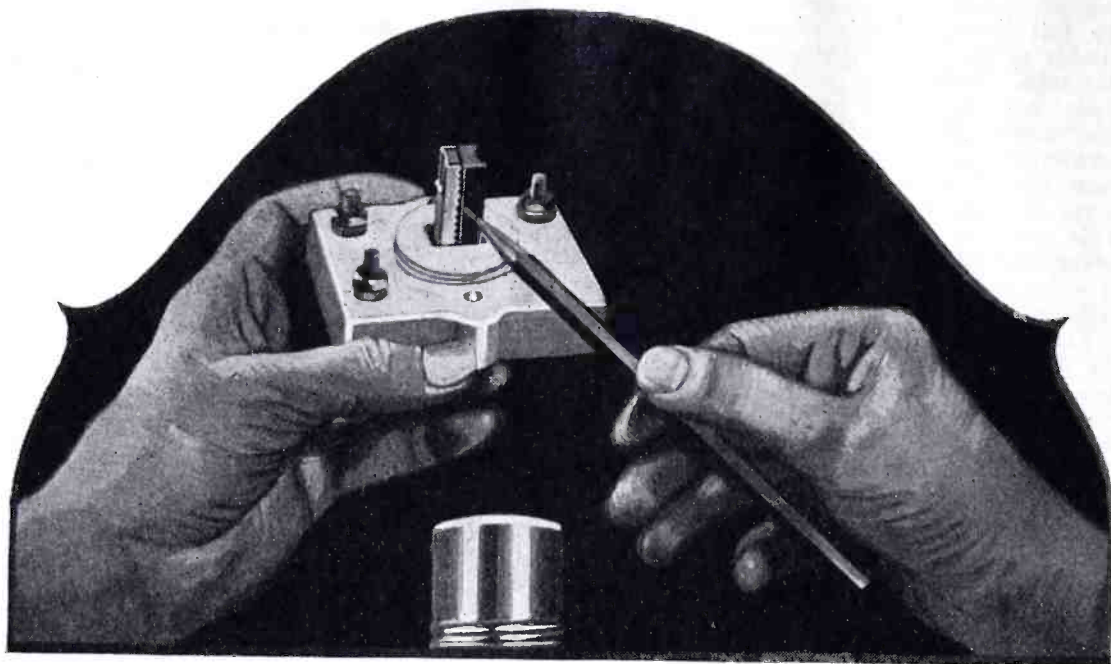

## The "sawtooth" gap makes the **FROST-RADIO PROTECTOR** positively self-cleaning

Every radio receiving set must have a protector approved under new rules as revised May, 1922. You should equip your set with a Frost-Radio Protector.



Note that the protector elements are closely spaced in accordance with new rules.

### Has THREE Big Features

1. Is positively self-cleaning, due to the "sawtooth" construction of the gap between carbon and metal.
2. Positively will not interfere with radio reception.
3. Mounts indoors like your telephone protector.

### Best for your set

because made by experienced telephone engineers who have made a long study of protectors.

Easily installed by anyone—absolutely safe.

Dealers: Your trade is demanding Frost-Radio Protectors.

Get in touch with your jobber today and order a stock for your customers. This is the season when every set must be equipped with an approved protector.

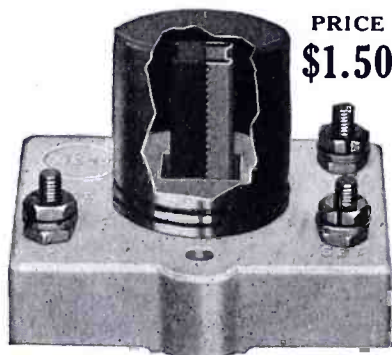

## THE AUTOSTAT

A radical advance in radio filament control is represented by the Autostat, developed in the engineering laboratory of the Automatic Electrical Devices Company, Cincinnati, Ohio, also manufacturers of the Homcharger. This super radio rheostat gives the most precise control of filament current, inasmuch as it is not necessary to turn the knob a hair's breadth to get a fine adjustment, since there are forty complete turns of the knob between maximum and minimum resistance. In its construction two parallel mounted, wire-wound, fire-proof resistance tubes are connected in series by a micrometer operated slider—the length of wire in the circuit depending upon the location of this slider.

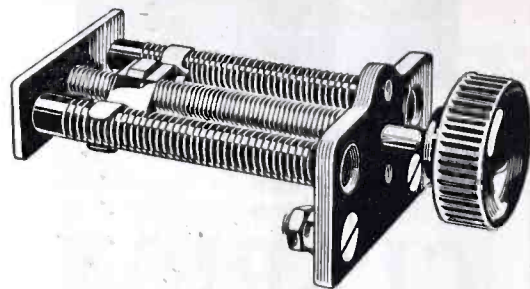

It is claimed that one full turn of the Autostat knob produces finer tuning than a hair's breadth adjustment on any other—that it brings in distant stations loud and clear, and tunes in those elusive stations that heretofore have remained unheard. It gives a uniform change in resistance with each turn of the knob, possessing practically "zero" resistance at full-on position.

The Autostat is compact in size, neatly mounted and requires a minimum of space. Furthermore, it is a most economical rheostat, inasmuch as only one Autostat is necessary to control two amplifying bulbs. It can also be used with six volt or WD-11 detector tubes, or one 5-watt power tube.

## RADIO TRADE NOTES

William Dubilier, president of the Dubilier Condenser and Radio Corporation, has returned from Europe with some interesting new radio developments, amongst which was a radio control system for trains developed by the Germans and installed on locomotives, which gives a signal to the engineer and which will greatly minimize collisions. Also that a new means has been devised for generating high frequency oscillations which is much cheaper and easier to build and maintain than tubes for high power. This new method can be used for power up to 25,000 kw. Interesting developments have been going on in the direction of "cracking" oils by means of high frequency currents, and of obtaining nitrogen from the air. Many large plants are now contemplated, one of which is to be installed in Egypt. Condensers are being designed for these installations which are almost as large as a dwelling house, and which will cost about \$100,000 each.

The Rauland Manufacturing Company, Chicago, manufacturer of the "All American" line of radio amplifying transformers, has moved its office from 35th South Dearborn Street to No. 200 North Jefferson Street. The new quarters offer improved facilities for taking care of their greatly increased demand.

To meet a very insistent demand, the Electric Specialty Company of Stamford, Conn., is now building a number of sizes of 2 bearing motor-generators for battery charging, signal work, etc. These are supplied with or without panel boards. Ratings 100, 200 and 300 watts. They are of the shell type, and the construction is unusually rugged, large shafts and bearings.



# HERBERT H. FROST, Inc.

154 WEST LAKE STREET, CHICAGO, ILLINOIS.

# RUSONITE

CRYSTAL RECTIFIER  
MULTIPOINT (Patent Pending)

A Synthetic CRYSTAL DETECTOR,  
sensitive over its entire surface.

Eliminates all detector troubles. Extraordinary clearness and volume. Endorsed by Radio experts and press. Sold in Sealed Packages only. Join the ever-increasing Rusonite fans.

Price Postpaid, Mounted  
Sensitiveness Guaranteed **50c**

**RUSONITE CATWHISKER**  
14 Karat Gold Multipoint contact. Super-sensitive ..... **25c**  
Order from your dealer or direct from us.

RUSONITE PRODUCTS CORP.  
16 Park Row, N. Y. Dept. "R."

## "Add-A-Vernier"

fits any

**Variable Plate Condenser**

Price 75 Cents

Jobbers and Dealers Write for Discounts.  
JOHNSON ELECTRIC CO., Mfrs.

1113 N. Broadway Oklahoma City

*Investigate!*

## WESTERN-RADIO DEALERS SERVICE

Wholesale RADIO Only

637 So. Hope Street, 565 Howard Street  
LOS ANGELES SAN FRANCISCO

Tell them that you saw it in RADIO



**THE NEW MODEL A  
REGENATONE**

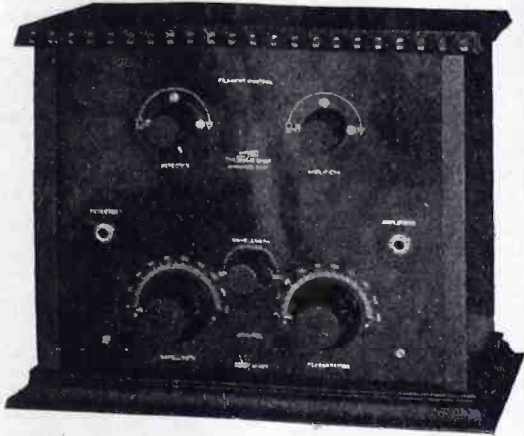

The Model A Regenatone is a well designed detector and two stage amplifier being distributed by The H. Earle Wright Co., of San Francisco and California. This regenatone receiver is entirely self-contained in a mahogany cabinet when dry cell battery tubes are used. With other tubes the only external accessory is a storage battery.

The circuit is so designed that only two controls are necessary, body capacity effects are eliminated, and sound reproduction is without distortion.

After extensive experiments the Leich Electric Company of Genoa, Ill., has devised a method whereby practically all of the interference between their frequency converter and radio receiving sets may be eliminated. The method consists of bridging two condensers, one between each outside terminal and center terminal of the left hand transformer. While not all the interference is stopped, it makes radio receiving practicable, and by keeping the contact points clean at all times, the results are much better.

**CALLS HEARD**

At 6CKC, Jack Ward, 1143 Francisco St., Berkeley, Calif.

C. W.: 1ht, 5bk, 5eo, 5la, 5ado, 6bq, 6ka, 6tq, 6zh, 6zz, 6ael, 6agi, 6amk, 6aoi, 6atg, 6baw, 6bic, 6bik, 6bip, 6bjr, 6bjq, 6bqw, 6bsz, 6bum, 6bun, 6buo, 6bve, 6bvr, 6bvg, 6can, 6cbg, 6cbu, 6ceu, 6xad, 7ab, 7ak, 7au, 7gf, 7gl, 7jd, 7jl, 7my, 7na, 7ne, 7nf, 7oi, 7om, 7ri, 7sc, 7tq, 7ve, 7vf, 7wk, 7wn, 7zf, 7zv, 7afw, 7all, 7amk, 9au, 9bx, 9bji, 9bzi, 9ccv. Total 65 calls. One step audio.

By TRI, John Soderstrom, Montesano, Wash.

C. W.: 1boa, 2xq, 3aro, 4ag, 4eb, 4eh, 4bi, 4hh, 5caf, 5adi, 3ado, 5air, 5ako, (5auo fone??), 5bm, 5ek, 5ky, 5jt, 5ka, 5mb, 5px, 5rh, 5sm, 5tj, 5uk, 5xab, 5xad, 5xac, 5xv, 5za, 5zas, 5zh, 5zo, 5zav, 6aa, (6ak), 6ao, 6ar, 6aw, 6aat, 6aaw, (abx), 6aib, 6ajh, 6alh, 6amk, 6amw, 6amz, 6anz, 6aio, (6arb), (6arf), 6alx, 6asx, (6aiu), 6atc, 6atg, 6atj, 6atk, 6auu, 6avr, 6avv, 6avx, (6awt), (6awx), 6bbk, 6bc, 6bcj, (6bcb), 6acm, 6bds, 6bcr, 6bct, 6beh, 6bic, 6bik, (6bin), 6biz, 6bjj, 6bjk, 6bjg, 6bkj, 6bmd, (6bnu), (6bru), 6bsj, 6bob, 6boe, 6bop, 6bow, 6bpl, (6bun), (6buy), 6bgg, 6bge, 6bsa, 6bsy, (6bua), 6bum, 6bux, (6can), 6cba, 6cbd, 6cbw, (6cc), 6ceb, 6cec, 6cee, 6cgg, 6chl, 6cp, 6cu, 6dd, (6dy), 6ec, (6esm), 6cay, 6ff, 6ft, 6fy, 6qf, (6qm), 6hm, 6hp, 6jd, 6jx, (6ka), (6ku), 6lf, 6lo, 6lu, 6mh, 6nx, 6pi, 6rd, 6rm, 6su, 6sz, 6ti, 6wi, 6zf, 6zh, 6zi, 6zt, 6zx, 6zz, 6xad, 7aad, 7abc, (7abb), 7abh, 7aby, 7acx, (7adg), (7adm), (7adp), (7aea), (7aem), 7afb, (7aff), (7afh), 7afo, 7aft, (7afw), (7ahw), 7aif, (7aiu), 7aip, (7aiy), 7ajv, (7ak), 7aw, 7ba, (7bj), (7bk), (7cz), 7dh, (7dp), (7eb), (7eq), (7er), 7fr, (7ge), 7gp, 7hi, (7hj), 7hm, 7hs, 7io, 7jf, (7ke), (7kf), (7ks), (7lr), (7ln), 7lu, 7lw, (7mc), (7mf), 7mq, (7na), 7nc, (7ne), 7nf, (7ng), (7nl), (7ny), (7ot), (7om), (7qf), 7jc, 7je, 7jg, (7jw), (7tq), (7rn), 7rw, (7pb), (7sy), 7sz, (7th), (7tt), (7ud), 7vf, 7wa, (7we), 7wg, (7wm), (7wq), (7ws), 7xb, 7xg, 7zb, 7zk, 7zl, 7zo, 7zv, 8ab, 8af, 8ahh, 8alt, 8bbe, 8bdu, 8bek, 8brq, 8cae, 8cih, 8cgz, 8cur, 8et, 8hn, 8ib, 8ow, 8qk, 8xe, 9abq, 9abu, 9ahh, 9amu, 9anq, 9ape, 9apr, 9apw, 9ar, 9asf, 9atn, 9aua, 9aww, 9awv, 9aws, 9bbx, 9bbf, 9bcb, 9bef, 9bch, 9bed, 9bic, 9bji, 9bjr, 9bjp, 9bm, 9bri, 9bsg, 9bsz, 9btz, 9bun, 9buy, 9bxm, 9bxg, 9bzi, 9cao, 9cba, 9cc, 9ccv, 9cgo, 9cit, 9cmk, 9cpa, 9crk, 9ctv, 9cui, 9cwc, 9cxo, 9ddl, 9dgv, 9dky, 9dsu, 9dsw, 9dte, 9dts, 9dvc, 9dxc, 9ece, 9ecz, 9eny, 9ep, 9et, 9gh,

9hk, 9ii, 9kp, 9lf, 9ox, 9pi, 9pn, 9qf, 9uh, 9ur, 9uu, 9yar, 9zaf. Spark: 6amk, 6ars, 7acm, 7cs, 7fg. Can., C. W.: 4bv, 4cl, 4co, (4dq), 4lh, 5ac, 5ak, (5ax), (5cn), (5ct), 5ej, (5go), 9bo, 9bx, spk-5hd. Will all stations hearing 7ri's 5 watter pse qsl, all cards answered.

By 6BFU, 1965 Marin Ave., Berkeley, Cal.

2fm, 2fp, 2agy, 3bt, 3ec, 4vi, 4oi, 5kp, 5qi, 5za, 5zh, 5zk, 5akf, 6cc, 6ef, 6ka, 6kc, 6ke, (6ku), 6rr, 6zo, 6zx, 6zz, (6aak), 6alu, 6anb, 6aoi, 6atq, 6awx, 6bah, 6baw, 6bjr, 6bob, 6boe, 6bpb, 6brg, 6bru, 7hi, 7hj, 7io, 7jg, 7ln, 7mf, 7my, 7na, 7nn, 7ot, 7sy, 7to, 7tq, 7tt, 7ve, 7vf, 7wq, 7zl, (7zu), 7acx, 7ads, 7agw, 7ari, 8ib, 8ml, 8vq, 8bfq, 8cmi, 9bx, 9fv, 9ami, 9ape, 9ayu, 9bji, 9bxm, 9xz, 9bzi, 9cds, 9cfy, 9cns, 9cui, 9dgi, 9dky, 9dgg, 9dwn, 9eil, 9elw, 9ehz. Can.: 5go, 5cn, 5ct, 9av, 9bd. Spark: 6od, 6ol, 6up, 6ald, (7kj), 7np, 7og, 9bd, 9bkj.

By 6CCY, Riverbank, Calif.

C. W.: 1cmk, 1tt, 2fp, 2om, 3tr, 3aro, 4oi, (Porto Rico), 4eh, 5xb, 5aag, 5ado, 5ej, 5os, 5ae, 5js, 5pn, 5rh, 5ok, 5sa, 5hh, 5iq, 5gn, 5ek, 5za, 5pb, (6's and 7's too numerous) 8aim, 8cf, 8ld, 8dd, 8sp, 8crb, 8cmi, 8yn, 8cog, 8bfq, 8bb, 8bom, 8cit, 8ws, 9bji, 9ym, 9bzi, 9bun, 9cfy, 9ap, 9eea, 9bxm, 9bhy, 9bg, 9awm, 9cth, 9aps, 9hho, 9cwr, 9ct, 9aks, 9bxt, 9aic, 9bhv, 9cgy, 9bed, 9yb, 9aeq, 9ede, 9cnh, 9dio, 9ctg, 9clq, 9hkm, 9bri, 9bkc, 9qr, 9ddy, 9dsm, 9uh, 9cby, 9bky, 9ccv, 9aau. (Can.) 3xn, 3co, 3zh, 4bv, 4ct, 5cn, 5ct, 9bx, (fone). Will answer all crds.

**CRYSTAL FANS**

Are you satisfied with your crystal, or do you want better results?

**MOLYBDIC GALENA**

A new detector just discovered is sensitive even when ground to dust.

Send 50c for one of these wonder crystals. We will refund your money if you are not entirely satisfied.

Phoenix Radio Laboratory  
Box 842, Phoenix, Arizona

**IF YOU HAVE A COPY OF  
"RADIO"**

for January or February, 1923, on hand, we will buy it from you for 25 cts. — "RADIO," Pacific Bldg., San Francisco.

**BRECO RADIO APPARATUS**

*Bring Best Results—They are Dependable*

Listed below are a few BRECO specialties. Owing to our increased facilities, we are able to reduce the prices on some of our manufactured products.

Variometers .....	\$7.00	Crystal Detectors .....	\$1.75
Variocouplers .....	5.00	Inductance Switches complete	
Variable Condensers, 43 plate....	4.50	with 7 points and 2 stops.....	.50
Dials, 3 in. Moulded.....	.50	Switch Points .....	.03
Rheostats .....	.75	A. F. Transformers.....	5.00
Binding Posts, N. P. or Insulated Knob.....			.08
Mahogany cabinets, various sizes.....			\$5.00 up
Bakelite sheets .....			per lb., \$2.00
Straight Circuit Tuner with Detector.....			\$35.00
Detector and Two Stage Amplifier.....			\$50.00
Straight Circuit Tuner with Detector and Three Stage Amplifier.....			\$115.00

Write for Catalogue

If your dealer cannot fill your requirements on BRECO apparatus, your order mailed to us will receive prompt attention.

**BRONX RADIO EQUIPMENT COMPANY**

Bronx, N. Y. C. "Manufacturers of Quality" 687 Courtlandt Ave.

6OE

KGO

6XR

**I Ship All Over  
the United States**

*"Everything Worth While In Radio"*

**AT THE RADIO STORE OF  
PAUL FRANKLIN JOHNSON**

DISTRIBUTOR FOR

GENERAL RADIO MAGNAVOX WESTON METERS  
BALDWIN FONES DX TRANSFORMERS

560-562 East Colorado Street  
PASADENA, CALIFORNIA

MAY SPECIALS

AMRAD AND CLAPP EASTHAM SETS ..... 20% Discount

Tell them that you saw it in RADIO







# DEMAND Your Money's Worth!—

Many Western radio fans are not aware of the fact that the current news of western broadcasters—new sixth district call letters—questions and answers—news of radio developments in the west—radio definitions—excellent editorials—constructional articles, and a mass of other valuable information in addition to the publication of complete broadcast programs and schedules for KPO, KLX, WMAQ, KRE, KLS, KGW, KFBK, KDYL, KHJ, KFI and other stations are published every week in

## "BROADCAST PROGRAM"

*Authority of the  
Broadcasting West*

Only  
5 Cents  
Per  
Copy

At Least  
36 Pages  
Every  
Week

**FREE!** A Standard \$3.50 "ADAPTOLA" for receiving music thru your phonograph is given free with only one subscription (\$1.00).

"RADIO," Pacific Bldg., S. F. Cal.

Send me "Broadcast Program" for 26 weeks and the ADAPTOLA. I enclose \$1.00 in full payment.

Name .....

Address .....

### Something New! A 12 point Rotary Switch

THIS Switch is designed to solve one of the most vexing problems of the amateur and professional builders of radio receiving sets. It eliminates unsightly front of board contact points, providing a complete unit for rear of panel mounting, to which variocoupler taps may be easily soldered. It is held in place by two mounting screws, heads of which are neatly covered by the indicating dial. The knob and dial are mounted on adjustable shaft held by set screw for any thickness of panel up to  $\frac{3}{8}$  inch.

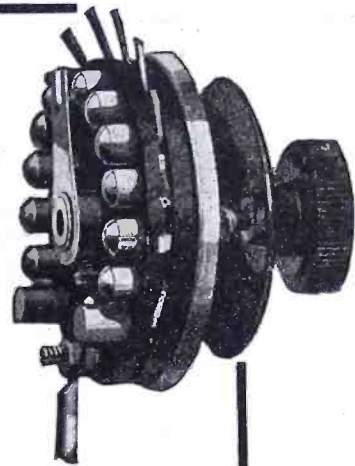

This Switch may be used with a voltmeter for reading voltage on individual tube filaments.

List Price \$1.50. Trade Discounts on Application.

*Sterling*

THE STERLING MFG. CO.

2847 Prospect Ave.,

Cleveland, Ohio

#### OTHER STERLING RADIO DEVICES

Portable Rectifiers for Recharging "A" Batteries

Audio Frequency Amplifying Transformers

Radio Frequency Amplifying Transformers

Filament Rheostats

Filament Ammeters and Voltmeters

Pocket Voltmeters for Testing "B" Batteries

Battery Attachment for Charging "B" Batteries

## Introducing the "SR 25"

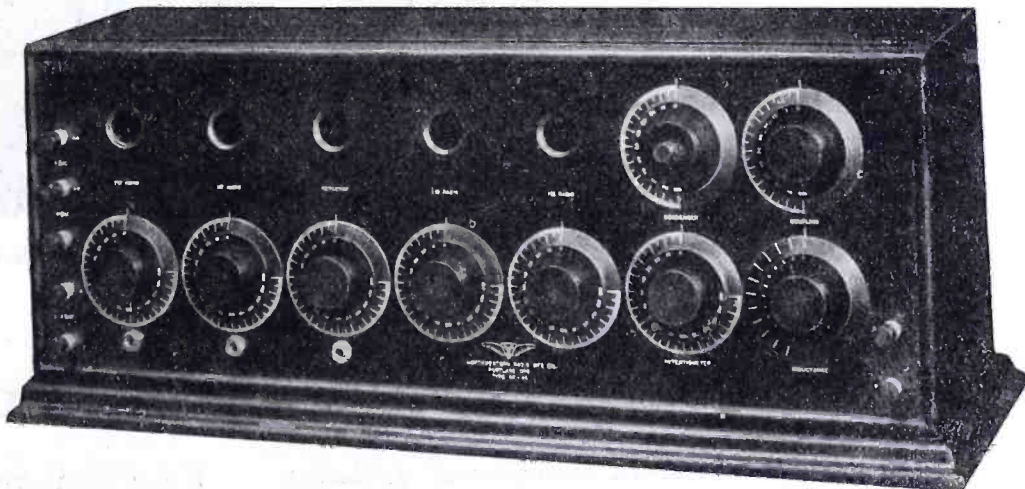

WE INVITE YOUR ENQUIRIES

**Hallock and Watson Radio Service**

192 Park Street

"KGG"

Portland, Ore.



### QUALITY PRODUCTS

Instruments 'Phones Loud Speakers

Send for Bulletins AI-10 and AI-20

ROLLER-SMITH COMPANY, 20 Park Place, NEW YORK

WORKS: BETHLEHEM, PA.

Offices in Principal Cities in U. S. and Canada

Tell them that you saw it in RADIO





## Dayton Radio Products

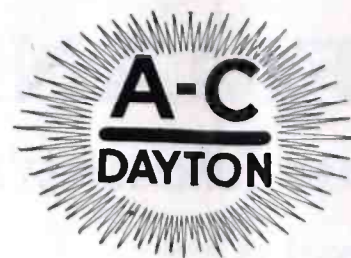

### FIL-FONE CONTROL SWITCH

# No Jacks—No Plugs

*Its Use Will Be Universal*

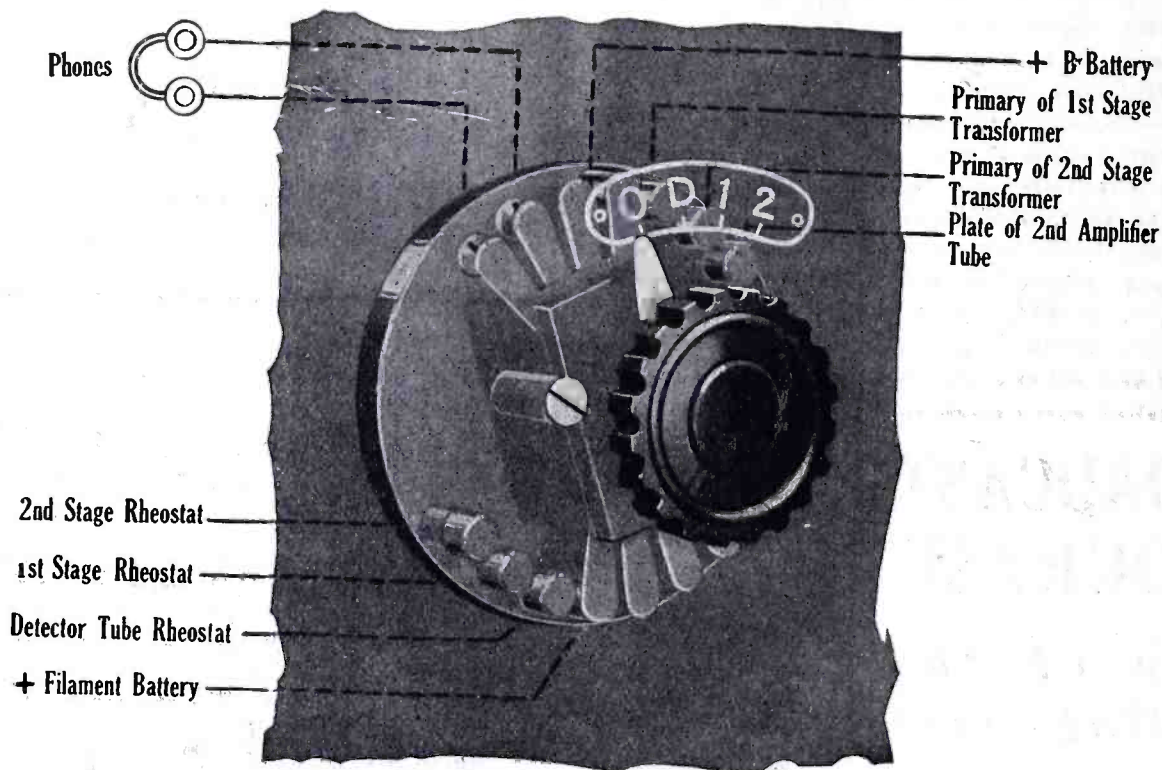

Design and Circuit Connections Protected by Patents Pending

## Price \$3.00

### DISPENSES WITH JACKS AND PHONE PLUGS

SAVES 10 feet of wire, 12 connections, soldering and three hrs. time in assembly of Vacuum Tube Sets.

CONTROLS the filaments, "B" Battery, and Phones with one movement from "OFF" position to Detector, first or second stage as desired.

ACTION is noiseless, progressive, positive.

LENGTHENS the life of the tube filaments.

IDEAL for adapting Tube Sets to local or long distance reception.

FIL-FONE Switches will be universally adopted in all Tube Set assemblies because of the saving in MATERIALS and LABOR, improvement in APPEARANCE of the Set, and convenience of operation.

Printed instructions for installing, with complete wiring diagram furnished with every Switch.

Send for FREE descriptive Circular F. F. S. No. 2. If you cannot find Fil-Fone Control Switch at your Dealer's send direct to factory. Immediate shipment.

*(Complete catalog of Radio Parts with useful Radio information sent on receipt of six cents in stamps for mailing.)*

## THE A-C ELECTRICAL MFG. COMPANY

DAYTON, OHIO

*Makers of Electrical Devices for Over Twenty Years*

Tell them that you saw it in RADIO



---

# GIBLIN-REMLER

# COILS

*Maximum Inductance. Minimum Distributed Capacity for a given number of turns*

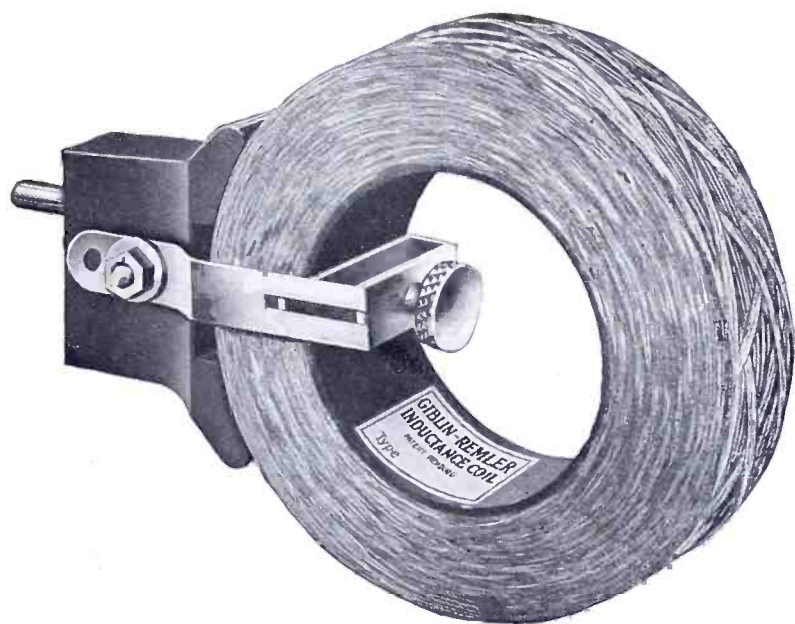

**Maximum Selectivity of tuning. Maximum signal strength and a minimum of Interference**

## *Reducing Interference to a Minimum*

**T**HE special form of winding used in the Giblin-Remler Coil results in maximum inductance, minimum distributed capacity and minimum high frequency resistance for a given number of turns of wire. These are the three features essential in obtaining the highest degree of selectivity.

A sharply tuned circuit is one that has an extremely low resistance to a current of the particular frequency to which it is tuned, and a high resistance to currents of all other frequency. In any receiving circuit there are two kinds of resistance—one, the straight high frequency of the coil, and the other, the resistance caused by the impedance of the coil and the condenser used with it. The first remains fairly constant over a small range of wave lengths. The second resistance is zero at one particular wave length and increases as the wave length

varies in either direction; hence, it is easily seen that when the inductance of the coil is extremely high in proportion to the high-frequency resistance, which is the case in the GIBLIN-REMLER COIL, the circuit in which it is used may be made to have practically no resistance to signals on one particular wave length, and yet have a proportionally high resistance to signals on all other wave lengths. This condition, which is always obtained in circuits using the GIBLIN-REMLER COIL results in a SHARPLY TUNED CIRCUIT, that is, one giving MAXIMUM SIGNAL STRENGTH on the desired wave length, with a MINIMUM OF INTERFERENCE from signals on any other wave length.

Write for Bulletin R, giving complete information, table of constants and prices on Giblin-Remler Coils.

## REMLER RADIO MANUFACTURING COMPANY

Factory and Home Office  
248 First Street, San Francisco, Cal.

Eastern Sales Office  
154 W. Lake Street, Chicago, Ill.



*The Most Beautifully Designed and Efficient  
Operating Radio Receiver on  
the Market for the Price!*

# Regenatone

Model A

## \$75

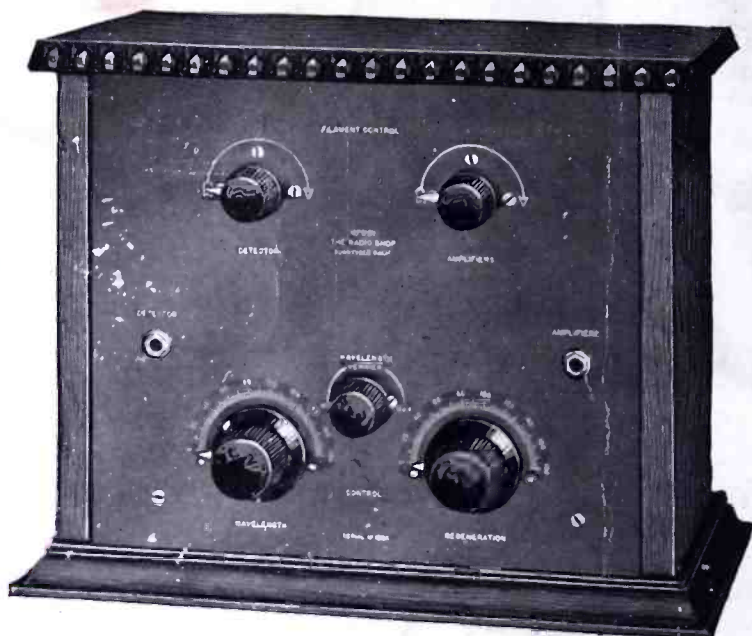

*Manufactured by the Radio Shop, Sunnyvale Calif. under Armstrong U.S. patent No. 1,113,149 and U.S. application No. 807,388.*

Radio broadcasting is here to stay as a public utility and the Regenatone is the leading medium for its enjoyment and usage.

If you have lost faith in the ability of radio to entertain or serve you get in touch immediately with a REGENATONE representative. There is a surprise awaiting you.

### SPECIFICATIONS

Highly polished and beautifully decorated mahogany cabinet. Well selected and flawless formica panel. Well balanced controls with tapering knobs affording smooth tuning action. Only well selected high grade material used throughout. Circuit arranged so that only two controls necessary. Use of "C" battery self contained gives maximum amplification without the usual distortion. All batteries contained in cabinet when using WD-11 tubes. Using other tubes, storage "A" battery only external. All special conveniences known are incorporated in the design.

#### Model "A" Regenatone Complete

Including tubes, batteries, phones and antenna material, ready to operate.

**\$115**

Other combinations of loudspeakers and tubes on request.

Ask your dealer to demonstrate or install on approval. If he cannot supply you write to us direct.

All of the objectional features heretofore found in radio receiving sets have been eliminated in the new Model A REGENATONE. No more trouble from body capacity effects, vernier control insures perfect tuning, simplified mechanical design has reduced tuning to two main adjustments, special circuit arrangement and mechanical design have eliminated all distortion.

These facts alone mean much to radio enthusiasts, in that they are assured a receiving set which will deliver wonderful results without the need of the operator acquiring a radio education.

No false claims are made for the REGENATONE, and when we claim it to be the most beautifully designed and efficient operating radio receiver on the market for the price we are willing to stand behind the statement with the Wright-Radio products guarantee. In every instance where a REGENATONE has been installed the user has expressed profound surprise and admiration for the distance attained and the lack of distortion together with the simplicity of control.

*A San Jose user of the Model A REGENATONE reports nightly reception from Canada, Los Angeles, Portland, Denver, Salt Lake; with occasional reception from Davenport, Iowa; Kansas City, Saint Louis and Havana, Cuba.*

*A Denver user of the Model A REGENATONE reports reception from nearly every class B station in the United States, besides Cuba and Canada.*

These testimonials are an example of the good work being done by the REGENATONE, and will afford you a comparison against the results you desire and the price you wish to pay for standard equipment.

This is the very set the country dwellers have been waiting for, since with it they are able to receive weather reports for crop protection, market reports, news reports daily, and in the evening they can enjoy the high class entertainments broadcasted from the several large Pacific coast broadcasting stations, thus bringing the Grand Opera stars and light opera entertainers directly to their fireside. This is a service you can well afford regardless of your remoteness from the city playhouses and information sources.

In ordering direct from advertising send P. O. money order or certified check on San Francisco Banking house.

## THE H. EARLE WRIGHT COMPANY

DISTRIBUTORS

*The Home of "Radio Center"*

914 South Flower St.  
LOS ANGELES

131-133 Eighth St.  
SAN FRANCISCO

