

The

April, 1926

RADIO HOME

20¢

Conducted by HENRY M. NEELY



TWO COMPLETE RADIO MAGAZINES IN ONE
Something of Interest for Every Member of the Radio Family

Announcing

OUR ENLARGED MAGAZINE

¶ If you like it, or if you think you're going to like it, you'll want to be sure to get it every month. ¶ Twice the price of the old one—yes; but more than twice the size and more than twice as good. ¶ Anyway if price is a consideration, you can have it at the old figure if you act promptly. ¶ Until April 25th, we will enter subscriptions at ONE DOLLAR a year.

¶ After that, we must go to our new price of
TWO DOLLARS



Don't neglect your tubes—
and good radio reception can be obtained all summer long!

Sterling-reactivate your tubes and you will find that the quality of your reception is practically as good as you get in winter—always enjoyable for porch dancing, baseball scores, concerts, and musical entertainment to make warm evenings more enjoyable.

Keep Your Tubes Full of Vigor

with the Sterling Tube Reactivator. The meter on this device shows you when tubes need reactivation and proves their increased efficiency after treatment. A high class instrument, easy to operate, and no guesswork in its results.

Price \$12.50 (50-60 cycle) \$14.00 (25-40 cycle)

For your complete radio home servicing equipment also use Sterling Tube Testers, Sterling Battery Chargers and Sterling Pocket Meters.

Ask your dealer!

THE STERLING MFG. COMPANY
 Cleveland, Ohio - Dept. K.

Sterling
 TUBE
 REACTIVATOR

Don't put it off



Put down the station call letters in the handy slots—right on the dial itself.

SCORES of this season's most advanced circuit-designs, depend on MAR-CO dials, for the searching, responsive tuning needed today. You have seen MAR-CO dials used on Radio-in-the-Home's most popular sets—you will find them in this issue.

So put MAR-CO dials on your own set now. To put it off is to miss the best your set can do.

Most dealers feature MAR-CO dials. They fit all sets. Martin Copeland Co., Providence, R. I.

Have-trigger response

MAR-CO
DIALS

Micrometer-like action



The 1926 model tuning control

Coast to Coast on a Loop with a VICTOREEN "SUPER"



And We Prove It!

That is real radio reception. No oscillations, howls or squeals—no matching of tubes. That means satisfaction and enjoyment for you.

Build your own "Victoreen"

You can secure complete parts to build the "Victoreen" from your dealer for moderate cost.

Victoreen Air Core Transformers are more than matched—they are actually tuned to guaranteed precision of 1-3 of 1%—a Victoreen feature.

Either UV199 or 201A tubes may be used—another Victoreen feature.

"B" Battery consumption is remarkably low—8-10 Milliampere with Potentiometer at negative side—less than some three-tube sets consume.

Range—clarity—volume—selectivity—ease of operation—that's what you get in a Victoreen "Super."

Ask your dealer for a free folder and hook-up of the Victoreen set or write directly to us. Your dealer can supply you with all necessary parts.

The Heart of the Circuit

4 No. 170 R. F. Transformers at \$7.00 each.

1 No. 150 Coupling Unit at \$5.50.

Should use of aerial be preferred to loop, the Victoreen No. 160 Antenna Coupler is required at \$3.50 extra.

The George W. Walker Co.
 6511 Carnegie Ave. Cleveland, Ohio

Branches in principal cities

New! Tone and Volume Control



ESSENTIAL to thoroughly enjoy present-day broadcasting. New high-priced sets feature tone control as their greatest improvement. You can have this new feature in your old set by attaching a Centralab Modulator Plug in place of the old phone plug. Takes but a moment—no tools required.

Gives any degree of tone volume from a whisper to maximum by simply turning the small knob on the plug. Static interference is reduced and programs come in clear and true with just the volume you most enjoy.

Order from your dealer, or mailed direct on receipt of the price, \$2.50

CENTRAL RADIO LABORATORIES
 18 Keefe Avenue Milwaukee, Wis.

Centralab Radiohms or Modulators are standard controls on sixty-six well-known sets.

Centralab



*"Your radio is always top notch.
What do you do to keep it so full
of pep?"*

KEEPING your "B" batteries full of pep, without frequent renewals, is simply a matter of using the right size Evereadys for your particular set with a "C" battery*.

The rule which determines the right size "B" batteries to use is so simple no one can make a mistake, and once learned it definitely settles the question of "B" battery service and economy.

On 1 to 3 tubes—Use Eveready No. 772.

On 4 or more tubes—Use the Heavy Duty "B" Batteries, either No. 770, or the even longer-lived Eveready Layerbilt No. 486.

On all but single tube sets—Use a "C" battery.

When following these rules, No. 772, on 1 to 3 tube sets, will last for a year or more; and Heavy Duties, on sets of 4 or more tubes, for 8 months or longer.

These life figures are based on the established fact that the average year-round use of a set is 2 hours a day.

A pair of Eveready No. 772's for a 5-tube set instead of 2 Eveready No. 770's or 2 Eveready Layerbilts No. 486—looks at first glance like an economy because of lower first cost. But in a few months the 772's will be exhausted and have to be replaced. After the same length of time the Eveready No. 770's

or the Eveready Layerbilts No. 486 will still be good for many more months of service.

We have prepared for your individual use a new booklet, "Choosing and Using the Right Radio Batteries," which we will be glad to send you upon request. This booklet also tells about the proper battery equipment for use with the new power tubes.

*NOTE: In addition to the increased life which an Eveready "C" Battery gives to your "B" batteries, it will add a quality of reception unobtainable without it.

Manufactured and guaranteed by
NATIONAL CARBON CO., INC.
New York San Francisco
Canadian National Carbon Co., Limited, Toronto, Ontario

Tuesday night means Eveready Hour—9 P. M., Eastern Standard Time, through the following stations:

WEAF—New York	WCA—Buffalo	WGN—Chicago
WJAR—Providence	WPAB—Pittsburgh	WOC—Des Moines
WJLB—Boston	WUAB—Cincinnati	WCCO—St. Paul
WJAG—Worcester	WUAB—Cleveland	WSD—St. Louis
WFI—Philadelphia	WJL—Detroit	

Pacific Coast Eveready Program, 1:00—San Francisco, 8 to 9 P. M.



LEFT—No. 486,
for 4, 5 or more
tubes, \$5.50



RIGHT—Eveready
Dry Cell Radio
"A" Battery,
1½ volts.

EVEREADY

Radio Batteries

—they last longer

HENRY M. NEELY, *Editor in Chief.*
 Associate Editors
 G. P. ALLEN, EDWARD B. PATTERSON.
 LESLIE G. BILES, ULMER G. TURNER, JR.
 THEODORE H. NAKKEN.
 Musical Editor, G. W. HARRIS.
 Sports Editor, PAUL W. GIBBONS.
 Washington Correspondent, R. S. MCBRIDE,
 Colorado Building.
 G. W. KRAFT, *Asst. Secretary and Treasurer.*

NORMAN NEELY, *Art Director.*
 J. B. MCKEOWN, *Advertising Manager.*
 HARRY E. DARR, *Circulation Manager.*
 New York Office
 110 West 42d Street.
 A. P. LEON, *Advertising Director.*
 Chicago Office
 30 North Dearborn Street.
 W. T. DIEHL, *Advertising Representative.*

CONTENTS OF THIS ISSUE

Broadcasting Section

Cover Picture by W. V. Chambers...
 Editorially Speaking, by Henry M. Neely 4
 Cover Picture Contest..... 5
 Gridleaks. A Page of Pictures on the Lighter Side of Radio, by Earle K. Bergey 6
 Interference—and What is Being Done to Eliminate it, by G. P. Allen 7
 Play Ball! The Season is on and the Fan Now Turns to His Radio Set Daily, by Paul W. Gibbons 10
 Man Wants Entertainment—What Does Woman Want from Her Radio Set? by Jean Sargent..... 13
 Oh, Yes; Radio's a Great Invention. But You'll Get a Good Laugh from This Article by Charles Magee Adams 16
 Is Hobgoblin Necessarily Bad? Both Sides of the Question of Super-Power Broadcasting, by R. S. McBride 19
 Sir Hobgoblin and His Magic Whistle. Did You Ever Hear All the Sounds of the Magic Wood Folk? By Elizabeth A. Anderson 23
 The Piano Request Lady of WLW, by Alvin Richard Plough..... 26
 Radio and the Music Student. This Month We Take Up Schubert's Great "Unfinished Symphony," by G. W. Harris..... 27
 Mrs. Heath, WJZ's Popular Housewife's Friend and—the Equally Popular Norman Brokenshire, by Elizabeth A. Anderson..... 29
 Our Radio Recipe Contest..... 30
 The Lil' Ole' Professor of WLW, by E. D. Cahn..... 34

Technical and Hook-Up

Editorial: What Next in Radio? By Henry M. Neely 37
 Will the "Wave-Splitter" Revolutionize Radio? By Ulmer G. Turner, Jr. 39
 The T-C Resistance-Coupled, by G. P. Allen..... 42
 Get Europe on the Long Waves, by J. George Uzmamm..... 48
 Tune 'Em Out With This Wave Trap, by G. P. Allen..... 50
 The Piezo Crystal at KDKA, by V. E. Trouant..... 52
 How to Understand Radio, by Theodore H. Nakken..... 55
 The Powertone—a Real One-Dial Set, by Sidney Finkelstein..... 59
 Try This "Audiodyne Oscillator," by the 3XP Staff..... 63
 A 200-Mile Crystal Set, by M. L. Hartmann, Ph. D. and John R. Meagher 67
 Here's Where You Bring Your Troubles, by Ulmer G. Turner, Jr. 69
 Why Do We Use Flux in Soldering? By F. A. Klingenschmitt..... 72



THE RADIO HOME (which is a continuation and enlargement of RADIO IN THE HOME—is published monthly by Consolidated Publishers, Inc. (James S. Gradwell, President; Henry M. Neely, Vice President and General Manager; Harry S. Dale, Treasurer; Leslie G. Biles, Secretary.)
 Publication Office Federal & 19th Sts., Camden, N. J.
 Editorial & Business Offices—Produce Exchange Building, N. E. Cor. Third & Walnut Sts., Phila., Pa.
 Address all Communications to Philadelphia Office
 Printed on the presses of The Hadison Craftsmen, Camden, N. J. Application for entry as second class matter pending at the Postoffice, Camden, N. J., under the act of March 3, 1879. Copyright 1926 by Consolidated Publishers, Inc. THE RADIO HOME is a member of the Audit Bureau of Circulation.

THE RADIO HOME is sold at 20 cents a copy at all newsstands, radio shops and bookstores. Subscription rates, in the United States, \$2.00 a year; Canada, \$2.50; foreign, \$3.50.
 BACK NUMBERS may be secured at 20 cents each while there is an available supply. Copies over one year old cannot be supplied.
 CHANGE OF ADDRESS. Renewal or Discontinuance instructions must be sent two weeks in advance of date they are to go into effect, and it is essential that both old and new address be given.
 AGENTS—We have an attractive proposition for those who wish to make extra money in their spare time. Every serial on a house is an open invitation to come in and talk radio and we find most families welcome the agents who show them this new kind of family radio magazine. Address the Subscription Department.

NEXT MONTH

NEXT month, we have a lot of good things in store for our readers. In the Broadcasting Section, there will be another article by Mr. Allen, telling how to go about locating interference—"man-made static"—which is such a nuisance. Then there will be a surprising article by one of the biggest and most prominent users of "link" or "network" broadcasting—the WEAF chain—telling the kind of programs his letters demand. And there will be another article for the women listeners—candy making, this time—and one about the famous Record Boys of WJZ and lots of others.

IN THE Technical Section, there will be a batteryless set—using the new McCullough A. C. tubes, which we have found quite successful at 3XP, and the first authentic hook-up of the new Hammarlund-Roberts circuit, and the T-C with impedance coupling. Mr. Nakken will continue his "How to Understand Radio." Mr. Patterson will tell you about the latest theory of wave propagation and why the 200 meter band is bad for broadcasting and he will also probably start a series on new ideas in tube development and there will be—
 But you'll simply have to get the May issue to find out about all the good things.

Our Advertising Policy

IN OUR issue October, 1925, we introduced an entirely new and revolutionary policy in radio magazine advertising. We have maintained this policy ever since. The 1925 announcement was:
 "Radio in the Home is devoted entirely to better class radio—the only kind that is fit to go into the American home. Radio in the Home is not in the market for general radio advertising. We make our own tests of apparatus and our own investigations of the financial and commercial reliability of firms, and we solicit advertising only from those manufacturers whose products we ourselves are willing to guarantee in the light of these researches.
 "This is to assure our readers that they can depend on the things they see advertised in our columns. It is a reader service."
 We have rigidly adhered to this policy and will continue to do so. Manufacturers who contemplate advertising in this magazine should first send samples of their products to us at Delanco, New Jersey. Here we maintain a completely equipped laboratory, Station 3XP and are prepared to make any tests required under this policy.



Editorially Speaking *and*

EVERY now and then, Lady Luck smiles sweetly upon an editor and vamps him into a wonderful sense of ease and comfort. She has so vamped me today as I face the task of writing the editorial for this issue. She has sent me two old friends, each with a constructive thought, much better reasoned out and much better expressed than the usual torrent of mere words that customarily gurgles through these two threshold pages of the magazine.

First, I have a letter from Harold N. Loeb, of Cincinnati, who has, in the past, contributed many interesting articles to us. Mr. Loeb speaks enthusiastically of our last month's exposure of the gyp methods used by many department stores in unloading their radio "bargains" upon an unsuspecting public and then goes on with a really constructive bit of advice to the radio dealer and manufacturer and to the buyers in general. He says:

"MERCHANDISE values in virtually every field are determined by the prospective purchaser in comparison with certain standards. A ring, for instance, should approximate fourteen carats pure gold; a suit should be about 95 per cent virgin wool; a shotgun should pattern so many pellets to the circle at a certain distance; an automobile should be capable of certain mileage and consume a known quantity of gasoline and oil.

"Yet in the radio industry even today there are no definite or even approximate standards of performance. One is induced to buy a receiver on certain general representations of sensitivity, selectivity and tone quality, and if the set fails miserably to verify the claims made for it, the salesman has a thousand alibis at his command.

"It is this condition that has made possible the dumping of department store 'bargains' and the vending of gyp merchandise by cut-rate dealers as recently exposed in these columns. And Mr. Average Man will continue to buy a cat-in-the-bag until a standard is set for him.

"This season the radio dealers in the writer's home city and presumably elsewhere, have refused to instal receivers on approval, claiming that unscrupulous persons obtain radio sets without cost from one dealer after another by such a plan, and never do buy. Whether or not the excuse is legitimate, the dealer's refusal to put out sets on trial leaves the prospective purchaser all the more in the dark.

"A radio standard of performance would to a great extent alleviate this condition.

Why Not Have a "STANDARD of PERFORMANCE" for Radio Sets?

By HENRY M. NEELY

Such a standard is herewith suggested, and while it does not reduce reception to an 'exact' basis, it is at least sufficiently definite to give the buyer a chance for his money.

"The receiver should be tested under the following conditions, which can be duplicated somewhere in almost any city, and anywhere in the country districts.

"Antenna: 100 feet long, including lead-in, of 7-strand wire, 30 feet from the ground, properly insulated and clear of obstructions, running horizontally east and west.

"Ground wire: Directly connected (by bridging the water meter with a wire) to cold-water pipe or other pipe embedded at least five feet deep in moist earth, ground lead being not more than 20 feet long.

"Cunningham, or Radio Corporation tubes;

Eveready, Burgess or Ray-o-vac tested B batteries or a B battery eliminator that has been approved by the laboratory of a recognized radio trade paper.

"Time: 9:00 to 10:00 P. M., October through April.

"Distance from nearest broadcasting station of 500 watts or more, one mile or more.

"Under these operating conditions, any receiver to be called satisfactory should do the following:

"Tune out any station in about fifteen graduations of the dials, if the set is less than five miles from the station and in gradually fewer graduations; five dial degrees if 15 miles from station.

"Bring in at least twenty stations, at least five of which are five hundred miles or more distant on an airline.

"BRING in stations broadcasting on 200 meters wave-length and on 550 meters wave-length.

"Bring in KDKA, Pittsburgh, or other station on about 300 to 320 meters at approximately the center of the dial scale.

"Bring in all these stations on the loud speaker with volume at least equal to that of a phonograph played with a soft needle. . . .

"With quality of reproduction at least equal to that of the phonograph. . . .

"This proposed standard has purposely been made sufficiently broad to preclude quibbling. Many persons demand more than this of a radio set, but it is believed that the average buyer would be well pleased to have a receiver performing as outlined, and if he took his case to court, the vendor would have no comeback.

"Perhaps the day will come when we can buy radio receivers with the same assurance of quality that we have when buying food. If so, this effort will not have been in vain."

Why they say "Eight Spot" in Broadcasting Bridge Lessons

MANY fans who listen in regularly to the broadcasting of the bridge games, wonder why the announcers always say "eight spot" when they do not put the word "spot" after any other figure. Odd as it may seem, this proves how badly the average radio set reproduces sound.

The first night the bridge games were broadcast, the phone at Station WEAf was kept busy asking whether McNamee had said "eight" or "ace" in various plays. To those of us who were in the studio, it had not occurred that there could be the slightest confusion of these two totally different sounds.

Then, as we discussed it, the explanation came to us.

The sound of "S"—known as a sibilant—contains a maximum of "harmonics" or a mixture of the original tone and many other tones formed of two, three, four or more times the original number of vibrations. Faulty transformers, faulty speakers and faulty design tend to suppress these higher frequencies, or harmonics, and pass only the broad general sound of the "a" and eliminate the "s" sound entirely.

If you will say "a" and "eight," you will realize how much alike they are. They become almost the same by radio. Therefore faulty sets and speakers made it impossible for the average listener to distinguish between them and it became necessary to add the word "spot" to "eight." H. M. N.

IT JUST happened that, while I was reading this excellent suggestion from Mr. Loeb, my old friend Harry Earle, of the Garod Corporation, came into my office and, as usual, helped himself to one of my cigarettes. While he was lighting it and putting his feet up on my new desk, I read Mr. Loeb's letter to him.

"He's perfectly right," said Harry. "It's too bad you haven't got the nerve to publish it. Of course, you'd offend a lot of advertisers if you did. So you'll throw it in the waste basket like a real

still Editorially Speaking

radio magazine editor. Hand me a couple more of your cigarettes and I'll sit down here at your typewriter and bat out something you ought to add to it. It's supplementary—if that is the right word."

So, for fifteen minutes, he sat at the typewriter and drowned out the riveting machine on the new building across the street and what he handed me—after I'd corrected the places where he couldn't find the right letters on the keyboard—was as follows:

"MY observations in the field have shown me that one of the weakest, if not the weakest, link in the radio merchandising chain, is the retail dealer. There are a few dealers who have already realized the condition that I have in mind and they certainly are cashing in on it. Most dealers will be inclined to disagree with me upon first reading this article, but I am sure that after a little careful thought, most of them will change their decision. In order to tell my story better, I think it best to go back into history a bit.

"I started selling some years ago. My first selling efforts were made on vacuum cleaners. When I first went into the game, all that was necessary was a store, a good window for demonstration and display, and a man on the floor to sell. People would stop, watch the window demonstration and, then, come into the store to ask questions. I have seen as many as twenty-eight sales made in one day in just a small neighborhood store, in this way. It really was a poor day, indeed, that did not net at least two to five sales. Remember, I am speaking of the small town and neighborhood stores.

"This condition went on for about one year and a half, and finally their sales went absolutely flat. The dealers were all bemoaning the dullness in business, but no one making the slightest effort to stop it.

"What was the trouble? Simply this, that the type of person who would stop, look, walk in and buy would be the only one reached in this way. On the other hand, there were plenty of people who might have been very anxious and willing to buy cleaners, if some one had gone out from house to house to dig them up. A person in the latter class might

not even try to buy a vacuum cleaner in any but this way. The majority of them probably had not even noticed the demonstration going on in their local store, or if they had, they were not interested enough to stop and find out what it was all about. Many people have to have their interest aroused by personal

home after a good dinner and give him a real program on a good set, you will readily sell him one.

"Mr. Dealer take the above for what it is worth to you. Try it. You will be surprised and very well pleased with the results. I know dealers who are doing it—and, believe me, it is paying them big."

Our Cover Picture is Our Show Window

DRESSING the show window is one of the hardest jobs in the store. Developing good ideas for cover pictures is one of the hardest jobs in a magazine office.

This is YOUR magazine and we want you to share the hard jobs and the good pay.

We want ideas for our cover picture.

SEND us a suggestion—only a few words or a rough sketch—though the sketch isn't essential. It's the idea we want.

We may develop your idea and change it out of all semblance to your original but, if you'll start us on a good line of thought, it will be worth the money.

**We'll Pay \$50.00
Just For the Idea!**

EVERY month we want to pay some reader \$50 for an idea. If you don't hit it the first month, try it again—and still again. Address:

Cover Picture Contest

The Radio Home

PRODUCE EXCHANGE BUILDING

3rd and Walnut Sts. - - - Philadelphia

contact and this means salesmanship.

"Finally the dealers came to the conclusion that this was the best way, and started after business again. Men were put out calling direct on the homes, and the results were rather amazing. So much for the cleaner game.

"I want to ask you in all sincerity if you don't think that there is a decided similarity between the above tale and the present situation in which the radio dealer finds himself. Of course, there is. It is almost identical.

"The above type of prospect is the same as in the radio game. He would never think of going into a store for a demonstration. He is not interested simply because he does not know what radio has in store for him. It might also be due to the fact that he is sour on radio on account of hearing it under poor conditions or by means of a poor set. In either case, if you can get him in his own

And so, having printed the opinions of Mr. Loeb and Mr. Earle, I think I've written a darn good editorial so I'll call it a day.

I ONLY want to add a few thoughts bearing on these two suggestions. The standard of performance set by Mr. Loeb is a most reasonable one and any set which will not meet this standard is a poor set and should not be bought at any price because it will never give satisfaction. This, however, must be qualified by the reminder that there are certain freak locations where no set will give good reception. If you are in such a place as this, the thing to do is to find out what your nearby neighbors get on their receivers and to buy no set which will not very nearly equal their performance.

Mr. Earle has expanded an idea which I have frequently advocated in this magazine. The dealer who will not place a set in your home for trial is a back number or else he knows that there

is something wrong with the set he is trying to make you buy.

You would not think of buying an automobile without a thorough demonstration and you know that you can have almost any household appliance installed in your home for trial before purchase. There is no reason on earth why the radio dealer should set himself apart and insist upon a plan of selling which was given up long ago by other industries which go into the home.

So, to sum it up,—do not buy a set which will not meet Mr. Loeb's standard of performance and do not patronize a dealer who will not meet Mr. Earle's standard of merchandising.

H. M. N. Signing Off.



GRIDLEAKS

by
EARL K. BERGEY



**NEW
WAVE
LENGTHS**

E.K. BERGEY 26



BROADCASTING



**A DARN GOOD
HOOK-UP**



**STAND BY FOR ANOTHER
ANNOUNCEMENT ...**



**SO'S
YOUR
AUNT
ENNA**

INTERFERENCE

How One City Located Its Sources of Man-Made Static and Eliminated All of Them

LANCASTER, Pennsylvania, has solved the problem of eliminating disturbances in radio sets caused by machinery made and operated by man. The solution of the problem is such a simple one that it seems strange other communities have not done the same thing.

In one word, *Co-operation* did it.

On November 3, 1924, a strange noise appeared in the radio sets in the city of Lancaster. This noise stopped on the night of November 4th, and reappeared on the night of the 5th.

From then on, it was continuous. The noise was so insistent, and persistent, that Lancaster began to lose interest in radio. Things got so bad that the sale of one radio set per month was considered a big business by the dealers. They began to close out their stock as fast as possible. Those who had other lines of business closed out their radio departments entirely.

Today, in a town of 60,000, there are twelve stores selling radio and doing a good business. There is no large source of "man-made interference" in Lancaster today, and every one you meet boasts of the wonderful radio reception in Lancaster.

Co-operation did the whole thing.

Of course, the Lancaster fans read the radio magazines, and in them they had seen statements to the effect that electric light plants were the cause of much interference in many cities. Now the public service company in any city is such a big target to aim at, that you can shoot anywhere and hit it some place. Nothing was more natural, then, that everybody should begin to make remarks about the Edison Electric Co. of Lancaster being a public nuisance. These remarks did not please the Edison officials any more than it would please you if you had been taking singing lessons for twelve years, and had the neighbors decided over night that you were a local nuisance from your practicing, and that you must do it in the woods after this. The pot was calling the kettle black all over Lancaster and no one was getting anywhere.

A group of local business men decided that they couldn't run a business in the manner that Lancaster was trying to solve its radio

Lancaster, Pa., was so Bad for Radio that the Stores Sold Only One Set a Month; Now it's a Fan's Paradise. The Answer is—Intelligent Co-operation.

By G. P. ALLEN

problems. The only thing feasible to them seemed to be to get a meeting of the local fans and talk the situation over in a sane manner. Arrangements were made to secure a hall

for the first meeting, the local newspapers devoted space in their columns to work up interest in the meeting, and out of it came the Garden Spot Radio Association. V. P. Smith, an old railroad telegrapher, now engaged in other lines of business, was chosen as the first president. Mr. Smith continues in office today. H. F. Lutz is the Secretary, and I. P. Hepler is the Treasurer. At the first meeting every one present contributed two dollars so that the organization would have some money to run on.

A meeting was arranged by the club to which Ralph B. Hull, General Manager of the Edison Electric Co., was invited, with the company engineers. The facts were presented and as the situation was explained, Mr. Hull saw that there might be something in the complaint of the fans.

The plant was operating an arc converter. With the growth of Lancaster more and more load was placed on the converter, until it was handling almost a capacity load. On the other hand, there was no particular evidence that it was the arc converter that was the source of trouble. It was in the limits of reason that it might be some user of electric current who was creating the disturbance.

Mr. Hull agreed that if it could be shown to their satisfaction that the light plant, or the lighting system was the cause of the trouble, immediate steps would be taken to remedy things, and later a permanent cure would be affected.

That put the case squarely up to the radio fans of Lancaster. Ordinary superheterodynes operating on loops, such as the Victoreen, or the Clarke, that we have published in past issues, were installed in automobiles. Just as many sets as could be secured were used on the job.

A circle of sets then was made around Lancaster. The operators gradually drew in and narrowed the search until they got closer and closer to the source of interference.

It proved to be within the electric light plant. This was only the work of inexperienced fans and they did not feel justified in putting the case before the Edison Electric Co. without outside advice. Music Master of Philadelphia sent

Let's Get Together and Stop This "Man-Made Static"

INTERFERENCE with radio reception is becoming a national problem as important as the World Court, coal strike or prohibition enforcement. Something has got to be done about it. The best solution is an open forum where all can present their difficulties and where some can tell how similar difficulties were solved in their localities.

This article tells how Lancaster, Pa., eliminated "man-made static"—the interference caused by defective power lines, decrepit electric machinery, radiating sets, and other things.

We want your experiences along this line. They will be valuable to communities which are faced with the same problems. And we want them to be valuable to YOU.

\$ 50.00

We will pay Fifty Dollars for every usable letter of about 2000 words (which runs roughly about six or seven typewritten pages) with photographs or diagrams and drawings. This article by Mr. Allen will show you about how we want it done.

Let's get together and exchange experiences and see if we can't do something to improve radio reception all over the country.

Next month, Mr. Allen will tell you how it has been done by a large power company.

H. M. N.

a couple of men up to Lancaster to aid in the search, and one of the local papers furnished money to eke out the scanty funds in the treasury of the Garden Spot Radio Association.

Claire Farrand, of New York, was called in. Mr. Farrand spent forty hours on the job. At the end of that time it was proved beyond any question that the source of the trouble was in the Edison plant.

As soon as the evidence was presented to Mr. Hull, steps were taken to eliminate the interference. You can not, in one night, alter a plant supplying 60,000 people with electricity. The General Electric Co. sent a Mr. Carpenter, of their staff of engineers, to Lancaster to install a filter system on the old machinery to take care of things until new machinery could arrive. The filter was successful. The Edison Electric Co. did not stop at that. It spent \$37,000 remodeling the plant so that there would be no chance of further interference with the radio reception of the fans of Lancaster.

When this large source of interference was taken care of, another source appeared that had not been noticed in the greater disturbance caused by the lighting system. Having learned their lesson thoroughly, the fans started out to find beyond question where this source was located.

This time, the trouble was somewhat harder to locate, as it appeared only at certain hours during the day. After some work, it was located at the telephone plant. In this connection I want to mention the work of Mathiot, one of the radio dealers in Lancaster. He has been untiring in his efforts to aid the fans in locating sources of interference.

When the matter of the suspected interference was brought to the attention of F. E. Cowan, local manager of the Bell System, he readily agreed to shut off certain portions of the system at a time, to find out what was causing the trouble. It was soon found that the cause was the system for charging the batteries. Temporary changes were at once made which took care of the trouble. As soon as the approval of the company engineers was secured, and it could be determined that these changes could have no effect on the proper operation of the telephone system, the changes were made permanent.

With the telephone plant taken care of, a large manufacturing plant showed up as an offender. The same cooperative effort that located the trouble in the lighting system, and in the telephone system, located the trouble

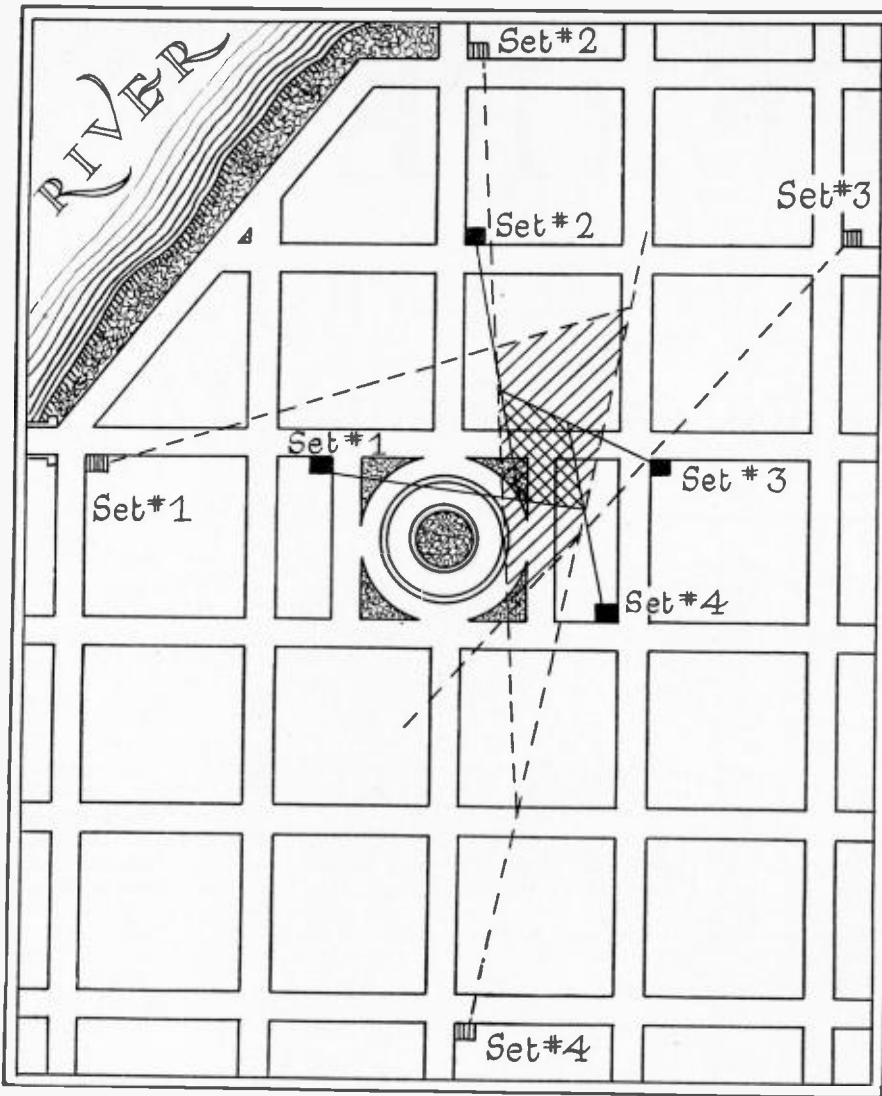

Figure 1—Dotted lines indicate first position of receiving sets. Solid lines indicate second position. Note the change of angle of the lines as well as the way the field has narrowed.

here. The management of the factory showed every willingness to help as soon as it was shown to their satisfaction that they were really to blame.

In this connection it is interesting to note that the Garden Spot Radio Club received a letter from this manufacturer offering his services in helping to locate other sources of interference as they developed. As near as the factory can tell from their present bills, they are going to save \$3,000 a year in electric power costs, by helping Lancaster to get rid of the interference caused in their own factory! The leakage which caused the interference was wasting that much power!

X-Ray, violet ray and other instruments of this nature cause considerable interference to radio fans. The doctors of Lancaster know, and appreciate this. They try to confine the use of this helpful form of electricity to hours when it is least likely to bother radio fans. Then, they use them only for as long as is absolutely necessary.

Cooperation has gone so far in Lancaster that the doctors themselves have agreed to shield their offices so that the disturbance can not get out, if any practical method of shielding can be devised, which comes within an expenditure

that they can afford.

Things have gone even further than that in Lancaster. The fans have located the operators of squealing regenerative sets. A committee rings the door bell of the suspected household and meets the set owner. Instead of pitching in "hammer and tongs" at him, they get into a friendly discussion about the set, and invite the owner to attend a meeting of the Garden Spot Radio Club. Once the owner of the set attends the meeting of the club, the thing that he is doing is brought home to him by means of the discussion. The talk is not directed at the set owner, so that he is made to feel uncomfortable.

To show you how far the thing has gone, I think you will be interested in an experience that happened to me in Lancaster. I sat in the home of Herbert B. Krone, the radio editor of *The Era* in Lancaster. We were listening to WJZ. I had been there some time and did not hear a squeal from a regenerative set. Mr. Krone said just after we had heard an unearthly squeal—

"There are fifteen radio sets in this block. We know who is doing that. We have reasoned with him, and tried to show him what he is doing. He will not listen to a station

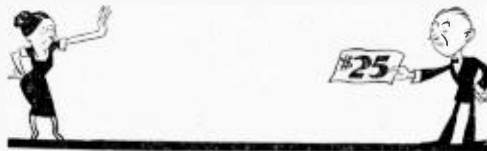

OH, LADY!

Could You Use \$25?

_____ or \$15?

_____ or \$10?

Oh, Lady, Lady!

See the Radio Recipe Contest on Page 30

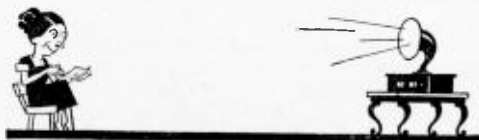

for more than fifteen minutes at a time. You will hear him again when he changes his station."

Sure enough, in about fifteen minutes we got the squeal again, but this particular squeal which was so distinctive that it was easily recognized, was the only regenerative set squeal that I heard all the time I was in Lancaster. Co-operation did it!

Co-operation rid Lancaster of radio interference. The residents are justly proud of what they have done. In one year, Lancaster has come from no radio reception to one of the best places for radio in the country. It is true that there are small local disturbances from a motor for running an oil burner in a house next door, or from some other use to which electricity is put to in an individual home. These are small things that it takes time to eliminate. Whenever a source of interference appears the people of Lancaster communicate with the Garden Spot Radio Club and the members of the club trace the interference to its source.

Lancaster held a banquet to celebrate. Who can blame them? Nearly two hundred were at the banquet. In order that the club should be at no expense the radio dealers contributed a large part of the funds for the music and entertainment. The list of guests included the Mayor, President of the Chamber of Commerce, President of the Manufacturers Association, Manager of the Edison Electric Co., and the Manager of the Bell Plant. The speaker of the evening was E. A. Davies, the manager of radio broadcasting at WIP in Philadelphia. Every one had a grand good time. Why shouldn't they?

To those who are not familiar with the work of locating interference it may seem a somewhat complicated problem. Four sets could cover a city.

Get a city map, or a town map from one of your real estate men, or from the city officials. Start on the outskirts of the district in which the disturbance seems to be most prominent. Tune your super until you get the interference at a maximum. Then rotate your loop until the noise disappears. According to the theory of loop operation, when you do not hear the signal, the source is at right angles to the plane of the loop. Remember, the loop only

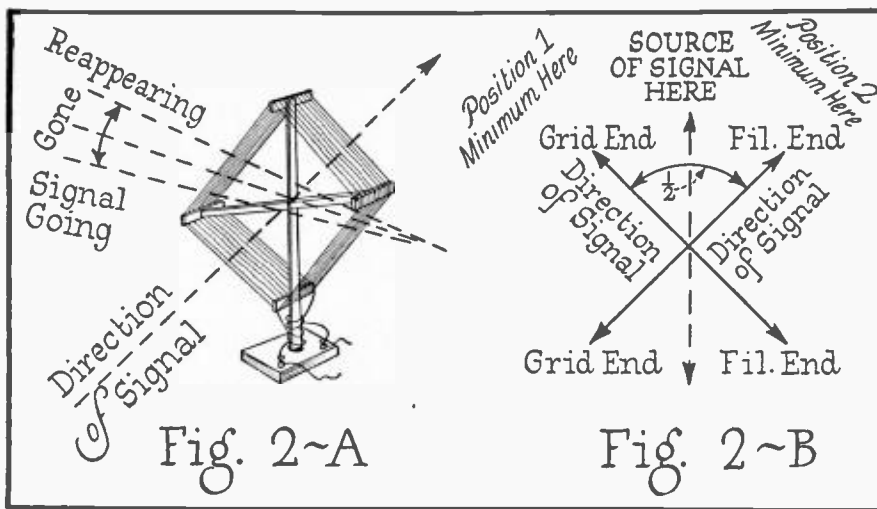

Fig. 2A shows a loop aerial and how the signal entirely disappears when the loop is turned so that it is at right angles to the direction from which the signal is coming. Fig. 2B shows a "freak" effect sometimes encountered when the loop is quite close to the source of interference. An interesting study of loop effects can be made in connection with the AUDIODYNE Oscillator described in the Technical section of this issue.

records the direction from which the signal is reaching it. Steel buildings, and other obstacles may so divert the path of the waves that you may get a false direction. A minimum is much sharper and much easier to find than a maximum signal.

Locate on the city map the spot at which you are taking your reading and draw a line indicating the direction from which the disturbance is apparently coming. Four such stations have been plotted on the map in Figure 1 in dotted lines and the directions of

over the different systems in the neighborhood to see if there isn't a wire brushing against a tree so that the insulation is worn off, a broken insulator on a pole; a doctor's sign that might indicate an X-ray machine; an absence of ashes around a premises on the day that the ashes are carted away by the local refuse disposal system, which would indicate an oil burner; or something of that nature.

But just because you have confined the trouble to one block, do not blame everyone in that block. Gently, and be sure of what you are talking about. People do not intentionally annoy their neighbors, and it takes them a little while to get over the shock of finding it out. If you can definitely show them what they are doing you will find that they are willing to meet you half way in getting rid of the trouble.

Further information as to the peculiarities of the different sounds heard in the receiving sets and their meaning will be given in a subsequent article. The main point for you to remember is that without co-operative effort you can do nothing.

Whatever you do, after reading this article, please do not call up your local power company and tell them that there is a defective transformer on the light pole at the corner! The chances are better than 50 to 1 that it isn't so. We hope to tell you how the complaints that a power company receives originate, and what the noises are actually traced to.

Maybe Your "STATIC" is in Your Own Home

TWICE recently at our laboratory we have come across a bad source of interference which may be more common than most fans imagine. The first time, we were listening to a concert when there came a loud roaring with the unmistakable sixty-cycle note of the lighting current. It was so loud as almost to drown out local concerts. We phoned several neighbors to see if we could trace it but no one else was being annoyed. That meant that the annoyance must be in or very near our own building.

In hunting around, one of us accidentally knocked against one of the electric lights. Instantly the light went out and the roaring stopped.

A little theorizing showed what had hap-

pened. The filament of the electric light had broken but the ends were sufficiently near together to permit the electric current to jump across. That meant that there was a tiny but very efficient arc light inside the electric light bulb. When we knocked the bulb, the ends separated and the current was stopped.

The second instance was exactly the same but we remembered the first and simply turned the main light switch, leaving the laboratory in darkness for a minute or two. Then when we turned the switch on again, one of the lights failed to light. That was the disturber. During the brief darkness, the filament had cooled and separated so far that the current could not jump the break when we turned the lights on again.

the first readings have been indicated in dotted lines. You will note that the lines do not all intersect, but that the trouble seems to be confined to about a city block.

Now move the sets in closer to the disturbance. It may be possible that you can narrow down the area on the map when you plot the second direction readings of the different sets. At any rate, you have a definite area to work from.

When you get close to the source of the disturbance you may notice a peculiar action

the popular idol, Babe Ruth.

The pretzel pinchers base their dope on the Athletics winning on the following line of reasoning:

The Athletics set the pace last year until they cracked in the homestretch on their last Western trip. Everybody on the team hustled last year, yet they didn't go "all out" as Mack always told the players not to over-try and he cautioned them not to watch the scoreboard.

Even on the Western trip when they cracked, the A's were always coming on strong from behind and losing in these crucial games only by a run or two.

The dopesters "figger" that this team of youngsters will be all the better for having been through the fire of having been championship contenders. They are bound to improve this year. The team's two southpaws, Walberg and Groves, are expected to have a vastly better year this season, while Rommel, Harris and Gray will round out the best pitching staff in either league. Gray had a wonderful start last year until his accident and his wife's death broke his stride. He should be one of the league's best this season.

Eddie Collins' White Sox will be dangerous while George Siler is building up a strong team of youngsters in St. Louis. Detroit with Ty Cobb is sure to be a contender as are the Yankees with Ruth, but Washington's veteran team depending as it must so heavily on Johnson, Bush, Reuther and Gregg, a quartette far past their prime, is too uncertain to carry the bets of Abner, Cy and their cohorts of the Stove League.

In the National League race the village seers are predicting that Pittsburgh will repeat. The World's Champions will be intact with the possibility of only two changes. Grantham who played first base through most of last season, fell down badly toward the end and particularly in the World's Series. When Manager Konetchey substituted Stuffie McInnes the veteran and a former star in Connie Mack's famous \$100,000 infield for Grantham, the whole Pittsburgh team pepped up and it is generally conceded that this change alone was responsible for the Pittsburgh team's victory in the famous baseball classic.

McInnes will undoubtedly be the regular first base guardian this season and the veteran will undoubtedly strengthen the Pirates. The other likely change is the probable benching of Eddie Moore the Corsair second sacker. Two promising youngsters are battling to succeed Eddie and it looks as though the Pirates will be stronger on the key-stone sack.

The New York Giants will, in all likelihood, again be Pittsburgh's closest rivals. Jimmy Ring, the pitcher obtained from the Phillies in exchange for Jack Bentley and young Dean will greatly strengthen the Giants. Ring is very temperamental and the Phillies' weak infield last year, making errors out of what would be easy chances for the Giants' inner line, discouraged Jimmy and his work undoubtedly will be much better in New York. He is a classy hurler, very much better than he showed in Quakertown.



Rube Marquard speaking to the radio audience of the W.E.F. chain of stations just before the cry "Batter up!" at the opening game of the 1925 season in New York. Graham McNamee is sitting beside him.

Travis Jackson, the Giants' classy shortstop has an infected leg and not only will be out of the early season's games, but may not play until late in the summer, if at all. This may cause the Giants to get away to a bad start, which might cause them to lose their chances of winning the flag.

It looks as though Eddie Farrell the clever captain of the U. of P. team of last year will

get his big chance in subbing for Jackson.

Wrigley threw a quarter of a million dollars into the ring this winter in an endeavor to buy a team to pull the Chicago Cubs out of the cellar. But Mr. Wrigley, the Chicago chewing gun king and part owner of Station WHT, discovered a new order of things in baseball. He found he couldn't buy a single star at any price. Public opinion has forced the club owners to stop trafficking in their star players. Mr. W. then issued orders to buy in Minor League stars by the wholesale. This has been done and the largest baseball Gang in captivity are now training under Mr. Wrigley's moneyed tent, but while he may strike Gold on one or two of them, they will not carry any of the mucilage money of the Stove Squatters around Huckin's Corners—No Siree!

The St. Louis Cardinals will also bear watching. From the moment that Hornsby took hold last year they came forward fast. They just missed beating Cincinnati out for third place. Watch the Cards this year!

And so we are all set for the 1926 performance of the great out-door Symphony.

Every evening, those well-known characters, the Tired

Business Man and the Honest Working Man, hustle home as soon as the desks are closed in the office and they turn on the radio set long before the hat is thrown on a chair or the hunch box is hurled into a far corner of the room.

Why shouldn't the radio set come first? Isn't it almost time for station GUFF to give the final scores of the day's game? And aren't we maybe high man or runner-up in the pool at the office?

So the radio set ties together all base-ball fans until the thrilling afternoons of what Ring Lardner calls the "World's Serious." And then, we hear Graham McNamee get all excited and yell into the microphone above the roar of the crowds—"Oh, boy! This is some game."

Some day soon, perhaps, we shall see the thing that radio, as an industry, needs more than it needs anything else in the world. What is that? A low-power broadcasting station connected to every major league ball park in the country with a direct play-by-play description of every game played during the season.

The radio industry weeps copious tears every year over the sickening slump that hits it in the summer. There wouldn't be much of a slump if we had most of the games broadcast.

Do you think that I am advocating more broadcasting stations in the already S. R. O'd ether? Not at all. Thirty per cent of the stations now grub-staking licenses and wave lengths aren't doing a thing to justify their existence. Sooner or later, they've got to go in the acid test of Public Service.

Let the wise ones among the little fellows hook up by land wire to their ball park and broadcast the games all summer and their local fans and the local dealers will see that they are protected by the Radio Commission.

YOU Get The Scores

BUT do you ever stop to think of the miracles that are happening inside your radio set to pluck that voice out of the void and bring it, loud and clear and resonant into your home?

You really ought to know something of the fundamentals of this marvel of science—and it isn't hard when it's explained simply. Turn to the Technical Section of this issue and begin

HOW TO UNDERSTAND RADIO

by

Theodore H. Nalken

MAN Wants Entertainment;

WOMAN Wants — WHAT?

By JEAN SARGENT

In Charge of Women's Features at
Station WHT, Chicago

Illustration by
H. WESTON TAYLOR



Jean
Sargent

From the Wealth of Her Experience in the Studio, Miss Sargent Tells How Different Audiences React to Different Programs.

does like to be entertained—not that he wishes less instruction, but he prefers to have his in a different way. He will put on formal dinner clothes, attend a dinner and sit and listen to a speaker for several hours. Returning home, he will inform his wife, "Great man!

I could listen to him all night,"—and from the clock in the hall, you would suspect him of having done so. But if you ask him what the man talked on, he will evade the question, as he has not paid much attention to the subject. It was the surroundings. Just let his wife say the same speaker is coming, and she would like to hear him, and try and get the man out! Nothing doing. I will tell you why; before the speaker addressed that dinner group, they were well fed, had compared notes with boon companions on pet topics, and had lounged at the table with a big fat cigar, that went out often, tight between their teeth, and of course they were ready to listen.

But why should women care about that, now there is the radio and a new type of speaker has been developed, as well as a new type of instructor? Ask any authority on a well-known subject to talk over the radio. He will say, "What! Ten minutes? Why, I couldn't tell in ten hours what there is on that subject, let alone in ten minutes."

But the good sales talk of the director will convince him that it can be done, and very soon you will have a talk for ten minutes, that would have taken two hours. Not long ago I heard a very splendid talk over the radio. Later reading an announcement that the same man would appear before a group of people that I knew, I was able to attend the talk. For a fact, that man gave the same talk, including the announcement that I had heard, in twelve minutes, allowing two for the announcement, and it took him just two hours. Why? Well, first off, "mike" cares nothing for beaming eyes, and the announcer knows

THIS is the third in the series of articles written for this magazine by Miss Jean Sargent. It seems to me that these articles have given us a very fresh and illuminating viewpoint of radio as it is seen from the other side of the microphone. Miss Sargent stresses the great importance of your letters to the broadcasters. Please bear that in mind. Whether you ever get an answer to your letter or not, rest assured that that letter has been most welcome. You don't get an answer to your applause in the theatre except, perhaps, in the form of a bow. So it's best not to expect an answer to your letter except in the form of better and better programs.

But—please write—and often!

H. M. N.

SINCE my first article appeared in *Radio in The Home*, I have had quite a number of letters regarding my work, both from readers of the magazine and from those who go to make up part of my audience each day at Station WHT.

Several of the writers have said, "I think you must love your work." That is true; in fact very true. I do love it and hope to have that love grow as time goes on, for there is nothing more interesting than having a genuine liking for what you are doing, especially when that "doing" is for others, and they have any pleasure from your efforts.

Creating radio programs for a great number of women, and some men is one of the most interesting things that I have yet done. There is no limit to the things that one can offer that will please and displease, and this article will have to do mostly with impressions by the way.

It always seemed to me when I saw a sane, intelligent woman order for her lunch tomato bisque, saltines, a toasted cheese sandwich and a chocolate pecan nut sundae with fudge sauce, that she had a real reason for doing so, especially when it might be directly after she had read a paper on diets before a group of women. So one day I had an opportunity to ask a woman acquaintance why she did such a thing. Her answer was, "Well at home, I am never quite sure about the bisque, and no one but me cares for a toasted cheese sandwich, and I like sweet desserts of the kind that we do not serve every day"—and she thereby proved her intelligence. Nothing wrong with the bisque, and she had her vita-

mines in the cheese, and it was topped by a dessert to her real liking.

RADIO programs have been a good deal like that woman's lunch.

During the day we have had our bisque, something that was good for us, our vitamins in the talks that were educational and entertaining, and amusement for our dessert, and that, I think, is what has made radio programs interesting. Yet so far, the instructive, or vitaminic, talks have been during the day, because the man of the house demands to be entertained. Ask the average program director and he will say, "We do not encourage talks at night, unless they are by a nationally known speaker like the President or some one of unusual importance. Our audience demands entertainment."

We all know that is very true. A man

that time counts most. Then when the speaker started, he had no eh's, ah's or pauses, or for that matter any gestures, all of which take up time.

Of course I don't mean that it would be nice to have all interesting talks "boiled" down to ten minutes. I like to see folks as well as hear them, and that stands true for the radio listeners generally. But it does open up a great big wonderful field for some very clever, concise instruction.

There are many women at home who would like a little more knowledge on many of the present day subjects. Instruction in many things; and so far lecture courses and all matters of that sort consume too much time out of the hours that the average busy house wife has for her own. But if the talks that are given in libraries, art centers and other places were to be put on the air for the general public, condensed for radio, what a big thing would be done!

I never read in a paper of this or that center having a man or woman talk on an interesting subject but I think, "Oh, what wouldn't I give if they would do that for the busy mothers, and for those shut-ins who listen each day," and I pray for the time to come when some good kind person will endow a fund for that purpose. I don't care who gets it—yes I do; I should like that to happen to the station I was with for I should like to help provide that pleasure for my listeners, every one of whom has grown very dear to me.

Women really and truly are natural seekers

after knowledge; it may not be for a well known science, but they are more easily educated than men, and so the day time programs must offer that feature as well as the frothy dessert, and women are generous, and so will enjoy and share with the males of their families, the dear old "Goldy and Dusty's" and the "U. S. L. Dance Orchestras" of the evening and really enjoy it. Men like things worth while, but secretly politics, instruction, etc. would not attract them quite as much if it were not the cigar, the companions or the excellent dinner. Feed that same man at home a well prepared dinner, and tune in on the same fine speaker previously mentioned

slips and pencils were passed and each one wrote several things she would like on programs. It may interest you to know that parliamentary law was asked for by a large majority, practical gardening, child welfare in all branches, more talks on art and music, and musical mornings on the several great masters, educational instruction in bridge, food problems and only one wanted more fashions, and beauty talks both physical and spiritual were requested. Less of the light music; and—everything that would help them be better mothers and wives as well as companions.

I wish you could have met those women.

They were so fine! Just at first they were a bit strange, but soon they were chatting and having a friendly time, and by the time we went to eat a very generous spread, we all were the best of friends. I want to add that when the notice of the meeting was sent, no mention was made of refreshments, so that was not the attraction—that was extra.

Radio seems to have made a very great difference in the lives of many women. It has warmed them up a bit, if I am to judge by my mail. Their offers to help at all times are so generous. They come and see us and are so friendly that I am sure it's radio and nothing else that has made them want to be friends, and it does make us who are giving the programs every day year in and year out, feel that we are doing something worth while.

There is one thing that has been a big help, and that is the letters from the women in the

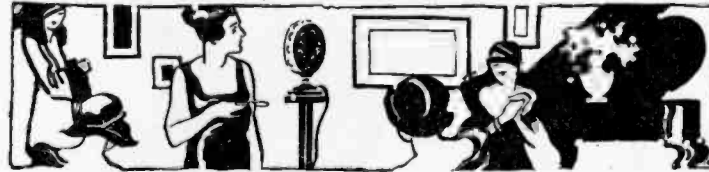

and he will very probably go sound asleep.

Just a word about the women who make up the Honorary Member list of the WHT Women's Club. In January, I called a meeting of these women. We were to meet and talk with them. I mean by "we," those who had talked to them from time to time over the air, there was to be music as well. But most of all they were to express just what they would like on their programs for the next few months.

So while they were hearing short talks,

To the PRESENT SUBSCRIBERS to "Radio in the Home"

THIS magazine is an extension and an enlargement of "Radio in the Home."

The slight change in the title has been made not only because of its brevity but because it more fittingly expresses the editorial viewpoint of modern radio—with the emphasis on the "Home" aspects and the "Radio"

as a qualifying adjective to indicate the class of home to which we appeal.

You will notice that we are offering new subscribers an opportunity until April 25 to enter a year's subscription to the new magazine for one dollar—the price of the old subscription.

We feel that our present subscribers are entitled to this same opportunity.

This offer expires April 25, 1926, and is void thereafter

If your name is on our subscription books as of April 10, you can extend your subscription for one more year from present date of expiration for

**ONLY
ONE DOLLAR**

Subscription Department,
THE RADIO HOME,
Produce Exchange Building,
3rd and Walnut Streets,
Philadelphia:

I am at present a subscriber to Radio in the Home and desire to extend my subscription for one full year from date of expiration at your special offer. I therefore enclose One Dollar for this purpose.

Name

Address

City State

Date

Cut out this coupon
—or send the same information in a letter—and forward it to us before April 25 and we will extend your subscription

**ONE
FULL YEAR**

small towns and on the farms. As a rule they have more time than the woman in the city, because they are not attracted by the many forms of entertainment that those in big centers have, and when they hear any thing they like and write about it, you are pretty sure of hearing some thing that is more than the usual message, saying the program came in fine. Of course you have heard that the woman in the country is to be pitied, but don't you think it for a minute. She has the best time of any of them day in and day out.

What do you suppose has happened to that old time fictionist who brought the tears to our eyes and a sob in our throats when he wrote about the pretty talented girl spending her summer in the country and falling in love and eloping with the farmer's boy. Father turns them away when they ask for forgiveness and she goes back to the farm in the hills to raise onions, tears, strawberries and chickens. Many children come to drag at her drab skirts—they are always drab; it's calico she has bought at the country store with her egg money. And in the early spring just as the buds are peeping out, the snappy implement salesman comes and stays at the farm and tastes her soggy biscuits, and at night when her country lout of a husband is sleeping and she sits in the melting twilight with her head against the lintel of the door, (there is always a lintel), he sees traces of her former beauty, and makes violent love to her; they flee and take with them all the money saved for the tractor. Sobs—tears—curtain!

I will tell you what has become of that salesman; he has turned into a salesman for super-hets and at night as he demonstrates the latest model to the farmer and his wife and they listen to the opera singer that his gasoline company is paying for, the novelist grits his teeth and shaking his fist at the set mutters. "Curses! You have taken away my income!"

So why pity the woman on the farm? She is getting as much as and in many cases more than, we are. At least she does not have to inhale smoke and gas all the time.

Radio and radio broadcasting are opening up still another field for women—that of employment. Designing is one; dealers appreciate their assistance, and now we see full page advertisements where a sales woman shows a set to a woman. There is one field, that of selling. But the woman entering it should learn a grid from a condenser, and why a connection should be clean. But to go back to designing. Compactness is the next move, and a set that will fit into a kitchenette apartment and not crowd the in-a-dor-bed is the next move.

Then another opening is in repairing, and as women are more orderly than men they should make good repairers, especially the women who have had to darn some of the holes made by men who are careless with acids. Naturally the hardships of the work can be overcome, as women are able to do well most of the work done by men.

Dealers and manufacturers at least, are appreciating women listeners if we are to believe their stories of this and that Doo-Dad to

eliminate battery charging and noiseless chargers, less mess and expense etc.

In broadcast stations there is the work of secretaries, directors, accompanists, hostesses and other things that women can do. But you will have to remember that it's long hard hours, and you must be able to eliminate yourself and remember the station first always.

Many women have entered the field through children's programs. There they seem more

At night as he demonstrates the latest model Super-Het to the farmer and his wife, they listen to the opera singer.



at home than in most positions. But the subject of programs for children—or shall we say juveniles—is a touchy one. So far I have found the so-called (or guess I can say mis-called) children's programs, are given by a couple of grownups tooting horns and acting up, to quote some of the youngsters, and are mostly enjoyed by older people. Among the best of juvenile programs is the Big Brother Club of WEEL. Bob Emery who directs this, is doing a real job. He seems to talk with the youngsters and not down to them and that is what is needed. Children are the logical future listeners as well as the entertainers and directors, and should have their proper place now.

Here at station WHT we have no chil-

dren's hour, but on Saturday mornings I have had juveniles to entertain, as I believe in offering them encouragement, and they come not as child wonders but with a real love for their work, also. I put them through just as I do older entertainers and they work on their merits. It's good to see them, and I call that time, the "busy mother's mornings," for it keeps the children occupied at home while mother is busy about the house. This is not a set feature but has been in successful operation since last July. Only a short while ago over a hundred telegrams, to say nothing of telephone messages, came in for a group of grammar school children who had been formed into a child's symphony. They enjoy their experiences and I have enjoyed the time they have been on the air.

While every station of any importance has a definite time allotted to programs for women, it's up to the women generally to set the pace for their future.

Send in your expressions to the station that entertains you the most. Tell the director what you enjoy or dislike, and encourage all you can those who are giving time and effort to pleasing you. If you will do this, they will be able to give better programs as time goes on.

It's a matter of great pleasure to us who direct the programs, to tell those we ask to talk to you or entertain you, that we have many fine women who listen daily, and show them the letters of encouragement we receive. Please do not imagine that your letters are not read. Every one that comes to our attention is read and if possible answered, but there again is a

great big obstacle—answering mail. So if your answer should be delayed or if you did not ask a direct question, you must not think the letter was not appreciated. It would be a physical impossibility to answer each letter, but we love them just the same.

Time alone will tell what radio will bring. I am prepared for 'most anything wonderful, and it is my sincere wish that radio programs will be guided by a fair minded listening public through their expressions, either of just and keen constructive criticisms or delight. The listening public should remember that each one is but a small part of the great audience, and that what you like may not be enjoyed by Bill Smith, and Bill has as good taste in some things as you have.

So when you have tuned in to something uninteresting to you, don't condemn the station, the director or the announcer. He is pleasing someone.

This radio is wonderful and I hope you will all join me in wishing it the best of success.

Oh, Yes Indeed! RADIO'S a Great Invention

By Charles
Magee Adams

Drawings by
JAMES H. HAMMON



Honest, now, when you come right down to it, how much do you believe of the picturesque and idealistic stuff that you orate about Radio?

truth and nothing else but, so help me Marconi—plain—unvarnished—brutal, some of you will think—but nevertheless the truth. No. I'm not a pessimist.

Finding when I came home tonight that somebody (I'm not saying who, but I have my suspicions) mixed the A and B leads dusting the set and blew all five tubes, hasn't soured me on this business of collecting W's and K's and C's on a log chart. No sir. It's just that the hour has finally struck (that's good) when, if the ether is going to be made safe for our great DX democracy, it's time we faced the cold naked facts like men, without a tremor of our aerials.

For instance—"Radio has revolutionized civilization." Does this have a dimly familiar ring? *Revolutionized civilization*—in other words, turned things as they would otherwise be up-side-down. Let's face the facts—impartial and unbiased.

Walk down the street to the first barber-shop, filling station, delicatessen, pool room, or other radio store, and look in the window. On a nice green cloth you will see a shiny, spick-and-span set; five tubes, loud speaker, hundred-hour A, a B eliminator, the latest lightning arrester; and a big sign "The Wonderdyne—\$100."

"That looks like a good buy," you say, and go inside up to the man at the counter.

"I like the looks of that Wonderdyne," you begin.

"There's none better," he says modestly, tuning in the one on the counter. "A hundred dollars. With accessories, a hundred and seventy-five."

And ten minutes later you go out, the owner of a set marked \$100 that cost you \$175.

Has radio turned things as they would be otherwise up-side-down? Would you pay \$700 for a car, and \$300 for the engine, body, tires, hood, gas tank, headlights, and ignition system? Would you pay \$6000 for a house; and \$4000 for the roof, walls, lot, wiring, plumbing, furnace, and paint? You would—not. Therefore—Q. E. D.

"Radio brings the world's entertainment to your very fireside." Do you have a faint recollection of reading that line somewhere or other, brothers of the tube and rheostat? Entertainment—something you listen to when you don't have to. Again, let's stick to plain unvarnished facts.

"Isn't it wo-o-o-o-nderful?" she wanted to know, her big baby blue eyes bigger and babier than ever. "Isn't it just perfectly wo-o-o-o-nderful?"

GRAHAM MCNAMEE had just put the last man out in the last game of the world's series, and I was snapping the filament switch to "off," when the coy young thing from next door who'd come over in the fifth inning (though I'd done my best to throttle the speaker down so she wouldn't know we were listening) let loose.

"Isn't it wo-o-o-o-nderful?" she wanted to know, her big baby blue eyes bigger and babier than ever. "Isn't it just perfectly wo-o-o-o-nderful?"

"I don't know," I said, a long way from enthusiastic. "I had my dollar on the Senators."

"Oh, but I mean radio," she objected, making a fancy gesture she'd seen in the movies. "I just can't help thinking how truly wo-o-o-o-o-nderful it is. Here we're all snug and warm, listening to every word and everything of that wonderful ball game, three hundred miles away! Three hundred miles!" She made another movie gesture. "And there isn't even a wire!"

I put the A on charge, and cleared my throat.

"Yes," I said, in my I-have-chosen-as-my-subject-for-this-evening tone of voice, "it is

wonderful. Modern magic. That's what I call it, and I've been fooling with it going on four years now. It's already revolutionized—"

But there's no use for me to go on and tell you what I told her—not the rest of you dyed-in-the-wool hopelessly incurable dial-twisters, circuit bugs, and DX hounds. You know.

"The twentieth century miracle"—

"Force that wipes out distance"—

"Greatest boon of the age"—

"Revolutionizes civilization"—

"Whole world akin"—

"New center for family life"—

"Great leavener of mankind"—

"Undreamed of possibilities"—

You've said it more times than there are hookups; and it's a good line too. It sounds like money in the bank to people like that coy young thing next door, who get their radio from some neighbor's loud speaker. But between ourselves, as one member of "the great unseen audience" to another, it—Well, I'll tell you what I'm going to do.

For once since the day I pulled over the chimney putting up my first aerial four years ago, I'm going to tell the truth—the whole

Here's a verbatim record of what I heard last night; what a lot more of you heard too. "Master William, the twelve-year-old violinist's next number—" "And this telegram from Mr. and Mrs. Smith of Zanesville, 'Program coming in fine'—" "Played at the request of John Jones of Lexington—" "The Chew-long Gum Orchestra will now play—" "Chicago hog receipts for the day were—" "Is an artist pupil of—" "The No-Tartar Tooth Paste quartet will now sing—" "Hopes his fourth cousin in the Bronx is enjoying the program—" "Is dedicated to—" "Through the courtesy of the Smoke-Up cigar corporation."

DID I have to listen to this? I did not. But I did. In four hours I heard "Carry Me Back to Old Virginy" sung by nine quartets, three sopranos, and seven tenors; "Souvenir" played by 19 violinists and six cellists; "Invictus" declaimed by 14 baritones; and "Where's My Sweetie Hidin'?" jazzed by 44 orchestras. Therefore, once more—Q. E. D. "Radio brings the family closer together—supplies a common bond of interests—a center which resists the outward pull of the times." Will all the knights of the kilocycle and log chart who have not read, seen, or said this, please raise both hands? Thank you. "Brings the family closer together." This raises some delicate points, friends; takes us out into the deep dark waters we call human nature. But let us cling steadfastly, even relentlessly to facts.

For instance—my first set was for phones only. You remember how they were in the early days. One night I tuned in WBAP. "I've got Fort Worth," I said in a polite respectful tone to my wife, who was reading five feet away.

"You needn't yell," she came back, frowning.

"I wasn't yelling," I answered, still quiet and gentlemanly.

"You were yelling," she retorted, "and you still are. Every time you put those things on you think nobody else can hear because you can't."

I didn't say any more. But an hour later she was listening, and as I came up from fixing the furnace, she said "I've got Dallas," so loud the neighbors half a block down the street could hear.

"You needn't yell," I said. "I'm not deaf."

And—Well, radio didn't bring our family closer that night.

I'm peculiar in one way. Whenever I go to a show or concert, a little noise can spoil the whole thing for me. If anybody whispers or rattles a program or moves around so the seats creak, there's no use for me to stay for the rest of it. Well, after we got our loud speaker set, I'd tuned in some DX one night that was coming in fine. There was a little static, of course. There's always some. The heating pad that belongs to the old lady four doors up the street was making a buzz now and then too; and a regenerator squealed once in a while.

But the music was getting through clear and sweet as anybody could want.

Then, just as I was going to remark about how good it was, my wife said,

"For goodness sake! Can't you stop that terrible noise?"

"Noise?" I said. "What noise?"

"Why, those cats and that boiler factory! Are you deaf? If there was a thousandth of that at a concert, you'd be calling for all the ushers and the house manager."

I have to admit radio wasn't exactly a common bond for our family that night, either.

One of the boys called me down to look over his set one evening. His first stage of R. F. wasn't just right, and after we'd got it straightened out we cruised around a while to see if it really was doing its stuff. You know—get a station, listen a minute, then go on to the next. We hadn't been at this more than

But let Bill try to sit up till even twelve o'clock on a night when the air's just popping with DX, and there's as pretty a row as you wouldn't want to hear.



fifteen minutes till his wife began objecting something awful. She said that was the way he always did; that she might enjoy radio if he ever listened to one station long enough to let a whole number come through, but that he just hopped from one to another all evening.

It embarrassed Joe to have her talk like that before me, and I felt sorry for him; especially when he tried to explain we were testing, and she kept right on. If any of you ever had that happen, you know how much, closer radio brought your family.

But between ourselves, women seem to have a kind of unreasonable prejudice against radio for some reason or other. Take one of the other boys, Al, for instance.

I was over at his place one night helping

him install a wiz of a new set. We brought the aerial in as usual—through the window and down; made a mighty snappy job of it too, if I did lay it out. But do you know, as soon as she saw what we'd done, his wife wouldn't have it like that a minute; said she'd never stand for her living room being cluttered up with a lot of wires like a power house; and made us run it down the outside and through the cellar, so it increased the losses 100%.

It bored Al. He told me afterward she'd always been cranky about this neatness business; that after they were married she made him stop laying his clothes on the chairs and tables when he came in like he always had.

I remember one night when I spilled some acid on a new rug too. It wasn't my fault. I was carrying the battery down to the charger and the dog bumped me. I couldn't see that it was much worse than spilling some ashes, which never causes more than a few words. But you'd have thought I ruined a priceless oriental, instead of just a common \$80-rug we'd been three years getting.

Women have prejudices about so many things in this radio business, though. You'd think if a man was willing to listen in on a church service while he minded the roast, and do it comfortably, with his pipe, and feet on a chair, and no collar, his wife would be tickled to death to know he was taking that much interest in the good of his soul. That's what Pete Stivers thought when he got his set. But do you think his wife thought so? I'll tell you she didn't. Poor old Pete had to shave, put on his new shoes, and sit in those crampy pews for an hour and a half, just as usual; with the same service coming out of his speaker back home.

They don't seem to understand—women don't—what a real kick a man gets out of sitting up and trying for DX either. Bill Jennings' wife, for instance, would stay up till morning and play bridge if she could get three other people to stay with her; I should say two because, of course, Bill would have to. But let Bill try to sit up till even twelve o'clock on a night when the air's just popping with DX, and there's as pretty a row as you wouldn't want to hear.

Speaking of bridge—you know what always happens when there's a party. The minute two women have been together long enough to get their gloves off, they begin—"I hear they're going to wear the skirts shorter again this spring." "But, my dear, they're terrible." "And by the way, I saw the sweetest little tri-corn down at—" "Spindler's are having a silk special tomorrow, a dollar ninety-eight." "Where did you get those darling pumps?"

You know.

Well, you'd think that instead of having us sit by like wooden Indians or talking shop like we used to, they'd be glad they had a new subject like radio that interested us all.

But are they? The minute you even reach for a pencil to show some other fellow your new hookup or mention the super you saw

downtown or what you had last night, somebody says, in a tone that's a long way from sweet or coaxing, "For goodness sake, stop talking radio long enough to watch your lead. Don't you think we get tired of hearing that gabble all the time?"

No. I've always been strong for this idea of the home being the bulwark of civilization and all that; but an unbiased analysis of the cold naked facts would seem to indicate that radio hasn't done much toward knitting the family circle into exactly a unified whole with a single interest.

TO GET away from these unpleasant things, though, you remember the other line you read in just about every Sunday radio section (which, by the way, we have to hide in the attic to keep the Mrs. from burning up)—"Radio is making the world smaller."

Now, you'd think on the face of things that this was mighty fine. Making the world smaller—bringing California and Providence and Europe right to your own radiator—giving a man a bigger outlook on things, hearing about people he doesn't see every day and all. But the trouble with these big general statements is that you've got to watch the local angles, as the sales managers say.

For instance—in the old days we used to think ten miles was a long way off to have neighbors you didn't want. A man that far away couldn't bother you with his player piano or phonograph or dog. But last night somebody ten miles away with an oscillator absolutely ruined KHJ for me—squawking and squealing all over the dials. You know. Why, if all the cusswords aimed at bloopers in just one night—brand new ones made up for the special occasion—were placed end to end, they'd reach more times around the world than the last year's crop of flivvers, and that's conservative.

Yes. Radio's made the world smaller all right—too small for some of these birds who jam the ether with their jowling and yowling. And that's not the worst of it.

Do you know that radio is making mean little men out of fellows who used to be all on the level? There's one, for instance, (I'm not mentioning any names, but I'll say I know him pretty well) who wouldn't dream of trying to break into the front of a boxoffice line, not dimming his lights even on a wide road, or doing any of these hoggish all-for-No.-1 things that make everybody swear; no matter what the other fellow did to him either. But he's got an oscillator; keeps one around deliberately with malice aforethought; and the minute one of his neighbors fifteen or twenty miles away begins squealing, he goes over to this set and proceeds to squeal back with a satisfaction that's positively savage—keeps it up too, till his neighbor gets off the air in disgust. Now what's radio done to improve this man's disposition?

What's it done for the man who always

hears a station 500 miles farther away than you do, too? You know. It used to be that we had to listen to fish stories in the summer, and golf stories from spring to fall, and thought that was bad enough. But now we have a barrage of DX stories just about the whole year round; and what makes me wonder sometimes if there isn't something to this stuff about civilization slipping backward, it's not the fellows who used to tell the fish and golf yarns at all, as you might expect,

in the subway. But that's all over now. Why?

SAM'S in the metal specialty business. He's got a neat little factory in the Bronx; and this fall he noticed his production began falling off about the last of September, getting worse as the season went along, and he couldn't understand it. He'd just put in some new machinery and processes, and thought he was in for a big year.

Then one day Sam, worried good and proper by that time, went out in the shop, and just when they ought to have been as busy as fleas at a dog show, there were his men standing around talking about what they'd got the night before, the latest hookups and so on.

No. You never can tell for certain just how a thing's going to work out till it's actually worked.

There's the one about the new radio humor. You've heard that too. "A distinctly new type designed for and adapted to the technique of this amazing art." It listens well. But I'll tell you what I saw happen.

Two fellows who'd been perfectly good buddies most of their lives mighty near came to blows the other night riding out on the 5:20, (and they still aren't speaking), because one of them pulled that one about opening the window and getting Chile. And that's the way it goes.

Now, don't make the mistake of jumping to the conclusion that I've been disillusioned or turned cynical or got to be one of these pessimists. I'm not. There's no crepe on my aerial or wreath with a purple bow on my panel, if the Mrs. has blown all the tubes. No sir. The fire of my fresh young enthusiasm (I got that at the Rotary Club last week) still burns as bright and undimmed from eight to one every evening as it did four years ago when local finally percolated through my first set after I'd worked on it six nights till two o'clock.

Only—and here's where the rub comes—whenever anybody tries to uncork one of these stock lines about what radio's done for the advancement of the race, looking the facts square in the eye as I do, the reply I have to make is—and I expect the rest of you dial-twisters do in the secret places of your cabinets—"Yes—radio may be the greatest boon of the age all right; but—"



And then one day Sam, worried good and proper by that time, went out in the shop, and just when they ought to have been as busy as fleas at a dog show, there were his men standing around talking about what they'd got the night before, the latest hookups and so on.

but a whole new lot.

Then there's the one about radio being "a great common ground where men of all kinds can meet as brothers." You know.

It used to be a favorite with Sam Springer, one of our charter members. He called radio the great modern leveler; said men who'd never found anything else they could talk about could talk about radio and DX and hookups now and forget their classes and prejudices. He used to come home nights and tell, proud and excited, how he'd talked radio to an Italian tailor, a Greek confectioner, a negro stevedore, and a Pole barber coming up

THE

END



Is BIGNESS Necessarily BAD?

The Increase in Power of Such Stations as WJZ and WGY has Swamped the Government with Protests, But there Are Two Sides to Every Story and These Expensive Experiments May Point the Way to the Future Progress of Radio.

By R. S. McBRIDE
Washington Representative of The Radio Home

IN Roosevelt's days "trust busting" was the favorite official sport in Washington. In those days anything big was regarded as necessarily bad. But today in official and general business circles it is a doubtful conclusion that bigness at all implies badness. As a matter of fact most well informed labor groups find it much easier to deal with large corporations than with small employers. Trust busting, as such, has gone out of fashion.

Now radio raises anew the question as to the Badness of Bigness. In this remark I do not at all refer to the question of radio monopoly or to the charges of a "radio trust." We, the listeners, are not worried about that subject. We leave it to the members of Congress, the Federal Trade Commission, and the Department of Justice. There is no danger from the business point of view that large radio units will hurt the service or raise the cost of radio in our homes.

There still remains, however, what appears to me to be an unsettled question—that is as to the merit or the evil of bigness considered as a technical question. This is the problem of super-power in broadcasting.

At the present time, I really believe that we do not yet know enough to decide what form of super-power radio station is wanted. There are such valid and convincing arguments on both sides of the case that I, for one, have not reached any decision. But even if there be no final or formal decision possible it is worth while to hear both sides of the story and then to make up our minds whether we, the listeners, should encourage or discourage super-power radio broadcasting.

Before we can well discuss this question we must go back to the first and most fundamental principle of radio in the service of the



A worm's eye view of one of the antenna towers of Station 2XAR (WJZ).

public. This principle, we might well call it an axiom, states;

Any change in radio is an improvement if it results in an increase in the number of satisfied listeners.

We should, therefore, test the super-power development of today with this yard-stick of public service.

There are three stations in the United States which can properly be called super-power broadcasters. These are KDKA at Pittsburgh, WGY at Schenectady, and WJZ now located at Bound Brook, New Jersey.

Strangely enough the first two named have developed almost without controversy, but the Radio Corporation station WJZ has certainly been a storm center, especially during the late winter months. It is not worth while to review this controversy, although an unexpurgated story certainly would be spicy reading. But it will be very interesting for us listeners to take an imaginary trip to Bound Brook and to a few other points, carrying with us a few typical radio receiving sets and accessories.

In our imagination let us first call upon the staff of Station WJZ itself. I have no doubt that if such call were really made and our interest in super-power were explained, the engineers of the station could give us some very interesting demonstrations. We would probably want to use our own small radio set first, and we would find that when this giant of the ether was operating we could get the signals at any dial setting and with such strength, even at the extreme points, that nothing else could be received.

Perhaps the engineers would then like to show us a more highly selective set, but I am

MR. McBRIDE points out in this article the necessity for a good "wave-trap" in all locations near a powerful broadcasting station. Now, no wave-trap can be absolutely guaranteed to solve all possible problems of interference but there is no question that it will greatly improve the operation of the average set.

In order to supplement Mr. McBride's article I have had the Laboratory build a good wave-trap and Mr. Allen has written full instructions for its assembly and operation. You'll find his article on page 50 of this issue.

H. M. N.

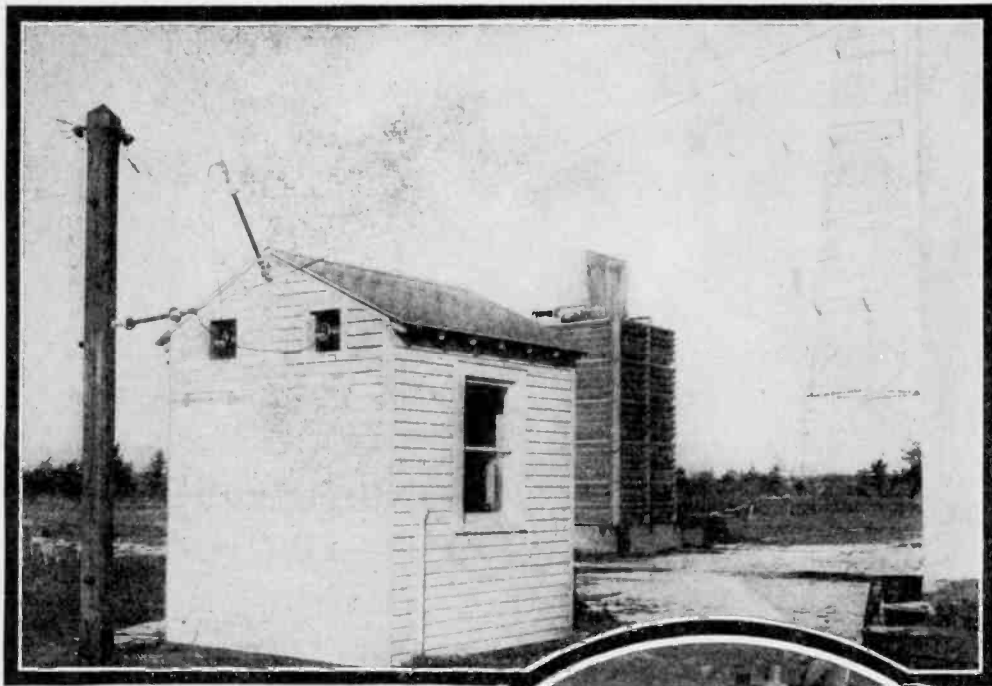

A view of the house which contains the antenna tuning apparatus.

inclined to believe that even the most careless listener would be highly displeased with any attempts he might make to get other stations while WJZ was on the air.

About this time the engineers of the station would probably produce some of their wave traps and, I am told, we could then enjoy a considerable number of other stations with ease even on only a moderately good set. The wave trap they say, would be quite effective in killing the powerful station's signals even though we were in the station building almost directly under the antenna.

NOTE.—This claim has been quite widely made but I do not believe it can be substantiated—certainly not with any wave trap that the average amateur can make at a reasonable cost.—H. M. N.

MOST of us who live within five miles of a powerful radio station know what blanketing is. We know that we must sacrifice quite a section of our tuning dial whenever this nearby broadcaster is using his thousand or fifteen hundred watts. Of course if we are fortunate enough to have a highly selective super-heterodyne or other especially good set this blanketing becomes negligible. But most of us have not yet bought such sets for we are still waiting to make that expenditure, probably foolishly, because it is doubtful whether next year we can buy anything materially better or cheaper than we can buy today. But even with the finest type of set when we get right under the antenna of the powerful station we cannot expect real selectivity near its dial settings. At such point we are hardly content to call the effect of the station "blanketing." It seems a whole lot more like complete smothering.

Now let us suppose that the engineers at

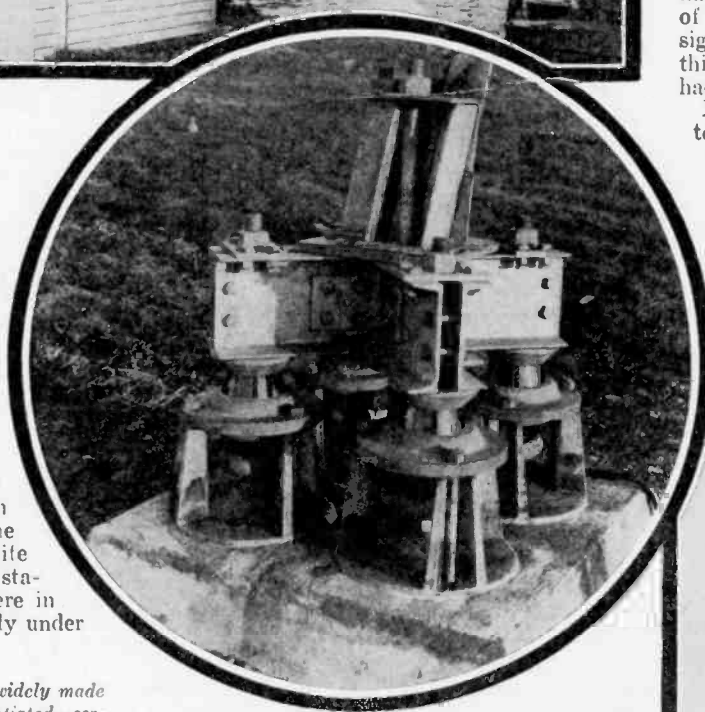

A close-up of the insulators at the base of the antenna towers.

WJZ have completed their demonstration and we are free to call upon some friends on the other side of Bound Brook, say two or three miles away. At their home we would have much the same experience in trying to receive an out-of-town program as at the station laboratory. Perhaps we would get a little better result, and with high selectivity in our set manage to cut down the smothering until it again could fairly be called only blanketing. But as our friends turn on their set, if they are wise, we certainly would find beside it a properly designed wave trap. Any man who lives within a few miles of a 50,000-watt broadcasting station is severely limited in the possibilities of his receiving set even if he uses a good wave trap.

In our further investigation of super-power we might go on into New York, about thirty miles from WJZ. There we would undoubtedly be able, even through the radio

barrage of New York City's many stations, to pick up WJZ's signals and enjoy them on the loud speaker at any time when that station was on the air. Fifty thousand watts thirty miles away gives really about as strong a signal as the ordinary 2000-watt station within five miles.

IN SUCH a test we would find out what the engineers mean by "the square-root rule" in signal strength. We would discover that the strength of signal at our receiver is not directly in proportion to the power used at the station; but the strength of signal increases much less rapidly than in proportion. The ratio is as the square root of the power employed.

Thus if the power is four times as great the signal has only twice the strength. If the power is 100 times as great the signal is only ten times as strong. Thus we can understand why it is that the R. C. A. engineers were not content to go up simply to 5000 or 10,000 watts in their big station. They felt that they must experiment with 50,000 watts, as they have done, in order to multiply the strength of the ordinary 500-watt class B station signal by ten. You see that in order to make this increase in signal strength ten-fold, they had to use a hundred-fold increase in power.

But we must now return to our inquiry as to WJZ's behavior over wider range. Suppose we take a train to Washington and reach a point a bit more than a hundred miles away from this station. There we would find either WCAP or WRC on the air with 500 and 1000 watts respectively.

Regardless of weather, or static, or fading of signals, we can at any point

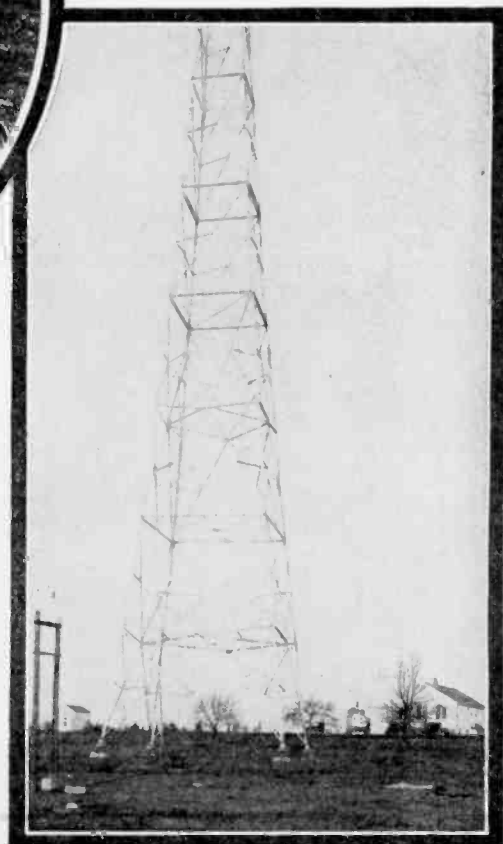

General view of the antenna towers, transmitter house, sub-station, cooling tower and antenna tuning apparatus house.

in or near the District of Columbia enjoy one of those two stations which so ably represent the A. T. & T. and the Radio Corporation. We would find, however, that almost regardless of weather, of static, or of fading, we could also receive WJZ on the loud speaker with sufficient clarity to be really a pleasure.

At this distance it would behave much as our nearby broadcasters which have only one-hundredth of the power. There would be no blanketing effect and any reasonably selective receiving set would confine the range of the signals to a few points of dial setting. Thus the super-power station would be for us in Washington virtually a medium-power local station. We could count upon it to furnish music for a dance, or dinner music, or the bedtime story for the children, as the case might be, whenever it was offering such a program. So far as its reception was concerned we could forget weather, static, and fading, except in the extreme cases of thunder storms.

ABOUT this time we might decide to get in touch with friends in Chicago and other friends in San Francisco. From our Chicago acquaintances we would doubtless learn that WJZ was really available to them for enjoyable reception in ordinary radio weather on their silent Monday nights. Of course no one in Chicago ever expects to get out through the maze of sixty broadcasters unless there be a silent night. (Really Chicago deserves the sincere sympathy of the rest of us. It is as unfortunately housed in by radio racket as a cat unwittingly nailed in a packing case.)

And from San Francisco we would hear that WJZ "came through fine last night." We would get this not only from DX fans, but also from our friends who like the thrill of distance occasionally but certainly refuse to sacrifice all else (including sleep) for radio fishing.

"But," our friends would add, "we cannot always get them, not unless the weather is particularly good. And then they fade very badly."

Thus we would understand that San

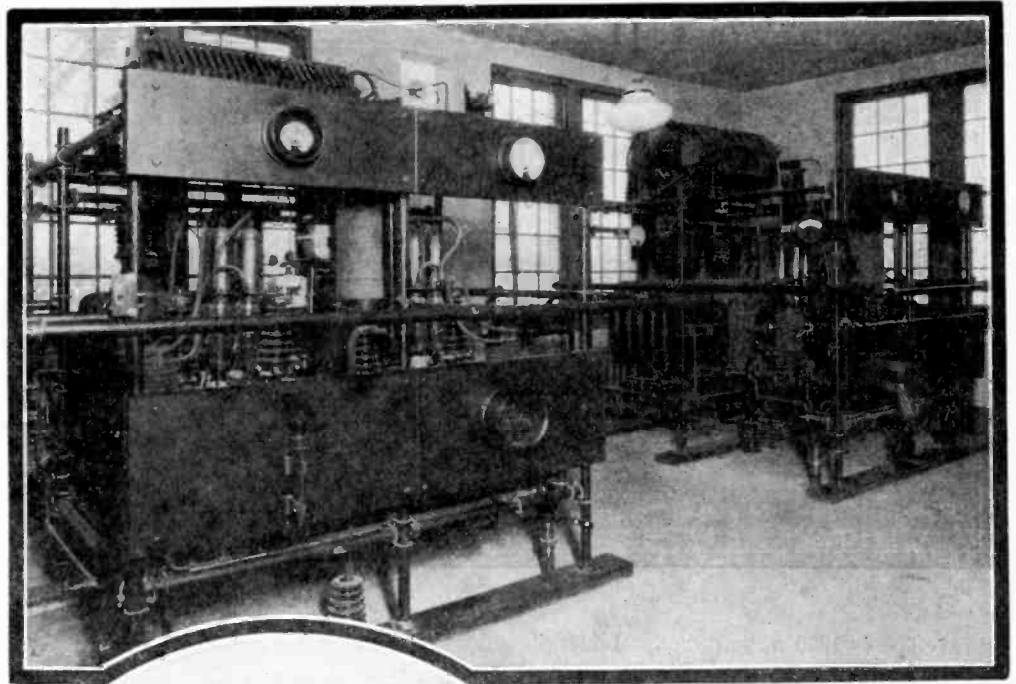

Here is a view of the main and spare oscillators used for broadcasting.

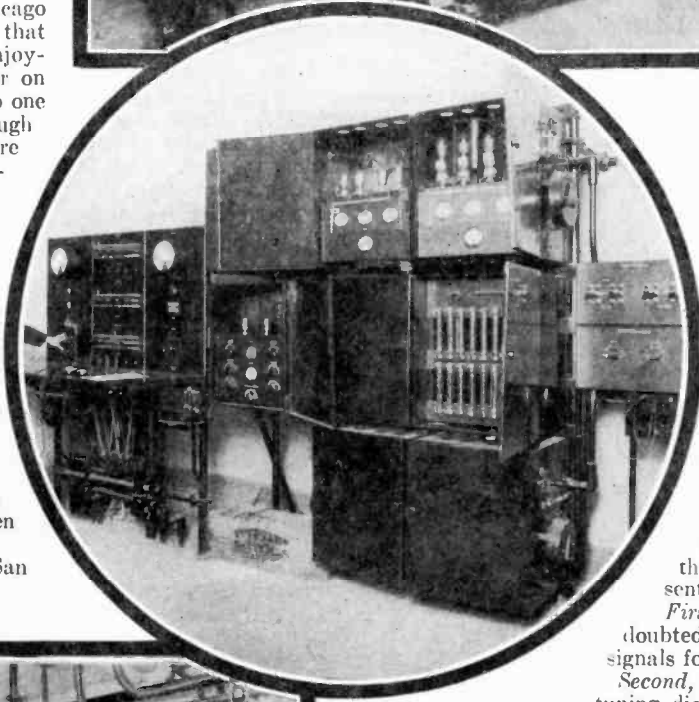

Francisco does not become suburban to Bound Brook even though this Jersey community is spreading upon the air some of the most powerful radio signals which man has yet attempted.

As a net result of this study I think we would be convinced of several things. Let us put them down one after the other in rather formal fashion. We may then attempt to strike a balance and see whether we believe that the super-power station represents a net gain or a net loss.

First, a very high-power station undoubtedly does smother all other radio signals for listeners who live nearby.

Second, the blanketing of wide areas on the tuning dial of many sets is much worse for very powerful stations than for those which use less energy.

Third, these evils can be largely corrected by choosing a set which is reasonably selective and by using a suitably designed wave trap; only a small portion of the nearby listeners are thus left really helpless against the powerful signal of such a super-power station.

Fourth, the range for dependable all-weather service of a powerful station is considerably greater than of those using less energy; but the extension of the radius of usefulness is only ten-fold for each one hundred-fold increase in power.

Fifth, the effects of fading prevent the useful radius during all weather conditions being extended much beyond one hundred miles, and as a consequence the power used for greater distances is wasted under many circumstances.

Sixth, the signal strength from a super-power station using 50,000 watts is above the so-called "static level" for distances up to a thousand miles. Within one hundred miles one can attain almost as effective overshadowing of static troubles as from a local station

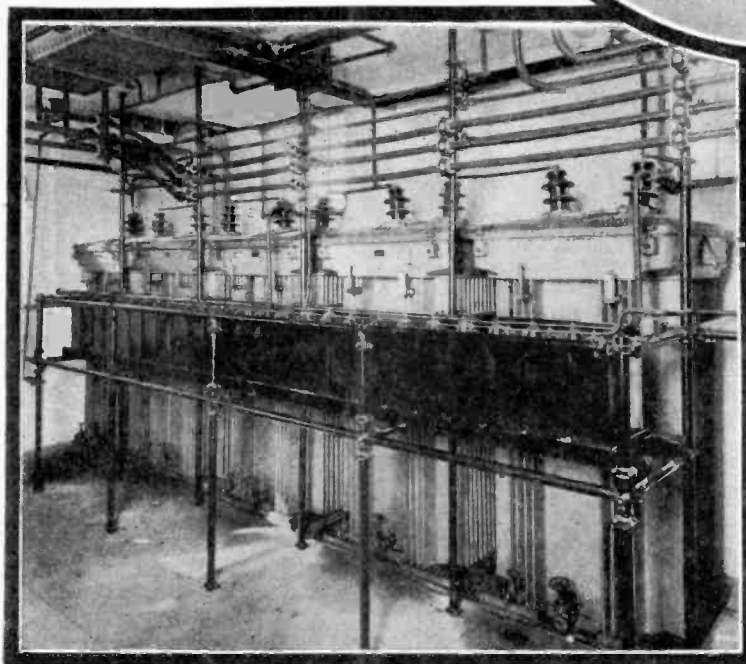

Above is shown the control room and wire line apparatus.



The smoothing reactors and condensers used for high voltage rectifiers

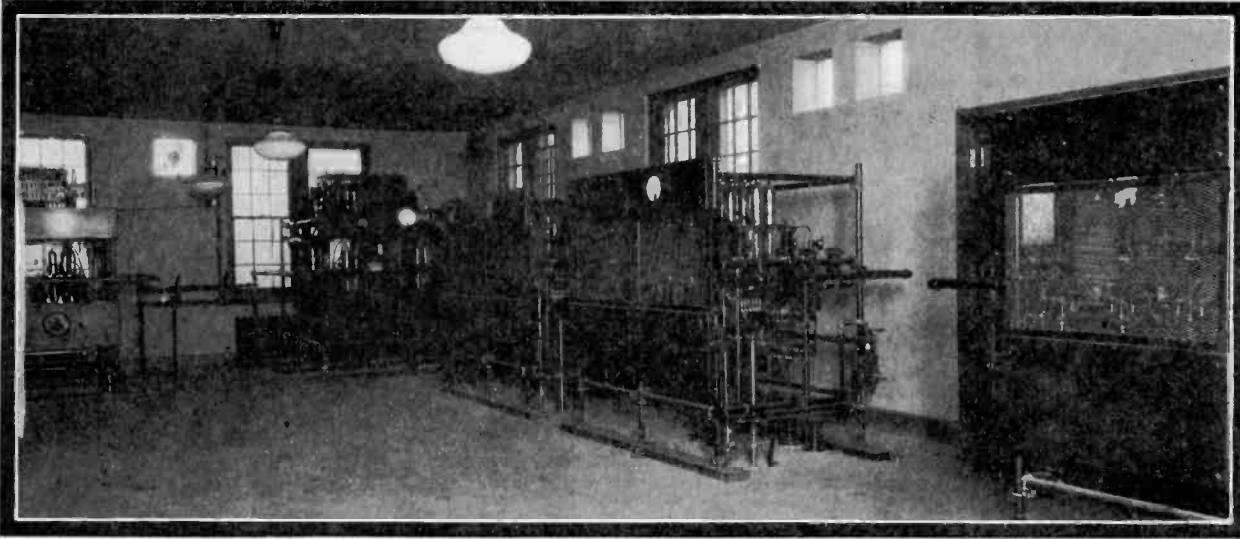

General view of broadcast transmitting equipment showing rectifier, modulator, spare and main oscillator frames.

of only 500 or 1000 watts power. Hence, it is argued that the use of power so great as that in our "super-power" stations is unnecessary when only avoidance of static troubles is required.

Seventh, any super-power station is bound to be something of a nuisance to its nearest listener neighbors and hence in the public interest must be placed at a reasonable distance out from closely settled areas. This will reduce to a minimum the number of persons who are seriously annoyed.

This is about the extent of our present certain knowledge in the criticism and the defense of the high-power stations. At this point we find ourselves compelled to judge between the present practice of the engineers of the American Telephone and Telegraph Company and those of the Radio Corporation group.

The radio men of the telephone group have deemed it wise to choose 5000 watts as more or less the standard for powerful broadcasting stations. This is not a formal and fixed policy to which anyone expects them necessarily to adhere for long. But it is as near as the outsider can estimate a fair statement of their present judgment of the

best policy in establishing big radio stations.

The Radio Corporation engineers, on the other hand, are working up to 40,000 or 50,000 watts and occasionally are known to propose, more or less seriously, stations of 500,000 or 1,000,000 watts. But these able engineers would be among the first to admit that they, too, are not going to insist upon this very high power unless experience can demonstrate that it renders a real and appreciated service to the public. They regard these very high-power stations as a tremendous commercial experiment. And they hope that this experiment can be conducted successfully with a minimum of annoyance and the maxi-

really best. But while experimentation is in progress I am hoping that we shall have developed some clever simple means of offsetting in a receiving set the annoying effects of blanketing.

In discussing super-power it is only fair to emphasize that the increase in range obtained from very powerful stations has proven quite a disappointment to radio engineers. It has raised again the discussion as to the best means of getting a national audience for important events. This is the old controversy between interconnected stations each of moderate power and the single big station which tries alone to cover the whole country.

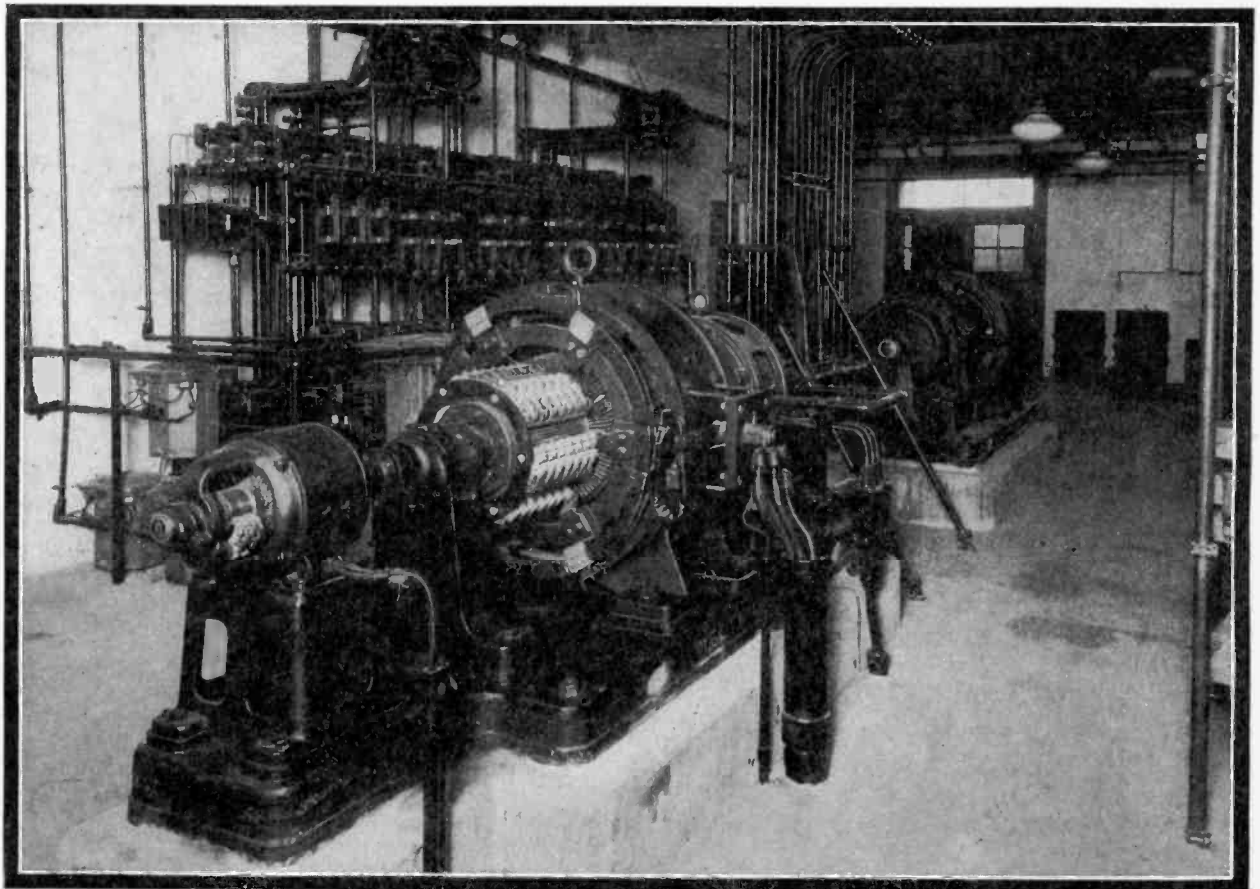

General view of basement, of the transmitter house, showing filament motor-generator sets.

*On Friday Nights, When Children Have
No Thought of School Tomorrow, Let
Them Hear the Adventures of the Fairy
Folk From Stations*

*WEAF WOO WCAP
WCAE WGR WJAR
and WEAR*

Miss Blanche Elizabeth Wade.



Sir

*By ELIZABETH
A. ANDERSON*

HOBGOBLIN *and His*

Magic Whistle

"AUNT BETTY, does Sir Hobgoblin really disappear when he blows the little whistle or does he just pretend like I do?"

That was the rather disconcerting question the child of one of my friends put to me when she heard me tell her mother about watching Miss Wade as she broadcast one Friday night from WEAF and six other stations.

"Don't you think my whistle sounds like his?" she persisted as she blew a tiny blast on a tin whistle.

I was forced to say it did sound like Sir Hobgoblin's, but before I could go any further, the little scamp continued, "Well, mine is no good cause I tried it on Daddy last night when he told me to go to bed, and he just looked at me and told me to make it snappy."

I might have continued in my dissertation and told her that as far as I was concerned Sir Hobgoblin did disappear—and the hare-bells, bell flowers, and hyacinths did tinkle their wee bells before my very eyes, for so great had my enchantment been that I had followed every word breathlessly as Miss Wade told when "Sir Hobgoblin Tries His Ice Glass

Again." Totally unconscious of any nervousness that may have besieged the story teller—and she told me afterward that her hand trembled as it always does—I listened and watched engrossed in the toys by which Miss Wade was surrounded. She must have had them arranged in just the right order, for without the slightest hesitation, she picked up a different little bell with its own characteristic note for each flower.

As she finished with each page of her story (which she read, but in such a simple unaffected way that I felt as if she were telling it) Miss Wade threw it on the floor. The studio looked as if it had been struck by a cyclone at the end of her story. Later she told me of a funny experience she had had when she first started to broadcast.

That night her tale was "The Story of Cen-

tiperella or the Fifty Glass Slippers." She told in rhyme of a royal centipede whose fad was shoes—the old favorite Cinderella adapted to centipedes of the present day. Read it sometime when you have a few moments to play with the kiddies. You can get it by writing to C. R. Kinney Company, Inc., 107-09 West 125th Street, New York, or if there is a Kinney shoe store near you, ask for a copy of this booklet when you buy a pair of shoes for the little folks. But I must get back to my story. It seems that in throwing down one of her finished sheets, another stuck to it as it fluttered away to the other side of the room well out of her reach.

A sort of panic came over her as she realized that she would be stuck when she came to that page, for the story was in verse and she had not even read it over before she went

The Hunting Horn is a wonderful toy, too.



into the studio. If it had been prose, she might have improvised, but not with rhyme.

Just then Ralph Wentworth, who announced the feature, came into the studio and by some sixth sense that instinctively told him of trouble, picked up the page, handed it to her and the day was saved.

I wish all of the members of the Kinney Club might see Miss Wade's toys. They are the cutest things I have ever seen.

Have you often wondered as you heard him sing, what the Evening-gale looked like? I did. He is the most exquisite piece of enamel and workmanship that I have seen in a long time. He lives in a beautifully carved gold box. There is a real opal button on the side of the box. When this is pressed, it releases a spring that opens the box and out comes the beautiful iridescent Evening-gale, fluttering his tiny wings and trilling his limpid song. It is a Swiss box and of course, runs by clock-work. Even its tiny key which has its own compartment under the box is cut in the shape of a bird.

I could not help noticing that Miss Wade placed the gold box in its own leather case, then wrapped it carefully in tissue paper, as she did the other toys and tucked each one away in its own particular place in her bag. "Extremely neat and very methodical," I concluded as I watched her put the toys away.

The cuckoo, unlike his prototype in real life, is a gay bird. He has brilliantly painted red, blue, yellow, black and white plumage, but he sings out just like the real cuckoo when you press the box-like base on which he stands.

The Hunting Horn—I think its technical name is fluta—is a wonderful toy too. On it

Miss Wade can play a number of tunes—which reminds me that she is a musician of real attainment, but more about that anon. One of the pictures shows her about to play one of her favorites.

Sir Hobgoblin's ice glass with its hollow squeak was a facer for me. Wasn't it for you? A resined cork turned in the wide mouth of a yellow glass bottle produces that weird squeak.

Seven burnished metal bells each with its own musical tinkle stood side by side on the table and I wondered how Miss Wade could tell which was which, but she seemed to know, because she unerringly picked up the one with the deepest tone when she talked about the bell flower's apple and one with a light clear tinkle when she came to the bell flower in her story.

The little music box you hear almost every time Sir Hobgoblin is on the air is of the kind to be found in almost every home where there are wee youngsters. Just turn the crank and it tinkles out its merry tune. Miss Wade knows how to turn it ever so gently and its melody sounds like fairy music that makes you feel as if all you have to do is to peer into the distance to see the little people dancing in their magic ring.

Did you spy the thick book on the corner of the table? "What can that funny looking volume be?" I said to myself as I examined it more closely. It looked like one of those old-time picture books with a barn-yard scene on every page.

Imagine my surprise when I opened a page to discover an arrow pointing from a lazy looking cow to a loop of string along the edge of the book. A pull of the cord and the cow

emitted a most life-like "Moo!" There is a cunning lamb on another page with a plaintive little bleat and an old ram in the next picture with a lusty "Baa"! Every barn-yard animal is there and each one has his own voice.

Between gasps of admiration and surprise, I managed to ask Miss Wade where she ever found so many different toys with squeaks and whistles.

"In the toy departments of the stores," was her reply.

"I always come to town on the 10.46 train the day I broadcast and I spend the afternoon looking around for toys that will help me with my stories."

So methodical was Miss Wade in packing away each toy that I was not prepared for her next statement which came in response to a remark I made to the effect that perhaps she had that afternoon been looking for something for a special story.

"Oh! no! I just look for anything that I think might be good. I don't know yet what I am going to write about in my next story."



The Evening-gale lives in a beautifully carved gold box. Sir Hobgoblin's tinkly music box is at the left on the table.

I never prepare more than the one I am going to tell each week.

"After I write my story I lay it aside. I never read it aloud before I broadcast it."

What a risk that would be under ordinary circumstances! But doubtless Miss Wade lives her stories out in her mind before she puts a line on paper—they seem so much a part of her.

The time-worn question—"Are you nervous before the microphone?" did not have to be asked. Miss Wade volunteered the information before I had a chance to question her.

"I was scared to death the first time they tried me out to see how my voice would carry. My knees shook, my hand trembled and I felt every second as if my teeth must be chattering audibly. There were three men in the room with me and one went outside while I

*"T*HERE is a real opal button on the side of the box. When this is pressed, it releases a spring that opens the box and out comes the beautiful iridescent Evening-gale, fluttering his tiny wings and trilling his limpid song.

was talking. I felt sure he couldn't stand any more of it, but at the end he came back and said my voice carried splendidly and then I realized that he had gone out into the reception studio where there is a loud speaker."

To those of us who have been brought up under less rigid regimes, the story of Miss Wade's younger days sounds much like a book, if not a fairy-tale. Her mother, Elizabeth Flint Wade, was on the editorial staffs of Harpers and of Saint Nicholas, and so the daughter grew up in a literary atmosphere. Mrs. Wade at one time had charge of the Camera Department of Harpers and as an outgrowth of this work, became associated in artistic photography with Rose Clark, a well-known artist of Buffalo. Their portrait photographs were known all over the country and they made photographs of many of the celebrities of the day.

Mrs. Wade early recognized the literary ability of her child, who if she had been allowed to follow her own inclinations, would have devoted her whole time to music. They



compromised and the morning was conceded to music and the afternoon to writing.

Miss Wade studied organ with Wilhelm Kaffenberger. Although she has never earned her living by her music she has frequently substituted for the organist in her church. On the evening that I talked to her, she said she had just had word that she would have to substitute for her organist for a Lenten Service the next day.

She seemed a bit disconcerted at the prospect of having to do it on such short notice as the High Church service is not at all easy to play smoothly without rehearsal. As we chatted about it, I realized that music was very close to her heart and that her mother had perhaps by her insistence on the afternoon writing deprived the world of a good musician. But then, in doing so, she gave us a wonderful teller of children's stories and so we are content to have our Sir Hobgoblin Lady who is so universally loved by the little folks.

Miss Wade's first book was published in 1905, and was followed in the next two years

"THERE is a cunning lamb on another page with a plaintive little bleat and an old ram in the next picture with a lusty 'Baa!' Every barn-yard animal is there and each one has his own voice."

by two others. Of these charming stories, I am familiar with at least three—"Mr. Do Something of the Island of Make Believe," "Annie, Princess of Everything," and "Magie Stone, Rainbow Fairy Stories." Like her Sir Hobgoblin stories, they show a rare imaginative quality while they are totally devoid of those objectionable features that so often cheapen, if they do not ruin, many fairy stories.

Her first story telling took place when she was very young and had a class in a Mission Sunday school in Buffalo. The boys were very troublesome and after trying to hold their interest with the lesson she began telling them Indian stories to keep them quiet, so they would not disturb the other classes. It worked like a charm.

Her grandfather with whom she spent her summers on a farm near Utica, had told her the most wonderful tales of the real Indians. In his youth, Indians still lived in that part of New York State. Every afternoon they went down across a little brook that wound through the place to a secluded spot where they could be undisturbed. The old gentleman was very lame and his granddaughter helped him over the rough ground.

As they walked along, he told her all about the birds, flowers, and other wonders of Nature. Thus did the little girl develop a real knowledge and love of outdoors. To me, one of the greatest charms of Miss Wade's stories lies in the fact that she really imparts authentic information, but does so in such an enchanting way that you do not realize that you are being educated.

Many of the 50,000 (more by this time)

correspondents who write to Miss Wade must share this feeling, for not a few of these letters are from grown-ups who declare themselves eager listeners to every story. Each child who writes to join the National Kinney Klub receives a number of good things free. Among these gifts is a miniature of Sir Hobgoblin, one of which Miss Wade gave me. Here he is now on my desk peering at me elfishly as I tell you of the interesting evening I spent with his originator. Another gift is the "Story of Centipederella" in an attractively illustrated booklet.

Since her mother's death, Miss Wade has lived alone in Norwalk, Conn., within easy commuting distance of New York but far enough from the rush and noise of the big city to be a pleasant environment for her work. She told me of watching the birds from her window that day and seeing a big bird swoop down on a flock of sparrows and almost annihilate one poor little fellow before she could drive it away. She thought the bird might have been a sparrow-hawk, but he seemed rather large and he flew away before she could be certain.

When I asked her if she did not think perhaps her cuckoo had come to life and had gone back to his bad habits in spite of his brilliant plumage, she said that she did not think her bird was that kind of cuckoo.

Let us hope that Miss Wade will continue her stories on Friday nights over WEAF, WOO, WCAP, WCAE, WGR, WJAR and WEAR. Many of us (grown-ups as well as kiddies) look forward eagerly to her hour and wait anxiously to hear what Sir Hobgoblin's next adventure will be.



The cuckoo is a gay bird. He has brilliantly painted red, blue, yellow, black and white plumage.

Ask the Request Lady

She'll Play Your Favorite Piano Selection for You

Mary
Louise
Woseczek

Photograph by
J. Anthony Bull

Mary Louise Woseczek Is Eagerly Listened For Every Tuesday Evening at Seven-Thirty by Many Thousands Who Write to Her at Crosley Station WLW in Cincinnati.



By Alvin
Richard Plough

IF YOU have ever written a request to have some number played or a song sung, then you are eligible to the world-wide class receiving a 20-minute course of instruction in famous classical piano compositions which Mary Louise Woseczek gives on Tuesday evenings at seven-thirty o'clock through the Crosley WLW broadcasting station, Cincinnati.

Miss Woseczek confines her playing to the requests which are sent to her by those of the radio audience who are interested in hearing their favorite compositions in piano form. In arranging her programs, she tries to include numbers which will have an appeal to the greatest number of listeners. And there are always some which appeal to a limited few—pieces with slow, beautiful chords; brighter, faster numbers and occasionally, older, semi-classical selections.

Each piano number is preceded by a short descriptive sketch about the number itself or about the composer. These notes are carefully compiled by Miss Woseczek and given in the hope that they will be both educational and interesting to the listeners.

Perhaps it will interest you to know that the "Piano Request Lady" as she is called, has received many wonderful letters of appreciation and requests from all parts of the country. There are letters from elderly couples in rural districts requesting selections like: "The Maiden's Prayer," which was popular some fifty years ago. Then, there

are letters from ambitious parents asking to hear shorter, classical "pieces" which their children are preparing for lesson work. Letters have been received from a doctor of philosophy; a professor in a select preparatory school who is an amateur composer and accomplished musician and who has made the necessary installation of receiving set and loud speaker so as to enable his pupils to listen to the piano-educational recital. Letters from cultured music lovers and from students of music who request difficult, technique-testing selections.

It is especially gratifying to the Request Lady to comply with requests from invalids and shut-ins who enjoy hearing their old favorites played again in the style they were once played by the writers. No request is ignored if it is sincerely written and fits in with the type of semi-classical and classical music to which the twenty minutes are devoted each week.

"I just dearly love to play in the Crosley solo studio," said Miss Woseczek when I asked her about her work at the request of H. M. N. "although that cold, sensitive microphone still scares me a tiny bit once in a while

—at those times when I particularly miss the the inspiration and encouragement from an audience that is present and when I think of how many merciless, unseen critics are 'all ears' for any little slips.

"I am always happy when I hear that I have given pleasure to some of the many listeners who have written to me. It is my wish, that everyone who enjoys my playing would write to me. I will, personally, answer

each letter as soon as possible and will gladly play the particular selections requested. Of course, I want criticism, too, for it is only through sincere criticism that any artist can improve and letters are the only means of getting the truth from the thousands of listeners throughout the country. In a concert in an auditorium, one may judge by the instant applause but in a studio recital, a week elapses

before all the mail is received from my listeners."

Miss Woseczek made her debut for radio last winter in a series of piano recitals and she was prevailed upon to undertake the weekly task of playing a number of short piano selections in the twenty minutes given to her during the Crosley educational hour.

This talented musician is quite youthful and is one of Cincinnati's best piano artists. She is the only daughter of Anna Meyer and Ludwig Woseczek, prominent Cincinnati artist who was born in Vienna, Austria, but who has been an American citizen for thirty years. Her elementary school years were spent in St. Louis, Missouri, but her high school, university and musical education was received in Cincinnati.

During her seven years as a scholarship student of the Cincinnati Conservatory of Music, she gave three unassisted recitals of difficult pianoforte masterpieces; assisted in innumerable concert programs as both soloist and accompanist; received an academic diploma under the noted pedagogue, Theodor Bohlmann and a collegiate diploma under the French master, Jean Verd, with whom she also delved into post-graduate musical literature.

Her summer vacations are usually devoted to a college camp up north. Between her short classes, she and her camp-mates hold swimming and diving meets; hike and motor through the woods; and sleep beneath the starry skies. And she is still single.

APRIL 6, 1926 - 7.30 P. M.	Handel Delibes Robinson Poldini Gounod
Largo Pizzicato ("Sylvia") Karmenol-Ostrow Murmuring Brook Marche Pontificiale	Chopin Debussy Wieniawski Saint-Saens Dett
APRIL 13, 1926 - 7.30 P. M.	Dvorak Friml Poldini Jungmann Schubert
PRELUDE, OP. 28, No. 20 Reverie Kulawiek Song (Without Words "Juba" (Dance)	De Koven Boccherini Masseny Arensky Tschalkowsky
APRIL 20, 1926 - 7.30 P. M.	
LARGO (New Opus Symphony) Music Box, Op. 69 Valse Serenade Will O' The Whisp Marche Militaire	
APRIL 27, 1926 - 7.30 P. M.	
PRELUDE, OP. 155, No. 2 "Annet in A" Meditation ("Thais") Le Coucou, Op. 34, No. 2 Humoresque	

Franz Schubert
and his
"Unfinished
Symphony"

Conducted by
G.W. HARRIS

THE music of other composers arouses our admiration, or gives us pleasure, or inspires awe and reverence, or invites respect, or refreshes us with an uplifting sense of the joy of life, or amazes, or bewilders, or even rebuffs us; but Franz Schubert's music compels our love.

Not all of it; only the best—for he was too prolific, and he lacked the faculty of self-criticism—but he was dowered, perhaps above all others, with the heaven-born gift of ingratiating melody, and the best of his music is infused and permeated with the quality of loveliness—is indeed the most lovable music that has ever been given to mortal men to hear.

In the best of Schubert's work there is not only surpassing charm, lyrical beauty, wealth of ideas and of melody, great dramatic truth and range, but, most important of all, life, movement, and freedom.

There is nothing forced or artificial about his music. He sings as the bird sings, from an irresistible impulse. The bird never sings because it ought, but because it must. And when it has no cause for singing, it is silent.

Schubert's inspiration is as natural and as spontaneous. His compositions belong to every department of music: opera, church music, chamber music, orchestral works, piano pieces, songs. There are, of course, degrees of beauty and differences of value in all this music, but most of it possesses in some measure that peculiar Schubertian quality which is as exquisite as it is indefinable. Schubert's individuality, his unlikeness to any other musician, is one of his supreme distinctions. And in its tender and pure quality of loveliness his best work is unique and unapproachable.

Franz Peter Schubert was born in the Lichtenthal suburb of Vienna, on January 31, 1797; and died in Vienna, on November 19, 1828. His forbears were peasants. His father came from Moravia and was a schoolmaster in Lichtenthal for many years. His mother, Elizabeth Fitz, before her marriage was in domestic service as a cook. Franz was the thirteenth of the fourteen children born to this couple.

There was love for music in this family, for two older brothers as well as Franz were taught violin playing by their father. Franz took lessons also in piano, organ, singing, and thorough-bass from Michael Holzer, the parish choirmaster (whom he soon outdistanced),

RADIO and the Music Student



Franz Schubert

and became first soprano in the church choir in his tenth year. He also composed songs and little instrumental pieces before he was ten years old. In 1808 he was admitted to the Vienna court choir, and also entered the training school for the court singers and played in the school orchestra, soon becoming first violin.

His extraordinary precocity bewildered his teachers, and he found no one to give him the strict training which such an exuberant genius needed. The diffuseness and even laxness of style in many of his larger works may be due to this lack of early discipline.

Leaving the choir school when his voice changed, he was assistant in his father's day-school from 1813 to 1816, teaching the primary classes. His fertility as a composer and the swiftness of his work are among the most remarkable phenomena in the history of music, particularly in those years of school-teaching drudgery. A few musicians, particularly Michael Vogl, a famous opera singer, discovering his genius, persuaded him to give himself wholly to music.

For the rest of his short life he lived a precarious and somewhat Bohemian existence in Vienna, always pinched by poverty, and hampered by lack of recognition. No composition of his was published until 1821. He first distinguished himself as a composer of songs, but at that time the song was not recognized as a serious art form. His operas failed. His wonderful gifts, and genial, buoyant disposition won many friends, yet he could

SCHEDULED FOR
TUESDAY EVENING
APRIL 13
Broadcasting from Crosley Station
W.L.W., Cincinnati, on Tuesday
evening, April 13, the Formica
Symphony Orchestra, conducted by
William C. Stoess, will play
SCHUBERT'S
"UNFINISHED SYMPHONY"
A treat no music-lover will want to miss

never gain a salaried position or attract pupils.

Nevertheless his reputation steadily grew. His works began to be heard in concerts. Publishers began to ask for them. In March, 1828, he gave a first public concert of his own works. He was about to enter upon a career of distinction when an attack of typhus fever snatched him away at the age of 31.

The vitality of his music has continued to impress the world more and more ever since Robert Schumann, 85 years ago, declared: "It carries with it the germs of everlasting youth."

ALMOST all of Schubert's fine and distinguishing characteristics—his tenderness, his candor, his sweetness and clearness, his melancholy, his poetry and his sense of drama—are to be found in the "Unfinished Symphony." Among all of his works not one is more beautiful in ideas or in perfection of form than this. And yet it is only a fragment.

The first two movements are complete. There are nine bars of a Scherzo, and with them the Symphony stops. No more of it has ever been found, and no one knows why Schubert should have abandoned it.

This Symphony in B Minor (No. 8 of the ten symphonies written by Schubert) was composed in 1822, in his 26th year, and was his recognition of the compliment of his election as an honorary member of the musical societies of Graz and Linz. (The Vienna Society of the Friends of Music had refused to admit him because he was a professional musician!) *Schubert himself never heard the symphony played.* The manuscript was sent to Graz, and there it lay hidden and forgotten

until 1865, when Johann Herbeck, a Schubert enthusiast, recovered it and brought it to a hearing in Vienna. The score was published in 1867.

In the first movement of this symphony (*Allegro moderato*) Sir George Grove found "the history of cruel disappointments and broken hopes."

There is grief in it, and protest, and melancholy brooding; but there is also much besides. Edmondstone Duncan in his *Life of Schubert* says he never hears it without being put in mind of the salt-flavored breeze, the splendid underlying pulsation of its waves, and the freedom and expanse which a wilderness of waters conveys to the mind"—though he does not impute any such pictorial scheme to Schubert, who never saw the sea.

Yet, he continues: "The free fantasia is truly wonderful. One may hear such mystic sounds in some desolate place where the tide breaks complainingly over the low-lying rocks. It is as a song of forgotten ages, it touches on the mystery of life and death, the yearning of man, the futility of despair."

Others have found in the famous 'cello theme of the first movement "the most charming melody in all music"; and Philip Hale has written of this movement that "there is nothing of more complete, well-rounded beauty in the literature of music."

The second movement (*Andante con moto*) is, if that is possible, even more characteristically Schubertian than the first movement, in its perfection and su-

avity of expression and its luxuriance of color. Formally, it consists of only two or three melodies slightly developed and repeated; but

its coloring is so rich that its final effect is the sense of satisfaction in complete and flawless beauty.

AIDS TO APPRECIATION

THE best biography of Schubert in English is Edmondstone Duncan's "Schubert," in the Master Musicians Series, published by E. P. Dutton & Co., New York.

Schubert's Symphony in B Minor ("Unfinished") in a transcription for piano solo is published by G. Schirmer, New York, at 60 cents; and also in a piano arrangement for four hands, at 75 cents.

Phonograph records of the "Unfinished Symphony" are available as follows:

COLUMBIA RECORDS—

Played by New Queen's Hall Orchestra (London) conducted by Sir Henry J. Wood: 1st Movement (7084M), \$1.50; 2d Movement (7085M), \$1.50.

Played by Prince's Orchestra (A5748), \$1.25.

VICTOR RECORDS—

Played by Philadelphia Orchestra conducted by Leopold Stokowski: complete in three records (6459; 6460; 6461), each \$2.00.

Played by Victor Orchestra: (35314), \$1.25.

Reproducing Piano Records:

DUO-ART—

Played by Albert Stoessel: 1st Movement (5120), \$2.50; 2d Movement (5130), \$2.50.

AMPICO—

Played by Milton Suskind and Arthur Loeser: 1st Movement (60923H), \$2.00.

ODE

*WE are the music-makers,
And we are the dreamers of dreams,
Wandering by lone sea-breakers,
And sitting by desolate streams;
World-losers and world-forsakers,
On whom the pale moon gleams;
Yet we are the movers and shakers
Of the world forever, it seems.*

*WITH wonderful deathless ditties
We build up the world's great cities,
And out of a fabulous story
We fashion an empire's glory:
One man with a dream, at pleasure,
Shall go forth and conquer a crown;
And three with a new song's measure
Can trample a kingdom down.*

*WE, in the ages lying
In the buried past of the earth,
Built Nineveh with our sighing,
And Babel itself in our mirth;
And o'erthrew them with prophesying
To the Old of the New World's worth;
For each age is a dream that is dying,
Or one that is coming to birth.*

Arthur O'Shaughnessy (1844-1881).

RADIO and the MUSIC STUDENT

is a regular monthly feature of this magazine. To follow it systematically is to add immeasurably to the cultural value of your radio set. A complete collection of its installments will be a textbook of musical appreciation from which you can draw inspiration for years to come. The following back numbers are available:—

December

"My Old Kentucky Home," by Stephen Foster, and Chopin's "Fantasie Impromptu" were the two selections chosen. Both have become dear to the hearts of all music lovers.

The Silver Masked Tenor was also the subject of a human-interest, personal article, illustrated with the only photograph of him without his mask—and pictures of his wife and baby.

Taking the Bothers Out of Batteries

This proved to be one of the most helpful articles we have ever printed. It was written by

HENRY M. NEELY

and showed various ways of connecting batteries so that all the bother of charging is done away with. The throwing of a switch one way or the other puts the battery on charge, or disconnects everything, or starts the set working.

It was in the February issue.

January

"Romeo and Juliet"—that great love-duet from the pen of Gounod, and an equally great example of the new school of music—"Thus Spake Zarathustra"—were the two compositions treated.

There was also, in this issue, a sane and constructive article—"What Can I Get?"—by Brainard Foote, which answers the questions that every novice asks about a radio set.

March

Mendelssohn's "On Wings of Song" was played by Godfrey Ludlow, the master violinist of Station WJZ on March 7. It was the subject of Mr. Harris' music article in the March issue.

"The Tragedy of the S O S" was also in that issue—a gripping explanation of how the cry of the sinking ship is relayed to rescuers and why your broadcasting station has to "stand by."

February

Beethoven's Fifth Symphony is one of the great immortal monuments of music. No musical education is complete—in fact, it cannot even begin—without some knowledge of this masterpiece.

Betty Crocker—that fascinating little homemaker whose pleasing voice tells you so much about things you want to know—is the subject of another article in this issue.

Those Department Store "Bargains"

No article in any radio magazine has ever created the sensation made by this straightforward narrative by

ULMER G. TURNER, Jr.,

of his experiences as an employee in the so-called "service department" of one of the big stores during the "dumping" season in radio. Before you or your friends buy one of these "bargains" you should read this article.

It was in the March issue.

Any or all of these back issues can be supplied at 20 cents each

Address BACK COPY DEPARTMENT, THE RADIO HOME, Produce Exchange Building, Philadelphia

Norman Brockenshire, WJZ's most popular announcer, introducing Mrs. Julian Heath to the afternoon audience.



By
ELIZABETH
A. ANDERSON

Hurry Up! It's 4 O'clock and Mrs. JULIAN HEATH

WHEN radio first became a home necessity and the daytime household hours of broadcasting for women were introduced, we all probably thought that men would be bored to death by such programs. That was my impression until one afternoon I went out to our laboratory to discuss with H. M. N. some editorial matters. We were sitting in his office adjoining the laboratory and were paying no particular attention to a new radio set which was being tested by the staff, when suddenly Mr. Allen rushed into the office all excited and shouted:

"Come quick H. M. Mrs. Heath is on and she's giving that ice-box cake again."

H. M. did not even wait to excuse himself to me. He jumped from his chair and as he ran through the laboratory, I heard him shout:

"Drop everything, everybody. Get your pencils and paper and copy while I go in and

*Is On the Air. She'll Give You
a Lot of Good Cooking Hook-
Ups That Your Wife Ought
To Try On Her Lorain.*

turn on the set for Mrs. N. in the house."

I went to the door and it was all I could do to keep from laughing as I saw three very serious and very highly expert radio technicians struggling with the job of taking down the recipe as Mrs. Heath gave it from Station WJZ.

After it was all over, H. M. came back from the house and said, "Did you get it?"

"Well," said Mr. Allen, rather ruefully, "I've got the list of apparatus all right but I

am not so sure of my hook-up directions."

I found out afterwards that the laboratory staff had been testing a new set one day and tuned in on WJZ just as Mrs. Heath was giving the recipe for this ice-box cake. At first, the men were interested only in the scientific performance of the set but after a while H. M. said:

"Gosh! That sounds good. Wish we had copied it when she started."

Since that visit of mine, when the staff managed to get the "list of apparatus and hook-up directions" down on paper, the members of the staff have had their wives experiment with the ice-box cake and the changes that they have made are given later on in this article. I started to make fun of them and told them that I did not think an expensive laboratory should be devoted to such a purpose but H. M. replied:

"Not at all. We have always boasted that

we did not print hook-ups without trying them out in this laboratory and I see no reason why we shouldn't apply the same policy to radio recipes."

Despite the rather threadbare old saying, which I for one have always thought more or less of a slander, especially if you confine it to men, about the way to men's hearts, there must be something more than the good things to eat that Mrs. Heath describes so wonderfully to attract the men who listen-in on her talks. G. P. is sure to find that he has to knock off from other work or relax a bit when he is in the laboratory, at 4.00 P. M. So are the others, and I am certain they do not try out all the recipes.

I thought I had the solution even before I went to WJZ studio a few weeks ago to talk to Mrs. Heath and I had not said a word to her before I realized that my estimate formed from tuning in WJZ during Mrs. Heath's hour whenever possible, was justified.

Personality—pure personality—is the answer.

You feel it whether you are sitting at home in your own little kitchen, or are so privileged as to have a place in the studio while she is broadcasting.

But before I tell you about Mrs. Heath herself, I am sure you will want to know the "hook-up" for the famous ice-box cake that so excited the serious scientists in our laboratory. Incidentally, I am going to give it in a way that will enable you thoroughly to understand the "Radio Recipe Contest" announced with this article.

I will print first the recipe just as given by Mrs. Heath by radio and as copied by our staff. Of course, we cannot give prizes just for copying a radio recipe. If we did, everybody would win a prize and we would have no money left for carrying on the magazine.

What we want you to do in this Radio Recipe Contest is first to give the recipe exactly as you copied it by radio together with the name of the broadcasting station from which you heard it, the speaker's name and the date.

Then—and this is the most important of all—you must give some change or improvement which you have made, together with full instructions so that any other woman can make it.

We have improved on the original ice-box cake recipe—at least each of us has a version we think particularly good. We leave the decision as to the best to our readers. It is such adaptations of recipes that they get over the air that we ask from our readers in this contest.

Original Ice-box Cake



Here is the studio of WJZ, and the table at the right is the teacher's desk of the world's largest class in home economics, for it is at that table that Mrs. Heath sits to give her afternoon talks to her thousands of radio followers.

Recipe—Split 40 lady fingers and arrange in upright position around edge of spring form. Also cover bottom of pan. Melt $\frac{3}{4}$ lb. or 1 small cake of sweet chocolate, add 4 tablespoonfuls or 1 cup of confectioner's sugar, 2 tablespoonfuls of milk, 1 teaspoonful of vanilla, yolks of 5 eggs, whites of 5 eggs beaten. Do not cook.

When cold put layer of chocolate, another of lady fingers and so alternate until 1 inch from top of pan. Put in ice box overnight. Just before serving fill top with whipped cream. Decorations of candied cherries add to its attractiveness.

Good? You bet it is—at least that is the verdict of all of us who have tasted ice-box cake made by the recipe Mrs. Heath has broadcast a number of times.

At first we thought that it was perfect in its original form. After several trials, we began to be more critical and to try innovations. H. M. N. thought the lady fingers made it a bit too dry and so Mrs. H. M. N. tried substituting sponge-cake sliced thin and he liked it better. Next, one evening when a guest who does not like chocolate was expected for dinner, she conceived the idea of making an orange filling instead of the other kind and I have the guest's word that it was the best dessert he ever tasted. Try it yourself and see if he is not right.

Orange Ice-box Cake, an adaptation of the recipe given by Mrs. Heath over WJZ.

slices of sponge cake	1 cup of sugar
1 cup of rich milk	3 eggs
1 tablespoonful of butter	1 orange (juice and grated rind)
1 teaspoonful of cornstarch	$\frac{1}{2}$ pint heavy cream

Mix egg yolks, sugar, milk, butter and cornstarch and cook for a few minutes, stirring constantly. When thick, remove from fire and fold in stiffly beaten egg whites, then add orange juice and grated rind. Fix same as for above cake in mold and place overnight in ice-box. Add to the whipped cream $\frac{1}{2}$ cup of confectioners sugar and a few drops of orange extract. Decorate with candied cherries and pistachio nuts.

The first time G. P. tried the orange cake he declared he thought that a mocha cake would be better than either of the others and after several trials, Mrs. Allen has achieved the following masterpiece:

Mocha Ice-box Cake, adapted from the one given by Mrs. Heath over WJZ.

Sliced sponge cake to line and fill a mold	
1 cup of hot milk	$\frac{1}{4}$ cup coffee grounds
2 tablespoonfuls of cornstarch	$\frac{1}{2}$ cup sugar
$\frac{1}{8}$ teaspoonful of salt	2 eggs
1 teaspoonful vanilla	$\frac{1}{2}$ pt. whipped cream

Cash For Radio Recipes

WE WANT all the women in the families of all the men who read this magazine to send us their own improvements on the recipes they hear by radio. Read this article about Mrs. Heath and see how the different members of our staff changed Mrs. Heath's recipe for ice-box cake. That's how we want it done. It's fun—and it's easy—and we offer

First Prize	Second Prize	Third Prize
\$25.00	\$15.00	\$10.00

—every month for these recipes. Remember, we don't want just the recipe you've copied. We want your improvement on it. Read this article and you'll understand. Send in your recipes at once addressed to—

Radio Recipe Contest

THE RADIO HOME

Produce Exchange Building - Philadelphia

Pour the hot milk on coffee grounds and keep hot for 10 minutes. Put cornstarch, sugar and salt in a double boiler. Pour mocha and beaten yolks of eggs over this and let cook until thick and smooth (of course strain milk from coffee grounds before adding). Then add the beaten whites and vanilla. Arrange in molds the same as for cakes given above.

Not to be outdone by the others, I have tried one that for deliciousness I think beats them all. It is particularly good at this season when strawberries are beginning to come into the market. Another advantage is that any other fruit in season may be substituted for strawberries. Raspberries and peaches make an equally delicious dessert.

Strawberry Ice-box Cake: enough sliced sponge cake or lady fingers to line a spring mold and to fill in layers; about a pound of cake will be enough to serve a family of six.

1 quart of ripe strawberries
4 egg whites (beaten stiff and dry)
1 to 2 cupfuls of XXXX sugar
(quantity varying with the juiciness and tartness of the berries)
½ pint of heavy whipping cream
1 dozen big ripe berries to garnish top of cake

Beat egg whites until dry, add the sugar to form a thick creamy consistency; next beat in the crushed strawberries. Keep all ingredients cold during this process and have a chilled mold lined with thin slices of sponge cake ready. Spread thickly with strawberry whip, and add another layer of cake; continue alternate layers until the mold is full. Place in ice-box over night. When ready to serve, turn the cake on a garnished plate, heap with whipped cream and decorate with firm red berries.

Some one asked me if it was not rather wasteful not to use the yolks of eggs and I was glad to be able to say that they were reserved for making a dish of old-fashioned lemon butter, which as a spread for crackers or thin slices of nut bread, has always been a great favorite in our family.

Presto! another idea for ice-box cake. I tried it with lemon butter filling and although the result is very rich, I believe that I like it best of all.

My aunt whose goodies were famous in her day gave me the lemon butter recipe.

Lemon Butter:

5 eggs (yolks) 1 cupful sugar
½ cupful boiling water ½ cupful of butter
1 lemon (2 may be necessary if small)
salt to taste

Beat the yolks of 5 eggs to smooth consistency with a cup of sugar, then add the grated rind of 1 large lemon to a half cup of boiling water. Pour boiling hot, beating all the time over the beaten yolks. Place in a double boiler and stir until it thickens, then beat in ½ cupful of fresh creamery butter, and last of all, add the strained lemon juice.

This cake is to my mind better if served with beaten egg whites to which sugar or

"As we talked, I realized why Mrs. Heath is so well qualified to lead the women of America toward the goal of better homes."



marshmallow whip has been added to taste, as whipped cream makes it rather heavy.

The Lemon butter recipe may be varied according to individual taste. If you like it very sharp use more lemon juice; if more bland less; in the latter case more water will be needed. Sometimes when eggs are high I use only two or three eggs, substituting a scant tablespoonful of corn starch or a full one of flour for each one omitted. The butter may be scanted, too, if you think it is too rich. I always add a pinch of salt, but that too, to use one of Mrs. Heath's expressions which she

uses often by radio, may be "as you like."

But I have wandered far from the story of my afternoon visit with Mrs. Heath in the WJZ studios.

The instant Mrs. Heath began to speak that day, I felt as though I had been transported to a different plane where there was no microphone, and no other visitor (two women who had come to the studio to hear the talk sat close to me)—just Mrs. Heath talking directly to me and Norman Brockenshire throwing in a little friendly banter, as I had heard them so often before at home.

After a while, I began to analyze my reaction to the speaker. Her repartee was quick. Her mind must be as sharp as a steel trap for she had no formal preparation before her such as I often had seen other broadcasters follow; merely a sheaf of letters and several recipes to which she referred. Otherwise her talk was impromptu.

But it went on as smoothly as usual. Later I recalled that Mrs. Heath had sat at the telephone for a few minutes before she went into the broadcasting room. She had been verifying the daily market reports. How she kept them all straight as she made her marketing suggestions is more than I can tell.

As I watched the speaker, I realized that here was a woman of perfect repose, and it is that quality that makes her seem so much at ease and makes her listeners feel so too, as she talks.

"How is it that the thought of such a vast and widely scattered audience does not make you nervous?" I ventured as we left the studio.

"Perhaps because I do not attempt to tell them what to do. I simply make suggestions along the lines of my own experience and they seem to be glad to follow."

There I sat talking as freely with Mrs. Heath as if I had known her all my life, not as a real celebrity not only in the realm of women but in our national life, but as I might to any of my own close relatives. A favorite expression of Aunt Hannah, an old southern cook of my acquaintance, came to my mind, Mrs. Heath is as "easy as an old shoe."

As we talked I realized more and more why Mrs. Heath is so well qualified to lead the women of America toward the goal of better homes. Hers has been a life rich in experience. Her career began years ago when as a girl she became actively interested in bettering the home conditions of women in the poverty-ridden sections of New York. Some one said of her once that it was all very well for a society woman to try to tell the poor how to manage their incomes, but what could she know of their true condition? To this,

Our Favorite Radio Recipe

THIS is an unpublished recipe for cooking carp. First you take a good-sized carp and nail it to a board and set it out in the sun for two days. Then rub coarse salt thoroughly into the carp and cook slowly before the fire. Then throw the carp away and eat the nail and the board.—From a New York Aquarium talk from WJZ on March 2d.



Ward Bread Merger. Her reply was that they would at that time take no public action, but that every housewife could make her position felt through the ballot and the spending value of the dollar.

"Housewives are becoming class conscious and recognize that they represent the biggest business in the world," Mrs. Heath told me.

Her statement carried me back to an editorial I remembered reading some years ago in *The Ladies' Home Journal*, when the Housewives League was in its infancy. My scrap book yielded this article and the following quotation from Mrs.

Heath:

"The other day this startling statement was made to me by a wife and housekeeper.

"I believe that my husband could run our home better than I if he were compelled to do it."

"Why?" I asked.

"Because," she answered, 'he would run it as he runs his business.'"

The memory of the storm of protest that this brought forth from women all over the country is still with me. But events have shown that Mrs. Heath's judgment, at that time, was sound and it is largely due to such pioneer efforts as hers that the average Ameri-

can home is no longer on such an unbusiness-like basis.

When I asked rather feebly if Mrs. Heath kept a budget of her own household expenditures, she laughed and said, "No, I don't do it myself, but I always say to other women who do—'God bless you if you can keep it.'"

Do not think that I mean to imply that Mrs. Heath does not live up to her own teachings. She knows all about her household expenses, and her mind functions so accurately and rapidly on these matters, that she does not need a written account to tell where she stands.

Radio has given Mrs. Heath a broader scope for her work than has ever been possible before. The avalanche of letters that pours into WJZ every day tells just how far reaching this influence is. Many of them are from men who write on various subjects. One I remembered was from a Pennsylvania farmer who said he was sorry Mrs. Heath had mentioned in her talk that she was glad that the price of eggs had dropped, for there had been a good demand for eggs in his locality and at a fine price, and just as his hens were beginning to lay, the price must go down.

Another from a man in some way connected with the bee-keeping industry thanked her for giving some honey recipes.

Every letter—and a single day's mail that I saw included more than a hundred and not all short notes by any means—is read carefully. A letter from a crippled woman who told of how much the Home Hour talks had meant to her brought tears to Mrs. Heath's eyes. Noticing my inquiring look, Mrs. Heath said that it is strange that she who had always considered herself free from sentimentality should be so moved. The only explanation she could offer for the feeling that always overwhelms her when she reads these tributes, was that she felt as if her radio friends were very close to her and she actually suffered when she read of their trials.

In this connection, she said further that she really considered this feeling of the closeness in spirit of her listeners to be her greatest asset in the work. She has often been asked

her reply was that she thought she had climbed up into more tenements than had any other woman in New York City. All this charitable work was done in a spirit of real love and a desire to help these people.

This parochial work led to settlement work in which she was a pioneer. In these days, she was closely associated with Jacob Riis in the organization of the famous settlement named for its founder. Many of the incidents described in Jacob Riis' book, "How the Other Half Lives," are Mrs. Heath's personal experiences.

When Theodore Roosevelt was Police Commissioner of New York City, Mrs. Julian Heath was closely associated with him in public and social welfare work and continued these activities in Albany when he was Governor. Later she went to Washington at President Roosevelt's request to similar lines of endeavor with a national scope.

Her entire life has been devoted to the maintenance of the sacred institution of the American Home and it was to this purpose that in 1911 she founded the National Housewives League, Inc.

This was an outgrowth of the need Mrs. Heath saw on all sides for some deeper understanding on the part of women of all classes in the management of the family income. With rare foresight and judgment, Mrs. Heath saw in the League an opportunity for women to put to best use the power that their position as the spenders of the family income gave them. She regarded and still regards the League as the neutral ground between the consumer and the producer, and certain it is that the consumer in concerted effort beginning with the famous boycott on butter in the early days of the League has been able to hold in check the dishonest producer and to place the honest one where he belongs.

To bring the scope of the League to a present day basis, Mrs. Heath said that she was asked to make a public declaration as to the Housewives League on the subject of the



what the technique of broadcasting consists of and her answer is that she has no technique, and her enthusiastic listeners will doubtless agree with me that her greatest charm lies in the way she just seems to be talking to you individually. It is a gift of being able to put her listener at ease.

I had the same feeling the instant I began to talk to Mrs. Heath—as if I had known her a long time, and so I had—intimately over the air and publicly through her work in the Housewives League. In fact, this feeling persisted to such an extent that I found myself asking all sorts of personal questions, and I found out that Mrs. Heath is of New England ancestry, of Mayflower stock, that her present household includes one maid of all work, and this maid is further evidence to me that she lives up to her teaching, for while she loves to tell her radio audience of the rich desserts, they ask her about, she prefers simple desserts and fruits for steady diet.

I know that she has one son, a lawyer, the best son a mother ever had and that he is not married yet and that his mother hopes that when he does marry, his choice will be a girl who can take care of his home as he is accustomed to having it kept.

This chat about her son brought up the question of the girls of the present day and I inquired as to whether she had much response from girls after her talks.

I then remembered a little by-play I had overheard not long ago at a party given at the "Shack," a log cabin built on the banks of a gem of a lake in South Jersey, the refreshments—provided by the girls who were guests—included some luscious doughnuts, the kind that melt in your mouth.

"Did your mother make them, Jerry?" asked one of the boys.

"No, siree, I made them myself."

"Applesauce; tell that to Joe. He's easy."

"All right, Mr. Smarty, I did too. You can ask Mother. I heard Mrs. Heath give the recipe over the radio and I followed her directions exactly. They are called 'comforts' and are easy to make if you just know how to go ahead. I love to listen to Mrs. Heath."

"Well, maybe you did. I heard her too when Anna had her on the air the other afternoon. I like to hear her talk; it sounds so good when she tells you what she had for luncheon."

This bit of conversation recalled vividly to my mind something Mrs. Heath had told me

about the coming housewife. Unlike many women, whose public work in the interest of women dates back to even pre-war days Mrs. Heath, believes in the girls of the present day and in their ability, when the necessity comes of rising to the occasion and building up even better homes than were possible in a less enlightened day. She bases this opinion on her experience in contact with the younger generation. Almost daily, her mail brings her letters from youthful listeners who tell her of their interest in her talks, of how she has taught them to cook, how to manage their allowances, and how to conduct the business of the household.

One "Little Mother" in particular I remembered Mrs. Heath told me about, who, when her mother died, was left with the care of the household for her father and younger brothers and sisters. This young girl had no time to go to school to learn how to keep house and by the time she had received a reply to an SOS to a magazine, the burning need which was so evident when she wrote had had a chance to cool off to a great extent, if not entirely.

Listen to what the Women's Hour has meant to her.

"But with Mrs. Heath it is so different. She tells me things before I think about them myself. She has shown me how to buy properly so as to take advantage of low market prices. Why, just think; it never occurred to me how many good egg dishes I could make in the spring when eggs are cheap and that it would be better for me to have desserts that call for eggs more often than. I simply can't think of all the ways she has helped me—

"And here's a secret, I have started a little bank account with the money I've saved.

"I'm not going to tell Daddy, but when I have enough money, I am going to buy a nice easy chair to put by the radio set so he can enjoy sitting there listening when he comes home tired at night."

It is surprising how many young women who are popularly supposed by some of the older generation to spend their evenings and nights at jazz parties and other affairs, too awful to talk about, and their days in bed recovering from the evening before, find time to listen to Mrs. Heath.

After we had talked a bit about the younger fry, the conversation shifted once more to the personnel of Mrs. Heath's correspondence, and since it just happened that I had heard on a number of occasions when she was broadcasting, comments upon recipes, and letters unmistakably from women of rural communities, I asked if the bulk of her letters came from such a source.

"No indeed; they come from all kinds of people and from everywhere. Women whose whole lives revolve around their own little home circle and those with wide outside interests write to me and tell me of their own problems and offer recipes that they have tried successfully for their own families. Lots of men too write to me in response to my talks."



THE RADIO HOME

This is the radio home as it is beginning to look in an increasing proportion of cases. Radio isn't a bread-board, kitchen-table jumble of unsightly junk any more. It is decoration and furniture as well as glorious home entertainment and culture. The photograph shows a Radiola 28 in the home of Edgar C. Gause, near Kennett Square, Pa.

The LIL' OLE PROFESSOR of Station WIL

Here are Billy Knight—the Lil' Ole Professor—and the wife and boy who won him from the footlights to the mike.

A Wife, a Son and the Lure of the Magic "Mike" Made Billy Knight Quit His Roaming Life as an Actor and Settle Down to Entertaining an Audience He Cannot See.

By E. D.
CAHN

STATION WIL is operated by the St. Louis Star and the Benson Radio Company and Billy Knight, otherwise known as "the Lil' Ole Professor," is its presiding genius. This is no mere figure of speech, either, for he combines the duties of announcer with those of program director and business manager and often contributes to the program as well.

Such a combination of jobs calls for no small amount of energy and Mr. Knight is that person we so often hear of but seldom see—a human dynamo. To observe him in action is to see that one man can do half a dozen things at once, be in as many places during the doing of them, and slip from character to character without hesitation or jar perhaps a hundred times during the making of one program.

Telephone calls come in galore and often none but the Professor's voice will satisfy. He reads telegrams, sees aspiring broadcasters and sprints back to the waiting microphone—making the transition from alert business man to his character of the Lil' Ole Professor somewhere and somehow en route.

His inimitable clowning is all the extemporaneous bubbling forth of his own youthful good spirits and native wit; keen, clean good-humored. He is "peppy" in a very amusing and stimulating way. The worst crank in the world would be obliged to smile with him for

his fun is never flip-pant nor irritating.

His stage training stands him in good stead in various ways. He not only knows how to sing a popular song and get over the punch lines—as theatrical slang dubs them—but he knows that the time to stop is while the audience is eager for more. It is as fatal to over-talk the microphone as to over-play in the theatre.

Beginning his career at the early age of six, the Lil' Ole Professor has been before the public ever since, appearing in vaudeville on the various well-known circuits throughout the country. But since his home is in St.

Louis, he has stayed in or near it as much as he could—the dainty little dancer, Maybelle Knight, who is his wife, and their small son being reason sufficient for that.

Billy Knight's first interest in broadcasting came through an appearance as a radio singer and his present work grew out of that first contact with the magic "mike." The owners of broadcasting stations are sometimes quick to recognize executive ability in people whose own estimate does not include any opinion, or even any realization, of that quality in themselves, and it was so in the Professor's case.

Accustomed only to entertaining people from theatre stages by voice, piano and comic talent with variations in New York, Detroit and Chicago with several different music publishers where he met and dealt with his fellow professionals, it had never occurred to him that the same qualities of tact, good humor and human understanding which had stood him in good stead before would also serve him well in that peculiar combination of art and business which is called for in the director of a broadcasting station.

Being a performer himself, he knows the strengths and weaknesses of his artists and unlike many another director, he can always fill in at a pinch—though it has got to be a real one before he does.

He has an able seconder—or perhaps it would be more accurate to say aider and abettor—in the studio pianist, Mary Raines, known in St. Louis as the Queen of the Ivories. This young lady is also of a whimsical turn of mind and she can be and quite often is as



NATIONAL Velvet Vernier DIAL
Type B. Variable (patent pending)



Gearless-Positive Control

WHAT a difference in the tuning of your set when you replace your plain dial with this new NATIONAL Type B Velvet Vernier Dial.

Has a variable ratio from 6-1 to 20-1. Requires but one small hole to be drilled in panel for mounting.

Write for Bulletin 109 R. H.

NATIONAL COMPANY, Inc.
W. A. READY, President
110 Brookline St. CAMBRIDGE, MASS.

Be the Jazz King Of Your Town!



Be popular. In demand everywhere. Have fun. Earn your welcome. Charm your friends with your

BUESCHER
SAXOPHONE

Teach yourself. 3 free lessons give you quick easy start. Try any instrument in your own home 6 days free. See what you can do. Easy terms. Send now for beautiful free literature. A postal brings details. (4)

Buescher Band Instrument Co.
1564 Buescher Block, Elkhart, Ind.

\$1.50 FOR YOUR OLD RADIO TUBES

regardless of make or condition, toward purchase of each new standard \$2.50 tube. Positively guaranteed. We do not sell re-built or bootleg tubes. Agents wanted.

Super-Service Laboratories
Dept. 66, Room 58,
39 West Adams, Chicago, Ill.



No. 135-A

Send for—
New No. 739 Circular describing special voltmeters for Radiola, Victor and Brunswick sets.

Order from Dealer

Jewell Electrical Instrument Co.
1650 Walnut St. Chicago
26 years making good instruments

droll as the Professor is himself. Mary can play any kind of music; transpose it, jazz it, make her piano roar or laugh, according to her mood. Slender, nonchalant, she has a real personality without realizing it—just one more of the mighty host of talented youngsters produced by these United States during the last twenty years from material that certainly did not seem particularly promising to itself at that time.

Mary sings, too, though she does it as off-handedly as she plays, and never attempts anything ambitious. The jolly little songs that are written in such numbers, have their brief hour and are forgotten. She sings them in a pleasant contralto, to her own accompaniment as softly as though she were running them over alone. She appears to do it all without any art which is only another way of saying that she is a skillful practitioner in that art which is beyond art.

WIL, though a Class A station, has been heard as far north as Alaska, as far west as Los Angeles and recently received a message from a ship far out on the Atlantic telling of the perfect reception of its program.

WIL has broadcast many voices and many orchestras, among them Jack Aranson's Forest Park Highlands, which is very popular not only locally but among its radio audience scattered over many, many miles of country.

Many stations report that their publics are showing a growing appreciation of good—that is to say—the more serious—music but with WIL the case is exactly opposite. The fans want to hear light music and good jazz from this quarter and made it very plain when the other sort was offered experimentally.

Surprisingly enough it was the older generation that was the most

emphatic in wanting jazz and saying so.

The older people like the Professor, too, and many have been the guesses as to his real age and appearance, the general opinion being that he has too much pep for an old man and too much sense for a young one.

He receives many presents from his admirers. One lady eighty-one years of age heard him sing a jolly song on her birthday and liked it so well she sent him a dollar bill. People telephone to the studio and ask what size hat and collar he wears and send him a great number and variety of each. He has received everything from a sweater to a Boston fern and letters asking for information on a diversity of personal matters ranging from his age to his wife's maiden name.

Some time ago St. Louis had a sort of clearing out of fortune tellers, crystal gazers and all such. One evening about that time the Lil' Ole Professor couldn't resist the opportunity to poke some good natured fun at the whole thing and he began to read an imaginary crystal located in the microphone before him with such success that he has had to retain it as a studio prop ever since. Fans like to hear that their telegrams are reflected in the crystal and their requests "divined" by the same occult means.

This seems to prove that the personal note is the one most valued by the steadily increasing audience of WIL and that the man behind the "mike" counts just as much as the man behind the gun.

The Lil' Ole Professor—who is not so little and not a bit old and Professor only in pretence—is a real entertainer and folks are finding it out. It is the old story of the world's willingness to wend its way to the door of the man it needs, be he situated where he may.

Cut out—Fill in—Send this—Quick

Date _____

Subscription Dept.
THE RADIO HOME
Produce Exchange Bldg.
Philadelphia, Pa.

Surest thing you know! I'll be glad to get a \$2.00 year's subscription to your magazine for only \$1.00 by sending this—with the dollar—before April 25.

So here's my dollar. Now you do your part.

Name _____

Address _____

R. F. D.

Pilot Light Switch



A combination of Pilot Light and Midget Battery Switch. Constantly indicates whether the radio set is "on" or "off." The pilot light bulb's eye is furnished in a choice of red, green or amber.

Pilot Light Switch, No. 210.
\$1.00. Lamp Extra

Pilot Light Bracket same as the Pilot Light Switch except that bracket is set up in the same panel hole as the glass bulb's eye instead of being mounted in the switch.

Pilot Light Bracket, No. 310.
50 cents, Lamp Extra

One Phone Plug



YAXLEY No. 50

Licensed Under Patent—No. 1,498,196

Has a polished bakelite handle, is small in size; phone tips instantly connected without use of tools. Cannot be disconnected until handle is removed. Perfect contact assured. All bakelite insulation prevents current leakage. Shorting is impossible. 50 cents each.

YAXLEY
APPROVED RADIO PRODUCTS

YAXLEY MFG. CO., Dept. K
217 N. Desplaines St., Chicago, Ill.

Send for Latest RADIO CATALOG and GUIDE

SETS, PARTS, KITS
BIG SAVINGS

You need this big FREE book. A practical guide to success in set building. Given advanced book-ups. Shows all newest parts and kits at prices far below others. Send today. Build the new sets. Make more money.



BARAWIK CO.
102-130 S. Canal St., Chicago

SAVE ONE HALF

Buy Direct From Factory, LANES
Guaranteed **\$12.50** Cash or C.O.D. Products

Now, by our method of direct dealing, we actually save you the dealer's discount and give you two powerful, high class, handsome looking products each at \$12.50 and equal to any at 3 times the cost.

100 Volts Storage **B BATTERY**
NON-ACID 75 Cells—Wonderful Reception

B ELIMINATOR Best for 5 Tube Sets
Works from either A. C. or D. C.
Each regularly sold for \$25. Now \$12.50

Greatest values. Finest reception. Lowest upkeep cost. Handmade steel crystalline case with rubber feet. We guarantee no disappointments. Mail your order today.

Lane Mfg. Co.
2941 West Lake Street
Dept. 27 Chicago

DON'T MISS THIS



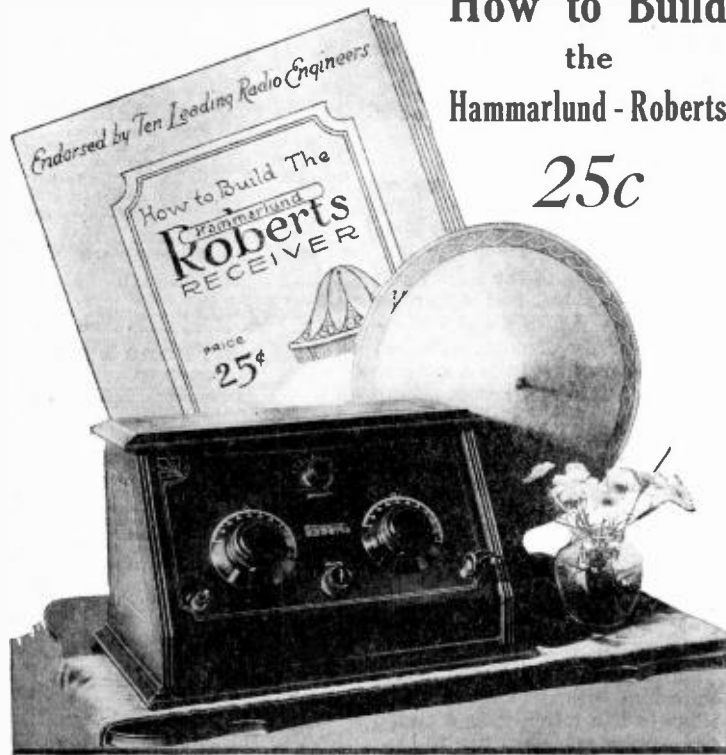

**How to Build
the
Hammarlund - Roberts
25c**

**Anyone Can Build
This Receiver!**

MOST books on how to build radio receivers are difficult to grasp because the sets they describe are intricate in design and involve complicated wiring and assembling.

Simplicity of design and ease of assembly are notable features of the Hammarlund-Roberts Receiver. Thousands have built it. Hundreds of testimonials from actual users pay tribute to its remarkable performance in volume, distance, selectivity and tone quality.

You can build the Hammarlund-Roberts from the simple, non-technical instructions in this book. You will have a laboratory designed receiver equal to any factory-built set and at half the price. Designed by ten of the country's leading engineers and backed by the manufacturers listed to the left.

**Co-operating
Manufacturers**

- All-American Radio Corp.
- Alden Mfg. Co.
- Radiall Co.
- ("Amperitas")
- Carter Radio Co.
- Union Radio Corp
- International Resistance Co.
- ("Durham Resistors")
- Westinghouse
- "Micarta"
- Hammarlund Mfg. Co.

Send for

This Book, giving full instructions on wiring, assembling and operating the Hammarlund-Roberts Receiver. Price 25c.

HAMMARLUND-ROBERTS
1182-M Broadway, New York City



**Hammarlund
Roberts**



H

*If You Appreciate Quality Results,
Build With Quality Parts*



*The
Hammarlund
S.F.L.
Condenser*

**HAMMARLUND
Condensers and Coils**

The best is always cheapest in the long run. Build your receiver "for the long run" with

In the entire history of radio, nothing has ever surpassed Hammarlund Products in excellency of design, workmanship and efficient performance.

Write for literature and send 25 cents for illustrated book on how to build the famous Hammarlund-Roberts Receiver.

HAMMARLUND MANUFACTURING CO., 424-438 W. 33rd St., New York

**For Better Radio
Hammarlund
PRECISION
PRODUCTS**

H



One of these radio sets and probably wouldn't attempt to.

You'd laugh at her if she tried.

But you bet she can hook up one of Mrs. Heath's radio recipes—the one for chocolate ice box cake, f'rinstance,

And you won't laugh at that!!

Don't forget that half this magazine is designed especially for her. So don't be stingy with it. Let her look over the Broadcasting Section before you take the book down—or up—to your den. Or cut the book right down the center fold and give her the front half. Or, better yet, buy her an extra copy and then you'll be happy, and she'll be happy,

And we'll be happy.

That's fair enough.

Technical *and* Hook-Up Section

IF YOU believe all the things you read in the imaginative magazines and the Sunday sections of the newspapers, we'll have radio movies in a year or two and we'll be running our trains and our steamships and our factories by radio power by the time little Johnny gets measured for his first pair of long trousers.

It's a perfectly easy and a delightful thing to let imagination run riot and paint these Julesvernesque pipe dreams. It's a thankless and a hazardous thing to go on record in print and sneer them off as applesauce. They did that with Watts and his tea kettle and, back farther than that, they did it with a chap named Galileo and a funny looking tube through which he looked at the stars and declared it showed him that the text books in the grammar schools were as useless as a biology book in Tennessee. They did it with Bell and with Morse and with Marconi and the Wright brothers.

And yet we can say this much—in the present state of our scientific development, there is no device which promises radio movies within the life span of any of us and, as for radio power, no reputable radio engineer expects to live to behold any such application of his science. He'd like to—but he knows he won't.

It is quite conceivable that these things will come in time. It is conceivable that most everything will come in time—even prohibition.

But the mere fact that this particular staff of so-called editors cannot vision this particular brace of miracles just over the next hill doesn't mean that there isn't anything promising in radio to maintain the interest of the fan. There is—plenty.

For instance, it won't be so very long before you can make your own complete record of a favorite song or symphony or opera just as it comes from your radio set and put it away in your record library, to be played at any convenient later time by putting it back on your set, whether there are any broadcasting stations on the air or not. It won't be a disk record, good for only three or four minutes. It will be in the nature of a spool of movie film and, you will be able to use much or little, just as you please—from a short Etude to a whole act of opera.

You'll be able to buy these records, too—much better ones than you can make yourself—recorded in a studio or public hall where conditions will be perfect. And you'll have a cabinet full of them and then, if the radio programs in the papers don't suit you, you'll simply put these records on your radio set and the radio set will reproduce them for you.

This isn't a wild dream of the distant future; I've heard the thing working in its laboratory stage and its commercial development isn't presenting any insurmountable obstacles. Incidentally, you may be interested to know that its basic device is an

invention of Theodore H. Nakken, one of our Associate Editors, whose series, "How to Understand Radio" begins on Page 55 of this section. Mr. Nakken will make his first public announcements through this magazine.

Outside of this, and its vast importance, I personally think that changes in tubes are the most interesting developments immediately in

Well; there are several men who are coming closer and closer to that very point. They themselves, in their laboratories, can almost tune out a lightning storm; the thing they are working on now is to simplify and cheapen their devices so as to make them generally available in the popular market. A static eliminator that costs a million dollars wouldn't

eliminate much static for you and me, would it?

But "Pat" is going to tell you all about these devices and the lines along

which these men are working and he will also tell you what we actually know about static—though it isn't really a whole lot.

There is another bugbear which we all suffer from more or less and that is "man-made" static—the disturbances caused in radio sets by electrical devices of all kinds—factory generators, violet-ray and X-ray machines, leaking power lines and things of that kind. There is a growing movement on foot all over the country to get together and swap experiences in this sort of thing. It has been found possible to hunt down the sources of these disturbances and eliminate them and the publication of actual experiences, with details of the methods used, seems to me to be about as important a contribution as any radio magazine can make to the betterment of reception generally.

So we have detailed Mr. Allen to specialize on this and his series of articles, beginning on page 7 of this issue, is offered in the hope that somewhere, in some one or more of them, you will find the very suggestion you have been looking for to help you and your neighbors eliminate those noises which are marring radio for you at the present time.

These, as I see the situation, are the immediate developments which are significant. They do not sound half so imaginative or romantic as radio movies or radio power, but they have a direct and important bearing on you and me and our families as we gather each evening to listen to our favorite broadcasters. They are practical and useful things; I would almost say they are essential to our comfort.

The fact that our staff has specialized on them is not what makes them important. It's quite the reverse.

Our staff has specialized on them because we realized that they are important.

Still we are closely watching all developments toward radio "vision"—or radio movies. Prof. Reginald Fessenden is quoted as saying that the thing is actually possible now. I am inclined to think he has been misquoted in this but if he really says it's so, then I'll have to take back what I've written here because Prof. Fessenden has forgotten more about radio than this staff will even know. I haven't said anything about the developments that are coming from the transmitting end. I don't know of anything revolutionary in sight; it seems to be a matter of development and refinement and growth in efficiency.

What Next in Radio?

It's Easy To Look Ahead and Predict Miracles, But Most Radio Prophets Use Too Much Imagination and Not Enough Basic Facts.

By HENRY M. NEELY

sight. The coming of the tube which will operate entirely from the house electric light socket is going to be of tremendous benefit to the public in general because, argue as we will, there is a vast army of people—women in particular—who simply will not consider having a storage battery in their homes. The day of freedom from this nuisance is very near. As I sit here in my office adjoining our laboratory, writing this editorial, "Les" Biles and G. P. Allen are operating a set entirely without batteries (we don't consider the little "C's")—using the new McCullough tubes and a good B battery eliminator. There is a piano solo coming through on the Western Electric cone from WFI and there isn't the slightest trace of AC hum or distortion and the volume and quality seem to be under perfect control. This is the set which Mr. Biles will describe in our next issue.

Another of our staff, Edward B. Patterson, has been making a long and intensive investigation of the ideas along which various laboratories are working in the development of tubes. He has found a tube working on AC and containing three grids and three plates—three complete tubes in one. He has found a storage battery tube which is also triple. Two tubes make a six tube set and three make a nine-tube super-heterodyne. These tubes won't be on the market for some time, however, so don't hesitate to buy that new lot that you need now. "Pat" will tell you all about these tubes in a series of articles he is preparing.

Incidentally, "Pat" has made a closer study of static and the possibilities of its elimination than any writing man in the game. There's a development we are all praying for. We'll put up with storage batteries if they'll only get rid of static.

*Ask Your Dealer
if he reads —*

The RADIO DEALER

The Radio Trade Journal for the Radio Business Man

The leading dealers in Radio Sets and Apparatus everywhere read this pioneer Radio Trade publication

BECAUSE

- ¶ It keeps them fully informed as to the latest and best products of all the leading manufacturers.
- ¶ Its practical articles on Merchandising enable them to keep their stores and their stocks in the way that attracts trade.
- ¶ Its Service Articles enable them to give the kind of Service that makes a one-time customer a steady patron.
- ¶ Because it is an inspiration for their clerks, salesmen and service men.

IF YOUR DEALER READS THIS PUBLICATION
HE'S THE ONE FOR YOU TO STICK TO

THE RADIO DEALER PUBLISHING COMPANY, INC.
10 East 39th Street, New York, N. Y.

Subscription \$2.00 a Year to Jobbers, Dealers and Manufacturers Only

Will This Young Man's Device Revolutionize RADIO?

Skala Believes He Has a Method by Which Many Stations in the Same City Can Broadcast on the Same Wave Length at the Same Time and Yet Not Interfere.



L. William Skala.

LATE in February, the newspapers throughout the country printed a dispatch from Chicago saying that a new invention had been perfected which would "revolutionize" radio communication to such an extent that an infinite number of stations could operate on a single wave length without interfering with each other!

Needless to say, the importance of such an invention was not to be overlooked, so in a very few hours I found myself the happy target of orders to "Go and get it!" In other words, if there was anything to the device or the claims made for it, I was to find out, and give the readers of *The Radio Home* first-hand information. The man who was credited with having made the startling discovery was L. William Skala.

Mr. Skala is only 28 years old. He is, however, a graduate of Prague University. Chemistry and other scientific studies were his best grades in this famous school, as it was in such work that he was interested.

He was born an Austrian subject, in the little state of Czeko-Slovakia—the "home of Bohemians." Thus, Mr. Skala might rightfully be termed a Bohemian. He was a lieutenant in the Austrian army but fought against that country when his little state decided to become a republic.

Now, if the reader will pardon me for having wandered into a bit of biography, I will continue with just what Mr. Skala's device is—and the revolution it *may* work in the radio field. Maybe it will and maybe it will not. It is very hard to say.

Through the courtesy of Frank J. Schraeder, engineer and patent attorney of Chicago, who represents Mr. Skala, I was able to make the trip to his laboratory and arrange a demonstration for *The Radio Home*.

I found the laboratory in a large store building, the display windows of which were coated with Bon Ami. Having lived in Philadelphia quite a while, I thought that it was just another of those big sales we read about getting ready to happen, but I was very much mistaken.

By ULMER G.
TURNER, Jr.

I was absolutely surprised when I entered the store. Instead of long rows of merchandise, I found laboratory apparatus! Two complete radio transmitters and a receiver were among the equipment there. I could see that Skala had been using them more than anything else, as they were the center of attraction.

It was just at that moment that I got my first view of Mr. Skala's device which has been termed a "wave splitter" by the Chicago papers. It was easy to see that Skala certainly knew just how to rig up what he wanted. Also that he had the apparatus for doing it.

THE demonstration had been all fixed up, ready to be shown me. However, to keep down any suspicions on my part, I was allowed to inspect the whole building. It reminded me of an account I had read of the first public demonstration of the Bell telephone. The people just wouldn't believe it! Well, Skala knew it would be that way with his device, so he invited inspection. No extra arrangements were on the transmitter or the receiver. You see, the inventor had not yet attached his device.

I tuned the transmitters to the same wave-length. I regretted not having brought a wavemeter from Station 3XP, as Skala did not have one. He certainly ought to rig one up. His demonstration would be far more convincing. Still, I managed to get the waves right by tuning them to zero beat note with the receiver—a three-circuit regenerative affair.

The antennae used were simply pieces of brass or copper rod about six feet long. They were insulated by sticking one end in a large gallon jug filled with dirt. The free end hung in the air—the rods being in a perpendicular position. The ground was attached to a water pipe or radiator.

The transmitters were of a power approximating two to three watts. Very low power, of course. Sufficient for laboratory testing, though.

Each station had a microphone and Mr. Skala's brother talked into one station—suppose we say Station A. Mr. Leonard sang some of his Irish tenors into Station B's "mike." They were terribly "garbled." Every time Mr. Leonard would sing, "Oh, Paddy, Dear, 'n did you hear—", Mr. Skala's brother would interrupt the song, filling in, "Chickawwgo, Illinois!"

Mr. Skala then brought out his device. I had to assure him that I would not question him as to the contents of the box.

There are two binding posts on each side. The antenna and ground from the set go to two of them while the real antenna and ground wires run to the two on the opposite side.

The inventor then hooked the device to the two transmitters and the one receiver. Cer-

Light and Power for Twenty Years

NO DOUBT you remember the first automobile you ever saw. Perhaps you'll remember, too, that it bore a shiny little tank marked "Prest-O-Lite" . . . for Prest-O-Lite gave the motor-car its first dependable eyes.

This same company, which has served the automotive industry so successfully for more than twenty years, today serves radio with a dependable, long-lived battery, of special design, that brings out the best in any set.

In engineering, materials and workmanship, Prest-O-Lite cannot be excelled. You can rest assured that Prest-O-Lite Batteries are cor-

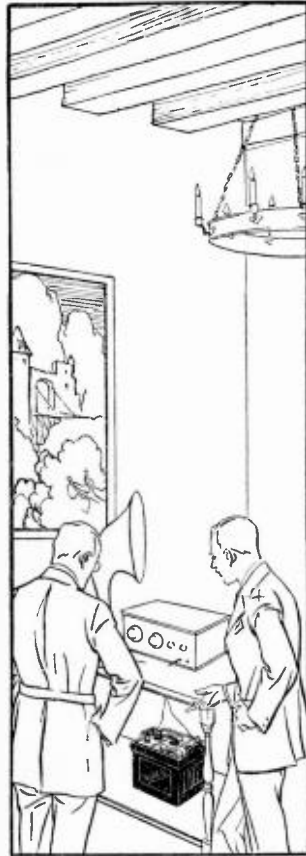

rectly rated and deliver full power at all times. They are attractively priced from \$4.75 up. There is a Prest-O-Lite radio dealer or service station near you.

THE PREST-O-LITE CO., INC.
INDIANAPOLIS, IND.
New York San Francisco
In Canada: Prest-O-Lite Company of Canada, Ltd.
Toronto, Ontario

Send for this free booklet

"What every owner of a radio should know about storage batteries" is a little booklet which every radio fan will find interesting and helpful. It is crammed full of hints that will bring surprising radio results—and save you money. It's yours for the asking—without obligation.

Designed especially for radio

Prest-O-Lite
STORAGE BATTERIES FOR
MOTOR-CARS AND RADIO



tain slight changes in wave length had been made by inserting these in each machine, of course, so the waves were adjusted to exactly the same point again.

Now as all radio fans know, a radio wave is of a certain shape. If you do not know it, then assume it for the time being. The shape of a radio wave is supposed to be like the waves in a rope when a child "makes snakes" with it. You know how I mean—waving the end continuously and producing "ripples" in the rope. Well, the shape of a wave has always been that—no matter what the wave length. Never before has an effort been made to alter the "shape" of the wave or any other of its characteristics.

Mr. Skala claims that he first thought of the idea while studying the shape and other characteristics of light waves. He now claims to have perfected a device for the changing of the form of a wave without changing its wave length. That is what the device I was investigating was designed for.

Now we will say that there are two transmitters to operate on the same wave length. That is not Mr. Skala's limit, as he says an infinite number may be operated on a single wave length. Anyway, two will illustrate the principle.

One of these stations is given 350 meters wave length but the form of the wave is "A" we will say. The other is on the same wave length but of form "B." Now a device to hear them must be capable of switching to the wave form of either "A" or "B."

Well, the two transmitters were given different "forms" of waves but on the same wave length. That is what Mr. Skala said was being done.

The receiver was tuned to the 350 meter wave length. The device on the receiver (a replica of the ones on the two transmitters) was turned to point "A" on all dials. The first station was heard. Then, upon switching to point "B" on the device, station B was heard! No change had been made in the dial settings of the receiver, either! There had been, apparently, some change in the transmitted wave from the two stations.

However, I would not wish to go upon record as saying that the device is a perfect success—not yet. First, we will have to get a very good wave meter on the job, or will have to know the details of the device. From either of the above we may determine just what has taken place. It might be a change of wave form, as Mr. Skala says, but it is possible that other things have occurred.

There is no limit to the possibilities of such a device. I certainly

do hope that it will prove as successful as Mr. Skala says it will. He will soon try it on the large broadcasting station near his home. The engineers are thoroughly satisfied with its performance, according to the inventor and his attorney.

Much has been said on the matter of radio taking the place of the ordinary telephone. This is a long way off, I think, but such a device would make it possible. One whole city could be on the same wave length and have a different wave form for each station—each subscriber, that is. No interference would result if all went well.

Let's consider for a moment that the device really is a success. Do

not expect any radical changes to take place any time soon. Even if all the transmitting stations in the whole world were to have these attachments on them you could still hear the broadcasting on your present receiver. That is a rather peculiar statement, but I will not explain it—not just now. You see,



the device has to be put on both ends if it is to work satisfactorily. When on the transmitter alone, no difference may be detected at the receiving end. When used on the receiver alone, the result is simply a good wave trap. That's all.

After the first demonstration which Mr. Skala gave me, I wired H. M. N. that the thing was proving very interesting and to such an extent that I'd bring back with me a good story for him to look over. Then little things began to happen that made me less confident and we had other tests in Mr. Skala's laboratory. At moments, I would have such feelings of doubt. Then Mr. Skala would turn some particular little part of the demonstration which would half-way convince me again. And so it kept up. It was a game of tug-o-war between Belief and Doubt.

The particular point at which my doubts began to assume larger proportions was when he so kindly began explaining the formula upon which his invention rests. Now through a promise to Mr. Skala, it is impossible to give this exact formula. As a matter of fact, I doubt if it would be understood in such a short article, anyway. Let's wait until we hear further of the results obtained with the device. Then we'll go into that. However, he gave me a very good illustration of just how his device functions mathematically.

The young genius claims to have found another factor in the wave length or frequency formula as we know it today. As all fans know, wave length is composed of frequency. This frequency is expressed in terms of kilocycles. A

kilocycle is a thousand cycles. Now every station has a certain frequency upon which it broadcasts. That, of course, is where all the different wave lengths arise. This frequency has always been looked upon as being a result of inductance and capacity only. The wave which left the oscillating circuit in a transmitter was always supposed to be the wave length, or frequency, of transmission. In other words, a simple equation which runs:

$$Fr = f$$

would probably show better what I mean. Fr is the transmitted frequency. The "f" signifies the frequency at which the receiving circuit was oscillating. They are the same.

Mr. Skala, however, claims to have a much different formula. A practical illustration may be shown as:

$$Fr = f \times K$$

Where: K is a newly found factor which has, heretofore, always been unity.

I asked Mr. Skala how he intended to change the form of his wave by simply changing K. It occurred to me that when he changed K from the conventional one (granting that there was such a factor and that he could change it) he would change the frequency of the oscillator. Then, changing the frequency of the oscillator he would have to change the frequency of the transmitted wave. It would take place automatically. And that would mean a change of wave length.

In answer to this he said that I must not take this sort of formula too literally—that it merely showed the principle. He insisted that he had discovered a different form of wave and that changing K would not change the frequency, but the form!

The limits within which he declared he could change K were boundless. Almost any number could be hung up where unity used to reside before being so ruthlessly dragged out and analyzed.

Let us see just how this formula works out. The readers who do not know radio transmission must assume that what I say in the matter of the frequency of oscillator being the frequency of actual transmission is true.

We will say that a station is operating on a frequency of 1,000 kilocycles. That is, roughly, 300 meters. The formula (still granting that Mr. Skala's newly discovered factor belongs there) would then read:

$$1,000 = 1,000 \times K$$

Now if K remains unity, as Mr. Skala said it always did before he learned how to change it, we cannot see why it is in there. It might be there just to remind us of something, or some operation to be carried out later, but certainly for no real practical purpose. But suppose Mr. Skala takes this particular K and makes it .9 instead of 1. Well, let's figure that out and see just what happens.

$$1,000 = 1,000 \times .9 \\ = 900 \text{ kilocycles!}$$

Has the wave length (or frequency) of transmission, been changed? Mr. Skala answers most emphatically, "No!"

I have shown the "cold facts" of the inventor's formula as he gave it to me. It is possible that the formula is simply a "practical" illustration of something else. If it is, though, I do not think it very practical. Yet, I can't help believe that such is the case. Mr. Skala is a graduate with honors in mathematics in the famous old University of Prague, so I think he ought to know what he is driving at. Probably he just can't explain it. Particularly to a cold hearted fellow who must be confronted with facts and who goes

other. Nowhere in the immediate vicinity could I find the station! Then I turned it in a wider scope taking in about ten degrees on each side of the first dial setting. There, five points lower, I found the transmitter signal! It had changed its wave length at least ten or fifteen meters, I think. Here again the lack of a wave meter prevented my getting any accurate figures!

That is just how the demonstration struck me, I am sorry to say. When I left, after the last of a number of tests, I had a little faith still left in the device. I thought that there was still a chance for it. Before I left the city I dropped around to see the attorney, Mr. Schraeder. I talked with him more on the commercial end of the game. He said he did not know just whether they would build the thing themselves, or not. If they received a large enough amount it is possible that they would sell outright, he said. This, of course, would be possible only after a thorough demonstration. He understood that and could see just what a hard time they were going to have to convince the public of the practicability of the plan.

At that moment I began wondering just how the device would come out. A better business man than Mr. Schraeder is very hard to find. His views are practical rather than highly theoretical. He doesn't talk for hours about nothing. His speech is brief and full of meaning.

At last, aboard the Steel City Express I was able to get the few moments I wanted to myself. I wanted to figure the formula and other problems out—backward, forward, and otherwise.

The more I figured, the more doubtful I became. Now, just a few days after the demonstration I am still "on the fence." My own technical self tells me to laugh at the thing. A little inkling of the first demonstration denies me that right, to a certain extent. If Mr. Skala would only send us those details! When we get them we may change our present attitude. We don't mind saying we are wrong.

Like most scientists, Mr. Skala does not seem to have his mind fixed on the commercial aspects of his invention. He regards it as his contribution to the progress of civilization. When I asked him about his nationality and his pending application for American citizenship, he said:

"I belong to the Brotherhood of Man. My scientific work has taught me to love all people. When I become an American citizen, I will always fight for the United States but at present I bear hatred for none."

Mr. Skala is keeping himself hidden from crowds as much as possible. He does not want to be hampered in his development work by throngs of idle curiosity seekers, and so he has located his laboratory in a little suburb of Chicago which is almost inaccessible except by taxicab.

But the place is well worth hunting.

WARNING—DON'T JUMP

at the conclusion that Mr. Skala's device is going to change the whole aspect of radio overnight. Don't let this article make you hesitate about buying that set you have been looking at or deter you from trying one of these new hook-ups.

No sudden revolution is on the radio horizon. Without wanting to disparage Mr. Skala's claims, we can at least point out the fact that the device is at present in an extremely tenuous laboratory stage and, even assuming his theories to be correct, it will require a considerable period of time to perfect their practical application and to arrange the commercial details of their widespread use. Furthermore, as this article points out, the Skala "wave splitter" is a separate unit to be connected to any existing set, so you are perfectly safe in going ahead with your buying or building and enjoying radio as it is now, pending the marketing of Skala "wave-splitters."

H. M. N.

at an investigation with that "I'm from Missouri" attitude tucked away down in his heart. Still, I can honestly state that I have given Mr. Skala an unbiased opinion. I had a wonderful idea of the device until he came along with the formula. Just how I lost faith in it—I mean the particular act—might be of interest, also.

Figuring that if K in the formula did change I ought to be able to change the frequency of transmission simply by moving Mr. Skala's device, I started the transmitter and receiver going. Just one transmitter, I mean. The whistle from this was tuned in with the regenerative receiver which was in an oscillatory condition. The "zero beat" method was used, for lack of a good wave meter.

I then walked over to the little sealed-up box which the inventor had hooked to the transmitter and varied the dials. I was trying to vary K. I had that idea foremost in my mind. I wanted to see if the device really did alter the wave length.

The whistle in the regenerative set began getting unsteady as I worked around the dials of the "wave splitter." I adjusted it to a new position—halfway between A & B, I think.

I then walked over to the receiver and turned the dial first to one side then to the

The T-C With

The Famous Circuit is Here Given For Those Who Believe This Audio Method Results in Better Quality of Reproduction—but Given, as the Lawyers say, "Without Prejudice."

By G. P. ALLEN

HERE'S the second part of our promise to give this T-C circuit three ways—transformer, resistance and impedance coupled. Next month it will be shown with impedance using the Thordarson "Autoformers."

I'm taking this opportunity to repeat my warning that you mustn't ask us which method gives the best quality. We have had many visitors to the Laboratory and have switched on one set after the other and the votes are just about even up all around.

I'm coming to the conclusion that quality in radio isn't so much a matter of circuits as it is of the listener's individual ear and his musical training and appreciation.

It's more or less like married life. The snappy little blonde around the corner may look pretty good but you're much more comfy living with your own wife. That is, you are—maybe.

H. M. N.

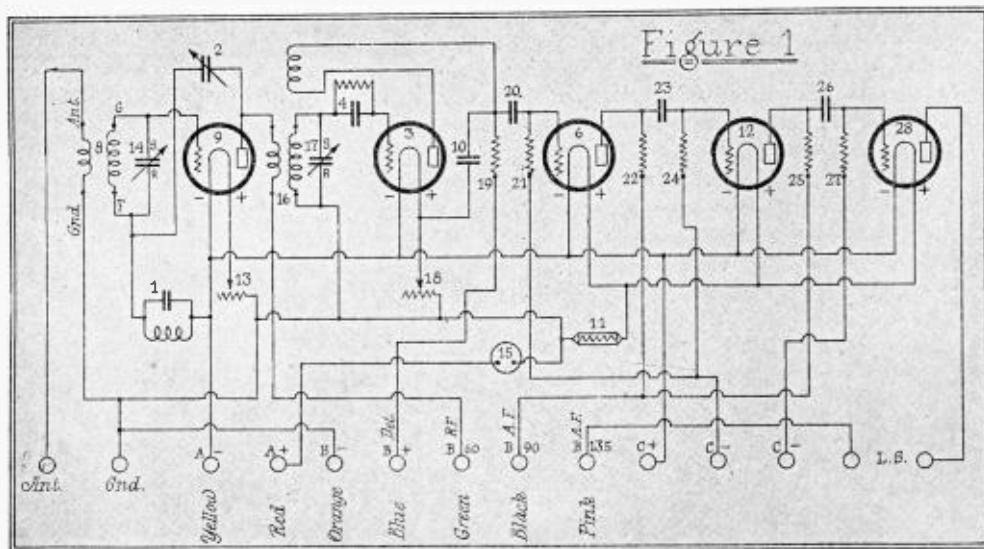

In the photograph showing the layout on the base board (Fig. 2), we have shown Amsco sockets. In the photograph on the sub-panel we have shown Airgap sockets. Now that does not mean that if you have Bremer-Tully sockets in your set you have to take them out and throw them away. Any good make of socket will do. That is why we have shown so many kinds.

In this article insofar as possible, we are going to keep to the same numbering as used in last month's article so that there will be as little confusion as possible.

In the article last month, the Samson fixed coupler No. 8 was shown mounted on the base board. In Fig. 2 there is no fixed coupler shown. On account of the size of the base board used last month you will have plenty of room to locate this coupler on the base board or else, you can try and locate the coupler in the same position that we have done in this issue. It all depends on the size

LAST month H. M. N. promised you that he would give the T-C with resistance coupling. He also promised that he would let you use the same panel, and the same sized base board.

The thought occurred to us that some of you might be making this set for the first time, and be starting fresh with this issue. The question at once arose as to whether we should stick to our promise and give the old base board layout or give you a nice sub-panel arrangement that is particularly adapted for use with resistance coupling. H. M. N., B. V. D., and I fought it out all over the place. (Pardon me! I mean Turner. You see, Turner had the call letters 4 V B in Columbia, S. C., before he joined the staff; and we just switched the letters around.)

We all won! We are giving both ideas here. There is so much to cover in construction in this issue that we shall have to let any further discussion of the circuit slide through to the next issue. The circuit is all that was claimed for it in the March number. We are just as satisfied now as we were then.

If you built the set from the March issue you will naturally be interested in learning what is necessary to do to use resistance coupling. In order to make the change you will need a resistance coupled amplifier kit; and in the filament ballast unit you will have to change to a 3/4 amp. or 1 amp. unit if you are

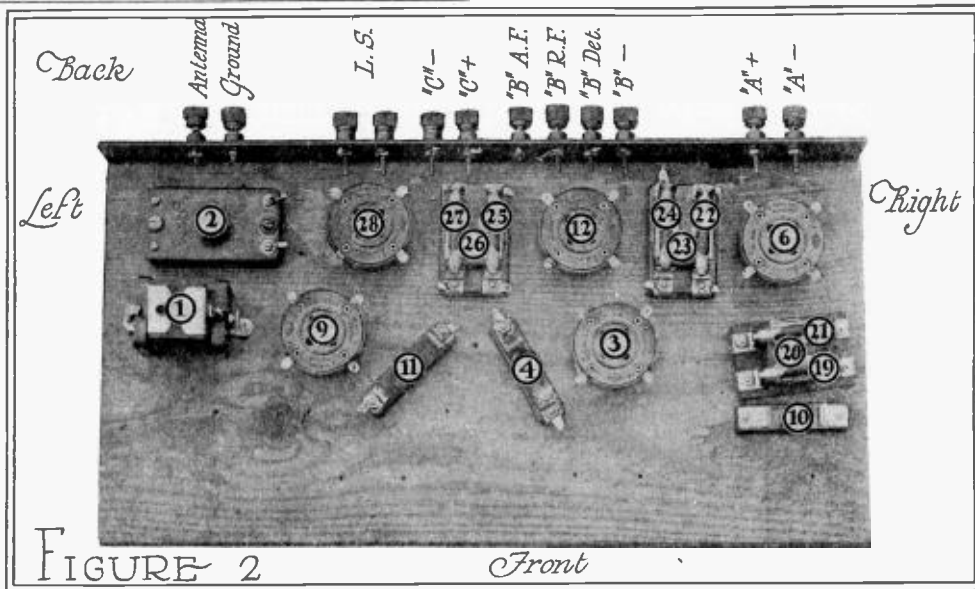

The upper illustration is the schematic diagram of the T-C circuit with resistance coupled amplification. The lower one shows a photograph of the baseboard layout.

using the Daven filament ballast. If you are using the Brach, change from a B2 to a B3 or B4. You will also need one additional tube socket and tube.

of the condenser that you are using and the amount of clearance that is needed for the blades. Don't forget the danger line mentioned in last month's issue!

Resistance Coupled Amplification

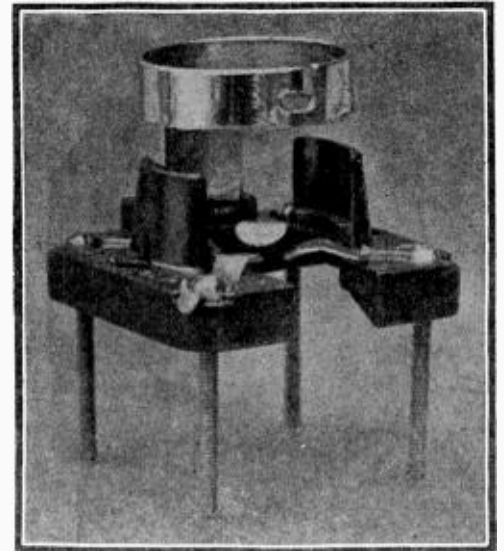

This shows the Airgap socket with the machine screws inserted ready for the sub-panel job.

Some of the readers seem to like the old method of mounting binding posts on one long strip. For that reason, we have mounted our binding posts in the base board hook-up on a piece of Formica two inches wide and running the length of the baseboard.

Many of the modern sets now on the market use cables. This involves only a single hole in the back of the cabinet. As it was our purpose to come as near to making a "factory job" of this set as we could, we used the Jones cable for the battery connections and put the speaker connection on the back in the sub-panel assembly.

The front panel is so simple that it does not seem necessary to give you the panel layout. The location of the holes can not be exactly given as we do not know what condensers you may be using. The location of the other parts

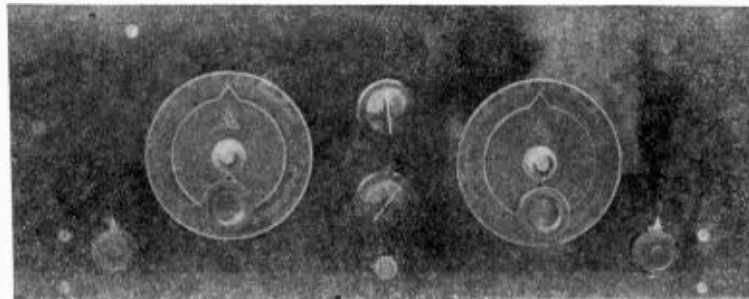

Above is a view of the panel taken so as to give a good idea of the location of the various holes.

mounting that suited us. For that reason we are going into details.

At the top of page 44 we are giving the layout for the sub-panel. The holes that are critical in spacing are the holes for the socket mounting. We compared a number of different sockets that we had on the shelves and found that the space between the binding posts was practically the same. But in laying out your sub-panel, be sure that the space between the holes on the sockets that you intend to use is the same as we have given in the diagram. For instance, the distance between holes 3 and 4 in the diagram is exactly $1\frac{1}{16}$ inches. That is

the distance between centers of the two filament terminals on the Airgap socket. Having measured your sockets to be sure that the spacing is right, drill the sub-panel. There are 44 holes. Of these, holes numbers 14, 15, 18, 19, 22, 23, 26 and 27 should be countersunk on the side of the panel that is

to be the top when completed. In mounting the instruments, you should use a flat head machine screw in these particular holes. We neglected to state the size of the drill to use. That depends entirely on the socket that you are using. For the Airgap sockets you will use a 6-32 screw. Take the socket in your hand so that the binding posts are facing you. Take off the knurled nut that is used to hold the leads to the sockets. Underneath this nut is a hexagonal nut that holds the screw tightly in the socket so that it makes a good contact with the prongs of the socket. Remove this screw and insert a 6-32 machine screw that is about an inch and a half long. In the Airgap socket the head of the screw should make contact with the socket prong.

Now take the hex nut that you have just taken off and use it underneath as a lock nut to keep the screw firmly in place. A glance at the picture at the top of this page will show how this is done. The machine screws used on these sockets should be round head screws. In changing these screws you should put a soldering lug under the head of the screw before putting it through the socket at the following points: G on socket No. 6; G and P on socket No. 12, and G and P on socket No. 28. You can see the way the lug is put on in the picture.

Now that the sockets are ready and the holes in the panels are drilled, we will proceed with the mounting of the instruments on the sub-panel. We will put those instruments on first that go on the underneath side of the sub-panel. If you are using the base board method of mounting you will want the regular resistance coupling units already assembled as in the picture on the opposite page. If you are going to do the sub-panel job, you will want the separate mountings for each resistor.

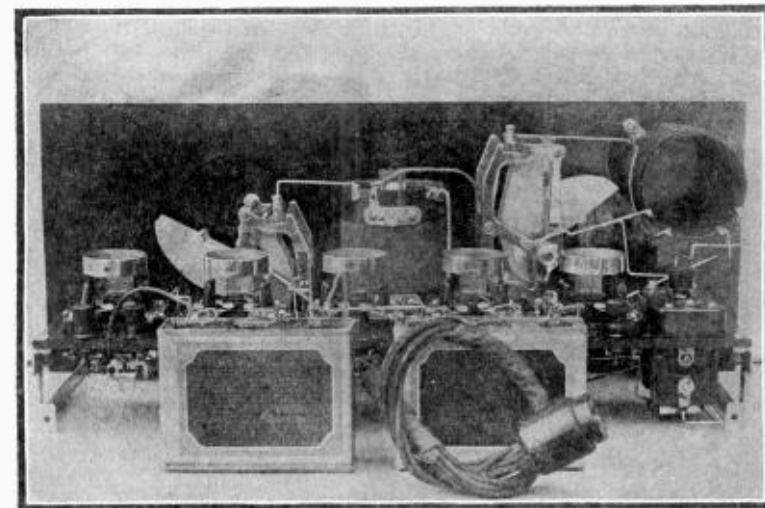

A rear view of the Sub-Panel Assembly.

depends entirely on the condenser blades and the clearance necessary for them. From the view of the panel, Fig. 4, you should be able to get the idea without very much trouble.

With the sub-panel, things are a little more complicated. We ruined a couple of perfectly good pieces of Formica before we got the exact

the distance between centers of the two filament terminals on the Airgap socket.

Having measured your sockets to be sure that the spacing is right, drill the sub-panel. There are 44 holes. Of these, holes numbers 14, 15, 18, 19, 22, 23, 26 and 27 should be countersunk on the side of the panel that is

In using the regular units, you will not need to make a number of the connections that will be specified in the hook-up lists as these connections are already made in the unit. This will be noted in the instructions so that you will not have to worry.

I'll buy it for you!

Free Shopping Service

I make no charge for purchasing and sending to you any parts or sets mentioned in this magazine. I'll send it C. O. D.

GET ACQUAINTED WITH THIS SERVICE

I am already serving 2500 through this plan. It is not a cut-price scheme, but was instituted two years ago, so that readers could readily obtain parts identical with those used in the sets described. I send you only those Parts that I have TESTED and KNOW to be good.

I have done the Experimenting You buy a CERTAINTY

All Parts are UNCONDITIONALLY GUARANTEED

SAMSON T. C. SET

with Daven Resistance coupling. Either Baseboard or Sub-Panel Mounting, as described in this issue.

Our Standard Kit of complete parts, with Daven 3-Stage Kit **\$42.50**

A Real De Luxe Kit, **\$47.75** very special at includes assembled Daven Super-Amplifier.

SAMSON T. C. KIT **\$14.75** only

QUADRAFORMER

This WONDER SET is fast becoming the most popular set in the country. We have sold 600 of these kits and every builder reports results far above their expectations.

We Have the NEW QUADRACOILS **\$12.75** (Per set of three)

OUR STANDARD KIT Made up in exact accordance with Gearhart-Schluter's list. **\$42.50**

OUR DE LUXE KIT Composed of the best parts money can buy. Special at **\$61.25**

Send for the Quadraformer Booklet. It's FREE.

Write us for full information on all our kits.

NOTE
Our SERVICE DEPARTMENT is being operated by **Mr. MERRILL NEELY**

the former chief of the laboratory at 3XP. We are prepared to take care of any and all Service work in an expert and workmanlike manner.

Pick out the set you want and let us build it for you. We guarantee it to perform at 100% efficiency.

Here are the Services of a Real **RADIO EXPERT** At Your Command

E. M. CLARKE
1523 Chestnut St., Phila., Pa.

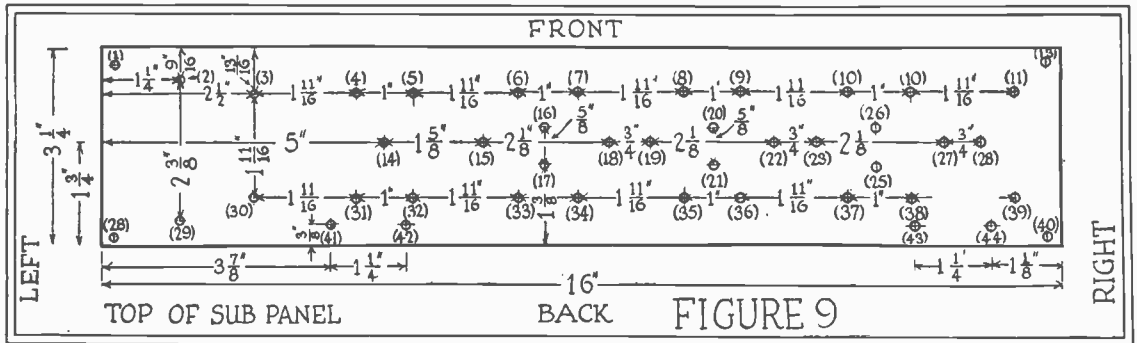

The layout for the sub-panel. The holes that are critical are the ones for the socket mountings and you must be careful to have them exactly right.

List of Parts

1. Samson choke coil and .00025 mfd. condenser.
2. Samson neutralising condenser.
3. Detector tube socket.
4. Grid leak and condenser mounting. (Grid leak is 3 meg and grid condenser is .00025.)
5. No part of this number in this article. Part 5 was in the March issue but is not used here.
6. First audio socket.
7. No part of this number in this article. Part 7 was used in the March issue but is not used here.
8. Samson fixed coupler (antenna coil).
9. Radio frequency tube socket.
10. Fixed condenser .002 mfd.
11. Filament ballast mount. In the March issue this was used to control only two tubes. This will have to be changed for resistance coupling. Use either a Daven 3/4 amp. ballast or a Brach B3, or else you will need an additional Amperite for the extra tube in this set. If you use the UX112 the ballast

12. Second audio frequency tube socket.
13. Radio frequency tube rheostat, 30 ohms.
14. .0005 mfd. Bremer-Tully S. L. F. variable condenser. Be sure that this condenser is .0005 if you are going to use one you now have. If it isn't, the set will not cover the wave band. If you bought condensers last month, do not change.
15. Filament switch.
16. Samson two rotor coil.
17. .0005 mfd. Bremer-Tully S. L. F. variable condenser.
18. Detector tube rheostat, 30 ohms.
19. Mount for plate resistor, .1 meg. First audio stage.
20. Daven Type A coupling condenser. First audio stage.
21. Mount for grid resistor, 1.0 meg. First audio stage.
22. Mount for plate resistor, .1 meg. Second audio stage.
23. Daven Type A coupling con-

24. Mount for grid resistor, .5 meg. Second audio stage. (For parts 22, 23 and 24 see previous note.)
 25. Mount for plate resistor, .1 meg. Third audio stage.
 26. Type A coupling condenser.
 27. Mount for grid resistor, .25 meg. (For parts 25, 26 and 27 see note on parts 19, etc.)
 28. Third audio frequency tube socket. If you are building over the set in the March number you will need this additional socket.
- We used a Formica sub-panel 16 x 3 1/4 and a 7 x 18 front panel. You will also need four binding posts, a Jones cable, type B.P., two mounting brackets for the sub-panel, and two dials. In the last issue we showed National dials. In this issue we show Apex dials. The Marco and Bremer-Tully dials are also well suited to this set. When you do buy your dials, be sure that you get a maximum on your dials when the condenser is fully in mesh. In other words, do not buy clockwise rotating dials for counter-clockwise rotating condensers.
- In the list of parts there is a note

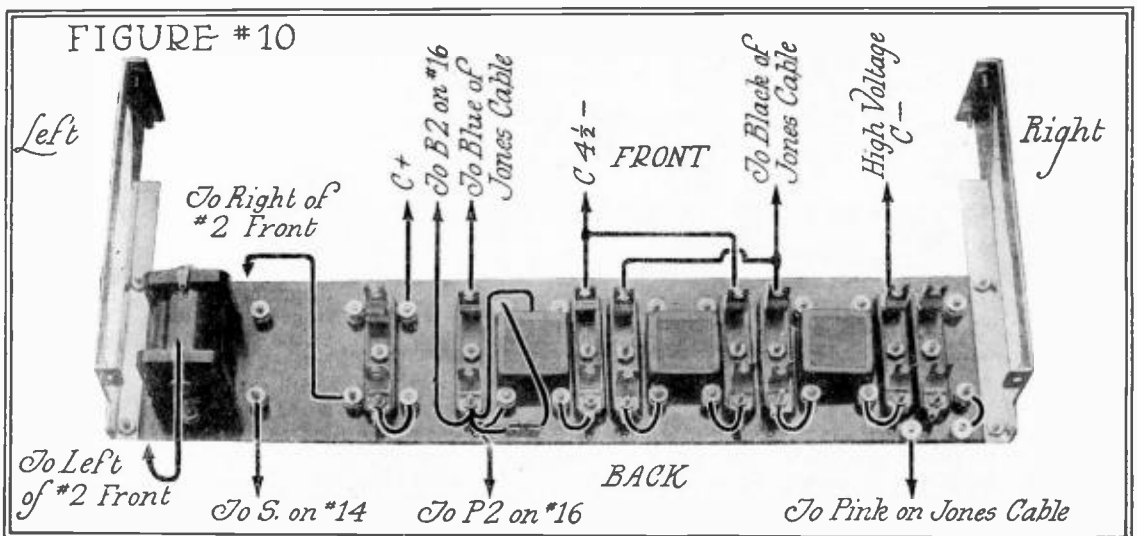

This shows the grid and plate leads on the bottom of the sub-panel.

that says that the parts 19, 20 and 21 may be secured in one unit. Further reference is also made to the parts pictured in Fig. 2. In order to clear up any possible doubt that may remain in the minds of some readers, I am referring particularly to such resistance coupled kit units as are made by Micamold, Daven, Brach and Bradley.

Before you forget it you had best solder the .00025 mfd. condenser to the choke coil No. 1. While you are waiting for the iron to heat, glance at the diagram at the top of Page 44. You will notice that each hole has a number in parentheses beside it. We didn't put the numbers on just because "Spuds" Neely likes to draw figures. In fact it meant quite a little work for him. We put them on so that it would help you to locate the parts. Until we tell you differently, all parts are to be mounted on the underneath side of the sub-panel. The flat-head screw will be inserted from the top, the part put over the screw, and then fastened into place by the nut. The middle picture on this page shows you how it is done (Fig. 7.)

Fasten the grid leak and condenser mount No. 4 in hole (14).

Part 19 is fastened by means of hole (15).

Now before fastening part 20 to the sub-panel, attach a soldering lug to one of the two screws on the coupling condenser. Insert the screws through holes (16) and (17) in the sub-panel from the bottom so that the fastening is made on the top of the sub-panel. The screw that has the lug on it should be inserted so that the lug is towards the front of the sub-panel. Before placing the nuts on these screws, put a soldering lug over the back screw. Put on the nuts and fasten the condenser in place.

Fasten part 21 in hole (18) and part 22 in hole (19) in the same way that you have just fastened in parts 4 and 19.

Condenser 23 is fastened to the sub-panel in the same way that you fastened condenser 20. Use holes (20) and (21). This time we do not have to put any soldering lug on under-

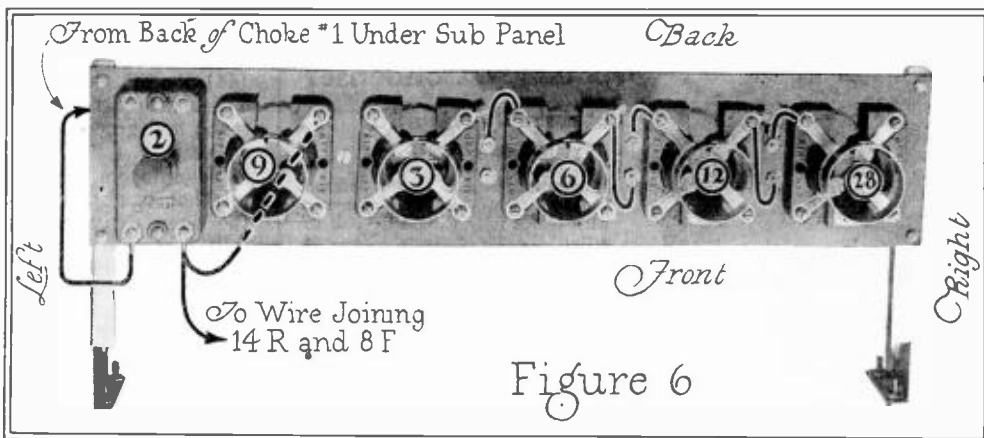

Figure 6

neath the panel but we put two on top, instead of the one that we had on condenser 20.

To fasten part 24 use hole (22) and for part 25 use hole (23).

Condenser 26 is fastened by means of holes (24) and (25). Put the two lugs over the screws on the top of the sub-panel just as you

the mounting of the instruments on the underneath side of sub-panel. Now we are ready to place the parts on top of the sub-panel.

While you are looking at the picture at the top of this page, which shows the wires that are to be put on it, I am going to tune in WJZ on the T-C so that I can listen to Mrs. Heath. All ready? Let's go!

So far nothing has been said about mounting No. 1, although it did come on the underneath side of the sub-panel. You will see the reason presently.

Take a round head machine screw and put it through the end of the neutralizing condenser No. 2 that does not have the contacts on it. Now put this through the hole (29) in the sub-panel. On the underneath side of the panel place one end of part No. 1 over

the screw and fasten both parts to the panel at once by tightening the nut.

Now, if you will swing part No. 2 so that the remaining hole in it is over the hole number (2) in the sub-panel, you will find that one screw will go through it and through the hole in the other bracket on part 1. This enables you to fasten both parts in place at the same time with but two screws.

At last! We are beginning to get some of the standardization that the radio manufacturers have been talking about!

Mount socket No. 9 in holes (3), (4), (30) and (31). Be sure that the screws that you have put in to replace the binding posts slip in easily through the holes in the sub-panel. This is no place for a mandrel, or press fit. The part must go in easily or you will crack the socket when you tighten the nuts on the screws underneath. I know what I am talking about because I broke two sockets that way myself.

The grid and plate connections should be mounted towards the back of the panel, in mounting all of these sockets.

Socket No. 3 goes in holes (5), (6), (32) and (33).

No. 6 socket is placed in holes (7), (8), (34) and (35). For No. 12, we use (9), (10), (36), (37). To mount the last socket, No.

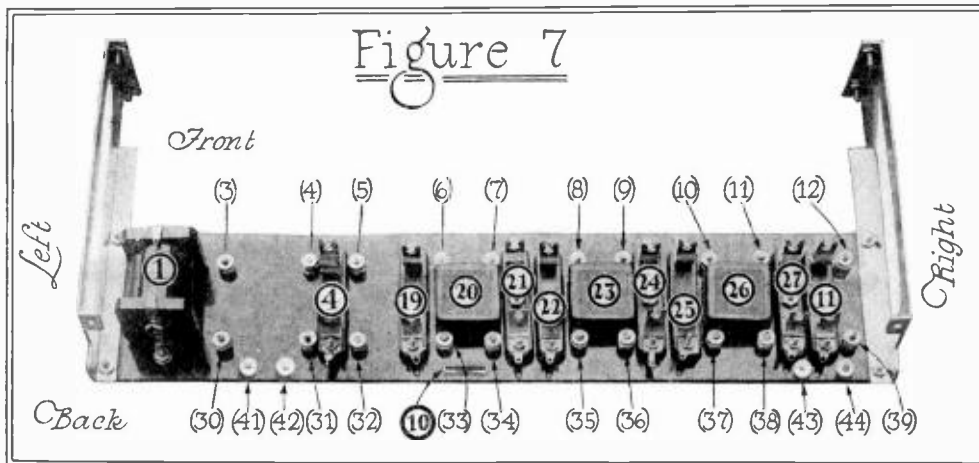

Figure 7

did with condenser 23 before you put on the nuts and tightened them.

Part 27 is mounted by means of hole (26) and number 11 is mounted by a screw through hole (27).

Mount the two sub-panel brackets by means of the four holes (1), (13), (28) and (40) at the ends of the panel. This completes

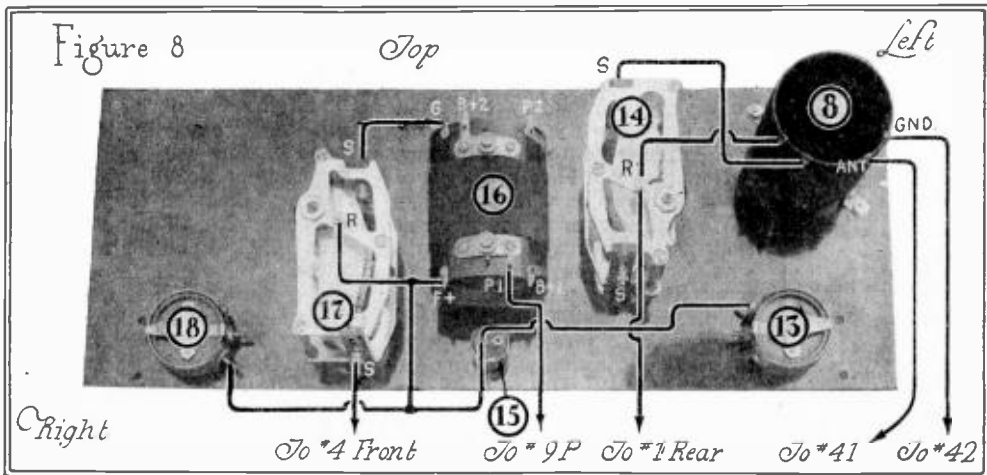

Figure 8

Smallest Uniform Frequency Condenser

easily fits into present sets



Illustration at left shows Samson Condensers are but 2 1/4" diameter with plates fully extended—half to a third the size of others. You can easily increase the selectivity of your present receiving set having ordinary condensers, and do away with the crowding of station readings—where 85 out of 100 come in below 50 on dial—by using

As condenser appears on a 4" dial.

Samson Uniform Frequency Condensers are built to a tolerance of 1-1,000 inch, silver plated all over for high surface conductivity, and—in addition—have gold plated rotor and stator plates to prevent oxidization.

These grounded rotor type instruments have losses lower than the average laboratory standards. This condenser, due to its design, does not have the defects caused by

Samson
Uniform Frequency
Condensers

either solid metal or dielectric end plates
500 mmf., \$9.00; 350 mmf., \$8.75; 250 mmf., \$8.50.

SAMSON ELECTRIC COMPANY
Manufacturers Since 1882

Sales Offices in 30 Leading Cities

MEMBER
RMA

Main Office and Factory, Canton, Mass.

28, we use holes (11), (12), (38) and (39).

In holes (41), (42), (43) and (44) we place four binding posts. These are to be used for the antenna and ground and for the loud speaker.

Your fingers are a bit sore from all that work with the nuts and the screw driver so we had better take a rest for a moment. While you are resting we might as well discuss the Jones cable.

We used the Jones cable that has seven leads. The set is provided with two voltages of C battery so that the UX 112 may be used if desired. It is also provided with a high voltage B lead so that we can use 135 volts of B battery for the UX 112 tube. Mr. Jones, of the Howard B. Jones Co., writes me as follows: "We believe that with the new tubes three positive B leads should be all that is neces-

Fig. 9. Thus, F minus No. 9 is the screw that is in hole No. (3).

Start at F minus (3) socket No. 9 and run a wire to F minus (5) socket No. 3. From there to F minus (7) socket No. 6, on to F minus (9) socket No. 12 to F minus (11) socket No. 28.

To F plus (4) socket No. 9 attach a flexible wire that will be long enough to reach the blade connection of rheostat No. 13 when the panel is fastened to the brackets. If you will mark on a piece of paper where this wire is to go and slip the paper over the wire you will have no trouble when you come to assemble the main panel and the sub-panel by making wrong connections. Do this with all loose wires as you come across them. If you remember, we did this last month with the transformer coupling.

From F plus (6), No. 3 connect



MICAMOLD 3-STAGE Resistance Coupled Kits

Contains everything necessary to build the finest Resistance Coupled Amplifier. Resistors and Condensers are moulded in genuine Bakelite, thus noiseless, moistureproof and indestructible. Each unit guaranteed within 5%—capacity and value unchangeable.

At all good Radio Stores. \$7.75

Micamold High-Mu and Power Tubes will improve the quality and volume of any R. C. Amplifier.

MICAMOLD RADIO CORP.
Flushing & Porter Aves., Brooklyn, N. Y.



"It gets that last mile"

The AIRGAP SOCKET

will rid your set of those squawks, howls and frying noises. They prevent closed circuit, absorption of current, inter-coupling of circuits, feedback and undesirable capacity. They make any circuit more stable and sharpen tuning, resulting in purer and clearer tones with more volume, particularly on distant stations.

At All Dealers **75c.**

If your Dealer cannot supply you, send direct.

Airgap Products Co., Mfg.
188 N. J. R. Rd. Avenue
Newark, N. J.

SEE THAT GAP?

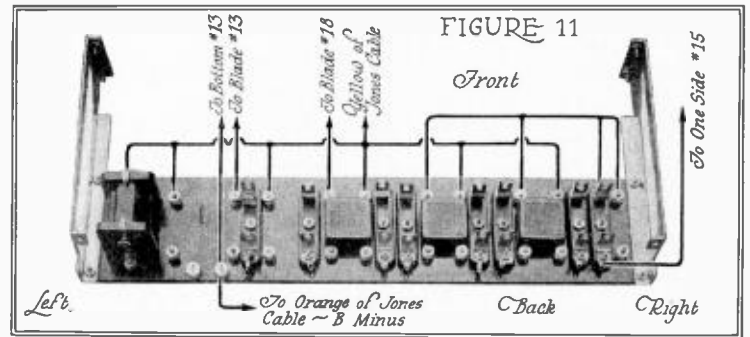

sary. The C battery leads should not be run into the cable. The C battery should be incorporated in the set, or very close to it."

You will find with your Jones cable a color chart showing the significance of the different colors. In view of my remarks about standardization a few paragraphs back, it is certainly inconsistent for me to disregard Mr. Jones' color scheme and tell you later in the article to use the wires for a different purpose than the code gives it. But we need all the wires we can get in the cable, so for that reason we are using a separate antenna and ground lead outside the cable. Here's hoping that Mr. Jones will forgive us! We think that we get better operation by using 60 volts on the radio frequency tube; but we are going to use separate leads outside the cable for the C battery.

Now that you have had a bit of a rest, let us go on with the wiring.

We will start with the filament leads as shown in Fig. 11. Run a wire from the negative filament connection of tube socket No. 9 to the front connection on choke coil No. 1. To be sure that you have the right connection when you are doing this work, refer to the figure in parentheses that we shall give you. As we have said before, this figure refers to the number given for the hole in the sub-panel in

a flexible wire that is to go to the blade of rheostat No. 18. Ordinary annunciator wire, or bell wire, will do for this.

From F plus (8) No. 6 to F plus (10) No. 12; to F plus (12) No. 28; to back of No. 11.

Connect the orange lead of the Jones cable to the ground binding post (42). This is the negative B connection.

Connect the yellow lead of the Jones cable to any point on the wire joining the F minus posts of sockets 9, 3, 6, 12 and 28. This is the minus A connection.

Connect a wire to front of No. 11 to go to the right side of switch No. 15 on the panel when the assembly is made. Do not forget to tag this so that you will know what it is later.

Another loose wire from the ground binding post (42) to go to the bottom of No. 13 on the panel, or to any point on the wire that will connect No. 13 and No. 15.

Fig. 10. Grid and Plate leads on bottom of sub-panel.

From the back of No. 1 to the left connection of No. 2 on the top of the sub-panel.

From G (32) socket No. 3 to the rear of leak and condenser mount No. 4.

From P (33) socket No. 3, loose wire to go to P2 on coil 16. These loose wires may be of bell wire.

BREMER-TULLY

SLF CONDENSERS EXCEL ON EVERY POINT

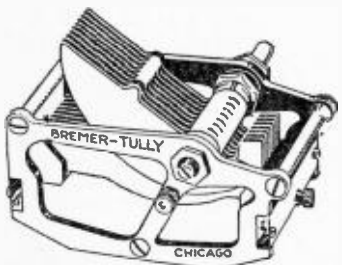

B-T realize the important part variable condensers play in the operation of any receiver. That is why they spare no expense or effort to produce a truly superfine instrument.

Everyone knows of the success of Lieut. F. H. Schnell's short wave experiments made during the cruise with the Pacific Fleet. His receiver was equipped with B-T condensers. Those who appreciate quality choose B-T.

The best money can buy should be your choice. You can do no better than select Bremer-Tully Condensers.

POPULAR MECHANICS Feb. issue contains an interesting article on the Counterphase Set. It is accompanied with a full page 2-color wiring diagram and several illustrations.

RADIO AGE, Jan. contains an article on the B-T four tube set using the Patented Torostyle developed by B-T.

Both articles are well worth reading and contain comprehensive wiring diagrams. Reprints of either or both articles sent on request.

"BETTER TUNING"

The 9th edition of this interesting B-T booklet sent to any address on receipt of 10 cents in stamps or coin.

BREMER-TULLY MANUFACTURING CO.
532 SO. CANAL STREET

From G (34) socket 6 to rear of mount No. 21.

From P (35) socket No. 6 to rear of mount No. 22.

From G (36) socket No. 12 to rear of mount No. 24.

From P (37) socket 12 to rear of mount No. 25.

From G (38) socket 28 to rear of No. 27.

From P (39) socket 28 to right hand loud speaker binding post (44).

Blue connection of Jones cable to front of mount No. 19. This is the connection for the detector B battery.

Pink connection of Jones cable to left hand loud speaker binding post (43). This is the high voltage B positive connection for the UX 112 tube.

Black of Jones cable to front of No. 25. This is the B 90 volt connection. If you are not going to use the UX 112 tube, run a wire from here to the left hand loud speaker post and disconnect the pink cable that you have fastened there.

Wire from the front of No. 27 to be left loose. This is the connection for the minus C that is used with the UX 112 tube.

Wire from the front of No. 24 to the front of No. 21 and then left loose to be used for the minus C connection for the first and second audio stages. If you are not going to use a UX 112 tube, connect the wire that is left loose from the front of No. 27 to the front of No. 24.

Loose wire to be used for plus C to any point on the A minus line that connects the tube sockets.

From rear of No. 19 a loose wire to go to B2 on No. 16.

From the lug on the underside of the sub-panel that is on the front post of condenser No. 20 to the back of mount No. 19 (see note at end of next section), and from there to the bottom of by-pass condenser No. 10. This is the first time that any mention has been made of No. 10 so far in the assembly. Simply solder this condenser in a vertical position to a wire connected to back of No. 19.

From the top of No. 10 to F plus (6) on socket No. 3.

From the right side of No. 2 on the top of the panel to P (31) of socket No. 9.

Read note at end before building.

Figure 6, Top of Sub-Panel.

From lug under nut on rear connection of condenser No. 20 (17) to lug under G (35) socket No. 6.

From lug under P (36) socket No. 6 to front lug under nut of condenser No. 23 (20).

From lug under nut of rear connection of condenser No. 23 (21) to G (36) of socket No. 12.

From lug under P (37) socket No. 12 to lug under front connection of condenser No. 26 (24).

From lug under rear connection of condenser No. 26 (25) to lug under G (38) socket No. 28.

Loose wire from rear of No. 1 to the wire that will join 14 rotor and F plus on coil 8 on the main panel.

Note: If you are building the T-C on the wooden base board, there are a number of these connections already made in the resistance coupled amplifier kit. In the directions for Fig. 10 you will not have to make the connection from the lug on the under side of the sub-panel to the front of condenser 20 to the back of mount No. 19. You will have to connect the back of mount No. 19 to the bottom of by-pass condenser No. 10. In the

section on Fig. 6, the only wire that you will have to run is the last wire that goes from the rear of No. 1. All the other connections to the coupling condensers are made in the blocks that you see in Fig. 2. We have numbered these blocks in Fig. 2 so that you can be sure that you know what we are talking about.

Figure 8, Front Panel Assembly.

On account of the wide choice in instruments that you have, and also on account of the simplicity of the layout we have not given you mounting instructions or a panel layout. From Fig. 8 and from the view of the other side given in Fig. 4 you should have little trouble in locating your parts and mounting them. It will pay you to read over the cautions that we gave in the previous issue. I am repeating part of them here. Be sure that nothing you mount on either the base or the

panel is going to interfere with the opening and closing of the condenser blades.

Run a wire from the bottom of No. 18 to the right side of No. 15.

A wire from the top of No. 13 to the right side of No. 15.

From G of No. 16 to the stator connection of No. 17.

From the F plus connection on No. 16 to the rotor of No. 17. Be sure that these two wires clear the condenser blades.

From the P1 connection of No. 16 run a loose wire that is to be connected to 9P in the final assembly.

A loose wire from No. 17 stator to be connected to the front of No. 4.

A wire from the rotor of No. 17 to the bottom of No. 18 or to any point on the wire that connects 18 to 15. Be sure that you run this wire so that it will clear the rotor of No. 17 when it is open.

From No. 14 rotor to 8F.

From No. 14 stator to 8G. Be sure that this wire clears the condenser blades when they are opened.

Loose wire from the antenna connection on No. 8 to go to the antenna binding post (41) on the sub-panel.

Loose wire to go from the ground connection on No. 8 to go to the ground binding post (42) on the sub-panel.

Final Assembly.

Fasten the front-panel to the panel brackets on the sub-panel. Connect all the loose wires to the places that you have tagged.

There are three connections to be made that have not as yet been given. Connect the green wire of the Jones cable to the B plus 1 connection on the two-rotor coil No. 16. This is for the plus B 60 volts for the plate of the radio frequency tube. If you do not want to use a separate voltage for the radio frequency tube and wish to use the same voltage as you do on the detector you can omit this wire and run a wire from the B plus 1 connection on No. 16 to the front of mount No. 19. If you wish to use 90 volts on the radio frequency tube you can do it by omitting the connection of the green wire to the B plus 1 connection of No. 16. Run a wire from there to the front of No. 25. This makes the connection to the black of the Jones cable, which is the plus B 90 volts.

The red of the Jones cable is connected to the vacant post on switch No. 15.

Run a wire from the stator of condenser No. 14 to the grid connection of tube socket No. 9.

Your set is now wired up if you have made no mistake in the connections.

Rotate the dials of your condensers to be sure that the path is all clear and that you have located no wires that are going to interfere with the motion of the condenser blades. If not, connect up the batteries and you are ready to shoot.

The only point that has not been covered is the neutralization of the set. Adjust the neutralizing condenser until no click, or only a very faint click is heard when the set is brought into resonance. This was covered in the March issue.

This particular set is the ninth Samson T-C that I have hooked up in the preparation of these articles. The volume is remarkable and the ease with which it is neutralized beats any of the others that we have put together at 3XP. I started to get swell-headed and lay it to the assembly. H. M. N. at once reduced my head several sizes by giving the credit where it is due.

Our Cover Picture is our Show Window

DRESSING the show window is one of the hardest jobs in the store. Developing good ideas for cover pictures is one of the hardest jobs in a magazine office.

This is YOUR magazine and we want you to share the hard jobs and the good pay.

We want ideas for our cover picture.

Send us a suggestion—only a few words or a rough sketch—though the sketch isn't essential. It's the idea we want.

We may develop your idea and change it out of all semblance to your original but, if you'll start us on a good line of thought, it will be worth the money.

We'll Pay \$50.00 Just for the Idea!

EVERY month we want to pay some reader \$50 for an idea. If you don't hit it the first month, try it again and still again. Address:

Cover Picture Contest

The RADIO HOME

PRODUCE EXCHANGE BUILDING

3rd and Walnut Sts.

Philadelphia

GET EUROPE

On the Long Wave Lengths

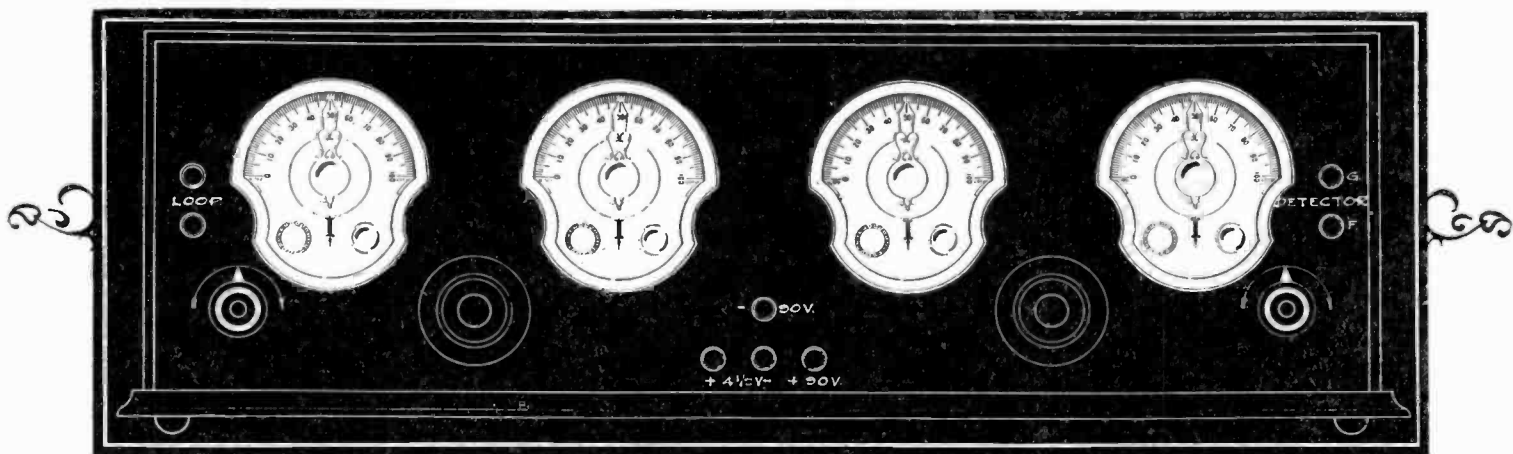

The Front Panel of the UZMANN Long-Wave Receiver for Foreign Stations.

Many Foreign Broadcasting Stations Are Regularly on the Air Using From 1000 to 3000 Meters.

IN LINE with the writer's opinion that the only logical means for the reception of these European test programs over a distance of 3,000 miles is:

- (1) when listening-in for stations of largest power,
- (2) where the wave lengths are free from receiving set radiation or "squeals," and
- (3) at such wave lengths where commercial signaling interference is not excessive.

Analysis of the problem clearly points to the desirability of working on the transmission of programs of Europe's high power stations which operate on so-called long wave lengths.

The latter broadcast spectrum can be considered extending from 1,000 to 3,000 meters. We have no better example of the utility of this method than was recently experienced in the retransmission of British programs by WJZ and associated stations on New Year's night. Reception on this side was affected by the signals radiated from Daventry, 5XX, operating on 1,600 meters.

In the present article, the writer will describe the design and construction of a four stage choke-coil (impedance) coupled radio frequency amplifier system.

While being somewhat more costly to build, this apparatus is highly selective in operation, and gives greater overall amplification. Though it was designed to operate from a loop, there are many who may prefer the use of an open antenna; both methods can be employed, as will later be seen.

Probably a few

*This Set Can Also Be Made
To Catch The New Trans-
Oceanic Phone Work Which Is
Rapidly Developing.*

By J. GEORGE UZMANN

words will prove helpful and interesting regarding the fundamentals of this type of amplifier. The input to the first stage may be an antenna of any convenient type. The output of this tube is tuned to resonance, or frequency of incoming signal.

The amplified voltage (signal) is then passed on to the grid of a second tube or stage by means of a coupling condenser, which also serves to "block," or insulate, the grid from the high voltage "B" plate supply. Of course, this means, in order to prevent the grids from

"floating," that a return path be formed, which is completed through the use of leak resistors.

This practice is followed in all stages except the last. While maximum signal strength and selectivity was a most important feature in the amplifier design, it was also required that it be gained without the use of an excess number of tuning controls.

In view of this, the last stage was developed to operate with a resistance type of coupling, thereby freeing itself from additional tuning. This idea also has another good feature in that self-oscillation becomes less serious. Further, the last stage output is so arranged that its two terminals can be led directly to the grid and filament of a tube detector; the coupling or gridleak condenser and leak resistor being of the proper order for good detection at the working wave lengths—1,000 to 3,000 meters.

Now just a word on the control of oscillation (regeneration).

Of course, where a heavy inductive load is placed in a tube plate circuit, as it is in this design, it becomes apparent that such a multi-stage device may prove hard to stabilize. And since it was desirable to employ standard honeycomb inductances because of their cheapness, variable wave length range, and good efficiency at these wave lengths, it will be seen that neutralization is out of the question.

For such reasons it was finally decided to employ a separate potentiometer for biasing the grid of the first stage. The last

*I*NTEREST in long-wave reception has been tremendously increased lately by the virtual establishment of trans-Atlantic telephone two-way communication between London and New York. The English station at Rugby uses 6770 meters; the American station at Rocky Point, Long Island, uses 6260 meters and this latter station should be heard all the way out to our West Coast on good nights. The set described in this article will reach these wave lengths by plugging in 400-turn honeycomb coils instead of the 200-turn ones specified here.

H. M. N.

stage, being free from regeneration, it will be seen how a second potentiometer controlling the second, third, and fourth stages, easily solves this problem.

Under this method, the latter stages can be operated just below the point of oscillation with a maximum of efficiency, while the first tube can be controlled as desired. With the input stage oscillating we find here a simple way for "crossing" or picking up the carrier wave of a distant station.

In order that greatest amplification be gained from the amplifier, it is important that all points within the circuit offering considerable high frequency resistance or impedance be by-passed. This is successfully accomplished by the use of the several condensers shown on the wiring diagram. Such capacities must of necessity be of the highest types obtainable.

A standard 7 x 24 x 1/4" Bakelite Formica or rubber panel and case completely houses the device. The entire tuning control is accomplished by the use of four Tune-Rite S.L.F. dials, which not only give the amplifier a pleasing appearance but also make possible close tuning. In addition to the input, output and battery binding posts we also find the potentiometer and rheostat dials on the panel front.

Where a loop type of antenna is employed, signal voltage pick-up must be sacrificed in order to gain directional characteristics.

The loop used with the set as designed was of square section, being four feet on a side. Thirty turns of #20 D.C.C. copper wire, spaced a half inch apart, and wound over bakelite corner sections results in a loop of ample inductance. When it is tuned by the .001 mfd. condenser, it covers the desired 1,000 to 3,000 meter wave band.

Those desiring to make use of an ordinary open elevated antenna can do so by simply hooking up to a two-coil honeycomb mounting,

Two-hundred-turn coils are needed for both the antenna (primary) and secondary circuits; the latter, of course, is connected to the amplifier "loop" terminals. The primary coil is operated untuned, its terminals being led directly to the antenna and ground.

On the reverse side of the panel, will be found the four main tuning condensers. These are of .001 mfd. capacity, or so-called "43-plate" variety. It is suggested that one of the better grade be employed.

Between these condensers are seen the three honeycomb inductances of 200 turns each, and when used with the above capacities, they

ployed. In very nearly all cases it will be seen that these capacities are placed not only across the "B" battery potential but also carry the high frequency signal component.

These condensers should not only be constant in capacity, be able to carry the "B" voltage but mainly must have their losses (phase difference) low, and be so designed that their elements are free from moisture and dirt absorption. Mica condensers within a moulded casing manufactured by Micamold or Sangamo are suggested. The several required values are shown.

A 10 x 3 inch Bakelite, Formica or rubber strip is fastened by brackets to the panel. On this are mounted four tube sockets of the 199 type. Beneath the strip will be found the various grid leak mountings and a number of by-pass condensers.

While 199 type tubes were used in the amplifier as built, more recent experiments have shown that hi-mu tubes can also be employed. It was found that the Daven MU-20 gave a stronger signal than the 199. Ordinarily, hi-mu tubes show considerable grid to filament capacity, but probably due to the single V filament in the Daven tube it is believed that its inter-electrode capacity remains low, and this, in conjunction with its high amplification constant, accounts for the increase in signal strength. These tubes are therefore suggested.

Any good type of coupling resistor and grid leak can be incorporated. Micamold's were used because of their current carrying capacity, constant resistances and bakelite containing case.

For the convenience of those building the described long wave radio frequency amplifier, there is shown a list of over twenty foreign transmitters operating at wave lengths above 1,000 meters, and within the spectrum covered by the writer's designs of equipment. This list was correct less than a month ago.

Long Wave Foreign Broadcast Stations

Country	Place	Call	Power	Wave Length
England	Daventry	5XX	25 KW	1,600
France	Paris—Eiffel Tower	FL	5.	2,650-2,200
	Paris—Radio Paris	CFR	1.5	1,750
Holland	Hilversum	HDO	1.5	1,050
	Amsterdam	PCFF	2.0	2,125
	Amsterdam	PA-5	.5	1,050
	Ymuiden	PCMM	1.5	1,050
	The Hague	PCGG	1.	1,070
Germany	Berlin—Königsruhrhausen	AFT	10.	1,300
	Berlin		20.	These three stations under construction.
	Cologne		20.	
	Herzstrand		100.	
Denmark	Lyngby	ONE	1.5	2,400
	Ryvang		1.0	1,150
Sweden	Boden	SASE	1.5	1,350
	Karlsborg		25.	1,250
Russia	Moscow	RDW	12.	1,450
	Moscow		2.	1,010
	Tuapse	RAW	4.	1,800
Switzerland	Geneva		1.5	1,100
Czecho-Slo	Brunn	OKB	1.	1,800
Yugo-Slavia	Belgrade		2.	1,650
Australia	Melbourne	7ZL	5.	1,760

cover the desired tuning range—1,000 to 3,000 meters. These coils are plugged into single coil mounts, which in turn are held fast to the panel. If all coils are of the same manufacture, and likewise the tuning condensers, then all dials will read alike in operation.

At this point it should again be remarked that at all coupling and by-pass points, fixed condensers of the best grade must be em-

Schematic Diagram of UZMANN Long-Wave Set for Reception of Foreign Stations.

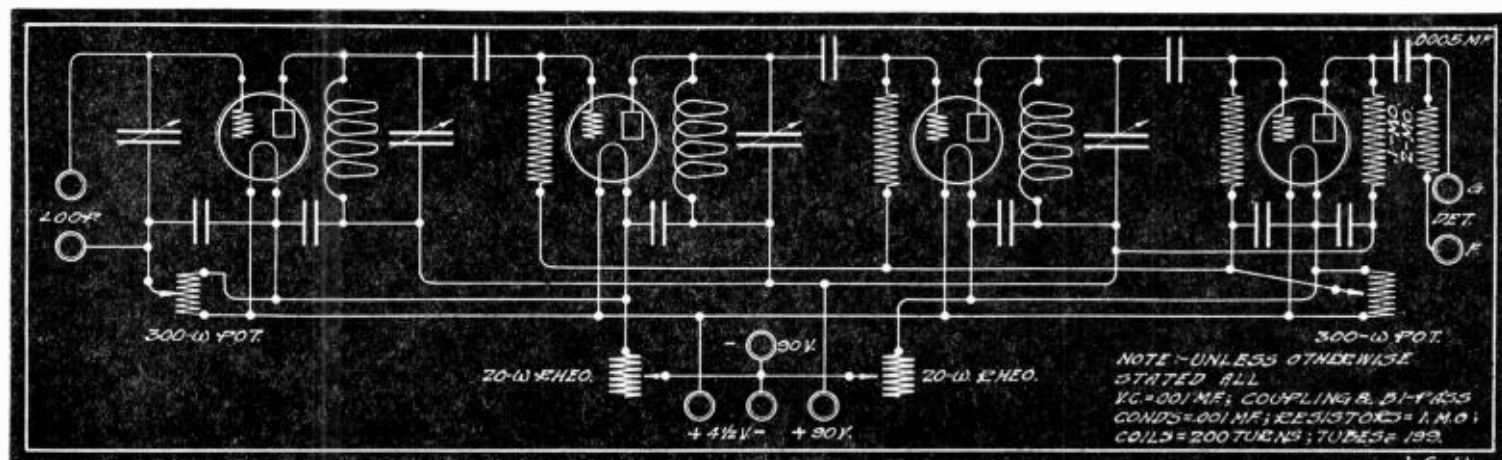

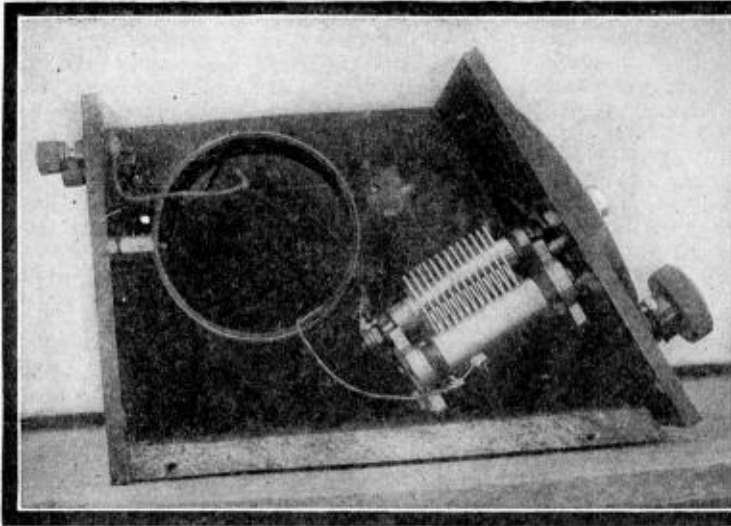

This side view shows the method of mounting the coil on the back of the case.

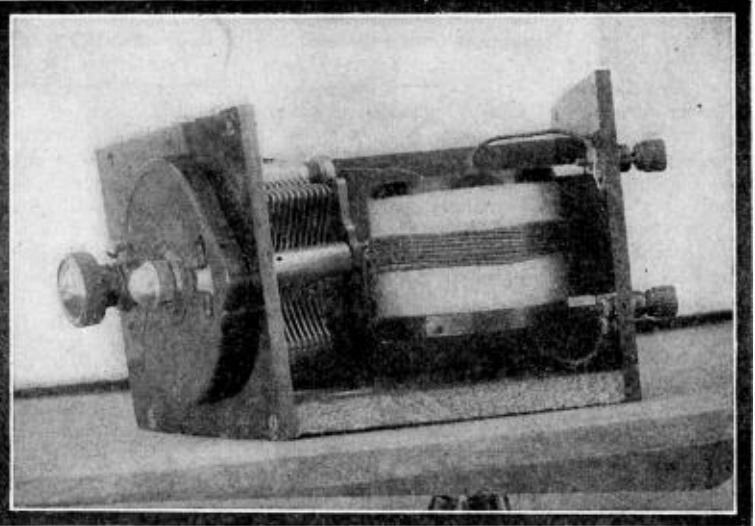

Looking straight down into the wave trap with top and side of case removed.

Maybe You Can Tune 'Em Out *with this* Wave Trap

Increase in Power of Many Stations Calls for Use of Auxiliary Unit Which Will Greatly Increase the Selectivity of Any Standard Receiving Set.

By G. P. ALLEN

ONE of the first things that good hunters learn is to set a trap. If you have your first radio set you are probably wondering how you can get rid of some nearby station that is bothering you in your hunt for distant stations. Well! Why not build a trap for it? Catch it, tie it, and get it out of your way?

There are so many letters in the mail from readers who are anxious to get rid of some interfering station that we think it will not only be worth while to give you the one that was published in the April 1924 issue of this magazine, but it will also save Turner a lot of work answering letters.

Since April 1924, radio has come out of the kitchen table stage, and has become a part of our living rooms. On that account we are showing the wave trap in a little more elaborate form so that it may more closely match the set with which it is to be used. Do not let the cabinet frighten you as the trap is very simple to build, and will require little work on your part. It consists of but two coils and a condenser. Nothing could be easier than that, could it?

First, let us get the idea of an absorption wave trap thoroughly understood, and then the construction will be even simpler. In large cities you have all seen the trick cages for squirrels in the windows of the animal and bird stores. On one side of the cage there is a wheel arrangement hung on an axis so that it can revolve. The squirrel gets in this part

signals come in the antenna, flow through the primary, and on into the set. Now that leaves the secondary unconnected to the set and only in inductive relation to the primary.

By revolving the dial of the variable condenser "C" which is attached to the secondary we can tune the circuit formed by the secondary and the condenser to the frequency of any incoming signal which is interfering. This circuit now becomes a "squirrel cage." The unwanted signal leaves the antenna circuit, enters the secondary circuit, and runs round, and round harmlessly without affecting the receiving set. By tuning the trap to any station that is bothering you, any unwanted signal may be eliminated from your set.

But only one station at a time can be eliminated by a trap of this sort. If you want more stations eliminated you will have to have one trap for each station

that you wish to get rid of at any one time. You cannot expect the trap to go two ways at once, any more than you could expect the drum in the squirrel cage to revolve if two squirrels got into it, and one started to go one way and one the other.

In the photographs you see what appears to be a box that someone forgot to finish, with a condenser and a coil inside. We left the top and side off in the photograph as we did not know how many of you might have access to X-ray machines, and we did want you to see the inside of the works.

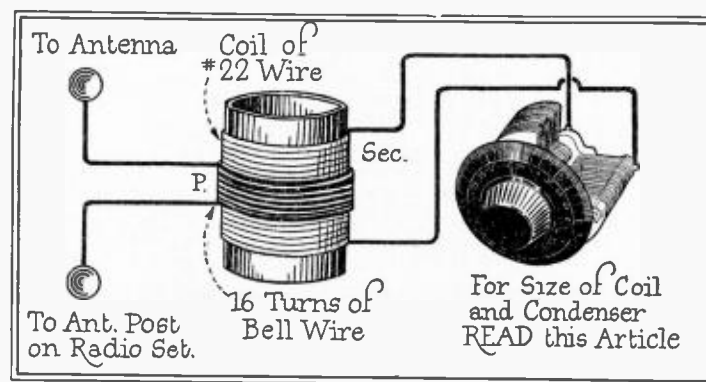

Nothing could be simpler than wiring up this wave trap.

of the cage, the drum runs round, and round, and round—yet the animal never gets anywhere.

In the wave trap we have the main part of the cage corresponding to the small coil of large wire that is called the primary. This is called P in the diagram. Then we have the large coil of small wire that is called the secondary in the diagram (Sec.). The radio

We used a sloping panel. You can use a vertical panel and a piece of ordinary base board if you want to.

In our trap we mounted the coil and the binding posts on the back as all of our sets at the lab have their antenna and ground connection at the rear. If you own a set that has the antenna and ground connections on the front of it, there isn't a thing in the world to stop you from putting your binding posts on the front panel beside the condenser dial so that you can have a short connection to your set.

We used wooden sides and top for the panel as well as a wooden base. We did this so that the cabinet might be stained to match the sets that it was to be used with. As the coil and binding posts were on the back we used a Formica panel for the back, and one for the front to mount the condenser on.

Now let us build the coil and get it off our minds. Take a piece of Formica, Bakelite, or hard rubber tubing, three inches in diameter, and three inches long. Drill a hole at each end to take the two mounting screws just far enough in from the edge to allow material enough to hold a screw. You can see in the photographs how we mounted the finished coil on the rear panel.

Find the center of the length of the tube. That is, measure $1\frac{1}{2}$ " from either end of the tubing. Drill two holes $\frac{1}{4}$ " on either side of this center in the same straight line large enough to take a piece of bell wire, or annunciator wire, as it is sometimes called. These two holes are to be for the primary winding which will be put on later. Before winding the secondary onto the tube you will have to make up your mind as to what size condenser you are going to use.

If you have an old 43 plate condenser you will want to use 33 turns of No. 22 wire for the secondary on a 3" tube. For the twenty-three plate, or .0005 mfd. condenser, you will use 53 turns. A condenser of a capacity between .00035 and .00037 will use from 55 to 60 turns. A .00025 condenser will need 78 turns. After having measured all this up for you, please don't write and ask us how many turns to use for a $2\frac{3}{4}$ " tube. As the diameter of the tube is slightly less, you will probably need a few more turns. You can tell when you have the job finished. If a station that is around 500 meters can be tuned out at about 80 on the dial of the wave trap you have the right number of turns. If the station tunes out below this then you need to take off one turn at a time from the secondary until you get the right reading. This is assuming that you are using the old semi-circular plate condensers. On SLF, 500 meters should be above 90.

IF YOU have decided on the condenser, you know how many turns of wire you are to have on your secondary. That being the case, measure for the holes in the tubing that you will use to fasten the secondary wires. Roughly, No. 22 wire runs about thirty turns to the linear inch. Drill two holes at each end of the tube so that you can fasten the winding and have it come in the center of the tube.

Thus, if you are using a .00035 condenser you will need 60 turns. At thirty turns to the inch the winding will take two inches. The tube is three inches long. In order to

get the winding in the center there will have to be a half inch at each end of the tube before we start to wind the wire. So, one-half inch from each end of the tube we will drill two holes. Now that the holes are measured, wind on the proper number of turns leaving enough wire on each end so that you can fasten the ends of the coil to the condenser.

NEXT, we will wind on the primary coil. Do you remember drilling two holes in the center of the tubing before you wound on the secondary? Take a match, or some blunt tool and push away the secondary winding until you uncover these two holes. Insert the end of the piece of bell wire in one of these holes leaving enough to fasten to the binding post. Wind on six turns of bell wire, in the

ON PAGE 19, our Washington correspondent, R. S. McBride, tells of the very serious problems caused in neighboring receiving sets by the "blanketing" effects of some of the high power broadcasting stations. He advocates the use of a well-designed wave trap.

Mr. Allen has written this description of our favorite wave trap in the hope that it may be found useful to readers who are so situated. It is extremely simple to build and operate, negligible in cost and can be placed in the aerial lead in of most sets with surprisingly beneficial results.

H. M. N.

same direction that the secondary winding goes, and pull the end of the wire through the hole at the other end. Leave enough to make a connection to the other binding post. These two holes are the second lot that were drilled and are spaced $\frac{1}{2}$ " apart at the center of the side of the tubing. We now have a coil with a large winding of No. 22 wire, and on top of this winding we have another of large wire but a small number of turns.

Mount the condenser that you are to use on the panel and fasten the dial in position. Mount the finished coil on either the base board, or, if you are doing it in the way shown in the picture, on the rear panel.

Connect one end of the secondary coil to the rotor of the condenser and the other to the stator. There is no other connection to be made to either the secondary of the coil or to the condenser. Connect the two ends of the primary coil made of bell wire to the two binding posts that are on the panel. We are ready to hook the trap to the set and see how well it works.

On your own radio set you have a post that is marked antenna or aerial. There is a wire coming to this post from outside your set. Disconnect this wire and attach it to one of the two binding posts on the wave trap. From the other binding post of the wave trap run a wire to the antenna post on your own radio set. There is a wire on the set called the ground wire. You do not have to alter or change the position of this wire in any way to use the trap.

Having connected the trap to your set, tune in a station that is bothering you in getting other stations. Now rotate the dial of the

wave trap condenser until the station disappears. You can then retune your set to some other station and in doing so you will not have to change the setting of the wave trap.

The only time you will have to change the wave trap is to tune in the station that you have the trap set for, or, to eliminate some other station. As was said earlier in this article—do not expect this trap to tune out more than one station at a time.

If you find that this trap does not tune out the station that you are trying to get rid of, it is probably because the coils of your set are picking up the station, and the only thing to do is to get a set that has coils with restricted fields; or else, shield the whole set. To be sure that it is the coils on your set that are picking up the station, and not your antenna system, connect a wire from the post marked antenna to the post marked ground on your own set. At the time you do this do not have the antenna itself or the ground wire connected to your set. If by tuning the set you can still hear the interfering station the trouble is beyond the help of any wave trap. A situation like this should only occur when the reader lives very near to some powerful station and should not happen as a general rule. The reader I have in mind is the fellow who writes "I live three blocks from Station PUNK and I can not tune him out. What can I do to make my set more selective?" Our only answer to him is "Move," or, "Wreck the station."

At 3XP, with the model of the wave trap shown in the photographs, we are able to tune out completely the nearby Philadelphia stations so that they can not be heard even when the receiving set itself is tuned for them. This shows how selective a well-made wave trap can be.

WHEN we first made this kind of wave trap at our laboratory, we thought we would be very smart and make as compact a job as we possibly could. We chose the condenser and tubing of such size as to allow us to slip the tubing and coils right over the condenser.

This looked fine but it simply wouldn't tune out any stations. After we thought it all over, we discovered why.

When radio currents flow around such coils as this, the whole inside of the tubing is filled by a field of magnetism caused by the currents. This magnetic field changes every time the current changes and this may be a million times a second.

It is a well known fact in radio that resistances or losses in tuning circuits broaden the tuning and keep the circuits from being selective. That is the reason for the modern "low loss" movement—greater selectivity and greater all-round efficiency.

Naturally, the very reason for the existence of a wave trap is just as sharp selectivity as possible. Consequently we must make it "low loss." That means that the metal of your condenser must be entirely outside of the magnetic field of your coil.

In tuning this wave trap—if it is properly built—you cannot twirl your dial around carelessly. You will have to use a vernier and feel very carefully for the exact setting at which the undesired station is eliminated. This can be made critical to a half-degree so that patient tuning is necessary.

The PIEZO CRYSTAL CONTROL

BBROADCASTING engineers are finding great hope in the Piezo crystal. Here is a tiny bit of carefully ground material which will hold a station absolutely to its wave length regardless of swinging aerial, circuit changes or accidents in the set. All that these things can do is to vary the amount of energy emitted; they cannot vary the frequency.

The U. S. Naval Laboratory at Belleview, near Washington, the Bureau of Standards and several of the larger electric and radio corporations have put a vast amount of time, money and effort into the study of the oscillating crystal and Station KDKA has now installed a Piezo unit in its big transmitter at East Pittsburgh.

If all broadcasting stations were Piezo crystal-controlled, we could eliminate most of the heterodyne whistling which now mars our reception of broadcasts.

H. M. N.

Science's Newest Method of Assuring an Unvarying Wave-Length is Being Successfully used in the East Pittsburgh Transmitter and is here described so that It can be Easily Understood by the Average Reader.

Fig. 3

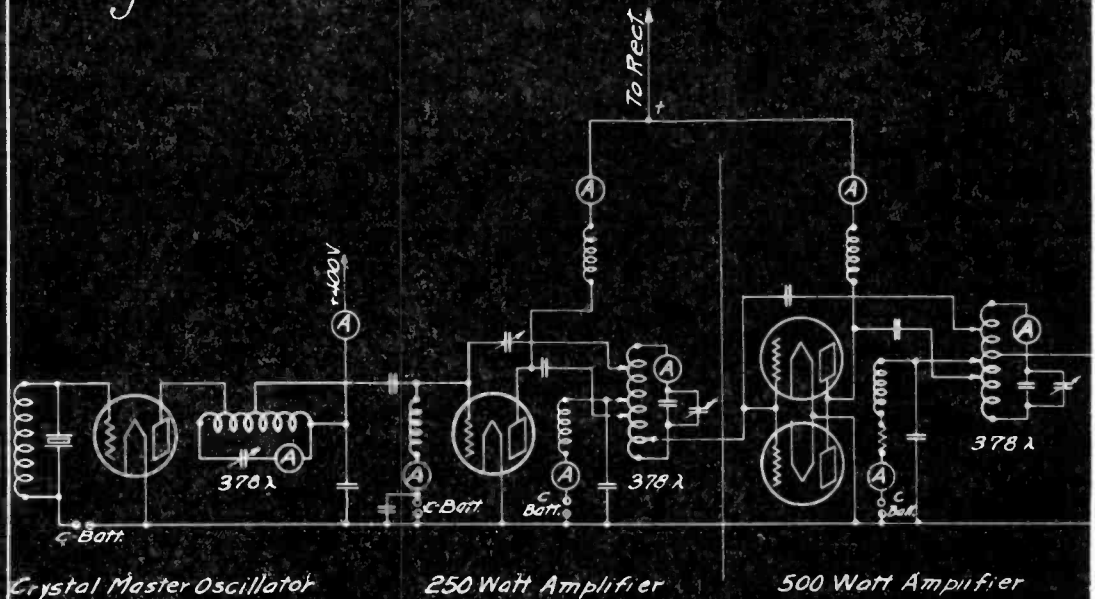
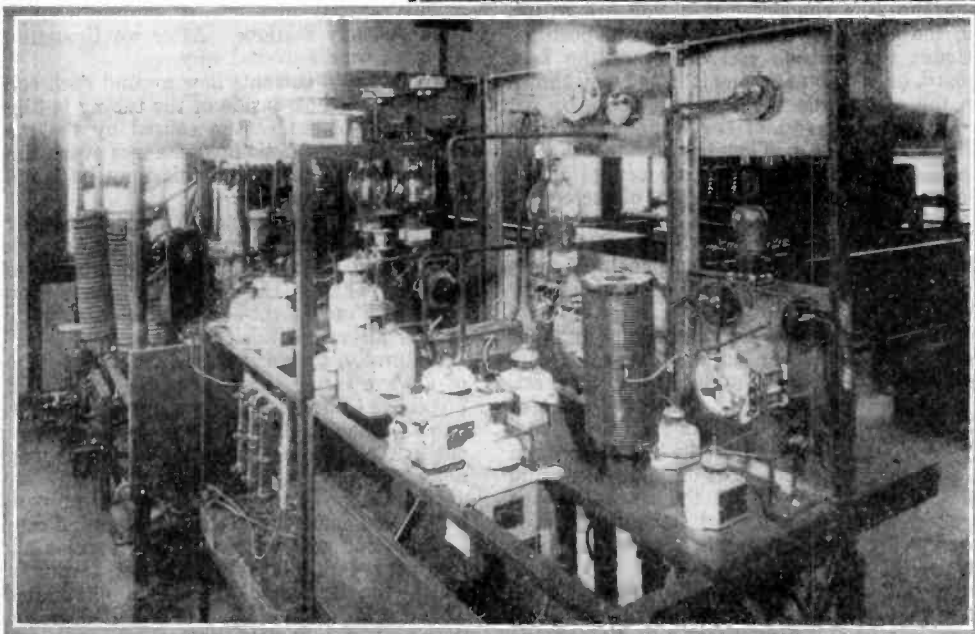

Fig. 5.—Rear View of Master Oscillator and Amplifier of the KDKA 63-meter set.



THE application of Piezo crystals to broadcasting transmitters to control their frequency is one of the latest developments in radio. It is rather difficult to imagine that a small quartz crystal approximately an inch square and one-eighth inch thick can control the frequency of high power broadcast transmitters. However, this is being done successfully.

A quartz crystal has what is known as the Piezo electric property. Briefly the crystal has the property of changing its shape when a voltage is applied to it, and vice versa, a change in shape produces a voltage difference between the faces of the crystal. These voltages and changes in shape are, of course, minute.

It is also a characteristic of quartz that its natural period of vibration is in the order of radio frequencies. If these two properties of the material are combined it is possible to produce sustained oscillations at radio fre-

at Station K D K A

By V. E. TROUANT

Radio Engineering Department, Westinghouse Electric & Manufacturing Company

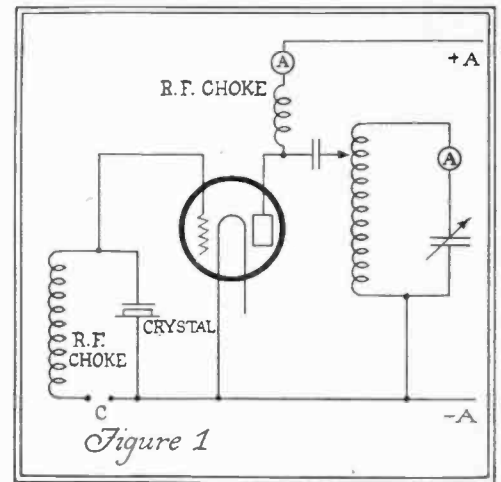

it is generally sufficient to excite the grid of a 50 watt or a 250 watt tube. The problem now resolves itself into a radio frequency power amplifier having the characteristic of oscillating at the desired frequency—in short, a perfectly neutralized amplifier controlled by a small quartz crystal in the grid circuit of a small tube. Since crystals to operate below 100 meters would be very thin, it is desirable to use some harmonic of a longer wave length.

The crystal master oscillator was first applied to the 63 meter set of KDKA. The circuit of the complete transmitter is shown in Fig. 3. As shown in the diagram, the 5 watt tube supplies the grid excitation for a 250 watt tube, which in turn supplies two 250 watt tubes in parallel, all operating at 378 meters. These stages are perfectly neutralized against feed back.

Up to this point the 309 and the 63 meter sets are identical except in frequency. For the 309 meter set the glass tubes supply sufficient energy to excite the grids of the power

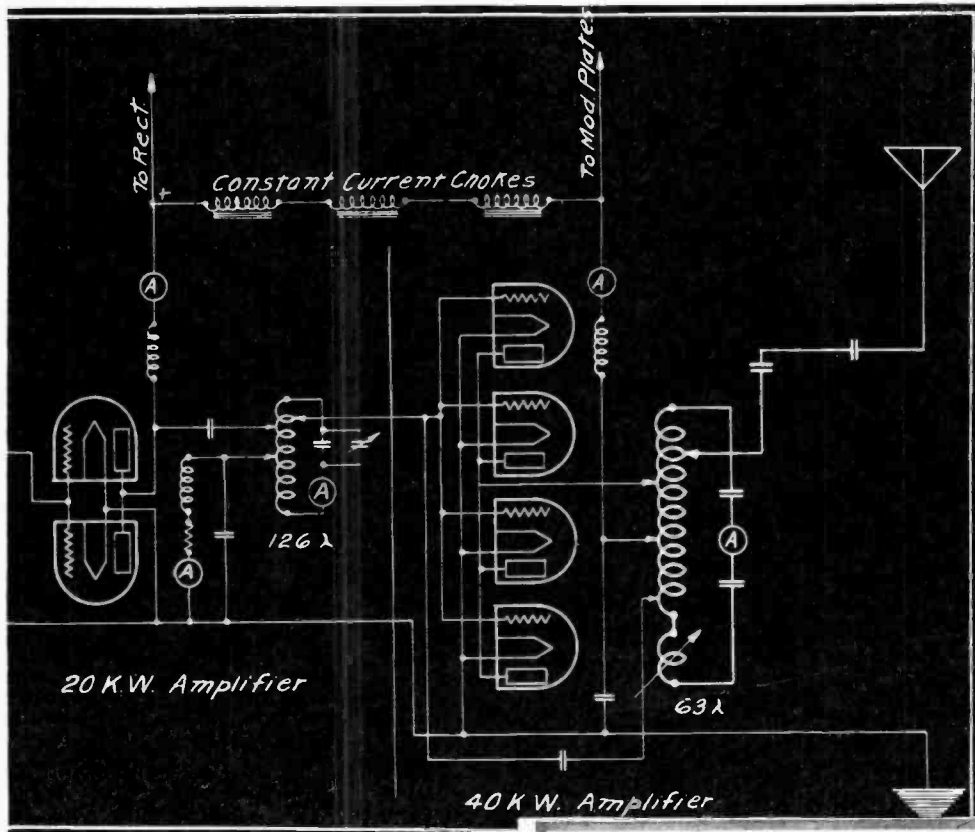
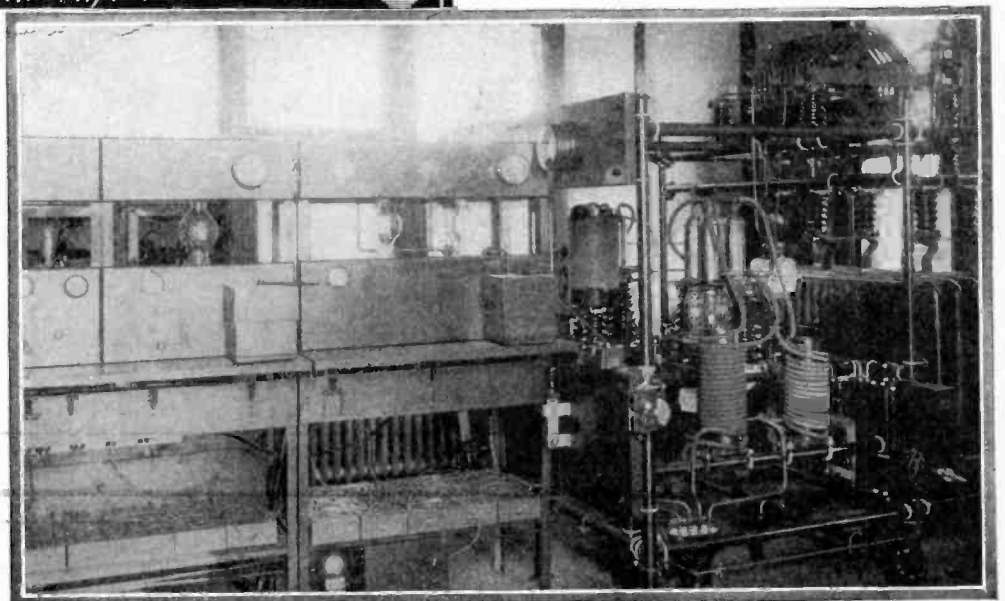

Fig. 6.—View of KDKA 309-meter transmitter with its crystal oscillator.



quencies. The particular frequency will be very constant since it depends only on the physical dimensions of the particular piece of quartz.

In practice the crystal is merely placed between two conducting surfaces; it should not be tightly held in position, but a thin plate may rest on it without interfering with its operation.

The crystal itself can not control a large amount of energy so it is necessary to amplify its output until sufficient energy is obtained to control the power transmitting tubes.

The crystal is ordinarily connected in the grid circuit of a small tube as shown in Fig. 1. The choke across the crystal supplies bias to the grid of the tube. When the plate circuit is tuned to the proper value the plate current will change somewhat as shown in Fig. 2. Also current begins to oscillate in the tank circuit.

The output of this tube will be small, but

tubes. For the 63 meter set the sixth harmonic of the 500 watt stage is not sufficiently pronounced to excite the power tubes. An intermediate stage is introduced and the increase in frequency is made in two steps. From the glass tubes the grids of two power tubes are excited and their plate circuit tuned to 126 meters. The grids of four power tubes are supplied from this stage and their plate circuit tuned to 63 meters. The antenna is coupled through capacity to this tank circuit.

A photograph of the 63 meter set with its crystal master oscillator and amplifier is shown in Fig. 4. A rear view of the oscillator and amplifier is shown in Fig. 5. Fig. 6 shows the 309 meter transmitter with its crystal oscillator. The "B" batteries shown in the photos furnish bias for the grids of the tubes.

The crystal master oscillator resulted in very noticeable improvement in quality of reception on both wave lengths. It completely

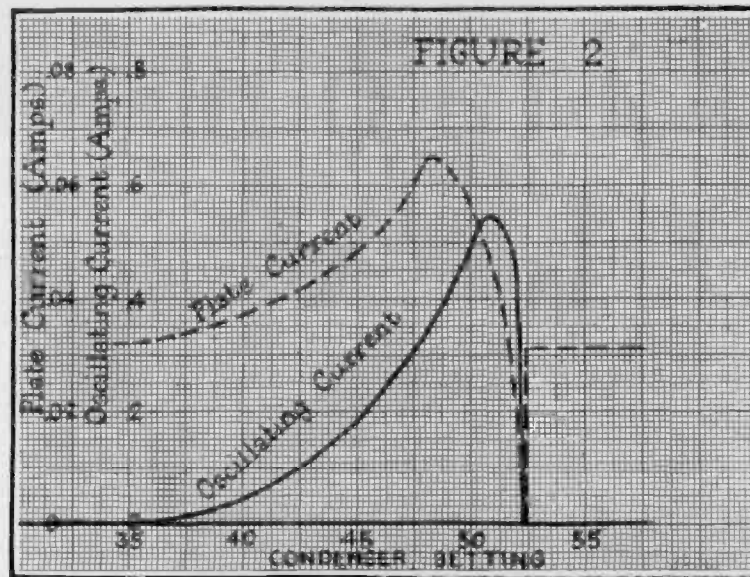

Characteristic curve of 5 Watt PIEZO Crystal Controlled master oscillator.

eliminated slight changes in wave length due to changes in the oscillator or to movement of the antenna.

In addition to the improvement in quality it reduced the possibility of beating with another station.

If all broadcast stations were equipped with this method of frequency control, interference between stations would be eliminated. Use of crystal master oscillators has proved to be entirely desirable and practicable on the transmitters at KDKA.

Other station owners, becoming familiar with the results at East Pittsburgh, have installed crystals and the Department of Commerce has recently issued a list of nearly a dozen broadcasting stations which have added this improvement to their equipment.

Much present heterodyning, or "beating," which spoils reception, particularly below 280 meters, will be done away with when such crystal control is in general use and its extension is most desirable.

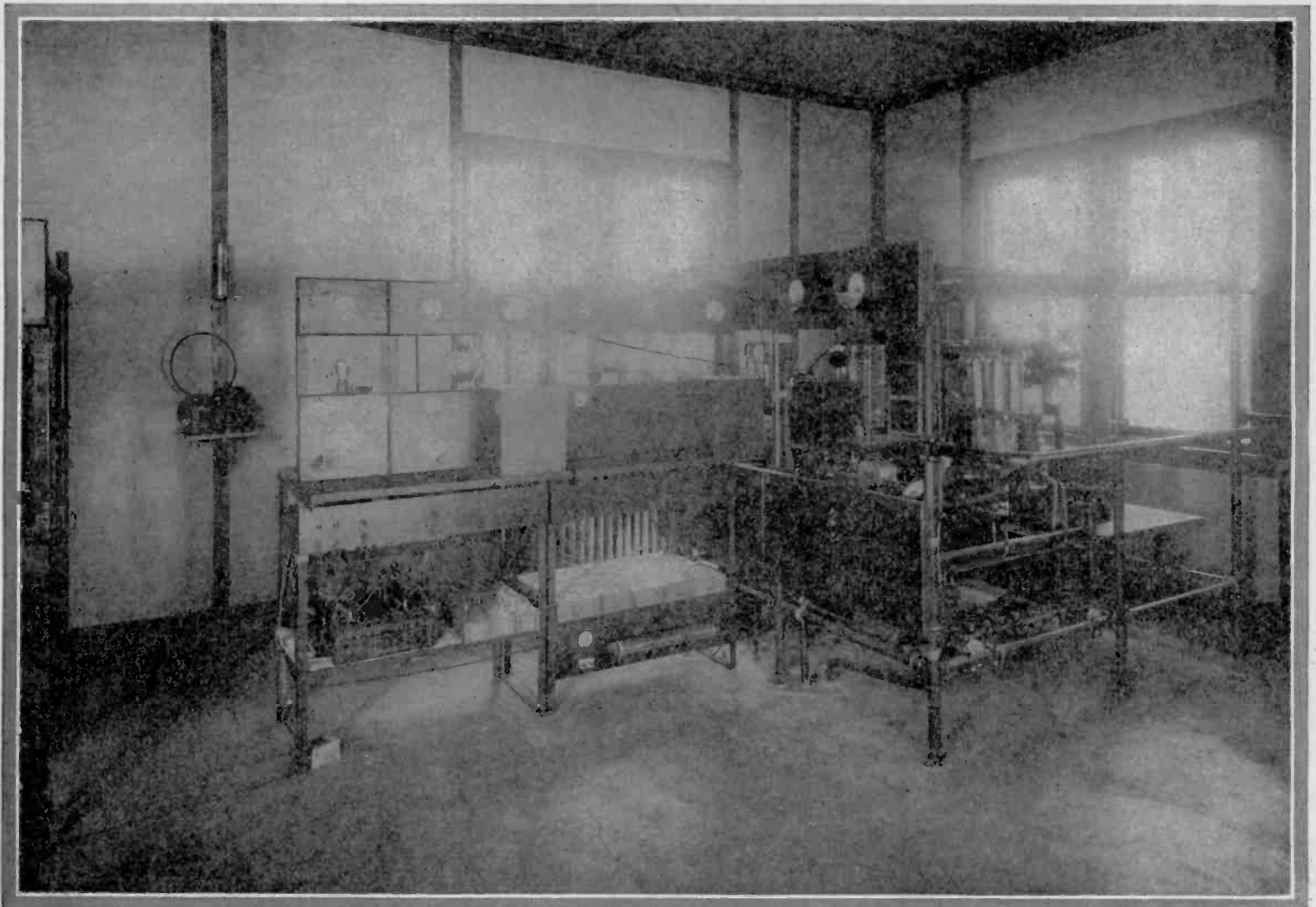

Fig. 4.—The KDKA 63-meter set with crystal master oscillator and amplifier.

How to Understand RADIO

By THEODORE H. NAKKEN

PART I

The Vacuum Tube

WHEN the author was invited to write a comprehensive series of articles on the subject of radio reception, to be published serially in *The Radio Home*, it was planned to make this series appear in such a form, that gradually all the vital parts of such receivers would be dealt with in a popular manner. It would therefore appear as if the logical way to proceed would be to start out with the very beginning—the antenna and its associated circuits in the ordinary receiver.

Notwithstanding this, the first article ultimately decided upon does not deal with reception proper at all, but with one instrument—the vacuum tube—which is found in almost any receiver, and which at the same time plays an all-important role in the broadcasting station. This course was adopted because it is necessary in all phases of modern receiver design always to turn again to the peculiarities of this vacuum tube, for no part of a radio receiver can be designed without taking this into consideration, and because for proper understanding of any and all phenomena in radio receivers these properties of vacuum tubes must be fully understood.

We will in subsequent articles refer time and again to different vacuum tube characteristics, and thus it seemed that this should be treated first of all.

Now the construction of our vacuum tube is well-known, and it seems unnecessary to give a very complete description of each one of the elements—filament, surrounding grid and the plate, which generally is built concentrically with the grid. It is also a well-known fact that these elements are mounted in a glass bulb, which has been exhausted as far as humanly possible, that is, a vacuum has been created in the bulb, from which the device derives its popular name.

It must not be thought that the name

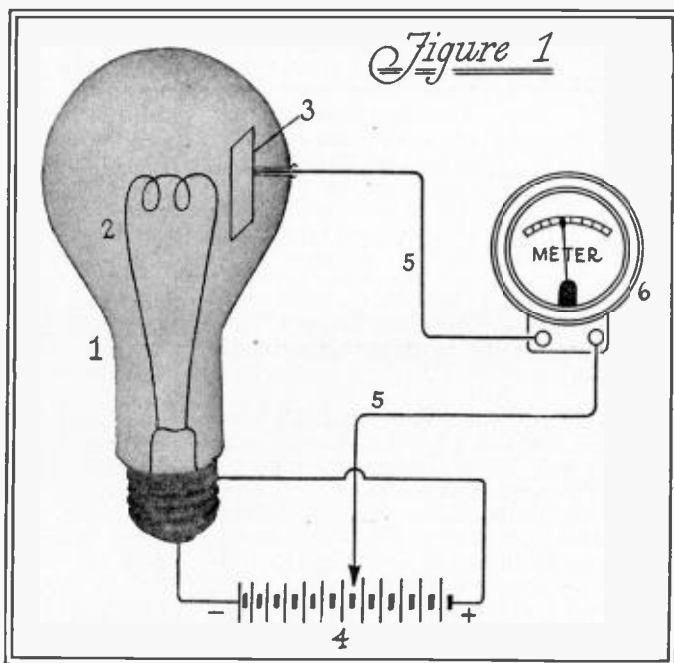

Above is a diagram of the Edison Effect.

“vacuum tube” describes our tube sufficiently, as there are many types of vacuum tubes in use for quite different purposes, and therefore the name “amplifier” tube or “three element” tube describes the device much more adequately. In honor of its inventor, Dr. Lee de Forest, who named his device the *audion*, we shall refer often to this name, because no matter what claims for improvements have been granted to others, our present-day amplifying tubes are no more than improved audions, and the only improvements since the first conception of the audion have been purely constructional. In no instance has a radically new principle been introduced.

The audion then is, without overstating facts, one of the most marvelous devices ever invented, because it enables us to control electrical currents almost without the expenditure of any energy. It is this fact that makes it possible for it to act as a so-called amplifying tube: which name has created quite a good deal of misunderstanding. The tube does not actually amplify, as the name seems to imply: It only enables us to control comparatively large currents by means of very small impulses, and this *controlling* takes place in such a manner, that the controlled electrical energy has exactly the same char-

EVERY time a manufactured set is sold, somebody, somewhere begins to sit back and wonder about this miracle that science has performed. He may bluster and bluff about not giving a darn what is inside the box but no man with an alert mind, alive to modern mechanical marvels, can long listen to radio without finding that mind demanding to know at least something of what it all means and how it is brought to pass.

He doesn't want a lot of technicalities. He doesn't want formulae and mathematical “flute music.” He wants somebody to tell him, in simple, every-day terms, how this music is snatched from the void and made to fill his house with melody.

It is for such men that Mr. Nakken has written this series of articles.

H. M. N.

acteristics as the energy which is utilized for purposes of control. It controls electrical energy in a manner somewhat similar to the way the throttle on an automobile controls tremendous power by a simple motion, as the valves on a steam engine control power output of the engine, as the faucet in the water-line controls the flow of water, apparently without any effort whatsoever.

In none of these instances would we speak of *amplification*, yet a certain pressure on the accelerator produces an enormous increase in power flow from the engine, which under the same circumstances is always the same. Similarly the audion controls the flow of electric current in the circuit of its associated instruments, and we will try to visualize the manner in which this control takes place.

In the year 1883 an entirely novel effect was discovered during the development work on incandescent lamps by Thomas Alva Edison, which consisted of a flow of current through the vacuum when a filament was heated in an electric lamp. In honor of its discoverer this effect is mostly referred to as the *Edison effect*. As its discovery was the first step towards our modern vacuum tube, we will deal with it a little more thoroughly, above all, as Edison's discovery was used in almost unchanged form at a later date.

In Fig. 1 we see an evacuated bulb (1) containing a filament (2) and a plate (3). The filament is heated by means of a battery (4) and the plate can be connected by a wire (5) over a sensitive galvanometer (6) to either the positive or the negative pole of the battery.

EDISON found that when the plate was connected to the positive pole of the battery, the meter would indicate a flow of current in the plate circuit, which current depended in its magnitude on the temperature of the filament. When the plate connection was made to the negative pole of the battery, however, no current would flow in the plate circuit.

This peculiar effect was not properly understood until thorough investigations of the subject had been made, and it could only be explained fully when the true nature of matter had been understood a little more clearly. Above all the investigations of the conduction

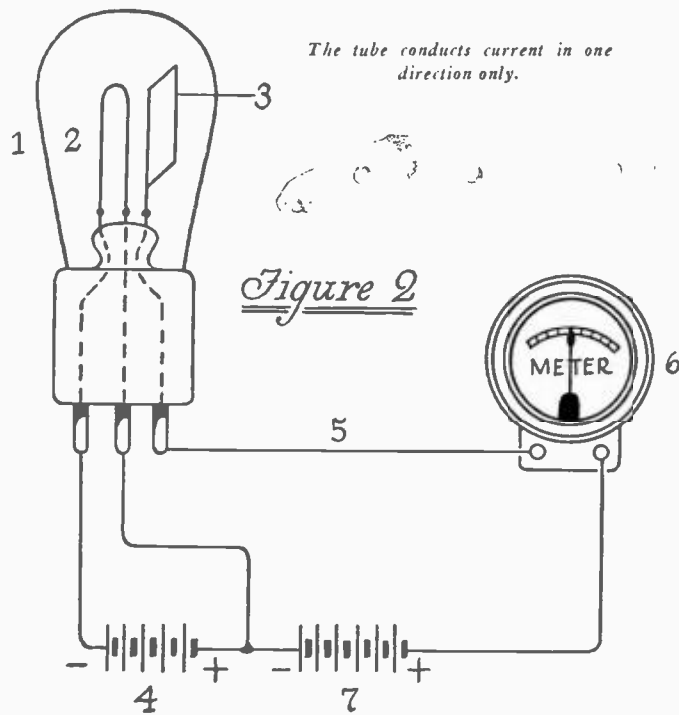

Figure 2

of electric currents through gases and the emission of electrons by hot bodies, in which investigations Sir Elisha Thomson and Richardson were most eminent, have given us a clear understanding of what happened.

A FULL explanation must take into consideration that matter nowadays is supposed to consist of atoms, which are the very smallest particles of matter that can exist as such. These atoms are supposed to consist, in turn, of a so-called proton, or a positive center, which is accompanied by a certain number of so-called electrons, actually small particles of negative electricity. The nature of the proton and the number of electrons attached to it determine what kind of matter—what *element*—the atom represents.

These electrons now are supposed to be in constant motion. They revolve around the proton more or less in the manner of the motion of planets around their sun. For different reasons an electron may become dislocated temporarily. For example, when the matter is heated above a certain temperature, this dislocation of electrons will take place, and we say then that electrons are being *emitted*. When, however, an atom loses an electron, the atom becomes positively charged, because the electron constitutes what we commonly call negative electricity: and thus the atom will try to attract a loose electron, so as to reestablish its own equilibrium.

If, however, we place a positive body at the place where such emitted electrons are present, we can make this body so strongly positive that it exerts a greater attraction on the electron than the atom which became positive through the loss of an electron. Thus we see, that in the case represented in Fig. 1,



The new RAYTHEON rectifying tube now increasingly popular in battery eliminators.

ing in the heated filament and flowing through the space intervening between filament and plate, and through the plate circuit returning to the filament.

IT WILL then be inevitable, that this current will flow also when the plate is made even more positive, for instance by means of a separate battery, as shown in Fig. 2, where we have added such a battery (7) in the plate circuit. Also, that if we reverse this battery, and thus make the plate more negative, no current whatsoever will flow.

On this fact were based the first rectifying tubes developed by Dr. Wehnelt in Berlin, who experimented with them quite extensively. He reasoned that the emission of electrons, while dependent on the temperature of the filament, also depended on the material of which it was made, and thus he endeavored to find a filament which would give a maximum flow of electrons at the lowest temperature possible, and the result of his experiments was the so-called Wehnelt or oxyd coated filament, which today is used in many of the popular vacuum tubes. These filaments give a copious supply of electrons when heated only to a red temperature. They consist mostly of a platinum core covered with oxides of calcium, strontium and other rare metals.

A very simple circuit for use with such a tube is presented in Fig. 3. We see there once more the bulb, containing a filament and a plate, with provisions for heating the filament by means of a transformer, with alternating current. The same transformer delivers an alternating current, which is made to flow in the plate circuit. But here the tube comes into action as a rectifier.

As is known, an alternating

current is characterized by the following phenomena: electric current starts flowing in a certain direction and increases to a certain maximum value, after which the current decreases to zero, and changes in direction. Once more it reaches a maximum in the opposite direction, decreases and goes again to zero. Such a current, if led through a transformer (which is nothing but two spools of wire placed closely together) will flow through one of the coils, called the primary, and by virtue of its presence create an alternating current in the second coil, the secondary. And as this current again is an alternating current, we can easily see that the terminals of this secondary are alternatingly caused to have a positive and negative potential.

Now one of these terminals in our rectifier is connected to the filament, the other to the plate. One moment the plate will then be more positive than the filament, and when the current reverses it will be negative with regard to that filament. As we have learned, there will be a plate current only when the plate is positive, and none when it is negative. The result will then be that the device will allow plate current to flow in only one direction, so that the plate current which will actually flow will be a succession of current impulses, flowing when the plate is positive but all in the same direction, and therefore in the nature of direct current, or unidirectional current. In a later issue we will return to this circuit, when dealing with battery eliminators.

During these experiments it was found, that the current flow in such a tube was dependent not only on the temperature of the filament, or, to say it differently, on the *electronic emission* from the filament, but also on the positive potential of the plate. As this positive potential was increased, the current flowing in the plate circuit increased proportionally, until a maximum value had been attained, after which an increase in plate potential did not result in an increased current flow. When however the filament temperature was increased under those circumstances, the plate current could once more reach a higher value.

And thus we may say that in the Wehnelt rectifier the plate current depended on two

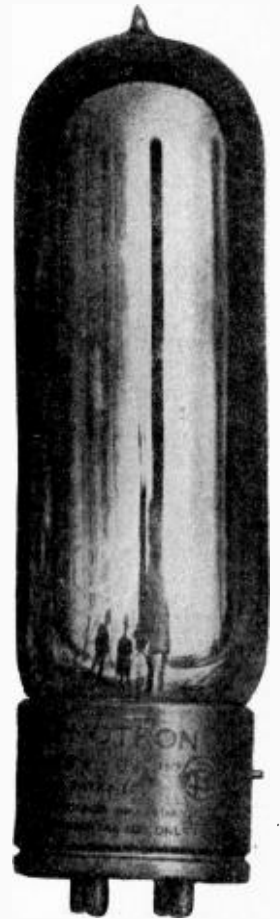

The KENETRON rectifying tube used in many 50 and 100 watt transmitting sets.

factors: The electronic emission from the filament and the potential of the plate.

It follows then, that seemingly these two are closely related and the explanation of this relationship was given by the calculations of Langmuir on the *space charge effect*.

In short, we may explain this matter as follows: As the filament, when heated, emits electrons, much as if they evaporated from its surface, it is completely surrounded by a cloud of electrons, or negative particles. Of course this cloud of electrons represents a negative body, as it were, and into this negative body, new electrons, evaporating from the filament, must penetrate. This is then fairly difficult, because both the space around the filament and the electrons are negative and therefore repel each other. The effect of this cloud of electrons was called the *space charge effect* by Langmuir.

If the space charge is very high, it is almost impossible for new electrons to travel away from the filament, because the space charge drives them back, repels them, and causes them to return to the filament.

If now we introduce a positive plate, the charge on this plate will partially—or completely—offset the effect of the space charge, and the more we increase the positive potential of the plate, the more completely will the effect of the space charge be nullified, until at last we reach the point where the space charge has been completely nullified in its effect and all electrons from the filament can reach the plate. This point is called the *saturation point*, and the current then flowing is the *saturation current*.

The celebrated English radio expert Fleming was the first who conceived the

idea of using this Wehnelt rectifying tube as a radio detector. It may be shortly stated here that radio signals are represented by alternating currents of such a high number of alternations, generally called frequency, that they cannot affect telephone instruments or the human ear. To make it possible to hear them by means of telephones, this alternating current must first be rectified, and all detectors ever used were based on this principle.

As a Wehnelt tube allowed current to flow in only one direction, it was a perfect instrument for the rectification of radio signals, and on account of its unidirectional conductivity Fleming compared its action with that of a valve in a pump system, which allows a fluid free passage in one direction only, but automatically is closed if the fluid should tend to flow in the other direction. He coined the name *electronic valve*, and even today it is the custom in England to call amplifying tubes by the name of valves. Often one will

read the name "thermionic valve," meaning that the tube acts by means of ions, the former name for electrons, which have been liberated by heat.

It is at this point that the work of De Forest on amplifying tubes started and to him seems to belong the credit of having introduced for the first time the third element, now commonly known as the grid. Independently of the American inventor this third element was introduced by the German scientists Drs. Lieben and Reiss.

While De Forest started out with the idea of constructing an improved detecting (or rectifying) device, the Germans had a full understanding of the ultimate possibilities, as they were working with the purpose of constructing a pure amplifying device, a thermionic relay. But very soon the work of De Forest was advanced far beyond that of his contemporaries, when once he grasped the true nature of the different actions taking place within the tube due to the presence of the grid.

THIS grid action is one of the most simple phenomena, and yet at the same time extremely complicated in its applications. The addition of the grid at once made the vacuum tube as used for rectifying tubes one of the marvels of electrical scientific applications. It opened the road to almost all of the improvements in communication of which engineers had been dreaming, for which they had been wishing fervently but which they also considered almost unattainable. Yet, looking back across the short time since its inception, we are astonished at the fact that it was not discovered before.

Imagine then once more the Wehnelt tube, with only its two elements, filament and plate, each one creating its own electrical condition in the interior of the tube—the space charge and the action of the positive plate. To speak in electrical terms, the two elements each were surrounded by their respective fields, and the proportion of these two fields determined the amount of plate current which could flow in the plate circuit, because it determined the number of electrons which could reach the plate.

Into this tube we now introduce a third element, the grid. We place this element in such a way that it is in a position where it can influence both the space charge and the plate field, therefore preferably between filament and plate. In order to make it possible for the electrons to reach the plate, we must give the grid such a form that electrons can travel freely through it, and thus we come to a *mesh* or *grid* form for the new element.

We give the new element, which has been shaped like an open mesh, a connection to the outside of the tube, so that we can apply to this grid an independent potential. At once it becomes clear that if we make this potential negative, we reenforce the effect of the space charge, and help it to drive electrons

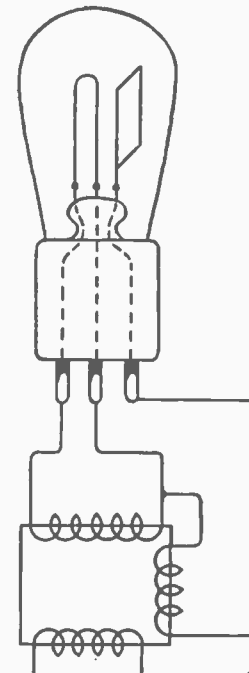

The WEHNELT tube as a rectifier of alternation currents.

Only direct current, but pulsating is present in the plate circuit

Figure 3

Alternating Current Supply

back to the filament: and thus we decrease the plate current. If, however, we make the grid positive, it serves to nullify the action of the space charge: and so the electrons can travel much more easily from filament to plate: and we thus increase the plate current, or, to express it the other way around: If we make it negative, we nullify partly the effect of the plate field, and thus decrease the current in the plate circuit, and if we make it more positive, it seems as if we reenforce the plate field, and thus increase the plate current.

It also seems but natural, in view of the fact that the grid is, so to say, placed at the strategic point between filament and plate, that slight changes in its potential should have a comparatively large effect on the plate current, which is what happens in actuality.

We saw that if the grid potential was made negative, it appeared as if the influence of the plate field was partially nullified. With an actual vacuum tube we can measure exactly how far this effect is true.

In Fig. 4 we see a diagram of a vacuum tube, with a filament (1), a plate (2) and a grid (3). The filament is heated by means of battery (4), while a plate battery (5) is used to give a positive potential to the plate. The plate current can be measured by means of a milliammeter (6). The grid is connected to the filament over a small battery, by



This is the new MAGNATRON REX rectifying tube.



The famous AMRAD "S" tube for rectifying

means of which we may give it any desired potential difference with the filament. This potential difference can be measured by means of a voltmeter (7).

Say now that the grid is connected directly to the negative leg of the filament. We will then read a certain amount of plate current on the milliammeter in the plate circuit. When we insert a certain amount of battery between grid and filament this plate current will assume another value. Thus, when we cause the grid to be one volt negative (or positive) with regard to the negative leg of the filament, we will get a different reading. And we make a note of the current after having done so.

Upon restoring the original grid potential, we see the plate current return to its original value. We can now bring the plate current to the same value we noted when the grid had a different value of potential by either decreasing or increasing the plate potential. With an ordinary 201-A tube we would then find that to cause a similar difference in plate current, it would be necessary to change the plate potential about seven volts.

In other words: a change in grid potential of one volt is equivalent to a corresponding change of plate potential of about seven volts: And therefore it is said that the voltage amplification of the tube is 7.

IT SHOULD be clear from all that has been said, that if we keep the grid at a negative potential as against the filament, no electrons can flow from filament to grid, so that no current can flow in the grid circuit. If the grid is made positive, it acts more or less as if it were a second plate, and attracts electrons, so that a grid current flows, and the grid then consumes a certain amount of power. This is the reason why it is always recommended to use vacuum tubes with a negative biasing voltage on the grid. The result is that the grid cannot consume any power in the first place, and, as we will see in the chapters on amplification, it prevents so-called distortion. At the same time an additional benefit accrues: The plate current is decreased, and this saves the plate or B-battery.

Because the grid functions

The vacuum tube is a voltage amplifier. Simple circuit for determining voltage amplification factor.

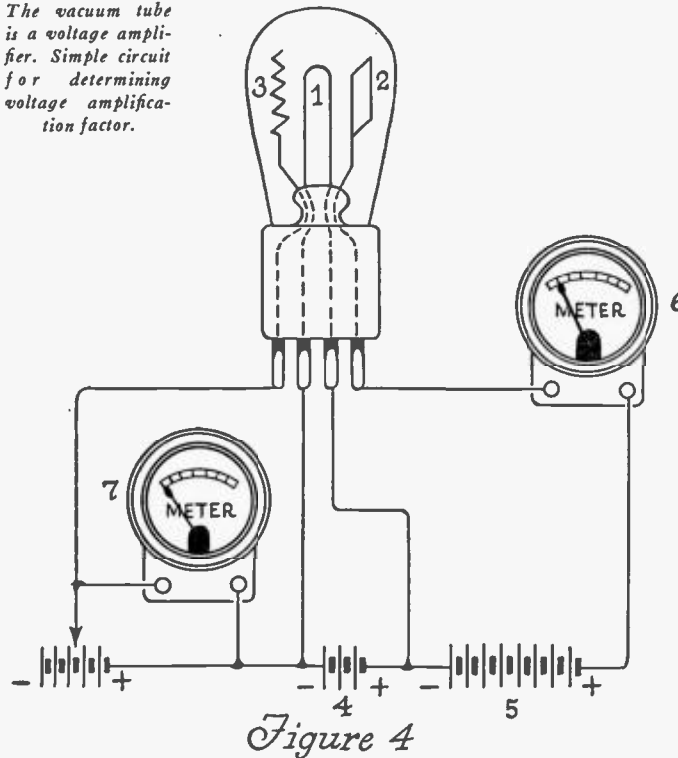

Figure 4

without consuming any power of its own, and solo by virtue of voltage changes, the vacuum tube is often called a voltage operated device. Even here lies the great wonder of its operation. It controls power without using power for doing so. In other words: When we have an extremely small amount of electrical power available, we may use any and all means for converting this power into the large

employ other terms, used in tube terminology. This, however, will be done directly in connection with specific receiving apparatus, and should be more easily understood when this first article has been properly digested and is kept for reference.

IT IS the hope of the author that this series of primary-grade lessons will serve to attract many readers of the "popular" section of this magazine and interest them in the study of the marvellous scientific achievements represented in their radio sets. Articles of a technical or explanatory nature are ordinarily "over the heads" of those who have not become familiar with technical terminology and schematic diagrams but it is extremely difficult to write of radio without assuming at least a moderate amount of such knowledge on the part of the reader.

Questions and suggestions will be most welcome for they will furnish an invaluable guide to the writer in the preparation of future articles, both as to the subject-matter and the style of the description.

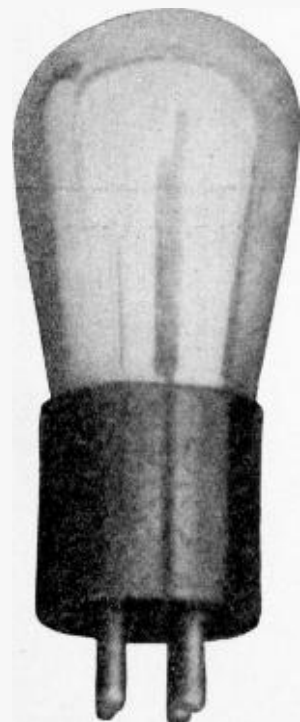

The modern "A" type of three-element tube.



WANT \$50?

Send in an idea for a picture for our front cover.

For details, see our announcement on Page 5 of this issue.



est potential differences possible, which differences, when applied to filament and grid of the tube, are capable of controlling the actual current flow from filament to plate in that tube.

Thus it is seen that the applied voltage controls a current flowing in the plate circuit and it does this with practically no lag in time. Further, the changes in plate current

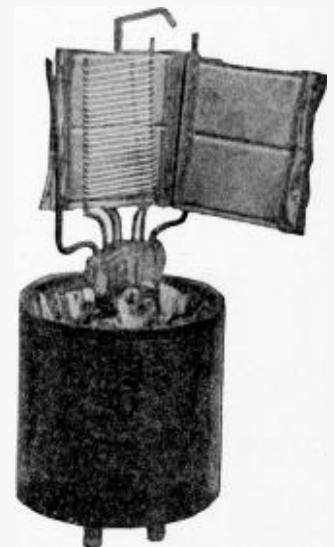

The inner works of the modern tube with glass broken off and plate torn open to expose the grid and filament.

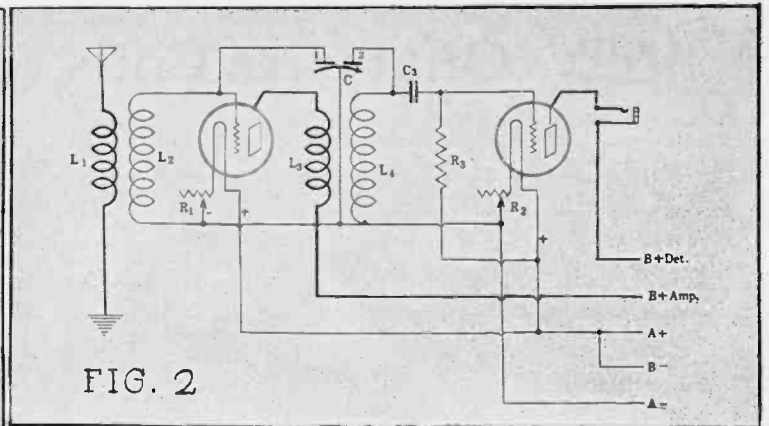
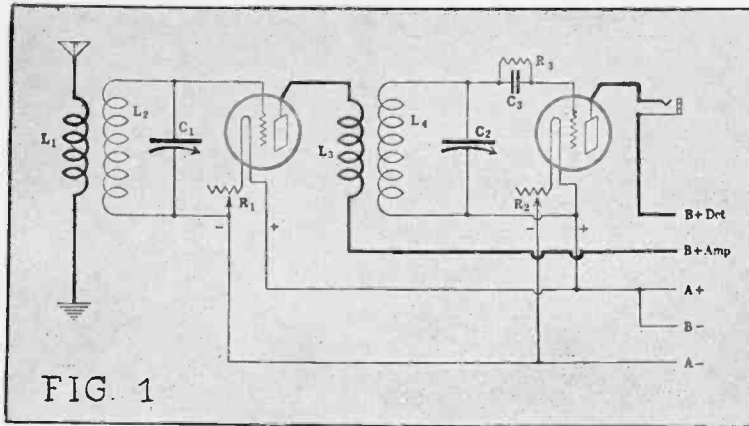

The **POWERTONE** *A Real* One-Control Receiver

THERE is a great demand for single-control sets. These receivers use one dial for wave length tuning, and no other tuning control.

Some receivers are of the modified single control type, having compensating devices to make up for differences in capacity or inductance in given settings of controls of tuned circuits. The 5-tube Bruno Powertone is in the strictly single control class. This is made possible by the use of only two tuned circuits, which are governed by a double condenser. This tuning element is composed of a common rotor and two separate stators. The capacity of each section is .0005 mfd. and the secondaries of the coils are matched so that any given setting represents a single wave length or frequency.

To get results from a set of this kind, it is necessary to have matched coils. This does not mean that exactly the same number of turns necessarily must be on the secondary of

Receiver

It Isn't at All Difficult to Match Two Circuits so That a Good Double Variable Condenser Will Give Accurate Tuning and Good Separation at all Settings.

By Sidney E. Finkelstein

Associate Member, Institute of Radio Engineers

each radio-frequency transformer. Instead, the reactance of the circuit in which the other secondary is used must match the reactance of the first. In nine cases out of ten this will mean that the same inductance on each secondary will give the desired results, but if volume is not obtained you may be certain that a disparity exists.

To cure this is no great task. The solution may be reached through any of several means. The simplest, and one of the most effective of all, will be discussed in this article.

A glance at the circuit diagram reveals that the receiver has a stage of tuned radio-frequency amplification, a non-regenerative detector, one stage of transformer-coupled audio-frequency and two stages of resistance-coupled A.F. The audio channel needs no discussion, since with a good transformer and with durable resistors you have audio amplification of recognized quality and volume.

The radio side is open to inspection, because

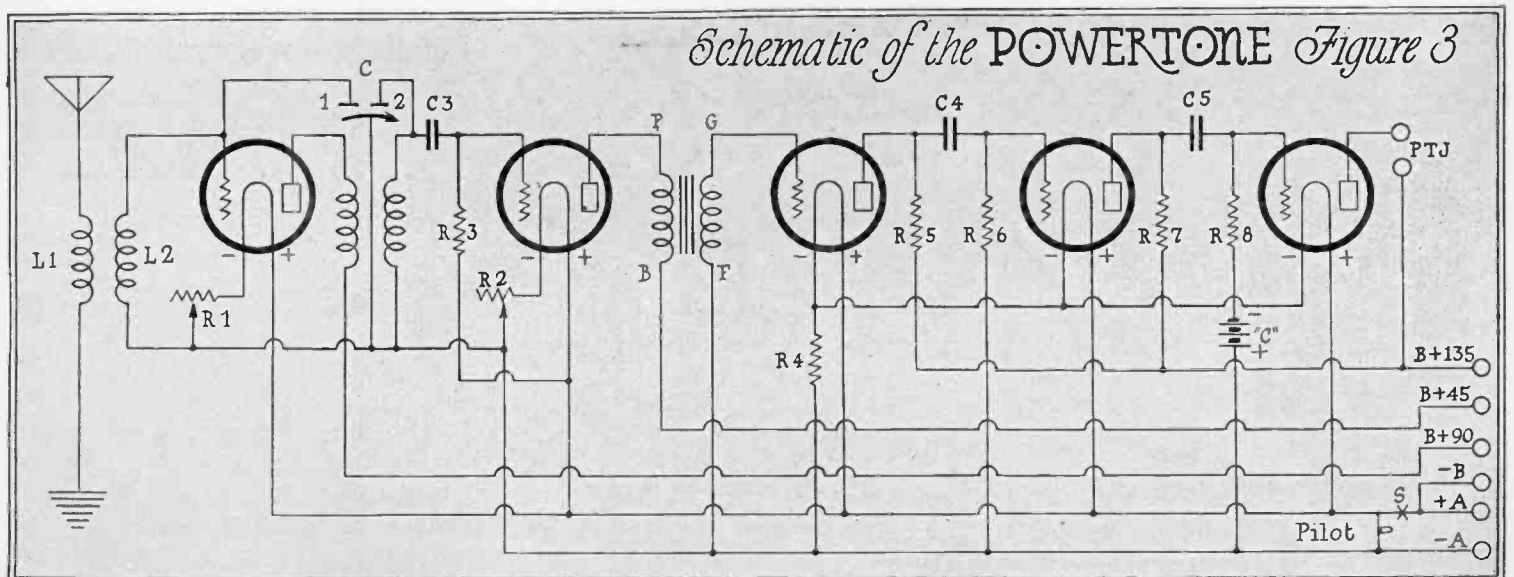

"Bruno" Quartzite Coils

will improve the efficiency of any receiver. Replace your old coils with a set of these famous low loss coils and wonder at the difference.

Bruno coils were chosen for the Diamond of the Air and the one control Powertone because of their high standard of efficiency, durable construction and pleasing appearance.



Bruno "99" 3-circuit tuner. Wound on quartzite glass tuning with .0005 condenser and has wave length range of 175-575 meters. Price **\$5.50**



Bruno "55" Radio frequency transformer. Matched with "99" tuner to have similar dial reading. **\$3.00** Tunes from 175-575 meters...

Just off the Press—"RADIO RESEARCHES,"

a bulletin in booklet form containing a blueprint issued every month from the laboratories of the BRUNO RADIO CORP., containing interesting data that every set builder should know; 10c per copy.

BRUNO RADIO CORPORATION, N. Y. C., N. Y.

Sales Offices

Philadelphia Detroit Chicago San Francisco
611 Widener Bldg. 159 E. Elizabeth Ave. 337 W. Madison St. 274 Brannan St.

so little has been said recently about such a hookup. Normally in a tuned radio-frequency receiver—and the Powertone falls in that class—you have two stages of tuned R.F. and a non-regenerative detector.

How far will only one stage of tuned R.F. get you?

Notice that the set uses no neutralizing condenser or other external balancing means. The set is kept just below the point of oscillation by rheostat adjustment, particularly R1. By lowering the electronic emission the oscillatory tendency is kept within bounds, and inevitably so, aided by the alteration of negative bias. The manner of connecting this rheostat, in the negative leg, with the grid return to A minus, gives a negative bias on the grid equal to the voltage drop in the rheostat, that is, the difference in voltage between the source, which is minus 6, and the negative filament, which will range, say, from $3\frac{1}{2}$ to 5 volts for the 201A type of tubes, or a bias spectrum of $1\frac{1}{2}$ volts. This is considerable.

So much for the control of over-oscillation, always an important factor in a tuned R.F. set.

As for the R.F. amplification, it is very satisfactory, the first stage factor usually running around 6 or 7. In actual operation this means the ability to bring in distant stations, under suitable location and atmospheric conditions. The setting of R1 is a determining factor here, since the circuit itself is capable of distance, if the amplification is properly sustained by bias and electronic emission.

While one tuned stage is next to useless, if used all by itself, since it lacks selectivity, two tuned stages—the R.F. step and the detector input—develop a fine degree of selectivity, the curve being on a par with that of a regenerative receiver. The filtering effect of the tuned R.F. stage, supplementing the detector input, is sufficient to enable separation of even the crowded low-wave length stations in congested areas. Thus you have a truly single-control set that will appeal to all who enjoy simplicity of tuning, including to an important extent the woman of the house.

WITH three dials to tune, as is the case in many receivers, failure to bring in distant stations is very often due to tuning inexperience, for it requires a crafty hand to set each of the three dials properly. When the controls are reduced, particularly to a solitary tuning device, this annoyance disappears.

The selectivity of the receiver (Fig. 1) is due to the filtering effect when the circuits are tuned to the same wave length, rather than to any virtue of selectivity that exists in either circuit as a unit, for each separately tunes broadly, while as units in the chain they are an effective dam against the undesired radio stream. This is the principle applicable to all tuned radio-frequency receivers, even if there are two stages of R.F.

For instance, KDKA is tuned in regularly while WGBS is on the air, with WGBS only two miles from the point of reception. WGBS is the Gimbel Brothers' station in New York City, operating on 315.6 meters (950 kilocycles), while KDKA, East Pittsburgh, uses a wave of 309.1 meters (970 kilocycles). The channel of separation between stations, as apportioned by the Department of Commerce, is 10,000 cycles (10 key.), hence there are only two channels (20 key.) between WGBS and KDKA. Any set that is as effective as that under such conditions is selective.

Now for the multiple tuning condenser and the arguments for and against its use.

It has been pointed out that the first stage, which is in the aerial circuit, due to coupling with the untuned primary, had better be apportioned a control of its own, since only in succeeding stages would you have very similar conditions, e.g., the plate of a tube, an

SINGLE CONTROL! for ease of tuning

Complete kit of parts for the

One Dial Powertone—\$22.50

With Cabinet \$25.75

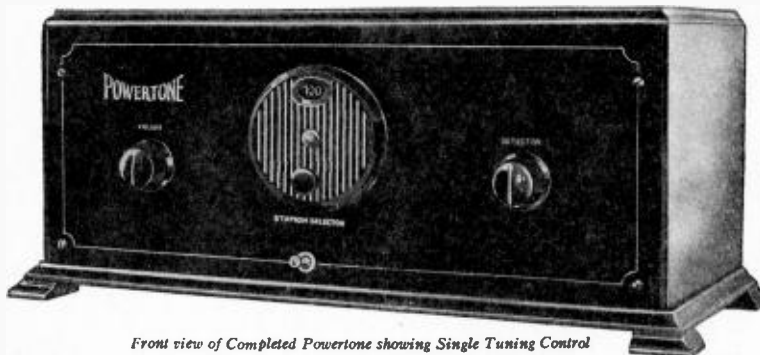

Front view of Completed Powertone showing Single Tuning Control

The materials supplied to each kit are of the best procurable as follows:—

- Two Bruno 99 or 55 RF transformers
- One 2-section condenser, each section .0005 mfd.
- One $\frac{3}{4}$ amp. ballast resistor
- Two .1 megohm resistors
- Three grid leaks; 2 megohms, 1 megohm; .5 megohm
- Three fixed condensers; .0006 mfd. each; 03 (grid condenser), .00025 mfd. all Aerovox
- One 7 x 18 drilled and engraved panel
- Two 20-ohm rheostats
- One 4" Bruno Magic Dial
- One audio-frequency transformer
- One pair of phone tip jacks
- Five sockets
- One battery cable
- One socket strip
- One pair Bruno brackets
- Screws, nuts, spaghetti, bus bar, etc.

"Bruno" MAGIC DIAL

The Newest Wonder in Radio

Makes condensers that are not straight-line frequency tune as if they were. Moulded Bakelite. No gears, no back lash. . . **\$2.50**

"Bruno Slo-Moshen" Vernier Dial, **\$2.00**

If your dealer cannot supply you, we can immediately



B-C-L Radio Service Co.

Subsidiary of Bruno Radio Corporation

Dept. H., 221 Fulton Street, New York City, N. Y.

Telephone Cortland 5026

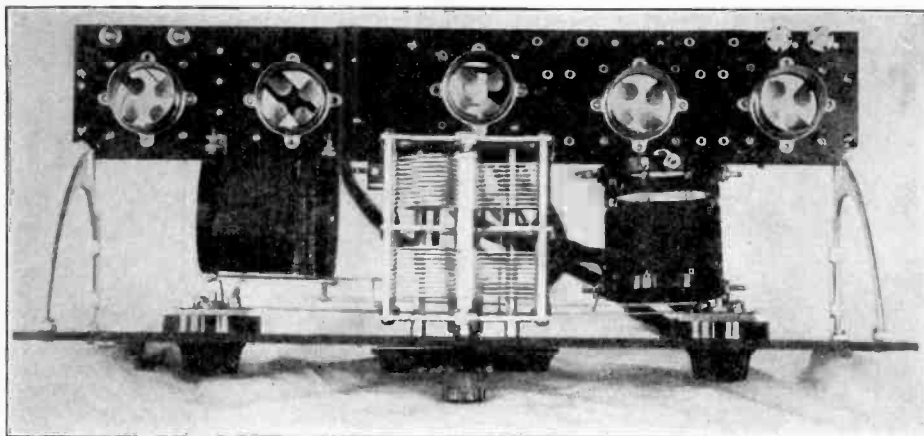

To the left is a view looking up under the sub-panel from the back. Note how the audio transformer acts as a support near the middle. The next picture below is a view looking directly down from above, and clearly shows the mounting of the coils. The lowest picture shows the front panel.

untuned primary for coupling, like impedances, etc. The real point pivots about the capacity contributed to the secondary L2 by virtue of the antenna capacity and the capacity coupling between primary and secondary. But by proper winding of the primary the coil capacity coupling is kept within workable bounds and by loose coupling of the primary and secondary, L1 and L2, this condition is further remedied, the practical result being that it is quite feasible to tune both circuits with one condenser.

NOT only in broadcast work, but by wave-meter tests this is confirmed. The real rub is that the tuning condenser must be one that affords equal capacity variation in each of the two sections, and this is a matter of discreet purchasing. In some circuits any old condenser may do. In this one it will not.

Fig. 1 shows the circuit diagram for wiring a two-control set which comprises one stage of tuned radio-frequency amplification and a non-regenerative detector tube with tuned input. Notice that the grid return of the R.F. stage—the

terminal of L2 other than the one that does to grid—is connected to minus A, while the detector grid return is to positive A. Also, observe that the grid leak, R3, is connected in the conventional fashion, in shunt with the grid condenser C3.

Now, as we proceed to convert this into a single-control set, we reach that stage of development represented in Fig. 2. These changes have taken place:

The receiver shown in Fig. 1 has been converted from two tuning controls to one.

The low potential end of the detector input secondary L4—the so-called grid return end—has been switched from positive A to negative A.

The low potential end of the leak (at left in Fig. 1) has been connected direct to positive A instead of through the coil L4 to positive A.

The object of the unification of control, of course, is the achievement of simplified tuning. The terminal of L4 other than the one connected to grid has been moved over to

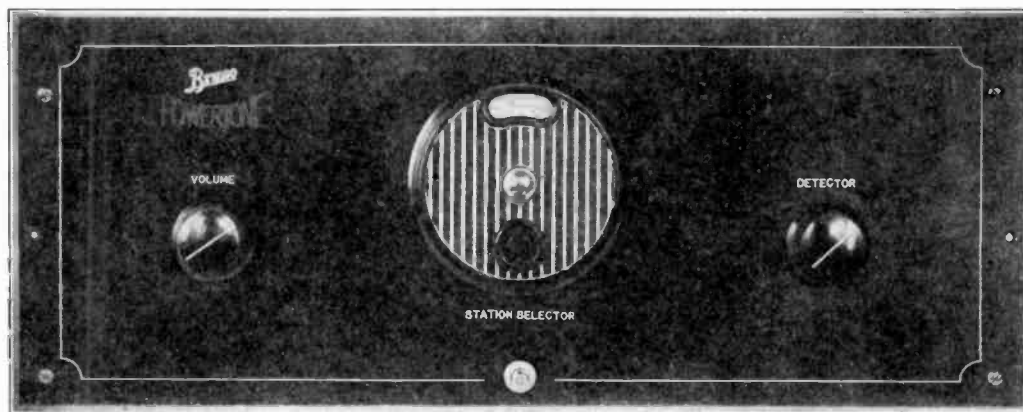
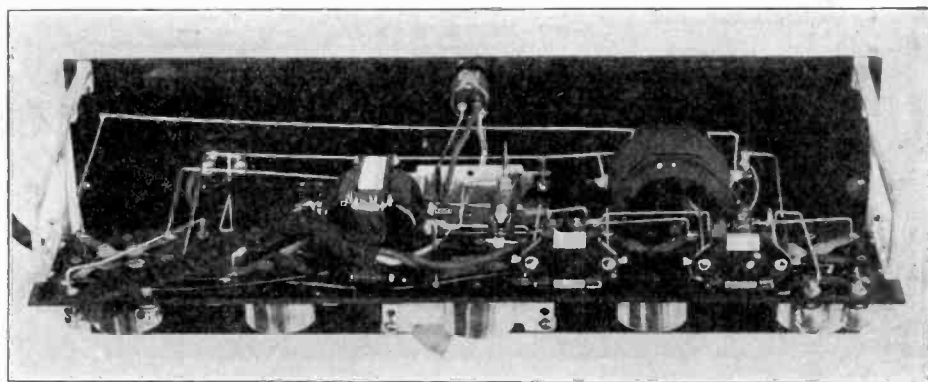

leak may be utilized in any other circuit, instead of the shunt position.

In building the set it is safe to go right ahead except that one should make only temporary connections to the coil L1 L2, because that is the one (if any) to be adjusted for correct inductance. As the in-

ductance (or rather reactance) of the L2 circuit may be too high, the simple solution is to remove turns from that coil, since it is far easier to take turns off that coil than to add turns to the other (L4). In either case the wave length band will be covered.

THE amplifying tube requires a negative grid return and this applies to all circuits and to all forms of amplification, whereas the detector tube functions most efficiently with its grid slightly positive in respect to the negative filament. This is because of the greater response in the plate circuit for a given impressed grid voltage when the tube is operated on the upper part of its characteristic curve.

The problem of obtaining the required positive bias is solved by the conductive connection of positive A to the grid through the leak. The bias actually results, although one might doubt at first thought that it amounts to anything, due to the extremely high resistance of the leak, normally about 2,000,000 ohms (2 megohms). This method of connecting the

ductance (or rather reactance) of the L2 circuit may be too high, the simple solution is to remove turns from that coil, since it is far easier to take turns off that coil than to add turns to the other (L4). In either case the wave length band will be covered.

The fact that the inductance of L2 is too large may be confirmed experimentally by connecting up a variable condenser in parallel with L4, in addition to leaving intact in the circuit the No. 2 section of the condenser C in Fig. 2. Any popular capacity tuning condenser may be used for the purpose, since at zero setting it will represent a very small capacity, say .00005 (50 micro-microfarad).

With an undersized secondary at L4 and the test condenser at zero setting (not zero capacity, for that it can never have), it may increase volume, or at least, when the external condenser is turned to a slightly higher capacity setting the volume will go up. Indeed it may be altogether too tremendous and it will be necessary to turn down the RF tube

Veby Products



are used in Bernard's "Diamond of the Air" to the exclusion of all others.

GRID LEAKS
RESISTORS
TUBES

A. F. 20 Hi Mu Tubes - - - \$3.00
A. F. 6 Power Tube - - - - 4.50

VEBY RADIO CO.
47-51 Morris Ave., Newark, N. J.

filament temperature to clear up the reception.

If you use the condenser method of matching, you need disconnect no fixed wires, because a supplementary capacity is introduced by bringing leads from the test condenser to L4 and leaving that condenser on the table close to the receiver. The temporary connection is made by twisting bared wire at the proper point. It will be advisable in most cases, however, not to have the receiver in a cabinet during the tests. By using the test condenser in parallel with first one and then the other section of C1, you determine readily which secondary, if any, has too few turns for matching purposes.

When you are removing or add-

ing the turns, do so by half-turns.

As for the construction of the single-control receiver designed on the basis of experiments covering several weeks, the diagram is shown in Fig. 3 and the photographs give valuable assistance. It will be noticed that commercially-made coils were used. These were the Bruno 99 RF.

The coils, if made by the constructor, may consist of 10 turns of No. 24 double cotton covered wire, on a 2 1/2" diameter tubing, 2" high, for L1, while the secondary L2 has 58 turns of the same kind of wire. The separation is 3/8". For L3 L4 use the same number of turns etc., but cut down the separation between L3 and L4 to 1/8".

The primary L1 should be at the low potential end of the secondary, while the primary L3 should likewise be so connected that the B plus and A minus leads adjoin. For this method of wiring it will be necessary to ignore markings on some of the commercial RF transformers.

The problems of construction have been discussed on the basis of making success as easy as possible. The actual wiring will prove simple to anyone who can read a schematic diagram and who is not building his first set.

The phone tip jacks are placed on the socket strip, while aerial and ground may go direct to coil posts.

Before you read the list of parts that follows will you please go back to the third column on page 61 and read again from there to the end of the article? While you are still thinking about it, and before you have started to assemble the set, will you please get the method of adjusting the coil L2 thoroughly in your mind? You will be glad of the time spent because then you will be sure of what you are doing. It is far easier for you to go slowly over things in your mind, and decide what is proper to do, than it is for you to add turns to the inductance L2 when, in your hurry, you have taken off turns by mistake. Go on the principle that it is better to be safe than sorry. In case you have forgotten, please note that the grid return of the detector tube is negative instead of positive. The reason for this has been fully explained in the text.

Kits may come and kits may go—but the 1926 Model

"Diamond of the Air," Kit \$35

is growing more popular every day. There's a reason!



The parts used in this boxed and sealed kit are of the best obtainable. They are matched and perfectly balanced to give the best possible results in this circuit.

Each kit bears the seal and signature of Herman Bernard and the approval of Sidney E. Finkelstein, two of Radio's foremost engineers. This is your guarantee of a perfect receiver.

We are pleased to announce that each kit will contain Sidney E. Finkelstein's special 16-page booklet, with a new full-size blueprint, which gives all data necessary for the construction, care and operation of the Diamond of the Air.

We are able to supply the consumers with a copy at 50 cents each.

Some of Our Money Saving Specials

KITS		CONDENSERS		TUBES		MISCELLANEOUS	
Bruno 3-Tube.....	\$18.00	Bruno No. 18-22 Plate.....	\$4.25	R. C. A. 201-A.....	\$1.50	Cuttler-Hammer 6-ohm Ver	\$0.59
Bruno 4-Tube.....	22.00	Hammarlund 23 P.S.L.F.....	4.10	Cunningham.....	1.50	Turn-It Grid Leak.....	.55
Ambassador 3-Tube.....	18.00	Ver.....	2.25	New Venus Blue, 201-A.....	1.00	U. X. Adapter.....	.30
Ambassador 4-Tube.....	20.00	General Instrument, Any Site.....	2.40	Veby Mu 20.....	2.95	Patent Plug.....	.25
Browning Drake.....	19.00	U. S. Tool 11-18-23-43 Plate Ver.....	1.75	Veby Mu 6 Power Tube.....	3.25	Soldering Iron.....	.95
Marodyne Kits.....	22.50	Health 11-23-43 Plate Ver.....	1.75	JONES' SINGLE AND DOUBLE JACKS		"A" Battery Switch.....	.25
		Murdock Enclosed 23-43 Plate.....	.95	Bruno Binding Post (per pkg. of 12).....	.40	Bruno Inductance Switch.....	.40
		U. S. L. 23-43 Plate Ver.....	1.50	Lightning Arrestor.....	.40	Battery Cable.....	.45
		Preferred 11-23 Plate Ver.....	1.35	Patent Rheostat.....	.60	Dubilier By-Pass Con. 0.25 mfd.....	.70
		Amsoo 17 Plate S. L. F.....	2.75	LOUD SPEAKER UNITS		D. P. D. T. Switches.....	.50
		Amsoo 23 Plate S. L. F.....	3.25	Baldwin (Type C).....	\$3.95	WD-11 Adapters.....	.50
		King Cardwell 11 Plate.....	2.10	Baldwin (Type II).....	4.95	S. P. D. T. Switches.....	.45
		Freshman Mercury.....	.95	Morrison.....	3.25	Phone Plugs.....	.25
		Manhattan 13-23 Plate Ver.....	2.95	Bosch Jr.....	14.90	Bessie 1" Nickel.....	.05
		Patent 11-43 Plate.....	.75	Baldwin Phones.....	7.25	Bessie 1" Gold.....	.10
		Streamline S. L. F. .0005.....	2.50	LOUD SPEAKERS		Glass Insulator.....	.20
		Streamline S. L. F. .00025.....	2.25	Farrand Jr.....	\$16.50	Toggle Switch.....	.20
		Streamline S. L. F. .00025.....	2.00	Manhattan, Large.....	11.50	Bruno Inductance Switch (14 Point).....	.35
		Wireless .0005 S. L. F.....	1.95	Acme.....	22.50	Bruno "86".....	2.25
		Garco 23 Plate Ver.....	1.95	Thorla Jr.....	13.95	Hydrometers.....	.60
		Comaco, All Sizes, Ver.....	1.25	Supreme Concert.....	13.95	Hell Wire (Half Pound).....	.40
				Crosley Cone.....	13.25	Naald UX Adapters.....	.35
				DIALS		Aerial Kit (Complete).....	2.50
				Naald Bakelite 4".....	\$0.50	Crystal Detector.....	.50
				Fada Bakelite 4".....	.45	Double Jacks.....	.40
				Freed Elsmann Bakelite 4".....	.45	Single Jacks.....	.30
				Garod Bakelite 4".....	.45	Steinle Eliminator.....	\$0.80
				Pathe 2", 3", 4".....	.25	Continental Midget Cond.....	1.10

Just off the press! "RADIO RESEARCHES," a monthly booklet and blueprint issued from the laboratories of the Bruno Radio Corp., containing data that every set builder should know. Free with every \$5 purchase, single copies 10c each.

Write for free Catalogue and Literature

B-C-L RADIO SERVICE CO., Dept. H., 221 Fulton St., N. Y. City, N. Y. TELEPHONE CORTLANDT 4467

LIST OF PARTS

Two RF transformers, L1L2, L3L4, Bruno 99 RF.

One 2-section condenser, each section .0005 mfd.; C1 C2.

One 7x18" panel.

Two 30-ohm rheostats, R1, R2.

One 3/4 ampere ballast resistor, R4.

Two .1 megohm resistors, R5 and R7 (Veloy).

Three grid leaks; R3, 2 megohms; R6, 1 megohm; R8, .5 megohm (Veloy).

Three fixed condensers: C5, C6, .006 mfd. each; C3 (grid condenser), .00025 mfd. (Aerovox).

One 4" Bruno dial.

One audio-frequency transformer, PBGF.

One Bruno switch (with pilot light socket) S.

One pair of phone tip jacks, PTJ.

Five sockets.

One socket strip.

One pair Bruno Brackets.

One battery cable with tags.

Accessories: Five storage battery tubes, one storage battery of 100 ampere-hours or more; three 45-volt B batteries, one speaker, 100 feet of aerial wire, 50 feet of lead-in wire, ground clamp, Brach lightning arrester, cabinet.



At the left, U. G. Turner, of our laboratory staff, is shown logging stations with the oscillator. At the right, he is testing an audio transformer.



Test Apparatus Hunt for DX *Measure Wave Length With*

The Audiodyne Oscillator

Here is a Handy Little Device, Easily and Cheaply Built, that is Invaluable Not only to Every Commercial Service Man but to all Fans Who Like to Try Their Luck Hunting For DX Stations that They Have Never Heard Before.

By THE 3XP STAFF

GORDON E. PIPE, Associate Member, Institute of Radio Engineers, wrote us a while ago describing what he calls "The Audiodyne Oscillator" and told us of the good results that he had been having with it. This little outfit is so good that we have almost forgotten the Big Brother that we have for use in the calibration of instruments at Station 3XP.

The Audiodyne is so much simpler in construction that it is worth passing on to you. There are endless uses to which you may put it. To the hook-up fan, it is a sure test for defective apparatus, for the "DX" fiend, it may make the difference between success and failure in getting the far off station for which he is seeking. The radio repair man should find it an invaluable aid when he goes out trouble shooting.

How many times have you got all done, found what you thought was the trouble, turned on the set, and were greeted by silence? No locals on for an hour or two! You either had to go away and return later, or else waste an hour or so of your valuable time to find out whether the set was actually working the way it should.

The Audiodyne oscillator enables you to log a new set so that you can record dial settings for stations even though they may not be on the air at the time! Think of being able to walk into a friend's home and tell him when you leave that "WJZ will come in

on 87 on the first dial and 88 on the second dial." Nothing short of marvelous? It's easy with an oscillator.

The photographs here-with show how really simple looking the outfit is. Yes! We know that there are two big blocks of B batteries and a switch showing in one photograph. But most of us do not want to lug an oscillator all over part of Kentucky. The repair man finds a simple solution of his problem through the use of a "C" battery for an "A" battery, and by using the smallest possible 45 volt B battery that he can buy. In his case, the outfit may be enclosed in a box so that it is really portable. "A grand piano is portable if you can get enough men to lug it around for you," as H. M. N. says. We don't mean portable in that sense of the word. A "C" battery never was intended for use in lighting a tube. Since, the repair man need not keep an oscillator turned on for long at a time, it certainly will be worth the battery expense to him. For the rest of us,—anyone who wants to come right out and admit that he can not build a one tube set should stop reading right now.

As you are still reading, we will first take up the question of parts. This unit can be built very simply "bread board" style, or you can build it more elaborately as we have done. If you are going to build this at all, it is worth building well. The more pains you take with it the better the chances are for its continued successful operation.

You may not be aware of it, but as soon as a coil changes its shape, its inductance changes. As you are building this with the idea in mind that when you turn the dial of the Audiodyne to a certain reading you will

be getting the frequency, or wave length, logged for that setting you should do your work so that handling will not be likely to cause any changes in the arrangement of the positions of the instruments or in the wiring. The parts should be the best that you feel that you can afford.

In the Big Brother of the Audiodyne that we use for our most accurate work, the condenser cost \$99.00 and the coils are wound on cylinders of Pyrex made especially for us. You have no need for any such expensive apparatus as this. If you now have a variable condenser that you know will not warp and turn its blades into a knife switch, use it by all means. If you are going to get a new condenser get the most sturdy construction that you can. A good vernier dial is an absolute necessity.

You will need a good by-pass condenser, (C2) .006 mfd. Do not try to use one of the paper condensers here. Use Micamold, Sangamo, or one of the other good products now on the market. G3 is a grid condenser, .00025 mfd. You will want a good variable grid leak. It depends on your grid leak what type of condenser you use for the grid condenser. It will be to your advantage to have some type of grid leak that can be adjusted from the panel.

You will want two single pole, single throw switches S-1, and S-2. One is to be used for shorting out the grid condenser and leak. The other is to be used for a filament switch. We used the knife switch for shorting out the grid condenser as we are using the oscillator a good deal and it is a decided saving of time to be able to look across the room at the switches to see if the Audiodyne is turned on. The jack switch of Yaxley or Carter will do nicely.

Select a rheostat, Rf, tube socket, and tube of the type that you intend to use. The 199

type is admirably suited for this purpose. To complete the list, you will need a piece of tubing to wind the coil on, a panel, closed circuit jack, and a spool of No. 22 cotton or silk covered wire.

It is not necessary for you to make the entire box or the panel of Formica or Bakelite. The depth of the box depends entirely upon whether you wish to include the batteries for carrying them about with you.

Fig. 5 shows how the apparatus is grouped around the tube socket. The coil comes directly underneath the socket. The variable grid leak is on one side, and the tube rheostat is on the other. This can be seen to better advantage in Fig. 6 and Fig. 7. At the other end of the box, on the inside, is only the variable condenser. This allows plenty of clear space for the condenser blades to rotate with no danger of any of the wires touching the condenser plates. It also gives very short leads to all the connections in the inside of the box. The coil is mounted on the condenser by means of an insulating strip.

No panel dimensions are given as we do not know what size condenser you are going to use. You will probably find a 7" x 9" panel large enough if your condenser rotor does not have a swing of over 2 3/4". If you are going to use Bakelite or Formica sides

for your cabinet you can get two pieces 8 5/8" by 3 1/2" and two pieces 7" by 3 1/2" out of one piece of panel stock 7" by 16". Before you go ahead and do this be sure that the condenser you are planning to use is not over three inches in depth behind the panel.

This, of course, makes no provision for space for batteries. If you wish to include batteries for portability, it probably would be better for you to use wooden sides for the box. These dimensions are intended for 3/16" panel stock. If you are feeling real rich and are particularly good at sawing and finishing Formica you can get a beautiful job out of the 1/4" stock. This, of course, changes the length of the long sides a little bit, but you can easily figure that out for yourself.

If you now have a set that you are intending to tear apart, and have in it a single layer coil tuned by a condenser such as is used in the Browning Drake for the first stage; a neutrodyne coil attached to its condenser; or something of that type, it will be all right to use it providing the coil and condenser already cover the broadcast wave band, and the coil has no primary on it. The tap shown in Figure 3 and Figure 4 should be taken so that it is 4/7 of the way from one end of the winding. The part of the coil that has the greatest number of turns in it is the plate portion of the coil.

Lacking a coil, but having a good condenser, we can easily fix you up. With a 3" tube, No. 22 wire, and a .0005 m.f.d. variable

condenser you will need 53 turns tapped at the 28th turn. A .00035 condenser uses 60 turns tapped at the 34th turn. For a .00025 condenser use 68 turns and tap it at the 40th turn. If you want to use 3 1/4" tubing wind 38 turns for the .0005 condenser and tap at the 21st turn. For a .00035 condenser use 50 turns tapped at the 29th turn. The .00025 condenser needs 56 turns tapped at the 32d turn.

There! We built six coils, and measured them with an oscillator and a laboratory condenser to get these figures for you. They are the results of actual measurement and not theoretical calculation.

The next question is "Suppose I build a coil according to these directions and the oscillator does not cover the wave band?" The answer is "The capacity of your condenser is not what is marked on it." Isn't

we used an All-American socket of the 199 type. The grid connection is the one near the knife switch, and the plate connection is diagonally opposite. Care should be taken to have the battery connections as fixed as possible. If you use flexible leads twist them together as shown in the photograph (Fig. 6).

Now that you have built your oscillator,— "What do you mean? Built my oscillator!" Yes sir, that is what we said. You remember, you were told to stop reading if you felt you could not build a simple one tube set. With all the hints and diagrams we have given, you surely should be done by now.

The first thing to do is calibrate,—c-a-l-i-b-r-a-t-e—your Audiodyne. Now don't put on the tall beaver and quit after you have built the thing! Turn to Figure 8 on page 66 so you can see what it is all about!

Tune your receiving set to WBZ, KDKA, WGY, WSB, WCAP, WJR, WRC, WEAF. These are what are known as "Standard Frequency" stations. Their wave length is practically constant and changes only slightly. The change at any one of these stations has been less than a fraction of one per cent over a long period of time.

Let us start with WEAF. Tune it in so that you have just as sharp tuning as possible.

Now turn on the Audiodyne. Rotate the dial of the Audiodyne, which has been placed in the same room somewhere near your set, but not connected to it, until you here a squeal or growl in your set. If it is the oscillator

you are hearing, the tone may be changed by adjusting the grid leak providing the switch is open that shorts out the condenser and leak. If your set is supposedly non-oscillating, and non-regenerative this will be the only way that you can hear the Audiodyne.

If you have a set that is regenerative, or can be made to oscillate, have it in a slightly oscillating condition, and have the knife switch closed. In that

case, you will hear a high pitched whistle. Once you have adjusted the setting of the grid leak to your satisfaction, leave it alone and do not change it. Perhaps, it is not quite correct to call the note of the Audiodyne that you hear when the switch is open a "growl." In yours, it may be a ringing sound. If you are tuning with the grid leak switch closed you will reach a point where you hear a whistle that varies in intensity, getting lower and lower to a certain point when it stops. By rotating the dial a little bit further it starts again and grows higher. The point between the two whistles where you hear none at all is the exact point at which the wave given out by the oscillator is of exactly the same frequency of the incoming signal from WEAF.

If you are using the oscillator with the switch on the leak open you will hear a ring-

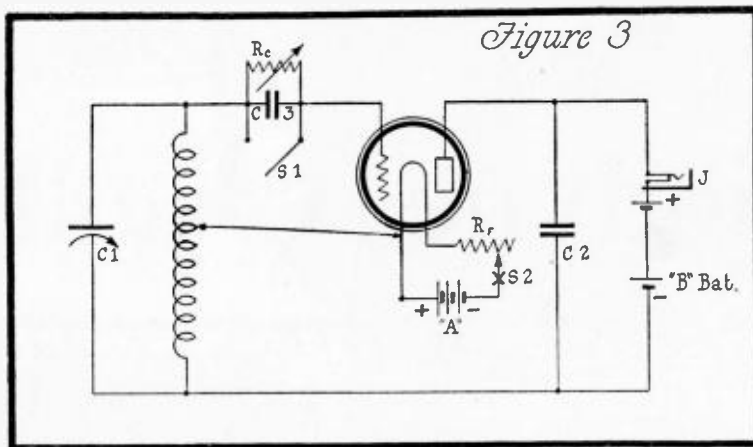

Above is the Schematic Diagram of the Oscillator.

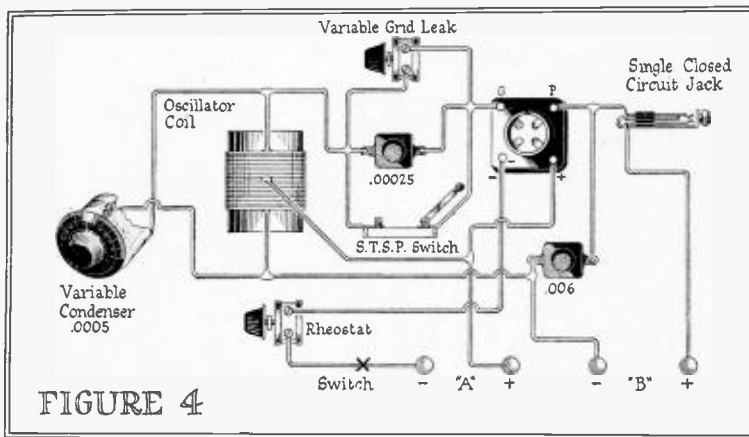

that a beautiful alibi for us? If your Audiodyne does not give you a reading of about 90 with a straight line condenser for 509 meters, or 80 with an ordinary condenser having semi-circular plates, then there are not the proper number of turns on the coil. If you get this wave length below 90, or 80, as the case may be, it means that you have too many turns on your coil and you have to remove one turn at a time, taking them from alternate ends, until you get a reading in this position. If the reading comes higher than the figure given you will have to add turns.

There are two things to point out to you before you start the assembly. The socket in Fig. 4 is one of the new type sockets that permits you to use any of the new base tubes. If you are using the old type 199 socket the connections at the socket are a little different than shown there. Refer to Fig. 5. There

ing, that will gradually reach a loudest point, and then begin to fall off. The "peak" is the point you are trying to find. If the grid leak switch is open and you hear a noise that sounds like a flock of birds chirping, you cannot get a good reading. This will be caused by a "non-oscillating receiver" being in an oscillating condition. By the way,—to avoid any possibility of us misunderstanding each other,—the note that you should be listening for will come out of the phones or loud speaker of your radio set, and you will have no phones in the jack of the oscillator.

You should have ruled off a piece of graph paper, like Fig. 8, so that up the left hand margin you have marked off the wave lengths in meters. Each division can represent ten or five meters. Along the base line you have marked off spaces so that each division represents one degree on your dial.

For the sake of illustration let us suppose that the reading you obtained with your oscillator on WEAF was $74\frac{1}{4}$. The wave length of WEAF is 491.5 meters. From the bottom of the chart, or graph, we measure up until we find the space indicating 491 meters. Now we measure over until we find the line that means 74 degrees on the dial. As the reading on the dial was $74\frac{1}{4}$ we want to divide the space into four and estimate where the $\frac{1}{4}$ comes. We are almost to the

straight line, but will make a gradual curve. The shape of your curve depends absolutely on the type of condenser you are using. If you are using one of the old type semicircular plate condensers, the curve will sag at each end so that it assumes the shape of an arch. If your condenser is of the so-called "straight line wave length type" the curve will be very nearly a straight line. If you are

thing is made of good flexible steel and will stand a lot of bending.

Get some one to help you, and have them hold the saw blade so that the two ends intersect, or cut, the two dots at the ends of the curve to be drawn. Gradually bend the hacksaw blade so that it comes nearer and nearer to intersecting all the points that you have marked out. It may even be necessary to use three or four hands on the saw blade if you have a peculiarly built condenser. At any rate, whatever condenser you do use, you will have a pretty good idea as to how truthful the manufacturer is in the statements he has made regarding it.

As soon as the saw blade touches all the points you have marked on the paper draw a line through them with your pencil. The finished curve is shown in Figure 10. This curve is for a condenser with semicircular plates.

Now that you have it, what are you going to do with it?

Let us suppose that you wish to get a station at 400 meters. Look on the graph you have drawn and read over from the left until you find the point at which the line meaning 400 meters intersects the curve. Now read straight down to the scale that means dial settings on your oscillator. In this case, let us say it is 60.

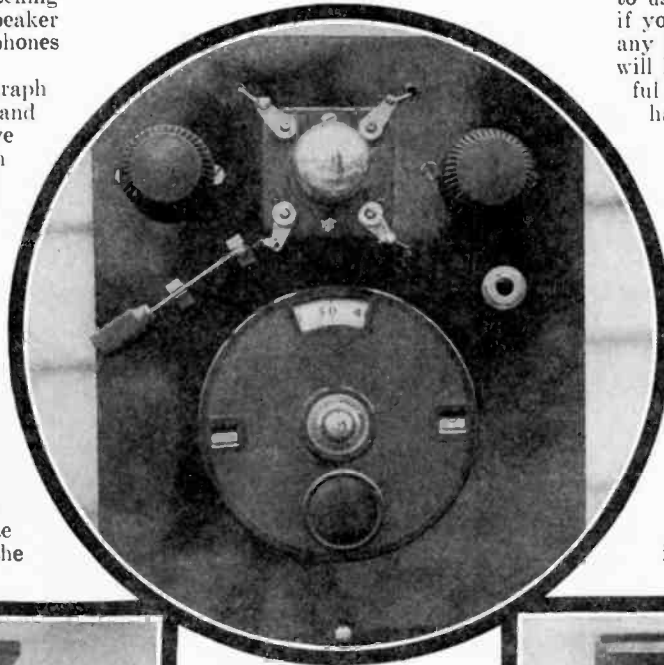

Fig. 5.

Above—Top view of the oscillator as we built it at Station 3XP.

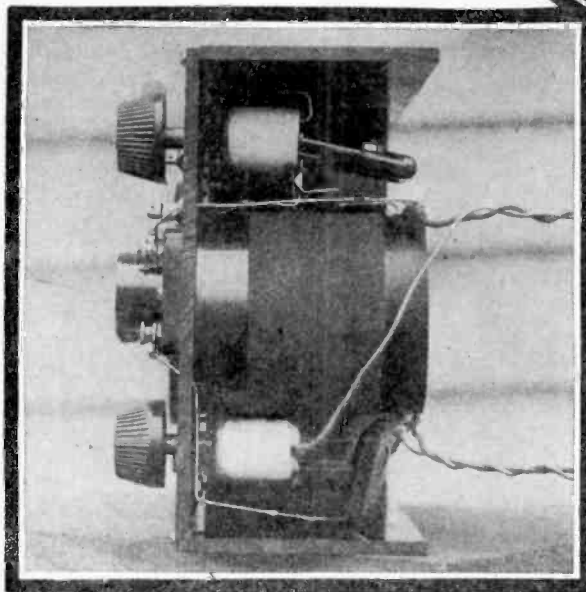

Fig. 6.

Left—This end view shows the placing of some of the parts.

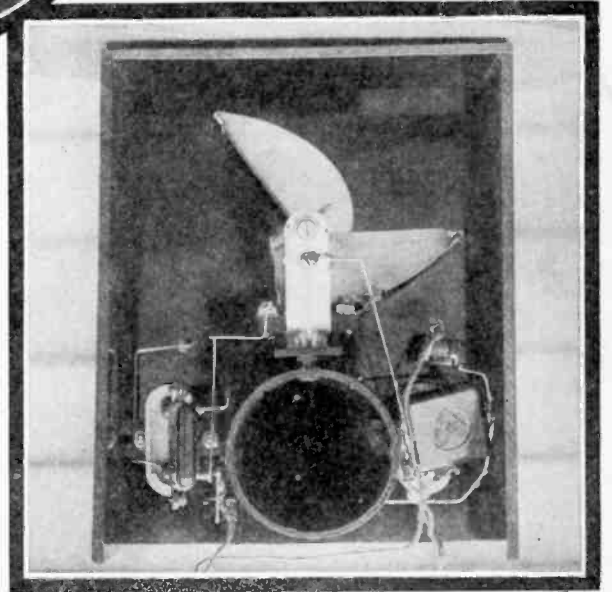

Fig. 7.

Right—Looking in from the bottom, you can see all the "works."

place we are looking for. In the vertical direction one space means so many meters so we have to estimate how far up we have to go to mark 491.5 meters. At exactly the point where the horizontal line that means 491.5 meters and the vertical line meaning $74\frac{1}{4}$ of the oscillator dial cross is the point to locate the dot like the one that is shown in Fig. 8.

If you live in the West, or South, it may not be possible for you to tune in WEAF. At any rate, there is some station near you in this high part of the broadcast wave band that you can use to start the curve. Tune in as many others on your receiving set as you can, and find points for them on the oscillator. Select them as far apart as possible so that your points will be fairly well spread out the way they are in Figure 8. You will probably find that your points will not lie in a

using the so called "straight line frequency" condenser the line you draw through the points will curve, as you are plotting your record according to wave length, and not to frequencies.

This meter is intended for the broadcast listener who only knows wave lengths as given in the daily paper. Those of you who are acquainted with frequencies are not bothering to read this anyway. Besides, you know all about them, so there is nothing to tell you.

Let us suppose that you find the points do not fall in a smooth line as will probably be the case. How on earth are we going to get a smooth line running through all these points?

Look at Figure 9. There you see a hacksaw blade with the smooth edge towards the paper. A hacksaw blade that is worth any-

Set the dial of the oscillator at 60, turn on the switch, and then turn on your receiving set. Tune the set to the oscillator signal, turn off the oscillator, and the station should come in—providing it is on the air. That is, it will if you have taken pains to calibrate the oscillator properly, and have tuned your set to the oscillator note.

One night we were sitting up rather late and we happened to pick up KFI at Station 3XP. We set our oscillator to the KFI signal, and tuned the other sets on the test table to the oscillator. We got KFI on every set on the test bench simply because we had a strong nearby signal (the oscillator) to tune the other sets to. Had we not had the oscillator to tune to, we might not have picked the station up on the other sets. As it was, it was easy.

Some night when you tune in a distant

station, record it exactly on your oscillator dial. Then if your friends doubt your ability to get it when you tell them about it, you have only to tune your set to the oscillator note and if conditions are right, in it will come. You can see then, how far from ridiculous our statement was that you can take a new set, and without having the sta-

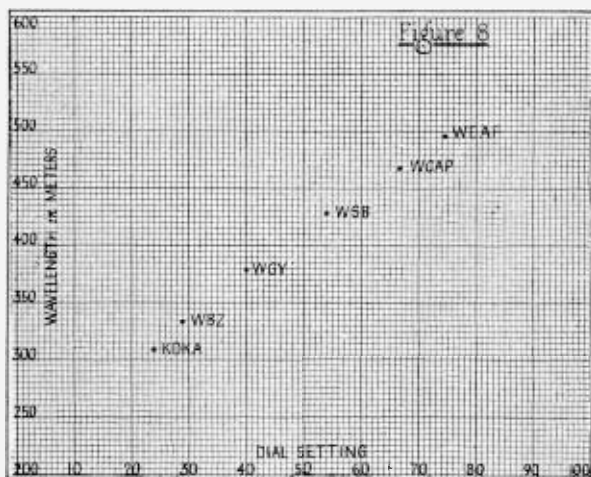

tions on the air, log the set for any stations you may wish to get without any previous knowledge of the set.

"What is the jack for?"

It answers the oft asked questions such as "When is a transformer not a transformer?"

If you have a transformer that you think has been "shot" or is defective, connect the primary to a phone plug. Connect the phones to the secondary of the transformer, open the switch on the grid leak of the Audiodyne, turn on the battery switch and listen. By revolving the dial of the leak you should be able to hear the note in the phones. That shows that both the primary and secondary must be O. K. or you would not get the note in the phones.

The Audiodyne can be used to tell whether any part that requires the passage of a current in this manner is all right. You can easily see how valuable this function of the oscillator should be to the service man. Then, when the defective part is located, and replaced, instead of having to wait to tune in several different stations (as he has had to do in the past to be sure that the set is working properly), all he has to do is set his oscillator.

By plugging in your phones on the Audiodyne you can also remove all doubt in your mind as to whether it is working or not.

In closing we want to bring up one point that might possibly bother some of you who are not acquainted with this form of apparatus.

"Where are the antenna and ground connections on the oscillator?"

There aren't any. You are all familiar with sets that receive on a loop without any antenna or ground connection. Roughly speaking, the oscillator transmits from the loop formed by the coil you have taken the time to build.

NEW DONLE DETECTOR TUBE LOOKS GOOD

By G. P. ALLEN

WE HAVE heard of so many marvelous new inventions at 3XP, and have chased down so many of them, that it was not to be wondered at that we did not at first get wildly excited over news regarding a new tube invented by Harold P. Donle of Meriden, Connecticut, inventor also of the Sodian tube. Nevertheless, yours truly packed his bag, kissed his wife good-bye, and caught the Nellie Blye for Meriden via New York.

The new tube is called the B-6. It uses $\frac{1}{4}$ amps on the filament at 5 volts. For best operation 90 volts should be used on the plate.

The tube is used *solely* as a detector. The peculiar function of the tube which

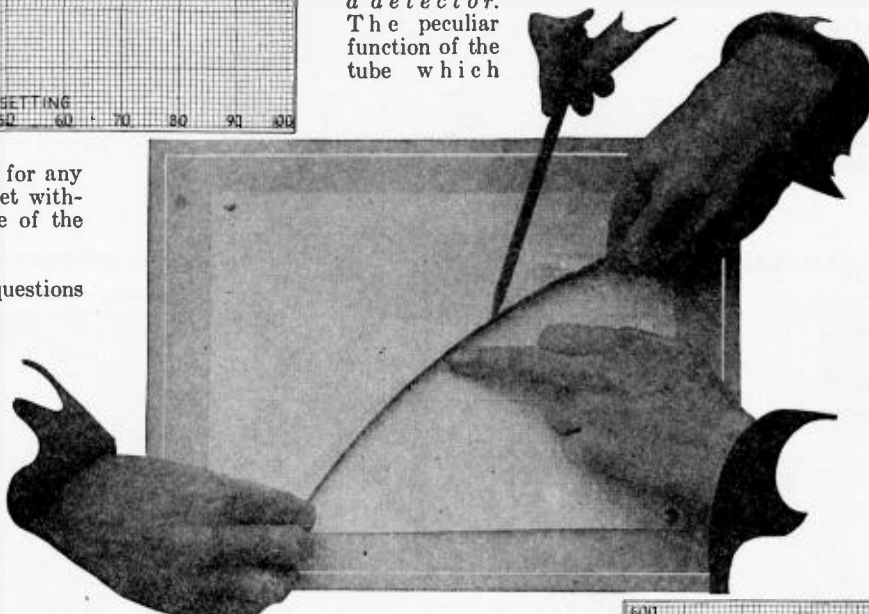

First you place a dot on the squared paper at the point where you find each station on your oscillator—as in the top picture. Then you bend a hack-saw blade or other stiff but flexible edge, until it cuts all the dots—as in the photograph above. Then you get someone to run a pencil along the hack-saw blade and you have a completed graph—as shown at the right.

makes it worthy of consideration is its remarkable ability to reproduce weak signals in much greater volume than the ordinary hard tube when used as a detector. Furthermore it will reach out and get signals which the hard tube will not touch.

The B-6 tube can be inserted in any radio set that is designed for use with the type 201A tube. It should not be necessary to change rheostats, or anything of that nature, but the grid circuit of the detector *must* have a positive return.

So far as use, and hooking up of the filament circuit is concerned, you have only to regard the B-6 as a type 201A tube. The

critical thing is the plate voltage. Instead of connecting the B plus terminal of the first audio stage to the plus B detector binding post as is usually done, a variable resistance of from 100,000 to 200,000 ohms is inserted in the lead between the transformer B post and the set binding post strip. By varying this resistance it is possible to secure the best operating condition.

A further means may be used to increase the sensitivity of the B-6 detector tube. Instead of using a grid leak and condenser in the grid lead to this tube you can use a 400 ohm potentiometer in the grid return.

As soon as Mr. Donle feels that he has his circuit really perfected, he is going to release the constants. The circuit in itself is not new; but the coils are so designed that by using the Donle tube in this manner, with two stages of audio, results may be obtained which equal a four tube set using a regenerative detector.

By means of an oscillator, it is possible to apply a steady signal of constant intensity in order to make comparisons between various tubes.

Mr. Donle had a number of hard tubes of good manufacture on hand. He permitted me to select one and to tune in the oscillator signal with the hard tube as a detector until I was sure that the tube was doing the best that it could. The oscillator was placed far enough away so that it only gave a very weak signal. The reading in the output meter was 20 milliamperes. The B-6 tube was substituted for the hard tube. The oscillator was not touched. The set was returned to maximum signal. Now the reading showed 200 milliamperes!

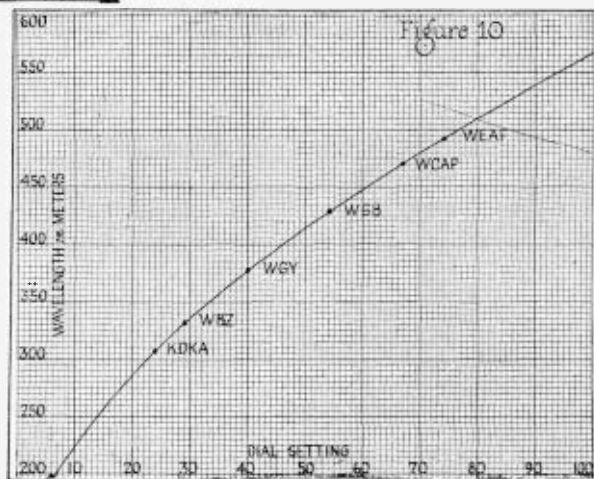

In other words, a signal that barely affected the hard tube because it was so weak gave a great response with the B-6.

As the signal strength was increased by moving the oscillator nearer the set, a point was found where the hard tube gave greater response than the B-6 gave. This corresponds to the condition caused in a set during the reception of a local station.

A 200-MILE CRYSTAL SET

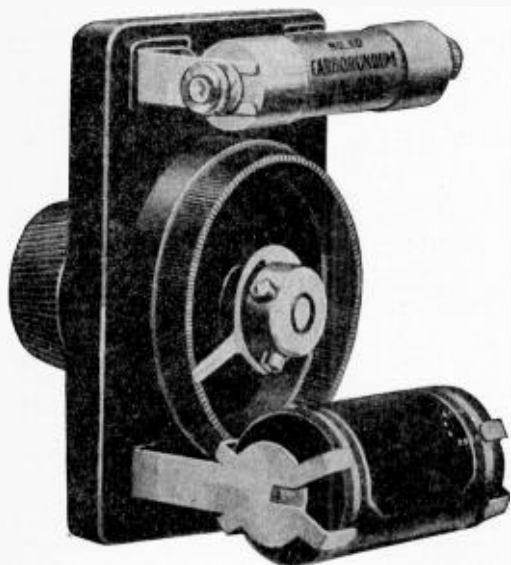

Rear view of Carborundum Unit showing fixed crystal at top, potentiometer and small flashlight battery for supplying necessary potential.

A Simple and Inexpensive Receiver Which Any Novice Can Easily Build and Operate and Which Will Give Excellent Reception on Headphones Within Reasonable Ranges.

By M. L. HARTMANN, Ph.D.
and JOHN R. MEAGHER

*M*ANY an old-time ship's operator has sworn at the kind of cat-whisker crystal sets put on the market since broadcasting began. The crystal detector unquestionably is without an equal in the reception of absolutely pure musical quality. But nervous cat-whiskers are continually being jarred off of the sensitive spots and even the best of galena gives a broad-tuning set of questionable distance range.

I have often thought of my own days as a ship's operator at sea, with a hefty piece of carborundum held fast by a firm-pressed point and with a slide potentiometer to help tune out interference. And so I have welcomed the appearance of this new unit on the broadcasting market and I am glad to give this circuit for the benefit of those who are satisfied to confine their radio expenditures to a small sum and to take their radio entertainment with the headphones over their ears.

H. M. N.

MANY readers will be surprised to learn that a simple crystal set has given a fairly consistent nightly range of more than 200 miles. Yet this is not unusual; it is just the average performance of a well designed crystal set and has been done repeatedly this and the latter part of last winter.

From our location in Niagara Falls, New York, with an aerial and location no better than the usual, we have regularly listened to Pittsburgh, 200 miles, to Springfield, 325 miles, to Schenectady, 250 miles and to Chicago, 450 miles.

This record may seem out of the ordinary and indeed we ourselves were surprised at first. But the manner in which the first set and others of the same type, used on our own and other people's aeriels operate, has convinced us that the feat may be duplicated almost at will.

Of course, there is a reason for this efficiency. It is owing almost entirely to the design of the circuit which incorporates the best 'low loss' ideas. (Incidentally the low loss plan, because of the absence of resistance-nullifying regeneration, is of far greater benefit in crystal than tube sets.)

The splendid range of this circuit and the admittedly fine reproducing qualities of crystal detectors makes this set really remarkable considering its extreme simplicity and low cost. As far as distinctness and clearness of tone is concerned, this, and in fact any well planned crystal set, is far superior to vacuum tube outfits.

The design of this set is far from being the result of a lucky accident; rather it is the product of considerable research and experimentation. For in the early part of this year, in order to find the particular circuit and arrangement of parts for a crystal set giving

the very best results, we spent considerable time comparing the relative merits of various forms of circuits, of different coils, of combinations of coils and condensers and of numerous variometers. The arrangement finally evolved is as efficient as can be made. It does not sacrifice volume for selectivity nor selectivity for volume, but combines and pleasingly retains the best features of both.

Briefly, the circuit is of the adjustable auto-coupled or conductive type. The inductance is fixed and tuning is accomplished with a variable capacity. Tests have shown this circuit to be fully as selective as any and far more sensitive than the majority.

The connections are shown in Figure 1 on the next page. The fixed inductance—it has no "dead ends"—is easily made, consisting of fifty turns of ordinary bell—or annunciator—wire wound in a single layer, turns side by side, on a cardboard, rubber or Formica form 4" in diameter and 5" long. An empty oat-meal container makes as good a form as any. One foot leads should be left at each end of the coil for connections to the circuit.

Annunciator wire (number 18 double cotton covered, paraffine coated, copper) may be bought in any radio or electrical supply store; it is admirably suited for the purpose and should be used. There is nothing mysterious about this coil and while it is not as imposing as spider-web and basket wound inductances, our tests have shown it to be better.

Taps are made to the coil at every tenth turn. One of the best and easiest methods of doing this is to insert a blunt point under a spot on each turn that is to be tapped and raise this spot slightly above neighboring turns. The raised portion may then readily

be scraped of its insulation and the lead soldered to the exposed wire. There are six leads in all from the coil, one at each end and the four taps at the 10th, 20th, 30th and 40th turns.

If the wire is wound tightly there will be no necessity for coating with some binding substance. However, if the turns are loose it is well to apply a coat of collodion, a few ounces of which may be purchased in any drug store. This should be done after the leads are soldered in place.

The variable condenser should be approximately .00025 mfd. maximum capacity. This value is generally found in the 11 and 13 plate types. If purchasing this item, it would be well to specify a straight line frequency (S.L.F.) type merely to keep abreast of the general popular trend. Actually any other style may be used with equally good results. The condenser should be well made mechanically and electrically. Price is not always a reliable indication of condenser worth.

The detector may be of any type, though for best results its impedance or internal character should suit the impedance of the particular headset being used. It should also bear a certain relation (rather difficult of exact specification) to the input impedance. These conditions can best be met through use of the electrically controlled carborundum permanent detector (Carborundum Stabilizing Detector Unit). With this detector the impedance may be regulated to match any conditions. Being electrical the control is positive and the design affords smooth adjustment accurate to less than one thousandth of a volt. This is accomplished in the unit with a high resistance neutral-point potentiometer having a positive and negative voltage range. A mica insulated shunting condenser is built in the

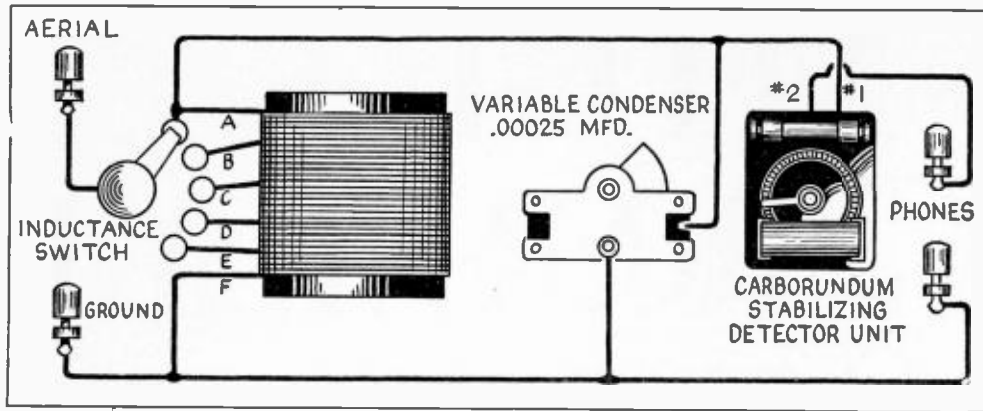

Fig. 1.—Here is the simple wiring-diagram of the set showing how easily the various parts are connected.

base of the unit which, as can be noted from the pictures, is a single control, single hole mounting device.

Another point in favor of the electrically controlled detector is that the damping effect of the detector on the tuned circuit may be regulated through a wide range—resulting in an equally wide selectivity range. This works out in such a way that stations spreading, say ten degrees over the tuning dial with an ordinary detector, may be restricted to two or three degrees through proper adjustment of the electrically controlled carborundum detector unit. This is a particularly valuable feature in crowded radio districts. A description of this unit appears in the booklet "Radio Detection," which is published by the Carborundum Company, of Niagara Falls, N. Y.

The coil, the condenser and the detector unit are the main items. They, together with the panel, bus wire, binding posts and inductance switch should be collected before starting actual assembly.

The parts may be mounted on a 7" x 15" radio panel or they may be fastened to a plain shellaced wood base in laboratory fashion. The switch points should be placed close to the coil in order that the tap leads may be as short as possible. A ready made "back of panel" inductance switch may be used, as it eliminates considerable work.

The circuit may be connected with bus-bar or annunciator wire. All connections should of course be tight and preferably soldered.

The aerial design proffered by the writers is as follows: Single wire, number 12 or 14, solid copper, enamel insulated, erected in a straight line as high above surrounding objects as conveniently possible and having a total length including the lead to the set of not less than 100 feet and not much more than 250 feet. Insulators should be used at all

The view above shows the set from a viewpoint directly above it and gives the correct locations for the various parts. Below is shown a panel layout with measurements for locating the different holes.

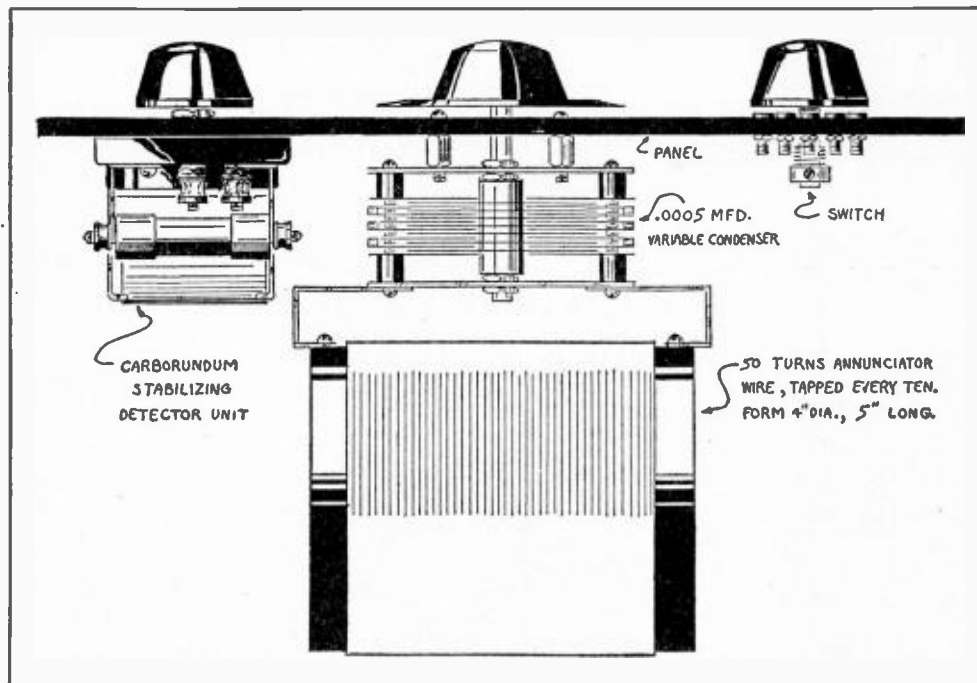

points of suspension.

The ground lead may be of the same wire as the aerial. It should be well connected to a water pipe system or some other grounded metallic structure.

Tuning is so simple that it would be a waste of time to give elaborate instructions. The switch and condenser control the wave length while the knob of the electrically reg-

ulated detector functions as a selectivity and volume adjustment, in that way controlling the overall sensitivity. The carborundum (silicon carbide) detector itself is, of course, permanently fixed at a sensitive point.

Copyright 1926 by The Carborundum Company.

A NOTE ABOUT BELL WIRE

THE claim made in the above article for the high efficiency of coils wound with ordinary bell wire have been fully substantiated at our laboratory over a period of many months.

Some time ago, there was a great craze for basket-woven coils made of No. 18 cotton covered wire. Whenever such a coil appeared, everybody referred to it as a "low loss" coil.

We made many tests of coils and we found that the type of coils spoken of in the above article, with ordinary bell wire wound on Formica tubing was the most efficient coil that we could build covering the entire broadcasting band of wave lengths.

The basket-woven coil did not prove the equal of it until we got down to wave lengths well below 100 meters so that, for the broadcast listener, the coil of bell wire has less losses than any other type which has so far been developed for home construction.

Incidentally, we much preferred hooking up a set with bell wire running directly from point to point rather than the neater but less efficient job of bus-bar wiring with the long leads sometimes made necessary in order to get all wires parallel and all corners square.

H. M. N.

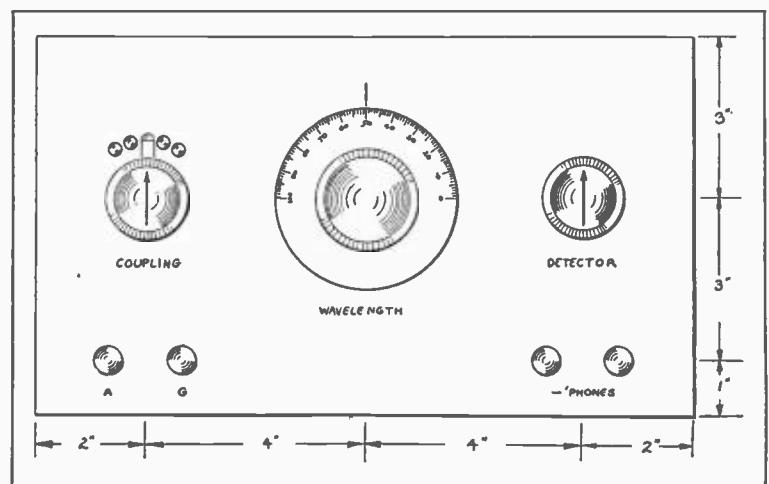

Here's Where You Bring Your RADIO TROUBLES

*The Laboratory at Station 3XP Answers
Some of the Questions of Most General
Interest Received From Readers.*

By ULMER G. TURNER, Jr.

(1) R. O. Launey, Woodhaven, L. I.

Question:

In G. P. Allen's article on the Victoreen set in the February issue of *Radio in the Home*, I noticed that he used three No. 174 and one No. 175 Victoreen radio frequency transformers. Mr. Biles also used these parts in his November, 1925, article.

I have been told that four No. 170 transformers could be used and that the results obtained would be as good. Is that right?

Answer:

Yes, this change is now recommended by the Victoreen manufacturer, George W. Walker & Co. This company now supplies the No. 170 transformer in place of the No. 175.

The old transformer, No. 175, was a "filter" transformer and was tuned sharply to the wave that was used as the intermediate frequency. It was found by the Walker Laboratory, however, that their No. 170 transformers were so selective as not to require a "filter" coil. Thus, the No. 175 was abandoned. This does not mean that those who have the No. 175 are out-of-date—far from it. It means that the usual practice of placing a filter transformer in the set has been abandoned, due to the quality of the intermediate transformers.

(2) J. R. Pulsifer, Rochester, N. Y.

Question:

I built a Victoreen superheterodyne as described in your magazine, following the instructions in the November, 1925, issue. While the first stage of audio works perfectly satisfactorily, I am unable to get anything but a terrible howl when I turn the stage control switch to the second audio position. What causes this?

Answer:

Your trouble is very likely caused by an "open" in the grid circuit of the last audio amplifier tube. I would suggest that you test the transformer windings of the second audio transformer for continuity. I am showing on the next page, a scheme for doing this. The test is easily made and may be used for other radio apparatus, as well. It may be made much more satisfactorily, however, if you have the Audiodyne Oscillator described on page 63 of this issue.

If the above trouble is not the source of your howl, then I would suggest that you go over the wiring for the control switch, checking this very carefully.

Another source of such trouble (and a very

frequent one, by the way) is the placing of audio transformers too closely together. Audio transformers should be mounted at least two inches apart, cores at right angles and grounded to the "A" battery line.

Microphonic tubes, of course, might cause the trouble, but this could be quickly located. Noise would gradually "build up" into a howl,

Answer:

In the first place, I am inclined to believe that there is something wrong with the way in which you have the antenna coupler and loop circuit wired in. This is evidenced by the fact that no more selectivity is shown with loop than with outside antenna. I would suggest that you check the circuit over carefully with the diagram on page 39 of the November issue.

The substitution of Rauland-Lyric transformers was perfectly all right. Any good audio transformer such as the forementioned, Karas, Thordarson, Samson, etc., may be used with just as good results.

Living only two miles from locals, you will naturally get much interference. You have a low wave station, a medium wave, and a high wave one to contend with. However, I think that you will be able to tune out any of the interfering stations in just a very few degrees after you have straightened out the antenna circuit of your set.

Shielding the set would help greatly, though I hardly think that will be found necessary.

All wiring in the antenna circuit of this set should be very short and direct.

We have received a number of letters from readers who tried the set. Their sets, as well as our laboratory models, were

very sharp. If instructions are properly followed, I think you will have no further trouble

(4) W. R. Boyd, Cleveland, Ohio.

Question:

When Henry M. Neely spoke to our convention last year, he mentioned a device you have at Station 3XP which allows one first to tune in a set to a given wave and to tune another to the same wave by driving a radio wave into it. If this device is not too technical for the average fan, I would like to build it. Will you please give me the necessary information? Also, can I use this device in hunting for DX stations on a given wave—where the wave, but not the dial setting, is known?

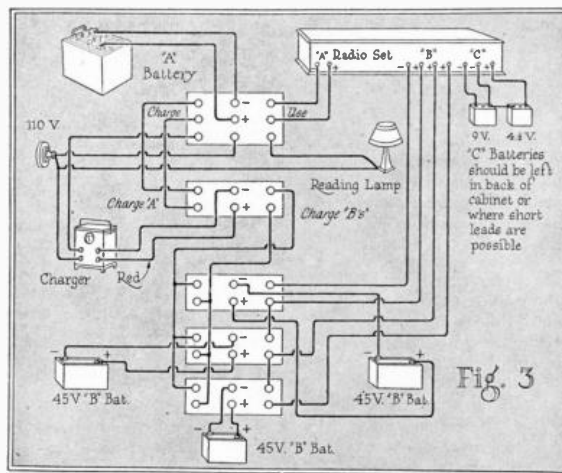

Showing how Mr. Neely's automatic battery switching scheme may be extended to accommodate three 45-volt storage B batteries in cases where a set requires a very high amplifier voltage—such as resistance coupling.

rather than start howling from the very first. Shifting tubes is the remedy in this case.

(3) Robert C. Cadmus, Philadelphia, Pa.

Question:

I built a Victoreen set and the only parts I substituted were the audio transformers. I used

Can Your Set DO THIS?



THE famous Harkness Counterflex Circuit was developed by Kenneth Harkness for this magazine while he was one of our Associate Editors. It proved so tremendously popular that increasing commercial demands on Mr. Harkness' time made it necessary for him to give up regular editorial duties and devote himself to business and to further development work in the laboratory.

The Improved Harkness Counterflex Circuit used by Mr. Young in making the enviable record spoken of in the clipping from the *Philadelphia Public Ledger*, reproduced above, was fully described in the issue of *Radio in the Home* for September, 1925. Every detail in the development of this famous circuit was recorded in the series of articles which Mr. Harkness wrote for us. They are: March, April, May, June, July and September, 1925.

Any of these back issues may be obtained by sending twenty (20) cents—stamps or coin—for each one, or complete set of six, postpaid, one (\$1.00) dollar addressed to

Back Issue Department

The RADIO HOME

Produce Exchange Bldg., Philadelphia, Pa.

Answer:

The device you spoke of is an ordinary radio frequency oscillator. On page 63 of this issue, you will find full instructions for building an Audiodyne Oscillator which works in the same way and is much better for average amateur use.

(5) Chas. Walzer, Jr., Mendota, Ill.

Question:

One of my local radio dealers tells me I can use three 45-volt batteries, instead of the two I now use, and get better results. He says this will not hurt my tubes. Another dealer says that it will hurt my tubes. Just which one is right? Not that I disbelieve either of them—but that I simply do not know—like many other fans.

Answer:

As a matter of fact, I think that you could go ahead and use the three 45 volt batteries without fear of hurting anything. I cannot, however, predict just what results you would get if your set is not equipped for "C" battery.

When you add another 45 volt battery you are going to increase the number of milliamperes used by the set. This, quite naturally, is something to consider, by itself. If you have accommodations for a "C" battery, however, you can easily take care of this by adding to the amount of voltage across the "C—" and "C+" posts.

There is no question as to the tubes being "used up" faster. The increased flow of amperage within the tube would do this. The increase would be negligible, however, if the filament of the tube was burned as low as possible.

To sum up my advice—it is:

If you have a "C" battery—then go ahead and use the extra battery. If not, then try it. If it gives any remarkable results, then tolerate it, but take care of your tube filaments and do not burn them very high. If very little increase in volume results, then discard the idea. As all sets act differently under the above conditions, it is impossible to give a hard and fast rule for what may happen.

(6) Fred Bateman, Toledo, Ohio.

Question:

Please tell me how to install a power tube in the Radiola super-heterodyne, semi-portable.

Answer:

In order to install the new UX-120 tube in your set, you must use a special adapter. Such a device may be bought from the Alden Mfg. Co., Springfield, Mass. The price is very reasonable, being about \$1 or \$1.50—I do not know just which.

(7) Warren Gordan, Reidsville, N. C.

Question:

After reading Mr. Neely's article on "Taking the Bother out of Batteries" I would like to install the system to work with my radio set. It is a Stromberg-Carlson, however, and uses three 45 volt batteries as well as two "C" batteries, so I do not

know just how to go about hooking the switches up—or how many to use, etc. Please show me.

Answer:

I am showing, on page 69 a sketch of the hook-up necessary in order for you to use the switching system Mr. Neely described. The drawing is self-explanatory.

(8) A. J. Garten, Fort Lauderdale, Fla.

Question:

I was very much interested in G. P. Allen's article on tubes, but cannot see just how I could install a "C" battery in my set, which is a Federal No. 59. How could I do this?

Answer:

Take off the screws on front of panel which hold the panel to cabinet by engaging in the metal clamps on cabinet. A glance inside set will show you what I mean. The whole "works" will then slide out. Now look at the audio transformers. You will note that each

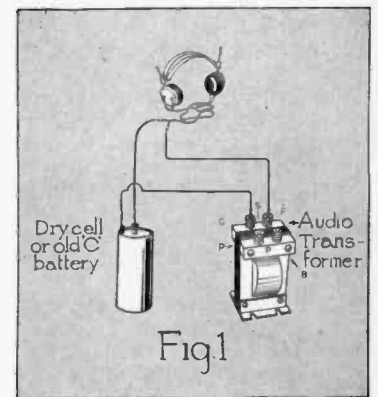

A Dry Cell will "click" the phones when contact is made. By making the current from the cell pass through a coil of wire, it is possible to tell whether the coil is complete or if it is broken. If no distinct "click" occurs, the coil has a break in it and is no good.

of them has a post on it marked "F." You will also note that a wire connects the two transformers together at these two posts and then runs to a sort of "bridge," or connecting block.

Cut this wire just before it connects to the block. Thus, you leave it connected to the two "F" posts on transformers and nothing else—just hanging loose. Solder a piece of flexible wire onto it. The wire should be long enough to reach outside the cabinet. Mark this the "C—" wire. The "C+" should be connected to the "negative A" post. Be sure to tape the joint in set thoroughly to prevent it from touching any other wires.

(These instructions are applicable to all sets where the audio transformers are connected together at the "F" post and then to the filament wire. The whole idea

is simply to cut the wire and place the "C—" of a 4½ volt battery to the side running to the two audio transformers while the "C+" of the battery will run to the negative of "A" battery, thus completing the circuit. Simple enough, isn't it?)

(9) Donald C. Goodrich, Auburn, N. Y.

Question:

I am a boy of 14 years and have the "radio fever" badly. I would like very much to build a set, as I cannot buy one, just now. Do you think I could do it—and, if so, could you tell me how to go about it?

Answer:

Yes, Donald; I really think that you can build a dandy good radio set.

First, if I were you, I would build a one-tube set so that I would become used to diagrams, etc. Then I would tackle a two- or three-tube set. Such a set is described in the January, 1925 issue of *Radio in the Home*, page 27. The diagram is a very easy one. By connecting sixteen wires you can build a very nice little set. The cost will be around \$15—counting tube, batteries, and everything!

By the way—there are lots of other boys, too, who read these columns and who are yearning for a set. Here's the chance, boys! Right here is an answer to the question you have asked yourself over and over again. When you wish to add to the set I will gladly show you how—by a diagram, that is just as easily read as the one telling how to build the actual set, itself. The range of this one-tube set is from 500 to 1,000 miles under good conditions! It is our favorite one-tube set here at Station 3XP. Tube for tube, I will guarantee it to beat any other hookup not employing the same system it does!

(10) Percy Thomas, Sheffield, Ill.
Question:



DON'T move your set
BIRNBACH
35, 150 TWENTY FEET EXTENSION CORD COULD CHANGE YOUR CONNECTION.
BIRNBACH
LOUD SPEAKER EXTENSION CORD
will move your speaker from room to room
\$1.00
ALSO MADE IN 20-40-60-100 FT. UNITS
ASK YOUR DEALER OR WRITE US FOR FOLDER
BIRNBACH RADIO CO.
370 SEVENTH AVE., NEW YORK CITY

On the night of Feb. 1, last, I tuned into a station using the call letters, 2XAR. This station came in at about KFI's wave length and the time was 12:30 C.S.T. Can you inform me who it was, and where?

Answer:

The station you heard, 2XAR, was really WJZ using its special experimental call letters. Such a licensed station may be identified from the ordinary amateur station by the letter "X," which comes after the numeral denoting the district. This, of course, holds true only where the U. S. Department of Commerce controls the license.

Why GOOD CONDENSERS Cost So Much

Here Is the Experience of Just One Firm that was Determined to Build its Reputation Into Every One of its Products.

By HENRY M. NEELY

SURE; you can get a variable condenser for 98 cents. Pick up your local newspaper any Sunday and you'll see 'em advertised. So why should you pay from \$5 to \$10 for the kind you see advertised in this magazine?

It's because this latter kind are worth every cent they cost—worth it in efficiency, durability, dependability, all-round satisfaction. And the 98 cent kind aren't bought a plugged nickel. We've bought them from the gyps and taken them out to the laboratory and let them stand in their original boxes on our shelves, and, six months later, when we unpacked them, they have almost fallen apart—just warped and loosened by temperature changes.

So I'm printing here a letter from a manufacturer of good condensers to show you the tremendous cost that goes into production before you and I can buy them in the stores. I do not print the writer's name but I'll give it to you if you are sufficiently interested to write me. Here's his letter:—

"MY DEAR MR. NEELY:

"I had a very pleasant talk with your Mr. G. P. Allen in New York recently, and I believe that I tipped him off to a few things which will be of interest to your readers.

"Among the things which we were talking about was our new condenser, and I was telling him of our trials and tribulations, and he seemed to think it was interesting enough for me to tell you our troubles as well, and this coupled together with the fact that I saw two or three advertisements in some radio publications which to my mind were obviously false, has put me in a mood where I am ready to bite some-

body if they mention radio parts built by "gyp" concerns.

"In the first place, we forwarded to you some condensers. We have actually been trying to manufacture these since last July, and are just now going into production on them. Prior to last July, there were two years of development work put in on the condensers, so in all you can see we have been about three years trying to make this piece of merchandise.

"The condensers which we originally sent you had hard rubber insulation. We find that the co-efficient of expansion of the hard rubber was not the same as that of the metal in the condenser, and that when the condenser was cold, it was impossible to turn the rotor, and when it was warm, the rotor fell. This occasioned us to change the insulation and scrap 50,000 pieces of hard rubber and use isolantite, having a mold made for this material and ordering 50,000 pieces of it.

"We next found that the braided pig-tail which we used, in about 4,000 revolutions would break away from its fastenings and make trouble. This caused us to scrap this material, and we are now using a phosphor bronze spring.

"We then found that our bearings could satisfactorily be increased to 1/32" in diameter. In doing this, it made it necessary for us to scrap all of the bearings that we had made, panel locking nuts, bearing locking nuts, etc. These new bearings were found very much better, but to improve them still further we are lapping them in on our latest condenser.

"We then discovered that if a person had one of our condensers, it was possible by turning one of the screws which holds on the top shield, or trying to adjust the bearings themselves, that they could readily ruin the condenser, so we had new jig and fixture made which places four holes in one side of the die-casting where set-screws are put in, locking the condenser so that it is impossible for anyone in the field to adjust the condenser after it is once received. We offer, in order to allay any fears that the public might have, to adjust or calibrate this condenser without charge upon request.

"We have found upon experiment that this condenser will not require any adjusting within 15,000 to 20,000 revolutions.

"Next we discovered that the die-casting which we were using for the frame was not sufficiently accurate, and that we could not hold it within plus or minus 1/10,000", and that it would have to be lacquered to prevent warpage by long exposure to the air. The die-castings for these condensers we have to lacquer in order to overcome this defect so we are scrapping the die for the die-casting, which, of course, cost us considerable and we placed an order for new dies and a die-casting of a different metal.

"Of course, in the process of making these various changes we had to scrap a great many jigs, and fixtures which, as you know, are very expensive, and take a long time to make.

"This condenser experience has cost us plenty as you can readily see, but I do not know whether it is because we are New Englanders with that old idea of not building anything unless we make the best, or what it is that makes us hang onto a proposition and put it through, but I know that this is what we have done, and I want you to know that there is at least one concern—doubtless there are many more—but at least one who value their good name more than a temporary sale of apparatus, and this brings me to the point that makes me hopping mad when I see advertisements of apparatus which I know from well are junk, lauded in the highest terms by the advertising man who places the copy in the magazine, putting it before the public who believe it because it is advertised in a reputable paper."

Jo-day -in every good set!

100% Value From Each Tube

What's the use of buying good tubes if you don't get their full value? Individual, automatic tube control is the answer. Amperite alone gives it. That's why it is specified in every popular construction set. Offers precision regulation—automatically No hand-throttles to regulate. Eliminates all errors of human judgment. A special type of every style and strength of tube. Price \$3.16.

Write for free hook-ups

Radiall Company
Dept. R. H.-4, 50 Franklin St., N. Y. City

AMPERITE
The "SELF-ADJUSTING" Rheostat

More Profits for the Professional Set Builder

We have an unusually interesting proposition to make to the man who is now building (or has the ability to build) radio receiving sets for resale.

This is a real opportunity. Write today for full information.

GEARHART-SCHLUETER RADIO CORP.
712 Voorman Avenue
Fresno, California

FOR CLEAR, QUIET "B" POWER

RADIO Storage "B" Battery

12 Cells Lasts Indefinitely—Pays for Itself
24 Volts Economy and performance unobscured by failure. Recharged at a negligible cost. Features including greater life, longer, thicker and metal-plate cells. Free Radio Literature. Pop. Mag. Int. Standard. Radio News. Radio World. Pop. and other important technical magazines. Radio World. Radio News. Latest catalog prices. Order yours today!

SEND NO MONEY Just state number of batteries to purchase. Extra offers. 1 battery in order and we will ship you one free—without any guarantee. 5 per cent discount for cash with order.

WORLD BATTERY COMPANY
Dept. 616 Chicago, Ill.
Makers of the Famous "World Radio" and "Storage B" Batteries.
Street 606, Ave. 100
All wired with World Radio Co.

Get your Radio Deals at 310
Henry for the new 1000
Watt World Storage Battery
Direct from the factory
Write for advertisements

World STORAGE BATTERIES
NEW YORK - WASH. D.C. - CHICAGO - PHOENIX - WYOMING

Why Do We Use FLUX in SOLDERING?

No Matter How Hot Your Iron is, You Can't Make the Metals Join Unless You Use Some Chemical To Neutralize the Film of Oxide Which the Heat Forms.

By F. A. KLINGENSCHMITT

THE function of the brown jelly-like paste which must be smeared on wires before they can be successfully soldered is something of a mystery to the great majority of radio fans.

The paste itself does not make the solder adhere, but it does remove a little known agent which otherwise would prevent the soft metal from doing so.

This agent is a thin film of a chemical compound formed on the surface of the metal when the hot soldering iron is applied to it. The hot metal combines with the oxygen of the air, and becomes coated with an invisible layer of what is chemically known as an "oxide."

This film prevents the liquid solder from reaching the actual surface of the wires. Unless it is removed, the solder will not stick, regardless of the heat of the iron or the quantity of solder applied. The hotter the iron, in fact, the more oxide is formed.

Now the specific purpose of the soldering "flux" is to absorb the film of oxide as quickly as it is generated. That's all there is to the whole affair. The paste simply combines with the film, the chemical reaction producing

harmless substances which do not affect the soldering operation.

Soldering fluxes take the forms of solids and liquids. Muriatic acid, in which pieces of zinc have been dissolved, is a common liquid flux, but it is highly undesirable for fine radio connections because it is strongly corrosive.

Ordinary rosin is the best flux for radio work because it does not corrode metalwork and causes no electrical leakage troubles.

One interesting thing is that aluminum cannot be

soldered by ordinary means because it possesses a natural film of oxide which standard fluxes cannot dissolve. Special chemicals and solders must be used on this particular metal.

The most convenient kind of solder for the average set builder is the one that comes much in the form of a thick wire. It has a core of rosin and the heat makes the rosin run out and neutralize the oxide as the solder flows. This solder can be bought in lengths or it can be obtained on spools. The latter form is the handiest and the most economical for the man who does a good deal of radio work.

AMPLION

For Better Radio Reproduction



Hear this World-Wide Favorite

Creation of Alfred Graham & Co., England. 38 years experience in producing loud speaking devices. Amplions lead in sales throughout the world. Hear an Amplion—in comparison with other models, including phonograph units, equipped with cones and plates, \$12 up. Write for "Amplion Pedigree."

THE AMPLION CORPORATION OF AMERICA

Sole U. S. 220 Madison Avenue, New York
Chicago Branch: 27-29 No. Morgan St.
Amplion Corp. of Canada, Ltd., Toronto

SAFETY DEMANDS



BRACH

VACUUM LIGHTNING ARRESTERS

Make sure of maximum protection from lightning storms by insulating on the first and best arrester.

L. S. BRACH MFG. CO.
NEWARK, N. J.

Rauland-Lyric Transformer
(For the Music Lover)
The Model R Receiver
(Rauland-Lyric-Equipped)
Constant-B
(Permanent "B" Power)
ALL-AMERICAN Toroid Coils



ALL-AMERICAN

Radio Built for the Years to Come

EVERYTHING IN RADIO

AT BARGAIN PRICES

NEWEST 1926 RADIO GUIDE!
Just hot off the press—brimful of latest ideas, newest hookups with illustrations—all free. Shows savings as high as 50% on standard guaranteed radio parts, sets, kits. Be sure to get this thirty book before you buy. It puts money in your pocket. Unusual? You'll say so when you get it. Also please send name of radio friend. Write today!

THE BARAWIK COMPANY
112-118 Canal St., Chicago, U. S. A.

Convert your present receiver into a light socket set with

FAN STEEL Balkite

Radio Power Units

FAN STEEL PRODUCTS CO., Inc.
North Chicago, Illinois

30 Days FREE TRIAL

New and Better Radio Set



JUST OUT! New Wonder Radio At Lowest Factory Prices.

Why be satisfied with any but the **NEWEST** radio set? Why pay high prices? Why take chances, when you can put this **NEWEST** 5-Tube Westinghouse Model in your home for 30 Days Trial on the absolute guarantee that if you don't find it the most beautiful in appearance—the most reasonable in price and the best radio set you have ever seen or heard—You Don't Have To Keep It! Built in the new style brown walnut cabinet with sloping front panel, gold embossed in Rembrandt design. Will receive concertina from coast to coast. Buy a Westinghouse set direct from manufacturer and save money.

5-TUBE RADIO Retail Price \$45.00
3-TUBE RADIO Retail Price \$26.00

Don't buy any radio until you get our **FREE** Folder, which describes this newest of all radio sets and gives you

Special Introductory Discount
Also our 30 Day Trial Offer. Write today!

AGENTS AND DEALERS WANTED
WESTINGHOUSE ELECTRIC CO.
Dept. 280 1751 Belmont Ave., Chicago

And So

THIS CONCLUDES OUR PROGRAM

¶ We're signing off. ¶ You've come to the last page and it's time to say good-bye. ¶ *You know the next announcement.* Your letters of applause or of criticism are solicited. We want to know what you think of our efforts, because it is only by means of your expressions of opinion that we can build future programs to suit you. ¶ Our next program will be in the May issue—on sale everywhere April 25th. The price of this new magazine is \$2.00 the year, but, in order to place new subscribers on the same basis as the old ones, we will enter a year's subscription for **ONLY ONE DOLLAR**, providing the subscription—with the dollar, of course—is received on or before April 25th. ¶ We feel quite sure you'll want to take advantage of this offer. It will not only save you money but it will assure your getting every issue even though your newsstand may be sold out. ¶ And, as Ben Birnie says,

"WE HOPE YOU'LL
LIKE
IT."

The RADIO HOME
Third and Walnut Streets
Philadelphia

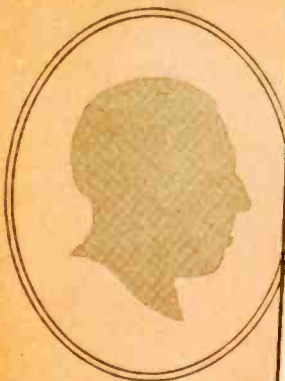

Day in, day out, the laboratories of The Crosley Radio Corporation are busy. Night after night, the lights are burning as engineers and scientists of the Crosley research staff seek out the solutions of problems. Powel Crosley, Jr., has set. New and better ways to make this part or that, revolutionary principles related to receiving and broadcasting, and entirely new fields for the employment of radio energy.

Always the eye of Mr. Crosley is on the work. Able as are his helpers in their respective fields, he alone directs their toil toward this goal or that. In his imagination originate the main objectives.



Out of this system of ceaseless search have come all those great improvements that Powel Crosley, Jr. has made in radio. Free of all restrictions of precedent and recognizing no bounds to possibility, Crosley research and engineering have already in several instances achieved the so-called "impossible." In fact, practically every Crosley improvement has been a radically new departure rather than a mere refinement of existing methods.

The Crosley Musicone is an outstanding example. In its first year it outsold all other makes, and today is replacing other types of loud speakers as fast as the world's largest radio plant can manufacture. True cascade amplification and the "Crescendos" are also examples of Crosley research results. And in this same department have originated the innumerable machines and devices now employed in the Crosley shops to simplify operations, speed production, and reduce costs.

Out of Powel Crosley's devotion to research great things indeed have come . . . but greater things than these may be expected.

Better radio receiving in the common sense is not the only object of his search. It is Powel Crosley Junior's conviction that radio energy can perform new feats for the public's entertainment and benefit, perhaps radio motion pictures in the home. . . a thousand and one dreams are in this restless brain, and Crosley dreams so regularly come true. And even the potentialities of radio activity cannot hold his whole concern. Inasmuch as the great public service of Powel Crosley, Jr., has been in putting worth while radio reception within the common reach, he can clearly see that many other products which impose price burdens on the average man likewise cry for cost reduction by mass production.

You may look to him to attack such problems as these. You may gauge your expectations of his success by the unusual facilities at his command and the repeated successes he has already won.



The Crosley 4-tube—4-29
in which the Crescendos is equal to one or more additional tubes of tuned radio frequency amplification **\$29**



The Crescendos
—an amazing new volume control exclusive to Crosley sets. Hear it!

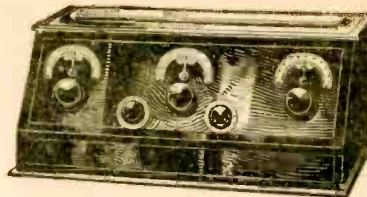

The Crosley 5-tube—5-38
All the volume, selectivity and purity of tone available in the best 5-tube set—plus the Crescendos **\$38**

Widespread Popularity Marks Another Great Success

Spectacular as has been each stride in radio achieved by Powel Crosley, Jr., never before has a Crosley success received such prompt and widespread recognition. Here in the radio plant which has made more radios than any other factory in all the world, every man and machine is going at top speed, every hour is a crowded hour, every night a working day, as the result of orders for the four new Crosley sets.

Even the sweeping success of the Crosley Musicone did not match this merciless demand upon an organization tuned to mass production. With the first demonstrations by Crosley dealers, public approval was expressed in orders that have increased in volume day by day and show no inclination to relax.

This popularity is distributed quite evenly between the four new 4- and 5-tube sets. Thousands who had formerly believed that worth while reception was exclusive to high priced sets, have found in Crosley 4-29 and

5-38 all that they could ask of radio. The accurate selectivity and pure tone of these instruments would be enough. That magnificent volume achieved through the Crescendos is the final touch.

And in Crosley "RFL" types there is a revelation for all. For here true cascade amplification makes its first appearance. Here what was considered impossible in expert opinion has been achieved by amplification closely approaching theoretical maximum efficiency per tube!

Your nearby Crosley dealer is now demonstrating these truly remarkable sets. By all means hear them. What a joy to find . . . and in a low priced set . . . rare beauty, rich tone, volume subject only to your desire, and no howling at any pitch by any mishandling under any conditions.

Each instrument delights the ear, fires the enthusiasm of the lay technician, converts the staunchest skeptic to love of radio.

See the new Crosley receiving sets at your dealer's or write Dept. 60 for descriptive catalog.

Crosley manufactures radio receiving sets which are licensed under Armstrong U. S. Patent No. 1,113,149, or under patent applications of Radio Frequency Laboratories, Inc.

THE CROSLLEY RADIO CORPORATION, CINCINNATI, OHIO

Powel Crosley, Jr., President

Owning and Operating WLW, first remote control super-power broadcasting station in America

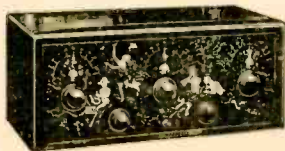

The Crosley 5-tube—RFL-60
A set of marvelous performance and beautified by the artistic decorative panel **\$60**



The Crosley 5-tube—RFL-75
Simplicity and speed in tuning, fidelity of tone, and decorative beauty, enhanced by the art panel **\$75**

Prices slightly higher west of the Rockies

CROSLLEY RADIO

BETTER—COSTS LESS

FOR THE ENTERTAINMENT CORNER

New and better ways to make this part or that, revolutionary principles related to receiving and broadcasting, and entirely new fields for the employment of radio energy.

or
thin
nc
it
para
pro
re
to
have
ings
re
the
is
tion
form
radio
n
ans
and
y com
ven the
s of ra-
cannot
ole com-
such as
public
Powel
Jr., has
putting
le radio
within t
nclearly
ducts w
ons on the
y for c
productio
look to h
ans as d
ications
ilities at
successes
out the l
io Corp
night, the
and scient
seek out
Powel Cros
er ways to
inary prid
broadcas
or the emp
eye of Mr
the work
his helpers
active fields,
directs their
and this goal
his imagin
e the main
is system o
arch have o
ens that Pe
n radio. Fre
nt and recog
ity, Crosley
have alread
chieved the st
n fact, pra
improvement
departure rat
k of existin
lev Musico
example. In
all other mak
ng other types
est as the v
nt can man
s amplificati
don" are als
research resul
the department
oratories of The
on are busy.
ights are burnin
s of the Crosley
s the solutions of
y, Jr., has set,
make this part or
ples related to
ng, and entirely
ymment, of radio