

May, 1925

RADIO IN THE HOME



Conducted by HENRY M. NEELY



H. Weston Taylor

In this Issue: The New C



Then you will say:
"This has the distinction of genius"

IN EVERY industry there is some product that is incredibly fine whose perfection beggars the comparison of price.

In radio, it is Rola. Not a "loud speaker" or "reproducer"—but a "Re-creator." It actually re-creates every note, every shade of voice and instrument, as faithfully as a polished mirror reflects an image.

Rola was built with a full appreciation of the important part that a reproducing device plays in radio. With the knowledge that the finest set can be no better than its loud speaker. Price, you will agree, is of little moment when you consider the many advantages to be gained by actually re-creating the beautiful radio programs.

There are many excellent loud speakers—just as there are many excellent musicians. But the subtle distinction that we recognize as genius in some musicians is easy to recognize in the performance of Rola.

its volume even—is self-
 the musician himself.
 re-creation auto-
 tion of over-
 weakest

A watch-like precision of manufacture assures you a lifetime of service. You will never care to replace your Rola—and that, in itself, makes it the wisest of investments.

When you hear a Rola—and we suggest that you hear it before you buy any loud speaker . . . you will appreciate that with it comes the same satisfaction that you experience in owning a thoroughbred horse—a grand piano of some master make . . . or anything that is unmistakably the finest of its kind. At the better radio stores. Price, complete with 14-inch horn and cord, \$36.00. Phonograph unit with adapter, \$22.50.

A product of the Rola Company, 4250 Hollis Street, Oakland, California. Marketed nationally through Baker-Smith Company, Inc. Head Office, Call Building, San Francisco, California. Branch offices in principal cities.

Rola
 RE ★ CREATOR

Philco Rechargeable "B" Battery

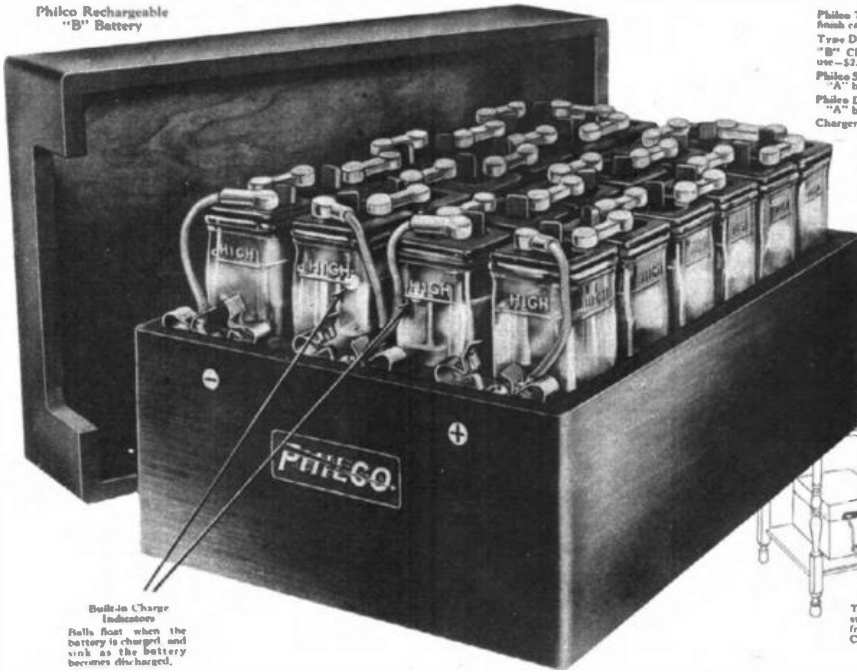

Philco Type DX "B" Battery with deluxe mahogany finish case with cover (48 volts). Price—\$20.00
 Type DXO, without cover—\$16.50
 "B" Charging Panel, factory wired and ready for use—\$2.75
 Philco Single Charger for all "B" batteries and UD44 "A" batteries. Noiseless. Price—\$9.75
 Philco Double Charger for all "B" batteries and UD46 "A" batteries. Noiseless. Price—\$15.00
 Charger prices include plugs and receptacles.

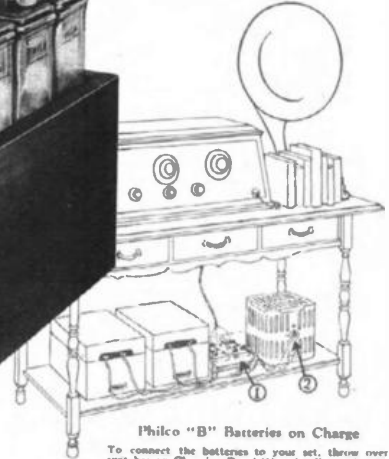

Built-in Charge Indicators
 Paths float when the battery is charged and sink as the battery becomes discharged.



Philco Frosted-Glass Case "A" Batteries
 Spray proof. Stay dry and clean always. Built-in Charge Indicators.
 Type UD46 for storage battery tubes—\$16.00
 Type UD44, "a dry cell replacement" enabling you to get better results out of dry cell tubes. Occupies less space than three dry cells and may be installed permanently in the radio cabinet. Price \$8.00



Philco Mahogany Case "A" Batteries
 Types RAR and RW for storage battery tubes. In beautiful Adam brown mahogany finish case harmonizing with your radio cabinet. Price—\$16.50 up.
 Philco Charge Tester—permanently mounted in filler cap—avoids fussing with a hydrometer—\$1.00 extra.

Recharge in your living room without changing a wire!

Philco has made storage batteries not only easy to operate but also economical. One Philco Storage Battery will outlast many, many dry cell batteries.

To Recharge a Philco "B" Battery, just throw the Charging Panel switches and insert the plug in the built-in receptacle of the Philco NOISELESS Charger.

You don't move the batteries or disconnect a wire. Cost—five to ten cents.

Philco "B" Batteries are clean, dry and beautiful. The tightly-sealed glass cells are assembled in Adam-brown mahogany finish cases harmonizing with radio cabinets and furniture.

Built-in Charge Indicators tell you at

a glance how much charge is in the battery at any time.

Philco makes storage "A" batteries of similar convenience and economy. Also high-powered starting batteries for your automobile.

Philco Batteries are Dynamic—shipped DRY but CHARGED. Being dry, they cannot deteriorate while in shipment or on the dealer's shelf.

The life of the Dynamic battery you buy doesn't start until the dealer pours in the acid. You are certain to get its full life.

Ask your nearest Philco Service Station, Radio or Music Dealer for Philco Dynamic—see the acid poured in—and you can't get a stale battery.

Philadelphia Storage Battery Company
 Philadelphia



DIAMOND GRID
 BATTERIES

EDITORIALLY SPEAKING



By HENRY M. NEELY

IN MANY ways, the last season has been an extremely significant one for the radio fan. Many new ideas have reached the stage of actual experiment and we have had enough experience with some of them

The Trend in Our Radio Programs

to be able to form some sort of estimate of what they preface for the future. Chief of these developments are the following:

1. Toll broadcasting or the use of radio for building up good will.
2. Link broadcasting or the connection of two or more stations either by land wires or by radio pick-up and rebroadcast.
3. Increase in power to determine how high a station can go without blanketing its community.
4. A genuine public sentiment against admission of any more stations until the present chaos in the ether is cleared.
5. The establishment of radio as a legitimate financial proposition as evidenced by the flotation of large issues of stock on the curb.
6. A tendency toward a sweeping reduction in prices on receiving sets and parts.
7. The development of a new art of program-making comparable to what is known as "presentation" in the motion-picture industry.

Several of these developments have already been discussed in these pages, and this month I should like to take up the last one mentioned—the development of the new art of radio program making.

Just for the sake of clarifying the distinction, let us divide radio programs into "foreground" and "background" programs. The foreground program is one which, by its very presentation or inherent qualities, compels all listeners-in to cease conversation and to listen to whatever the loud-speaker is producing. Foreground entertainment by radio becomes the leading interest of the social gathering which happens to be receiving it and every one remains silent and listens.

Background entertainment is the opposite. It is such material as the broadcasting of a luncheon concert by a cafe orchestra or an ordinary program or miscellaneous music by various artists who are not particularly well known. With such programs, the radio set is left turned on during the evening, but if you and I and several friends are sitting in the room, we do not hesitate to talk about the weather

or business or social affairs. Now and then, if we happen to hear something that interests us, we listen, but the principal thing that holds us together for the evening is our own social intercourse or our game of poker, and the radio is merely a background which serves to fill in any possible gaps in our conversation, or now and then to give us something a little more interesting than what we were talking about.

With the development of toll broadcasting by linked stations, the cost of such broadcasting makes it essential that those in charge should so frame their programs that every one of them shall be of foreground caliber. Otherwise, much of the tremendous expenditure is wasted because thousands of people sit around the loud-speaker and converse and listen only now and then.

The development of this foreground style of program has begun during this last season. It is a new art, facing new problems, and, while it may in many respects be comparable to phases of other entertainment, the very peculiarities of radio, when everything is transmitted through the ear and not the eye, make it somewhat different and compel its advocates to develop their own style of art.

The last season's experiments have indicated two things: a foreground program must be coherently tied together first, by personality, or second, by carefully planned "continuity." This latter term indicates some sort of thread of story or

some method of so knitting together the whole program that you and I will not talk during its rendition, but will listen constantly for fear that we will lose this thread.

Roxy and his gang at the Capitol Theatre in New York are an excellent illustration of the first-named type. Roxy's personality ties the whole thing together. Without him these programs would be simply very good regular programs which might be transmitted from the studio of any really first-class station. The interjection of Roxy's personality spreads that personality over every single thing that is rendered and we listen to everything for fear that we will lose some small part of this binding sense of personality.

In the last-named type of program—continuity—the Eveready Hour stands supreme and, indeed, almost alone. Take that masterpiece of experimental radio writing, the Golden Wedding Anniversary, which they have been compelled to repeat. There was a story unfolded before us as we listened, and there were few of us who did not feel a lump rising in our throats and a suspicious moisture in our eyes as the party progressed, finally to leave the two old folks alone after fifty years of happy married life, and that splendidly dramatic but unaffected final touch where the old woman tries to sing once more one of her girlhood songs but breaks down in the midst of it from sheer happiness—and the Eveready Hour is over.

Every song sung during that hour was an old-time one that all of us had worn almost threadbare. They were well sung by the Eveready Entertainers, but any first-class group of entertainers could have sung them as well. Put out merely as an unrelated program, we would have listened to some, but would have talked every now and then among ourselves. As tied together by this heart appeal of the Golden Wedding Anniversary, they became irresistible, and we all sat silent and listened to the end.

That is representative of the new art of radio presentation.

This kind of thing, it seems to me, is pointing to a new school of writing—the development of the scenario writer particularly for radio. Paul Stacey, of the N. W. Ayer Advertising Agency, who is doing these continuities for the Eveready Hour, should here be put down as the pioneer in this field, and the development of his new form of art is, it seems to me, the most significant phase of

(Continued on Page 21)

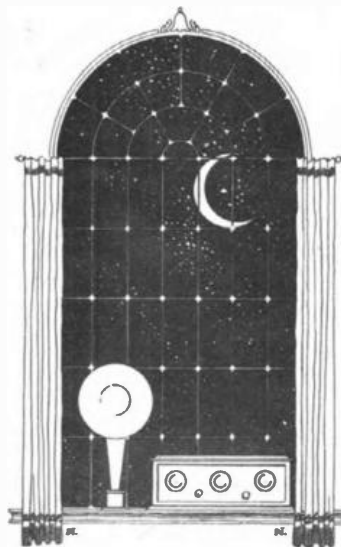

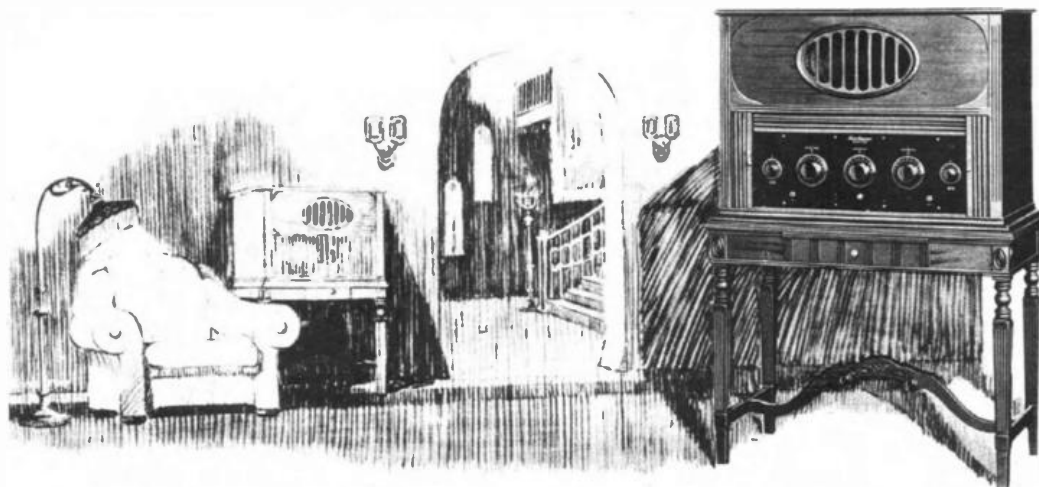

A Radio Investment That's Permanent



The Highboy with doors closed and grille detached, to permit changing of Superspeaker horn interior.



Rear view showing enclosure compartments on either side of built-in Superspeaker, housing all batteries, wet or dry.

The time is coming when many people are going to separate their purchases of Radio and Furniture.

The leaders want to do so today. They have welcomed our announcement of the Superspeaker Highboy by an actual flood of approval.

And the others will follow, for the common sense of such an idea is plain.

The Highboy can never become obsolete or out of date. It is merely a handsome piece of furniture, with built-in reproducer, and

housing the owner's current Set and equipment.

It will house the Radio of the future as gracefully as the Radio of today. And it will always answer the question "Where shall we put it" by providing a handsome Radio Unit, complete with a world-famous reproducer, and amply capable of gracing the most perfectly appointed drawing room.

Meet the demand for fine Radio Furniture with this Permanent Radio Investment. Ask for our folder, "Decorative Radio."

The Superspeaker Highboy, complete with table, in finest African Mahogany or No. 1 American Walnut. Set compartment 30 1/2 inches long. Design and mechanical patents pending.

"THERE IS NO SUBSTITUTE FOR THE BEST"

JEWETT RADIO & PHONOGRAPH CO.
5682 TELEGRAPH ROAD PONTIAC, MICHIGAN



The Jewett Highboy

EVEREADY HOUR
EVERY TUESDAY AT 9 P. M.
(Eastern Standard Time)
 For real radio enjoyment tune in the "Eveready Group." Broadcast through stations—

WEAF New York	WFI Philadelphia
WJAR Providence	WCAB Pittsburgh
WEEI Boston	WGR Buffalo
WEAR Cleveland	WOC Denver
WSJ Detroit	WCCO Minneapolis
WSAI Cincinnati	St. Paul

*The proven
 Dry Cell for all
 Radio Dry Cell
 Tubes*

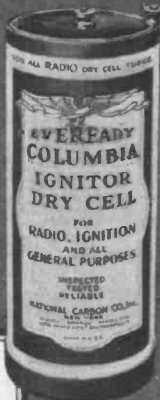

Eveready Columbia Ignitor Dry Cell "4" Battery for all Dry Cell Tubes 1½ volts

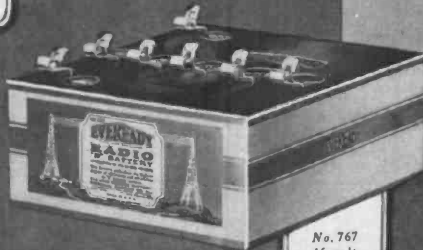

No. 767 45-volt Large Horizontal Price \$3.75 With variable taps

Recommend good batteries

IN AN effort to reduce the first cost of a radio set, a newcomer in radio often buys inferior batteries. You know such "saving" is really wasteful. Tell your friends who are about to buy receivers that the best batteries obtainable will prove to be the most economical. Tell them to buy Eveready Radio Batteries—they last longer and, because they are greatly superior, they give complete satisfaction.

There is an Eveready Radio Battery for every radio use.

Manufactured and guaranteed by
NATIONAL CARBON COMPANY, Inc.
 New York San Francisco
 Canadian National Carbon Co., Limited, Toronto, Ontario

EVEREADY Radio Batteries

—they last longer



No. 770 45-volt Extra Large Vertical Price \$4.75 For use on multi-tube sets

RADIO IN THE HOME

Grimes-Flewelling-Harkness

Associate Editors, Writing for No Other Magazine

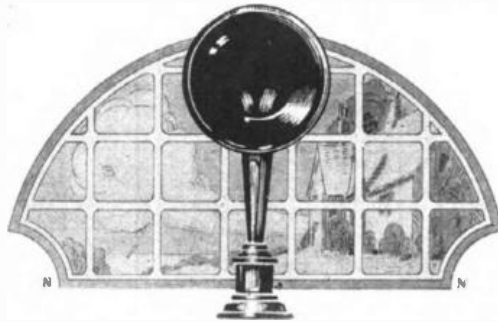

Take New York City, for Example

NEW YORK CITY is having its radio growing pains and most of the listeners as well as the broadcasters of the metropolis are well aware of this fact. But New York is only typical of all of the country. And this creates great interest for every well-wisher of radio in the conference conducted by the Department of Commerce officials recently to determine what should be done about broadcast wave-length assignments in and about Manhattan.

Judge Stephen B. Davis, who presided at the conference, well stated at its opening that the situation of New York is different only in degree of difficulty from the problems of the whole country. "There is no let-up in the desire to establish new stations. More are now asking for licenses than ever before in the history of radio." And this rather distressing picture of the trend refers to all of Uncle Sam's jurisdiction.

In New York City district there are eight class "B" stations with wave lengths within the usual class "B" range. Three other stations are already officially on record with the Department with applications for licenses of this sort and one of the eight already in asks permission to move up to a higher and more desirable wave length. Under the cir-

By R. S. McBRIDE
 Washington Correspondent of "Radio in the Home"

circumstance listeners might expect that Secretary Hoover would tell Judge Davis, "You settle this matter. Fix things as they ought to be." But this is not the department

system. It very much objects to being boss or Czar; it much prefers simply to exercise a friendly guiding hand. To one who knows this, it is not surprising, therefore, that Judge Davis concluded the conference with a request that the four important New York stations, not now satisfac-

torily accommodated, should get together and make a joint recommendation, which it is hoped, can then simply be approved by the Department. As a basis for such conference the Department indicates that it is quite probable there would be no difficulty in arranging to give to the New York group the privilege of working on the same wave length as Manhattan, Kansas, one of the namesakes of the central borough in the great metropolis.

The purpose of radio broadcasting is and must continue to be the service of the people. Every speaker at the New York meeting who undertook to secure any modification of the present scheme of things emphasized this point. "Half-drunken announcers," who, it is claimed distress the listener, must go! If they exist, as one man claims, the public and the Department will see to it that they do go.

But a much more positive, constructive

Volume III CONTENTS FOR MAY, 1925		No. XIII
Cover Design— <i>H. Weston Taylor</i>		PAGE
Editorially Speaking— <i>Henry M. Neely</i>		4
Take New York City—for Example— <i>R. S. McBride</i>		7
The Problem of Interference— <i>George Lewis</i>		8
Portable Sets of the Season— <i>H. M. N.</i>		10
A Radio Interview on the Superheterodyne		13
More About Low-Loss— <i>E. T. Flewelling</i>		14
Hear the Conquering Harmonica via Radio— <i>Golda M. Goldman</i>		16
How to Make the Countersex Super-Selective— <i>Kenneth Harkness</i>		18
New Semi-Toroid Coils Make a Corking Good Set— <i>Henry M. Neely</i>		20
How to Make the Quadraformer Receiver— <i>E. T. Gearhart</i>		20
From in the Air to on the Air— <i>Mary Gray Reed</i>		26
Am I Using the Correct Voltage?— <i>Brainard Foots</i>		28
The New World for the Shut-in— <i>E. D. Cahn</i>		33
The "Showmanship" of Radio Announcing— <i>Paul Hale Bruabe</i>		41
Published Monthly by the Henry M. Neely Publishing Company, 608 Chestnut St., Philadelphia, Pa.		
Bell Telephone—Lombard 3431	Experimental Station (2XP), Delanco, N. J.	
HENRY M. NEELY..... President and Editor	DAVID GRIMES..... Associate Editor	
G. W. HRAFT..... Secretary and Treasurer	EDMUND T. FLEWELLING..... Associate Editor	
W. L. DUDLEY..... General Manager	KENNETH HARKNESS.....	
R. E. MORRIS..... Advertising Manager	BRANARD FOOTS.....	
NORMAN NEELY..... Art Director	W. FRANCIS GOODREAU..... Contributing Editor	
MERRILL NEELY.....		
G. P. ALLIX..... Laboratory Assistant		
Radio in the Home is sold at 15c per copy at all newsstands, radio shops and bookstores. Subscription rates in the United States, \$1.00; Canada, \$1.25; Foreign, \$2.00 per year.		
Printed on the rotogravure process of the Public Ledger, Philadelphia, Pa.		
Copyright, 1925, by the Henry M. Neely Publishing Company		
Entered as second-class matter May 20th, 1923, at the Postoffice, Philadelphia, Pennsylvania, under the act of March 3, 1879.		

(Continued on Page 39)

The Problem of Interference

THE successful application of radio as a dependable means of communication is limited only by the efficiency of the receiving apparatus in collecting the desired signal and excluding all other signals. Undesired signals or interfering noises, with the present form of receiving equipment, cannot be completely eliminated; therefore, the efficiency of a receiver is measured by the ratio of the volume of the desired signal to that of the undesired signals.

Dr. Erskine-Murray, the great British physicist, and author of one of the first advanced radio books published in our language, definitely stated many years ago that: "the difficulty in wireless is not to receive a signal, but to keep one out." Just what is the signal that must be kept out? One would immediately answer that "it is the signal interfering with the clear reception of a desired signal," or, better yet, "the sound interfering with the desired sound."

Interference can, in a general way, be classified in two broad groups:

(1) The undesired energy collected by the antenna, the interfering energy generated outside and beyond the receiving equipment, which we shall term "external or distant interference," and

(2) The interfering noises introduced or generated within the receiving equipment and factors within the station commonly known as internal, instrumental or local interference.

It may be well to subdivide each of these groups, so as to have a more clear understanding of the various classes of interferences.

We have been led to believe that interference is solely caused by other radio

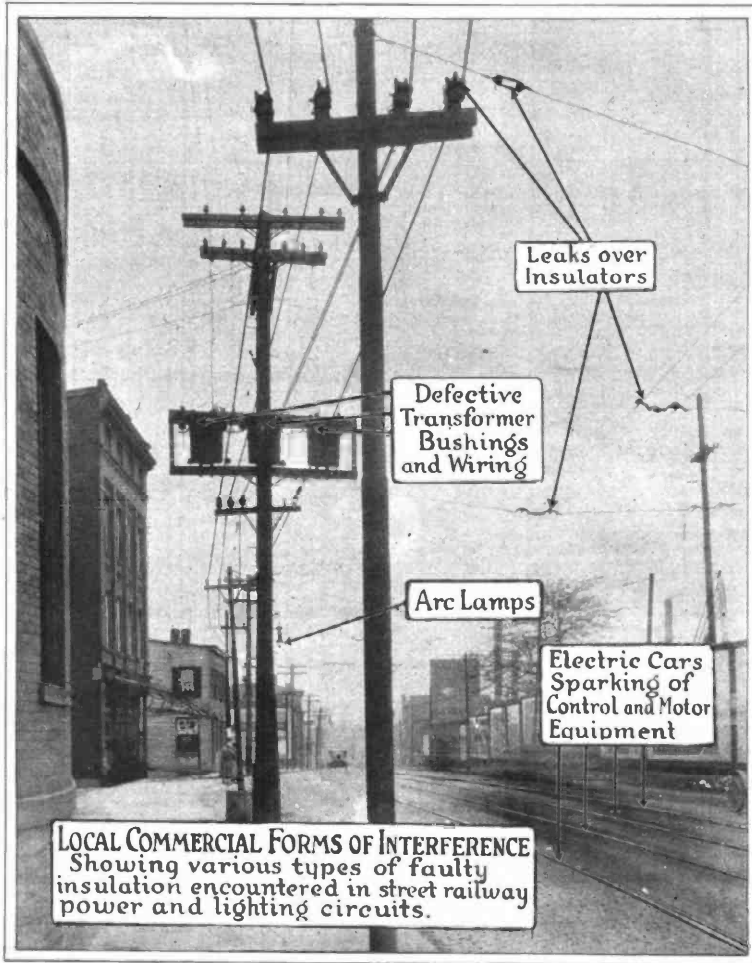

By GEORGE LEWIS

The Crosley Radio Corporation

transmitting stations operating on an adjacent wave length with such intensity, or strength as to conflict with the reception of the desired transmitting station. This is not the case. Interference can be caused, for instance, by mechanical noises made in a room after the desired signals have been transformed into sound waves by the headphones or loud-speaker.

In Group 1 we have, first of all from a radio standpoint, the undesired signals from a second transmitting station, which can be caused by the direct wave interference, or the continuous shrill scream known as "heterodyning;" the atmospheric interference commonly called "static;" the interference brought about by the radiating qualities of neighboring receivers; the inductive interferences caused by electrical equipment, such as transmission lines,

generators, X-ray machines, telephone ringing and arc light systems; and other interference propagated in wave form and collected by the receiving antenna.

In Group 2 should be listed the more properly termed interfering noises, rather than interfering signals, as audio frequency howls, due to resonance in the amplifier circuits; the rustling noises caused by current leaks throughout different parts of the circuits; the noises introduced by certain inherent defects of the vacuum tube and batteries which may have bad connections; the grating sounds caused by loose connections; as well as the hissing or howling sounds resulting from improper adjustment of the tuning elements of the equipment as a whole.

What is the remedy for all of this interference? The external interferences are being materially reduced as the popularity and importance of radio increase. The Government, through the Department of Commerce, has completed the most elaborate study of the subject and the higher-powered radio broadcasting stations are licensed for operation on different wave lengths, so selected and distributed geographically throughout the United States as to prevent interference between different stations when fairly selective receiving equipment is employed. The stations are carefully inspected to detect any radiation of energy, other than that assigned the station as an operating wave, which may take place in the form of harmonics. In addition, the station is required to maintain a standard degree of modulation, noiseless carrier wave and other factors which might introduce interference are carefully watched. Therefore we may rest assured that our Government,

through its force of radio inspectors, is acting as a radio police to protect our interests in this great subject of interference between broadcasting or transmitting stations.

It has been found that the radio listening public have assisted the electric power companies in locating faulty equipment before the apparatus has become completely damaged. A striking instance of the vigilance of the radio public took place in St. Louis, where a partial short circuit was caused by a laborer puncturing the insulation of a high-tension cable. The continued reports of interference from a restricted zone caused an investigation by the Missouri Radio Listeners' Association, which resulted in the discovery of the faulty cable.

The extremely sensitive receivers utilized in radio broadcast reception very readily detect electrical disturbances caused by faulty line insulation, transformer bushings and other sources of leaks and arcs which could not be discovered otherwise until the defect had reached a state whereby the operation of the circuit or apparatus was endangered. In fact, a special form of directive radio apparatus is being used by several electrical utility companies to

discover and remedy defects of this type.

Such radio interference as that caused by commercial electrical equipment is at the present moment receiving the serious study of radio committees appointed by the larger electrical associations, such as the National Electric Light Association, the Associated Manufacturers of Electrical Supplies and the Power Club of America. These committees are composed of leading electrical and radio engineers of America, whose assistance in this particular field will tend to minimize commercial interference.

The remaining subject classified under external interference is "static"—a term given such wide publicity. It may be stated at the outset that occasionally static completely blankets the reception of signals, but this condition is only experienced in certain tropical locations for a very limited time. Static may become quite pronounced in the temperate zones directly before or during severe electrical or thunderstorms; however, the seriousness of this subject is greatly exaggerated. The increased power of radio broadcasting stations will materially reduce the interference caused by static. In commercial radio telegraphic

communication, night and day service is maintained throughout the year without interference, while on the other hand, radio broadcast concert listeners—modernly called "coherers"—are prone to cover the limitations of their receiving apparatus and their skill in tuning under the guise of the severity of static. It is not static alone that causes the hissing, frying and cracking noises produced by a loud-speaker; it is the static combined with circuit noises which are amplified and generated at each stage of the receiver.

If the "external or distant interference" is being lessened in violence, will we not shortly reach a period where pure signals of any strength can be amplified indefinitely without interference? No; this is not a fact and we shall not reach this ideal condition until the interfering noises grouped under the heading of "internal or instrumental interference" are eliminated.

The external form of interference is beyond the control of designers and manufacturers of radio receiving equipment. These external factors are being rapidly minimized, but what is being accomplished to reduce the instrumental noises—those noises directly under

(Continued on Page 33)

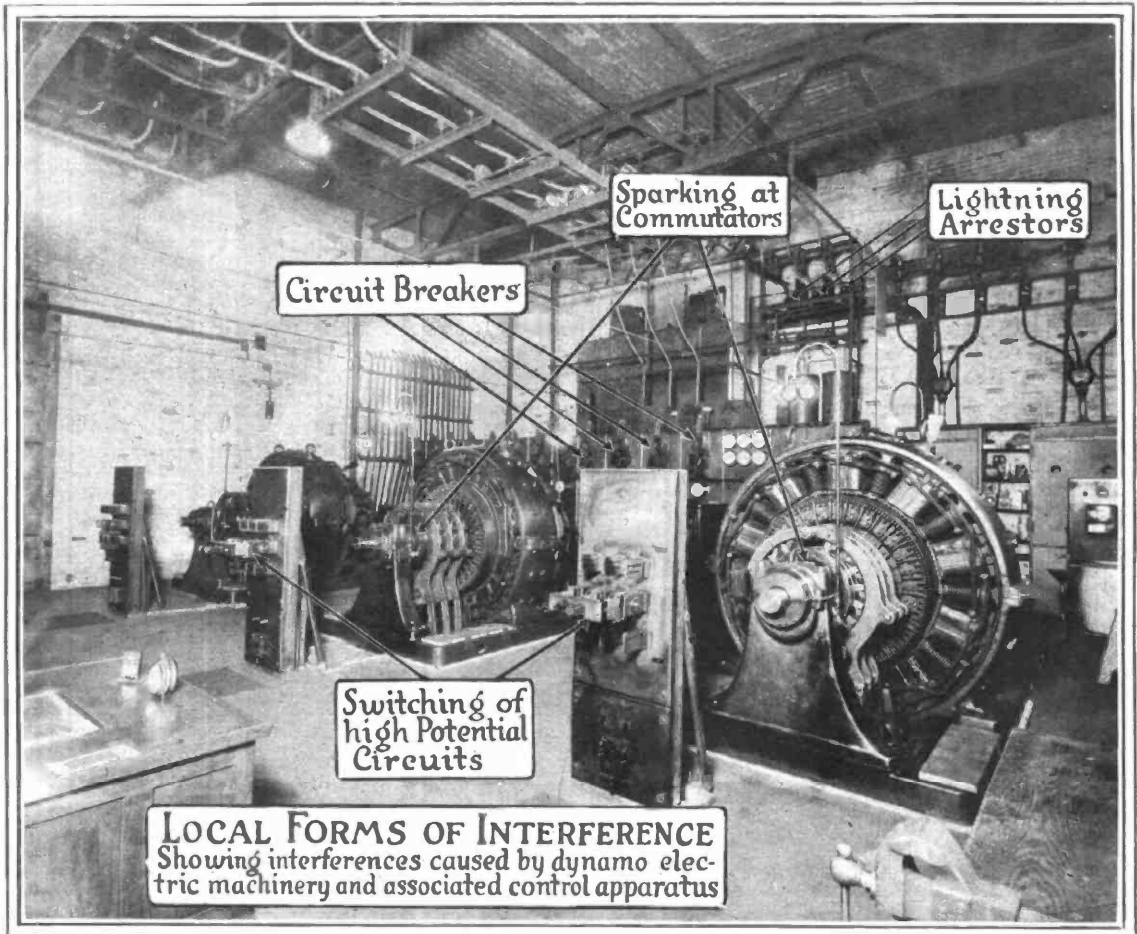

Portable Sets of the Season ~ ~

WITH the adoption of high power by a dozen or more of our best broadcasting stations there is every prospect that this summer will see a more widespread use of the portable radio receiver than has been known in the past. Radio has now become such an integral part of the home life of so many people that even the summer vacation will not now be considered complete unless the evenings are brightened by the sound of music from the radio set.

For this summer, the manufacturers are putting on the market sets which include virtually every degree of portability. For the man who is on a walking tour, the word portable will naturally mean something totally different from its meaning to the man who is touring in a large automobile. The

By
H. M. N.

The Operadio "convertible" can be adapted to home surroundings by means of the special cabinet

Phyllis Sacta, Galesville, Wis., winner of the 1925 Crosley-Dolly Varden Annual Beauty Contest, with her Crosley portable receiver

Another view of the Operadio portable receiver without the special cabinet

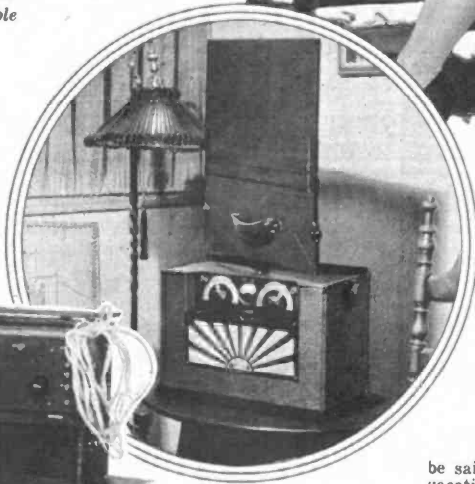

of space without sacrifice of efficiency from a radio standpoint. They are neat and attractive and many of them are not much harder to carry than a fair-sized camera.

For the motorboat fan, with a comfortable cabin cruiser, almost any of the larger of these portable sets will double the pleasure of his annual cruise. The same may

be said of the man who likes to take his vacation in his motorcar.

Such sets are equally adaptable to the family taking a cottage at the seashore or in the mountains or one who is going to a summer boarding house for his vacation. The larger size portable set can easily be transported for such purposes as these. Virtually all of them are built to use the UV199 of C299 tubes, and so the storage battery is not essential. These little tubes require so small an amount of current from the battery that one set of dry cells ought to last for the length of vacation that the average man is able to get.

Portable sets using a detector and one or two stages of audio-frequency amplification will present very few difficulties on account of these tubes. For the larger set, where radio-frequency amplification is required, it is very wise to have one or two

latter vacationist can easily carry with him storage batteries and quite an elaborate equipment, which will not take up too much room in the car, but which would be totally out of the question to the man who is walking or riding a bicycle. There is a saying in the radio industry that you can put a strap and a handle on a grand piano and call it a portable instrument if you want to.

This year's portable sets are really a revelation of what can be done by careful design and good workmanship. The sets show a clever utilization of every cubic inch





Above is shown the Kodol P11 one-tube portable receiver. Set works either with or without an aerial. Measures 5¾ inches by 4¼ inches by 3 inches and weighs but 4¾ pounds

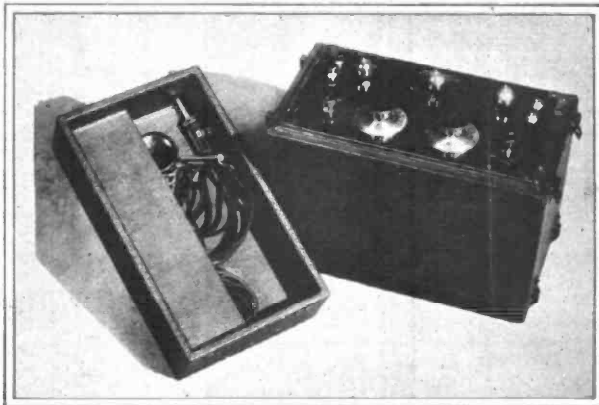

Here is the Kennedy Model III, three-tube portable receiver

extra tubes which have already proved to be good radio-frequency amplifiers and which can be kept as spares in case one of the tubes in the set should happen to die during the vacation. With such a provision as this, the portable set becomes an essential part of the equipment of modern vacationists.

With this article we are showing some of the better known manufactured portable sets which are now being put on the market for this coming summer. These are all standard and can be depended upon to give excellent satisfaction. The choice will lie entirely with the user and will be dictated by his pocketbook, by his peculiar individual needs, and by the appeal which each one makes to his personal fancy.

Following are the descriptions of the sets shown in the pictures:
Operadio Convertible—Something entirely new is revealed in



Right — the Kodol P12 two-tube portable receiver, which works a loud-speaker on local and nearby station. Entirely self-contained in a cabinet 5½ inches by 7½ inches by 9 inches and weighs 8 pounds

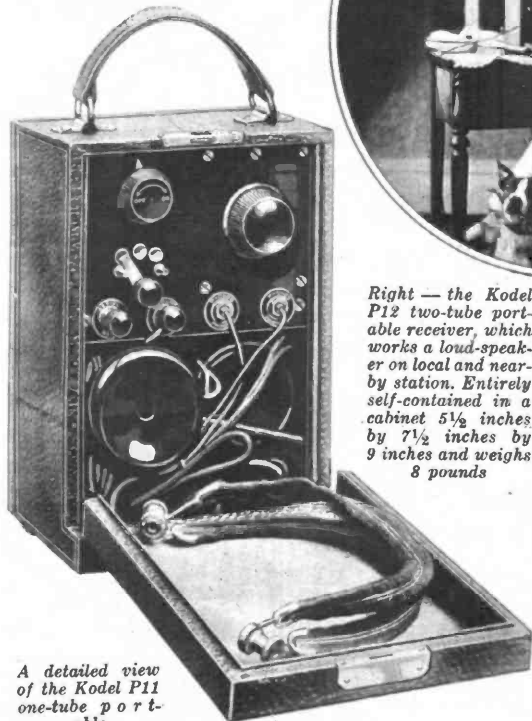

A detailed view of the Kodol P11 one-tube portable



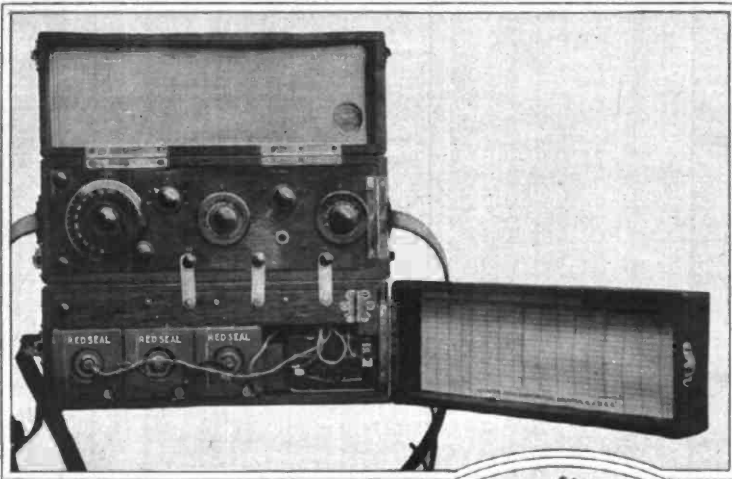

The Boonton Portable consists of two neat carrying cases, one containing the set itself and the other holding all batteries, phones and aerial and ground wire. The two cases are easily connected by three metal strips, as shown in the upper picture. The central photograph shows how the set can be swung out for easy access to tubes and parts. The lower picture shows the front panel with tuning controls

the announcement of the Operadio "Convertible." This pioneer of portable radios has combined a distinctive console furniture model with the well-known six-tube, self-contained portable Operadio.

The new "Convertible" is offered in two styles, the one a Windsor cabinet, and the other a pedestal model—the Empire. Both are finished in diamond-match stump walnut of heavy weight with finest of hardware, and though probably the smallest six-tube furniture models on the market today, they are of unusual solidity.

The convertible feature is of unusual interest. In console form the "Convertible" has every appearance of a permanent installation. The front door of the set drops down to form a shelf for the log sheet and the elbows while tuning. The panel is revealed, set in a walnut front easily accessible for tuning.

Back of the set in the rear of the cabinet is a loop aerial of new design. It incorporates the Operadio principle of plug-in-jack connection, and when in the set is in connection so that the set is instantly ready for unidirectional tuning. When directional loop effects are necessary, the loop is readily lifted from its place in the back of the cabinet and inserted through the lid into the jack on top of the set, thus being rotatable through 360 degrees. In order to fit the loop into the set, partial folding is necessary, and this is performed by pivoting the loop on its axis, the wires

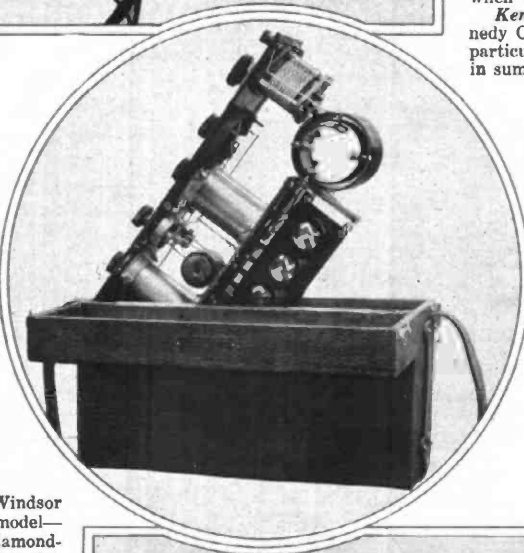

slipping through their anchors at the ends of the cross bars.

In furniture form the Operadio "Convertible" is complete in itself, compact, good to look at. But the new feature is the fact that the radio set itself is instantly portable. Although Operadio engineers have now seen fit to introduce the furniture model, they have refused to relinquish the feature of portability. Consequently the standard 1925 Operadio is located within the console. When portability is desired, the cover of the console is raised and the set is lifted out. The standard Operadio wave-bridge, or loop, which is also the cover of the portable, is then fitted in place and the set is ready to be carried away by its handle.

Of course, present owners of Operadio sets need only purchase the console in order to have an Operadio "Convertible." The console loop, being a part of the cabinet equipment, gives them a complete "Convertible" ready for immediate operation when their set is fitted in place.

Kennedy Portable Model 3—The Kennedy Company has put out a new Model 3 particularly for the use of the vacationist in summertime. This is not a compromise

set for the sake of portability, but is the full size set giving the same volume and using the same radio unit as their Model V.

The set itself is contained in a leather-covered case and phones and plug nest snugly into the cover. The dimensions are 13 $\frac{3}{4}$ x 13 $\frac{1}{4}$ x 8 inches and the weight is 25 pounds.

UV199 or C299 tubes are used and the set contains a detector and two stages of audio-frequency amplification. The "A" battery may be either storage or dry cells and a "B" battery voltage of 67 $\frac{1}{2}$ is recommended.

The tuning of the set is extremely simple and stations are found merely by the turning of one dial

(Continued on Page 35)

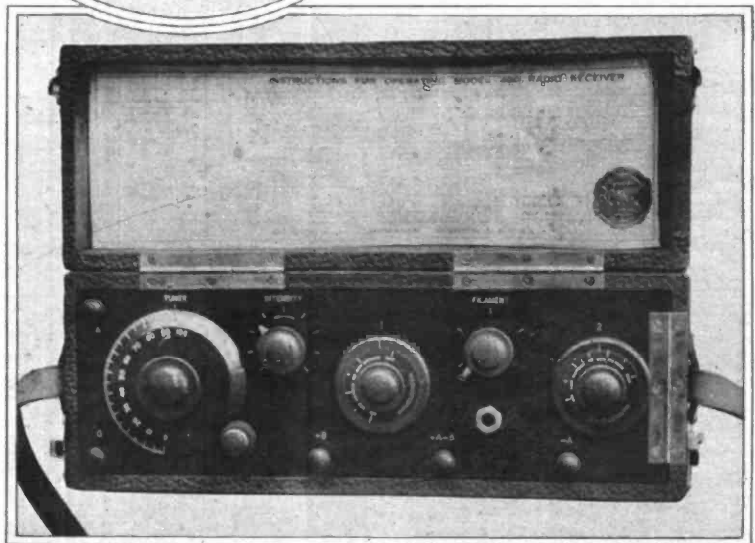

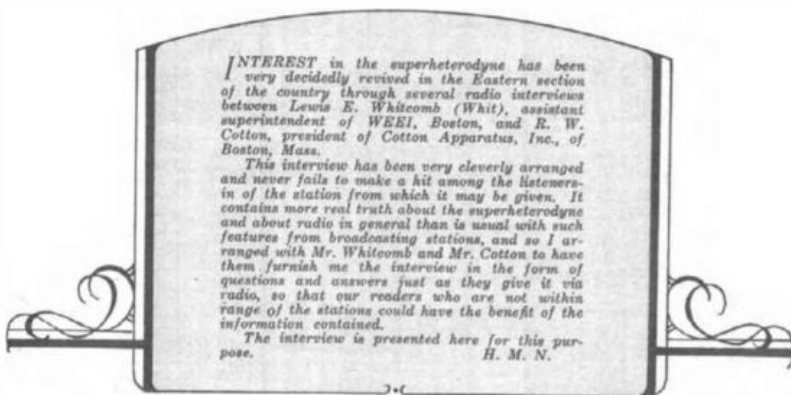

A Radio Interview on the Super-Heterodyne

Q. Dick, in your opinion, what is the best type of receiving set available today?

A. Without question or doubt the superheterodyne is the best system of broadcast reception.

Q. I have several friends who have superheterodyne receivers who do not seem to hold them in the same high opinion that you do. What do you believe to be the reason for this?

A. The reason for this is probably that the persons you refer to are not operating good superheterodynes, with emphasis on the good, or they are expecting too much from the sets themselves.

Q. These people I have reference to constructed their own superheterodynes. Is it possible that they are at fault in the construction of their sets?

A. The probabilities are, Whit, that it is not their fault.

Q. What would you say the reasons are for their poor results?

A. In most cases I would say that the trouble was due largely to one of two things. That is, either poor design or poor parts or a combination of both.

Q. Well, if this is true, how may one be assured of constructing a superheterodyne which you would class as good?

A. That is rather a difficult question to answer, as it involves many details, but in general I might say, first, obtain a design worked out by somebody in whom you have confidence. Secondly, use for parts those that are the best. Thirdly, be sure that you follow instructions faithfully.

Q. Do you believe that the average man can construct one of these sets if he has available the material as you state?

A. There is no question about this, as I have received many letters from people who have never before constructed any radio set, but have had no difficulty in building and operating a superheterodyne.

Q. You have recently written

a booklet on the subject of the superheterodyne, haven't you?

A. Yes.

Q. What does this booklet contain?

A. The booklet contains rather a non-technical discussion of the superheterodyne together with the diagrams, photographs, etc., showing how to construct a set with which I have had very good results.

Q. I am building one of your sets now, Dick, and will you guarantee that I can obtain Pacific Coast stations?

A. No.

Q. Why not?

A. For the simple reason that a guarantee of distance means nothing in radio.

Q. That is funny. I have heard a great many people say they would guarantee sets to receive certain distances.

A. That statement is true, Whit, but the receiving distance of a set is not altogether governed by the set itself, and a person is very foolish to guarantee reception when so many factors enter the field besides that of the set itself.

Q. What are these factors you speak about?

A. Probably there is no single factor which counts for so much in radio as the location in which a set is used. Also the weather conditions and interferences from man-made static.

Q. Well, what would you say was the receiving range of your superheterodyne?

A. The receiving range of this set may be roughly defined as follows: The set is capable of receiving down to the static

level, whenever and wherever it may be operated, and there are no sets with which it is possible to do more.

Q. What do you mean by the "static level" limiting the receiving range?

A. The static level is the point at which the signal from a broadcast station and the static are equal in strength, and it is obvious that you cannot receive a broadcast station when the static is stronger or equal to the strength of the broadcasting station's signal.

Q. What results have been obtained by owners of the Cotton superhet that you know about?

A. Whit, I prefer that people who operate this receiver answer this question, but I will state that people who have written me about the results they obtain do much better than I do myself with the same set. It may be of interest at this point to say that all the letters I have received to date from owners of the Cotton super have reported the West Coast on a loud-speaker.

Q. And still you do not guarantee California on the Cotton super I am building?

A. No, Whit, as I have told you before a guarantee of distance in radio does not amount to anything, as so many factors besides that of the receiving set itself enter into the field.

Q. Do the vacuum tubes have to be picked out with care for use in this set?

A. No; the set is not critical as regards the selection of tubes, although somewhat better results may be obtained providing a person has a set of matched tubes.

Q. Do you recommend storage "B" batteries?

A. Yes, I believe storage "B" batteries to be more economical in the long run in any multi-tube set.

Q. What is the wave-length range of the Cotton superhet?

A. The wave-length range in meters is from 215 to 550, and in this connection (Continued on Page 22)

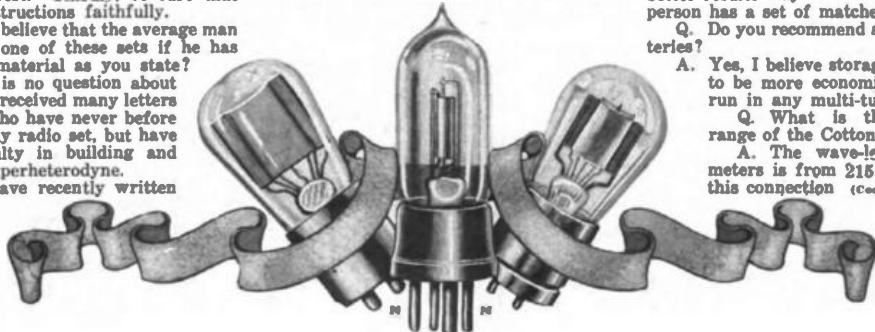

More About Low Loss

By E. T. FLEWELLING

Associate Editor of "Radio in the Home"

THE popular demand for low-loss radio parts, etc., is in itself sufficient answer to the question, "Does low loss pay?" There seldom is a popular demand for anything that is not worth while. As a student of the subject I can most certainly voice my sentiment on the question by suggesting ways and means for further securing the very desirable features obtainable when radio receivers are built with an eye to low-loss features.

The importance of this "low loss" business to my mind has been a bit overlooked. It seems to me to point to the next constructive step that radio is to make. If you have ever heard a set that even approached the low-loss idea, I'm sure you'll be on my side. One trouble so far has been that, as with everything else, it takes time, hard

tuning condenser so that the point of resonance is reached and we thereby tune in our station. Tuning in our station, then, simply means having our set so adjusted that it is in resonance with (in tune with, again) the incoming wave. Let's try to picture being in resonance with a station.

still hear it a bit at 350 meters. No selectivity at all, at all!

Look now at Fig. 2. Here we start to hear the station at 298 meters, maximum at 300 and lose it at 302 meters—a fair illustration of what a good receiver should do at this frequency.

But our volume has doubled. What is the answer? Several things of course enter into it, but among the very important ones are our coils and condensers, not to mention our old friend regeneration and multiple-tuned circuits, etc.

We can not go into a dry discussion of reactance, impedance, etc., but we can point out and emphasize this great big idea, namely that as every bit of resistance to the signal that we can take out of our coils, condensers, wiring,

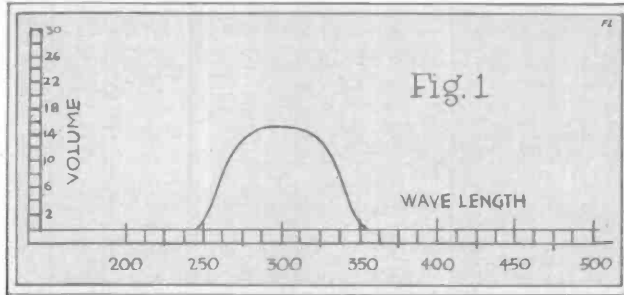

In Fig. 1 we have a yardstick marked in wave lengths from 200 to 600 meters—the broadcasting wave band. Another scale at the left of the yardstick measures the vol-

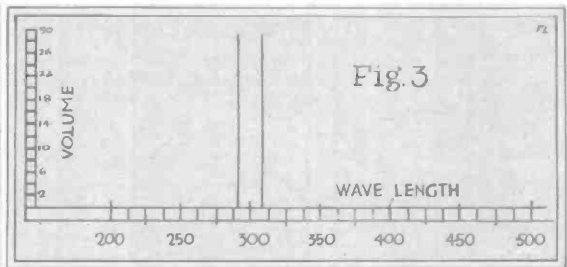
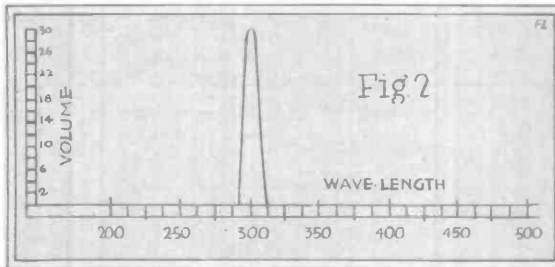

work and patience to develop the thing. We all know that Rome wasn't built overnight and that radio must go through its stages of development. To me "low loss" is a stage of development.

In last month's issue of *Radio in the Home* we printed a few suggestions about condenser design—suppose that in this issue we think about the coils and wiring of a radio receiver.

The coils that we are using nowadays in our radio receivers certainly do cover a multitude of sins, some that we know about and more that we do not. Your questions then, we will assume, are:

"How can I tell what is a good coil and what is not a good coil?"

"And what has wiring to do with it?"

All set? Let's go!

Perhaps the easiest way to take up the consideration of coils is to call to your attention one or two first principles in the usual manner. Consider first what we use coils for anyway. We use them to obtain sufficient inductance to match with our

ume of the signal. The higher up our resonance peak, the better the signal strength.

Notice that we start to hear the station when we really are tuned to only 250 meters; it is a maximum at 300 and we

etc., is removed, then just so much higher and more narrow will the signal be able to push the resonance curve and a nearer approach made to the curve shown in Fig. 3. Where the peak is—no man knows where. The curve has to have some width to it, you know, in order to let in all the high and low notes of the music—the harmonics—but the curve will show selectivity and large volume in proportion as the losses are removed. This statement has been proved enough times to be almost an axiom.

Different types of coils most certainly will give different results in a radio receiver, due not alone to their resistance, but also to the important fact that the shape of their fields, combining as it does with their resistance, has a marked effect upon the shape of the resonance curve for the receiver. Sufficient attention has evidently not been paid to see that the shape of the coil used is not such that it will introduce resistance to the receiver.

Pictures of a few of the coils in general use will perhaps show a few things that

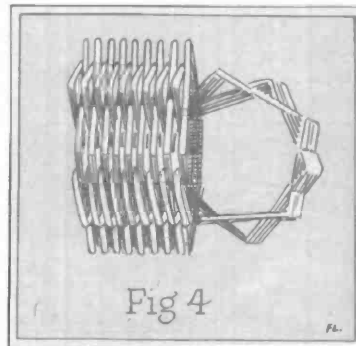

will help us out. In Fig. 4 is shown the Lorenz type of coil, Fig. 5 shows the popular spiderweb coil, Fig. 6 is the typical single-layer coil.

Perhaps it will be obvious why these coils are not the answer to the coil question if a few discrepancies in them are pointed out. First they are all insulated by the use of cotton or silk. These materials will absorb moisture from the air. This is one reason why our sets work better in the winter, when the furnace means dry air. The average radio set follows the weather.

Next about coils is that the self-supporting types of Figs. 4 and 5 must use extra length of wire (more resistance) for the sake of the self-supporting feature. These points are self-evident, and, of course, mean the abolition of these coils in the near future unless there is something to the claim for the spiderweb coil of Fig.

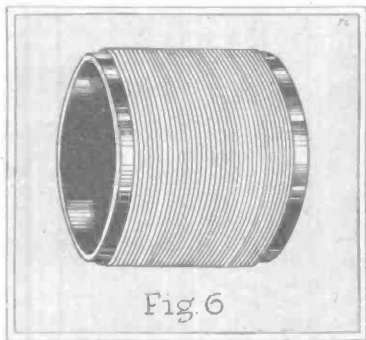

5 that its field is concentrated. This brings up the next point in the consideration of coils. *What kind of a field does the coil have and what has that to do with it?*

In testing this the writer used several methods, but if you care to do it yourself it is very easy to draw a complete picture of the field surrounding any radio coil.

First one must have an extra coil and condenser that will tune over the same wave-length range as the coil to be tested. Place the coil to be tested in an oscillating circuit, but be sure to isolate it from every part of the circuit. In our laboratory the circuit shown in Fig. 7—a plain regenerative circuit—is used. Oscillation is obtained by adjustment of the variometer L2, and the coil to be tested, L1, was suspended over a table free and clear from all the rest of the circuit, which was on another table. Fig. 8 shows the testing or exploring coil "X" with its variable condenser C2.

Now if the coil "X" is placed near coil L1, and the condenser C2 turned, you will find a point where a click will be heard in the headphones and the oscillation will stop. Place a sheet of paper under coil L1 and remove coil "X" to a point where you just hear the disturbance to the oscillation, when condenser C2 hits the right point. Place a mark on the paper at this point. Now gradually work around the coil L1 with your exploring coil, placing a dot at

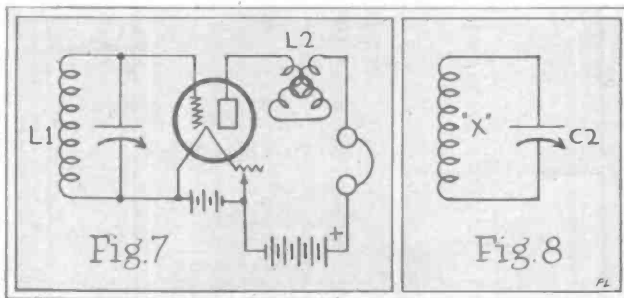

each point of disturbance and with experience and practice the outline of the field around the coil can be drawn. Of course,

thing like Fig 11. Your coin did three things. First it pushed the part of the field nearest it back toward the coil; second, it pushed it further out on the opposite side, and third, it can be shown that it also added resistance to the coil. Here at 9XBG these experiments were made with high power and it was very easy to see these things. How do we know that we added resistance to the coil? Well, reset



this operation would have to be carried out in all directions from the coil for the complete field. The field in the plane of the

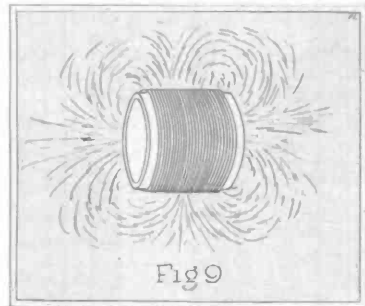
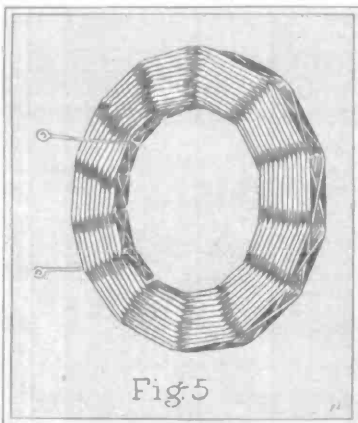

the variometer to the point where the set just oscillates. Now take the coin, a piece of bakelite, composition or whatever you will and, listening carefully, push the object into the field of the coil. If you use due care you will find that the set will stop oscillating when the object is sufficiently in the field. Read the dial on the variometer before you start the experiment. It is, say, at 26°. After the object is in the field and the set has stopped oscillating you can start it oscillating again by increasing the dial to, say, 27 degrees, that is to say by increasing the regeneration. Then we have the use of regeneration as a measure of efficiency of our apparatus. Provided the same conditions are used in each you can very readily test different materials this way and so tell for yourself which is best suited to your use.

Now for a little bombshell—has it occurred to you so far that the coin or object that you placed in the field of the coil *might have been a socket, a condenser, a panel or any other part of a radio set? That they all will distort the field of the coil and create a resistance? Even a piece of bus wire will do it!*

Here at 9XBG is a set that illustrates this point very well. It is such a circuit as shown in Fig. 7, except that the variometer is replaced by a tickler coil that turns inside of coil L1 thereby furnishing the regeneration. Coil L1 (Continued on Page 34)

Hear the Conquering Harmonica via Radio

WHAT is your favorite musical instrument? Is it the ultra-modern saxophone? Is it the kettle drum? Is it a Steinway grand? Are you interested in the restoration of the harp, which lost its place as a thing of beauty in homes of culture and is just being restored to its own? Does a Stradivarius violin, played by a master hand, raise you to heights of ecstasy?

Or are you modern of the moderns, and do you boast as your latest accomplishment that you can make Paul Whiteman sick with envy when you draw your harmonica out of your pocket?

"Modern of the moderns!" I hear you say, with scorn. "Why, I played the harmonica when I was a barefoot boy back in old Vermont. We called it a mouth organ." To be sure, this noble instrument has been in demand for many years. Back in the country when the town gallants gathered at the general store to play checkers, or swap yarns, there was always some one who could upset the checkerboard and get the feet a-stamping as he played an old-fashioned country reel. As a matter of fact, I am convinced that Whittier's barefoot boy did not really whistle as he sauntered along the country road in the clear sunshine, but that as he went he made the day melodious with "Old Black Joe" and "Abide With Me." What city dweller is there who does not recall being late for an appointment because some newsboy or bootblack had collected a mob about him while with eyes rolling, body quivering, he intoned "Rosy O'Grady" to your intense delight, while you were carried back to the days of your childhood?

But, behold! the harmonica has come back into its own. No longer is it to be a novelty employed by rustic simplicity or street-corner urchins. It has risen into the ranks of accepted musical instruments, and is playing a definite and important role in the musical life of America.

Its recent rise of fortune may be directly attributed to an enterprising New Jersey principal, who hit upon the idea of using the harmonica as a means of developing interest in music among his students. Most of us recall with shudders the attempts made in our grammar and high school careers to instill in us a love of harmony. We had no ear for music, we couldn't carry a tune, and we were always off key. The teacher blew a pitch-pipe at us and insisted that the sound it had made was called "C." For lack of defense we believed her and made desperate attempts to imitate this vocally; then we sang the song—at least that was what they called it. We sang all the

By GOLDA M. GOLDMAN

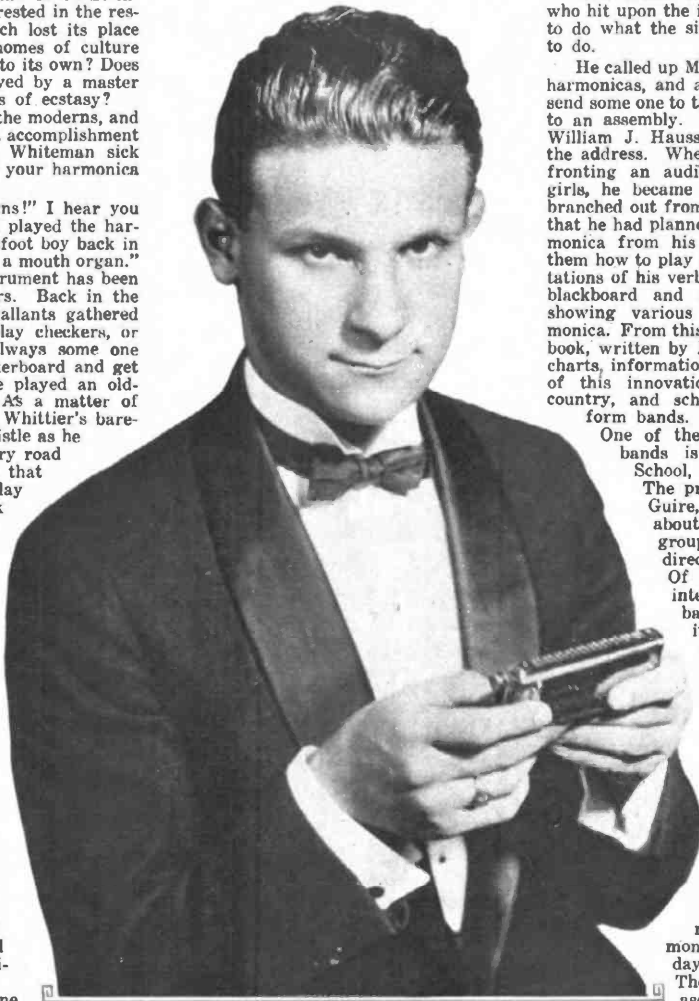

Borrah Minevitch, world-famous harmonica virtuoso, now featured with Elsie Janis in "Puzzles of 1925" at the Fulton Theatre, New York

accepted hymns, such as "Nearer, My God, to Thee" and "The Battle Hymn of the Republic," and we also assisted in the murder of other well-known compositions such as "Sweet and Low" and Mendelssohn's Spring Song. We even attempted to do them in parts.

The results were not usually all that could be desired, and conscious of our own limitations, the music period was a thing

to be dreaded on the part of all except the few who were naturally gifted.

Now comes this New Jersey principal who hit upon the idea of using harmonicas to do what the singing lessons had failed to do.

He called up M. Hohner, Inc., makers of harmonicas, and asked them if they could send some one to talk about this instrument to an assembly. The vice president, Mr. William J. Haussler, volunteered to give the address. When he found himself confronting an audience of 3000 boys and girls, he became so enthusiastic that he branched out from the little historical talk that he had planned, and, drawing his harmonica from his pocket, began to show them how to play it. Recognizing the limitations of his verbal talk, he turned to the blackboard and drew a great diagram showing various positions on the harmonica. From this talk grew an instruction book, written by Mr. Haussler, containing charts, information and music. The report of this innovation spread through the country, and schools all over began to form bands.

One of the most notable of these bands is that at Junior High School, No. 61, New York City.

The principal, Edward R. McGuire, started the organization about two years ago with a group of fifty boys under the direction of Mr. Aaron Keil. Of course, this widespread interest in the harmonica is based upon the actual qualities of the instrument itself. Mr. Haussler says of it:

"That educators throughout the country are realizing the educational significance and almost unlimited possibilities of the harmonica as a musical instrument is proved by the fact that one school after another is introducing it into its curriculum. In fact, hundreds of schools now have their own harmonica orchestras, and each day the number increases. The harmonica has truly ascended the ladder of popularity and it is now held up as a decisive factor in the shaping of the lives of the youth of the

land and inculcating a musical taste and appreciation in young America which will lead to a proper love of music. As a moral force, and still further, as of great social value, the harmonica is doing wonderful work.

"Practically all children have a love for music and every boy and girl has a natural yearning to play the harmonica, for it affords inspiration, education, recreation, happiness and musical accuracy. The harmonica is the only instrument of its kind and size that gives perfect intonation with-



Section of boys' Harmonica Band of Junior High School No. 61, New York, with Principal Edward R. McGuire (left) and Arron H. Keil, director (right), broadcasting as part of the "Hohner Harmony Hour" program from WEAF

out musical knowledge or ability on the part of the performer. "Consider the convenience of its size. What other musical instrument can one carry around in his pocket anywhere he may go, always ready for the production of melody? With the harmonica, when a boy wants music, he simply takes it from his pocket and plays. He does not have to tune it. It is always in tune. He can't make a mistake as to tone because the tone of each reed is fixed.

"Played at the time of life when his first musical ideas are being formed, he may have no definite musical ear, no conception of musical values, but the harmonica indelibly registers on his mind tones which are absolutely true. When, later in life, he may take up the piano, violin, cornet, trombone, or any other musical instrument in which he is interested, the fundamental perfection of tone gained from playing a harmonica will be of invaluable aid to him.

"Then there is the ease with which he can learn to play. A harmonica requires a certain degree of skill before it can be played well, but any boy can acquire it, and it will be a genuine pleasure for him to learn. There is none of the long, arduous practice which is required for the learning of other musical instruments.

"In a day or two he is adept at running the scale, which is all he needs for the melody. After that he develops his own ability to as high a degree as he wishes. Regardless of the ability of a person to carry a tune vocally, by playing the harmonica according to directions he has the proper tone to the last vibration.

"It should be remembered that the harmonica affords the simplest means of providing the fundamentals essential to a



Douglas Wakefield Coutlee, who is conducting the "Hohner Harmony Hour" programs over Station WEAF

Taking his weekly harmonica lesson during the "Hohner Harmony Hour" programs. Note the instruction books which the boy has received as a result of his request addressed to the radio station. The radio set is a Stromberg-Carlson neotrodyne

knowledge of music. That is but one of the reasons why musical authorities the country over advocate its use wherever boys and girls are found."

About the time that this great interest in the harmonica began to develop, interest in radio broadcast as a means of publicity was also developed, and it occurred to Mr. Douglas Wakefield Coutlee, who handles the publicity of M. Hohner, Inc., for the Charles C. Green Advertising Agency, that here was a medium made to order. Arrangements were made with Station WEAF for a series of Friday evening recitals which have become known as the "Hohner Harmony Hour."

And is this a popular feature? Well, rather! The hour is conducted as follows:

First, of course, comes the station announcement, that this hour has been engaged by M. Hohner, Inc. The name Hohner is not mentioned again in the program until the closing announcement. A typical opening announcement is as follows:

"The uplifting influence of music is today more generally appreciated than ever before. Its value and usefulness in education is recognized by leading authorities who are utilizing it in their work among the children of the public schools.

"By getting our boys and girls interested in music we automatically make better citizens out of them. But in order to arouse and hold their interest, they must be encouraged not only to listen to music, but to make music.

"In order to stimulate interest in good music by teaching people to play, a series of weekly harmonica programs and lessons are being broadcast from this station.

"These programs, known as the 'Hohner Harmony Hour,' are being conducted (Continued on Page 31)



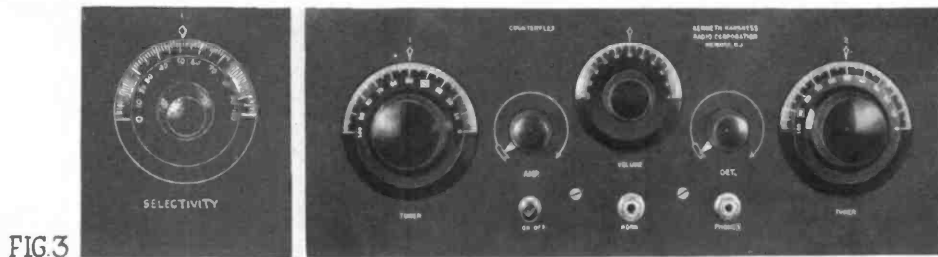

FIG. 3

Fig. 3—Stand the "selectivity control" beside your set

How to Make the Counterflex Super-Selective

QUESTIONS on the Counterflex circuit are still pouring in. I thought I had about cleaned up most of the important questions in the February and April issues, but it seems there are still a few unsolved problems in the minds of readers. I shall try to solve these problems this month.

I have received a good many complaints that the Counterflex is not selective enough. These complaints come from readers who live in districts surrounded by powerful broadcasting stations. Interference is experienced when these local stations are transmitting. I am asked to suggest some methods for increasing the selectivity to meet these conditions.

As I explained in a previous issue, it is quite easy to make any set more selective. The hard part is to work out some method of increasing selectivity which does not complicate the operation or decrease the sensitiveness of the set. You can add a stage of tuned radio-frequency amplification, or you can tune the antenna circuit and use loose coupling between the antenna and secondary circuits. Either of these methods will greatly increase selectivity and audibility as well, but they complicate the operation of the receiver and add materially to its cost. If either of these methods is used it is necessary to tune three circuits, whereas the standard Counterflex has only two tuning controls. These methods, therefore, are not necessarily the most desirable.

Another effective way of increasing the selectivity of a receiver is to decrease the amount of energy impressed on the set by incoming signals. The Counterflex is very selective when receiving distant stations, or even stations just a few miles distant; it is the local stations which alone cause interference. This is because the energy impressed on the receiver by local stations is very large as compared with the energy impressed by more distant stations. If the amount of energy impressed by local stations could be reduced, interference would be eliminated.

It is immediately evident, however, that one cannot decrease the amount of energy impressed by local stations without proportionately decreasing the audibility of signals from distant stations. If, by using a very short antenna, or by some other means, a receiver is permanently adjusted so that a comparatively small amount of energy is impressed on the amplifying circuits by the strong signals of local stations, distant signals will be very weak indeed. This method of obtaining selec-

By KENNETH HARKNESS

Associate Editor of "Radio in the Home"

tivity, however, can be effectively used if a variable adjustment is provided to enable the operator of the receiver to increase or decrease the amount of received energy at will and thus meet different requirements.

In Fig. 1 I show how to connect a "selectivity" control of this type to the Counterflex receiver. All you need is a variable coupling condenser; the three-plate Counterdon vernier condenser is ideal for the purpose. You can mount this condenser on a small 7 inch by 5 inch panel and stand it alongside your receiver as suggested in Fig. 3. Hook it up as shown in Fig. 1. Disconnect your antenna from the primary of counterformer T1 and connect it instead to one side of the coupling condenser. Connect the opposite side of this condenser to the grid of the reflex tube.

Now, by varying the capacity of the coupling condenser, you can increase or decrease the selectivity of your set to meet whatever your requirements may be. The selectivity of the Counterflex with this simple control added is surprisingly good. My laboratory is situated just a few blocks from WEAf and I can roughly measure the selectivity of any receiver by its ability or inability to tune in WJZ without interference from WEAf. Very few sets are able to do it. The Counterflex, with this added coupling condenser, is one of the few. With the coupling condenser at its minimum position I can tune in WJZ with excellent audibility and with absolutely no interference from WEAf.

This condenser, I may explain, acts as a capacity coupling

between the antenna circuit and the tuned grid circuit, the antenna being untuned. When the capacity is varied the coupling between these two circuits is varied, thereby enabling the operator to control the amount of energy transferred from the antenna to the amplifying circuits.

Fig. 2 shows the complete three-tube Counterflex circuit with this coupling condenser incorporated.

To use this system of controlling selectivity it is not necessary to change anything in the standard Counterflex receiver except to disconnect the antenna from the primary of Counterformer T1. All other connections remain unchanged. The primary of T1 is no longer used, but it is not absolutely necessary that this winding be removed. If it is allowed to remain the receiver will operate in very much the same manner as it did before the coupling condenser was added, except that the selectivity will be enormously increased. On the other hand, if the primary of T1 is removed, the resistance of the tuned grid circuit is reduced. This, of course, is an advantage, but it may throw the set off balance. If you remove the primary of T1 you may have to decrease the capacity of the fixed condenser across the secondary of the reflex audio-transformer, or remove this condenser altogether, the object being to restore the re-

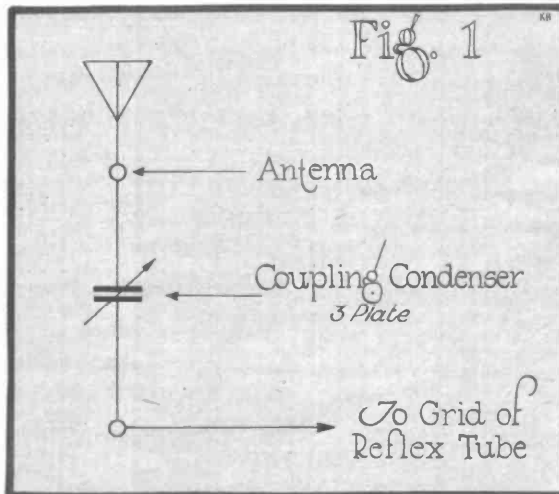

Fig. 1 — Selectivity control for the Counterflex

ceiver to its balanced state. In this connection, see my article in the April issue.

With this coupling condenser to control the amount of energy transferred from the antenna to the tuned grid circuit you need not be afraid to use a high, long antenna with the Counterflex. You can safely use an antenna 125 feet long, erected as high as possible. Decreasing the capacity of the coupling condenser has the same effect on selectivity as decreasing the length of your antenna.

In operating this system it will be noticed that variation of the coupling condenser changes the tuning of the first Counterformer, and also necessitates adjustment of the Counterdon.

It is not necessary, however, to adjust the coupling condenser continually. A value of coupling which provides the degree of selectivity your average conditions necessitate can easily be determined. The coupling condenser should then be left in this position and should only be changed when some unusual condition necessitates greater selectivity.

For instance, at my location and with my antenna, which is about 125 feet long, I set the coupling condenser at about 50, and this gives me the correct degree of selectivity under average conditions. However, if I want to tune in WJZ when WEAF is transmitting, I have to turn the coupling condenser to zero, thereby greatly increasing the selectivity of my receiver to meet this unusual condition.

The great advantage of this method of controlling selectivity is its simplicity. As can be seen, very few changes are required to incorporate the system in a standard Counterflex. Just one inexpensive condenser is required and the operation of the receiver is not complicated in the least.

Contrary to what one might expect, the average audibility is not decreased. In fact, since a long antenna can be used, the audibility is, in many cases, considerably increased. Only unusual conditions, such as I have described, necessitate extremely loose coupling between the antenna and the tuned grid circuit with consequent slight reduction in audibility.

If, upon adopting this method of obtaining selectivity, your set develops a tendency to pick up interference from electric light lines or other sources, these noises can be eliminated by connecting an inductance coil between the antenna and ground, as shown in Fig. 4. The exact value of the inductance coil is not important. It should have approximately the same value of inductance as the

Fig. 4—An extra coil eliminates power line interference

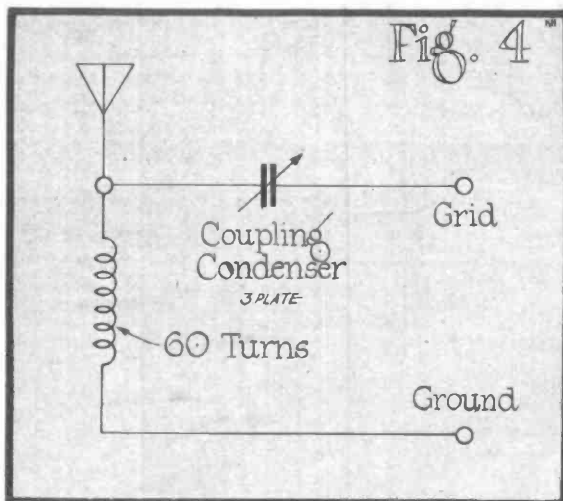

secondary of Counterformer T1.

And now, I hope the problem of interference is solved forever.

The next problem is "audio-frequency hum." Many readers have told me that their sets give forth a steady hum, which is especially noticeable when the Counterdon is at its maximum position. From the description of the symptoms, it appears that this hum is not the audio-frequency oscillations which are set up when the circuits are also oscillating at radio-frequency. This hum is present when the circuits are not oscillating at radio-frequency and can be produced by increasing the capacity of the Counterdon.

My experiments show that this hum is only produced when the audio-frequency transformers are wrongly connected in the circuit. In my diagrams I have been showing the terminals of the audio-frequency transformers as "P," "G," etc. Readers have wired their sets in accordance with these markings and yet have experienced this objectionable hum. This is unfortunately due to the lack of standardization in transformer markings. Some manufacturers mark the inside or beginning of the primary coil of an audio-frequency transformer as "B plus" and the outside or end of the primary coil as "P." Other manufac-

urers reverse these markings. Until some standard can be agreed upon and adhered to, therefore, the radio constructor should examine his audio-frequency transformers before connecting them in any circuit. Otherwise, howling may be caused by a primary coil which is wrongly connected inside the transformer, even though the markings on the terminals correspond with the circuit diagram.

In Fig. 2 I show how the audio-frequency transformers should be connected in the Counterflex circuit. In place of the usual markings I show the primary terminals of each transformer as P1 and P2, the secondary terminals as S1 and S2. P1 represents the beginning of the primary coil, on the inside, next to the iron core. P2 represents the end of the primary coil. S1 is the beginning of the secondary coil and S2 the end, the latter being the outside lead of the transformer. If the audio-frequency transformers are connected in the Counterflex circuit in this way, no audio-frequency hum will be experienced.

It will be noticed that Fig. 2 also shows how the primary and secondary of Counterformer T2 are connected in the circuit. In this case, terminal P1 is the beginning or left-hand lead of the primary coil and P2 the end. Similarly, S1 is the beginning of the secondary on the left-hand side and

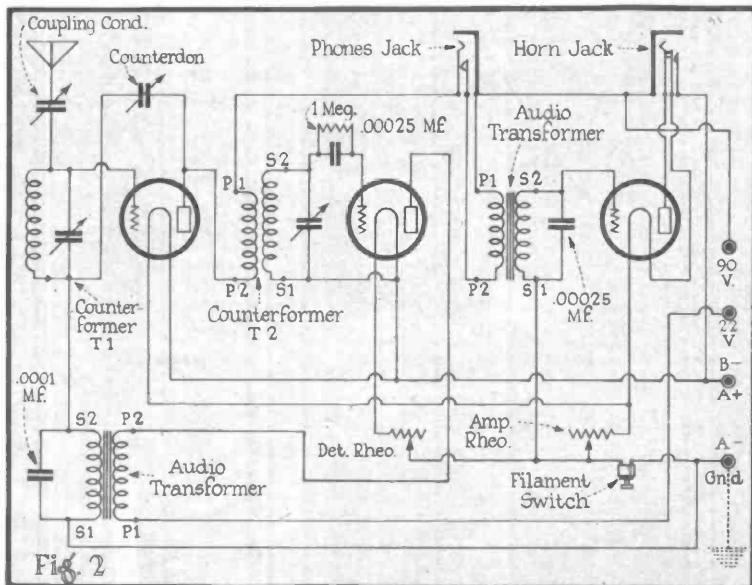

Fig. 2

(Continued on Page 62)

New Semi-Toroid Coils Make a Corking Good Set

IN OUR issue of March, 1924, we printed an article on "The Multiflex Tuned Plate Reflex," written by Edward A. Schleuter and Stuart Rogers, of Fresno, Calif. This set proved to be one of the most popular that we gave last season. It performed very satisfactorily for those who built it, and it seemed to present little difficulty in assembly or construction.

Two months ago, we received at Station 3XP a completed five-tube set sent to us by E. J. Gearhart, of Gearhart-Schleuter Radio Corporation of Fresno, Calif., with a letter asking us to put the set through all kind of tests which we could think of, and claiming that it was far better than their original Multiflex. Mr. Gearhart said that if this set did not bring in a California station from our laboratory at Delanco, N. J., I was to buy myself the best lunch that I could possibly find and send him the bill. Now it is extremely rare for us to get California at Delanco. Conditions at our laboratory are not even normally good, due to absorption of surrounding buildings and trees, and I think we have had Pacific

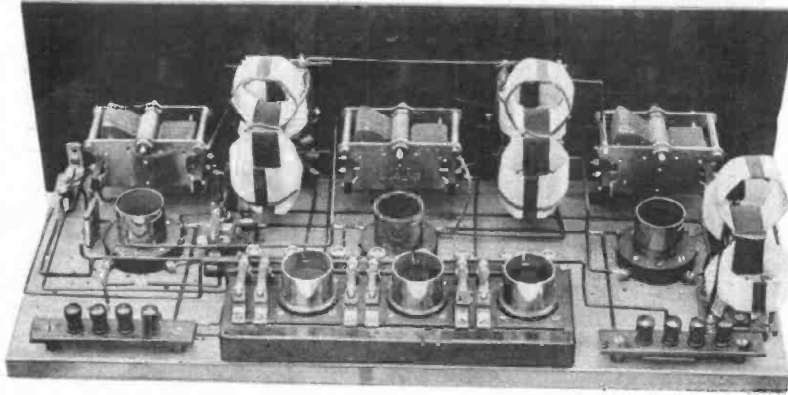

The whole layout makes a neat and symmetrical set. This is a view looking down from the rear

By HENRY M. NEELY

Coast stations only twice before we received this set.

The new set which Mr. Gearhart sent us had been on our test table only a few nights when I was compelled to write him that the lunch was on me because, while I wrote, Station KFI was booming in on the loud-speaker strong enough to be heard all over the room. We have received KFI two or three times a week on this same set ever since.

So far as the circuit itself is concerned, there is nothing new, and Mr. Gearhart does not claim any novelty. What he has developed is the new form of coil which is shown here in the pictures. You have all seen a great deal in the radio magazines

and why it is. If you will imagine taking an automobile tire in one hand and a spool of wire in the other and winding the wire around the automobile tire until you come to the place of beginning, you will, in imagination, have constructed a toroidal coil. It is a coil wound around a ring.

As to the "why" of the toroidal coil, you need go back only a year or two to remember the difficulty we encountered when we first tried to use two stages of radio-frequency amplification. We found that it was almost impossible to control the whistling that was due to what we call "feed-back." This feed-back was blamed upon the condenser effect of the elements inside of the tubes, but it was not long before most of us were convinced that this was only a small part of the reason and that much of the effect was caused by

How to Make the Quadraformer Receiver

By E. J. GEARHART, of Gearhart-Schleuter Radio Corporation

NON-OSCILLATING tuned radio-frequency amplification does not radiate.

For that one reason, if there were no others, it is far superior to the regenerative system.

Despite what others have written, when properly designed it is also far more sensitive and selective. Please note that I say *when properly designed*.

The big drawback to efficient tuned radio-frequency has always been the internal noises generated, due to the disturbing self-oscillations originating in the circuit. This was true also of circuits using the fixed radio-frequency transformers, so popular a year ago.

These self-oscillations were supposed to have been caused by electrostatic feedback through the minute capacity existing between the plate and grid of the vacuum tube itself.

Taking this theory for granted, most radio engineers, realizing that only a differently designed tube could correct this difficulty, spent their efforts in designing ways and means to damp out these oscillations.

Potentiometers, resistances, absorbing coils, so-called "neutralizing condensers" and other methods were adopted with more or less success, but every one of these methods suppressed a great deal of energy in order to stop the undesired attributes. In other words, such methods produced losses in themselves.

Mr. Edward A. Schleuter and myself did not believe that tube capacity was the real cause of the self-oscillations originating in the amplifier. We found, as have other recent investigators also, that it was caused instead of electromagnetic feedback between the various circuits in the set.

Electrostatic coupling in the (Continued on Page 24)

Permission is granted to the readers of "Radio in the Home" to use these circuits, diagrams and instructions for experimental use only. All the improvements described by Mr. Gearhart in this, and succeeding articles, are being protected by patents pending. Their use without authority would constitute infringement.

straying magnetic fields about various pieces of apparatus in the set.

This feed-back whistle was the cause of the neutrodyne scheme for balancing it out. It also gave rise to the potentiometer method of control.

In the neutrodyne, a small condenser is connected across two circuits in such a way that the tendency to feed back through the tube capacity is counteracted and killed by the neutralizing condenser or neutrons. In the potentiometer method the grid returns of the first two radio-frequency tubes are connected to the movable arm and the two outside connections of the potentiometer are wired to plus and minus on the "A" battery. Then swinging the movable arm from one side to the other places either a positive or negative bias on the grids of those first two tubes and this controls the tendency to oscillate.

These methods were made necessary because the ordinary form of coil wound upon a cylindrical piece of tubing creates a very widespread magnetic field all around it, and this field, clashing with the fields of other parts of apparatus, starts the tubes oscillating. Recent experiments have had for their object the development of some form of coil which would not have these widespread magnetic fields. In other words, we wanted a coil which had an equal amount of inductance, but which would confine its magnetic field very closely to itself.

Very many different types of coils have been developed for this purpose, but greatest efficiency seems to have been attained by means of the toroidal form of coil. Unfortunately, it is very difficult to wind this

at right angle to each other, and the tendency is for these four coils to keep the magnetic field going around in a circle much as it would do if the form were truly toroidal.

We have found this set to be about as easy to hook up as anything we have ever tried. It is virtually fool-proof and any one with even a rudimentary knowledge of

various points of construction. For the present we are giving here the regular 3XP-style wire-ups of the Quadraformer receiver with the Daven unit. It seems to me that the diagrams and the check-up list are so very complete in themselves that no further article is necessary. Mr. Gearhart is printing herewith an article about the theory of the new Quadraformer coils

and his instructions for making them. Personally, I would advise that you buy these coils unless you are quite expert in radio work. Instructions for making coils of this kind sound simple enough, but I can assure the novice that he is going to run into some trouble before

he gets done if he tries to wind them himself. The average experienced amateur can get away with it, but I think the novice would much better buy his coils complete.

Mr. Gearhart's article speaks for itself. I have told what we have been able to do with this set and so nothing is necessary now but the printing of the diagrams and the check-up list which follows:

- List of Parts:
- 1 7x24x3/16 panel.
 - 1 9 1/2x23x3/4 baseboard.
 - No. 1—1 103 Carter jack condenser.
 - No. 2—1 .0005 mf. Cardwell variable.
 - No. 3—1 Quadracoil.
 - No. 4—1 10-ohm. rheostat (Pacnet).
 - No. 5—1 .0005 mf. Cardwell variable condenser.
 - No. 6—1 Quadracoil.
 - No. 7—1 30-ohm Pacnet rheostat.
 - No. 8—1 .0005 mf. Cardwell condenser.
 - No. 9—1 No. 3 Carter jack switch.

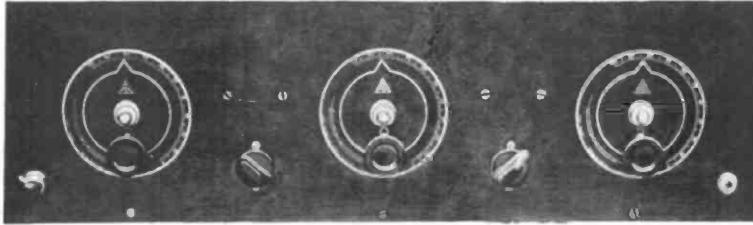

Front view of panel showing the neat way in which the vernier dials and rheostats are mounted

how to hook up a radio set ought to be able to put this five-tube outfit together and get the same results we have had with it.

After using Mr. Gearhart's completed set, we wired him for a set of the coils and put the circuit together ourselves, using the Daven Superamplifier, with three steps of resistance-coupled audio-frequency amplification. We found that this combination gave a set which ought to satisfy anybody for pure quality of tone, distance, volume, ease of assembling and all-around efficiency. Wired up in this way, you have a six-tube set.

In this month's article we are showing the set hooked up to this Daven unit. I am firmly convinced that this unit, just as it comes from the factory, is worth the difference in price between it and the parts necessary to build it. We have been un-

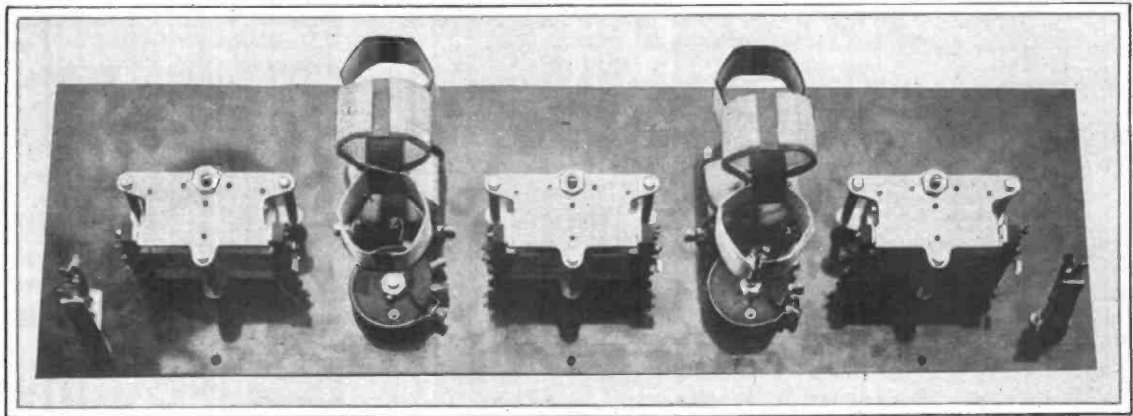

Rear view of panel showing apparatus to be mounted before wiring

form by machinery. Two or three manufacturers have recently developed methods for doing this, but the amateur finds it almost impossible. What Mr. Gearhart and his partner have done in this new set is to develop a semi-toroidal form of coil. That is, instead of having the winding of the wire go continuously about a ring, they have placed four small coils in series, set

able to build a resistance-coupled amplifier which was as good as the factory-made unit. Next month we will show this same circuit connected to the regular audio-frequency transformer outfit. Mr. Gearhart will also have an article next month on

- No. 10—1 1A Amperite and mount.
- No. 11—1 .002 mf. Micadon fixed condenser.
- No. 12—1 General Radio standard sockets.
- No. 13—1 .0006 mf. Micadon fixed condenser in Daven condenser mount.
- No. 14—1 5 meg. Daven grid leak and amount.
- No. 15—1 General Radio standard socket.

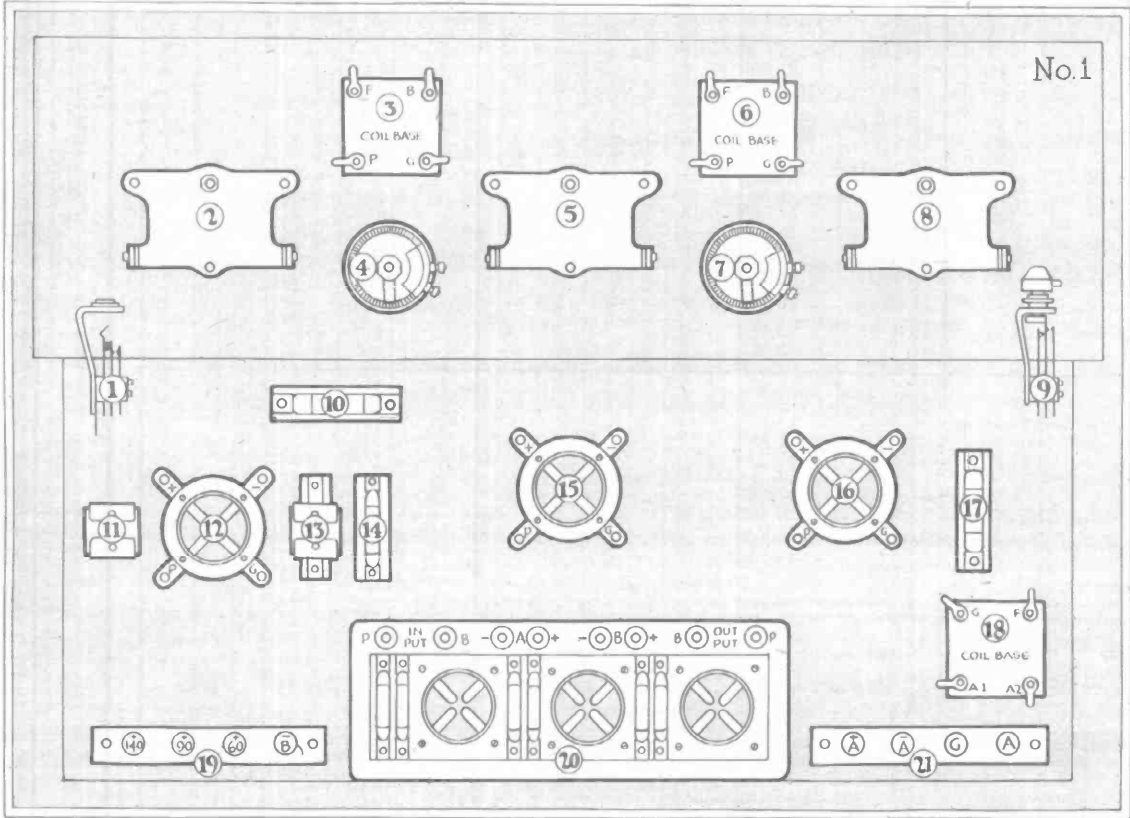

- No. 16—1 General Radio standard socket.
- No. 17—1 1A Amperite and mount.
- No. 18—1 Quadracoil (aerial).
- No. 19—1 Binding post strip with 4 Eby posts.
- No. 20—1 Daven Super-amplifier.
- No. 21—1 Binding post strip with 4 Eby posts.

Diagram No. 2

- Wire No. 1—from A1 on coil base No. 18 to bottom blade jack switch No. 9.
- Wire No. 2—from A2 on coil base No. 18 to top blade of jack switch No. 9.
- Wire No. 3—from aerial binding post on binding post block No. 21 to center blade of jack switch No. 9.

Arrangement of apparatus just as we laid them out on the set

- Wire No. 4—from +F on socket No. 12 to +F on socket No. 15 and on to +F on socket No. 16.
- Wire No. 5—from ground binding post on binding post block No. 21 to A+ binding post on block No. 21. Then to nearest point on wire No. 4.
- Wire No. 6—from +A on Daven amplifier No. 20 to nearest point on wire No. 4.
- Wire No. 7—from -B binding post on

Below is the panel layout for the Quadraformer with resistance coupled amplifier. The panel is 7x24x3-16 Celeron

strip No. 19 to nearest point on wire No. 4.

- Wire No. 8—from -A binding post on block No. 21 to top blade of jack No. 1.
- Wire No. 9—from next to top blade of jack No. 1 to front of amperite No. 10 and on to front of amperite No. 17.
- Wire No. 10—from center connection of rheostat No. 4 to nearest point on wire No. 9.
- Wire No. 11—from center connection of rheostat No. 7 to nearest point on wire No. 9.
- Wire No. 12—from rear of amperite No. 10 to -F of tube socket No. 12.
- Wire No. 13—from lower binding post of rheostat No. 4 to -A binding post of

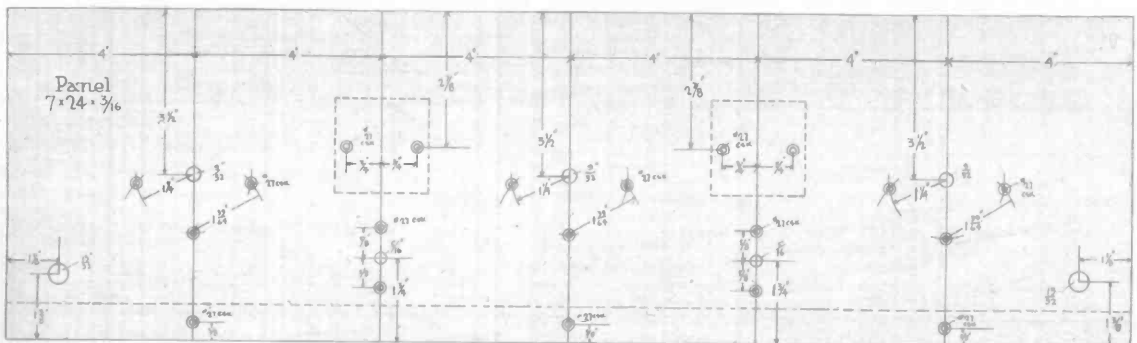

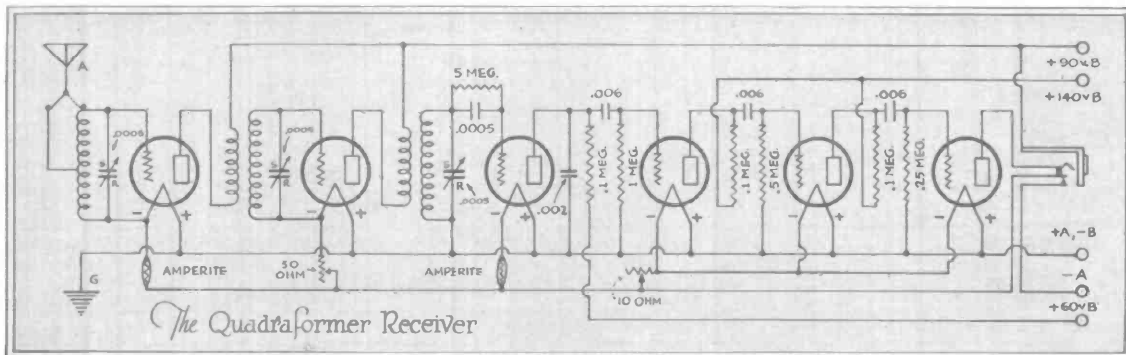

Daven super-amplifier No. 20.

Wire No. 14—from lower binding post of rheostat No. 7 to —F connection of tube socket No. 15.

Wire No. 15—from rear connection of amperite No. 17 to —F of socket No. 16.

Diagram No. 3

Wire No. 16—from grid connection of socket No. 16 to grid connection of coil No. 18 and to stator plates of variable condenser No. 8.

Wire No. 17—from —F of socket No. 16 to F on coil No. 18 and to rotor plates of variable condenser No. 8.

The schematic diagram of the new Quadraformer

Wire No. 18—from G connection of socket No. 15 to stator plates of variable condenser No. 5 and to G connection of coil No. 6.

Wire No. 19—from —F of socket No. 15 to rotor plates of variable condenser No. 5 and to F on coil No. 6.

Wire No. 20—from grid connection of socket No. 12 to one side of grid condenser

Filament, Aerial and Ground Wires

No. 13 and grid leak No. 14.

Wire No. 21—from other side of grid leak No. 14 and condenser No. 13 to stationary plates of variable condenser No. 2 and to G of coil No. 3.

Wire No. 22—from +F of socket No. 12 to rotor plates of variable condenser No. 2 and to F of coil No. 3.

Wire No. 23—from +F of socket No. 12 to front of fixed condenser No. 11.

Diagram No. 4

Wire No. 24—from P connection on socket No. 16 to P connection on coil No. 6.

Wire No. 25—from P connection on

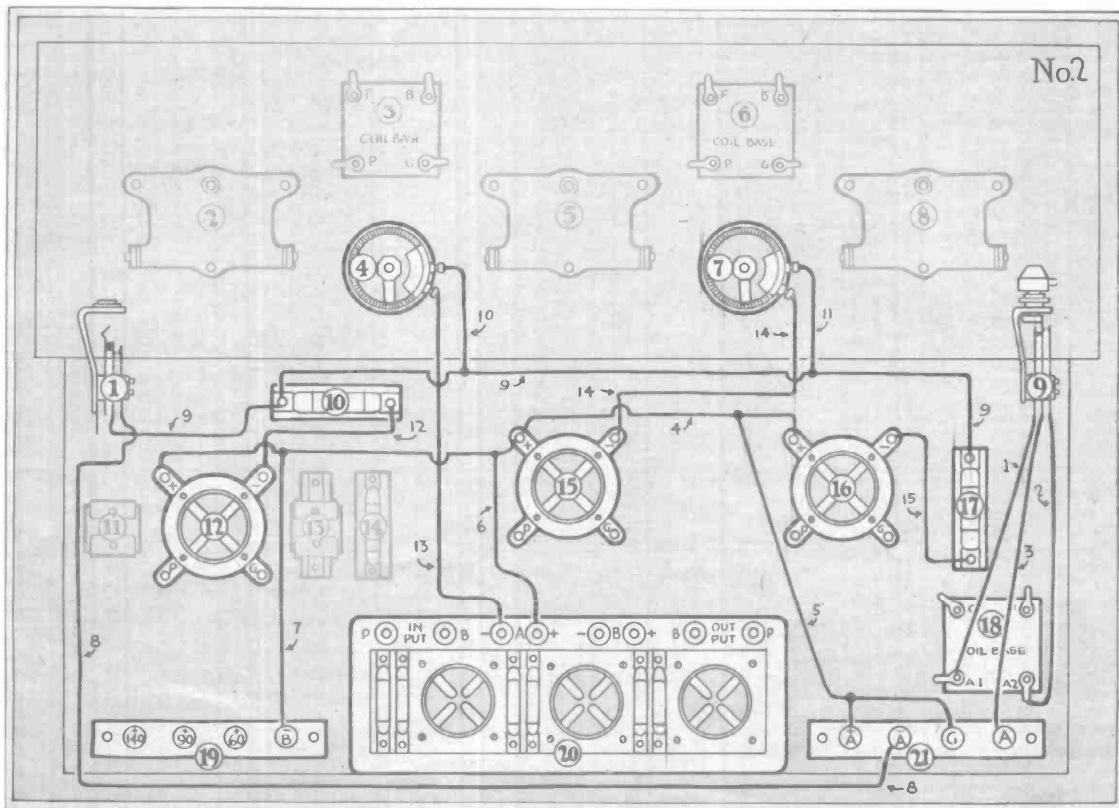

socket No. 15 to P connection on coil No. 3.

Wire No. 26—from B binding post on coil No. 6 to B binding post on coil No. 3 and on to the +B 90-volt binding post on strip No. 19.

Wire No. 27—from plate of socket No. 12 to plate input terminal of Daven super-amplifier No. 20.

Wire No. 28—from B input terminal of Daven super-amplifier No. 20 to +60-volt B binding post on strip No. 19.

Wire No. 29—from plate connection of socket No. 12 to rear of fixed condenser No. 11.

Wire No. 30—from +B 140-volt binding post on strip No. 19 to +B binding post of Daven super-amplifier No. 20.

itself, although it can cause distortion. The use of modern low-loss condensers entirely removes any trouble from this source.

Knowing the cause, we determined to eliminate it entirely, instead of merely suppressing it, as others had done. Coils can be made of low voltage amplification and carefully placed so that their fields do not clash, but that also reduces the possible efficiency greatly.

We wanted high grid voltage with no coupling between coils. That meant designing a coil with no external magnetic field. For if there were no external fields there certainly could be no coupling.

Consider the ordinary tuned radio-frequency transformer in Fig. 1, Page 34.

that the magnetic lines of force are thrown off by one pole of the coil and are attracted by and return to the opposite pole. Naturally, since we are dealing with alternating current this polarity is constantly reversing itself rapidly, but at any given instant the statement just made is true.

It was with this law in mind that we set out to design a coil that would have no external and no stray fields.

The design shown, in simplified form, in Fig. 2 (and fully covered by patents pending) is the result of many experiments.

Four small coils, connected in series and arranged as shown, form the secondary of the transformer. A is the beginning of the winding and B its end. All four coils, at a

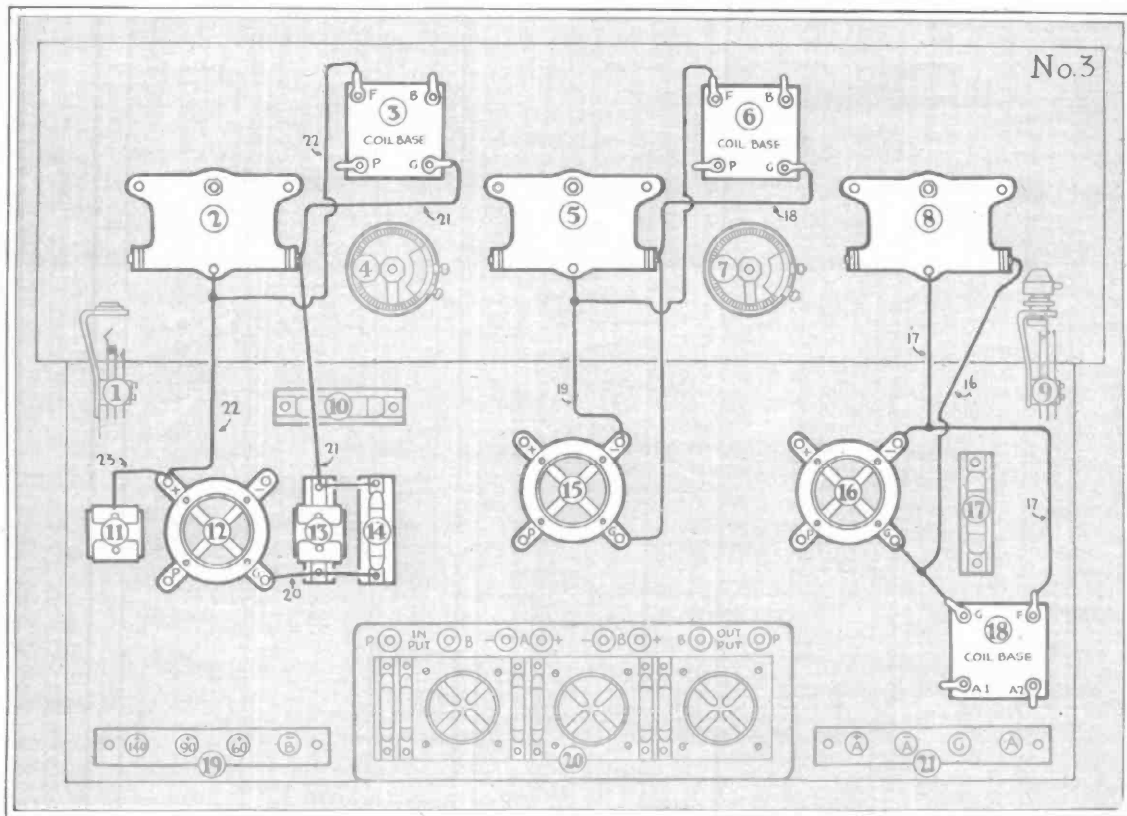

Wire No. 31—from nearest point on wire No. 26 to bottom blade of jack switch No. 1.

Wire No. 32—from P output binding post on Daven super-amplifier No. 20 to next to bottom blade of jack No. 1.

How to Make the New Quadraformer Receiver

(Continued From Page 20)

wiring layout and the condensers is partly to blame, but it is not nearly as important as the electromagnetic coupling between the coils of the set. If the electrostatic coupling is entirely removed, electrostatic coupling does not cause self-oscillations in

Grid and Grid Return Wires

Assume that the transformer is in a radio-frequency amplifier and tuned to resonance.

At a given instant, most of the magnetic flux flows as is roughly shown by the lines A, B and A1, B1, the density and extent of the field being determined by the electromotive force (EMF) flowing in the coils. Other portions of this magnetic flux stray off as at C and C1 and cause what is known as "end losses."

It is the clashing of these electromagnetic fields about the various instruments in a set that causes distortion and the radio-frequency self-oscillations. Note

given instant, are in polarity. Each coil attracts the magnetic lines of force of the coil next to it, and much like a dog chasing his own tail, produces a continuous flow of magnetic flux inside the coils, with a minimum amount of leakage and no end losses.

By simply adding a properly designed primary winding of the same style, as shown in the wiring diagram in Fig. 3, we have a radio-frequency transformer that when used in a tuned radio-frequency amplifier completely eliminates all internal noises in the set, instead of merely offsetting them. It does away with all complicated devices heretofore thought necessary.

All of the radio energy is utilized in developing the true signal. Speech and music

come in with rich sweet tones and with a volume that is surprising to the most hardened experimenter.

Except for three transformers, standard equipment is used throughout in the construction of this remarkably different receiving set.

The transformers, known commercially as Quadroformers, may be purchased in matched sets of three, but for the man who likes to "roll his own" the following directions, if carefully followed, will result in a set of transformers equal in most respects to the factory product.

The four little coils that make up each transformer could be wound on separate bakelite tubes, but this would introduce unnecessary dielectric losses into the circuit.

onto its end. Make the mandrill fit snugly, by shimming, if necessary.

Bend one layer of very thin sheet steel (shim steel is just the thing and can be purchased at any auto supply house) around the mandrill and fasten with a rubber band at each end.

Procure a ten-cent roll of quarter-inch photo mending tape. Place a strip of the tape 1½ inches long on one face of the winding form at the extreme right, gummed side up. Starting about a quarter of an inch from the end of the tape wind on 29 turns of No. 21 DCC magnet wire. Dope coil lightly with pure collodion and let dry. Bend wire to left, and starting ¼ inch from the end of coil No. 1, wind coil No. 2 in the same manner, tape and all. Dope

same way wind the primaries of No. 3 and No. 4 and finish the coils. Be sure to leave five or six inches of wire at the beginning and end of the series of secondary and primary coils for connecting leads of the transformer.

The steel form can now be slipped off the wooden mandrill and by bending it in, the windings can be slipped off.

Complete another transformer winding exactly like the first.

These two, when mounted, will be the second and third transformers in the set. To make the aerial and ground coupler, wind a series of coils in the same manner, leaving off the primary coils, as we will use conductive coupling in our completed set. Tap the center of the first coil. To

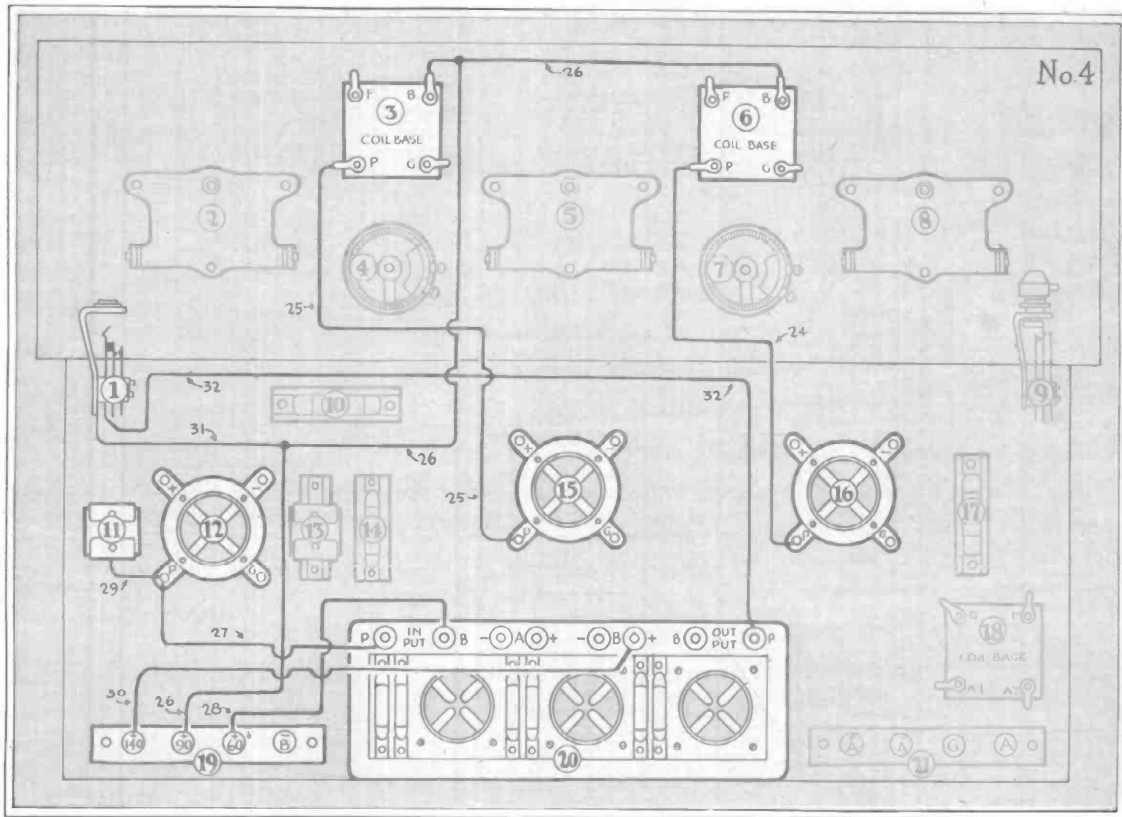

So I will describe a method to make them in real low-loss style, with no dielectric in the fields of the coils at all.

This will require a special little winding machine that is easily made at home.

You will need a mandrill of wood 1¾ inches in diameter, 6½ inches long, hexagon shaped. (See Fig. 4). Drill a ¼-inch hole in the exact center of one end. Procure a one-foot length of ¼-inch brass rod. Bend this at one end to form a crank handle. Get two standard iron angles ½ x 1½ x 2½ x 2½ for the standards. Screw the angles down on a baseboard, about four inches apart, and in line. Insert the brass handle through the two top holes of the brackets and slide the wooden mandrill

Plate and "B" Battery Wires

end dry. In the same way make coils No. 3 and No. 4. This completes the winding of the secondary coils.

At the end of coil No. 1 wind one turn of string for a spacer and tie, cutting off closely at knot. Then wind three turns of No. 21 DCC wire, dope with collodion and dry. Now turn up ends of binding tape, bend over coil and fasten down, thus binding the complete coil. Bend the wire running down, thus binding the primary coil of No. 1 over to the end of coil No. 2, first putting on the spacer string, and wind three turns for the primary of coil No. 2. Finish coil No. 2 as you did No. 1. In the

mount the coils you will need three little hardwood blocks 1¾ inches square and ¾ inches long, three little squares of bakelite or hard rubber 2 inches by 2¼ inches, drilled as shown in Fig. 5, and three strips 2¼ inches by ½ inch, also drilled as shown, machine screws, nuts and lugs for terminals, and a few strips of photo-mending tape.

Mount each transformer as follows: Bend the coils around the block of wood, so that each coil of the four making up the transformer is at right angles to the adjacent coils. Bind securely to the block with a strip of the photo-mending tape. Prepare the base and clamping strip of bakelite or hard



Above—Captain H. A. Bruno, program director and chief announcer at WEBJ of the Third Avenue Railway System, New York City

Below—Garrow T. Geer, secretary of the Third Avenue Railway System and executive director of WERJ



From In the Air ~~ to ~~ On the Air

By MARY GRAY REED

OF COURSE any one who is going to run a radio station should be thoroughly familiar with "taking the air." That is probably why Bruno and Blythe, the inseparable and, to me, almost indistinguishable pair at the Red Trolley Broadcasting Station WEBJ, were as much at home in the studio in the first week as veteran managers and announcers are after a year of experience.

It is not that the two men are similar in physical appearance which makes them so hard to tell apart, for Richard R. Blythe is much the taller and brawnier of the two. In manner, however, there is a strong similarity. The prevalent atmosphere at WEBJ is that of a home, and one is inclined to feel that one is being cordially welcomed by the two sons of the house. It is through experience, however, that they really became blended and fused into one person, for their interests and their tastes and their experiences have been almost parallel.

Bruno grew up in Montclair, New Jersey, while Blythe was raised in British Columbia, so that their antecedents are quite different. Yet in the wilds of the Saskatchewan country and in the midst of civilized New Jersey the two boys found a similar hobby in their love for airplanes.

When young Bruno was only 17 he built and flew the world's smallest airplane. These flights took place at Montclair, New Jersey, and the recognition of their inventiveness made young Bruno a member of the United States Aeronautical Reserve, the members of which included such well-known men as Wilbur and Orville Wright and Glenn H. Curtiss. It was necessary for a special ruling to be made by officials of the reserve before he could be admitted, due to the fact that he was only 17.

This was at a time when aviation was in its infancy, and in 1912 his parents objected to his experimenting along these lines any more. Then his thoughts turned to wireless, and while still at high school he had one of the first amateur wireless stations in the country and formed a company to sell wireless receiving sets to other



Above—Captain Richard R. Blythe, assistant program director and announcer of Station WEBJ
Photo (c) Stafford Meeson

Below—Jimmie Clarke and His White Way Entertainers are heard once a month from WEBJ



amateurs. When the war broke out, he returned to his first love and eagerly enlisted in the British Royal Flying Corps then being formed in Canada.

Meanwhile Blythe's father had discovered gold in a large sand and gravel pit and moved to Victoria, B. C. This tremendous piece of good luck meant that the family had sufficient money to allow young Blythe to play with his hobby of airplanes.

His first practically successful motorless glider was finished and made trial flights from the hill at Beacon Hill Park, Victoria. Blythe's interest in this was interrupted by the outbreak of the war and he enlisted in the Fiftieth Gordon Highlanders in 1915. After a year of active service, he was sent to Southern California to recuperate. Quiet life did not appeal to him and he became by turns movie actor, commercial airplane builder and cross-continent motorcyclist. This last adventure terminated in his becoming mixed up with the Mexican bandits and the Pershing Expedition and four wound scars testify that he found plenty of excitement here. Eventually he found his way back to Canada and in August 1918, he too joined the Royal Air Force. This is where the histories become definitely joined. From this time on both became writers and lecturers on subjects relating to aviation and together they made the first circumnavigation of the Great Lakes in a flying boat. Both were working with important aeronautical boats, Bruno having become chairman of the Association of Aeronautic Executives, his earnest pioneer work having merited a letter of commendation from President Harding, while Blythe had been vice president of the Aero Marine Companies.

In 1923 they formed a partnership for the purpose of handling advertising publicity for aeronautical and other clients.

So at the age of thirty, with a lifetime of thrills and achievements at each of their backs, they have once more become partners in the management of the broadcasting station of the Third Avenue Railroad systems of New York, and to cap the climax, they both wear Royal Flying Corps neckties and have small mustaches and both boast in a real foolhardy manner of the fact that they are single. How could any young woman interviewer hope to keep them unconfused in her bewildered and impressed mind? Now for Station WEBJ itself. This is the first partly equipped radio broadcasting station to be owned and operated by a street railway company. It is located on the roof of the executive offices and trolley barns at 30th street and 3d avenue. It was entirely constructed by members of the electrical station and under the supervision of W. J. Quinn, chief electrical engineer manager of the company. One of the most amazing facts about it is that it was constructed in two months.

The executive director of the station is Garrow T. Geer, who is also secretary of the Third Avenue Railroad Company. Mr. Geer is a native of Oyster Bay, Long Island, and is a newspaper and railroad man of long experience. He was on the staff of the New York Times for two years, in which capacity he traveled to California and New Mexico. On his return east, he became editor of the B. R. T. monthly. This concern went into receivership and Geer became secretary to Lindley M. Garrison, the receiver, until three years ago, he became associated with the Third Avenue

R. R. system as executive of the company. He has always been interested in radio, and when the question of operating a broadcasting station came up, he was one of the first to indorse the idea. The station is still young and its policy is still developing, but Mr. Geer has a number of ideas for making it a center of usefulness to the community.

Originally the sole idea of the station was to give amusement to the company's own employes and to the residents in the territory which is served almost exclusively by the Third Avenue Railway system. This includes the borough of Bronx and the Westchester counties of New York State. The desire is to present not only amusement of a high type, but also industrial features that would be of value to these people, possibly in conjunction with local boards of trade and chambers of commerce. Some of the regular entertainers who appear most often on the WEBJ programs are already well known.

One of these is Jimmy Clarke, a versatile young man connected with the music publishing house of Irving Berlin. He has introduced through Station WEBJ a new broadcasting feature, consisting of an international review presented by artists

from many countries. This review is an exclusive feature at WEBJ, although he, himself, does appear at other radio stations.

Jimmy Clarke appears regularly at WEBJ with his White Way entertainers. He, himself, is a wizard at syncopation on the piano. His review mostly includes anywhere from five to a dozen well-known Broadway favorites, such as "The Kaufman Brothers," "Hope Vernon," and the eight Vodka singers, who are now being presented by Ed Wynn at his "Grab-Bag Review."

I always think that the listeners-in who can't see the broadcasters, particularly the attractive girls who do their bit in the studios, are missing a great deal. WEBJ is fortunate in having as a frequent visitor Henryetta Turner, a young lady of extraordinary accomplishments. She is popularly known as the "Ukulele Girl" because of her sweet voice and ukulele accompaniments, although she also plays the piano remarkably well.

Her favorite purpose in life is to succeed in the business world, where by day she is connected in an executive capacity with a large Fifth Avenue dress concern. Her evenings are not spent in idle pursuit of amusements. On the contrary, when she is not broadcasting at the Red Trolley barns, she is taking ukulele or advanced vocal lessons.

If we had not published the accompanying picture of Miss Turner, we could have sprung a nice little surprise on you by adding that she is a hoola dancer of such note that she has been called "Ned Wayburn's Star Pupil."

This picture was not at all her idea of how she should be introduced to her radio audiences, but I think it is much too good to be missed.

In order that the boys may gain as much worthwhile knowledge as the girls, I may add that Bruno and Blythe are not the only unmarried members of the WEBJ broadcasting corporation, for Miss Turner's heart is also fancy free.

Some day, when we are able to have radio transmission of vision as well as of sound, I think perhaps Miss Turner will be even more popular than she is now.



Henryetta Turner, the ukulele girl, another feature at WEBJ

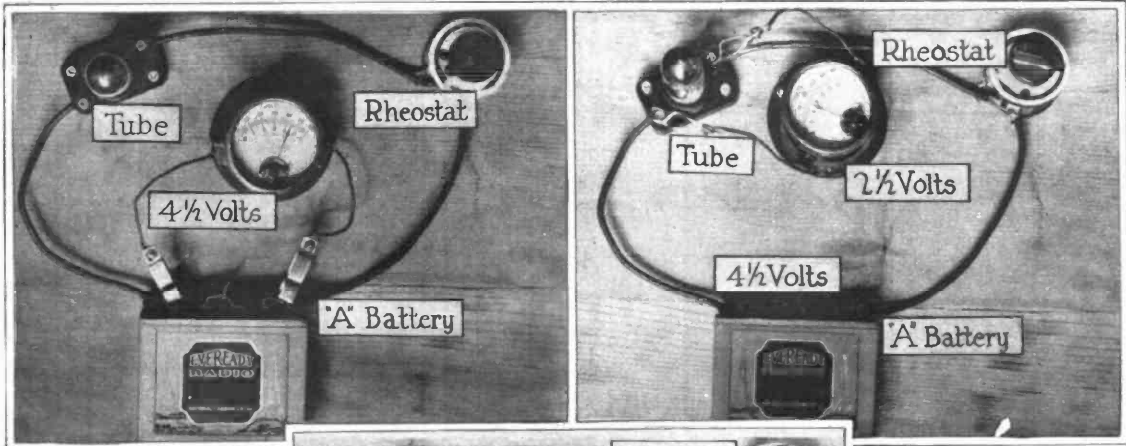

Fig. 1—The filament circuit includes the "A" battery, tube filament and rheostat. Current leaves at the positive battery terminal, traverses the circuit and returns at the battery's negative post. What voltage is the tube getting?

Fig. 2—Placed across the tube filament, the voltmeter indicates the voltage being applied to the tube. This voltage should not be over the specified figure for the tube in question

ONE of the most useful accessory articles which the radio set owner can possess is a voltmeter. With that, and a good hydrometer, he is completely equipped to keep tab on both his filament and plate batteries. If he uses dry cells for lighting the tubes and has no storage battery, the hydrometer is not needed and the voltmeter alone suffices for all the necessary measurements.

A meter for measuring the current flow (ammeter) is not essential. Sometimes a radio man will have a "milliammeter," or ammeter graduated in thousandths of an ampere, for measuring the plate current delivered by the "B" batteries. In general, however, this is superfluous.

Where a storage battery is used, the hydrometer is sufficient to keep watch on its condition of charge or discharge, and the voltmeter is then valuable chiefly for the "B" batteries. In such case, the voltmeter need not be an expensive instrument.

Cheap voltmeters draw quite an appreciable amount of current and should, therefore, not be left connected to batteries for any length of time. A momentary connection is enough to register the voltage.

For testing dry cells used for filament lighting, a cheap voltmeter is also satisfactory. If,

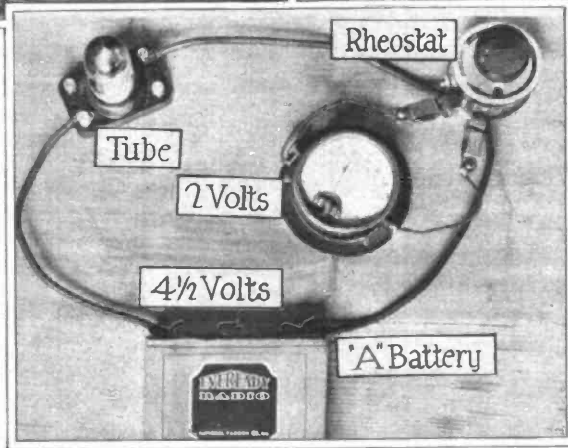

Fig. 3—The difference between the battery voltage and the tube voltage is found across the rheostat. Simple calculations based on these measurements tell all about the filament circuit

drawn more or less into it by the magnetic action of current passing through the coil. Such an instrument often takes nearly as much "juice" to operate it as an amplifier tube itself, so that it is utterly useless for such measurements.

One of the most convenient forms of voltmeter for radio work is a combination instrument having two scales. One is graduated from zero to about sixty volts for the measurement of "B" batteries, while the other scale, brought into use by depressing a button, shows voltage readings between zero and six, for the filament batteries. The meter illustrated is of this character.

To comprehend fully the balance of voltage in a radio circuit, we should understand something about the flow of current in it. Let us consider the filament circuit, for example.

In Fig. 1 we find a pictorial filament circuit. In it are the tube in its socket, the

rheostat and the "A" battery. The case illustrated is that of a UV-199 or C299 tube, with a 50-ohm rheostat and a 4 1/2-volt "A" battery. Let us adopt the old theory that current flows from positive to negative, the left-hand terminal of the battery illustrated being the positive. Current travels from this post to

however, the voltmeter is to be used for determining the correctness of the voltage applied to the tube filaments, the higher-grade type of instrument should be chosen. The more expensive voltmeters operate on different principles and do not demand an appreciable amount of current to actuate them. There is a large permanent horseshoe magnet within the case and a delicately balanced coil of hair-like wire through which a slight amount of current passes from the battery on test. There is a magnetic reaction between the coil and the magnet which deflects the pointer.

The cheaper voltmeters merely involve a coil of heavier wire with an iron plunger

Am I Using the Correct Voltage?

By BRAINARD FOOTE



(Continued on Page 45)

"This Is WWJ"

Radio with the Detroit News is a tradition—a tradition based upon more than a quarter of a century of experimental work inaugurated by the late James E. Scripps, founder of the News itself.

The News began broadcasting away back in September 1920. Today Radio the world over, admires WWJ for the clear, even, mechanical perfection of its message. And the Detroit News Orchestra is everywhere an accepted standard of sound, musical excellence. Hear it, at its very best, through The Superspeaker.

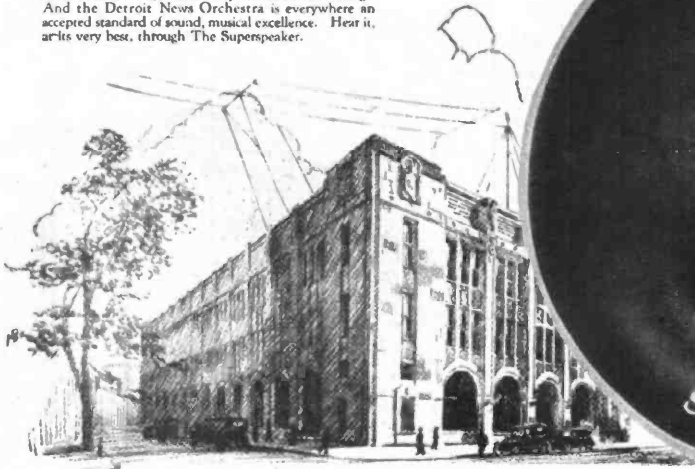

“COAST to Coast on the Cloudspeaker” is your ultimate hope from a modern Radio Set.

But this is 100% performance and needs the 100% loudspeaker—The Jewett Superspeaker, nothing less!

The throat is as straight as an organ pipe. No extra batteries are needed.

Compare It—You'll Buy

Jewett Radio & Phonograph Co.
5682 Telegraph Road Pontiac, Michigan

The
Superspeaker
Trademark Registered



A corner in Dr. Wadsworth's Dental Laboratory, Pasadena, Calif.

The New World for the Shut-In

By E. D. CAHN

HOWEVER marvelous radio may be to the rest of us, it has created a new heaven and a new earth for the shut-ins, and in the case of Radio Doc, of Pasadena, Calif., it has opened the door of misfortune and something very close to actual want and led him back to usefulness, a place in the busy world and financial success.

And one of the pleasantest things about this fact is that it is the fruit of his appreciation of the work of the artists and announcers whom he heard on his first little set, and his urge to tell them what they were doing to brighten his hours and stimulate his mind.

Although, almost absolutely helpless, he could just manage to use one hand to write, but by patience and labor he contrived to put his thanks on paper.

Letters composed under such circumstances could not fail to be well thought out and reflect the writer's humorous outlook upon life.

And he gave back something besides thanks and that was real help, for in the days when radio was even younger than it is now, many stations were glad to get data concerning the reception of the programs, and glad to have Radio Doc pitch in and help with his cheerful letters and constructive criticisms.

One of the things he did was to prevail upon Uncle John, of KHJ, the Los Angeles Times, to allow the audience present during the broadcasting of his programs to applaud. With his genius for putting himself in the other fellow's place, Radio Doc had realized how hard it must be for an artist to work without the stimulation of applause, and he knew, as a listener, how much he had wanted to applaud good work, so he wrote such an eloquent plea for it that Uncle John not only suspended the rule but broadcast Radio Doc's letter besides.

This letter so impressed a lady listening in Honolulu that she wrote to Radio Doc and sent him a little souvenir of Hawaii in care of Uncle John. This he delivered

in person on Easter Sunday, 1922, and for the first time met Radio Doc in the flesh.

He found that "Doc" meant Dr. D. I. Wadsworth, formerly president of the State Dental Society of Oregon, professor of prosthetic dentistry of the North Pacific College and practicing dentist for over twenty-six years, a man who had worked hard for and won a substantial professional success, only to fall victim of arthritis, the most terrible form of rheumatism, which reduced him to existence in a wheel chair with financial anxiety of the most pressing sort for his daily companion.

Yet he had his little radio set—for his interest in radio dated from the appearance of the first station in California—and he kept in touch with the world through it. His mind was alive. He had his right hand, a pad and pencil, his friends, and an idea.

Through his friends it became known that Radio Doc had a little stock of radio parts to sell and from that small beginning has grown a business which employs two assistants and has paid such dividends in a year that he has been able to buy a half interest in the insurance business which has been employing his wife for the last five years and to give it to her for her very own.

He speaks of Mrs. Wadsworth with admiration as well as gratitude, for when the tide turned against him she took a business course and then went quietly to work to support the family.

Radio Doc is sending one of his daughters to high school and is seeing the other through a commercial college, and the business which was started on nothing and which is housed in a small shop built in a backyard is paying for it. A business conceived and supervised by a man too helpless to dress himself or to cut his own food, yet in whose strong face there is no bitterness nor a shadow of regret for what cannot be. His message to invalids is to be

grateful for what they have and to make the most of it. He says that the first thing an invalid has to do is to "learn how to be grateful" and then to find out how to express it. He conceded that it is true that many invalids can do very little to repay the friends and relatives to minister to them, but he thinks that many of them fail to take the trouble to do what little they can. Radio Doc strongly believes that to feel gratitude is not enough, and that it ought to be expressed to be of any particular account.

On the historic occasion when he was taken to KHJ to see for himself just how a program was broadcast, he voiced this philosophy for the benefit of all the other shut-ins who might be listening in as he had been so many times. Radio, he said, is the invalid's one great life-saver—the greatest gift ever given shut-ins.

He sees the radio artist as a striver like himself and so he sends his encouragement even if it is no more than a few lines on a printed applause card. Even when he is in bed he has a set close by and notebook at hand. He keeps up with every mechanical development of radio and in some respects is ahead of the field. And, though the world may carelessly imagine that he is down, he knows that he is by no means out.

The same is true of Frank Dana Thorne, who also lives in Pasadena and suffers from the same disease though in a much more aggravated form. He, too, is a radio enthusiast, a man who has been flat on his back for more than eleven years and whose only contact with life was through his devoted nurse and the visits of his friends and what he could gather from what was read to him.

He was a graduate of Syracuse University, has practiced law, traveled all over the world and had the benefit of all the good things of modern existence together with a great capacity for using and enjoying them. To such a man inaction must be much harder than

(Continued on Page 64)

Hear the Conquering Harmonica via Radio

(Continued From Page 17)

by Mr. Douglas Wakefield Coutlee, through the courtesy of M. Hohner, Inc., who have engaged the use of the facilities of this station for the purpose.—Mr. Coutlee."

"Then Mr. Coutlee gives a four or five minute talk of which the following may be taken as typical:

"Good evening, Radio Friends: "Here we are once again—ready for our tenth harmonica lesson and musical program. In weather like this it feels good to be here in the comfort of the studio, and as you are all sitting back in the comfort of your homes, we will forget the wind and snow and endeavor to contribute our share toward your evening's entertainment. As in previous evenings the little harmonica will play an important part in our program tonight.

"All hail to the little harmonica. It will never take the place of other musical instruments—opera and the symphony orchestra, but neither can its place be taken in the life of American youth, in the heart of the homesick and the need of those who know the joy of individual musical expression.

"So long as there is youth there will be harmonicas; and so long as there are harmonicas there will be youth. Like marbles, tops, kites and baseball, the harmonica is the inalienable right of boyhood.

"Evidences of the universal popularity of the harmonica are offered by the radio, the municipal contests, the school orchestras, the Boy Scout bands, the church and Sunday school groups, the professional soloists on the vaudeville and concert stage and its part in the movies and modern drama. It has even been taken up by the musical organizations of several of the larger colleges and universities.

"The harmonica was originally intended to be sociable and consoling—to assuage the homesickness of the boy who goes from the farm to the city or from home to school. The world knows its war record. It went with the Tommies and doughboys into the trenches—so much so, in fact, that it is handed down to fame in the song that says, 'Tommy with 'is moutborgan, 'e's at it all the time.'

"And on the farm also, among the hired hands, there was often one who showed precocious skill in that particular art. One recalls the thrilling rendition of 'The Mocking Bird,' with improvised variations, of course, and the imitated call of the whip-poor-will. Harding back still farther we may recall the soothing melody of 'Sweet Belle Mabuses,' under the slow cadences of which the weary farmboy on a summer evening found it difficult to keep awake.

"Later came 'My Grandfather's Clock,' and still later the popular airs composed by Charles K. Harris and the more ambitious exploiters of catching harmonies before the advent of jazz.

"The harmonica player throughout the generations, since his favorite instrument became popular as an inexpensive and efficient broadcaster of melody, has mastered both the old and new tunes. But since those early days when we grown-up boys and girls considered ourselves adepts in the player's art, there have been perfected many modern methods of manipulation and execution.

"And now, today, as a result of simple charts and lessons in the instruction book which are available to all, we find boys and girls between the ages of 8 and 80 who are able to give renditions of every conceivable kind of music, from popular melodies and jazz selections to classical and operatic compositions.

"Tonight we have with us here in the studio eight boys and girls, selected from as many public and high schools in New York who are going to demonstrate the possibilities of the harmonica as a stepping stone to music. These boys and girls are all under 15 years of age and have never had any previous musical training

prior to their debut with the harmonica. If you enjoy the performance of these young musicians tonight, won't you drop us a line and say so? A few words of encouragement from you will inspire them to greater achievements in the careers which they have started."

Then follows an hour of music, broken halfway by three or four minutes' instruction by Mr. Haussler. This is the point which is most important with the harmonica fan who sits at home with his radio set, instruction book propped up before him and takes his lesson. At the end of the period comes the closing announcement, which contains the invitation to write for the book of instruction, and some idea of the widespread interest may be gained from the fact that over 200,000 copies have been distributed.

Recognizing the point which Mr. Haussler brings out—namely, that a love of music is inborn in most children but may be stifled by too

mechanical means, that the harmonica tones are always accurate, that in order to play this instrument he learns to read music as well as he would in the study of some other more highly advanced instrument, and that the stimulation of interest by means of this simple instrument may lead to a future interest in more advanced types of music—musical directors, principals and leaders of boys' clubs all over the country have organized harmonica bands. The one mentioned above, that of J. H. S. No. 61, New York City, has grown from a company of fifty boys to over 150 boys and girls. The interest taken by the girls is one of the unique features of this renaissance of the harmonica. This band has been a steady entertainer on the Hohner program.

Mr. McGuire, the enterprising principal of the school, says:

"Every school ought to have some musical organization connected with

it. Harmonicas cost so little that the matter of expense is eliminated. It is true in musical pitch. It is small and easily carried. The instrument is capable of expressing musical themes, and the taste of the performer, growing with his increase in proficiency, is his guide in rendition.

A good deal of this interest is caused by the fact that the programs include so varied a type of selections. Here is a typical program, in which you will note that the harmonica covers all types of music. Here you see we have included popular melodies, the good old-fashioned songs, a classic and a patriotic number. You will also note that the program is composed, with the exception of Mr. Haussler, of child performers. This has been done consistently in order to stimulate the ambition of the youngsters of our country, who will feel that what is possible for other children is possible for them. The harmonica used in these performances range from the one-inch "Little Lady" to the chromatic harmonica which contains sharps and flats. Here is the program:

1.—Our first number tonight will be a "Medley of Popular Airs," arranged by 12-year-old Milton Burstan and



KEEP reception clear!



The Tungar is a G-E product, developed in the great Research Laboratories of General Electric.

The New Model Tungar charges radios. A and B storage batteries, and auto batteries. Two ampere size (East of the Rockies) \$16.00

A Tungar is also available in five ampere size, design unchanged (East of the Rockies) \$24.00

60 cycles—110 volts

Keep it clear. Keep it loud—with all the volume your set should have. Keep the battery at top notch—fully charged—poppy. The Tungar charges your storage battery overnight while you sleep and at a cost of hardly more than five cents. It's easy! Just two clips—and a plug for the house current. Or you can make a permanent connection, and just throw a switch. Keep your set at its best all the time—with a Tungar.

Tungar

REG. U.S. PAT. OFF.

BATTERY CHARGER

Tungar—a registered trademark—is found only on the genuine. Look for it on the name plate.

Merchandise Division
General Electric Company, Bridgeport, Conn.

GENERAL ELECTRIC

The Finer Side of Radio

A Song That Reached Home

A great baritone sang with uncommon fervor to his enraptured listeners. The melody seemed to string a golden chain of words for some responsive heart.

It reached ten times a million hearts. For as the music faded into silence, the singer said, "GOOD NIGHT, MOTHER!"

And then we knew that song had gone straight and true to some one somewhere in that vast invisible audience.

Some one whose tear-dimmed eye saw not the wonderful singer but a little boy whose tousled head lay on her breast.

And in that spell of mother love which makes millions kin.

All those listening hearts "tuned in" to one heart.

A heart that must have felt the magic of ten million prayers unified in one "God bless her!"

Our Bristol Loud-Speaker had given us all the rich tonal quality of the singer's voice, its natural sweetness, its pathos. It had been a wonderful evening.



FIVE MODELS
Cabinet shown is of beautiful mahogany, 17 x 10 x 10 1/2. Has full-bank wooden horns with large expansion chamber, electro-magnetic tone reproducer. Price \$30.00. Horn 17 x 10 1/2. \$12.50 to \$20.00. Send for Bulletin 2092-G. Ask dealer to demonstrate them on this Bristol Company.

The BRISTOL COMPANY, Waterbury, Conn.

BRISTOL

MADE IN U.S.A.

AUDIOPHONE

LOUD SPEAKER

The Bristol Company Waterbury, Connecticut



played by five of the boys on chromatic harmonicas. Milton Gershen-son, 18 years old, is at the piano.

2-The next selection is entitled "Perfect Day," and will be played by Wm. J. Hausler and Billie Hausler, using the chromatic harmonica in the key of F.

3—"Love's Old Sweet Song" is the next number to be played by six of the boys and girls from the harmonica band of School No. 61, New York.

4-The next selection to be played by four boys on chromatic harmonicas is a beautiful but very difficult number for which we have had numerous requests—"Song of India."

And now before continuing our

that brings memories of other days—"In the Gloaming."

9-And one more number and we will bring the "Hohner Harmony Hour" to a close. I'm going to ask the boys and girls to play "Old Lang Syne."

Of course the work has been handled by experts, which to a great degree is responsible for the marvelous responses which have come in. Mr. Hausler is considered an expert not only in giving instructions but in playing the harmonica. He has also been interested in children, particularly in boys. About two years ago Mr. Hausler was active in boys' club work and at the same time was connected with the National Bureau for

It's easy to play a

HOHNER HARMONICA

Low notes to left

BLOW "do"
DRAW "re"

Low notes to left

BLOW "mi"
DRAW "fa"

Low notes to left

BLOW "sol"
DRAW "la"

Low notes to left

DRAW "si"
BLOW "do"

Play the scale and you play all!

One of the charts from the instruction book "How to Play a Hohner Harmonica"

musical program I am going to ask Mr. Wm. J. Hausler, who has been conducting our weekly harmonica lessons, to say a few words to his radio class of students. Then we will proceed with our musical numbers. Mr. Hausler.

5-And now, friends, before Mr. Hausler gets too far away from the microphones, I am going to ask him to play something for us. A duet by Mr. Hausler and his 12-year-old son, Billie, Jr. They will play "Mighty Lak a Rose"—in the way every father and son should play—in harmony.

6-The next selection by the boys and girls will be a "Medley of American Airs."

7—"Only You," a popular dance number is the next selection.

8-And now an old-time favorite

the Advancement of Music. Naturally then his interest was twofold and so he has come into this campaign of M. Hohner, Inc., with the utmost zest, ably seconded by his young son Billie, who is playing in Dad's footsteps with a vengeance.

Mr. Coutlee, who gives the introductory talks, also boasts of three children who can entertain on the harmonica and is proud of the fact that he can join in himself. He is a man of wide advertising experience, and was formerly connected with George Batten Company, Frank A. Munsey Company and Popular Science Monthly. Later he became the president of the Douglas Wakefield Coutlee, Inc., advertising agency. In addition to his work, Mr. Coutlee has developed and created mail-order advertisements, but he feels that no other form of publicity gets the same

type of response that radio broadcasting achieves.

This, of course, does not mean that broadcasting takes the place of other advertising, as M. Hohner, Inc., use all known forms of advertising. Mr. Courtlee is a versatile gentleman. He writes short stories, lyrics and music for amateur theatricals, movie scenarios and poetry in the spring. Besides, he is a baritone. All of this enables him to join with Mr. Hausaler in arranging programs and talks for the "Hohner Harmony Hour." At present he is a member of the Copy and Plan Committee of the Charles C. Green Advertising Agency and is a director of the corporation.

Mr. Hausaler and Mr. Courtlee have every reason to be pleased with the results they have obtained in this broadcasting campaign. The response to their first hour was 3000 requests for instruction books and an average of 2000 has been consistently maintained. Some idea of the type of interest taken in this revival of the harmonica may be found in the statements of educators and musicians all over the country. They come from people like Phillip Gordon, director of music in the South Side High School, of Newark, N. J., who says:

"The harmonica band may become the stepping stone to serious musicianship. With the desire to play, ability to read notes and the knowledge of orchestral routine, many of the children will probably take up one of the regular orchestral instruments and thus benefit both the school and themselves. Taking all these reasons together, one can safely say that every school ought to build up a strong harmonica band for the sake of the school and for the sake of the children."

From Nellie C. Hudd, the principal of the Mozart School in Chicago, who says:

"We can no more dispense with our harmonica club than we can with our rhythm band, our orchestra, or our ukulele band. I feel that it is one of our established activities. Each one of our musical activities is invaluable in its way, but none has given the boys and girls more real joy than they have had in learning to play upon the harmonica. Aside from the joy, I feel that it has real educational value in that it requires effort, concentration and attention. In our school, where the development of character is the big purpose underlying all that we do, we hail with pleasure anything that will help us to create a spirit of good fellowship and kindly neighborliness."

Mr. Nathaniel Finston, conductor of the Chicago Theatre Symphony Orchestra, Chicago, says:

"In the years that I have been actively engaged in music I have heard many musical instruments of various kinds and characters and on which unusual performances were rendered. I must confess, however, that the 'Chromonica' as played by Mr. Borrah Minevitch, proved not only unusually interesting, but truly electrified me as well as the many audiences before whom he played while at this theatre.

"His melodic, harmonic and lighting-like progressions were certainly not on the harmonicas I have heretofore heard.

"The mastery and almost unbelievable renditions on the harmonica by Mr. Minevitch make this instrument well worth the serious consideration of the amateur and professional musician."

The Mr. Minevitch mentioned was a Boston boy who felt that he could play the harmonica. He made his way to New York and asked the Hohner Harmonica Company to bear

him play. The result was an engagement at the Rivoli and Rialto Theatres, with his name in electric lights. Since then he has been playing in vaudeville and today is featured with Elsie Janis in the "Puzzles of 1925," and it is rumored that he gets a salary of \$750 a week.

It is stated that at the present writing there are over forty-five professional harmonica players in vaudeville, some of whom receive over \$450 as a salary. Of course not all of them reach the proficiency of Mr. Minevitch, who plays every type of selection, from the highest of grand opera to the most jazzy of blues. Owing to the many difficult modulations and chromatics involved, such proof as this young man has given here would have been considered impossible years ago. In fact, it is the creation of chromatic harmonicas that has made this possible.

One of the most unusual testimonies in behalf of the harmonica comes from Dr. Paul V. Wilson, famous ear, nose and throat specialist, president of the National Round Table for Speech Improvement and consulting laryngologist at Brooklyn State Hospital, who says:

"I have experimented very extensively with the harmonica to establish its value as a therapeutic agent. I have ascertained that this instrument is a most effective medium in developing the chest and respiratory organs. In anemic children and adults a program of regular practice with the mouth organ, which develops breathing, results in aeration of the blood and tones the system generally.

"The development of the breathing power, which can be obtained most effectively through the harmonica, is an important factor in building up the body. In practically every form of exercise deep inhaling and exhaling are striven for, and this is exactly what you get in playing the harmonica. Therefore the hygienic results are most satisfactory."

It is, however, the letters which come from the radio fans which really show why the sale of harmonicas has increased from 3,000,000 to 15,000,000 a year in a little more than three years. These letters come from small country places, community centers, naval hospitals, from old men who remember playing the instrument in their youth, from parents anxious to instill the love of the instrument in their children, from principals and leaders of boys' clubs who want to organize boys' bands, from Americans, from foreigners, from rich and poor, from office boys to bank presidents.

The Problem of Interference

(Continued From Page 9)

the command of those selecting the component parts making up the apparatus, as well as the arrangement of the parts in the receiving circuit?

In the more modern equipment, each part is designed with this factor in view: the rheostat, the vacuum tube sockets, transformers, condensers, inductances, jacks, switches and the manner in which the wiring is arranged and connected to these different parts.

In conclusion, it may be stated that Dr. Erskine-Murray pointed out many years ago the great problem of radio reception—the problem of keeping out the undesired signal, or the problem of receiving only the desired radio signal and rejecting all other signals or noises which we have classified under "interference."

HARKNESS Counterflex Kit



Canadian List Price, \$48.00

WITH this complete kit of parts you can build the 3-tube Harkness Counterflex receiver described by Mr. Harkness in the March issue of Radio in the Home.

This is the set which "makes distant stations sound like locals." You can build it for less than forty dollars. To get the same volume, selectivity and receiving range with any other circuit you would have to spend two or three times as much.

The parts in the Harkness Counterflex kit were designed by Mr. Harkness to make it easy for you to build the set. The 7" x 18" Celeron front panel and the triple socket sub-panel are completely drilled and engraved, ready for you to assemble the parts.

An instruction booklet, written by Mr. Harkness, is supplied with each kit. This booklet clearly illustrates and carefully explains each progressive step in the assembly and wiring so that you cannot possibly make a mistake.

Ask your dealer for the genuine Harkness Counterflex kit. Avoid cheap imitations. If your dealer does not stock genuine Harkness products, send your order directly to us, giving your dealer's name and address.

WARNING: Deliberate imitations of the Harkness Counterflex kit, unlawfully using the signature and photograph of Mr. Kenneth Harkness, have recently appeared on the market. Legal action is being taken to stop the further sale of these kits. To protect yourself, examine the label of the kit you buy and make sure that the words "Kenneth Harkness Radio Corp., Newark, N. J." appear on the label.

KENNETH HARKNESS RADIO CORPORATION
727-739 Frelinghuysen Avenue, Newark, N. J.

Kenneth Harkness
President

Mail this Coupon for Illustrated Book

Kenneth Harkness Radio Corporation, RIM 4-55
727-739 Frelinghuysen Avenue,
Newark, N. J.

Please send me a copy of your illustrated booklet, written by Mr. Harkness, describing the commercial model of the new, simplified 3-tube Harkness Counterflex receiver with detailed building instructions and step-by-step wiring diagrams. I enclose 25 cents to cover cost of handling and mailing.

Name
Address

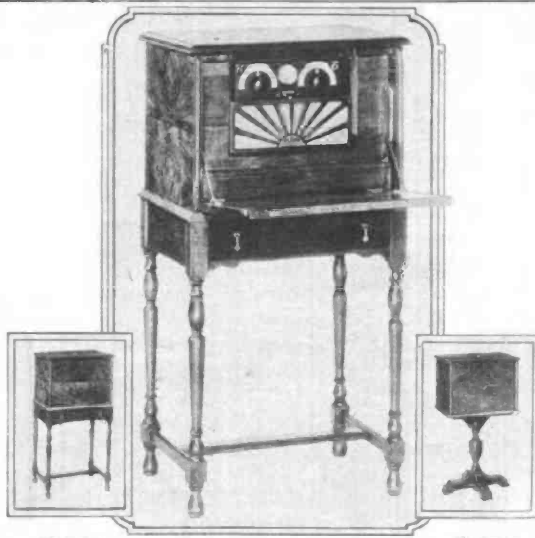

The Tudor cabinet

The Tudor

The Empire

Announcing the OPERADIO CONVERTIBLE

A DeLuxe Cabinet Housing the Powerful Operadio Portable

The remarkable success of the 1925 Operadio—a six tube set of exceptional efficiency in a compact carrying case, has led to another new and revolutionary development.

Operadio engineers, in conjunction with leading designers of fine furniture, have evolved two dignified and beautifully proportioned walnut cabinets, to house the portable set when used in your home. These two Period models, graceful of line, and unique in design, provide a worthy interior setting for this most talked of receiver of the year, with its features of great power and efficiency and wonderful tone quality.

Now in this one set there is every desirable feature of radio. In the home you may have a cabinet of unprecedented beauty, that uses no outside wires or connections, no separate loud speaker.

Or by removing the

set, you have a complete, self-contained receiver with loud speaker, six tubes, large battery supply and all parts enclosed in a smart-looking case—ready for you to carry with you on trips or vacations.

The Operadio has shown itself in every way the equal, if not superior, of any big set on the market. Range, selectivity, ease of tuning, clear, true, beautiful tone, all of these are here, and in addition, its amazing convenience—permitting radio to be enjoyed anywhere, indoors or out, upstairs or down.

You can buy the Operadio Convertible in either the Tudor or Empire Model. Or you can buy the standard set in the carrying case alone. And if you now own the 1925 Operadio you can secure one of these beautiful cabinets in which it may be placed.

Ask your dealer—or write us direct.



The 1925 Operadio removed from cabinet and ready for use.

Mail this Coupon

THE OPERADIO CORP.,
8 S. Dearborn St., Chicago, Ill.
Please send me complete particulars about the 1925 Operadio.
Name.....
Address.....
City..... State.....



“More About Low Loss”

(Continued From Page 13)

is mounted an inch back from the panel, with its terminal post at the end, as shown in Fig. 12.

If the antenna is connected directly to the terminal post on the coil the set oscillated say at 40 degrees tickler coupling. But if the terminal post is connected by a right-angled piece of wire one inch to the panel and one

when radio sets will be built and not wired?

Still there is the field of the coils themselves; what can be done about them? May I make a prediction? No, I hardly dare—let's make it a suggestion.

Two years from now, or less, present-day coils will be entirely out of

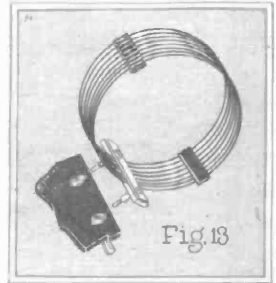

inch along the panel to the binding post on the panel and the antenna connected here the set will not oscillate until we increase regeneration to 44 degrees to overcome the added resistance caused by using the additional

the limelight. We will have the coil that is not affected by the weather, hence will be the same day in and day out. This requirement might be covered by the coil shown in Fig. 13, the space wound, probably enameled wire coil.

Next the coil will have practically no external field to be bothered by poor materials in its field. This is not so hard either. For instance, take

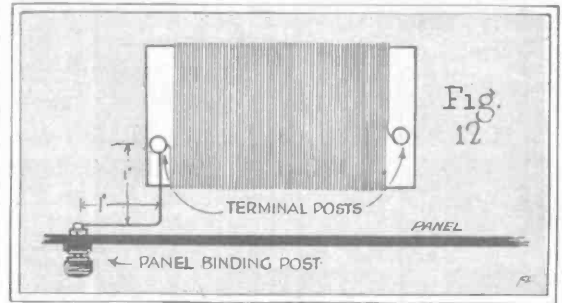

length of wire, the binding post and placing the bakelite of the panel in its field. The same thing can be illustrated on most any oscillating receiver.

Every piece of wire in your set has its own field around it, all subject to this very point. Do you wonder that I say that the day is not far off

the coil of Fig. 12 and bring the two ends around to meet each other after the fashion of a doughnut. Then you have the coil shown in Fig. 14. This type of coil, called the “Toroid” has been in only limited use for years due to the difficulties encountered in winding it. These difficulties have, however, been to a great extent overcome, and the many advantages possessed by the coil will doubtless mean its greater use.

The outstanding features of the Toroidal coil are its comparative freedom from the influence of other apparatus in the set, freedom from atmospheric influences if properly built and the fact that it will not send its own field roaming about the receiver to cause all kinds of trouble.

For better low-loss work then, it is possible to recommend the use of such a Toroidal coil as has just been described. Use short direct connections with as little wire as possible. Study the fields around the condensers, coils, wiring, etc., of the receiver and see that no panel material or other apparatus is within

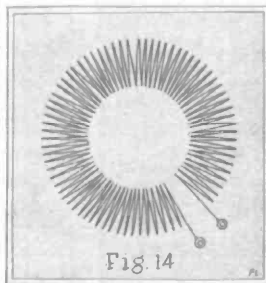

The coils shown in Figs. 13 and 14 use terminals that plug into Carter Imp phone jacks; this holds the coils up free and clear of the mounting, and they are extremely efficient coils as a result of all these things.

Whether you build a reflex, neutrodyne, regenerative or superheterodyne receiver the use of any point brought out in this article will mean just so much better receiver and your time will have been well spent.

A Radio Interview on the Superheterodyne

(Continued From Page 13)

I would like to state that it is advisable for any one purchasing a set today to see that the set is capable of receiving stations below 250 meters, as there are a great many stations operating in this neighborhood.

Q. Is it possible to substitute other parts than those recommended by you?

A. Yes, it is, and in a great many cases they do produce results; but I believe that in picking the parts that I have for this set, I have been able to obtain a combination which appears to be very satisfactory; and unless it is impossible to obtain these parts, I would not recommend that any person substitute others.

Q. Do you use an antenna on your set?

A. No.
Q. Wouldn't it be better if you did?

A. No.
Q. Why not?

A. For the reason that operating a superheterodyne on an antenna is

in reality a confession that your particular superhet is not as efficient as it should be, and also though you obtain more volume you also obtain more interference.

Q. Are there any other reasons why you should not use a superheterodyne on an antenna?

A. Yes, there is one very good reason. We are all upset more or less on hearing squeals or howls on the air from radiating receiving sets and a superheterodyne if used with an antenna would create trouble also, and, as it does not help your own reception, why bother other people?

Q. Is the superheterodyne simple to operate?

A. Yes, it is simple to operate, as it has only two controls, and I might say at this point that one of the enthusiastic owners of this set wrote in rather a good definition regarding the simplicity of operation, in which he states that it is one-third easier to operate than the usual five-tube set.

Q. Is it possible to log a superheterodyne so that you can always obtain the same station at the same dial setting?

A. Yes, this is as true of the superheterodyne as well as of many other receivers.

Q. Is a superheterodyne expensive to operate?

A. No, it is not.

Q. I should think with eight tubes that it would be more expensive to operate than some other sets.

A. As a matter of fact, a person very rarely uses more than seven tubes, and these seven tubes draw less current than a three-tube set which was in common use a year and a half ago. In fact, the only additional current required to operate a super-

(Continued on Page 47)

How to Make the New Quadraformer Receiver

(Continued From Page 35)

rubber. Countersink from the bottom side of the four corner holes in the base and the two marked "x." Place a No. 6 flat head machine screw from the bottom in each corner hole,

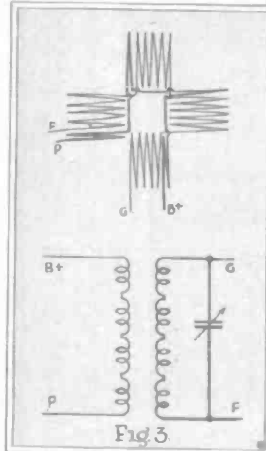

and on the top side place two soldering lugs and clamp down with nut. Mark these terminals as shown. Also

I will buy for you!

Free Shipping Service in the great Radio markets of New York and Philadelphia for readers of this Magazine.

I MAKE NO CHARGE FOR THIS SERVICE!

Avail yourself of the services of an expert BUYER in these markets. I will buy any apparatus mentioned in this magazine, and send it, carefully packed, direct to your door, at its regular price, plus only parcel post and insurance. It is conducted in close co-operation with Mr. H. M. Neely, and is for the convenience of his readers.

By All Means build the set which is described in this issue
H. M. Neely's

QUADRAFORMER CIRCUIT with the DAVEN AMPLIFIER

It embodies range, volume, selectivity, and a quality of tone that only Resistance coupled amplification can give.

COMPLETE PARTS \$65.00

Including Quadraformer, Amperites, Panel, Baseboard, Wire, DAVEN 3-stage Super Amplifier and Apex dials.

REMEMBER!

We are the authorized Mail Order Purchasing Service for "Radio in the Home."

This Seal is Your Guarantee

We are the authorized Sales and Service Station for Marhness, Browning-Drake and Silver-Marshall Apparatus.

E. M. CLARKE CO.

Office 202, 1523 Chestnut St., Phila., Pa.

The DAVEN SUPER AMPLIFIER

is for those who desire quality amplification. With the Resistance-Coupled method, there is a pleasing lack of distortion, for under tones and over tones are amplified equally. The most delicate shadings in musical composition, either with instruments or the voice, are reproduced with a faithfulness not obtainable with any other method of amplification. The DAVEN RESISTANCE-COUPLED SUPER AMPLIFIER is truly a revelation and certainly the last word for distortionless amplification.

DAVEN RADIO CORP.

"Resistor Specialists"

Newark

New Jersey

Obtain from your Dealer the "RESISTOR MANUAL," our complete handbook on Resistance-Coupled Amplification. Price 25c, postpaid, 35c.

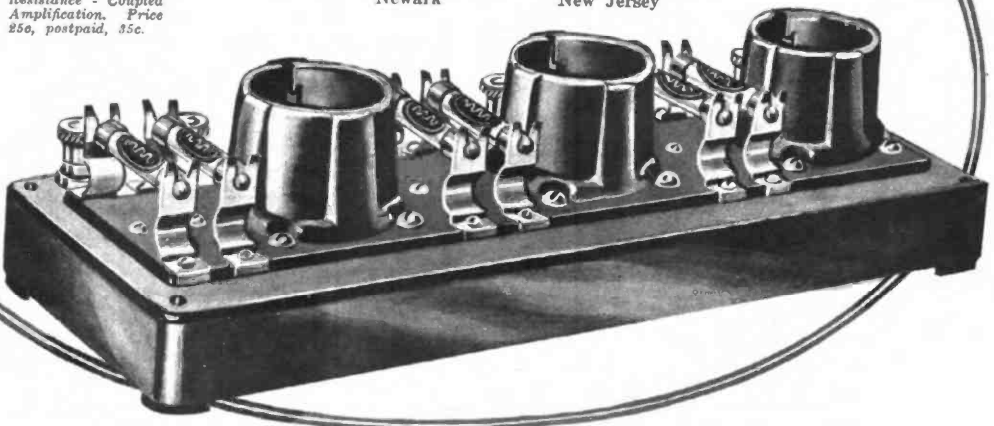

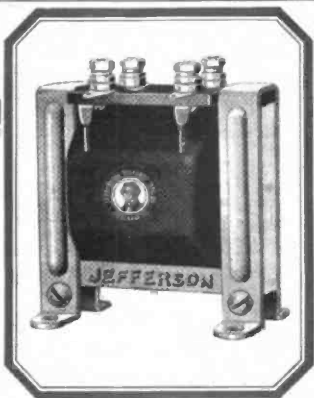

Reliability

That trait of thoroughness which merits confidence is always met with high regard. For there is deep satisfaction in knowing that the task in hand is being done as well as it is possible to do it.

This appreciation for reliability has established the leadership enjoyed by Jefferson Transformers. Sheer quality and performance have won the favor of unbiased radio authorities the world over.

Full, rounded amplification over the entire musical range—a constant delight to radio listeners. Such splendid performance is the result of 20 years' specialization in the manufacture of transformers. Replace the transformers now in your set with genuine Jeffersons and see how your set will improve.

Jefferson Electric Mfg. Co.

503 South Green St.,

Chicago.

Manufacturers of:

- | | |
|---|-------------------------------------|
| Radio Transformers | Auto Transformers |
| Bell Ringing Transformers | Testing Instruments |
| Sign Lighting Transformers | Toy Transformers |
| Automobile Ignition Coils | Furnace and Oil Burner Transformers |
| Jump Spark—Make and Break Coils | Oil Burner Ignition Coils |
| Special High and Low Voltage Transformers | |

"You've got a wonderful set with all the power and none of the grief of the Supers"

SO WRITES Henry M. Neely, Editor of RADIO IN THE HOME. He adds:

"This afternoon we hooked up the QUADRAFORMER set of coils you sent us. It took about half an hour. This evening we traveled west with it and at this minute a mixed quartette is singing a Negro melody at KFI (Los Angeles)—117 miles away from us. I am thirty feet from the loud speaker and hear it clearly. Those coils certainly know where they come from!"

The QUADRAFORMER is a trouble-proof set, far more sensitive and far more selective, of greater volume and more natural tone than any set that you have ever heard.

All so-called "neutralizing" devices are done away with. They are not needed. Internal set noises are eliminated instead of being imperfectly suppressed. The QUADRAFORMER System will reward you with a remarkable difference in real music—rich, sweet tones and great volume (without distortion) when desired.

Write today for the QUADRAFORMER BOOK. It will start you on the way toward a new radio experience.

Profusely illustrated with photographs and drawings, it takes you step by step through the making of a five-tube QUADRAFORMER receiver. The method of description simply takes all the difficulties right out of set construction.

Don't doubt—know for yourself what the QUADRAFORMER is. Just write and ask for the QUADRAFORMER BOOK. Inclose 25c to cover cost of handling and mailing and you'll have it by return mail. But don't delay—the number of copies available for this offer is limited.

Gearhart-Schlueter Radio Corp.

P. O. Box 212, Fresno, Calif.

put a No. 6 machine screw through each of the holes "x" from the bottom, and tighten a nut down on each from the top. Strip C should have a hole in each end so that it will just

beginning of the primary (also from coil No. 1) goes to the B plus terminal. The end of the secondary (from coil No. 4) goes to the filament terminal, and the end of the primary

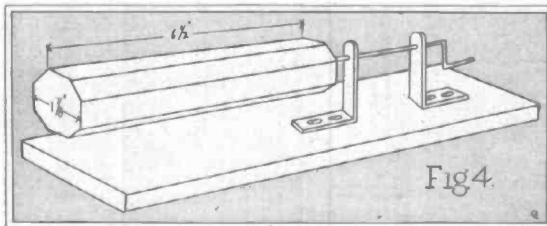

fit on the two screws "x." Place coil No. 1 of the transformer in position on the base and clamp down tightly with strip C and two additional nuts. While this is all rather difficult to describe, a study of the accompanying

(also from coil No. 4) goes to the plate.

The beginning of the aerial and ground coupler goes to negative filament. Connect a lead to the end of coil No. 1 (between coil No. 1 and

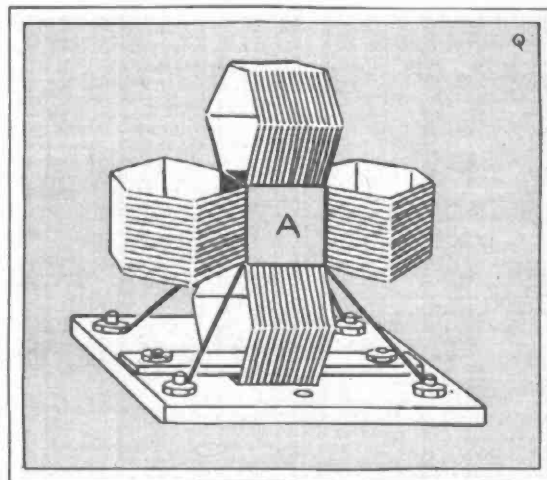

drawings will undoubtedly make the procedure clear.

Connect the leads from the two radio-frequency transformers to the terminals as follows: The beginning of the secondary (from coil No. 1) goes to the grid terminal. The be-

ginning of the secondary (from coil No. 2.) This goes to the aerial post. The tap on this first coil may be connected to a second aerial post for greater selectivity, if desired. The end of the fourth coil goes to the grid.

The completed transformers may be

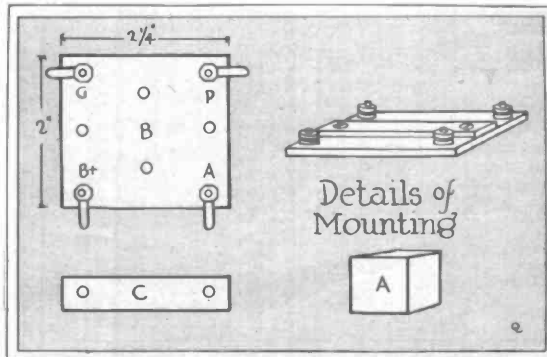

NEW JERSEY to CALIFORNIA on Loud Speaker
 With New **Quadformer**
6-TUBE CIRCUIT
 As described in this Issue
 Radio-in-the-Home
 Complete Parts \$47.25

BASE AND PANEL INCLUDED
 REGULAR PRICE \$60.50

A TRIED and proved circuit with a new coil that kills self-oscillations, the drawback of every radio-frequency circuit. New results never before thought possible—2500 miles on loud-speaker several times in one week. No radiation, no self-oscillation. Dials always log. Wonderful clarity—volume. Simple to hook up and operate. Tested and tried out by our radio engineers, and on demonstration. Parts neatly packed, and ready for you anywhere.

Recommended by Henry M. Neely in his feature article in this issue

The M. & H. Radio Engineering Service

Will Supply Parts or the Complete Set of Any Hook-up Ever Published in Any Issue of This Magazine at No Extra Charge
 This Service Is Recommended by **HENRY M. NEELY**

Another Big Special Complete Parts
 Including Drilled Panel
3-Tube Harkness Counterflex \$17.50
 Circuit . . .

Described in October and January Radio in the Home

Any DX up to 1500 miles is yours with this wonder set—Hastings, Neb.; Miami, Chicago, Ottawa, Canada, etc. Even European Stations have been picked up. See Page 19, February Radio-in-the-Home. The equal of any 5-tube set in audibility and selectivity. So simple, child can operate it. Dials always log.

Still Another Special COMPLETE PARTS BROWNING-DRAKE 3-Tube Set . . . \$34.75
 Described in the April "Radio in the Home." Regular value, \$46.40

Only One Kind of Quality
 here—the best, Radio Sets that give satisfaction demand quality parts. We use no other. Our reputation built up by 19 years' faithful service, is back of each set.

M&H SPORTING GOODS
 512 MARKET ST. PHILA. PA

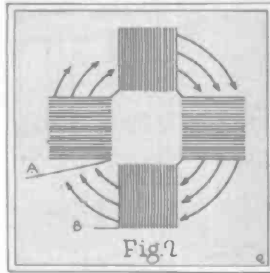

used, with .0005 mfd. low-loss condensers across the secondaries in any radio-frequency circuit.

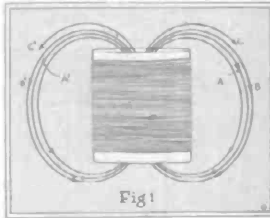

Editorially Speaking

(Continued From Page 4)

today's radio entertainment. When it was first announced that the Victor Talking Machine Company was going to put its artists on the air through this link of stations, everybody thought that was going to be the supreme achievement of radio. There is no question that it should have stood head and shoulders above everything else on the air. There was virtually no limit to the talent at the disposal of this company and the widespread popularity of this talent, has been attested by the hundreds of thousands of records which have been sold.

Yet as I look back on the Victor programs, there are only two which stand out above ordinarily good programs from other stations and these two were the first and the last—the McCormack and the Werrenrath broadcasts. Here again we had a sense of continuity due not to a story or to a scenario, but to the power of a personality.

John McCormack himself has a tremendous popular appeal aside from the beauty of his voice. His public appearances have proved this. Therefore, like Roxy, he can put on a radio program of numbers which might not be at all interesting when put on by another singer, but the fact that it is McCormack and the McCormack personality which comes through by radio holds the listener from start to finish.

The same is true, but in my opinion in an even greater degree, of the exquisite artistry of Werrenrath. In the latter case, there is not only a marvellously flexible and pleasing voice, seemingly capable of anything demanded of it, but there is always a superb intelligence in the rendition, a sense of deep and understanding sympathy with his fellow-men in the way he interprets his songs, an abiding kinship with all of us evidenced in his selections and a radio personality

which comes through the loud-speaker just as strongly as though Werrenrath himself were standing in the room.

Radio is a totally unique test in this matter of personality. On the concert stage, Alda and Werrenrath might create just the opposite impressions to the one which gets through our loud-speaker. Alda has not a good radio personality; Werrenrath is an ideal radio personality.

The Silvertown Cord Orchestra is another example of personality, but here, remarkably enough, there is no individual who gives this impression except the singer in the Silver Mask. Yet the orchestra itself has seemed to put a composite personality on the air and it has become one of the greatest drawing cards that we have in our radio entertainment. This, I think, is largely due to the masterly announcing of Philips Carlin.

The Happiness Boys stand almost alone in their particular phase of personality projection. It is a great pity that they are not put out over the entire chain of broadcasting stations so that the whole country could have a chance to sit back and laugh and enjoy itself for at least one half-hour once a week. The Happiness Boys are geniuses and I know of no other entertainers who can touch them.

These are only a few of the significant features in our entertainment of the last year picked at random for discussion. They serve, however, to make clear the point which I have in mind—that we are developing an art of radio entertainment which is going to be somewhat different from the usual art of personal appearance.

The projection of a radio personality is going to build up radio stars who will be just as popular and just as real to their admirers as are the stars of the motion-picture world or of the speaking stage. We are only at the threshold of this new art, but the last season can be considered as the doormat with the word "Welcome" in big letters upon it, bidding us all to enter and to help in the fine work of further development.

For the presentation of such programs at this large sum of money involved, High-priced men must be retained to devote virtually their whole time to this work and the presentations must be made by artists of such standing and such ability that they can command very large retaining fees.

No individual station can possibly afford to defray this expense. There is only one logical way by which it can be borne and that is by the interlinking of a number of stations and by permitting the mention once or twice, as a credit line, of the name of the firm which is paying for the entertainment. We should all be glad to know who these benefactors of ours are. It is time to stop talking about the "advertising" that this gives by radio; if they can get a certain amount of advertising out of it in this way, more power to them.

Personally, I feel more kindly disposed toward Eveready batteries, toward Happiness candy, toward Goodrich tires, toward Gold Dust, and toward the Capitol Theatre in New York than toward any other firms which are competitors of theirs, regardless of the quality of the output. I am quite sure that progressive firms such as I have mentioned will keep their products at least as good as the products of their competitors, and they have created in me such a friendly feeling by radio that that would be the deciding factor if I were purchasing. It seems to me that we should all feel this way about it.



KENNEDY MODEL XV

It cuts through powerful local broadcasting and brings in distance. Yet even a child can tune this highly selective receiver; stations are always found at the same dial settings.

Descriptive circular sent on request
 Price \$142.50 without accessories
 The Colin B. Kennedy Company
 St. Louis

KENNEDY



The Kit the Whole World's Been Waiting For



FRESHMAN MASTERPIECE
 COMPLETE KNOCKDOWN \$39.50 SET

Contains every single item necessary to build the Freshman Masterpiece five tube tuned radio frequency receiver.

A 24 page book of instructions, containing 7 full page illustrations and many smaller ones, explains every operation, step by step, in language that even the most inexperienced can easily understand.

At all good dealers

Chas. Freshman Co. Inc.
 Radio Receivers and Parts
 FRESHMAN BUILDING
 240-246 WEST 40TH ST.—NEW YORK, N.Y.



**"I selected it for its high insulating qualities
It cuts down the losses in the circuit"**

THOSE were the exact words of a prize-winner in a radio set-building prize contest, when asked why he used a Radion Panel. Like thousands of others, he had found by experience that there is nothing quite like Radion for real results. Our engineers developed Radion Panels especially to order for radio. Losses from surface leakage and dielectric absorption are exceptionally low. And low losses mean clearer reception, more volume and more distance.

Easy to work—moisture proof—resists warping
RADION is easy to cut, drill and saw. You need not have the slightest fear

of chipping. Radion resists warping. It's strong. It's moisture proof. It comes in eighteen stock sizes and two kinds, black and mahogany.

Radio dealers have the exact size you want. The use of Radion by the manufacturers of ready-built sets is almost invariably a sign of general good quality in that set.

Send for booklet, "Building Your Own Set"

OUR new booklet, "Building Your Own Set," giving wiring diagrams, front and rear views, showing new set with slanting panel, sets with the new Radion built-in horn, lists of parts and directions for building the most popular circuits—mailed for ten cents.

AMERICAN HARD RUBBER COMPANY
Dept. N 5, 11 Mercer St., New York City
Chicago Office, Conway Building
Pacific Coast Agent: Goodfear Rubber Company, San Francisco, Portland

RADION
The Supreme Insulation
PANELS

Dials, Sockets, Binding Post Panels, etc.

AMERICAN HARD RUBBER CO.
Dept. N-5, 11 Mercer St., New York City
Please send me your new booklet "Building Your Own Set," for which I enclose 10 cents (stamp or coin).

Name
Address

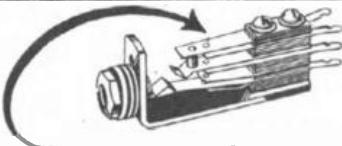

Pacent Jacks
Come in 10 types
50c to 90c

The spring's the thing!

Don't underestimate the importance of good joints. Don't buy joints because they're cheap. Try our leading set manufacturers use only Pacent Jacks. They have that most important essential—the springs that keep the tension constant and the contact perfect.

Write for catalog of complete Pacent line.
PACENT ELECTRIC COMPANY, Inc.
91 Seventh Avenue, New York City

Washington San Francisco Chicago Birmingham Philadelphia
Buffalo New York St. Louis Hamilton, Ont.
Detroit Jacksonville
Canadian Licensees
R. H. White Co., Hamilton, Ont.

DONT IMPROVISE — PACENTIZE™

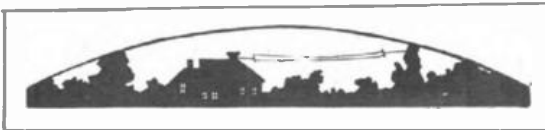

Portable Sets of the Season

(Continued From Page 12)

with a slight movement of the second dial to regulate volume. The best feature of this is that each station has its own dial setting, whether you are at home or in your summer cottage or in camp. Once you have logged the station on this set, you will always find it in the same place

is also provision made for the "C" battery if one is desired. The case of the 51P provides room for one or two coils of insulated flexible wire to be used as antenna and ground and there is another compartment for headphones.

The set is mounted in a ruggedly

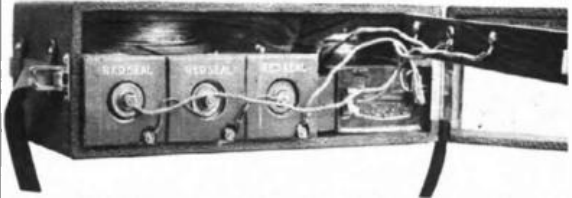

The small space behind the battery binding post strip in the Boonton set is cleverly utilized for phones and a spool containing aerial and ground wire

so that you do not have to hunt continually for stations you want to hear. **Crosley 51P Portable**—The Crosley 51 P, which is a variation of the well-known Crosley 51, has ample space for three full size 6-inch dry cells to furnish the filament current for either the UV199 or the WD12 tube. This gives economical life and does not

built leatherette covered carrying case completely equipped with all of the accessories for its operation. Equipped thus, it weighs 21 pounds and measures approximately 12 inches long, 12 inches high and 7 inches deep. **Boonton Portable**—Here is an extremely clever proof of the possibi-



The Telemaco portable has loop, set, batteries and loud-speaker all contained in this case

necessitate frequent renewal of "A" batteries, as is the case when the small flash light batteries are used for the filament.

There is also room in the Crosley portable for three Eveready number 164 vertical intermediate 22½-volt "B" batteries which give 67½ volts for the plate, assuring loud speaker volume and long enough life for the batteries to satisfy any vacationist. There

ties of good design in a portable receiver. Every cubic inch of space is utilized to the best advantage, and the result is a set which can be transported complete without much trouble and that gives results which are really comparable to the standard home equipment.

The Boonton outfit comes in two different cases. Each one is a neat leather carrying case with a strap to

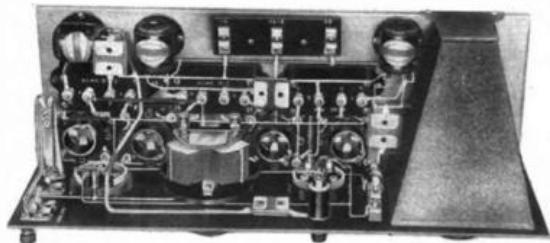

The inner "works" of the Telemaco, showing how the loud-speaker is installed

be swung over the shoulder. One contains the set itself. Four UV199 or C299 tubes are used and one of the photographs shows how the panel may be swung out on its hinges to reveal all of the inner works to give easy access to the tube sockets.

The other carrying case contains the dry cells for lighting the filaments and the "B" batteries. These are wired up permanently and still leave space for a small panel which, when it is swung out, reveals a compartment which holds a spool containing a 100-foot aerial and the headphones.

When the owner wishes to use this set, he places one case on top of the

the value of seven tubes. Virtually all of the tuning is done with one four-inch dial and all of the tubes are operated by one rheostat. This simplifies the operation very much.

A portable set using a loop antenna is ideal for the summertime because the use of the loop greatly minimizes static which is one of the main drawbacks to good radio during vacations. The makers of the Telmaco, receiving on the loud speaker at their Chicago laboratories using loop only have had stations at Fort Worth, Tex.; Atlanta, Ga.; Jefferson City, Mo.; Minneapolis, Minn.; Detroit, Mich.; New York City and Washington, D. C. and Pittsburgh, Pa. These were received satisfactorily when an-



Dropping both lids of the Telmaco reveals the panel, loud-speaker and batteries

other, opens the lids, swings the three little metal connections on the battery case up and under the binding posts on the set case and this makes all necessary connections to the batteries. The aerial wire is then taken out and unreeled and thrown over the most convenient limb of a tree or telegraph pole or over the top of the automobile or anything that is handy. The ground wire is attached to the ground binding post and the other end is dropped in a stream or buried in damp earth. In this way the set is ready for use and will compare favorably with any of the standard four-tube sets on the market. This is a particularly handy set for the automobile tourist or for the person who can pack it in a trunk and take it to the seashore cottage or the summer boarding house.

Telmaco Acme Type T1—The new Telmaco Acme Type T1 is different from most portable receivers. The case contains the loop, the set, the loud speaker and all batteries. In other words, it is absolutely self-contained. Considering that the case is only eight inches wide, ten inches high and eighteen inches long, and weighs only twenty-six pounds complete, this is another evidence of what can be done by the careful thought and planning of radio engineers.

The complete loop aerial equipment is built into and permanently connected inside of the case. This gives the marked directional effect of the loop which greatly aids selectivity. The receiver will reproduce on the loud speaker good stations not too far distant when it is being carried in the hand, on the train, used in auto or boat, all without additional aerial. There is a throw-over jack switch for changing to an outside aerial if greater distance or more volume is desired.

This set uses four UV199 or C299 tubes and by means of the use of the Acmelex circuit, gives theoretically

tenna and ground reception was impossible on account of static.

Another interesting development of the season is the production of at least two first-class loud-speakers, sufficiently small to be included in suitcase or trunk. One of these is the Crosley Musicone and the other the Amplion "Dragon Fly."

Take New York City, for Example

(Continued From Page 1)

policy than merely elimination of coarse and vulgar offerings is desired. The station which renders the best service, the one most wanted by the public, is the one that will survive and the one that will receive any favors which the Department may have to bestow.

WMCA, the new McAlpin Hotel class "B" station, came in for a lion's share of discussion at the New York meeting because it is one of the three newcomers already operating, but not accommodated with a class "B" wave length. Consideration of its affairs showed two decidedly conflicting points of view. One of these is represented by the inquiry, "What does WMCA intend to furnish that is not already furnished to the public in abundance by other stations?" The opposing idea is typified by the statement of Rev. James F. Cronin, spokesman for the Paulist Fathers, who are planning a new station, when he said, "There is still plenty of room for more stations." And he went on to explain by this that he meant a greater number, each with part time, could and should be accommodated in order that there should be as great variety as possible in the programs offered to the public.

Mr. Coons, a spokesman for WGBS, promptly answered Father Cronin

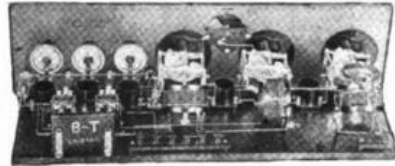

The Greatest of All Radio's Pleasures

When the last wire has been soldered in place—and the aerial, ground and batteries connected up—and you plug in to see if "she works." Then—when the call letters of a distant station come in as if voiced at your elbow then, is the joy of "building your own," the greatest of all of radio's pleasures.

The B-T "NAMELESS" is the unbeatable combination of a most efficient circuit with the highest grade of properly designed essential parts.

With the Bremer Tully system of construction even the inexperienced set builder is able to construct a 5-tube "NAMELESS" with assured success. Test as you go, step-by-step—plug in your speaker and listen to the world and you will understand the enthusiasm which follows B-T products everywhere.

Write today for circular and booklet describing the "Nameless" as well as B-T Condensers which Armour Institute of Technology prove has less resistance than laboratory "Standards."

Pioneers of "Better Tuning"

BREMER-TULLY MFG. CO.

532 S. Canal St., Chicago

New Model

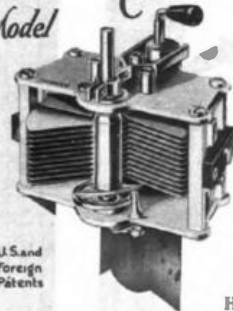

U.S. and Foreign Patents

For Better Radio Hammarlund PRECISION CONDENSER

(Copyright March 17, 1926)

When you find Hammarlund Condensers in the receiver you buy, it indicates that the manufacturer built for quality, not price, and that uppermost in his mind was your complete satisfaction.

Hammarlund Condensers are not expensive, but it is often expensive not to use them.

All models plain and variable. Sold by the better radio dealers used in the better radio receivers.

Write for interesting Folder

HAMMARLUND MFG. CO.
424-426 W. 33rd St., New York

What Last Season PROVED TO Radio Manufacturers!

It proved that there is mighty little market for cheap-looking radio equipment.

It proved that good material and workmanship are every day more essential to secure the confidence of the dealer — and build real business.

Service trouble at up what little profit the dealer made on many really cheap sets—and he will sell no more of them!

The season proved that cheap substitutes for Formica panels are one of the most costly things a manufacturer can use.

Such expedients create a sales resistance that is far more costly in the end than good panels are in the beginning. That's why so many manufacturers who tried them are giving them up. Last year was the biggest Formica ever had in radio.

This year the volume will be done on sets that have Formica base panels—as well as Formica front panels, with their wonderful finish and permanent beauty!

Formica is one of the most lasting and unchanging materials in the world.

THE FORMICA INSULATION COMPANY
4654 Spring Grove Ave., Cincinnati, Ohio

Sales Offices

66 Church Street...New York, N. Y.
9 South Clinton St....Chicago, Ill.
119 Canton Bldg....Cleveland Ohio
1145 Granite Bldg...Rochester, N. Y.
688 First Avenue....Pittsburgh, Pa.
6 Beacon Street....Boston, Mass.
65 Oak St.....Havana, Cuba

288 Victoria St...Toronto, Ont., Can.
1628 Second Ave...Hillsdale, N.J.
725 Bellvue Bldg...Philadelphia, Pa.
700 Yale Building...Baltimore, Md.
545 Mission St....San Francisco, Cal.
110 Ohio Bldg....Toledo, Ohio
289 Plymouth Bldg...New Haven, Conn.
Whitney Central Bldg...New Orleans, La.

Writes for Booklet "What Formica Is"

- Formica is made by 125 leading makers—and has for years been used by more makers than all other materials.
- Formica will last forever.
- Formica, in appearance, is the finest of all insulating materials and always remains so.
- Formica's electrical qualities of every kind far exceed any possible requirements.
- Formica has high mechanical strength and will not break in use.
- Formica will not sag from heat or cold. New under pressure, it retains its dimensions. Everything you fasten to it stays tight and precisely where you put it.
- Formica panels are sold in neat cardboard envelopes which assure you that you are getting the genuine.
- Formica is one of the most widely approved materials in radio.



Hear the Formica program... Tuesday evening 7:30 P.M. Central Standard Time, over WLW.

Rubicon Kits Cut Cost

Go the coming summer weather one better by building a home—at a saving. Write for the free folder on RUBICON Kits. It tells just what's needed. Check off the parts you have. Then from your dealer, or from us direct, get the Kit that fits your needs.

Postcard brings free folder.

RUBICON COMPANY

29 N. Sixth St. Philadelphia, Pa.



Kits to build 8 or 9 tube sets. \$25.00 to \$120.00

Index Your Radio

RADIO INDEX

The Key To 720 Stations 50¢ POST PAID

All the 720 Broadcasting Stations of North America indexed by wave-length, Dial Readings, Locations, Frequencies and Call Letters. Nothing to write but your dial settings. Gives dial positions for stations you have been unable to find. Self-indexing. 36 pages, 7x10 inches with beautiful bound cover. 50¢ postpaid. 5¢ a copy taken.

THE RINDEX PRESS
202 Euclid Avenue Annex
Cleveland, O.

Make \$100 Weekly-sell RADIO

Demonstrate Once—Residual Sales Grow

Cost to cost, lowest price, attractive out-tube instrument \$10.50. Big commission to you. Exclusive territory to proven salesman. Territory right here, write today for large illustrated book No. 100. Don't fail to name your county.

OZARKA, Inc.
353 Washington Ave., Chicago, Ill.

See the Profit

with an offer in which he said, "If the Paulist Fathers want to put on a program, they can do it through our station." Thus was emphasized the desire of some that all new-comers should undertake to improve the standard of programs from existing stations by taking a suitable period of time in studios at present functioning. Mr. George C. Furness, one of the foremost advocates of toll broadcasting and manager of the Eveready Entertainers of the National Carbon Company, explained how one great corporation had practiced this policy. In his opinion more class "B" stations means poorer programs and a direct loss, not only to the public, but also to the radio industry and the art of radio. The money which such broadcasters can afford to put into the business should go through the best-existing stations by means of toll broadcasting.

Chain broadcasting by linkage of several stations through long-distant land wires is often practiced by those who wish a national audience. One dare not attempt too much in interpreting the Government policy with respect to this matter; but probably it is fair to say that the Department of Commerce certainly looks with no disfavor upon this development.

The two systems organized already by the Radio Corporation of America and the American Telephone and Telegraph Company have been planned without any official approval, because the Department feels that it is none of its business to pass upon these matters. But the writer suspects that every announcement of additions to these chains of stations brings a sigh of relief at the Department. Certainly every such linkage reduces the demand for a further advance in the power used at any single station. And, of course, every delay in advancing the power of class "B" stations to higher values means a delay in the time when serious inter-station interference may be expected.

The question of station interference involves two problems: first—how close a spacing in frequency can safely be made; and second—how great power increases should be allowed. On the first of these questions there is growing up slowly, but none the less surely, evidence of demand for wider separation than 10 kilocycles. Speaking on behalf of listeners, our worthy Editor-in-Chief of Radio in the Home, Mr. Henry M. Neely, indicated to the New York conference, the desirability of 15-kilocycle separations regardless of distances between them. Apparently this wider spacing will wholly eliminate those distressing whistles of heterodyning that the multi-tube set owner at times experiences. At present, however, Washington offers us no encouragement that this greater separation can be granted in the immediate future. Perhaps improvement in the radio art will give us instruments so much more precise in selectivity and more accurate in transmission that this trouble may eliminate itself. If not, Uncle Sam is going to have a job cutting down 50 per cent the number of class "B" wave-length channels.

Fans the country over are beginning to appreciate that Washington has two different sorts of high-power station problems. The first of these relates to those much-talked-of, and much damned, "superpower" establishments, none of which has yet become a reality in broadcasting. It is likely that one such station will be built and tried out during the coming summer. Out on the Jersey flats

such a station, it is rumored, is even now under construction.

But this fact need cause no listener worries. Uncle Sam's inspectors will be Johnny-on-the-spot whenever they grant of radio begins to use the ether. In effect they will have one hand on the broadcasting switch every moment of the time, for any new developments that cause trouble will at once result in interruption of experiments on any such large scale. Only good can come, therefore, from the trials.

Of course the object of such extremely powerful stations is to raise the signal strength so far above the static and other interfering effects as wholly to eliminate these troubles of the listener. If such result can be accomplished, Washington certainly will look with favor upon a few big stations. But, rest assured, they will be wisely located and closely watched.

Increasing power of present stations by steps of 500 watts goes on apace. Already a dozen or more are taking advantage of this privilege. Inspectors are, however, watching these folks too. In this connection Washington tells one good joke, and it is clearly "on" the fans. One of the class "B" stations, having been granted permission to raise its power, permitted the newspapers to announce the fact. Almost at once the Department of Commerce began to receive a flood of protests. These described all sorts of blanketing, interference and new troubles, "never before experienced." The fact was, authority had been granted, but no change in power actually had been made. Can it be that the fans ever do imagine things? If, for one, will not venture to deny it in the face of this unquestioned evidence.

But the listener-in does not need to trust his imagination when it comes to determining which is the best program. That is clearly a matter of personal opinion or personal judgment. And the fan not only is entitled to such preferences; he also should make them known. There is no other way in which either broadcaster or supervising Government official can tell what is wanted or what we can well spare.

There is no question of the desire in every broadcasting organization to give the public what it wants. Without accomplishing this end the station obviously fails of its primary purpose. That the fan is not unmindful of this is evidenced by the millions of messages received by every form of communication available at every important station. To supplement these communications sent directly to the station, it is a good scheme to write occasionally to the Radio Division of the Department of Commerce at Washington, or to the District Radio Inspector. Why wait to write such a letter until some real or imagined cause of complaint arises? Why not give the Department as well as the broadcast artist and station, the encouragement of a "thank-you" letter now and then?

But when you write to Washington, unless you really need an answer, please be sure to phrase your letter so that the busy Department staff can read, enjoy, and file, without replying. Thus it becomes merely the intended stimulus and encouragement; it does not become an added burden to the already overloaded correspondence staff. For we must remember that every unnecessary letter takes time of these radio guides from urgent and important other work. There is, however, always time to read that mail which gives the Department a background of understanding of the needs and wishes of the radio public. And in the Department there is no greater desire than to serve and satisfy this need.

The "Showmanship" of Radio Announcing

By PAUL HALE BRUSKE

Dear Mr. Neely:

It has occurred several times to me that some magazine is going to strike a harmonious note with a large proportion of its readers by devoting a relatively small proportion of its space to contributions from the radio laity, one of whom I aim always to be.

Articles by an expert are surely instructive and enlightening to a reasonable proportion of your readers. Yet I am sure there must be a large proportion of your orientals who would welcome something more within their own experience with which they could intelligently agree or disagree.

The accompanying article is submitted as the viewpoint of one listener-in.

Yours very truly,
Paul Hale Bruske

IN THIS candid, outspoken Nation of ours, there have long been two occupations on which the open season for adverse criticism lasts proverbially the year around.

Everybody who has ever been a guest of a hotel admits he could run it far better than the person now on that job.

And only the very meek and humble fail to cherish an inward grief that destiny has never placed them in charge of a newspaper. What sweeping improvements they would make!

Now comes a third "mismanaged" job—another of those semi-public affairs—which each of us believes himself better fitted to handle than those to whom it has been assigned.

Comrades of the horn and headset, gather 'round, and deplore the lamentable lack of good broadcast announcing!

Pam swiftly over the misguided lad, who, in making his announcement, modestly omits naming his station! Dire retribution will surely overtake him—if not in this world, then in the next. Proceed, rather, to consider the broad fundamental side of his responsibilities.

What is he really there for? And what is he making of his matchless opportunity?

From the high aerial over his head, his voice may reach out nightly into more homes than he has ever seen, asking the attention not of mere hundreds—not of even thousands—but actually of millions!

The duty of an announcer is to inform. Even the announcer will probably agree in that definition.

But what information is he there to pass out? Why the information we want, of course! The information that's interesting! The information that keeps our sets open to his station!

For there can be, I imagine, little sense of satisfaction in broadcasting to the empty air. Stations exist to be heard and appreciated. Every announcement should carry, therefore, its implied invitation to listen. And every announcer should put everything he has into making his invitation attractive to those of us who are tuned in.

Do we lend him our ears? Nay, rather, what does he do to deserve them? In brief, how good a showman is he, anyhow?

Does he hold us, or do we listen momentarily and then reach for the dial?

That depends largely on the showmanship of the announcer.

For his station is merely one of many along the midway of the ether.

And he is its sole ballyhoo. We'll stop—if he makes us. It's up to him. He can make us linger and listen to a mediocre program, if he's good enough—yes, and send us away boosting for it, and for him!

This need for showmanship may be a new idea to most of these heralds of the air. As most of them seem to construe their responsibilities, they are merely substitutes for signboards. A nice little formula is their common stock in trade. The first section of this formula contains call letters, home town, and possibly the broadcasting corporation. In the second comes the name of the next performer, the selection or subject and perhaps a more or less frantic attempt at the name of some musical composer.

A day's work consists, apparently, of enough repetitions of this formula, with slight changes in the second section.

Does this kind of announcing hold us? It does not. But there's another kind, Henry Re!

There was the lad, for instance, out at WOS. His station wasn't the strongest by any means in the reach of my set. It was pretty plain that the management wasn't spending much if any money for performers. His standard reliance was the talent that was doing time in the State prison—a prospect which could not be considered at all alluring.

Yet the announcer took the prison piano player and, with this one lone performer, gave repeated programs that had us all tuning in. The pianist was proficient enough to hold down a good dance hall job, if there is such a thing. As such performers go, he was "there." But it wasn't piano music that held us. We were in the grip of showmanship.

That WOS announcer told us things about that piano player that won our interest. He gave him a title that was pat. He worked on our sympathies. When his convict piano player was at last set free, the announcer also eased himself out of radio and into a field of effort where showmanship is better understood and presumably, better paid. The piano player is in vaudeville, and the announcer is his press agent and manager.

Then there's the versatile Roxy at WEAP.

The best part of the concerts by Roxy's gang is undoubtedly the announcing done by Roxy himself. That's what makes the rest so good.

Roxy was a showman before he was ever an announcer. He's a showman at the "Milk." Well does he realize that we listeners-in are more interested in people than in mere music. So Roxy tells us that the soprano is gowned in peach and lets us in on a bit of dialogue that proves she has a speaking as well as a singing voice.

With Roxy, announcing is really introducing. And his introductions are so well done that often we feel almost acquainted with the artist.

Another announcer we all enjoy is Wendell Hall. Between songs, chatter and "uke" manipulation, Wendell is doing a lot of announcing and introducing. All of it concerns Wendell Hall.

Just think of the personal knowledge we have all picked up about this talkative troubadour. How generously he has quenched our thirst for facts about the human being back of the performer, and how much better we appreciate the music because of the personal acquaintances he's had with us!

Yes, ladies! There should be more to any radio artist than a mere name. What does she look like? How is

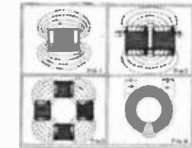
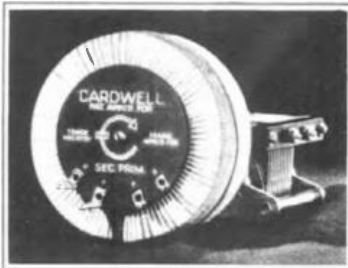

General Theory of the Toro-Tran
Figure 1 shows how the field of the winding coil extends into space and increases with distance. The field of the winding coil is a "double series" winding which restricts the field of the winding to a narrow "Toro-Tran" field and the inner coil to stray fields. The field of the winding coil is a "Toro-Tran" field and the inner coil to stray fields. The field of the winding coil is a "Toro-Tran" field and the inner coil to stray fields. The field of the winding coil is a "Toro-Tran" field and the inner coil to stray fields.

—and now the TORO-TRAN!

CARDWELL, whose pioneer "low-loss" condenser established new standards of radio efficiency, is now introducing the Toro-Tran™—the ideal balanced coupling inductance for all radio frequency work.

The Toro-Tran eliminates signal energy picked up by ordinary coils from nearby stations. It eliminates magnetic feedback in multi-stage radio frequency circuits, thus removing the most active factor in causing howling and distortion and thereby increasing selectivity and distance. It rejects almost entirely the interference effects caused by electrical

power machinery, elevators, door bells, arc stations, etc.

The Toro-Tran winding confines the field to the inside of the coil, a small area, and thus avoids one of the greatest causes of loss known to radio receivers—that of stray magnetic fields which result in the absorption of signal energy and reduce the efficiency of the receiver tremendously.

Note these unusual advantages in assembly and operation

1. Compactness. The coils do not require spacing or angular mounting. They occupy less space than your condensers.
2. Permit exact nullification for tube and stray capacity without guess work or tedious testing.
3. Closed magnetic field eliminates magnetic feed-back in tuned radio frequency amplifiers.
4. Low distributed capacity due to air spacing of each winding and to low voltage drop per turn of small diameter wire.
5. Maximum coupling and high ratio of voltage increase due to concentrated field with zero leakage.
6. Absence of all supporting insulation in the field of the coil. This is one of the great

7. Lack of neutralizing coil factors in the ordinary circuit and is not remedied by "shelton" or so-called "low-loss" windings.
8. Ease of neutralizing coil factors in the ordinary circuit and is not remedied by "shelton" or so-called "low-loss" windings.
9. Low capacity between primary and secondary, affording maximum transfer of energy to succeeding grid-circuit.

The Toro-Tran has a lower "circuit resistance" (i. e. effective resistance as assembled in a set and not as isolated in the laboratory for theoretical measurements) than any inter-stage tuned transformer made and has a correspondingly higher amplification factor, its ratio exceeding ten.

To appreciate the many remarkable advantages of the Toro-Tran write for our two free booklets: "The Torodyne Circuit" and "The Most Interesting Radio Frequency Transformer Ever Invented."

Toro-Trans are ready to mount in any tuned radio frequency circuit. Replace your ordinary coils with Toro-

Tran. You will be astonished by the results. Most .00035 mfd. variable condensers will tune them, but by using Cardwell Condensers you get maximum efficiency.

- Order from your dealer or direct
- CARDWELL TORO-TRAN WITH BALANCING POTENTIOMETER... \$ 4.00
 - Cardwell .00035 Condenser for tuning... 4.75
 - Cardwell .00035 Variable Condenser... 5.25
 - Cardwell .00035 Dual Condenser (two-in-one)... 6.00
 - Cardwell .00035 Triple Condenser (three-in-one)... 12.00
 - Cardwell Audio-Tran (compound audio transformers)... 10.00
- The Allen D. Cardwell Mfg. Corp.
61 Prospect Street, Brookline, N. Y.



The Best Transformer Money Can Buy

You secure Marvellous Reception with these New KARAS HARMONIC AUDIO Frequency Amplifying Transformers. Because they amplify with GREAT VOLUME the extremely low frequency tones that other transformers fail to amplify at all. They amplify EQUALLY all of the many vital harmonics and rich overtones that combine to form pleasing musical sounds. There is no smudging of sounds—no rum on the edges of words—no thin, squeaky, distorted tones. EVERY tone is clear-cut, separate and distinct from every other tone—soft, rich, round, full, mellow, tansy—a surprising volume of REAL MUSIC to which it is a delightful pleasure to listen. Price \$2.00 each. Karas Electric Company 2005 N. Broadway, Chicago

Obsolete

Take the "GUESS" Out of Tube Control \$1.10 Everywhere

AMPERITE—the Self-Adjusting rheostat takes care of tube current better than any expert operator could regulate it. No more hand rheostats or filament meters necessary. Bring the most out of each individual tube automatically. Simplifies wiring, doubles tube life, lowers set cost. Approved by all leading laboratories. Used in every popular construction circuit.

RADIAL COMPANY
Dept. B. E. - 1.90 Franklin St., New York City

Write for FREE Book-upto

AMPERITE
MFG. U.S.A. PAT. OFF.

Means right ampers



pep
up your set
with good tubes

"I DIDN'T think that tubes made such a difference—until I changed to **MAGNATRON S.**" That's what one enthusiastic **MAGNATRON** user wrote us.

You, too, will be pleasantly surprised by the way that **MAGNATRON S.** "pep" up a set and give it a new lease on life.

MAGNATRON DC-199, 201A, and DC-199 with large base, sell for only \$3 each at your dealers.

CONNWEY ELECTRIC LABS.
309 Fifth Ave., New York
Factories, Hoboken, N. J.

MAGNATRON S.



Make Money Building This Set for Friends

Here is a 4-tube set with 5-tube volume and a wonderfully sweet tone. It is not reflexed, but employs the circuit (with improvements) which made the Greene Concert Selector such a favorite in the East.

The secret is the L+K Variable Clarifying Selector and the VT25 Variotransformer, so widely praised by radio authorities. The Selector is a patented aerial tuner that gives needle-point selectivity. The VT25 is a variable transformer, operating without a condenser, that gives the amplification of two ordinary fixed R. F. transformers. Both will improve any standard hook-up.

We'll supply all the parts and charts and free expert advice to build this excellent set. Get just one set working in your neighborhood and you'll soon be good and busy on very profitable work. Write for Free diagram spread and particulars.

Address
The Langbein-Kaufman Radio Company
511 Chapel St., Dept. R., New Haven, Conn.

An L+K Product

TUNERS ELKAY SETS, KITS

she gowned? What does she do in working hours?

Can the pianist also talk? Does that rumbling bass come from a gram or a shrimp?

Is the violinist loose-jointed or on his dignity? Does the coo-singer sing from her toes up, or only from the chest?

Is the accompanist a close friend or just an emergency pick-up?

What's going on in the studio besides the things we're supposed to hear?

Loosen up, lads!

Don't be maudlin or verbose. Don't try to be funny, if you can't, but just remember that everybody wants to know everything that's interesting.

Your performers may not be extraordinary, but it's up to you to make them interesting to us. Do that and you'll be surprised at the applause cards.

Use the old think tank a bit. Rig up a little stage business once in a while! Dignify and glorify that job of yours. If there's a spark of showmanship in your soul, fan it till it bursts into a blaze! There's a chance for more fun and more dough in the old envelope on Saturday night.

Ballyhoo us a bit, lads; we like it.

And don't forget to let us know your call now and then after you start this reformation. We surely want to recognize you, and the contrast is going to make it hard.

How to Make the Counterflex Superselective

(Continued From Page 19)

S2 the end. If these connections are reversed the set will operate inefficiently.

Other questions on the operation of the Counterflex are contained in letters I have received from readers. Many of these letters report experiences with the Counterflex. I shall reproduce a few of them and answer any questions they contain.

Mr. George H. Baltz, of Philadelphia, writes as follows:

"I think you will be pleased to know I tuned in KFI, Los Angeles and held same for forty minutes at 1:30 A. M., only using two tubes with your famous Counterflex circuit. I feel that I could get China if I could get three tubes going, but when I tune in with two tubes and then transfer to three I get distorted volume for about ten seconds, then a 'pop' like the bursting of a toy balloon, and the set is paralyzed. No amount of twisting of dials will bring in a thing, so I go back to two tubes. I am using the hook-up shown in the January issue with the addition of a "C" battery as shown in the February issue and 201A tubes."

As Mr. Baltz is getting such excellent results with only two tubes, I would suggest that he examine the connections and apparatus of the third tube and locate the trouble. It is very likely some simple little fault, though difficult to find. It may be just a loose connection, or a faulty audio-frequency transformer. I do not think the set is "paralyzed." This is a case, however, which one cannot

very well diagnose without actually testing the set itself.

Mr. Horace L. Smith, of New Haven, Conn., writes:

"The pictured drawing of your two-tube Counterflex in the December, 1924, issue appealed to me so strongly as a simple, yet efficient set, that I immediately started to build one. It has given wonderful results in distance and selectivity, having given us as far West as Hastings, Neb., and Dallas, Tex.

"Now my problem is this. I have added another tube of straight audio-amplification, but have been unsuccessful in getting any adequate results. Will you give me a drawing of the necessary connections to make?"

I am reproducing this letter because a number of readers have asked me how to add a stage of audio-frequency amplification to the Counterflex circuits. I am not going to show the diagram requested, however, because it is not practical. The standard Counterflex circuit has two stages of audio-frequency amplification, and it is useless to add another stage. The result will be continuous howling. The howling can sometimes be removed by using resistance and condensers across the transformers, but these merely reduce the audibility, and no advantage is gained by using the extra tube and transformer.

Mr. Charles W. Bock, of Philadelphia, writes:

"I have built a two-tube Counterflex using two condensers rated at .00037 mfd. each and find the 509-meter stations come in at 55 on the dials and 395 meters at 25. How can



Finer Selectivity

Equip your receiving set with Apex Vernier Dials. They will greatly increase the efficiency of any set. Make tuning positive—being in distant regions. Your dialer has them. If not, send \$2.00 for Royal Brass Finish, or \$3.50 for Silver Finish, or \$3.50 for DeLuxe Gold Plated (Lab.).

APEX SUPER 5

This highly efficient tuned radio frequency receiver is most advanced in design and construction. An instrument that meets every critical expression of the radio enthusiast.

Housed in a highly finished walnut cabinet, complete with Jones Multiplying Battery Cabinet. All settings highly gold plated. Sells for \$95.00 net plus shipping accessories.

At All Good Dealers
APEX Elec. Mfg. Co.
1428 W. 59th St. Chicago
Dept. 418

I change the tuning to higher figures on the dials so as to be able to get down to at least 250 meters? I want to say I have never heard a set of any kind that I liked better for clear reception and volume."

The remedy in a case like this is very simple. Just remove some turns from the secondaries of the radio-frequency transformers. With .00087 condensers the secondaries of the r. f. transformers should have not more than sixty turns of the No. 24 wire on 2½-inch tubes.

Mr. Edward G. Ingram, of New York, writes:

"I have completed my Counterflex, and I want to tell you that its excellent performance has far exceeded my fondest expectations. Its volume on both local and long-distance stations is perfectly amazing and the tone quality is wonderful. Local stations can usually be operated on the first stage with ample volume. Distant stations like Chicago, Cincinnati, Cleveland and Pittsburgh come in on the second stage almost like the big local stations. The second night I had the set in operation I received KOA, Denver, Col., on the phones. An my brother's eight-tube superheterodyne has so far failed to bring anything in further west than this, you can imagine that I am pleased.

"The ability to bring the Counterflex right up to the oscillating point when doing DX work seems to give it all the advantages of a tickler coil regenerative circuit.

"I think a little information on how

to balance your Counterflex would be of great value to those who are building this outfit with home-made parts. Every one recognizes that when he buys the manufacturers' kit he gets a better set than he could build himself, but there will always be some who will try to build the set with cheaper parts, or with home-made parts. How can these fans approach the balance obtained by the manufacturer? For instance, if a man builds a set using the number of turns that you suggest on T1 and T2, and the receiver does not function properly, what method of procedure should be followed? Would varying the primary of one or both the transformers bring results?"

In the hypothetical case suggested, the procedure to be followed would depend entirely on how the receiver did not function. In any case, if the radio-frequency transformers are wound correctly the cause of the set's failure to function properly must be elsewhere. If it is impossible to produce self-oscillation, I would first check up the connections to the radio and audio frequency transformers. The trouble may lie in a reversed connection. If these are correct, and all other wiring is correct, the set may merely be off balance because of the high resistance of some of the parts used. The resistance can be reduced by using a higher value of by-pass condenser across the reflex audio-transformer. I explained how to "balance" the Counterflex receiver in the April issue.

Mr. Geo. M. Hand, of Louisville, Kentucky, writes:

"Last night (January 19), I made an all-night distance test with a friend of mine, doing fine work. We worked from 10 P. M., Central standard time. We recorded eighty-two stations in all, bringing most in with good volume on head set. The stations included KGO, KFI, WEPF, WMBS, WOC and others too numerous to mention. At 6:15 A. M. I think we set the pace for the Counterflex, but have no way of verifying it unless you can help me investigate. At about 6:14 A. M. we tuned in what we think was England. The voice was as strong enough for us to get the call letters but the music was good. For verification please try to find out if any of the English stations were broadcasting a pianologue or the piano and voice at the same time. The voice did not sound like singing. I think the announcer said, 'I wonder how many of our American friends are listening in at this time in the morning.'

"This little 3-tube 'Air Devil' is the set of sets and, believe me, O. M., I don't believe you can improve it much, but I hope you can. I have followed you from the reflex up. Although I did beat you with the two rheostats and A. F. by-pass condensers, when the January issue came out you had me beaten with the counterdrum, so I had to put it on. Selective! Say, O. M., I live half a mile from WHAS and it doesn't make any difference to me whether he is running or not. I get through just as long as they are not on 400 meters. How's that? If I had a set built out of first-class balanced parts instead of my knock-down built-up things that have been in everything from a three-circuit regenerative to a superbet, I'm afraid I'd keep the neighbors awake. I'm using W. D. 12's in this set. The English broadcasting I speak of was between 408 and 410 meters."

I am afraid I can't help Mr. Hand very much to check up on his reception. He might be able to get some particulars of the British stations and programs from the British Broadcasting Company of London. To pick up eighty-two broadcasting stations in one night is quite an achievement, whether he was successful in receiving England or not. I notice that Mr. Hand, in common with many others

Radio at its Finest Now Within Your Reach

WIN AN ALL-AMAX RECEIVER
At your favorite Radio Store
Ask them about the great ALL-AMERICAN Slogan Contest
You can win a set by submitting a SLOGAN
Everybody can enter. It costs nothing

Factory-Mounted—Ready to Wire

You buy ALL-AMAX SENIOR with all the parts properly mounted on panel and baseboard. Wire it in one delightful evening. Price \$42
ALL-AMAX JUNIOR (1 tube) Price \$22

Ten cents will bring you the new Radio Key Book, and upon request we will include, free, a complete wiring blueprint of either ALL-AMAX SENIOR or ALL-AMAX JUNIOR.

ALL-AMERICAN RADIO CORP.
E. N. Reimold, President
2666 Coyne Street, Chicago

This is Not a Kit

ALL-AMERICAN

TIMMONS
B-Limitator

Pat. May 16, 1923

How it Operates on An Atwater Kent

How well the Timmons B-Limitator, which takes the place of B batteries and uses house current, operates on an Atwater-Kent set is told in the following, taken from the letter of Thomas H. Latta, Armstrong & Latta, 1929 Sansom Street, Philadelphia: "The B-Limitator was of great assistance in clarifying reception when I tuned in Los Angeles Station KFI on my 6-tube Atwater-Kent set."

The B-Limitator operates from any 110 volt, 60 cycle alternating current lighting circuit. Price now \$38 with special tube. At all good radio dealers.

TIMMONS
RADIO PRODUCTS CORPORATION

GERMANTOWN PHILADELPHIA



The One Tube Where "Distance Makes No Difference"

SEA GULL
Detector and Amplifying Tubes



Here are tubes to gladden the heart of every radio fan with ambitious standards. Each Sea Gull tube is nursed along individually through every stage of its construction as though it were the first, last and only tube that we intended making.

That's why both static and dynamic tests show so high on Sea Gull tubes. That's why Sea Gulls achieve such wonderful performance in operation.

Quantity production is of no interest to us—quality and reputation are, and ever will be, our first considerations.

Isn't that an excellent reason why you should immediately send us your order for Sea Gulls today?

\$3.00 per tube, p. p. C.O.D. Do it now.

ABERDEEN MFG. CO.
Mail Order Dept. 310
1520 Chestnut St.
Philadelphia, U. S. A.

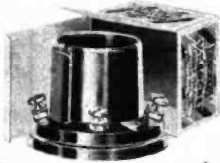

Clearer reception this easy way

THE important thing is to have clean, perfect contact between tubes and sockets. Otherwise disturbing noises will continue.

You can always have clean, perfect contact by using Na-Ald Sockets—the only sockets with these three essential features:

- (1) **Lowest losses.** Laboratory tests proved that of 13 best-known makes Na-Ald Sockets were the only ones having losses lower than a good low-loss condenser.
- (2) **Low capacity.** The same tests showed that Na-Ald has the lowest capacity of any socket—very essential for short wave length reception.
- (3) **Positive side-scraping contact** (not just side pressure) that cleans corrosion from tube terminals.

Use Na-Ald Sockets in the set you build or buy, if not already installed by the manufacturer. De Luxe, 75c; others, 35c and 50c.

ALDEN MANUFACTURING COMPANY,
Also makers of the famous Na-Ald Dials
Dept. J-6, Springfield, Mass.

free

Booklet—
mail
coupon
below

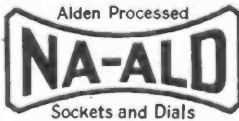

ALDEN MANUFACTURING CO.,
Dept. J 6, Springfield, Mass.
Please send free copy of booklet, "What to Build," showing tested and selected circuits.

Name
Address
City State

using dry cell tubes, finds the standard Counterflex very selective. Mr. Ernest Moss, of 49 Camp street, Providence, R. I., says: "I have made your Counterflex set which was described in the January issue. I am pleased to say that it is surely a good set, with plenty of distance and as clear as a bell. The only trouble I have had so far is body capacity effect. How can I stop this effect?"

If this effect is troublesome it can only be remedied by shielding the panel behind the counterformer T1 dial and the counterdial and grounding the shields. These shields can be pieces of aluminum or copper. Holes must be drilled to pass the shafts of the condensers and the mounting screws without touching the shields. There must be no electrical connection between the shields, which are connected to the ground, and the tuning condenser or the counterdial.

The concluding letter this time is from Mr. G. B. Wright, of San Francisco. He writes:

"In the October issue of *Radio in the Home* your Counterflex hook-up first came to the writer's notice. Since that time I have done considerable experimenting with this hook-up and have found in some respects it is almost too good to be true, while in others it is not so good. As a DX set it has anything beaten off the board that I have ever had anything to do with, including all dynes and supers. I have night after night picked up stations within a radius of 2000 miles on a loud-speaker and have held stations as far distant as Detroit, Memphis and Cleveland for a period of an hour without a break, with every word and note audible. In order to do this you have to tune in when the local stations are not on the air. In all respects, with the exception of selectivity, it is much the best set the writer has ever had. I have picked up stations as far away as WGY on the loud-speaker. I never use phones. The best part of it is its clearness. If you can hear a station at all it is clear."

Mr. Wright just needs one thing to make his set perfect—the coupling condenser described in the opening paragraphs of this article.

The New World for the Shut-in

(Continued From Page 20)

for one who has never known the keenest zest of living and therefore can not miss it so much.

But, like Radio Doc, Mr. Thorne is deeply appreciative of all he has enjoyed in the past and spends no time in vain regrets for vanished days.

He remembers the time when he hung up a very respectable record as a runner on the cinder path—and smiles. He thinks of his newspaper days with a chuckle and laughs as he recalls his adventures in the real estate and advertising fields of various cities. He speaks humorously of needing an adding machine to count up his operations and tells of a painful and, as it proved, useless journey from Pasadena to a Baltimore hospital on a stretcher, as if it were a great joke on everybody concerned.

Radio Doc can sit in a sunny corner and manage to touch the things on the swinging shelf which serves as a desk, but Mr. Thorne must lie motionless in a dark room. The rheumatism "bug," as he terms it, has blinded one of his eyes and dimmed the other and he cannot stand the sunlight any more.

He used to lie and stare at the ceiling, but it was a dull occupation, and he longed desperately for something to do—something to get his teeth into and occupy his mind. Finally he hit on the magazine subscription business and was happy

again for, with the help of his nurse and the interest of his friends, he found that he could give a real service and take some part in affairs once more. He got busy and now he is selling magazines published in all parts of the world to people living in all parts of it.

And then, two years ago, radio came to transform his many remaining dark and lonely hours and change the whole complexion of existence for him.

He says he has "perked up a lot since then," for now he can go to the theatre or hear a symphony. He used to be a great dancer and he can dance again—in memory—while he listens to the music of some snappy hotel orchestra.

Radio gives him food for every part of an alert and well-informed mind and not the least of his pleasures is in listening to Sunday services. "Yes, I always go to church," he told me, "and if one fellow can't preach, I go somewhere else. I like to hear the choirs sing, too, and don't miss a thing but the collection plate." The fact, however, is that his bit finds its way into the plate in spite of his mischievous chuckle.

Radio keeps him informed on politics, and he is still marveling at the wonder and privilege of hearing President Coolidge's inaugural address right in his own room. Less than an hour after President Harding's death the news was at Frank Thorne's bedside. He got the returns of the last national election even before the waiting crowds in the streets.

I asked him what his thoughts were when he heard radio for the first time. His set was the gift of friends and when he heard it begin out in the hall beyond his room he thought it was a phonograph. "Then the door opened and they carried it in—and all of a sudden it rolled right out—a mighty chorus of voices, and it was so wonderfully and overwhelmingly beautiful that I cried like a baby with sheer joy."

Since then there have been many hours of music. Great organs have poured out their solemn anthems until he has wondered if they were really of this earth after all. He has heard his own name mentioned by his friend, the Reverend Doctor Freeman, broadcasting through KPCC, and known the thrill of meeting the listening, invisible thousands in that way.

Indeed, it is largely due to his interest and intelligent agitation that the Pasadena Presbyterian Church has a broadcasting station. He was one of the very first to see the need for it and to make others see it also.

Fate has taken many things away from him and yet given him gifts well worth having in their places. And one of these gifts is friendship. Mr. Thorne has more friends that he can count and many he has never seen. At holiday times greetings pour in by the hundreds and he makes them last just as long as he can by not reading them all at once.

Many of these greetings come from people who only know him through radio, but they are not any the less interested or constant for all that. Mr. Thorne says he can understand interest or thoughtfulness for anybody who is ill for a month or so, but how people can be bothered to think about any one who has no more consideration or judgment than to drag out an illness for nearly a dozen years is beyond his comprehension. Cards, letters, Christmas carols, visits and radio—he is grateful for them all and enjoys them in a greater degree than most ordinary mortals.

His body may be down for the count but his brain is still very much in the ring. "It's a good world yet," he says, "and radio is a lifesaver. No, I can't see what the shut-ins have to complain about now."

CARTER New Loop Aerial Pentagon Winding



This loop has new electrical and mechanical characteristics not found in any other loop. The Carter pentagon winding eliminates losses by removing all wood and metal from within the electrical field, thus giving greater signal strength. It also makes possible a loop only 18 inches in diameter which is an ornament rather than an eyesore in any home. Spring binding posts insure quick and permanent connections.

Any dealer can supply

In Canada
CARTER RADIO CO., Limited
Toronto, Canada.

Carter Radio Co.
1012 REPUBLIC BUILDING
CHICAGO

The Low Loss "Supercoils" Fully Adjustable for all Circuits Three Circuit Tuner \$7. Is Shown Above

Bucket weave windings—large wire—duplex insulated. Minimum of disiccable—each coil fully adjustable—100' inductor. Extreme volume—distance—selectivity. This Three-Circuit Tuner is endorsed by H. M. Kelly—the Non-resonating Coil—the "Designer's Best Set."

At all dealers or direct C. O. D. plus Parcel Post

"Radio Broadcast's" "Kubekout" Walter Van B. Roberts' Circuit—



Combining Radio Frequency, Resonation and Reflex. Supercoils are endorsed by Mr. Arthur H. Lynch, Editor "Radio Broadcast"

Per Set, 5 coils in 2 mountings, \$8
Tap Antenna Coils \$1.00 Extra
Jobbers and Dealers Write for Open Territories

Perfection Radio Mfg. Co.
Dept. R, 1820 Chestnut St.,
Philadelphia, U. S. A.

Am I Using the Correct Voltage?

(Continued From Page 28)

the tube, through the filament of the tube, which it heats to incandescence, then through the rheostat which limits the amount of its flow and finally back to the battery again at the negative or right-hand terminal.

The "circuit" is therefore most appropriately named, for it is a closed path returning to itself. With the voltmeter connected across the "A" battery, the reading is 4½ volts, the normal voltage of the battery. This is also the voltage "across" the entire circuit, looking at the thing the other way around.

Now in Fig. 2 we find the voltmeter shifted to a position across the

that the sum of the various voltages in the circuit must add up to the total voltage across the circuit. The voltage across the tube is 2½ and the battery voltage is 4½. Hence the rest must be made up in the rheostat.

In Fig. 3 we find the meter across the rheostat, where it registers two volts. Here the left-hand terminal of the voltmeter is still toward the plus side of the battery, to keep the "polarity" of the meter correct. Here we have a complete electrical circuit, 4½ volts across it, and 2 and 2½ volts across each of two elements which form the circuit in conjunction with the battery.

"The Little Service Station in the Home"



Sterling RECTIFIER

Charges "A" or "B" Batteries from a Single Unit!

NO SEPARATE ATTACHMENT

Each quarter turn of the selector switch automatically adjusts the rectifier for charging 8-volt "A", 24, 45 or 72-volt "B" or two sections of 48-volt "B" Batteries.

No confusing array of binding posts to connect.

No need to insert resistance lamps.

No expensive bulbs to replace.

No special care or wear.

No chemicals or liquids to replenish.

No metal contacts to fuse or burn out.

Adequate charging rate. Battery fully charged over night.

Model 27 (for 8 volt radio "A" and auto Model 19 (for "A" batteries), \$18.50 (50 or 60 cycle); \$21.50 (60 or 60 cycle); \$21.50 (60 or 60 cycle); \$21.50 (60 or 60 cycle).

THE STERLING MANUFACTURING COMPANY
2831-33 Prospect Avenue, Cleveland, Ohio Dept. K.

ATLAS RADIO TUBE

"BRINGS IN THE WORLD"

Made in All Standard Types

INSTRUMENT TESTED

Read the guarantee furnished with every Atlas Tube:

"This Atlas Tube has been individually instrument tested and is guaranteed to give entire satisfaction. If unsatisfactory for any reason whatever, it may be returned within a period of thirty days to the manufacturer or to the dealer from whom it was bought, provided the filament has not been burned out."

"Dealers are authorized by the manufacturer to make replacement or refund (in such cases) whichever may be desired by the customer."

Atlas Instrument-Tested Tubes are guaranteed in function efficiently in Reflex, Superheterodyne, Superheterodyne, Radio Frequency or any of the circuits which require highest efficiency in tubes."

At best dealers or direct from us. **\$3.00** each promptly filled.

SPECIAL OFFER—At an extra charge, we will furnish selected, instrument-tested, matched tubes in sets as follows:
Reflex Set—3 Tubes \$8.00
Superheterodyne Set—3 Tubes \$15.00
Superheterodyne Set—3 Tubes \$4.00
They will get the most out of your Radio Set.

DEALERS and JOBBERS—There is satisfaction as well as profit in handling ATLAS TUBES. The first tubes to be sold on these terms, principles affording full protection and satisfaction to your customers.

Write or wire for proposition.

THE PEAK CO

309 Canton Building, Cleveland, Ohio
609 Chamber of Com., Pittsburgh, Pa.

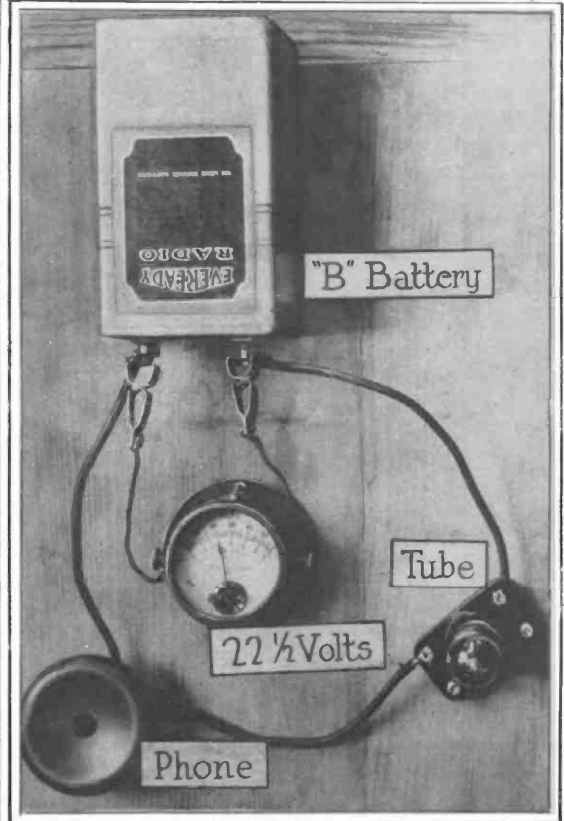

Fig. 4—The voltmeter shown as it is connected for measuring the "B" battery. This is perhaps the most important function of the instrument—to let you know when your "B" batteries are running down

tube filament. As the rheostat happens to be adjusted, the voltage at this point is just 2½, or ¼ volt less than the maximum voltage for such a tube specified by the manufacturers.

It is well to keep in mind the directions of current flow in the circuit, being from plus to minus or clockwise in the illustrations. Observe also that the left-hand terminal of the voltmeter is attached to the positive end of the "A" battery in both cases. Low-priced voltmeters can be connected in either direction, whereas the good type must be correct as to polarity or the pointer will swing in the wrong direction.

It is an electrical law, and quite obvious after a moment's thought,

Some interesting conclusions may be drawn from the facts ascertained together with an application of "Ohm's Law." This law expresses a simple relationship between current, voltage and resistance in an electric circuit. It is expressed fundamentally as follows:

$$\begin{aligned} \text{Voltage (E)} &= \text{Current (I)} \\ &\times \text{Resistance (R)}, \text{ or} \\ \text{Volts} &= \text{Amperes} \times \text{Ohms,} \\ \text{or } E &= I \times R \end{aligned}$$

Now to apply these laws to our

Earn \$100 a Week in RADIO!

Easy to Learn at Home

The money every week for fascinating, easy work—wonderful future. Hundreds of big-paying positions in this big, new industry!

More Money for YOU in Radio

THOUSANDS of Radio Experts are needed to design, repair, maintain, sell radio apparatus, to operate broadcasting stations, as ship and land operators, to go into business; to instruct, sell, demonstrate, superintend and for scores of other big paying radio jobs.

And now, you can easily become a Radio Expert. Studying at home in spare time, you can quickly qualify for a splendid Radio position. Astonishingly small cost. Famous radio instructors give you individual help by mail. Training Guaranteed.

Free Employment Service

Hardly a week goes by without our receiving urgent calls for our graduates. "We need a competent Radio Engineer"—"We want men with executive ability in addition to radio knowledge to become our local managers"—"We require the services of several resident demonstrators"—these are just a few small indications of the great variety of opportunities open to our graduates.

FREE—Receiving Set and Special Parts

Our course of practical instruction includes not only several of our own special patented instruments, but in addition we furnish material and diagrams for building receiving sets—all without additional cost. This is an absolutely complete course which qualifies you for the government first-class license and for the big-pay jobs in radio.

We Help You to Big-Pay Positions

Scores of young men who have taken our course are already earning from \$15 to over \$200 a week. Merle Wetzel of Chicago Heights, Ill., advanced from lineman to Radio Engineer, increasing his salary 100% even while taking our course! Emmett Weish, right after finishing his training, started earning \$300 a month and expenses. Another graduate is now an operator of a broadcasting station, 1PWX of Havana, Cuba, and earns \$250 a month. Still another graduate only 16 years old is averaging \$70 a week in a radio store, and we help our graduates to positions like these.

Send for FREE BOOK

There's more money for You in Radio. Find out what this field has meant to hundreds of our graduates—and how YOU, too, can profit in "Rich Rewards in Radio" has just been printed. It is filled with the latest Radio facts, figures and illustrations of tremendous interest to you. Right now—if you are at all ambitious—send for this valuable free book. Write now while our Special Offer is still open. Fill out the coupon—and mail it now!

National Radio Institute, Dept. 640R, Washington, D. C.

NATIONAL RADIO INSTITUTE, Dept. 640R, Washington, D. C.

Without obligation send me your book, "Rich Rewards in Radio," which tells all about the opportunities in Radio, how spare time at home will qualify me quickly as a Certified Radiotician and can give me one of these splendid positions, and how your Employment Service helps me to secure a big-pay job.

Name Age

Street

City State



This NEW Super-Horn Brings Magic Clearness to Radio

The new Kellogg *Symphony* Reproducer is a new-type horn recently developed by our experts—based on the magnetic diaphragm principle.

It brings to radio a marvelous tone-quality, a beauty you have never heard before. Attaches to any set and can be adjusted for the particular "volume" requirements of the set.

At all radio dealers. Ask for it by name. See it, hear it—compare!

KELLOGG *Symphony* Reproducer

With Every Kellogg Radio part, Use—Is the Test



Price
\$20

KELLOGG
SWITCHBOARD
& SUPPLY CO.
Chicago, Illinois

filament circuit. The resistance of the filament of the 199 or 299 tubes is approximately 50 ohms. The voltage across that resistance is $2\frac{1}{2}$ in Fig. 2. To find the filament current we apply Ohm's Law No. 2, $I = E/R$. The current is therefore equal to $2.5/50$, or .05 ampere (five one-hundredths of an ampere).

Since this current is necessarily the same as is flowing through the rheostat (in series with it) we may next determine how much of the rheostat's resistance is in circuit in order to limit the current flow to .05 ampere.

Here we must apply Ohm's Law No. 3, $R = E/I$. Thus we find the resistance of the rheostat as its arm is set to be $2/.05$ or 40 ohms. In case the rheostat happens to be a 50-ohm instrument, we should find that about $4/5$ of its resistance element was in circuit to reduce the filament current to .05 amperes. Fig. 3 illustrates this situation.

Thus, a voltmeter is not only serviceable in measuring the "A" and "B" batteries, but is also useful in determination of the voltage applied to receiving tubes. Generally speaking, it is best to illuminate the tube filament at the minimum temperature consistent with full signal strength. Under-illumination does not, of course, shorten the life of the filament, but it usually weakens the signals and in the instance of an audio-amplifier, causes more or less distortion. Over-illumination is useless, for it not only brings no improvement in reception, but it shortens the life of the tube considerably.

The other battery circuit of the receiving set with which trouble is often experienced is the "plate" circuit and includes the "B" batteries which supply the plate voltage. Here it is not necessary actually to determine the strength of the plate current, but it is enough to know the voltage of the "B" batteries. "B" batteries very low in voltage cannot supply current enough for the ordinary receiving set.

A 45-volt "B" battery that has fallen to much less than 40 volts is not a very satisfactory power medium for a receiving set. Very frequently, run-down "B" batteries will, by their increase in resistance, start the audio-amplifier to howling. This is due to the resistance coupling between the audio tubes—the resistance providing the unwanted coupling being the resistance of the "B" batteries, where both tube circuits are common.

Fig. 4 illustrates how a voltmeter is employed in measuring the "B" battery's voltage. Of course, the battery need not be in a circuit for such a measurement any more than the filament battery. However, it is not necessary to disconnect the batteries when taking the measurements.

Once in a while a section of a 45-volt "B" battery will be found at fault, as often happens when a connecting wire that isn't well covered causes a short-circuit between two of the contact posts. In such cases the voltmeter is highly useful in locating the defective portion, which can then be bridged by a piece of wire to take it out of the circuit. Many a time a whole set of "B" batteries, worth perhaps ten or twelve dollars, has been thrown away when only one little 25¢-volt section was run down. And it often happens that one of two 45-volt units will become discharged even though the other one is in perfect condition. Such accidents sometimes occur because one of the units was too close to a radiator, which heated and dried out the moisture so essential to a "dry" battery.

A knowledge of the use of the voltmeter, together with an elementary understanding of Ohm's law, is most helpful when the radio builder attempts to design some special battery

or filament arrangement. Suppose he wishes to build a five-tube receiver for loud-speaker only. He will then use a rheostat for the detector and in all probability one other rheostat for the two radio and the two audio amplifier tubes. What resistances rheostats should be select?

He knows that the detector tube, if it is to be a UV201-A or C301-A, is to be lighted at five volts from current supplied by a six-volt storage battery. The rheostat then, must reduce the voltage one-sixth or one volt. The current for the tube is to be 0.25 ampere, or one-quarter ampere.

Using Ohm's law, $R = E/I$, he finds that the proper rheostat resistance for this condition is about four ohms. This he obtains by dividing the voltage across the rheostat, 1, by the current through it, one-quarter. However, he also knows, or has found by voltmeter trials, that such a tube often detects better at a lower voltage, sometimes as little as four volts.

Applying the formula once more, the resistance needed then is $2/.25$ or eight ohms. He also knows that the voltage of a fully charged storage battery is often somewhat over six volts, so that at the minimum filament temperature the rheostat may have to reduce the voltage as much as $2/5$. Hence, although a ten-ohm rheostat will serve, he decided on a 15-ohm unit to be on the safe side.

The disadvantage of using a 20 or 30-ohm rheostat for such a tube, as is often suggested, is that the useful section of the device is confined to only a small portion of its circumference and it is correspondingly difficult to set it just "right."

Choosing the rheostat for the four amplifier tubes is a little more complicated. Four tubes draw 1 ampere altogether, since they require $1/4$ ampere each. To pass 1 ampere and vary the voltage between 4 and 5 or over, the rheostat must reduce the voltage from 0 to 2 volts. At the 2-volt point, all of its resistance should be "in." Again applying Ohm's law No. 3, he learns that the rheostat should have a maximum resistance of $2/1$ or 2 ohms. The nearest approach to such an instrument is the 6-ohm size and this he chooses, providing it has a current-carrying capacity of at least 1 ampere. To use a much higher resistance instrument than this would be to make it more difficult to get just the proper setting, simply because the useful sector on the rheostat would be too much "compressed."

Another important use for the voltmeter lies in the measurement of the grid bias or "C" battery. It is difficult to tell whether the "C" battery is becoming exhausted or not without some such instrument and we are working in the dark if we must simply guess at it. The purpose of the "C" battery is two-fold: (1) To improve the tonal reproduction of both voice and music, and (2) To maintain the grid voltage continuously negative so that the drain on the plate batteries is almost cut in half. Naturally, the "B" batteries will last nearly twice as long if the "C" battery is used in all possible grid return leads.

The voltmeter brings enlightenment in many other ways: For determining the plus and minus posts of an unmarked storage battery, to test for broken wires and short-circuits, to locate errors in wiring, etc. The use of such an instrument in operating his radio set more intelligently and more successfully and he seldom spends hours hunting for the causes of poor reception.

But, when you do get a voltmeter, spend a little money and get just as good a one as you can possibly afford.

DURHAM Grid Leaks

Used by Eagle-Howard, Thompson, Zenith and others. Fit all sets. Sold on guarantee.

50¢ Metalized Fixed Leaks
10 sizes under 1/4 meg.,
7¢; over 1/4 meg., 5¢.

Glass Sealed Variable Leaks
1 size fit all sets; 75¢
each for 1/10, 1/5 and
10 meg. **75¢**

Get dealers or postpaid

DURHAM & COMPANY, Inc.
1916 Market Street - Philadelphia, Pa.

E B Y BINDING POSTS

Twenty-free
Different
Engraved Tops

They Don't
Last
Their Heads
New 15c
At dealers everywhere
H. H. EBY MFG. CO.
Philadelphia

60 FT. Aerial Mast \$45

30 Ft. Mast, \$11.
50 Ft. Mast, \$16.

We Pay
Freight

All masts complete with guy wires and mast head pulley. No concrete used in the foundation. Write at once for literature and send FREE technical blueprint.

S. W. HULL & CO., Dept. J-6
2948 E. 79th Street, Cleveland, Ohio

TRADE MARK KARDON READY-WIRED UNITS

for all of the favorite circuits.

Detector unit Detector and one step
Detector and two steps
Two-step amplifier
Five tubes for any hook-up.

KARDON PRODUCTS CO.
451 Greenwich St., New York City
Philadelphia Office, 900 Chestnut St.

"Wake up" your set!

Model S-4000
5 volt, Standard Base, 1/4 amp. Detector Amplifier

\$3

Use Schickler tubes. THE ONLY tubes with the 4th element—no tube noises or distortion

Mail orders filled promptly
SCHICKLER PRODUCTS CORP.
401-407 Mulberry Street
Newark, N. J.

All models sold with a 10-day written guarantee

Price \$1850

Complete with Car-2, Battery Leads and Clips.

Valley Battery Chargers

with
Ten Points of Superiority
VALLEY ELECTRIC CO.
3187 S. Kingshighway, St. Louis, Mo.

RADIO BOOK

only **\$1**

514 PAGES

Just off the press! The greatest book on radio ever written. Price only \$1. Filled with sound, practical, tested information for every Radio fan, from beginner to hard-boiled owl. Written, compiled and edited by men of national reputation. Every page tells you something useful—and there are 514 pages. Mail \$1 today and get this 1. C. R. Radio Handbook before you spend another cent on parts. Money back if not satisfied.

Box 2850 E. Scranton, Penna.
International Correspondence Schools

WHIT WITH RADIO

Three straight through the locals, gets distance, brings in more stations—clearly and with volume—in a given length of time than any other set. Direct comparisons invited. Zenith receiving sets cost more, but they do more. The exclusive choice of MacMillan for his North Polar Expedition.

Zenith Radio Corporation
332 S. Michigan Avenue, Chicago

TRITECTOR

An unexcelled crystal detector for radio and crystal sets.

Special Features

1. Three silver ribbon cat-whiskers.
2. Any one of the cat-whiskers may be switched on, as desired.
3. Jarring or shaking will not disturb adjustment.

Sent C.O.D., exp. money or p. o. order, \$1.35
Money back if not satisfied!

The TRITECTOR Co.
215 Macalester Ave.,
St. Paul, Minn.

Pat. App. for

LIKE A SENTINEL

GUARDING YOUR RADIO

The Lightning Season is Approaching Protect Your Radio And Home NOW!

with a

BRACH VACUUM ARRESTER

Used by Principal Radio Manufacturers to Protect Signal Systems



NOW \$350

Direct from Factory to you

THE RABAT SENIOR

4700 MIL. AMPS. CAPACITY

For a Limited Time Only

Two sets purchase for \$3.99 - 10.10 10 sets \$29.99

Special features: 4700 mil. amp. capacity, 100% efficiency, 100% reliability, 100% satisfaction.

THE RADIO RABAT COMPANY
1781 W. 12th Street, Cleveland, Ohio

A Radio Interview on the Superheterodyne

(Continued From Page 35)

hetrodyne is that of two tubes over the ordinary five-tube set.

Q. I have always had an idea that a superheterodyne was a very bulky set.

A. The majority of superheterodynes in the past have been large, but in present-day practice they are not much larger than the average set.

Q. What is the size of your superheterodyne.

A. The size is 7 inches by 28 inches.

Q. That is about the size of an average set, isn't it?

A. Yes.

Q. What are the outstanding requirements for a radio set in your estimation?

A. In order of their importance, I should say, quality, selectivity, volume and distance.

Q. Has superheterodyne good quality?

A. The outstanding feature of a good superheterodyne is the quality of the reception, and I do not believe any set surpasses it in this respect.

Q. Is a superheterodyne selective?

A. A good superheterodyne is one of the most selective of radio receiving sets.

Q. Has the superheterodyne much volume?

A. Yes, a good superheterodyne rarely needs more than one stage of audio amplification in order to receive on the loop and loud-speaker practically any station within its range.

Q. Is the ability to receive distance also a feature of the superheterodyne?

A. Yes. Although I make this statement with the reservation regarding distance-receiving ability that I answered in one of your previous questions.

Q. How much would it cost to buy the parts to build one of your sets?

A. Roughly, around \$85.00.

Q. That is not very expensive, is it?

A. No; much less than the average person has been led to believe.

Q. Is it possible to purchase one of these sets all built?

A. No; but there are several high-class dealers who without doubt would construct one for you if you purchase the parts from them.

Q. In that case, how much should a complete set cost?

A. I should say, roughly, about \$125.00 to \$150.00.

Q. That is for the set alone, you mean?

A. Yes.

Q. Well, if I had nothing at all and wanted a complete installation in my house, how much would it cost?

A. I should estimate in the neighborhood of \$225.00 to \$250.00.

Q. If some of my friends should build one of these sets, what guarantee have they that it will not be obsolete in a short while?

A. The best answer to that question, Whit, is, I think, a comparison between the automobile and the radio. You would not hesitate to purchase an automobile today on account of the fact that you believed in a year's time it would be obsolete, would you? The same thing holds true regarding a super in the radio field. And it might be well to state that the greatest improvements in radio today are coming in the broadcast stations themselves, rather than in receiving sets, as it is recognized by most authorities that the superheterodyne is the most sensitive of sets and making them

any more sensitive would be unwise and unnecessary.

Q. One of your sets was used in the recent trans-Atlantic tests, wasn't it?

A. Yes. One of my receivers was an official listening post on Long Island.

Q. How did it work out there?

A. It so happened that it was the only set on the test in that particular place that received signals from Europe.

Q. How was this accomplished?

A. The reception was all accomplished on a loop and on a loud-speaker.

Q. It is true, then, although you are conservative in your statements on receiving ability, that in most cases where distance is to be obtained a superheterodyne is used?

A. Yes, Whit, in practically all cases where dependable distance reception is wanted a superheterodyne is used.

Q. I notice that you give a list of parts used in the construction of this set. Do you sell all these parts?

A. No, we do not. I selected the parts which I believe to be the best for the set after long experimentation regardless of whether we sold them or not.

Q. In constructing a superheterodyne, what do you consider the most vital point?

A. The success or failure of a superheterodyne depends entirely or practically entirely on the intermediate frequency transformers used.

STATEMENT OF OWNERSHIP, MANAGEMENT, CIRCULATION, ETC. Required by the Act of Congress of August 24, 1912

RADIO IN THE HOME

Published monthly at Philadelphia, Penna.
FOR APRIL 1, 1928

State of Pennsylvania } ss:
County of Philadelphia }

Before me, a Notary Public in and for the State and county aforesaid, personally appeared George W. Kraft, who having been duly sworn according to law, depose and say that he is the Secretary-Treasurer of the RADIO IN THE HOME and that the foregoing is to the best of his knowledge and belief, a true statement of the ownership, management (and if a daily paper, the circulation); etc. of the aforesaid publication for the date shown in the above caption, required by the Act of August 24, 1912, embodied in section 111, Postal Laws and Regulations, printed on the reverse of this form, to wit:

1. That the names and addresses of the publisher, editor, managing editor, and business managers are:

Publisher—Henry M. Neely Publishing Company, 608 Chestnut Street, Philadelphia, Pa.
Editor—Henry M. Neely, Delanco, N. J.
Managing Editor—None.
Business Manager—W. L. Dudley, Plainfield, N. J.

2. That the owner is: (If the publication is owned by an individual his name and address, or if owned by more than one individual the name and address of each, should be given below; if the publication is owned by a corporation the name of the corporation and the names and addresses of the stockholders owning or holding one per cent or more of the total amount of stock should be given.)

Henry M. Neely Publishing Company, 608 Chestnut Street, Philadelphia, Pa. Henry M. Neely, Delanco, N. J.; John C. Martin, Wynote, Pa.; George W. Kraft, 1608 Larchwood Ave., Philadelphia, Pa.; Norman Neely, 422 S. Washington St., Philadelphia, Pa.

3. That the known bondholders, mortgagees, and other security holders owning or holding one per cent or more of total amount of bonds, mortgages or other securities are: (If there are none so state.) None.

4. That the two paragraphs next above, giving the names of the owners, stockholders and security holders, if any, contains not only the list of all such holders but also those who appear upon the books of the Company, but also, in cases where the stockholder or security holder appears upon the books of the company as trustee or in any other fiduciary relation to the names of the persons or corporation for whom such trustee is acting, is given; also that the said two paragraphs contain a statement embracing a full knowledge and belief as to the circumstances and conditions under which the stockholders and security holders who do not appear upon the books of the company as trustees, hold stock and security in a capacity other than that of a bona-fide owner; and that this affiant has no reason to believe that any other person, association, or corporation has any interest direct or indirect in the said stock, bonds, or other securities than as so stated by him.

GEORGE W. KRAFT, Secretary
Sworn to and subscribed before me this 20th day of March, 1928.
(Seal) JOHN C. RIONBY, Notary Public.
(My commission expires February 9, 1929.)



Do You Hear Each Instrument Distinctly?

With the unique design of Rauland-Lyric comes a peculiar excellence. There is brought before you, as a noted critic remarked, "the very personality of each artist," as he explores the resources of his instrument. Such a quality, indeed, as to render insignificant, in any radio set, the added cost of Rauland-Lyric Amplification.

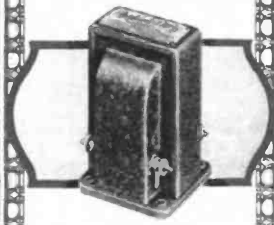

Rauland-Lyric is a laboratory-grade audio transformer designed especially for music lovers. The price is also dollars. Descriptive circular with amplification curve will be mailed on request. All-American Radio Corporation, 1666 Coyne St., Chicago.



The Choice of Noted Music Critics

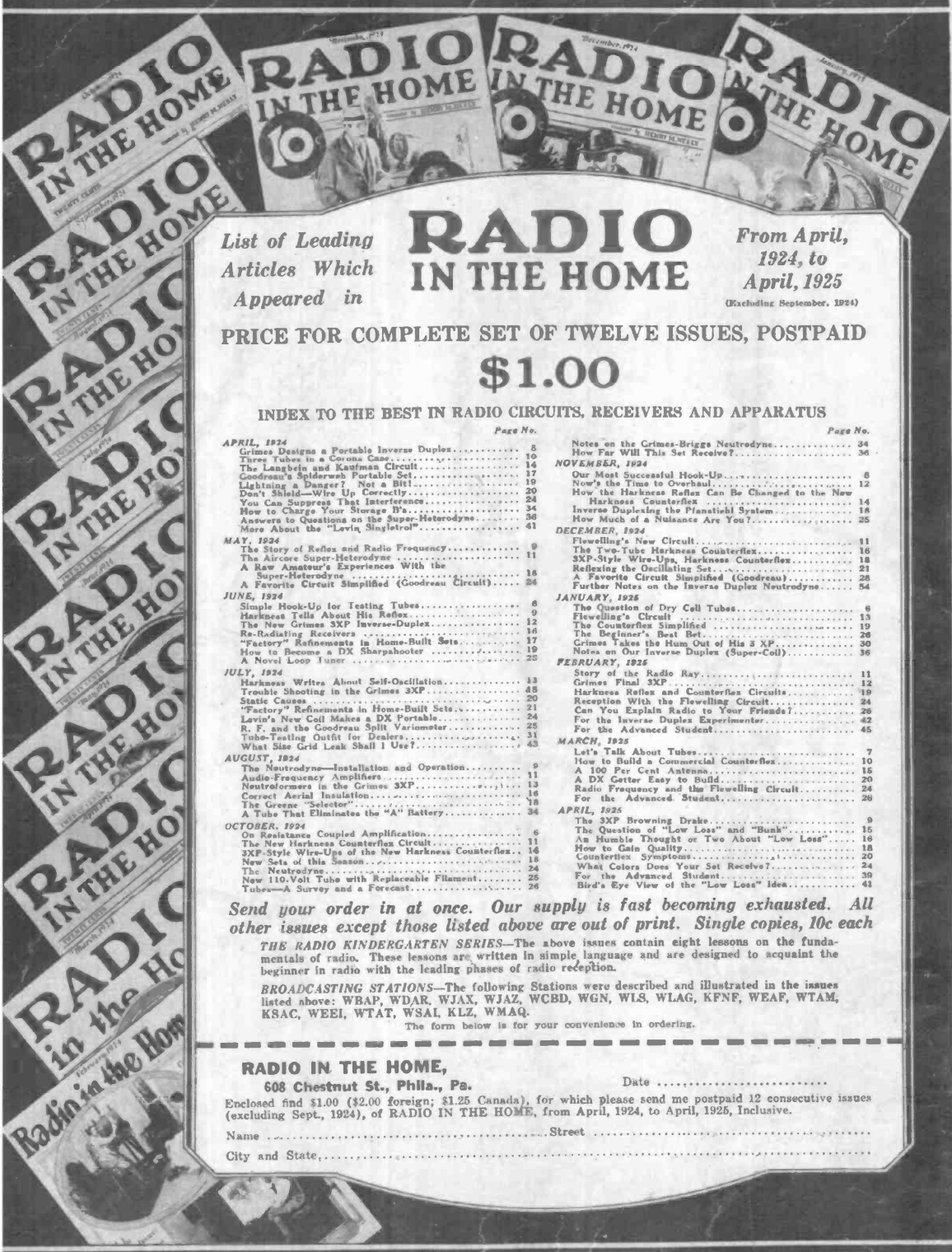

List of Leading
Articles Which
Appeared in

RADIO IN THE HOME

From April,
1924, to
April, 1925

(Excluding September, 1924)

PRICE FOR COMPLETE SET OF TWELVE ISSUES, POSTPAID

\$1.00

INDEX TO THE BEST IN RADIO CIRCUITS, RECEIVERS AND APPARATUS

	Page No.		Page No.
APRIL, 1924		Notes on the Grimes-Briggs Neutrodyne.....	24
Grimes Designs a Portable Inverse Duplex.....	8	How Far Will This Set Receive?.....	36
Three Tubes in a Corona Case.....	10	NOVEMBER, 1924	
The Langbein and Kaufman Circuit.....	14	Our Most Successful Hook-Up.....	8
Goodreau's Spiderweb Portable Set.....	17	Now's the Time to Overhaul.....	12
Lightning a Danger? Not a Bit!.....	19	How the Harkness Reflex Can Be Changed to the New	
Don't Shield—Wire Up Correctly.....	20	Inverse Duplexing the Planistich System.....	14
You Can Suppress That Interference.....	24	How Much of a Nuisance Are You?.....	25
How to Charge Your Storage B's.....	34	DECEMBER, 1924	
Answers to Questions on the Super-Heterodyne.....	38	Flawelling's New Circuit.....	11
More About the "Levin Singletrol".....	41	The Two-Tube Harkness Counterflex.....	16
MAY, 1924		The Counterflex Simplified.....	19
The Story of Reflex and Radio Frequency.....	9	Reflexing the Oscillating Set.....	21
The Airco Super-Heterodyne.....	11	A Favorite Circuit Simplified (Goodreau).....	26
A Raw Amateur's Experiences With the		Notes on Our Inverse Duplex (Super-Coil).....	36
Super-Heterodyne.....	18	JANUARY, 1925	
A Favorite Circuit Simplified (Goodreau Circuit).....	24	The Question of Dry Cell Tubes.....	8
JUNE, 1924		Flawelling's Circuit.....	13
Simple Hook-Up for Testing Tubes.....	6	SXP-Style Wire-Ups, Harkness Counterflex.....	16
Harkness Tells About His Reflex.....	9	The Beginner's Best Bet.....	20
The New Grimes SXP Inverse-Duplex.....	12	Grimes Takes the Hum Out of His SXP.....	30
Re-Radiating Receivers.....	16	Notes on Our Inverse Duplex (Super-Coil).....	36
"Factory" Refinements in Home-Built Sets.....	17	FEBRUARY, 1925	
How to Become a DX Sharpshooter.....	19	Story of the Radio Ray.....	11
A Novel Loop Tuner.....	25	Grimes Final SXP.....	12
JULY, 1924		Harkness Reflex and Counterflex Circuits.....	19
Harkness Writes About Self-Oscillation.....	13	Reception With the Flawelling Circuit.....	24
Trouble Shooting in the Grimes SXP.....	48	Can You Explain Radio to Your Friends?.....	28
Static Causes.....	20	For the Inverse Duplex Experimenter.....	42
"Factory" Refinements in Home-Built Sets.....	21	For the Advanced Student.....	45
Levin's New Cell Makes a DX Portable.....	24	MARCH, 1925	
R. F. and the Goodreau Split Variometer.....	25	Let's Talk About Tubes.....	7
Tube-Testing Outfit for Dealers.....	31	How to Build a Commercial Counterflex.....	10
What Size Grid Leak Shall I Use?.....	43	A 100 Per Cent Antenna.....	15
AUGUST, 1924		A DX Getter Easy to Build.....	20
The Neutrodyne—Installation and Operation.....	9	Radio Frequency and the Flawelling Circuit.....	24
Audio-Frequency Amplifiers.....	11	For the Advanced Student.....	28
Neutroformers in the Grimes SXP.....	13	APRIL, 1925	
Correct Aerial Insulation.....	16	The SXP Browning Drake.....	9
The Greene "Selector".....	18	The Question of "Low Loss" and "Bunk".....	15
A Tube That Eliminates the "A" Battery.....	34	An Humble Thought or Two About "Low Loss".....	16
OCTOBER, 1924		How to Gain Quality.....	18
On Resistance Coupled Amplification.....	6	Counterflex Symptoms.....	20
The New Harkness Counterflex Circuit.....	11	What Colors Does Your Set Receive?.....	24
SXP-Style Wire-Ups of the New Harkness Counterflex.....	16	For the Advanced Student.....	30
New Sets of This Season.....	18	Bird's Eye View of the "Low Loss" Idea.....	41
The Neutrodyne.....	24		
New 110-Volt Tube with Replaceable Filament.....	25		
Tubes—A Survey and a Forecast.....	26		

Send your order in at once. Our supply is fast becoming exhausted. All other issues except those listed above are out of print. Single copies, 10c each

THE RADIO KINDERGARTEN SERIES—The above issues contain eight lessons on the fundamentals of radio. These lessons are written in simple language and are designed to acquaint the beginner in radio with the leading phases of radio reception.

BROADCASTING STATIONS—The following Stations were described and illustrated in the issues listed above: WBAP, WDAR, WJAX, WJAZ, WCBD, WGN, WLS, WLAG, KPFF, WEAF, WTAM, KSAC, WEEL, WTAT, WSAI, KLZ, WMAQ.

The form below is for your convenience in ordering.

RADIO IN THE HOME,
608 Chestnut St., Phila., Pa.

Date

Enclosed find \$1.00 (\$2.00 foreign; \$1.25 Canada), for which please send me postpaid 12 consecutive issues (excluding Sept., 1924), of RADIO IN THE HOME, from April, 1924, to April, 1925, inclusive.

Name Street

City and State