

THE NATIONAL PERIODICAL
MAR 14 1925

June, 1924

RADIO IN THE HOME

TWENTY CENTS

by HENRY M. NEELY



In
This Issue:
GRIMES
HARKNESS
NEELY
GOODREAU
FOOTE

*Photograph courtesy of
Timmons Talker, Inc.*



Vincent Lopez and his Hotel Pennsylvania Orchestra

From one who knows

VINCENT LOPEZ praises and endorses the rich, clear, natural quality of MUSIC MASTER reproduction. His Hotel Pennsylvania Orchestra is heard over the radio by untold thousands.

He has enjoyed radio music—mellowed and clarified as it passes through MUSIC MASTER's amplifying bell of selected wood. His trained ear noted instantly the faithfulness of each re-creation.

Even the most delicate and fugitive impulses, from distant stations are caught by the precision instrument of MUSIC MASTER hidden in the art metal base. These impulses are developed into full, natural tones, free from blast and distortion, in the tapered tone chamber of heavy cast aluminum—which also imparts a quality of brilliancy to the reproduction.

MUSIC MASTER is an enduring musical instrument. Hear it and see it at your dealer's, or have him send one to be tried and proved with your own set.

Dealers Everywhere

Connect MUSIC MASTER in place of headphones. No batteries required. No adjustments.

14-inch Model, for \$30 the Home

21-inch Model, for \$35 Concerts and Dancing

Music Master Corporation

(Formerly General Radio Corporation)

Makers and Distributors of High-Grade Radio Apparatus

S. W. Cor. 10th and Cherry Streets

Chicago PHILADELPHIA Pittsburgh

May I say a few words regarding the merits of the MUSIC MASTER, which to my way of thinking is superlative in its field. For clearness of tone it exceeds any loud speaker which has been brought to my attention, and being directly interested in radio work I consider your product a big achievement and a valuable asset to the radio world.

Please accept my heartiest congratulations.

Sincerely yours,

Vincent Lopez



Music Master

RADIO REPRODUCER



Approved By Over 200 Experts

New Crosley Engineering Achievement

A three tube set with five tube efficiency—the greatest selectivity with the minimum effort—positive calibration to any wave length between 200 and 600 meters. These are only a few of the many advantages offered in the remarkable new Crosley Trirdyn Radio Receiver.

It was only after a year of constant experimenting, that our engineering department perfected this exceptional receiver. Thorough tests proved to us that it would out-perform any receiver ever before produced. But we were not satisfied with our own opinion. So we shipped out 200 of these sets to experts in every part of the United States. Their criticisms are one and the same—"tried out your new Trirdyn Receiver Saturday night and logged 13 stations, among them Cuba, New York and Omaha, between 9 and 10 o'clock. The set was very selective. During the time this test was on, local station KSD was operating and we went through them without any difficulty or interference whatever. The range of the local station was not more than three points variation in the dial setting."

"Tried one of these sets and obtained wonderful results. Were able to log all stations which we heard very successfully. This set should go over big." "The set has wonderful volume and is selective"—etc.

This new Crosley triumph is called the Trirdyn because of its original combination of the three "R's"—Radio frequency amplification, Regeneration and Reflex. The first tube incorporates non-oscillating, non-radiating tuned radio frequency amplification; the second tube, a regenerative detector reflexed back on the first tube for one stage of audio frequency amplification. Then it has a third tube which acts as a straight audio frequency amplifier. It uses the ultra selective aperiodic antenna circuit and external selector coil, which adds to its wonderful selectivity.

The Crosley Trirdyn in range, volume and selectivity is the equal of any five tube receiver on the market. Greater volume will, of course, be obtained through the use of storage battery tubes, but it will function well in any type and can be used with either indoor or outdoor antenna.

The opinions of many experts have convinced us that the Trirdyn is the best receiver ever offered the public regardless of price.

Practically every radio dealer can furnish you Crosley Radio Sets, including not only the Trirdyn, but the Model 51, a two tube set for only \$18.50; the Model V, a single tube receiver at \$16.00; the Model VI at \$24.00; the Super VI at \$29.00; the Model X-J at \$55.00 and the Super X-J at \$65.00.

See This New Wonder At Your Dealers

All Crosley Regenerative Sets
are Licensed under Armstrong
U. S. Patent No. 1,113,149.

CROSLEY
Better - Cost Less
Radio Products

Crosley produces more Radio
Receiving Sets than any other
manufacturer in the World.

THE CROSLEY RADIO CORPORATION

POWER CROSLEY, Jr., President

Formerly
The Precision Equipment Company and Crosley Manufacturing Company

660 ALFRED STREET

CINCINNATI, OHIO

Congratulations!

I NOTICE that all of the other radio magazines are devoting pages and pages to self congratulation on arriving at their second birthdays.

Well, this issue begins our third year—but who cares!



RADIO IN THE HOME of Clyde L. Herring, of Des Moines, Iowa. The set is a Kennedy Jacobean Console Model

Photo courtesy of Colin B. Kennedy Corporation

EDITORIALLY SPEAKING

ONE OF my very valued correspondents writes me in some perplexity and asks me for advice in his problem.

A short quotation from his letter will summarize the matter.

Are You Waiting for a "Revolution?"

not be satisfactory to me?

"I have a very good five-tube set now. It has given me the greatest satisfaction all this season, and I have become very fond of it. I hear talk of a revolution coming next winter, however, and I see advertisements of firms saying that the sets which they are going to put out are going to make my set look like junk. I am frankly worried about it. What shall I do? Shall I junk my present set and get one of the new ones next year? Or shall I keep my present set and wait until something really revolutionary does happen?"

I think that this man is typical of a great many thousand novices at the present time. There has undoubtedly been a good deal of propaganda in advertising, all leading to the purpose of making fans dissatisfied with their present sets, of

holding up intending purchasers at present until next year, and generally giving the impression that something tremendously important is coming out next season.

I know of nothing that makes me see red quite so quickly as this constant propaganda creating the idea that a "revolution" is going to take place in radio. There is no other one thing which is doing more harm to the radio industry by keeping away from it the very people who would be its best customers if they could be won to it. They cannot be attracted now because they hear so much talk of this coming revolution. They are going to wait. They are wise business men and they do not propose to buy something today which is going to be on the junk heap tomorrow.

There isn't going to be any revolution in radio.

There isn't going to be any revolution next season nor the next one nor for many years to come.

There is going to be constant and progressive improvement and a steady march of radio up to the point of perfection, but it will never reach that point any more than has any other industry or art reached perfection.

In my editorial some months ago, I said that I did not look for a revolution in radio. A dealer in the Middle West wrote at that time and asked me if I would give him

(Continued on Page 22)

RADIO IN THE HOME

Published Monthly by the Henry M. Neely Publishing Company, 600 Chestnut St., Philadelphia, Pa.
 Bell Telephone—Lombard 5431 Experimental Station (2XP), Delancey, N. J.

<p>HENRY M. NEELY.....President and Editor G. W. KRATT.....Secretary and Treasurer W. L. DUDLEY.....General Manager NORMAN NEELY.....Art Director</p>	<p>DAVID GRIMES..... } Associate Editors KENNETH HARRINGTON..... } BRAINARD FOOTE..... } W. FRANCIS GOODREAU..... } Contributing Editors</p>
--	---

MERRILL NEELY.....Laboratory Assistant

Radio in the Home is sold at 20c per copy at all newsstands, radio shops and bookstores. Subscription in the United States and Canada \$2.00 per year.

Printed on the retroversary process of the Public Ledger, Philadelphia, Pa.
 Copyright, 1924, by the Henry M. Neely Publishing Company
 Entered as second-class matter May 29th, 1922, at the Postoffice, Philadelphia, Pennsylvania,
 under the act of March 3, 1879

Build your Harkness Reflex With Genuine Radio Guild Parts

You can get cheaper imitations of Radio Guild parts for the Harkness Reflex, but don't forget they are cheap imitations and cannot give you the results you will expect. Only the genuine parts can and will give you the results. Ask for RADIO GUILD parts and see that you get them. Look for the Radio Guild Seal on every package. Don't be cheated!



35⁰⁰
Complete 2-Tube Kit

Flexoformers

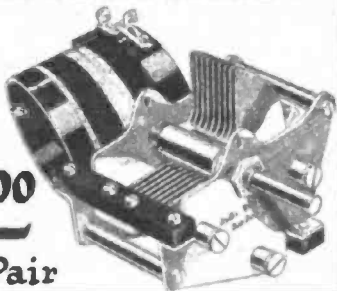

\$**12⁰⁰**
Per Pair

This Complete Kit Contains All Parts For 2-Tube Set

The parts in this Kit were designed by Kenneth Harkness, Chief Engineer of the Radio Guild, and are manufactured under his direct supervision. You may be certain, therefore, that the receiver you build with these parts will be perfect in every detail. You will find, too, that each part is specially prepared to simplify the work of construction. The panels are drilled; the terminals are numbered; the kit contains every necessary item—right down to the last screw. With only a screwdriver and a soldering iron you can put the whole set together in just a few minutes.

But be careful; don't let anybody sell you a bunch of cheap junk and tell you you can build the "Kenneth Harkness" Reflex with it. You can't, any more than you can build a Packard with Ford parts. Get the genuine RADIO GUILD parts and you'll save yourself real money.



Crystal Detector

\$**2⁰⁰**

Audio Transformer

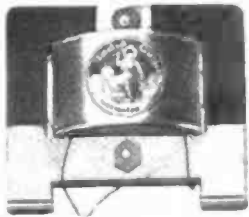

\$**4⁸⁵**

JOBBER, DEALERS
Write for Our
Proposition



Distributors
Radio Stores Corp.
222 West 34th Street,
New York City

Distributors
Trilling & Montague
40 North Seventh St.,
Philadelphia, Pa.

Mail this Coupon for Illustrated Book

THE RADIO GUILD, Inc.,
256 West 34th Street, New York, N. Y.

RIH 7-24

Please send me your 36-page book with colored illustrations, photographs, wiring diagrams, blueprints of panel layouts and complete instructions for building the 2-tube Harkness Reflex, together with full descriptions of Radio Guild products, for which I enclose ten cents. Mail at once.

Name

Address

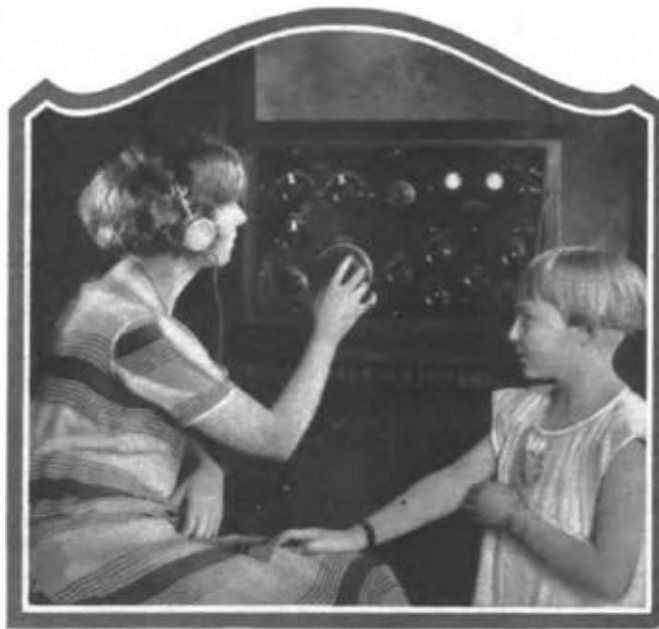

The radio set shown in the above photograph is a Federal, Type 59

THE problem of defective tubes is becoming so acute that it is essential that some means be developed to protect the purchaser and user of vacuum tubes. Consequently we have developed this simple testing apparatus at Station 3XP.

A month ago we built a supersterodyne set for nine tubes of the 19" type. We bought tubes indiscriminately, using UV199, C299 and the new Audiotron 199.

Before we could get nine tubes which were good enough to operate our set we had bought TWENTY-TWO TUBES altogether.

After only a week of use, the set died and we once more tested our tubes. Two of the tubes had gone absolutely dead and we had to buy four tubes to replace two good ones to replace these.

The A type of tubes and the 11 and 12 seem to run evenly and there are not so many defective ones. The 99's are so undependable that such outlets as described here should be on the counter of every dealer for the purpose of testing these tubes before the customer buys them. H. M. N.

IN THE last lesson of this kindergarten class, I dealt with the problem of defective tubes and I promised to furnish my dealer with a diagram showing how he could hook up a simple apparatus for the testing of tubes in order to learn exactly what their condition is.

Since then I have had a great many letters from readers asking if it were not possible for the average amateur to test his tubes without such a great outlay of money as is represented in such measuring instruments as good volt meters and milliammeters. This demand has seemed to me to be so legitimate that we have spent a great deal of our time at Station 3XP devising such an instrument. I am very glad to say that these experiments have been entirely successful and any novice may now tell exactly the condition of his tubes if he will put together the simple little hookup shown on this page. This requires no measuring instruments and the only indicator is an ordinary pocket compass. The one that we use at Station 3XP was bought at a second-hand Army and Navy goods store for ninety-five cents.

All that is required for this testing apparatus is seven binding

posts, a potentiometer, a tube socket, a rheostat, a honeycomb coil of 1250 or 1500 turns and the compass. With that, you can always tell in a minute or two exactly what condition your tubes are in, and if your set does not seem to be functioning as you think it should, it is a simple matter to take the tubes out, put them into this testing instrument and learn immediately whether the fault lies with your tubes or somewhere else in your apparatus. The operation of this little testing set is extremely simple and any novice can understand it if he will simply remember the kindergarten lessons which we have already had in this series.

First he will remember that we have explained the action of a current of electricity going around a coil of wire. We have learned that this current, whirling around and around in the turns of the wire, creates a field of what we call magnetism in the space surrounding the coils and that this magnetism will effect various instruments which come within its field.

Now every one knows that the ordinary pocket compass is effected very strongly by any magnetism, and so it was natural for us at 3XP to think of the pocket compass just as soon as we realized that the current coming from the B battery and going to the plate of our tubes pulsates, or grows greater and less with the pulsation of the signals. Consequently, it was only necessary for us to devise a little instrument which would permit these currents from the B battery to go through a coil and then place the pocket compass in the field of magnetism in this coil and the needle would then show how the current was rising and falling in the plate circuit of the set. If it rises and falls considerably, it shows that the tube is functioning properly. If it does not, it shows that there is something with the tube.

Now let us take this diagram and see just what we are doing with it in the testing of tubes. We know

NINTH LESSON

The RADIO KINDERGARTEN

By HENRY M. NEELY

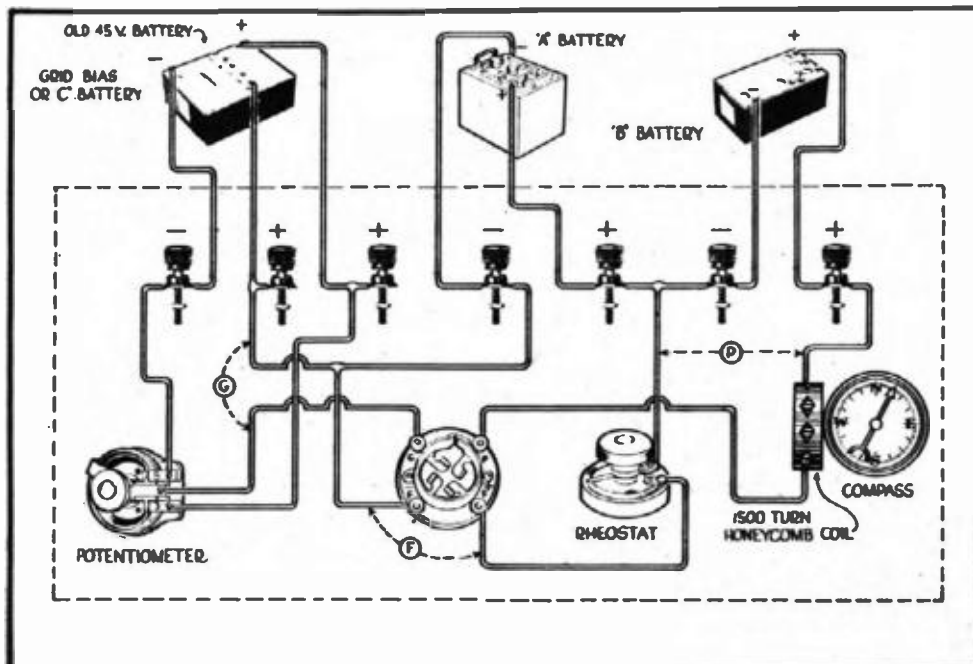

posts from the B battery to go through a coil and then place the pocket compass in the field of magnetism in this coil and the needle would then show how the current was rising and falling in the plate circuit of the set. If it rises and falls considerably, it shows that the tube is functioning properly. If it does not, it shows that there is something with the tube.

Now let us take this diagram and see just what we are doing with it in the testing of tubes. We know

(Continued on Page 39)

Announcing:—



A new Magnavox M4 requiring no battery

The supreme achievement of Magnavox engineers represented in a Reproducer of truly *exquisite* tone quality.

THE efficiency, the appearance and the price of this new instrument clearly reflect the research and production facilities of The Magnavox Company, largest builders of radio reproducing equipment in the world.

Its exquisite tone quality results from a further perfecting of the Magnavox semi-dynamic operating principle—magnetically balanced armature, improved diaphragm and extremely high resistance winding.

Beautifully finished in dark enamel with gold high lighting, the graceful appearance of M4 suggests its use in the most dignified surroundings.

The amazingly low price of this Magnavox reproducer establishes an absolutely new standard of value in the radio industry.

Magnavox Reproducers, Combination Sets and Power Amplifiers can be had of good dealers everywhere. Write for catalog.

THE MAGNAVOX CO.
OAKLAND, CALIFORNIA
New York Office: 350 West 31st Street
Canadian Distributors: Perkins Electric Limited,
Toronto, Montreal, Winnipeg

Price
\$25⁰⁰



MAGNAVOX

The Reproducer Supreme



"THE AIR IS FULL OF THINGS YOU SHOULDN'T MISS"



No. 7111 Eveready "A" Dry Cell The best battery for use with dry cell tubes

No. 706 "B" Battery, 22 1/2 volts Six Fahnestock Spring Clips

More Power for Summer Radio

When you take radio away with you—take Eveready Radio "A" and "B" Batteries, the batteries whose great power lasts longer. Remember, summer's the time when radio signals are weaker.

Batteries do get used up in time. The ones you've been using, though partly exhausted, may be satisfactory for the strong winter signals, but are probably inadequate for the weaker summer signals.

For a "B" Battery use the familiar standard 22 1/2-volt Eveready "B" Battery No. 766. It has variable taps for "soft" detector tubes. Put two, three or four in series to provide sufficient power for amplifying tubes.

To light the filaments of your dry cell vacuum tubes for the longest time, use Eveready Dry Cell Radio "A" Battery No. 7111. The Eveready "A" will astonish you by its long-sustained vigor. It is advisable to use two Eveready "A's"

connected in multiple for each WD-11 or WD-12 tube—this gives the "economical eighth" ampere drain per cell which insures maximum economy and longer life. For sets employing from one to three UV-100 tubes use three Eveready Dry Cell Radio "A" Batteries No. 7111 connected in series.

The greatest electro-chemical laboratory known created these famous dry cell batteries on which radiolargely depends. The experience of thirty years in battery making stands back of them.

Buy Eveready Radio "A," "B" and "C" Batteries—lively, peppy, long-lived producers of power.

For your light-weight sets to take camping or on hikes, Eveready has suitable small batteries.

Manufactured and guaranteed by NATIONAL CARBON COMPANY, INC., New York—San Francisco Headquarters for Radio Battery Information Canadian National Carbon Company, Limited, Toronto, Ontario

Informative and money-saving booklets on radio batteries sent free on request. If you have any questions regarding radio batteries, write to G. C. Furness, Manager, Radio Division, National Carbon Company, Inc., 120 Thompson Avenue, Long Island City, N. Y.

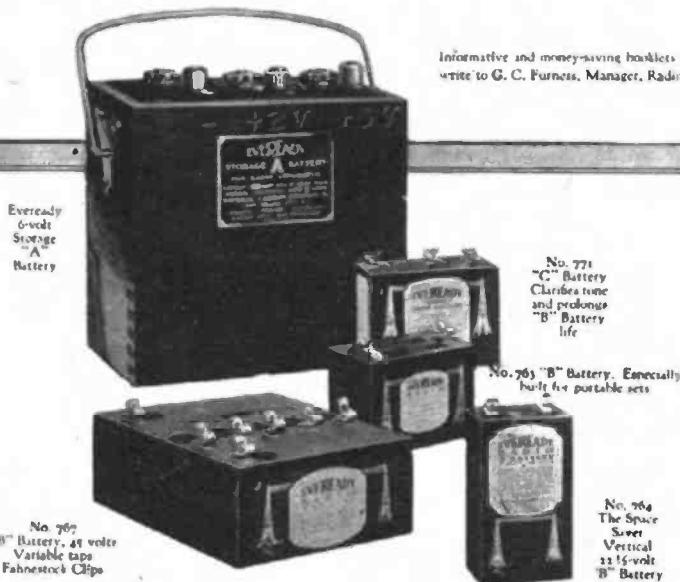

Eveready 6-volt Storage "A" Battery

No. 771 "C" Battery Clarifies tone and prolongs "B" Battery life

No. 705 "B" Battery, Especially built for portable sets

No. 704 The Space Saver Vertical 22 1/2-volt "B" Battery

No. 707 "B" Battery, 25 volts Variable taps Fahnestock Clips

EVEREADY

Radio Batteries

- they last longer

RADIO IN THE HOME

HARKNESS tells about his REFLEX

AS WE announced last month, Kenneth Harkness, inventor of the famous Harkness reflex circuit, has now become a member of the staff of this magazine and will write exclusively for us.

This is his first article and he very naturally devotes it to the latest and most authoritative instructions for the assembling of his one-tube and two-tube sets.

H. M. N.



KENNETH HARKNESS
Chief Engineer, The Radio Guild, Inc.

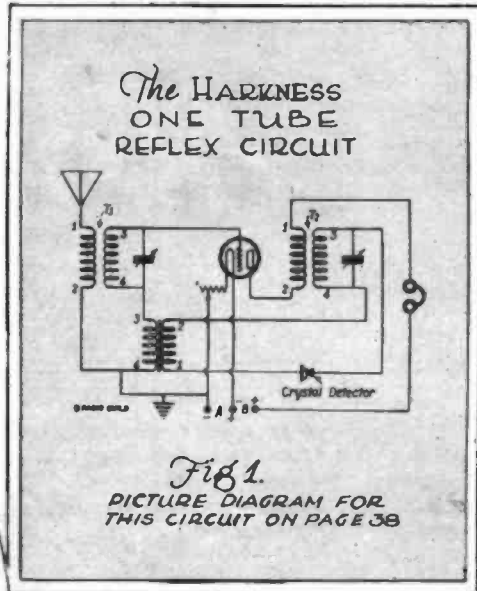

TO MOST of the readers of this magazine I presume the "Harkness Reflex" requires no introduction. However, for the benefit of those who are not familiar with the history of this receiver, a brief account of its origin and development may be of interest.

This receiver was developed last summer in our laboratories at the Radio Guild under the direction of the writer. The object of our experiments was to develop a non-oscillating receiver which would be simple to operate, inexpensive to build and which would have sufficiently high audibility and selectivity to make it of practical service.

The results of our experiments were initially shown in the first edition of the author's book, "Radio Frequency Amplification" published in September, 1923. Thereupon, the editors of radio magazines and newspapers, recognizing the advantages of the system, printed numerous articles on the subject in their publications. As a result, amateur constructors built receivers using the circuit and were pleasantly surprised to find that the system did more than was claimed for it. The circuit immediately became exceedingly popular. It has been estimated that, in Philadelphia alone, over 20,000 Harkness Reflex receivers have been built during the past four months. The system is equally popular in other radio centers. It is particularly interesting to realize, too, that this popularity was not brought about by means of advertising. It was purely a popular recognition of the merits of the re-

ceiver. In fact, the chief "advertisers" of the Harkness Reflex have been those amateurs who built the receiver and enthusiastically recommended it to their friends.

The Harkness Reflex is commonly, though somewhat ambiguously known as the receiver which "operates a loud speaker with only one tube." While this is undoubtedly the most impressive attribute of the system, it possesses many other advantageous qualities, as analyzed and briefly described below:

High Audibility: With one tube this receiver actually does operate a loud

speaker—and in a most convincing manner. Ordinarily, only local stations can be received in this way, but I have sufficient evidence to know that loud speaker reception of distant stations is not uncommon. With two tubes (the second tube being used as an audio frequency amplifier) the average range is 1000 to 1500 miles and many of my correspondents have testified that the stations within this radius are frequently received with high audibility.

Good Selectivity: As this receiver uses tuned radio frequency amplification its high audibility is not gained at a sacrifice of selectivity. The selectivity is very good—indefinitely better than the ordinary type of reflex receiver with untuned radio frequency amplification.

Easy to Operate: The circuit has only two tuning elements. Consequently, the operation is exceedingly simple. Moreover, as the receiver does not oscillate, no particular skill is required on the part of the operator. The two controls are independent of each other and the dial settings for different stations are permanently accurate. A record can be kept of the best positions of the dials for receiving the respective broadcasting stations and, with this record

to refer to, any desired station can be tuned in by merely turning the dials to the positions indicated on the log.

Inexpensive to Build: The Harkness Reflex costs much less to build than any other receiving system of equal efficiency. This is not because cheap apparatus can be used to build the set but because—

(1) The essential parts are simple in

VOLUME III	CONTENTS FOR JUNE, 1924	NUMBER I
EDITORIALLY SPEAKING		Page 4
RADIO KINDERGARTEN		6
HARKNESS TELLS ABOUT HIS REFLEX		9
THE NEW GRIMES 3XP INVERSE DUPLEX		12
RE-RADIATING RECEIVERS		16
"FACTORY" REFINEMENTS IN HOME-BUILT SETS		17
HOW TO BECOME A DX SHARPSHOOTER		19
WGR. AT "THE KEY CITY OF INDUSTRY"		21
BRINGING YOUR LODGE TO YOUR HOME		24
A NOVEL LOOP TUNER		25
WHY WJAZ BECAME WGN		34
HERE'S A MIDGET THAT REALLY WORKS		35
THE SLANT OF THE TRADE ON RADIO		42
FANS CROWD IN TO SEE THEIR ENTERTAINERS		44
RADIO SURE HELPS RUFUS McGOOFUS A LOT		45

ceiver. In fact, the chief "advertisers" of the Harkness Reflex have been those amateurs who built the receiver and enthusiastically recommended it to their friends.

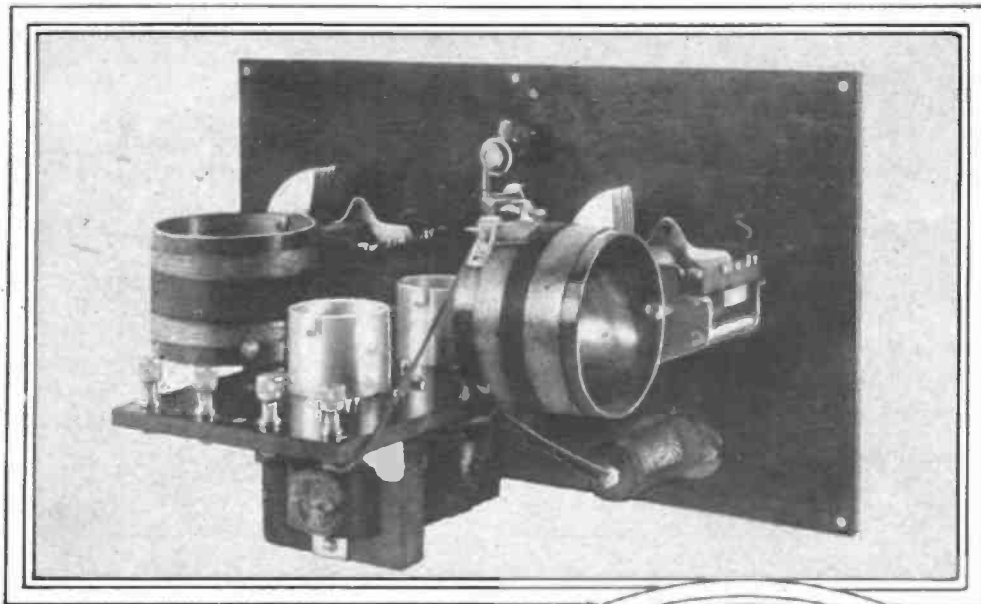
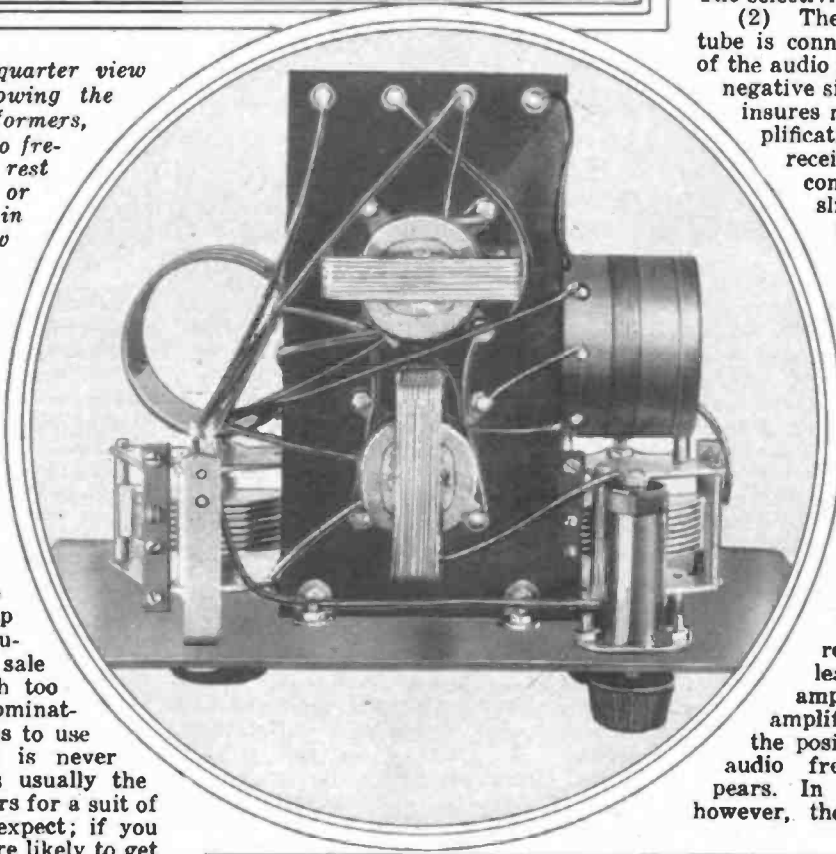

Fig. 8—Above is a three-quarter view looking from the rear showing the sub-panel, sockets, flexoformers, and the position of the audio frequency transformers, which rest on the surface of the table or cabinet. The photograph in the circle shows another view under the sub-panel, and shows how the audio frequency transformers are placed



design. (2) Comparatively few parts are required.

In common with every other receiver, this set can be built with cheap apparatus for a very small amount or with good apparatus for a reasonable amount. It is entirely up to the constructor to decide whether he shall use cheap parts or good parts. Unfortunately, both kinds are for sale in most radio stores, with too many of the former predominating. Naturally, our advice is to use good parts, for "ill ware is never cheap" and the cheapest is usually the dearest. If you pay ten dollars for a suit of clothes, you know what to expect; if you pay sixty dollars you are more likely to get your money's worth. The same holds true of radio apparatus—only more so!

No Whistles or Squeals—Cannot Oscillate. When built with the parts designed for the circuit the Harkness Reflex does not oscillate and therefore does not generate a single whistle or squeal, or cause interference to others by radiation. For many reasons, this is one of the most important virtues of the Harkness Reflex—an attribute which must eventually be possessed by every radio broadcast receiver. If a receiver is designed so that continuous oscillations can be set up in the receiving aerial, the operator will, by accident or design, radiate continuous waves and produce whistles and squeals in surrounding receivers. With thousands of these radiating sets within a few miles of each other, each loud speaker renders its own particular version of the resulting chorus of insufferable howls and squeals.

To the owner of a non-radiating receiver, this interference is, to say the least,

annoying; for he is not responsible for it, cannot eradicate it and must suffer it—until the time comes when radiating receivers are no longer used.

How the Circuit Functions: The fundamental Harkness Reflex circuit is shown in Fig. 1. The functioning of the circuit is based, of course, upon the principle of reflex amplification. The amplifying tube serves a double purpose. It amplifies the high frequency currents of incoming signals and, after rectification by the crystal, also amplifies the audio frequency current variations.

The main distinctive features of this circuit are as follows:

(1) **Tuned** radio frequency amplification is used. T1 and T2 are special radio frequency transformers with untuned primaries and tuned secondaries. In the ordinary reflex receiver the transformer which corresponds to T2 is untuned. Much higher radio frequency amplification is secured by tuning the secondary of this transformer. The selectivity is also greatly increased.

(2) The grid of the reflex amplifying tube is connected (through the secondary of the audio frequency transformer) to the negative side of the filament circuit. This insures maximum audio frequency amplification. In previous types of reflex receivers it was found necessary to connect the grid return to the sliding contact of a potentiometer shunted across the filament circuit, in order that self-oscillation could be controlled. This method of controlling self-oscillation, however, greatly diminishes the audio frequency amplification of a reflex system. In fact, if, by moving the sliding contact of the potentiometer, the grid is given a positive potential with respect to the negative side of the filament, the audio frequency amplification is practically reduced to zero. This can easily be proven by reversing the filament battery leads of any audio frequency amplifier. When the grids of the amplifying tubes are connected to the positive sides of the filament the audio frequency amplification disappears. In the Harkness reflex circuit, however, the grid of the tube remains

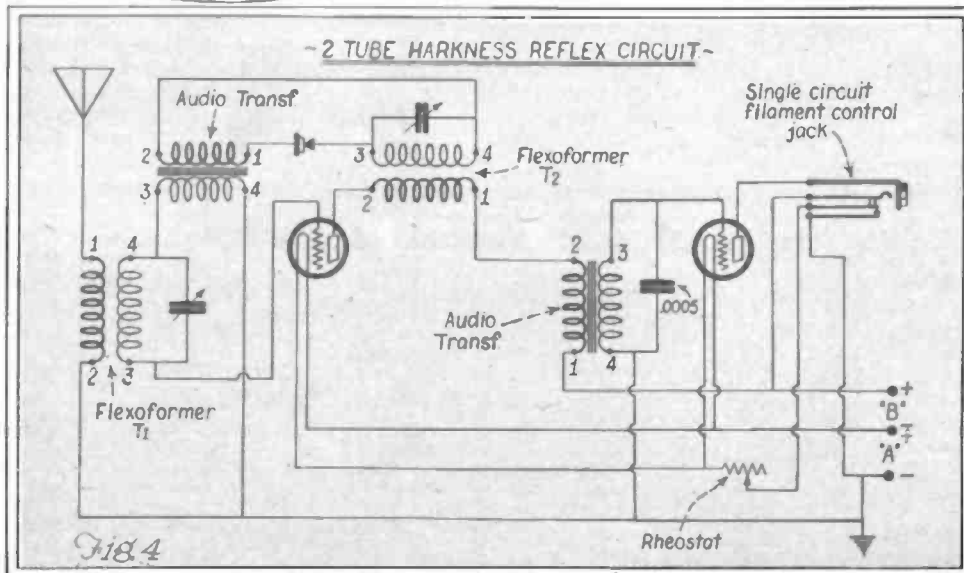

permanently connected to the negative side of the filament.

(3) The Harkness Reflex does not use a potentiometer, neutralizing condenser or any of the other known methods of controlling self-oscillation. Nevertheless, the receiver does not oscillate.

The reason for this lies, particularly, in the design of the radio frequency transformers. The impedance of transformer T2 is arranged so that the oscillations set up across the primary of this transformer do not feed back sufficient energy through the capacity of the tube to generate continuous oscillations. A detailed explanation of this feature of the circuit will be the subject of a succeeding article.

In the meantime, it will be evident that the successful operation of the Harkness Reflex depends, in great measure, upon the design of the parts used in the circuit. If transformer T2 is incorrectly designed the receiver will either give poor amplification or it will oscillate.

It is important to realize, too, that this transformer can be correctly designed only if the characteristics of the other essential parts used to construct the receiver are known. For instance, with a .0005 mfd. condenser across the secondary, transformer T2 must be wound with approximately 32 turns on the primary and 55 or 60 turns on the secondary; whereas, with a .0003 mfd. condenser the transformer requires only 20 turns on the primary and 70 turns on the secondary. Moreover, the T2 depends also upon the characteristics of transformer constants of transformer T1, the resistance and losses of the variable condensers used in the circuit, the characteristics of the audio frequency transformers, etc., etc. This may seem unusual, but is quite logical. For example, if transformer T2 is designed for use with specific parts with known characteristics and a receiver is built using these parts with the exception of the variable condensers, other condensers being substituted, it is evident that the resistance of the oscillatory circuits is altered; it is either increased, or decreased, as the case may be. In either case, the balance of the circuit is destroyed. If the resistance is increased,

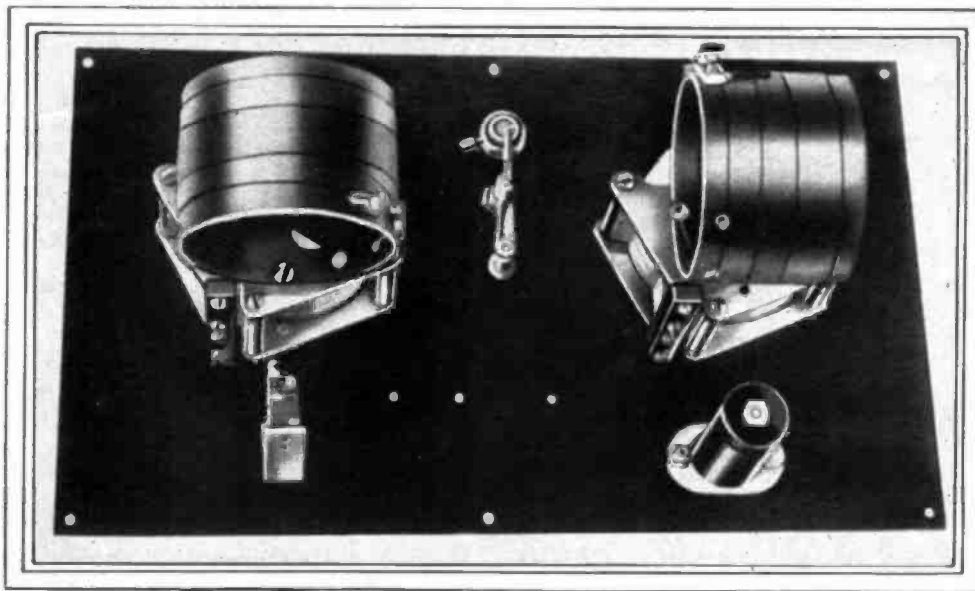
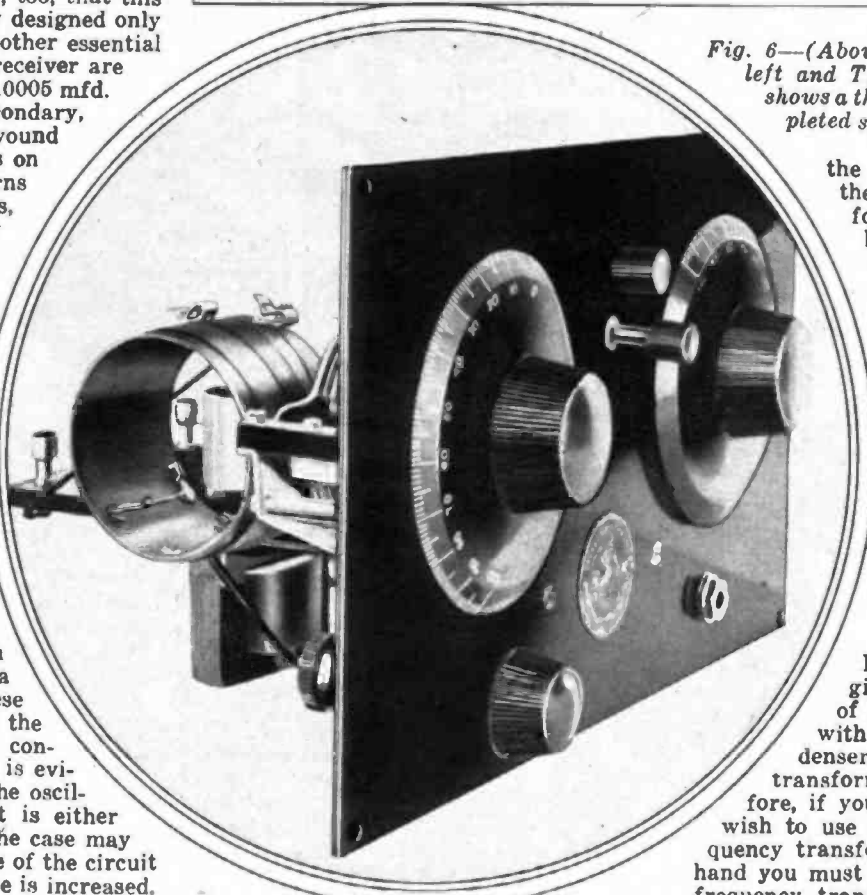

Fig. 6—(Above) Flexoformer T2 on the left and T1 on the right. The circle shows a three-quarter view of the completed set, looking at the front panel



the oscillations set up across the primary of T2, designed for other condensers, will not be strong enough to give good amplification; if the resistance is decreased, continuous oscillations may be self-generated. In articles elsewhere I have given specifications for the construction of the radio frequency transformers of this circuit and I again give these specifications below: but it must be clearly understood that if different condensers and audio frequency transformers are used, these specifications are no longer correct. It is impossible for me to give the correct specifications of these transformers for use with every combination of condensers and audio frequency transformers on the market. Therefore, if you are building this set and wish to use condensers and audio frequency transformers which you have on hand you must experiment with the radio frequency transformers yourself and determine their correct values.

To insure the successful operation of home-built sets, I have designed complete radio frequency transformer units and a special audio frequency transformer for use with the circuit. The radio frequency transformers are known as "Harkness Flexoformers" and are made, of course, in two types (T1 and T2) as required by the circuit.

Type T1 is shown in Fig. 2. Type T2 has very much the same appearance as T1, except that the coil is mounted in a horizontal instead of a vertical position.

In each case, the air-core transformer is wound on a formica tube $2\frac{3}{8}$ in. in diameter. The primary of T1 has 20 turns of No. 28 silk-covered wire with a tap at the 10th turn. The secondary has 70 turns of the same wire. T2 has 20 turns on the primary, with no tap, and 70 turns on the secondary. The object

(Continued on Page 38)

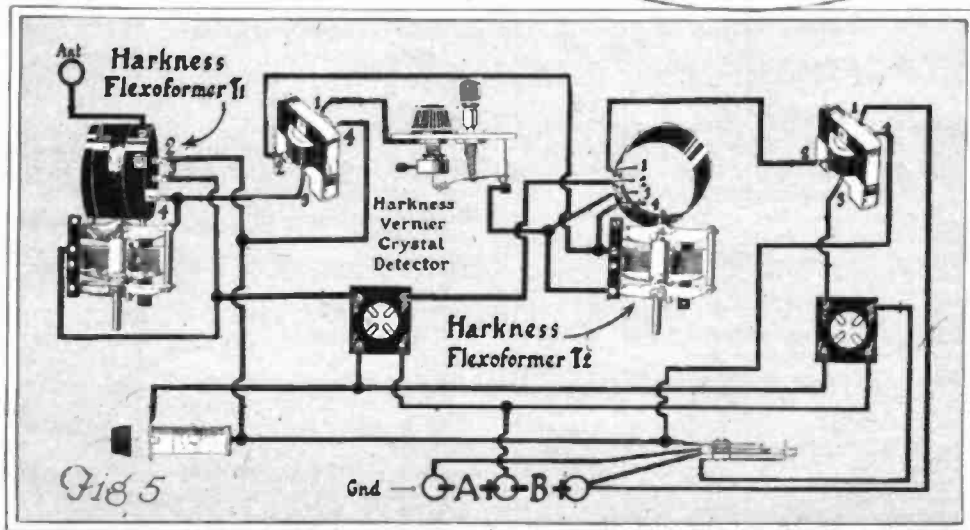

Looking down three-quarters from rear you see the placing of the tubes and the transformers—these are Jeffersons—with the jack for loop and the coils

The New Grimes 3XP Inverse Duplex Circuit

By
**DAVID
GRIMES**

Chief Engineer Sleeper Radio Corporation.

BY this time most of you no doubt know that we are devoting all of our future writing efforts to the coming issues of *Radio in the Home*. This means that every article written at station 3XP on the Grimes Inverse Duplex System will be the result of special tests conducted on the points in question. It is our hopes that you may exhibit sufficient interest to warrant continued disclosures of radio research work not only on the Inverse Duplex but on other circuits as well. The fascination of experimental work originally led the writer away from his chosen study of journalism and caused him to take a technical course preparing for his career.

Experimentation can be made much more than a hobby, too! Besides being a pleasant pastime, it has earned great rewards in many cases. Most of the world's developments have been conceived through spontaneous experiment. It is a profession and, like all professions, it has its rules. These rules have been formulated by those having considerable experience, and these rules stand as a sort of "code of preferable practice." It is not absolutely necessary to follow the hard and fast law to reach the end of the rainbow, but most of us like to follow the road signs anyway—we are a little bit more sure that we won't find an impassable mudhole.

In writing these articles, then, we are going to let you work right along with us just as if you were personally at Station 3XP. We will reason every move out together and discuss the results. In order that we, who are actually at the experimental laboratory, will not have too much of an advantage, we are going to leave certain questions open for general discussion and solution. You are invited to give your best answer. In any case, write in your

IN PRESENTING this new circuit developed by Mr. Grimes, I really feel that we are making a distinct contribution to radio. It is extremely easy and inexpensive to build and yet I would almost say that I have never used a three-tube circuit which gave the results that this one does.

The volume which comes through it is simply astonishing and yet the quality is almost perfect reproduction. Best of all, it can be used with a loop aerial on stations within a reasonable distance or it can be used for an outdoor aerial.

Anybody who has the slightest experience in radio can wind the few turns of wire that are necessary around these honeycomb coils and so the circuit offers no difficulties to the amateur. Mr. Grimes and I both realize that the circuit is not yet fully developed and we would be very grateful to any experimenters who will write us and tell us of the results of their work and of any changes that they make.
H. M. N.

results and send in photographs of your sets. If we can find any error in your method of research attack, we will start you off again correctly. Should you have gone about the work in a straightforward, plausible manner you will be given special credit in the coming issues.

All right now, LET'S GO!

We, in the research laboratory, must always try to keep at least a year ahead of the commercial field. Sometimes we wander even farther ahead than that. So we must be concerned with the present troubles of radio if we would ever hope to solve them. Our work, then, is trouble! trouble! trouble! But don't let that discourage you. The proper solving of troubles is a game—

it is the solving of puzzles. There must always be some answer. Often, there are several. One is usually the best. It requires mentally balancing one result against another. It requires reason, and all of us have that. After a while, with a little experience, we will acquire radio judgment. We DO NOT require advanced mathematics nor do we need to know the technical nomenclature of the profession. That is merely the shorthand used by the expert. If one be thoroughly versed in his subject he can explain it in plain English. Let us understand our subject first and the shorthand will come later.

The main trouble that has bothered all of us in working on the inverse duplex is the problem of the best combination. We can put the inverse duplex on any standard circuit from the simple regenerative to the complex superheterodyne. We have put it on many of them and have written many articles covering the various adaptations.

Some confusion has resulted because of these "different Grimes circuits." Troubles inherent to the particular circuit "inversed duplexed" have been blamed on the Grimes System. Many experimenters with no knowledge of the circuit they are playing with immediately wanted to inverse duplex that circuit. The system of inverse-duplexing any circuit is simple enough should the original circuit be working properly. If it is not, it is useless to try to duplex it. The trouble will still be there and will interfere with the proper performance of the set. In this case you can see that the fault is not in the duplex system.

It was originally our plan to devote the time here to duplexing the standard circuits and then give the information to the reader. In doing this we would be satisfying his desire to try anything new once;

but most new circuits are not new and are not nearly as efficient as many of the older ones. The widely heralded extreme sensitivity of the superheterodyne is not due to any particular efficiency of its own but merely to the excessive number of tubes employed. What couldn't one do with the neutrodyne, for instance, if he used from

six to twelve tubes? We will, however, include from time to time articles showing the method of Inverse Duplexing these circuits reducing the number of their tubes to reason. These articles will not be a part of our laboratory series.

We have decided, in the laboratory, to develop a special adaptation of the Grimes Inverse Duplex System, combining all of the desirable features of every known circuit with the advantage of a minimum number of tubes.

This circuit we are calling the "Grimes - 3XP." We consider this to be a basic thing from which to start. It will enable us to add features from time to time without much change. It is our idea of what radio is eventually requiring.

We have decided that the ideal set should not have more than three amplifying tubes. Any number of amplifying tubes in excess of this number is merely flirting with the "B" batteries and often is merely the lamest excuse for inefficiency. A very poor radio location may sometimes necessitate a fourth tube.

Our first tests will be started on the circuit shown in Figure 1. It is realized,

of course, that this is not in itself perfection. We, in the laboratory, probably never will reach this stage. It is by far the best three-tube set yet devised.

The arrangement employs two stages of radio, a crystal detector and three stages of audio. The two radio tubes are tuned and the input into the crystal is tuned. This

of the new type, high grade, audio transformers on the market are of the low ratio type. Low ratio means in the vicinity of 3½ or 4 to 1. Never use higher than 5 to 1 in any case.

The tuned radio all the way through the set is used because it gives greater selectivity under all conditions. This is necessary

near large broadcasting stations. The three dials are not a serious drawback in the country districts where selectivity is not such an item. Eventually, we will try to combine two of the controls in order to reduce the number of them to the number of our hands—a fairly simple operating condition.

By using tuned radio such as this, the experimenter can build his own radio transformers and then tune them to the desired wave length by a variable condenser. If relying on fixed transformers, he ordinarily cannot build them and is forced to buy any available kind.

This kind may not be suited to all types of tubes or to the desired wave lengths. The set, then, does not receive all stations and the inverse duplex is blamed.

And now you will undoubtedly take issue with us. We have decided that the ideal set must have some sort of efficient fixed crystal. The advantages of crystal reception have long been appreciated. They are almost unequalled for pure and quiet reception. They create no inherent sizzle of their own, and add nothing to the circuit in the way of interference. They perform the service of detection without con-

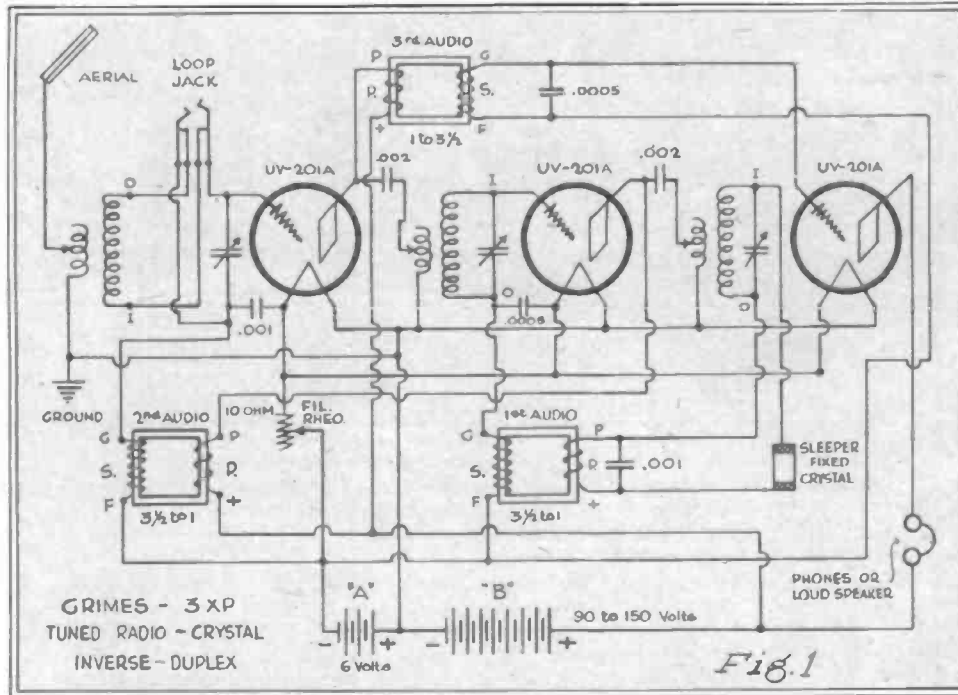
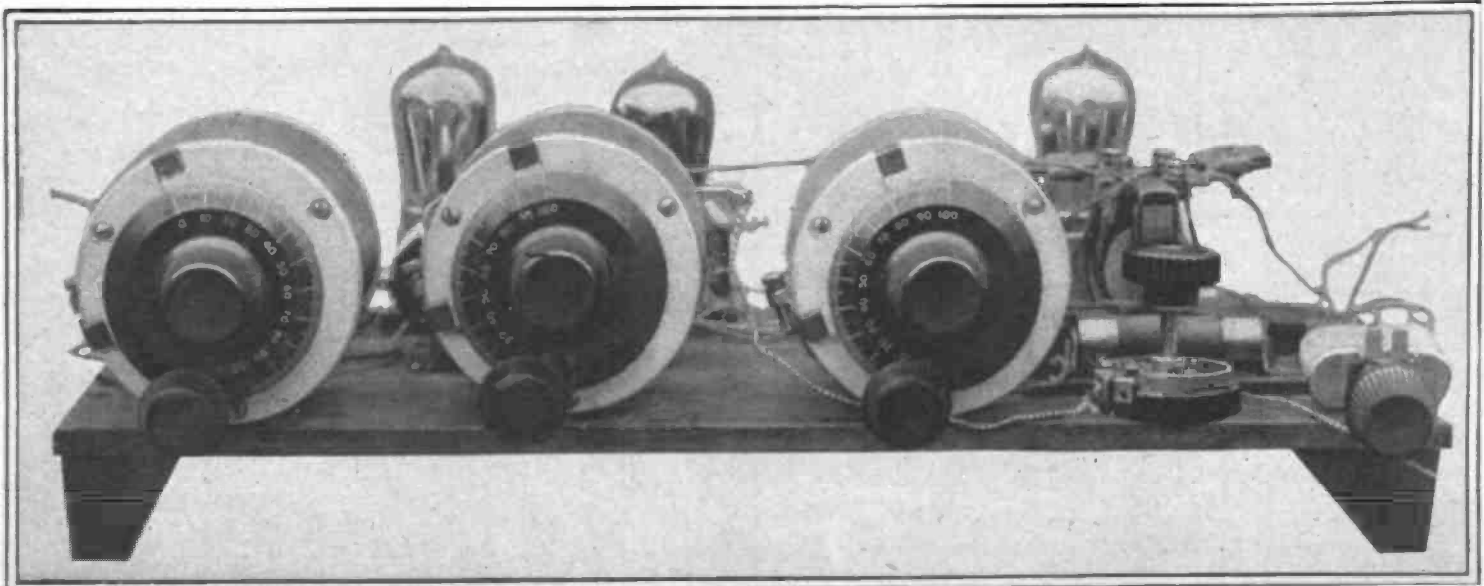

Fig. 1

gives three tuning controls, the three dials running practically alike when tuning on a given station.

Three stages of audio amplification are used because it will deliver the volume without undue distortion. If one desires to push the volume from merely two stages of audio, he will have to use his high ratio audio transformers, and therein lies the sad tale of distortion. It is possible to obtain clearer, sweeter and louder speech and music from three stages of low ratio audio than from two stages of high ratio audio. Do not let anyone fool you. Most

This is the way the practical experimenter mounts a first hookup roughly on a board and runs his wires any old way. Mr. Grimes did it to prove that his new 3XP hookup doesn't require an expert to put it together. Note the newly discovered fixed detector in its cartridge form. When it is put on the market it will probably be the standard size and shape of a grid leak



suming any power from the "A" or "B" batteries. They, of themselves, will not regenerate or howl. Their only drawbacks have been their lack of sensitivity and the nuisance of adjustment. The tuned radio frequency stages ahead of the crystal remove the insensitive objection. It is now possible to obtain long-distance reception with a crystal with two stages or radio amplification on ahead.

We have been working for a long time on the problem of adjustment in the crystal situation. We have tried about every make on the market. We have been searching for a really fixed crystal that has not lost all of its sensitivity in the fixing process. We thought that we had the answer last summer. But we encountered disappointments in the "lab." Now after six months of extensive effort we have an encouraging article—a workable product—a sensitive crystal—and IT'S FIXED. The circuit shown in Figure 1 will work excellently with an adjustable crystal, but we wouldn't be so thoroughly "sold" on

Figure 1 if we were forced to employ an adjustable crystal. We have finally persuaded the Sleeper Radio Corporation to put enough of these on the general market to supply the readers of *Radio in the Home*.

The idea of a fixed crystal in the Ideal Set has several other advantages not listed

denser in the circuit for a one-control unit. Furthermore, it brings within the realm of possibility that long-sought dream of alternating current operation. It makes the problem of operation direct from the house lighting circuit quite easy. The tube detector has always been the prime stumbling block in lighting the filaments on anything but a battery. The crystal eliminated this difficulty, and all that is left to consider now is the amplifying tubes. This will form one of our coming experiments as well as combining two condensers on one shaft. Now, you will have to play fair with us and not "jump the gun." We have let you in on some of our future secrets merely to show you how interesting it's going to be. But if we catch any of you trying out some of these stunts ahead of time you will be penalized. It would be unfair to the rest of us. In doing research work, we have great need of vivid imaginations. Yes, it is true. The most hardboiled research man must be very imaginative. Otherwise, he is not creative.

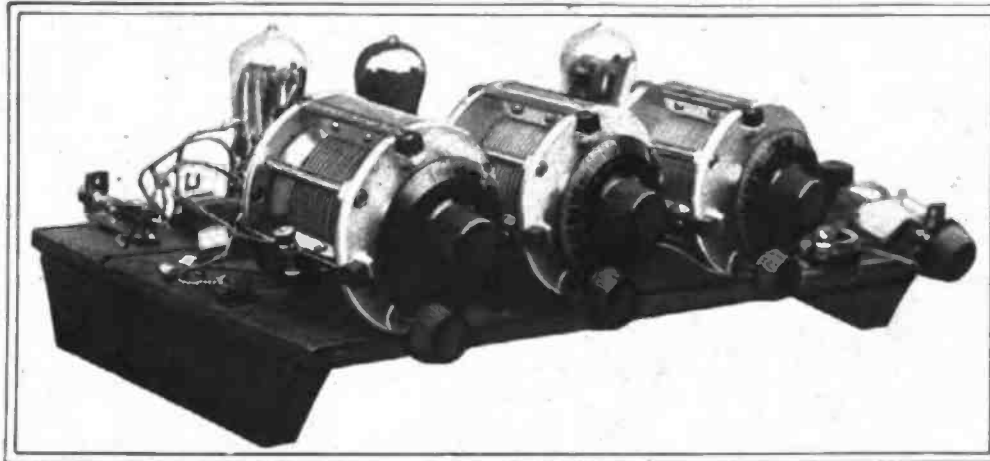

The new Grimes 3XP set. To the left, the aerial and ground clips and the jack for loop. This also shows an excellent view of the new Acme inclosed condensers which are particularly good for "open construction" like this, as they keep dust and dirt from getting in between the plates.

above and which we will appreciate more fully as time goes by. The crystal circuit has enough resistance to broaden the last tuning condenser. This makes the adjustment less critical and permits this condenser to be combined with the middle con-

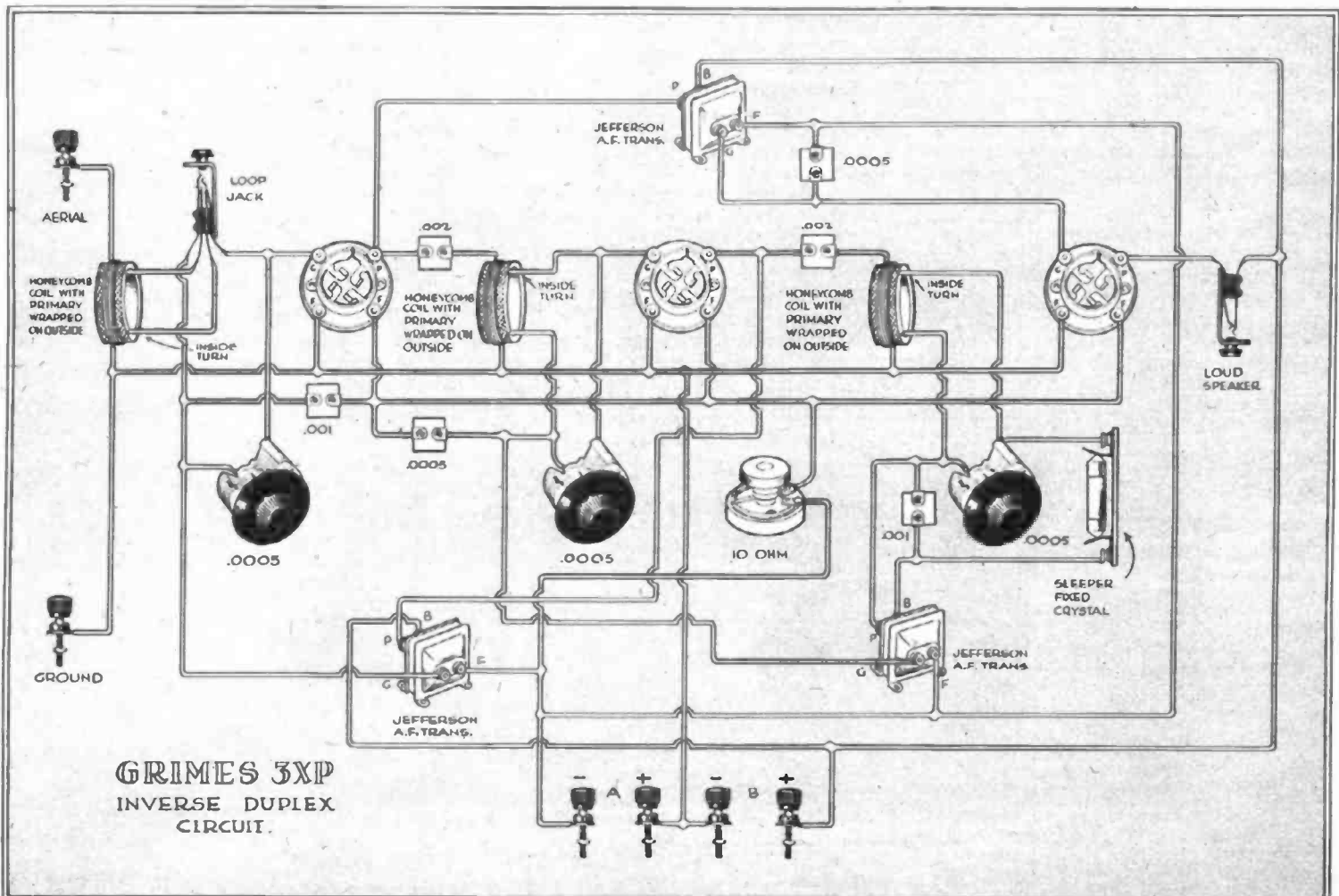

If without imagination, he is obliged to follow in the path of those who lead. The work in hand for this particular issue is to construct the circuit shown in Figure 1. We must become absolutely familiar with the peculiarities and special operating features of this before we can make any changes for the better. When the entire operation of the arrangement in Figure 1, is known we will be able to recognize any new kink or change when we alter the circuit for a future stunt. These slight changes furnish us with the best clues for the final answer when experimenting. It would be absolutely foolish to build any of this experiment up in a cabinet or panel. Research work is not conducted on that basis. The tests are always run on flat boards where every wire is readily accessible. Quick changes thus can be made and trouble easily located.

Maybe, when many months have gone by and some of the improvements we now hope for have been accomplished, we will wish to mount the set in a finished form. That time will come and then, and then only, should serious consideration be given to cabinet mounting. We have never at the outset hooked a thing up the way we finally wanted it. All the experimental work on the inverse duplex invention was done on a simple flat board. Our general comment on the impression as to the great care necessary in running wires just so, is that there are many things in the circuit that will give infinitely more trouble than the mere manner of running a wire. The experience has been that when other things are right there is not much trouble caused by the method of wiring.

Figure 2 gives a few of the details for making the tuned radio transformers for the set. The ordinary honeycomb coil is used—the coil proper acting as the secondary winding. A layer of tape is wound around the outside of the coil and the primary winding is then wound onto this with about number 22 double-cotton copper wire.

The secondary or honeycomb winding should have about 56 turns properly to cover the broadcast wave lengths with a twenty-three plate condenser. A coil is just being placed on the market. If you are unable to locate any, it is rather easy to

unwind from a coil having more turns. After the required number of turns has been removed, the end should be waxed as it was originally.

The primary winding should be waxed or taped on. It is desirable to wax or tape only in a few places rather than over the entire coil. These coils should be mounted at right angles to each other and separated somewhat. They should be located at least five inches apart. The photograph of our experimental set demonstrates the method

of pheric interference. We found the series resistance in the loop circuit necessary to control oscillation caused by the loop feeding back into the radio transformers. This could be best prevented by shielding the set but requires a certain amount of knowledge and skill. We would be particularly pleased to hear about any exceptional results you obtain on a loop and the results from any of you who have had experience with the shielding of radio sets would also be appreciated. For those who will not be able to shield the set for loop operation the resistance will be found necessary.

For those of you who are not ready to proceed with the experiments on the loop, Figure 4 is shown. This gives the wiring of the input to Figure 1 when only aerial operation is desired. The primary windings on the tuned transformers are shown as variable. This will constitute one of the experiments that you will conduct. The more turns, up to about 15, that you can have on the primary, the greater distance you will receive; but there will be a tendency toward oscillation and noise.

We found for our particular arrangement that twelve turns worked out best except for the primary that connects to the aerial and ground. Here we had 15 turns.

It will be necessary to have several taps on the primary of the coil connecting to the aerial. These taps are desirable to reduce the amount of incoming energy to prevent overloading the set on local stations. Sometimes when the receiving set is within a few miles of a high-power broadcasting station, the signal is so strong that a howl is heard when the condenser is tuned to that particular station. This overload howl can be overcome by simply dropping the number of turns in the aerial circuit down to as low as one turn. You will have to determine this for your own location and stations. Of course, on distant reception, it will be necessary again to increase the number of turns. This is done by means of a tap switch.

Well, let's all hook it up and compare notes and be sure to write in no matter how strong your language may be to express your feelings.

You must remember in trying out a new hookup like this that (Continued on Page 49)

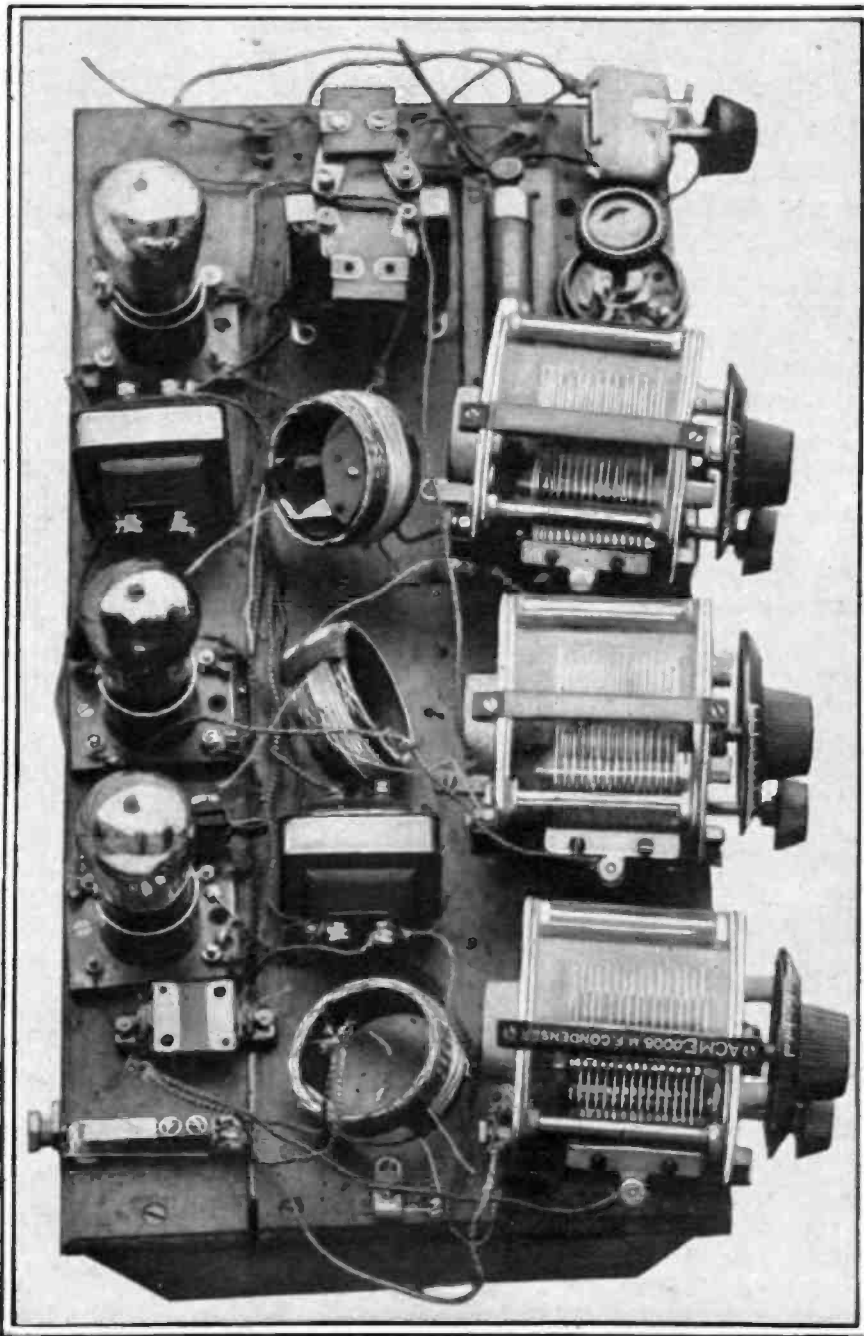

Looking right down on the whole works showing how the coils can be turned at different angles so that their magnetic fields will not interfere. It also shows how the primaries are wound on and taped to the honeycomb coils

of proceeding with both wiring and mounting.

Figure 3 illustrates the details of the loop circuit in case one is desired. We do not believe that you will obtain any great distance with the set on a loop but it gives excellent results on local stations with the resulting freedom from static and atmos-

RADIATING RECEIVERS

SOME time ago Bratford Foote in one of his articles in *RADIO IN THE HOME* spoke of various types of commercial receivers which were guilty of radiation. Among others he mentioned the Kennedy set.

Immediately after the publication of that issue, E. F. McNames, research engineer for the Kennedy Corporation, wrote me that his company had commissioned R. S. Glasgow, assistant professor in the department of electrical engineering of Washington University, St. Louis, to make very thorough tests on radiation of various types of receivers, and that Professor Glasgow's report showed the Kennedy Model V was virtually free from any such criticism.

This interested me not so much from the standpoint of the various commercial sets, but it struck me that a report from Professor Glasgow giving in a general way his conclusions as to the different types of receiver and their radiating qualities would be intensely interesting. I therefore wrote to him and asked him to send me such an article and I am very pleased to present it herewith.

To me, the most astonishing result of this investigation is Professor Glasgow's proof that the double-circuit set will radiate more strongly than the notorious single circuit.

H. M. N.

By R. S. GLASGOW

Assistant Professor of Electrical Engineering,
Washington University, St. Louis

THE problem of radiating receiving sets is becoming one of increasing importance to the radio public, judging from the large number of articles constantly appearing on this subject. But, as Mark Twain once remarked about the weather, a great deal has been said about it but nothing has ever been done about it.

At the present time, next to static, which is always with us during the summer months, the radiation from other receiving sets is the most fruitful source of interference. Most of the other causes which prevent the enjoyment of radio programs, such as howling detector or amplifier tubes, commercial spark station interference, "key thumps" of amateur C. W. stations, or inability to tune our undesired broadcasting stations, can usually be remedied by the operator himself. Good apparatus, intelligently adjusted, will take care of the majority of such cases.

But the interference due to regenerative receivers when in the oscillating condition cannot be eliminated by anything the receiving operator can do.

Two remedies suggest themselves—legislation and education. The former is manifestly impractical owing to the difficulties that would be encountered in attempting to enforce any legislation which prohibited regenerative receivers from being operated in the oscillating condition. And since the regenerative vacuum tube is the most sensitive detector yet devised, it would be extremely inadvisable to prohibit its use altogether.

If this were done, it would mean that persons would have to build or purchase more elaborate sets of

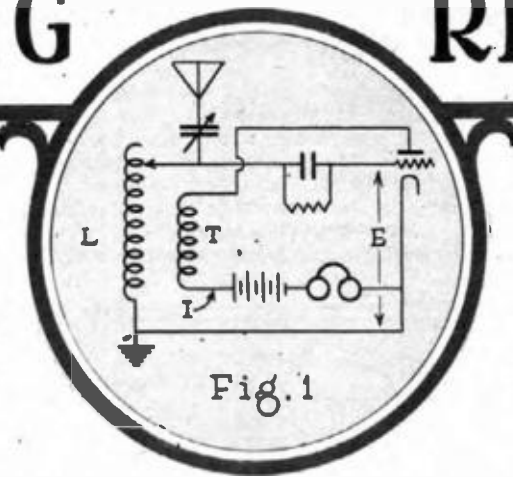

Fig. 1

the various "dyne" types at considerably increased cost in order to duplicate the results now obtainable with the ordinary type of regenerative receiver. Therefore it would seem that the only satisfactory solution of the problem lies in educating the users of such apparatus to operate their sets in such a manner as to cause as little interference as possible.

With the steadily increasing number of listeners there are often as many sets today in a single block as there were in an entire town a few years ago. Ultra-sensitive receiving sets of various types are becoming common, and it is these types that are particularly harassed by the whistles and squeals due to the radiation from their neighbors' sets. The fact that in the cities the aerials are so close to each other greatly increases the intensity of the whistles.

All types of regenerative sets will cause the connected aerial to radiate energy if allowed to oscillate. These include all single-circuit and double-circuit types em-

ploying a tickler coil or a variometer in the plate circuit, the ultra-audion, Reinartz, and most of the various "dyne" circuits when not properly adjusted.

In Figure 1 is shown a schematic diagram of a typical single-circuit receiver. When an alternating voltage, E, due to an incoming signal, is impressed between the grid and filament of the detector tube an alternating current, I, of the same frequency flows in the plate circuit. This current in flowing through the tickler coil, T, induces in coil, L, a voltage which reinforces or adds on to the voltage E. This increase in E gives rise to a further increase in I, resulting in a greatly increased strength of signal.

If the tickler coil is coupled too close to L the circuit will maintain a continuous oscillation, the frequency of which will be dictated by the constants of the circuit. When this takes place the set is functioning in exactly the same manner as a small transmitting station.

The writer has tried inserting a telephone transmitter in the ground lead and has been able to converse with stations more than a mile away under favorable conditions, using the same tube and B-battery voltage as are ordinarily employed for a receiver.

In operating a receiving set of one of the above-mentioned types the usual procedure in picking up a broadcasting station is to set the apparatus into oscillation and manipulate the tuning dial until a high-pitched whistle is heard.

This note is produced by the difference in frequency between the carrier wave of the broadcasting station and the oscillations generated in the receiving set. By slowly tuning the set so as to decrease this beat or heterodyne frequency to as low a pitch as possible and stopping the oscillations by reducing the tickler coupling, the speech or music being broadcast is heard—usually a slight retuning being necessary to bring it in clearly.

It is also possible to hear the program without stopping the local oscillations by what is known as "zero beat reception." This method consists in very carefully synchronizing the frequency generated in the set with that of the carrier wave of the distant station, so that the "beat frequency" between the two is zero. The volume of sound is usually much greater when receiving in this fashion and it is therefore often resorted to in an effort to obtain suffi-

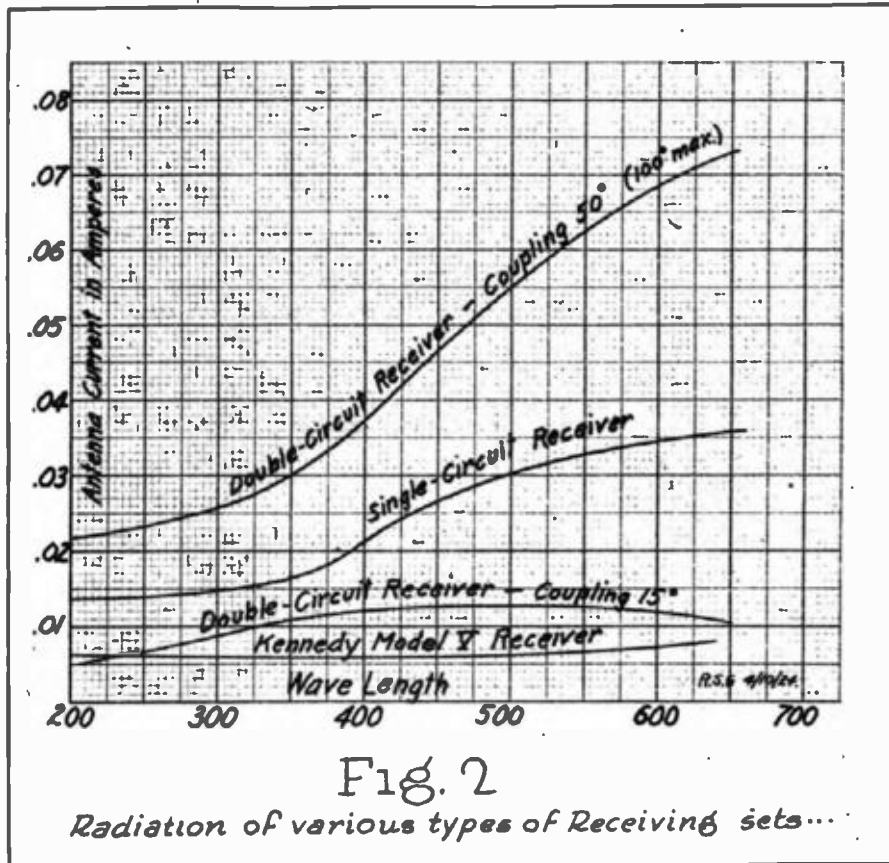
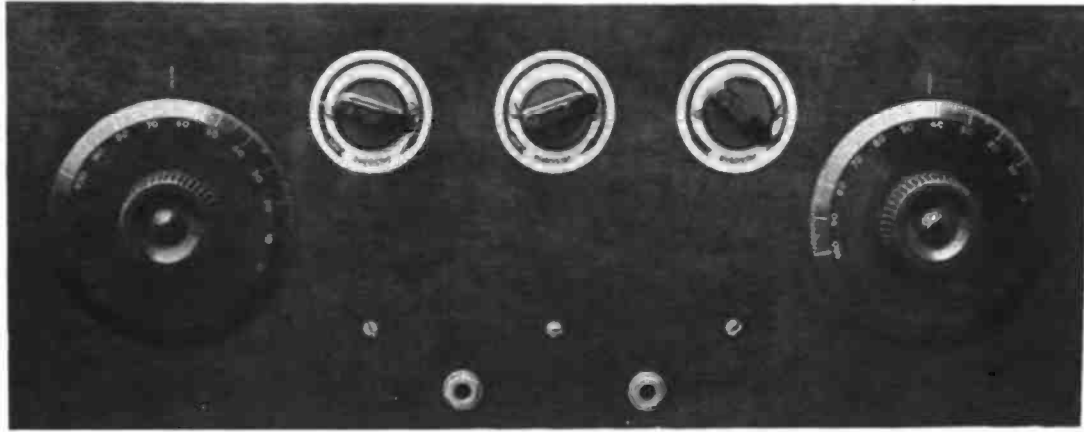

Fig. 2

Radiation of various types of Receiving sets...

(Continued on Page 28)



Showing the neat workmanlike appearance obtained by using uniform rheostat knobs. These are Pacents

"Factory" Refinements in Home-built Sets

By HAROLD N. LOEB

IT WILL probably be admitted by the man who has built himself a good radio receiver—perhaps by this man most of any—that the average factory product is far superior to a home-made outfit. In fact, many manufacturers freely give consent to the disclosure of their circuits in the radio press because they find that a large proportion of the persons who originally "build their own" discard their handiwork eventually in favor of commercially made sets.

Why is the factory product favored? The writer believes that the general preference for factory-made equipment (not considering the purchases made by men who find no pleasure in radio construction) is due to two things—the superior appearance of such outfits and the results obtained with them.

Much can be learned by the serious home worker, however, from the examination of good factory-made apparatus. Let us consider in detail some of the refinements noted in commercial sets of various makes and the receiver of the radio "engineer."

First, the cabinet. Cabinets are usually built on one of three plans: (1) Without a lid, (2) with a hinged lid that constitutes only a part of the top, and (3) with the entire top hinged. In the writer's opinion,

cabinets without lids (usually necessitating the removal of panel screws and the panel for inspection of the mechanism or for tube replacement) are distasteful to most persons, who like to "see the works." Lids that give access only to the tubes are unpopular for the same reason.

Yet the most common type of cabinet, in which the entire top is hinged, also is not ideal from several viewpoints. First, it affords too great a temptation for constant tinkering. Second, unless a sub-base is employed, the open cabinet is a dust-trap. Third, such a cabinet usually has a groove or rabbit for the panel that is subject to breakage, as is also the panel when lifted vertically from the groove with its burden of instruments.

Recently, for this reason, there has been growing in favor a type of cabinet with a lid that extends the full length of the box but not the full width. This lid abuts, when closed, against a wooden reinforcement strip across the front. This construction affords a rigid cross-member at top-front; the panel may be attached with screws, and yet access is afforded to all essential parts of the receiver without removing the panel.

Another excellent type of cabinet has lately been developed, in which the top may be slid open like the top of a roll-top desk. Such a cover could, with patience, be made of wood strips and canvas in the home, and it is, to say the least, unique.

Still another type of cabinet features a hinged baseboard; while knock-

down cabinets can be bought at low prices and finished as desired. The man who wishes to house both his phonograph and his entire radio outfit in one cabinet with a single amplifying horn can obtain such cabinets from various manufacturers and department stores. The wood of which the cabinet is made is a matter of personal

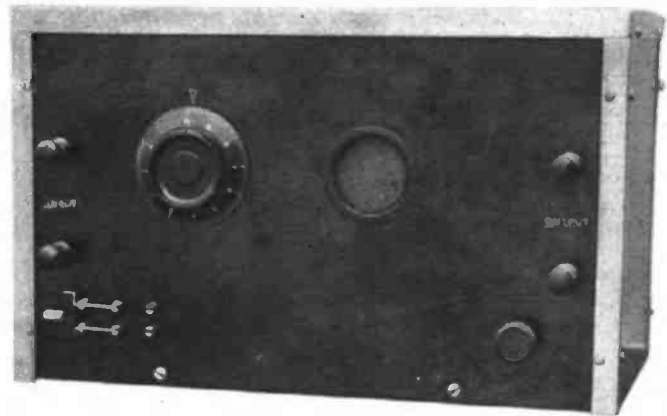

Here is the panel after the bezel or screened "window" is placed exactly in front of the tube



This lid with its supporting hinge affords easy access to the inside. The horizontal front strip protects the panel. The set is a Garod Neutrodyne

preference, since commercial manufacturers use many different kinds in both high and natural finishes. Poor wood and poor assembly should, however, obviously be avoided, being suggestive of a "cheap" set no matter how fine the electrical instruments which the cabinet houses. It should also be remembered that wood with a hand-rubbed finish is less likely to show scratches and dents than is the varnished material. Miniature cedar chests, recently introduced to radio fans, commend themselves because of their low price and rugged surface.

A metal arm or pair of arms from an old camera for holding the lid open is a desirable adjunct, as is also a so-called piano hinge, the full length of the cabinet. A printed log-sheet affixed inside the lid is a "professional" touch as well as a convenience; and rubber feet for the cabinet, obtainable in any hardware store, are an added refinement.

The next item for consideration is the panel. It goes without saying that this should be of good dielectric material, as cheap stuff both gives rise to electrical leak-

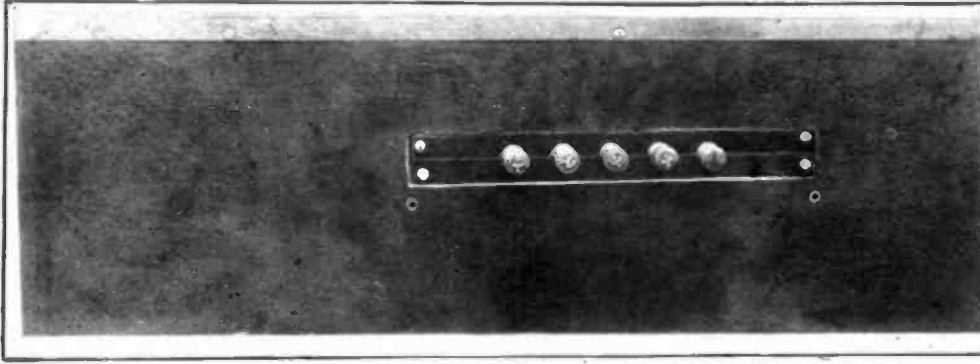

age and is likely to warp or sag under the weight of the instruments affixed to it.

It will be noted that the panels of most factory-made apparatus have a satin surface rather than a high polish. The satin or sanded surface is less likely to show scratches acquired either in the construction of the set or afterward; and after a panel has been worked on in the home it is often difficult to give it a finish as brilliant as that which features some commercially made receivers, even though it had a high finish when purchased. Most workers know that the dull finish is quite easily obtained with medium emery paper, applied to the surface with long, even strokes. The panel should then have a dose of 3-in-1 oil to be rubbed dry with a soft cloth.

The new red panels and the white or "pyralin-ivory" effects are also worthy of consideration by the man who has an eye for beauty. Some of the newer commercially-made sets feature a slanting panel, which is both attractive and convenient for operation of the receiver.

Virtually all factory-finished panels are engraved—indeed, the engraving is one of the "hallmarks" of factory-built receivers. Yet engraving of the softer materials is not beyond the ability of the average amateur, using the blunt point of a pair of scissors for a tool; and if it seems impossible where the denser dielectric is employed, the home worker in even the smaller cities can find a halftone engraver or a silversmith for whom tooling a panel is easy work. In the writer's personal taste, any kind of labels or "transfers" intended to be pasted to the panel seem crude indeed.

Another point worthy of note is that a majority of factory-made sets do not have binding posts on the panel. Binding posts

One method of installing the binding post in the back of the set, keeping the front panel absolutely free of wires

at the front seem to be a favorable expedient of the average young amateur builder (doubtless because it is most easy to locate them there), but after the set is completed and put in operation, wires running to the front are both unsightly and troublesome. Better disposal of binding posts will be

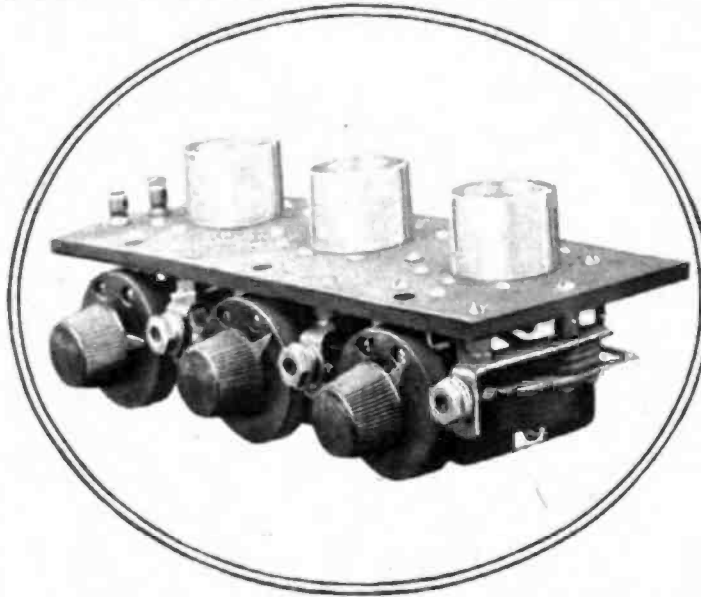

Above is a view showing how to drill through the sub-base, to make room for the socket. The wires are connected to the sockets before the sub-base is mounted. The illustration shown here is a Kardon unit. The photograph below shows that a decidedly different effect can be obtained by using the wheel-like type of rheostat. They also give the set a finished appearance and are easy to adjust. The photograph shows an Eisemann set

suggested later. A minor detail of good factory-made equipment that is likely to escape the attention of many copyists is the fact that all instrument-retaining panel screws are flathead and blackened, and that the holes for them are countersunk. Brass may be blackened, after cleansing, by immersion for ten minutes in a dilute solution of one part of neutral nitrate of tin and two parts of chloride of gold. Countersinking is best performed with a tool made for the purpose, called a counter-sink bit, but may be done with a pocketknife.

For fastening the panel to the base-board or to the cabinet, French-head (slightly convex) screws, either black or nicked, are preferable. The holes for these should not be countersunk. At this point it may be well to caution the worker not to use iron screws in any part of his receiver, as they often cause trouble in the reception of signals.

Bezels, or screened "windows," used to be quite popular, but with the advent of dull-emitting tubes they would seem to be of slight value. In fact, many radio stores do not stock them. Few factory-made sets have bezels of the screen variety, although these are the most easily applied in the home, since the apertures in which they are inserted need not be cleanly cut.

Since a screen mesh bezel is too "gingerbread" for most tastes, if a bezel is felt to be a necessity it would seem best to have a circular aperture with beveled edges cut at a radio store at the same time that socket holes are cut in the sub-base—of which more will be said later. A series of holes drilled close together in a circular or an angular pattern forms a neat and simple bezel. In any event, the amateur should take care that his bezels be squarely before the tubes when the set is completed.

It is worthy of notice that the custom in designing radio sets is to position the antenna and the ground binding posts at the left of the set, and the battery and the output terminals at the right. The writer believes that this is a mere convention. It is both permissible and desirable to reverse this order if antenna and ground leads come through a window at the right of the spot where the apparatus is to be set up.

If the set is designed for both antenna and loop reception, it is good practice to include a four-prong (Continued on Page 32)

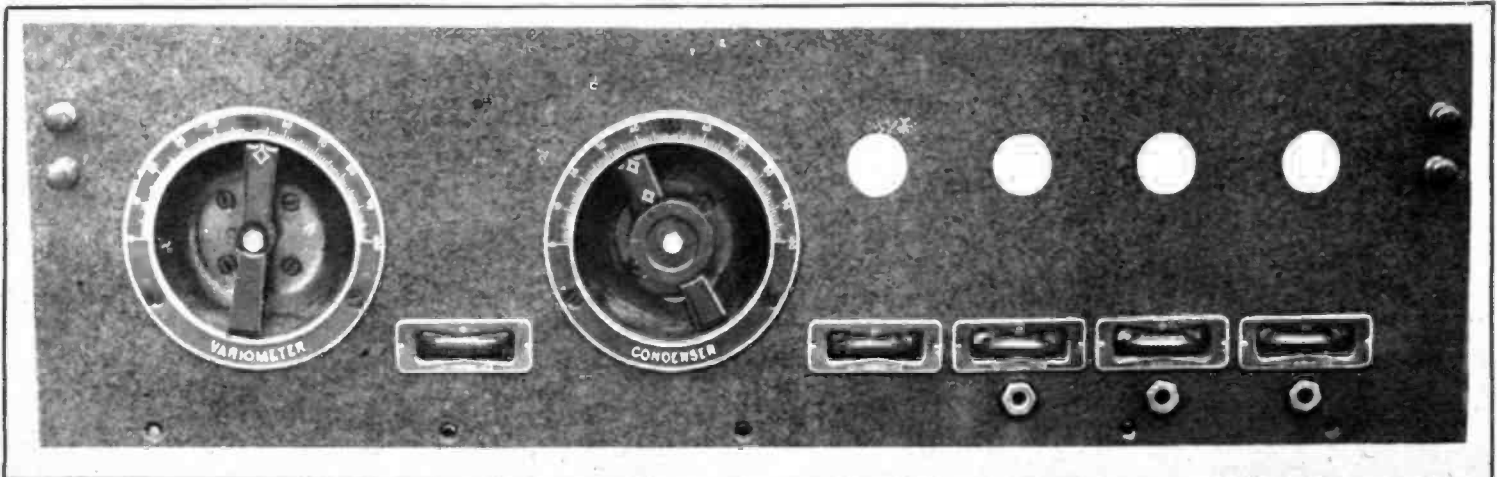

To the left is the tuning chart made for Mr. Foote's receiver

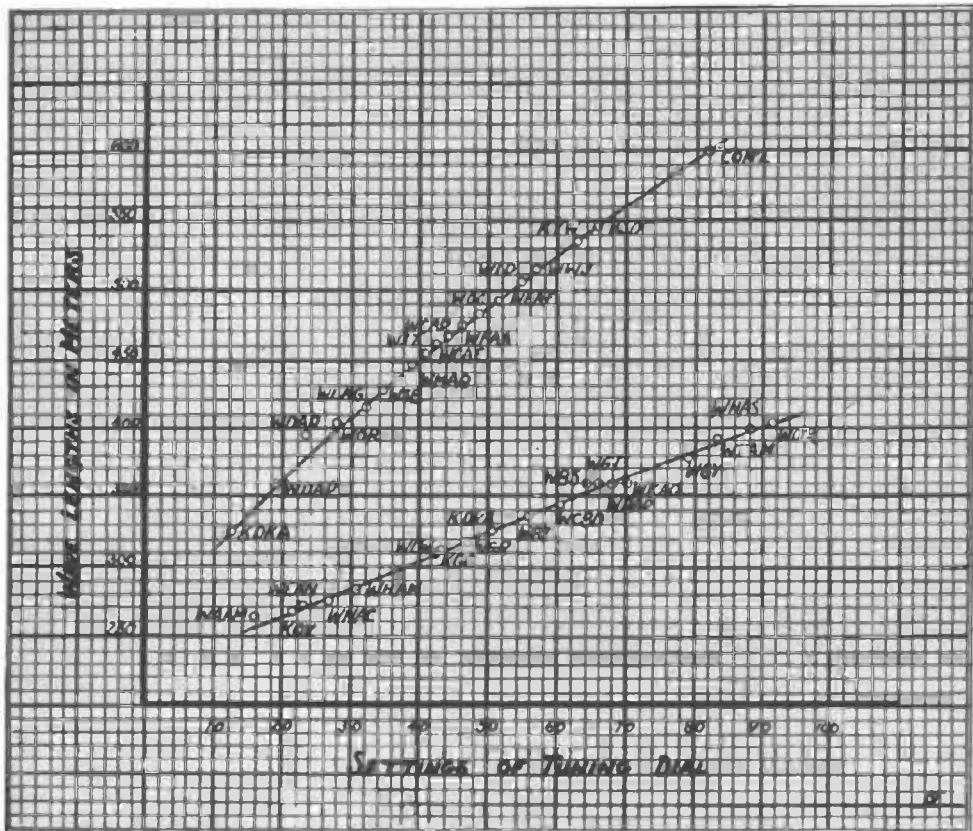

How to Become a DX Sharp-shooter

By BRAINARD FOOTE

IF YOU went off on a trout fishing expedition, you wouldn't cast your bait hour after hour on the waters of some unknown pond, would you? Most likely you'd hunt up Uncle Josh and get some tips on the unfrequented brooks where they're just jumping out of the water after the fly—you'd find out where the fish were, and you'd fish for them there.

Sure, and if you're the possessor of a marksman's medal, you'll admit you never won it by banging away blindfolded at a row of distant bullseyes!

But most of us fish for DX stations with our radio receivers in just some such haphazard manner. Perhaps we do succeed in capturing the call letters of PWX once in a while, but there are lots of other distant fellows whose initials ought to appear on the DX list, too.

The trouble is that we don't know where to hunt for them. We ought to be able to confine our search to perhaps four or five degrees of the tuning dials instead of spinning them from zero to the top so often. Besides, this exercise wears out the bearings.

The fisherman finds out where the trout lurks and he hunts for him at that location. We should discover, somehow, where our tuning dials should be set for PWX and the chances are a thousand per cent greater that PWX'll come through.

Two indispensable helping hands we cannot do without. One of them costs little in either money or effort, for it's the daily newspaper with programs of all stations given in local standard time. A radio program is of slight value to the DX sharp-shooter if it's incomplete. Most every town has a publication carrying complete programs and the DX-er should compare the various journals to learn which ones gives the most complete DX program.

The arrangement of the stations is important, too, but it is most common to find stations merely listed by their call letters,

without regard for the time of the individual broadcasting.

However, it is this sort of program which we'll find most useful if we decide to "make a business" of reaching across the continent or down to Cuba now and then. From the paper we may find the time at which the station we have determined to hear starts to broadcast, and if any names of performers or selections are included, so much the better for identification purposes. The wave length is also given. Thus we have some valuable information—the wave length, the time, the materials to be transmitted.

But before we may concentrate our "aim" in the vicinity of our invisible and elusive target, we must know how our dials are to be set in order to receive that wave length. Some time ago, it was considered requisite to secure the services of a wave meter—the "yardstick" by which wave lengths are measured—to "calibrate" the tuning dials. Nowadays there is a much more satisfactory

and in truth a more accurate method which scarcely costs a nickel, if you don't count paper, pencil and ink.

This is our friend the "graph," ordinarily called a "curve" in radio parlance. Those of us who aren't up on such matters as resonance, coupling, electro-magnetic waves and phase angles used to look with awe upon this device of the initiated for concealing information in sign language.

Really, though, the graph isn't such a bogie after all, and any one who has mastered the income tax blank is able to draw a tuning chart with one eye shut. The necessary tools include a pencil and a ruler;

or if you're a little more fussy about appearances, a ruling pen and some India ink. Then we must have a sheet of graph paper, obtainable at a stationer's. The squares on the sheet ought to be of generous proportions, and it will aid the eye in locating various points on the paper if every tenth line is a bit heavier than the others.

Before proceeding further, we need a good list of both local and distant stations, with their wave lengths and dial settings all arranged in order. Sometimes there are several dials which tune independently, as with the neutrodyne. Then again, there are other sets using but one tuning dial, and still more of such combination that a change in the coupling between the primary and the secondary upsets the adjustment of the tuning condenser.

In the last-named event, it is necessary that we set the coupling at that position where reception is best for both volume and selectivity, as found by experience.

In the case of the neutrodyne, it is perhaps best to record the settings of the detector dial—the large dial farthest to the right.

In the case of the single circuit receiver, the condenser adjustments will have to be recorded together with a notation of the position of the switch lever.

The very easiest sort of a circuit for DX listing is the three-circuit with untuned antenna coil, described recently in *Radio in the Home* as the "Kelcoil."

Users of single circuit receivers having a variocoupler and series condenser are urged to change to this form of circuit as being many times more satisfactory in every way. The selectivity is as near perfection as anything could be, and so is the volume. Any variocoupler circuit may be adapted by connecting the aerial and ground posts together and then connecting a 15-turn coil, coupled to the outer winding of the coupler, in between the aerial and



ground leads, thus making up a separate primary circuit.

The accompanying graph was obtained from the dial settings of such a receiver, where there was a tap on the winding for using only half the coil when tuning on shorter wave lengths.

The tuning dial whose readings are listed must be one which does not change its indications no matter what is done to any of the other dials. For convenience sake, the list is arranged in order of wave lengths, from low to high. A horizontal line on the graph paper, near the bottom of the sheet, is divided off to represent the dial numbers, from zero to one hundred in most cases. The curve shown uses one small space to represent two dial divisions. The vertical line, near the left margin is divided for wave lengths between 200 and 600 meters. If the squares on the graph paper are not too tiny, each may represent ten meters, as in the illustrated chart. Next we "plot" the curve. Suppose we find KSD, 546 meters, to tune in at dial setting 66. We make a dot or small circle with the pencil at the intersection of the vertical line marked "66" on the dial setting base line and the horizontal line marked "546."

Of course, there really isn't a line marked "546," and "540" is the nearest one. Estimating six-tenths of the space to the 550 line gives the 546 point.

Similarly, the intersection of 536 meters with dial setting $62\frac{1}{2}$ places KYW. A continuation of this process locates all the stations heard, and the more stations, the more accuracy. The line drawn through the points shows the general direction of the curve. It cannot include all stations, because some of them are a little off their advertised wave length.

The curve must be smooth and should include as many of the points as possible. Usually, a number of applications of the straight-edge will result in a good graph.

If the number of turns in the coil are changed, as by a switch and tap, another curve is drawn for the stations picked up on that combination. Such an arrangement is of infinite value in short wave tuning, for it "spreads out" the dial settings so as to make the setting of the dial much easier.

For instance, with an 80-turn secondary on the General Radio variocoupler used for the accompanying plot, the upper curve was secured. WDAP and KDKA, 360 and 326 meters, are only about seven dial divisions apart on the upper curve. Yet, when the switch is moved over to connect to the center tap of the coupler and use only 40

turns, WDAP and KDKA are eighteen divisions from each other.

This means that it is comparatively easy to tune on shorter waves, whereas with any circuit where a single condenser covers the whole range, it is very difficult to get the dial on the exact right spot for a far-off short wave broadcaster. Users of the Kelcoil and other similar tuning devices will find immense benefit by the addition of a small two-point switch and center tap on the winding. In getting KGO, for instance, the lower scale is always employed because the adjustment is so very critical on the upper range.

With the curve finished, we are in a position to set the tuning dial with great accuracy to any given wave length, or to learn the wave length of a station we may receive.

The outstanding example of DX "sharp-shooting" for Atlantic Coast listeners is perhaps that of KGO, Oakland, California.

the graph given. Tuning slightly lower, WOC should be found with ease.

A most interesting example of selective tuning of which most any good receiver is capable is that of WEAN and WNAC, the Shepard Stores of Providence and Boston, respectively, on 273 and 278 meters. As a rule, the two stations transmit the same program, so it is almost always possible to recognize them at once because they tune so closely together and broadcast the same material.

A glance at the lower graph will show WNAC coming through at $261\frac{1}{2}$ and WEAN at $231\frac{1}{2}$. WRW, of Tarrytown, is listed as 273 meters also, but WEAN is probably a little low (and it's a good thing WEAN IS low), so that WRW squeezes in right between the two other stations.

A week's listening-in with the tuning graph as a guide will mean a revelation in the matter of dial adjustments. The receiving set becomes more and more of an

individuality in itself with its marvelous ability to reach forth and "pick up" a station again and again on the same dial points. And you will be astonished time and time again to note how you can look up the time and wave length of some hitherto unlisted distant station, find the right spot on the dial from the curve and actually log that station. It is due in great measure to the fact that you deliberately decide to get after that fellow and you go about it in sure logical procedure.

The practice of DX sharpshooting need not interfere with others' reception of local programs. Indeed, every listener ought to be on his guard vigilantly and never on any

consideration permit his receiver to oscillate on the wave length of any local broadcaster. A certain amount of oscillation is perhaps unavoidable when you hunt for the "whistle" of a weak fellow out in Oregon, but it is entirely inexcusable to allow a sign of a "whistle" when your dial passes the wave length of a nearby station.

And with your tuning chart and a little experience with it to guide you, you'll soon learn the settings for WDAR, WFI, WIP, WOO, etc., if you live in or near Philadelphia, and if you're a fan of the District of Columbia you will scrupulously avoid any "whistling" on the wave length of WRC-WCAP. All you need to know is the dial setting for the local station and when passing that wave, adjust the regeneration dial so the set is not "squealing."

Even when looking for a DX station, it is better to keep regeneration under control and to hold the regeneration just below the point of actual (Continued on Page 23)



Radio in the home of J. Edeson, 4664 Frankford avenue, Philadelphia, Pa. The set is a Crosley, Model XXV, with a Music Master loud speaker
Photograph courtesy of Ross Music Store, Philadelphia

That station transmits on 312 meters. Running along the 312 meter horizontal, we find the intersection with the curve at a dial reading of 43. Hence we are sure to find KGO, if we hear him, at about 43.

Now there are other helps of which we should avail ourselves in hunting for such a station. WLW and WSAI, of Cincinnati, the curve tells us, broadcast on 309 meters. We know, then, that KGO would be tuned in just a fraction above WLW or WSAI, and we thus have two quite accurate guiding points for KGO. We can tell by the graph the dial setting for 312 meters and we can tune in the 309 meter stations easily because they are so much nearer, and then "fish" for KGO just above that wave length.

Another case is that of WOC, 484 meters. Perhaps the station whose wave length is nearest is WEA, within range of East Coast listeners without difficulty. WEA comes in at 492 meters or $51\frac{1}{2}$ on

The Hotel Statler, Buffalo, N. Y.; the home of Station WGR



WGR, at "The Key City of Industry"

JUST for the information of any broadcast listener who has not happened to listen-in on WGR, Eastern Time, 319 meters wave length, it should be stated at the beginning that when Announcer O. E. Becker, in his deliberative, measured accents, says "The Key City of Industry," he means Buffalo, N. Y.

Briefly, in order to get necessary facts out of the way as soon as possible, it may be said that WGR is owned and operated by the Federal Telephone and Telegraph Company atop the new Hotel Statler. Its aerial is more than 350 feet above the level of the street at Niagara Square, the civic center in downtown Buffalo. Its studio is on the eighteenth floor of the hotel, the highest finished floor, and the operating room is directly above. Besides the "pick-up" in the studio, WGR also has several other microphones located at strategic points in the hotel, conduits for which were installed during the construction of the hostelry.

That's that.

Dry facts have no place when there are so many human and interesting things to

be said. Some people think that the human side of radio, which, after all, is its most interesting side, has been sadly neglected in the rush and scramble for the latest thing in "hookups," distance records and the like.

At least all that seems dry when there are available such things as the inside dope on the experiences of W. H. F. Tenny which led him to write his "Songs of the North" with which he, himself, often goes on the air.

All that is dry when one knows and can tell of the secret behind all that zip and pep as well as artistry that is in the delightful violin solo work of Ann Joseffer, the girl who probably helped more than any other one person to make the afternoon concerts of the Radio Dealers' Association of Western New York an instant hit when they were put on, beginning last February.

The folks at WGR are a happy family. Those who are on the payroll of the station work hard and enthusiastically to make it an even greater success than it is. And at the present time it stands as one of the leading independent stations of the country, noted among its audience for its clarity and

balance of programs and its perfection of transmission.

Speaking of the audience of WGR, the fan letters received at the station indicate that its greatest audience, aside from the local group in the vicinity of Buffalo, is in the States of Indiana, Minnesota and Illinois. WGR also has a big Canadian audience in the province of Ontario. Canadians count on it.

M. A. Rigg, Jr., has been manager since it opened at the Hotel Statler. The station first went into operation at the plant of the Federal Telephone and Telegraph Company, which is on the outskirts of the city, but as soon as the Statler was finished it was moved downtown. Before radio invaded Buffalo, Mr. Rigg lived in the Smoky Town. He is young and handsome and brisk. He has the qualities of an organizer.

You probably have never heard Mr. Rigg's voice and you have missed something thereby, for he seldom goes on the air himself. Anyhow, he is married. And a lady of beauty was his choice. Mrs. Rigg is well known in the WGR family, for she has often acted as hostess on big occasions

at WGR. She is a musician and can tickle the ivories something scandalous.

It is Mr. Rigg, backed by the eternally vigilant experimental department of the Federal organization, which has built up the station. Its studio is said to be one of the most beautiful in the country, as to furnishings as well as equipment. It was largely due to Mr. Rigg and his tireless efforts in the early days of the new studio that it was speedily graduated from Class C to B. Those were the days when he had to be on the job about twenty-five hours a day.

There was a time months back before the rule for the announcers to sign off with the use of their initials was discontinued that one of the most popular announcers signed "E. S." You don't hear the voice of E. S. any more. But E. S., who is Edward Stanko, is on the job behind the scenes just the same. It is E. S., as senior operator, who sits up in the operating room on the nineteenth floor level with a pair of headphones on, vigilantly listening to the transmission to see that it is going on the air as well as possible.

Any one who broadcasts from WGR has usually heard indirectly from E. S. The program will be on. Suddenly the inner-phone in Mr. Riggs' office will buzz and E. S. will be saying perhaps, "Tell Miss So-and-So to stand about a foot farther away from the microphone," or, "Tell Mr. Blank to speak more distinctly and be a little more careful about running his words together."

It is E. S. who sees that the music goes out on the air with the proper amount of amplification; not too much, not too little. WGR does not go after distance records. The people in charge of the transmission know that there is such a thing as too much power back of the music. They know there is a happy medium in transmission that makes for good reception, and it is the job of E. S. to watch the transmission and try to obtain as perfect reception as it is possible for the station to induce. E. S.

is slender, keen-eyed and clean-cut. But he, too, is married. He was married about six months ago, not to a girl who heard his voice while he was an announcer, as the usual broadcast studio romance is supposed to be, but to a boyhood sweetheart from the hills of Pennsylvania.

There was a time when broadcast listeners would hear a precise male voice sign off as "R. M." Now, R. M. is none other than Robert Munn. Mr. Munn's title is announcer. That is official, but his unofficial title should be studio pinch-hitter.

For every one who listens to WGR programs knows that Robert Munn is often on them. He is best known for his organ recitals, usually on Sunday afternoons. Mr.



The top photograph is of Ann Joseffer, violinist, and a favorite with WGR fans. Circle—Edward Stanko, present chief operator, taking a turn at the microphone. Mrs. M. A. Rigg, Jr., at the piano. At the left is Robert A. Munn, announcer of Station WGR

Photographs by Colegrove Studios

Munn is often scheduled on the programs for singing or for a piano solo. And here is where the pinch-hitting comes in. Mr. Rigg is a stickler for having programs begin on time. Now it sometimes happens in the best regulated studios that entertainers do not arrive promptly: Often one

or two come straggling in a bit late. It is then that Mr. Munn, if he happens to be the announcer on duty, steps in, incognito, and announces himself playing a piano solo.

He really can make a piano produce music. Result: The program begins on time, the late entertainers arrive while his number is on; and the public, Mr. Rigg, the entertainers and every one else is happy. Naturally, Mr. Munn has not lost any popularity with the entertainers for this sort of co-operation.

The latest acquisition to the studio is O. E. Becker, he of the deep, bass voice and perfectly measured, deliberate accents. Some say that Mr. Becker was born an announcer, but until radio got ready to give him his true place in the world, Mr. Becker spent his time at Cornell University and did something or other with stocks and bonds for several years. Mr. Becker is comparatively long married (comparative as marriages go these days) and happy. He has a boy eight years old who is starting the way of all true radio fans. He is pestering his dad to get him a crystal set all for his very own.

The thought just came that an extremely important part has been omitted about Mr. Munn. Mr. Munn is not married. He is the bachelor of the studio staff. He is tall and slim and dark. Dark hair. Dark eyes. Such eyes! But his chief passion in life seems to be for music. He likes tennis. So does Mr. Becker. These two men are as far apart as the poles in temperament, but they have two things in common: Radio and tennis. So their studio relations are entirely compatible.

If you should happen to be at the Statler some time and want to see the studio, as many people do, you will be most welcome.



any visitors take a peek at the studio, be they from Dunkirk (N. Y.), or Hongkong, her day is utterly ruined if for any reason they get out of the place without signing the studio visitors' register. One might think she had been a hotel clerk some time, but she hasn't been. Truly, it is just her way of being hospitable. She thinks no visit is complete unless that courtesy is extended to a guest. She's probably right.

Before we begin to talk about the entertainers there are a couple of men behind the scenes whom every broadcast listener should know about. You have never heard their voices and you probably never will.

One is "Tom" Longbotham. Tom is a really handsome person. He has a hearing, a manner—if you know what I mean; and an occasional smile that is a knockout. He used to be a newspaper writer, but he is

The other man is A. H. Erisman, who is concert manager for the Radio Dealers' Association of Western New York. It is this organization which is providing the concerts at WGR from 2:30 to 4:00 o'clock daily except Sunday. It is up to him to select and provide the talent and to arrange the programs. He has got to keep the standard up and see that the programs are carried out without a hitch. His job is one of the reasons why some men die young. These programs were started in February by the radio dealers as a sort of experiment. They were such an instant hit in a country whose radio afternoons at that time were as devoid of complete concert programs as an alligator is of feathers that the dealers had to keep them up. And Mr. Erisman is the man who pulls the strings.

All of which brings us to Ann Joseffer, whose work with the violin in the first days of those afternoon concerts helped make the programs such an instant hit.

Letters came from all over the map about the violinist. A lot of people want to know about Ann Joseffer, what it is about her that gives her music the quality it has I don't know. But she has personality, character. She is attractive. She has interesting eyes. And she has more pep, vitality, aliveness than any three average girls one could find anywhere. She doesn't believe in walking. She dances to where she wants to go. When she is on a program and there are rest periods, does she rest? She does not. The studio won't hold her. Like as not you will find her out in the quiet eighteenth floor lobby of the Statler, dancing to the strains of music that come faintly from the studio or dancing to a tune she herself is whistling.

And when her body is not in motion, her eyes are; intensely curious about everything, active, lively. She is seventeen, so they say, and comes from a long line of musicians. She has played in public since she was eight and critics predict a career ahead of her. Her father is Max Joseffer, master of many instruments and director of the Majestic Theatre orchestra, graduate of two (Continued on Page 27)



The chances are the first person you will see will be Miss Helen M. White, a quiet, personable, somewhat intellectual-looking young lady, extremely kind and considerate of other people's feelings; so much so, in fact, that you are likely to see a flush of embarrassment mount to her cheeks if the red light happens to be on over the heavy plate-glass door of the studio and she has to tell you that no one except entertainers and the announcer is admitted while WGR is on the air. There really is nothing to be embarrassed about, for this is a thoroughly good rule and visitors can see the entire studio from the outside of the plate-glass door anyhow.

But Miss White is that way. She practically grew up with the studio. She is Mr. Riggs' right hand "man." She has probably read and digested more fan letters than any other person connected with the studio. She knows WGR broadcasting policies from A to Z. She is a walking compendium of information regarding rules, copyrighted music, entertainers and the thousand and one things that some one person around the studio has just naturally got to know. Truly, she uses that part of her anatomy to the rear and above her horn-rimmed spectacles for something besides the sub-structure of a marceled wave.

Miss White is just the kind of person who will some day be asked to marry. And if the fellow is the right one and the conditions are right, Miss White will feel a slight flush of embarrassment coming on either cheek and will probably say, "Yes." That's Miss White.

Then there is Miss Helen House. She is a fiend so far as the studio register is concerned. That is her pride and joy. If

At the top of the page is a photograph of M. A. Rigg, Jr., general manager of Station WGR. Circle—Miss Helen M. White, and the right George Albert Bouchard, who is the organist at the Hotel Statler, Buffalo, New York

Photographs by Colegrove Studios

now on the executive staff of the Hotel Statler, Inc., and one of his duties is to act as sort of liaison officer between the studio management and the hotel management. He helped smooth the way for the present broadcasting of the Vincent Lopez Hotel Statler Orchestra, which is one of the regular features of the station. He often cooperates in a quiet sort of way in helping WGR get other Statler talent on the air.



Officers of World Radio Camp of WOAW. Left to right—Earl Stiles, banker; Levi L. Coryell, watchman; Earl E. May, consul commander; Dr. John Simpson, physician; Willard Krutinger, clerk, and John Crawford, escort



Mrs. Earl E. May, consul commander of World Radio Camp of WOAW

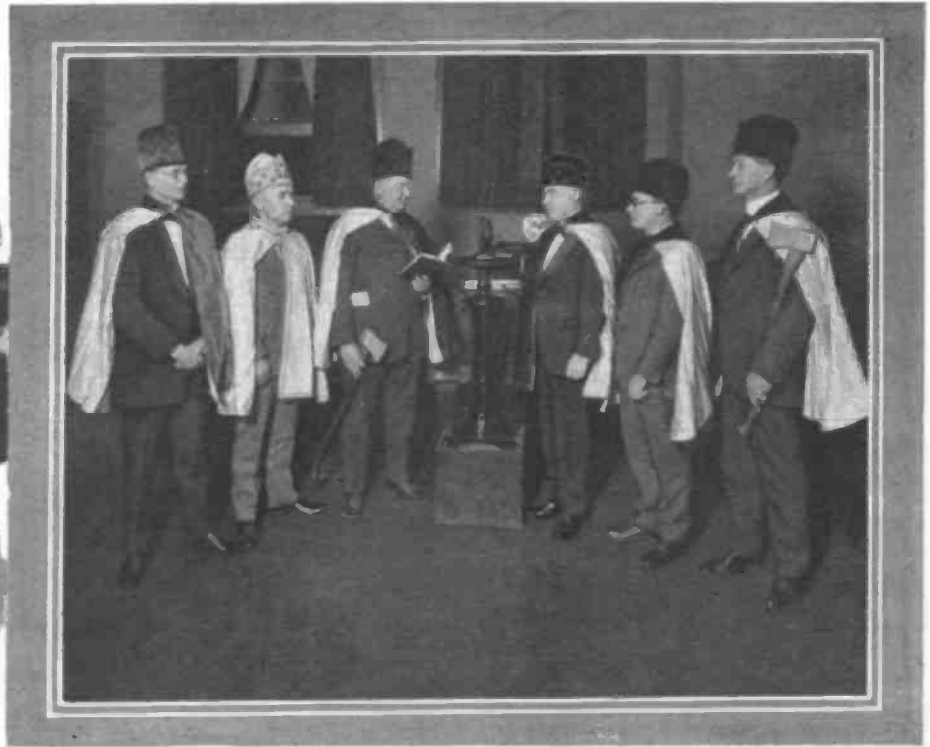

Bringing Your Lodge to Your Home

By EUGENE KONECKY

A New Development in Fraternalism and Radio

THAT radio is an unlimited field of expanding activities, is proved by one of the latest innovations in radio broadcast from Station WOAW, at Omaha, Nebraska. Readers of *Radio in the Home* will recall the extensive article which appeared in the January issue giving the history of this well-known Middle Western station, which claims the largest religious congregation in the world. This congregation was the result of an attempt to "fraternize" the air. Now comes the World Radio Camp as a further interesting experiment to develop this "fraternity of the air."

The Woodmen of the World Life Insurance Association is mainly interested in broadening the scope of its fraternal endeavors. It was because W. A. Fraser, president of this organization, realized the necessity for keeping abreast of the times that he proposed the operation of a broadcast station by the Woodmen of the World, with headquarters at Omaha. With this background in mind the reader will more easily appreciate the significance of the World Radio Camp, which is, to express it in terms of Oriental imagery, "bringing the mountain to Mohammed."

By this I mean, through the World Radio Camp, the Woodmen of the World organization is enabled to bring its message and its benefits to men who have heretofore been unable to look for any practical value in such affiliation. This may have

been due to their residence, where no local camp was chartered and hence no lodge meetings could be enjoyed; or it may have been due to their occupation as traveling salesmen. Whatever the reason, these men could not engage in practical fraternalism,

which is largely a matter of meetings, rituals and co-operation. To these men, wherever they are, in hotel, isolated homes or on trains, the Woodmen of the World, through the medium of the World Radio Camp, brings the lodge meeting, the ritual and social enjoyments of the meetings.

The entire proceedings of the camp meetings are broadcast for reception by members scattered in every part of the country. These proceedings include roll call, reading of the minutes, reports of committees, initiations, orations and prescribed rituals. In addition to the order of business and rituals, a social program is broadcast which includes vocal and instrumental numbers, so that the membership at large lack nothing in their Radio Camp meetings.

The Radio Camp was suggested to the executives of the Woodmen of the World by Earl E. May, a business man of Shenandoah, Iowa. Upon visiting the Woodmen of the World headquarters at Omaha, Nebraska, he became so enthusiastic over the radio station, as well as the general organization of this life insurance society that he proposed the inauguration of the World Radio Camp. He secured a certificate of insurance in the sum of twenty-five thousand dollars as an expression of his faith in the idea.

Mr. May was made consul commander of this camp and the work of organization proceeded under his direction. The camp was officially inaugurated January 17, 1924, and has met regularly once a month since that time. The rituals of the last meeting were performed in the official uniforms of the Woodmen of the World. In the accompanying photograph (Continued on Page 29)



Above is a photograph of Gene Rouse, chief announcer of Station WOAW

Pages 25-28 are missing in the original.

tion is still too great. In order to operate this type of receiver without causing objectionable interference, it is necessary to keep the coupling dial set at 10 or less whenever the receiver is allowed to oscillate. Since the radiation can be reduced in this manner, it has a decided advantage over the single-circuit type, but only if the coupling is at all times kept very small.

The Kennedy Model V receiver was the only one of the various types tested wherein the radiation was low enough to be classed as non-interfering, regardless of what adjustments an unskilled operator might make. While the double-circuit receivers tested showed by audibility tests that they could also be adjusted so as to be non-interfering, if weak enough coupling were used, yet the fact remains that they are not inherently so.

Bringing Your Lodge to Your Home

(Continued From Page 24)

we see in the background the skull which is used in the initiation of candidates. In the picture of Mr. May will be noted the axe which is the symbol of woodcraft, each member of the Woodmen of the World being conceived as a pioneer blazing the path of



Radio in the home of J. A. Bailey, of Narberth, Pa. The set is an E. I. S. Super-Heterodyne with a Western Electric loud speaker

progress with his mighty axe as the old pioneers literally did in peopling, building and civilizing this country.

Membership in the World Radio Camp is open to men between sixteen and fifty-two years of age who can pass the necessary physical and moral qualifications for membership. Each member is entitled to participate in the meetings at any time, either in person or by mail. It is apparent that the organization is now in an experimental stage, but the numerous requests for information and the growing membership indicate that the idea will be extensively developed in the future.

The officers of the camp at present are as follows: Consul commander, E. E. May, president of the Shenandoah Chamber of Commerce; banker, Earl Stiles, past head consul of Nebraska; physician, Dr. John E. Simpson, past consul commander of Seymour Camp; escort, John Crawford, superintendent of the Woodmen of the World Building; watchman, Levi L. Coryell, president of a large group of independent Nebraska oil dealers; clerk, Willard Krutinger, an auditor of the Woodmen of the World.

The additional photograph of the man with the big smile before the microphone is G. R., the famous an-

nouncer of WOAW, who is telling the world about the Radio Camp.

G. R. is the abbreviation for Gene Rouse. He is officially employed as a newspaper representative and commenced his career as a radio announcer when an Omaha daily started operating Station WNAL several years ago. The exceptional quality of Mr. Rouse's voice brought him to the attention of the executives of the Woodmen of the World, and he was appointed as a regular announcer.

There have been many titles applied to Mr. Rouse, the principal one being, "the man with the heavenly voice." So well known is his voice that people recognize the station immediately when they hear him speak.

How to Become A DX Sharpshooter

(Continued From Page 26)

oscillation or "whistling." The carrier wave of a far-off fellow will come to you as an "air-rush." Perhaps you'll hear a sort of sobbing note accompanying the transmission from the weak station, and that is a sign that quite a few other listeners are inconsiderately using the "squeal" method of reception. But, above all, no matter what other listeners may seem to do, never receive by the

Bristol Single Control Radio Receiving Set, together with Bristol Neuter Audiophone Loud Speaker as used in one of the Fibre Horns.



Radio Reception Simplified to Single Control Dial

IT IS an easy matter for any member of the family to operate a set like this. A good illustration of the absolute simplicity of

BRISTOL SINGLE CONTROL RADIO RECEIVER

Using Grimes Inverse Duplex System (Patents Pending)

is the fact that a set is installed in the home of a blind woman who operates it herself and is able to bring in station after station at her will.

Powerful enough to get long distance reception. It is a four-tube set using Grimes Inverse Duplex System, which makes it equal to six tubes because the first two tubes are utilized for both Radio and Audio Amplification.

Non Reradiating—will not disturb your neighbor's reception when you tune in.

Many refinements, including panel with telephone jacks on back of the case for making connections.

Used with Aerial or loop, and in some locations short Inside Antenna will give good results. When Aerial and Loop are both provided it is only necessary to operate a lever to change from one to the other.

The case is solid mahogany finish with walnut stain. It is handsome in appearance, and at the same time provides a rugged protection for the working parts.

Price of Bristol Single Control Radio Receiver without accessories \$190.00.



BRISTOL

TRADE MARK

AUDIOPHONE

REG. U. S. PAT. OFFICE

LOUD SPEAKERS

made in three models. Senior \$30.00, Junior \$22.50, Baby \$12.50.

The most recent development in these models is the fibre horn with which the Baby Audiophone is now furnished, as illustrated below.

Write for Bulletin No. 3013-Q



MADE AND SOLD BY

THE BRISTOL COMPANY

Waterbury, Conn.



This Radio Battery Has "Over Twice The Life"

THE Burgess Radio "A" is exclusively a radio battery, designed especially for service on the "A" or filament circuit of dry cell vacuum tubes.

In Radio service it has over twice the life of the ordinary No. 6 ignition battery... costs approximately the same... has a rapid recovery to high voltage after short periods of rest... practically no voltage is lost when not in use.

Replace your worn out "A" battery with a Burgess. Compare the service in your own set under any and all conditions. Then let your experience guide you in your future purchase of Radio 'A,' 'B' and 'C' batteries; there's a Burgess Battery for every radio purpose.

"ASK ANY RADIO ENGINEER"

BURGESS RADIO BATTERIES

BURGESS BATTERY COMPANY

Engineers - DRY BATTERIES - Manufacturers FLASHLIGHT - RADIO - IGNITION - TELEPHONE
General Sales Office: Harris Trust Bldg., Chicago
Laboratories and Works: Madison, Wisconsin

Branches: New York Boston Kansas City Minneapolis Washington Pittsburgh St. Louis New Orleans

In Canada: Plants: Niagara Falls and Winnipeg
Branches: Toronto - Montreal - St. John



Radio Kindergarten

(Continued From Page 8)

that a radio signal that comes in on our aerial swings back and forth from positive to negative electricity many thousands of times a second. We know that we receive this alternating current and lead it by some method or other to the grid of our tube. Here we have already learned the current acts on the grid like a trigger and releases or stops with each vibration the current from the B batteries to the plate. This current going through our phones and pulsating makes the diaphragms in the telephones vibrate and so gives us the sound which we wish.

This little apparatus then simply duplicates the actual receiving conditions of a radio set, only instead of

over to the right, it makes contact with the positive side of the C battery and places a positive bias on the grid, and when the blade is swung all the way over to the left, it makes contact with the negative side of the C battery and places a negative bias on the grid. When it is swung part way to the right or the left it puts a lesser positive or negative potential on the grid and by means of varying it slowly we can get any amount of positive or negative voltage that we wish as a grid bias for making measurements.

This variation in the bias on the grid is exactly what we get when we are using our tubes in our receiving set. Using it this way slowly and



Radio in the home of Arno B. Reincke, Chicago, Ill. All batteries, etc., are contained in the cabinet, and the loud speaker is concealed behind the right-hand door. The set is a Cutting & Washington Console Model of the Teledyne

taking radio signals from the aerial we use an artificial means of making the current of the grid swing from positive to negative. This is necessary because the ordinary radio signal vibrates entirely too fast for the human eye to see and consequently it would be virtually impossible for the novice to make a measurement of it.

If you will look at the diagram and place your pencil on the grid binding post on the tube socket and then follow the wire from that binding post you will find that it goes to the blade of the potentiometer. This then means that whatever voltage there is on the blade of the potentiometer will be placed upon the grid as what we call a "grid bias."

Now if you will follow the wires which are attached to the two outside binding posts of the potentiometer you will see that one of them goes to the negative side of the C battery and the other goes to the positive side. It is easy to see that when the blade of the potentiometer is swung

under perfect control in the testing apparatus, we can watch the effect of the variation of grid bias upon the currents which we are drawing from our B battery to the plate through the honeycomb coil in this apparatus.

This honeycomb coil is placed in the circuit in exactly the position which would be occupied by the telephones or the loud speaker, and so any action that would take place in the telephones is reproduced in this honeycomb coil. With the telephones, our ears would be the measuring instrument, but here we use the pocket compass so that we can see exactly what is happening in that plate circuit.

Going back now to the potentiometer, let me explain that this C battery is really one of the batteries which we buy under the name of a B battery. We place a 45-volt battery in the position of this C battery because we want to be able to swing the voltage from ten volts positive to ten volts negative, and that will mean that

"The only loud speaker that can hold my receiving set is the

THOROPHONE

—says Wm. G. Smith

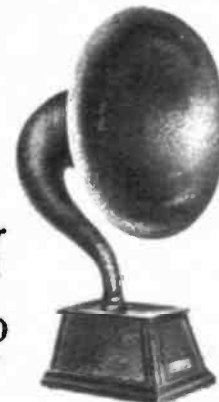

High Power Model S-5 \$45.00

Power that makes other loud speakers jump off the table merely makes the Thorophone produce greater volume. The Thorophone will take all you can give it and still reproduce voice and music so naturally that you'd think speaker or musician were right in the room.

Until you have heard the Thorophone you have not learned how wonderful radio is. Whatever your receiving set, the Thorophone will make it sound better. It reproduces perfectly. The controlled mica diaphragm; the scientifically designed Thorite horn; the additional power from the 6-volt storage battery — these things make the Thorophone the ultimate loud speaker.

For endless satisfaction, buy the Thorophone.

Write for booklet

WINKLER-REICHMANN CO.
4801 S. Morgan St., Chicago, Ill.

An Expert Says: **RESISTANCE COUPLED AMPLIFICATION!**



G. V. Allen, of the Westinghouse Electric and Manufacturing Co., writes in the May RADIO BROADCAST:

"True, great improvements have been made, but the fact remains that fundamentally the transformer cannot ever give distortionless amplification. For those who demand quality at all cost, the resistance coupled amplifier is unquestionably the most desirable."



Cost is no longer a drawback! DAVEN specialized resistance coupled amplifier parts have cut the price to less than \$1.00 per stage!



Special inexpensive resistors from 5000 ohms up. Our RESISTANCE COUPLER, 10 h.c. resistor, leak and condenser \$1.50

Ask your dealer—or let us help you out

DAVEN RADIO COMPANY

"Resistor Specialists"
9-11 Campbell St., Newark, N. J.

there must be at least twenty volts in this battery. Consequently we use an old discarded 45-volt B battery which has not sufficient current left to work our telephones and which we were about to throw away. You see, in this particular position, all that we need is voltage and the circuit draws virtually no current from the battery, so an old battery which is nearly dead will do perfectly well in this position, provided it will show twenty volts across its two outside terminals.

You may be somewhat confused by my speaking of a B battery used as a C battery, but you must remember what I have already explained—that any battery that is used to light the filament is called the A battery, and any battery that is used in the plate circuit is called the B battery, and any battery which is used in the grid circuit is called a C battery. We speak of these big blocks of batteries which rate from 22½ to 45 volts as B batteries only because that is the usual purpose for which they are sold; but if we take the same battery and place it in the grid circuit, as we are doing in this hookup, it becomes a C battery, no matter what we called it when we bought it.

The other two batteries necessary for this testing outfit should be good ones. What we are doing with this outfit is to test the tubes to see if some fault in the reception is due to them. If it should happen that the fault is due to the batteries, those same batteries would produce the same result in this testing outfit and we might think it was the fault of the tubes. So, if you are perfectly certain of your batteries, you can use the same ones on this set, but in making a test of a tube you must be absolutely sure that your A and B batteries on the testing outfit are in good condition and are delivering proper voltage.

Almost any size honeycomb coil will do for this testing outfit, but the larger it is the more deflection you will get on the compass needle and the more obvious will be the evidence of the condition of your tube. We use a fifteen-hundred turn coil and I would very earnestly urge any amateur to use the same size.

To make a test, place the coil upon its edge, and put the compass on a match box or some similar support which will bring it about to the middle of the coil. The edge of the compass should just about touch the side of the coil, but it is better not to let it project inside of the opening. In other words, you can place a sheet of cardboard alongside of the coil, stand your compass up and let it rest against the cardboard. Then you are in position to make the test.

Insert your tube and turn on the filament to the proper brilliancy. Then swing the potentiometer blade all the way over to the minus or negative side.

Now look at your compass. Turn the honeycomb coil and the compass around until the needle of the compass points exactly to the zero mark, or the north mark with your potentiometer blade set all the way over on the negative side.

With the compass set in this way, swing the potentiometer blade all the way over to the positive side and watch the compass needle. If the tube is in proper condition, the compass needle will fly out almost at right angles away from the honeycomb coil. If it should happen to fly toward the coil instead of away from it, turn the coil upside down. It is much better to have the coil set in such position that the needle will be repelled by it when the potentiometer blade is on the positive side.

Sometimes you will have a tube which will show a certain amount of

deflection of the compass needle, but this deflection will be steady and it will not increase as you continue to bring the potentiometer blade over to the positive side. This means that the tube is permitting a certain amount of current through the plate, but that it is in bad condition and is not functioning efficiently. An efficient tube will make the compass needle fly out and stand out almost at right angles with the grid bias all the way over on the positive side of the potentiometer.

Always disconnect your C battery when this set is not in use, because there will be a steady drain through the potentiometer if you do not and the C battery will soon die.

For the dealer or the man who wishes to make a definite and exact "characteristic curve" of this tube, exactly this same hookup can be used, but he will need some measuring instruments instead of the honeycomb coil and the compass.

One instrument should be a Weston volt meter with a double reading, one side giving up to 7½ volts and the other up to 150 volts. Then he will want a good milliammeter which will give him at least 20 milliamperes, preferably divided into fractions or decimals.

The process of testing a tube is then this: the outfit is used exactly as shown here except that the 1500-turn honeycomb coil and the compass are not used. The milliammeter is connected in the circuit in place of the honeycomb coil.

The rheostat used can be the Federal type, which is built with three different windings, so that it can be used with any type of tube now on the market. This will enable the dealer to test any tube that his customer wants to buy.

When the tube is inserted, the potentiometer blade is placed exactly in

the middle of the potentiometer and the high reading side of the volt meter is connected across the circuit as shown by the dotted line marked P. This will tell exactly what voltage is being placed upon the plate. For the 11 or 12 type of tube, we usually use about 40 volts; for the 99 tubes use 60, and for the A tubes use 90.

With the plate voltage adjusted the rheostat should be turned up and the low reading side of the volt meter be placed across the wires where the dotted line is marked F. This will show the exact voltage being placed upon the filament of the tube. For the 11 or 12, this should be 1.1 volt, for the 99 tubes it should be 3 volts and for the A tubes it should be 5 volts.

With the voltages set in this way, the test is ready to begin.

Swing the potentiometer blade over to the left and connect the volt meter across the circuit shown by the dotted line marked G. Watch out for your "polarity" in connecting the volt meter, because we are now measuring a negative voltage. You should touch the volt meter very lightly to the wires in order to see that the needle does not go backward.

Set the grid voltage at anything from 7 to 10 volts negative and then take a reading on your milliammeter in the plate circuit.

If you will look at the "characteristic curve" which I gave in the last Kindergarten lesson, you will see the kind of graph paper that should be used for these tests. The voltage is marked off horizontally across the bottom line of the graph sheet and the milliamperes are marked up on the left-hand side.

Let us say that we are testing a 99 tube and that we are beginning with 7 volts negative on the grid. If we look at our milliammeter we will

SLEEPER MONOTROL

REG. U.S. PAT. OFF.

With the Grimes Inverse Duplex Circuit

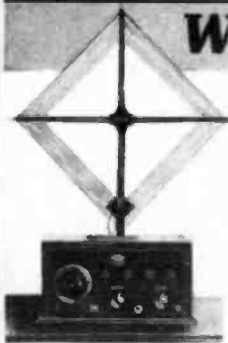

Dealers Please Note
Absolutely dependable in operation at any time of year, you will find the Sleeper Monotrol particularly salable in Summer.

Through the Summer With a Loop

The Sleeper Monotrol is free to rove with you this Summer. It is not fixed in any spot—moored by aerial or ground connections. You can move it out upon the porch for Summer evening concerts. You can carry it and listen-in while riding in your car—set it up on mountain top or beach—

point the loop towards stations that you want to hear and hear them with that sweetness, clarity and purity of tone that you get *only* through a loop in sets especially built for loop reception. Your dealer will be glad to put a Sleeper Monotrol into your home *on trial*. Try it.

SLEEPER RADIO CORPORATION, 88 Park Place, New York



UNIFORM CROSS SECTION
OF THE NA-ALD DE LUZE
SOCKET

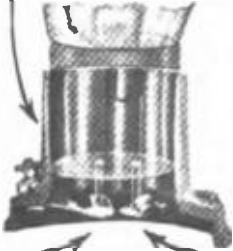

SPECIAL DIPPED BRIGHT
PHOSPHOR BRONZE CLIPS,
LAMINATED AND EXERTING
DUAL-WIRE PRESSURE.

THIS ILLUSTRATION SHOWS HOW
THE CONTACT STRIPS CAN BE
MADE TO CLEAN TUBE TERMINALS
AUTOMATICALLY BY ROTATING
THE SEVERAL TIMES.

Look for the socket board

In leading radio stores you will find the Na-ald Socket Board, displaying the five standard Na-ald Sockets: For the 200 and 201 tubes, the De Luce at 75c, and also the Small Space at 35c. For the UV-199, No. 499 at 50c and adapter at 75c. For WD-11, No. 411 at 75c. Ask your dealer to show you the self-cleaning arrangement of contacts in Na-ald De Luce, No. 499. These dual-pressure, contact strips cut into the sides of tube terminals, keeping their surface clean and bright, and resulting in perfect contact.

These sockets have the highest dielectric properties, obtained by the thorough cure of the Bakelite used, and made possible by uniform cross-section.

There can be no noisy circuits due to poor contact with these sockets in use.

New telegrapher booklet "What to Build," now packed with each Na-ald product. If your dealer's stock doesn't have this booklet, send cover of Na-ald carton or list for it.

NA-ALD

ALDEN MANUFACTURING CO.

DEPARTMENT T

SPRINGFIELD, MASS.

THE NATIONAL PERFECT VERNIER CONDENSER

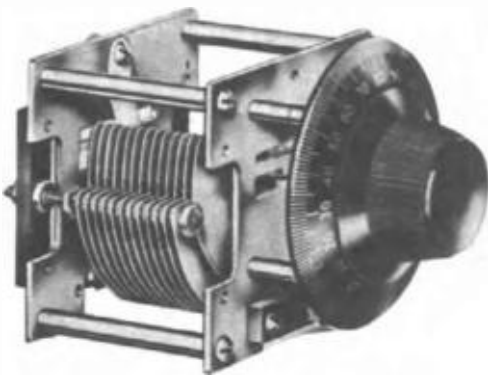

Type DX

A Vernier Condenser, that operates with no back lash and with a touch of "velvet smoothness."

Its mechanical and electrical characteristics have justified its commendation by a number of the country's prominent radio engineers.

Excellent results have been obtained when used in combination with Reflex, Radio Frequency, Neutrodyne and Super-Heterodyne circuits.

Sizes:	.001	.0005	.00035	.00025
Prices:	7.00	6.00	5.75	5.50

Write for Bulletin No. 104 A

MADE BY

NATIONAL COMPANY, INC.

Estab. 1916

Engineers and Manufacturers
CAMBRIDGE 39, MASS.

find that it reads about one milliamperes. We then turn to our graph sheet and make a little dot or a circle at the place where the minus seven-voltage vertical line crosses the one milliamperes horizontal line.

We then move the potentiometer straight up until our volt meter across the grid circuit shows that we have one volt less and then we make another reading of the milliammeter and place a dot on our graph where those two lines intersect.

So we got on with the potentiometer taking a reading at each volt until we are all the way up to the positive side. We will then find that our graph shows a series of dots with which a smooth curve can be drawn.

At Station 3XP we make all of our tests with grid voltage, swinging from minus 7 to plus 7. We do this because our Weston milliammeter on its low reading scale goes up only to 7½ volts, but it has decimal divisions and enables us to get very exact readings. This is sufficient voltage bias, however, to give an accurate curve of the tube and it is all that is necessary.

A good tube of the 99 type should show something around one milliammeter in the plate circuit with a negative bias of 7 volts and with a positive bias of 7 volts it should go up to about five or six milliamperes.

The A type of tubes should go from about one milliamperes to about fourteen or fifteen milliamperes and the 11 or 12 type should go up to about four or five milliamperes.

Factory Refinement in Home-Built Sets

(Continued From Page 18)

jack for the loop. If the loop jack is mounted in the lid (with flexible lead-in wires connecting its inner prongs to antenna and ground binding post so that the lid can be opened without breaking connections) the arrangement affords the further advantage that a loop mounted on a phone plug can be rotated in any direction when inserted. For the head phones and the loud speaker as well as for the loop jacks are preferable to binding posts.

As has been said, the best place for binding posts is either on the back of the cabinet or inside the cabinet, in which latter case they should be made accessible through a hole in the back board.

If the panel is removable from the cabinet horizontally, perhaps the most satisfactory plan for location of the binding posts is to cut a rectangular aperture in the back board. Into this opening fits a rectangular piece of panel material fastened to the baseboard, on which strip the binding posts are mounted. A more simple plan is to drill into the back board individual holes through which the binding posts protrude. If the wires must be passed through the holes and fastened within each time it is desired to connect the receiver, the builder may later regret, however, that he took the short cut.

The size and pattern of dials and other knobs is another matter for individual taste. Four-inch dials are growing in public favor, particularly those with large central knobs, which facilitate minute adjustments. It may be pointed out here that few factory-made receivers come equipped with the small, rubber-tired secondary knobs which are intended to be mounted as verniers near the larger dials and to turn them by friction. These, unless mounted just right in their relation to the larger dials, frequently give trouble. A much better simple vernier is a rod of dielectric material fastened to the knob of the dial, parallel with the panel, by means of which the dial can be levered

through infinitely small spaces. Dials which have recently appeared on the market with a reduction gear built into them are also excellent verniers.

Needless to say, the dials should be of good dielectric material, and the knowing amateur will choose dull-finished dials for a satin-finished panel, and polished dials for a glossy panel. The graduation of the dial (whether clockwise or counter-clockwise) should also be given consideration in relation to the instruments which they are intended to rotate. It should also be borne in mind that shaft holes in dials are not uniform in size, although most manufacturers standardize on quarter-inch holes and shafts. Also, in some dials, the set-screws are not sufficiently low to grip short shafts. Again, the shaft holes may not be drilled so that the dials run true, but scrape against the panel.

All this stress is laid on dials because they are truly one of the little things that can cause great annoyance. A sign-manual of a careless worker is the use of several different styles of dials on his receiver. Even the rheostat knobs should harmonize with the main controls—it goes without saying that rheostat knobs should be uniform with one another.

A wheel-like type of rheostat control that projects laterally through a slot in the panel, as exemplified in certain well-known commercially built apparatus, is good looking and easy to adjust. Semi-circular rheostats suitable for lateral control are also available individually for the man who wants something "a little different." The slot for the wheel or the lever can be cut in the panel with a circular metal-slitting saw, which latter should be part of the equipment of every serious home worker. Lacking this tool, the amateur can drill a row of contiguous quarter-inch holes, then chisel the slot and square it up with a file.

Coming now to the "innards" of the set, shielding against hand capacity effects was formerly almost universally recommended and practiced, although in some instances it was found to reduce the efficiency of the receiver. A shield of lead foil ("tin-foil") is generally used and is best applied after the panel has been drilled, shellac being used as the adhesive medium. The shielding should be scraped away from all holes for a distance of a quarter-inch to prevent possible short-circuiting of panel-mounted instruments.

Brass or copper foils are preferred by some to lead foil, being stiffer. The peer of all shielding material is, however, aluminum (not aluminum paint or "liquid" aluminum). All these heavier foils are put on in the same way as lead foil, but if carelessly crumpled before application may be found stubborn to work with.

In particularly severe cases of hand capacity effect, grounding the shield—that is, connecting it with the ground terminal—usually improves operation. Hand capacity is more likely to occur in regenerative than in non-regenerative circuits; therefore, as has been intimated, in the newer radio frequency circuits it is not so likely to be needed. In many of these, however, the advantage of aluminum "wings" or partitions as a shielding between instruments should not be overlooked. In many sets, these shields can be fastened to the baseboard; but where the design precludes this method, they can be fastened to the panel or to the panel-shield with aluminum solder. One form of such solder consists of scrap zinc and Venetian turpentine heated with a blowpipe.

As in regenerative sets, however, caution should be exercised concerning the introduction of any shielding into radio frequency receivers, but for a different reason. In the radio fre-

quency set the metal is likely to introduce undesirable capacitative effects by its mere presence. For this reason, also, metal brackets for fastening a sub-base or a baseboard to the panel, metal socket-holding brackets and all similar supercargo should be reduced to a minimum. Iron and steel should be shunned religiously, as they may exert magnetic influences.

Conforming to this precept, the writer prefers tube sockets that are molded to those with metal shells, though care should be taken that the walls of the molded sockets are not unduly thin. Panel-mounting sockets are space savers, and perhaps the most satisfactory kind to use where sub-base design is not adapted for the receiver. A gang of two or three panel-mounting sockets can be bought at the radio supply store if desired.

Carefully designed sockets have contacts well separated to preclude the possibility of leakage of radio frequency currents at this point. A form of socket, which for lack of a better term may be called a skeleton socket, has also recently appeared. This type has no shell, the prongs of the tube simply entering four diminutive metal jacks similar to those in a so-called tube adapter. This new socket would seem to insure good contact, rigidity and avoidance of current leakage.

Horizontal mounting of sockets flat on the panel is to be deprecated, as the grid of a horizontally mounted tube is likely to sag and touch the filament after a while. In fact, there is no particular advantage to be gained through crowding all or as many instruments as possible on the panel—a form of construction in which many "old-fashioned" set builders seem to take delight.

If a wooden baseboard is introduced into the set, it should be thoroughly shellacked, both for appear-

ance and for the electrical insulation of any wires or instruments that may touch it. A sub-base of dielectric material is, in the writer's opinion, the best thing to use, if a majority of the instruments going into the set can be placed under it. The sub-base protects the instruments from dust, short circuits and prying fingers alike, and presents a workmanlike appearance to any one who may inspect the set.

The principal deterrent of the more extensive use of sub-bases by the amateur is doubtless the problem of drilling the large holes in them through which the shells of the sockets must project. Several alternatives circumvent this difficulty, the first being to mount the sockets on top of the sub-base; another (which is preferable) is either to have these large holes drilled at a radio store, or to proceed according to the plan that was suggested for cutting slots for horizontal rheostat controls.

If the worker will examine a gang of sockets at any radio store, he will get the clearest conception of how to mount his own sockets in his sub-base.

Next month I will take up other phases of home set-building.

Editorially Speaking

(Continued From Page 4)

my reasons for that viewpoint, because he said that his customers constantly asked him about this supposed revolution that was coming and he did not know how to answer them. It seems to me that any one who will look over the history of recent scientific developments will see an excellent analogy with radio and it is be-

cause of this analogy that I say there will be no revolution.

Each one of the big modern industries has shown an early groping about, a few faltering infant steps, then one great upheaval which was the real revolution—and then after that only a long line of steady improvement and progress.

For many years, men tried to devise a carriage which could be propelled or drawn without the aid of horses. My own memory goes back to the very first of the so-called horseless carriages which were the granddaddies of our present automobiles. They were certainly weird and appalling looking contraptions in the light of modern development, but they were a step in advance. They had the old high wheels with solid tires and were driven by electricity or steam or a thumping one-lunged gasoline motor.

For some time, these attempts at locomotion were looked upon with awe and then came the revolution. As a matter of fact, the revolution in the automobile industry consisted in a number of things which happened virtually at the same time. The pneumatic tire, the modern transmission idea, the modern system of braking, the modern steering system and such things came almost at once. That was the revolution in the automobile.

That was many years ago, and since then, in spite of the fact that the minds of many thousands of scientists have been directed to the problem, there has been no other revolution in the automobile industry.

Since then it has been a story of steady progress and improvement.

The history of aeronautics tells the same story.

My own memory is even more vivid than it is with the automobile industry because I was personally associated with the first phases of the airplane and was the first man in

the country to make a profession of delivering popular lectures on the flying machine. I was Chairman of the first contest committee of the National Association of Aero Clubs in the days when the Wrights and Curtiss put out their first exhibition machines, and so the story of airplane development is quite familiar to me.

For over a century, after the invention of the balloon, man tried his best to fly with a heavier-than-air machine. He did not succeed. The balloon was improved and more and more was accomplished with it until the day when the Wright Brothers announced their first flight in a heavier-than-air machine.

Here, as in the automobile industry, many things happened at once.

At the same time the Wrights were performing their early miracles, Europe was developing the Bleriot, the Farman, the Demoiselle, the Antoinette and many others.

The successful development of the airplane, crude as it was at that time, marked the great revolution in aeronautics. Since then, there has been no revolution in aeronautics. The airplane has progressed and developed but it is still essentially the airplane of the Wright Brothers. As a matter of fact, it is essentially the airplane covered by the English Henson patent, dated, if my memory serves me right, about 1841.

We have the same story in radio. From the day when Hertz first proved in his laboratory that a signal could be sent without connecting wires, many men tried to commercialize the miracle. Marconi was the first to make it a commercial possibility and from that time it developed quite rapidly, but still it was crude and not nearly so efficient as it should have been.

I remember the old days of the coherer and de-coherer, the magnetic and electrolytic detectors, and the



Why You Should Choose Your Loud Speaker in Your Own Home

—Because here you have it operating on your own set. Here also you are away from the high power wires, generators and motors in the more central sections of the city. These are often responsible for crackling noises and harsh notes.

Often you will find that the loud speaker which appeals most in the store is a nightmare of sound in your own home, and similarly, the loud speaker which is not quite so good in the store is liable to have a perfectly beautiful tone at home.

So by all means, before you buy any loud speaker, hear several types and kinds at home. In asking your dealer to send home these several loud speakers, tell him to include both A and N (adjustable and non-adjustable) types of Timmons Talkers, the cabinet type loud speakers. These are priced at \$35 and \$25. We would like you to hear both these loud speakers in comparison with any other makes which you might select, or your dealer recommends.

"Volume Without Noise," the Timmons Talker folder, will gladly be sent if your dealer does not have a copy.

TIMMONS TALKER, Inc.
339 E. Tulpehocken St.
Germantown, Phila., Pa.

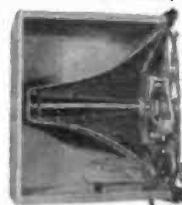

Timmons Talkers

CABINET TYPE LOUD SPEAKERS

RADIO FREQUENCY AMPLIFICATION with the BALLANTINE VARIOTRANSFORMER

The final "punch" for the "Knock-Out" Series of Reflex Sets

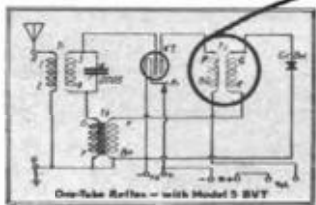
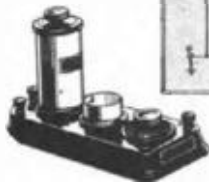

Model 5 BALLANTINE VARIOTRANSFORMER With bakelite base or split metal collar for panel mount. Complete, ready to use. Price... \$9.90



This instrument simplifies construction and operation

SINCE its first appearance in RADIO BROADCAST for November, the One-Tube Reflex Circuit has fully lived up to its promise in distance, volume and quality. And the fans, in their letters, heartily endorse the term "Knock-Out" as applied to the results obtained.

Fewer parts—greater results
The above diagram is a refinement of the original in that the condenser-and-coils of the radio frequency element are replaced

with the tunable BALLANTINE VARIOTRANSFORMER. This makes tuning easier and prevents oscillation due to changing the crystal detector. Furthermore, on weak signals especially there is a marked increase in volume.

The words of unbiased experts in the January "R-B Lab." Section, the sponsors of the original circuit say of the BALLANTINE improvement: "Reception generally superior to that achieved by the set described in November."

BOONTON RUBBER MFG. CO.
Pioneers in Bakelite Moulding

724 Fanny Road, Boonton, N. J.

RADIO FREQUENCY AMPLIFICATION with the BALLANTINE VARIOTRANSFORMER



WATCH FOR ANNOUNCEMENT IN JULY



Just as the first Neutrodyne eclipsed all other circuits so the New Workrite Super Neutrodyne will eclipse all predecessors.



DEALERS: send your name so that you will receive bulletin announcing the new Workrite Neutrodyne.

THE WORKRITE MFG. CO
1841 E. 30th St., Cleveland, Ohio
Branch Office: 638 Lake Shore Drive, Chicago

later day when we amateurs used to walk around the streets with our pockets full of many different kinds of crystal detectors—silicon and perikon, zincite-bornite, galena and carborundum—when we used to meet on street corners and take out our specimens and talk about them and argue about them and swap them, and that was as far as it seemed possible for the art of radio reception to go.

All commercial stations were equipped with some sort of crystal detector and the wireless experts, feeling that this was the ultimate in reception, paid most of their attention to increasing the power of transmitting stations so as to increase the range. It did not occur to most of us at that time that it was possible so to increase the sensitivity of the receiver that the range would be increased, using the same or even less sending power.

Then came the great revolution of radio in the invention of the audion bulb.

From that time on it has been a story of progress and development. I do not look for any other revolution in radio because no other industry of like character has shown a revolution within two generations. Neither will radio.

The man who has a perfectly satisfactory receiver or even a moderately satisfactory receiver today will find it just as satisfactory next year. In fact I believe he will find it more satisfactory.

I am quite convinced that, as we have reached a temporary point of more or less marking time in the development of receiving sets, the immediate future will give us a better division of transmitting wave lengths. To increase the selectivity of the present receivers is going to cost us something in the quality of reproduction which we will get. It is absolutely essential for really good reception to have a fairly wide band of waves available on each side of the actual received signals and when you confine this band too much you are likely to get distortion. That is the great trouble with the quality produced by the super-heterodyne receiver.

In my estimation, the very greatest advance shown by the sets already in sight for the next season is the elimination of radiation. This radiation evil has become so great that it is at present a menace to the entire future of radio.

Personally I want only two things for the immediate future.

One of these is the entire elimination of radiating receiving sets and the other is a limiting of the number of broadcasting stations so that they can be spread farther apart in wave lengths in such a way that the average good receiver of today will have no difficulty whatever in separating the stations.

This in my estimation will be more valuable and is much more practical than any revolution in the receiving sets.

I have tried a great many of the sets which are ready for the market next season. They are very fine pieces of work.

Summarized, my advice is just about this:—

If your receiver which you have today is quite satisfactory to you, I should not be worried about the sets that are coming out next year. If you can sell your present receiver at anything like a reasonable figure, then it would be wise to do so and invest in one of the new sets. If you cannot, I certainly would not junk the whole outfit and go to the expense of a brand new one because you will not find the improvement worth the very great cost involved in such a process.

If you have no receiving set at all, but are waiting for the "revolution,"

I would forget all about that revolution and would look over the market for next season and pick out any one of the very fine receivers which are to be placed on sale then and which are even now finding their way into the market.

I certainly would not wait any longer to get a receiving set if I had not one at the present time. Radio as it stands today is worth every cent that it costs and ten times more—and there isn't going to be any revolution.

Why WJAZ Became WGN

THE recent change by which station WJAZ in Chicago became WGN still seems to puzzle a great many listeners-in. In order to clear up this matter I am reprinting here a part of the address given by E. F. McDonald, Jr., president of the Zenith Radio Corporation, on the evening of March 29th when the change was announced.

On that date, the Chicago Tribune assumed control of the policies and programs of station WJAZ, and when its call letters were changed to WGN, its wave length was changed from 448 meters to 370 meters.

Incidentally I understand that the new arrangement is not working altogether satisfactorily and it may be, before this article is printed, that there will be still another shift in the Chicago stations, involving WDAP and making a totally new alignment.

The part of Mr. McDonald's address which dealt with the change is printed here. H. M. N.

TO THE audience of WJAZ, now WGN, I extend sincerest greetings.

One of the first acts of the Chicago Tribune when it assumed control of the policy of this broadcasting station was to ask me to address you as the first speaker on its inaugural program. I consider it an honor and a pleasure to talk with, not to, the great audience built up by WJAZ, which now automatically becomes the audience of WGN, our new call letters.

Here is a frank confession. While the announcement of the Chicago Tribune's association with this station may have come to you as a surprise last night and this morning, I have worked for one solid year to bring about this combination. I always believed that every successful broadcasting station should be associated with, and if you please under the direct control of a large conservative, metropolitan newspaper, who with its highly skilled, highly paid, mature corps of editors we believe is best qualified through years of experience to know what the public desires most. These editors have for years been feeling the public pulse, not only from the standpoint of news, but entertainment. I point to the theatrical and music critics of the newspapers with whose judgment we may not oftentimes agree, still it is respected.

We have long believed that radio is fast becoming a mold of public opinion, and we know of no one better qualified to assume this responsibility than the Chicago Tribune. While the policies of the various newspapers throughout the country do not agree, still they, the newspapers, have very successfully carried us through many years of prosperity.

It is obvious that the Chicago Tribune through its hundreds of channels of information is better able to determine just what the public desires and to provide a means of fulfilling those desires than any individual or commercial organization. A newspaper is more nearly impersonal in

(Continued on Page 41)



Above is the front view of the little "Midget" in its card index box, while to the left is Roy B. Bachman, of Gratersford, Pa., who built the set

Here's a Midget That Really Works

SHORTLY after the publication of the issue of this magazine in which we showed a number of portable sets, a friend of mine walked into my office and deposited on my desk an ordinary index cardcase such as you will find on the desk of so many men in business. When I raised the lid I found that it contained a complete one-tube radio outfit.

I took this outfit out to Station 3XP and put it under test because I thought frankly that it was nothing but a toy. The results have surprised me and I am offering it here as another suggestion for the solution of the problem of the traveling man who wants to take a small but efficient outfit around packed away comfortably in his grip. The outfit was built by an eleven-year-old boy and when I got in touch with him and asked him to write about it, he sent me the article which I am printing, but I am first publishing a letter from his father.

H. M. N.

My Dear Mr. Neely:

Inclosed you will find a letter and drawings made by my son Roy, of his small tube set, which he requested me to mail to you.

Radio reception is a hobby of mine and I have been experimenting for about two years. The little chap has been my constant companion and has shown a very remarkable aptitude in this very interesting art.

With his assistance, we have built thirty-nine complete receivers, all of which we were able to use with various degrees of success.

We have still sixteen complete receivers which were selected out of the lot as being extra good and worthy of a permanent place in our collection.

Roy and I have heard nearly three hundred stations to date. We do not log a station as really received unless

we can distinctly hear and understand at least two selections or a whole address together with the call letters and location.

Last December, during the London tests, we succeeded in tuning in 2LO on two occasions. Heard Mr. Marconi speak and a musical program. Had them for twenty minutes on Sunday night and nearly an hour on the following Tuesday night.

The midget set which you have is the result of Roy's determination and perseverance to accomplish what I declared was impossible. He was handicapped in every way for lack of space and to see just what he would do I kept telling him it was impossible and refused to help him.

His challenge to me was a wager of \$5 he would not only get it in that box, but would hear plainly stations

The New CLEAR-O-DYNE MODEL 70 A PROVEN PRODUCT

4 Tube
\$75

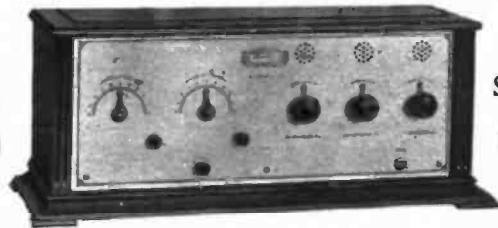

Selective
—
Logable

The new GOLDCREST Clear-O-Dyne model 70 is a receiver designed to fill a long felt want for a loud speaker receiver of the Neutrodyne type, that is selective, very easy to operate and a receiver that will log accurately.

The features of selectivity, logability, long range reception with loud speaker volume and extremely simple tuning have all been combined in the new model 70, which has been heartily approved by all of those now using the model 70.

The beautiful etched gold finished panels and the distinctive solid mahogany cabinets combine to give a receiving set which is a real source of education and a great pleasure for the entire family.

All Cleartone receivers are guaranteed in every way. We will be very glad to send you illustrated circulars on all of the beautiful Cleartone cabinet models. Our beautiful console cabinet models are considered the best values available.

DEALERS and JOBBERS: If you have not seen or heard Cleartone sets in operation, send to us for samples and complete detailed information on our interesting proposition:

Model 60.....\$60.00	Model 71.....\$90.00
Model 61..... 75.00	Model 72.....135.00
Model 62.....120.00	Model 80.....120.00
Model 70..... 75.00	Model 82.....190.00

THE CLEAR-TONE RADIO COMPANY, Cincinnati, O.

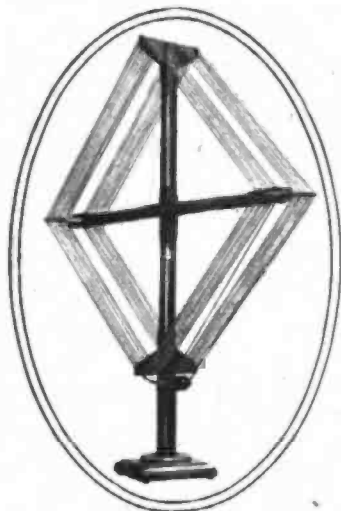

LIST PRICE
\$10.00

A Super-Heterodyne
is no better
than its

LOOP AERIAL

Anyone can build a loop. But it takes the most careful figuring by scientists and the most careful construction by experts to build a loop that will gather and lead into your set that barely discernible, faint impulse that means another DX station.

The CALVERT LOOP

was figured by scientists and built by experts. It is the ultimate word in efficient loop reception. Wave length range, 190 to 600 meters using **\$10.00** .0005 mf. variable condenser.

CALVERT SPECIALTY CO., Inc.
1312 Callowhill St. Philadelphia

P. W. AIRKORE SUPER EIGHT

A Real Super Heterodyne

Complete Parts
\$85.00

Identically the same
as tested by
Henry M. Neely

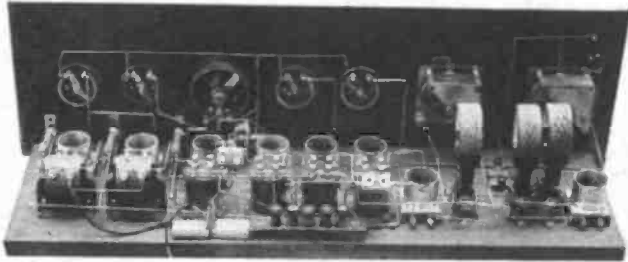

CUT SHOWING ASSEMBLY AND WIRING OF P. W. AIRKORE SUPER

Operates from a loop, either indoor or outdoor type and will give loud speaker volume on DX stations regardless of local interference.

Our Transformer is the heart of the Super Eight Airkore, absolutely prevents distortion and results in sharp tuning. Set of four transformers, including panel layout, base board layout and circuit diagram..... **\$25.00**

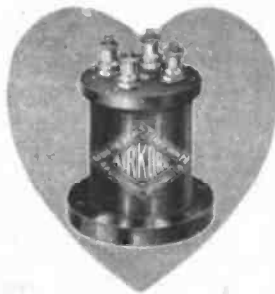

Complete package of parts, including everything necessary to build your Super Eight identically as illustrated by Mr. Neely. Drilled engraved panel, base board and all parts ready to put together, even including the solder.. **\$85.00**

Philadelphia Wireless Sales Corp.

133 N. 11th Street, Philadelphia, Pa.

Formerly 1533 Pine St., Philadelphia



The New CARTER VERNIER CONTROL RHEOSTAT

Eight exclusive Carter Features

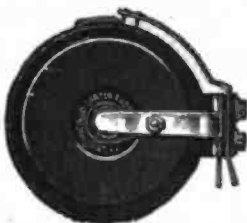

- Only Rheostat with Pigtail Connection. Slight click indicates positive "off" position.
- Heavy phosphor-bronze contact spring.
- Positive Vernier control from "on" to "off."
- Extra large tapered Knob and Pointer one.
- Heavy brass bearings—long life—no wobble.
- Wide spaced solder terminals for connections.
- Only one hole to drill in panel, mounts like jack.

6 ohms—\$1.50
20 ohms—1.75
30 ohms—1.75

Carter Radio Co.
1812 REPUBLIC BUILDING
CHICAGO

Any Dealer
Can
Supply

up to 1000 miles. Needless to say, he won, and with plenty to spare.
His greatest trial was to get a rheostat in and I kept teasing him on his inability to complete it and after about a week of thought on his part he conceived the idea of the switch lever and the resistance unit.
Roy is eleven years of age and made the receiver, drawings and all without any assistance whatever.
With thanks from both of us for

First of all, let it be understood that I was not born with a knife-switch in my mouth, in place of the proverbial silver spoon, nor did I, at the tender age of six months, prattle gurglingly of capacities in microfarads and the polarity of grid potentials. On the contrary, my interest in the gentle (?) art of radio reception dates from the spring of 1922 when my father brought home for the proposed edification and delectation of

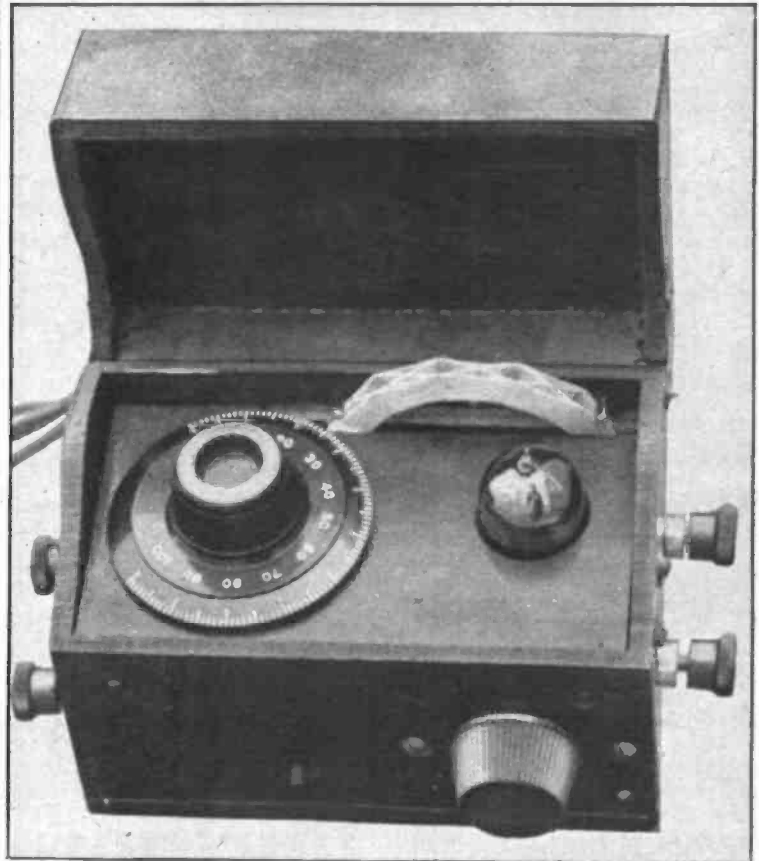

Looking down on the little "Midget" we see how Master Bachman arranged the control dials, tube and inductance coil

your recognition of the boy's efforts. I beg to remain,
Yours very truly,
M. W. BACHMAN, D. D. S.,
1901 Chestnut street, Philadelphia.

the family, a novel little crystal receiver, ensconced snugly in a small filing cabinet (dimensions over all 5 1/4"x4"x3"). When, however, after calling down all manner of malediction upon the inventor of radio (whoever he might be), the sum total of our efforts was the alleged reception through the medium of a bed spring, of a brief and fragmentary rendition of "Old Black Joe," the crystal was relegated to the attic (so to speak) and treacherously supplanted by a relatively imposing one-tube set, which was somewhat more successful, despite the fact that one might hear simultaneously, a lecture on civic welfare, a dance orchestra and a soprano solo or any number of possible combinations. At that time

The Story of the Midget Set

Gratersford, Pa.
My Dear Mr. Neely:
In reply to the letter you sent me I will accept the offer gladly. As you see I have inclosed the diagram and the different views of the set inside. I have also inclosed one of my pictures if it will help any.
I have written a history of the set and hope that you have all the necessary information. The following is the history of "Midget."

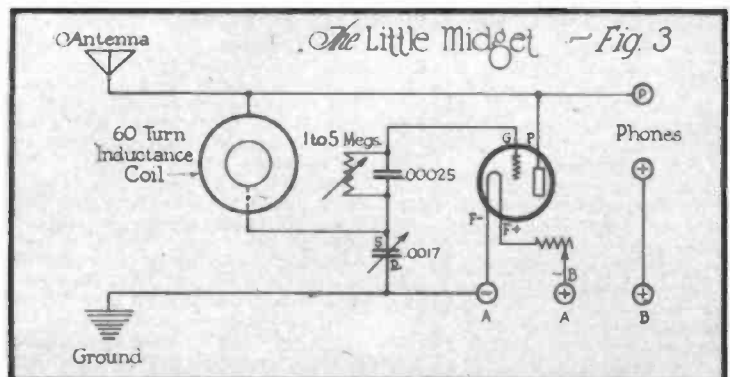

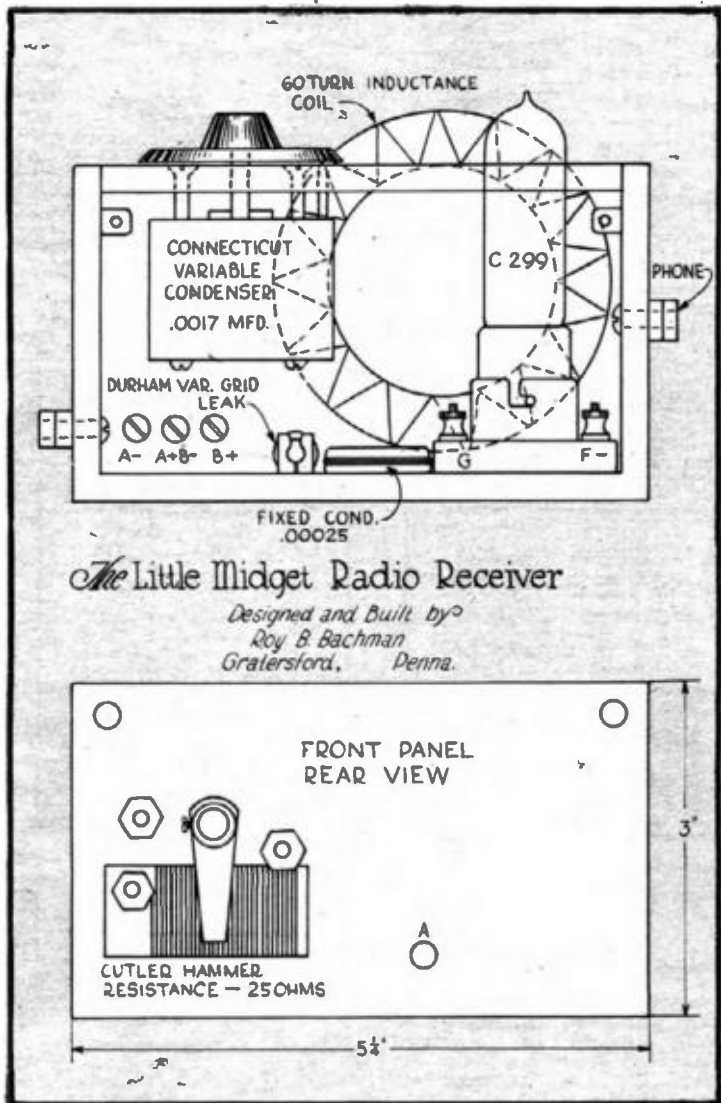

The top drawing shows the set with the front panel removed, showing the construction and arrangement of the parts. The bottom drawing is of the front panel reversed showing the rheostat panel. "A" is the hole for the Durham grid Leak

anything beyond Philadelphia was considered DX and greeted with frantic summons to the rest of the family along with frenzied doffing and donning of head phones.

Finally, after much experimenting and attendant disappointments, we attained the envied exalted, magnificent and Utopian ownership of an "honest to goodness" three-tube regenerative, two-stage amplifier set, operating with a super-abundance of assorted squeals, back-fires, etc.; a home-made loud speaker, to the annoyance of our immediate neighbors, and the envy of every self-respecting tom-cat in the vicinity.

However, we slowly recuperated from our first impressions concerning the infallibility of magazine diagrams and the recurrent rumors of mythical one-tube loud speaker sets and the like and when at last we redirected the filing case hoax, I suggested the possibility of a miniature vacuum tube set constructed therein. This proposal was greeted with derision and badinage by my relatives which, as usual, merely strengthened my belief in my ability to "get away with it." At once, I proceeded to ransack the closet in which our spare parts were kept to the detriment of the neat orderly appearance thereof. Out of the clouds of battle and a chaos of disrupted apparatus, I emerged, the triumphant possessor of the following items:

- 1 variable condenser (Connecticut)
- 1 Durham variable grid leak
- 1 fixed condenser

- 1 damaged finger
- 1 60-turn Pfanstiehl inductance coil.

1 small socket (for 299 tube)
 I then manipulated some bell wire, pliers, drills and gray matter impartially with the result that I mounted the entire collection on two bakelite panels, one fitting in the front of the cabinet and the other on top just beneath the lid. Utilizing a modified Gibbons circuit I placed the variable grid leak (a Durham which I found indispensable for tuning) in such a way that it could be varied through an opening in the front panel. Besides this I desired to place a rheostat, but was unable to find one small enough. Believing that where there is a will there is a way, I found a 25-ohm Cutler-Hammer resistance unit and mounting this together with a knob and a reversed switch arm (see diagram number 2) had a compact and practical rheostat for the Cunningham 299 tube or UV199 tube.

On the top panel I mounted the variable condenser, and drilled the opening for the tube. In addition at the back of the panel I removed a rectangular section through which the top of the inductance coil projected. Binding posts for antenna (antenna preferably about 75 feet long) and ground were on one end of the box and those for phones on the other and three others for battery connections at the back.

When completed a little to my surprise, I admit it worked, and after
 (Continued on Page 41)



Performance plus Beauty

Choose your panel for its insulating value as well as for its appearance.

MAHOGANITE Radion Panels

give you both the supreme insulation and the beauty of polished mahogany. For Mahoganite is not a surface finish but an insulating material which extends from one side of the panel to the other.

RADION

The Supreme Insulation

PANELS



Look for this stamp on every genuine RADION Panel. Beware of substitutes and imitations.

21 Stock Sizes

Mahoganite and Black

6 x 7	7 x 14	8 x 26
6 x 10 1/2	7 x 18	9 x 14
6 x 14	7 x 21	10 x 12
6 x 21	7 x 24	12 x 14
7 x 9	7 x 26	12 x 21
7 x 10	7 x 30	14 x 18
7 x 12	7 x 48	20 x 24

At all good Radio Shops everywhere or write to

AMERICAN HARD RUBBER CO., 11 Mercer St., N. Y.

We repair the following RADIO TUBES and Guarantee Them

WD-11	\$2.50	DV-4	\$2.50	UV-301A	\$2.50
WD-12	2.50	DV-1	2.50	C-301A	2.50
UV-300	2.50	DV-3	2.50	Marconi	2.50
UV-301	2.50	DV-4A	2.50	Neoroad	2.50
C-300	2.50	UV-199	2.50	6 v. Plain Amp.	2.50
C-301	2.50	C-300	2.50	6 v. Plain Det.	2.50



Mail Orders solicited and promptly attended to. Dealers and Agents write for Special Discount.

H. & H. RADIO CO.

P. O. BOX 22-K
 CLINTON HILL STA. NEWARK, N. J.



Duplex pairs tested for balance \$12
 Audio Frequency...\$6.00
 Radio Frequency...\$6.00

Summer entertaining needs RUBICON Push-Pull System

Music for dancing or to entertain outdoors when the set is inside, needs some form of power amplification. Louger daylight with weaker signals received is another reason. And for the extra building-up of these signals, the RUBICON System of Push-Pull or Duplex Transformers have won merit based on faithful reproduction. Like RUBICON Audio and Radio Frequency Transformers, RUBICON Duplex are guaranteed without reservation. From your dealer or postpaid.

THE RUBICON COMPANY

Send for folder
 918 Victory Building Philadelphia

E. M. Clarke bringing in the country's best programs on a SUPER-HETERODYNE that he built.



Your Summer Radio

Super-Heterodyne

It is our opinion that this wonderful circuit will completely displace all others in the multi-tube field next fall. Do not let the summer interfere with your experiments. We have the parts for two REAL Supers.

The Famous "M & H" 8-Tube SUPER-HETERODYNE

Complete List of Parts for Receiver..... **\$95**
 Complete With Tubes, Batteries, Loop, Speaker, etc. **\$175**

"PW" AIRCORE SUPER-8

Complete "P. W." Super Kit— which includes drilled and engraved panel, base board, wire and all parts..... **\$85**

"P. W." Air Core H. F. transformers and the Input Coll..... **\$25**

Read what Neely says about the following, in this issue— then decide.

GRIMES "SNP" INVERSE DUPLEX... **\$47.50**

Grimes is one of the "Greats" in Radio. When he brings out a new one, it's good. Give this set extra consideration; it's the best he has done yet. Price includes complete kit.

GOODREAU LOOP CIRCUIT

Here's another little cracker-jack that outperforms its promises. It's the leader in its class. **\$33**
 Complete parts cost but

HARKNESS New Reflex Circuits

Everyone admits Harkness is an authority on Reflex. You who favor reflexing will certainly enthuse over these latest hook-ups. We supply those parts which he calls "Best."

1 Tube Set..... **\$25.00**
 2 Tube Set..... **\$35.00**

500 "Fans" bought plans for The "CLARCO"

circuit last month. Simple, cheap, selective and has excellent tone.

Blue print and full description for 50c

CLARKE & CO.

W. J. J. MANNING
 E. M. CLARKE

RADIO APPARATUS

Mail Order Dept., Room 316
 1520 Chestnut St.
 Philadelphia, Pa.

Harkness Tells About His Reflex

Continued from Page 11)

of the tap on T1 is to make the unit adaptable for different sizes of aerials. A long aerial needs only ten primary turns, whereas a short aerial may use 20 turns.

In each case, the secondary is wound on the formica tube itself, and the primary wound on top of the secondary, although separated from it by a strip of heavy insulating paper or Empire cloth.

The variable condenser of the Flexoformer has a maximum capacity of .00032 mfd. and a minimum of .00001 mfd. Its resistance (at radio frequency) is only 4-10ths of an ohm, and its "phase angle difference" is

can be completely eliminated by connecting the movable plates to the grounded filament side of the circuit. The movable plates are electrically joined to the brass framework which shields the stationary plates from the capacity of the hand.

The audio frequency transformer designed for this circuit is visible in the photographs. The ratio of this instrument is 4 1/2 to 1, which is much more suitable for a reflex receiver than a high ratio. No fixed condensers are required when this transformer is used, as the capacities of the coil winding are the correct values to bypass the radio frequency currents.

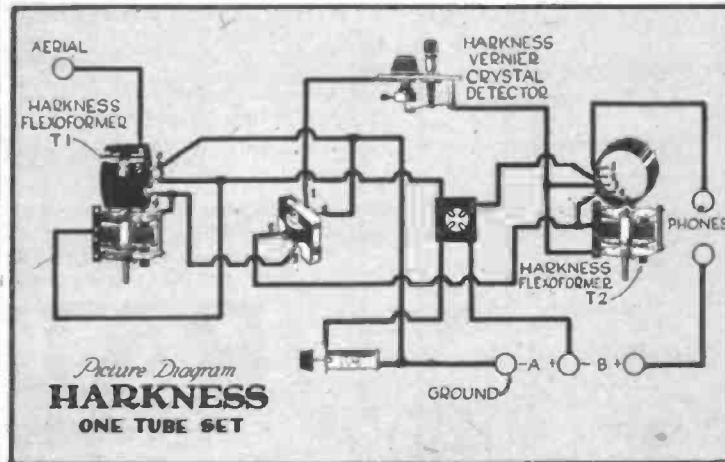

less than 2 minutes. The plates of the condenser are die-cast so that the stator is one solid piece and the rotor another solid piece. The rotor is connected to the brass framework by a clockspring pigtail. It is this method of construction which is responsible for the low resistance of this condenser. Dielectric losses are also greatly reduced by insulating the stator casting with two small pieces of insulation.

When using this condenser in any radio circuit, body capacity effects

Binding-post terminals are purposely omitted from this transformer to minimize capacity and resistance losses. Much shorter and more efficient connections can be made with the flexible leads of the transformer coil itself.

How to Build the 2-Tube Harkness Reflex

For all-round service it is advisable to use a stage of audio frequency amplification in addition to the fundamental 1-tube reflex circuit. Distant

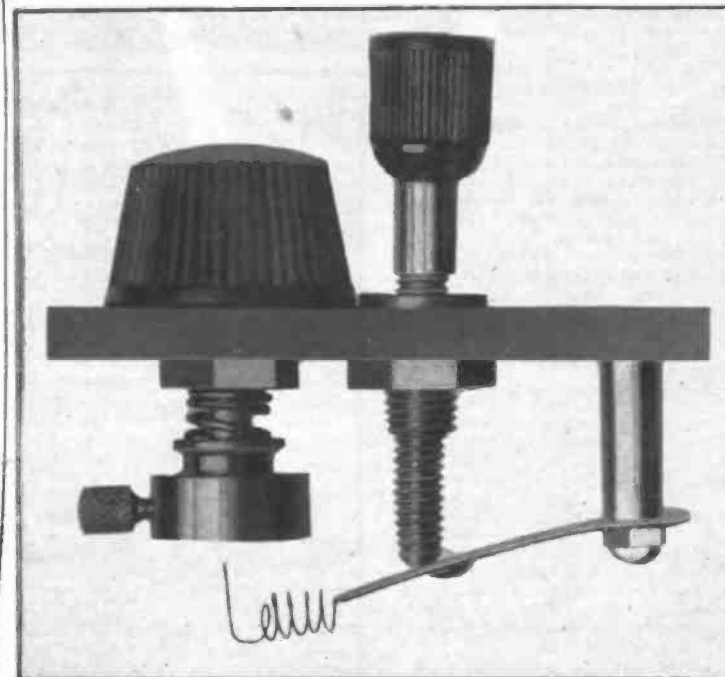
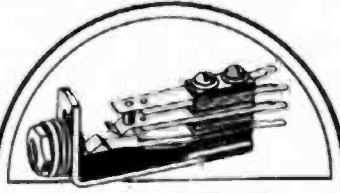

Fig. 3—A view of the crystal detector, which is very simple in construction, yet remarkably effective. The large knob turns the crystal itself, while the smaller knob adjusts the tension of the catwhisker



Pacent Jack No. 70

Look to Your Jacks!

When soldering jacks, use only resin. Most soldering flux, running away from the hot iron and into the jack insulation, will cause a leakage, even in a new jack. Leaky jacks cause "frying" noises.

Pacent Jacks, carefully soldered, are noiseless. Look for them in the set you buy. Use them when you build your own. There are ten types from which to choose.

AT ALL GOOD RADIO SHOPS

Pacent Electric Co., Inc.
 22 Park Place, New York, N.Y.
 Philadelphia Sales Office
 221 North 11th Street

Pacent RADIO ESSENTIALS

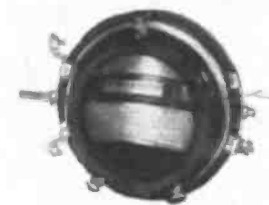

Amplify with

LANGBEIN & KAUFMAN TUNED RADIO FREQUENCY VARIOTRANSFORMERS

TYPE VT25 LIST \$8.50

Connected same as a fixed radio-frequency transformer, but continuously adjustable to the peak of the wave.

MAXIMUM AMPLIFICATION AT ALL WAVE LENGTHS

The Home of Molded Tuner Specialties

LANGBEIN & KAUFMAN
 654 Grand Avenue
 NEW HAVEN CONN.

KENNEDY PORTABLE RADIO RECEIVER



Model III

A handsome set for auto trips, camps, summer cottages or any room in any home at any time of year.

A first class regenerative receiver that can be picked up and taken along anywhere. Completely self-contained — batteries and all. Operates on any aerial — or even with a wire fence for an antenna. Stations are always found at the same dial setting—wherever you are and regardless of the kind of aerial used.

Licensed under Armstrong Patent No. 1, 113, 149

Write for special circular

The Colin B. Kennedy Company
Saint Louis, Missouri

RATHBUN SINGLE-HOLE MOUNTING SUPERIOR CONDENSERS

A RATHBUN condenser never "Shorts." Plates cannot under any circumstances touch each other. First, the stator plates are anchored into the micrometer spaced slots of tubes, and die-cast so that they are practically ONE SOLID PIECE. Stator plates are freed of any tension strain by single hole mounting and long brass bearings. The plates are further protected by full circle Bakelite discs. On sale at all good dealers.

Write for literature

LIST PRICES

11 Plate.....	.00025	\$3.00
23 ".....	.0008	3.50
5 ".....	.000125	3.00
43 ".....	.001	4.50
3 ".....	.000075	1.00
15 ".....	.0003	3.00

RATHBUN MFG. CO., Inc.
Jamestown, N. Y.

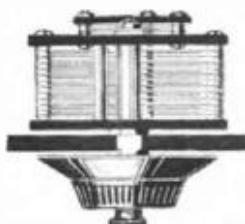

stations can then be received more consistently and with far greater audibility. In conclusion, therefore, I will explain how a 2-tube receiver of this type can be built.

List of Parts: The following parts are required to build a 2-tube Harkness Reflex:

- 1 Pair of Harkness Flexoformers (T1 and T2)
- 1 Front Panel (7"x12")
- 1 Shelf Panel (2x7 1/2")
- 2 Tube Sockets
- 2 Harkness Audio Frequency Transformers
- 1 Crystal Detector
- 1 Rheostat
- 1 Single Circuit Filament Control Jack
- 4 Binding Posts
- 2 Dials (4" in diameter)

Mounting brackets, wire and insulating tubing.

One of the accompanying photographs shows a crystal detector designed by one of the Radio Guild engineers which is particularly adaptable for the circuit. As can be seen, this detector is very simple, yet it is remarkably effective. The upper knob turns the crystal itself, while the lower knob adjusts the tension on the catwhisker. I show this photograph as I believe some constructors experience trouble in finding a stable crystal detector to use in their re-

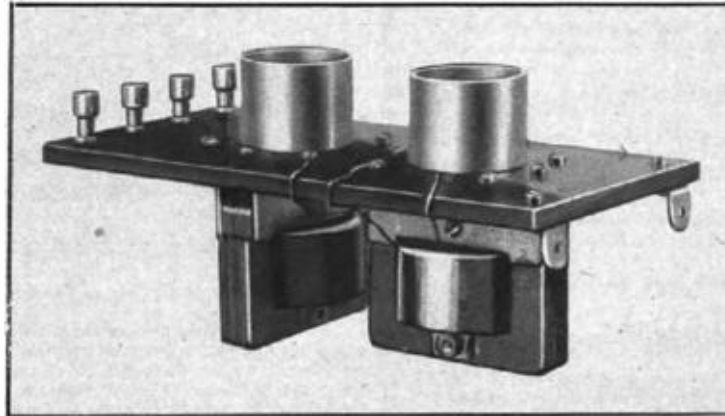

Fig. 7—The two audio frequency transformers, tube sockets, binding posts and mounting brackets should be attached in the manner shown in the above photograph

ceivers. An arrangement such as that shown is very stable, easy to adjust and much more satisfactory than a fixed crystal, which is rarely sensitive.

Assembly: The photographs illustrate the progressive steps in assembling the receiver. The Flexoformers, crystal detector, telephone jack and rheostat should first be mounted on the front panel in the positions indicated. In the photograph (Fig. 6) Flexoformer T2 appears on the left and T1 on the right. The distance between the center shafts of the condensers is 6 inches.

The two audio frequency transformers, tube sockets, binding posts and mounting brackets should then be attached to the rear panel as shown in Fig. 7. The tube sockets of the panel illustrated in this photograph are already wedged into two large holes in the panel itself, the contacts being fastened underneath. If individual sockets are used they may be mounted on top of the shelf panel.

Note the manner in which the audio frequency transformers are mounted. The housings of these transformers are formed so that, with only two screws in each case, they may be mounted directly underneath the tube sockets, thereby permitting unusually short and direct connection to the tube socket terminals.

The completely assembled sub-panel is attached to the front panel by means of screws passing through

the front panel and tightening into the threaded mounting brackets. The holes should be drilled in the front panel so that the audio frequency transformers rest squarely on the surface of the table or cabinet, holding the completed receiver in an upright position, as shown in Fig. 8.

Wiring: The diagrams of Fig. 4 and 5 show how to wire the receiver. Fig. 4 is an ordinary schematic diagram, while Fig. 5 pictures the actual apparatus and the actual connections to be made.

Use soft-drawn copper wire covered with insulating tubing. The terminals of the Flexoformers and audio frequency transformers are numbered and connections must be made to these numbered terminals exactly as indicated in Figs. 4 and 5. Note particularly that terminal No. 3 of Flexoformer T1 is connected to the stationary plates of the variable condenser. Note, also, that the wiring diagrams show only three battery binding posts whereas there are four posts mounted on the shelf panel. The fourth is intended for the antenna and one end of a flexible wire should be connected to this post so that the other end may be inserted in either of the two primary clips on Flexoformer T1.

Of the three remaining posts on the shelf panel, one is used for the posi-

Henry M. Neely
recommends this
RADIO HANDBOOK
only



\$1
\$14 page
Pocket
Size
40,000
SOLD

"The I.C.S. Radio Handbook is the best book of its kind I have ever seen. I use it constantly and I believe that every radio fan should have a copy."

HENRY M. NEELY
Editor, "Radio In The Home"

THIS I. C. S. Radio Handbook is without question the greatest book of its kind ever written. Filled with sound, practical, tested information for every radio fan, from beginner to veteran hard-boiled owl.

Compiled by Harry F. Dart, E. E., formerly with the Western Electric Company, and U. S. Army Instructor of Radio. Technically edited by F. H. Doane.

514 pages. Will save you many times the small cost of one dollar and enable you to get more pleasure out of Radio.

Send \$1 to-day and get this \$14. page I.C.S. Radio Handbook before you spend another cent on parts. Money back if not satisfied.

TEAR OUT HERE

INTERNATIONAL CORRESPONDENCE SCHOOL
Box 8259-B, Scranton, Penna.

I enclose (two dollars). Please send me—post-paid—the 514-page I. C. S. Radio Handbook. It is understood that if I am not entirely satisfied I may return this book within 30 days and you will refund my money.

Name _____
Address _____

For That Summer Portable You Want
Efficiency and Compactness

Therefore use the New

Pfanstiehl
VARIOMETERS
and
VARIOCOUPERS

Pat. Pending

Pfanstiehl Variometer, P-301.....\$4.75
Pfanstiehl Variocoupler, P-300..... 5.00
PFANSTIEHL RADIO SERVICE CO.
Highland Park, Ill.
Chicago:1001 W. Washington St., Haymkt. 0010

JEFFERSONS Chosen!

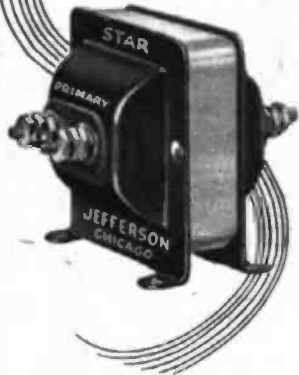

EVERYWHERE leading radio authorities are choosing Genuine JEFFERSON Audio and Radio-Frequency Transformers in making up their circuits.

They know that:

- (1) Genuine JEFFERSONS are the culmination of over twenty years of experience in the manufacture of transformers.
- (2) Genuine JEFFERSONS reproduce the voice and instrument perfectly.
- (3) Genuine JEFFERSONS give clear and even amplification over the entire musical range.
- (4) Genuine JEFFERSONS allow for full amplification without distortion.
- (5) Every Genuine JEFFERSON must successfully pass a series of exacting electrical and mechanical tests before being shipped.
- (6) Every Genuine JEFFERSON must meet matched construction specifications.

Make Your Set a Musical Instrument

Don't blame the broadcasting station if your reception has not the right quality. Make sure of your Transformers. JEFFERSON Transformers have been designed to correct the faults of other Transformers.

Try a JEFFERSON
Your Dealer Has Them

JEFFERSON ELECTRIC MANUFACTURING CO.
432 So. Green St., Chicago, Illinois

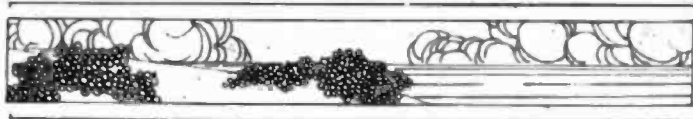

VACATION NEEDS Sterling Quality Accuracy Reliability Results

Whether You Stay at Home or Go Vacationing this Summer You'll Need

Sterling
RADIO EQUIPMENT for your Radio Set

These Devices Make Summer Radio a Success

- | | |
|--|---------------------------------|
| Sterling Pocket Meters | Sterling Portable Rectifiers |
| Sterling Micro Condensers | Sterling Transformers |
| Sterling Panel Meters | Sterling 12-Point Rotary Switch |
| Sterling "B" Battery Charging Attachment | |

THE STERLING MANUFACTURING CO.
2831-53 Prospect Ave., Dept. J. Cleveland, Ohio

The New Grimes-3XP Inverse Duplex Circuit

(Continued From Page 15)

patience is one of the prime requisites of the true experimenter. This is really a very simple circuit and ought to give you very good results the first time you try it, but you must remember what we have already said in the beginning—that this is the first experimental form of this Grimes-3XP

neighbors. We have tried experiments at station 3XP, setting this set to howling as loudly as possible, and H. M. N., in his house only about 100 feet away, was unable to pick up these howls on a nine-tube super-heterodyne set. From this you can easily under-

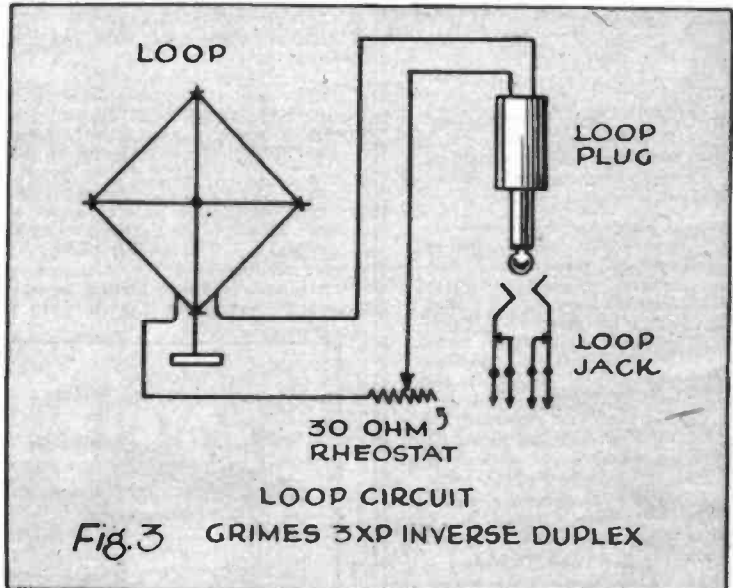

circuit, and it is by no means perfected.

You will find that these three tubes give an unusual amount of volume on stations within 25 miles or so, and the set is likely to howl once in a while. You may think that this howl is oscillation, but it is not; it is merely

stand that the howls do not radiate at all. If they did, surely a nine-tube set within a hundred feet would have detected it.

This one feature alone is something which will be a great recommendation for this circuit because there is no question but that this radiation of

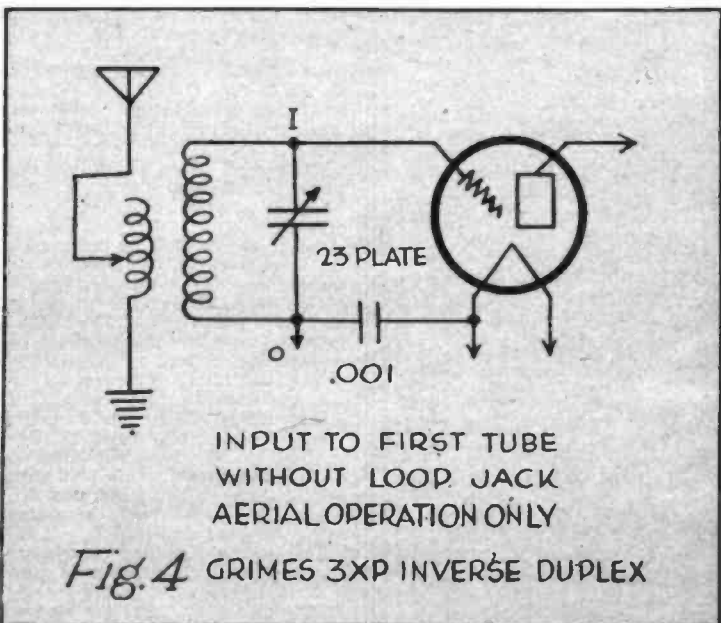

that the set is feeding so much power into the tubes that they are overloading and cannot handle it.

There is one very great advantage of a set using this circuit and that is that no matter how much it may howl due to overloading or anything else, this noise is not radiated by the set, and so you will not be annoying your

badly constructed or badly handled receiving sets is doing more harm to radio than any other one thing.

And so, H. M. N. and I want you all to get busy on this circuit and join us in our experiments on it.

Do not attempt to put it in a cabinet. Do it in the regular experimenter's way. Fix up a good flat

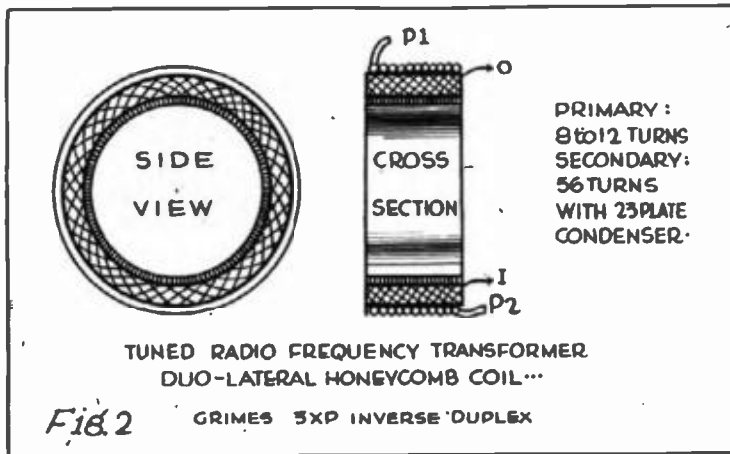

board about twelve inches deep by eighteen inches wide, mount all of your instruments as far apart as you can and in the same general layout shown in these photographs, and then go ahead wiring up and unwiring and inserting various things and taking them out again and so help us see what we can do with this circuit.

We want this circuit to belong to the readers of *Radio in the Home*. It was developed for them and we hope it will be developed by them.

Here's a Midget That Really Works

(Continued From Page 37)

one or two trials I found that stations such as WAAD, WJAR, WJAX, WOC, WCBD, and many others might be obtained consistently on regular dial settings with clarity and remarkable volume. At one time, under favorable conditions, WBZ, Springfield, Mass., was audible, without additional amplification, on a Dicto-Grand loud speaker for a distance of about 6 feet without straining your ears to get it.

At present I have in course of construction a companion unit containing two stages of audio-frequency amplification using "Hedgehog" transformers, with a single filament control. When completed these two units will be the equivalent of any two-stage audio frequency amplification receiving set.

As you said you would like me to tell you about what I have been able to do with the set, I inclose a list of most of the stations I have heard.

WOO, WIP, WFI, WDAR, WCAU, WWA D, Philadelphia; K DKA, WCAE, Pittsburgh, Pa.; WAAD, Cincinnati, Ohio; WDAP, Chicago, Ill.; WGI, Medford Hillside, Mass.; WEAF, New York City; WCBD, Zion, Ill.; WBZ, Springfield, Mass.; WGY, Schenectady, N. Y.; WHAS, Louisville, Ky.; WJAR, Providence, R. I.; WJAX, Cleveland, Ohio; WOC, Davenport, Iowa; WOR, Newark, N. J.; WTAM, Cleveland, Ohio; WOS, Jefferson City, Mo.; WSB, Atlanta, Ga.; WCAP, Washington, D. C.; WJZ, New York, N. Y.; WWJ, Detroit, Mich.

Very sincerely,
ROY B. BACHMAN.

Harkness Tells About His Reflex

(Continued From Page 39)

tions of the two audio frequency transformers and the negative of the filament. Connect the positive side of the "C" battery (2 or 3 volts) to the negative of the filament.

To install the receiver, connect the antenna, ground and batteries to the four binding posts on the rear panel, remembering that the ground and negative filament connect to one post;

the negative "B" and positive "A" to another single post.

Operation: To prepare the receiver for continuous operation, make the following adjustments, in the order given:

1. Turn the lower knob of the crystal detector to the left until the catwhisker is resting gently on the surface of the mineral.
2. Plug in your loud speaker or headphones.
3. Turn both dials until a station is heard; then turn the right-hand dial to the position which produces the loudest sound. Then turn the left-hand dial and *reduces* the volume of sound until the station is just audible.
4. Turn the lower knob of the crystal detector to the right and left a number of times and revolve the upper knob, if necessary, until an adjustment of the crystal detector is found which gives loudest signals.

The receiver is then ready for steady operation. Thereafter different stations can be tuned in by merely revolving the two large dials.

When seeking a station, these two controls should be turned simultaneously until the signal is heard, then each dial should be tuned individually until the positions are found which produce the most volume of sound.

Why WJAZ Became WGN

(Continued From Page 34)

its relations with the public than any other organization or institution. It views facts and features, entertainment and instruction from the viewpoint of the public opinion rather than from the viewpoint of any individual or group of individuals.

The Chicago Tribune will from this date on be serving you with its enormous editorial and news gathering mediums always on the alert for a new and interesting type of entertainment for you, having not only its domestic but its enormous foreign staff. In the past ten days the Chicago Tribune has spent over \$1000 in cablegrams advising the various countries of Austral-Asia and the Orient of the special program that we are to put on for them at 3:00 A. M. These cablegrams have been reprinted in the various newspapers throughout Austral-Asia and the Orient thereby focusing their attention in these far off places on our city, Chicago.

It might be well to correct an erroneous impression, though a natural one perhaps, that the Edgewater Beach Hotel and the Zenith Radio Corporation have sold or relinquished their interests in this station. Such is far from being the case. We have given over for what we believe to be the best interests of our listeners the control of the policy of the station, but we will continue to give the same interest to its operation that we have in the past.

I have always looked forward with
(Continued on Page 46)

SYCO KELCOIL

The Wonder Tuning Coil
Most-Talked-About Coil on the Market

SELECTIVE
SENSITIVE

THIS IS THE ORIGINAL AND ONLY KELCOIL
DISTANCE—VOLUME—CLEARNESS

SIX DOLLARS

SYCO ABSORPTION TRAP

STATIC FILTER

USE WITH REGENERATIVE RADIO FREQUENCY CIRCUITS
UNUSUALLY SELECTIVE **\$10** INCREASED VOLUME

SYCO WAVE TRAP

FOR USE WITH ANY CIRCUIT OR RECEIVING SET
ELIMINATES INTERFERENCE—MOST SELECTIVE
\$8

ALL ABOVE GUARANTEED
SAME STANDARD
THAT HAS MADE
KELCOIL FAMOUS

FOR HOOK-UPS AND
WIRING DIAGRAMS
SEND US
TWENTY-FIVE CENTS
MAILING EXPENSE

SYCO RADIO PRODUCTS CORPORATION
440 Drexel Bldg. Philadelphia, Penna.

MACKONTROL Saves Your Tubes!

An everlasting insurance against burnt-out tubes. One protects all the tubes in a set. Does not interfere with operation of a Set. Price **\$2.50**

Your Dealer Will Demonstrate It

Mackline
of Superior RADIO PRODUCTS
MACK Company
1810 Market St., Phila.

MACKCONTROLS SENT PREPAID!!

Don't fail to read the above manufacturer's advertisement. It is the only appearance on the market absolutely guaranteed to protect your tubes. We will be glad to send you a MACKONTROL PREPAID on receipt of price..... **\$2.50**

J. M. HETHERINGTON & CO., Direct Factory Distributors
Hunting Park Avenue and E. Lycoming Street, Philadelphia, Pa.

Grimes

and his famous

INVERSE-DUPLEX SYSTEM

are found exclusively in "Radio in the Home."
David Grimes is one of our Associate Editors
and writes for no other publication.

The Slant of Trade on Radio

SUPER-HET NOT WORRYING DEALERS IN MIDDLE WEST

By Stuart C. Mahanay

St. Louis, May 20.

SUPER-HETERODYNE popularity held its own in the St. Louis territory during the last month, although a number of dealers who stock the parts and complete sets frankly admitted that the super-heterodyne receiver of the present day is too complicated for the layman to attempt to build, and that even as a radio receiver it still needs more improvement for it to make good the claims which have been heralded far and wide concerning its vast superiority over all other types of sets.

It is the consensus of opinion that the recent demand for parts materially fell below that of the preceding eight months. Some attributed the cause to the common belief that good radio reception ends with cool weather in the spring and that little can be expected of radio until fall.

Others are convinced that the great majority of enthusiasts are through experimenting with every new circuit announced and are satisfied that real results are not to be had with home-constructed apparatus. Hence, when the fall radio season opens there will be a tremendous "boom" and more complete sets will be sold than ever before. This, of course, is largely conjecture, but it shows the trend of thought among various dealers who have tried to account for market fluctuations.

Returning to the super-heterodyne, it is the belief of the writer that some dealers (four to be exact) are disappointed in super-heterodyne sales. The first one interviewed said that it is not "delivering the goods" and that the extravagant claims made for it have caused the buying public to expect more than the super-heterodyne or any other receiver yet to make its appearance on the market could deliver. The fourth dealer, when questioned as to how many of one of the new models (selling for \$425.00) he had sold replied, "none," and that there were just 425 good reasons.

The comment of another was, "When the public finds out what the super-heterodyne really isn't, there won't be any more super-heterodyne sales," adding further that, using UV-199 tubes, it lacked the range and volume of the neutrodyne and is a great deal more noisy.

It is certain however, that of the smaller sets on the market the Radiola III, IIIA and the Balanced Amplifier have made it "interesting" for dealers pushing other makes of one-, two- and three-tube sets. All R. C. A. agents agree that this is the best "buy" on the radio market today and that they cannot get enough to supply the demand. Five sales in one day is not considered unusual, although St. Louis is not considered a leading radio city.

A concerted effort on the part of local dealers was begun recently to convince the radio public of the merits of crystal sets. Practically every show window "blossomed" with crystal receivers. Large signs announced "bargains" in crystal sets at prices varying from \$5 to \$15 for complete equipment. As a result, sales have been very good—in fact better than was anticipated.

The attitude of one merchant was reflected in his statement that "no more radio demonstrations would be given in homes by his men until next

fall, unless the receiver under consideration has actually been paid for. Conditions are too unfavorable," he said, "to conduct demonstrations during summer months, and the prospective customer cannot be sold."

Neutrodyne receivers are still good sellers, with Garod and Freed-Eisman in the lead. More sets than parts are being sold, and it is believed when the super-heterodyne craze dies down that neutrodyne will still be a "good seller."

It has been prophesied that in the long run more neutrodyne sales will be made than super-heterodyne principally because there is more competition among neutrodyne manufacturers, and, too, the lower price at which neutrodyne sets can be bought will make some difference.

Crosley receivers are "moving" and there is a good demand for Michigan sets.

Balkite battery chargers are moving rapidly, according to one salesman. It was also his belief that dry cell vacuum tubes never would supersede

Every dealer interviewed declared that as yet there has been no demand for portable sets. Various reasons were given. One was, that under the impression that radio "doesn't work" during the summer the public is not seeking a heavy outfit to lug along on the vacation. Another suggested that few people can afford to own a set for home use and another for taking on their camping trips, and the sets available at the present time are not well adapted for both.

The worst "slump" is expected during the month of June, after which most merchants expect their radio sales to increase steadily, although the fact that sets can now be calibrated and stations "logged" will be no small factor in making this the largest and best summer—from the merchant's standpoint—we have had. It was "hunting" for stations through "chunks" of static that made listening-in such a disagreeable task during the warm months.

It must be realized by the reader that the expressions outlined above

opinion, is one reason for the decrease in the sales of parts and the accompanying increase in demand for complete receiver, for the fact cannot be overlooked that many who tried to "roll their own" without any previous knowledge of the principles of radio failed to get the results expected and are now seeking a reliable set made by a manufacturer with an established reputation.

MILLION-DOLLAR SEASON IN NEBRASKA TERRITORY

Omaha, Nebr., May 20.

EQUINOCTIAL storms which were promised early this year by the men who make a study of the heavens have descended with a vehemence upon this section of the middle west, and as a result, radio broadcast reception, in so far as the DX fans are concerned, has been knocked for a row of proverbial cocked hats.

Broadcasting station operators, however, mindful of what was to be expected in this respect, have made adequate preparations and no single community should be out of range of some class "B" station. Chief among the things which the mid-western fan will be listening for the month of June will be the Democratic National Convention in New York, and the Republican Convention to be held in Cleveland. The political powers-that-be have decreed that the middle west should not seat either convention, and so the politically inclined fans have made arrangements to content themselves with "listening in" to the broadcasts of both conventions.

But when the spring storms came along with their accompanying electrical disturbances these fans were somewhat disappointed, believing that with such interference they would not be able to hear a single word from either convention. Announcement that the speeches and doings would be carried from the conventions to several broadcasting stations in various parts of the country by land lines seemed to solve the problem, though. Present plans call for the broadcast of at least one and possibly both conventions from one Omaha station or from Kansas City, either station of which can easily be heard under almost any circumstances.

If the Nebraska, Iowa, Kansas, Missouri, South Dakota and Wyoming listeners can pick up these two conventions under such local conditions as prevail now, it will be a big step over what could be accomplished under similar conditions at the same time last year.

The local stations and those within summertime range of here have been putting out an excellent quality of programs of late, and station attaches promise that this quality will be kept up even though they realize their number of listeners will be considerably diminished during the next few months.

WAAW, the 500-watt station operated by the Omaha Grain Exchange, accomplished a feat during the past month which was exceedingly noteworthy in the realm of radio. Telegraph and especially the press lines in South Dakota were leveled by a severe windstorm. The Chicago office of The Associated Press (division headquarters) which feeds the Dakota communities with news immediately got in touch with Correspondent J. A. Rawlings, of Omaha, and advised him to start a broadcast of news in hopes that some of the



Radio in the Home of Stanley Goldman, 6464 Cecil avenue, St. Louis, Mo.

Photograph by Griffith Yore

the "A" model. "People don't seem to object to buying a storage battery and rectifier, and so with practically every multi-tube set we sell there is included a battery and charger."

The demand for loud speakers has not decreased. Magnavox, Brandes and Atlas are the leading makes called for.

Head phones are also "moving," but the public has reached the discriminating stage and, after trying cheaper sets, is now asking for the best made.

Storage "B" batteries have not become popular, probably because of their high cost and the trouble and bother of caring for them after they are installed.

In two different stores tables were set aside with a sign above them "Bargains in Regenerative Receivers." On one of these tables were three well-known sets. One—which originally sold for \$80—was "marked down" to \$26.50. Many other regenerative products of standard manufacturers were likewise cut in price.

are only the individual opinions of dealers who have had more or less experience with radio and in the radio business. Some knew little or nothing about radio before entering the business of selling radio parts, sets and accessories, and therefore their opinions cannot be accepted as authoritative.

It may be added finally that the interviews which took place in obtaining the above data lead the writer to believe that the majority of dealers are doing what they can to discourage the sale of parts and accessories with which receivers can be assembled principally because the profit in complete sets is decidedly greater, and, too, there is little "comeback" when a complete set does not function—at least the trouble can easily be found and repaired, for the average fan is far more certain of getting satisfactory results with a manufactured set than with one at home carrying out instructions which he only vaguely understands.

This, therefore, in the writer's

association's South Dakota member papers would hear it.

Co-operating with Frank J. Taylor, president of the 'Change, Rawlings and an assistant began reading the A. P. dispatches into the air at 1:30 P. M. via WAAW. At 3:30, which was press time for the South Dakota papers, they signed off, without knowing, of course, whether their efforts had been in vain. That night, however, when communication by wire was re-established, they were advised that papers at Yankton, Mitchell and Sioux Falls had succeeded in picking up the reports and had gone to press with a front page full of news "By Radio." Listeners in each of the three towns happened to be tuning when the reports were started from Omaha and each notified his local newspaper. Shorthand operators immediately were sent to the several receiving sets and the news was copied by radio.

Because of the success attending the broadcast, Superintendent E. T. Cutter of the "A. P." has instructed each of his correspondents to utilize their local broadcasting station in case of emergency.

Radio business in the Middle Western States and especially in Nebraska is settling down to a real merchandising basis rather than one where, a year ago, it merely "filled a demand," in the opinion of Meade Burnett, of Chicago, district manager of the Radio Corporation of America, who "made" this and adjacent territory this month.

And this opinion is entertained by the four Omaha jobbers and the two dozen retailers who have just closed the biggest season in radio history. A conservative estimate of the volume of sales in Nebraska alone, in the six months just past—or the real radio season—places the figures at more than \$1,000,000 and reports from adjacent States are that sales were as great, per capita. This estimate is arrived at from the statements of the Omaha jobbers, whose sales have approximated \$850,000. When 30 per cent of this figure, which represents the average "spread" between wholesale and retail prices, is added in, the estimate seems low.

Mr. Brunett, speaking to a group of local dealers, expressed the idea that the manufacturers are striving harder than ever to merchandise their wares through real retail outlets and thus are getting away from the "pioneer stage" in the business, through which, he explained, every business must pass.

He stressed the point that the day is rapidly passing when the radio prospect will go to the nearest neighborhood "expert" rather than to the local dealer for a set or for information.

"Every business must necessarily pass through the pioneer stage and next through the 'opportunists' stage," Mr. Brunett explained. "The manufacturers now are striving, and have been for some time, to find the best class of dealers, and we are now on the eve of having real merchants in radio."

District Manager Kellogg for the Crosley Radio Corporation, who also was a trade visitor here, expressed the same view. He said the Crosley line had been going exceptionally well.

In keeping with its retailing program, the Zenith company sent one of its service men, Frank Zimbalman, into this territory the past month. He brought news of a new portable set, a six-tube affair, which the Zenith people hope to have in this market within three weeks. Zimbalman spent several weeks meeting jobbers and retailers and in discussing the "service" or technical side of the Zenith products. He represents one of

(Continued on Page 46)

KELLOGG RADIO

OFFICIAL SCORE BOARD

CHICAGO	00021
ST LOUIS	01000
NEW YORK	00000
BROOKLYN	02111
CINCINNATI	00000
PHILADELPHIA	10001
BOSTON	04000
PITTSBURG	00000

BASEBALL SCORES BY RADIO

SAY THE RADIO BUGS

BASEBALL fans the country over will be counting on Radio this year more than ever before. Most Radio fans are baseball fans. Every one of them should see that his new set of Kellogg radio parts is ready in time for the baseball scores.

Get the Sport records and scores quickest by Radio—build your set of Kellogg radio parts for dependability and economy.

There is a certainty of satisfaction with Kellogg as shown by records of this equipment in use. Kellogg transformers rank among the best. To hear them in operation is to want them. Kellogg tube sockets give the utmost of service, while Kellogg switch arms and knobs are in a class by themselves for quick assembly, low resistance and satisfying operation.

Kellogg variable and fixed condensers, variometers and variocouplers are all designed and built to give the satisfaction which the word Kellogg expresses in the electrical apparatus field. Kellogg rheostats have but one movable part. They come in six and twenty-five ohm resistances, easily interchangeable. They are simple, yet vary in control on the half turn of the resistance element. Kellogg DX head sets are known wherever radio is in the air. They are built mechanically and electrically for long service, sensitiveness, extreme lightness in wearing, and handling does not affect their tuning. They have Kellogg solid bakelite shells and are furnished with the Kellogg famous receiver cords of which many hundreds or thousands are in use to day in the telephone field. Kellogg radio parts are especially suitable in portable sets because of their strength and high class manufacture. They will stand rough handling as will no other radio equipment and yet have the range and afford the selectivity, in the limits of the circuits used, surpassed by none.

If you don't want to bother to pick out the parts for your favorite hookup buy one of our Radio Kits which include all the necessary and suitable parts including two stages of audio amplification; you can select the tuning units, as you desire.

This summer as never before radio will be heard in every summer resort and camp. See that your set is made of Kellogg radio parts.

Specify Kellogg Radio—

Use—Is the Test

KELLOGG SWITCHBOARD & SUPPLY COMPANY

1066 West Adams St., CHICAGO, ILL.

RADIO
in the
HOME

It Is a Reader Service

It is devoted entirely to better class radio—the only kind that is fit to go into the American home.

RADIO IN THE HOME

is not in the market for general radio advertising. We make our own tests of apparatus, and we solicit advertising only from those manufacturers whose products we ourselves are willing to guarantee in the light of these researches.

This is to assure our readers that they can depend on the things they see advertised in our columns.

Fans Crowd In To See Their Entertainers



WORLD BATTERY
Saves You 50%

Famous Guaranteed Quality and Service—Backed by Years of Successful Manufacture and Thousands of Satisfied Users.

Prices That Save and Satisfy

Auto Batteries	Radio Batteries
6-Volt 11 Plate, \$12.25	6-Volt 80 Amps, \$ 8.50
6-Volt 13 Plate, 14.25	6-Volt 90 Amps, 10.00
12-Volt 7 Plate, 17.00	6-Volt 100 Amps, 12.50
	6-Volt 120 Amps, 14.50
	6-Volt 140 Amps, 16.00

Special 2-Volt Storage Battery for W. D. 11 and 12 tubes will run 20 hours on one charge. Rechargeable. \$8.00. Special 2-Volt Storage Battery for U. V. 15 tubes. Same features as 2 Volt. \$8.00.

Shipment express C. O. D. subject to examination. 5% Discount for cash in full with order.

2-Yr. Guarantee Bond in Writing With Each World Storage Battery proves satisfactory World performance. Mail this ad with your name and address and we will ship battery day order is received; and give you a 4-Volt "H" Battery and Hydrometer Free with each battery purchase! Write today.

World Battery Company
Dept. 35
1219 S. Wabash Ave. CHICAGO, ILL.

FREE
45 V. B. BATTERY
AND
HYDROMETER



Of course you want to improve your summer reception.

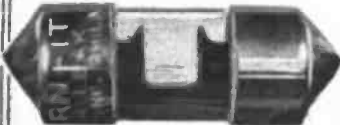

USE TURN-IT
ADJUSTABLE
GRID LEAK
Price \$1.00

National Distributors
TURN-IT RADIO SALES, Inc.
30 Church St., N. Y. City

Manufactured by
CHARLES E. BONINE
20 S. 15th St., Phila., Pa.



Above—A corner of the Main Studio Station WIP, Gimbel Brothers, Phila. Left—Edward A. Davies, Director of Station WIP. Below — Chris. Graham, otherwise "Uncle Wip," WIP's Bedtime Story Man

KEYSTONE
RADIO LIGHTNING
ARRESTERS

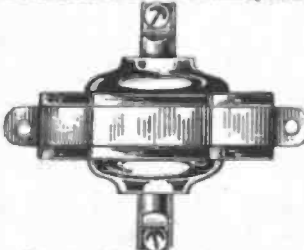

The new Keystone, made of genuine Bakelite, approved by Underwriters. Absolutely weather, dust, damp proof and has no vacuum to lose.

At Your Dealers, \$1.50 each

ELECTRIC SERVICE SUPPLIES CO.
Manufacturers of Over a Million Lightning Arresters
17th & Cambria Streets, Phila.

IS THE radio fan interested in the personality of the artists who entertain him?

This has long been a disputed question among directors of broadcasting stations and so the answer which was most emphatically given by the Philadelphia fans on the evening of Saturday, May 10th was both interesting and significant.

For a week or more before that event, station WIP, Gimbel Brothers, announced that on that evening they would broadcast direct from the stage of the Metropolitan Opera House with all of the regular entertainers of the station who had been broadcasting with them for some time. They announced that admission would be by tickets, but that the tickets would be free and would be sent to all who wrote in for them—first come, first served.

There was a good deal of doubt in the minds of everybody connected with WIP as to whether the demand would be large enough to make the evening a success, but immediately after the



the house was absolutely packed long before the time for the beginning of the entertainment. 4400 people crowded in just for the opportunity of seeing the artists to whom they had been listening for so long via radio.

There was nothing at all original or startling in the program. It was merely the same kind of thing that the same people had been broadcasting for some time, but the most significant feature of the entire evening was that there was not a handful of the spectators who left their seats until the very last number had been rendered. They stayed all through the long evening so as not to miss the chance of seeing in person every one of the friends whom radio had made for them.

The entire affair was under the management of Edward A. Davies, director of the station who introduced Chris. Graham, better known as Uncle WIP, the kiddies' friend. Uncle WIP did most of the announcing but Mr. Davies did enough to inject his own personality all the way through the program and to give it a flavor of humor which was a large feature of the success. He also joined one of the quartets as baritone and his voice proved even more pleasing in person than it does by radio.

Station WIP has probably never had an event which made it more popular with the radio fans because at the same time the 4400 fans were listening inside of the Metropolitan Opera House, the countless thousands who were unable to secure tickets sat at home and heard the entire thing broadcast with a background of continuous and hearty applause that left no doubt in any one's mind as to the complete success of the unique stunt.

The participants were the Shrine Band of Lu Lu Temple; Elliott Lester, dramatic critic, who interviewed Miss Lotta Woods, Douglas Fairbanks' scenario editor; Ted Weems and his Victor Recording Orchestra from the Cafe L'Aiglon; Gene Hogle, secretary of the Auto-

(Continued on Page 46)

very first announcement all doubts were removed. The requests came in in a perfect avalanche.

Within a very few days, all of the 4400 seats in the great Metropolitan Opera House had been allotted and no more could be sent out.

On the evening of the broadcasting,

RADIO SURE HELPS RUFUS MCGOOFUS A LOT

REG. U. S. PAT.

YOU all know Rufus McGoofus. He's the character in the famous comic strip that is appearing in newspapers all over the country. I had the good fortune to see Rufus born and brought up because I have known his creator, "Joe" Cunningham, for twenty years or more and at the present time he draws his famous character in an office directly under mine.

Joe told me the other day that he had fallen hard for radio at last, although a year or two ago he would not even let me mention it to him—said that he couldn't see it and never would. But he is the first to admit it now and when he told me that he really wears the earmuffs these days while he is drawing his comics, I shipped a photographer out to his house, had him snapped and then made him write me something about his reaction to radio.

Here is Joe's wish me to insist that though his name is Cunningham, he has nothing to do with the radio tubes. After the man who makes the radio tubes reads this article, he will probably be the one to insist on the distinction.

RMN.

By "JOE" CUNNINGHAM

THE wife's favorite husband was annoyed by Hank Neely, who entered the office to announce that he was the greatest radio editor in the world and to borrow a cigarette. Not being flustered and having the same careless freedom in handling truth, the aforesaid husband declared, "Applesauce." Then, "Ask me a lotta questions about aerials and things, as I've had a set for a week and I know all the answers."

Not being asked the reason for the lapse from sanity, I told the world's greatest editor that radio was a great boon to cartoonists. All one had to do was to hook on the ear muffs while sundry bands play jazz and sweet music and thus dash off cartoons without being bothered.

"From the look of some of your cartoons you are not even bothered by ideas," remarked the great Ed, which crack had all the earmarks of a dirty dig.

Hank seemed so slightly interested in wireless art that I told him all about it without being confined to facts. He assured me I had a great mind for fiction, and if I would write same he might give it the benefit of publicity. Trouble with writing is that facts keep slipping in here and there.

For the last couple or few years the radio stuff was all wet to me because



"Joe" Cunningham, creator of "Rufus McGoofus," wears the "Ear Muffs" as he draws his famous cartoons

the language was as simple as a menu in a Greek restaurant. Diagrams of hookups I can understand as easily as I read French, and as the old gag has it, in France even the little children speak the language. A crystal contraption or iodine special was one thing I was not going to accomplish. When the wife decided that I should have a radio, as I said before, I am one of those self-willed, determined guys and I know my own mind. We got a radio.

With the Secretary of the Treasury talking of tax reduction, and the bathing season being open to photographers in Palm Beach, it is no time to be technical, so I will not bore you with a detailed description of the outfit. A guy in the neighborhood built the thing and from the trade mark on the front I'm not sure if it's a rheostat or an amplifier hookup. There's a lotta wires from a small cake box and

two small door bell batteries that cost forty cents each.

In the back of all the knobs there are two electric light bulbs, but I guess the batteries are not very strong because they don't light very bright. One of the lights must be a spare, like the extra tire on a Ford, because I only have to light one to hear music. When that burns out I can use the other light. I turn on some knobs until I hear something and if I have time and can fool with it long enough I can hear the stuff without a lotta whistles.

The paint ain't been knocked off the outfit as yet. When the wife says she is going to take the kids up to see all her relatives, I get all excited and figure what a swell time I'll have to get an earful of all the broadcast stuff in the peace and quiet of the home, undisturbed by man or beast. Yeh! The winter is no time to be left flat by the wife in any neighborhood. The peace and quiet of the home is as soothing to the nerves as a riot or such.

To get all harnessed up for the day's toil at home is an intrickit operation, like shaving the neck or Mah Jong.

The drawing board is placed on one chair and the pens, pencils, cigarettes, paper and ink placed handy and the one-man top ear phones put up. As the trilbys get chilly, an army blanket is wrapped carefully around the limbs. Just as you tune in on a thrilling lecture as to the "growth of the cotton industry in Nome, Alaska," the doorbell rings. It takes four minutes by a stop watch to unhook all the stuff and get to the door, only to find it is the man trying to collect some of the easy payments on our furniture.

As one gets all bundled up again the radio starts to splutter and fuss for no good reason. Later when there is smoke among the splutter you discover that the oil stove is crying for food. Very peaceful and awful quiet. Awful. Drawing pictures at home is more to be pitied than censored.

Radio is an asset to home work if all the work is done in the office. There is really nothing to bother one



MAR-CO

YOU need not pay more than 40c. for complete plug-satisfaction, if you don't want to! A quarter-million MAR-CO STA-PUTS are delivering "leak-proof" service in actual use. They look well—they work well—they stay put!



40¢



TUNE HIM OUT!

Just a touch—and it's done.

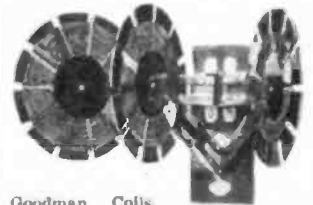

Goodman Collis, in their beautiful mount, are an ornament to any panel. Their sharp tuning is a joy to any radio fan. They can be used in any of the standard hook-ups, and improve them all. Diagrams given in our pamphlet. Send for one.

\$6.00 one pound

L. W. GOODMAN
Manufacturer
Drexel Hill, Pa.

NEW

EBY

Tip-Top
Post, 50c



It takes 3 pair of phones. You can mount it in a jiffy. See them at your dealer's.

THE H. H. EBY MFG. CO.
Philadelphia, Pa.

"Oh boy! You ought to hear it NOW! I just put on a

FOOTE

CRYSTAL



Radio Safeguards

STORM KING LIGHTNING ARRESTER

Approved by the National Board of Fire Underwriters



\$100 at all dealers

Solderall
Solders All Joints Permanently.
25¢
SOLDERALL CO.
NEWARK, N.J.

EISEMANN RADIO EQUIPMENT

comprises
Headsets, Variometers, Varioscopes, Condensers, Potentiometers, Detector, Resistance-Adapter, Radio and Audio Amplifier Units, A.F. Amplifying Transformer, and ready drilled metal panels. Also, the new R.F.-2 Broadcast Receiver.
Write for Prices and Descriptive Literature



EISEMANN MAGNETO CORPORATION
165 Broadway, New York
Detroit Chicago San Francisco

Use Price 75¢
DURHAM
Variable Grid Leak

At all dealers or postpaid
Fits all sets, home made or factory built. Snap a DURHAM in place of present fixed leak.
Send for Folder H.

Satisfaction Guaranteed

DURHAM & CO., Inc.
1030 Market St., Philadelphia

The Most Efficient VACATION SET



SIMPLEX RFB PORTABLE

For camping, picnics, auto trips or any of those "in-between" hours of every vacation. Loud speaker volume, distance and clearness. 5 tubes on 2 dry cells. All concealed in handsome case. Price without accessories. \$80
At Most Reliable Dealers
SIMPLEX RADIO CO. (Mrs.) Phila., Pa.

HARKNESS REFLEX

The circuits that put efficient radio within the reach of all. All developments of this system are now found exclusively in Radio in the Home.

KENNETH HARKNESS
Is one of our Associate Editors and writes for no other publication.

at home. Nothing but answering the door bell forty-eight times, raking the heater, sifting the ashes and cooking meals. One gets tired eating cakes. A cake eater gets a lot of advertising, but there ain't much nourishment in cakes. Eggs are good and there is a variety of ways of cooking them, but one gets tired of fried eggs. It's a good thing the wife and kids came home, as it began to look like I would have to wash some dishes. I could hardly get another one in the sink.

Thus I must agree with the other experts like Babe Ruth, Henry Ford, Peggy Hopkins Joyce and the guy that invented six per cent, that the radio is a boon to humanity; a child can use it as well as a man, and it will likewise remove tar, pitch, paint, varnish and grease spots from the clothing.

You must come over and hear our set.

Fans Crowd in to See Their Entertainers

(Continued From Page 44)

mobile Club of Philadelphia; Harold Leonard and his Red Jackets Orchestra from the Club Madrid; the University of Pennsylvania Male Quartette; Uncle Wip and some members of his Kiddie Klub; the Gimbel Tearoom Orchestra; Thelma Melrose Davies; the Gimbel Glee Club; Dick Regan and his WIP Concert Orchestra; the Philadelphia Police Band; the WIP Grand Opera Quartette; Ben Stad and his WIP Symphony Orchestra with Karl Bonawitz from the Germantown Theatre; the St. James Hotel Orchestra; and addresses by Albert H. Ladner, Jr.; illustrious Potentate of Lu Lu Temple and Ellis A. Gimbel, Sr.

Why WJAZ Became WGN

(Continued From Page 41)

pleasure to every night that I was to be at our station and talk with the invisible audience. I feel just as the artists do that appear here, that we are talking to you out in Nebraska, you out in California, you in Ohio, and you in Saskatchewan.

In a little while you are going to listen to Miss Edith Mason of the Chicago Civic Opera Company, and while you are listening to her remember that we are sitting here watching her get the same thrill, not from that little diaphragm called the microphone into which she is singing, but from the realization that thousands upon thousands, yes even millions are being entertained by her.

Seldom does an artist come from our Crystal Studio after a first appearance that they do not say, "How many people do you suppose heard me?" Until we took our Listeners vote even we did not have any idea of the number we were entertaining, but having received over 170,000 responses in a period of twelve days, conservative advertising men estimate our audience was around eight million in that number of days. Our audience is not only the United States, but Alaska, Hawaii, Samoa, New Zealand, Central America, Cuba, Virgin Islands, Labrador and the North Pole. from all of which places we have had communications.

The wonderful co-operation that we have received from all of you whenever we have asked you for your opinion on any subject has not only been gratifying but truly appreciated. This station will continue as it has in the past to stand for the rights of the independent music writers and publishers and will resist any attempt on the part of the so-called American Society of Authors, Composers and Publishers to collect unfair tribute, and it will be only a few days until we will ask you to write your Congressmen and Senators on this sub-

ject, and I feel that we will receive the same hearty response and co-operation that we have in the past. We intend to work as we have in the past in fullest harmony and co-operation with WDAP, WMAQ and KYW, the other stations in Chicago.

May this new association of the Chicago Tribune with the Edgewater Beach Hotel and the Zenith Radio Corporation be the cause of improvement in our programs to the extent that WGN will stand for the World's Greatest Broadcasting Station, as well as what it has stood for for so many years—WGN the World's Greatest Newspaper.

The Slant of Trade on Radio

(Continued From Page 45)

the few manufacturers giving "service" with its sales.

The slump in the radio business came the first part of May or about a month earlier than last year, due, possibly to two conditions. One was the arrival, about a month earlier than in 1923 of the seasonal rainstorms with their accompanying lightning and static and the other seems due to the inability of the Radio Corporation to fill its orders in this trade territory. All retailers and jobbers are oversold on R. C. A. super-heterodynes and on its Radiola III's. A great many fans have been waiting for the opportunity to test out these sets before they buy and this has brought about a condition which naturally hurt the entire business to some extent.

The "build-your-own" or parts business seems to be holding its own with most volume of business in tubes and batteries. There are good supplies of these two items in all stores and competition is keen. Some retailers are "price cutting" with a view to cleaning out their stocks before the real hot weather arrives.

Omaha and Nebraska dealers are agreed that it is humanly impossible to make the big radio sales in the summertime that they do in the winter and many are featuring other electrical appliances to tide them over until fall, when the radio business will get back to normal again.

"Radio is a seasonal business just the same as almost every other business," declared one wholesaler. "We could hardly expect the hatter to sell straw hats in winter or the clothier to dispose of overcoats in the summer, and the same rule applies to the radio dealers. We are going to make money out of it, but we must do it in the fall, winter and early spring."

PORTABLE SETS POPULAR IN SOUTHERN CALIFORNIA

Los Angeles, May 15.

When Captain Edward Salisbury, traveler, invited friends in radioland to a barbecue at his La Joya estate, 65,000 people responded. He has talked for more than a year from the Times, KHJ. Now the gigantic estate has been divided into a vast country club composed entirely of radio fans. Some fifty 'dobe homes have already been erected and a large club house is in process of construction.

Many of the artists who are heard from the Examiner radio studio were recently presented in person at the annual hi-jinks given by this newspaper to the Soldiers' Home in Sawtelle. Upon the return of the fleet to the Southern California waters a similar celebration was given in San Pedro.

The lecture period from the Examiner is now permanently established in the minds of the public as a daily attraction, having passed the experi-

mental stage. Six months ago the public expressed a preference for educational talks rather than news items at the 5:15 period. Series of talks of education, camping, travel, diet, scenario writing and every conceivable topic are included.

Many movie nights have been held within the past quarter from the Anthony studio. Several well-known screen actors have officiated as announcers and presented a galaxy of talent from screenland.

Whistling, singing lessons, clog dancing, and other radio novelty programs have practically been abandoned or discarded locally, not entirely because the public doesn't want it, but because of the difficulty in concocting new schemes and original ideas for the entertainment of ye radio fan family.

Uncle John of KHJ has recently made a number of personal appearances in surrounding towns. Most of the neighboring communities look upon radio announcers as one of them, much more so than in cities.

The usual summer slump in radio sales has apparently not been felt in a decided way hereabouts as yet. Since there is practically little difference between seasons in Southern California

Portable Sets

Will Feature the July Issue

Sets for the traveling man and the vacationist. Just the things to make it a Radio Summer for you.

RADIO IN THE HOME

it is difficult to distinguish seasons in radio sales activity. It is true that sales in general have fallen slightly the past month but this has been traced largely to the increased number of separate radio stores and radio departments of concerns already established.

The Radio Central Station, KFI went greatly over its quota of telegrams for the Dill Bill. Between the Dill Bill, the proposed 10 per cent tax on radio equipment, and the music controversy, radio fans near Los Angeles have had plenty to keep their interest in radio activities at a high pitch.

During the hoof and mouth disease epidemic, travel across county lines was limited and a quarantine often lasting six hours became necessary. Auto parties, camping, hunting and fishing were also strictly prohibited while travel across the Arizona boundary by auto was at a standstill. During this period it is estimated that the number of radio listeners was practically double the usual number. This was due to the many families who had to remain at home, and to the stranded auto parties who had to camp for days at a time during quarantine. Bulletins were broadcast each day from all stations. These gave the quarantine areas and the restrictions imposed on citizens from day to day.

The new R. C. A. lines are now well in the market here and are meeting with much interest. In the meantime the old lines are daily advertised in the papers and they also make their appearance in second-hand stores.

The three-day show of summer radio and allied goods created much interest locally. This was held in a local auto salesroom and featured portable radio sets, camp equipment and furniture.

With the advent of the summer vacation season, a spurt in radio sales is evident. This has largely been attributed to the fact that most people dislike to move their sets and consequently are buying portables for the beach or mountains. At the same time an increase in the sale of parts is directly attributable to this source. The younger element is building home-made sets to accompany the family on the vacation jaunt.

A brief survey of homes in the process of building reveals the fact that many are having radio cabinets installed with the fixtures or are having them built in the wall to become a permanent part of the dwelling.

By county order, no more Sunday dances are allowable in the hundreds of small mountain camps and resorts within the radius of many miles of the city. Radio has come to the rescue for entertainment in these public places and receiving sets are now installed in practically every public camp of any size. The installation, however, has brought forth many difficult problems due to climatic conditions and altitudes.

Radio has reached the stage here where the "swap" columns of the dailies have developed to an additional one for Radio Equipment. Second-hand sets are advertised frequently and many stores handle this class of equipment. The non-technical fan much prefers to sell his old set when graduating to a new make rather than bother with knocking it down and utilizing the various parts.

With the summer season at hand, a goodly number of house boats and yachts, particularly in San Pedro and at Catalina Island, have been equipped with receiving sets. Jazz music pre-

dominates from California studios in the summertime and many dance parties are held on shipboard.

The new Kennedy portable is apparently meeting a need locally and it is being used by automobile camp parties and in mountain cabins where a portable set is necessary.

The studios of Hollywood and movie-land continue to use radio for parties on location in the desert or in the mountain regions. Radio orchestral programs have materially assisted in staging dance sets in some studios although, of course, the studio quartettes are necessary for continuity in staging and re-staging scenes indoors.

Sets which are proving popular at this writing in Southern California may be narrowed down to a few. The DeForest Radiophone, requiring neither aerial nor ground, has been featured extensively and is meeting with approval by many users. Others include Freed-Eisemann, N R 5 Neutrodyne, Harkness, Eria Reflex and the Crosley.

Unquestionably radio developments in the West have been a trifle behind the East due to certain local situations as well as to the fact that the center of the industry is on the Atlantic seaboard. Radio publicity, however, is gradually taking hold of the Pacific Coast. Syndicate radio columns in country weeklies, radio pages in the metropolitan dailies, radio stories in the magazines and radio jokes on the vaudeville stage are becoming a part of every-day life and are even now beginning to pass from the novelty state.

Two members of the State University Glee Club in Los Angeles have composed a song, "Radio Bug," which has been published and dedicated to Dr. Ralph L. Powers, the Sky Crier of the Examiner radio studio.

Southern California is now fully supplied with church services from broadcasting stations. The Angelus Temple is on the air practically continuously while the Bible Institute operates three days a week. On Sundays the Times broadcasts the services by remote control from The First Methodist Church, while the combined Examiner-Anthony program by the Federation of Churches includes morning and vesper services. Saturday afternoon, vesper services given during Lent via KFI will be continued in the summer months.

The Times, KHJ, has made extensive alterations in the radio department. The roof has been glass inclosed and now affords space for approximately 200 people. This makes it possible to accommodate orchestras and bands with no inconvenience.

New radio orchestras in the Southwest include Wes Bennett's Pasadenas and the Kentucky Colonels.

Favorite string orchestras in Los Angeles now being featured via radio include the new Davis Ladies' Trio, Marshall Neilan's string quartette and the Fairbanks-Pickford Quartette. Older organizations include the famous Los Angeles Trio and the well-known Philharmonic Trio.

Through the courtesy of the Examiner, Dr. Ray Hastings played selections on the Philharmonic Auditorium organ direct to the new Los Angeles Coliseum a half hour before the gigantic Easter sunrise service. Broadcasting was by means of portable panel with about twenty loud speakers arranged in the monster arena.



FADA "ONE SIXTY" NEUTRODYNE RADIO RECEIVER



Summer Advantages of Neutrodyne

IN THE summer time, Neutrodyne maintains the advantages of good radio reception—you can bring in signals on Neutrodyne receivers that are too weak for other receivers to get.

The FADA "One Sixty" is a remarkably efficient Neutrodyne receiver. If distant stations are broadcasting and it is at all possible to get them, the FADA "One Sixty" will bring them in. Selectivity, volume and clarity of reproduction are outstanding features that have made the FADA "One Sixty" so deservedly popular everywhere—it usually brings in stations, near and far, on the loud

speaker, even when local stations are on the air.

Freedom from radiation is another advantage that is vitally important, as absence of radiation from your receiver is a deserving courtesy to your neighbors.

Buy a FADA "One Sixty" Neutrodyne receiver and enjoy all the advantages of summer radio at its best. It's a receiver you'll never have to apologize for—an ornament to any home. For your protection, a serial name-plate is fastened inside the cabinet. Be sure to look for it. Price of FADA "One Sixty" \$120. Tubes, batteries and phones are extra.

F. A. D. ANDREA, INC., 1581 Jerome Avenue, New York

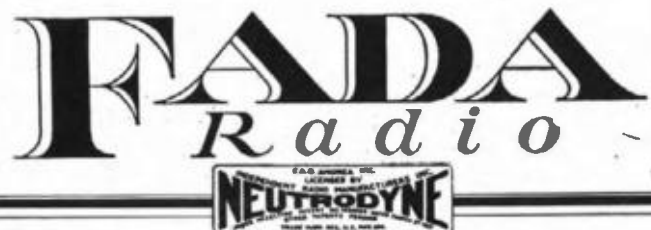



Cheer with the Galleries When the Delegates March In!

Radiola Super-Heterodyne

is the great Radiola for the big events of summer broadcasting. Listen in, at your office, to the conventions and the ball games. Take it everywhere. It needs NO ANTENNA—no ground—no connections of any kind. Has a handle to lift it by. Tunes in with just two knobs that you turn to marked spots on the dial. Tunes out powerful near stations to get the far ones. A wonderful new achievement in the perfection of its tone—its sensitivity—and its supreme selectivity!

Complete with six Radiotrons UV-199 and Radiola Loudspeakers everything except batteries . . . \$286

External, rotating loop, easily assembled, larger than self contained loop in Radiola Super-Heterodyne, for extreme reception range. Loop AG. \$12.00 #14 . . .

Operates
On Dry Batteries

Watch the radio columns of your newspaper for the big convention broadcast schedules.



No "influence" needed this year for a gallery seat at the big political conventions! Get it all with a Radiola Super-Heterodyne.

When the delegates march in—their banners streaming; when the bands play and the galleries cheer—be there with a "Super-Het." Hear the pros and cons as they fight their way to a "platform" for you. Hear the speeches for the "favorite sons." The sudden stillness in the audience when the voice of a great speaker rings out. The stamp and whistle and shrill of competitive cheering. Hear the actual nomination of a president.

It used to be all for the delegates' wives and the "big" folks of politics. Now it's for everybody. Listen in. Get it all! With the newest Radiola.

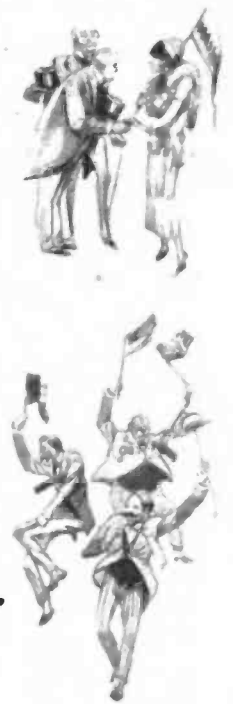

"There's a Radiola for every purse"

Radio Corporation of America

213 Broadway, New York

Sales Offices:
10 So. La Salle St., Chicago, Ill.

413 California St., San Francisco, Cal.

RADIO CORPORATION OF AMERICA
Dept. 174 (Address office nearest you.)
Please send me your free Radio Booklet.

RCA
This symbol of quality is your protection.

Name _____
Street Address _____
City _____ R. F. D. _____
State _____

Radiola

REG. U. S. PAT. OFF.



Natural tone quality
wonderful volume with a FADA Neutrola.

IN THE "Neutrola," FADA has produced a radio receiver that possesses every essential to your complete enjoyment of radio. It is a new and better designed five-tube Neutrodyne set, refined to give the most faultless reproduction of music and voice. You can, without exaggeration, imagine yourself in the very presence of the musicians and artists.

Selectivity is but one remarkable feature of the "Neutrola." With powerful local broadcasting stations operating, the "Neutrola" cuts through them and brings in outside stations, hundreds of miles away, on the loud



speaker with minimum interference.

The "Neutrola" cabinet is of genuine mahogany, inlaid with a lighter wood. A decorative grill covers the built-in loud speaker, and a drop desk lid hides the panel when the set is not in use. The "Neutrola" is fitting company to the finest furniture in the home.

In addition to the "Neutrola" there are other FADA Neutrodyne receivers in sizes and styles to meet every desire; three, four and five tube receivers in plain and art cabinets at prices ranging from \$75 to \$295, each extraordinary in results; each a remarkable value.

F. A. D. ANDREA, INC., 1581 JEROME AVENUE, NEW YORK

FADA
Radio

FADA Neutrola
Five-tube FADA Neutrodyne, with self-contained loud speaker. Genuine mahogany, artistically decorated with wooden inlay. Ample space for all batteries and charger. Drop desk lid that hides receiver when not in use. Price (exclusive of tubes and batteries) \$220.



FADA "One Sixty"
No. 160-A
"The receiver that has taken the country by storm." The best known of all Neutrodyne. Four tubes. Price (less tubes, batteries, etc.) \$120.



FADA Neutro Junior
No. 190
Three-tube Neutrodyne. A wonderful performer. Price (less tubes, batteries, etc.) \$75.

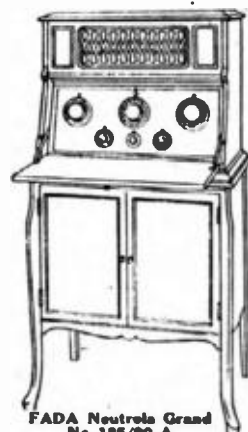

FADA Neutrola Grand
No. 185/190-A
The five-tube Neutrola 185-A, mounted on FADA Cabinet Table No. 190-A. Price (less tubes, batteries, etc.) \$2