

December, 1924

RADIO IN THE HOME

Conducted by HENRY M. NEELY



*In this
Issue:*

*Flewelling's New Circuit
A Two-Tube Harkness
Counterflex*

"The Musical Instrument of Radio"

—horn of natural wood, mellow and resonant

MODEL VI
(14" Horn) \$30

MODEL VII
(21" Horn) \$35

Tops the Gift List

A Music Master for Christmas! A gift the whole family will enjoy.

A gift that re-creates in pure, audible tones all that's best in thought and entertainment, broadcast from five hundred stations daily.

Music Master—the musical instrument of radio—embodies all of the proved principles of sound reproduction.

The reproducing unit is extremely sensitive and responds to the faintest impulses. The tone chamber is heavy cast aluminum, unequaled for developing sound waves free from distortion. And the amplifying horn is natural wood, mellow and resonant like a violin.

Have you heard Music Master? Your dealer will be glad to demonstrate it for you, or to place one in your home on trial.

DEALERS EVERYWHERE

Music Master Corporation

Makers and Distributors of High-Grade Radio Apparatus

Tenth and Cherry Streets

Chicago PHILADELPHIA Pittsburgh

Music Master
RADIO REPRODUCER

MODEL VIII



The New Music Master Cabinet model, with "Full floating" horn of violin wood, possessing all the wonderful reproducing qualities of the famous horn type Music Master. Powerful, sensitive unit; heavy cast aluminum tone chamber; handsome mahogany cabinet.

Size 17 1/4" x 10" x 10 1/4".

\$35

Connect any

Music Master

in place of Headphones. No batteries required. No adjustments.



Of Course It's
a CROSLEY
Better-Costs Less
Radio

THINK of the boundless delight of that dear old mother, confined to the house by the rigors of winter or the infirmities of age, when she listens in for the first time on a Crosley Radio. Imagine the joy of the kiddies, when they awaken you Christmas morning with the glad tidings that "Santa has brought us a Crosley Radio." Then decide to make this a Crosley Christmas.

There can be no gift with greater possibilities for continued happiness than a Crosley set. It carries Christmas along through the year, continually giving new thrills and happiness, and bringing pleasant thoughts of the giver.

It is a delight to operate a Crosley. The immediate response to the turn of the dials; the clearness of reception from far distant points; the real ease with which local stations may be tuned out; all help to make Crosley reception distinctive and exceptionally pleasurable. The very low cost at which this really remarkable radio performance can be obtained places Crosley sets within the reach of all—the ideal Christmas gift.

The Crosley Trirdyn—in Regular, Special or Newport Cabinet as illustrated—has especially opened the eyes of the radio world. Coming through the summer period of rather poor reception with colors flying, the Trirdyn, with its original combination of one stage of tuned radio frequency, regenerative detector and reflexed amplification, has proven beyond a doubt that the features of selectivity, volume and ease of operation can be obtained with three tubes better than heretofore has been possible with five.

**BEFORE YOU BUY—COMPARE
YOUR CHOICE WILL BE A CROSLEY**

For Sale By Good Dealers Everywhere

*Crosley Regenerative Receivers are licensed under Armstrong U. S. Patent 1,113,119.
Prices West of the Rockies add 10%*

Write for Complete Catalog

THE CROSLEY RADIO CORPORATION

Paul H. Crosley, Jr., President

1260 Alfred Street

Cincinnati, Ohio

Crosley owns and operates Broadcasting Station W L W



Crosley One Tube
Model 50, \$14.50

With tubes and Crosley Phones \$22.25



Crosley Two Tube Model 51, \$18.50

With tubes and Crosley Phones \$30.25



Crosley Three Tube Model 52, \$30.00

With tubes and Crosley Phones \$45.75



Crosley Trirdyn Regular, \$65.00

With tubes and Crosley Phones \$90.75



Crosley Trirdyn Special, \$75.00

With tubes and Crosley Phones \$90.75



Crosley Trirdyn Newport, \$100.00

With tubes and Crosley Phones \$115.75

Mail
This
Coupon
At Once

The Crosley
Radio Corp.
1260 Alfred St.
Cincinnati, O.

Mail me, free of
charge, your catalog
of Crosley receivers
and parts.

Name _____

Address _____

Eveready Heavy Duty "B" Battery, 45 volts. Three Fahnestock clips. Length, 8 3/16 inches; width, 4 7/16 inches; height, 7 3/16 inches; weight, 13 3/4 pounds. Price \$4.75.



*Dry "B" Batteries
are more economical
and more dependable
than any other
source of plate
current!*

REDUCE Operating Costs

THOUSANDS of people are already cutting their "B" Battery costs one-half, or even two-thirds, by using the new Eveready "B" Battery No. 770 on their heavy drain sets.

This new Eveready Heavy Duty Battery marks a marvelous advance in reducing "B" Battery costs.

If your "B" Batteries have lasted only two months on a five or six tube receiver, this Eveready Heavy Duty "B" Battery will increase the service two to three times.

Use this Eveready Heavy Duty "B" Battery on any receiving set on which the "B" Batteries last less than four months. When thus used to its full capacity, it is the cheapest as well as the best source of "B" energy ever offered.

Manufactured and guaranteed by

NATIONAL CARBON COMPANY, INC.

Headquarters for Radio Battery Information

New York

San Francisco

Canadian National Carbon Co. Limited, Toronto, Ontario

EVEREADY
Radio Batteries
-they last longer

THE
JOHN C. FISHER
LIBRARY

RADIO IN THE HOME

Volume III

FOR DECEMBER, 1924

Number VII



Radio in the Home of W. C. Simons at Lawrence, Kansas, editor and owner of the Lawrence Journal-World, one of the oldest newspapers in Kansas. The family are all interested, mother and children. The set is a Grebe Photograph by Alfred Lawrence

CONTENTS

| | | | |
|---|----|--|----|
| Editorially Speaking | 6 | New Studios Ready for WLW's Super-power | 24 |
| Easy with those Supers, Folks! | 6 | WEEL, The Friendly Voice, and WTAT, Edison Light, Boston | 26 |
| Welcome! Newcomers in Radio | 8 | A Favorite Circuit Simplified | 28 |
| Flewelling's New Circuit | 11 | No Wonder the Kiddies Love Her | 30 |
| Will Big Business Pay for Our Programs? | 13 | Little Tales of Radioland | 31 |
| The Two Tube Harkness Counterflex | 16 | The Slant of the Trade on Radio | 53 |
| The Two Tube Counterflex (3XP Style Wire-Ups) | 18 | Further Notes on the Inverse Duplex Neutrodyne | 54 |
| Reflexing the Oscillating Set | 21 | | |

VOLUME III

RADIO IN THE HOME

NUMBER VII

Published Monthly by the Henry M. Neely Publishing Company, 608 Chestnut St., Philadelphia, Pa. Experimental Station (3XP), Delanco, N. J.

| | | | |
|-----------------------------|---|---|--|
| Bell Telephone—Lombard 8431 | HENRY M. NEELY.....President and Editor | NORMAN NEELY.....Art Director | HARINARD FOOTE.....Contributing Editor |
| | G. W. KRAFT.....Secretary and Treasurer | DAVID GRIMES.....Associate Editor | W. FRANCIS GOODREAU.....Laboratory Assistant |
| | W. L. DUDLEY.....General Manager | EDMUND T. FLEWELLING.....Associate Editor | |
| | M. M. MORRIS.....Advertising Manager | KENNETH HARKNESS.....New England Representative | |

Radio in the Home is sold at 10c per copy at all newsstands, radio shops and bookstores. Subscription rates in the United States, \$1.00; Canada, \$1.50; Foreign, \$2.00 per year.

Printed on the rotogravure presses of the Public Ledger, Philadelphia, Pa. Copyright, 1924, by the Henry M. Neely Publishing Company Entered as second-class matter May 26th, 1922, at the Postoffice, Philadelphia, Pennsylvania, under the act of March 3, 1879

Editorially Speaking

By

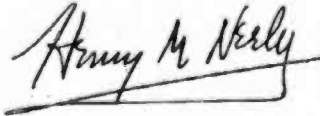

I HAVE been a good deal concerned lately by the growing

About "Current-Tap" Devices

number of advertisements of devices which are designed to take both "A" and "B" battery current directly from the alternating current house lighting system. These outfits are now known technically in the trade under the generic name of "current-tap devices."

The propaganda in favor of these current-tap devices is following the same lines that have been followed by all other crazes in radio. In fact, radio seems to be particularly and peculiarly a succession of crazes. It is the most remarkable game of "follow the leader" that I have ever seen in industry. The moment any one gets out any sort of an idea, everybody else rushes in to cash in on it whether they know anything about it or not.

This same system is being followed with these current-tap devices.

Now let us consider dispassionately the real situation of these devices.

In almost all of the advertising of such units, you will see the wildest kind of statements about the "noises" in storage and dry cell batteries. Such statements are either deliberately untrue or are the results of an ignorance so abysmal that the publication is quite as culpable as a deliberately untrue statement.

What is the truth about "noisy" batteries? In the beginning of the radio enthusiasm, the Bureau

of Standards outlined a long series of exhaustive tests through which they intended to put various types of batteries. One of these was a "noise test."

This test was designed to classify and study the supposed internal noises of run-down batteries. These noise tests were continued for two years. At

the end of that time, the results were tabulated and it was found that there was not a single case of internal noises of batteries due to the fact the batteries were run down. The few cases of internal noise were directly traceable to the fact that rough handling or something of that kind had caused a loose contact inside of the batteries, and it was this bad contact that was causing the noise.

There is no such thing as a chemical noise in a run-down battery.

Such a fault as a loose contact is not peculiar to batteries. It is peculiar to every single instrument used in radio and is just as likely to take place in a current-tap device as it is in a battery. Another view which should be taken of this con-

cerns the wild statements in advertising about the perfect current which is delivered by a current-tap device.

As a matter of strict fact, science cannot produce any current which is as nearly perfect as the current taken from a good battery, either storage or dry cell. Every other device is merely an approximation of this battery current. Broadcasting stations which are run on rectified AC or on

Easy With Those Supers, Folks!

THE worst menace to radio that has yet threatened us is the home-made super-heterodyne when it is coupled to an outdoor antenna.

Last month I almost made myself very unpopular with a large body of readers as well as manufacturers because I had already prepared and had set in type an editorial denouncing all makers and users of super-heterodyne kits. However, just about the time we were going to press a number of my friends with whom I talked it over convinced me that wholesale denunciation was not the way to handle this question, and so I withdrew the editorial.

There is apparently only one thing left that we can do in facing this menace, and that is to plead for the co-operation of owners of super-heterodyne outfits and get them to realize that as long as they are operating their sets on outdoor antennae, they are ruining radio reception for other people within a good many miles of them.

The super-heterodyne, when operated on an indoor loop, is not so offensive. Let me just state as simply as possible what happens while you are using one of these supers and then, with this pictured clearly in your mind, you can decide for yourself what kind of radio citizen you want to be.

Let us take first the super-heterodyne operating on an indoor loop. I will give you one example of an experience which we had at Station 3XP and you can draw your own conclusions.

About six months ago a prominent manufacturer who was putting one of these kits on the market phoned me and asked if he could bring the set out to Delanco to show me what an excellent outfit he had. I naturally was very much delighted to have him do so, as I like in this way to keep in touch with all developments in the art. It just happened that one of my neighbors had recently put together one of this man's sets, and so I phoned the

(Continued on Page 66)



MODEL VI (Illustrated)

Splendid for loud speaker reception of distant stations. Selective, but simple to tune. Anyone can use it. Each station is always found at its own setting on No. 1 dial. The other dial regulates volume. Non-radiating—no squeals to annoy others.

Less Accessories . . . \$105.00
West of the Rockies . . . 107.50

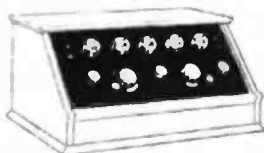

MODEL XV, five tubes, Super-selective long range radio frequency model. It cuts right through local broadcasting and brings in distant programs. Simple tuning with only two controls. Volume can be controlled. Non-radiating.

Less Accessories . . . \$142.50
West of the Rockies . . . 145.00

A HINT quietly given to the Right Party is likely to bring you this royal gift. It's worth trying!

When you're out together, lead the way so it takes you past the store where KENNEDY Receivers are on display. If you show interest in one, the dealer will demonstrate it. Once a KENNEDY is heard, there is sure to be a strong recommendation to Santa to bring that set on Christmas Eve.

The KENNEDY tone quality is superb

and full rounded. It insures musically pure reproduction of any program within a good long range. No hollow tones or distortion. No fussing or fishing for stations. Simply turn one dial to a certain point, and there is the station you want.

N. B. to Santa—Nothing will bring a family more hours of keen delight than a KENNEDY. It keeps young folks home and older folks happy. KENNEDY models are so troubleproof that even a mechanical enthusiast can find nothing to improve.

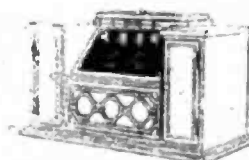

MODEL XI, Sheraton period mahogany cabinet with satinwood and ebony inlays. Dials and metal fittings finished in gold. Built-in loud speaker. Combines the charm of fine furniture with the most advanced principles of radio construction. Brings in out-of-town stations with loud speaker volume. Logged tuning on one dial. Controlled volume. Non-radiating.

Less Accessories . . . \$185
West of the Rockies . . . 190

generators go to tremendous expense and trouble in order to filter out all of the noises of such currents in order to make them *as nearly equal to battery operation* as is possible. But battery operation is the ideal and the standard and anything else must have its success or its failure measured according to the nearness with which it approaches a good battery.

So far as I know, there are only three of these current-tap devices which even approach the commercial stage at the present time. These three devices are being put out by reputable firms who are absolutely guaranteeing the customer's money back if the device does not work in his own home.

Some months ago I spoke of such devices as these and I advised my readers very strongly then not to purchase any such device unless it was backed by an absolutely iron-clad guarantee of money back—this guarantee to be made by a firm whose standing was unquestioned.

Since then, dozens of fly-by-night concerns, gyp stores in various sections of the country, unknown dreamers in the realm of radio, and the whole fraternity of Get-Rich-Quick Wallingfords have come out with glaring announcements that they have solved this problem.

As a matter of fact, all of their devices are based upon principles which have been known for many years to such concerns as the Westinghouse, the General Electric, the Western Electric and the A. T. and T. All of these great firms, with limitless capital at their disposal, with the greatest engineering brains in the world belonging to their staffs, with every incentive to perfect such

devices if they could be perfected, have worked with them, have developed very wonderful laboratory models, but have been convinced that the day is not yet here when such devices can be put out upon the market generally at a reasonable price, and yet so constructed that they can be guaranteed to work

under all conditions of current supply and on all types of receiving apparatus.

The three devices which I have already mentioned are put out with this fully understood. They will work very satisfactorily, I should say, in 90 per cent of the cases and the manufacturers are perfectly willing to return the purchaser's money in the other 10 per cent where they will not work.

I simply want to impress here the advice which I gave some months ago. *Don't buy one of these devices unless there is an absolute money-back guarantee behind it.* Don't buy it on the salesman's say-so. Most of these fly-by-night

manufacturers do not even know the problems that they are facing; they are not engineers, and the engineers whom they may have on their payroll developing these devices are not men whose practical knowledge is so broad as to include all of the difficulties of the many different types of hook-ups and the many different peculiarities of current supply which are found in various sections of the country.

I firmly believe that the day of the current-tap device will come. I do not believe that it will ever furnish the pure current given by a good battery, but I believe the current which it will supply will be thoroughly satisfactory to the average radio fan, and he will prefer the

Welcome! Newcomers in Radio

NOTHING has pleased me more in recent months than to receive demands from my correspondents in all sections of the country for hook-ups for the simplest kind of radio set.

To me, this means just one thing: *radio is receiving, this year, a great influx of people who have not heretofore been attracted by it.*

Last winter the pessimists talked about the radio market then being saturated. My claim was that the radio market was really not 10 per cent yet sold.

This new demand for the simplest type of circuit proves that my point was probably well taken. We are now getting into radio thousands of people who have been holding off and who are today becoming attracted to it because of the improvement in programs.

These people look over this magazine and see the hook-ups for inverse duplex neutrodynes, for superheterodynes, and for all of the elaborate outfits which the advanced fan demands. They are not yet ready for these sets. They want to start just as you and I started with the single-circuit regenerative set or even, perhaps, with the crystal set.

This demand is a very healthy sign. To me it is the best sign that I have seen yet this season. *It means that radio is beginning to be sold to the general public.*

I am accordingly starting in this issue a series of just such hook-ups as these folks demand. In the old days, when we put together a regenerative set, our greatest

(Continued on Page 58)

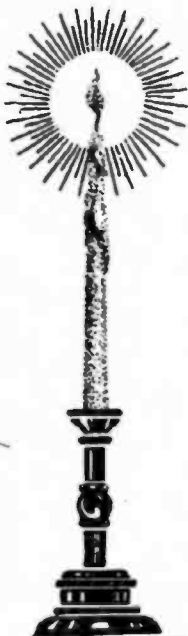

(Continued on Page 38)

MAGNAVOX Radio

*The Utmost
in Quality and Value*



YEARS AGO, when Radio meant little more than listening through a set of headphones to a phonograph record played a few miles away, Magnavox developed the now famous electro-dynamic Reproducer.

This instantly opened the door to that astonishingly vast fund of free musical entertainment, lectures, and feature programs which Radio offers the world today.

The name Magnavox now stands for a great organization pledged to the highest manufacturing standards, initiative in research, and policies insuring unequalled value to the purchaser of any Magnavox instrument.

Especially important to the new radio user (and also those who de-

sire to replace their old equipment with the latest and best apparatus obtainable) are the remarkable cabinet receivers and storage battery tubes now exhibited by Magnavox dealers everywhere.

Magnavox Radio Products

Broadcast Receivers—A 5-tube tuned radio frequency circuit with Unit Tuner and Volume Control, in handsomely carved cabinets with and without built-in Magnavox Reproducer

Vacuum Tubes—Amplifier and Detector Tubes designed on new principles making them far superior to ordinary storage battery tubes for all standard sets

Reproducers—Instruments of the electro-dynamic type with Volume Control, and of the semi-dynamic type requiring no external battery, for all vacuum tube receiving sets

Phonograph Attachment—The semi-dynamic Magnavox Reproducer mechanism in a unit readily attached to any standard phonograph

Reliable dealers in every community are prepared to demonstrate Magnavox Radio equipment. Catalog on request.

The MAGNAVOX COMPANY
OAKLAND CALIFORNIA

New York: 350 West 31st Street
San Francisco: 274 Brannan Street

Canadian Distributors:
Perkins Electric Limited, Toronto, Montreal, Winnipeg



THE FAMOUS 3XP!

*The 3-Tube Inverse Duplex Combining
Tuned Radio With This Super of Reflexes*

This new arrangement of the Grimes System which created National enthusiasm when first developed in the Laboratories of "Radio in the Home" and described in the June and July Issues, is NOW, for the first time, produced for you in this Official Laboratory Model.

Of course, the Inverse Duplex Principle is well recognized in these unique outstanding features.

- (1) *The only Balanced Circuit.*
- (2) *A Three-Tube System really giving Six-Tube Results.*
- (3) *Natural Reproduction that only Inverse Duplex can give.*

SPECIFICATIONS

2 Stages of Tuned Radio Frequency
Tuned Fixed Detector
3 Stages Audio Frequency
Sloping Panel

Rubber-Hung Sockets
Chamber for Batteries
3-Control Selectivity
Antenna and Ground Operation

Mahogany Cabinet

THE INVERSE DUPLEX
Insures Natural Tone Quality

LICENSED UNDER PATENTS ISSUED AND PENDING

INVERSE DUPLEX SYSTEM
Insures Natural Tone Quality

Licensed Under Patents Issued and Pending

*Jobbers' territories are
being allotted very rapidly.*

Retail Price **\$85.00**
(without accessories) only

For further information apply to your jobber or direct to

DAVID GRIMES, Inc.

1571 Broadway : : : New York, N. Y. : : Strand Theatre Building

Radio in the Home

GRIMES-FLEWELLING-HARKNESS

Associate Editors, Writing for No Other Magazine

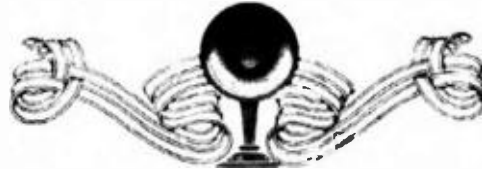

Flewelling's New Circuit

By
EDMUND T. FLEWELLING

Associate Editor of "Radio in the Home."

HERE is Mr. Flewelling's first announcement of his latest improvement and simplification of the circuit which made his name famous in radio.

This article is intended primarily for the fans who have already hooked up the original Flewelling circuit and who are sufficiently familiar with the operation of the old arrangement to be able to adapt it to this new one. This article is also detailed to enable any fairly experienced radio fan to get an introduction to one of the most fascinating and mysterious circuits in radio.

Next month Mr. Flewelling will take up more in detail the constructional data and will tell of some of the operating characteristics of it. H. M. N.

JUST about two years ago the subject of super-regeneration, or regeneration carried to the utmost, was brought before the public by Edwin H. Armstrong, a man who has been of tremendous help to the science of radio communication. Considerable work had been done on this subject by such men as Turner and Bostitho across the water and by our own engineer, Charles V. Logwood. C. V. Logwood has done work of inestimable value in the radio field and now holds priority and patent rights on super-regeneration. I speak of Logwood here because of the above connection, and because I shall have more to say of him in future articles that I hope to write for *Radio in the Home*, and I wish my readers to become acquainted with the name if not the man.

Being a bit familiar with the work of these engineers I was more or less armed to tackle the question myself and to the dismay of my folks did tackle it. Inceas-



E. T. Flewelling at the test table at Station 3XP, the laboratory of Radio in the Home

ing regeneration certainly does increase the signal strength as you all know. How many times though, have you wished that you could go right on increasing it without having your set start up with a howl of protest? I imagine that every one who has used a regenerative receiver had that wish often.

Well, super-regeneration is the granting of the wish. It was the effort on my part to accomplish this in a simple manner that resulted in the Flewelling circuit.

The circuit was published for the first time in October, 1922, and because of its simplicity immediately became quite popular, but I felt that because of its well-known trickiness in operation its popularity would be short-lived. It had its day and we felt was about to be among those who have passed by, when a cable came from England asking for full and complete details. France, Germany and Australia followed and before I knew it, Flewelling circuits were in use around the world. Today finds, perhaps, more of them in use than ever and I suppose it can be considered the most tricky and also the most delightful circuit known.

I say delightful because it seems continually to furnish new surprises to its user. One never knows until told by the announcer whether the station that is coming in is one or one thousand miles away. Antenna, loops, grounds, etc., don't mean much to the receiver, so that I shall recommend its use without any of them, but a



All the material in this article is fully protected by the copyright laws. Permission to republish, either in whole or in part, will be cheerfully given providing the republication is fully credited to "RADIO IN THE HOME, Philadelphia." Otherwise this circuit and these instructions must not be used by other publications nor in any other unauthorized manner.



ground and that only as you may care to try it. Tricky because of apparatus unsuitable for the needs, because it seems so hard to have it constructed exactly as per directions and because of the exact circuit used. The trickiness has been removed so far as getting the set to function is concerned, but still remains in *w*l its glory so far as concerns what station you will get on it.

I am going to describe in my article next month the development of the circuit through its various stages, but in order to whet your appetite I shall show in this article, a hitherto unpublished modification and improvement of the Flewelling circuit. It is an improvement that makes it possible for any one to build and operate the circuit immediately without any fuss or feathers provided, of course, they do not go too far astray from directions. First let me describe some of the characteristics of the receiver because you had better not build it unless you know of them. Your neighbor, who has heard of it, will say that it radiates and disturbs every other set in the neighborhood, and he will be right if you use it on an antenna, *which you should not do*. Without an antenna, however, the radiating feature is entirely negligible and can be dismissed.

During operation of the set there will be heard a continuous high pitched whistle. Here is the main characteristic of the circuit. The continuous whistle has made audio amplification undesirable and thus has automatically barred the receiver from the position of a satisfactory quality music

receptor. You are building this receiver, you know, for the pure fun and mystification that it contains and must overlook the whistle temporarily.

In succeeding articles I might be able to show you how to remove the whistle, add audio amplification and still do the mysterious things, but on the loud speaker in-

stead of head phones. This is not a promise, remember—just that it might be done, and I speak of it to ask that you follow implicitly the layout to be given so that your set will not have to be thrown into the discard for a better type.

Then next—what volume can you get from one tube? Everything favorable and and the set in good humor, local stations often operate the loud speaker quite decently, distant stations also, because one has almost the same volume in this receiver as the other.

Consider now the plain single-circuit regenerative diagram shown in Figure 1. Familiarity with it means more or less ability to handle the Flewelling circuit, because we shall only cut a little here and add a little to it there and have for our pains the circuit shown in Figure 2. Flewelling fans will recognize the

familiar .006 mfd. condenser, but will be surprised at the location of the variable grid leak in the connection marked "X," now fairly well known as the "X lead" in the circuit.

Mention of "single circuit" probably makes you say, "good-by, selectivity." Be warned here, my friends; 90 per cent of your trouble will be that the circuit is so selective that you will not handle it carefully enough to tune in even a local station until you become accustomed to it. Besides this we shall remove a bit of the single circuit feature as we go on.

Remembering that no antenna is to be used, note that under no circumstances is any connection other (Continued on Page 46)

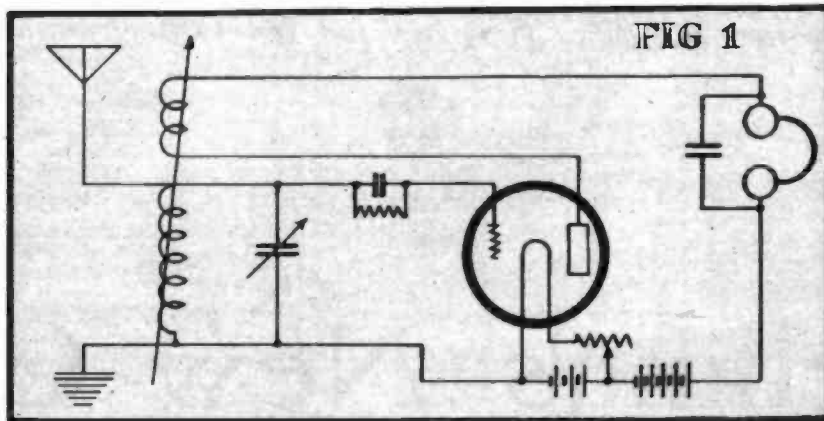

Here is the plain single-circuit regenerative receiver familiar to every one



And here is the latest modification of the famous Flewelling super-regenerative circuit

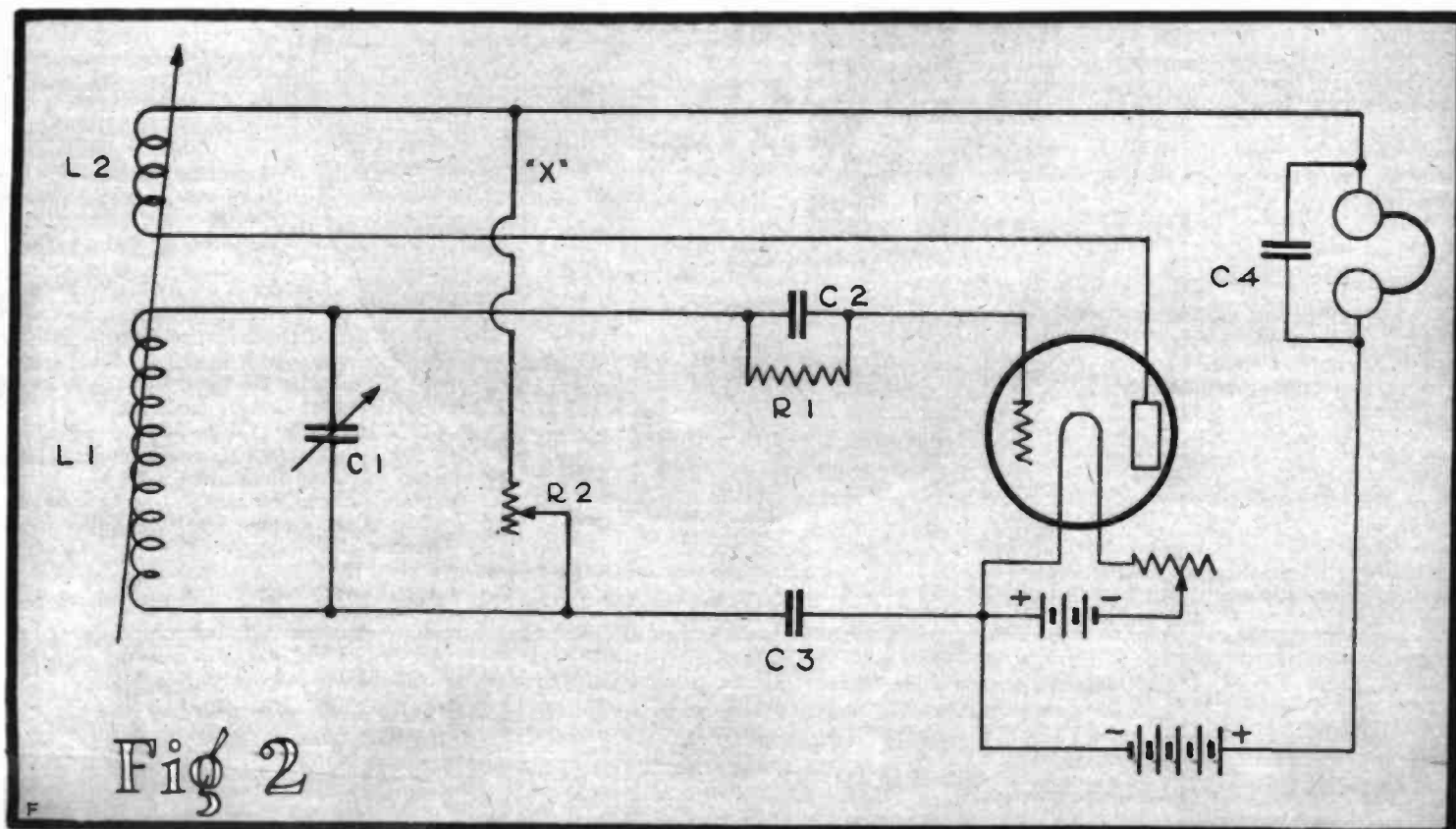
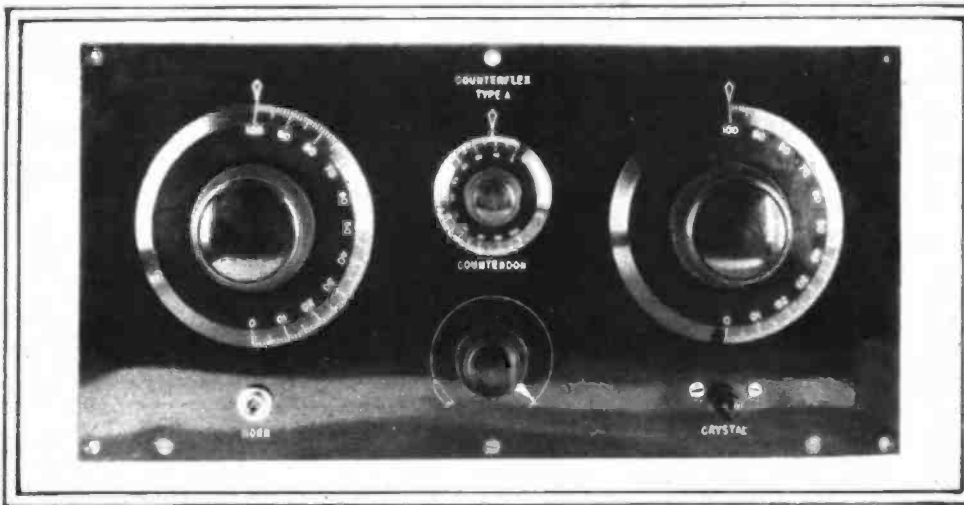

Fig 2

Pages 13-16 are missing in the original.



to exaggerate the faults of the crystal detector and thereby deter you from building this receiver because it is really a very excellent set and has most desirable qualities; but there is no such thing as a perfect crystal detector, and, no matter what mineral is used, it will burn out and lose its sensitiveness after a few weeks. If you continue to use a worn-out piece of mineral in this set you will be disappointed in its operation and you will probably lose your temper each time you try to find the few remaining sensitive points on the crystal.

However, if you are willing to accept the fact that a crystal wears out and must be replaced every few weeks, the operation of your receiver will be comparatively simple, although not nearly as simple as the vacuum tube detector set.

Before building the receiver I described in this article I (Continued on Page 44)

ceedingly simple to operate and will possess none of the erratic, undesirable qualities of the crystal set; moreover, you will receive stations with greater volume and will pick up distant stations which you could not possibly hear on the crystal set.

On the other hand, of course, the vacuum tube detector set will cost you just a little more to build and to maintain than the crystal set, and the quality of reproduction will be slightly inferior.

If you choose to build the two-tube set with crystal detector, as described in this article, your receiver will reproduce broadcasting with a natural faithfulness and delightful perfection which few sets can equal. The volume when receiving local stations will be just right—loud enough, but not too loud. On the other hand, your receiver will not be nearly as good a "distance-getter" as the vacuum tube detector set.

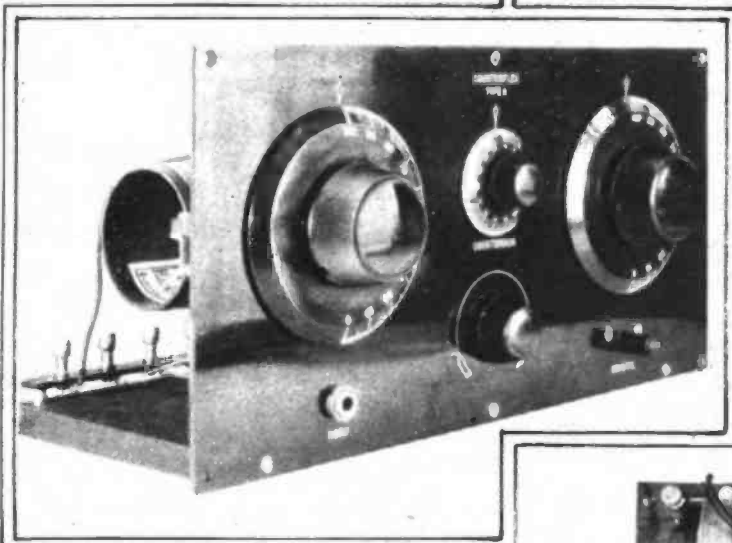
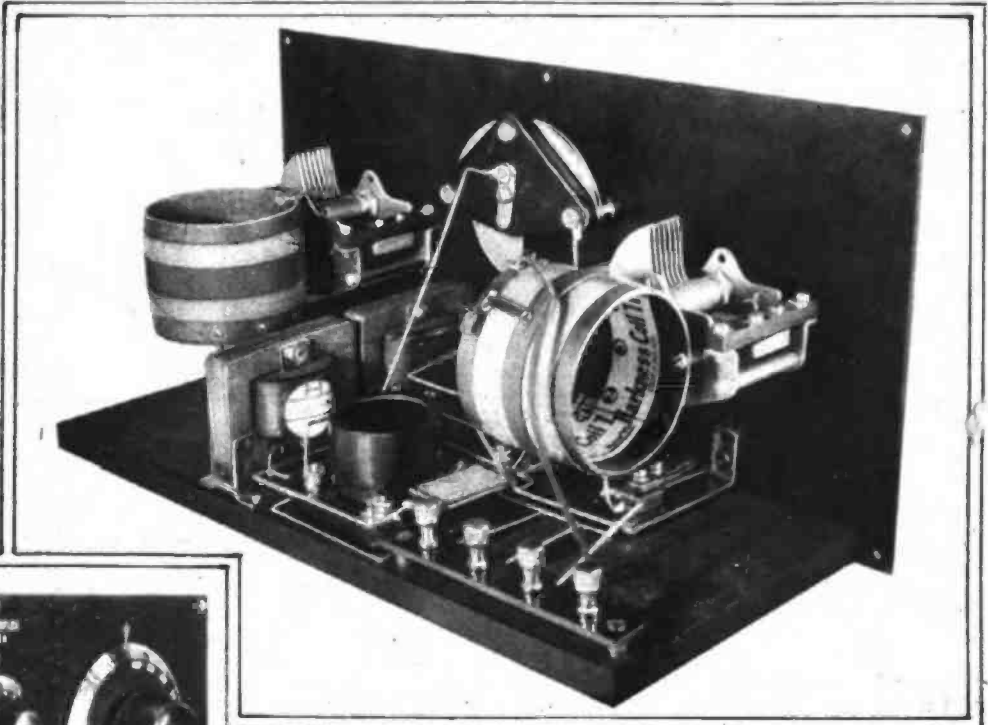

These photographs show various views of the commercial form of the Harkness Counterflex for two tubes and crystal detector. The amateur would do well to make the changes suggested in this article

I do not mean that it will be impossible for you to receive distant stations, as the average range of this two-tube set is about 1000 miles, but if it is "distance" you are after, by all means build the three-tube set with vacuum tube detector.

I recommend this two-tube crystal set only to those who value quality more than distance, and who value it so highly that they are willing to accept and endure the faults of the crystal detector rather than sacrifice even a little quality to obtain the greater ease of operation and sensitiveness of the vacuum tube detector. I do not wish

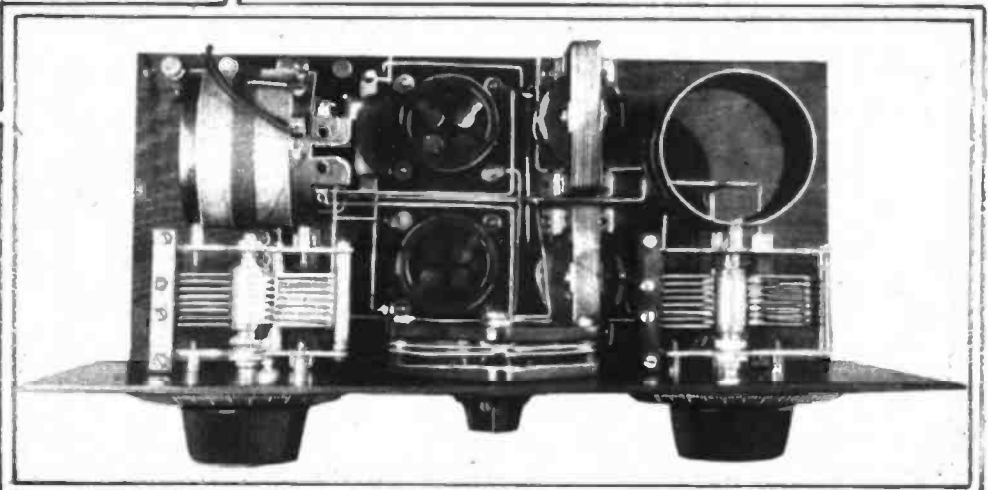

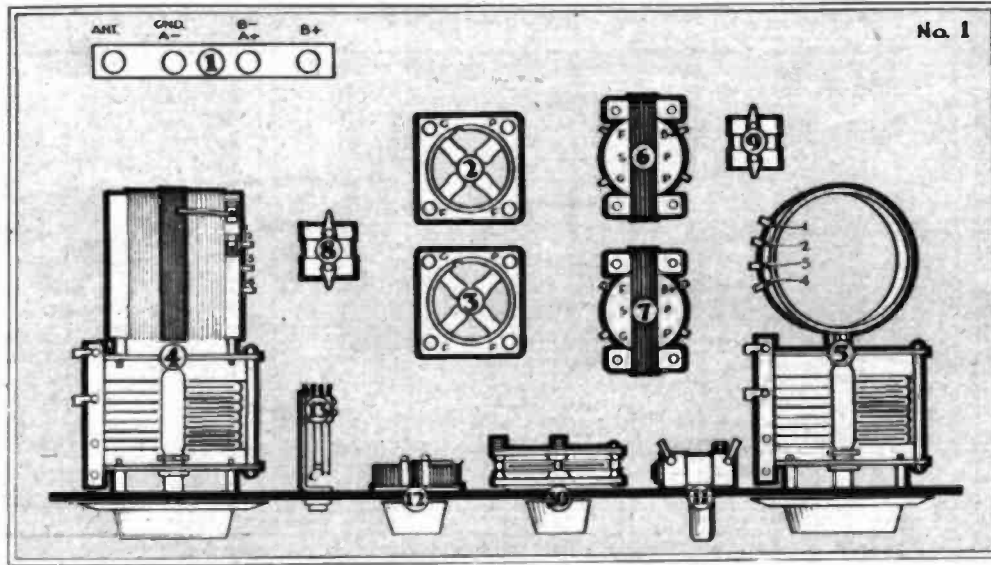

The Two Tube Counterflex

By **KENNETH HARKNESS**

Associate Editor of "Radio in the Home"

IN THE preceding pages I have described and shown photographs of a two-tube Counterflex receiver with crystal detector. In the accompanying diagrams, each step in the wiring of this receiver is clearly illustrated. In diagram No. 1, all the parts used in the construction of this receiver are roughly illustrated. As a matter of fact, the telephone jack, rheostat and crystal detector are not actually visible when looking down into the receiver, but it is necessary, of course, to show these parts in the diagrams. The actual arrangement of the

3XP-Style Wire-Ups to Help the Novice Who Cannot Understand the Symbols in the Schematic Diagram Given on Page 16

apparatus is shown in the photographs with the preceding article. In the first diagram, part No. 1 is a strip of radion with four binding posts mounted on it and soldering tube sockets. Nos. 2 and 3 are standard tube sockets. No. 4 is the Harkness counterformer Type T1, and No. 5 is Harkness counterformer type T2. The winding specifications of the coils of these units were given in the preceding pages. Nos. 6 and 7 are Harkness audio-frequency transformers. If you have other good audio-frequency

transformers on hand you may use them, provided the ratio is not higher than $4\frac{1}{2}$ to 1. No. 8 is a .00025 mfd. fixed condenser. No. 9 is a .001 mfd. fixed condenser. No. 10 is the Harkness counterdon, a three-plate variable condenser made for this circuit. Any vernier condenser, however, will operate satisfactorily, provided it covers the necessary range of capacity. No. 11 is the Harkness crystal detector. This detector is described in the preceding article. No. 12 is a 15-ohm rheostat. No. 13 is a single-circuit filament control jack.

Diagrams Nos. 2 to 6 depict the actual connections to be made between these various parts, each diagram illustrating the

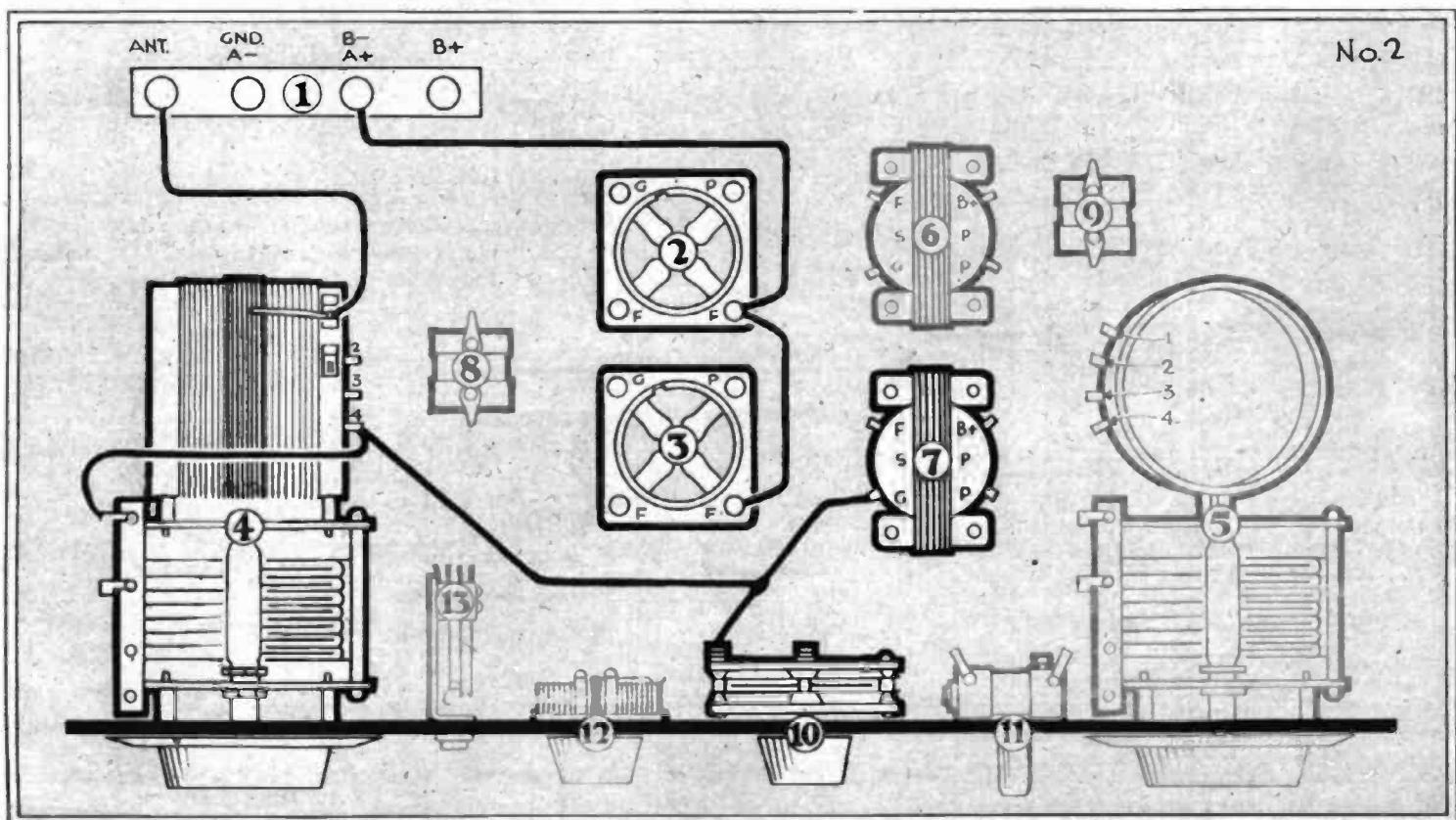

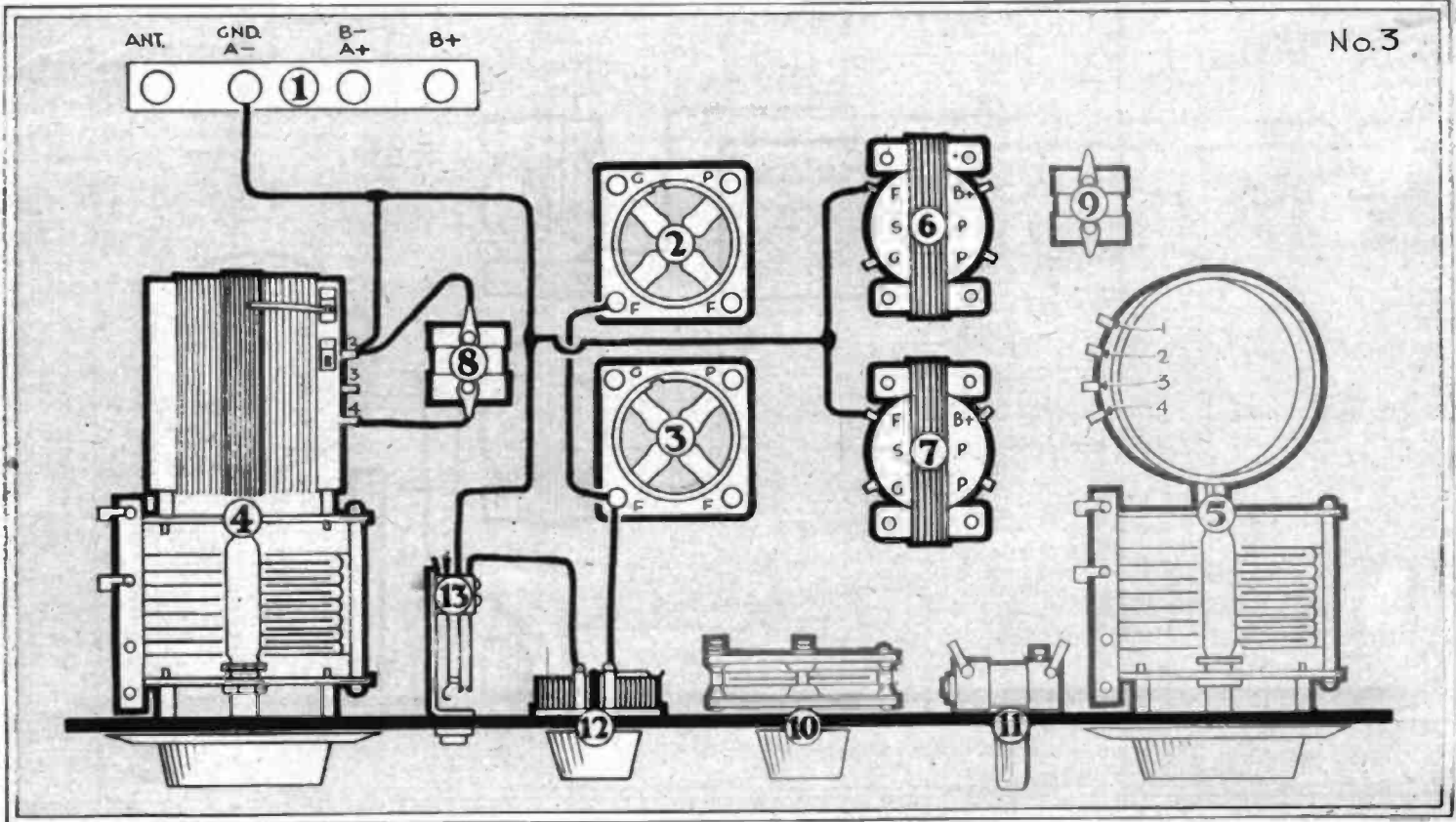

progressive stages in the wiring until it is completed. The wiring should be performed in accordance with the instructions given below:

Diagram No. 2

From positive filament binding post on block No. 1 to positive filament terminal of tube socket No. 2.

From positive filament terminal tube socket No. 2 to positive filament terminal tube socket No. 3.

From antenna binding post block No. 1 to one of the Fahnestock clips on counterformer No. 4. Use a flexible lead for this connection.

From terminal No. 4 of counterformer No. 4 to the rotor of the variable condenser of Counterformer No. 4.

From terminal No. 4 of counterformer No. 4 to "G" (grid) terminal of audio transformer No. 7.

From stator of counterdon No. 10 to

wire connecting terminal No. 4 of counterformer No. 4 and "G" (grid) terminal of audio transformer No. 7.

Diagram No. 3

From negative filament terminal socket No. 2 to negative filament terminal socket No. 3.

From negative filament terminal socket No. 3 to right-hand terminal of rheostat No. 12.

From left-hand terminal of rheostat

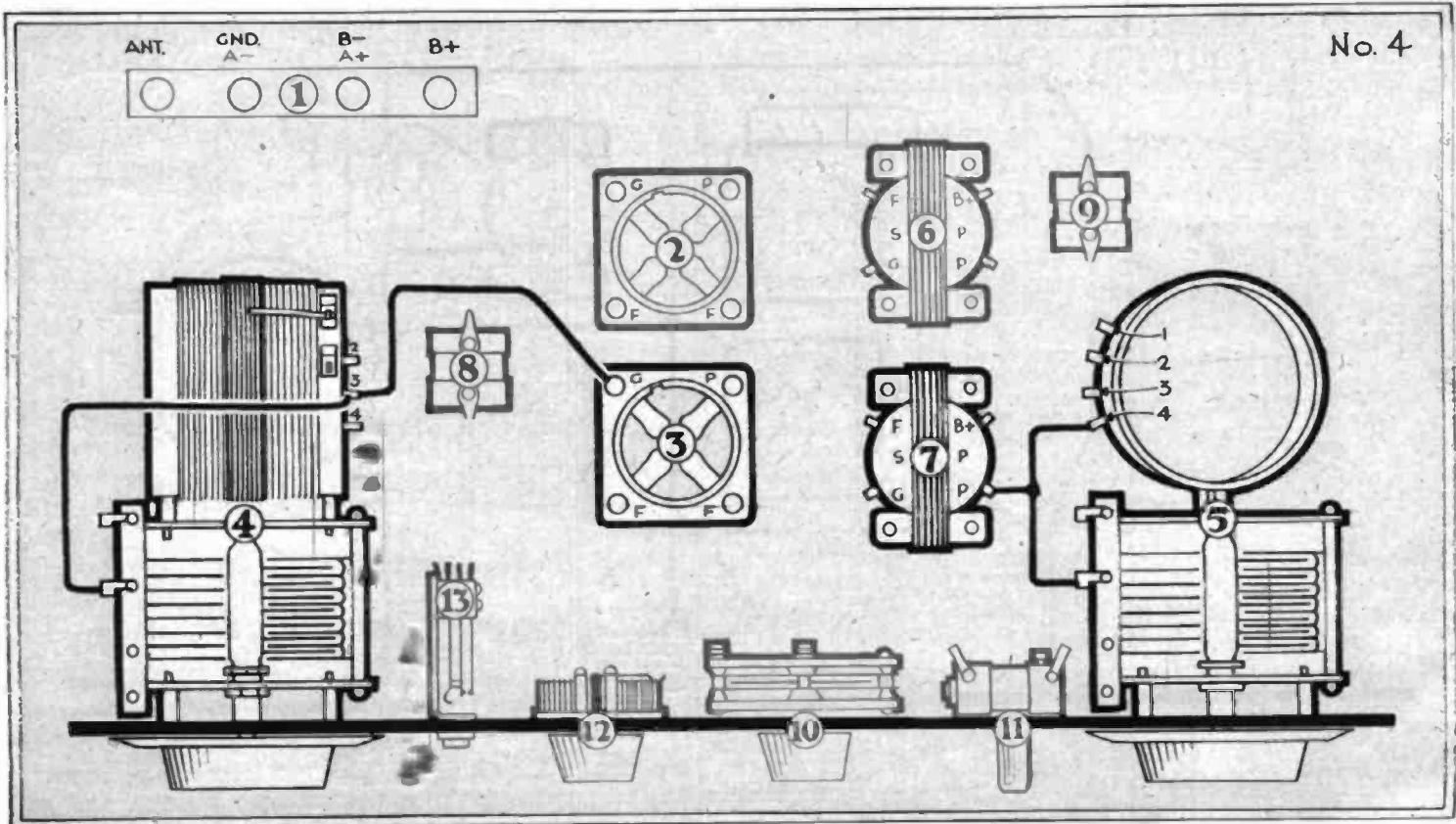

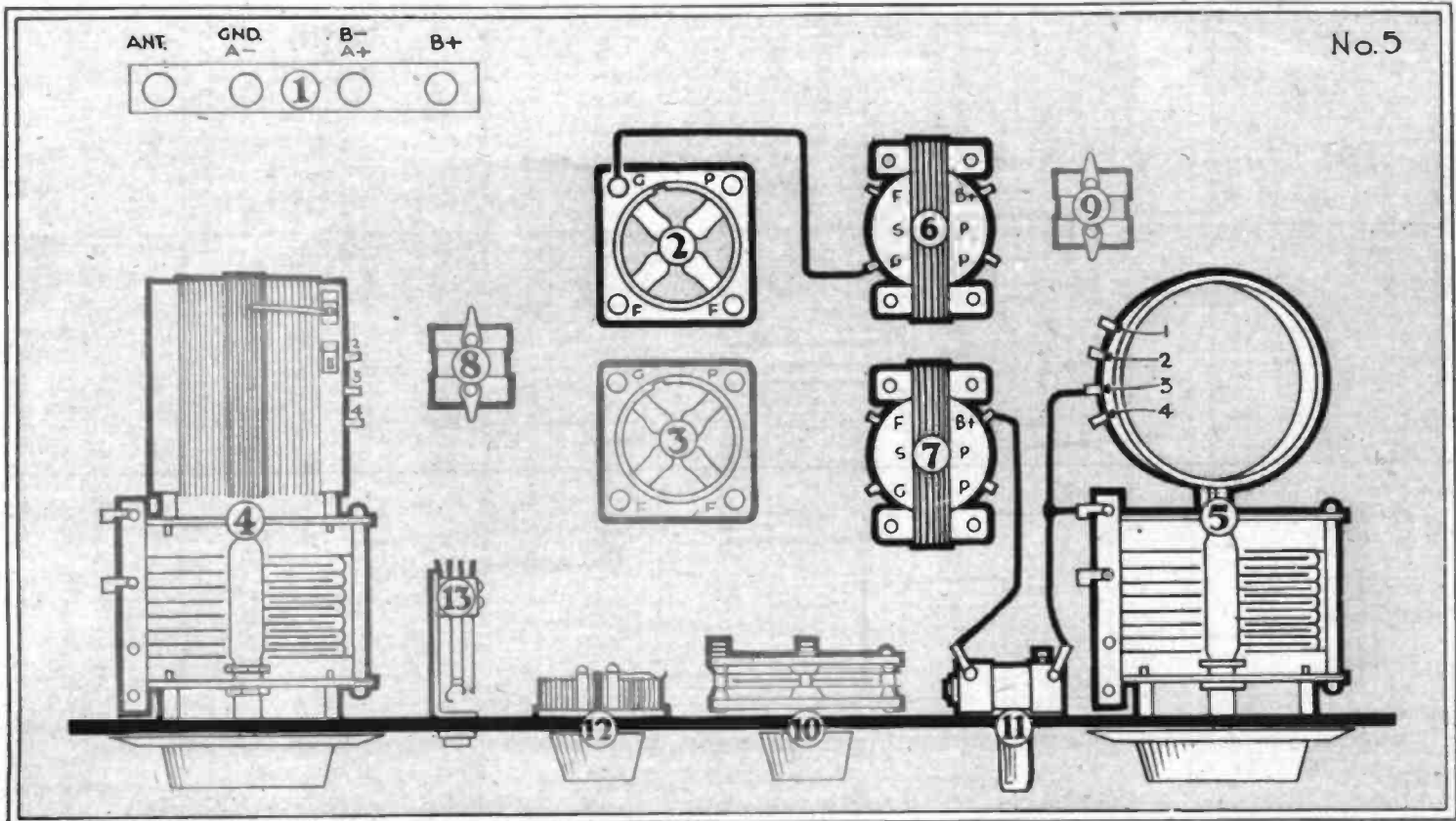

No. 5

No. 12 to top blade of jack No. 13.
 (By the "top" blade I refer to the blade farthest from the frame of the jack, the "bottom" blade being attached to the frame itself.)
 From next to top blade of jack No. 13 to negative filament binding post on block No. 1.
 From terminal No. 2 of counterformer No. 4 to wire connecting next to top blade of jack No. 13 to negative filament binding

post on block No. 1.
 From filament (F) terminal of audio transformer No. 6 to filament (F) terminal of audio transformer No. 7.
 From wire connecting filament terminals of audio transformers 6 and 7 to the wire connecting next to top blade of jack 13 and negative filament binding post of block No. 1.
 Connect one side of fixed condenser No. 8 directly to terminal No. 2 of counter-

former No. 4, using no wire.
 Connect opposite side of fixed condenser No. 8 directly to terminal No. 4 of counterformer No. 4, using no wire.
Diagram No. 4
 From terminal No. 3 of counterformer No. 4 to the stator of the variable condenser of counterformer No. 4.
 From terminal No. 3 of counterformer No. 4 to the grid terminal of tube socket No. 3.
 (Continued on Page 43)

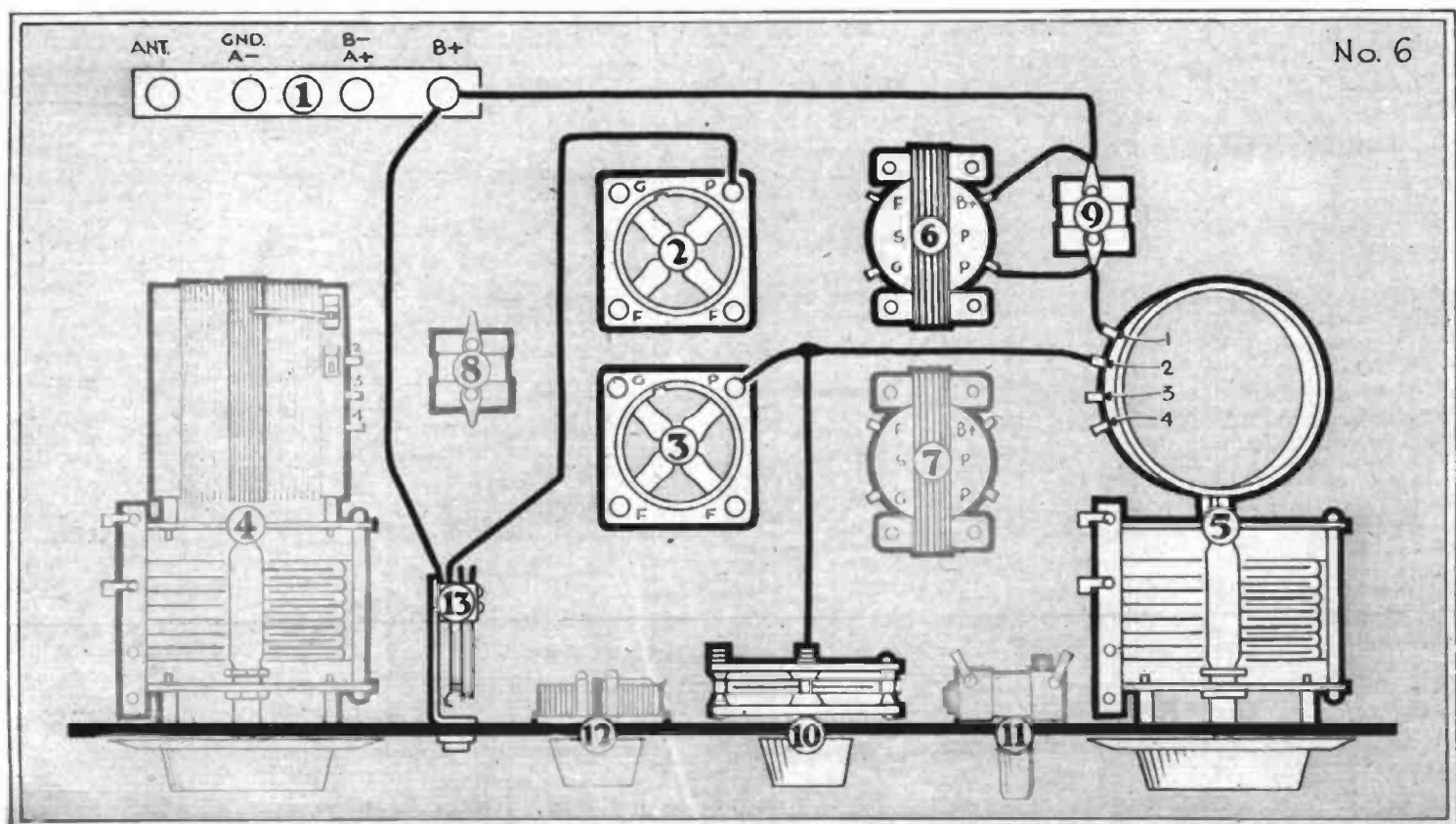

No. 6

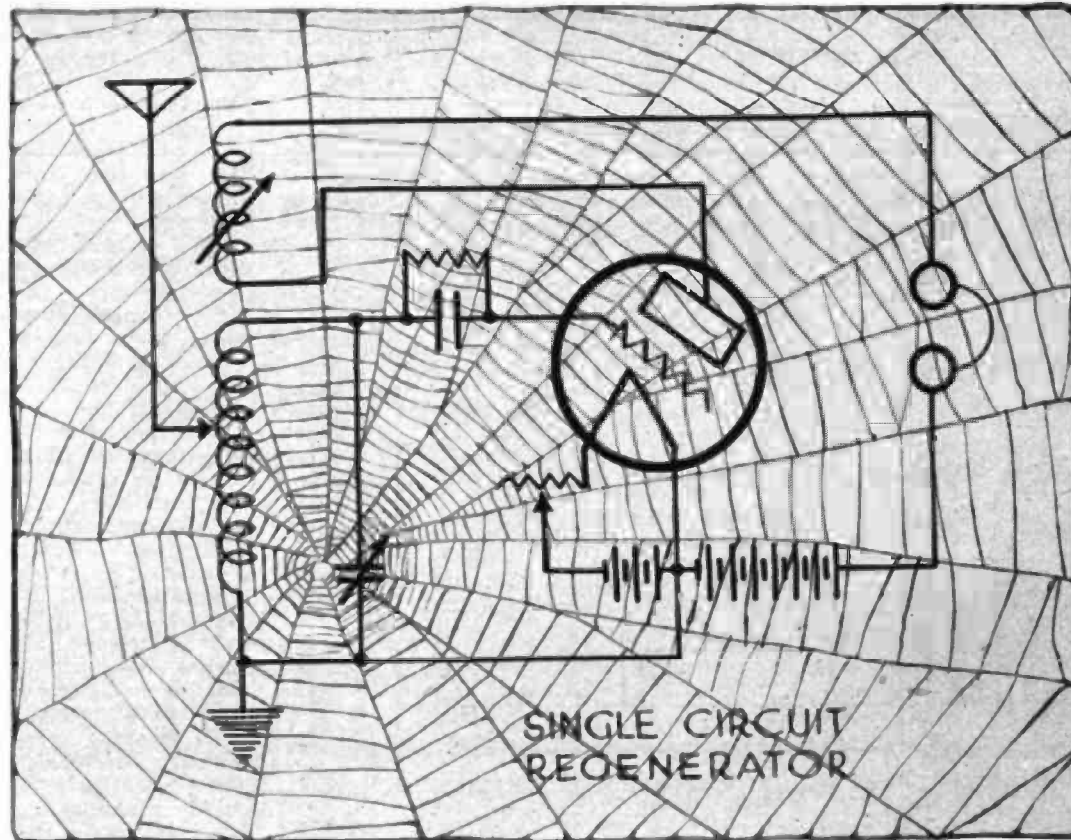

Reflexing that Oscillating Set

THE recent Radio Conference, held under the direction of Secretary Hoover, in Washington, developed certain very definite feelings on the part of the delegates. Those attending the sub-committee on "Interference" were particularly convinced that one certain nuisance of the ether had to be overcome or the reaction against radio would multiply rather than diminish. Nor was this feeling confined entirely within the walls of the committee room. In last month's article we touched upon this increasing menace to radio, and those of you who read the article will appreciate the exasperating annoyance of radiating regenerative receivers.

It has, too, a more serious aspect than the disturbance the whistling causes us directly. It is indirectly responsible for all the spark interference from ships. When the spark nuisance was brought up at the radio conference, the most damaging defense the ship owners presented was the fact that the major portion of ether interfer-

By DAVID GRIMES

Associate Editor of Radio in the Home.

ence at the present time was the whistling from radiating regenerative receivers, and not ships. The ship owners intimated that until the broadcast listeners cleaned their own house and eliminated these whistles

Below—Your single-tube set can be reflexed, stopping radiation and increasing efficiency at the same time

they didn't have a ghost of a chance to clean up the spark question. *And it's a fact.* We're in a nice, strong position to demand that some one else "get off" the air with their interference, when we ourselves are the worst offenders, aren't we?

This is in no way, shape, or manner, a knock at regenerative receivers, but only at that type designed to produce oscillations in the antenna system, or to radiate. These are, in reality, transmitters as well as receivers. And, according to law, you mustn't

transmit without a license. So you are violating the law as well. But it is the easiest thing in the world to prevent or reduce this whistling interference of your set to a negligible minimum. It is the object of this article to show you just what the large manufacturers are doing with their regenerators to enable them to "keep the peace."

About a year ago, when Major Armstrong, the inventor of the regenerative principle, was questioned in regard to this inherent whistling

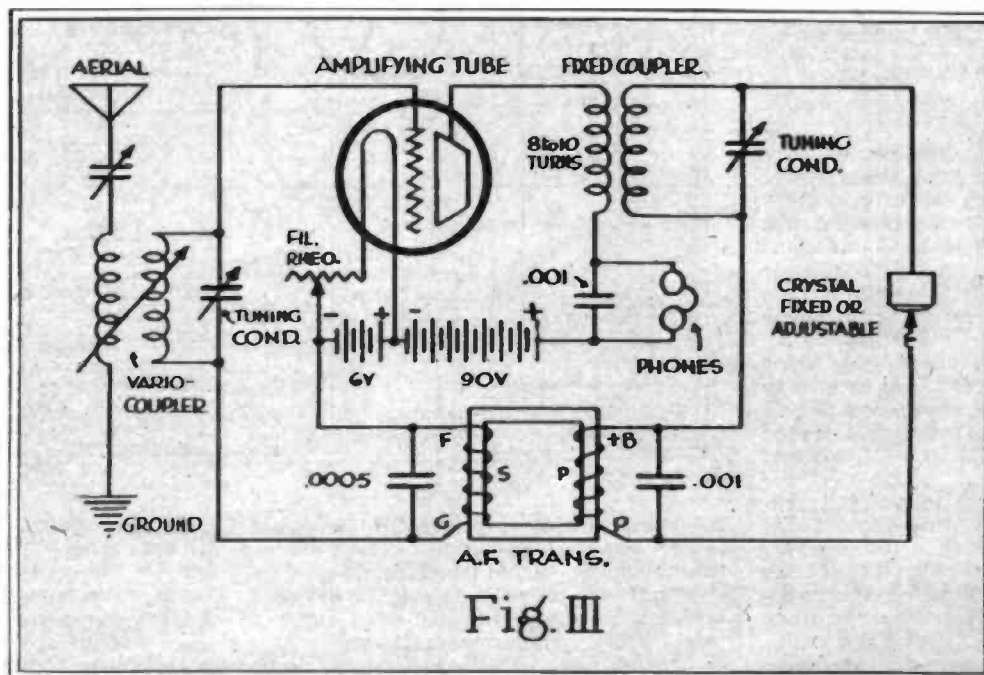

Fig. III

of his set, he stated that a muffling device ought to be perfected to prevent the oscillations of the set from reaching the aerial where they disturb others. He compared it with a muffler on an automobile. Such things, as you know, are now compelled by law. This suggestion of Armstrong's led to several companies adopting this feature; so that now most of the expensive regenerative sets made by the reputable com-

panies incorporate the muffler idea. The best radiation reducer so far proposed is the nonoscillating radio-frequency tube. This is connected between the aerial and the regenerative detector, acting as a one-way amplifying device. It aids any signals passing from the antenna to the set, but stops any disturbance otherwise passing from the set to the antenna. Of course, this muffler tube must be in itself a nonoscillating tube. If this radio-frequency tube squealed, it would be a worse offender than the detector, because of the higher plate voltage. This was fully discussed in the article last month. With this tube working properly, the set is greatly benefited—quite different from an automobile muffler where the power of the motor is reduced! The radio-frequency stage thus employed increases the range of the set and greatly improves the selectivity.

connect the plate and "B" battery of the muffler tube to the aerial and ground posts of the old set and reduce the number of primary turns on the set down to four or five. It will be noticed that only 22½ volts are used on the plate of the radio tube. This will suffice where the tube is used primarily as a muffler and selector. If you desire to obtain some amplification in addition, it is

amplification as well as for radio work. If you are inexperienced in reflexing hook-ups, it is suggested that Figure 1 be tried and its peculiarities thoroughly understood before proceeding with Figure 2.

Ninety volts are necessary on the muffler tube when used as an audio amplifier. Less than this will not give results to warrant the expense of the additional equipment.

The general defense for radiating regenerative receivers seems to be one of cost and cost only! A disturbing neighbor excuses himself by saying that he has the most efficient receiver his money will buy. Possibly granting him his point, the day has long since passed when a man may remove his muffler to obtain slightly more power from his automobile. Such a machine is a public nuisance.

The sad part of radio reception today is that the fellow with the cheap squawky radiator can disturb the program of literally hundreds of expensive set owners. The greatest objection we have found to Figure 1 is this question of dollars and cents. It means adding another tube, socket, rheostat, coupler, etc. Many of you may be reluctant about adding this unless you can use the arrangement for audio amplification as in Figure 2.

Incidentally, many of the radiating regenerative receivers already employ additional tubes for audio amplification. This greatly simplifies the expense question because one of the audio stages may be employed as the muffler tube.

But if you possess only a tube set and positively refuse to go into more, we still believe, in spite of this, that you will want to do something to stop yourself from being a disturber of the peace.

For this purpose, Figure 3 comes to our rescue. This is the well-known one-tube reflex as developed by Schloemilch and Von Bronk, back in 1913. This has always met with great favor over in Europe. It has

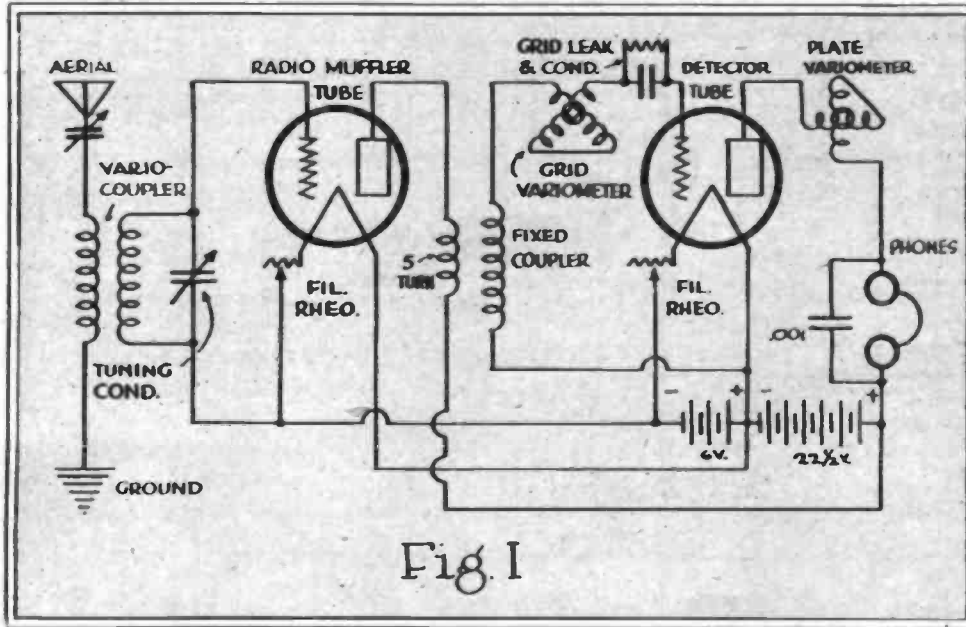

Fig. I

panies incorporate the muffler idea. The best radiation reducer so far proposed is the nonoscillating radio-frequency tube. This is connected between the aerial and the regenerative detector, acting as a one-way amplifying device. It aids any signals passing from the antenna to the set, but stops any disturbance otherwise passing from the set to the antenna. Of course, this muffler tube must be in itself a nonoscillating tube. If this radio-frequency tube squealed, it would be a worse offender than the detector, because of the higher plate voltage. This was fully discussed in the article last month. With this tube working properly, the set is greatly benefited—quite different from an automobile muffler where the power of the motor is reduced! The radio-frequency stage thus employed increases the range of the set and greatly improves the selectivity.

Above—A "muffer" tube placed ahead of the familiar "two-variometer" circuit

Below—The "muffer" tube can be reflexed to give additional audio amplification

Figure 1 shows the method of installing a radio muffler ahead of your regenerative receiver that has worked out exceptionally well in the majority of cases. Here the tube is connected to the aerial by a standard variocoupler with a tuning condenser across it. The output of this tube is then connected to the regenerative set by some form of fixed coupling. This is usually accomplished by winding four or five turns of wire around a honeycomb coil or next to a variocoupler. In case a variocoupler is employed, the regular primary is not used unless it is tapped and four or five turns only are utilized.

The rest of the circuit is just the well-known two-variometer regenerative circuit that has always been such a disturber of the public peace. Of course, virtually the same scheme of connections on the radio-frequency tube applies if you happen to be using a tickler coil regenerative system. In all of these devices it is merely necessary to

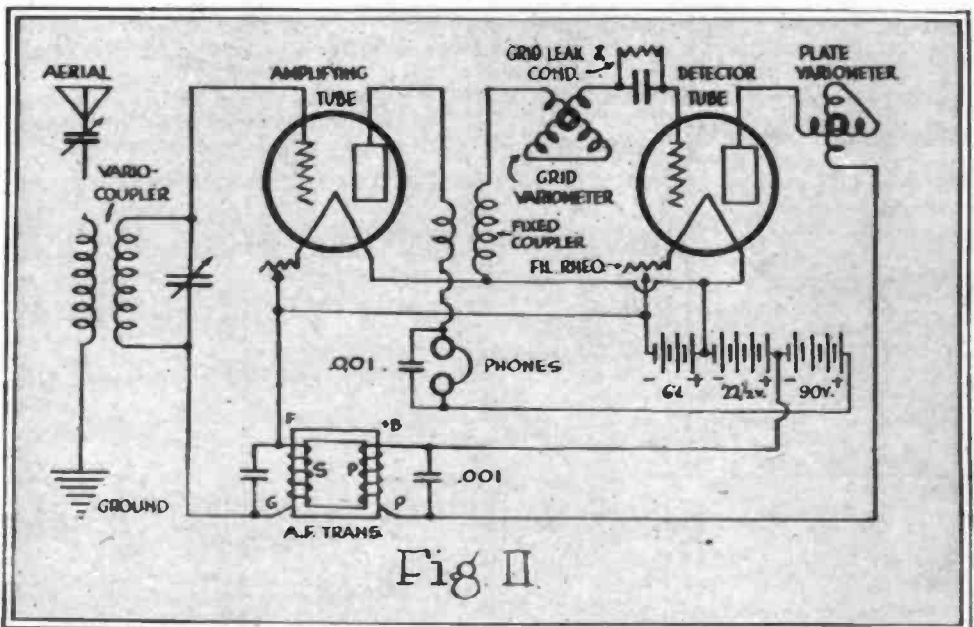

Fig. II

suggested that 45 to 90 volts be connected to this part of the circuit. The detector tube, however, should be left at 22½ volts.

Figure 2 shows a more complicated hook-up, involving the use of a reflexed tube. This is given because it will enable you to use your additional tube for audio

only recently come into its own here. The distance range of this set depends a great deal on the sensitivity of the crystal detector. We have had sets like this that equaled any regenerative receiver on distance and greatly excelled them on local reception. Incidentally (Continued on Page 42)

Chasing Up the Whistles

By BRAINARD FOOTE

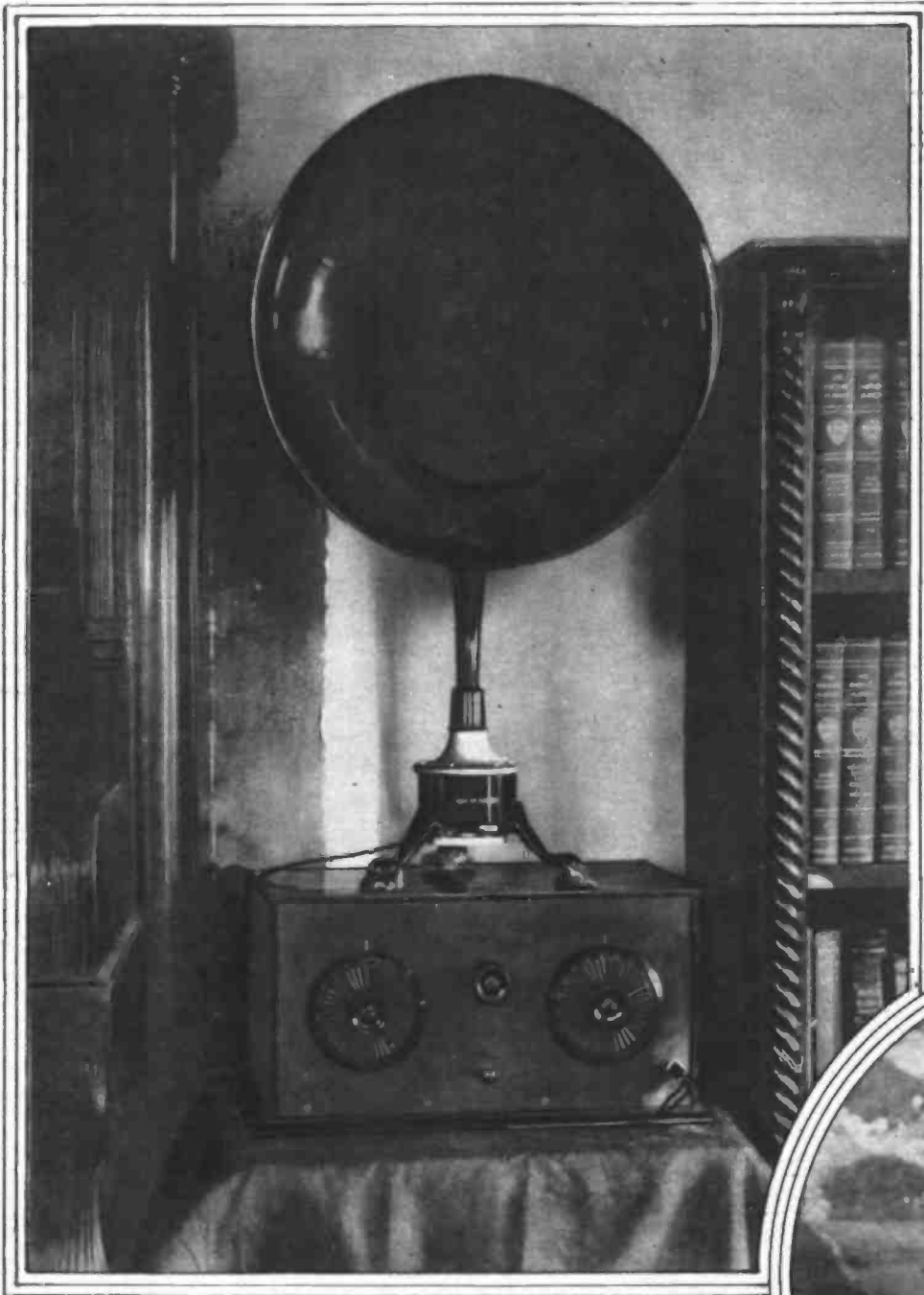

The little knob is the tickler control and despite its small size causes more trouble in radio receiving than most of us realize. Don't use it too much and you'll have less whistling and squealing



You don't have to be a professor of physics to try this experiment. Two weights on threads of unequal length are caused to swing. The threads move a cross-beam carrying a central pointer. When the weights "get into step" the pointer moves to form a single "beat." The whistle in your receiving set is a slow vibration similarly made up of two rapid vibrations

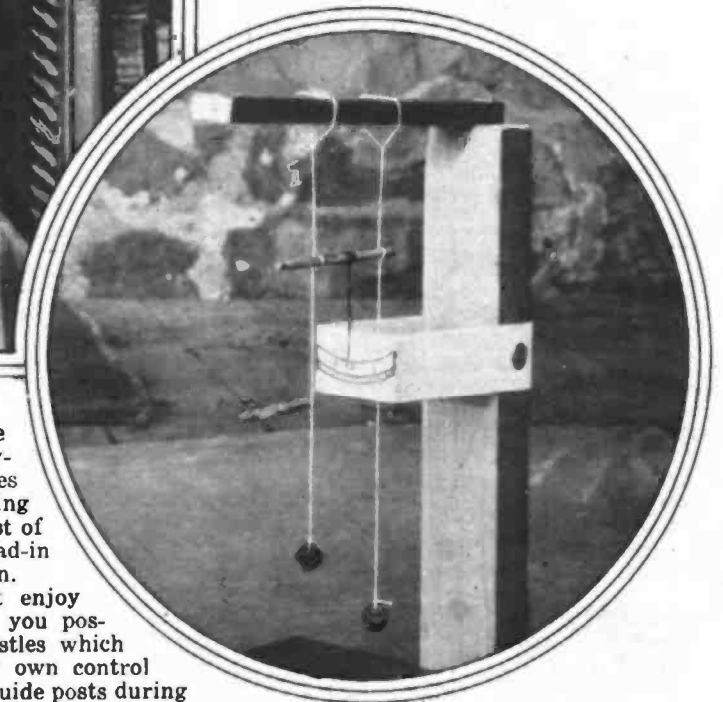

IF YOU'VE become a radio fan, the word "whistle" has taken on deeper and more impressive significance. A "squeal" has ceased to be an expletive delegated solely to Mr. Porker. And "howling" no longer refers exclusively to canine conversations with the full moon, but suggests the winter's wind moaning about the chimney or the last complaints of a lost soul.

Some of these characteristic radio noises, you discover, will commence at your bidding—starting with a squeak way up high, chirping merrily down the scale to silence and then swooping up again in the reverse order as you twist your dial past the wave-length mark.

Other whistles, however, come and go as they will, and your efforts to catch them and put them out of business are totally unavailing. These peculiarities, you prob-

ably realize, indicate that some of this canary-bird music originates within your own receiving apparatus, while the rest of it comes down the lead-in from the great unknown.

Naturally you don't enjoy such disturbances, but you possibly find that the whistles which are plainly under your own control seem often valuable as guide posts during the "tuning-in" procedure. Not that the whistle is essential for securing the correct dial adjustment, but it seems to help you a lot and you therefore restrain your impatience when you hear it. While that same whistle helps you somewhat to locate your station, *have you ever really understood what it does to every other listener on that*

wave length within a mile or so of you?

That's what you ought to know before you "hunt the whistle" too industriously this winter. What is the reason for this howling and squealing, anyway? Well, to bring home the idea (Continued on Page 46)

The solo studio is large enough to accommodate a group of artists or jazz band. It is here that Fred Smith, studio director of the Crosley WLW broadcasting station, has his office



Circle—A large auditorium has been provided for the visitors who nightly come to the Crosley WLW broadcasting studios. Visitors are separated from the artist by a heavy glass partition but are able to hear what is going on in the solo and ensemble studios through loud speakers

New Studios Ready— for W.L.W.'s Super Power

FOR more than two decades radio has been growing.

Marconi came to America in 1904 in the interest of wireless. Like many scientists, he found himself face to face with skeptics. What could wireless do? How far would it reach? Other questions were asked him and one of his replies was to the effect that wireless probably would reach some twenty miles.

Think of it: twenty miles could be spanned in the air twenty years ago! And then it was doubtful. Today it is possible to transmit from a point and have the sound

Below — Bands, orchestras and large groups of artists can be comfortably arranged in the ensemble studio at WLW. Everything possible has been done to give perfect acoustical quality to the speeches and music. The draperies of heavy Monks cloth and a specially treated ceiling do away with any reverberation

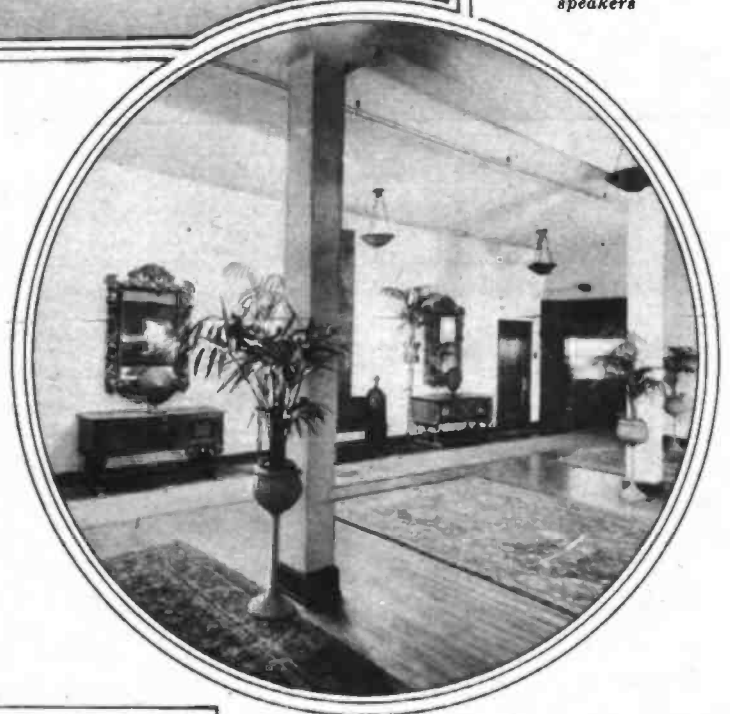

of the human voice reach around the world. And we marvel not at this achievement. It is taken for granted that with our receiver in New York City we can turn the dial and hear the music and voices in California. Perhaps we feel annoyed when some station only fifty miles away interferes with our reception although that station is being heard by listeners in some far western State. And Marconi said wireless might reach twenty miles.

Dedication of the new WLW broadcasting studios of the Crosley Radio Corporation in Cincinnati was a notable achievement for the art that is supposed by many to be new.

While these studios are the very latest design and have the most modern developments of 1924, to be bromidic, they are but the infants of the radio industry.

Powel Crosley, Jr., head of the corporation which bears his name, has given to the radio world the most beautiful studios and an auditorium that surpasses anything of the kind in radio (Continued on Page 61)

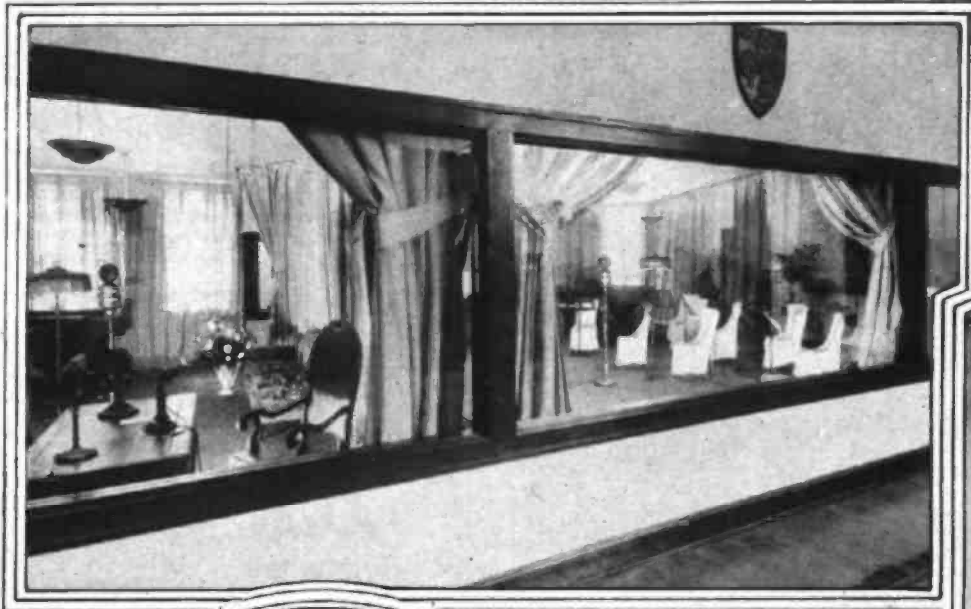

Left—Visitors in the auditorium of the Crosley WLW studios may watch the artists broadcast. The plate-glass partition extends along one side of this large auditorium and loud speakers provide the spectators with the same program that is heard by the radio audience



Circle—The newly developed microphone stands in the Crosley WLW studios do away with any wait between numbers. Two signs, "Prepare" and "Broadcast" are illuminated as required and there is no loss of time between numbers, as one microphone in the solo studio is open to "Broadcast" while the one in the ensemble studio informs the musicians to "Prepare." Fred Smith, studio director, is shown using one of these new microphones

Right—Ancient and modern science combined in the auditorium of the Crosley WLW studios is found in the furniture and new broadcasting equipment. Temperamental artists find surroundings to their liking in the new studios and auditorium

Right—It is in this triangular-shaped room, located between the solo and ensemble studios, that the amplifier and microphone switches are located. The operator has a view of both studios from this room and operates the telephone lines which carry the voice from them to the transmitting station some miles away

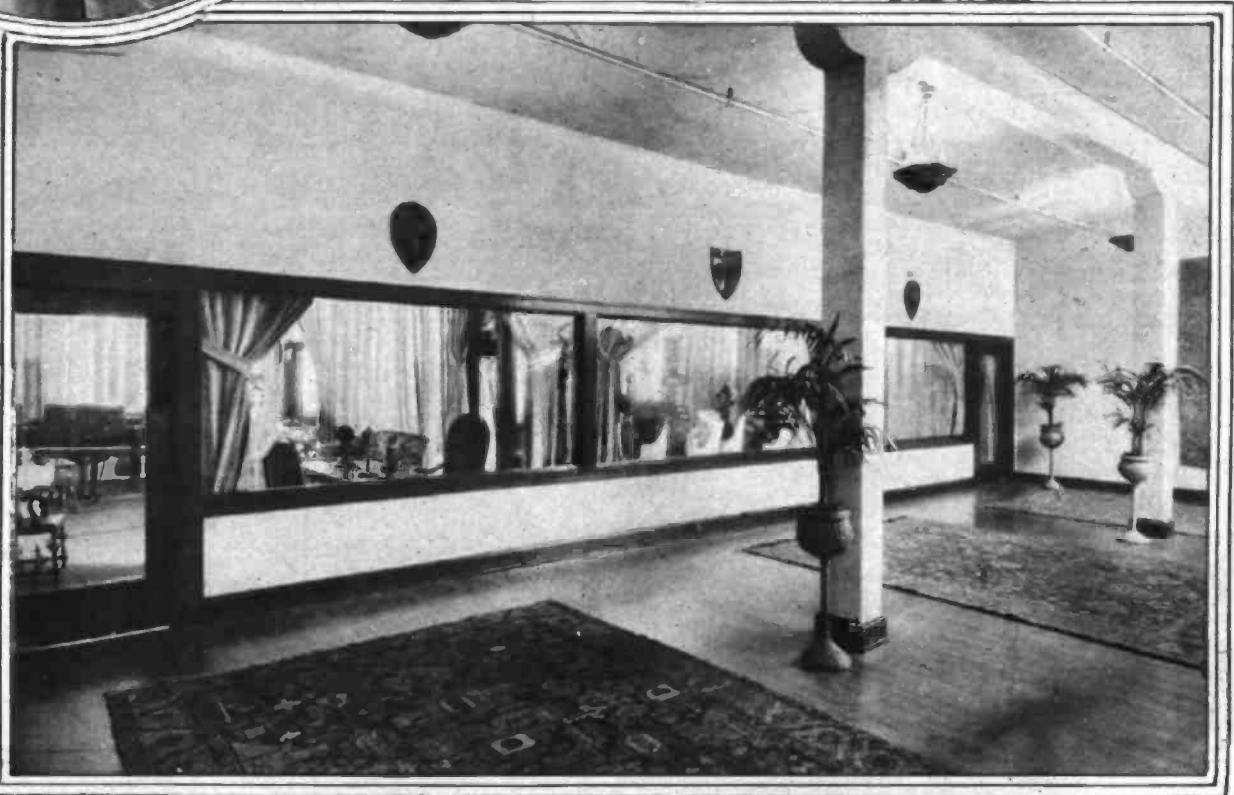

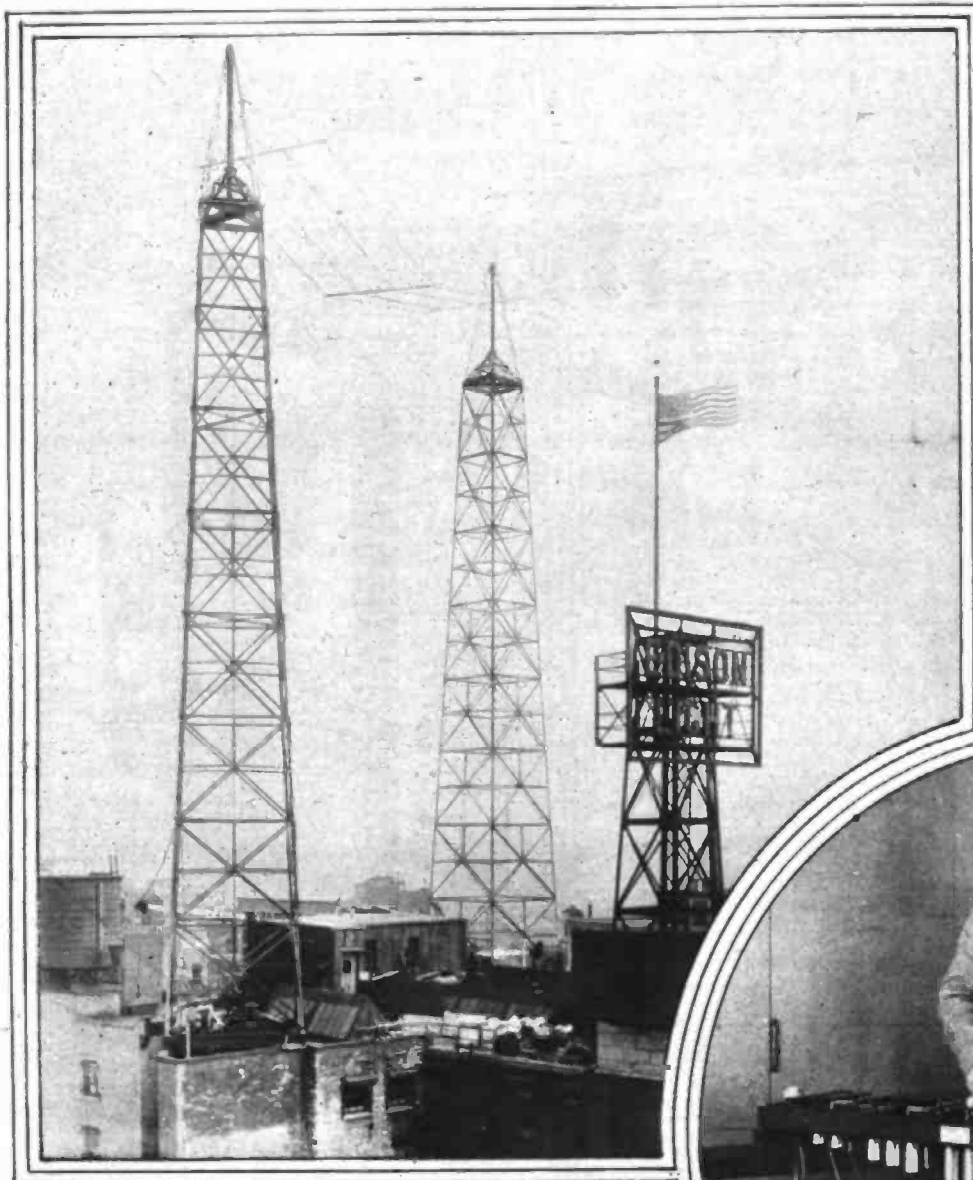

Above is a view of the towers and antenna of Station WEEI, Boston

Circle—Big Brother Bob Emery, program director of WEEI, otherwise known as "BE"

Below is a view of the main studio of WEEI, on the fourth floor of the Edison Building

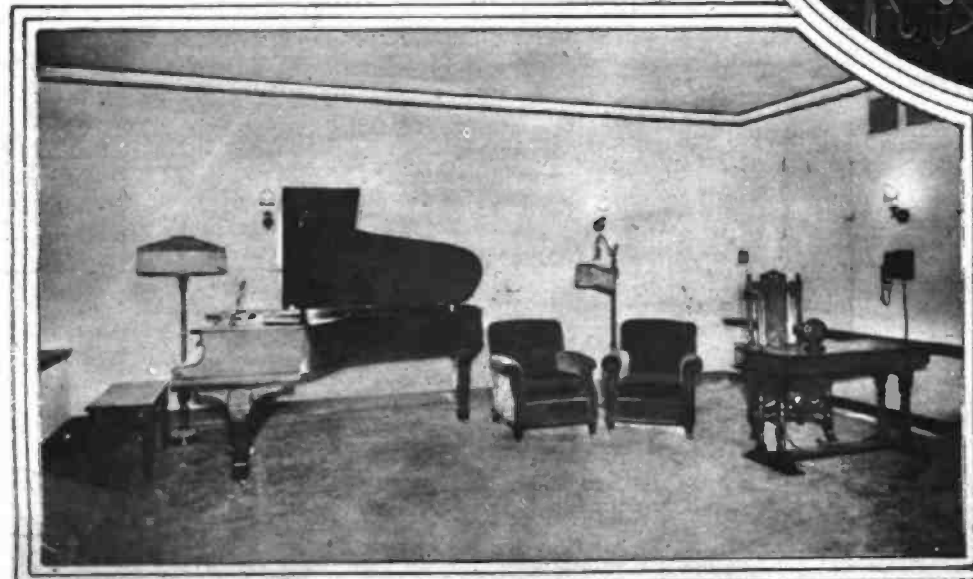
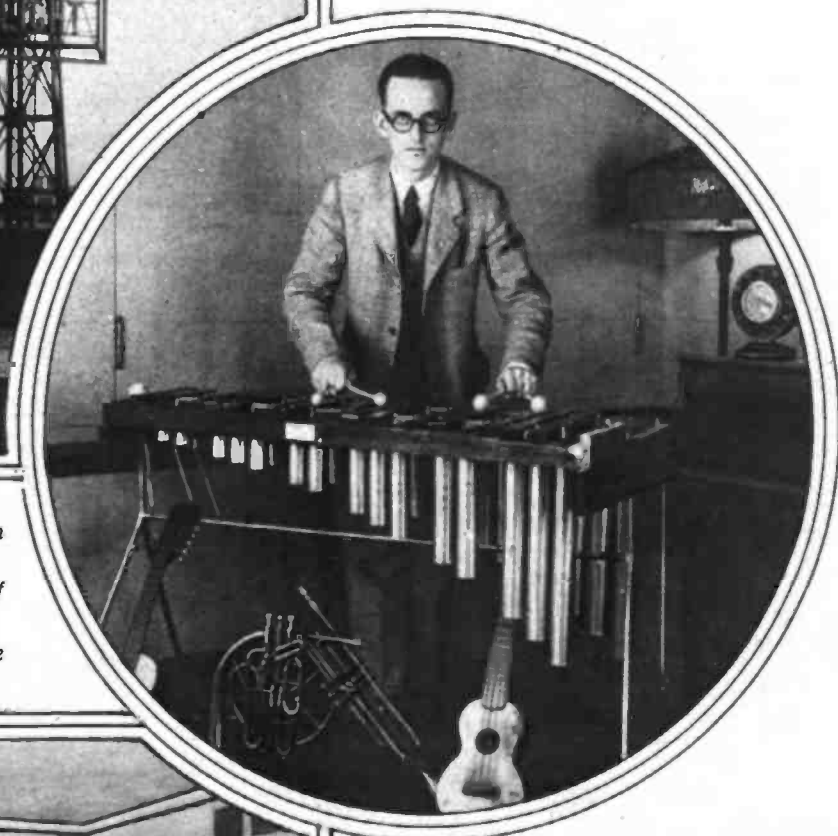

WEEI The Friendly Voice and WTAT Edison Light Boston

By G. P. ALLEN

New England Representative of Radio in the Home.

NOW don't get alarmed at the title above! This is not a general survey of the broadcasting stations, but merely an attempt to get you acquainted with the new station that has made its debut in New England.

WEEI and WTAT are the two stations of the Edison Electric Illuminating Company, of Boston. WTAT, like most small brothers, is known to the intimate friends of the family, but not to the widening circle of friends that WEEI is making outside New England. The circle really is widening, for in the first week of broadcasting, WEEI was heard in Southgate, England, by a friend of one of the artists, who immediately cabled. Reports have come from as far south as Cuba and Porto Rico;

from Canada on the north and from South Dakota and Nebraska on the west.

Perhaps it is not fair to call WTAT, the 100-watt portable station of the Edison Company, "little brother," for while it is small in size, it has been in existence for a year, and little brothers are generally younger than their other brothers. The station, which is a 2A, 100-watt Western Electric transmitter, is self-contained in a special body on a Reo speed wagon and is the only one of its kind in the country. It is used when it is impracticable to use the customary pick-up apparatus usually employed by the broadcasting stations. Upon arrival at the scene of activity the aerial is mounted on two convenient supports. The ground is a metal pin driven into the earth if no better one is available. Transmission is done directly from its own antenna on a wave length of 244 meters.

The most spectacular work of this outfit was putting on the air the speech of Theodore Roosevelt, from Oyster Bay, when he accepted the nomination of the Republican party to run for Governor of New York this fall. It was not possible to secure the services of WEAJ, so in response to a call, WTAT left the service station at seven one

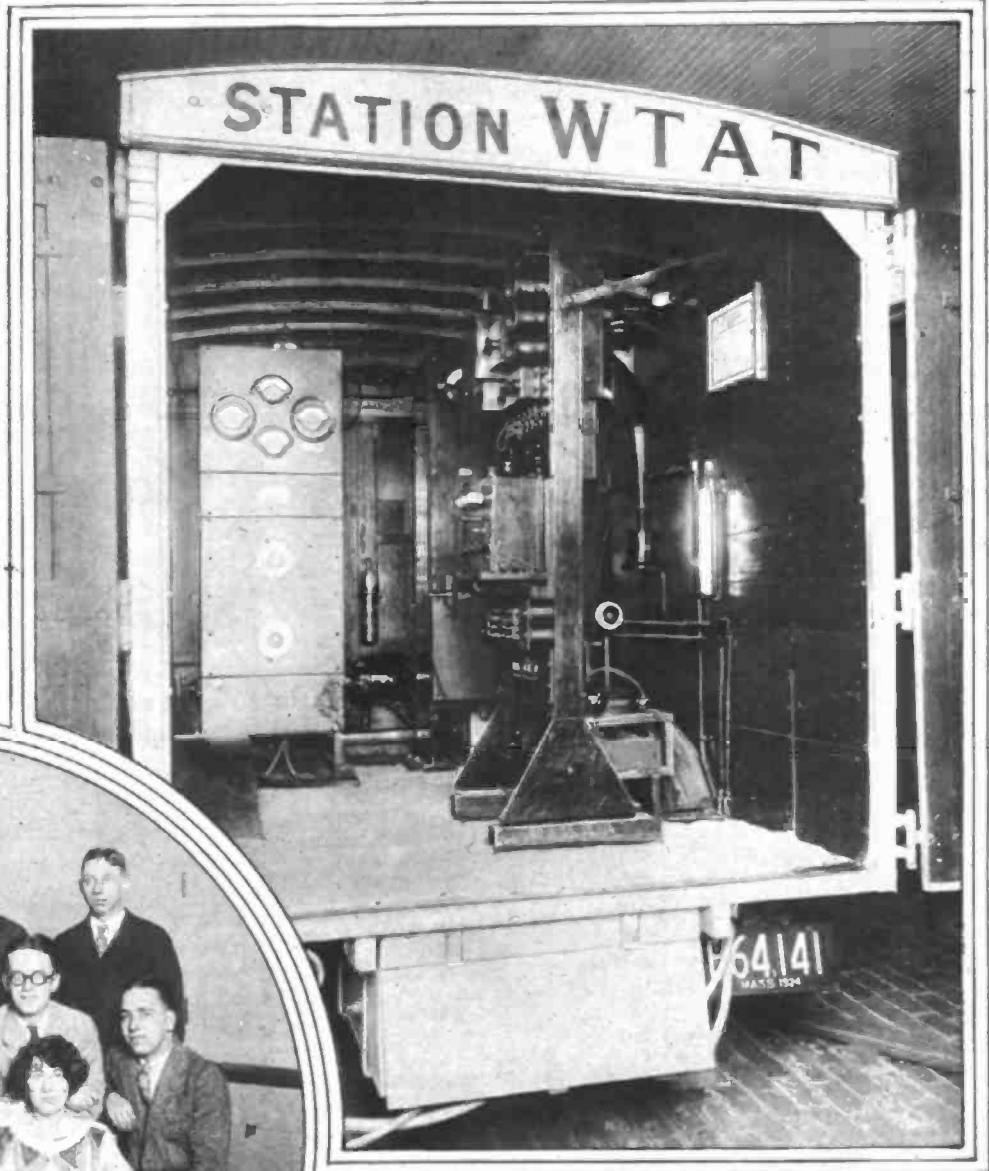

WTAT, the portable transmitter as it stands in the service station awaiting a call

Below is a view of a corner of the reception room of Station WEEI



The chief and part of his gang. Working the famous left-to-right act, they are: Rear row—P. W. Pratt, "FZ," chief operator; "Matty," R. W. Mathewson, operator "CV," and Purcell, chief of operating division. Middle row—"Uncle Eddie" Dunham, studio director; "Whit," Lewis Whitcomb, assistant superintendent; "Chief" Charles Burton, superintendent; Bob Emery, programme director; W. M. Hentz, operator. Front row—Miss Dorothy Blackwell, broadcasting department; Miss Marjorie Drew, program department

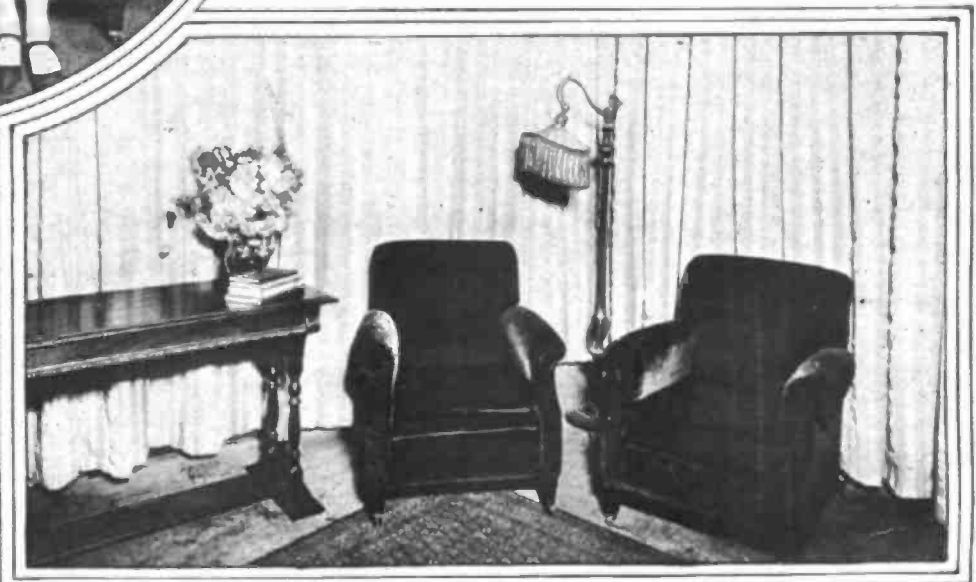

night arriving at Oyster Bay at ten-thirty the next morning, where it broadcast Roosevelt's speech. (Continued on Page 48)

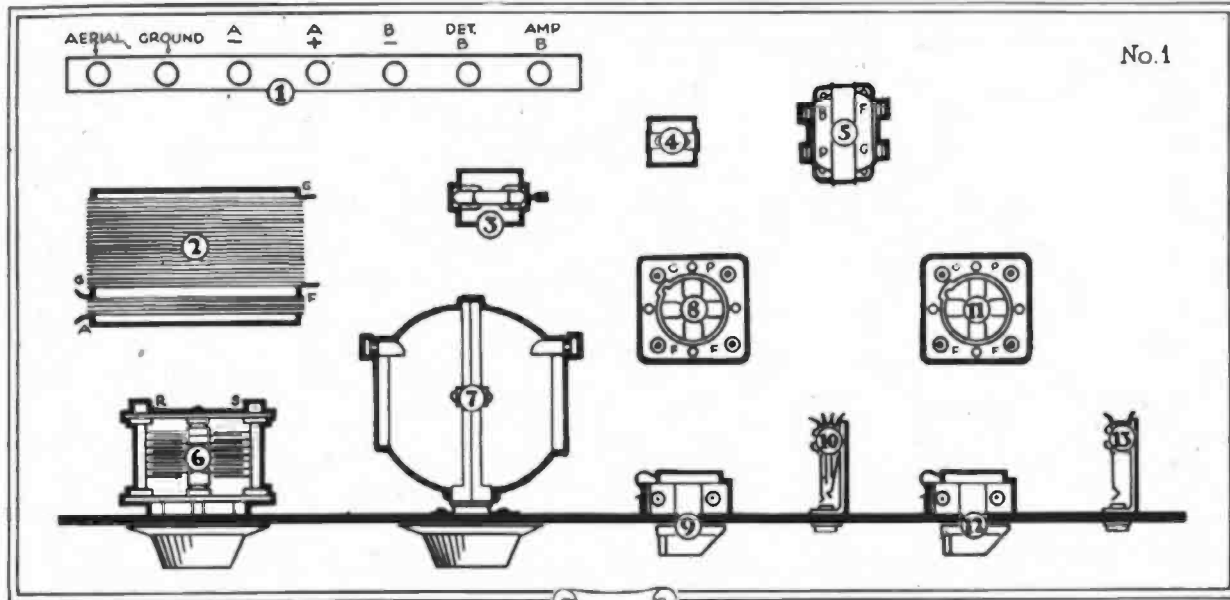

SOME time ago an article appeared in this magazine which was entitled, "A Favorite Circuit Simplified," which was written by myself. I have always thought that there was a genuine demand on the part of radio fans, for real good circuits—not a rehashed version of old circuits with extra parts and a new name, but the real tried and tested circuits, which have been in use for so long that they have come to be known as "standard" circuits.

Circuits may come and circuits may go, but these seem to remain with us year in and year out. There is only one reason for this—the circuits are good. Of that there can be no question.

These circuits had several drawbacks. They have had as a rule too many controls, too many parts, or were rather complicated to build. I have tried the originals of all these circuits and have liked the way they worked, but I did not like the five or six controls which were incorporated in the tuning systems. I believe that our modern

Another Favorite Circuit Simplified

by
W. Francis Goodreau

receivers should have two or at the most three controls.

With that idea in mind, I have been working with standard circuits for some time, trying to simplify them in construction and operation *without any sacrifice of volume, selectivity or range as compared with the original*. This has not been easy; it has required much experimental work, and many hours of testing different ideas before the desired results were obtained.

But H. M. N. wrote me that he was receiving many requests from new readers for just this sort of thing and so I have stuck to the work.

When the desired results were secured, they more than justified the time and labor spent. But I would like to say that the desired results were secured only when the highest grade of parts were used, and the set was built in accordance with the well-known rules of radio construction. Poor quality parts and a poor wiring job will not make a set to equal the original circuit.

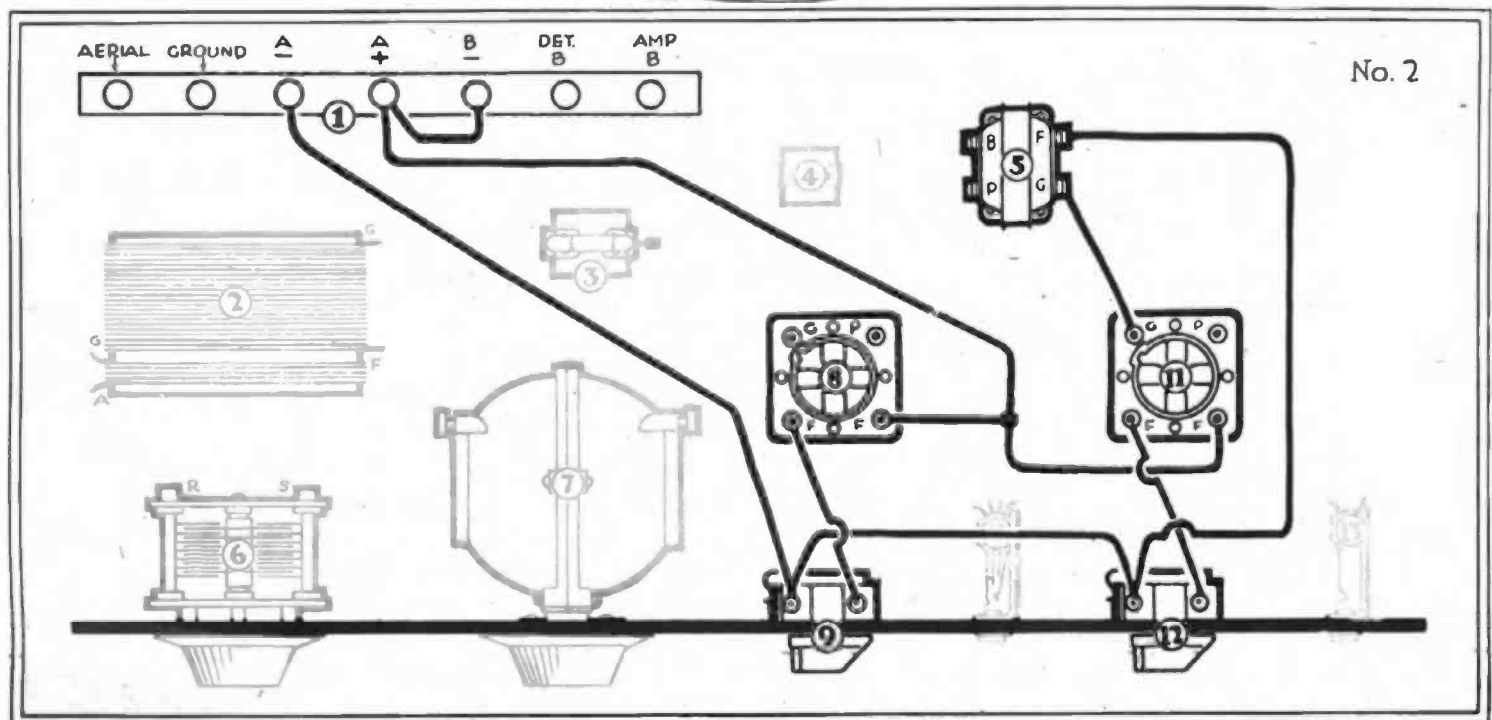

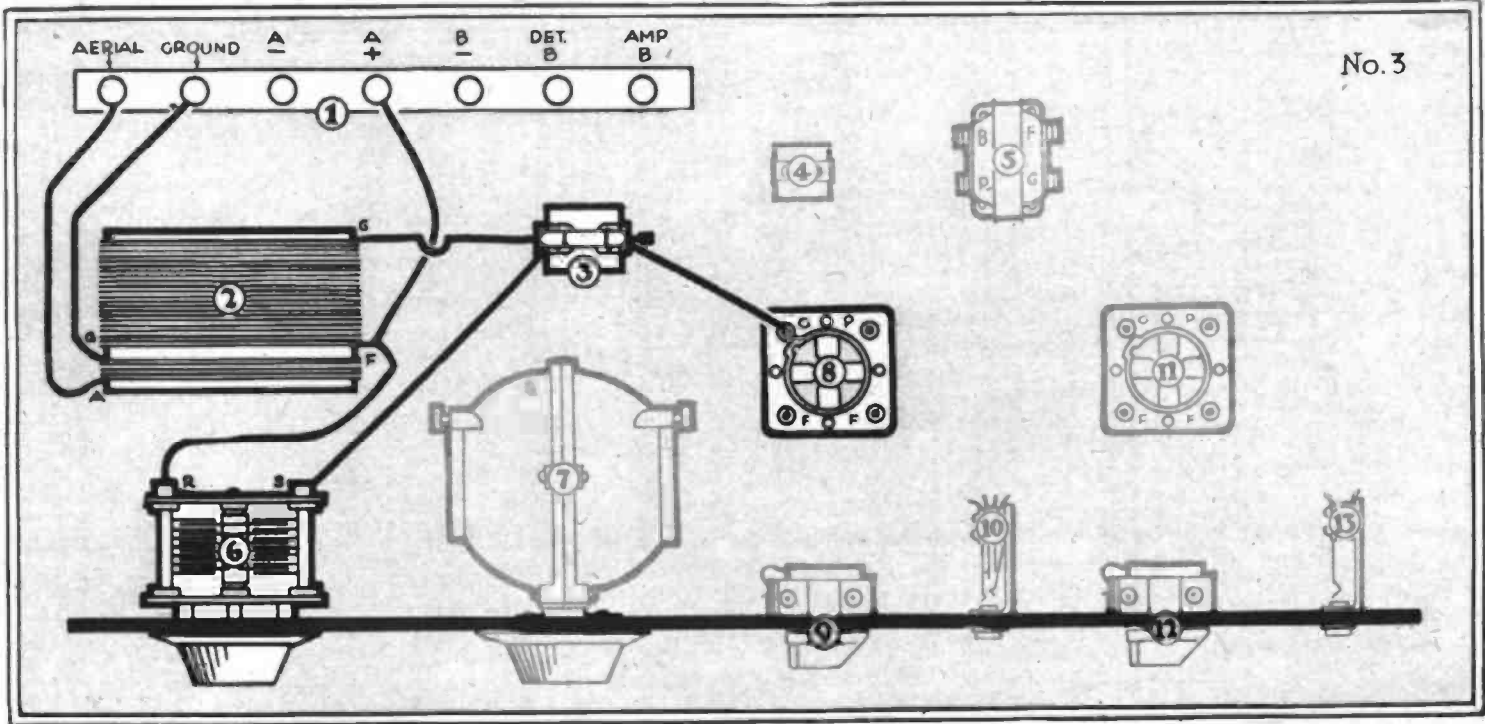

If you are to simplify standard circuits, you must use the best of parts, as you are expecting as much of the few parts you are using as you have been getting from the many parts used in the standard sets.

You will notice that despite the fact that fewer parts and fewer controls are used, the fundamental wiring diagram remains the same. No changes are made in the standard circuit; the only changes are in the parts.

Many new circuits, so-called, are appearing every day, but if you will study them, you will find the same old circuits and some changes in wiring and a few extra parts that usually do not improve the circuit, but sometimes make it worse. I do not believe in this practice, and for that reason I always state in my articles, when it is true, that this is a standard

circuit. Whenever possible I prefer to simplify, not complicate, these circuits, for I believe that what the radio fan desires of his receiver is contained in this one word, RESULTS. And for that purpose these simplifications have been made.

To build this receiver I used the following parts:

- 1 Electrad verni tuner.
- 1 Kellogg variometer.
- 2 Kellogg sockets.
- 1 Pacent 30-ohm rheostat.
- 1 Pacent 6-ohm rheostat.
- 1 Electrad variomh (variable grid leak).
- 1 Dubilier grid condenser, capacity .00025 mf.
- 1 All American or Kellogg audio transformer.
- 1 Pacent open-circuit jack.

- 1 Pacent double circuit jack.
- 7 Eby binding posts.
- 1 Panel, radion mahoganite or black, 7x18x3-16.
- 1 Baseboard.
- 2 Dials.

Fixed condenser, capacity .002 mf.

I have often been asked why I mentioned certain makes of parts in my articles. This is the one and only reason: to guide you in your selection, so that you will be able to get the most from your receiver.

The listing of the parts mentioned does not mean that the particular parts are the best in the world, but that they rank among the best, and that these parts mentioned have been tested in actual receiving service and found to be good. I will never list parts that have not been tried by myself or H. M. N. at Station (Continued on Page 34)

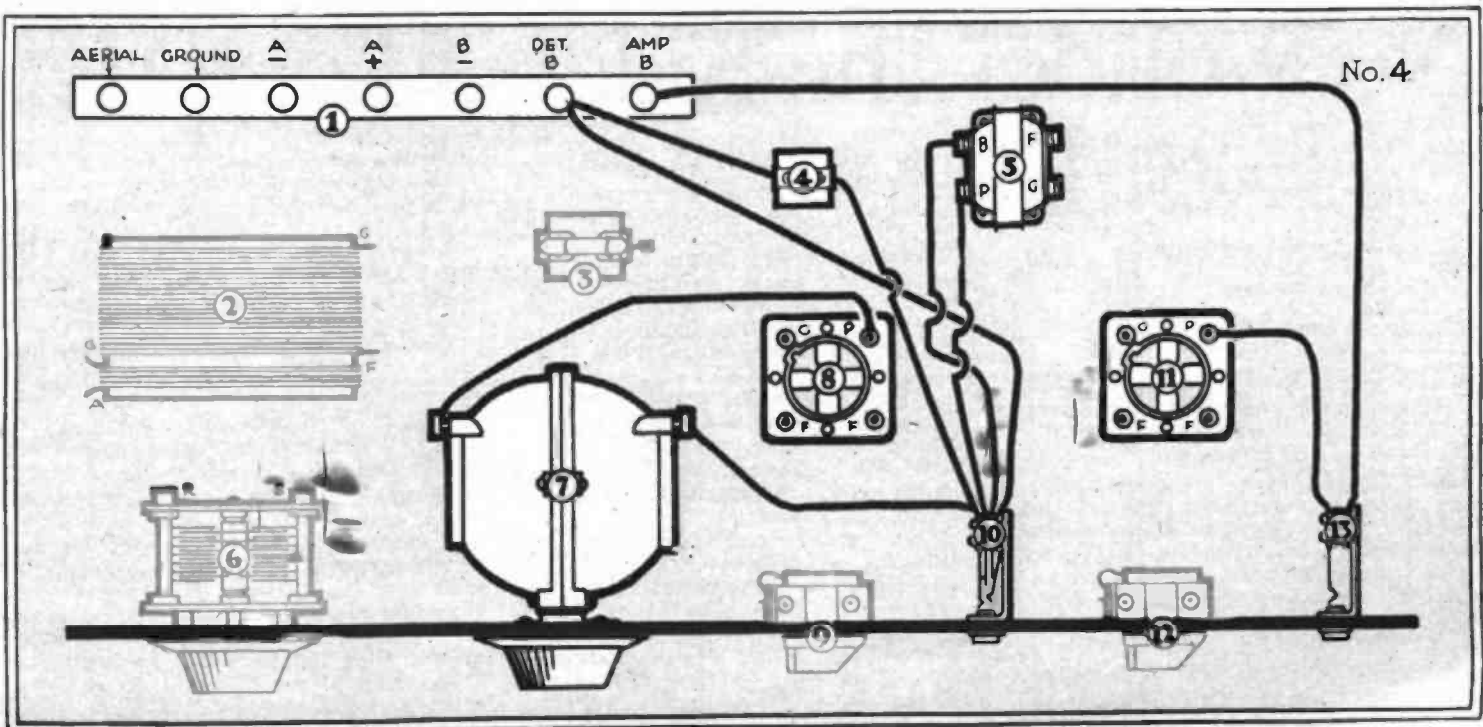



Miss Agnes Leonard, now appearing in Earl Carroll's "Vanities" in New York. Miss Leonard's ukulele and bedtime songs have endeared her to thousands of kiddies

No Wonder the Kiddies Love Her

*"All little girlies and all little boys,
If you'll listen a moment or so
On your radio
I'll sing some songs I know.
I'd like to go to see you, you know
And see all your playthings.
But! O!
You live too far away,
So just for today
Listen on your radio."*

THUS sings Agnes Leonard in her charming soprano as she softly strums the black walnut ukulele, which her brother made when he was fifteen.

Agnes loves kiddies. Indeed she planned to be a kindergartner, and, after finishing the course in Newark State Normal School, she taught a class in Glendale, N. J., for a year. But Agnes is far too attractive and versatile to be confined within classroom walls, even for the sake of being with her beloved little ones.

So while she does the dozen other things which make her life interesting, she

By MARY GRAY REED

keeps close to the children, trotting off night after night to WJZ or WOR, where she sings to them the delightful little compositions which are her own original work.

And if you doubt—although I don't see how you can—that the kiddies love her songs and her voice and the tinkle of her ukulele, you should see the scrapbook of letters which they have written to her. For all over the country, when it comes seven o'clock in the evening, "all little girlies and all little boys" push daddy and mother away from the earphones and give themselves up to a half hour of delight.

It is no wonder that Agnes Leonard can "soothe the savage breast," for her entire family can do the same thing.

There is her father, for instance, a college professor, who can play seven instruments, and her mother who is an excellent pianist. Then there is friend brother who made the ukulele and who now has his own

orchestra down in Shaffer's Grill, at Lake Hopatcong. An older brother, who was a radio operator and aviator, could play six instruments, and at the time of his death was saxaphoning in Panama. And even little sister plays her ukulele as well as the piano and sings sister-songs with Agnes.

How's that for a family?

What are some of these dozen-and-one activities which took Agnes Leonard out of the kindergarten? Perhaps you won't believe it at all when I tell them to you, but I've seen her do these things so I know they're true.

I suppose I really began at the wrong end of things; I really should have introduced this little lady with her gorgeous mop of curly, brown hair, enormous gray eyes with their black fringe, and the most dazzling row of teeth on the Atlantic seaboard. Maybe you would have recognized her more quickly if I had presented her as "Miss Coney Island," for this fall she won first prize in the bathing

(Continued on Page 52)

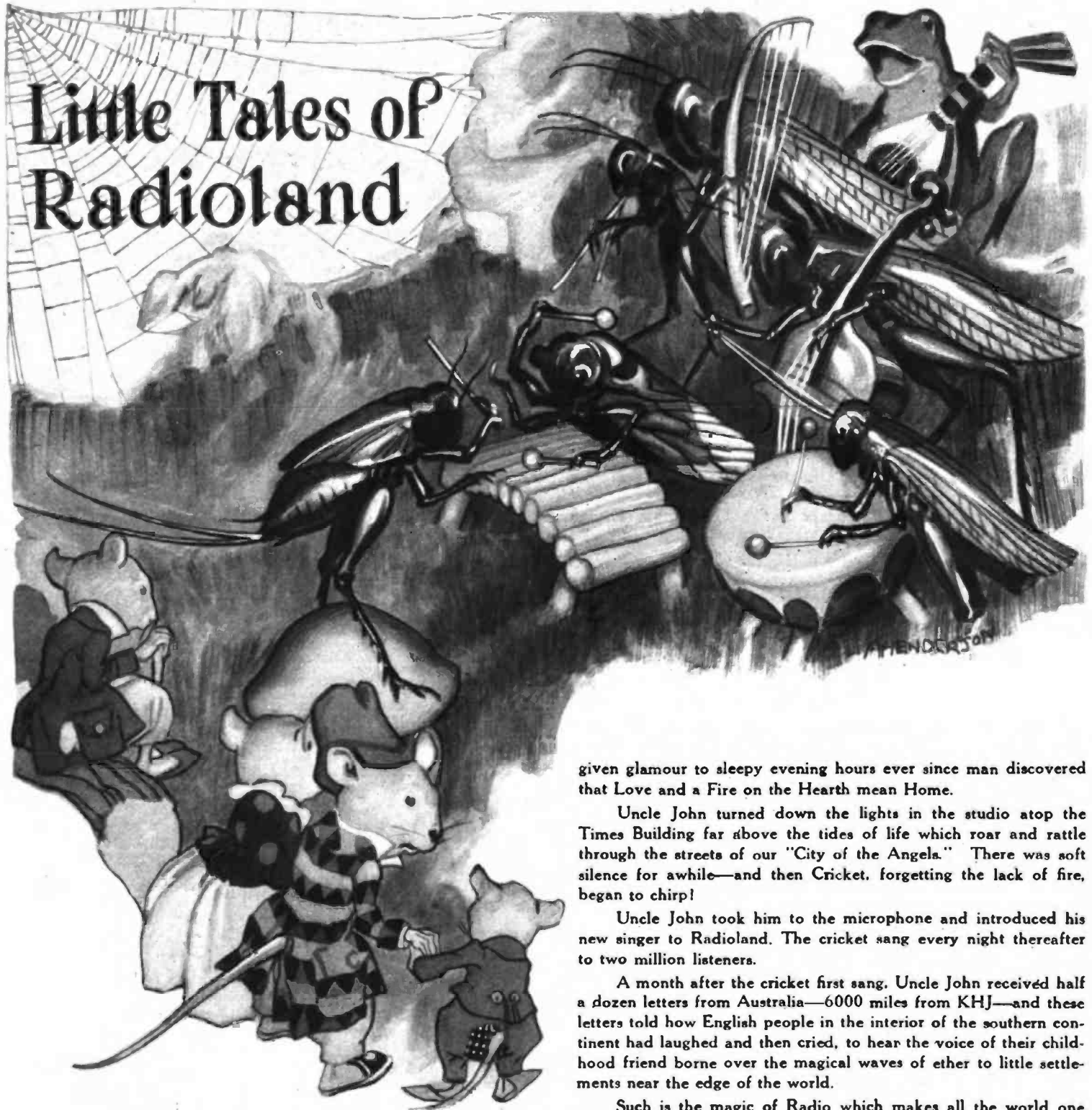

Little Tales of Radioland

By **PETER GRAY WOLF**

Illustration by Arthur Henderson

THE story was told to me by Uncle John of KHJ—the Los Angeles Times.

One day he received from a child friend the gift of a bunch of wild flowers. On putting them in water, Uncle John discovered a cricket. To the cold-blooded scientist a cricket is merely "an insect belonging to the order orthoptera, the group saltatoria, and the family achetador." Not so to Uncle John, the man who had the genius to know that a new "international nation" has been born and to christen it Radioland.

To Uncle John a cricket is the Singer on the Hearth which has

given glamour to sleepy evening hours ever since man discovered that Love and a Fire on the Hearth mean Home.

Uncle John turned down the lights in the studio atop the Times Building far above the tides of life which roar and rattle through the streets of our "City of the Angels." There was soft silence for awhile—and then Cricket, forgetting the lack of fire, began to chirp!

Uncle John took him to the microphone and introduced his new singer to Radioland. The cricket sang every night thereafter to two million listeners.

A month after the cricket first sang, Uncle John received half a dozen letters from Australia—6000 miles from KHJ—and these letters told how English people in the interior of the southern continent had laughed and then cried, to hear the voice of their childhood friend borne over the magical waves of ether to little settlements near the edge of the world.

Such is the magic of Radio which makes all the world one Hearth and gives even the humble cricket an audience which no orator in the world, be his voice ever so powerful, could have reached five years ago.

Radioland is man's new invisible republic. It has come upon us softly "in the clouds." Poets and prophets have said that "heaven is all about us"—a statement which Radio has scientifically proved true.

But there is more to heaven than what we see now. There are wonders in Radio not yet manifest.

Radioland will give the people what they want. Ask Radio for the lovely things in music, for the dream of poet and prophet, for the joyful songs of youth, for all innocent merriment. Ask—and Radio will respond.

We are today in the outer courts of the temple of Radio. The inner secrets are not yet revealed.

Satisfaction from Your W Depends Upon Yo

*Why Purchase a Fine Radio Set
and be Satisfied with a Less Fine*



Timmons Type
A (Adjustable)
Talker. Price
\$35. Beautiful
hand-rubbed
mahogany fin-
ish, bronze-
gold screen
and Gothic
scroll grill.

TIMMONS

Whole Radio Investment in a Loud Speaker

Housed in a Beautiful Cabinet
Less Beautiful Loud Speaker?

In purchasing radio equipment, remember that the loud speaker is the final expression of the radio set. No loud speaker can make a poor set good, but a poor loud speaker can certainly mar the reproduction of even a *good* radio set. A loud speaker to reproduce all the delicate tone shadings—naturalness—is of necessity a piece of precision apparatus. And making such apparatus requires the finest engineering skill and experience as well as the best mechanical equipment, highly skilled workmen, constant supervision

and testing. Naturally such quality and care cannot be built into a loud speaker to be sold on price alone.

Then there is the question of appearance: It is inevitable that loud speaker design will follow that same evolution experienced in phonograph design; entirely housing the exposed horn and mechanism in beautiful cabinets. The Radio Public has turned to Timmons Talkers because it is economy to purchase a cabinet type speaker which will be in perfect taste when all radio apparatus has become fine furniture. Timmons Talkers are the pioneers of the cabinet type. There are two types, Adjustable \$35 and Non-adjustable \$18. Little need be said about the excellence of Timmons Talkers. They have an established reputation for

unsurpassed tone purity, naturalness and volume. You should hear them. Your dealer will be glad to demonstrate Timmons Talkers in comparison with other loud speakers.

Dealers Are Now Receiving More B-Limiters Which Take the Place of "B" Batteries

So tremendous has been the demand for B-Limiters that we have not been able to ship most dealers enough to make immediate deliveries to every one. Now, however, with hundreds of B-Limiters leaving our plant every day, your dealer can fill orders more rapidly.

We'll be glad to send folders on Timmons Talkers and Timmons B-Limiters. Remember that all Timmons Radio Products are sold under an absolute guarantee, so that all jobbers and dealers are authorized to return the purchase price of any Talker or B-Limiter that may not operate to the purchaser's complete satisfaction.

TIMMONS RADIO PRODUCTS CORPORATION

GERMANTOWN PHILADELPHIA



Timmons B-Limiter. Takes the place of Radio "B" batteries. Price \$35. Fine crystalline finish—at home with the finest Radio set. Patented May 15, 1923.



Timmons Type N (Non-Adjustable) Talker. Price \$18. Hand-rubbed mahogany finish. Gothic scroll grill with screen harmonizing with the beautiful mahogany finish of the Talker.

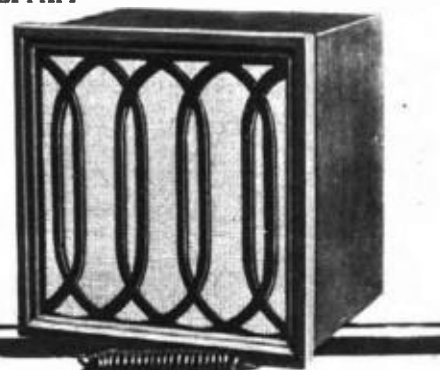

Radio Products

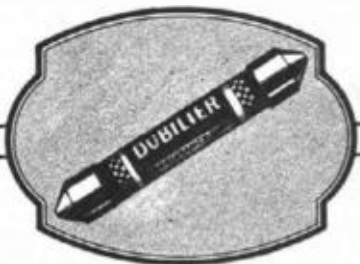

Published in following resistance values:
 3 .75 1. 1.5 2. 2.5
 3. 4. 5. megohms.
 Price 50c

The RESISTANCE UNIT

Accurate and Efficient
A new Dubilier Product

The Dubilier engineers have perfected a resistance unit that is at once efficient, accurate and constant.

A good resistance unit will not change in resistance value with age. If it is marked 2 megohms, it should have that same value to within commercial tolerance, after months of use.

It is easy to design a resistance unit, but it has taken us years to produce one that is right—quiet, efficient and constant.

You will find that the Dubilier Resistance Unit greatly increases the range and efficiency of your set.

For a descriptive folder

Address 45-47 West 4th Street, New York

Dubilier

CONDENSER AND RADIO CORPORATION

Another Favorite Circuit Simplified

(Continued From Page 20)

3XP. This is to assure you that you can depend on the parts mentioned.

I have also been asked if I receive money from the various manufacturers for mentioning their parts in connection with my articles. I wish to say in reply to that, that I have never received one penny from any manufacturer for this service, and that any recommendation I may make is made on merit alone. I recommend these parts to help you secure the best results from your set, and these recommendations will be given to any good make of parts, but such recommendations are not for sale.

You will notice in the picture where the parts are mounted. I like this arrangement very well, but you may

hooked up before you connect the "B" battery. If the tubes light O. K. and everything seems to be as it should be, you may connect the "B" battery.

It is best with this particular set to use only 22½ volts on the detector, but this depends somewhat on the tube you use. If you use UV201-A or 199 for a detector you may use higher voltages. The amplifier voltage may be from 45 to 90 or more. If you desire quality, rather than noise, it is best to use moderate voltages on both tubes.

Connect antenna and ground. Set condenser dial on zero, and variometer dial at about ten. Turn condenser dial slowly from zero to about twenty. If no signals are heard ad-

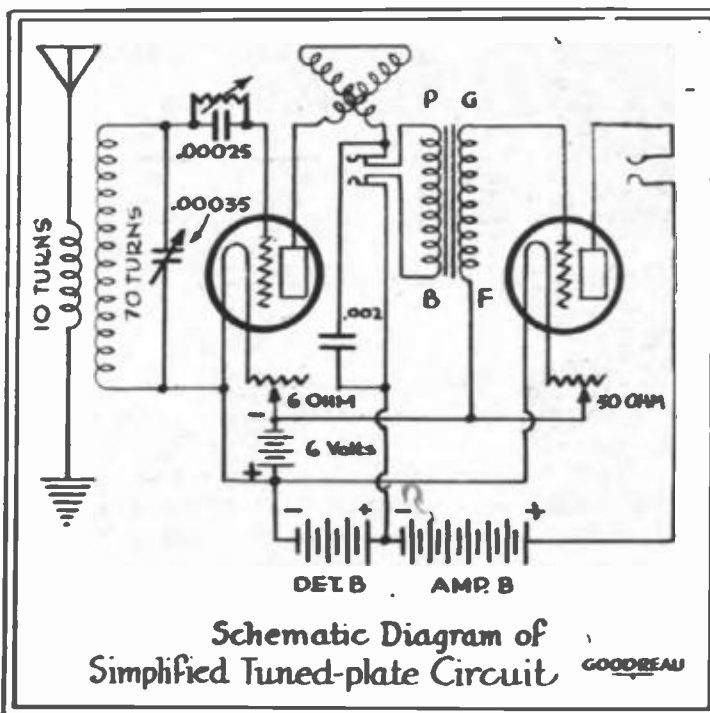

HEATH Radiant

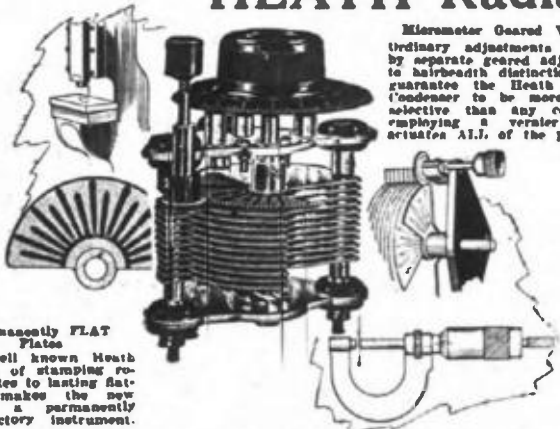

Micrometer Geared Vernier
 Ordinary adjustments reduced by separate geared adjustment to hairbreadth distinction. We guarantee the Heath Vernier Condenser to be more highly selective than any condenser employing a variable which adjusts ALL of the plates.

Permanently FLAT Plates

The well known Heath process of stamping rotor plates to lasting flatness makes the new Heath Condenser permanently satisfactory instrument.

PRICES FOR VERNIER CONDENSERS

| | With Dial | Without Dial |
|--------------------------|-----------|--------------|
| No. 12AV. 12 Plate | \$5.00 | \$4.25 |
| No. 24AV. 24 Plate | 5.50 | 4.75 |
| No. 44AV. 44 Plate | 6.50 | 5.75 |
| Plain types in all sizes | | |

Non-Dielectric Condensers

A new type of rod plate which banishes leakage and capacity effects, added to the popular Heath features of permanently FLAT Plates and the most perfect type of vernier. These advantages of Heath condensers are the best guarantee of lasting satisfaction.

HEATH Sockets with the Exclusive Shock Absorber Feature

Bakelite base into which re-inforced phosphor bronze, self-cleaning contacts are securely embedded. Binding posts are slotted hexagon nuts. HEATH Standards of material and workmanship. Price 75c

HEATH Bakelite Dials
 Specially designed easy grip-knob, beautifully proportioned, highly polished and clearly incised. Brim binding centered by precision machinery to positive accuracy for perfect balance. Made in two (2) inch, three (3) inch and four (4) inch diameters. A typical HEATH product.

| PRICES | |
|-------------------------------------|---------|
| No. 101--2 in. dial for ¼ in. shaft | 30 cts. |
| No. 102--3 " " " " " | 45 cts. |
| No. 103--4 " " " " " | 60 cts. |

Write for Literature

HEATH RADIO & ELECTRIC MFG. CO.

205 First Street, Newark, N. J.

Exclusive Canadian Distributors—Marconi Wireless Telegraph Co., Ltd., Montreal, Canada

use plans of your own, keeping in mind the following ideas: plate and filament wires should be separated from each other, grid wires must be short and away from plate wires, audio transformer should not be too close to tuning unit.

You will notice in my arrangement that the plate wires are up at the top of the panel, and that filament and grid wires are at the bottom. This is a good arrangement. I can suggest one improvement if you are going to use this for a cabinet receiver—that is, put all binding posts on the rear of the baseboard so that they will not be seen from the front of the set.

In wiring, I have used bus bar in this set, covering the filament wires with rubber tubing. I have also used this rubber tubing at any place where there was a possibility of a short circuit. You may use bus bar or cotton-covered wire about No. 18. H. M. N. has already told you that he always uses Celatsite wire at Station 3XP.

When you have done the wiring and are ready to test the set, place the tubes in the sockets and connect the batteries. It is always best to connect the "A" battery first and make sure the filament circuit is correctly

vance variometer dial and turn condenser dial slowly from twenty to forty. Repeat this until stations are heard.

When a station is heard turn condenser dial until signals are loudest, then adjust variometer dial for best results. Sometimes a slight adjustment of detector rheostat will help.

Improperly handled, this set will radiate, so please do not advance the variometer dial too far, because if you do you will spoil the concert for your neighbors. When you yourself hear a whistle, you will know your set is radiating.

I shall be glad to hear from any one building this set. If you have any trouble of any kind with it I shall be glad to help you. Please address me in care of *Radio in the Home*. I should also like to know what other circuits you would like to see simplified.

And now let us turn to the details of wiring this set. Those who understand something about radio can use my schematic diagram; beginners will find the 3XP-Style Wire-Ups simpler and easier to follow:

NOTE: In the 3XP Wire-Ups, we have shown the variable condenser and the coil of the tuning unit separ-

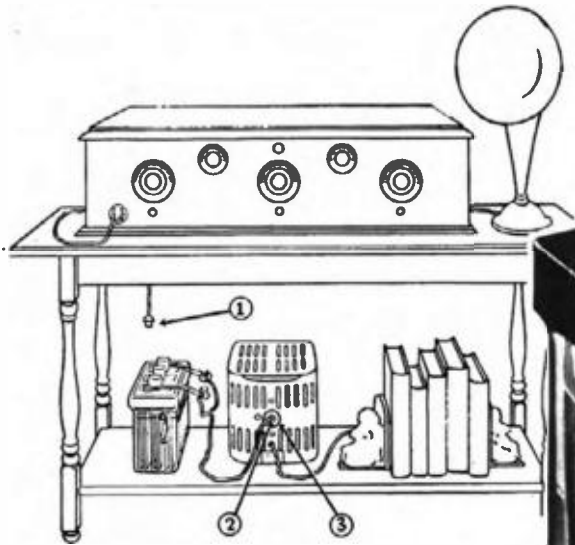

Philco "A" Battery on Charge

To connect the battery to your receiving set just pull out plug (2) from receptacle (3) of the Philco NOISELESS Charger and push into receptacle (1). (You can operate Philco "B" batteries in the same convenient fashion.)
 Philco Double Charger for 6-volt "A" batteries and all "B" batteries \$15.00
 Philco Single Charger for dry-cell tube "A" batteries and all "B" batteries \$9.75
 Prices include plugs and receptacles (1), (2) and (3).

Built-in Charge Indicator
 Balls float as the battery is charged, and sink as the battery is discharged.

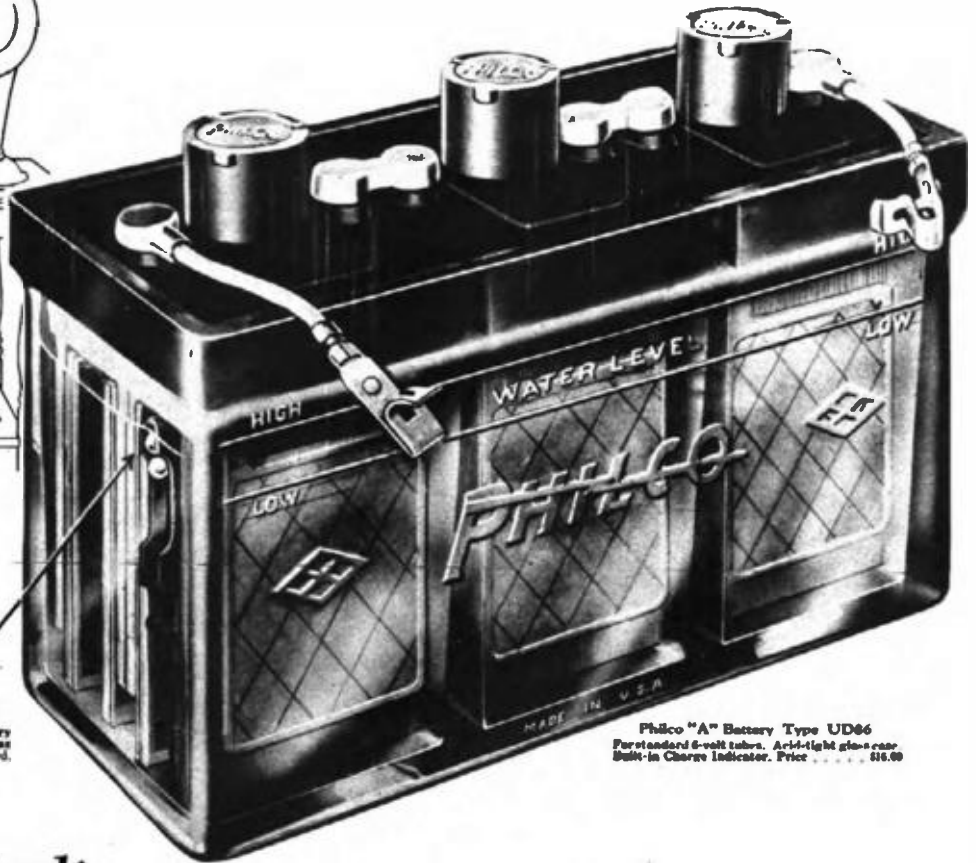

Philco "A" Battery Type UD66
 For standard 6-volt tubes. Acid-tight glass case. Built-in Charge Indicator. Price \$15.00



Philco "B" Battery

Storage "B" batteries are essential for clear and distant reception. Philco "B" Batteries stay clean and dry. Charge without disconnecting a single wire. Use a Philco Charger and "B" Charging Panel (22 1/2").
 With de luxe mahogany-finish case with cover (all volts) \$20.00
 With handsome mahogany case without cover (all volts) \$14.50



Philco "Dry Cell Replacement" Rechargeable "A" Battery

This storage battery enables you to get the most out of dry-cell tubes. Built-in Charge Indicator. Charged with a Philco Charger (22-75) without disconnecting any wires. Price \$2.50



Philco "A" Battery

Mahogany case true for standard 6-volt tubes. Price \$14.50 up.
 Charge Tubes—permanently mounted in Silver cap—(1 extra). It tells how much charge is left in the battery any time. Avoids fussing with a hydrometer.

For Radio—

Easy to operate as the Philco in your car

Recharging a Philco Radio Battery with a Philco NOISELESS Charger means merely pulling a plug from your radio socket and pushing it into the charger socket. See sketch above.

No changing wires. No moving the battery. No worry about burning out tubes by getting positive and negative wires mixed.

Philco Radio Batteries—both "A" and "B"—have other big advantages that make storage battery operation easy, convenient and economical.

They are assembled in attractive, acid-tight,

spill-proof glass cases—or in wood cases finished in beautiful Adam-brown mahogany.

They have exclusive Charge Indicators that tell you at a glance how far the battery is charged or discharged.

They deliver strong, non-rippling current without hum, roar or buzz—the absolute essential for clear and distant radio reception.

You can buy Philco Radio Batteries at your nearest Philco Service Station, Radio or Music Dealer.

Philadelphia Storage Battery Company, Philadelphia

MOTOR CAR OWNERS— avoid the danger and humiliations of battery failure by installing high-powered, long-life Philco Diamond-Grid Batteries. With Philco Retainers, they are **GUARANTEED FOR TWO YEARS**. Philco-made automobile batteries range in exchange price from \$14.95 up.

PHILCO DIAMOND GRID BATTERIES

JOBBERs and DEALERs— Philco has brought radio batteries out of the cellar and put them in the living room. Our new Radio Manual tells how. Fill out coupon below and we will mail you a copy.

Name.....
 Street..... City.....
 State..... Jobber Dealer (P)

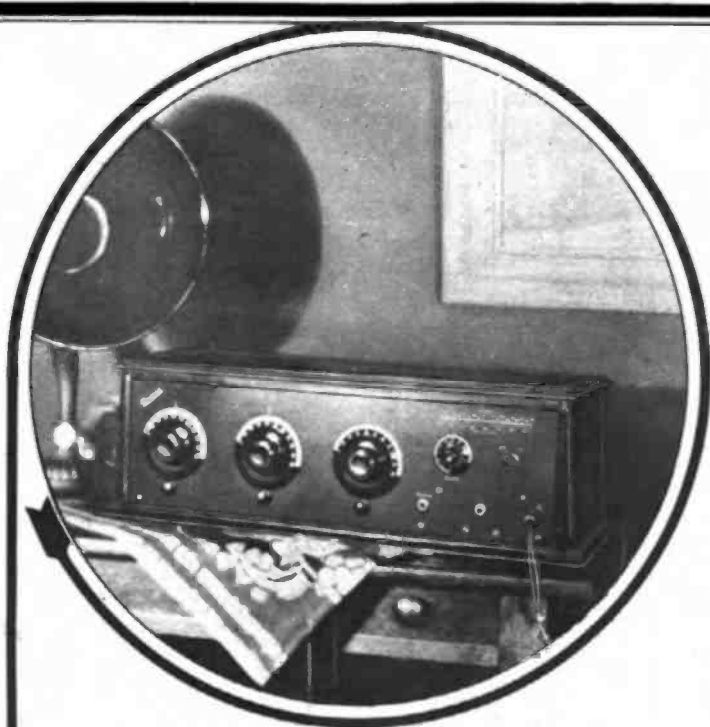

—And it comes in like Velvet

There is no station whistle on the Pfanstiehl Model 7. You hear no "air rush," no "overload," no suggestion of noise of any kind. You slowly turn the dials and the music comes in like velvet.

Pfanstiehl long ago made up his mind that it ought not to be necessary to invent methods of stopping howls and squeals in radio sets—it ought not to be necessary to neutralize or introduce the costly losses of potentiometer control. In his physicist's laboratory he developed delicate instruments with which he explored all the invisible magnetic and electro-static fields in standard sets. And he discovered that distortion and noise were primarily the results of clashing fields that interfered with each other. Reduced to simplest terms, he found that these disadvantages were due to inefficient design of coils and faulty placement of parts. With these two errors corrected, no other compensation was necessary or desirable—for all compensation means loss of valuable energy.

The Pfanstiehl Model 7 embodies his solution of these problems. It is a totally new system, incorporating two stages of tuned radio frequency, tube detector and two stages of audio amplification—low ratio, of course, to give perfect quality, with all the volume desired.

And, with the other improvements came the great step forward which takes all the guesswork out of tuning—which makes it a perfectly simple matter for the merest novice to bring in the desired station as easily and surely as he can produce a tune by putting a record on his phonograph.

PFANSTIEHL RADIO COMPANY
HIGHLAND PARK, ILLINOIS

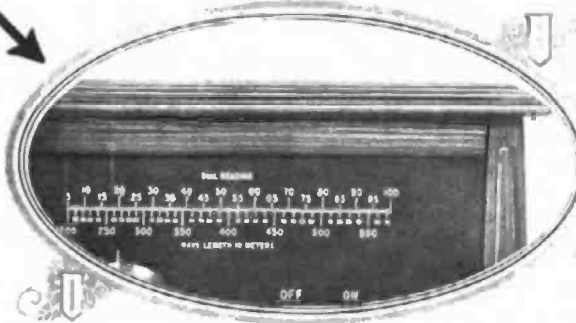

There are three large dials which are turned identically, or to the same number, for any given station. This means that to receive on any one "wave length" you need to know but one number. That number is given by the "Station Finder." On its lower scale, read the "wave length" of the station desired. Directly above read the number at which the three large dials are all to be set to secure reception. Tuning may finally be sharpened by means of the vernier knob. The women, children, "old folks," novices and all who want results, and want them promptly, may enjoy the Pfanstiehl Model 7 because the "Station Finder" takes the guesswork out of tuning.

Suggestion to Dealers
It will pay you to get in touch with us at once. This new system holds the greatest promise in radio today.

ately for those who already have a variable condenser of about .00035 capacity and who like to wind their own coils. This tuning unit may be wound on the same piece of tubing in the manner shown in the diagram. The ten turns of the primary are put on first with the two ends firmly fastened and brought out for connection to aerial and ground. The secondary is wound on the same form, with a space of about an eighth of an inch between primary and secondary. It is wise to bring out the two ends of the secondary on the opposite side of the two ends of the primary as we show in the drawing. We are also following Mr. Goodreau's suggestion

wire or can be run directly to the same positive filament binding post on socket No. 11.
6. From unconnected post on rheostat No. 12 to negative filament connection on socket No. 11.
7. From unconnected post on rheostat No. 9 to negative filament post on socket No. 8.
8. From grid binding post on transformer 5 to grid binding post on socket 11.
9. From filament binding post on transformer No. 5 a wire is run to the original binding post of rheostat No. 12 or is connected at any point on the negative filament line. It can

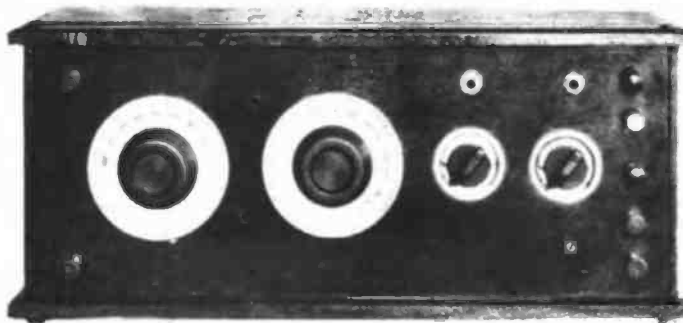

of showing the binding posts on the baseboard.

H. M. N.

Diagram No. 1, Layout of Apparatus

1. Strip of insulating material containing seven binding posts.
2. Tuning unit if home-made. (If you buy one of the manufactured tuning units with the variable condenser already attached, then coils 2 and variable condenser 6 will all be in one instrument, and the wiring will be done as later noted.)
3. Grid condenser .00025 mfd. and grid leak.
4. Fixed condenser .002 mfd.
5. Audio-frequency transformer.
6. Variable condenser about .00035 mfd.
7. Any good high-grade variometer.
8. Tube socket.
9. Rheostat for detector tube.

be run direct to the minus A binding post on the binding post block if so desired.

Diagram No. 3, the Tuning Unit

1. From antenna binding post on the binding post block to the connection to the Verni-Tuner marked A or to the aerial lead of the primary of your home-wound tuner.
2. From the ground binding post on the binding post block a wire is run to the post on the Verni-Tuner marked G or to the ground lead of the primary of your home-wound coil.
3. From the variable condenser of the Verni-Tuner marked F a wire is connected to the positive A binding post on the binding post block.
4. From the other condenser post of the Verni-Tuner a wire is connected to the left-hand side of the grid leak and condenser.

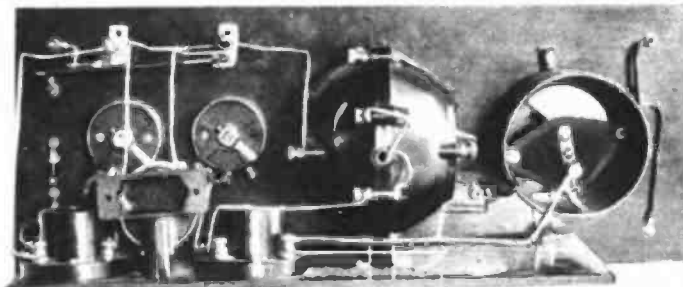

10. Double circuit jack.
11. Tube socket.
12. Rheostat for amplifier tube.
13. Open circuit jack.

Diagram No. 2, Filament Leads

1. From negative A binding post on binding post block over to one side of rheostat No. 9.
2. From that same side of rheostat No. 12 to the identical side of rheostat No. 12.
3. From plus A binding post to minus B binding post on binding post block.
4. From positive A binding post on the binding post block over to positive filament connection on tube socket No. 11.
5. From positive filament binding post on socket No. 8 a wire is connected at any place along the former

With the home-made coil shown in the diagram this will be changed so far as the variable condenser is concerned, to read as follows:

- From rotor plates of variable condenser to filament end, or end nearest primary of your home-wound coil.
- From that same filament end of that secondary to positive A binding post on binding post block.
- From grid, or end farthest away from the panel on the secondary of the tuner, to left-hand connection of grid condenser and leak No. 3.
- From stator plates of variable condenser to left-hand connection of grid condenser and leak No. 3.
- From here on the two sets will be wired identically.
5. From right-hand connection of

Table-Talker



What greater gift?

Fun for the holidays—for all the year. Fun for the fellow who gets the gift—and for the family. Give it all—give a *Table-Talker*.

You're sure of its tone. Sure that it will always be loud yet pleasant, because its horn is matched to the unit. It reproduces every word, every note with vivid clarity—it makes the joys of radio real!

Brandes

 Superior
 Matched Tone
 Headset \$6
 \$7 in Canada

 Table-Talker
 \$10.
 50¢ extra west
 of the Rockies
 In Canada \$12.50

The name
to know in Radio

 Navy Type \$8
 Matched Tone
 Headset
 \$9 in Canada



Engineers developed this special panel material for radio ONLY

THERE is nothing quite like Radion—"the supreme insulation"—for real results. Authoritative laboratory tests conclusively prove highest insulating characteristics. In the set you build, it may give you just that extra energy needed to tune in a distant station. When you see Radion in a ready-built set, it is usually an evidence of general good quality in that set.

You can see the difference between Radion and common panel materials, if you will look at the finish. Radion has a high, polished finish. That keeps out dirt and moisture, which even in little particles on the surface sometimes cause short circuits and reduce good reception. Look at Radion and other panels under a magnifying glass if you can.

Everyone knows Radion is an easy panel material to drill, cut and saw. There are eighteen stock sizes, two colors, black and mahogany. Sold universally by dealers who know radio. Better performance will make it worth your while to ask for it by name, and to look for the name on the envelope, and the stamp on the panel.

Radion dials to match, also sockets, binding post panels, insulators, knobs and new Radion built-in horn.

Send for Booklet

MAIL coupon below for our catalog and booklet, "Some Insulation Stickers Explained."

AMERICAN HARD RUBBER COMPANY
11 Mercer St., New York City
Chicago Office: Conway Building

Pacific Coast Agent: Goodyear Rubber Company
San Francisco — Portland

RADION

The Supreme Insulation

PANELS

Dials, Sockets, Binding Post Panels, etc.

| | | |
|--|-------------|-------|
| AMERICAN HARD RUBBER COMPANY | | RM-12 |
| 11 Mercer St. New York City. | | |
| Please send me your catalog and booklet, "Some Insulation Stickers Explained." | | |
| Name | | |
| Address | | |
| City | State | |

grid condenser and leak No. 3 to grid binding post on socket No. 8.

Diagram No. 4, Plate Leads

1. From detector B binding post on the binding post block a wire is run to the lowest of the four connectors of jack No. 10.
2. From the connector next to this on jack No. 10 a wire is run to B battery binding post on transformer No. 5.
8. From the next connector on jack No. 10, or the one next to the top, a

connecting them by wire as shown in the photographs to make a standard variometer of it.)

6. From detector B binding post on binding post block to one side of fixed condenser No. 4.

7. From other side of fixed condenser No. 4 to top blade of jack No. 10.

8. From amplifier B battery binding post on binding post block to lower connector of single circuit jack No. 13.

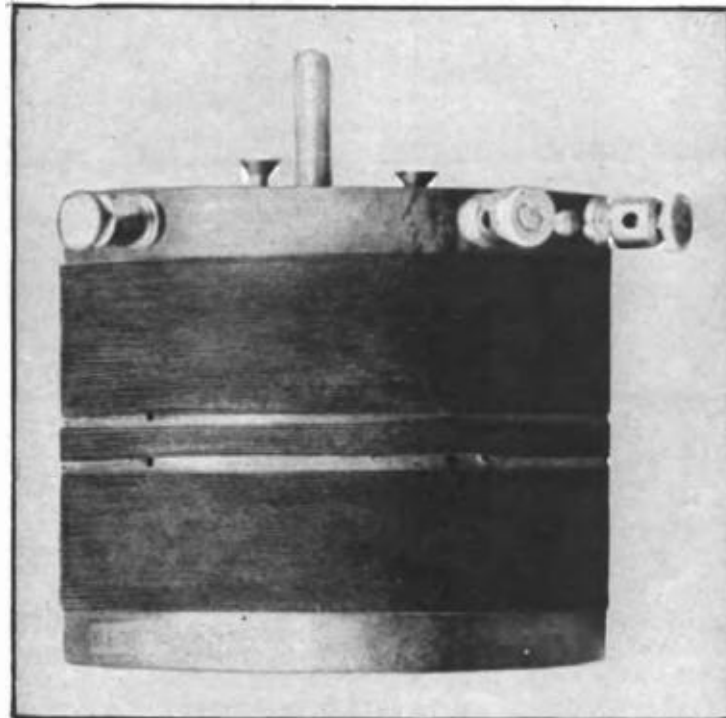

These photographs show the actual Verni-tuner mentioned by Mr. Goodreau in his article. The pictures are printed so that readers who use this instrument will be able to see the connections and readers who wind their own coils will see the difference between this and the coil shown in our diagrams.



wire is run to binding post marked P on transformer No. 6.

4. From top connector of jack No. 10 a wire is run to one binding post on the variometer.

5. From the other binding post on the variometer a wire is run to the plate binding post on socket No. 8.

(You will notice, in the photograph, a wire on the variometer which has not been mentioned. This wire merely makes a standard variometer of a "split" one. A split variometer has separate windings; in a standard variometer the windings are connected in series. You will find it worth while to buy a split variometer if you do much experimenting with hook-ups, as it can be used in any circuit either using the two windings separately or

9. From upper connector No. 13 a wire is run to the plate binding post of socket No. 11.

The actual verni-tuner is not built exactly as our diagrams show it. The coil shown in the diagram is the simplest one to build and works quite efficiently. The Electrad verni-tuner has the primary wound in between the two sections of the secondary. This will be made clear by examining the photographs of the actual verni-tuner shown with this article.

Editorially Speaking

(Continued from Page 8)

current-tap device on account of convenience, though a great many more will prefer to use the batteries because they have learned to make the use of the battery quite as convenient and as little trouble as the use of an automobile.

I believe that there is a legitimate field for both the current-tap device and the battery, whether dry cell or storage, and I believe that there is money enough in the future of radio for the manufacturers of all of these devices to make a very comfortable profit out of them.

Don't let us go wild over all of this newspaper propaganda that is being spread around.

And let us also remember that a printed guarantee of money-back is not worth the paper it is printed on unless the name signed to it is a name which carries confidence through years of square dealing and successful business endeavor.

This Transformer Has Improved Thousands of Radio Sets

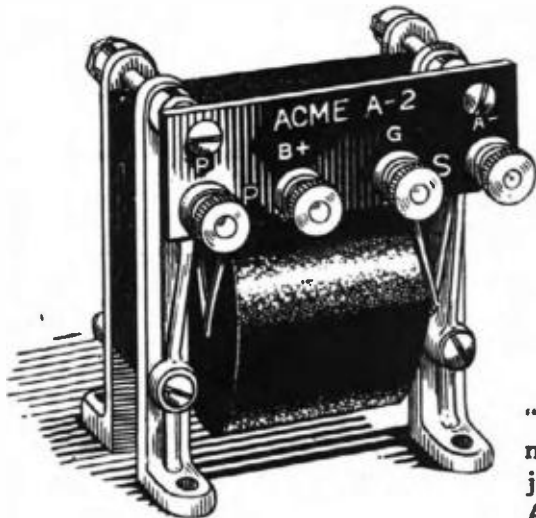

Acme A-2
—for volume

"... YOUR letter answering mine of December 10th came just as I got home with an ACME A-2 in my pocket. I installed it in my reflex set in place of the — and believe me you cannot exaggerate its good qualities . . ." From Winnetka, Illinois.

"... Am using your four-tube Acme circuit, using three audio and three radio transformers, and can pick up any 50 watt station in the U. S. A. . ." From Fitzsimmons, Colorado.

These are just typical samples of testimonials picked out at random from our files. If we tried to show them all to

you, we'd have to publish a book. You couldn't read them through in a day.

But right here and now today you can, if you will, get the benefit of ACME Transformers. Use them in the set you build. Insist on them in the set you buy. Then your loudspeaker will have a chance to reproduce loud and clear without distortion.

Send 10 cents for 36-page book, "Amplification without Distortion," containing many practical wiring diagrams and many hints for getting the best out of your set.

ACME APPARATUS COMPANY, Dept. 142, Cambridge, Mass.
Transformer and Radio Engineers and Manufacturers

ACME

~ for amplification

ACME APPARATUS COMPANY,
Dept. 142, Cambridge, Mass.
Gentlemen:—Enclosed find 10 cents for copy of
"Amplification without Distortion."

Name

Street

City

State



Both Must Be Musical Instruments

If you are to enjoy the rich resonance of an old Cremona violin, your loud speaker must also be a true musical instrument. So designed and powered as to respond as faithfully to the inspiring crescendos of a Wagner opera as to the whispers of a Moonlight Sonata.

The new Bristol AUDIOPHONE does that. With its joyous, open-throated rubber horn, and its finely adjusted tone mechanism, it is on a musical plane with the noblest instrument or voice at your favorite station.

In addition to Model S, shown here, the Bristol line includes Model J, \$20; Baby Grand, \$15, and the "Baby" at \$12.50. Send for Bulletins 3011 and 3017-Q, mentioning the name of your dealer.

THE BRISTOL COMPANY
WATERBURY, CONN.

BRISTOL AUDIOPHONE

TRADE MARK REG. U.S. PAT. OFFICE

LOUD SPEAKER



Model S Audio-
phone—\$25

Rubber Horn 14½" diameter. Velvet mat finish of mottled bronze and gold classic base.

Chasing up the Whistles

(Continued From Page 23)

let us cite an analogy with which we're all of us familiar. Did you ever strike two adjacent notes on your piano and hear as an accompaniment to the two individual tones a sort of throbbing or beating effect? Try it some time. Take two keys just one-half tone apart and well down near the lower end of the keyboard.

The throbbing drone of the German bombing plane was familiar to every Allied soldier in the trenches and served to identify the "Boche" plane instantly. Two motors were employed on each, and they usually ran at slightly different speeds.

Next suppose we consider two men walking across a light wooden bridge. Suppose their strides are slightly different, so that although they are out of step most of the time, every now and then the faster stepper catches up with the slower and they both bring a foot down at the same instant. The bridge then receives a double shock and will register an extra strong vibration under the strain. And this extra shock occurs again and again, every time the two walkers happen to get into step.

The interested reader may quickly rig up a surprisingly striking experiment which will demonstrate effectively the principles upon which depend the production of a third vibration by two other dissimilar vibrations.

The photo shows a little wooden stand arranged with a horizontal bar about eight inches above the base. From this are suspended two small weights at the extremities of two threads, one about seven inches long and the other about six inches.

The threads are tied to a match about one and a half inches below the top bar. A simple scale is tacked to the upright piece and bent to come between the threads just below the center of the match. A short length of wire twisted about the center of the match between the threads forms the pointer. Now if the weights are pulled aside and started together on their swinging movements, the pointer registers an oscillating movement back and forth in time with the weights.

But as the threads are of different length, the shorter one swings more rapidly and gets ahead of the longer one. The match then begins to twist, but its center point continues to swing back and forth with reducing speed until finally, when the weights are opposite each other, the pointer comes practically to a standstill. Then as the weights begin to "get into step" with each other again, the pointer once more starts to swing, too, and it reaches its maximum motion as the two weights swing in unison.

With movements counted by a watch, the longer thread and weight swung seventy-two times in a minute and the shorter thread and weight eighty-one times. Then the "beats" or movements of the pointer were counted, and just nine times in the minute did the pointer show its maximum motion and thus indicate the occasions when both weights were in perfect synchronism. Nine is just the difference between seventy-two and eighty-one and brings out an important fact about the production of beat vibration or "heterodyning." *The beat note is equal to the difference in frequency between the two vibrations producing it.*

The radio whistle is exactly like these instances in its nature. You have a broadcasting station tuned in.

The music pouring from your speaker is transported on a "carrier wave" or a steady succession of impulses that occur hundreds of thousands of times every single second. WIP, for instance, each second sends forth from its aerial about 590,000 of these impulses or individual waves forming the "carrier" of voice and melody.

Your ear, however, is incapable of hearing vibrations of such inconceivable rapidity, and the best it can do is to register vibrations occurring 10,000 times a second as a very high squeak. That's the "upper limit" of human audibility. Therefore, you cannot hear the individual impulses in WIP's carrier at all and notice solely the "modulations" or fluctuations in that carrier that form music or speech.

But we're still in search of the whistle.

Your own set, unless it be of the "nonregenerative" or "nonoscillating" type, is a radio transmitting station like WIP, but on a very tiny scale by comparison. It has, however, every item used to radiate radio impulses except the microphone. You have a vacuum tube, though small in size; tuning coils for adjustment to various wave lengths; an aerial and a source of sending power in your "B" battery.

Your receiver, when operated in a certain way, is therefore capable of sending forth a "carrier wave" of its own. When the carrier from the broadcasting station is tuned in and your receiver is simultaneously adjusted to the transmitting or "oscillating" condition, the two carriers come into conflict. They resemble the two men walking on the bridge. Every so often an impulse from one carrier strikes the detector tube of the receiver at exactly the same instant as one from the other carrier wave. Then there's a double effect that is felt by the detector and passed along to the phones or loud speaker in the form of a click. The steady recurrence of the time when both waves "get into step" causes a series of clicks which, when rapid enough, resolve themselves into a whistle or squeal.

By changing the tuning of your receiver you alter the frequency with which these two carriers coincide with one another and consequently raise or lower the whistle. When the frequency of the receiver's carrier or oscillation is slightly lower or higher than the incoming oscillation the whistle is heard. Its pitch depends directly upon the numerical difference between the two carrier waves. If your receiver is tuned to say 589,000 "cycles" or about 510 meters, and is oscillating, a whistle of 1000 frequency will be heard. This is a note in the soprano range.

The whistle is called a "beat note" just as the throbbing of the German airplanes is a "beat note." Should the frequencies of the two vibrations or carrier waves become identical, the beat note is silenced, and the tuning is then said to be in "dead beat." With the oscillation frequency of your receiver either raised or lowered, the pitch of the whistle rises, finally becoming so high that it passes "above" audibility.

Such a whistle is heard not only in your own receiver, but in all others within a mile or so that are tuned to the same wave length. For this reason the "whistle method" of tuning is exceedingly annoying and objectionable to other listeners and in-



**THE INVERSE
DUPLEX**
Insures Natural Tone Quality
REGISTERED TRADE MARKS PATENTS PENDING



Do You Operate a Ford or a Rolls-Royce in Radio?

SSMALL cars are good enough for "hack-
ing" around town. An inexpensive or
old-fashioned set may satisfy you for most
local radio reception. But when you want
to tour long distances or climb steep hills
or travel on bad roads in unfrequented
places, you want the finest car that's made.
And when you want to take your pick of
radio reception, listening in comfort and
enjoyment to an ever-broadening circle of
the stations that your neighbors never hear
—you want a—

Sleeper

MONOTROL

REG. U.S. PAT. OFF.

The new Sleeper Monotrol does things that your neighbors' sets can't duplicate. With three stages of tuned radio frequency and three stages of audio, it has tremendous reserve power. It reaches out hundreds of miles and brings in speech and music with a power, clarity and tone that most sets cannot give from stations a few miles away.

It separates stations with a knife-like sharpness—in almost all cases penetrating the barrage of powerful local broadcasting and tapping in on distant points as quietly and privately as though on a desert island. It is a set with 24 improvements—a versatile set—a universal set—a set you can control under all conditions—a good set when conditions are bad—a fair set when conditions are "impossible" for others.

By all means see, hear and operate the Monotrol. Your dealer will install it for **FREE** trial in your own home and you can buy it on the most convenient terms of monthly payment.

Sleeper Radio Corporation

432 Washington Avenue

Long Island City, N. Y.

CHICAGO

SAN FRANCISCO

10 South La Salle Street

111 New Montgomery Street

"HOW TO CHOOSE A RADIO"

Do not make the usual mistakes in radio selection. This unique booklet tells you just what radio improvements to look for and expect in 1925. **FREE** copy on request. Write for booklet.



The Bestone V-60 five-tube receiver in beautiful, distinctive, antique polychrome cabinet, with built-in high-grade loudspeaker and battery compartment. List \$165.00
Bestone V-60 five-tube receiver, Imperial Model, in beautiful polished mahogany cabinet. List \$115.00



TRADE MARK

The Aristocrat of Radio

Different From Any Set You've
Ever Heard or Seen

An Xmas Gift That
Will Thrill, Satisfy
and Serve

Give the finest of all Radio Receivers
for Xmas—the one everyone knows as
the peer of them all—BESTONE V-60.

Gives a new meaning to the word
Radio.

There is prestige in owning a
BESTONE V-60.

There is philosophy in buying the
best.

A piece of furniture worthy of the
machine it contains.

Manufactured, Guaranteed and Distributed by

HENRY HYMAN & CO., INCORPORATED

476 Broadway, NEW YORK

212 W. Austin Ave., CHICAGO

terference of this sort is termed radiation interference. It is only by careful tuning on the part of all operators of regenerative or oscillating receiving sets that such disturbances can be minimized. The proper mode of tuning is to avoid actual oscillation by careful control of the tickler dial or potentiometer (in the case of radio-frequency receivers).

Enough regeneration may be employed for maximum sensitivity, but the whistle is really unnecessary and a nuisance. The carrier wave of distant broadcasting stations is always plainly manifest by a hissing or "rush of water" sound as its wave length is passed.

Now for the whistles and squeals that come from the outside—a more difficult problem to manage than those you cause yourself. Whistles that chirp away, down and then up again, are caused by other receiving sets whose owners employ the whistle method of tuning. You can't avoid them, can't do anything unless you happen to know the source of your worst interference of this nature and feel emboldened to have an explanatory chat with the interferer.

Education through magazines and newspapers is doing much to overcome the whistle nuisance and the spread of nonoscillating sets like the neutrodyne and others of the non-oscillating tuned radio-frequency type is to be acclaimed and furthered in the interest of undisturbed programs.

There's still another type of whistle. It is not caused by receiving apparatus, however. Two or more broadcasting stations are often assigned similar or adjacent wave lengths. A slight difference in their carrier frequencies sets up a steady wail like winter wind around the chimney. It can be tuned in and out just like a station, but not changed in tone. Usually there's a slight swinging effect, too, so that the pitch of the squeal rises and falls a little in most mournful fashion.

The responsibility for this condition lies at the door of the United States Government Radio Service and the remedy is gradually being made by the reassignment of wave lengths and of broadcasting time periods, and seeing to it that the stations keep exactly on their assigned wave lengths.

The system mentioned above as "dead beat" reception is used by some because they believe very weak stations are more satisfactorily heard in that way. However, *re-radiation* takes place then—the incoming speech and music modulating the carrier wave being transmitted by the oscillating receiver and thus adding to the ethereal confusion. Dead-beat reception robs the atmosphere within an appreciable distance of energy on that wave length without improving reception for the listener who practices it.

When your signals suddenly fade out with a swish and downward whistle, you may be sure some one is practicing this method of tuning. The *re-radiation* by dead beat often startles a crystal-set listener with announcements from Kansas City or Atlanta and makes him think his crystal has suddenly become super-sensitive. *Re-radiation* should not be confused with *radiation*, the latter referring merely to the transmission of a plain carrier wave from an oscillating receiving set and being by far the more common cause of interference.

Understanding how whistles and squeals originate, it is squarely up to each receiving set owner to keep guard on the regeneration control and thus never permit his own outfit to offend by radiation. Through co-operation we may quell the whistles.

The Two-Tube Counterflex

(Continued from Page 28)

From plate (P) terminal of audio transformer No. 7 to stator of variable, condenser of counterformer No. 5.

From terminal No. 4 of counterformer No. 5 to wire connecting plate terminal of audio transformer No. 7 and stator of variable condenser of counterformer No. 5.

Diagram No. 5

From grid (G) terminal of audio transformer No. 6 to grid terminal of tube socket No. 2.

From B plus terminal of audio transformer No. 7 to left-hand (cat-whisker) terminal of crystal detector No. 11.

From right-hand (mineral) terminal of crystal detector No. 11 to terminal No. 3 of counterformer No. 5.

From rotor of variable condenser of Counterformer No. 5 to wire connecting crystal detector No. 11 and terminal No. 3 of counterformer No. 5.

(When wiring to the crystal detector do not place your soldering iron on the detector itself, as the heat may harm the crystal. Remove the soldering lugs from the crystal, solder them on to the ends of the connecting wires and then screw the lugs back in place.)

Diagram No. 6

From B plus binding post of block No. 1 to bottom blade of jack No. 13.

From next to bottom blade of jack No. 13 to plate terminal of tube socket No. 2.

From B plus binding post of block No. 1 to B plus terminal of audio transformer No. 6.

From plate (P) terminal of audio transformer No. 6 to terminal No. 1 of counterformer No. 5.

From one side of fixed condenser No. 9 to B plus terminal of audio transformer No. 6.

From opposite side of fixed condenser No. 9 to plate (P) terminal of audio transformer No. 6.

From terminal No. 2 of counterformer No. 5 to plate terminal of tube socket No. 3.

From rotor of counterdon No. 10 to wire connecting terminal No. 2 of counterformer No. 5 to plate terminal of tube socket No. 3.

Reflexing That Oscillating Set

(Continued from Page 22)

they are fairly selective. A few precautions are necessary to insure success. A low ratio audio transformer should be used and the fixed by-passing condensers should be adjusted to different values to suit the particular type of audio unit employed. It may be necessary to increase the .0005 mf. to .0025 mf. for instance. If an oscillation is experienced, reducing the primary turns in the fixed crystal circuit to six will usually help matters.

The day of single circuit is past, although the three-circuit sets are almost as bad. The diagram with the heading of this article suggests the obsolescence of such apparatus, so please follow the hook-up exactly and employ a good spider to weave his web all over such a circuit. It is in reality the real spiderweb set.

I AM very glad to be able to announce that since the publication of our last issue the patent office in Washington has allowed David Grimes, our associate editor, his basic patents on the inverse duplex system.

On September 15th, the patent office allowed Mr. Grimes the improvement patents which took the audio out of the radio frequency circuit, but this still left the fundamental patent undecided. Now, however, Mr. Grimes has had this patent allowed and this definitely clears up his claim to the inverse duplex system.

H. M. N.

Nothing Electrical But the Performance

You add no electrical complication to a radio set when you install a Superspeaker.

No extra batteries or coils—nothing to wear out or get out of order.

Even the adjustment is on last-forever fundamentals—a positively operating cam of metal that stays put. Just a simple, musical instrument that gets its music from an exceedingly sensitive reproducing unit, and amplifies by means of a strictly non-vibrating horn.

An instrument designed and built by experienced musical instrument manufacturers who know acoustal laws and put this knowledge into practice. An instrument, therefore, from which you justly expect—and receive—amazingly different performance.

The experienced Radio operator found out long ago that there was far more to a loud speaker than a horn and a reproducing unit. Superspeaker performance alone has been striking proof that certain secrets do exist. Whatever these secrets may be, he has found that The Superspeaker gives him results he cannot otherwise duplicate. So he is content. Do you wonder that Superspeaker demand has increased more than 1000% during 1924?

By sheer merit, The Superspeaker has won its leadership and performance. Give your set a chance to show what it can do with Superspeaker equipment!



The Vemco Unit

For Phonograph adaption, we furnish separately the Vemco Unit which is the heart of The Superspeaker. It comes complete and ready for immediate use on any standard tone arm. Simple adapter for special arms are easily fitted.

This Unit is adjustable for volume, and develops the reproductive ability of a phonograph horn to the absolute limit of tone and distance.



JEWETT RADIO & PHONOGRAPH CO.
5682 Twelfth St., Detroit, Mich.

The Superspeaker



THE SUPER HILCO-DYNE RECEIVER—a seven-tube set superior in every way and different from the conventional super heterodyne (note wiring diagram below) is made from the \$30 SUPER HILCO-DYNE KIT and about \$45 worth of standard radio parts sold by any dealer. It operates either on storage battery or dry cell tubes.

SELECTIVITY. A fan receiving in New York next to the high voltage elevated railway tunes in or out all the nearby high-powered broadcasting stations and gets what he wants when he wants it.

DISTANCE. A fan receiving in a large metropolitan hotel uses the steam radiator as his antenna and gets coast to coast reception.

TUNING. Only two dials. Stations can be located today, tomorrow or next month by turning back the dials to the place where those stations came in before.

CONSTRUCTION. Inexperienced fans all over this continent have built these sets without trouble.

RADIATION. Not a squeak, squawk or squeal comes from the SUPER HILCO-DYNE to bother your nearest neighbor. It does not radiate.

DISTORTION. Absolutely true tone qualities from the lowest note of a bass horn to the highest note of a coloratura soprano.

VOLUME. You can dance any night with a SUPER HILCO-DYNE RECEIVER. Loud speaker reception on all stations.

WAVE RANGE. 90 to 600 meters.

SIZE OF RECEIVER. Only 7"x28" panel.

Each SUPER HILCO-DYNE KIT is thoroughly tested and the air core transformers are matched and balanced in our own laboratories.

Here is selectivity, great distance, volume, clarity, easy tuning, simple construction. It is YOUR set, custom built to your requirements. It is the ONE you want; the ONE you have been hoping for. Order from your dealer or send for descriptive literature on the SUPER HILCO-DYNE KIT and other famous Hilco radio apparatus. Address Dept. 14.

Scientific Radio apparatus that is distinctively different and superior in efficiency and appearance.

SUPER HILCO-DYNE BOOK

Free with kit!

A-E HILL MFG. CO. Atlanta, Ga.



The Two-Tube Harkness Counterflex

(Continued from Page 17)

searched the market for a suitable crystal detector. I did not even attempt to use any of the so-called fixed crystal detectors because they are manifestly too inefficient. One detector (called the RUF) is described as "fixed," but it owes its efficiency to the fact that it is really adjustable. I found this particular make to be one of the best on the market.

One of my assistants showed me the plans of a detector which he had designed, using a rather ingenious method of control which he had adapted from a certain detector of French manufacture, as described in one of my articles over a year ago.

cannot easily be shaken from the position it occupies.

I do not claim this crystal detector is fool-proof, but it is undoubtedly very simple to adjust, and, provided the mineral is renewed from time to time, little trouble will be experienced in finding a sensitive point.

In the matter of minerals, I think that galena is undoubtedly the most suitable. The usual method of using this mineral is to imbibe a small piece in melted Wood's metal, but this method heats the crystal and tends to destroy its sensitiveness. There is one galena crystal on the market, known as the Tip-Top crystal, which is clamped in a special cup and uses no Wood's metal. I find, as a result, that this crystal is somewhat more sensitive than the ordinary type.

The circuit used in the two-tube Counterflex, with crystal detector, is shown on page 16. It will be noticed there is a slight difference between this circuit and the one which I gave last month, a fixed condenser being shunted across the primary of the second audio frequency transformer. I find that this addition improves the operation. The circuit, of course, is practically the same as that of the old two-tube Harkness Reflex, except that the Counterdon is added to control self-oscillation. The use of this control also changes the inductance values of the radio frequency transformers, thereby improving the efficiency of the receiver.

The following is a complete list of the parts required to build this receiver:

- One front panel, measuring 7x14 inches.
- One counterformer, Type T1.
- One counterformer, Type T2.
- One counterdon.
- Two audio frequency transformers.
- One crystal detector.
- Two tube sockets.
- One fifteen-ohm rheostat.
- One single circuit fil. control jack.
- One fixed condenser, .00025 mfd.
- One fixed condenser, .001 mfd.
- Four binding posts.
- One two-inch dial (180-degree calibration).

Two four-inch dials.
In the October issue I gave the constants of the counterformers. The variable condensers I used at that time had a maximum capacity of .00032 mfd. Since then I have changed to variable condensers with a maxi-

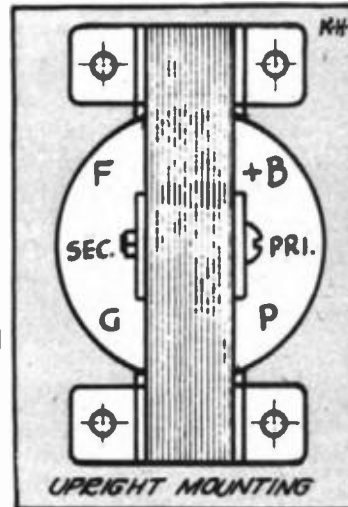

The audio transformer No. 6 and No. 7, as shown in diagrams

He had greatly simplified the mechanical construction of this detector and made it much more practical. This detector seemed to possess distinct advantages over existing types so I arranged for its manufacture. The drawing with this article illustrates how the device operates. Each time the controlling knob is given a complete turn the catwhisker leaves the crystal, revolves slightly and returns to the crystal at a different point. By turning the knob a few times a sensitive point can be easily located. Additionally, a small piece of fine wire gauze is stretched across the surface of the crystal so that, when a sensitive point is found, the catwhisker

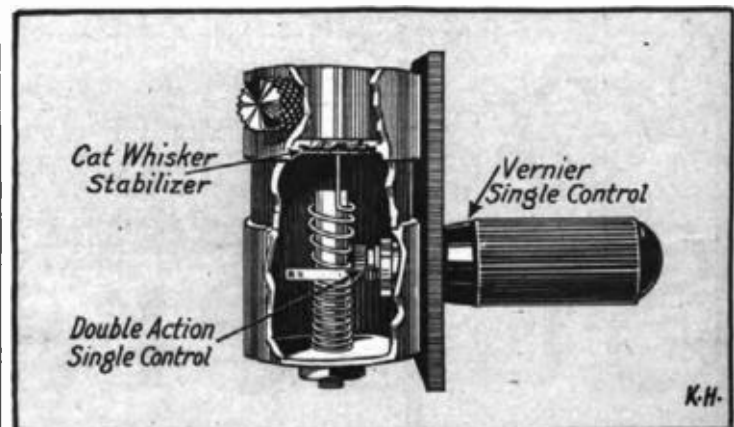

A clever new mount for the crystal in the two-tube Harkness Counterflex

If you want clear radio, you must have perfect contact!

Exacting tests prove efficiency of Na-Ald Sockets

CLEAR contact between socket and tube is necessary, above all, to insure clear radio reception. This contact is the important point to watch in all sets.

For greatest contact efficiency, experienced radio owners use Na-Ald Sockets. They have been subjected to exacting tests and have proved their real worth.

Perfect Contact assured with Na-Ald De Luxe Sockets. Broad wiping surface of four special dipped phosphor bronze socket clips press both on sides and ends of tube terminals making perfect clean, bright contacts.

Tension is permanent. Strips are laminated like automobile springs to insure continued resiliency and pressure against terminal prongs, no matter how often tube may be removed. Tube held **FIRMLY** in place in socket.

Clean Easy Feature. The two to eight tubes do not have to be removed and sandpaper used to scrape contact surfaces bare. Duo-contacts easily cleaned and film of oxide between tube and socket, better known as corrosion, which can ruin contact, is quickly removed by twisting each tube back and forth in the socket two or three times. This feature of Na-Ald Sockets saves trouble and time.

In Na-Ald Sockets, upper contact cuts into side of terminals, scraping off all corrosion, making a clean bright surface. Lower contact wipes over bottom of prongs without danger of scraping filament wires bare.

Highest Insulating Qualities. Na-Ald Sockets are genuine bakelite Alden processed. This gives a socket of well-cured not-too-heavy bakelite of even cross-section throughout.

Thus Alden Processed construction insures highest insulating qualities and lowest loss. All possible current is carried from socket clips to tube terminals. This is most essential as current flow is so minute, any loss is noticeable in efficiency results.

Na-Ald Sockets are easy to mount. Sockets equipped with slotted knurled nuts. Tightened with ordinary screw-driver.

You can obtain Na-Ald Sockets at radio, electrical and hardware stores everywhere. Be sure you have Na-Ald Sockets in the Set you build or buy. Sockets for all tubes—De Luxe, 75c; others 35c, 50c, 75c.

Send for free copy of radio booklet—"What to Build," giving a number of the best selected and tested circuits.

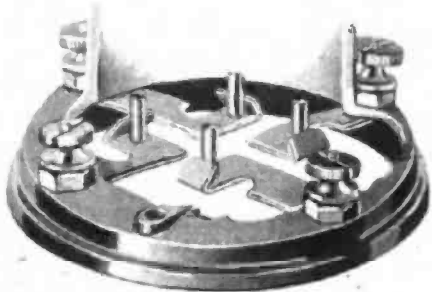

"It's the contact
that counts"



Socket instantly cleaned
by twisting tube

ALDEN PROCESSED
NA-ALD
SOCKETS AND DIALS



ALDEN MANUFACTURING COMPANY
Also Makers of the Famous Na-Ald Dials
Dept. J-1, Springfield, Mass.

A-C DAYTON XL-5

The A-C DAYTON XL-5

Dark Mahogany
Cabinet

PERFORMANCE

If you are going to expect consistently satisfactory performance from your new Receiving Set, you will be delighted with an A-C DAYTON XL-5.

In selectivity, volume, wave-length range, ease and simplicity of operation, the XL-5 is unsurpassed. In CLEARNESS of radio reception, it leads the field of fine Receivers.

The XL-5 is a five-tube super-Receiver that out-performs any set in its price class. It sells on performance—performance that is a pleasant surprise to the most exacting fan — performance that will more than satisfy you.

Ask to see and hear the A-C DAYTON XL-5. Your dealer will gladly demonstrate its wonderful performance and clear reception.

Radio Jobbers and Dealers! We are expanding our distributing organization. Write for complete information.

THE A-C ELECTRICAL
MFG. CO.

DAYTON : OHIO

Makers of fine electrical equipment
for twenty years.

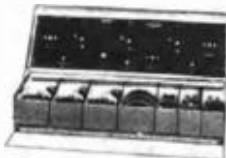

A-C DAYTON

Knock-Down Set. The XL-5 is sold in knock-down form, complete with all parts and directions for \$72.50 (\$76.50 Denver and west).

\$115.00

Less tubes and batteries (\$120 Denver and west).

Designed for use with either storage battery or dry cells.



AIRTRON RADIO TUBES

with the new highly developed dielectric molded Bakelite base which eliminates all kinds of electrical losses.

AIRTRON TUBES

speak for quality, volume and all other characteristics demanded of a radio tube. Designed and manufactured to give the highest efficiency that a tube at the present time can possess.

Type 200—4-Volt, 1 Amp. Detector.
Type 201A—5-Volt, .25 Amp. Detector and Ampl.
Type 12—1½-Volt, .25 Amp. Det. and Ampl.
Type 129—3-4-Volt, .05 Amp. Det. and Ampl.
Standard Base.

Every Tube Guaranteed
List Price, \$4.00

Sold by all dealers, or shipped C. O. D. direct by Parcel Post. When ordering mention type. Discount to Dealers



Type 201A

H. & H. RADIO CO.

Clinton Hill Station, Box 22, Dept. 103, Newark, N. J.

We Are Still Repairing
All Types of Radio Tubes at \$2.50

mum of .00026 mfd. to permit the use of larger inductance values. The new constants are as follows:

Countercoil T1: Secondary coil has sixty-five turns of No. 28 silk-covered wire wound on a formica form 2½ inches in diameter. Primary coil has fifteen turns, with a tap at the tenth turn, the primary being wound on top of the secondary coil but separated from it by a piece of insulating paper or Empire cloth. Both coils are wound in the same direction.

Countercoil T2: Secondary has sixty turns of No. 28 silk-covered wire, also wound on a form 2½ inches in diameter. Primary coil has thirty turns. The coils are wound in the same direction and in the same manner as type T1.

The above constants, of course, are only correct when variable condensers with maximum capacity of .00026 mfd. are used with the coils.

The terminals of the manufactured countercoils are numbered and these numbers appear in the diagram of Figure 2. In this diagram terminal No. 1 of T1 is the beginning of the primary coil and terminal No. 8 the beginning of the secondary. Terminal No. 1 of T2 is the beginning of the primary coil of this transformer, but terminal No. 4 is the beginning of the secondary. When wiring the receiver it is essential that the connections to these terminals be made correctly.

The Harkness counterdon, mentioned in the above list of parts, is a three-plate variable condenser which is visible in the photographs of the complete set.

The assembly of the receiver can be seen in the photographs on page 17. It is not essential, of course, that this particular form of assembly be followed. In fact, if you are unaccustomed to wiring closely grouped apparatus, it might be better to use a front panel measuring 7x18 inches and space the parts a little more. Incidentally, after building this receiver I was inclined to believe the crystal detector might better have been placed in a more accessible position.

In the photographs it will probably be noticed by some readers that a fixed condenser is connected across the secondary of the second audio frequency transformer. This was a mistake, and, after the photographs were taken, this condenser was removed and placed across the primary, as indicated in the wiring diagram.

The wiring of the receiver is given on page 16, and, for the benefit of those who are unaccustomed to this type of diagram, detailed wiring instructions in the 3XP-style wire-ups are given on pages 18, 19 and 20.

The usual accessories are required to operate the set. UV201A or C301A tubes give the best results, and a ninety-volt plate battery should be used with these tubes. In connecting the batteries to the receiver, note that the negative lead of the plate battery and the positive lead of the filament battery both connect to one binding post; similarly, the negative lead of the filament battery and the ground lead both connect to one post. It is usually best to connect the antenna to the ten-turn tap on the primary of T1, but if your antenna is very short it may be better to use all fifteen turns.

When operating this receiver, do not tune in stations by turning the counterdon to its minimum position, permitting self-oscillation to take place and listening for the carrier waves of transmitting stations. If you do this you will cause interference to your neighbors.

When tuning in, always turn the

counterdon to such a position that self-oscillation cannot take place. After you have adjusted the tuning dials to receive a certain station you can increase the audibility by decreasing the counteraction. Thereafter, however, do not touch the tuning dials without first increasing counteraction so that your receiver cannot radiate.

I shall be glad to hear from those readers of this magazine who build this receiver. I am always interested to learn the experiences of others and to render any assistance when necessary.

Flewelling's New Circuit

(Continued from Page 18)

than those shown to be made to the circuit, because to do so almost invariably means trouble. Here is perhaps the best place to speak of the apparatus to be used.

As engineer for the Ruell Manufacturing Company, it is my duty to design condensers, coils and what not for them. Because of a puritanical conscience they must be of fairly decent design, but I must confess they were designed to meet the stringent requirements of the Flewelling circuit, with the knowledge that if they would work there they would work anywhere. However, I have no monopoly on efficient apparatus, and while I shall use my own apparatus in the descriptions, I shall also recommend that of others, and you may be sure that your receiver will be "top-hole" if you use any of the better types on the market.

The variable condenser C1 is the typical 11- or 23-plate condenser. Eleven plates will be recommended and care should be taken that it is of a high-grade type. The tuning coil and plate coil must be of "low-loss" type and contain fifty turns apiece—that is, one coil is the same as the other. The grid condenser C2 is larger than usual, being of .005 mfd. capacity, and the fixed condenser C3 is of .006 mfd. capacity. Everything else in the set is as usual except the constructional features and the famous "X lead."

The "X lead" contains a variable grid leak R2, and there is only one made in America that I know of that is at all suitable for this circuit. It is the Bradley leak and no results can be guaranteed unless it is used. The Allen Bradley Company should pay me a million dollars for this advertising, but they haven't paid me a cent, and they don't even advertise in this magazine, but so long as they make the only grid leak suitable for this circuit we must insist on its use.

For the grid leak R1 you may use a fixed one megohm or one-half megohm leak of reliable manufacture.

This article should go on and tell how to build the receiver. Unfortunately, we are not allowed to use the entire magazine for this issue, and the things that we have spoken of so far are of such vital importance that it would be foolhardy to leave them out.

You must know what and why about a set before you will consider building it and I have tried to tell you. I hope that as we build it here in Radio in the Home you will once in a while refer back to this article so that even if the various points are not printed in red ink you will be able to refresh your memory on them.

If you follow the same course that thousands of others have followed, you will become acquainted with the most weird reception stunts that you have ever seen, and, too, will probably have more fun than you can shake a stick at.

Kenneth Harkness

Radio Products

COUNTERFLEX KITS

TO INSURE the successful operation of home-built Counterflex receivers, the Kenneth Harkness Radio Corporation has prepared a special kit containing the essential parts for this circuit. This kit contains:

Two Kenneth Harkness counterformers, T1 and T2.

Two Kenneth Harkness audio-frequency transformers.

One Kenneth Harkness counterdon.

These parts were especially designed for the Counterflex circuit by Mr. Harkness, and are needed to build either the two-tube or three-tube Counterflex receivers. Use them to build your set and you will be certain of maximum efficiency.

Moreover, by using genuine Kenneth Harkness parts throughout you will also save a little money. The price of the Counterflex kit is about one dollar less than the total amount these parts would cost you if you bought them individually.

Special kit of Counterflex parts, \$22.50.



MR. KENNETH HARKNESS, Associate Editor of *Radio in the Home*, and designer of the Harkness Reflex and Harkness Counterflex receivers, has formed the *Kenneth Harkness Radio Corporation*, to manufacture and distribute the special parts required for his famous circuits. This corporation, financially responsible and with unusually fine manufacturing facilities, is now providing radio dealers with an adequate supply of correctly designed *Kenneth Harkness* products, packed in containers bearing Mr. Harkness' signature so that the public may easily recognize and obtain these *genuine*

parts and not be deceived into purchasing inferior imitations heretofore sold by unauthorized manufacturers. The products manufactured by the Kenneth Harkness Radio Corporation are designed by Mr. Harkness himself, and manufactured under his direct supervision. When you buy parts for the Harkness Reflex or Harkness Counterflex circuits ask for *genuine Kenneth Harkness* parts and look for the signature on the containers.

COUNTERFORMERS

T1 and T2



\$ 6⁰⁰
EACH

COUNTERDON



\$ 1⁷⁵

CRYSTAL DETECTOR

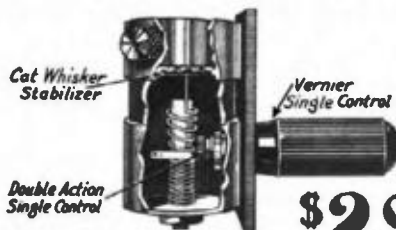

\$ 2⁰⁰

The COUNTERFLEX

HAVE you tried the new Counterflex circuit yet? If not, you have a pleasant surprise in store for you. The three-tube Counterflex easily outdistances the average type of five-tube set. With this inexpensive, easily-controlled receiver you can, under average conditions, hear all the broadcasting stations within a radius of at least 1500 miles—most of them with sufficient volume to operate your loudspeaker!

If you desire the finest of quality and are not so anxious to receive distant stations, build the two-tube Counterflex with the Kenneth Harkness crystal detector. The quality of this set is amazingly perfect. There is no mushy voice distortion; the human voice is reproduced with sharp, clear-cut natural tones. Music is reproduced with a soft and melodious purity.

Go to your dealer today and ask him to demonstrate the Counterflex receivers to you. You can obtain from him the Kenneth Harkness kits or parts to build your own set. If your dealer does not stock genuine Kenneth Harkness products, send your order directly to us, giving your dealer's name and address.

Jobbers: Good territories are still open. Write for particulars.

Kenneth Harkness Radio Corporation

727-739 Frelinghuysen Avenue,

Newark, N. J.

MODERN "Push-Pull" Transformers

Recommended by the leading radio authorities everywhere for all circuits.

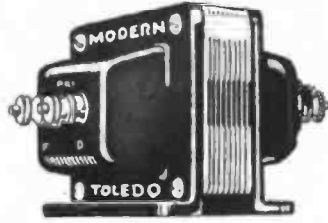

Not only was the MODERN "Push-Pull" the first transformer of this type to be offered the radio public, but it is also first in the matter of Quality Amplification.

Super Six "Reflex"

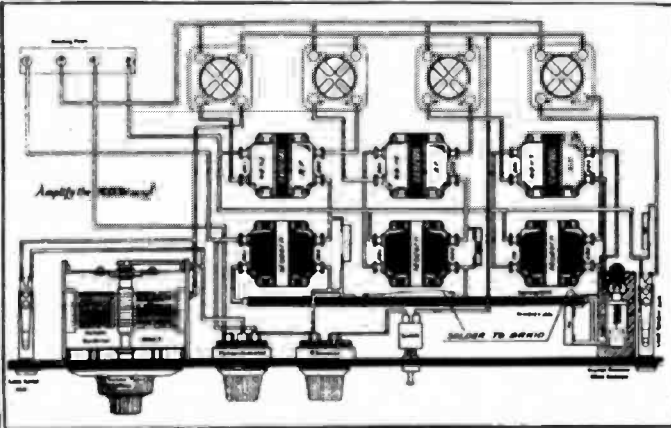

The Circuit Is Easy to Build

Full-size wiring diagram and complete constructional bulletin of above circuit mailed on receipt of 4 cents in stamps. Write for it today.

Modern Transformers make any set better. Insist on genuine Modern Transformers.

The Modern Electric Mfg. Co.

World's Largest Manufacturers of Radio Transformers Exclusively
Toledo, Ohio

Amplify the MODERN way!

WEEI, the Friendly Voice, and WTAT, Edison Light, Boston

(Continued From Page 27)

Ordinarily WTAT does not leave the district served by the Edison Co. The broadcast of the Electric Show at Stoneham, Mass., on October 13 is more in its usual line of work. Of course the station can be used in an emergency to keep the company in touch with its sub-stations if other means of communication fail.

Long technical discussions are out of place in articles whose purpose is to introduce you to the "Men behind the guns." However, there are several features of the WEEI installation that are worth your attention, and I hope you will allow me time to tell you about them.

The antenna towers are 250 ft.

This shack is of brick inside walls of cement. The outside is of sheet copper, soldered and grounded to prevent any radio frequency feeding back from the antenna to the set. If you are versed in the intricacies of transmission it will be sufficient to tell you that WEEI is using a Western Electric Radio Telephone Broadcasting Equipment number 101-B. All of which means nothing in my young life!

In every day speech Edison Light is using the largest and most modern set available for broadcasting. It is a 500-watt transmitter using a wave length of 303 meters, and its supply of filament and plate current is fur-



The operating room at Station WEEI. To the left are the combined oscillator and modulator. To the right the control racks, containing monitor circuits, etc. In the right background is the battery and generator room.

above Tremont St., in the retail shopping district of Boston—yet they are free from any sky line obstruction. In view of the limited space, their erection was no small mechanical achievement.

Nestled between the towers is the shack which contains—besides the operating room with the transmitter—the motor generators, a battery station and an emergency studio.

nished by two separate direct current generators. To prevent any possibility of generator noises entering the microphone they have been placed in a sound-proof room with doors of heavily padded sound-proof material. More briefly, there are four 250-watt "bottles," and one 500-watt power amplifying tube.

WEEI has the customary power panel and a combined oscillator and modulator panel. In addition there is a "rack" where the local and long distance lines from outside the station terminate and it also contains the monitoring circuits. By means of the monitoring circuits the broadcasts may be checked in three ways: (a) before they enter the transmitter at all; (b) after being passed through the input equipment; and (c) after it has been converted into radio frequency. The rack also contains a three-stage speech amplifier with controls.

In glancing at the photos of the station, be careful you do not mistake the reception room that is hung with drapes (for their decorative effect) for the studio. In accordance with modern procedure the emergency studio on the roof and the main studio on the fourth floor of the Edison building have their walls finished with the new composition of sugar cane stalks. This substance is supposed to give perfect sound without the "deadness" of the drapes. The usual desk full of phones and the wires along the floor are noticeable by their absence. All signal and communicating apparatus



Charles W. Burton, Superintendent of Broadcasting at Station WEEI

WESTINGHOUSE

Rechargeable "A" Battery for 2-Volt Tubes



If you are using WD-11 or WD-12 type tubes you can have all the advantages of storage battery operation by using the Westinghouse type 2-DC-9 Battery.

Small, compact and powerful, housed in a one-piece, clear glass case, it furnishes a steady dependable filament current. When discharged you don't throw it away, simply recharge it. Ask your

dealer to show you the Westinghouse 2-DC-9 storage "A" Battery. You will like its looks and the name Westinghouse on the case insures its service to you.

WESTINGHOUSE UNION BATTERY CO.
Swissdale, Penna.

used between the studio and the transmitting shack has been combined in one unit and is mounted on the wall. The microphone is plugged in wherever it is most convenient by means of receptacles in the baseboard.

Nothing that could be written would convey to you the spirit behind WEEI better than the address of President C. L. Edgar at the time of the dedication of the station. It follows in part:

"It gives me great pleasure tonight to talk directly into the homes of our thousands of customers through our new broadcast station WEEI," said Mr. Edgar. "Edison Light of Boston, though a great public service company, is a human institution and not a soulless corporation. We are nearly three thousand people endeavoring to give you, our customers, the best electric service within our power.

"In order to help you realize that we are real human beings, we are planning, through this radio station, to have the friendly voice of Edison Light, as well as the friendly glow of our electric service, reach you regularly through the week.

"If you get pleasure from programs which we shall broadcast, if our voice to you nightly through the air has a cheerful tone, we shall have accomplished our purpose. A happy human voice can often spread more sunshine and happiness than a friendly light. We have no other motive in the establishment of this new station than that of humanizing ourselves to you, our customers.

"Big business today must humanize itself in order to continue big. A big public service corporation like the Edison Company wants friendly relations with its customers. It is endeavoring to maintain those friendly relations by giving good service.

"It intends through this new station to give you good entertainment, and the price we hope you will be willing to pay for this entertainment is a friendly feeling for this company. Our prosperity is dependent upon this relationship, and the continued growth of this great community is, in a measure, dependent upon our prosperity."

President Edgar failed to say much regarding the staff he has assembled at WEEI, and without whose efforts a large part of the splendid welcome that has been given it would be missing. The chief or "CB," as you have heard him, appears on the official stationery as "Charles Burton, Superintendent of Broadcasting"; "Whit," or Lewis Whitcomb, is the Assistant Superintendent. The chief was the former Radio Editor of the Herald-Traveler, in Boston, and "Whit" was the Radio Editor of the Boston Post and Boston correspondent of *Radio in the Home*.

Let me say right here that they make no desk jobs of it. If it were not for the chief's secretary, Miss Helen Putman, you would think that you had stepped into a vacant office. In all the trips I have made to the station I have yet to catch either of them superintending. They are in some part of the station working.

Nor is the staff "top heavy"! "Bob" Emery, or "BE" is more familiarly known as "Big Brother." "Bob" is program director and comes to Edison from WGI, which, according to its own statement, is "where broadcasting began." Assisting Mr. Emery is Miss Marjorie Drew, the program clerk.

E. L. Dunham, better known as "Uncle Eddie" and "ELD," is the studio director. The gentleman signing off as "Merry" is C. C. Merryfield, Mr. Dunham's assistant.

There is a bunch up on the roof that occasionally get their voices on

WORKRITE RADIO SETS WORK RIGHT

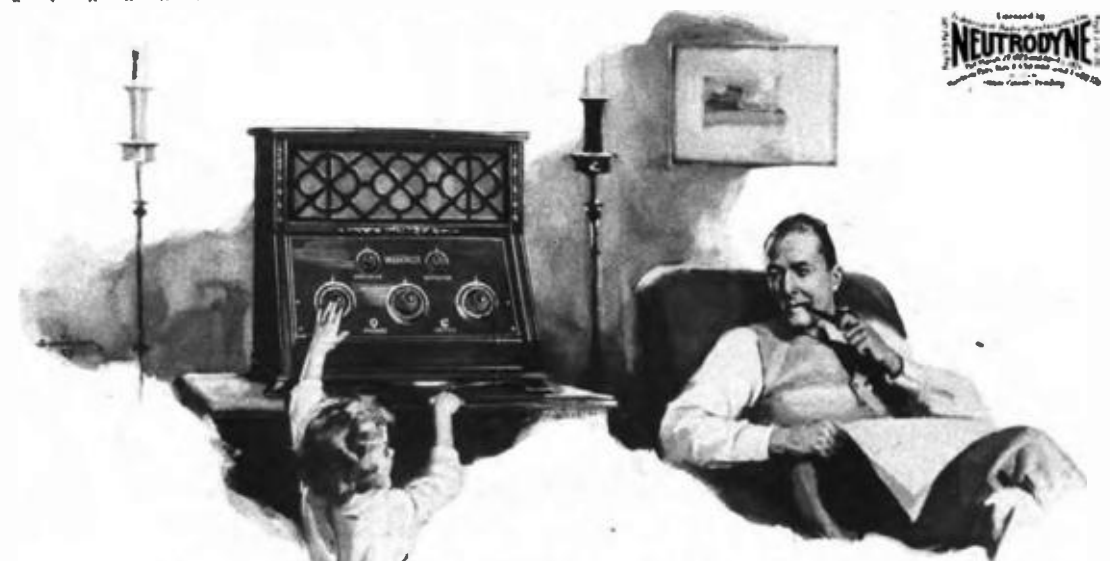

"Look Daddy! I can make music, too!"

Anybody can "make music" with WorkRite Super Neutrodyne Receivers. WorkRite is so simple to operate and yet so unerring in results that it is a continuous source of delight and fascination for everyone in the family.

Really, if you've never used a WorkRite set you'll be astonished to learn how easy it is to get—and hold—any station you want. You'll find no provoking interruptions, no irritating distortion. And once you have tuned in a station you can get it instantly at any time, simply by using your previous dial settings.

WorkRite positively assures an unusually vigorous reception with all the original depth and clarity of tone—unmarred by howls, whistles and other disturbing noises.

Another WorkRite superiority that's a revelation even to experienced radio fans, is the astounding selectivity of these superb sets. Just a slight turn of the dials tunes out the most powerful local stations—and keeps them out. If you live in a city you know what an advantage that is.

Then there's WorkRite's exceptional range! Under favorable

conditions it will easily span the continent for you. Even distant stations come in regularly and distinctly on the loud speaker.

There are other WorkRite advantages, of course. The ingenious super neutrodyne "hook-up"—the fine materials that we use—the painstaking care given to building each individual WorkRite set—all these combine to make receivers that establish a brand new peak in radio performance.

Don't be disappointed if the dealer you visit can't demonstrate WorkRite for you. WorkRite has won such tremendous popularity both among novices and experienced operators that most stores find themselves pressed to meet the demand.

So, if the one you visit hasn't WorkRite in stock, write us and we will send you the name of a store that has. Also, if you want a beautifully illustrated rotogravure folder, giving full information on all WorkRite models, fill in the coupon below and send it to us. You'll get the booklet by return mail.

But above all, know what WorkRite will do before you invest another dollar in radio.



WORKRITE AIR MASTER

A 3-tube Neutrodyne Set Encased in brown mahogany cabinet with graceful sloping panel. Almost identical with WorkRite Radio King, shown in main illustration, except the latter has a loud speaker built into cabinet.

Prices: Air Master, without accessories, \$40 Radio King, without accessories, \$70

WORKRITE CHUM

A 3-tube Neutrodyne Reflexed Set Similar to Air Master in appearance. Equal to 4 tube sets in performance. Cabinet provides space for both A and B batteries.

Price, without accessories, \$75

WORKRITE ARISTOCRAT

A 5-tube Neutrodyne Set In this beautiful mahogany console, the loud speaker is placed on one side and compartment for A and B batteries on other side. All connections made inside with cable and plug. A set unsurpassed in any respect. Price, without accessories \$150



Send Coupon for FREE Rotogravure Booklet

The WorkRite Manufacturing Co.
1008 East 30th Street Cleveland, Ohio

Please send me FREE a copy of the Rotogravure booklet which describes WorkRite

Name
Address
City State

WORKRITE SUPER NEUTRODYNE RADIO SETS

A BIGGER AND BETTER BOOK AT HALF THE PRICE

If GRIMES, of Inverse-Duplex Fame,

offered you his services for the price of a movie ticket—you would be interested, wouldn't you?

But We Can Offer You a Better Bargain Than That

Would it be worth the price of a good dinner to you—to get the combined services and advice of such radio experts as — GRIMES — HARKNESS — NEELY — FLEWELLING — FOOTE — GOODREAU — etc.?

The services of the above mentioned experts cost us hundreds of dollars, but you can get the same

services for the trifling sum of \$1.00 (8½ cents per month), by subscribing to *Radio in the Home* for a year. (Twelve monthly issues.)

SEND IN THE BLANK TODAY

RADIO IN THE HOME, 608 Chestnut Street, Philadelphia, Pa.

Please find enclosed check, M. O., cash, for one dollar (one-fifty Canada), (two foreign), for one year's subscription to *Radio in the Home*.

Name
Address
City State



Buy High Grade Parts and **FORMICA** Panels

If you want real results from your radio set, buy high grade parts, low loss condensers, good transformers and Formica panels! Then after you have labored over your set you will not find others using the same number of tubes who get stations you can not get.

The manufacturers of the finest radio sets built in America have endorsed Formica by using it. It is the panel material of 125 leading makes.

There are reasons for this almost unanimous choice of Formica—and the reasons are longer life, no warping and sagging, low electrical losses and fine appearance. Formica works easily with ordinary tools.

Formica is made in four splendid finishes: Gloss black, dull black, mahogany and walnut.

It is the standard radio panel material from coast to coast. More of it is used every year. In big sets incorporating radio frequency amplification, it is now regarded as essential for base panels and terminal strips. Mount everything on Formica. Don't let it touch wood.

DEALERS: Formica service and quality and the universal demand for the material make it the most satisfactory and profitable panel line you can carry.

THE FORMICA INSULATION COMPANY 4654 Spring Grove Ave., Cincinnati, Ohio

Sales Offices

50 Church St., New York, N. Y.
422 First Ave., Pittsburgh, Pa.
1142 Grand St., Rochester, N. Y.
419 Ohio Bldg., Toledo, Ohio
1210 Arch St., Philadelphia, Pa.
1022 Second Ave., S. Minneapolis, Minn.

555 Mission St., San Francisco, California
Whitney Central Bldg., New Orleans, La.
516 Carlton Bldg., Cleveland Ohio
9 S. Clinton St., Chicago, Ill.
708 Title Bldg., Baltimore, Md.
47 King St., Toronto, Ontario

"Hear the Formica Band every Wednesday evening from 9 to 10, Central Time, over W.L.W."

FORMICA
Made from Anhydrous Bakelite Resins
SHEETS TUBES RODS

FREE RADIO EQUIPMENT

You can earn any radio parts free by sending us subscriptions to RADIO IN THE HOME. You may be in need of condensers, couplers, transformers, honeycomb coils, tubes or batteries; a loud speaker or a head set. You may wish to possess a tube-testing outfit, or a Grimes 3XP Inverse-Duplex set, or a Harkness Counterflex set, or any other good standard set.

These sets and parts are available to you free of any cost in exchange for your help in introducing RADIO IN THE HOME to your friends and neighbors.

Let us know what parts you want, and we will tell you how many subscriptions you need to obtain in order to get the parts free.

At the new rate of only \$1.00 a year, you should find it comparatively easy to get subscriptions for RADIO IN THE HOME. The radio season has arrived and many subscriptions are to be had for the asking.

You remit the full amount collected with the names and addresses of subscribers, and ask for the apparatus that your subscriptions entitle you to, or you can continue sending in subscriptions until you have accumulated a large credit and then order the equipment you want against your credit account.

For additional information regarding our free parts plan write to

Circulation Dept., RADIO IN THE HOME
608 Chestnut Street Philadelphia, Pa.

the air, and but for whose efforts no one would be heard. That is the operating division. "CV" Purcell is the head of the division. Miss Dorothy Blackwell is the clerk. Those of you who pound brass know P. W. Pratt, the chief operator. In "the old days" he used to have the call "FZ" and he still uses it when he gets on the air. The other operators are Leon Hents, of WTAT fame; R. B. Sawyer and "Matty" R. W. Mathewson.

Have you ever noticed how flat and devoid of expression some voices are that you meet on the air? Some one at WEEI hit on the idea of talking into a dictaphone, and then having the cylinder run over while they listened to themselves on the monitor circuit in the shack on the roof. Now every one there is doing it. They are in hopes that by listening to themselves they can correct their faults and make their part of the program more pleasing to their audience.

The last time I was up in the "shack" the chief came in and asked for one of the operators. He was informed that the "op" had been there until 5 o'clock that morning testing. Just before I left at noon the man in question showed up ready for the World Series broadcast at 1:45. It takes some enthusiasm to start in at 1:45, run a World Series working from a long-distant input, work through an evening program until midnight, and then test until five.

New England was well served from Boston by WNAC and more recently by WBZ. If WEEI had tried to do no more than compete with them for talent its opening would not have been justifiable.

From the start, however, there has been a difference in its programs. Four times a week the program of WEAJ is broadcast by means of a wire connection with that station. This makes it possible for the less powerful sets to have the same opportunity of hearing New York that the more powerful ones have had in the past. Not only that—think of the thrill of parking at a formerly despised crystal set and listening to the World Series game played in Washington—"Oh, boy," as Graham MacNamee said on one of those memorable occasions!

There is a connection to the new home of the Boston Chamber of Commerce. This "line," in itself, is worth an article. In passing just let me say that it has in addition to a public address system a special radio receiving set connected with it and provision for lines to the broadcasting stations so that anything of interest may be broadcast. The Chamber has a Wurlitzer organ, which I have been told is the only one in the country that can play jazz or, as Meyer Davis now says we must call it—*syncope*.

Another of the rapidly extending connections is the one to T. D. Cook's Amber Room, from which is broadcast the music of "Dok" Eisenbourg and his symphonians. So popular has this feature become that the other night "Dok" said that he was very sorry, but Cook's really needed its phone for business purposes and that he would be unable to comply with any more requests to play certain pieces and, in the future, he would set aside Wednesday nights as request night. At that time Mr. Eisenbourg said he would be glad to play any requests received by mail.

And now look at the close-up of the musical prodigy with the serious face

and the cheaters. "Big Brother," all set to do his stuff. Between you and me the cheaters are worn for cause and not effect. His serious mien does not agree with his usual air-voice. It compiles more with the announcement he made from the Amber Room when he said, "An announcer has a tough job! Here I am with all the pretty lights, nice music and lots of lovely girls—all alone!" I guess it was more than "Bob" could stand, for since then he has been doing the announcing of that particular broadcast from the studio, and "Dok" has been making whatever announcements were necessary from the Amber Room.

But why "the Big Brother Title"? The Big Brother Club meets on the air at 7:00 P. M. Each evening after the reading of the business there is either an educational or entertainment feature.

Every child who writes to "Big Brother" signifying his or her intention to become affiliated with the club receives a copy of the by-laws, a membership card bearing the name and official seal of "Big Brother," and also a small gold pin designed from the regulation electric light bulb and bearing the station call letters and initials of the Boston Edison Big Brother Club. According to the by-laws the club is a radio fraternity organized to create good will among the younger listeners-in of WEEI. Its aim is to entertain and educate in a pleasing way by association and good fellowship.

In refreshing contrast to the policy of some stations of "let her go Gallagher," WEEI is trying to avoid interfering with its neighbors and they in their turn are trying to avoid interference with WEEI. "CB" has been giving talks on how to increase the selectivity of existing sets "so that you will not have to listen to us if you do not want to."

Although WNAC is on 268 meters, it "stood by" during the broadcast of the World Series so that the least selective set could get it.

WEEI is silent Saturdays so that there will be one day when it will be sure to bother no one. WBZ rebroadcast the opening program and WNAC stood by. Coming at a time near the opening of the Radio Conference, at Washington, it did much to show what intelligent and open-hearted co-operation could do without regulation.

The doctors have pronounced me a hopeless addict to radio, but they say that I am slowly recovering from the terrible DX fever. Possibly the cure is due in part to WEEI. Who knows?

Welcome! Newcomers in Radio

(Continued from Page 8)

difficulty was in the tapping of the variocoupler and drilling decent looking semicircles for the various switch points. This was a job which proved the undoing of many a novice.

I have accordingly commissioned our contributing editor, W. Francis Goodreau, to take all of the favorite old-time hook-ups and simplify them just as much as possible.

Mr. Goodreau's first article appears in this issue. He has taken one of the most efficient of the old circuits—the double circuit with the variometer-tuned plate—and has so adapted it to modern instruments that all of this bother of drilling circles for tap con-



tacts and all of the trouble of wiring up these taps are done away with.

Mr. Goodreau will from time to time take others of these standard sets and simplify them in the same way. These are not new circuits and we do not wish people to think that we are asserting that they are. They are merely the best of the old ones simplified to meet the demands of today's novice in radio.

Let me give a little word of warning to the novice who is going to handle these sets. Read the articles which we publish from time to time about radiation. Most of these regenerative sets will radiate badly if they are not carefully handled.

Read Brainard Foote's article in this issue; read David Grimes' article; read my editorial about the super-heterodyne.

To be strictly consistent in my viewpoint on radiation, I suppose I ought to refuse to publish hook-ups of sets that will cause any more bedlam on the air. I would be very well pleased to take that attitude if I could only offer nonradiating hook-ups which are equally simple and easy for the novice to build.

Unfortunately, I cannot do this. I think the only thing to do is to meet this demand of the novice by giving him the regenerative circuit and then refer him to Mr. Grimes' articles on how he can later take that same circuit and turn it into a still more efficient one which will not radiate. I have about come to the conclusion that this is the line of progress which the average novice will take.

And this is only natural. The beginner taking his first faltering steps in radio is not at all sure of his ground. He wants to feel his way very carefully and be sure that he is stepping upon a firm foundation before he attempts to walk fast or to run.

Consequently we must let him go ahead with the very simplest kind of circuit until he becomes accustomed to its use. Then, if all goes well, I hope he will join the rapidly expanding ranks of radio fans who have some consideration for their fellow-men and who will go to a little extra expense and a little extra trouble in order to fix their sets so that they will not be a nuisance to their entire neighborhood.

I very gladly welcome all of these thousands of new radio fans. I promise that, if they will not be discouraged by their first troubles, they will very soon consider themselves radio experts and they will then enter upon a game which is more fascinating, more profitable, more entertaining, more educational, and more far reaching in its influence than any other offering that science has yet given us.

Oddly enough, coincident with this demand of the novice comes an equally unmistakable demand for me to go still farther into the technical atmosphere of radio than we originally intended to go with this magazine. This shows quite conclusively that those who started with us as beginners two years ago are now well advanced, that they have learned the scientific fundamentals of radio and perhaps some of its mathematics and that they now want to be kept fully informed of the advances being made in the more technical aspects of it.

I will meet this demand in the next issue by starting in the back part of the magazine a new department, "For the Advanced Student." This department will contain each month the best and most comprehensive technical articles that I can get. These articles will be over the heads of the novice, but they are designed only to meet this second demand of which I speak.

Quality - Easily Recognized

Gifts that will bring joy to any Radio BUILDER

TYPE 247-H
Geared Condenser
Price \$5.00

TYPE 231-A
Amplifying Transformer
Price \$5.00

TYPE 268
Variocoupler
Price \$3.00

TYPE 269
Variometer
Price \$5.00

TYPE 247-W
Wavemeter/Filter
Price \$10.00

For a Merry Radio Christmas

Acceptability

In selecting articles for Christmas giving, those who choose with the true Yuletide Spirit consider *acceptability* and *practicability*.

To the radio builder who knows the necessity of good apparatus, nothing is more acceptable and practical

Practicability

than General Radio parts, which are scientifically designed by radio engineers.

A set built with General Radio parts is your unfailing assurance of quality reception. Ask the man who has built one

GENERAL RADIO CO.
Cambridge, Mass.,
U.S.A.



RADIO IN THE HOME A BIGGER AND BETTER BOOK AT HALF THE PRICE

Commencing with the November issue the subscription rate to *Radio in the Home* is reduced to

\$1.00 THE YEAR

Sixty-four pages of useful and interesting facts about radio every month from the pens of the greatest radio authorities.

GRIMES—HARKNESS—NEELY—FLEWELLING—GOODREAU—FOOTE
and Others

Subscription Order Blank on Page 49



The Satisfaction of Perfect Reception



An evening of reminiscence with the radio; cherished memories recalled by songs of younger days—school—and sweethearts—and shady lanes—songs long unsung but not forgotten; scenes of the present—jazz—orchestra—speech—all perfectly received with no distortion to mar their full enjoyment.

That's the work of Jefferson Transformers! Perfect reproduction of the voice or instrument with the natural tones faithfully preserved. Full, smooth amplification over the entire musical range. Radio fans the world over will attest as to these Jefferson qualities.

Such excellent performance is but the natural outgrowth of over 20 years specialization in the perfection and manufacture of high-grade transformers. Jefferson Transformers meet matched construction specifications. You have the advantage of the best transformer that science and engineering can produce, at a most nominal price.

Sold by all reputable dealers and distributors.

- Manufacturers of
- Radio Transformers
 - Bell Ringing Transformers
 - Sign Lighting Transformers
 - Automobile Ignition Coils
 - Jump Spark—Make and Break Coils
 - Oil Burner Ignition Coils
 - Furnace and Oil Burner Transformers
 - Testing Instruments
 - Toy Transformers
 - Auto Transformers

Write for our latest booklet giving information on how to secure proper amplification. It's free.

Jefferson Electric Mfg. Co.

442 S. Green Street, Chicago

Jefferson Super sensitive Transformers



Loud Clear RUBICON

Pure tones and full-voiced volume can be had only with Push-Pull amplification. A good speaker operated from a pair of RUBICON Duplex transformers leaves nothing to be desired. It's the Duplex winding!

Free Folder Tells Why

Your copy of "The Inside Story" ready to mail. Just send name and address on a postal.

Duplex, pairs tested for balance **\$12**
 Audio Frequency...\$6.00
 Radio Frequency...\$6.00

RUBICON COMPANY
 918 Victory Building Philadelphia, Pa.

HARKNESS REFLEX

The circuit that put efficient radio within the reach of all. Mr. Harkness has now developed a still more efficient moderate-priced circuit known as the Harkness Counterflex. All developments of this system are now found exclusively in *Radio in the Home*.

KENNETH HARKNESS

is one of our Associate Editors, and writes for no other publication.

No Wonder the Kiddies Love Her

(Continued From Page 36)

beauty contest down in Long Island, and so it became her mission to appear in the intercity contest at Atlantic City.

Perhaps "Miss Philadelphia" did win the prize, but you should have heard the cheers as "Miss Coney Island" appeared on her float in a violet silk bathing suit, on which orange fishes, handpainted by Samuel Russell, swam, while stretched

This is her first appearance on the stage and so signal is her success that she has been given two things which practically never come into the possession of a novice in a musical comedy. The first is a "bit"—that longed-for prize of every new actress! She does one of the comedy sketches of the show with Al K. Hall, and she has eighteen lines all to herself!



Miss Leonard, as "Miss Coney Island," in the recent Atlantic City Beauty Pageant

behind her was an enormous scarf, decorated in a similar manner, so that the fish swam from the scarf to her and back again. A sight for Old Neptune himself!

While the girls were in Atlantic City, as many as cared to were invited to broadcast from WIP, and Agnes, plus her mother and her ukulele, accepted the invitation. So well did they like her that they asked her to return that night and "Uncle Wip" surrendered his time, so that the little Philadelphians and their neighbors might enjoy her.

The best part, however, is yet to come. If you've been so unfortunate as never to have heard Agnes's voice over the radio and you failed to see her on her float in Atlantic City, you may still see her at the Music Box in New York, where she is appearing in Earl Carroll's "Vanities."

Eighteen lines! Just imagine that. You remember that the chorus girl in the "Gold Diggers" was proud enough with two.

And her other valuable possession is a "term-of-the-show" contract which ordinarily is given only to the principals.

In spite of all this success and popularity, the studios have not lost Agnes for good. She is only waiting until the "Vanities" have settled down for the winter and extra rehearsals are over and then once more the kiddies will hear her sing her little lullaby as she rings off:

*"I know a lady, all dressed in white,
 She'll come to visit you, maybe to-night;
 She flies on rainbow wings,
 She brings the nicest things!
 As soft lullabies she sings—
 The dream angel, Night."*

The Slant of the Trade on Radio

RADIO PROPERLY BELONGS IN MUSIC STORE, DECLARES SECRETARY OF TRADE BODY

Omaha, Neb., Nov. 20.

CONTRARY to what manufacturers of phonographs, pianos and other musical instrument manufacturers expected, radio is proving to be a boon to the music industry, in the opinion of Matt J. Kennedy, of Chicago, secretary of the National Association of Music Merchants, who has been in Omaha for the golden anniversary celebration of the A. Hospe Music Company, of this city.

Radio is educating thousands of people every day to understand and to appreciate music better, Mr. Kennedy believes, and he says this will do more just now to increase the profits of the music merchants than anything else.

"Unfortunately, music men were slow to grasp the opportunity offered by radio," he declared, "but now hardly a music store can be found that does not have its radio department. The radio properly belongs in the music store, because primarily it is a musical instrument. I believe the time is not far away when the bulk of the radio business will be handled and sold right along with phonographs and pianos.

"With the advent of the phonograph coming, promoters of grand opera shuddered at the thought of how grand opera would suffer. It was argued that when people could buy a Caruso or other opera record for a dollar and could play it over and over in their homes without additional cost, they would not pay \$2 or \$3 to see and hear the artist in person.

"It worked just oppositely. People played the records in their homes, learned to appreciate grand opera, and the result was that grand opera was popularized. As one Chicago promoter said, 'Grand opera was taken out of the blue book and put in the telephone book.'

"The same thing is true in the radio situation. The music dealers profit every time a radio fan learns to hum a popular or grand opera tune."

The Radio Corporation of America has selected Omaha as the city in which it will stage its radio educational exposition from November 10 to 15, inclusive. The Omaha municipal auditorium, with 7000 feet of floor space, will be utilized. A portable broadcaster will be set up and operated from the stage of the auditorium during the week. Hal Edwards, in charge of the McGraw Company, jobbers for the Radio Corporation in this territory, is making the local arrangements.

As in other cities, an admission of twenty-five cents will be charged to the exposition, and any money above actual expenses will be donated to charity.

An idea of what one of the largest of the Mid-West's jobbers thinks of prospects in this territory can be gained from the fact that following the first Omaha radio show the Nebraska Buick Company put in an order for a carload of radio sets and radio apparatus. The majority of this order was placed with the Zenith company.

J. W. Sherry, in charge of the company's radio department, says the Nebraska Buick was the first company in the country to buy a trainload of automobiles and first to buy a carload of radios. Mr. Sherry is endeavoring

to "sell" his company officials the idea of installing a broadcasting station.

The Keno Four, a local quartet, well known to radio listeners of both stations WAAW (Omaha Grain Exchange) and WOAW (Woodmen of the World), are being given the bulk of the credit for bringing the 1925 convention of the American Legion to Omaha. At the recent convention in Minneapolis the quartet was dubbed "Omaha's Mounted Quartet" after they had ridden about the town on horseback singing the praises of Omaha.

As a reward the Omaha Post of the American Legion—Post No. 1—and incidentally the largest post in the world, made the Kenos its official quartet.

Omaha Musicians' Association, Local No. 70, recently voted almost unanimously to lift its ban which prohibited members from playing over the radio without the union scale of wages. The ban was in force during the summer months. Those who sponsored the movement which resulted in the ban being lifted argued that the members could not afford to do without the advertising offered by radio.

There is a decided trend in this section toward the manufactured set idea. With the multitude of new circuits on the market, dealers and others interested are hesitant in advising prospective customers what to build, and the result is that more and more manufactured sets are being sold day by day. One of the big wholesale houses here is three weeks behind in its orders at the present time.

ST. LOUIS DEPARTMENT STORE GIVES ITS SLANT ON RADIO AND HOW THE PUBLIC BUYS

By STUART C. MAHANAY

ST. LOUIS, MO., Nov. 20.

FEW dealers there are who seem completely "sold" on the merits of the super-heterodyne. There was one, however, who gave it his unstinted praise.

"Its great advantage," he said, "lies in its selectivity and range when operating with a loop." Another talking point he made was its simplicity in tuning. His chief objection to the neutrodyne type of receiver was made on the grounds that the third dial made tuning awkward. He said that the neutrodyne was first in popularity last season, but this fall would see the super-heterodyne "first in everything"—referring, of course, to public opinion and sales—both as to parts and complete receivers.

An interview with the radio salesman in one of the large department stores disclosed the following facts: That department stores have a much greater demand for complete receivers than parts; that many of the sets sold are bought on "charge accounts"; that the buying public displays notable interest in the "service" rendered in connection with the installation and guarantee of satisfaction with every complete receiver sold; that with few exceptions, women seldom buy expensive sets; and when they do, the purchase is not made until after every type, make and model has been given a thorough inspection; that customers of the masculine persuasion usually make their selection after seeing only one or two models.

The salesman said that unusual in-

(Continued on Page 56)

Sweep the Air With *Air-Way*

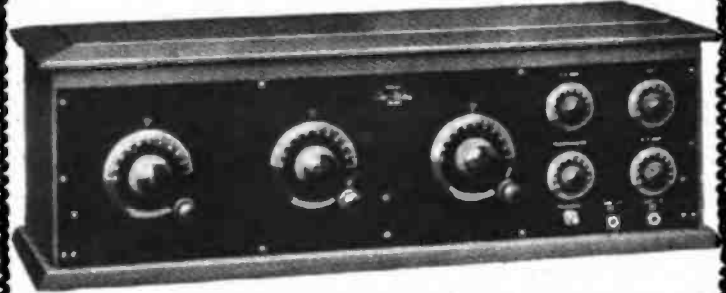

AIR-WAY No. 51, 5-Tube

Two stages tuned transformer radio frequency, detector, and two stages transformer coupled audio frequency amplification.

Offered without reservation as a set that will give general satisfaction to all broadcast listeners, regardless of previous radio experience.

Price, as illustrated, \$125.00.

Also furnished in handsome Console type cabinet of solid walnut. Price \$375.00.

All distant signals come to any set, but they will not fight their way in through unnecessary losses and high resistances.

AIR-WAY Receivers are the last word in LOW Loss construction and tuned radio frequency amplification, and build up the weakest signals to pleasing audibility.

Oscillation is perfectly controlled and all extraneous noises eliminated without neutralizers or complicated adjustments.

AIR-WAY Receivers meet every demand of the most fastidious and exacting—in Tone, Selectivity, Distance, Volume and outward Appearance.

Cabinets are five-ply selected American Walnut of soft-toned brown that harmonizes with all period furniture.

AIR-WAY No. 41, 4-Tube

One stage of tuned transformer coupled radio frequency, detector, and two stages transformer coupled audio frequency amplification.

A set that meets all receiving conditions, all market conditions and all individual requirements. There is no set on the market for 1925 that will compare with No. 41 for less than double the price.

A demonstration will convince the most critical observer. Price \$65.00.

AIR-WAY Apparatus is distributed through established Jobbers and Dealers only. Write our Sales Department for Catalog of the complete line.

Manufactured by
AIR-WAY ELECTRIC
APPLIANCE CORP.
Toledo, Ohio

Sales Department
THE ZINKE COMPANY
1828 S. Michigan Ave.,
Chicago, Ill.

FILTER YOUR RADIO PROGRAMS with a B-T LIFETIME CONDENSER



| B-T Lifetime Condenser Type | Plates | M. M. P. | Price |
|-----------------------------|--------|----------|--------|
| 7-L | 7 | 125 | \$4.25 |
| 11-L | 11 | 250 | \$4.50 |
| 23-L | 23 | 500 | \$5.00 |
| 33-L | 33 | 750 | \$6.50 |

You wouldn't drink impure water! Then why be satisfied with a jumble of stations when a B-T Lifetime Condenser will filter your reception and give you—*greater selectivity, longer distance, stronger signals, easier tuning.*

The B-T plate shape spaces the stations uniformly over the dials instead of bunching them at the lower end. Each wave length has its own particular channel.

Plate alignment is not disturbed when you adjust for wear or friction—the B-T 2-step, thrust type, lubricated bearing takes care of that.

Losses are too low to be measured. The appearance is attractive—the workmanship beautiful—No wonder every one says, "Good for a Lifetime."

The same simplicity and efficiency characterizes the B-T Low Loss Tuner. Both types have the improved B-T windings, skeleton frame and adjustable untuned primary that insure low losses and unusual selectivity.

Place your order for these B-T parts with your dealer today and get the best out of your set.



B-T Low Loss Tuners shown covered with a type 11-L Lifetime Condenser. Type N 200 to 285...\$7.00 Type NW 50 to 150...\$3.00

The 6th edition of "Better Tuning," a profusely illustrated booklet of hook-ups, construction and general information is now ready. Send 10 cents for a post-paid copy. If it isn't worth more we'll return your money.

Bremer-Tully Mfg. Co.
 "Pioneers of Better Tuning"
 538 S. CANAL ST. CHICAGO, ILL.



When it's "Pacentized" you are sure of results

SELECTIVITY—**distance**—**volume**—these results are dependent on the parts you use. It's your own way to slight each vital part as facts, inductors, condensers, etc., when Pacent Radio Essentials, built by the foremost radio parts manufacturer, cost no more than inferior parts.

10 years of radio experience are back of every Pacent part. Over 20 of the leading makers of receiving sets are Pacent equipped. This is convincing proof that the Pacent radio parts are made for long life. Let the judgments of these makers be your guide in buying parts. Send for our complete catalog.

THE PACENT ELECTRIC COMPANY, Inc.
 91 Seventh Avenue, New York City

Washington Chicago Minneapolis Birmingham Dallas San Francisco Philadelphia St. Louis Los Angeles

Pacent
 RADIO ESSENTIALS



IMPROVISE — PACENTIZE

Further Notes on the Inverse Duplex Neutrodyne

By JOHN De Q. BRIGGS

MANY readers have written in that they get a very high squeal in using the inverse duplex neutrodyne. This puzzled me for a long while until I consulted Mr. Grimes, and we decided that various methods of individual wiring introduced various capacities into the circuit. Mr. Grimes offers the following suggestion:

If your inverse neutrodyne gives this high squeal, there is one change you can make. In the diagram of apparatus given in September at the top of page 11 in the 3XP-Style Wire-Up, you will find a small fixed condenser numbered 21. In the list of parts, this is given as .001 mfd. If you have that value condenser there, try a .005. This latter is the value given by Mr. Briggs in his schematic diagram on page 10.

H. M. N.

these stations came in well on the Thorophone, comparing about as they did on the phones with one less tube. All the tests were on distant stations. WLAG, our local station, was closed at the time. I might add that it is possible to add still another stage of push-pull power amplification to No. 2, but it is interesting only as an experiment. Such terrific volume is unpleasant and of no practical value. However, I made it work with a Dictograph unit by grounding the shell of the unit to kill howls.

In these tests set No. 1 used thirty-five milliamperes of plate current, while set No. 2 used exactly eleven milliamperes. Food for thought for superheterodyne advocates.

Set No. 3, before it was tamed and adjusted, had more straight volume than either No. 1 or No. 2. But as the taming proceeded it was necessary to lop off this volume little by little to bring the output under control, and now that the set is beginning to eat out of the hand, it has become more and more like No. 2. There is little to choose between them.

In No. 3 half the secondary of an old Ford spark coil serves as a choke instead of the RF transformer, a saving of \$5 cash for about \$10 labor extracting the Ford coil. Otherwise No. 3 is exactly like H. M. N.'s diagrams, celatside and all.

You may remember Mr. Neely's assertion that no neutrodons were necessary in the circuit, and that the joke was on me in that the set really was not a neutrodyne. A month of careful experimentation has convinced me that the joke has landed in the wrong place. Set No. 3 oscillated like any ill-bred and ill-adjusted neutrodyne until the neutrodons were adjusted. This oscillation may be recognized (1) by a thump and the sudden death of the signal you happen to be listening to when the three dials bring the circuits into resonance, and (2) by distinct body capacity on the dials under the above circumstances.

In this connection I had an amusing experience with set No. 2. When Mr. Grimes was in St. Paul not long ago he came in and inspected No. 2, and promptly disconnected both neutrodons. He said the set would work just as well, and with more volume. Unfortunately it was afternoon, and there was no broadcasting on, but results with a buzzer signal seemed to bear him out. I was almost convinced. But after just ten minutes of listening that evening I had the neutrodons in again. Without them all the low-wave stations came in with a whistle, and the tone-quality was ruined. So we'll still call the set an *Inverse Duplex Neutrodyne*. (Of course, removing a turn or two from the primaries of the neutroformers would stop the oscillation, but at the cost of more loss of volume, I think, than by the use of the neutrodons.)

Well, to return to No. 3. The neutrodons adjusted (it needn't be done too exactly), the oscillations stopped and the terrific volume of the set became somewhat more tractable. Then came the question, "To shield or not to shield?" When the loop was parallel with the panel, that is, at right angles to the plane of the neutroformers, all was well. When it wasn't, all was very far from well. Even removing the loop six feet from the set didn't eliminate the feedback. If the magnetic field round a neutroformer

SINCE the publication in the September number of *Radio in the Home* of the description of my "Inverse Duplex Neutrodyne," almost all my spare time—and some that has not been spare—has been spent on a series of careful experiments with this circuit, with a view to determining two things. First, to find out by direct comparison the range, clearness and tone-quality of this circuit beside the best superheterodyne I could build. Second, to settle in my own mind whether the changes in the circuit that Mr. Neely made in his article were a real improvement over my published circuit. I am giving the following notes on the results of this experimentation for what they may be worth to other experimenters who care to check up on their results.

For convenience in referring to the three sets, I shall designate them as follows: Set No. 1, a very carefully built and adjusted seven-tube superheterodyne, using 201-A tubes, 50 volts on the two detectors, 100 volts on the other tubes. Set No. 2, my original Inverse Duplex Neutrodyne, using 150 volts on the amplifying tubes, and 7½ volts, negative bias, on all three of these tubes. Set No. 3, the Neely version of my set, with such modifications and changes as were necessary as the tests proceeded. The same 18-inch loop (pictured in the September number) was used on all three sets, but when used with the superhet it was coupled to a good outdoor antenna, which took one turn round the loop and then went to the ground, while with sets Nos. 2 and 3 no antenna or ground wire used.

Using set No. 1 and set No. 2, the former with antenna, six tubes, and phones, the latter with loop, three tubes and phones, the two were about equal in volume. Set No. 2, however, was very much clearer, and brought in far less of the static and miscellaneous interference that had jammed the air those last weeks of September. In range, No. 1 was slightly greater, but only slightly. It brought in KGW (Portland, Ore.), and CYL (Mexico City), which I could not get hold of on Set No. 2. Set No. 2, however, showed that it was no slouch on distance by bringing in WBZ, KGO and KIX. Probably the antenna made the difference with the other two.

Adding the seventh tube to No. 1 and the fourth tube to No. 2, all

(Continued on Page 62)

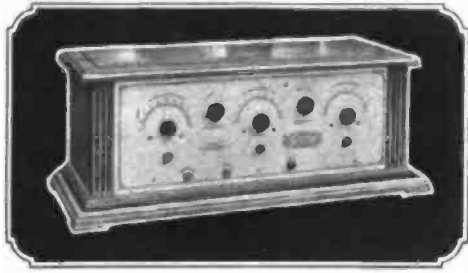

Five Tube Tuned Radio Frequency Set \$120

The Powerful, Coast-to-Coast
SUPER

CLEAR-O-DYNE

LOUD SPEAKER signals that will fill your house over distances of 3,000 miles in good radio weather! The greatest selectivity that is possible in any set! Stations always come in at the same settings—a child can get distance!

Solid mahogany cabinets and gold-finished panels—a set that harmonizes with the richest furnishings. You can't buy more in any radio set! At the astonishingly low price of \$120.00 this is the greatest purchase in radio today!

Jobbers and Dealers: Write now or wire for our proposition. Clear-O-Dyne is a sensation. It is going big. Quick deliveries on your orders.

Clear-O-Dyne Model 70...\$75.00 Clear-O-Dyne Model 80...\$120.00
Clear-O-Dyne Model 71... 90.00 Clear-O-Dyne Model 82... 190.00
Clear-O-Dyne Model 72... Console... 190.00
Console... 135.00 Other sets from \$60.00 up.



Five-tube Console, \$190
Four-tube Console, \$135



THE CLEAR-TONE RADIO COMPANY, CINCINNATI, OHIO

Music is Immortal

THE Earliest History of Man was told to the strumming of primitive melody. His wars, defeats and triumphs are written in our symphonies today.

Music will outlive our present system of radio a hundred—a thousand years from now. But, until then, the RESISTANCE COUPLED AMPLIFIER—the only system that does justice to the qualities that make music live—will be first among fans of discrimination.

Amplification truly without distortion—reproduction that is auditive perfect—is the distinctive achievement of the DAVEN SUPER AMPLIFIER illustrated below.

On Sale at Your Dealers

Resistance Coupled Amplifier KITS

Without sockets and condensers:

3-Stage \$ 8.00
4-Stage 10.50

Complete with sockets and condensers:

3-Stage \$12.50
4-Stage 16.00

Read the Daven "RESISTOR MANUAL" by Zeb Bouck. This manual contains the how-to-make-it data on Resistance Coupled Amplification. Sold Everywhere. Price, 25 Cents

Daven Radio Corp.
"Resistor Specialists"
Newark - New Jersey

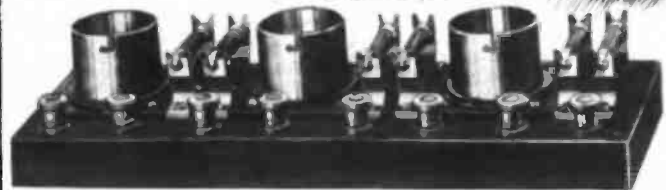
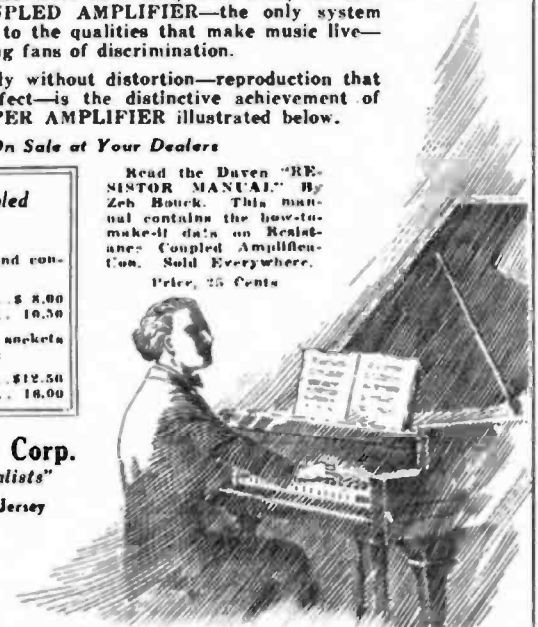

Made by the Makers of Laboratory Equipment

NOLOSS
TRADE MARK

Type 51
PYREX INSULATION

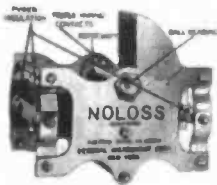

NOLOSS
TRADE MARK

Type 56
ISOLANTITE INSULATION

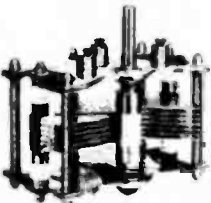

It is now possible for the amateur to get results formerly reserved to laboratories.

The experimenter who requires every micro watt of energy to bring in heretofore inaudible signals must turn to General Instrument NOLOSS Variable Air Condensers.

They are constructed with laboratory methods, and insulated with laboratory insulations—Pyrex or Isolantite.

Products worthy of your purchase.

General Instrument apparatus costs a little more but is worth infinitely more.

General
Instrument
Corporation
Manufacturers of Radio
Equipment

423 BROOME STREET
NEW YORK, U. S. A.

LOOK WHAT POP GOT! for Christmas



This is a lucky Christmas for Pa. He didn't get a necktie nor a box of cigars.

He got a new Sterling Rectifier, a gift from the family worth more to Dad than several individual gifts—and less costly, too.

When he gets home at night he will always find his radio set ready to entertain. He has a battery charger which represents still greater value than the charger he always wanted—the famous 1924 model Sterling Rectifier.

To charge up, he will simply turn the switch to the point on the dial marked 6 volt "A" battery or 24, 48 or 72 volt "B" battery. He won't even hear this quiet working, tireless battery caretaker. He will know that, enclosed in its metal case, it is protected from moisture, corrosion and dust and can never overcharge his battery.

No wonder Pop's glad. Here is a Christmas suggestion for you.

MODEL 19
For charging both
"A" and "B"
batteries.
Price, \$22.00
(60 and 60 cycle)
\$26.00 (25 cycle)

MODEL 17
For charging 6-
volt "A" or auto-
mobile batteries.
Price, \$18.00
(50 and 60 cycle)
\$21.00 (25 cycle)



THE
STERLING
MANUFACTURING
COMPANY
Cleveland, Ohio
Department J.

Sterling

NEW RECTIFIER

Charges 6 volt "A" Batteries and 24, 48 or 72 volt "B" Batteries.

If Your Set "Lisps"

Or if the tone is thick, or fuzzy, or all the stations are jumbled up—you need this Variable Clarifying Selector.

It gets in between stations like a born peacemaker, and clears up the tone to full brilliance in a way that amazes everyone.

It affords complete control of the antenna coupling, and replaces fixed and variocouplers, tapped coils, aerial variometers and other aerial tuners.

It works alone in any standard hook-up, and is a splendid companion for our VT25, Variotransformer, which gives the amplification of two fixed R. F. stages without condensers. The Selector is \$7.00; the VT25 is \$8.50. Send for

FREE BOOK

showing complete L+K line, Greene Concert Selector hook-up, and other effective circuits. (Jobbers, Dealers, write.)



Pat. Appd. For
L+K Variable
Clarifying Selector, \$7.00

LANGBEIN+KAUFMAN **L+K**
High Grade "Low Loss" Tuning Devices A Guide to TECHNICAL ACCURACY

Address Dept. R, 654 Grand Ave., New Haven, Conn.



A GOOD condenser makes ANY circuit better! You need not look twice at a MAR-CO CONDENSER to see the evidence of "leak-proof" precision.

MARTIN-COPELAND COMPANY, PROVIDENCE, R. I.

The Slant of the Trade on Radio

(Continued from Page 53)

terest had been shown in their two models, which combined the Victor or Sonora phonograph in the same console cabinet with the Federal radio receiving set.

In his opinion, his department had comparatively few calls for parts and accessories because the fan who was constructing his own dialiked to "shop" at one store and then another for his parts.

This brought out an interesting point. The time has almost arrived for the specialization of radio dealers. In the future will they not confine their merchandise either to complete sets, perhaps with a repair or "service" department for the upkeep, or else deal exclusively in parts, accessories and only a limited number of sets which, perhaps, may be of such an unusual type that it would not pay the other class of dealer to handle? If so, would this not have a tendency to divide the radio enthusiasts of the land into "dial twisters" and experimenters? (Meaning by the first term, those who confine their interest in radio to "tuning in" the desired station, listening, then turning off the set and interesting themselves in some other form of diversion—and by the second term, those who are the real "radio bugs," whose chief interest lies in experimentation with circuits for the betterment, not only of quality or signal strength alone, but of the art as well.)

This radio salesman of the department store also brought out another point on the side of human interest. He said that not in a long time had any one confessed to him that they were utterly ignorant of radio and that they wanted "a good set."

"Instead," he said, "they generally have a pretty good notion as to the kind of set—and circuit—they want. They understand to a greater or less degree, what may be expected from each of the leading receivers on the market, and they are reasonably well versed in the nomenclature of technical radio terms. Quite the opposite of what we encountered in the early days of broadcasting," he concluded.

One St. Louis dealer attempted to "start the business-ball rolling" by offering a three-tube receiving set complete with batteries, tubes, loud speaker, aerial wire, insulators, lightning arrester, ground-clamp and connecting wire at a figure slightly less than fifty dollars. This is the first time, to the writer's knowledge, such a "bargain" has been offered to the St. Louis public and the results will be watched with great interest.

Some very interesting figures were obtained from one manager regarding the percentage of business transacted during the "on" and "off" seasons of the year. They are based on sales made during the last two years, and while he says they are only approximate, they shed some valuable light on the commercial side of the radio industry.

Fifty per cent of the annual business was done during October, November and December.

Thirty per cent of the annual business was done during January, February and March.

Twenty per cent of the annual business was done during April, May, June, July, August and September.

He said that fifty per cent of the last twenty per cent would be transacted during the early part of April and the latter part of September.

Each interview with different dealers brought forth different speculations as to the probable effect on the battery industry the advent of "B" battery eliminators would have.

Some held the opinion that until these devices are available at a price near to that at which battery rectifiers can now be purchased, they

would make little inroad into dry battery sales. Other merchants did not believe them to be practical, while one ventured the opinion that the public would "wait until they could buy one device which would supply both plate and filament currents."

So much for the prognostications. No deliveries, however, other than dealers' samples have made their appearance in St. Louis, and one merchant said that since the sample had been on his counter, he had lost six sales by not having any for delivery.

INVERSE NEUTRODYNE PROVES TO BE BEST SET THIS FAN EVER HANDLED

LEBANON, PA., Nov. 13.

My dear Mr. Neely:

This letter is written so that I can in a small measure show my appreciation of being made the owner of such a wonderful set as the Inverse Duplexed Neutrodyne. I have in my house *Radio in the Home* for every month and I feel that I must buy it from now on trying in that way to repay you, Mr. Grimes and Mr. Briggs.

I will not describe my set nor tell what I have done with it since I have finished it, for I found everything acted as your article described in the September number. I used all parts described except a Hamerlund condenser for National and as the radio supply house sent me red instead of brown Celatsite wire I used it, not wishing to wait to exchange it.

It is a hard job not to make a set correctly with your 3XP-style wire-ups and photographs. I soldered the last wire at 10 o'clock four nights ago and five minutes later was listening to WBZ.

This town of Lebanon is very poor for radio. I owned a fine factory-made neutrodyne for one year and only sold it a few months ago to my brother who wanted a set after I loaned it to him to give him an idea of what to expect from radio. Well, that was a good set but this is better. I know that I can do anything on my loop that I did on the 5-tube neutrodyne, and when I put an aerial to this set I will get it or no other person in the same spot will.

I only suggest that you mention in your magazine that any person who uses neutrodons is foolish and reduces the efficiency of the set.

I receive most all my stations on the eighth or ninth tap. I am never bothered with my set feeding back in the loop. This I don't understand, more so since I have read your article in the October number. I have only had that feed back howl once or twice and that in only one direction, and by reversing the loop it stopped. This may be because my set is not as sensitive as your set. But I have never seen any set as good as this one and I have heard most all that are on the market today. I had thought that it may be due to my position in the room, but had no different trouble in my mother's house a few blocks away.

I know this letter is too long and you won't have time to read it, but I felt that I had to thank you and Mr. Grimes and Mr. Briggs. There is no manufactured set that I would trade for. I used square-type loop and as I have no trouble separating WGN (270), WGY (380), WTAM (390), Louisville (400), why I am satisfied—and I mean separated.

Well closing I must say it is a shame that all radio fans don't know the difference between your magazine and what it contains and the other magazines.

I am yours truly,

Guy C. Keeber.

Pages 57-60 are missing in the original.

"Turn-It" greatly increases the volume, secures greater distance and reduces noise.

TURN-IT

ADJUSTABLE GRID LEAK

Changes the range of resistance to suit the strength of reception. ABSOLUTELY GUARANTEED



Only \$1 at Your Dealer or Direct From Us

Turn-It Radio Sales, Inc. 71 Murray St., New York

EBY

There is only one **GENUINE** EBY Binding Post

"with Tops which Don't Come Off"

EBY Posts are scientifically designed, beautifully finished and their price is right.

This is our design post which can be furnished in a variety of plain or engraved in twenty-five different markings.



EBYS Are Binding Posts PLUS

H. H. EBY MFG. CO. Philadelphia

SIMPLEX DY TUNER

NEW MODEL 180°

Spiral Wound Moulded Rotor A high-quality tuner specially designed for the Three-Circuit Tuned Primary Circuit. Excellent for long distance and extremely selective. Good volume. No soldering necessary.

At Reliable Radio Stores **SIMPLEX RADIO CO.** Mfrs., Philadelphia

FOR THE BEST RESULTS

With the Keystone Radio Lightning Arrestor there's no loss in signal strength because your lead-in can be continuous from aerial to set. With many arrestors it is necessary to break the lead-in wire at the arrestor. And the Keystone is the only arrestor with approved binding posts. Genuine Pakette. Install a Keystone Arrestor. Get reliable protection the year round. Listed as standard by the National Board of Fire Underwriters.

KEYSTONE RADIO LIGHTNING ARRESTERS

Complete With Instructions **\$1.50**

In Canada, \$2.00

Mfrs. of over a million lightning arrestors

Electric Service Supplies Co. 17th & Cambria Streets, Phila. 50 Church St., New York Woodstock Bldg., Chicago

my brother, Merrill, our laboratory assistant, to my home about 100 yards away and had him tune in to my house set which also operates on a loop and which is not a superheterodyne.

Then, with the signals which we always use in our radiation experiments, I operated one of these superhets and tuned about as the amateur does hunting for stations, making the set squeal and whistle as I passed certain points, and whenever I did find such a squealing point I squealed with the prearranged signal. Later my brother came back and reported that every time I did that I entirely wiped out any signals he was receiving on my home set. This was with both sets working on indoor loops.

This experience ought to be very significant for those who are operating these home-made supers in apartment houses. Every time you make your own super squeal, as it does when your dials are passing certain points, everybody in the apartment house is very likely to hear that squeal even more loudly in his own set than you do in yours. This applies even when you are working your super on an indoor antenna.

Now, let us see how very much worse this is when we operate one of these circuits on an outdoor antenna. Here we face an even more difficult problem than when we are operating it on a loop.

As you all know, the super-heterodyne functions by means of an oscillator tube. This oscillator is always oscillating. It is constantly sending out a carrier wave which is exactly the same as the carrier waves sent out by various broadcasting stations. This carrier wave is going out at radio frequency and is not audible and does not become audible until certain things are done to it. This is so of all radio-frequency carrier waves.

Super-heterodyne sets work by means of imposing a "beat note" upon this oscillating circuit or carrier wave and these two waves, acting upon each other, change the total of the wave into whatever frequency is provided for by the intermediate transformers of the super-heterodyne set. Let us assume, then, that our intermediate frequency is 30 kilocycles.

Now we tune in a certain broadcasting station with our super-het coupled to the outdoor antenna. We do not have any squeals because we are sitting down comfortably listening to a whole evening's program from the station. Everything is coming in beautifully; we hear no squeals, no howls, no whistles, and we are quite satisfied that we are enjoying radio and that we are not annoying anybody else.

What is really happening? Our oscillator, constantly sending out a carrier wave 30 kilocycles above or below the station we are listening to, is now coupled to the outdoor antenna and by this means is able to radiate that carrier wave for several miles around us.

As I have said, this carrier wave is of such high frequency that it is not audible. But suppose that John Jones, down the street, wants to tune in a station on another wave length and the wave length of that station happens to be anywhere from one-half to five kilocycles above or below the carrier wave which we are sending out.

As soon as his receiver strikes the correct carrier wave for that station, the oscillations in his own receiver on the frequency he is going to receive, heterodyne or "beat note" with our super-heterodyne carrier wave and he gets a constant whistle in his receiver which he cannot possibly tune out as long as he stays on the station he wants to get and we stay on the station which we are receiving.

The indoor loop does not radiate sufficient energy on an ordinary carrier

wave to make this interference felt by anybody except the very closest neighbors. In fact, I imagine that a man would have to be in the next apartment to you or on the next floor above or below you in order to get it and then it would probably not be strong enough to cause a very great deal of annoyance.

But the moment the super-heterodyne is coupled to an outdoor antenna the radiating power is enormously increased and then the set becomes a nuisance to everybody within a mile or two who happens to tune in within a 5000-cycle wave length of the oscillator.

Won't you, then, consider your neighbors when you are using a home-made super-heterodyne outfit? Until long after the ordinary broadcasting is over, please do not couple your super-het to the outdoor antenna. Use your indoor loop. This, with a good super-heterodyne will give you everything that any reasonable man can ask in radio during the ordinary broadcasting hours.

If you want to indulge in the fascinating game of hunting distant stations, you'll then, of course, want to hook up to your outdoor antenna to get the ultimate distance, although, of course, no super-heterodyne gives decent quality on an outdoor antenna. Still you want the distance just for the fun of it.

You must then consider yourself in the same category with the transmitting amateurs. As soon as you couple to the outdoor antenna, you really become a transmitting station, and, as a good sport and a good citizen, you should observe the same rules that govern the transmitting amateurs. You should remain silent until after ordinary broadcasting hours are over.

Radio engineers are now working toward the superheterodyne which will have some sort of device in it to prevent this radiation. It will be here very soon.

Meanwhile, go ahead and get all of the joy you can out of your super, but be a good sport and let me enjoy my radio programs until at least eleven o'clock at night.

After that the air belongs to everybody, and I myself will probably be radiating just as badly as you will in the fascinating hunt for distant stations.

New Studio Ready for WLW's Super-Power

(Continued From Page 54)

broadcasting. As we know, great artists are temperamental, and the surroundings of the new WLW studios are important for this reason. There is a color scheme in the surroundings which teems with the artistic atmosphere. Artists want to be on the programs so as to have the proper setting for their offerings.

One finds a combination of the old world and the new as one enters the auditorium which is joined to the two studios. A partition of plate glass divides the auditorium from the solo and ensemble studios, with swinging doors at each end for the use of the artists who broadcast. The visitors remain in the auditorium where two amplifiers, connected with the broadcasting equipment, permit the work of the artists to be heard.

The solo studio and office of the director is large enough to hold a small group of musicians. A Baldwin piano and celeste are used in this studio. An old bronze lamp vies with one of modern design for decorative effect while tapestries adorn the walls. A swinging door leads into the ensemble studio and another into the control room while a third is for use as an



Every Radio Fan Should Have This Book

LIKE a little radio encyclopedia, this I. C. S. Radio Handbook is packed with concise, sound information useful to everybody from beginner to veteran hard-bolled owl. It starts with simple explanations of radio phenomena and leads you along gently until you can understand the most technical diagram.

You may dip into it at random, or hunt up special information you want, or read it right through. Different types of receiving and sending hook-ups are explained; electrical terms and circuits; antennas; batteries; generators and motors; electron (vacuum) tubes; interesting experiments; definitions, and thousands of suggestions for getting more pleasure out of radio.

A pocket course in radio! Every page tells you something useful, and there are 514 pages; hundreds of illustrations and diagrams. It is the biggest dollar's worth in radio, and will save you from wasting money on things that don't work.

Send \$1 to-day and get this 514-page I. C. S. Radio Handbook before you spend another cent on parts. Money back if not satisfied.

TEAR OUT HERE

INTERNATIONAL CHRISTIANITY BOOKS
Box 225-D, Evanston, Penna.

I enclose One Dollar. Please send me—post-paid the 514-page I. C. S. Radio Handbook. It is understood that if I am not entirely satisfied I may return this book within five days and you will refund my money.

Name

Address

Check here and enclose \$1.50 if you wish the deluxe edition, bound in leatheroid.

Have you your EKKO Broadcasting Station Stamp Album?

Here's what every radio fan has wanted—a convenient, permanent and authentic means of recording all stations heard over your set. The EKKO Album contains spaces for a stamp from each of more than 650 stations. These stamps are verified and prove your reception of the station.

Proof of Reception cards are furnished with the album. Send the card to the station, together with ten cents, to cover cost of verification, fine facts which prove you have heard their broadcasting. In return they send you their verified stamp as evidence of actual reception. The stamps are beautifully engraved in different colors, an individual stamp for every station showing the call letters.

The album is 9 1/2 x 11 inches, handsomely bound in a two color cover. It contains 95 pages, with spaces for stamps of all recognized stations arranged alphabetically by state and call letters. Also an alphabetical list of the official names and other interesting features of stations, as well as a convenient log.

See your dealer today, get a copy of the EKKO Album and start a collection of these stamps. You will find this a new and fascinating method of verifying the stations you hear. If your dealer cannot supply you, send direct on receipt of price. Money back if not satisfied.

Price \$1.75
THE EKKO COMPANY
111 West Monroe Street, Chicago

FREE

To Each Purchaser of a World Battery



A 24-Volt "B" Storage Battery positively given FREE with each purchase of a WORLD "A" Storage Battery. The WORLD Battery is famous for its guaranteed quality and service. Backed by tests of Successful Manufacturers and Thousands of Satisfied Users. You save...

Prices That Save and Satisfy

| Auto Batteries | | Radio Batteries | |
|--------------------------|---------------------------|---------------------------|---------------------------|
| 6-Volt, 13 Plate \$12.25 | 6-Volt, 60 Amps. \$19.00 | 6-Volt, 180 Amps. \$22.00 | 6-Volt, 100 Amps. \$24.00 |
| 6-Volt, 13 Plate 14.25 | 6-Volt, 120 Amps. \$20.00 | 6-Volt, 100 Amps. \$24.00 | 6-Volt, 100 Amps. \$24.00 |
| 22-Volt, 7 Plate 17.00 | 6-Volt, 100 Amps. \$24.00 | | |

2-Yr. Guarantee Bond in Writing With Each World Storage Battery

WORLD BATTERY COMPANY
1219 So. Wabash Ave. - Dept. 909 - CHICAGO, ILL.

GIVEN FREE

To purchaser this set, and register to allow us to return the battery to the Public.

entrance to the auditorium. The floors are of hardwood, covered with Oriental rugs, and the woodwork is solid mahogany.

No other broadcasting studio equals the arrangement of the ensemble studio. This large room can accommodate a military band or large orchestra. Large divans with soft, springy cushions are against the walls. Several chairs of antique design and high backs, lend a touch of dignity to the draped walls. A large chime clock is both useful and ornamental. Here, too, tapestries are used in the decorative scheme. A Baldwin concert grand piano is in one corner. Many great artists have played upon it.

The walls of both studios have hangings of Monk's cloth, a deep fringe at the bottom reaching to the floor. These hangings are so hung as to be drawn back in places when certain types of voices require a different acoustical quality. Elimination of reverberation is the function of the wall draperies. The same is true of the specially treated ceiling which is of membrane material. Deep knap carpet covers the studio floors.

Control of the microphones in both studios and connection with the broadcasting station, which is some miles away from the studios at 3401 Colerain avenue, is done in a triangular shaped room between both studios. Special telephone lines attached to the amplifier in this room carry the concerts to the station and relay the incoming broadcasting from remote places.

The familiar red signal light is no more. In its place the Crosley engineers have developed a new microphone stand. Upon a small circular stand rests the microphone, but in the stand there is a system of illuminated signs to inform the artist when to "Prepare" and when to "Broadcast." By illuminating these signs automatically, the voice of the announcer or artists is carried into the air by the turn of a switch. No longer will it be necessary to ask the audience to "wait a minute" while one artist prepares for his turn following that of a fellow broadcaster, for the two studios have done away with this. A demonstration of the rapidity of this system was made on the night of the dedication when twelve things were given from both studios without a loss of a second between them.

Development in radio broadcasting is going on and when the new high power five-kilowatt WLW transmitter is placed in operation, it will be possible for Marconi in Italy to hear its inaugural ceremonies from Harrison, Ohio, some twenty-five miles from the Crosley studios.

Further Notes on the Inverse Duplex Neutrodyne

(Continued From Page 54)

—were visible in color, I think the air would be blue for some fifteen feet in every direction. Anyway, what is the use of a loop fifteen feet from a set?

So I shielded the whole cabinet—top, sides, ends and bottom—with sheet copper. Had already shielded the panel. Grounded all these shields to the positive A, and shellacked thin paper all over them to guard against short circuits by accidental contacts. The shielding cut another generous slice off the volume, but there was plenty left. Contrary to my expectation, it did not broaden the tuning. The set still separates KHJ and WTAM (five meters apart) perfectly. Also, the loop now roasts innocuously and conveniently on top of the set. (Note: When neutralizing a set in a shielded cabinet, close the lid after

each slight change in the position of the neutrodons.)

The next problem was to eliminate a lovely howl from the last stage of audio amplification. Swapping contacts on the primary of the last transformer did no good. Neither did swapping tubes. Putting a ground wire on the positive "A" stopped the howl—and changed the tuning. Not a satisfactory solution anyway, since this set should work without antenna or ground. But raising the value of the bypass condenser numbered 21 in the diagram—the one next the potentiometer, cured the trouble completely.

Now, having a fairly tame, tractable set, with stations satisfactorily logged from coast to coast to the number of about forty, I set out to disprove Mr. Neely's italicized dictum that grid bias should not be used on tubes carrying RF amplification. Had been using 100 volts, with the "C" battery in the grid return of the last tube only. Changed the grid return from "F" on the first two audio transformers from its original destination, which was the negative "A," over to the negative "C," so that the negative bias was on all three amplifying tubes. Raised the plate voltage to 150. Raised the "C" battery to seven and one-half volts.

Result, wonderful. Try it! More volume, smoother tone. May be theoretically wrong, but it works.

A few words about using antenna and ground. You may use both by putting one turn of wire loosely round the loop and fastening the antenna to one end and the ground to the other. The tuning will be a little broader, and consequently easier. Not a bad scheme when you are trying to locate station readings on a new set. But the volume, of which you have plenty and to spare already, will be much greater, so that the net result is to overload the amplifying tubes, necessitating carrying the tap-switch lower. I don't recommend an antenna, except perhaps to bolster up a poor detector tube.

There is something to be said, however, for the use of a ground alone. Just connect a ground-wire to one end of the above-mentioned single turn, leaving the other end free. This does away with much of the directional effect of the loop, and gives a little more volume on very distant stations. The loss of directional effect is of little consequence, since the set is so sharply selective anyway.

An inverse duplex is no better than its detector tube. And in this circuit the plate voltage used on your particular tube makes an immense difference. Try every plate voltage from 16½ to 22½, carefully readjusting the filament to just below the hissing point after each change. You will probably find one plate voltage immeasurably better than all the others for each tube you try, and it may not be the same with any two. I have tested thirteen of these tubes in the last week, and should grade just two of these as A1. Found one that needed thirty-five volts to function at all.

This is a very fair description of the kind of careful, patient experimenting necessary to get the best out of a super-sensitive radio circuit. It is absorbing and fascinating work. The inverse duplex neutrodyne is not quick and easy to build and adjust, and no set so sensitive and selective is quick and easy to tune for long-distance work. But, the adjusting and tuning mastered, you have a set with all the range you want, tonality to challenge all comers (homemade or commercial), and all the volume it's decent to let loose in a civilized neighborhood.

I should be very glad to hear from other experimenters who have tried out this circuit.

B-METAL

HECK! A CRYSTAL that is worth its weight in gold to any radio owner. It is sold on the very broadest guarantee to MATTY THE FARMER, and thousands of letters of grateful appreciation testify to the merits of B-METAL TALKING CRYSTALS. Get it from your dealer, but remember that there is no substitute for B-METAL CRYSTALS.

B-METAL comes a long way to be made into a radio crystal, and goes a long way to satisfy. Your dealer will accommodate you.

B-METAL REFINING COMPANY
16th Floor, 325 Woodward Ave., Detroit, Mich.

FARAWAY RADIO

\$29.50

Gets stations Far and near Loud and Clear

FARAWAY Radio Sets are amazing values of complete price. They are set stations from New York to Fresno and clear across with either dry cells or storage batteries. Beautiful cabinet finished in mahogany with new platinum-finish J neon LAMP FILTERS (U.S. PAT. 1,817,712). Best you can get for \$29.50. Write for our money-saving plan and booklet.

2-Tube Set - \$29.50
4-Tube Set - \$9.50

Dealers - Agents: Request permission you are bound. Write for plan and literature quickly.

THE FARMER BATTERY CO. 101 W. THIRD ST., CHICAGO, ILL.

Mailing Lists

Will help you increase sales. Send for FREE catalog giving names and prices on thousands of classified names of your best prospective customers, including new lists covering the radio field.

99% guaranteed by refund of 5¢ each

ROSS-Gould Co. St. Louis

MAGNADYNE REFLEX COILS

The Real Low Loss Coil

Adaptable to practically every set designed to bring to an absolute minimum distributed capacity and dielectric losses. No substance used to mar the efficiency of the coils.

Mailed postpaid in the United States for a pair \$2.00 a pair

COAST COUPLER CO.
Manufacturers and Dealers
East Seventh Street
Long Beach, California

GRIMES and His Famous INVERSE-DUPLEX SYSTEM

are found exclusively in "Radio in the Home." David Grimes is one of our Associate Editors and writes for no other publication.

Use Only the Best **SPAGHETTI**

Armed "Spaghetti" is varnished tubing in all over brass bar wire to insulate it from other wires in a set. Flexible as rubber; will not harden or crack. Water, oil, acid and gas proof. In five beautiful colors to fit No. 12 to 18 wire. Ask your dealer and send for free folder on Arme Radio Products, which also tells how to solder.

THE ACME WIRE CO.
Dept. R, New Haven, Conn.

ACME WIRE RADIO NEEDS

Radio and Home Demand Safeguards

ADD to the delights of your radio by giving it the protection that radio engineers demand and National Board of Fire Underwriters insist upon.

Caution is unnecessary when the dependable Brach Vacuum Arrestor is available. Dominant for 18 years.

Millions now in use throughout the world by principal railroad, telegraph and fire alarm systems.

Get yours today.

BRACH VACUUM ARRESTER
L. S. BRACH MFG. CO.
Newark New Jersey

Coillite

NO matter what style of Radio Receiver you prefer "Coillite" coils will give you greater selectivity, distance, volume and quality.

A set manufactured in Philadelphia using "Coillite" Coils in a 2-tube Reflex brings in California stations on loud speaker.

Ask your dealer for "Coillite" Coils for Neutrodyne, Reflex or three circuit tuners.

or Write **Temple Instrument Co.**
111 Federal St.
Camden, N. J.



Radiotron WD-11
The ideal
dry cell tube.



Give Radiotrons *for Christmas*



*This symbol of
quality is your
protection*

It isn't a genuine WD-11
unless it's a Radiotron.
It isn't a genuine WD-12
unless it's a Radiotron.
It isn't a genuine UV-199
unless it's a Radiotron.
It isn't a genuine UV-200
unless it's a Radiotron.
It isn't a genuine UV-201-a
unless it's a Radiotron...

Take a peek into any radio fan's set—and you know what to give him for Christmas. Note the type of Radiotron he uses. Go to any radio store—and when you buy, look for the name RADIO-TRON and the RCA mark. Then you are sure to be giving him *genuine* Radiotrons. And mighty sure to be giving him the gift for a Merry Christmas.

Radio Corporation of America

Sales Offices

233 Broadway, New York

10 So. La Salle Street, Chicago, Ill.

28 Geary Street, San Francisco, Cal.

Radiotron

REG. U. S. PAT. OFF.



Natural tone quality
wonderful volume with a FADA Neutrola.

IN THE "Neutrola," FADA has produced a radio receiver that possesses every essential to your complete enjoyment of radio. It is a new and better designed five-tube Neutrodyne set, refined to give the most faultless reproduction of music and voice. You can, without exaggeration, imagine yourself in the very presence of the musicians and artists.

Selectivity is but one remarkable feature of the "Neutrola." With powerful local broadcasting stations operating, the "Neutrola" cuts through them and brings in outside stations, hundreds of miles away, on the loud



speaker with minimum interference.

The "Neutrola" cabinet is of genuine mahogany, inlaid with a lighter wood. A decorative grill covers the built-in loud speaker, and a drop desk lid hides the panel when the set is not in use. The "Neutrola" is fitting company to the finest furniture in the home.

In addition to the "Neutrola" there are other FADA Neutrodyne receivers in sizes and styles to meet every desire; three, four and five tube receivers in plain and art cabinets at prices ranging from \$75 to \$295, each extraordinary in results; each a remarkable value.

F. A. D. ANDREA, INC., 1581 JEROME AVENUE, NEW YORK

FADA
Radio

FADA Neutrola
Five-tube FADA Neutrodyne, with self-contained loud speaker. Genuine mahogany, artistically decorated with wooden inlay. Ample space for all batteries and charger. Drop desk lid that hides receiver when not in use. Price (exclusive of tubes and batteries) \$220.



FADA "One Sixty"
No. 160-A

"The receiver that has taken the country by storm." The best known of all Neutrodyne. Four tubes. Price (less tubes, batteries, etc.) \$120.



FADA Neutro Junior
No. 190

Three-tube Neutrodyne. A wonderful performer. Price (less tubes, batteries, etc.) \$75.

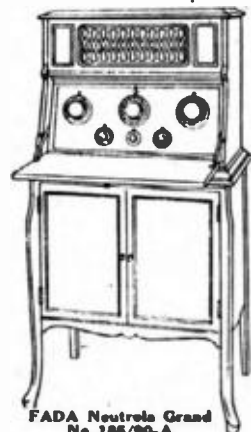

FADA Neutrola Grand
No. 185/190-A

The five-tube Neutrola 185-A, mounted on FADA Cabinet Table No. 190-A. Price (less tubes, batteries, etc.) \$2