

**FOUR-GANG T.R.F. High Fidelity TUNER**

# RADIO WORLD

REG. U. S. PAT. OFF.

**NOVEMBER**  
1936  
25c Per Copy



**New Windo-  
Pole Antenna**  
See page 32

# ANOTHER MILESTONE OF PROGRESS



**C**ORNELL-DUBILIER has come a long, long way in twenty-six years. From exceedingly small quarters on Broadway in New York, we moved to our present large plant of three floors and two annexes. The acceptance of C-D condensers by the radio and electrical industry now once more necessitate our removal to still larger quarters in an even greater, more modern plant in South Plainfield, N. J.

In this new home of ours, covering 33 acres, with 210,000 square feet of plant space, added production facilities, and closer engineering control, it will be possible to still further improve a highly-perfected condenser line. Required delivery time will naturally be considerably reduced. We prophesy that in our new home C-D will continue to lead, because improvement is fundamental with Cornell-Dubilier.

*To the engineering fraternity we extend a most cordial invitation to stop by and inspect the new factory.*

**WET AND DRY ELECTROLYTIC • PAPER • MICA • DYKANOL**

**CORNELL DUBILIER**

**CORNELL-DUBILIER CORP. 1024 HAMILTON BLVD.  
SOUTH PLAINFIELD, N. J.**



# HAMMARLUND

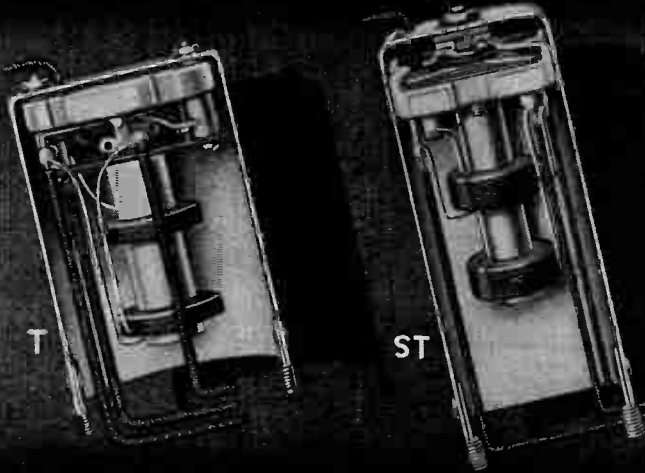

## I. F. TRANSFORMERS

*for Better Radio!*

**A**N ideal group of I. F. replacement and experimental transformers by Hammarlund for broadcast and short waves, for the critical engineer, research student, repairman, and amateur demanding superior results for better radio. Ten types are available in a round can "T" model for 175 and 465 kc. and a square can "ST" model for 175, 262 and 465 kc.

The electrical characteristics of "T" and "ST" are identical, with tuned grid and tuned plate lattice wound coils, impregnated to prevent moisture effects. The tuning condensers are the highest grade mica compression type, mounted on Isolantite bases and adjustable from the top of the shield can. Leads are RMA color coded, and tagged for easy installation. Secondaries are either plain for standard screen grid tubes, or center tapped for tubes requiring split input circuits.

Aluminum shield of "T" model is  $2\frac{1}{8}$ " outside diameter x  $3\frac{1}{8}$ " high, with threaded mounting lugs on 2" centers. The "ST" aluminum shield can is  $2\frac{3}{4}$ " high x  $1\frac{1}{16}$ " square, with threaded mounting studs on  $1\frac{1}{8}$ " centers.

Here are, truly, quality transformers, and now available at the new low price of \$1.45 each list!

Write for the special I. F. transformer bulletin with further details! Just mail the coupon below.

HAMMARLUND MANUFACTURING CO., INC.  
424-438 W. 33rd St., New York RW-11

- Check here for new I. F. Transformer bulletin.  
 Check here for Hammarlund General Catalog.

Name .....

Address .....



**HAMMARLUND'S 25<sup>TH</sup> YEAR**

*Now—a high-powered*



## Radio Engineering Library

—especially selected by radio specialists of McGraw-Hill publications.

—to give most complete, dependable coverage of facts needed by all whose fields are grounded on radio fundamentals.

—available at a special price and terms.

THESE books cover circuit phenomena, tube theory, networks, measurements, and other subjects—give specialized treatment of all fields of practical design and application. They are books of recognized position in the literature—books you will refer to and be referred to often, if you are a practical designer, researcher or engineer in any field based on radio, you want these books for the help they give in hundreds of problems throughout the whole field of radio engineering.

**NEW!**

The Library now comprises a revised selection of books culled from latest McGraw-Hill publications in the radio field.

5 volumes, 3064 pages, 2000 illustrations

1. Glasgow's RADIO ENGINEERING
2. Hund's PHENOMENA in HIGH FREQUENCY SYSTEMS
3. Chaffee's THEORY OF THERMIONIC VACUUM TUBES
4. Terman's MEASUREMENTS IN RADIO ENGINEERING
5. Henny's RADIO ENGINEERING HAND-BOOK

10 days' examination. Special price. Monthly payments. \$25.00 worth of books cost you only \$23.50 under this offer. Add these standard works to your library now; pay small monthly installments, while you use the books.

# YOU'LL NEED THIS BOOK!



### The New 1936-37 Edition of the Sylvania Service Booklet Can Bring You New Profits!

There will be more automobile radios installed this winter than ever before. More cars will come from the factories equipped with radios than ever before. A new source of business and profits is opening up before your eyes! Will you be prepared to meet it?

You can be prepared with this new Sylvania Service Booklet! Here are just a few of the features:

Elimination of motor interference for every make of 1936 car. . . Tube complement chart for practically all models of automobile radio sets, with I.F. peak frequencies. . . Set and Antenna installation hints. . . Power supply hints, etc. These and hundreds of other problems you will meet in auto-radio installation and servicing are covered in this amazing book.

Fill out the coupon below and mail it NOW. You will receive your free copy of this valuable book within a few days.

Hygrade Sylvania Corporation, makers of Sylvania Radio Tubes and Hygrade Lamps. Factories at Emporium, Pa.; Salem, Mass.; and St. Mary's, Pa.

## SYLVANIA

The Set-Tested Radio Tube

**SEND THIS ON-APPROVAL COUPON**

McGraw-Hill Book Co., Inc., 330 W. 42nd St., N. Y. C.

Send me Radio Engineering Library, 5 vols., for 10 days' examination on approval. In 10 days I will send \$2.50, plus few cents postage, and \$3.00 monthly till \$23.50 is paid, or return books postpaid. (We pay postage on orders accompanied by remittance of first installment.)

Name .....

Address .....

City and State .....

Position .....

Company ..... RW11-36

RW-116

**HYGRADE SYLVANIA CORPORATION**  
Emporium, Pa.

Please send without obligation your new service book, "Auto-Radio Installation and Servicing."

Experimenter  Amateur  Call.....  
 Serviceman  Employed by dealer   
 Independent   
 Member Service Organization.....

Name .....

Address .....

City ..... State.....

Name of Jobber .....

Address .....

**IF IT'S RADIO... it's in**  
**THE 1937**  
**"BLUE RIBBON"**  
**RADIO**  
**CATALOG!**

**B**UILDING your own? Buying a new S.W. or All Wave Receiver? Need a part for a servicing job? This **BIG, NEW RADIO CATALOG** will make your selection **EASY . . . AND ECONOMICAL.** **WHOLESALE RADIO SERVICE CO., INC.,** with its tremendous purchasing power, offers values which cannot be beat! Five strategically situated branches are filled with fine, fresh stocks of radio products, shipments are made within twenty-four hours of the receipt of your order.

**AND IT'S FREE!**

Write today for your copy of Radio's greatest catalog—upward of 150 pages—over 2,500 illustrations—more than 50,000 items listed. Use this valuable book—to make your shopping easy—to save money—to save time.

**EVERYTHING YOU NEED IN RADIO!**

Resistors, Condensers, Volume Controls, Transformers, Wire, Antennae, Speakers, Tubes—Transmitting and Receiving, Short-Wave Kits, Parts, Test Equipment. Everything we carry is of the finest, having passed the rigid inspection of our laboratories before being accepted. Get the Wholesale habit—buy with complete confidence.



**HOO! MON! 'TIS SMART TO BE THR-RIFTY! SEND FOR THIS BRAW-BONNY BOOK—'T WILL SAVE YE MONEY**



WHOLESALE RADIO SERV. CO., Inc.  
 100 Sixth Avenue, New York, N. Y.  
 PLEASE RUSH FREE BLUE RIBBON RADIO CATALOG 65-K11.

NAME .....

STREET .....

STATE .....

**WHOLESALE RADIO SERVICE CO., INC.**

CHICAGO, ILL.  
 901 W. JACKSON BLVD.

NEW YORK, N.Y.  
 100 SIXTH AVENUE

ATLANTA, GA.  
 430 W. PEACHTREE ST. NW

BRDNX, N.Y.  
 542 E. FORDHAM RD.

NEWARK, N.J.  
 219 CENTRAL AVE.

# RADIO WORLD

*Fourteenth Year*

ROLAND BURKE HENNESSY  
*Editor*

HERMAN BERNARD  
*Managing Editor*

HERBERT E. HAYDEN  
*Advertising Manager*

## Table of Contents for NOVEMBER, 1936

<b>A High-Fidelity T.R.F. Tuner..</b> 8	<b>Two Delays in A.V.C.....</b> 28
<i>Four-Gang Condenser and Overload Relay</i>	<i>One Depends on Voltage, Other on R and C</i>
By Jack Goldstein	By Wright Hoagland
<b>Six-Tube Universal Super.....</b> 12	<b>Input Capacity and High Fidelity</b> 30
<i>Considerable Power for Small Set</i>	<i>Effect on the Acoustical Response</i>
By Lawrence A. Burr	Laboratory Findings of Hygrade Sylvania
<b>Universal Vacuum-Tube Voltmeters</b> 14	<b>New Windo-Pole Antenna.....</b> 32
<i>Rectified Line Current Used for Bias</i>	<b>Phase Shifter and Ray Index...</b> 34
By DeGulla Gaw	<i>In High-Performing Nine-Tube Super</i>
<b>Practical Facts on Line Cords..</b> 16	By Kenneth H. Tiffany
<i>Resistance Values and Connection Data</i>	<b>Overload, Commonest Evil.....</b> 38
By Herman Bernard	<i>Methods for Preventing It Easily</i>
<b>9 to 15 Meters on Four Tubes...</b> 21	By Capt. Peter V. O'Rourke
<i>Simple Set in Wooden Cabinet</i>	<b>High Ratio of Signal to Noise..</b> 42
By Harry G. Cisin	<i>Methods Used in NC-100 to Accomplish It</i>
<b>Right or Wrong?.....</b> 23	By James Millen
<i>Five Propositions and the Answers</i>	<b>SERVICE BUREAU</b> 46
<b>A High-Fidelity P.A. System...</b> 24	<b>Radio Circuits for Treasure Seeking</b> 48
<i>6L6 Push-Pull Output, Low Distortion</i>	<i>Outstanding Methods for Quest of Riches</i>
By E. F. Coleman	By J. E. Anderson
<b>Coil Switch and Regeneration..</b> 26	<b>RADIO UNIVERSITY</b> 54
<i>Electron Coupling in Compact Set</i>	<i>Questions Answered</i>
By Guy Stokely	<b>A Very Simple Bridge.....</b> 58
<b>Resonance—What Is It?.....</b> 27	<i>6H6 and 0-1 Milliammeter Used</i>
<i>The Circuit Fixed-Tuned to All Frequencies?</i>	By Jack Tully
By Grant Furness	<b>Oddities of Radio Technique...</b> 59

Vol. XXIX, November, 1936. No. 8. Whole No. 698. RADIO WORLD, published monthly by Hennessy Radio Publications Corporation, 145 West 45th Street, New York, N. Y. Editorial and executive offices, 145 West 15th Street, New York, N. Y. Executives of RADIO WORLD: Roland Burke Hennessy, editor and business manager; Herman Bernard, managing editor; Herbert E. Hayden, advertising manager. Officers of corporation: Roland Burke Hennessy, president-treasurer; Roland Burke Hennessy, Jr., vice-president; Herman Bernard, secretary. Entered as second-class matter March, 1922, at the Post Office at New York, N. Y., under Act of March 3d, 1879.

### SUBSCRIPTION RATE

Price 25 cents per copy. Subscription \$2.50 per year (12 issues); \$1.25 per six months (6 issues); postpaid in United States and Possessions; \$3.00 per year, \$1.50 per six months, postpaid in all other countries. Remittance for foreign subscription should be by International money-order (postal or express) or draft against or discountable at New York bank.

RADIO WORLD is distributed by the American News Company and its branches

# A 4-Gang T.R.F. Tuner

## Automatic Overload Relay Included

By Jack Goldstein

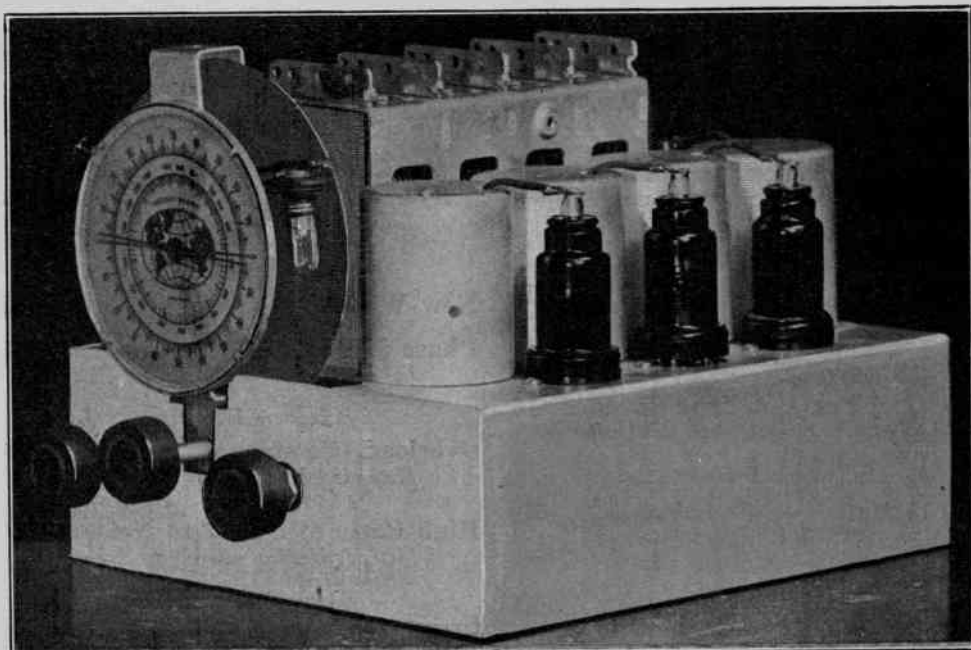

Mayfair Studio

Left to right the knobs are for the following: line switch, dial and volume control. The three r.f. tubes, at right, are in their circuit order, front to back. A four-gang condenser is used because necessary for adequate selectivity.

**D**ISCRIMINATING radio listeners, particularly those who have the cultural asset of musicianship, often enjoy the use of a tuner with a separate audio amplifier, because the tuner may be closely held to acoustical tolerances, and the amplifier, an existing device in the home or studio, is of notable quality. Therefore the combination makes for the finest sort of musical reproduction and the separate power supplies render the system free of audio regeneration and other such interaction.

When one desires to select a tuner circuit he has in general the option of a tuned-radio-frequency set or a superheterodyne. With either circuit the quality may be the same. With the superheterodyne the problems become more serious, therefore a person not too keenly versed in technical radio might prefer the t.r.f. set for that reason. Likewise the proper tracking of a superheterodyne and provision of adequate pre-selection for elimination of all squeals are a task of proportions. On the same score of preference for t.r.f. may come the argument that the pass-

age of the full modulation width of the audio tones, as they appear when counterparts of the carrier, is accomplished with utter ease, and it is in general not necessary to make acoustical measurements.

### ENOUGH SELECTIVITY

The sensitivity of either system may be the same. The superheterodyne always can be made more selective than the other. But enough selectivity for every local purpose is fully accomplished in the t.r.f. set, and if there is only the standard broadcast band to cover, no selectivity trouble need arise, and the separation should be good enough to permit tuning out a local, and tuning in a distant station only 10 kc removed from the local in the frequency spectrum.

So that there will be sufficient separation it is prerequisite that there be four tuned circuits, and preferably that there be tubes between each succeeding pair of tuned circuits. Thus the circuit consists of three stages of t.r.f., a tuned



input to the detector, and nothing much else save the rectifier and the usual components. In this instance we have restricted the volume control to a single unit, especially so as the audio is not taken care of in the tuner beyond the mere detection.

And it is detection in the real sense, in that a negatively biased pentode is used. Hence the tube is operated in plate bend fashion, as distinguished from the grid-leak rectifier or the diode rectifier of the type commonly found in superheterodynes.

### TROUBLESOME STATION

The bias on this tube is made higher than what would be present for amplification purposes, and that is accomplished by using a high value of resistor in the cathode leg of the 6J7, 30,000 ohms, and for low-note protection it is necessary to bypass this resistor with a very large capacity. Fortunately, such a capacity is obtainable in electrolytic form, at 25 mfd., 25 volt rating, although actually the bias voltage

will not be anything near 25 volts. A rating of 10 volts would be sufficient. The important point is that the capacity must be as high as stated, and may be still higher.

It is still possible to overload the detector, particularly on the strongest local in certain cities and towns. In many places there is always that single station to cause trouble. Grid current could flow. That would mean the voltage as developed by the tuner ahead of the detector has become high enough at peak value to overcome the effect of the bias on the tube, hence the grid becomes positive, grid current flows, and there would be distortion of a high order, due to detector overload, were not some special precaution taken against this terrible nuisance.

### THE AUTOMATIC RELAY

The protection is provided by interrupting the return of the secondary that feeds the detector, inserting a resistor between that terminal of the  
(Continued on following page)

## LIST OF PARTS

### Coils

Four shielded r-f transformers for 365 mmfd. condensers.  
One AC-DC filter choke.

### Condensers

One four-gang tuning condenser, 365 mmfd. per section, with trimmers.  
One .00025 mfd. Two .25 mfd.  
Two .002 mfd. One 25 mfd. 25-volt electrolytic.  
One .02 mfd.  
One .05 mfd. Two 8 mfd. electrolytic.  
One .1 mfd.  
[Fixed condensers are Cornell-Dubilier.]

### Resistors

One 40-ohm pilot shunt resistor.

One 150-ohm.  
One .05-megohm volume control potentiometer.  
One 30,000-ohm bias resistor.  
One .5 meg.  
Two 1 meg.  
One 200-ohm, 30-watt ballast tube.

### Other Requirements

Two 6.3 pilot lights.  
One line cord with switch.  
One six-contact socket.  
Four octal sockets.  
Four small grid clips.  
One five-tube chassis.  
One airplane type dial.  
Three knobs.

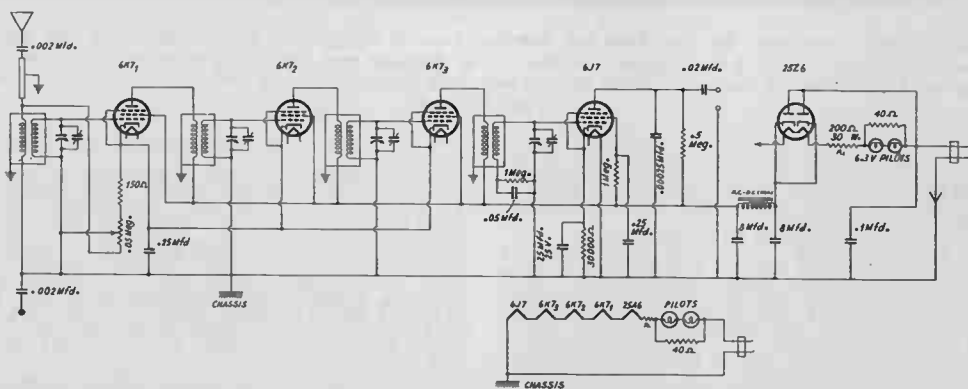

The 1 meg. resistor and .05 mfd. condenser across it represent an overload circuit. On the strongest local, in some communities, the plate-bend detector might be overloaded, therefore when such possibility exists, the detector becomes automatically a rectifier, and the average grid potential is maintained negative. This constitutes the overload relay.

(Continued from preceding page)

secondary and ground, and putting a large capacity across the resistor. The values used were 1 meg. and .05 mfd.

So when the signal voltage, in those rare instances, does rise to otherwise prohibitive height, the grid current passes through the resistor, and the grid is maintained effectively negative. This is true because of the phenomenon attaching to all grid-leak rectifiers, that the rectified voltage is effectively higher than the average of the a.c. signal input. The discharge

little by this loading, an exception must be made, e.g., reception of stations 10 kc on one side and 10 kc on the other side of this problem station is not to be expected.

### SIMPLEST RECTIFIER

The tuner, as stated, has its own power supply, but it is a simple one, consistent with the main objective of retaining simplicity throughout. Hardly can a substantial circuit be simpler than a t.r.f. tuner, and when a simple rectifier is added, even the whole becomes an

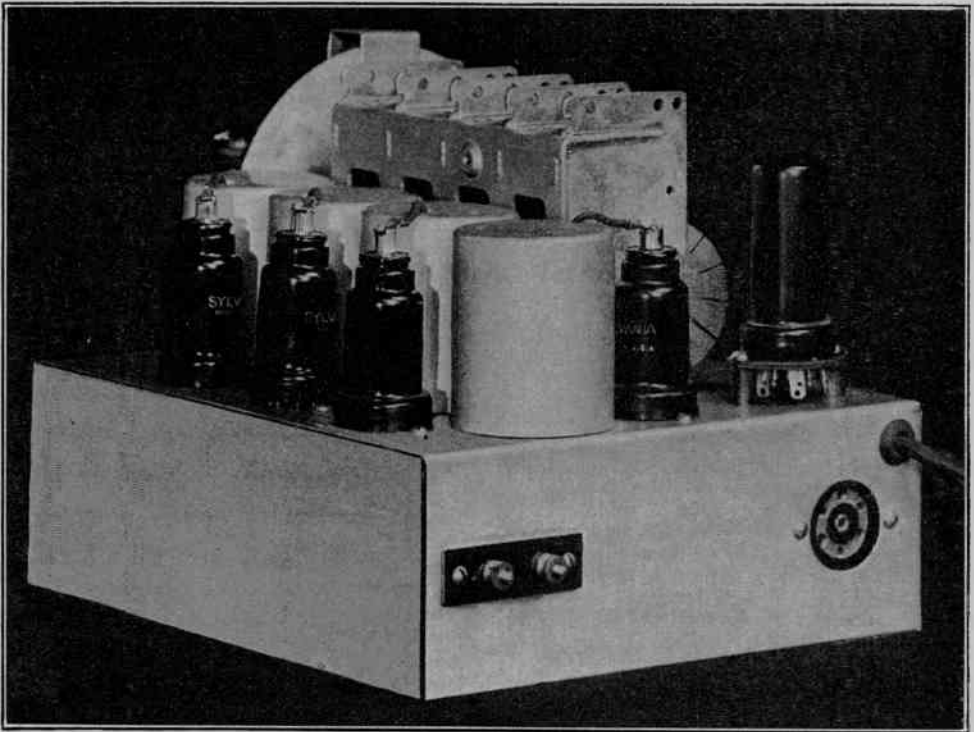

Angular view taken from the rear shows the detector tube to the right of the rear coil. The tube elevated from the chassis is the B supply rectifier. This elevation was just a convenience and there is no need to follow the method if there is a chassis hole to accommodate this tube. Ballast tube is out of sight.

of the condenser through the leak takes place at a slower pace than does the change in the alternating current values fed to the rectifier, hence the biasing effect due to the protective device is held over, as it were.

A confirmation of the fact is obtained by injecting a signal voltage high enough to produce grid current flow and noting that the plate current decreases, compared to what it is when a normal value of signal voltage is applied. Hence the voltage bias is maintained negative. This is what is wanted always, also it is what is achieved. The only real difference is that until the grid current flows there is practically no load on the grid circuit, but when grid current flows there is some load, hence for the extra-strong local, because selectivity is lessened a

easy matter to comprehend, to wire and to line up.

The rectifier consists of a double-diode tube, the 25Z6, but since full-wave rectification is not needed, the plates are interconnected, the cathodes are interconnected, one side of the line goes to the plates, and the rectified B voltage is obtained through the cathode branch, which is first filtered. This filter consists of an a.c.-d.c. choke and two 8 mfd. electrolytic condensers.

A ballast tube, 200 ohms, 30 watts, reduces the a.c. or d.c. line voltage to the values required for the five tubes. The method of connecting the heaters in series, so that a single current of .3 ampere will pass through all of them, is shown under the circuit diagram. Two pilot lamps are included, because the dial was of the

type that provided brackets and sockets for them, and the lamps gave a brilliant appearance to the dial disc when the set was turned on.

### HEATER CIRCUIT

The diagram reveals that one side of the line—and in actual construction, it is immaterially either side—is connected to the chain of pilot lamps, which is bridged by a 40-ohm resistor, and next comes the ballast, attached to either side of the rectifier heater. The other side of that heater has an arrow pointing away from it, in the diagram, thus indicating that some other heater is to be picked up. The 6J7 has one heater side to the opposite lead of the line, as this is a requirement for quietest reception. What the connection is for the rest of the tubes, or open sides of heaters partly accounted for, is shown, as stated, in the detail under the wiring diagram.

The first photograph showed a side view, taken with the front partly exposed, and the three knobs, left to right, are for line switch, dial shaft and volume control. Also, that view showed the tubes, front to back, with accompanying coils, first r.f., second r.f., third r.f. The detector tube is on the other side of the fourth coil, which is the last coil in view.

### MUST BE SHIELDED WIRE!

An angular view from the rear shows a socket to which audio amplifier plug may be connected, also the antenna and ground posts. The antenna is connected to the right-hand post in this view, and the wire running from the rear of this post to the primary terminal used for antenna connection to the first coil, *must be shielded*. It is preferable to use that type of shielded wire that has a thick serving of cotton insulation between the rubber covering of the wire and the criss-cross of the external shield. It is useless to include this shielded wire unless the outside or shield is grounded, and it is advisable to ground it near the antenna post, by connection to the ground post adjacent, and also to ground it in

one or two places along the feed to the primary of the first r.f. coil.

The object of this shielded wire, and grounding of the outer covering, is to prevent common pickup, which produces feedback of a troublesome magnitude. A little feedback perhaps may be encouraged, as t.r.f. sets can stand some aid at high radio frequencies on the selectivity score, but the intensity of the back coupling due to the antenna wire inside the set serving as pickup of strays in phase, is altogether too much, and the shielding must be introduced just as described. Otherwise it is admitted the control of oscillation becomes nearly impossible.

### USE LOW-GAIN COILS

If the coils are not of the high-gain type, there should be no oscillation whatever. Attempts to use high-gain coils in such systems as the four-gang t.r.f. set have proved unsuccessful. The squealing problem rises to insurmountable heights. With low-gain coils, therefore, the gain is higher than with high-gain coils, as when oscillation sets in the gain goes down, and indeed reception, if any, is ruined.

Sometimes at the higher frequencies, say, 1,400 to 1,600 kc, there may be some regeneration. But, as stated, it becomes a virtue, not a vice because without some regenerative aid there would be nothing like the selectivity at the high-frequency end as was found at the low-frequency end. Roughly speaking the selectivity would be only one-third as good.

### WATCH THE GROUND

If there is anything in this high-frequency region suggestive of over-regeneration, a small turn of the volume control will get rid of this, because the control is of the dual-purpose type. It increases the negative bias, also when it does that it decreases the input, and in affecting the input it increasingly loads the antenna winding. This loading effect can be relied on to get rid of surplus of regeneration, if any appears.

(Continued on following page)

As the text sets forth, this tuner is simple to construct, and the bottom view of the wired job proves this. The identities of the controls are plain, the line switch at lower left, then the dial shaft, then the volume control. The a.c.-d.c. choke is shown at an angle, lower center. The chassis opening, as shown, is required if an airplane type dial is to be used.

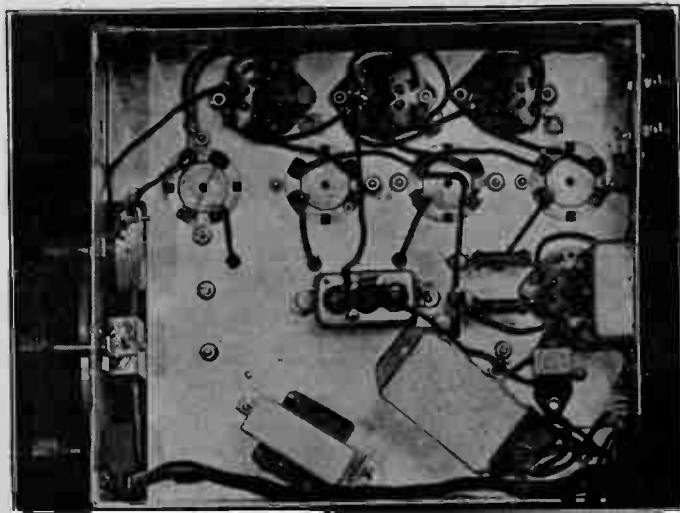

# Now Six Tubes for A.C.-D.C.

## Three-Gang Condenser Improves Performance

By Lawrence A. Burr

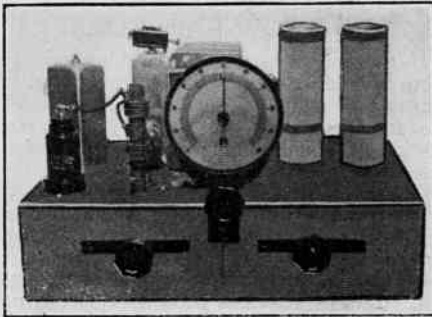

Typical layout for a universal superheterodyne using a two-gang condenser and unshielded r.f. and oscillator coils.

**M**OST attention is concentrated on four and five-tube sets where the a.c.-d.c. principle is invoked, and the main reason is economy of outlay, whereas it may be considered economy of a higher sort if, in adding an extra tube, extra tuning condenser section and extra coil, the improved reception is properly rated. There is no getting away from the fact that in all cities, and in many small communities, and wherever there is a strong local station, insufficient pre-selection attaches to the type of receiver of any sort that includes only a two-gang condenser.

Of course there is utmost simplicity with the two-gang arrangement, and when one considers the performance in the light of the cost there can be little to quarrel with, but if a couple of

dollars don't mean too much the performance of the more discriminating three-gang receiver is imperative.

In the smaller set, an example of which is illustrated in the photograph reproduced herewith, even honeycomb coils are used in unshielded fashion, and they certainly do work well enough when the antenna coil is placed atop the chassis, as it is in the illustration, and the oscillator coil is beneath, thus to avoid any great stray coupling between them. The object is to confine oneself to the intended coupling, as that will be large enough indeed.

The simple honeycomb coil arrangement does not provide for shielding but when three coils are used there must be shielding, and of course this type of coil is widely obtainable commercially.

There is only a little more to the diagram when the extra tube and its serving components are added, as can be seen from examination of that diagram, where the six tubes comprise an r.f. pentode amplifier, a pentagrid converter, one intermediate amplifier, a quadrode detector, a pentode power tube and a half-wave rectifier. The current through the heaters is the same, the heaters therefore may be in series, and a line cord of 135 ohms, 30 watts, or equivalent ballast tube, used for diminishing the line voltage to the sum of the voltages required for the chained heaters.

The d.c. voltage for the plates of the tubes is about equal to the r.m.s. of the line voltage, say, 110 volts, and the screens get the same voltage, unless it is desired to use the detector as a pentode rather than a quadrode, when a resistor

*(Continued from preceding page)*

Without disparagement of any stations, it might be said that most listening is done at lower radio frequencies, where no peril of any over-regeneration is present. The tuner therefore should be utterly quiet, in the sense of producing no extraneous or internal noises, from 1,400 kc to 540 kc, and from 1,500 kc to 1,600 kc there may be some regeneration under control, to advantage.

Mention has been made of the ground post, one of the two outlets shown on the twin assembly. It should not be suspected that the chassis connected to line, and ground connected externally to the post, are the same. They are quite different. One side of the line is grounded. If ground were brought directly to the chassis, should the ungrounded side of the line be picked up by plug insertion in the convenience outlet

there would be a short of the line, due to ground being connected to both sides. First, the power company connected ground to one side. Then you connected ground to the other. It is then the line fuse serves its purpose.

So the chassis symbol does not represent conductive connection to external ground, and a stopping condenser of .002 mfd. is placed between chassis and external ground. An inspection of the diagram will clear up any doubts that one may have as to which is which, and why.

In conclusion I might say that this tuner has given really delightful performance for several months and is well worth building. Of course the audio amplifier should be excellent, because though the tuner protects quality throughout, the audio amplifier if not up to par will do all the injury anything need do to spoil quality.



# Universal Tube Voltmeters

## Rectified Line Current Used for Bias

By DeGulla Gaw

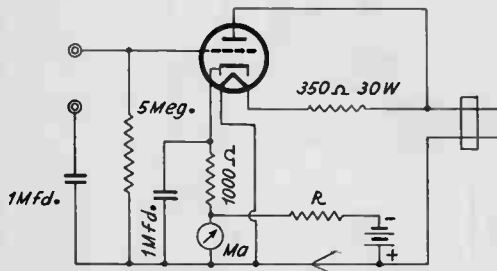

Universal type tube voltmeter, using a triode. The rectified current will greatly exceed one milliamperere, so the meter is used at less sensitivity than one ma, the bucking circuit being used for reduction of the reading to approximately zero. Then the 0.1 ma meter is substituted, a readjustment of R made, and the circuit is ready for calibration.

THE half-wave diode rectifier, familiar in B supply practice, may be used as a vacuum tube voltmeter. Two examples are given, the simpler one applied to a triode, the little more elaborate one to a pentode. If a pentode is used, the detector type tubes are preferable, identities being given on the diagram for 6.3-volt series tubes.

Both tube voltmeters are the same in principle, and are intended for a.c. application, although d.c. may be used, if positive of the line is connected to the upper prong of the plug in the diagrams. Only when the plate is positive, for either a.c. or d.c. operation, does the tube conduct.

### SENSITIVITY TO POLARITY

Taking the example of the triode, it will be seen that the tube, which may be a 37, 76 or 6C5, has a limiting resistor, which may be in the line cord, to reduce the line voltage for the heater to 6.3 volts. This is marked 350 ohms, 30 watts in the diagram. Plate is connected to the upper side of the line, and for a.c. operation this is the side assumed to be positive, which it always is for half a cycle, or one alternation, no matter which way the line cord is connected to the outlet. However, for d.c. use the tube voltmeter works only with plug connected to the outlet a particular way, so reverse if no current flow is indicated.

The meter in each instance is assumed to be a 0.1 milliammeter. In the case of the triode more than a milliamperere will flow, so a less sensitive meter is used, or the present meter

shunted for the same purpose with a low resistance, so that needle reads full scale. Nothing need be connected to the unknown input posts at left. Then a 3-volt dry battery, any small type, is connected as shown, with battery positive to the line, negative through a resistor to the positive side of the meter, the resistor, R, being large enough at first to prevent excessive reverse current.

If R is 1,500 ohms or so that will be adequate. Then the resistor R is adjusted until the meter reads zero, as current is being passed through the meter in reverse direction to the rectified current.

### PRECAUTION AS TO LINE

Now the meter may be safely established at the 0.1 milliamperere sensitivity, and a slight readjustment of R made, if necessary, until the meter just reads zero. For any future use, then, R may be composed of a fixed resistor of a little less resistance than that now found, and a variable in series of about one-quarter that value, the variable used for zero adjustment before each measurement.

The 5 meg. load resistor in the grid circuit is necessary for application of the negative bias to the grid. This bias results from the use of the tube as diode, in familiar leak-condenser fashion, although the resistor and condenser are somewhat displaced from their more familiar position in oscillators and the like.

Since one side of the tube voltmeter must be connected to the line, as since the line is grounded, it would be short-dangerous to the line and the measured circuit to have continuity to d.c., hence a stopping condenser is shown. This is 1 mfd., paper dielectric, and should have very little leakage. Since low voltage is to be connected in series with it, and 5 meg. are practically in parallel with it, for low impedance of measured circuit, checked as a resistor at around 45 volts the condenser should show a resistance of 3 meg. or more.

### DRAWS A LITTLE CURRENT

The rectified current due to the diode being in series with the line voltage causes a potential difference across the 1,000-ohm fixed resistor, and this voltage is used as the steady negative bias.

The voltmeter does draw a little current from the measured circuit, due to the grid loading for application of the bias, but this is very small indeed. If the effective resistance, stopping condenser and 5 meg. considered, is 2 meg., the

current drawn at 5 volts a.c. applied to input terminals would be only a quarter of a micro-ampere. At less than assumed maximum voltage of 5 volts of course the current would be less. At any rate, the drain is so small it may be neglected for practically all uses, including those of measurement of tuned circuits.

The stopping condenser, however, introduces an element of reactance to low audio frequencies that must be considered. The capacity reactance is 2,650 ohms at 60 cycles, so at low audio frequencies the measurement will read less than it should, especially for a load of low reactance presented by a measured circuit. If the measured circuit had a reactive load of 2,650 ohms the error would be 50 per cent. At 600 cycles the error would be less under all circumstances, because the reactance of the condenser is 256 ohms, while at 6,000 cycles the reactance of the condenser is 25.6 ohms, and at 60 kc is 2.56 ohms, which is negligible.

### CALIBRATE AT R.F.

So for radio frequencies the circuit is entirely suitable, only the calibration must be made at some radio frequency. This would imply a

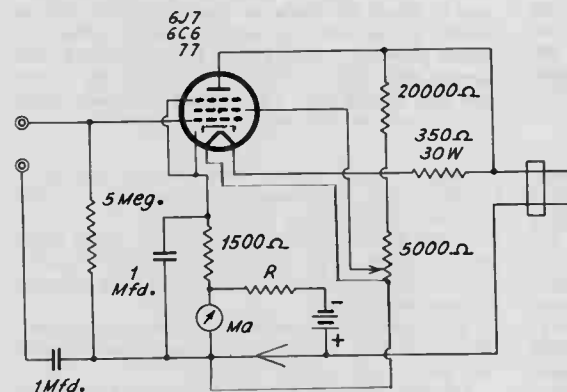

The same principle as used in the previous triode example is here applied to a pentode. The rectified current due to the diode part of the tube being in series with the line may be limited to one milliampere right away, by starting the potentiometer at zero resistance, arm to line, and gradually increasing the screen voltage until one milliampere rectified current flows. Then, for 1,500 ohm load resistor, the bias is 1.5 volts negative.

frequency of 50 kc up, and usually the selection would be 1,000 kc or some frequency in that region, at least in the standard broadcast band. The calibration then would apply practically nonreactively to very high frequencies, say, 25 mc.

Of course, the effect of series capacity on low frequencies may be reduced by increasing the capacity, using, say 4 mfd., which at 60 cycles would have a reactance of 662.5 ohms, but electrolytic condensers must not be used. As nothing below 120 cycles would likely be measured, the reactance would never be greater than 331.25 ohms, and would become progressively smaller as the frequencies increased. Nevertheless the calibration would have to be made at a radio frequency, would apply strictly to radio frequencies, but the error on audio frequencies would be less. Relative values, of course, could be determined at any one audio frequency, using 1 mfd. or any higher capacity.

The pentode presents the same general case,

but here we may introduce the resistance values shown, omitting R and the battery temporarily, and adjust the screen voltage, starting at zero, until one milliampere flows in the meter, in other words, needle is at full scale, when the limiting resistor R may be selected on the basis of the battery voltage, equalling 1,000 times that voltage. For 3 volts the resistor would be 3,000 ohms.

### SCREEN VOLTAGE CONTROLLING

This adjustment to full scale current of one milliampere, not practical at once in the other instance, is possible because the plate current depends on the screen voltage rather than on the plate voltage. That is one of the peculiarities and individualities of the screen grid tube.

Like all other tube voltmeters, except the simple diode, this one has to be calibrated. Details on how to calibrate were printed in last month's issue.

The diode's rectified voltage (d.c.) is equal to the average of the a.c. voltage. Assuming that the a.c. is a sine wave, the diode-rectified voltage equals .636 of the peak, or for r.m.s. values, 1.111 of the d.c. voltage just described.

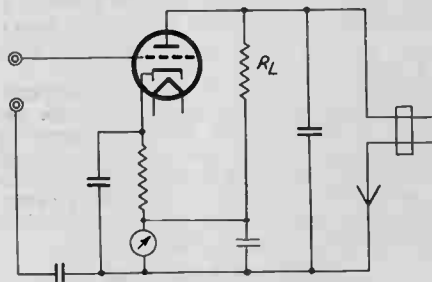

It might be assumed that the bucking battery circuit could be eliminated by this means, but the a.c. input is directly across the  $R_L$ -meter circuit, and the needle fluctuates. It is not practical to have a condenser across the meter large enough to stop this fluctuation, as around 100 mfd. would be necessary merely only to reduce the fluctuation intensity 50 per cent.

# Practical Line Cord Facts

## Resistance and Quick Wattage Computation

By Herman Bernard

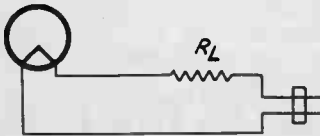

The greatest heat is dissipated in the line cord when only a single tube is served, because the limiting resistance  $R_L$  then has to be highest, for a given current, and the power expended in the coil resistance element is proportional to the resistance. For the above case, 115 line volts, the limiting resistor may be 370 ohms. The heater connections themselves are interchangeable, i.e., polarity does not matter.

**L**INE cords being very widely used, some facts about their selection and use are in order. The object of the line cord is to reduce the a.c. or d.c. line voltage, assumed to be 115 volts, to the heater potential required for the total series-connected tubes. This potential is equal to the sum of the voltage drops across each of the series. Thus, if there are three tubes, each to drop 6.3 volts, then the voltage drop for the heaters is  $6.3 + 6.3 + 6.3$ , equals 18.9 volts. Since the drop across each tube is here the same as that across any one of the other tubes, the total drop may be taken as the total number of tubes times the voltage drop required for one tube, or  $3 \times 6.3$  volts, equals 18.9 volts.

When multiplication is used, the assumption is made that each tube should drop the same voltage at the heater as does each other tube, but since that really does not always apply, some power tubes and rectifier tubes requiring about four times as much voltage as a detector or amplifier tube, heaters alone considered, the addition method is preferable.

### BLEEDER RESISTOR

Another assumption made, and applicable to the addition or multiplication method, is that the current through each heater is the same. That naturally would be required of a simple series circuit, as there is only one current, and it can not have two different values. Whenever a tube carrying more current is to be included in the chain, the current drawn by the most conductive heater is the current to be considered. In other

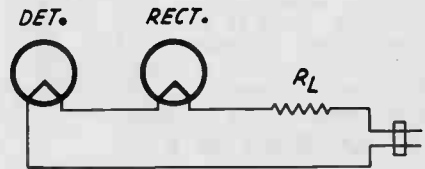

When two tubes are used, the power expended in the line cord is a little less, but another consideration arises. There is a choice of series connection, and it should be made on the basis shown above, assuming one tube is a rectifier and the other is a signal detector. That choice is that detector has always one side of its heater connected to the low side of the line. The limiting resistance value may be 350 ohms for this example.

words, it is the heater that requires the most current that determines what the total current through the limiting resistor must be. Then, to serve tubes requiring less current, these tubes are set apart, as to heaters, and a single bleeder resistor is selected of a proper value to take up the excess current.

The foregoing general statement covers practically all the current and voltage requirements for the a.c.-d.c. heater circuits.

Because the line voltage has to be reduced, a certain loss, in the form of heat, is necessarily suffered. Hence all line cords get warm. This condition is not indicative of any defect in the receiver, oscillator or other operating unit. Neither is the warm cord any reason for becoming alarmed. It may not be the most comforting practice to use a line cord, but such use is widely prevalent, and the present discussion has to do with electrical considerations.

Considering now only the tubes that draw a particular current, the minimum value, which is .3 ampere for the general run of tubes, the most heat will be generated when only one tube is used, uniform resistance wire being supposed.

### WHY HEAT IS MAXIMUM

The reason for the maximum heat generation in the single-tube set is that such a small part of the total voltage is taken up by the heater that the large remainder must be taken up by the line cord. The current is the same in all instances, and for the same current the power dissipated is greater, the higher the resistance. In other words, the mere fact that the line cord



requires more resistance, because called on to drop more voltage, causes the generation of more heat.

The formula for determination of the resistance required of the line cord, or other limiting resistor  $R_L$ , is as follows:

$$R = \frac{E-e}{I}$$

where  $R$  is the resistance in ohms,  $E$  is the line voltage in volts,  $e$  the total voltage in volts to be dropped by the heater or heaters, and  $I$  is the current in amperes. As  $E$  is taken as 115 volts and  $I$  equals .3 ampere we have

$$R = \frac{115-e}{.3}$$

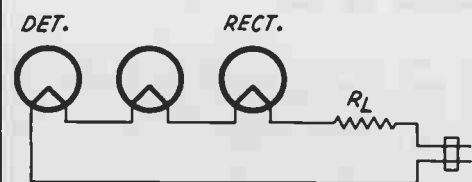

When three tubes, one a signal detector and another a rectifier, are used, there is no choice for the third one, except the immaterial one as to which side of its heater should go toward the rectifier heater and which side toward the detector heater. The rectifier, whenever convenient, is put next to the limiting resistor, the value of which for 6.3 volts, .3 ampere tubes, the only ones considered in the captions, is 320 ohms.

In practice the line cord resistance is of some convenient round number, as there is nothing critical about the value, even a requirement of 362 ohms being met in practice by inclusion of 350 ohms, although it is the better to keep closer to the actually computed value, or, if there is to be any deviation, that the resistance be somewhat higher, rather than lower. Say, 370 ohms would be preferable, where 362 ohms is the computed value, in the case where 350 ohms was cited as an applied value.

### RESISTANCES TABULATED

From the formula, then, we may determine the value of the line cord resistance. If this value is not imprinted it becomes necessary to measure the resistance on an ohmmeter, or compute the resistance from measurement of current, using a meter and limiting resistor. The formula for computing the resistance is

$$R = \frac{E}{I} - R_0$$

where  $R$  is the unknown resistance of the line cord in ohms,  $E$  is the voltage in volts of the cell or battery used with the meter,  $I$  is the current in amperes through the series meter and  $R_0$  is the value of the limiting resistor that safeguards the meter from more than full-scale deflection at heated unknown terminals. The

current through the meter may be in milliamperes, where .001 equals one milliampere.

Since more than six tubes hardly would be used, because line-cord sets are normally small ones, the examples of from one to six tubes inclusive are given:

Number of Tubes	Resistance of Line Cord in Ohms
1	362
2	341
3	320
4	299
5	278
6	257

### RESTRICTED APPLICATION

It should be borne in mind that the foregoing

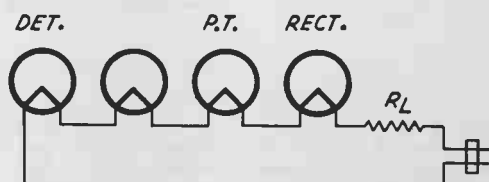

Now the power tube comes into play. The detector and rectifier tubes have assigned positions. The same definiteness attaches to the power tube, which is put next to the rectifier always, unless bleeder considerations are simplified by another type of location. Here, too, there is no choice save an immaterial one, because the third tube or one newly added, may be considered the power tube. Limiting resistance, 300 ohms.

applies only to the tubes requiring 6.3 volts across the heaters and that draw .3 ampere when that voltage is applied. If the tubes fall into the voltage and current classification, if the voltage is correct the current automatically will be correct, because the tube when functioning normally has a constant heater resistance of 21 ohms. This resistance may be computed, since it equals the voltage in volts divided by the current in amperes, or  $6.3/.3$  equals  $63/3$  equals 21 ohms.

It is therefore clear that one tube requires 362 ohms, and two tubes, being one tube more, requires 21 ohms less; three tubes require 42 ohms less than one tube alone, or 21 ohms less than two tubes. The application to the tabulated resistance values for line cords is obvious, since each succeeding smaller value in the table is just 21 ohms less than the preceding value. To show that clearly, the line cord resistance values were given closely. But round numbers would be used in practice. Certainly instead of 299 ohms, 300 ohms would be used, also 278 ohms might become in practice 280 ohms, and 257 ohms become 260 ohms.

### WATTAGE CONSIDERED

We have found that considerable power is dissipated in the line cord, most power when

(Continued on following page)

(Continued from preceding page)

one tube is used. The power for a sine wave equals the product of the voltage and the current. Thus for 108.7 volts dropped in the line cord serving only one tube, with .3 ampere current as assumed in all the specified cases so far, the power dissipated would be  $108.7 \times .3$

remaining open sides of the heaters of the two tubes are interconnected, thus establishing the series network.

The reason for connecting one side of the signal detector to the line is that hum is much less that way, particularly modulation hum. In addition it is well to put a condenser across the

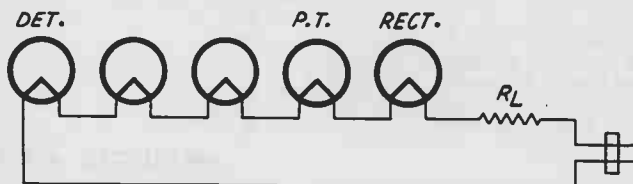

In a five-tube arrangement there is some choice, as two tubes enjoy a degree of freedom as to heater connection. Limiting resistance, 280 ohms.

or 32.61 watts. Normally this is accepted as 30 watts.

Because the wattage requirement does not have to be satisfied precisely, once the line cord resistance is known the wattage may be approximately determined by dividing the limiting resistor  $R_L$  by ten. Thus, we found 32.61 watts required actually. The line cord resistance was 362 ohms. Divide by ten, the answer is 36 watts. The error is on the safe side.

This little trick of moving the decimal point one place to the left is applicable because of another form of the expression for wattage.

$$\text{This is} \\ W = I^2 R$$

in which  $W$  is the unknown wattage in watts,  $I$  is the current in amperes and  $R$  is the resistance in ohms. The current is known, .3 ampere, the square of which is .09, which is close enough to .1 for the quick conversion purposes we have in mind. Actually the current would have to be .316 for the decimal system to work out closely, as that value is the square root of .1.

The foregoing formula also serves to clarify the reason why the heat loss in the line cord is greater the fewer the number of tubes served, since the fewer tubes, the greater is  $R$ , hence the higher the wattage and consequent heat loss.

### DIAGRAMS DISCUSSED

The first diagram shows a single tube served, and is in skeleton form, as are the rest, since the main object is merely to show the supply, the heater and the limiting resistor  $R_L$ , and tube location when consequent. When there is one tube only, then one side of the heater of that tube has to go to the line. If the line also must go to a plate, as to a rectifier tube, it is always that side of the line opposite to the one that goes directly to one side of a heater.

When there are two tubes, if one is a signal detector, the other a rectifier in the sense of changing the line a.c. to d.c., the detector should have one side of the heater connected to the line. The other side of the line then goes to the limiting resistor, the other side of that resistor to one side of the rectifier, and the two

full line voltage. The capacity may be .1 mfd. A paper dielectric condenser, not condenser, not an electrolytic, should be used. If there is to be a line switch, connect it in the lower leg, considering the diagrams, and have the condenser between the high side of the line and the set side of the switch. Then the condenser is not in circuit unless the set is switched on.

### STATED ORDER

When there are three tubes, since the rule about the signal detector is adamant, and the rectifier is put next to the limiting resistor, a rule to which an exception will be noted, the power tube is then placed next to the rectifier, and the other tube is connected in the one possible manner. Then which side of heater is used for connection to an adjoining tube in the chain does not matter.

The rule then follows naturally, with signal detector, rectifier and power tubes fulfilling their stated order, that the rest of the tubes have heaters joined in series in any manner that makes for convenience in wiring or clearance of radio-frequency leads by these line-current-carrying wires. The choice rests with the constructor and there are no particular rules.

So for four tubes there is no choice, if one of the four is a power tube, because the signal detector and rectifier have their assigned positions, so also the power tube has a particular place in the picture, and there is only one other tube.

### ONE CHOICE HERE

When five tubes are to be considered, a choice exists, because two tubes may be connected in any selected or preferred order, but the rest have fixed positions, if power tube and rectifier are included. In the six-tube example, there is a choice applicable to three tubes, there being nine different possibilities for even these three tubes.

So far we have considered in detail tubes that take .3 ampere, and in the tabulation of line cord resistance values, only such .3 ampere tubes as take 6.3 volts across the heater. Since with a single current, the voltage consideration is

easily taken care of by addition of the required voltages of all the tubes, if one or more require 25 volts, the line cord resistance will be less, and the value may be computed.

But when the current is different for the heaters there is in general only one difference: some of the tubes require .3 ampere, one other tube requires more than .3 ampere, for instance, .4 ampere. It then becomes necessary, as already intimated, to assemble the heaters of the lower current group in a separate series chain, and put a bleeder resistor  $R_B$  across that part. It would be practical, of course, to put a separate bleeder resistor across each heater, but the general case, one bleeder resistor, is simpler and more economical.

### BLEEDER DETERMINATION

How this is done is shown in a diagram. The power tube is usually the one that requires the greater current. Since only a single current will flow through the limiting resistor  $R_L$ , it must be the higher current, say, .4 ampere. Therefore the line cord resistor is selected on the basis of .4 ampere flowing. The total voltage drop is computed by addition of the heater voltages, and one may assume .4 ampere through the .3 ampere tubes, as the extra .1 ampere will flow through the bleeder. So, if there are four tubes, 6.3 volts apiece, the total voltage to be dropped by the heaters is 25.2 volts, and as the bleeder resistor is to carry .1 ampere, its resistance may be computed as

$$R_B = \frac{e}{.1}$$

where  $R_B$  is the unknown bleeder resistance in ohms,  $e$  is the voltage in volts to be dropped across the total chain of .3 ampere tubes, and .1 is the current in amperes through the bleeder. Numerically,  $25.2/.1$  equals 252 ohms for the example cited. The wattage equals  $25.2 \times .01$  or 2.52. It will be noted that the bleeder resistor's wattage requirement may be comparatively low in respect to the line cord wattage, because the current through the bleeder is less.

### POSITIVE AND NEGATIVE

The rectifier is not placed next to the limiting resistor  $R_L$  in the diagram. It is permissible to transpose rectifier and power tube, especially as convenience and economy are served, when the rectifier is a 6.3 .3 ampere type tube. Otherwise it is permissible to put the rectifier next to the limiting resistor, separately paralleling its

heater with another resistor to take up the .1 ampere or other difference current, then include the larger current power tube next, and finally put in the .3 ampere tubes, with one bleeder for all of them. However, the diagrammed method . . . one resistor and is entirely satisfactory.

Manufacturers of line cords do not follow a common standard, or there is no standard, hence the color markings of the three wires do not mean anything in particular. One manufacturer's product has a red wire emerging that should be connected to the side of the line that is joined to one side of the detector heater. This may be referred to as the "cold" side, as with half-wave rectification, only the other, or "hot" side of the line, the one leading to the limiting resistor, produces rectification, when that hot side is positive. When that upper side is negative the rectifier idles. Another manufacturer has a black lead for the cold or "negative" side of the line.

Ordinarily the word "negative" would have no meaning, as an a.c. wave reverses itself, and a lead that is now negative is next positive, but, as stated, the circuit is idling when the lower branch in the diagrams is positive, and upper branch negative, so this idling condition may be ignored, and only the conductive condition considered, when the upper branch is always positive, and the lower branch always negative.

### TEST RECOMMENDED

Care should be exercised to test the line cord so that no misconnection results. If the full line voltage is applied to the heater by mistake (or even by intention) the heater will burn out.

The following check will be of assistance. Considering the a.c. cable with built-in line cord free of any connection, put on ohmmeter or other continuity tester across the prongs of the plug. There should be no reading. This is just a safety check.

Now proceed as follows:

- (1) Connect one side of tester to one prong of plug and consecutively to the terminals of the three emerging wires, or until a "short" is read. This is one side of the line.
- (2) Move the one tester lead to the other prong and put the remaining tester lead to one after the other of the three cord leads until a short is read. This is the other side of the line.
- (3) Short the prongs, leave one tester lead there, and check all three wires. Two will read shorts as before. The third will read between short and open, that is, some resistance, and rep-

(Continued on following page)

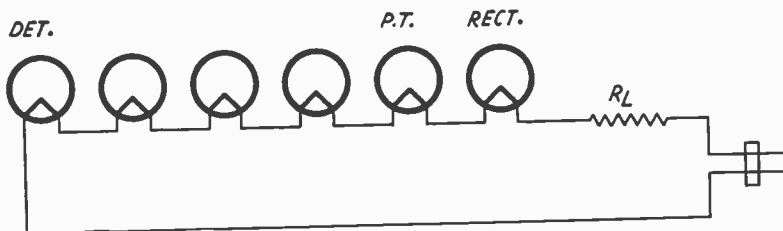

The case of the six-tube receiver.

(Continued from preceding page)

resents  $R_L$ . The precaution is taken under this heading just to be doubly careful, since when (1) and (2) were determined, (3) became known.

The limiting resistor used to be identifiable

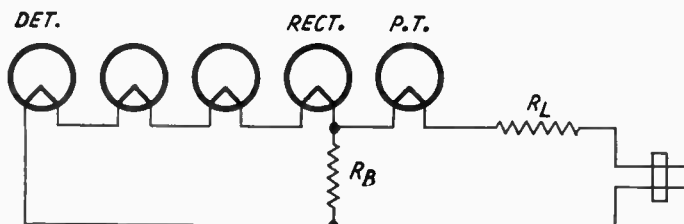

The power tube is put next to the rectifier to spare the necessity of an extra bleeder resistor. Assuming .3 ampere, 6.3 volts for the four tubes at left, .4 ampere in power tube,  $R_B$ , the bleeder resistor, is 252 ohms. For 6.3 volts for all tubes, the limiting resistor  $R_L$  is 209 ohms.

by an asbestos covering, but many line cord manufacturers do not have this distinguishing characteristic for the limiting resistor lead any more, and an ohmmeter or other continuity check becomes imperative. If on turning on a

As previously set forth, the line cord resistance should be measured as to ohmage, and this is a precaution in addition to ascertaining which lead is which. Too low ohmage may prove disastrous.

## National Company Issues New Spectacular Catalogue

National Company, 61 Sherman Street, Malden, Mass., has just issued a new catalogue, known as "Bulletin No. 260," describing all the standard parts and equipment it manufactures. There are 20 pages, each in two colors, and the listing is right up to the minute. Paper stock, format and printing are of exceptional excellence. A copy is obtainable on application to your jobber, or to National Company at the above address.

Transmitting variable condensers of very moderate price listings are featured, also a large variety of receiver variable condensers and padders. Standard cabinets, low-loss choke coils, shields, R-39 coil forms, low-loss sockets, insulators, coil chart frames, i.-f. coils and air-dielectric condensers, shafts, couplings, and numerous other parts are listed.

Two pages are devoted to the HRO Receiver, standard and junior models; one page to the NC-100 Receiver. The One-Ten Receiver (one to 10 meters) and the SW-3 Receiver (15 to 550 meters) are described; also the FB-7 Amateur Receiver and the HFC-56 Mc Converter. Power units, relay rack units, oscilloscope apparatus and other equipment conclude the listings.

## Cornell-Dubilier TJ Rated to 100,000 Volts

The Cornell-Dubilier Type TJ high voltage transmitting capacitor was recently introduced to the broadcast and amateur fields. Extremely compact, (only 2½" high for 1 mfd.), filled and impregnated with Dykanol "A," they are hermetically sealed in welded metal containers. Dykanol "A" is a special non-inflammable liquid diphenyl impregnating medium of exceptionally high dielectric constant and dielectric strength remains chemically stable under all temperature conditions. It has also been possible to materially improve the leakage resistance and power-factor change by the use of this impregnating material.

The Type TJ capacitors have been successfully operated at voltages exceeding 10% above their rating. This condenser series is available in a complete capacity range at voltages up to, and including 6,000 volts, d.c. Capacitors up to 100,000 volts d.c. can be obtained in the Type TB construction. Catalog No. 127, obtainable from Cornell-Dubilier, 1024 Hamilton Boulevard, So. Plainfield, N. J., covers these devices.

The corporation, due to increased business, has located its factory in South Plainfield, as the quarters in the Bronx were greatly outgrown.

## Allied Has Notable Display

The record crowd at the recent nation-wide Amateur Radio Show held in Chicago testified to the intense, ever-growing interest in amateur radio. Leading radio houses vied with one another in producing attractive exhibits. included in the Allied display.

One of the most interesting displays was that of Allied Radio, a leading mail order house. Latest products of National, RCA, Hammarlund, RTL, Sargent, Hallicrafters, Raytheon and other well-known radio manufacturers were represented in the display.

# 9 to 15 Meters, Four Tubes

## Simple Set in Wooden Cabinet Looks Professional

By Harry G. Cisin

Allied Engineering Institute

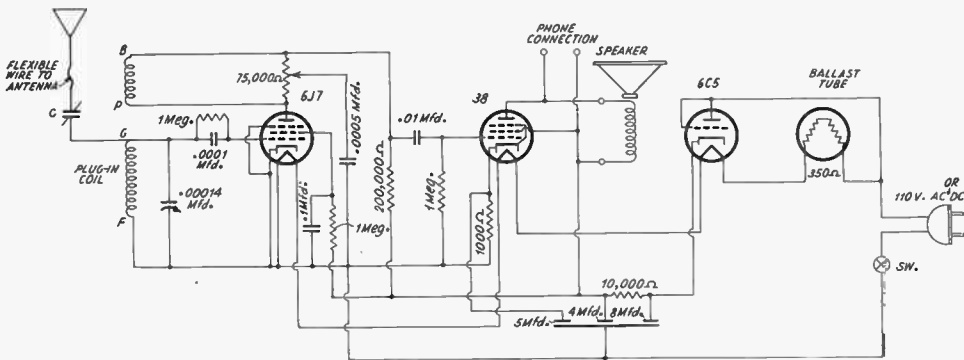

Simplicity marks the circuit design of the four-tube Junior Space Explorer.

SHORT-WAVE fans may construct an efficient all-electric, all-wave loudspeaker operated set at a price formerly considered low for an earphone set. This desirable end has been attained through careful design, aimed towards maximum efficiency with minimum cost of parts. Fads and frills have been discarded. A straightforward circuit has been designed to bring in both foreign and domestic short-wave stations with loudspeaker volume.

The Junior Space Explorer is a four-tube set. It uses a regenerative 6J7 detector, resistively coupled to a 38 power output tube. The rectifier tube is a 6C5. The fourth tube is a ballast tube to drop the line voltage to the value required by the heater series, and is an improvement over the use of a line cord.

### CAN GO TO 1,500 METERS

This set uses a system of overlapping plug-in coils. The shorter leads and better contacts made possible with plug-in coils result in lower losses which, in the last analysis, are a deciding factor in determining the distance range of a receiver. Six plug-in coils are used to cover the band from 9 to 550 meters. By means of a special long-wave unit and long-wave coil, it is possible to increase the range of this set to 1,500 meters, thus permitting the reception of airport signals, beacons, commercial code, etc. A 'phone pack is conveniently located at the front of the panel. This provides a desirable aid for tuning in the more difficult distant stations.

The ballast tube and the heaters of the tubes

are connected in series across the 110-115 volt line. This ballast tube concentrates and localizes the heat necessarily developed to obtain the required voltage drop, keeping it away from delicate parts such as electrolytic condensers, but radiating it readily because of the metal construction and black finish. The ballast tube also provides protection from line surges and this improves operation of the other tubes and increases their life span. The ballast tube serves as an automatic fuse in case of a short circuit and it can be replaced readily at low cost.

### ADVANTAGES OF WOODEN CABINET

One of the most important features of the Junior Space Explorer is the adoption of a wooden cabinet instead of a metal one. Wood has many advantages. First of all, machining is simplified through the use of wood. Possibility of short circuits due to panel contacts is eliminated, and the wooden cabinet acts as a sounding board, permitting superior tone quality to that obtainable with the metal cabinet.

Since the new self-shielded metal tubes are employed, there was found no need for a metal cabinet. In addition to its other advantages, wood is lighter and very much cheaper than the metal. In fact, the cabinet can be constructed at home by anyone, thus reducing the cost of a first class receiver to that of the essential components.

Through the use of a new type of crystalline black lacquer which is put on with a brush like any other paint, the cabinet can be given a very

(Continued on following page)

(Continued from preceding page)  
attractive and handsome black crackle finish, at least equalling in appearance finishes sprayed on metal.

It will be noted that this receiver uses a minimum number of controls. The station selector knob is located at the right in a natural position for easy tuning.

### ATTRACTIVE TO NOVICES

The combined switch and regeneration con-

trol is located in the center of the panel. No other controls are necessary.

Due to the extreme simplicity of the circuit, a novice can complete the receiver successfully merely by following a template pictorial diagram. All parts mount directly either on the baseboard or on the panel. Coils not in use are inserted in holes drilled for them at the rear of the baseboard. An idea of the arrangement of the parts and of the extra coils is given in the photograph below.

## TEMPLATES HOLD UNUSED COILS

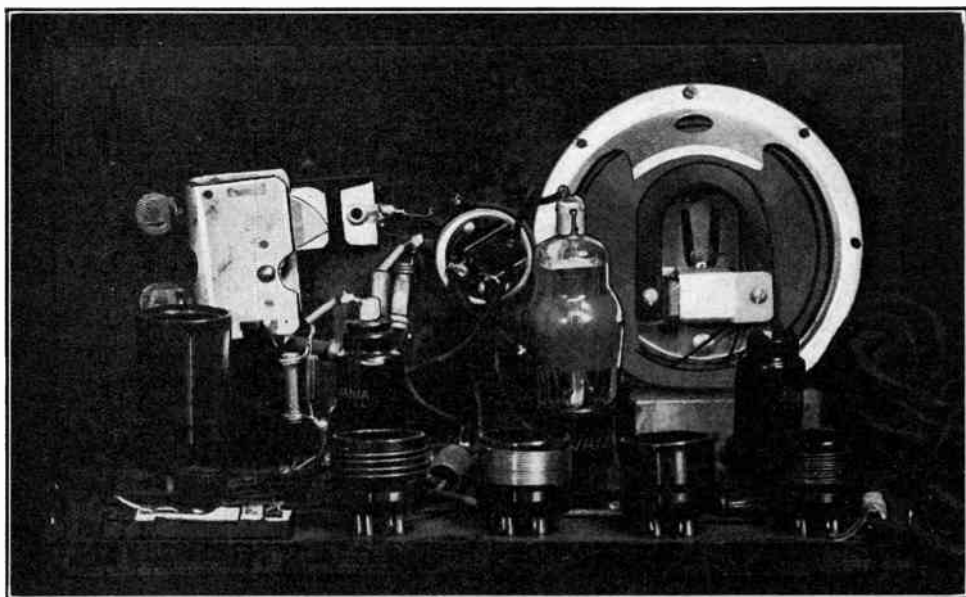

Coils not in use are kept at the rear of the baseboard, in which snug holes are provided. The location of practically all parts is shown in this rear view.

A wooden cabinet is used, but a new type paint gives the same appearance as that of a wrinkle-finished metal cabinet. Also, wood is acoustically advantageous.

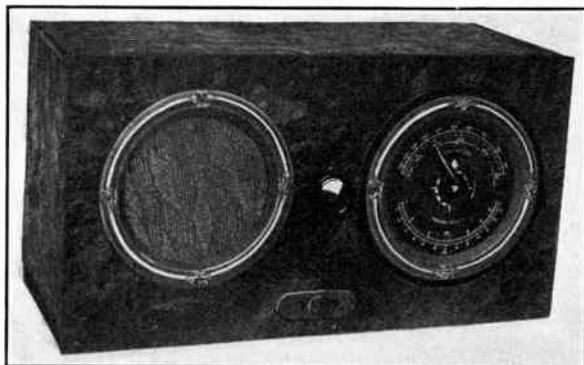

# Right or Wrong?

## PROPOSITIONS

- 1—A superheterodyne using a three-gang condenser is sufficient to prevent all squeals due to inadequate pre-selection, at least in the standard broadcast band.
- 2—When an a.c. receiver is reported not to function at all, it is proper to insert the plug into the a.c. outlet and measure all voltages and currents in an effort to determine what is wrong.
- 3—Modulation hum is due to radio-frequency-current-carrying parts being too near the power transformer.
- 4—Reversal of the connections to the primary of a radio-frequency or intermediate-frequency transformer stops oscillation at these levels, if due to inductive feedback.
- 5—Overloading of a diode-biased triode results from causing too great a flow of plate current in that tube, so that the tube is operated near or at saturation, hence large changes of input produce little or no change in output, and choking results.

## ANSWERS

- 1—Wrong. A three-gang condenser is not sufficient in areas where there are powerful locals, particularly where one or two of those locals lay down an extraordinarily high intensity carrier. A three-gang condenser implies a stage of t.r.f., tuned modulator input, and tuned local oscillator. If there is no t.r.f., but band-pass coupling, the pre-selection will be no better, usually worse. A four-gang condenser, implying two stages of t.r.f., could produce sufficient pre-selection for avoidance of all squeals even in congested areas, provided the receiver is well shielded.
- 2—Wrong. Before a defective receiver is connected to the line voltage it should be checked by the point-to-point method, using the ohmmeter principle, and especial care should be taken in checking the power transformer and filter condensers. Test the condensers for short at low voltage, leakage at rated voltage. Offhand connection to the line may damage the transformer or other parts.
- 3—Wrong. Modulation hum is primarily due to the line cord picking up carrier energy from a station, delivering this with the fundamental line a.c. to the rectifier tube, the filter of which wipes out the carrier but leaves the line frequency in the B feed, thereby putting hum into all tubes served. If the B filter were sufficiently effective at the fundamental line frequency, say 60 cycles, the tunable hum should not result. The filter is designed to work well at 120 cycles, the value to which the line frequency is changed by the full-wave B rectifier. If the proximity of r.f. parts were the cause, moving the parts away from the transformer would provide the remedy, but it doesn't. After putting two condensers, .01 mfd. or larger, across the power transformer primary, grounding the joint of the series capacities, stops modulation hum, or tunable hum as it is sometimes called, because the pickup of r.f. by the line cord is bypassed from the rectifier tube.
- 4—Right. But oscillation is seldom due to inductive feedback, rather to capacity and resistance feedback, so reversal of the connections, to change the phase, seldom affects oscillation trouble at all.
- 5—Wrong. The negative bias on the triode is equal to the rectified component of the diode, assuming full rectified voltage is put into the triode. Hence the stronger the carrier, the more negative the bias and the less plate current in the triode, so that instead of overloading being due to the grid swinging into positive regions, and plate performance approaching saturation, it is due to cutoff, so choking results, and modulation changes have small effect, especially as the distortion may run so high that it is impossible to tell what is being broadcast. A remedy is to use a.v.c. on r.f. and i.f. tubes. One a.v.c. stage usually will be sufficient at least to prevent cutoff on the strongest local.

# Quality 6L6 P.A. Amplifier

## Very Low Distortion, Simplified Driving

By E. F. Coleman

THE urge for innovation and development in the field of public address amplifiers has been given new impetus by the appearance of the 6L6 power-output tetrode. The most obvious advantage to be gained with this tube is very high power (up to 60 watts) with negligible distortion and without the need for more than two output tubes or very heavy-duty power supply design.

Another feature of the 6L6—its large *power sensitivity*, or output wattage per squared grid-voltage input—is easy to overlook, though it means much in the practical design of public address or phono systems.

To illustrate, consider by contrast an output stage of two push-pull 45's in Class AB. Heretofore this has been about the highest powered quality stage available with two receiving-type tubes, and was capable of some 18 watts output. When thus operated, it gave 5% distortion (small, but distinctly noticeable in spots), at the great expense of well over 200 volts peak driving voltage and almost 2 watts driving power. Resistance coupling, desirable because cheap and relatively distortionless, was out of the question because of the 1 or 2 milliamperes grid current per tube.

### THE INPUT TO THE DRIVER

A driver stage and driving transformer which would do all this and still hold down to 5% distortion had to be really good, which meant expensive components and critical adjustments, both seldom realized in practice. Because of the necessity of transformer input-coupling, moreover, a high- $\mu$  tetrode or pentode as driver could not be effectively used; and the high- $\mu$  triodes are out because plate-current cutoff occurs for them very near or at zero bias, requiring Class B operation to get any usable output-voltage swing from them.

The only thing left is a medium- $\mu$  triode like the 56. Remembering that the total turns ratio of the driver transformer cannot be far from 1:1 when so much driving power is being delivered, we find that the total input to the 56 drivers must be of the order of 15 or 20 volts. A great deal of preamplification would therefore be necessary with microphones and phono pick-up input.

### DRIVING LESS ONEROUS

So much for the horrible example. Now consider what can be done with a pair of 6L6's. Up to 34 watts can be obtained, at the truly negligible distortion of 2%, with no grid current and hence negligible grid power input—and with a total grid-voltage swing of only 50

volts. Thus the power sensitivity, watts output per grid input volts squared, is some 27 times that of the 45 stage considered. Now, with no grid current, we can use resistance coupling, with as high as half-megohm grid-leaks tying the 6L6 grids to ground or to fixed-bias voltage. Under such regime, a pair of 57's or metal 6J7's can be very efficiently used as drivers.

At this point a natural suggestion occurs to us. The only reason we cannot get a resistance-coupled 57 to give a voltage amplification comparable with its  $\mu$  of over 1,500 is that a very high-resistance plate load is necessary, thus reducing the available plate voltage by the amount of the IR drop of the steady plate current through the plate load. If we step up the plate supply voltage considerably, we obtain the double advantage of operating the tube at a more efficient plate voltage and also allowing larger plate-voltage swing—that is, larger audio output voltages.

### THE POWER SUPPLY

Since we need a high-voltage supply for the 6L6 plates anyway, nothing is simpler than to tie the junction of the two half-megohm 57 plate loads directly (or through a decoupling resistor) to the 400-volt 6L6 plate supply terminal—or even to get an additional 50 to 100 volts by going back to the high end of the second or first choke in the power-pack. When this is done, it is found that the simple two-stage push-pull rig is worked 'way beyond full output by all phono pickups and all but the least sensitive microphones.

Although it is possible to use the total plate current of 120 milliamperes or so as speaker field excitation, a more flexible scheme is shown in the diagram. A 600-0-600 volt 150 ma power transformer of the sort used in low-power ham outfits feeds an 83 rectifier, whose output is filtered by two 300-ohm chokes. Choke-input (i.e., no condenser tied to high side of first choke) is used to lower the voltage to where it is wanted and improve regulation, or voltage-load characteristic, of the rectifier. A 10-watt bleeder across the 400-volt output yields screen supply for the 6L6's, and is bridged by a large-capacity electrolytic condenser.

### NEED FOR SEPARATE SWITCHES

Note that if the high voltage is turned on before the 6L6 cathodes have heated up, the rectifier will work into no load and its voltage will shoot up till the electrolytic condensers blow out. Hence separate switches for 6L6 heaters and high voltage must be provided, the high voltage to go on some 20 seconds after the



heaters. A simpler solution is to use the heater-type 83-v as a direct substitute for the 83 rectifier; it will put in an ample time-delay of its own.

The speaker field, as shown, is excited by a separate unit consisting of a 20-watt multi-tap transformer of the line-voltage changing type which delivers about 250 volts to an 80 worked as a half-wave rectifier with its two-plates tied

husky speaker indeed to handle all this amplifier can supply without rattling; but even with a smaller speaker and modest output, such as for home radio-phonograph use, you will find the low distortion, reserve power, and operating dependability of the amplifier out of all proportion to its cost.

The input circuit shown was designed for a balanced crystal pickup or crystal microphone,

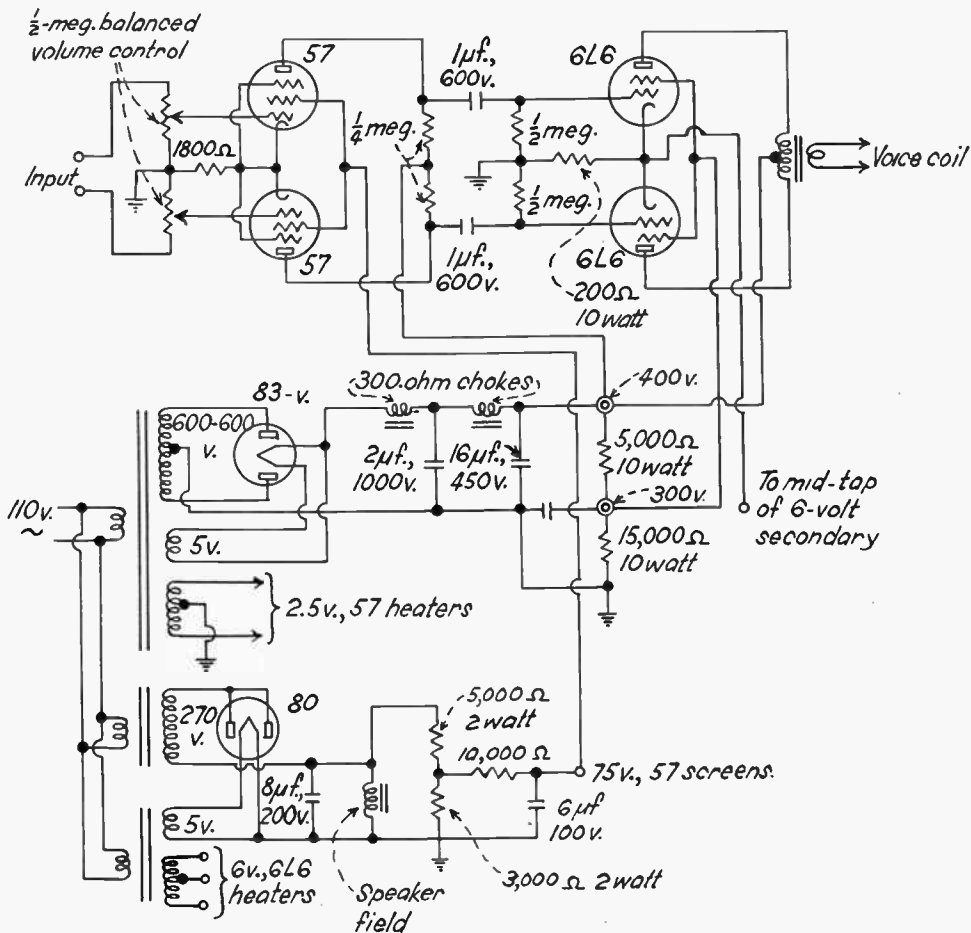

Public address amplifier, carefully designed by the author for lowest distortion and full operating safety.

together. The output of this simple rectifier is fed directly to the speaker field, which is shunted by 8 mfd. or more of low-voltage electrolytic condenser. The negative end of this voltage is tied to ground, and the simple network across it supplies smooth screen voltage for the 57's.

### LOW DISTORTION STRESSED

The recommended plate-to-plate load impedance for the 6L6's is 6,600 ohms. This condition is satisfied closely enough by using an output transformer designed for Class AB 2A3's, or the corresponding taps on a universal type output transformer. It will take a very

and is suitable for any balanced high-impedance source. For unbalanced sources (i.e., one side grounded), and for inputs having impedance lower than a few thousand ohms, a matching transformer is necessary.

The high-impedance balanced input shown uses a half-megohm balanced volume control, which consists merely in two tapered potentiometers ganged on the same shaft so that at any setting each side of the line is attenuated by the same fractional amount.

The entire input circuit all the way to the grid-caps of the 57's must be carefully shielded; a twisted two-conductor wire in a single shield is available for such use.

# Bandswitch and Regeneration

## In Powerful Five-Tube Receiver

By Guy Stokely, E.E.

*Eilen Radio Laboratories*

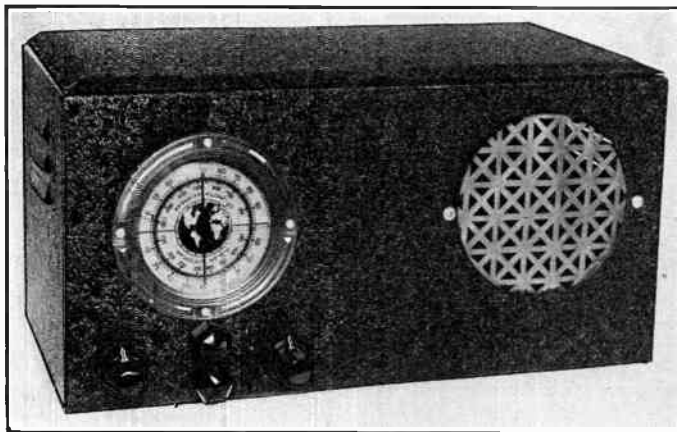

Front view of Stokely's five-tube regenerative band-switch receiver. Electron coupling is used for the regenerative purpose.

**M**ODEL BS-5 receiver has been designed to meet the requirements of the short-wave fan who wishes a sensitive and highly efficient band-switch receiver. Covering the entire wavelength range of 12 to 550 meters in five bands with no skip, this type of instrument does away with the necessity of continually changing plug-in coils each time the listener wishes to receive on a different wave band.

Operating from the owner's 105 to 130 volt a.c. or d.c. house lighting system, and containing a dynamic loudspeaker and automatic headphone jack, this unit is completely self-contained and very compact. The usual bothersome antenna trimmer adjustment has been successfully eliminated in its design. The regeneration and bandspread controls are extremely smooth in operation and even a beginner may obtain excellent results with it.

### CIRCUIT DISCUSSED

Examination of the accompanying circuit diagram reveals the use of the late type tubes, i.e., 6D6, 6D6, 76, 43, 25Z5 and a ballast. The first tube functions as aperiodic r.f. amplifier. There is an electron-coupled screen grid regenerative detector and powerful two-stage audio-frequency amplifier with pentode output stage. Rectifier and completely built-in power supply, plus ballast, complete the tubes.

Signals are fed into the control grid of the first 6D6 tube and given a considerable increase in strength due to the high amplification proper-

ties of this tube. Bias for this stage is furnished by a resistor-capacity combination. The suppressor grid and cathode are tied together.

The output of the r.f. stage is electro-magnetically coupled into the grid winding of the detector stage, the proper windings for the wave band in question being selected by means of the bandswitch. This switch is one having an extremely low distributed capacity and a very high r.f. impedance in order to reduce losses to an absolute minimum. Electron coupling is used in the oscillator system due to its high order of sensitivity, selectivity and smooth operation. The cathode taps on the five coils have been carefully worked out in order to insure maximum sensitivity and ease of control.

### REGENERATION CONTROL

Regeneration is controlled by means of the potentiometer, (100,000 ohms) having a specially tapered resistance characteristic. This method of oscillation control has no effect whatever on the tuning adjustments. The audio frequency component of the output of the detector stage is fed into the two stage audio frequency amplifier. Resistance-capacity coupling is used throughout the amplifier in order to insure the highest quality of reproduction. The output of the amplifier is ample to work the dynamic loudspeaker to full capacity on all signals.

The filaments of all tubes are connected in  
(Continued on following page)



# The Two A.V.C. Delays

## One Depends on Voltage, Other on C and R

By Wright Hoagland

**T**WO types of delay occur in automatic volume control. Since any delay must be related to time, both are related to time. However, since in one instance the diode plate is negatively biased so that there will be no conduction, hence no a.v.c., until the signal reaches an amplitude greater than the d.c. bias, this will be referred to as voltage delay. Actually it is often called time delay, but the second instance is one where time plays the full part, and that will be called time delay for the present. It consists of selection of resistor-capacity filter constants in the return circuits to make the a.v.c. act, whenever it does act, a little bit after the signal detector acts.

If there is too much time delay the a.v.c. action is called sluggish. That means it is effective an appreciable period after the station is tuned in. So for the tuning purpose there is for a brief moment effectively no a.v.c., and a certain loudness is attained, whereas as soon as the a.v.c. gets working, its effect on reducing the loudness may lead a customer to wonder if there is something wrong with the set. Perhaps there is.

### THE SIMPLE CASE

If there were only one resistor and one condenser in the filter circuit the duration of the delay could be easily computed as the reciprocal of the product of the capacity in microfarads and the resistance in megohms. Actually there is more resistance, also usually more capacity purposely included.

First, the audio detector has a load resistor and likely a capacity across this resistor. If there is no voltage delay, then the same detector may serve for a.v.c., in which case there is a resistor in series with the high end of the diode load, and besides there is the filter resistor of the coil return circuit of the controlled tube. All these increase the quantity of capacity and resistance, so the time constant will be higher, the frequency lower.

What is meant by *frequency*? It is the number of cycles per second, or fractional cycle per second, that the a.v.c. system requires to take hold. The formula was given for the simple case. It can be seen that the higher the time constant, the lower the frequency, because the formula is a reciprocal. Thus, if the capacity is .05 mfd. and the resistor is 1 meg. the product is .05 and the frequency is  $1/.05$  equals  $100/5$  or 20 cycles.

In general, it is well to select resistors and condensers so that the time constant will fall within .04 to .09 inclusive. The equivalent terminal frequencies for these are 25 and 11 cycles, hence effects produced in from  $1/25$  to  $1/11$  of a second.

### ANTENNA TEST

To get a closer result in the combination, consider the time constants separately take the geometric mean (square root of product of the two), then apply the formula as given.

However, without resort to any computation, it is practical to use a very short antenna, a few feet of wire, on a sensitive receiver, with a strong local tuned in. Have the extreme end of this wire bare. Then suddenly pinch it with forefinger and thumb. The capacity effect of the body is such that considerable augmentation of pickup is produced, and the length of time taken to establish a marked difference in quantity of sound when the pinching is done is somewhat a measure of the rapidity with which the a.v.c. takes hold. If it seems to take time nearly as great as one second, the circuit constants may be altered, i.e., resistance reduced or capacity reduced or both reduced, to speed up the action.

If the a.v.c. works too fast it will follow the radio frequency sufficiently to act on the modulation frequencies in a degenerative manner. If a.v.c. is too slow then locals blast in during tuning.

### QUALITY PRESERVED

The considerable amount of tuning in i.f. channels, particularly where two i.f. stages are used (three coils) is consistent with passage of a sufficiently wide band to admit the full modulation transmitted, if circuit constants otherwise are correct. When a.v.c. is included, and particularly when there is voltage delay when there must be another diode, or another twin of the diode brothers, sideband cutting is avoided due to the load presented to the circuit by the diode, and also to the Q reduction caused by the resistor-capacity filter circuits.

Except for these facts, the selectivity easily could become excessive, and the higher audio frequencies would be wiped out, which is what is meant by the expression sideband cutting. There could be elimination of lower frequencies from sidebands, too, but the expression as commonly used does not include that interpretation,

(Continued on following page)



# Tube Input Capacity

## Its Effect on Audio Amplifier Shown

THE effects of the input impedance of tubes on the performance of circuits may be very appreciable in many cases and are often overlooked in circuit design work. It is the purpose of this Engineering News Letter to present some quantitative data on this subject that will be readily usable by circuit engineers.

### INPUT IMPEDANCE

The input impedance of a vacuum tube is usually represented by a resistance in parallel with a capacitance. While the resistance component at audio frequencies is often of such magnitude that it may be neglected, the magnitude of this component is a function of the interelectrode capacitances (rated capacitances), the gain of the stage involving the tube, and the phase angle of the plate load. For purposes of simplicity the use of purely resistive loads is considered here so that, neglecting the output capacitance of the tube, the last factor becomes unity.

The following approximate formula is readily derived from an examination of the circuit with currents and voltages involved:

$$C_{\text{eff. input}} = C_g + (1 + A) C_{gp}$$

where  $C_g$  is the rated input capacitance,  $C_{gp}$  is the rated grid-plate capacitance, and  $A$  is the amplification of the stage. The derivation of this formula is given in a separate box herewith.

### TWO TEST METHODS

This formula enables the prediction of the effective dynamic input capacitance from standard tube ratings and a knowledge of the circuit used with the tube. All the data presented in this Engineering News Letter were obtained experimentally by direct measurement of the input capacitance using the input of the tube under test as the "unknown" arm of a capacitance bridge. In making these measurements precautions were taken to minimize the effects of stray capacitance to ground of the tube and circuit and to make the input signal to the tube small in amplitude compared with the grid bias voltage. The measurements were made using a frequency of 1,000 cycles.

A slower but equally satisfactory method of measuring the effective input capacitance is by

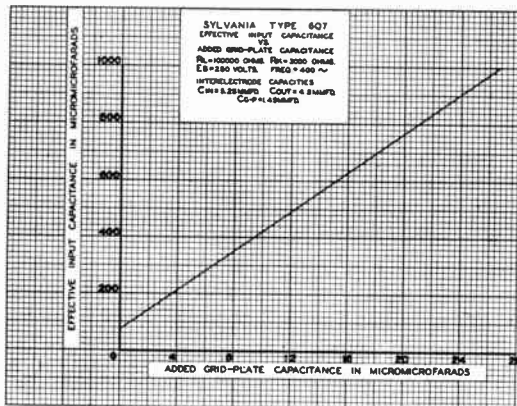

FIG. 1  
With a plate load of 100,000 ohms, a biasing resistor of 3,000 ohms, and a test frequency of 400 cycles, the rise in effective input capacity due to increase grid-plate capacity.

means of the usual audio fidelity setup. In this method the voltage-frequency characteristic of a resistance in the output of a tube is noted with the input of a succeeding tube connected across this resistance. This succeeding tube is the one whose input capacitance is to be determined, and must be used with the correct load and operating voltages. After this frequency characteristic is obtained, the input of the second tube is disconnected from the resistance acting as the load for the first tube and a variable capacitor substituted across that resistance. The variable capacitor is then adjusted until the first frequency characteristic is duplicated. The resulting capacitance of the variable unit is equivalent in value to the effective input capacitance of the tube. Care must be taken that capacitances of wiring, particularly between the grid and plate circuits, do not cause abnormally high readings.

Table 1 gives a summary of the effective input capacitances of a number of representative tube types, at the usual operating voltages, with plate loads such as generally employed.

Fig. 1 shows the effect on input capacitance of adding capacitance, such as that resulting from wiring, between the grid and plate of a tube.

### IMPORTANT TO HIGH FIDELITY

Obviously such wiring capacitance becomes of great importance in high fidelity amplifiers, both as regards its actual magnitude and its constancy from unit to unit. It takes only a slight variation in grid-plate capacitance to cause a large change in input capacitance, particularly

TABLE I

Type	Effective Input Capacitance <sup>o</sup> in Micromicrofarads	Plate Load in Ohms
6C5	42	50,000
6C5G	50	50,000
6C6 (Pentode)	8	250,000
6C6 (Triode)	38	50,000
6F5	162	250,000
6F5	120	100,000
6F5G	155	250,000
6F5G	124	150,000
6F6	26	7,000*
6F6G	28	7,000*
6J5G	75	50,000
6K5G	107	100,000*
6K6G	38	7,600*
6L6	29	2,500*
6L6G	52	2,500*
6Q7	84	250,000
6Q7	64	100,000
6Q7G	91	250,000
6Q7G	73	100,000
6R7	37	50,000
6R7G	35	50,000

<sup>o</sup>These capacitance values are the averages of five tubes of each type.

\*A.C. impedances. All other loads shown are resistors.

with the high mu types, so that the fidelity of an amplifier will be subject to considerable variation when the wiring capacitances are not carefully controlled.

If a bypass capacitor is connected across the plate load, the input capacitance is reduced along with the gain of the stage particularly at the higher frequencies. The resistance component of the input impedance may also be reduced to a value which must be considered, especially when a resistor filter is used in series with the grid. Under these conditions a voltage divider effect may be attained which will greatly reduce the high frequency output.

The variation of effective input capacitance of a tube, as a function gain, is usefully employed at present in signal-seeking circuits (automatic frequency control) and in automatic tone compensation circuits. It is to be expected that other useful applications of this characteristic of vacuum tubes may be forthcoming.

[Engineering News Letter No. 30, of Hygrade Sylvania Corporation.]

## Masked Component Present for Resistance of Grid

Even if there is no grid current measurable with a d.c. instrument, there may be a resistance component in the input capacity of a tube. This is mainly due to reflected plate resistance as a result of the grid-plate capacity.

## Derivation of Formula for Input Capacitance

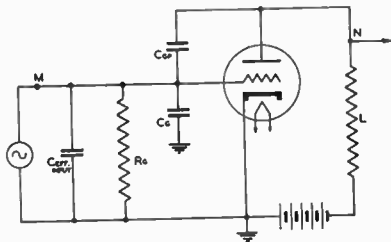

Circuit for measuring capacity effects.

The approximate formula for effective input capacitance may be derived as follows:

Referring to the circuit diagram, M represents the signal voltage at the grid, while N represents the signal voltage across the plate load L. Now if  $L = 0$ , N would equal zero, the capacitance current resulting from the voltage on the grid would flow through  $C_s$  and  $C_{sp}$  in parallel and its value would be a function of M only. Accordingly, under this condition the effective input capacitance would be equal to the rated input capacitance as ordinarily measured, namely  $C_s + C_{sp}$ .

### PHASE STATED

If L is made finite so that  $N = AM$  where A is the voltage amplification attained, we know that for all practical purposes N is  $180^\circ$  out of phase with M so that the current through  $C_{sp}$  is a function of  $M + N$  or  $M + AM$ , while the current through  $C_s$  is still a function of M. The effect of increasing the voltage across  $C_{sp}$  has the same effect as increasing the value of  $C_{sp}$  by the same factor. This is obvious, as the current through a capacitance is equal to  $E \omega C$ .

### SIMPLIFICATION

Accordingly, the capacitive current from the grid is equal to  $M \omega C_{eff. input}$ , and of course:

$$M \omega C_{eff. input} = M \omega C_s + (M + AM) \omega C_{sp}$$

as the effect of the plate-cathode capacitance is ordinarily negligible.

Therefore, dividing by  $\omega M$  we arrive at the formula mentioned in the text, namely:

$$C_{eff. input} = C_s + (1 + A) C_{sp}$$

In this formula A is the effective voltage amplification, which may be written

$$A = \mu L / (L + r_p)$$

## Tobe Announces Windo-Pole Antenna

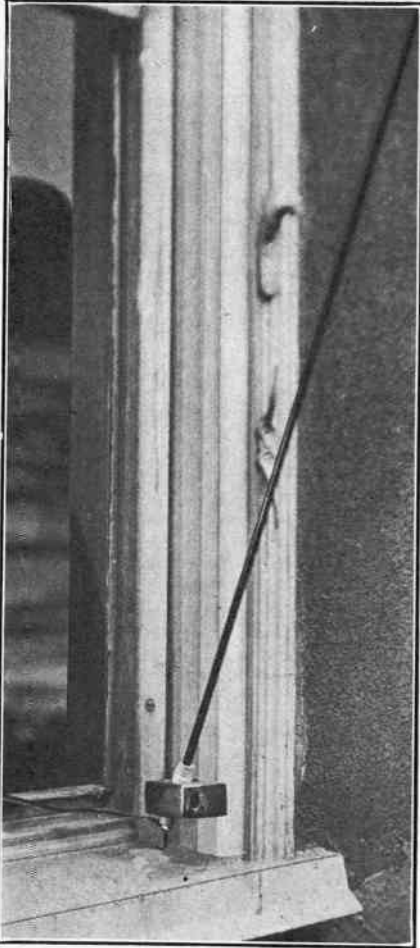

Windo-Pole antenna, installed in a jiffy, provides ample pickup.

The Windo-Pole aerial is a new patented product announced by the Tobe Deutschmann Corporation, Canton, Mass., as being of particular interest to the radio serviceman and dealer. It is a pole type antenna and can be readily mounted to any window sash or sill at 45 degrees or horizontally. Its length extended is eight feet, and is said to provide ample pick-up with a modern receiver. While not primarily a noise reduction antenna, it is claimed that its use results in a superior signal to noise ratio in many instances, as it can be located in a noise-free area, while some portion of other antennas almost invariably projects into a noise field.

The Windo-Pole is recommended as a permanent installation and for demonstration purposes. Collapsed, it is readily portable by

the serviceman, and its use insures against demonstrating a receiver with a possible defective antenna system. The antenna is inconspicuous and is approved by landlords where other antennas are forbidden. The Toby Windo-Pole is supplied complete with insulated mounting bracket and lead-in strip. It actually takes only ten seconds to install the Windo-Pole. No tools are required. The clamp is slipped over the side window-casing and thumb screw tightened.

It is highly suitable for use in apartment houses and in private houses.

According to a report from the engineering department of the Corporation, recent tests have demonstrated the superiority of the pole type antenna also for automotive radio reception. Measurements were made, using as a basis of comparison a roof type antenna in a fabric-roof car having demonstrably better characteristics than either an under-chassis or running-board aerial. The pole antenna was a standard "Auto-Pole" having an extended length of eight feet and telescoping in three sections to five and three feet.

Tests were made with a powerful signal generator, modulated at 400 cycles and radiating from an antenna located sufficiently far from the auto radio to insure uniform field distribution. The output of the receiver was measured directly on a decibel meter. The gain with the antenna fully extended was 17 db. With one section telescoped the gain over the ordinary  
(Continued on following page)

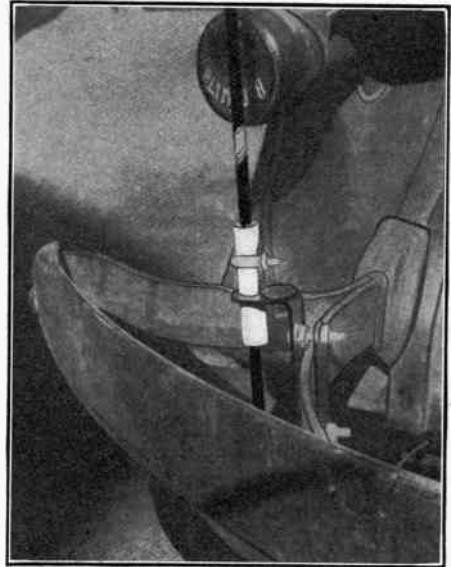

The pole type antenna for automobiles has been subjected to tests that show its superiority. Both antennas are Tobe products.



# Super with Phase Inverter and Ray Index

## Cross-Continent Reception on Nine-Tube Receiver

By Kenneth H. Tiffany

THIS eight-tube standard-broadcast band superheterodyne, nine tubes if the ray indicator tube is included, follows a proved circuit and produces very remarkable results. The sensitivity and selectivity are high enough to permit the reception of far-distant stations, and especially have West Coast stations been tuned in, at a New Jersey location, early in the morning.

There is no difficulty in the tuning process, either, as the ray indicator tube is included for the sole purpose of facilitating tuning. As is well known by this time, the tube is very sensitive to small changes, and the shadow angle is narrowed as the voltage produced by resonance is increased, so that there is visual indication for any station that can be tuned in audibly. The additional advantage is that the station can be tuned in very exactly, a requirement difficult to meet aurally because of the inclusion of automatic volume control.

When there is such control present, true resonance develops a certain output voltage, or quantity of sound in the speaker, when a station is being received, and also positions a little off resonance produce about the same level of output. The more effective the a.v.c. the greater the tendency toward such equality. The tone is best at true resonance and therefore quality is aided by a ray indicator tube.

The illustration typifies the situation of tuning rendered so simple with the ray indicator tube that a boy four years old encounters no difficulty. The indicator tube is mounted horizontally, above the tuning condenser.

There are four knobs. The upper one works the dial. At lower right is a 10,000-ohm wire-wound potentiometer for radio-frequency volume control. At lower center is a .5 meg. potentiometer for audio-frequency volume control, shown elsewhere with long shaft. This is the device that the boy in the photograph is manipulating. At lower right is the tone



The author's four-year-old son, Robert Henry Tiffany, tuning his father's superheterodyne, with which West Coast stations were tuned in from a location in New Jersey.

control, a.c. switch attached. Two tubes are served by the three coils next to the tuning condenser, as one of the tubes is of the

double-purpose type, a 6A7 pentagrid converter, which supplies the oscillation and enables input of the r.f. level and output at the inter-

mediate-frequency level. Note that the first intermediate transformer is the third object at right, counting from the front.

Full rectified voltage is not given the grid of the 75, yet the full rectified voltage is used for a.v.c. This precaution is taken for reasons discovered experimentally. The high mu tube will not stand anything and everything as input, and operating conditions require therefore that a limitation be imposed, which the extra .05 meg. resistor accomplishes, because in reality more that is enjoyable is obtained that way, since overloading is avoided, and reception can not be sensibly called such if accompanied by distortion.

It will be noticed that the triode part of the 75 is not diode-biased, but has a bias resulting from the voltage difference across a resistor of 3,500 ohms in the cathode leg. Thus the cathode is at a few volts potential above ground, or positive, and yet those tubes controlled by automatic volume methods are returned to that cathode, hence at no signal could be easily run with positive grids, with consequent noise and distortion due to the flow of grid current.

To avoid this condition the semi-fixed bias on the controlled tubes is raised. For instance, if the 75 has its cathode lifted 3 volts above ground, the controlled grids would draw current if they had about 3 volts semi-fixed bias, but when their cathode resistors drop 6 volts, at no signal input, the grids then are at the potential difference, 6 minus 3, or 3 volts, which is the standard value, for 250 volts on the plates. So instead of 300 ohms for biasing resistors, values for two of the controlled tubes will be found as 600 ohms, which about doubles the voltage drop, while the semi-steady voltage drop on the 6A7 biasing resistor should be around 4 to 4.5 volts, and if it is not, the resistor marked 250 ohms should be made 300 ohms or a little more, to accomplish the specified result.

In this way the input to the detector tube is properly safeguarded as to tone quality and clarity generally, and the next consideration is the audio amplifier.

(Continued on following page)



denser, connect it to ground again, instead of just across the .4 meg. resistor, and now see whether the bypass condenser across the 3,000-ohm biasing resistor makes any change in the volume. Again, if it does, include it, or, as it is likely there will be no change now with condenser in or out, leave it out, and leave the .1 mfd. condenser connected to ground.

The arrangement of the B supply choke coils is such as to provide sufficient filtration and proper voltaging. All the B current is passed through the speaker field, while only the B current for the tubes ahead is passed through the small choke.

is, what is to be the bottom of the coil. The oscillator coil is wound the same way, only there are 75 turns of No. 32 enamel wire for the secondary, and the primary or tickler has 40 turns. It is of no great consequence what the primary wire is in any case, except that it should not be very large diameter wire compared to that used for the secondary. The same kind of wire suffices for both windings of all coils, and all cases presuppose tight winding; that is, one turn as close to another as possible.

The diagram does not show the connections for the ray indicator tube, as some may prefer to use a meter. If so, a 0-6 voltmeter may be

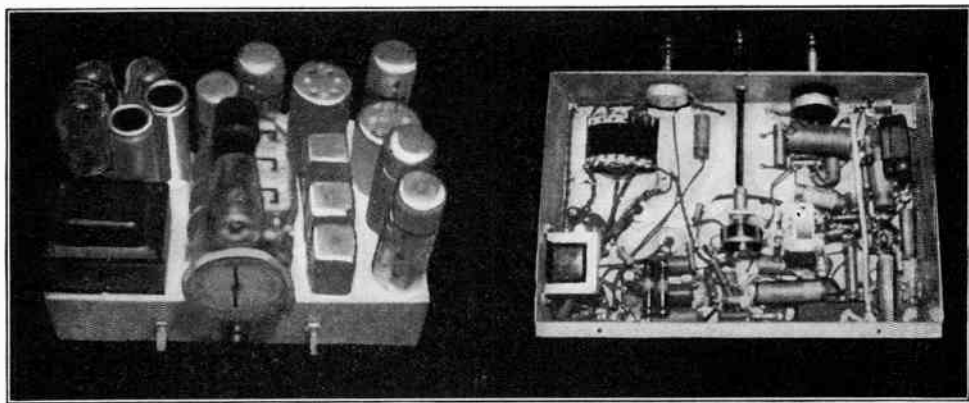

Two views of the superheterodyne that provided cross-continent reception. The .5 meg. audio volume control has the long shaft.

Aside from what has been stated, everything is standard in the set, and even the phase inverter is acquiring that title.

Each section of the three-gang condenser has a capacity of .000365 mfd. If one desires to wind the coils himself he may do so by using one-inch diameter tubing, putting on 127 turns of No. 32 enamel wire for the secondaries of the two r.f. coils, and with insulating wrapper between, put on primaries of 35 turns, wound over the secondaries, near the ground end, that

connected across the 600 ohm resistor of the 6D6, or a 0-10 milliammeter put in series with the plate of this tube, or 0-20 ma in series with the 10,000-ohm wire-wound resistor.

For inclusion of the ray indicator tube, the 6E5 would have heater connected to the 6.3 volt source, plate to a 1 meg. resistor returned to 250 volts, target direct to 250 volts, and with cathode to ground, grid would go to the joint of the two resistors that constitute the load of the 75's diode.

## Many Obsolete Sets Are in Use on Farms

Washington.

Among rural owners of radio receivers there is a large percentage of obsolete sets, according to an official survey by the Federal Communications Commission.

The Commission's survey included 116,000 postcard questionnaires. It was concluded with total usable returns of 32,671 postcards from rural owners of radio sets. Very few 1935 receiving sets were included in the survey, but the Commission's official returns showed that nearly half of the rural receivers in use at the time of the survey were more than four years old. More than two-thirds of the farm sets contained from five to seven tubes and this, according to the Commission's report, indicates that the average farm receiver was a super-

Following is a tabulation in the Commission's report:

Year of Receiver	Per Cent
1929 or earlier.....	26.1
1930 .....	12.7
1931 .....	10.1
1932 .....	12.1
1933 .....	13.8
1934 .....	21.6
1935 .....	3.6

Number of Tubes	Per Cent
4 or less.....	5.6
5 to 7.....	69.9
8 or more.....	24.5

# Overload, Commonest Evil

## Remedies to Apply and Tests to Make

By Capt. Peter V. O'Rourke

SOMETIMES just a simple remedy will make the performance of a superheterodyne top-notch, compared to previous poor reception. Troubles may be due to the set being too sensitive, or gain too high, though the working sensitivity may be low. Then if the gain is reduced to practical values the sensitivity is increased a great deal. This is one of the peculiarities to be expected.

One of the expedients sometimes used in set construction is the inclusion of high-gain coils at the r.f. level (excluding the local oscillator coil from this category, as the tube functions at a higher frequency). If one desires to operate with a very small antenna the high-gain coils may be used, but with certain precautions.

### FIXING SCREEN VOLTAGE

One of the first considerations is to get the d.c. voltages right. This may be done conveniently at a stage where there is no a.v.c. The first, or only, r.f. stage may be the one, as it has been found that a.v.c. applied here reduces the sensitivity without increasing the degree of control proportionately, and so from this stage a.v.c. may be omitted. Then a 300-ohm resistor supplies the semi-fixed bias, and a high resistance voltmeter is put across this resistor when the tube circuit is complete and there is no signal fed to the set, i.e., antenna is disconnected.

The screen voltage is apportioned usually from a bleeder network, the object of which is to keep the screen voltage constant independent of the signal fed to the set. Therefore two resistors are connected in series, and to their joint the screen is attached.

Since these two resistors are across the total available B voltage for the r.f. and i.f. tubes, if the upper resistor, the one from B plus to screen, is about equal to the lower resistor, and neither of them a comparatively high resistance, the bleeder current will be sufficient for the stabilizing objective, and the screen voltage may be adjusted by varying the value of the lower resistor ( $R_1$ ) until the voltage across the 300-ohm biasing resistor is just three volts, for 250 volts applied to the plate, which is loaded with any impedance of negligible d.c. resistance. In r.f. and i.f. circuits this is practically always true, but the presence of a very high resistance plate load, as in audio circuits, would necessitate some amendments. But audio circuits are not now considered.

### THE PLATE CURRENT CHANGE

If the biasing voltage reads less than 3 volts, this is usually due to the screen voltage being too low, therefore the variable resistor  $R_1$  would be put in the upper position, between B plus and screen. The upper resistor should be 5 watts rating, or more, for values around 10,000

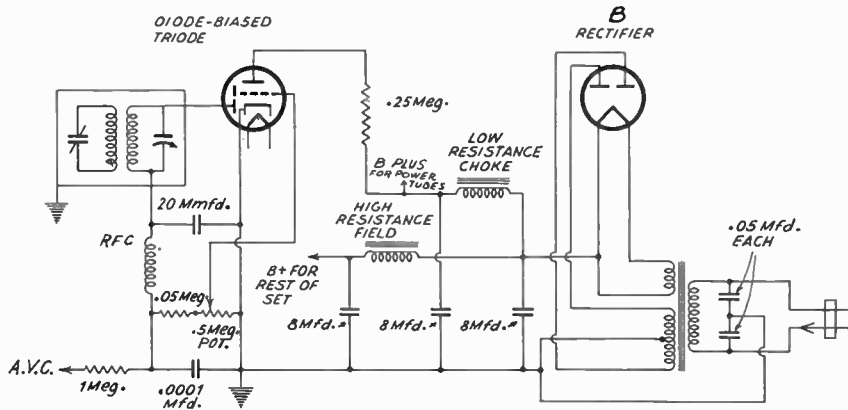

A diode-biased triode, and particularly pentode, may be overloaded readily, and cause most annoying distortion, due to too low plate current. Again less than the full rectified voltage may be taken off, even for maximum volume position of the potentiometer. Also the B voltage applied to the triode or pentode should be as high as practically obtainable. A method of getting higher B voltage by using two chokes is shown.



# High Signal-to-Noise Ratio Design Factors for Accomplishment Set Forth with NC-100 Receiver as Basis

By James Millen

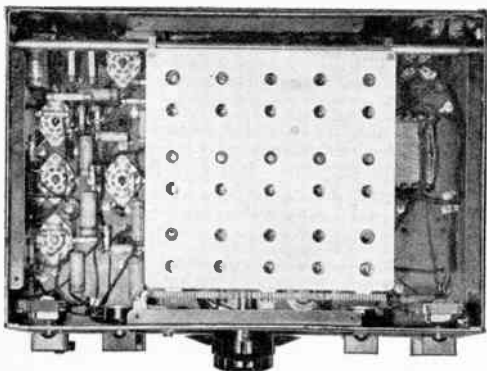

FIG. 1

The coils are permanently in place in their shielded assembly, which is moved by rack and pinion action, so that the coils for any one band are right under the tuning condenser. This makes for high efficiency, yet introducing the convenience of front-panel switching.

PERHAPS the greatest problem in designing a modern high-frequency receiver is to obtain high usable sensitivity. By "usable" sensitivity is meant the strength of the weakest signal that can actually be copied, and this value is usually quite different from that obtained by connecting up a signal generator and simply measuring the input required to produce a standard output at the speaker.

The reason for this difference is obvious. When actually receiving a signal, the important thing is to have the signal enough louder than the background noise to permit accurate copying of the signal. Many sets which give standard output with a signal of less than one microvolt are so noisy that it is very difficult to read any signal weaker than ten microvolts.

In short, the important thing is the signal-to-noise ratio. This fact is so well understood that there is much discussion of a new test procedure that would place emphasis upon readability rather than upon absolute sensitivity.

## FIRST R.F. STAGE CONTROLLING

Unfortunately, achieving a high signal-to-noise ratio is both difficult and expensive. It requires the highest possible efficiency in r. f. and i. f. circuits. This means not only costly materials and painstaking adjustment, but an advanced design that takes advantage of every means to reduce noise and increase the signal.

Since any noise generated in the first r. f. stage of the receiver is amplified by the succeeding stages along with the signal, most of the improvement in signal-to-noise ratio must be achieved at this point. Low-loss construc-

tion will of itself reduce the background noise somewhat, but the greatest benefits come from increasing the gain. High gain requires that the tube work into a high impedance, and this

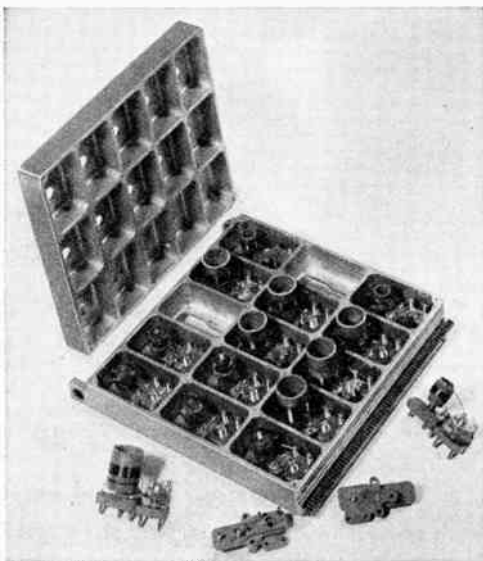

FIG. 2

Intimate view of the coil compartment. Two coils are shown removed from their position in the assembly.

ohms. The adjustment would be made, either by sliding a conductive tab, or turning a knob or shaft, until three volts are read from cathode to ground. If the bias is too high the variable resistor, as shown in the diagram, is in the correct place, and the adjustment is made.

An exception to the above is that if the resistance between screen and B plus is too small,

being a contributing cause to the reception of a given station at two points on the dial no far removed from each other. This would apply to several local stations, but not to distant ones.

It is assumed that the intermediate amplifier is not oscillating nor in a condition verging on oscillation. To stop oscillation a suitable diode filter is used, as shown in the first diagram

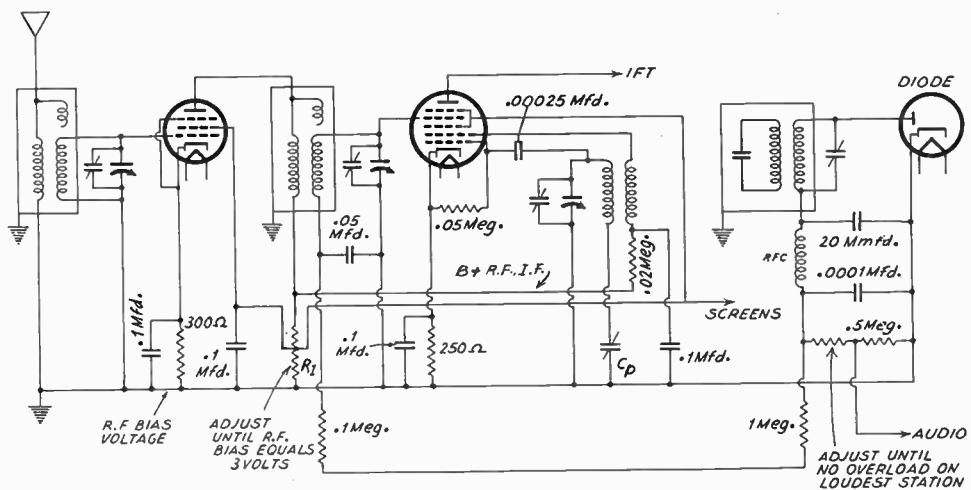

Some r.f. or i.f. tube not subject to a. v. c. may be used for establishing the proper screen voltage. The resistance network affecting the screen voltage is adjusted (at R1) until the voltage drop across the cathode biasing resistor is the recommended value, usually three volts. Overload of the audio amplifier is prevented by limiting the amount of rectified voltage taken off (at right).

that is, the applied voltages to these elements are nearly equal, the screen draws nearly as much current as the plate, and so increasing the screen voltage may decrease the bias, because the net change is due to greater reduction of plate current than increase in screen current. It should be remembered that the plate current is dependent on the screen voltage, and hardly at all on the plate voltage.

Once the screen voltage has been established it should be checked nevertheless by high resistance voltmeter measurement. If the resistances used in the bleeder are of the order of 10,000 ohms, then the usual 1,000-ohms-per-volt instrument will suffice, and the reading from B plus to B minus should be the same as the sum of the independent readings from B plus to screen and from screen to ground. If there is any noticeable difference between sum and single reading then the meter has insufficient ohms-per-volt for the present measurement.

## TWO-SPOT RECEPTION

With the plate, screen and bias voltages correct at this stage, attention now may be directed to the second detector. The peril of an overloaded diode detector may be dismissed as an unlikely condition, since the diode will stand nearly 100 volts, and the subsequent tube never will. Hence audio overload is a common evil, and it introduces detection in the audio channel,

where a small capacity, 20 mmfd., is from the coil return to cathode, a radio-frequency choke continues the d.c. feed to the load resistor and across this load resistor is a .0001 mfd. condenser. The value of the choke may be up to 25 millihenries, but if the intermediate frequency is unusually high, and the lowest broadcast frequency is therefore inordinately close to the i.f., regeneration may set in at 600 kc or thereabouts, and all stations to the lowest receivable frequency be attended by squeals. In that instance the choke should be of much inductance.

## PROTECTING THE BIAS

If a.v.c. is used on only one tube, the voltage taken from the rectification circuit of the second detector, or demodulator, it should be the full rectified voltage, as this improves the control but since the danger of an overloaded audio channel exists, less than the full rectified voltage will be necessary for a.f. input. The reduction is accomplished by interposing between the load resistor, shown as .5 meg in the first diagram a resistor of such value the effect of the bias on the following audio tube is not completely overcome.

For instance, assume no signal is fed to the set, or preferably that the grid of the first audio amplifier tube is grounded directly, and a plate current reading taken for this tube, with normal

(Continued on following page)

((Continued from preceding page))

self-bias or fixed bias present. Direct coupling is not now under consideration. The plate current is the result of the plate voltage and bias voltage and may be noted. Then the grid is returned directly to cathode, no loading, and the plate current noted. Now we have the value of plate current that represents zero grid bias.

Restoring the biasing system to what it was and should be, say, a triode with 10 to 20 volts negative on the grid, we know the no-signal current, and even with antenna disconnected this may be a bit higher than was found when returning grid through a shortening wire to cathode, because the noises amplified in the set produce some rectification and deliver some small audio signal value to the driver that may be noticed in terms of plate current increase.

### AN ASIDE ON NOISE

By the way, if this increase is substantial, then there is a bad tube, loose connection, poor contact or other trouble in the set, as the noise should not be so great as to result in any serious change of plate current reading.

For transformer loading of the plate circuit, no isolation, the plate current for normal bias may be around 10 milliamperes, for resistive loading it may be around one or two milliamperes, nevertheless it is the limiting value we are seeking. This should be a plate current never more than the value found for zero-bias under the experimental method just discussed. Thus for 20 milliamperes found at first, we shall accept a limit of 20 milliamperes on station test, and for 2 milliamperes a limit of 2 milliamperes. These are the assumed values for grid shorted to cathode.

Now tune in the strongest local. If there is a.v.c. is it necessary to have a tuning indicator, which may be a high-resistance voltmeter across the cathode biasing resistor of any a.v. controlled tube. The meter will read a certain bias voltage, then will read less as the station is tuned in, and when the meter reads least

voltage, the station is "tuned in on the nose." The idea that stations have noses is peculiar to radio men.

Now the resistor that was interposed between the diode load of .5 meg. and the end of the r.f. choke coil is adjusted. If there is overload the plate current will reach or nearly reach the value found experimentally for zero bias, if the extra resistance is negligible compared to the rest of the load.

### IMPROVED I. F. FILTRATION

By increasing the variable until the plate current of the driver tube (first audio) is below the prescribed limits, the overload problem is practically solved. The adjustable resistor may be measured and a fixed resistance put in its place, of the same value. Remember the strongest local in your guide.

This method has an additional effect, in that it aids i.f. filtration. Much less i.f. will get into the audio tube, hence the double-tuning-in of stations may stop, also the i.f. channel becomes much quieter. The reduction of gain may or may not reduce the practical sensitivity, depending on whether the gain had pressed the receiver under certain reception conditions to levels beyond its capability of good or any reproduction. Nevertheless the set has been made workable and has been protected from a very serious form of distortion. If the sensitivity has been decreased somewhat, and is desired to be recaptured for some special DX work, then a switch may be put across the additional resistance load of the diode, although with sets fully controlled by the automatic volume method this is hardly advisable, as the extra bias due to the station is small when the station carrier itself is weak.

If gain control is present at the r.f. or i.f. level, some particular setting is selected for non-overload, and the position is not changed except for DX work.

In the second diagram the value of .05 meg. has been selected as the limiting one, and the rest of the diode load this time is a potentiometer of .5 meg. The diode and the driver are in the same envelope, i.e., this is a twin-diode-triode, and one of the diodes either is not used, as shown, or may be connected to the other diode.

Connection of the slider is made to the grid, and volume is controlled by taking off as much or as little as desired from the available rectified signal. What is put into the grid is pulsating d.c. The stronger the station, the more negative the grid, i.e., the bias works against the signal here too, as with transformer coupling or resistor-capacity coupling.

### HEARING NOTHING AT ALL

In the reactive examples the bias is negative to start with, and the signal effectively reduces this, whereas in the diode-biased example the starting bias is zero, and the signal makes it more negative. It is clear that a strong enough signal will make the bias so much negative as to cut off the plate current, hence if the station

## Cornell-Dubilier Condensers

### Flew Ocean with Richman, Too

Possibly the fastest round trip to Europe ever undertaken by a radio part was that by several Cornell-Dubilier condensers incorporated in the new radio compass which played a vital part in the successful completion of the round trip flight to and from Europe recently undertaken by Harry Richman and Dick Merrill in the airplane "Lady Peace."

Cornell-Dubilier condensers were used in the construction of the Dayton Products Company's recently perfected radio compass and the radio compass functioned perfectly during the flight.

The type of condensers used was Type DH. This is a Dykanol filled, hermetically sealed condenser which is particularly impervious to climatic conditions and extreme dampness and humidity.



is tuned in "on the nose," it is just possible that nothing will be heard, though it is the strongest local!

The test for overload here is very simple. A current meter is put in series with the triode plate, and the limiting resistor is selected (.05 meg. shown) on the basis of strongest local being tuned in, limiting resistance high enough to insure readily observable plate current on a 0-1 milliammeter, say, .2 milliampere. That would be normally the first deflection bar on the meter scale.

Plate current cutoff is related to the B voltage, and since avoidance of cutoff, or even its approximation, is greatly desired, the B voltage for the plate of the triode, or pentode, should be taken from the highest available filtered B voltage tap.

Many build receivers with the dynamic speaker's field serving as the only B filter choke. Naturally a lot of voltage is dropped in the field, particularly since the power tube plate current goes through the field. An average drop of 100 volts or so may be expected. Around 80 volts more of B voltage is obtainable if we use a low-resistance filter choke that will stand the power tube current, and have around 200 ohms d.c. resistance in that choke.

### GREATER POWER OUTPUT

Not only may we return the diode-biased tube's plate to that point, but since we have increased the available B voltage for the output tube, we have increased the power output capabilities as well. Some recasting of the biasing of the power tubes may be required so that the recommended limit of plate current for them will not now be exceeded.

Performance is much better, from the diode-biased triode's position, when the B voltage is increased as recommended. If the receiver is sizable, then all the other tubes may be served by the high-resistance field of the speaker, which is transferred to the position shown in the second diagram.

The filtration will be sufficient, if the low-resistance choke will stand the current, but insufficient if the choke is worked anywhere near saturation, because the inductance reduces sharply as saturation is approached. The inductance therefore depends on the amount of direct current, and is not a constant, despite much opinion to the contrary.

The second diagram includes the B rectifier, and it will be seen that the primary has two .05 mfd. condensers across it in series, center of the capacities grounded. These reduce or eliminate interference caused by the line feeding

r.f. to the set, and in particular are often a remedy for modulation hum, present only when a station is tuned in. If general hum is present, putting a .1 meg. resistor in series with the triode plate load resistor of .25 meg., and connecting a 8 mfd. electrolytic condenser of 500-volt rating from joint to ground, will usually get rid of this trouble.

### VALUES FOR A.V.C.

The a.v.c. circuit, leading to the left, has a 1 meg. resistor. The local resistance of the diode is about .5 meg. The capacities across the load may be neglected for the moment. However, the filter resistor of the r.f. or i.f. circuits subject to a.v.c., under diode loading and a.v.c. filter resistance as shown, should be around .1 meg. and the bypass capacity, from coil return to ground or cathode in the controlled circuits, .05 meg. The time constant for each then will be approximately  $1.6 \text{ meg.} \times .05 = .08$ , equivalent to a frequency of  $1/.08$  or 12.5 cycles.

This frequency is lower than the lowest the set can reproduce, so no audible trouble will result, and the speed of the a.v.c. action is not so great as to attenuate high audio frequencies, or any reproducible frequencies in fact, nor so slow that the a.v.c. action is postponed until after the station is tuned in with much greater than final resting volume. A speed of one-twelfth of a second is fast enough.

In the foregoing mention has been made of tuning in stations at two adjacent points. The cause is not to be confused with alternate reception on short waves, due to poor pre-selection affording about equal response when the oscillator frequency is lower, as well as when it is higher, than the station frequency. Nor should the remark that detection in the audio channel is a contributant be regarded as indicating that this is the sole or principal cause of the trouble.

If there is overloading, there may be no reception, particularly in the example of diode-biasing, which already has been stressed. That obtains for tuning in the station "on the nose." But if the station is incorrectly tuned in, i.e., "off the nose," say, perhaps somewhere around the cheekbone or the ear, the off-resonant voltage is not great enough to stop reception, or even create any overload, so at a point one side of resonance that station is heard, at another point, the other side resonance, the station is heard again, nothing heard in between and two-spot tuning is suffered. With no overload from any cause, reception is strictly one-spot as least for the standard broadcast band, or intermediate short waves, before r.f.-oscillator frequency difference becomes a small percentage of either.

## International 10 kc Limit Proposed for Short Waves

The International Broadcasting Union, representing all the leading broadcasting organizations of Europe, has recommended in its proposals for the Bucharest radio conference that a minimum of 10 kc separation be adopted for short-wave stations.

The separation, which is uniformly observed

in the United States, "is necessary to insure good reception," the Union states.

"It is necessary to consider a greater separation corresponding to two or three channels of 10 kc between stations which can be received simultaneously with a field of the same order of strength in the same region," it adds.

# High Signal-to-Noise Ratio

## Design Factors for Accomplishment Set Forth with NC-100 Receiver as Basis

By James Millen

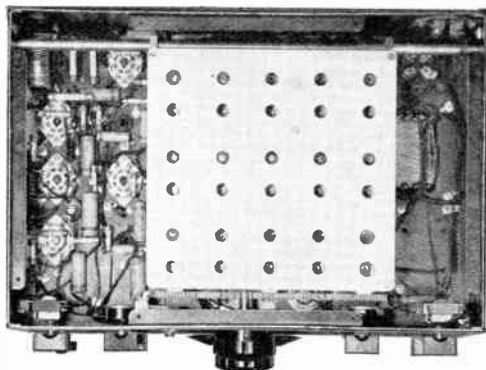

FIG. 1

The coils are permanently in place in their shielded assembly, which is moved by rack and pinion action, so that the coils for any one band are right under the tuning condenser. This makes for high efficiency, yet introducing the convenience of front-panel switching.

PERHAPS the greatest problem in designing a modern high-frequency receiver is to obtain high usable sensitivity. By "usable" sensitivity is meant the strength of the weakest signal that can actually be copied, and this value is usually quite different from that obtained by connecting up a signal generator and simply measuring the input required to produce a standard output at the speaker.

The reason for this difference is obvious. When actually receiving a signal, the important thing is to have the signal enough louder than the background noise to permit accurate copying of the signal. Many sets which give standard output with a signal of less than one microvolt are so noisy that it is very difficult to read any signal weaker than ten microvolts.

In short, the important thing is the signal-to-noise ratio. This fact is so well understood that there is much discussion of a new test procedure that would place emphasis upon readability rather than upon absolute sensitivity.

### FIRST R.F. STAGE CONTROLLING

Unfortunately, achieving a high signal-to-noise ratio is both difficult and expensive. It requires the highest possible efficiency in r. f. and i. f. circuits. This means not only costly materials and painstaking adjustment, but an advanced design that takes advantage of every means to reduce noise and increase the signal.

Since any noise generated in the first r. f. stage of the receiver is amplified by the succeeding stages along with the signal, most of the improvement in signal-to-noise ratio must be achieved at this point. Low-loss construc-

tion will of itself reduce the background noise somewhat, but the greatest benefits come from increasing the gain. High gain requires that the tube work into a high impedance, and this

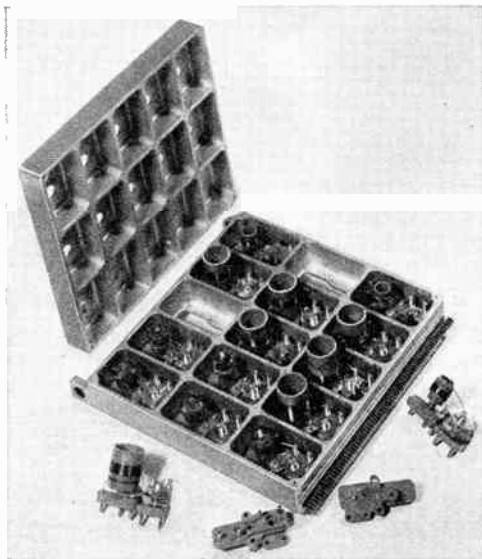

FIG. 2

Intimate view of the coil compartment. Two coils are shown removed from their position in the assembly.

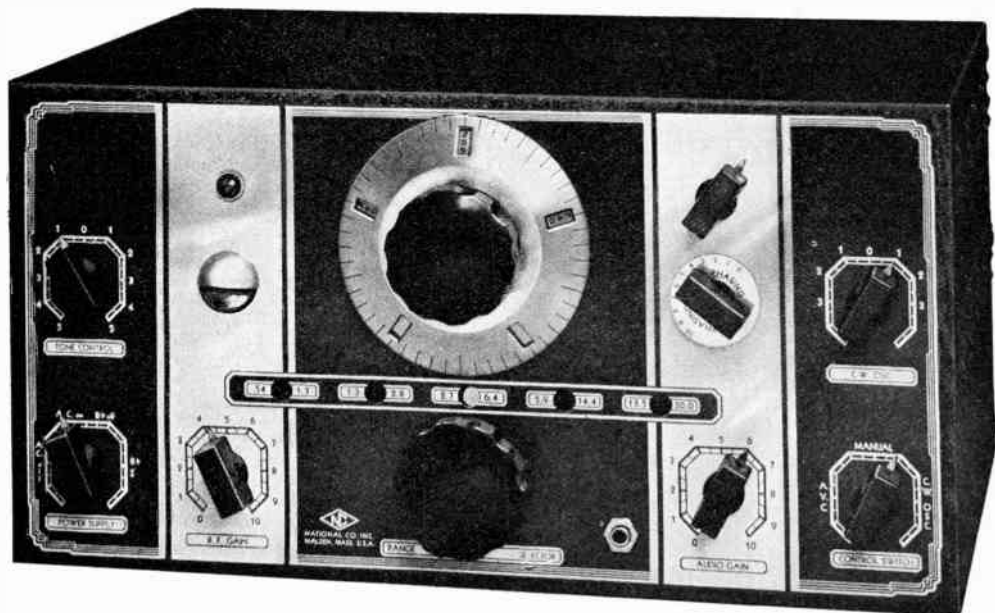

FIG. 3

Appearance of the front panel is very striking, consideration having been given to eye appeal as well as to electrical efficiency.

in turn requires that the losses be low, that the coils be of efficient form factor, that the shielding be of generous proportions, and that the  $L/C$  ratio be as high as possible.

Considering these in turn, low losses require the use of high quality insulation (Isolantite or R-39) with air used as the dielectric in all h. f. circuits. Coils must be designed with electrical efficiency, not small size, as the criterion. Shielding should be designed to fit the coils, and not vice versa. A high  $L/C$  ratio requires that the tuning condenser be as small as practical. For a given tuning range, the condenser size is determined by the minimum capacity. Consequently, the layout should be arranged to permit short leads to reduce stray capacity.

### THE SWITCH PROBLEM

In addition to these positive virtues, certain common faults must be avoided. To prevent absorption losses, all coils must be individually shielded. Whatever contacts are used in the range changing system must provide dependable low-resistance connections.

There is no difficulty in filling all of these requirements when plug-in coils are used, but if an attempt is made to use a conventional coil switch, we are faced with a problem in dimensions. Large, individually shielded coils and air dielectric padding condensers take up a lot of room, making long leads necessary and increasing stray capacity. High performance communication type receivers such as the National HRO still use plug-in coils for this reason, but where convenience is of primary importance

some sort of knob-controlled switching is desirable.

The National NC-100 Receiver is particularly interesting in this connection because it represents a successful and unusual solution of this problem. In effect, plug-in coils are actually used, but they are all contained within the receiver, and ranges are selected by a knob on the front panel. Fig. 1 shows the general arrangement.

### THE UNIQUE COIL SYSTEM

The h. f. and oscillator coils required for the five ranges are mounted in a heavy cast aluminum shield, together with their trimming condensers. This shield is mounted on a track, so that it can slide back and forth under the chassis. Movement of the assembly is controlled by a knob on the front panel, operating through a rack and pinion. By this means, the coil range in use is brought directly below the main tuning condenser and close to the tubes, thus making leads short.

This design also fills the other requirements for coil efficiency, as is evident from Fig. 2. Each of the fifteen h. f. and oscillator coils is mounted in its own individual shielded compartment, together with its air-dielectric trimming condenser. It is obvious that the shielding is very complete, and, as would be expected, there are no measurable losses from absorption by idle coils. Further, by moving the idle coils completely out of the way, the individual coils

*(Continued on following page)*

(Continued from preceding page)  
are not cramped for space as they would be if grouped around a coil switch.

### COILS SNAP INTO POSITION

Fig. 2 also shows two of the coils removed from the shield. The mounting base is of low-loss R-39, with the five contacts moulded in. The coil and the air-dielectric condenser are both mounted on this base and wired as a unit. The contacts themselves are similar to a tube prong, and operate against stationary side-wipe contacts on the chassis. The construction is patterned after that used in trans-

in the coolest part of the receiver, temperature variations are reduced to a minimum.

Although signal-to-noise ratio is largely determined by the characteristics of the first r.f. stage, the other h.f. circuits are vitally important. Upon the tuned circuit of the detector is placed a large share of the burden of eliminating image frequencies, and it must provide as much gain as possible consistent with high selectivity. Consequently, efficient design is practically as important in the detector as it is in the first r.f. stage. The oscillator likewise requires very careful design, for upon the stability of the h.f. oscillator the calibration of the

FIG. 4

What you see when you look from top at the chassis is an orderly array of components, each of high calibre, selected to insure maximum performance. Admitting the difficulty of handling all tuned stages on all bands, this arrangement is a contribution to the complete solution.

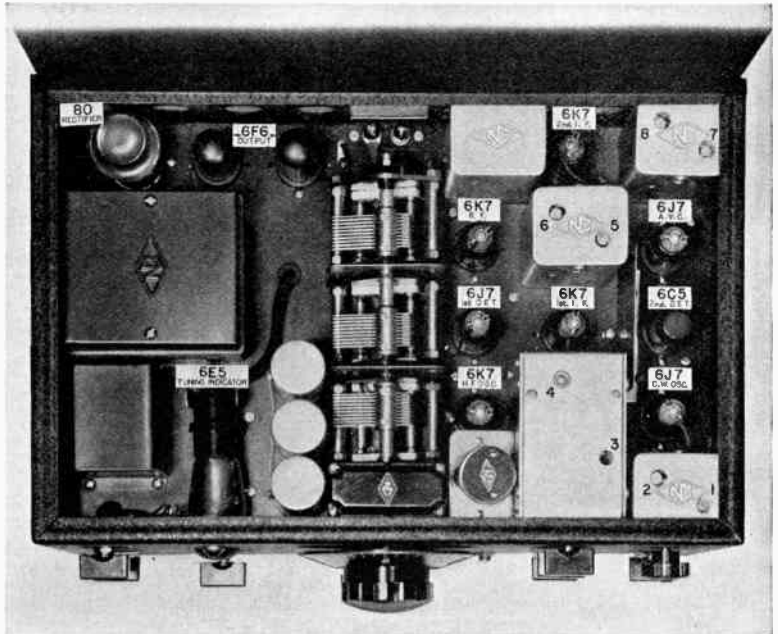

mitting tube sockets, and has proved to be thoroughly reliable.

Quite aside from its merits in helping to achieve very high signal-to-noise ratio, the movable coil tuning unit has other very definite advantages. As constructed, the coils lock into position after each shift with a definite snap. This positive detent action, together with the accuracy of the slide, insures that the coils will come to exactly the same position every time, thus making calibration exact and reliable. This is of great importance.

### CLOSE LIMITS FOR CONSTANTS

The micrometer dial on the precision tuning condenser reads direct to one part in five hundred. Accuracy of this order is almost essential for precise calibration and accurate logging, but it obviously means that circuit constants must be held within close limits. It also requires that the temperature drift be kept small, and here again the arrangement described is of great help. With coils located below the chassis,

receiver depends. Experience has shown that separate tubes for the detector and oscillator give more stable operation than a combination type, especially on shorter wavelengths.

### THE I.F. CHANNEL

The intermediate frequency amplifier of the NC-100 Receiver is of high-gain construction. In general its details are more or less conventional. Two stages are used, and all tuned circuits have air dielectric condensers and Litz honeycomb coils. To avoid the reduction of gain and selectivity in the last stage, which occurs when diode rectifiers are used, due to the load which they put on the tuned circuit, the second detector is a biased triode. The circuit is not loaded by the a.v.c., for a separate tube is used, giving amplified and delayed action.

High selectivity in the intermediate frequency amplifier makes an appreciable reduction in background noise, because much of the noise is of high enough frequency to be rejected by a

(Continued on page 46)

### SCHEMATIC DIAGRAM — TYPE NC-100 RECEIVER

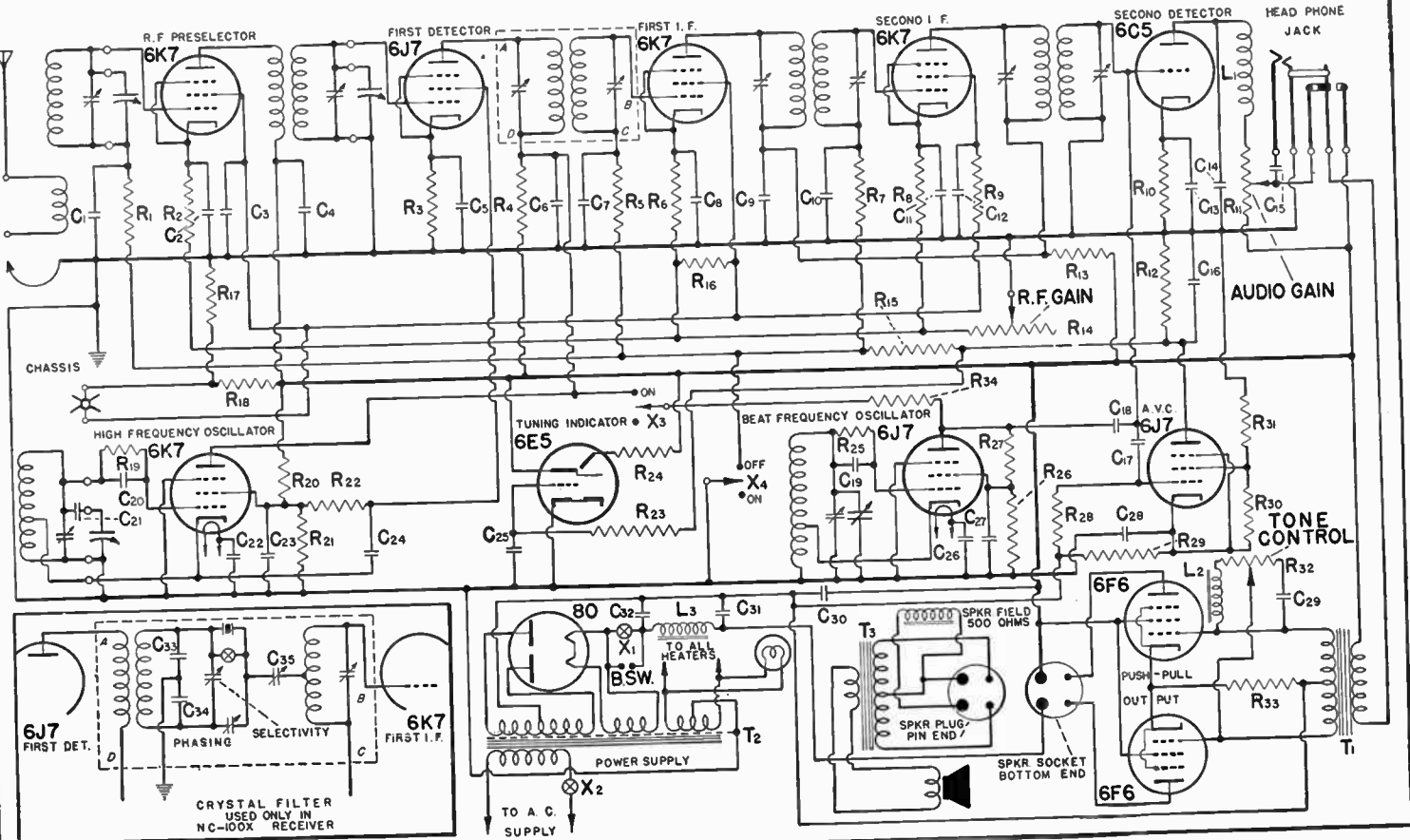

FIG. 5

# SERVICE BUREAU

## Inductance Measurements Next

By Leroy C. Wilson

**S**ERVICING is progressing fast. Only a few years ago practically no service man used an oscilloscope, or was interested in a capacity meter and checker. The next step seems to be a requirement for measurement of inductance. Indeed, some part of this step has been taken, as bridges that include inductance measurements are on the market.

There is one problem that buffaloes practically every service man, and that is superheterodyne tracking, where the inductances are mismatched. The usual procedure is to send the set back to the factory. However, as servicing methods and knowledge improve, the service man sends fewer and fewer sets back to the factory. Sometimes there is no factory to which to send the set. You know how the radio business is.

### PROBLEMS FOR YOU

How can you tell if the coils are wrong?  
How can you distinguish whether the oscillator

coil is wrong, or the r.f. coils are wrong, provided you can establish the fact that they do not match? What is the key to the solution of the coil mystery? Think it over and see if you have any sort of an answer to *that* problem.

Of course the solution depends on being able to measure accurately radio-frequency inductances. Besides, some knowledge must be applied to the inductance facts that the inductance meter brings out. How can you tell what the inductance should be, without knowing under which case the selection was intended to be made? There are three cases: (1), for oscillator minimum trimming capacity exceeding r.f. minimum capacity; (2), for r.f. minimum capacity exceeding oscillator capacity; (3) where the trimming capacity in both instances is deemed to be zero.

Remember that in r.f. inductance measurement the thing that counts is the true inductance, and  
*(Continued on following page)*

*(Continued from page 44)*

well-designed amplifier. The amount of the improvement depends on the selectivity of the i.f. channel, of course. The crystal (single signal) filter represents this idea carried to its logical conclusion.

When static or interference is present, the crystal will make the noise about 100 times weaker, thereby greatly improving the readability of the signal. The crystal is invaluable in communication work for this reason, but it is hardly suitable for broadcast reception, since it rejects most of the sidebands of the signal and tone quality is very poor for this reason.

The last court of appeal in reducing noise is the audio. It is too late to do much at this point, but what little can be done is done on the NC-100. As will be seen by referring to the circuit diagram, the tone control has a tuned circuit instead of the usual condenser. With the tone control dial set at 0, the frequency response of the receiver is flat from 50 to 10,000 cycles. When the control is rotated to the extreme counter-clockwise position, high-frequency cutoff occurs at about 1,500 cycles. Rotated to the extreme clockwise position, low-frequency cutoff starts at 300 cycles, and the characteristic rises about 6 db between 1,000 and 5,000 cycles. When receiving fairly weak signals through considerable interference it is often helpful to

retard the tone control so that the noise will be reduced in comparison with the signal.

So much for the general subject of signal-to-noise ratio. By way of conclusion a brief general description of the receiver is in order.

As is evident from the circuit diagram, the NC-100 is a twelve-tube superheterodyne. It covers all frequencies from 540 to 30,000 kc in five ranges. The circuit employed on all ranges consists of one stage of tuned r.f., separate, tuned first detector, high-frequency oscillator, two i.f. stages, a bias type power detector and a transformer-coupled push-pull pentode output stage. Maximum undistorted output is ten watts. A separate tube is employed to provide amplified and delayed a.v.c. action and a separate beat frequency oscillator is coupled to the second detector for c. w. reception. A built-in power supply provides all voltages required, including excitation for a dynamic speaker field. A 6E5 tube acts as an indicator both when tuning and when using the calibrated r.f. gain control for signal strength measurement.

*[The foregoing gives an insight into the NC-100 Receiver. The engineering and experimental work preceding the finished product is replete with fascinating technical revelations. These are being restudied and classified and will be the subject of an article to be published in an early issue.—EDITOR.]*

(Continued from preceding page)

not the apparent inductance which is a fictitious quantity, since the capacity in circuit, even if only the distributed capacity of the coil, is treated as an inductive reactance, which it distinctly is not. You do not make a capacity an inductance by calling it an inductance.

Just as the capacity problem exists for radio-frequency values, so do problems exist for low-frequency inductance, such as B supply choke coils, speaker fields, etc., including audio transformers that carry considerable primary current. It is well known that the core affects the inductance. With high-permeability material the reduction of inductance with increase of d.c. through the winding is very considerable. With all devices it is ratable. Therefore it becomes necessary to measure the inductance under actual conditions of loading, that is, with d.c. flowing that actually flows when the coil is in its operating condition in a set, with the superimposed a.c. present likewise. In other words, the inductance meter should be able to measure the inductance of the field or choke or transformer not only without removing any part from the set, or unsoldering a single wire, but rather when the full set is working, and the normal operation conditions, currents and voltages prevail.

## Ray Tube Sensitivity Aids Measuring Devices

Here is a flexible device of compact construction which has been designed for the measurement of capacitances and resistances. It has a built-in rectifier, a condenser filter, and a voltage divider.

The rectifier is a 1-V heater type tube. Visual indications are employed. For some measurements a ray indicator tube, a 6E5 tube, is used. This tube is very sensitive to changes in voltage on its grid.

The other indicator is a neon tube, which is used for other tests and measurements. By means of an intricate, yet convenient, switching arrangement different ranges for both capacitances and resistance can be selected. There are three terminals for connecting the unknown.

Of these the red is common for both resistance and capacitance measurements. The other terminals are appropriately marked with RES. and COND.

Besides the provision for d.c. supply for strictly direct current measurements, there is also provision for using 60-cycle a.c.

MENNOHIN W. GRAVALOT,  
Boston, Mass.

A handy capacitance and resistance bridge for measuring with either alternating or direct current. A ray indicator tube is employed for showing balance. An alternative method for certain tests is a neon tube indicator.

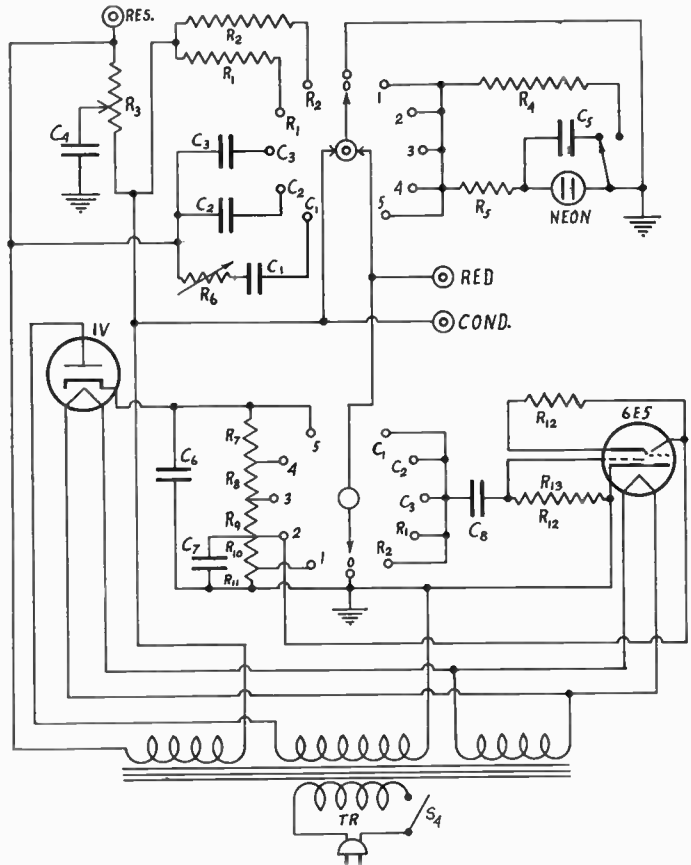

# Radio Treasure Quest

## Circuits and Methods for Wrestling Precious Secrets from Earth

By J. E. Anderson

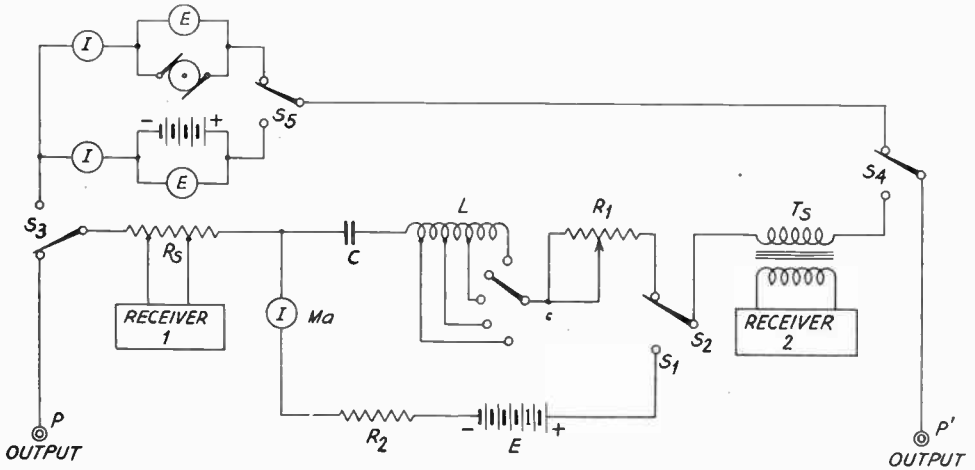

FIG. 31

The impulse generating circuit together with means for measuring the a-c impedance and the d-c resistance of the earth between the two grounded electrodes.

*This is the third and final instalment of J. E. Anderson's notable article on radio circuits for treasure-seeking. Next month a general, comparative article will conclude his discussion of this absorbing topic.—EDITOR.*

of the current,  $R$  the ground resistance between the two grounded electrodes in the receiving instrument,  $I$  is the effective value of the current pulse during the time  $T$ . By measuring this energy at many points in the field under similar conditions, it is possible to determine the nature of the soil under the surface, for the presence of any conducting bodies will be indicated by a marked distortion of the current flow lines.

### TRANSMITTING CIRCUIT

**A** METHOD of locating mineral deposits and electrically conducting bodies underground based on the sudden transmission of an intense current pulse through the ground has also been devised by Jakosky. The current pulse, which may be that of the discharge of a large condenser charged to a high voltage, is impressed on the earth between two metal rods driven into the ground at a suitable distance apart. The ground between the two metal stakes is then explored by means of a receiver which has been designed so that it integrates the current pulse, for example, a ballistic galvanometer. By means of such an instrument, or a similar one, it is an easy matter to measure the energy of the received pulse; for the energy is equal to the time integral during a time  $T$  seconds of  $Ri^2dt$ , or to  $I^2RT$ . In this  $i$  is the instantaneous value

The circuit in Fig. 31 is a suitable arrangement for generating the high current pulses and for impressing them between two points in the ground, marked  $P$  and  $P'$  and labeled output. Provision is made for impressing either a pure direct current or an alternating current. The choice between the two is made by switch  $S_5$ . The purpose of these is to enable the operator to measure either the d-c resistance  $R$  between the two grounded points or the a-c impedance  $Z$ , or both. Appropriate instruments are incorporated in the circuit for measuring the currents and voltages required. When either of these circuits are to be used, the switches  $S_2$  and  $S_4$  are set so that  $P$  and  $P'$  are included in the circuit.

The condenser which holds the charge is  $C$ .



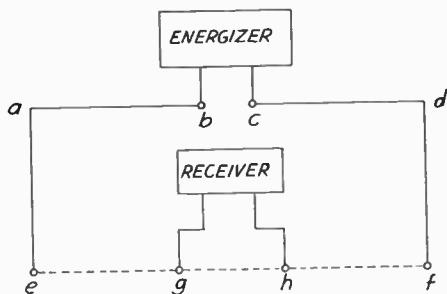

FIG. 32

A simplified sketch showing the arrangement of the energizer circuit and the receiver circuit. The grounded electrodes are shown along the dotted line.

It should have a large value. It is charged through a variable inductance coil  $L$ , a variable resistor  $R_1$ , and a limiting resistor  $R_2$ . The battery  $E$  is the charging battery and the milliammeter  $Ma$  measures the current. The purpose of  $L$  and the variable resistor  $R_1$  is to change the rate of discharge of the condenser and thus to change the shape of the current pulse during the discharge period. The switch connected to  $R_1$  is set at  $S_1$  for charging and at  $S_2$  for discharging. This switch is arranged so that the charging and discharging can be done rapidly.

**SIMPLIFIED SCHEMATIC**

In Fig. 32 is shown a simplified layout of the transmitter and the receiver. Two leads from the energizer, or transmitter, run parallel to  $b$  and  $c$  and thence the two wires run in opposite directions to points  $a$  and  $d$ . Thence the leads are run to the grounded stakes, here indicated by  $e$  and  $f$ . The lines  $ae$  and  $df$  are at right angles to the lines  $abcd$  and  $eghf$ . The two end lines which appear to be vertical are really lying on the ground.

The receiver is arranged the same as the transmitter but its leads are shorter. This distance  $gh$  between the grounded receiver stakes is small compared with the distance  $ef$  between the grounded transmitter stakes. The midway point between  $g$  and  $h$  is also the midway point between  $e$  and  $f$ , but the receiver stakes are not always on the line joining the transmitter stakes. They may be on lines parallel with  $ef$ .

A sectional view of a portion of the earth being studied, together with the arrangement of the transmitter and receiver circuits, is shown in Fig. 33. Directly under the survey equipment is assumed to be a conducting layer or a metal pipe. The dotted lines show the course the current pulses will take. Since the conducting layer or pipe has a much higher electrical conductivity than the surrounding earth, most of electrical current will flow directly down to the conductor rather than flow through the earth above the conductor. If the earth under the equipment were homogeneous, the current would follow the geometrically shortest path, for this then would also be the electrically

shortest path. In the figure the end lines of the transmitter and the receiver appear to run upward. Actually they are horizontal.

**METHODS OF DETECTING**

In the preceding figures the receiver was connected conductively to ground. But there are other methods in which the effect of any buried conductor may be studied. For example, instead of measuring the current pulses picked up by two grounded electrodes, the electric or the magnetic field may be measured at the observation points. If the electric field is to be measured, the use of a Hertzian doublet antenna is indicated; and if the magnetic field is to be measured, a loop is the proper means for getting an indication.

The magnetic method is illustrated in Fig. 34.  $SS'$  is the surface of the earth in the neighborhood of the observation points.  $CC'$  is the center of the buried conducting body or a pipe. The

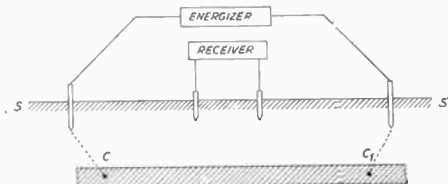

FIG. 33

A section of the earth below the receiving and transmitting equipment showing the relative positions of the ground electrodes. A conducting layer under the surface is also represented.

point of observation is directly above  $CC'$ . The point  $abcd$  on the surface is a section of the lead similarly marked in Fig. 32. A magnetic field exists about  $abcd$  as is indicated by the concentric circles. This field is due to the flow of the electric pulses in the conductor from  $a$  to  $d$ . Since the conductor lies on the ground, the magnetic field on the ground at the observation point  $O$  will be vertical, and this vertical component is indicated by  $F_v$ .

(Continued on following page)

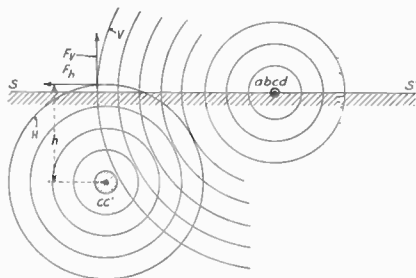

FIG. 34

This shows the primary and secondary magnetic fields, the first about the above ground conductor and the second about the buried one. The vertical,  $F_v$ , and horizontal  $F_h$  components of the field can be measured separately on the surface.

(Continued from preceding page)

There is also a magnetic field about  $CC'$  because the conductor carries current. This may be either the result of induction or of conduction, or a combination of the two. If the observation point is directly over  $CC'$  the magnetic field at the surface due to the current in  $CC'$  will be horizontal. It is indicated by  $F_h$ .

The two field components  $F_v$  and  $F_h$  may be separately measured by means of a loop provided it is placed properly, or their resultant may be measured with the loop. The loop placed for maximum signal will give the direction of the resultant; and the current induced in the loop will give the intensity which may be measured with a ballistic magnetometer directly or with a ballistic galvanometer in conjunction with a suitable rectifier.

A ballistic galvanometer or magnetometer is an instrument in which the period of swing of

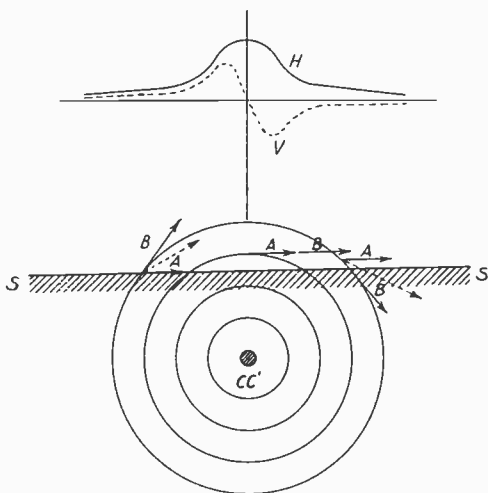

FIG. 35

This shows the variations in the vertical and horizontal components of the magnetic field as the observer moves on the surface at right angles to the buried conductor.

the movable coil or of the swinging magnet is very long compared with the time it takes the current pulse to discharge. The effect, whether it be a current pulse or a magnetic pulse, is over before the moving element has had time to move through any appreciable angle. Under such conditions, and if the damping is negligible, the total deflection is proportional to the quantity of electricity that flows.

### FINDING CONDUCTOR CENTER

In Fig. 35 is illustrated the method used for determining the center of the conductor underground.  $SS'$  is the surface of the earth in the immediate vicinity of the tests.  $CC'$  is the center of the conductor. The magnetic field about this conductor is represented by a number of concentric circles. Suppose we measure the vertical and horizontal components of the field

at the left of the center of the conductor. If the field from the  $ad$  part of the circuit is pointing toward the right, which it will for a certain polarity of the current, it is clear that the direction of the resultant magnetic field will point upward and toward the right. The horizontal component will be composed of the magnetic field due to the primary current, which is all horizontal, and the horizontal component of the secondary field. At the extreme left this will be mostly vertical and therefore the resultant field will point sharply upward. As we move toward the right and toward the center of the conductor, the direction of the resultant magnetic field will change until at a point directly over the center of the buried conductor it will be horizontal for then both the primary and the secondary fields are horizontal.

The magnetic field due to the primary conductor remains constant along the line of measurement, which is at right angles to the line joining the two grounded electrodes of the transmitter, and it also remains horizontal. Hence the variation in direction and magnitude of the resultant is due to the variation in the secondary field alone. The expected variations in the vertical and horizontal components of the resultant field are shown in the sketch directly over the magnetic field illustration in Fig. 35,  $H$  being the horizontal and  $V$  the vertical components. In order to coordinate the magnetic field figure with the graph, the axis of ordinates has been drawn so that it passes through the center of the buried conductor.

### ALWAYS POSITIVE

It will be noticed that the horizontal component  $H$  plots into a curve that is symmetrical about the axis of ordinates, and that it is always positive, that is, always points in the upward direction. From left to right, the intensity first increases slowly and then more rapidly, coming to a maximum at a point directly over the buried conductor. Then it decreases in exactly the same way as it increased. The vertical component  $V$  also increases, from left to right, but it attains its maximum value at a point to the left of the conductor. Then it decreases rapidly, reaching zero at the point directly over the buried body. At this point the field changes sign, as the magnetic field points downward instead of upward. The curve in the fourth quadrant is just like that in the second except that the sign is reversed. The vertical component, therefore, is symmetrical about the origin.

It is clear that the location of the buried conductor can be determined by measuring either the vertical or the horizontal component. If the horizontal component is determined, the instrument will be directly over the conductor when the intensity of the field is greatest; if the vertical component is measured, the instrument will be directly over the buried body when the intensity is zero. As in all measurements of the kind, the most accurate readings will be obtained when the no-intensity position is determined.

It will be noticed that if the observations are made directly on the resultant field, the read-

ings will be maximum when the loop is directly above the conductor and then the field will be horizontal. In order to measure the resultant it will be necessary to have a loop that can be rotated about a horizontal axis parallel with the long dimension of the underground conductor. At the point of maximum signal strength, that is, directly over the conductor, the plane of the loop will be vertical. It then points to the buried conductor. If it were not for the influence of the steady horizontal component, the loop would always point directly to the conductor when set for maximum signal.

### METHOD OF TAKING A SURVEY

In exploring a region by the present method the transmitter should be set up at any suitable place in the field, with the two grounded electrodes considerable distance apart, say 1,000

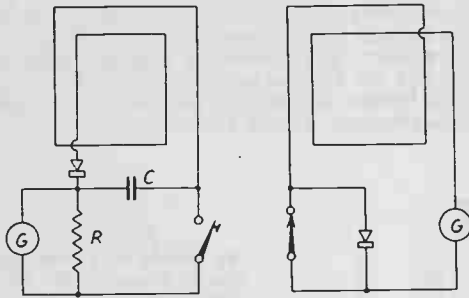

FIG. 36

Two loops, with rectifiers and galvanometers, by means of which the vertical and horizontal components of the magnetic field can be measured.

feet. Then field measurements should be made in the neighborhood of the center of the system, that is, half way between the two stakes. These should first be made in line with the stakes and then in lines parallel with that line, on both sides of it. The points of measurement should be at intersections of coordinate lines suitably spaced in both directions. Afterward the data collected should be entered on graphs, such as that illustrated, and the information gleaned from these graphs should be collated. If the maximum of the resultant field does not fall on the same coordinate line on all the graphs, it means that the long dimension of the buried conductor is running at an angle with these lines. The course of the conductor can be easily traced. Moreover, when it becomes necessary to move the transmitting apparatus, the positions of these maxima will indicate in which direction to move it in order to follow the conductor. The second time the equipment is set up, and on succeeding times, it is well to set the grounded stakes so that the line between them is at right angles with the axis of the conductor.

In Fig. 36 are shown two loop-detector combinations suitable for receiving the pulses sent out by the equipment in Fig. 31, especially for

magnetic field measurements. A crystal rectifier is indicated in each case but any other type of rectifier will do just as well. Loops are more suitable for reception of alternating current signals, but they can also be used for transients, such as those of the discharge of a condenser. There is nothing against the use of oscillatory discharges, of course. They might be made such by reducing the resistance in series with the charged condenser. The frequency of the oscillatory discharge will then depend on the capacity of the condenser, the inductance in the circuit, and to some extent on the resistance. The duration of an oscillatory discharge can be varied by means of resistance variation. The lower the resistance the longer a discharge will last.

### A RECEIVING CIRCUIT

Fig. 37 shows details of a receiving circuit in which the detector is conductively connected to the earth. *G* is a ballistic galvanometer in series with the two grounded electrodes *g* and *h*. The only essential part in the circuit above ground is the galvanometer. The rest of the circuit is therefore convenience. Thus there is a condenser *C* which may be cut into the circuit to block the current in case the potential difference between the grounded electrodes is excessively high. This condenser may be cut into the circuit by opening the switch connected across it. There is also a condenser *C*<sub>0</sub> in shunt with the galvanometer, which may be disconnected by opening a switch. *C*<sub>0</sub> is a shunt to cut down the portion of the current pulses that goes into the galvanometer. A damping resistance may also be connected across the galvanometer, in place of *C*<sub>0</sub>, by means of the switch. This alters the period of swing of the instrument and the length of time it swings after it has received a given impulse.

There is also a provision in the circuit for balancing out the effect of stray earth potentials. A low voltage battery *E* is provided for this purpose together with a potentiometer across it by means of which any desired portion of the battery voltage may be connected in series with the galvanometer. Since the earth potential may be in either direction in respect to the desired potential between *g* and *h*, a reversing switch is inserted in the circuit. The earth potentials are balanced out when, with the switch across *C* closed, there is no steady deflection in the galvanometer.

### DISTINCTIVE FEATURES OF METHOD

The distinguishing features of this method of exploring for buried treasure is the use of a high current pulse of short duration and ballistic instruments for measuring its effect at various points in the area to be prospected for minerals or other conductors. In respect to the method of impressing the signals on the ground, this method is similar to other methods employing conductive coupling between the transmitter and the ground. In respect to the layout of the field for observation points, this method is like all other methods, because the points may

(Continued on following page)

(Continued on following page)

be laid out either on Cartesian or polar coordinates. The square layout is the simplest to use and for that reason is the one most generally employed.

In order to get very large current pulses into the ground it is necessary not only to have a condenser of very large capacity but also to have a very high voltage for charging it. The condenser, of course, must be able to stand the high voltage used.

The quantity of electricity that can be impressed on a condenser is equal to the product of the capacity and the voltage to which the condenser is charged. Thus if  $Q$  is the capacity in coulombs,  $V$  the voltage in volts, and  $C$  the capacity in farads, we have the relation  $Q = CV$ . If this quantity is discharged in a time  $T$  seconds, at a uniform rate, the electric current is  $I = CV/T$ . Now suppose that the discharge occurs in a tenth of a second, that the voltage is 500 volts, and that the capacity of the condenser is 10 mfd. The mean current during the one-tenth second will then be 50 milliamperes. The maximum current, which occurs at the start of the discharge is many times higher than the mean current.

struments are costly and not easily portable. The trouble is not that they are heavy and cumbersome but that they are delicate and require careful mounting and leveling before they will give correct readings. Their high cost, perhaps, rules them out of use in many cases where this method of prospecting could be advantageously used.

The illustrative drawings showing the resultant magnetic field have been based on the presence of a definite conductor in the ground, such as a pipe line, an electrical conductor, or an elongated orebody having a high conductivity. But there are many valuable deposits which are no conductors at all, but rather insulators, and very few natural deposits are elongated like a pipe even if they are conductive. The method may still be used, however, even when the mineral is not a conductor, or when it is not an elongated body. It will work in any case where there is a pronounced inhomogeneity of electrical conductivity. Even if the mineral under ground is a perfect insulator, its presence will disturb the magnetic field set up, and the location and nature of such a body then become a matter of interpreting the field data obtained. It will take experience to draw

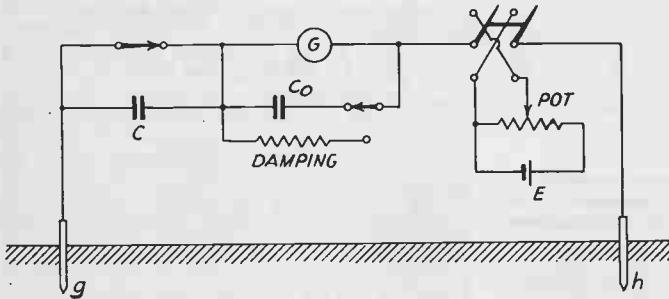

FIG. 37  
The details of a receiving circuit designed for conductive coupling between the ballistic galvanometer  $G$  and the energized ground. A potentiometer, with a battery, is provided for compensating earth potentials.

The actual value of a current pulse, and hence of the magnetic field, as received at any observation point depends not only on the discharge current but also on the distribution of the current after it has entered the ground. In the first place the discharge current depends on the resistance in the ground as well as on the resistance of that part of the circuit which is above ground. Since there is no way of changing the resistance in the ground to increase or decrease the current provision is made in the above-ground circuit. About the only way of increasing the pulses for a given condenser is to increase the voltage of the battery used for charging.

#### DISADVANTAGES OF METHOD

This current pulse method of exploring the sub-soil for conductors is not free from faults. Perhaps the gravest is the need of a ballistic receiving instrument of some kind, either a magnetometer for measuring directly the magnetic field set up or a galvanometer by means of which the field strength can be measured with a loop and a rectifier circuit. Such in-

struments are costly and not easily portable. The trouble is not that they are heavy and cumbersome but that they are delicate and require careful mounting and leveling before they will give correct readings. Their high cost, perhaps, rules them out of use in many cases where this method of prospecting could be advantageously used.

While hundreds of patents on geophysical exploration devices have been granted, and the claims in them run into thousands, there is a remarkable uniformity of method. An electromagnetic field is set up in the area to be explored and the disturbance in that field is measured at many points in the area.

## WGY Asks 500 Kilowatts

Schenectady, N. Y.

The General Electric Company, owners of station WGY, KOA and KGO and pioneers in radio broadcastings, has filed an application with the Federal Communications Commission asking permission to increase the power of WGY in Schenectady from 50 to 500 kilowatts. Along with this petition on General Electric Company asked permission to remove its transmitter station from the South Schenectady plot on the Mariaville road to some other location yet to be determined.

# Frequency Modulation

## Poses Some Impressive Problems

By Einar Andrews

**F**REQUENCY modulation has been studied for a good many years, yet few applications of it have been made in the communication art. The reason for this, no doubt, is difficulty in effecting the applications. Maj. Edwin H. Armstrong published a paper on the subject and demonstrated the theory by means of a circuit. It was extremely complex. This fact was the only one that left any impression on some who heard the paper read and saw the demonstration. In view of the many claimed advantages of this method, some practical applications of the principle should soon be brought out. One of the outstanding advantages of the scheme is that an extremely high selectivity is possible, and that without the sacrifice of side band frequencies. Just what is frequency modulation and in what manner does it differ from amplitude modulation?

In amplitude modulation the amplitude of the carrier frequency current varies according to the amplitude of the modulation frequency. The envelope of the trace has the same shape as the modulating wave. After detection, the output is a wave of the modulating frequency.

### SOME PROBLEMS POSED

In frequency modulation the carrier amplitude remains constant and the frequency is varied according to the intensity of the modulating frequency wave. The envelope consists of straight lines. The theory of this method of modulation, though it is very complex relatively, is sound, but there are difficulties.

Suppose, for example, we have an audio current of amplitude  $I$ . This is used for modulating the frequency of a radio-frequency carrier. After detection, the output is proportional to  $I$ . Is the frequency the same as that of the  $I$  current, or is it the same as that of some other current that happens to have the same intensity as  $I$ ? There is one difficulty.

Suppose the frequency modulation is the other way about. The carrier amplitude remains constant and so does that of the modulating frequency. The frequency of the carrier, however, is varied according to the frequency of the modulating wave. After detecting this signal the output is of the modulating wave frequency. But how about the amplitude? Is that the same for all waves of all frequencies? If so, how is the intensity of one sound distinguished from that of another? Well, there is another difficulty.

### DEPTH OF MODULATION

One way of obtaining frequency modulation is to vibrate one plate of a condenser by means of a loudspeaker or by means of the microphone directly, and then make this condenser a part of the oscillating circuit.

Thus, as the sound intensity increases, the

frequency is either increased or decreased, depending on the details of the arrangement. But the greater the intensity of the driving current of the condenser, the greater is the range of the frequency modulation. This fact can be made to express intensity differences in the detected sound.

Frequency differences, of course, can be expressed by the rate at which the frequency modulating goes through complete changes, or cycles. The depth of modulation, then, is determined by the range of frequency modulation, whereas the frequency of the modulation is determined by the rate at which the depth cycles change, regardless of the amplitude of the depths.

## Ready to Cheer for "Systematic Servicing", But Not Quite Yet

A systematic servicing method, an idea proposed in last month's *RADIO WORLD*, would be fine if it could be accomplished, but I have my doubts. Receivers are not of just one kind. There is no end to the variety. The system would have no end, either, as it would have to be longer than the problem. That is the rigorous rule for every remedy. It must outrun the ailment.

Nevertheless I appreciate the courage behind the idea Herman Bernard proposed, and if the system can be developed I'm for it. That is, I am always on the winner's side after he has won, although I may have voted for the loser. I vote that the "system" will lose. You can outvote me, and others like me, by developing a system. I do not expect that to be done overnight.

When I get a set to repair first of all I check the tubes, in a tube checker, outside the set, free from bad influences. That might be Step No. 1 of your expected system. Then I check for shorts and low resistances (partly shorted constants) and for opens. All this is done of course without voltaging the receiver. There is Step No. 2. Now for No. 3, the quest is for unusual troubles, e. g., electrolysis in i.f. transformers, low  $Q$  coils etc. You see, to get only to Step 3 you (or I) need an oscilloscope and a  $Q$  meter, apparatus not a large percentage of service men possess.

I hesitate like the dickens to turn on the set to determine whether it does play, as that is risky, but sometimes I have to do that against my will.

GASTON V. QUELLETIER.  
Des Moines, Ia.

# RADIO CONSTRUCTION UNIVERSITY

Answers to Questions on the Building and Servicing of Radio and Allied Devices.

## SINGLE-TUBE MULTIVIBRATOR

I WAS glad to see a twin-tube multivibrator described in Radio University last month. Such a device, though with two separate tubes, has been used by me for a long time, and it is an excellent audio oscillator, performing as you set forth. I was wondering whether you could print a circuit of a one-tube device of this nature, that is, not even twin tubes in one envelope, but just a single tube in a single envelope?—O. W. D.

Yes, this is entirely feasible, and the method was described in the March 2d, 1935, issue of RADIO WORLD. The standard multivibrator, be-

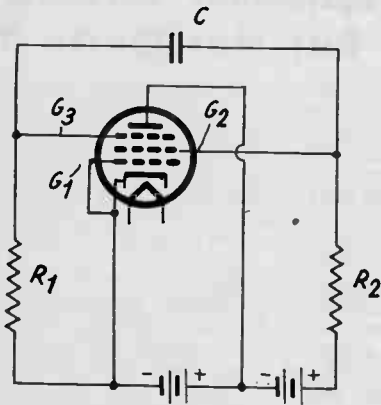

The one-tube multivibrator. The audio frequency generated equals approximately  $.159/[R_1 R_2 C (C_p + C_s)]^{1/2}$  where  $R$  is in megohms and  $C$  in microfarads.

ing a two-tube resistance-capacity-coupled device, back-coupled to produce oscillation, is such only because the grid and plate phases in a single tube are opposite. If, however, the tube is set up as a negative resistance oscillator, say, of the current-controlled relaxation type, where the phenomenon does not depend on secondary emission, there will be the same practically free inertia. The tubes that lend themselves to such use are the 6C6, 57, 77 and 6J7. The suppressor grid has to be brought out independently in the tube manufacture, and such is done with these tubes. The screen is used as the effective plate, at the highest B voltage, while the formal plate is returned to a lower voltage, plate current not utilized; also, the

normal control grid may be used for attenuation purposes, while the suppressor grid serves as the real control grid, to which the screen circuit, or effective plate, is coupled through a condenser, as diagramed. The phase inversion accomplished by two tubes in the formal multivibrator to produce oscillation is unnecessary. The No. 3 grid, normal suppressor, now used as control grid, when made more negative deflects electrons toward the cathode and thus the plate current decreases. The formal plate is meant, and, as stated, the current in this circuit is not utilized. Some of the electrons rebounding toward the cathode, however, are attracted to the positively-voltaged screen, which serves as the true plate, and the current in this branch then increases. Now, ignoring the formal plate, which is effectively grounded, and comparing Grid No. 3 to Grid No. 2, or formal suppressor to formal screen, when the suppressor voltage is made more negative, or decreases, the screen current increases. This proves the existence of the negative resistance characteristic. One need only consider Grid No. 2 as the plate and Grid No. 3 as the control grid to see that there exists a negative grid-plate transconductance. The amount of negative bias on Grid No. 1 may be varied to affect the quantity of oscillation output, and the output device may be connected in series with the Grid No. 3.

\* \* \*

## HIGH GAIN COILS IN SUPER

MY home-built superheterodyne did not have quite as much pep as I expected, so I took out the two r. f. coils, with their small or low-gain primaries, and I put in coils with high-gain primaries. The pair is practically standard. The antenna coil has a large honeycomb primary inductively related to the secondary, and besides two turns of wire brought from the antenna side of the primary around the secondary, other end of this small winding free, as the capacity effect alone is intended to be utilized. The interstage coil has a relatively high inductance primary, a honeycomb, non-inductively situated inside the secondary, with the capacity coupling through the two turns. My trouble is that I tune in some local stations at two places on the dial, the set overloads badly, and while one might roughly say the theoretical sensitivity has increased, the practical sensitivity has not, as I do not get more volume except from 700 kc to 530 kc, than I did before. Can you suggest a remedy?—C. R. D.

The gain at the r. f. level has been increased greatly, in fact, too much, for the conditions that prevail. You said nothing about automatic volume control, but if high-gain coils are used on the standard broadcast band, a. v. c. must be included for all i. f. stages, and should be applied also to the modulator input. However, that may be the state of affairs already existing. Therefore you are using an antenna input far too strong for the receiver and will find that if you shorten the aerial very materially, either physically, or electrically, by insertion of a small capacity series condenser, your overload trouble will disappear. This is the same cause that produces the two-point response for strong locals. If you live in a locality where there are numerous broadcasting stations, the antenna may have to be reduced to a few feet, or the series condenser may have to be as small as 50 mmfd. A little experimenting will yield the correct constants readily. You did not say that when the volume control is turned all the way up on strong locals, reception almost stops, or becomes greatly distorted, but this condition would be concomitant with the other. The one remedy should cure all troubles.

\* \* \*

### THREE OR FOUR GANGS?

SOMEbody asked you a few months ago about the use of three-gang and four-gang condensers, and, as I recall it, you did not specially state which theory was right. You said some manufacturers use four gangs on the standard broadcast band, three gangs on lower and higher frequencies, while others use four gangs on the highest frequency band only, three gangs on the rest, and it was a matter of engineering opinion which choice should prevail. Can you be more definite this time?—R. D.

We were quite definite the last time in stating that the selection depended on the importance the design engineer attached to the bands under consideration. We did not state which band we considered the most important to us, if economy required any restriction, but are free to declare it to be the standard broadcast band, and it is here we would prefer four gangs. The reason is the better image rejection and improved inter-channel selectivity, hence reduction of chirps, squeals, howls and

birdies in tuning. Since highest quality is expected only on this band the device for attaining greatest freedom from interference, hence permitting no interfering with quality, should be in this band. If the circuit is so designed as to produce the necessary freedom from interference on this band, and economy requires that the number of coils be reduced, hence four gangs can not be used on more than one band, then that band naturally would be the highest frequency one, where the need for image suppression is greatest, for the suppression becomes less the higher the station frequencies, because the object and image frequencies differ by a much smaller percentage of the intermediate frequency. Waiving the consideration of economy, of course it is best to have four gangs on all bands, as especially as the band one considers most important may not be the same one so somebody else so considers, and the best possible performance on all bands is the logical engineering choice.

\* \* \*

### I. F. COILS COMPARED

IS there a substantial advantage in the use of air-dielectric i. f. transformers over mica-dielectric compression type, also pie-wound coils in i. f. transformers over plain-wound, also metal-core i. f. over air-core?—K. W. C.

The air-dielectric type condenser is far preferable because the capacity stays put, hence the sensitivity of the i. f. channel remains uniform. The mica type has its good uses, especially where economical considerations are important, but is more subject to change due to meteorological and vibrational causes. The pie-wound method is used where the coil inductance has to be relatively large, the shield relatively small, so that the cross-sectional distance of the winding is reduced, due to distribution among several coils, hence coils are not so close to the shield, and losses less. This may not be very important in some i. f. channels where there is more gain obtainable than can be fully utilized. The metal-core coils permit less wire for a given inductance, hence also improves the coil Q.

\* \* \*

### INDUCTANCE MEASUREMENT

WHICH is the simplest of the r. f. inductance measurement methods you have outlined in a series of articles just concluded (July,

$$1600 \text{ KC} + 465 \text{ KC} = 2065 \text{ KC}$$

$$465/1600 = 29\%$$

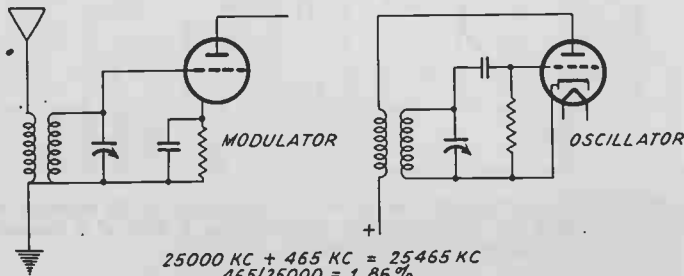

The modulator and oscillator circuits of a superheterodyne are symbolized. For the standard broadcast band's highest frequency to ratio of the difference between modulator and oscillator frequencies to the carrier is 29%. For 25 megacycles the percentage is only 1.86. The smaller the percentage the greater the need for pre-selection.

(Continued from preceding page)

August, September and October, 1936)? Your recommendation would be appreciated.—D. M.

Measure the wavelength of a circuit in which the coil is put in parallel, with any or no external capacity across it, square this wavelength, then add 281.73 mmfd. across the circuit, measuring the new wavelength, square this also, subtract the smaller from the larger squared term and the answer is the inductance in centimeters. For microhenries divide by 1,000. The method measures the true or pure inductance and eliminates the effect of the distributed capacity, which effect influences the apparent inductance.

\* \* \*

**ACCURACY, DIAL VS CURVE**

**I**N general, can greater accuracy be obtained from reading a dial or from reading a curve? —W. D.

Greater accuracy obtains from reading a dial. First of all, the curve is based on dial readings, hence can not be more accurate than them. Moreover, a precision dial may be read to one part in 1,000, but it is impractical to have a sheet large enough to permit curve readings to much better than one part in a hundred. So the dial may be ten times more accurate (.1 per cent error) compared to the curve (1 per cent error).

\* \* \*

**CAPACITY TESTER**

**W**HAT is the type of capacity tester that tells you the magnitude of the capacity to put in any circuit to accomplish the desired end?—L. W. D.

The tester you refer to has various condensers in it, of different capacities, and these are switched into circuit, so that the capacity required for a replacement can be determined on the basis of results in the receiver. The diagram herewith represents such a tester and follows a commercial product, the one manufactured by Sprague.

\* \* \*

**ANTENNA IMPEDANCE**

**K**INDLY state the impedance test for a tuned transmitting antenna, giving the formula.—K. R.

If the antenna input is tuned, the impedance is resistive. This condition exists when the an-

tenna leads form a smooth line, the terminals being chosen at a current node or antinode. The input resistance then may be obtained by the use of a second section of smooth line whose length is equal to a quarter wavelength and whose characteristic impedance  $Z_0$  is any convenient value. The second section of smooth line is connected between the antenna input leads and the source of power. A device for measuring current or voltage is introduced at each end of the auxiliary line. If the currents or voltages so read are designated  $I$  and  $E$ , and the subscripts  $n$  and  $f$  are used, respectively, to denote the ends of the line nearer to or farther from the transmitter, the antenna impedance is given by the following expressions:

$$Z_r = \frac{Z_0 I_n}{I_f} = \frac{Z_0 E_r}{E_n}$$

where  $Z_r$  is the antenna impedance and  $Z_0$  is the characteristic impedance.

\* \* \*

**BALLYHOO SILENCER**

**W**HAT is a ballyhoo silencer and may it be incorporated externally to a set to improve reception?—M. S.

A ballyhoo silencer is a switching device, usually across the antenna input of a set, connected thereto by long leads that permit "remote control" of the set's input. When an announcer on a sponsored program starts to deliver his sales talk which some call ballyhoo, the switch is closed, and nothing is heard, a guess being made as to the duration of the sales talk, when the switch is opened and the program heard again. It does not seem right to listen to a program for which a sponsor pays and then to refuse even to listen to his representative's encouragement to buy the product or service.

\* \* \*

**EMISSION DEFINED**

**K**INDLY define and distinguish thermionic emission and electron emission, also define secondary emission.—W. C. H.

Thermionic emission is the emission of electrons or ions under the influence of heat. Electron emission is the liberation of electrons from an electrode into the surrounding space. In a vacuum tube electron emission is the rate at which the electrons are emitted from a cathode,

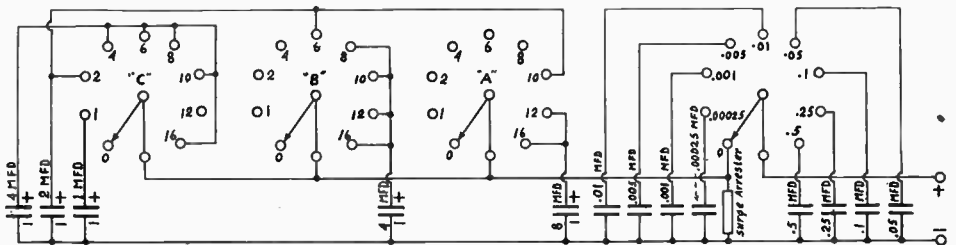

By switching various capacities into circuit, starting with the lowest, the magnitude of the capacity required to do a particular filtering or bypassing job is determined. The diagram is that of a commercial product, manufactured by Sprague.



ordinarily measured as the current carried by the electrons under the influence of a potential sufficient to draw away all the electrons. Thus when the full cathode or filament emission is attracted to the plate, the plate current is equal to the emission current. Secondary emission is electron emission under the influence of electron or ion bombardment. Hence when electrons are drawn from the cathode to the plate under the influence of the plate polarizing potential, some of them rebound from the plate and thus, moving in the opposite direction to normal, diminish the plate current and limit the plate efficiency.

\* \* \*

### SIGNAL GENERATOR ACCURACY

**H**OW can the accuracy of a signal generator be improved to such an extent that one may rely on the measurement even of a short-wave station's frequency, as determined by the generator?—L. W.

The reliability of a signal generator is upset as some high frequency is approached where the inconstancy of the tube and circuit have a noticeable effect on the frequency of generation. Thus, at low frequencies slight input capacity and plate resistance changes, as take place during operation, and even d.c. voltage changes, do not affect the frequency much. To around 10 mc or so the stability of the oscillator therefore may be excellent, and the problem of accuracy becomes largely a mechanical one, relating to the accuracy to which the dial may be read, the permanence of the relationship of dial to the condenser, and the absence of parallax in reading. The capacity range of the condenser, or difference between maximum and minimum capacity, should be smaller than in commercial receivers. A resultant frequency ratio of 2 to 1 might be considered maximum, especially as the accuracy to which the calibration may be made depends inversely on the magnitude of the frequency or capacity ratio. So a .0001 mfd. variable condenser, or other arrangement to reduce the frequency or capacity ratio, is a great aid to accuracy. For stabilization purposes various schemes may be used, but few of them apply to variable frequency oscillators. A stabilized Colpitts, variable in frequencies, is practical, and for extremely accurate work a temperature oven may be desirable. This works on a relay principle to maintain the temperature about the tube and parts constant.

\* \* \*

### LOW-RANGE TUBE VOLTMETER

**K**INDLY show a very simple tube voltmeter, using a 30 tube and low plate voltage, without grid biasing battery, also give directions for calibration.—O. W.

The diagram shows the tube voltmeter you request. With no resistor in the negative filament leg, and grid connected directly to negative filament, hence to minus A, note the plate current reading. Next connect grid to minus A through the resistor of several megohms. If there is a plate current reduction it is due to grid current. Insert a fixed resistor in the negative filament leg of such value (several

ohms) that there is no change in plate current now, comparing grid returned directly to negative A (not negative filament this time) and return indirectly to the same point through the resistor. The filament voltage originally adjusted to exactly two volts is readjusted by using less resistance of the 30-ohm rheostat to restore the two full volts. Measure the drop across the negative filament resistor. Since this is a very small resistance, a few ohms, the

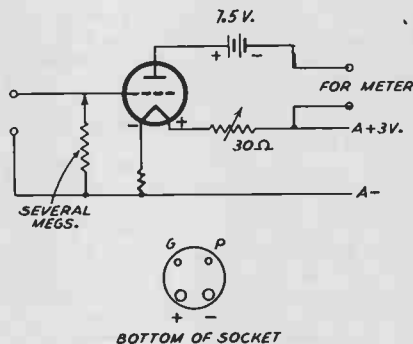

Simple tube voltmeter, using low plate voltage, no grid biasing battery, and providing a low a.c. voltage range, around .5 volt maximum.

drop will be about a quarter of a volt or so. Any increase in this drop, by using more resistance, say, until the plate current is nearly zero, when the 30-ohms also are reduced to re-establish two volts across the filament, establishes the range. This may be around half a volt. When the same d.c. voltage as the drop across the negative filament resistor is introduced in reverse between grid and A minus (positive of cell to grid, and a potentiometer taking off fractional volts), and the voltage bias for stopping grid current, previously found, as around a quarter volt, is subtracted, the maximum peak voltage measurable is approximated. The r.m.s. value would be .707 of the peak. Calibration methods need not be repeated here, as they were discussed in last month's article on tube voltmeters. Please read carefully the directions therein given.

\* \* \*

### POSITIVE MU OSCILLATOR

**I**N the dynatron oscillator is the mu negative or positive? What is the answer in respect to the oscillator, also of the negative resistance type, that does not depend on secondary emission?—O. B.

In the dynatron the mu does not figure. In the other the mu is positive.

### THE ANTENNA PRIMARY

Small or medium antenna primaries are preferable for superheterodynes on the standard broadcast band because interference is less

# Quick, Watson, the Bridge!

## Here's One Most Rapid to Create

By Jack Tully

A VERY simple bridge may be set up as shown in the diagram. A 6H6 tube is shown because it is necessary that there be two separate cathodes. The same purpose would be served by using any two equal tubes as diodes. If they are triodes, etc., the elements other than heater and cathode may be interconnected.

While the diagram shows the bridge as in actual operation, the first step would be to wire up as shown, except not to connect the bottom part of  $R_1$  to the line. Just leave it free.  $R_2$  is about 50,000 ohms, but is selected of a closer value, such as will result in exactly full-scale deflection of the 0-1 millimeter. Under these

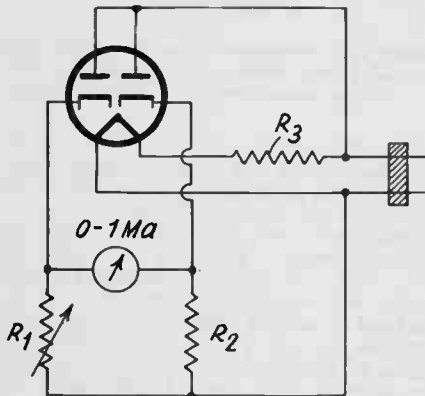

A handy method of quickly establishing a bridge circuit, useful for many measurements.

conditions both diodes are functioning, the current of the left-hand diode alone passing through the meter.

The object of establishing just one milliampere is to limit the current to full-scale deflection of the meter, even if  $R_1$  is zero.

### MATCHED PAIRS

Now when  $R_1$  is inserted, adjustable in a range that includes the fixed value found for  $R_2$ , the bridge may be brought into balance. This condition exists when the potential at one cathode is exactly the same as the potential at the other cathode. In other words, there is balance when there is no difference.

Now if the resistance values of  $R_1$  and  $R_2$  are measured separately and compared, if there is any unbalance in the diode this may be determined. For instance, assuming a difference, the diode that requires the higher re-

sistance is more conductive than the other diode. If the search is for a diode with true internal balance, different diodes may be tried until a pair is found that satisfies the condition  $R_1=R_2$ . For this exploration  $R_2$  need not be changed. But when the resistance of  $R_1$  is measured, this should be done with the bridge disconnected from the voltage source, which is the line.

### BRIDGE ANALYZED

The bridge condition consists of the following: The plates of both diodes are connected to one side of the a.c. line, the cathode of each has a separate load resistor, one terminal of each resistor being common to the other side of the line. Therefore, with  $R_p$  for plate resistance and  $R_L$  for load resistor we have  $R_p R_{L1}$  across the line, as and likewise  $R_p R_{L2}$  likewise, with the meter between the junctures of the  $R_p$ 's and the  $R_L$ 's.

Bridge measurements depend on cancelling unbalance or reading unbalance directly, and in the present instance the null point is at one end, not at center. This requires that the unknowns shall shunt  $R_1$  for the simplest case. If known values of resistance are used as standards, the device may be calibrated as a medium and low-range ohmmeter.

As a.c. in use, the impedance aspect comes into play, and inductance and capacity may be determined likewise. Anything put across  $R_1$  will increase the current, thus make the meter read higher.  $R_1$  as a short will not make the meter go off scale.

### COMPARING VOLTAGES

The voltage may be too high, however, for measuring the capacity of electrolytics, because their leakage resistance may be low compared to the capacity reactance, and thus falsify the reading. Also, small capacities, of the mica group, can not be determined, and the voltage is too low for any noticeable change in current even with .01 mfd. across  $R_1$ . The capacity reactance, and because of the enormous resistance to leakage therefore practically the impedance, of the mica condenser is 265,000 ohms, which is out of proportion to the load resistance. There is no point to increasing the load resistance without introduction of a more sensitive meter.

If the two plates of the balanced bridge as are disjointed, then a.c. from another source, even of another frequency, may be injected, and the unknown will equal the known when the

(Continued on following page)

# PHENOMENAL FACTS

**R.F. Best Tracked at I.F.—Crystals Are Inductive-Capacitative Relays—Rod Fixes Frequencies — Off-Resonant Oscillations**

**By Brunsten Brunn**

## TRACKING in Superheterodyne

**T**HE tracking problem in a superheterodyne is either solved very easily by the set builder, or it is not solved at all, unless he also happens to be somewhat of a radio engineer. The reason is that the main part of the problem is solved, if solved at all, by the maker of the coils that go into the circuit.

Assuming that the gang condenser used in the superheterodyne has all sections equal, not only in maximum capacity but all the way, the first part of the tracking problem is then to get a set of coils of the proper inductance.

All the coils designed for radio-frequency tuning should be the same, and these coils should determine the range of the tuner, that is, when taken in conjunction with the given tuning condensers. But the inductance in the oscillator should be different, smaller when the oscillator frequency is to be higher than the signal frequency. The amount by which it is to be smaller depends on the intermediate frequency that is to be used.

For an intermediate frequency of 456 kc the oscillator for the broadcast band may have an inductance 57 per cent. as high as the inductance in the r.f. circuits. If the oscillator coil has much more or much less inductance than this, only approximate tracking is possible. At best, adjustments will prove unsatisfactory.

Only a change in the inductance will improve

matters. Perhaps this change can be effected by adding or subtracting a turn, but the necessary change may be more.

The phenomenal fact is that the best way to measure the tracking of a superheterodyne is to feed the receiver an unmodulated signal equal to the signal that is to be received at a given setting and then noting the intermediate frequency generated, by means of an i.f. oscillator. The best way to get the proper unmodulated signal is to make one of the r.f. tubes an oscillator. The signal frequency will then have the right value wherever the condenser is set, but it is necessary to limit the output of this oscillator.

Tracking in any superheterodyne can be effective to within about one per cent. of the intermediate frequency provided the tuning band is not wider than the broadcast band. As this is widened the deviation from tracking increases rapidly. For example, the best possible tracking in a circuit covering the broadcast band might be off 5 kc at 550 kc. At 530 kc this same oscillator may be off as much as 20 kc. At the other end of the scale the same situation exists. For best possible tracking the oscillator may be off 5 kc at 1,550 kc, but at 1,570 kc it may be off 20 or more kilocycles. To prevent the deviation from becoming excessive at the ends of the tuning band, the adjustments of the trimmer and tracking condensers should be about 50 kc from the ends. If the band is much wider than the broadcast band, the total maximum variation, at four points, will be more than one per cent. but it will be no greater at the ends than at 1,250 and 750 kc. When the tracking is optimum.

*(Continued on following page)*

## Grounding Precautions for Bridge

*(Continued from preceding page)*

balance is restored. This restoration is accomplished by varying the voltage of the unknown. Or, instead of the line a.c. being used at all, two radio frequencies may be substituted, although the heater feed has to be retained of course.

### PUSH-PULL TUBES

The sometimes tough problem of selecting two tubes that have equal dynamic characteristics for push-pull may be solved with the aid of this circuit, by connecting plate of one tube

to one side of the meter, plate of the other tube to other side of the meter, filament to the junction of  $R_2$  and grids tied together and returned to negative of a C battery, positive of which goes to the return side of the line (lower branch in diagram).

As one side of the line may be grounded, the tube circuit under test for balance should not have filament winding center connected elsewhere than to one side of the line. One tube may be left in the test circuit and others put in the remaining test circuit, one at a time, until balance is restored.

# AN OUTSTANDING ACHIEVEMENT!

## RACO AC-4

Communication  
Receiver

2½-555 Meters

An All-Purpose Receiver  
That Defies Competition

And when we say communication receiver we MEAN it. The AC-4 is built to the highest amateur specifications for serious communication and long distance reception under all conditions. Isolantite insulated high frequency and band-spread tuning condenser; continuous, all electrical, band-spread; perfect regeneration stability; super-regeneration below 15 meters; and a host of other features. The 20 meter band, for instance, covers 100 degrees on the big 3¼" German silver band-spread dial with NO hand capacity effect. You will be amazed at the way the AC-4 separates the crowded foreign stations on the short wave bands.

### BUILT-IN A.C. POWER PACK

The AC-4 uses three of the powerful new Sylvania 6J5G tubes as electron coupled detector and two stage audio, plus an 80 rectifier with built-in high voltage supply which is really quiet.

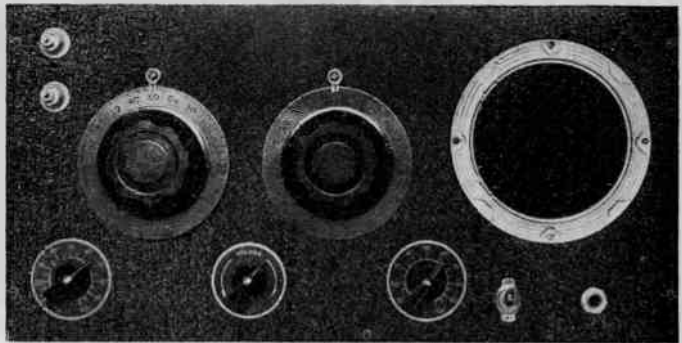

THE MOST REMARKABLE RADIO VALUE WE HAVE EVER OFFERED

Separate panel controls for antenna coupling, audio volume and regeneration. A standby switch is provided and also an earphone jack which cuts out the speaker.

RACO AC-4; Complete Kit of parts, unwired, less \$10.75  
only cabinet and tubes..... 1.25  
Crystalline finished metal cabinet..... 2.05  
Kit of four picked Sylvania tubes..... 2.59  
Wiring and testing ..... 2.59

SPECIAL PRICE ON COMPLETE RACO AC-4;  
wired, tested and ready to operate from any \$15.85  
110 volt A.C. line.....

## RADIO CONSTRUCTORS LABORATORIES

Dept. RA, 136 Liberty St.  
New York, N. Y.

## THREE TUBE SHORT WAVE RADIO only \$3.25

(Less tubes, phones, unwired)



A real, powerful, 3-tube radio set capable of bringing in amateurs, broadcast stations, police calls, and foreign as well as domestic short wave stations with excellent volume under fair conditions.

Operates entirely from your AC or DC house current. Range 10-600 meters. Extremely simple to build and operate. Furnished complete with coil and detailed instructions.

### 2-TUBE BATTERY SET

Operates from inexpensive dry batteries.

### 3-TUBE BATTERY SET

Operates from inexpensive dry batteries.

Kits wired, extra, 75c. Tubes, extra, 50c each. Cannon ball double headphones, extra, \$1.35.



## BS-6

### 6-Tube Band switch Receiver

12 to 600 meters  
A powerful, sensitive, and selective 6V receiver covering the entire wave-length span of 12 to 600 meters in 5 steps.

NO PLUG-IN COILS are used. Simply turn the waveband selector switch and enjoy reception on any wavelength within this range.

Uses two 6Ds, one 76, one 43, one K42A and one 2525 tubes as RF amplifier, electron coupled screen grid regenerative detector, powerful 2 stage audio amplifier with pentode output stage, rectifier, and complete built-in power supply.

HUM-FREE—Hi-fidelity dynamic loudspeaker—illuminated, airplane type vernier dial—band spread tuning control—automatic headphone jack—extremely smooth acting controls—operates from your AC or DC house current—beautiful, heavy, black shrivel finish chassis and cabinet.

DELIVERS GREAT LOUDSPEAKER VOLUME ON THE GREAT MAJORITY OF SHORT WAVE FOREIGN STATIONS UNDER FAIR CONDITIONS.

PRICE, complete with 6 tubes, cabinet, speaker, wired, ready to use.....

**\$16.95**

BS-6 KIT, of necessary parts, including speaker and detailed instructions, less tubes, cabinet, unwired..... **\$10.95**

SPECIAL: Complete kit, cabinet, tubes and instructions, unwired... **\$14.95**

(If metal tubes are preferred to glass type, add \$1)

AMATEURS:  
Model BS-6-AB has same specifications as BS-6 except that it has special bandspread circuit for 20-40-80-160 M bands and is equipped with plate voltage cut-off switch. Add \$1.00 to above price.

FREE: Large, illustrated catalogue of short wave receivers and transmitters.  
Send for your copy.

EILEN RADIO LABORATORIES, Dept. RW12, 136 Liberty Street, New York City

# PHENOMENAL FACTS

**R. F. Best Tracked at I. F. — Crystals Are Inductive-Capacitative Relays—Rod Fixes Frequencies — Off-Resonant Oscillations**

**By Brunsten Brunn**

## TRACKING in Superheterodyne

**T**HE tracking problem in a superheterodyne is either solved very easily by the set builder, or it is not solved at all, unless he also happens to be somewhat of a radio engineer. The reason is that the main part of the problem is solved, if solved at all, by the maker of the coils that go into the circuit.

Assuming that the gang condenser used in the superheterodyne has all sections equal, not only in maximum capacity but all the way, the first part of the tracking problem is then to get a set of coils of the proper inductance.

All the coils designed for radio-frequency tuning should be the same, and these coils should determine the range of the tuner, that is, when taken in conjunction with the given tuning condensers. But the inductance in the oscillator should be different, smaller when the oscillator frequency is to be higher than the signal frequency. The amount by which it is to be smaller depends on the intermediate frequency that is to be used.

For an intermediate frequency of 456 kc the oscillator for the broadcast band may have an inductance 57 per cent. as high as the inductance in the r.f. circuits. If the oscillator coil has much more or much less inductance than this, only approximate tracking is possible. At best, adjustments will prove unsatisfactory.

Only a change in the inductance will improve

matters. Perhaps this change can be effected by adding or subtracting a turn, but the necessary change may be more.

The phenomenal fact is that the best way to measure the tracking of a superheterodyne is to feed the receiver an unmodulated signal equal to the signal that is to be received at a given setting and then noting the intermediate frequency generated, by means of an i.f. oscillator. The best way to get the proper unmodulated signal is to make one of the r.f. tubes an oscillator. The signal frequency will then have the right value wherever the condenser is set, but it is necessary to limit the output of this oscillator.

Tracking in any superheterodyne can be effective to within about one per cent. of the intermediate frequency provided the tuning band is not wider than the broadcast band. As this is widened the deviation from tracking increases rapidly. For example, the best possible tracking in a circuit covering the broadcast band might be off 5 kc at 550 kc. At 530 kc this same oscillator may be off as much as 20 kc. At the other end of the scale the same situation exists. For best possible tracking the oscillator may be off 5 kc at 1,550 kc, but at 1,570 kc it may be off 20 or more kilocycles. To prevent the deviation from becoming excessive at the ends of the tuning band, the adjustments of the trimmer and tracking condensers should be about 50 kc from the ends. If the band is much wider than the broadcast band, the total maximum variation, at four points, will be more than one per cent. but it will be no greater at the ends than at 1,250 and 750 kc. When the tracking is optimum.

*(Continued on following page)*

## Grounding Precautions for Bridge

*(Continued from preceding page)*

balance is restored. This restoration is accomplished by varying the voltage of the unknown. Or, instead of the line a.c. being used at all, two radio frequencies may be substituted, although the heater feed has to be retained of course.

### PUSH-PULL TUBES

The sometimes tough problem of selecting two tubes that have equal dynamic characteristics for push-pull may be solved with the aid of this circuit, by connecting plate of one tube

to one side of the meter, plate of the other tube to other side of the meter, filament to the junction of  $R_2$ , and grids tied together and returned to negative of a C battery, positive of which goes to the return side of the line (lower branch in diagram).

As one side of the line may be grounded, the tube circuit under test for balance should not have filament winding center connected elsewhere than to one side of the line. One tube may be left in the test circuit and others put in the remaining test circuit, one at a time, until balance is restored.

(Continued from preceding page)

## PHENOMENAL ROD

### Magnetostriction Oscillator Explained

WHEN a rod or wire of certain magnetic metals and alloys is magnetized it changes its length by an amount which depends on the magnetostrictive property of the substance. Magnetostriction is the name applied to this change of size. Pure nickel and many of its alloys are strongly magnetostrictive. Two common alloys which show the property are Nichrome and Monel metal. Another nickel alloy showing the property is the steel known as invar, which contains about 36 per cent. nickel and 64 per cent. iron.

The change in length of these metals and alloys under magnetization is similar to the change in dimensions of a piezo crystal when it is subjected to electric stresses. Just as piezo-electric crystals are used in constant-frequency oscillators, so magnetostrictive rods are used for the same purpose, but at considerably lower frequencies. Whereas crystals are suitable for frequencies in excess of 50 kc, magnetostrictive oscillators are useful below that frequency and away down in the audio range.

When such a magnetostrictive rod is used to control the frequency of an oscillator, it is ordinarily placed inside two windings of a transformer, as a kind of free core. One of the windings is in the plate circuit of a tube and the other is in the grid circuit. They are connected in series, as in a Hartley oscillator, but they are connected in opposite phase. There is a condenser across the two windings, or between the grid and the plate.

When the electric circuit is tuned to the same frequency as the rod, or very nearly to that, the rod will control the frequency generated.

## CRYSTALS INDUCTIVE

### Applies to Narrow Frequencies

WHEN a piezo-electric crystal is used in an electric circuit it is placed between two metal plates, or a tin foil is attached to each side. Obviously, this forms a condenser, for there are two electrodes separated by a dielectric. The dielectric constant of quartz is about 4.5. Hence the capacitance of this condenser is 4.5 times greater than if the dielectric were air.

If this device is put on an a.c. bridge and its reactance measured for different frequencies, the measurements would show that at some frequencies the reactance would be positive. That is, the crystal is then an inductance. The range of frequencies in which it is an inductance is very narrow. Above and below this band the crystal is a capacity.

The reason why it is inductive is it constitutes an effective tuned circuit coupled to the driving circuit in much the same way as a tuned secondary is coupled to the primary. It is the mass inertia in the quartz that accounts for the equivalent inductance. A loudspeaker or a pair of headphones presents the same kind of reactance variation as a piezo crystal. The piezo-electric property of the quartz is only a means for driving the crystal.

## A N O T H E R O S C I L L A T O R That Oscillates Off Resonance

Recently there have appeared oscillators of the negative resistance type which require the use of a grid connection. That is, they are not true dynatron oscillators. Neither are they feedback oscillators of the usual type. A tuned circuit is connected to the screen and the suppressor, used as control grid, is connected to ground through a high resistance. The positive voltage on the screen is higher than that on the plate. A characteristic of a tube operated in this fashion is that the screen current increases as the control grid voltage decreases. This means that there is no change of phase. The  $\mu$  of the tube is positive.

When this is the case, oscillation can take place if the grid to screen reactance is negative, the grid to cathode reactance also negative, but the reactance from the screen to the cathode must be inductive. The tuned circuit therefore must be off its resonance point in the positive direction. The tube grid to cathode capacity is sufficient to supply the necessary negative reactance.

## Fewer and Better Coils Is His Plea

Coils used in radio could be much better than they are. A Q of 25 is high indeed for commercial coils, yet a Q of 75 is attainable without great difficulty. The main reason for the present status seems to be economy of room and dough. Here's for fewer and better coils (not babies).

LEONARD J. KRAVMELL,  
Cincinnati, O.

featuring **SPLIT-SECOND INSTALLATION!**



## IDEAL FOR APARTMENT HOMES

**T**HIS is a real time saver for service men and consumers alike. You can install this TOBE WINDO-POLE ANTENNA in a few easy seconds. No tools required...inconspicuous...approved by apartment house landlords...quickly removed...and giving all the performance of a big antenna installation.

**SERVICE MEN, ATTENTION!** How often have you wanted a quickly-installed aerial for demonstration purposes? This is just the portable unit you want! While not primarily a noise reduction antenna, it is so portable that a noise-free location can usually be found. It is just as effective, for small homes as for apartment houses.

*Skillfully manufactured at Canton, Mass., by  
the makers of TOBE Condensers and Filterettes*

# WINDO-POLE

Trade Mark Reg. Pat. Pend.

## A NEW ANTENNA WITH LOW NOISE PICK-UP!

## WINDO- POLE

This is the first real departure in antenna installation for many years! At last the whole problem of a good antenna installation, with low noise pick-up, is solved!

### ALSO...the TOBE Auto Pole

Thousands of cars are now equipped with the TOBE AUTO POLE—unquestionably the most effective auto antenna ever devised. By actual measurements signals show an increase of 17 db on the TOBE AUTO POLE as compared with the standard auto rooftop antenna!

### MAIL THE COUPON

If your dealer or jobber can't supply you, mail the coupon below for the TOBE WINDO-POLE at \$1.95 list, or the TOBE AUTO POLE at \$3.95 list. We pay all carrying charges.

TOBE  
DEUTSCHMAN  
CORP.  
Canton, Mass.

Please send me at once  
the following:

Tobe Windo-Pole at  
\$1.95 each.  Tobe Auto  
Pole at \$3.95 each.  I am  
enclosing \$..... in  
full payment. All postage  
charges prepaid.

Name .....

Address .....

## HAMS! S. W. FANS!! HARRISON HAS IT!!

No matter what you may need—you will find us better equipped to serve you—economically and satisfactorily. We carry a most complete stock of all standard lines. Also hard-to-get parts! The latest amateur communications receivers are on demonstration. Time Payment Plan. Out-of-towners will find our Mail Order Department service the fastest and our prices the lowest.

COME TO THE FRIENDLY HAM STORE!

### HARRISON RADIO COMPANY

12 West Broadway — 227 Greenwich Street  
NEW YORK CITY

## Attention Dealers TOBE WINDOW POLE

Solves Your Antenna Problems

Read About It in This Issue

DISTRIBUTED BY

### Fischer Distributing Corp.

19 Park Place

N. Y. City

BRclay 7-0555

WHEN WRITING TO ADVERTISERS  
PLEASE MENTION THAT YOU SAW THE  
ADVERTISEMENT IN RADIO WORLD.

**RADIO WORLD AND POPULAR MECHANICS MAGAZINE**  
—Radio World is \$2.50 a year, and Popular Mechanics Magazine is \$2.50 a year. Popular Mechanics Magazine does not cut rates, but Radio World will send both publications to you for one year for \$3.75. Radio World, 145 West 45th St., New York City.

## H. G. CISIN'S NEW 1937 METAL TUBE JUNIOR SPACE EXPLORER

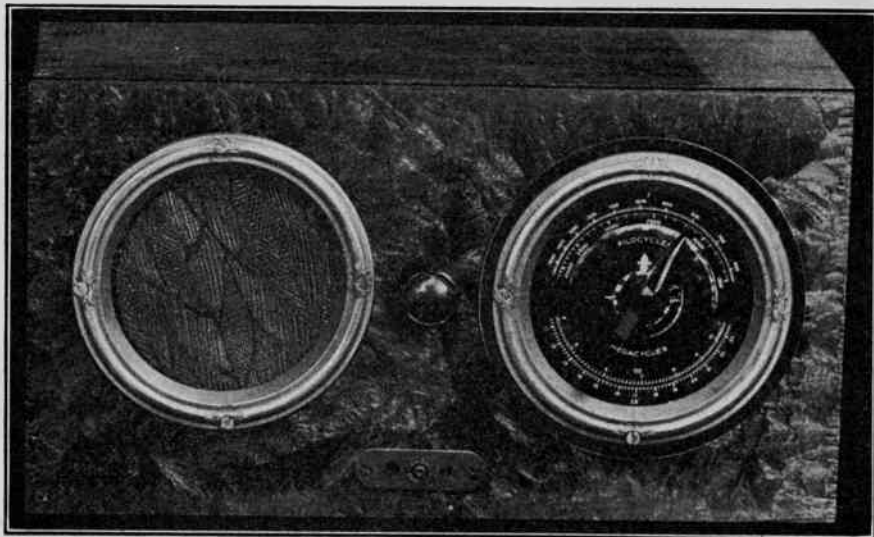

**Model 6B COMPLETE KIT**—High quality Find-All parts including Loud Speaker, diagram, instructions (unwired, less tubes, coils, cabinet). — Four Find-All Short Wave Coils—\$1.65. Two Broadcast Coils—85c. Special Long Wave Coil with L. W. Unit—95c. Set of Four Matched Tubes Inc. K-105-A—\$2.95. Two ornamental Rings for Panel Front—25c each.

**All-Electric 4-Tube Receiver  
COMMUNICATION TYPE—PROFESSIONAL PERFORMANCE  
CERTIFIED FOREIGN RECEPTION**

SIX bands, range 9 to 560 meters continuous coverage—also long wave to 1500 meters if desired. Self-contained power supply and full-toned quality speaker. Phone jack at front. Antenna control. Dual regeneration control. Metal 6J7 pentode regen. det.; metal 6C5 screen grid 1st audio; newest metal tube K-105-A Ballast; 33 power output pentode. Full-vision triple calibrated dial. Precision instrument type Bar Knob. Operates a.c. (any frequency) or d.c. Cisin Circuit Patent pend. No. 592,586. Easily built—no dual purpose tubes to complicate wiring. Wood cabinet easily made saves cost of metal and gives superior tone quality. Full directions with kit.

**H. G. CISIN, Chief Engineer ALLIED ENGINEERING INSTITUTE**  
Dept. R 98 PARK PLACE New York, N. Y.

\$ **6**.95



# CLASSIFIED ADVERTISEMENTS

7 cents a word. \$1.00 minimum.

**AMATEUR RADIO LICENSES.** Resident and correspondence courses. Every graduate a licensed operator. New York Wire-less School, 1128 Broadway, New York.

**USED ENCYCLOPEDIAS.** Correspondence School Courses, etc. Mention interest for reply. Educational Course Exchange, 908 Cottage Grove, Flint, Michigan.

**40 ACRES**—near White River, unimproved, poultry land, \$100; \$5 down, \$5 monthly. Free list and literature. Hubbard, 274 Grossman Bldg., Kansas City, Kansas.

**STEER HORNS FOR SALE.** Seven feet spread, fine decoration for den or office. Lee Bertillon, Mineola, Texas.

**GUARANTEED RADIO TUBES.** 6D6, 39c; 42, 39c; midge-t radio, \$7.55. Free literature. Hanns, 1411 Pacific Street, Brooklyn, New York.

**BARGAIN LISTS 6c.**—We buy anything. BI-Cam-Ex, Dept. RW1, 1451 Broadway, New York.

**THREE CAMERAS in one.** Takes snapshots, moviebooks, 16mm movies. Springmotor driven. Only \$5.00 brand new. Films \$1.00. Send no money. Pay postman. Projectors \$1.00 up. Free lists. Home Movies, Box 33-RW, Easton, Pa.

## SPECIAL 2-FOR-1 OFFER RADIO WORLD

Radio World is \$2.50 a year (12 issues), 25c. per copy. Canada and foreign, \$3.00 yearly. Offers of Radio World and other worthwhile publications for one full year on each (NET):

- RADIO WORLD and SHORT-WAVE CRAFT, \$3.50.
- RADIO WORLD and POPULAR SCIENCE MONTHLY, \$3.50.
- RADIO WORLD and RADIO-CRAFT (12 issues), \$3.50.
- RADIO WORLD and RADIO INDEX (monthly, 10 issues), stations, programs, etc., \$3.50.
- RADIO WORLD and SERVICE (monthly), \$3.50.
- RADIO WORLD and EVERYDAY SCIENCE AND MECHANICS (monthly), \$3.50.
- RADIO WORLD and BOYS' LIFE (monthly, 12 issues), \$3.50.
- RADIO WORLD and MOTION PICTURE MAGAZINE (monthly), \$3.50.
- RADIO WORLD and TRUE STORY (monthly), \$3.00.
- RADIO WORLD and LIBERTY (weekly), \$3.00, U. S. only.

Select any one of these magazines and get for an entire year by sending in a year's subscription for RADIO WORLD at the regular price, \$2.50, plus a small additional amount, per quotations above. (Add \$1.50 for extra foreign or Canadian postage for both publications.)

Name .....

Address .....

City and State.....

If renewing an existing or expiring subscription for RADIO WORLD, put cross in square.

If renewing an existing or expiring subscription for other magazines, put cross in square.

Special Trial Offer for Radio World only: \$1.00 for 5 months, postpaid. Mail order with remittance to Radio World Office. NET.

## The Remedy for... ANNOYING COIL PROBLEMS!

WINDING solenoid coils for radio frequencies requires knowledge of the number of turns of any selected type of wire on any sensible diameter to attain an inductance suitable for the tuning condenser and lowest frequency. Hence, with capacity and frequency known, there are two unknowns: (1), the required inductance; (2), the number

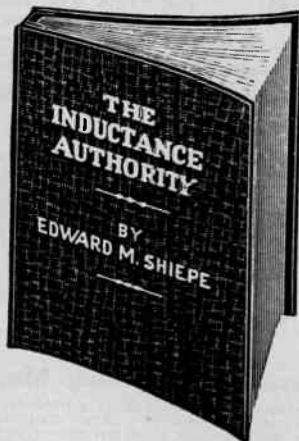

of turns to establish that inductance. The answers are obtained without computation by use of "The Inductance Authority," by Edward M. Shiepe, and an 18 x 20" supplement. On the large supplement are plotted the "curves" of frequency, capacity and inductance in straight lines, so for a desired low frequency and known capacity the unknown inductance is solved by mere inspection. The number of turns for attainment of that inductance, for all popular tubing diameters and all generally used wire diameters and wire insulations, is read from the inductance-turns charts which are in the bound volume. Coil and set manufacturers, as well as home and shop experimenters, students and teachers freely use this book. Accuracy is 1%. The only book of its kind in the world.

Order Cat. INA (price includes bound volume and supplement) postpaid anywhere **\$2.00** on earth .....

The supplement chart is obtainable separately, CAT. SIA @ 25c postpaid.

**Or send \$5.00 for a two-year subscription for RADIO WORLD, regular rate, and this valuable book will be sent FREE. Order Cat. PE-SIA. Supplement 25c extra (total \$5.25).**

Those specially interested in coil data for the standard broadcast band will find extremely valuable a straight-line chart of frequency, capacity and inductance. 500 to 2,500 kc very closely plotted, 2,500 to 12,000 less closely, published in the October, 1936, issue of RADIO WORLD. Order Cat. 695. 25c per copy (extra).

BOOK DEPARTMENT

**RADIO WORLD**

145 West 45th Street, New York City

## The EXPERIMENTERS TREASURE HOUSE

Since 1923, we have been catering to the needs of Radio and Electrical Experimenters. From cat-whisker to television tubes, miniature motors, relays from 29c to \$6.50—photoelectric cells, neon lamps from 15c to \$1.50, in fact anything and everything you may need, in stock or know where to obtain for you. We have been shopping agents for well-known schools and institutions for many years, why not for you?

Headquarters for Parts—Since 1923

### BLAN

THE RADIO MAN, INC.

W-177 Greenwich St., New York, N. Y.

NO CATALOGUE—BUT LOWEST PRICES

Record Piano Music at 33 $\frac{1}{3}$  r.p.m. with



### UNIVERSAL Professional Recording Machine

New, improved design—Superlative performance—Solid, heavy—Precision machined—18-in. distortion proof turntable disc—Constant speed rim drive—110-volt AC 100% asynchronous reversible motor—Individually calibrated timing bar provides for both 33-1/3 and 78 r.p.m. at 90, 110 and 130 lines per in.—Solid steel bar slide—The climax of four years of research and experiment.

UNIVERSAL MICROPHONE CO., LTD.  
424 Warren Lane, Inglewood, Cal., U. S. A.

## METAL CHASSIS

We can supply chassis for any make receiver, experimental or otherwise.

Inquiries should be accompanied with sketch and complete details enabling us to give quick service as to prices and delivery.

Dept. R.W. 738

KORROL MFG. CO., Inc.

232 Greenwich St.

New York City

WHEN WRITING TO ADVERTISERS  
PLEASE MENTION THAT YOU SAW THE  
ADVERTISEMENT IN RADIO WORLD.

# 1.00

## a month

is all you need to pay for  
**LIFE INSURANCE**

\$1194.00 of insurance at age 21; \$813.00 at 35. Other ages in proportion in this Old Line Legal Reserve Company that sells without agents and gives the saving to its policy holders. Postal has paid out \$43,000,000 in 31 successful years. It has millions in assets and reserves. Just write a card today with your name, address and exact date of birth and you will get full details and rates for your age by return mail. Insurance is vital! Act promptly while rates are low.

POSTAL LIFE INSURANCE COMPANY  
Dept. RD-195—511 Fifth Avenue, New York

## "AN HOUR A DAY WITH RIDER"



John F. Rider has written a series of pocket-sized books, 60c each, with the idea readers will spend an hour a day reading and studying them, and thus acquiring a full servicing knowledge. Latest of these is devoted to automatic volume control (a.v.c.). The subject is fully covered. 64 pages. Well illustrated. Order Cat. RAVC postpaid @ 60c.

### "ALTERNATING CURRENTS"

"Alternating Currents in Radio Receivers," Hour-a-Day, is a comprehensive book covering the basic functions of the various components of a radio receiver, what each unit does and how it works. Various types of parallel and series resonant circuits, different kinds of coupling, inductance, reactance, impedance, and how these electrical phenomena are employed in radio practice are fully explained. 80 pages. Order Cat. BAC, postpaid, @ 90c.

A clear explanation of what happens when a circuit is tuned to resonance. All types of circuits described and how and why they work. How these circuits should be aligned so that maximum efficiency is obtained. Knowledge of the latest high-fidelity I-F amplifiers is becoming more and more necessary and "Resonance and Alignment" tells what you should know about all this. 84 pages. Order Cat. RRA, postpaid, @ 60c.



### "D. C. VOLTAGE DISTRIBUTION"

Every receiver contains some sort of d.c. distribution system supplying the d.c. voltages from the power unit to the elements of the tubes. The many different forms these systems take are thoroughly described in Rider's "D.C. Voltage Distribution," which explains networks from the simplest to the most complicated. The calculations of the value of the resistors and their wattage ratings are more clearly described than ever before, in this brand new combination of theory and practice. 64 pages. Order Cat. RDCVD, postpaid, @ 60c.

[Above four "Hour-a-Day" books are all of the series published to date. All have hard covers. The order of their publication is No. 1 A.C.; No. 2, Resonance; No. 3, D.C.; No. 4, A.V.C.]

### RIDER'S MANUALS

Vol. VII—(new) Rider's Volume VII has 1600 pages! This is the biggest and best Manual that has ever been published. In Volume VII the number of manufacturers has been increased and therefore the size of the book was increased. The greatest collection of servicing data ever gathered and not only from the large manufacturers, but the smaller ones as well. Not only 1936-37 sets, but many old timers. 100-page Index ..... \$10.00  
Vol. VI—Data on sets produced up to October, 1935—since the start of the metal tube era—are contained in this Manual. Double-Spread pages are used for the more complicated receivers. 1240 pages. \$7.50  
Vol. V—Sets manufactured up to October, 1934—and older sets, too—are covered in this volume. Electrical and mechanical data are given so that everything is where you want it. 1,200 pages. .... \$7.50  
Vol. IV—In this volume will be found information on receivers manufactured up to March, 1934.  
1,060 pages ..... \$7.50  
Vol. III—Sets released from the middle of 1932 to June, 1933 are presented in this volume.  
1,070 pages ..... \$7.50  
Vol. II—Data are here contained on sets manufactured between early 1931 and the middle of 1932. Many sets unavailable when Vol. I was published will be found in Vol. II. 800 pages. .... \$6.50  
Vol. I—This volume contains information on the old timers—from 1919 up to 1931—and there are still many of these in use today. 1,000 pages. .... \$7.50  
[Order Rider Manuals by volume numbers as listed above. Remit with order. Books will be sent postpaid.]

Radio World, 145 W. 45 St., N. Y. City

# THE SKY ROCKET!

**1½ - 555 METERS**  
**A SENSATIONAL PRICE**  
 ON A  
**REMARKABLE SET**

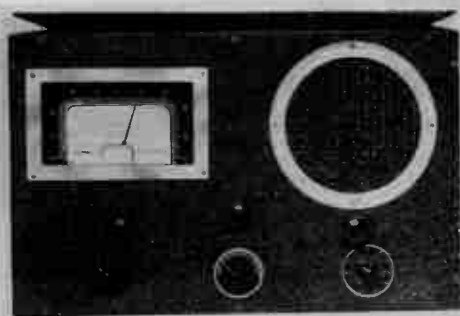

Dollar For Dollar, We Believe This To Be The Biggest Value In Radio That Has Ever Been Offered To The Short Wave Fan. A big powerful radio with a tremendous tuning range. A unique dial with plenty of bandspread, and look at its size! Bandswitching from 15 to 600 meters. No plug-in coils — just snap a switch and there, at your finger tips, are all the thrills that radio can offer. Short wave foreign stations, ship to shore conversations, inter-continental telephones, aeroplanes, police, amateurs, experimental television, Apex stations, direct pickups of sport events on the ultra-high frequencies, etc., etc. And, finally, the regular long wave broadcasting stations with a good dynamic speaker to reproduce the programs for you. (Note: The ultra-high frequencies, below 15 meters, are handled by a separate built-in high frequency tuning unit using a ceramic insulated three plate tuning condenser and self supporting interchangeable coils).

**THE KING OF THEM ALL!**

**ELECTRON COUPLED REGENERATION PLUS SUPER-REGENERATION**  
 The SKYROCKET uses a carefully developed and engineered circuit consisting of one stage R.F. amplification, two detectors (regenerative and super-regenerative) and the new 2B6G power amplifier tube with its large, low harmonic distortion output. The new Sylvania 6J5G high frequency tube is used as super-regen. detector. The most successful of the regenerative circuits has been adopted, utilizing the 6K7 metal tube as detector with double regenerative control, while another 6K7 serves as a stage of untuned R.F. amplification.

**THE SKYROCKET KIT:** complete with drilled panel and chassis, wired switchboard assembly, power pack, high frequency tuning assembly, dynamic speaker, **\$11.95**  
 Metal Cabinet, black cracked finish..... 2.50  
 Five tested Sylvania tubes..... 3.81  
 Assembly, wiring and testing..... 3.00

**THE SUPERIOR INSTRUMENTS COMPANY** with their past record of service instrument design and manufacturing experience has at last decided to enter the radio receiver field.  
 The SKYROCKET is the final result.  
 The experienced radio experimenter is bound to acclaim it as the **MOST SENSATIONAL VALUE IN RADIO TODAY!**

**SPECIAL COMBINATION PRICE ON COMPLETE SKYROCKET:** wired, tested and guaranteed for one year; ready to plug in to 110 volt outlet (A.C. or D.C.) and operate..... **\$19.95**

**SUPERIOR INSTRUMENTS CO.**  
 Dept. 101, 139 Cedar Street, New York, N. Y.

You need  
 . . . these **2** books

**PRINCIPLES of PUBLIC ADDRESS SYSTEMS**

A practical handbook, full of useful information, fully illustrated, written by M. N. Beitman, an engineer and noted authority on audio amplifiers.

Considers in detail various microphones, radio and phonograph inputs, acoustic feedback, mixing and volume controls, use of vacuum tubes, interstage coupling, power amplifiers, output coupling, loud speaker placement, the decibel, P.A. measurements, power level, and other points of importance, including actual circuit diagrams of tested P.A. systems.

**MATHEMATICS of Radio Servicing**

Introduces and explains the use of arithmetic and elementary algebra in connection with units, color code, meter scales, Ohm's Law, alternating currents, ohmmeter testing wattage rating, series and parallel connections, capacity, inductance, mixed circuits vacuum tubes, curves, the decibel, etc., etc. and has numerous examples.

Plainly written and easy to understand. Only useful data included. M. N. Beitman author. Size, 8½ x 11 in.

Price, 50c each book.

**SUPREME PUBLICATIONS**  
 3727 West 13th St., Chicago, Illinois

**FREE** Allied Radio CORPORATION  
 Everything in Radio  
 RADIO'S GREATEST VALUES!  
 AMATEUR GEAR · PARTS · KITS · TEST EQUIPMENT  
 P.A. SYSTEMS · SETS · TOOLS · BOOKS  
**IN THIS NEW CATALOG**

Send for the new 1937 ALLIED Radio Catalog!—Radio's Leading Supply Guide. 152 pages packed with 10,000 selected and approved parts; dozens of Set-Builders' kits; newest Amateur transmitting and receiving gear; complete lines of Public Address equipment; high quality test instruments; latest books, tools, etc. You need this great book!—it contains Everything in Radio at lowest prices!

**ALLIED SELLS FOR LESS.** We buy in vast quantities, pay less and so can sell for less. Every item is tested and approved by ALLIED's expert engineers—your assurance of quality always. Send coupon for FREE copy!

**ALLIED RADIO**

ALLIED RADIO CORP. Dept. 16-L  
 833 W. Jackson Blvd., Chicago, Ill.  
 Send me your FREE 1937 Radio Catalog.

Name .....

Address .....

City ..... State .....

# AN OUTSTANDING ACHIEVEMENT!

## RACO AC-4

Communication Receiver  
2 1/2-555 Meters  
An All-Purpose Receiver That Defies Competition

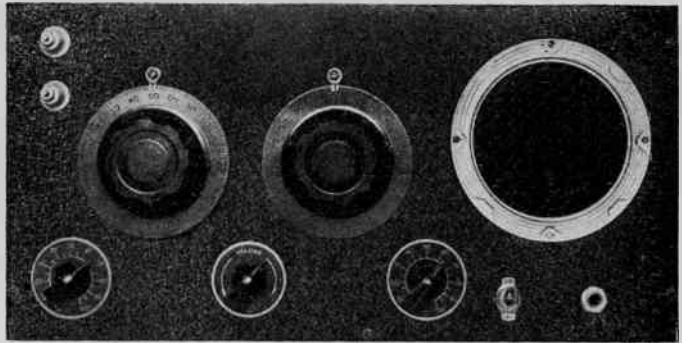

And when we say communication receiver we MEAN it. The AC-4 is built to the highest amateur specifications for serious communication and long distance reception under all conditions. Isolantite insulated high frequency and band-spread tuning condenser; continuous, all electrical, band-spread; perfect regeneration stability; super-regeneration below 15 meters; and a host of other features. The 20 meter band, for instance, covers 100 degrees on the big 3 3/4" German silver band-spread dial with NO hand capacity effect. You will be amazed at the way the AC-4 separates the crowded foreign stations on the short wave bands.

### THE MOST REMARKABLE RADIO VALUE WE HAVE EVER OFFERED

Separate panel controls for antenna coupling, audio volume and regeneration. A standby switch is provided and also an earphone jack which cuts out the speaker.

RACO AC-4; Complete Kit of parts, unwired, less \$10.75 only cabinet and tubes..... 1.25  
Crystalline finished metal cabinet..... 2.05  
Kit of four picked Sylvania tubes..... 2.05  
Wiring and testing ..... 2.53

### BUILT-IN A.C. POWER PACK

The AC-4 uses three of the powerful new Sylvania 6J5G tubes as electron coupled detector and two stage audio, plus an 80 rectifier with built-in high voltage supply which is really quiet.

**SPECIAL PRICE ON COMPLETE RACO AC-4:**  
wired, tested and ready to operate from any \$15.45  
110 volt A.C. line.....

## RADIO CONSTRUCTORS LABORATORIES

Dept. RA, 136 Liberty St.  
New York, N. Y.

## THREE TUBE SHORT WAVE RADIO only \$3.25

(Less tubes, phones, unwired)



A real, powerful, 3-tube radio set capable of bringing in amateurs, broadcast stations, police calls, and foreign as well as domestic short wave stations with excellent volume under fair conditions.

Operates entirely from your AC or DC house current. Range 10-600 meters. Extremely simple to build and operate. Furnished complete with coil and detailed instructions.

### 2-TUBE BATTERY SET

Operates from inexpensive dry batteries.

### 3-TUBE BATTERY SET

Operates from inexpensive dry batteries.

Kits wired, extra, 75c. Tubes, extra, 50c each. Cannon ball double headphones, extra, \$1.35.



## BS-6

### 6-Tube Band switch Receiver

12 to 600 meters  
A powerful, sensitive, and selective SW receiver covering the entire wave-length span of 12 to 600 meters in 5 steps.



NO PLUG-IN COILS are used. Simply turn the waveband selector switch and enjoy reception on any wavelength within this range.

Uses two 6D6, one 76, one 43, one K42A and one 2525 tubes as RF amplifier, electron coupled screen grid regenerative detector, powerful 2 stage audio amplifier with pentode output stage, rectifier, and complete built-in power supply.

HUM-FREE—Hi-fidelity dynamic loudspeaker—illuminated, airplane type vernier dial—band spread tuning control—automatic headphone jack—extremely smooth acting controls—operates from your AC or DC house current—beautiful, heavy, black shrivel finish chassis and cabinet.

**DELIVERS GREAT LOUDSPEAKER VOLUME ON THE GREAT MAJORITY OF SHORT WAVE FOREIGN STATIONS UNDER FAIR CONDITIONS.**

PRICE, complete with 6 tubes, cabinet, speaker, wired, ready to use.....

**\$16.95**

BS-6 KIT, of necessary parts, including speaker and detailed instructions, less tubes, cabinet, unwired..... **\$10.95**

**SPECIAL: Complete kit, cabinet, tubes and instructions, unwired.. \$14.95**

(If metal tubes are preferred to glass type, add \$1)

**AMATEURS:**  
Model BS-6-AB has same specifications as BS-6 except that it has special bandspread circuit for 20-40-80-160 M bands and is equipped with plate voltage cut-off switch. Add \$1.00 to above price.

**FREE: Large, illustrated catalogue of short wave receivers and transmitters.**

Send for your copy.

**EILEN RADIO LABORATORIES, Dept. RW12, 136 Liberty Street, New York City**

# NC-100 RECEIVER

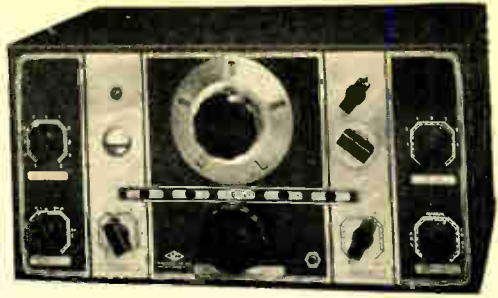

## 1. PERMITS COMPACT WIRING

Unlike a coil switch, there are no long leads in the NC-100 Receiver. Each coil range in turn is brought into position directly below the tuning condenser, and close to the tube. This compactness results in a minimum of stray capacitance and stray inductance, resulting in high gain without instability. It permits a smaller tuning condenser capacity, with improved performance at high frequencies.

## 2. ISOLATES IDLE COILS

Each of the fifteen H.F. coils is in its own individual shield, and idle coils are always out of the way. There are no dead spots and absorption losses in the NC-100 Receiver. The heavy cast aluminum shield is located at the bottom of the receiver where it is protected from the heat of the tubes and power supply. Its generous proportions retard temperature changes.

## 3. ASSURES PRECISE TUNING

The shifting mechanism brings each set of coils into positive, exact position. Unlike many coil switches, turning the range changing knob does not tune the receiver. The Micrometer Dial contributes a smoothness that makes tuning easy, and an accuracy that makes logging precise. The effective scale length is twelve feet, and readings are direct to one part in five hundred.



**NATIONAL COMPANY, INC., MALDEN, MASS.**

# TRIPLITT Pocket Volt-Ohm Milliammeter D.C. and A.C.

Size:  
3-1/16" x 5 5/8" x 2 1/8"



MODEL 666

DEALER PRICE **\$15.00**

A complete instrument for all servicing needs. Can be used for all AC-DC voltage, current and resistances analyses.

LEATHER CARRYING CASE for Model 666, Model 669, supplied extra. Very attractive, of black heavy leather with finished edges and strap.

- Uses large 3" Sq. Triplet Instrument. AC-DC Voltage scales read: 10-50-250-500-1000 at 1000 ohms per volt.

Milliampere Scale Reads: 1-10-50-250.

Ohm Scale Reads: low 1/2-300; high to 250,000.

Case and Panel: Black Molded.

Low Loss Range Selector Switch.

Complete with Alligator Clips; Battery and Test Leads.

DEALER PRICE ..... **\$15.00**

**SEE YOUR JOBBER • WRITE FOR CATALOG**



**ELECTRICAL INSTRUMENTS**

The Triplet Electrical Instrument Co.  
2711 Harmon St., Bluffton, Ohio.

Without obligation please send me  
More information Model 666.

I am also interested in.....

Name .....

Address .....

City..... State.....