

100
Jan. 27th
1934



15¢
Per Copy

RADIO

REG. U.S. PAT. OFF.

WORLD

The First and Only National Radio Weekly
618th Consecutive Issue—Twelfth Year

THE ICONOSCOPE

*Greatest Contribution so Far
to Television Art*

**Inside Facts on
Test Oscillators**

THE 8-TUBE PATHFINDER

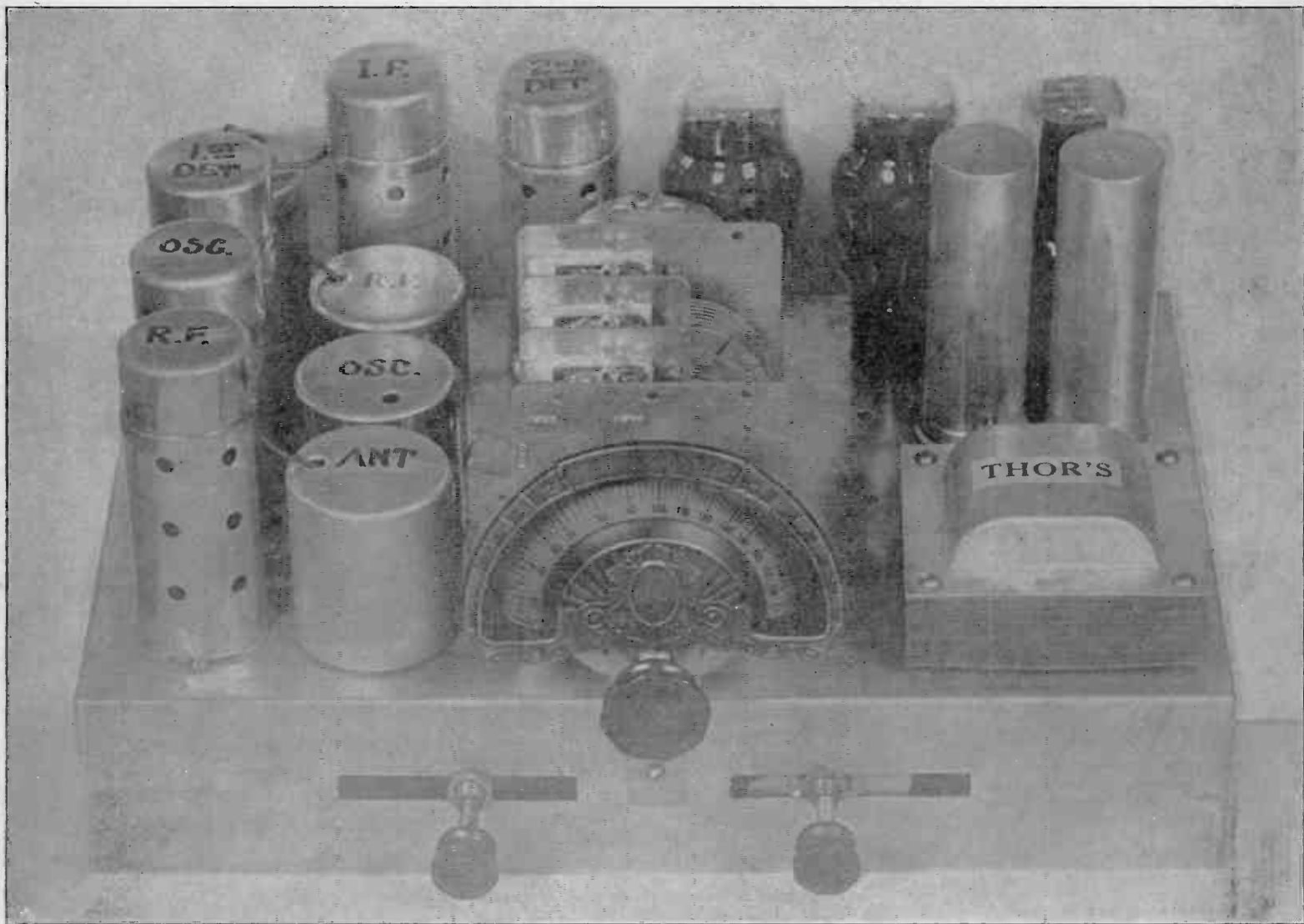

A DX superheterodyne for broadcast frequencies, designed by
Robert G. Herzog, E.E. See pages 12 and 13.

2-TUBE SHORT-WAVE DIAMOND TUNER

AN OLD STANDBY FOR THE NEW YEAR
 The PATHFINDER 8-Tube A.C. Super. Equipped with the latest tubes
IMPROVED AND PERFECTED!

Using 1-55, 1-56, 3-58, 1-80, Push Pull 2A5 in the Output. With A. V. C.
 AS DESCRIBED IN THIS ISSUE

Kit of complete parts including DRILLED CHASSIS—ACCURATELY
 DESIGNED—ALL PARTS TO BUILD and Dynamic Speaker **\$18.95**

MAIL ORDERS FILLED

THOR'S BARGAIN BASEMENT

167 GREENWICH STREET

NEW YORK CITY

"Be Prepared"
 FOR THE THRILL of YOUR LIFE



Scout
 SHORT WAVE RECEIVER
 15 to 550 Meters



A RECEIVER that will cover the entire short-wave and broadcast band. Amazing the way it intercepts short-wave signals — police signals ship-to-shore signals, airplane conversations, amateurs, etc. An inexpensive way for beginners to master the code by practical experience.

Will out-perform many other one-tube broadcast receivers when used on the 200 to 500 meter band.

It is exceedingly easy to build. A clear diagram shows the layout of parts and hookup of receiver. All parts in the kit are of the highest quality, assuring perfect reception.

Smooth regeneration control does not vary when the different coils are changed. The 230 tube was selected because of its low current consumption on the "A" battery. Two dry cells will last indefinitely without necessitating replacement. One 45-volt "B" battery is required for plate voltage.

USING **Hammarlund**
 QUALITY PRODUCT

The kit includes a metal panel and base which gives the receiver a professional touch. The metal panel, used to eliminate hand capacity, is finished in a beautiful, modernistic black crystal.

- Model SR-1-K kit of parts \$3.95
- Model SR-1-W wired and tested \$1.00 extra
- Set of batteries \$1.50
- Set of matched headphones 95c

Send for NEW
 1934
 Catalog
FREE

TRY-MO RADIO CO.
 85 CORTLANDT ST., NEW YORK, N. Y.

Service men's Handy
 Manual only
25c
 FREE with kit sold.

NEW PRICES
TROUBLE SHOOTER'S
MANUAL, Nos. I, II and III

Having assembled 2,000 diagrams of commercial receivers, power amplifiers, converters, etc., in 1,200 pages of Volume No. 1 of his Perpetual Trouble Shooter's Manual, John F. Rider, noted radio engineer, has prepared Volume No. 2 on an even more detailed scale, covering all the latest receivers. Volume No. 2 does not duplicate diagrams in Volume No. 1, but contains only new, additional diagrams, and a new all-inclusive information on the circuits covered.

- Volume No. 3 (Recently issued). Order Cat. RM \$7.50
- Volume No. 2—Perpetual Trouble Shooter's Manual, by John F. Rider, Shipping weight 6 lbs. Order Cat. RM-VT @ \$6.50
- Volume No. 1 (8 lbs.). Order Cat. RM-VO @ \$7.50

We pay postage in United States on receipt of purchase price with order. Canadian, Mexican and other foreign remittances must be in funds payable in New York.

RADIO WORLD
 145 West 45th Street New York City

BOTH FOR ONE FULL YEAR

RADIO WORLD
 and **"RADIO NEWS"**

\$7.00

Canadian and Foreign, \$1.50 extra.

You can obtain the two leading radio technical magazines that cater to experimenters, service men and students, the first national radio weekly and the leading monthly for one year each, at a saving of \$1.50. The regular mail subscription rate for Radio World for one year, a new and fascinating copy each week for 52 weeks, is \$6.00. Send in \$1.00 extra, get "Radio News" also for a year—a new issue each month for twelve months. Total 64 issues for \$7.00.

RADIO WORLD, 145 West 45th Street, New York, N. Y.

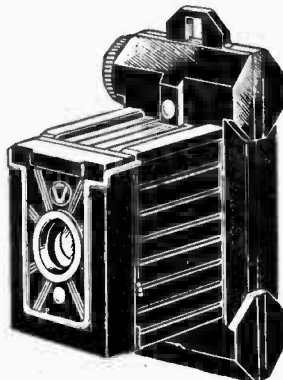

CAMERA SENSATION 50¢
 OF THE CENTURY

Including Film Roll (Extra Films, 6 exposures, 10c.)

UNIVEX ULTRACHROME

Can be carried in pocket or lady's handbag. A camera for the old as well as the young. Simple, foolproof and economical for youngsters—thoroughly practical and reliable for grownups. Enlargements can be made up to 8x10 inches. Nothing to get out of order. Adopted as special service equipment by Los Angeles Police Department. Copy of letter authorizing use of Univex Ultrachrome:

The Los Angeles Police Commission authorizes your company to supply one Univex auto camera for each Los Angeles radio police car, on or about November 14, 1933.

The extreme simplicity of operation of your camera as well as its ability to take clear pictures within 12 inches of a subject, leads us to believe that our officers will be able to gather indisputable evidence in cases of accident and crime.

Yours very truly, (Signed) MARTIN C. NEUNER,

President, Board of Police Commissioners producing excellent negatives and thus assures your obtaining consistently fine results:

EXTREMELY HIGH SPEED. Univex Ultrachrome has remarkable "balanced" speed; very high sensitivity to relatively weak light makes it possible for you to take good pictures early in the morning or late in the evening, and yet this film is so constituted that your negatives will not be over-exposed when made under strong noon-day brilliance.

ULTRA-CHROMATISM. Univex Ultrachrome has, in the highest degree, the property of rendering colors (in monotone) according to their true relative importance to your own eyes. Your pictures will look natural from the standpoint of color balance.

NON-HALATION PROPERTIES. With Univex Ultrachrome it is not necessary to pose your subjects with light shining directly into their eyes which causes the unpleasant squinting so often seen in snapshot prints, for a special anti-halation backing greatly minimizes light flare.

UNIVEX Ultrachrome, with one Film Roll, sent postpaid for 50 cents.
RELIABLE RADIO CO., 145 West 45th St., New York City

Vest Pocket Size Flashlight
for Radio Repair Work—
FREE

Great for getting right down into your set!

Obtain one free with 3 months' subscription for Radio World at the regular rate of \$1.50. Send postpaid.

Sub. Dept.
RADIO WORLD
 145 West 45th Street New York, N. Y.

COMPLETE TUBE CHARACTERISTICS WITH SOCKET CONNECTIONS

In Radio World dated Sept. 9, 1933. 15c a copy; or start your subscription with that issue. Radio World, 145 West 45th St., New York City.

"SOUND PICTURES," by Cameron & Rider. Over 1,100 pages, 500 illustrations. The whole question of Sound Motion Pictures treated from a new angle. A Complete Guide for Trouble Shooting. Explains in detail the construction, operation and care of sound recording and reproducing equipment. Price \$7.50. Radio World, 145 W. 45th St., New York City.

Recommending - - -

NEW 1934 DIAMOND of the AIR

A-C OPERATED SHORT-WAVE RECEIVERS

12,500-Mile Reception

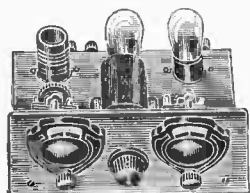

2-TUBE

Introducing the latest in short-wave receivers. The "Diamond of the Air" 2- and 3-tube battery receivers for many months have been acclaimed by owners to be the most remarkable short-wave receivers in their class. Now, for the first time, Reliable Radio Company introduces the 1934 A-C SHORT-WAVE "DIAMOND"—incorporating all the features of the battery-operated sets plus the convenience of a-c operation. The receivers have to be powered additionally and the power pack quotations will be found on this page.

IMPROVED RECEPTIVE QUALITIES

All 1934 features have been incorporated in the new "Diamond of the Air" a-c short-wave receiver and, besides, the popular battery-operated models have been improved in a new 1934 design. The lowest in price, yet these sets will log stations from all parts of the world regularly.

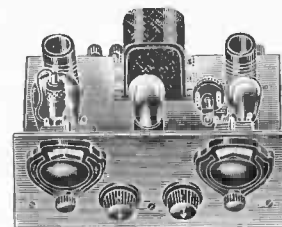

3-TUBE

The 3-tube a-c receiver uses a 58 as an r-f amplifier, followed by a 57 detector and a 56 as an output tube. This receiver can be used on batteries by using 77, 78 and 37 tubes as detailed above. Capable of logging stations from all parts of the world.

Employs the Highest-Grade Materials

A receiver is only as good as the parts used in its construction. Only the finest parts are included. Hammarlund condensers, representing the finest, are used. The metal panel eliminates body capacity.

The A-C "Diamond of the Air" Receivers

The a-c receivers have been developed for those who have the benefit of electric service. They use the latest type triple-grid tubes, resulting in more selective and sensitive reception.

The 2-tube model employs a 57 tube, resistance coupled to a 56 type output tube. For those desiring to use this receiver on batteries, simply replace the 57 type tube with a 77 and the 56 tube with a 37, for heater excitation from a 6-volt storage battery and use B batteries for plates. Loudspeaker reception on all local and many distant stations.

DIAMOND OF THE AIR

Battery-Operated Short-Wave Receivers

The battery-operated receivers employ the 2-volt low-current tubes, saving considerable expense to those living in districts where no a-c is available.

The two-tube model uses two 30 tubes. Especially designed for headphone reception, although loudspeaker reception may be obtained at ordinary room volume.

The 3-tube two-volt model employs one 34 and two 30 tubes. It will receive short-wave stations from all parts of the globe on a loudspeaker.

Electric Models

- Cat. No. 5025-D. Two-tube A-C kit, with blueprint. Shipping weight, 5 lbs. \$8.45
- Cat. No. 5026-D. Above, wired and tested. Shipping weight, 5 lbs. 9.45
- Cat. No. 5027-D. Complete set of tubes for above, either one 57 and one 56 for a-c operation or one 77 and one 37 for battery operation. Specify which. Shipping weight, 2 lbs. 1.45
- Cat. No. 5028-D. Three-tube a-c kit, with blueprint. Shipping weight, 7 lbs. 11.45

- Cat. No. 5029-D. Above, wired and tested. Shipping weight, 7 lbs. 13.45
- Cat. No. 5030-D. Complete set of tubes, either one 58, one 57 and one 56 for a-c operation or one 78, one 77 and one 37 for battery operation. Specify which 2.45

Two-Volt Battery Models

- Cat. 5019-D. Two-tube kit, with blueprint, less accessories listed below. Shipping weight, 5 lbs. \$7.75
- Cat. No. 5020-D. Above, wired and tested, less accessories listed below. Shipping weight, 5 lbs. 8.75
- Cat. No. 5021-D. Complete accessories including two 230 tubes, one set of standard headphones, two No. 6 dry cells, two standard 45-volt B batteries. Shipping weight, 22 lbs. 4.50
- Cat. No. 5022-D. Three-tube kit, with blueprint, less accessories listed below. Shipping weight, 7 lbs. 9.95
- Cat. No. 5023-D. Above, wired and tested, less accessories listed below. Shipping weight, 7 lbs. 10.95
- Cat. No. 5024-D. Complete accessories, including two 30 tubes and one 34 tube, one set of standard headphones, two No. 6 dry cells, three standard 45-volt B batteries, one 6-inch magnetic speaker. Shipping weight, 32 lbs. 8.95

DIAMOND of the AIR SHORT-WAVE POWER PACK

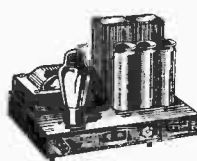

Supplies clear hum-free power regardless of circuit sensitivity. Especially designed for use with the "Diamond of the Air" Short-Wave receivers, but can be used on any short-wave battery-operated receiver for B supply.

Contains a brute-force filter, employing two heavy-duty 30-henry chokes, specially-designed power transformer, and three electrolytic condensers. These factors assure pure d.c.

Will deliver 180 volts. Supply your own taps. 135, 90 and 45 volts. Supplies 2½ volts at 10 amperes for filament drain. All taps terminate at binding posts on the side of the pack. Employs an 80 rectifier. Will stand up to 75 ma. drain for B current.

All parts are mounted on a sturdy metal base finished in silver.

- Cat. DAPP. Price, including 80 tube \$5.95

Shipping Weight, 20 Lbs.

ALL SHIPMENTS MADE EXPRESS COLLECT UNLESS OTHERWISE DIRECTED BY PURCHASER

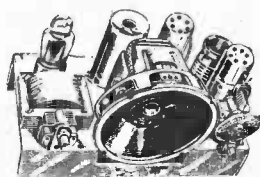

Four-Tube A-C Short-Wave Receiver with Built-In Speaker

Will tune in short-wave stations from all parts of the world with ease. Uses four plug-in coils to cover the entire short-wave band from 15 to 200 meters. The built-in power supply is entirely free from hum or disturbing line noises. Uses an ultra-sensitive dynamic speaker which aids in tuning in the weaker signals.

- Cat. 4TK. Kit of Parts, less cabinet, less tubes. \$17.50
- Cat. 4TW. Above, completely wired and tested \$19.50
- Cat. 4TCB. Cabinet only... \$1.50 extra
- Cat. 4TTU. Complete set of licensed tubes. \$2.50 extra

Reliable Radio Company
145 West 45th Street
NEW YORK CITY



For A-C and D-C Operation

Will work anywhere that 110 volt A-C or D-C is available. U. S. amateur reception is assured on loudspeaker by the use of a 43 power tube in the output.

With headphones the entire world is at your finger-tips. Chassis is completely encased in a beautiful crystal finished cabinet. Covers the short wave, band from 15-200 meters. Uses one 78, one 25Z5 and one 43 tube.

- Price Kit..... \$8.95
- Wired.... \$2.00 extra. Tubes..... \$3.25

FREE
HANDY SERVICEMEN'S
MANUAL
WITH EACH PURCHASE OF
A SHORT-WAVE RECEIVER



ROLAND BURKE HENNESSY
Editor

HERMAN BERNARD
Managing Editor

RADIO WORLD

REG. U.S. PAT. OFF.

The First and Only National Radio Weekly
TWELFTH YEAR

J. E. ANDERSON
Technical Editor

J. MURRAY BARRON
Advertising Manager

Vol. XXIV

JANUARY 27th, 1934

No. 20. Whole No. 618

Published Weekly by Hennessy Radio Publications Corporation, 145 West 45th Street, New York, N. Y.

Editorial and Executive Offices: 145 West 45th Street, New York

Telephone: BR-yant 9-0558

OFFICERS: Roland Burke
Hennessy, President and
Treasurer.
M. B. Hennessy, Vice-Presi-
dent.
Herman Bernard, Secre-
tary.

Entered as second-class matter March, 1922, at the Post Office at New York, N. Y., under Act of March 3, 1879. Title registered in U. S. Patent Office. Printed in the United States of America. We do not assume any responsibility for unsolicited manuscripts, photographs, drawings, etc., although we are careful with them.

Price, 15c per Copy; \$6.00
per Year by mail. \$1.00 extra
per year in foreign countries.
Subscribers' change of ad-
dress becomes effective two
weeks after receipt of notice.

NOTES on OSCILLATORS

HARMONIC TYPE FOR I-F AND BROADCAST USE, FUNDAMENTAL TYPE FOR SHORT WAVES—ASSISTANCE ON CALIBRATION

By Herman Bernard

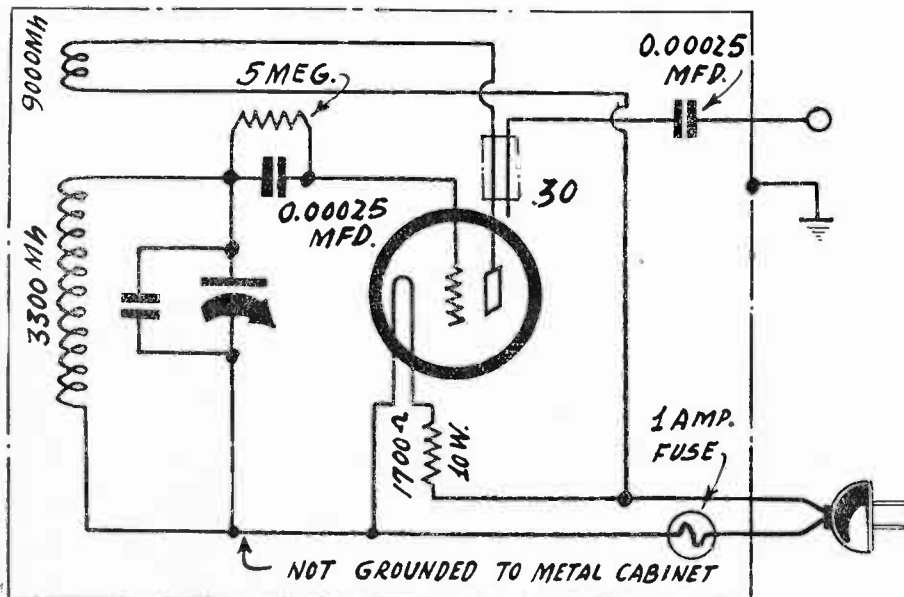

FIG. 1

Circuit diagram of the Model 30-N Test Oscillator, for use on 90-120 volts a.c. (any frequency), d.c. or batteries, and requiring no separate excitation of filament. Constant modulation is provided in all three uses. A frequency-calibrated scale is used, hence the instrument is direct-reading. The fundamental frequencies are 135-380 kc, and harmonics are used for higher intermediate frequencies and for the broadcast band.

ONE of the considerations brought home to the service man and experimenter in radio during 1933 was that he could not very well get along without a test oscillator. At the same time strong advances were being made in the expert engineering field toward the stabilization of oscillators. As yet the stabilized oscillator has not appeared in a broadcast receiver, nor yet in the test oscillators of less than the precision

type, all of which will cost more than \$100. As for the theoretical side of stabilization, this is being pressed by engineers all over the world, and the leading scientific journals in the radio and allied fields frequently contain articles dealing with this topic. The reason for the high interest is the growth of precision requirements in variably tuned circuits.

The problem of frequency stability in the

fixed-frequency oscillator was solved long ago by the use of the quartz crystal, but the systems applied to variably-tuned oscillators achieved a frequency-constancy in fixed-frequency use well comparable with that of a crystal-controlled oscillator. However, for fixed-frequency work a crystal type oscillator is used almost invariably.

Llewellyn's Work

The requirement to stabilize an oscillator against change in frequency from any cause save that of tuning with the intentional tuned circuit presents numerous problems and is a complex mathematical work, as well. Some of those who have theorized on the subject evidently have not built the oscillators and tested them, otherwise oscillators requiring absence of grid current for assurance of stability, in connection with the special circuit, would not be suggested in forms that scarcely can avoid grid current.

The leading work in this country has been done by F. B. Llewellyn, of Bell Telephone Laboratories, who has showed methods of frequency-stabilization of the most popular types of oscillators.

All systems require more coils than the simple oscillator, and the Colpitts, by its very nature, independent of stabilization, requires a two-gang condenser and extra coils.

The factors that change the frequency of an oscillator from what is intended include the alteration of the terminal voltages, the inequality of the oscillation amplitude over the tuning range, the inductance changes due to meteorological effects, capacity changes from a like cause, and mechanical displacements due to other than weather conditions, and harmonics.

Case of Batteries

The change in terminal voltages means that the A, B and C voltages change, as they do when batteries are used, and even when rectified a.c. is applied to plates, or to plates and filaments, and includes a.c. operation of filaments and heaters. Even a storage battery changes likewise. In the case of batteries it is perhaps closer to the truth to state that the resistance of the battery in-

creases with use and age, and therefore the constant voltage across the battery is inconstant in respect to the circuit served, since the voltage to the external circuit is reduced by reason of the current flow through the increased resistance of the battery. That applies to dry cells as well as to a storage battery. Therefore while the battery voltage may be regarded as never changing, the service voltage does change.

No matter what the intrinsic reason, the fact remains that changes like these cause changes in the impedance of the tube circuits, and therefore an oscillator calibrated for a definite frequency at a particular position, when the terminal voltages are normal, will have a different frequency of generation at the same setting when the terminal voltages are materially reduced, unless the oscillator is stabilized.

Therefore the requirement to be fulfilled, to make the oscillator frequency-stable, is that the circuit constants and voltage supply shall be so arranged that the tube is made to behave as a pure resistance. The distinguishing factor in a pure resistance is that it is constant, independent of frequency and independent of variations in current. The significant factor is the independence of frequency. The current changes in the tube, which here represents the resistance, need not be considered, as all currents are deemed to be within the capabilities of the tube. Anybody who knows enough about radio to stabilize an oscillator certainly knows enough not to overwork tubes.

Dynatron Stabilizable

The voltage supply enters only in the sense that the polarities are designated. Hence, if a dynatron is to be built, the usual higher voltage on the plate does not obtain, but the screen voltage is higher than the plate voltage, and the grid voltage bias, if any, becomes of small importance. Even the wobbly dynatron can be stabilized.

General availability of stabilized oscillators not yet being a fact, the next consideration is a test oscillator of suitable characteristics, without frequency stability of an order exceeding 0.1 per cent.

Practically all of the popular oscillator circuits are satisfactory for what might be termed course use, the Hartley being particularly useful for a frequency-doubler or harmonic type oscillator, and one of the readiest oscillators. Thus an oscillator may be constructed for covering some span of frequencies such as 135 to 380 kc, where the fundamental is useful for lining up intermediate frequencies, or, if some intermediate frequencies are higher, use a fundamental half of the desired frequency, so that the test oscillator's fundamental will yield a second harmonic equal to the desired frequency. Hence, by the second-harmonic method, the channels that can be lined up with the 135-380 kc oscillator are 270-760 kc. The fourth harmonic then would account for the broadcast band, 540 to 1,520 kc.

Frequency-Calibrated Scale

Constructors of oscillators, while they may like to calibrate their own, may have difficulty in doing so, although some helpful suggestions will be given later on. Any who desire to construct an oscillator that is in a sense pre-calibrated can do so by using a commercially-obtainable combination of coil, condenser and dial. The reason why the entire combination must be a unit is that the scale is frequency-calibrated on the basis of a given inductance and a definite variation of capacity in respect to dial position. The resultant frequencies imprinted on the scale therefore would not apply if the combination consisted of the right coil and the wrong condenser or the right condenser and the wrong coil.

In the general run of test oscillators, all of which avoid total frequency-stabilization because of the extra cost, some measure of stabilization is obtained nevertheless by the use of grid leak and condenser. The reason for the grid leak in oscillators is that the resultant grid current flowing through the

leak causes the bias on the tube to vary in proportion to the amplitude of the oscillation. Thus the oscillator, no matter what type of tube is used, aside from a gas-discharge valve, is of the diode-biased triode, quorode, pentode, etc., type. The bias is negative the greater the amplitude, because, through the aid of the grid condenser, the electrons accumulate at the grid.

Another factor working in the same direction is the use of high capacity for tuning. This is scarcely practical for wide frequency coverage, say, 2.8-to-1 frequency ratio, or more, yet if a somewhat larger maximum capacity is allowed for, the trimmer capacity may be increased considerably, without rendering the frequency ratio too small, and at least part of the tuning will be fairly well stabilized. This is at the lower frequencies, for then the tuning capacity is larger than at the higher frequencies.

Plate Current Stays Put

In general, with any reasonable maximum the stability runs smoothly until around 100 mmfd. Observation of the steadiness of plate current in an oscillator over the higher capacity portion of the tuning, contrasted with wobbliness at the lower capacities of tuning, will confirm this. Moreover, with the plate current steady the amplitude is steady, and without steady amplitude one could not have stability of frequency.

The steadying effect of the leak is that it bucks the oscillation, and the more the oscillation voltage tends to rise above a certain value, the more the leak potential rises to meet the requirement, although the leak circuit has a saturation limit, which is often reached in oscillators at the smaller capacities of tuning, toward the low capacity end of the condenser.

Current Distribution

The steadying effect of the large tuning capacity is due to the bypass effect on the harmonics. The presence of intense harmonics is an indication of lack of frequency stability, and especially is it true that the harmonics draw power from the circuit. While the harmonics are present, they are weaker when they are multiples of a frequency which depends largely on capacity. However, they are strong enough for use

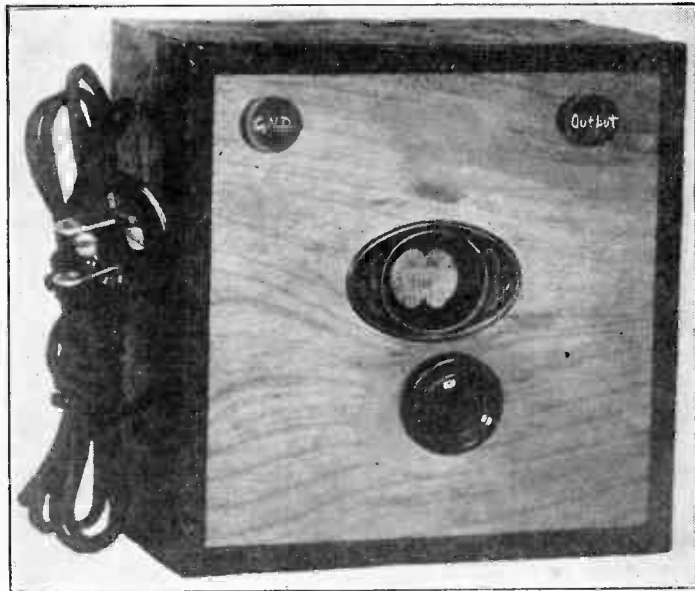

FIG. 2
View of the Model 30-N Test Oscillator in a wooden box. If a metal box is used the trimmer adjustment is affected, and must be experimented with until zero beat results when the oscillator proper is put into the metal cabinet.

in test oscillator work, even if the tuning capacity is 600 mmfd.

Another consideration is that when the capacity is large the current through the coil is less. This tends to reduce the intensity of the oscillation. Also, it is known that condensers work in the direction of stability, and coils in the opposite direction. This does not deny the excellence of stabilized oscillators using inductive means.

The tuned grid oscillator, with leak and condenser, if the voltage supply is abundant, or without leak and condenser, if the voltage available is low, is another favorite. Perhaps it has seen greater use than any other type. It consists simply of the tuned secondary in the grid circuit inductively coupled to an untuned tickler in the plate circuit.

If the voltage supply is sufficient the leak and condenser may be used, and if not, omitted, because otherwise the tube might not oscillate, or, if it does oscillate, might stop at too high a frequency.

Effect of Metal Cabinet

Without the leak and condenser the circuit can be quite simple, and even the filament of a 30 tube may be heated by a 1.5-volt dry cell directly, and some 22.5 volts put on the plate, even less. Somewhat more tickler would be used than in conventionally voltage circuits.

The Model 30-N Test Oscillator diagram, for 135-380 kc, with harmonics useful for broadcast and even higher frequencies, is diagrammed and photographically illustrated. It is an exceedingly popular and serviceable instrument, of the tuned grid type. Due to the accuracy of the inductance used it requires only a capacity adjustment at some high frequency. The beat between some broadcasting station, 1,400 to 1,500 kc, and the corresponding high-frequency, low-capacity setting of the condenser, may be resolved to what passes for zero beat, and the adjustment is complete.

If the oscillator is to be put into a metal box, however, the effect will be to lower the frequency, because in this instance the cause is capacitive. The trimmer adjustment may have to be repeated a few times until the trimmer is unscrewed enough to atone for this effect, so that when the instrument is placed in the box the zero beat will be established.

(Continued on next page)

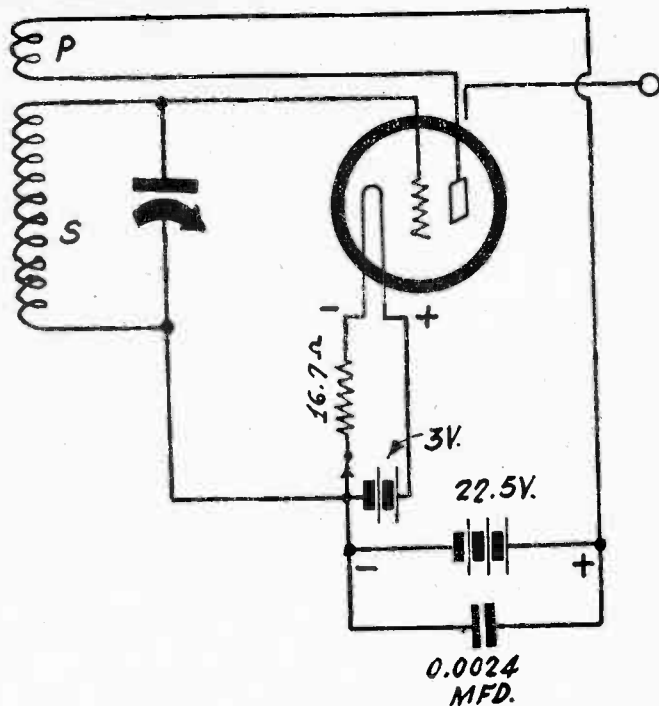

FIG. 3

A battery-operated test oscillator, used with plug-in coils, for covering from near the high end of the broadcast band to higher frequencies, with the largest of four short-wave plug-in coils. By using the three extra coils the frequencies may be extended to the generally useful limit of the short-wave band.

(Continued from preceding page)

If one is to calibrate his own oscillator, he will naturally use broadcasting stations as primary standards. If he has a tuning condenser of known maximum capacity, the commercial rating being sufficient, he can allow for the minimum circuit capacities (say, add 20 mmfd.) and he can know what the low-frequency extreme will be, and even approximately the high-frequency extreme. If the computation is not readily made, Edward M. Shiepe's book, "The Inductance Authority" gives the answer at a glance.

Use of Harmonics of T. O.

It is very simple to calibrate an oscillator when the one has his bearings, as he can divide broadcasting frequencies by 2, 3, 4, 5 etc., and beat harmonics of the low-frequency test oscillator with the station fundamentals. For instance, in the Model 30-N example, if one uses the broadcasting channel of 700 kc as standard, there will be a beat near the low-capacity end of the condenser due to 350 kc of the test oscillator yielding a second harmonic that beats with the fundamental of the station. Then as the dial is turned there will be beats at the following positions on the dial scale: 233.3 kc, 175 kc, and 140 kc. These are due to the third, fourth and fifth harmonics of the test oscillator beating with the same station fundamental. Also these four zero beats four positions on the dial for four known frequencies of computable differences, i.e., 116.7 kc, 58.3 kc, and 35 kc.

Short-Wave Use

For short-wave use the harmonics of such low-frequency oscillators as have been discussed are not of much use, except for peaking without knowing what the frequency is. The absolute value of frequency is best determined from a high-frequency oscillator's fundamental, or at least the tuning should start at or near the end of the broadcast band, and go to higher frequencies, for fundamentals, and harmonics then may be used, if desired, although another coil for each succeeding desired band would be preferable.

So far work has been done on calibrating one of the short-wave coils, the red one of the Insuline group of four. The circuit used is given in Fig. 3 and the curve is shown in Fig. 5. The tuning condenser used was

a General Radio 247, the capacity curve for which is repeated here from the January 13th issue as Fig. 4.

The inductance was 48 microhenries. The circuit capacities were 20 mmfd. and the condenser capacities as on the frequency curve. Therefore the actual capacities were the sum of the two, since the condenser curve is for its own exclusive capacity, distributed circuit capacities excluded.

Real and Theoretical

The frequency curve starts at 1,100 kc, although this is a point at or near which oscillation stops, so sometimes there may be oscillation, sometimes not. The capacity then is actually 420 mmfd., and as this is more than will be used ordinarily, a 350 mmfd. condenser would start you off at 1,400

kc or thereabouts. If any have or can get the General Radio condenser, it may be used, and then Fig. 4 applies too, but the dial should not be used at more than 350 mmfd. capacity for assurance of oscillation.

The curve to 2,000 kc is real, having been obtained by heating with standards, but from 2,000 kc up the curve is theoretical, being based on computation, using the ascertained inductance and the capacity curve, with 20 mmfd. allowed for circuit minima. Hence any values of capacity C for the condenser alone as read from the condenser curve in Fig. 4 should be taken as circuit equivalent of C-20, where C is in micromicrofarads.

The numerals to the right of the frequency curve give actual condenser values (circuit minima excluded) as an aid to calibrating any equivalent condenser.

It is not the intention that the frequency curve should be taken as the absolute basis of the reference and so avoid calibration, but rather that it be used as a means of finding your bearings. It is possible to utilize harmonics of broadcast receivers as they exist in the receivers themselves, if earphones are used in the set, because these harmonics are very weak. Thus, to find 1,800 kc, use 900 kc in the broadcast band, and tune the test oscillator until the beat is heard in the phones. The capacity will be 0.000155 total, or 0.000135 mfd. tuning condenser and 0.00002 mfd. circuit minima. For purposes of this work, however, it is handier to speak of micromicrofarads, hence 155 and 135.

Two Oscillators Suggested

When 1,800 kc is registered thus, or any other frequency near it, by use of some other broadcasting station, the second point may be registered because of the next harmonic, hence 2,700 kc, and also the next, 3,600 kc. The capacity tuning curve is not very much help above 4,000 kc, because of the extremely rapid change of frequency with small changes in capacity. As this trouble will multiply as frequencies are increased, it is just as well to omit the first few degrees of the condenser for all bands of a test oscillator.

Since the oscillator is a very simple arrangement, it is suggested that two oscillators be built, and then Oscillator B may be calibrated against Oscillator A, when the next smaller coil is put into Oscillator B, and then Oscillator C calibrated against B and D against C, simply by plugging in the right coil. Overlap can be checked and only

(Continued on page 8)

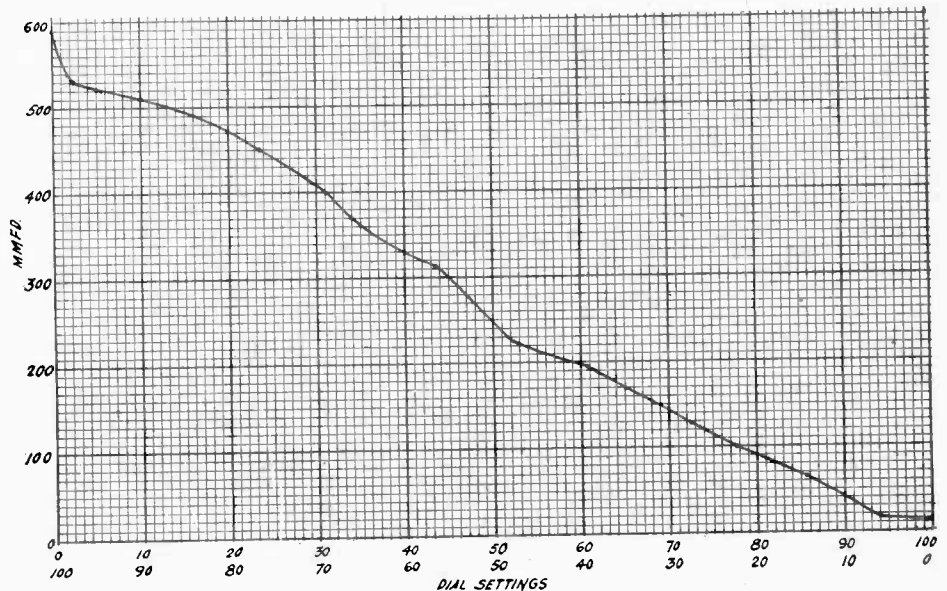

FIG. 4

In case a General Radio 247 condenser is used, this curve may be followed for the capacity values at the dial settings, which are given for 0-100 and 100-0, depending on what type of dial or scale is used. This condenser closes to the left, hence capacity increases when the rotor is moved to the left, where maximum exists. Turning the condenser the wrong way would make the curve meaningless.

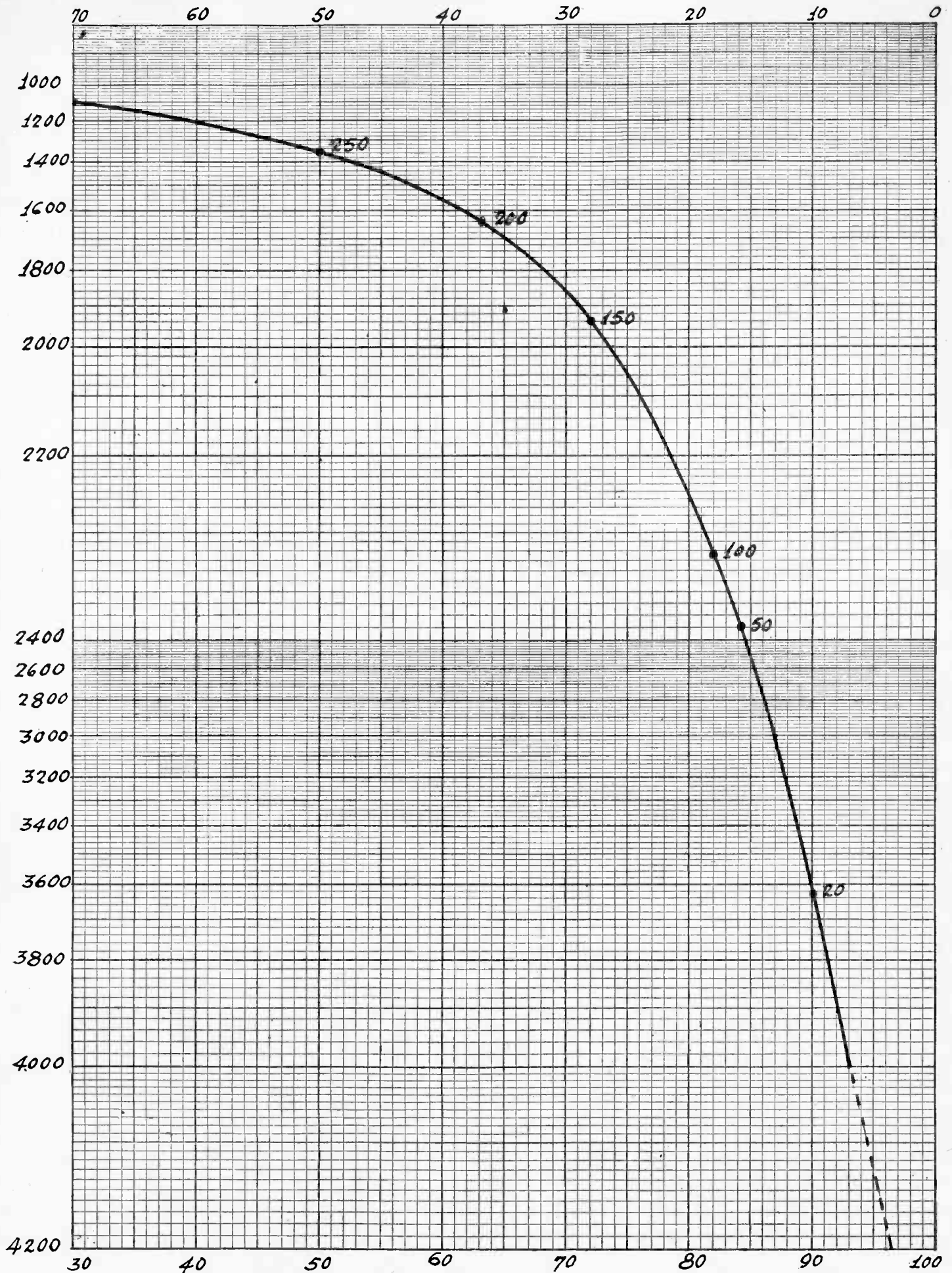

FIG. 4

Calibration curve, actual for the lower frequencies, theoretical for the higher ones, of a General Radio 247 condenser used with an Insuline red plug-in coil on UX base, inductance 48 microhenries (Cat. 1421). The numbers to the right of the curve represent the exclusive condenser capacity in circuit, as an aid to calibrating any condenser within range, when using this coil. The total capacity is 20 mmfd. more than what the numbers signify. The dial readings are 100 to 70 or 30 to 100.

THE ICONOSCOPE

Greatest Contribution to Television so Far—Engineered by Dr. Zworykin, It Affords Electrical Pickup Scanning, Almost Humanizing a Tube

By J. E. Anderson

*"Johnny Get Your Electron Gun,"
Latest Title to Vision Tune*

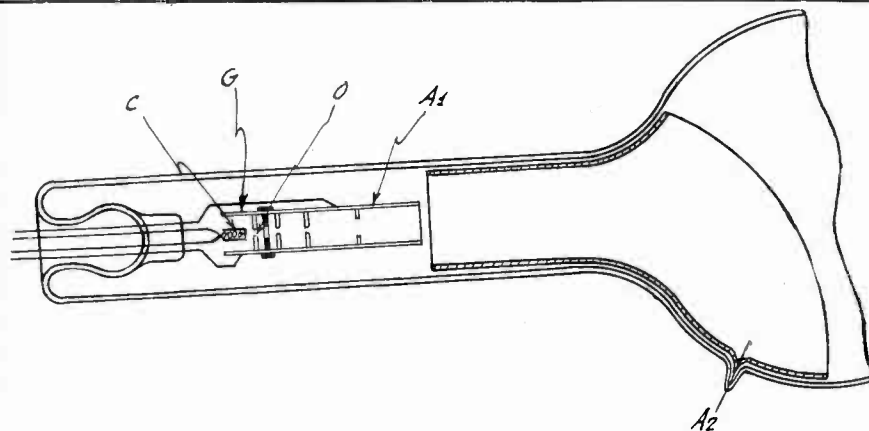

FIG. 1

This shows the construction of the electron gun which is used in both the iconoscope and the kinescope.

ICONOSCOPE is a name given a device developed by Dr. Vladimir Zworykin, of the Radio Corporation of America, for use in television transmitters and constitutes the greatest single contribution so far made to the television art. Literally the term signifies "image viewer." The apparatus is a cathode ray oscilloscope of special design, which is sometimes also called the electron gun. This term is apt, for it is literally an electron gun. There is a cathode, or source of electrons, then a long "barrel" through which they are accelerated, or given speed, by a positive element. The construction of the gun is shown in Fig. 1. C is the cathode, which, it is clear, is of the indirectly heated type, G is a grid for controlling the flow of electrons, just as the grid is used in any vacuum tube, and A1 is the anode, or the "gun barrel." It will be noticed that in the tubular anode, or barrel, are two obstructions, with small holes in the center. The purpose of these is to narrow the electron stream into a narrow beam. By virtue of the high speed the electrons are given in the

tubular anode, the electron beam shoots out into the bulb and finally impinge on the fluorescent screen.

Optical Analogy

In Fig. 2 is a more detailed diagram of the electron gun, showing the cathode, the control grid, the tubular anode, and the obstructions. There are really three obstructions, one at the beginning of the anode and two farther on. How these obstructions narrow the beam is shown by the lines. There is a second anode, which is in the form of a coating on the glass bulb.

The device is equivalent to an optical system containing four lenses as indicated in the lower part of Fig. 2, where the dotted lines show the course of the electrons. The principal feature is that the electrons converge at a point on the screen, and a very small point at that.

Deflection of Electron Beam

A voltage of about 1,000 volts is applied

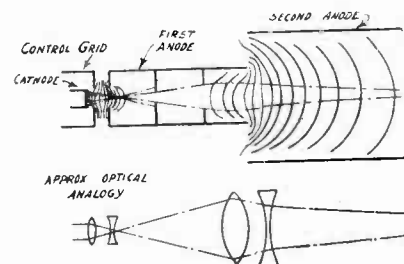

FIG. 2.

This is a more detailed view of the control end of the electron gun, showing how electric fields are disposed to simulate an optical system

to the second anode and a fraction of this voltage on the first anode.

If the electron gun is to be used for constructing an image on the screen, there must be a means for deflecting the beam in two directions, at right angles to each other. The first is used for moving the beam, or rather the point where the beam impinges on the screen, across the screen horizontally, and the other for moving it vertically, and both movements must be linear with respect to time. That is, in each direction the spot should move equal distances in equal times. The movement of the spot in the horizontal direction should be at a rate equal to the line scanning frequency and the movement in the vertical direction should be at a rate equal to the frame frequency. Thus for a 120-line picture repeated 24 times per second, the horizontal movement should be at a rate of 24×120 per second and the vertical movement should be 24 times per second.

Deflection plates are coils used for this purpose. They are placed so that an electrostatic or a magnetic field will deflect the electrons in the proper directions. Every cathode ray oscillograph tube is equipped with a set of each of the deflectors, of one type or the other.

Linear Deflection Voltage

There is no difficulty of producing voltages or currents to cause these deflections. But if the deflections are to be linear in time a special arrangement is required. Cir-

Wave Band Coverages of Typical Condensers

(Continued from page 6)

second harmonics, except for the fundamental overlap, need be released on. This method is easier in the long run, because harmonics tend to become confusing as the frequencies become higher and higher.

Preferably the receiver used as standard for broadcast frequencies should be of the tuned radio-frequency type, because then the beats are scarcely ever spurious or adventitious, whereas in the case of a superheterodyne one has to consider the funda-

mental and its harmonics, the oscillator and its harmonics, as well as frequencies lower than the fundamental by twice the intermediate frequency, as well as beats between local oscillator and its harmonics with broadcasting frequencies and their harmonics not sufficiently rejected by the t-r-f portion of the super to prevent the spurious or undesired and confusing beats. However, with a curve such as Fig. 5 as guide the off-curve responses may be rejected immediately, and only such points as fall somewhere close to the curve accepted.

The wave band coverage with larger than 150 mmfd. condensers will provide very considerable overlap, and this should be taken into account in avoiding confusion in calibration. The frequency ratio of a 350 mmfd. condenser may be taken as about 3, that of a 200 mmfd. condenser as about 2.6 and that of a 140 or 150 mmfd. condenser as about 2.3. Therefore when the low-frequency extreme is established the approximately high-frequency extreme is that frequency multiplied by the factor. The ratio holds for all bands.

cuits for producing voltages that vary rapidly from minimum to maximum in a linear manner have been produced recently and suitable tubes have been made available. The principle used is that of charging a condenser with a constant current and then discharging it rapidly. As the condenser is being charged with a constant current, the voltage across that condenser increases linearly with time. When the voltage reaches a certain value the condenser is discharged through a neon tube or some gas discharge tube having similar characteristics. The discharge takes place at a very high rate compared with the rate of charging.

The device used for charging the condenser with a constant current is a saturated vacuum tube. A constant voltage would not do for that would charge the condenser exponentially. A saturated vacuum tube, however, works because the current is limited to the emission of the tube, and this is constant, as long as the temperature of the cathode is constant and the plate voltage is high enough to insure saturation.

A Saw-Tooth Wave Producer

A voltage or current wave in which the increase is linear with respect to time and the discharge is rapid, is called a saw-tooth wave because of its similarity with a saw when many cycles are plotted. A circuit for producing such a wave is shown in Fig. 3. The saturated tube employed is a 34. It has independent voltage sources. A small grid battery is used for providing bias and this bias is varied by means of a potentiometer across the battery. This helps to control the current. The tube also has its own filament and screen voltages. The saturation can be obtained by varying the screen voltage as well as by varying the filament current.

The anode voltage which determines the saturation current is applied between the plate of the 34 and ground. It will be noticed that the cathode of the 34 is connected to the plate of the 885, through a resistance of 700 ohms.

There are three condensers between ground and the cathode of the 34, any one of which can be selected by means of the switch. Suppose the switch is set on one of them. The current through the 34 will flow into this condenser at a constant rate, and it will not flow through the plate circuit of the 885 because this tube is not conducting. The condenser selected will therefore become charged at a constant rate determined by the current through the 34. When a certain voltage has been reached, the 885 suddenly becomes conductive to the extent that it virtually shorts the condenser. Hence this discharges at a rate which is partly determined by the limiting resistance R1. The current through the 34 is so small compared with the current through the 885 that it cannot appreciably prolong the discharge period. When the voltage across the 885 has fallen to a certain value, this tube ceases to conduct, and the charging process is repeated. R1 is mainly used to limit the discharge current to a value that is safe for the tube. It is subject to variations to meet requirements. That is, it may have to be adjusted to a value depending on the capacity of the condenser that is discharged through it.

Exponential Charging Rate

If the direct voltage were applied to the high side of the condenser directly without the medium of the 34, the produced wave would not be linear, but the voltage would rise exponentially, and it would drop back in the same way, but more rapidly. The return to minimum is exponential in any case. The output of the saw-tooth wave generated is taken from the condenser by shunting a 0.5 mfd. condenser in series with a 10 megohm resistor across the active condenser. The 0.5 mfd. condenser is used merely to stop the d-c, and its value is so large that it does not affect appreciably the operation of the circuit. The voltage across the 10-

megohm resistor is used on the deflecting plates of the oscillograph.

The Gas Triode

The 885 is a gas triode of the heater type and is used in place of a neon tube. Its grid serves to control the plate current up to a certain plate voltage, after which it has no control, and the plate current rises to a large value by ionization of the gas in the tube.

The grid voltage determines definitely the voltage on the plate at which the discharge takes place, and the discharge voltage is a linear function of the bias. Judging from the curve supplied for the 885, the relation between the discharge voltage and the grid bias is $E_d = 10(E_g - 1)$, in which E_d is the positive voltage on the plate and E_g is the bias voltage on the grid. The slope of the curve is 10 and there is minimum bias of one volt. This might mean that the tube will begin to glow when the grid bias is one volt positive and the plate voltage is zero. For large values of bias the minimum bias is negligible and the striking voltage can be taken as ten times the bias. At 300 volts on the plate the glow begins when the grid bias is 30 volts.

This relationship has many useful applications. Thus it may be used for controlling the frequency of oscillation and the amplitude as well. But the two may be controlled independently by controlling the rate of charge by controlling the current through the saturated charging tube. Another application of the relationship is to synchronization of the output voltage with a signal. A small coil L is placed in the grid circuit of the 885 and on this is impressed a signal. This can be adjusted so that the discharge occurs at just the desired time. For example, it can be adjusted so that the discharge of the sweep oscillation in television occurs at the end of the line, or at the end of the frame. This would provide a synchronizing means not only once a frame but also once for every line. This is actually done.

It is also clear that a device of this kind can be used for controlling relays. The bias on the tube could be controlled by a voltage in the plate circuit of a photo tube, and the circuit could be adjusted so that the plate current would begin to flow at a given value of light. It would be necessary to provide a means for reducing the voltage below the striking voltage, or the tube would continue to conduct. This could be done in the same way that it is done in television, that is, by means of a condenser.

Shape of Output Wave

The shape of the output wave from an

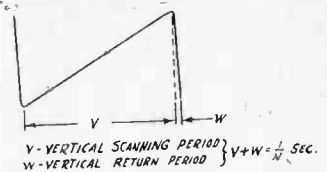

FIG. 4

The wave form produced by the oscillator in Fig. 3. The voltage rises linearly until the tube begins to conduct, then falls rapidly.

885 and a saturated vacuum tube is shown in Fig. 4. V is the time required for the charging of the condenser to the voltage at which the 885 breaks down. When the voltage has reached this value, which is represented by the vertical distance at the highest point, current begins to flow rapidly through the tube, and the condenser is discharged. This occurs in the brief time represented by W. The total time for charging and discharging is $V + W$, and the frequency of the oscillation is $1/(V + W)$. This time can be varied to suit requirements. For example, it can be made 1/24 second if it is to be used for controlling the rate of repetition of pictures, assuming that the picture is to repeat 24 times a second, or it can be made 1/2,880 second, if this picture is to consist of 120 lines. For a complete scanning device both these would have to be used simultaneously.

This leaves the question of modulation of the electron beam, for it is not sufficient that it be made to move over the screen in a systematic manner. The modulation of the beam, that is, the control of its intensity, is done by the grid of the electron gun. The television signal is impressed on the grid, and it controls the number of electrons that arrive at the screen in the point, and hence the illumination on that spot.

The Iconoscope

We started out to tell about the iconoscope and then continued to tell about related devices. The iconoscope is used at the transmitting end of a television system, just as the kinescope is used at the receiver. Fig. 5 shows the iconoscope together with an amplifier for taking off the image signal. In the first place there is an electron gun and the two sets of deflecting plates and the focusing arrangement to produce a small spot of light. But the plate is quite different. It is the screen for the electrons from the gun but it is not set at right angles as in the case of the kinescope, or receiving cath-
(Continued on next page)

FIG. 5

The complete circuit of the iconoscope, showing the electron gun, with the photo-sensitive target, and the lens that throws the image to be transmitted on the photo-sensitive surface.

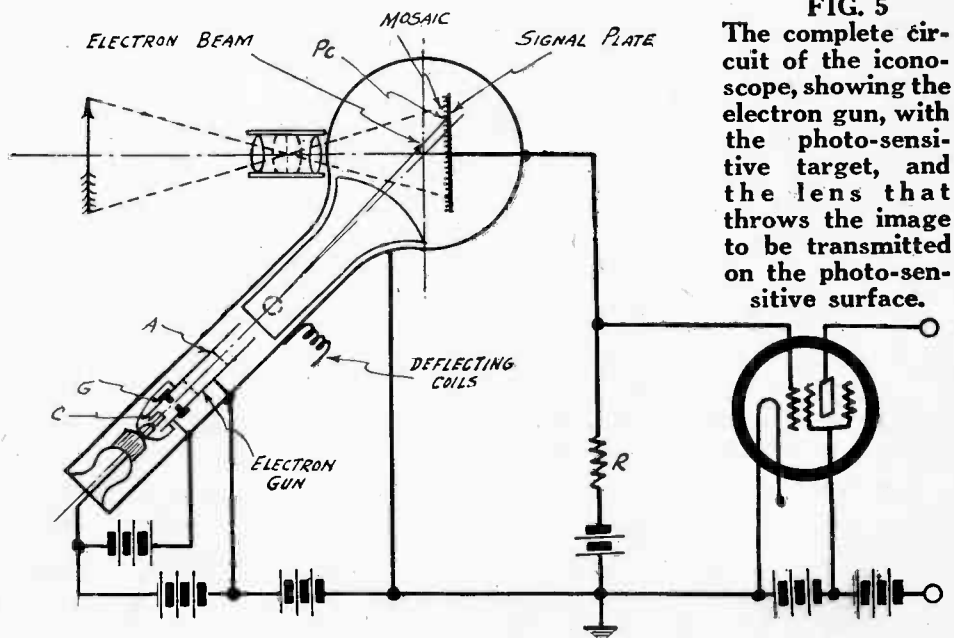

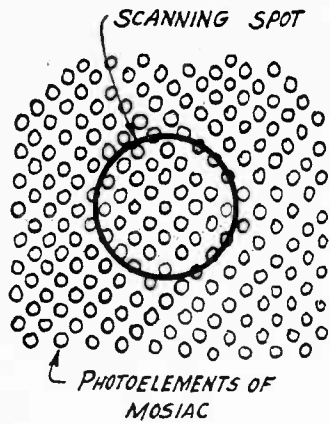

FIG. 6.

An enlarged view of the photo-sensitive surface, the small dots being photo-electric cells and the circle the electron spot.

(Continued from preceding page)

ode ray device. Neither is it covered with fluorescent substance, but rather with a photo-sensitive substance. This photo-sensitive material is not making a continuous layer but is made up of a mosaic of a large number of minute photo-sensitive dots, each one an emitter of electrons when light falls on it, just as an ordinary photoelectric cell. There is an insulator between the plate and the photo-sensitive material, and there is a certain capacity between the plate and the sensitive element. In the figure the plate side of the condenser is connected to the grid of the amplifier, and it is also connected to the positive side of the electromotive force. When light falls on one of the small elements, it emits electrons, leaving it positively charged. The intensity of this charge depends on the intensity of the light signal. When the electron beam falls on the positively charged element the charge is neutralized. This charging of the tiny condenser and discharging it through the electron beam amounts to an electric current through the resistance R in the grid circuit. The voltage drop in R resulting from this current is the signal impressed on the amplifier. Its intensity varies directly as the intensity of the light.

Scanning

On the side of the bulb will be found a photographic lens with its axis at right angles to the plate containing the multitude of photo-sensitive spots. This is a high grade lens that collects as much light as possible from the scene to be transmitted and brings it to a focus on the sensitive plate. Thus

there is a sharp image of the scene on the plate. Not all the sensitive elements in the mosaic will be subjected to the same light, and therefore not all the tiny condensers will be charged to the same extent. Hence when the electron beam sweeps over the cells the current through the resistance R will vary according to the intensity of the light in the image. If the image is stationary each cell will be charged to the same degree after every discharge by the electron beam. If the image varies due to motion in the scene, there will be a variation in the charge from time to time, but whatever it may be, the resulting current will be proportional to the intensity of light that exists.

Advantages of the Scheme

This device has many advantages not possessed by any other scanning device. In the first place it utilized the natural illumination on the object, which is most desirable. It avoids, therefore, the unnatural effects obtained by the flying spot method of scanning. The arrangement takes full advantage of the optical properties of the lens, and there is nothing more nearly perfect than a modern photographic lens. Besides these advantages, there are no rotating parts involved, and no inertia to slow down the scanning. The response all around is instantaneous for any frequency ever likely to be used for deflecting the electron beam. There might be electrical inertia in the circuits to suppress high frequency responses, but that is something else that has nothing to do with this scanner. The scanning can be done at any rate required by the necessary detail in the picture. This can be done by means of the saw-tooth wave generator.

In Fig. 6 is an enlarged picture of the photo-sensitive mosaic. Each tiny circle represents a photo-electric cell coupled capacitively to the grid of the amplifier tube. The large circle encompassing several of the tiny circles represents the cross section of the electron beam. The smaller this circle is the finer the detail possible. The ultimately is when the area of the scanning spot is equal to the area of one of the small photo-sensitive spots. This, however, is not possible, for the sensitive spots are microscopic while the cross section of the electron beam at its focus is considerable. It is the function of the focusing arrangement to make the spot small.

There is no object, however, of making the scanning spot extremely small when the number of lines is not small, even though it may cover many of the microscopic photo-cells. If the image is divided into n equal lines and the ratio of line to depth of image is R, then there will be n picture elements in the vertical direction and nR in the horizontal direction. The total number of picture elements into which the image is divid-

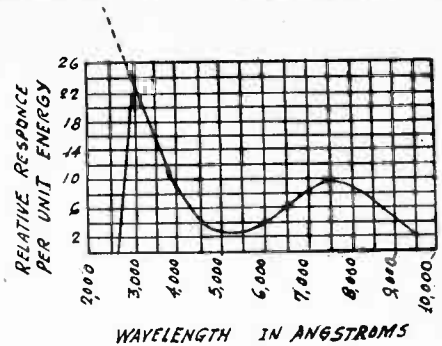

FIG. 7.

The iconoscope, showing that the device is sensitive outside the visible spectrum as well as inside it.

ed is n^2R . The area of the scanning spot should be equal to one of them.

The sensitivity of the iconoscope at present is about the same as that of photographic film operating at the speed of a motion picture camera. Thus it is possible to transmit scenes where they can be photographed by such a camera. The resolving power of the device is high and is sufficient for television. The resolving power is essentially a matter of making the scanning spot small so that the scanning can be done by many horizontal lines.

The new device has many possible applications in fields requiring an electric eye. This is not limited to the visible spectrum, for its sensitivity goes down into the infra-red rays. In Fig. 7 is a wavelength sensitivity curve covering the range from 2,000 to 10,000 Angstrom units. The highest sensitivity occurs at 3,000 Angstroms, which is below the visible violet. The sensitivity is least around 5,500 Angstroms, which happens to be about where the human eye is most sensitive. In the infra red region there is another sensitivity maximum.

The very rapid drop in the sensitivity curve below 3,000 Angstroms is no doubt due to the absorption of the short light waves by the glass of the lens and of the cathode ray tube bulb.

(Continued next week)

Commission's Attitude On Television Stated

In its annual report the Federal Radio Commission expresses the opinion that the television art has not yet advanced to the stage where it should be offered to the public as another form of entertainment, and for that reason it will keep television licenses in the experimental or in the laboratory class. Television, the Commission holds, undoubtedly will be consigned to the ultra short waves where there is plenty of space available for the wide transmission bands that must be used to insure a picture quality that will command sustained interest.

The quality of pictures which have been demonstrated as possible to transmit on the very high frequencies," the report of the Commission states, "has steadily increased and some laboratory productions are capable of holding sustained interest. Pictures need no longer be confined to 'close-ups' but larger scenes may be transmitted. The art, however, has not yet progressed to the stage which would justify the adoption of standards of the visual broadcasting industry."

Most of the work in television is done in large commercial laboratories and by private investigators who are looking to the future. Yet there are many television stations licensed for purely experimental purposes. The schedules of these stations are usually irregular and they are followed by a relatively small number of engineers and experimenters who are interested in the development of the art, either as professionals or amateurs.

Two for the price of One

Get EXTRA one-year subscription for any One of these magazines:

- POPULAR SCIENCE MONTHLY.
- RADIO-CRAFT (monthly, 12 issues).
- RADIO INDEX (monthly, 12 issues), stations, programs, etc.
- RADIO (monthly, 12 issues; for Amateurs and short-wave experimenters).
- EVERYDAY SCIENCE AND MECHANICS (monthly).
- RADIO LOG AND LORE. Bi-monthly; 5 issues. Full station lists, cross indexed, etc.
- AMERICAN BOY-YOUTH'S COMPANION (monthly, 12 issues; popular magazine).
- BOYS' LIFE (monthly, 12 issues; popular magazine).
- OPEN ROAD FOR BOYS (monthly, 12 issues).

Select any one of these magazines and get it free for an entire year by sending in a year's subscription for RADIO WORLD at the regular price, \$6.00. Cash in now on this opportunity to get RADIO WORLD WEEKLY, 52 weeks at the standard price for such subscription, plus a full year's subscription for any ONE of the other enumerated magazines FREE. Put a cross in the square next to the magazine of your choice, in the above list, fill out the coupon below, and mail \$6 check, money order or stamps to RADIO WORLD, 145 West 45th Street, New York, N. Y. (Add \$1.50, making \$7.50 in all, for extra foreign or Canadian postage for both publications.)

Your Name.....

Your Street Address.....

City..... State.....

- If renewing an existing or expiring subscription for RADIO WORLD, please put a cross in square at beginning of this sentence.
- If renewing an existing or expiring subscription for other magazines, please put a cross in square at the beginning of this sentence.

RADIO WORLD, 145 West 45th Street, New York. (Just East of Broadway)

DOUBLE VALUE!

AN ALL-WAVE MIXER

May Avoid Series Padding Entirely

By Erskine Foster

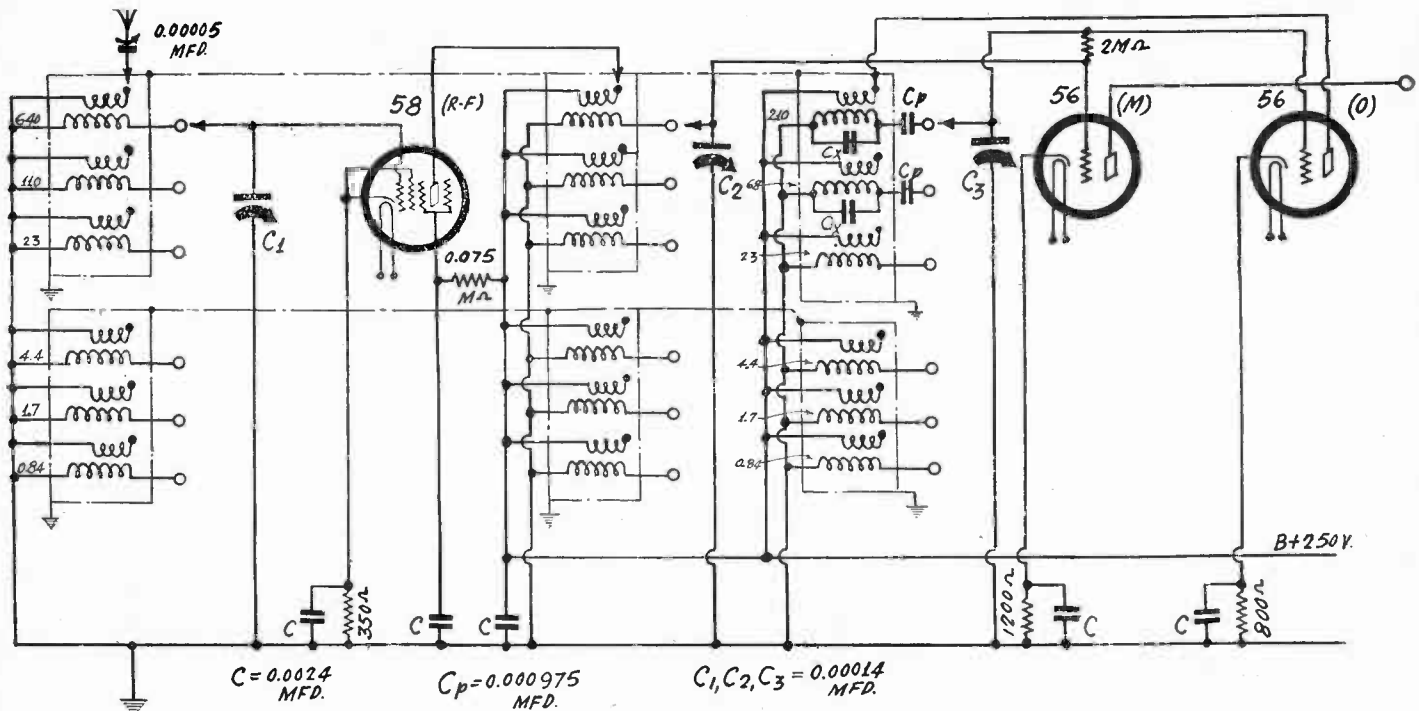

A coil-switch arrangement for a 465 kc superheterodyne mixer, 540 to 20,000 kc, where C1, C2, C3 are 0.00014 mfd. The imprinted secondary inductances then apply. If 0.0001 mfd. is used the series padding Cp may be omitted. This type of switch coil construction will be on the market in a few months.

THE diagram for a switch-coil tuner and mixer for a superheterodyne to cover the broadcast band and short waves is shown, with the tuning condenser a three-gang 0.00014 mfd. The secondaries have their inductance values imprinted on the diagram, the primaries being in general of the ratio of 1 to 4, except that the tickler for the oscillator, also considered as primary, has a 1-to-1 ratio for the highest frequency band and a 1-to-2 ratio for the second from highest frequency band.

This is the type of outfit that has been discussed from somewhat different angles in these columns in recent weeks, the construction being within the ready grasp of any one handy with tools and possessing an advanced technical knowledge of radio.

Series Padding Avoidable

Since the three-gang condenser is obtainable in small physical size it may be put on top of a shield box, and the switch put underneath, so that the shielded coils may be placed at the sides, or even underneath the chassis, below the condenser shield.

In the course of the theoretical work the requirements for 0.00001 mfd. tuning condenser were considered, and it was found possible to dispense with the series padding condensers altogether, and rely on parallel trimmers, this requiring a trimmer Cx for three bands instead of for two bands. The reason for this is that the frequency ratio in the low-frequency regions, two for the broadcast band and a bit more than that band, another for the first short-wave band is so small, or, the capacity difference is so little, maximum to minimum.

The circuit has the usual 58 tube as radio-frequency amplifier, and also the 56

is not unfamiliar as oscillator, however the 56 as modulator is unusual. The performance is good in the modulating region, and therefore it is convenient to have a tube that does not require another connection to an overhead grid cap. The leads are shorter this way and the results serve the purpose nicely. It is true that the sensitivity is less, but if the intermediate amplifier has two stages (three coils) then there is always amplification enough, and more than enough, so that voltages applied to the i-f tubes have to be reduced a bit or a resistor put across a tuned winding, or some other stabilization device inserted, besides the usual filtration by means of chokes and bypass condensers here and there. Using a 56 modulator is at least as good a way.

Unusual Trimming

Except for the oscillator for two bands, if 0.00014 mfd. is used for tuning, or for three bands of the capacity is 0.00014 mfd., there are no trimming condensers shown. That is, of the five coils per stage, as diagramed, there are no trimmers in three instances in the oscillator section, and no trimmers in the r-f level at all. This means may be adopted, not that the trimming is wholly absent and avoided, but the compression type condenser, that will not stay put, due to weather and other similar conditions, might as well be out of circuit. The capacity can be adjusted to a desired value by the position of loads connecting grids particularly, as the closer such a lead runs to a grounded potential, the greater the capacity. Or, shielded wire may be used for a short grid stretch, shield or sheath grounded, and enough of the shield removed to re-

duce the capacity to the proper value for equalization for one band.

The question arises whether capacity equalization for one band applies to all bands, and it does not. However, other leads have to be considered for other bands, and therefore the same wire-lead-position treatment may be applied for each band.

The effect of the radio-frequency level tuning, that is, of the t-r-f stage and the tuned input to the modulator, declines rather fast as the frequencies increase, so that while it is true small capacity differences make large frequency differences, the rejecting capability of the circuit diminishes.

False Idea from Tuning

This is true although the mere process of tuning seems to prove the opposite, but that merely means the frequencies are changing so fast that an actual reduction in selectivity appears as an increase in selectivity.

Switch Popularity Grows

It is never satisfactory to judge selectivity solely by the sharpness with which a station tunes in or out. The effective resistance of the circuit is what counts. This is usually shown as a resonance curve, with plotting for a certain power input. Selectivity curves for increased powers at the same setting are sometimes shown.

The switch type of coil system for wide frequency coverage is fast gaining favor and will be improved in months to come. In fact, the whole shortwave receiver field may be assumed to be in a condition comparable with that of the automobile fifteen years ago.

THE NEW 8-TUBE Push-Pull 2A5 Output in High-I

By Robert
Thor Radt

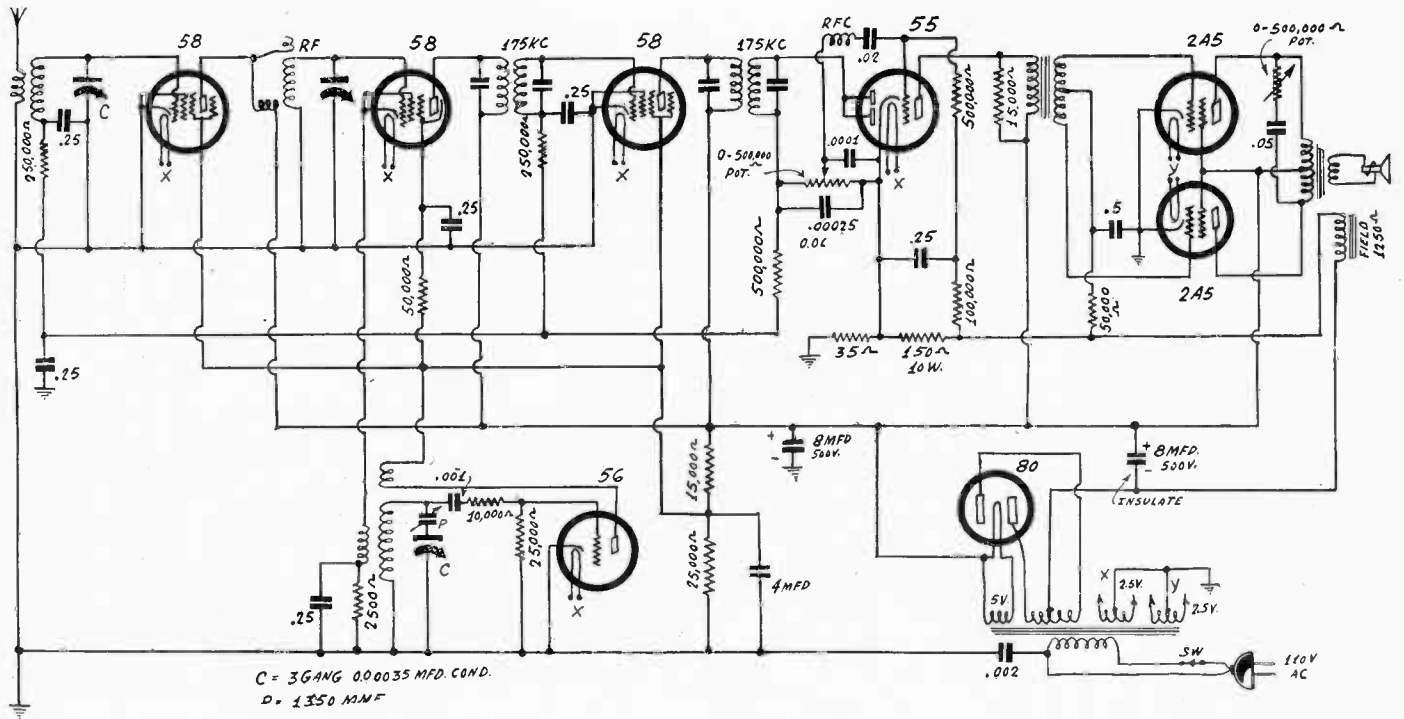

C = 3 GANG 0.00035 MFD. COND.
D = 1350 MMF

FIG. 1
The circuit of the Pathfinder eight-tube superheterodyne. It contains two 2A5 tubes in push-pull in the output stage, which insure high power sensitivity and good quality.

THE popularity of a superheterodyne can be ascribed to its exceptional selectivity and sensitivity. These qualities are combined with simplicity in the receiver printed herewith, that of the new 8-tube Pathfinder. In addition we have attempted to give the enthusiast a receiver that has as good tone quality as those expensive factory models he has long admired.

Automatic volume control is used on the r-f and i-f stages, the volume level being set with a potentiometer at the first a-f grid. Isolation is employed only in the r-f and i-f grid returns that are connected to the a.v.c., which has a minimum value of -3 volts (with respect to ground potential). This arrangement allows the cathodes and suppressors to be grounded directly.

As was mentioned before, the plate and screen circuits are not isolated but are connected together, respectively, and then to their positive voltage leads. Should this produce feedback in any particular model, isolation can always be used to prevent it.

The Audio Amplifier

The plate of the triode section of the 55 is fed into a suitable push-pull input transformer, which in turn transfers the signal to the grids of the 2A5 tubes. The output of the 55 is ample to drive the 2A5 grids even in a push-pull stage. As

a proof of this, a model tried in New York and it brought in Pacific coast stations early in the evening with full loud-speaker volume without any interference from stations near by.

In mounting the parts on the chassis, place the sockets and coils in such positions that the plate and grid wires be as short as possible and do not cross. It is advisable to shield all plate leads when all parts are mounted. Wire grid and plate leads first, soldering the shielding of the plate leads to the chassis. The other wiring can be made around the edges of the chassis for convenience in trouble-shooting and also to make room for resistors, by-pass condensers and such small parts that should not be intermingled with the wiring.

It may be well to mention here that it is necessary to keep the oscillator grid resistors one inch away from the chassis and clear of all other resistors. Undesired coupling results when the oscillator grid leak is too close to other resistors and oscillation may stop if the leak is placed too close to ground. This applies, of course, mainly to the high potential end of the leak.

Alignment of the Super

After the circuit has been assembled and wired, the first adjustment should be the intermediate frequency tuner. While the intermediate circuits are rated

at 175 kc, they are not necessarily tuned to that after the transformers have been put into the receiver. They are merely tunable to that frequency by the adjustment of the trimmer condensers. The best way of making the adjustment is to provide a 175-kc signal from a laboratory oscillator, putting the signal is at the grid of the mixer tube, and adjust each trimmer condenser until the volume is loudest. While doing this it is important that the volume be as low as possible. This can be varied either by varying the output from the test oscillator or by varying the amplification of the intermediate amplifier. It is best to vary the input signal for then the a.v.c. will not have to cut the amplification. Optimum adjustment for a very weak signal may be slightly different than optimum adjustment, and it is most important to adjust for weak signals, for the strong signals will come through without question.

When the intermediate tuners have been adjusted so that they are exactly lined up to the 175-kc signal, the frequency of the laboratory oscillator should be changed to 1,450 kc and this signal should be impressed on the regular input to the set. Arbitrarily set the main dial on about 6. Now tune in the signal provided by means of the trimmer on the oscillator condenser. Two points may possibly be found where it comes in. If so, select the power at which the fre-

THE PATHFINDER

Performing Broadcast Receiver

Verzog, E.E.

Company

LIST OF PARTS

Coils

- One antenna coil.
- One interstage r-f coil.
- One No. 102, 175 kc oscillator coil.
- Two Hammarlund Litz wound doubly tuned 175 kc i-f transformers.
- One r-f choke.
- One type UMC power transformer.
- One type U32A push-pull input transformer.
- One Roladynamic speaker for P.P. 2A5, 1,250-ohm field.

Condensers

- One Hammarlund 1,350 mmfd. padding condenser.
- One 0.00035 mfd., three-gang tuning condenser.
- Two 8 mfd. electrolytic condensers.
- One 4 mfd. electrolytic condenser.
- One by-pass condenser block.
- One 0.05 mfd., 400-volt condenser.
- One 0.001 mfd. condenser.
- One 0.00025 mfd. condenser.
- One 0.0001 mfd. condenser.
- One 0.02 mfd. condenser.

Resistors

- Two 0.25-megohm resistors, ½ watt.
- Two 50,000-ohm resistors, ½ watt.
- One 25,000-ohm resistor, ½ watt.
- One 10,000-ohm resistor, ½ watt.
- One 2,500-ohm resistor, ½ watt.
- One 0.5-megohm resistor, ½ watt.
- One 0.1-megohm resistor, ½ watt.
- One 15,000-ohm, 2-watt resistor.
- One 25,000-ohm, 2-watt resistor.
- One 15,000-ohm, 1-watt resistor.
- One 150-ohm, 10-watt resistor.
- One 35-ohm, wirewound resistor.

Other Requirements

- One Thor Pathfinder Chassis.
- Five tube shields.
- One Crowe dial and pilot light bracket.
- Four grid clips.
- Socket: three 58s, one 55, one 56, two 2A5, one speaker, one 80.
- Antenna posts.
- Phonot posts.
- Knobs.
- Line cord.
- Hardware.
- Hookup wire.

frequency is the higher, that is, where the trimmer capacity is least. When the circuit has been tuned this way, proceed next with the r-f trimmers, tuning each until the signal is loudest. Do not touch the trimmer on the oscillator during this adjustment.

Now suppose that the r-f and oscillator circuits have been tuned to the 1,450 kc signal. Change the frequency of the test oscillator to 1,500 kc and note, by turning the main condenser, whether this comes in before zero on the dial is reached. If it does, all is well. If it does not it is necessary to do the high frequency adjustment over again by setting main condenser on about 7 or 8 and then proceed

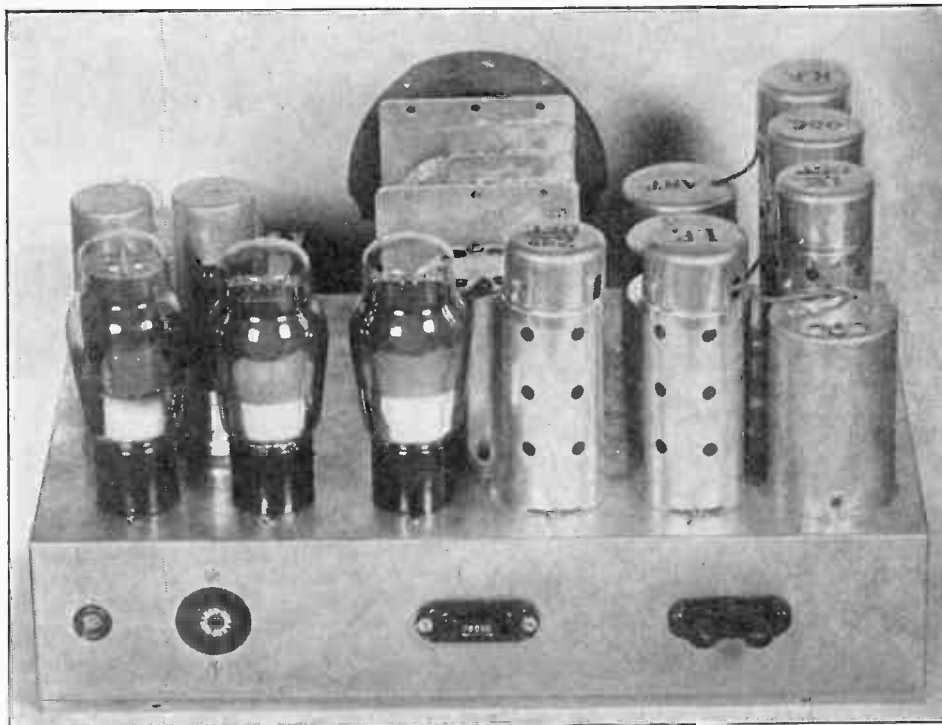

FIG. 2

Rear view of the Pathfinder eight-tube superheterodyne. The construction is very simple and the layout is well considered to give high sensitivity with stability.

as before until first the oscillator and then the r-f trimmers are adjusted.

Adjustment of Padding Condenser

When the adjustment has been made at the high frequency end so that 1,500 kc comes in above zero but not far from it, proceed with the adjustment of the series padding condenser. No trimmer condenser should be touched from now on, for if it is, it is necessary to start over again.

The adjustment of the padding condenser is the most difficult part of the alignment, and it is not the same in all sets. The first thing always to do is to determine where on the dial the r-f signal comes in without being affected by the oscillator and the intermediate. When the circuit can be converted conveniently to a t-r-f set by switching the grid clip of the mixer, this is the easiest way, but this is not applicable to a case where a 55 or similar tube is used as second detector. If a headset is available it is possible to plug it in in the plate circuit of the first detector. Suppose this is done. Then provide a signal from the test oscillator of about 600 kc. Turn the dial until this is heard loudest in the phones. Note the dial reading.

Now restore the circuit to the condition that it is to be ultimately and leave the condenser set at the position where the 600 kc signal came in loudest. Tune it

in with the padding condenser, and with nothing else. When this has been done, the circuit is adjusted. If a headset is not available, it is usually possible to substitute a milliammeter in the plate circuit of the first detector and note when the current is greatest.

The adjustment can also be made by a cut-and-try method. It is known approximately where the test signal should come in. Set the dial at that point and tune in the signal with the trimmer condenser. A slight improvement might be effected by changing the dial a little one way or the other, and readjusting the padding condenser. After a few trials the adjustment can be made just as close in this manner as by means of the previously described method. But it is not a straightforward method.

Indirect Adjustment of Intermediate

It is even possible to adjust the intermediate frequency without the aid of a test oscillator. Before any adjustments have been made, the maximum response will be at the mean frequency of all the intermediate frequency circuits. This is not far from the correct value. Then if each circuit is tuned with the trimmers until the signal is maximum, the final frequency will not be far different from the

(Continued on page 22)

Uses for the New Cathode-Ray OSCILLOGRAPH TUBES

Image Bright Enough for Photographing Clearly, if 905 or 906 is Used—Terminal Voltage High, But Power is Small

WHERE an instrument is desired for studying either transient or recurrent wave forms, to trace vacuum-tube characteristics, to measure percentage modulation, to measure peak voltage, and to study phase relationships, the cathode-ray oscillograph furnishes a simple and convenient means.

Cathode-ray tubes have reached a state of development such that the user can depend upon them for information previously obtainable only by more costly and more delicate apparatus. In general, oscillograph apparatus which does not employ cathode-ray tubes is slower and less convenient in operation. A cathode-ray tube will show a clear sharp trace in a well-lighted room and can be calibrated so that quantitative measurements may be made directly on its screen. When desired, photographic records of the trace can be made.

Two new tubes recently developed for oscillograph work are the 905 and 906, the 905 having a screen 5 inches in diameter and the 906 a screen 3 inches. Their operating features are:

	905	906	
Screen diameter.....	5	3	inches
Deflection by means of electrostatic plates	2	2	pairs
Heater voltage.....	2.5	2.5	volts
Heater current.....	2.1	2.1	amperes
Anode No. 1 supply voltage (E_{b2})....	2000 max.	1000 max.	volts
Anode No. 2 supply voltage (E_{b1})....	1/5 E_{b2} approx.	1/5 E_{b2} approx.	volts
Control-grid voltage (E_{c1}) for cut-off..	-40	-40	volts
Electrostatic deflection sensitivity for $E_{b2} = 1000$ volts.....	.38*	.46	.33* .35 mm/volt
Electrostatic deflection sensitivity for $E_{b2} = 2000$ volts.....	.19*	.23	mm/volt

*Top set of deflecting plates.

Electrons Control Illumination

All four deflecting plates of the 905 are brought out to small metal caps on the bulb cone. With the 906, however, one of each pair of deflecting plates is connected to a base terminal; the other two plates are connected within the tube to Anode No. 2.

The illumination on the screen of either the 905 or the 906 is controlled by the number of electrons reaching the screen and by the velocity of their impact. Their velocity depends on the magnitude of the Anode No. 2 voltage.

To keep the electron pencil focussed to a small spot at the point of impact, a constant ratio of Anode No. 2 and Anode No. 1 voltage must be maintained, says RCA Radiotron Co., Inc. The sharpness of focus is usually adjusted by changing the Anode No. 1 voltage. Screen illumination is controlled by varying the power input to the screen; this power is the product of the Anode No. 2 voltage and the beam current. Anode No. 2 current can be controlled by adjusting the negative bias on the control electrode. The electrostatic deflection sensitivity varies inversely with the Anode No. 2 voltage.

The fact that the 905 and the 906 each has a control electrode makes them most valuable for oscillographic work, since the beam current can be controlled by means of the

control electrode without varying the deflection sensitivity. Beam current, of course, also can be controlled by variation of the Anode No. 1 and No. 2 voltage, but this method is not desirable since it causes some defocusing of the beam.

Choice of Tube

In choosing between the 905 and 906 for oscillographic purposes, several factors should be considered. They are:

1. The size of trace desired.
2. Whether or not photographic reproduction is desired.
3. Accuracy to which measurements are desired.
4. Cost of equipment.
5. Physical size of the tube. Size of equipment.

Either the 905 or 906 will give a clear, well-defined, and brilliant trace. However, the 905 having a screen 2 inches greater in diameter than that of the 906, will be much easier to use in making comparative measurements. For high-speed photography, the

higher voltage rating of the 905 permits of obtaining better photographs. Where either cost or size is the predominate factor in the selection of the tube, the 906 may be preferred.

Timing Methods

The amount of auxiliary apparatus required depends to some extent on the function which the oscillograph is to perform. Certain applications require a time base, certain applications do not require a time base, and some applications require a base not linear with time. In general, where a study of wave form is to be made, a time base is required. The time-base potential is applied across one pair of deflecting plates in order to cause the spot to sweep over the screen at the desired frequency. The voltage being studied is applied across the other pair of deflecting plates. The figure that then appears on the screen is a wave shape of the voltage being examined. With a linear time base, this wave will be shown in its true shape; with a non-linear time base, the wave shape is distorted. Either transient or periodic voltages can be studied by this method.

For some applications, the base required is not a simple time base. For example, to show the resonance curve of an i-f stage in a radio receiver, an oscillator which will sweep through the desired frequency range is required. The output voltage from this oscillator should have constant amplitude

over the range to be used. This voltage is applied to one pair of deflecting plates and the output voltage from the i-f stage under observation is supplied to the other pair of plates. The envelope of the resulting picture represents the resonance curve of the i-f stage. If only the trace of the envelope is desired, this can be obtained by rectifying and filtering the input to the second pair of deflection plates.

The apparatus required for oscillographic purposes will always include a voltage supply for the cathode-ray tube and, depending upon the use of the tube, may include a sweep circuit. However, where the oscillograph is to be used for general laboratory use, the sweep circuit should be included so as to be available when required.

Fig. 1 shows the circuit of the apparatus. The cathode-ray tube requires high voltage but very little current; hence, the power requirement is very small. In determining the power-transformer secondary voltage, it is sufficiently accurate to assume a peak value of the r-m-s voltage equal to the maximum voltage needed for the cathode-ray tube. This assumption is practical, since the current demand on the rectifier system is very small. Thus, a power supply suitable for the 905, which has a maximum rating of 2,000 volts, should have a power transformer designed to give at least 2,000 divided by the square root of 2 = 1,420 volts rms at its secondary. Rectification can be accomplished by means of the 878, a tungsten-filament half-wave high-vacuum rectifier.

Three voltage adjustments are provided; the first, on the primary of the power transformer to vary the total rectified voltage; the second, on the high-resistance voltage divider to vary the Anode No. 1 voltage for focusing; the third, also on the voltage divider, to vary the control-grid voltage for changing spot size and brilliance. A high-resistance voltmeter M is connected as shown across the voltage divider to facilitate adjustment or resetting of voltages.

The deflecting plates are returned to the positive lead which is grounded for convenience of circuit arrangement. The free deflecting plates should be connected through resistors as shown in the diagram. This arrangement insures that the electron beam is not distorted by d-c potentials built up by the deflecting plates.

When Beam Current is Too High

If, during operation, the zero axis should be permanently deflected, it is because the beam current is too high for the resistor used. Ordinarily, low beam currents should be used. When photographs are taken or at such times as it is necessary to use a high beam current, the values of the deflecting plate resistors should be reduced so that the zero-axis shift will not carry the spot off the screen. If one side of the circuit under observation is grounded, one plate is shorted to ground. Operation of the plates at ground potential necessitates operating the cathode and heater at a negative potential. The transformer supplying the cathode-ray tube filament must then be insulated between windings for the highest d-c voltage used. It is advantageous to have an extra winding on the power transformer which

may be used to supply a sixty-cycle signal for deflecting the beam.

Precautions

It should be mentioned that in the design and construction of cathode-ray oscillographic apparatus, every precaution should be taken to make the apparatus safe for the operator. Particular care should be given to the correct placing of safety switches which will make the apparatus completely "dead" when any electrodes are exposed. All the high-voltage leads should be properly insulated and the entire apparatus enclosed in a suitable cabinet.

886 Sweep Circuit

A circuit for supplying a linear time axis, also shown in Fig. 1, employs an 885, a special gaseous-discharge tube developed for this service. It has an excellent frequency range. A current-limiting resistance of 700 ohms in series with its plate is recommended in order to limit the peak currents to the recommended value for the tube. In order for the time axis to be linear, the condenser should charge at uniform rate. To make this possible a type 34 tube is connected as shown. The 34 acts as a current-limiting tube making it possible to charge the condenser at a linear rate.*

The total supply voltage for the timing axis can be obtained from any well-filtered a-c operated voltage supply. The 2.5-volt filament of the 885 can also be operated from the a-c power line. However, in order to avoid interference at sweep frequencies other than 60 cycles, it is recommended that the 34 be operated with d-c voltages on its screen grid, control grid, and filament. In Fig. 1 'E_s', the synchronizing voltage, is applied for the purpose of holding the frequency of the sweep to that of the wave under study or to a sub-multiple of it. When working with sensitive radio receivers or devices, it may be necessary to take certain precautions to prevent interference from the 885. The interference consists of the high-frequency disturbances generated during the operation of gaseous tubes of this type. These disturbances are produced only on the return of the timing wave, and hence do not affect the picture, although they may have an undesirable effect on any measurements of the device being examined. The remedy is to use shielding and shielded leads for the sweep-circuit apparatus.

Modulation Measurements

One of the outstanding applications of the cathode-ray tube is its use for measuring the percentage of modulation. Percentage modulation of a properly modulated wave is the ratio, expressed in per cent, of the amplitude of a sinusoidal modulating signal wave to the amplitude of the carrier wave. There are various ways of checking this ratio on a cathode-ray oscillograph. The simplest method is to apply the carrier to one set of deflecting plates and to observe the length of the line which the moving spot traces on the screen. This represents the amplitude of the carrier. When the modulated signal is applied, the length of the line will be increased. If the increase is such that the line is twice its former length when the carrier alone was applied, the modulation is 100%; if one and a half times its former length, the modulation is 50%, etc. If it is desired to spread this line out, a sweep frequency of 60 cycles is usually applied to the other pair of deflecting plates to give a picture of the modulated carrier.

The percentage modulation is $a/A \times 100$, where a is the maximum increase in carrier amplitude produced by the modulating voltage, and A is the amplitude of the unmodulated carrier envelope.

Photography of Tracings

The use of the cathode-ray tubes for observation and checking the modulated signal as

*See Cecil E. Haller, "A Linear Timing Axis for Cathode Oscillosopes", *Review of Scientific Instruments*, July, 1933.

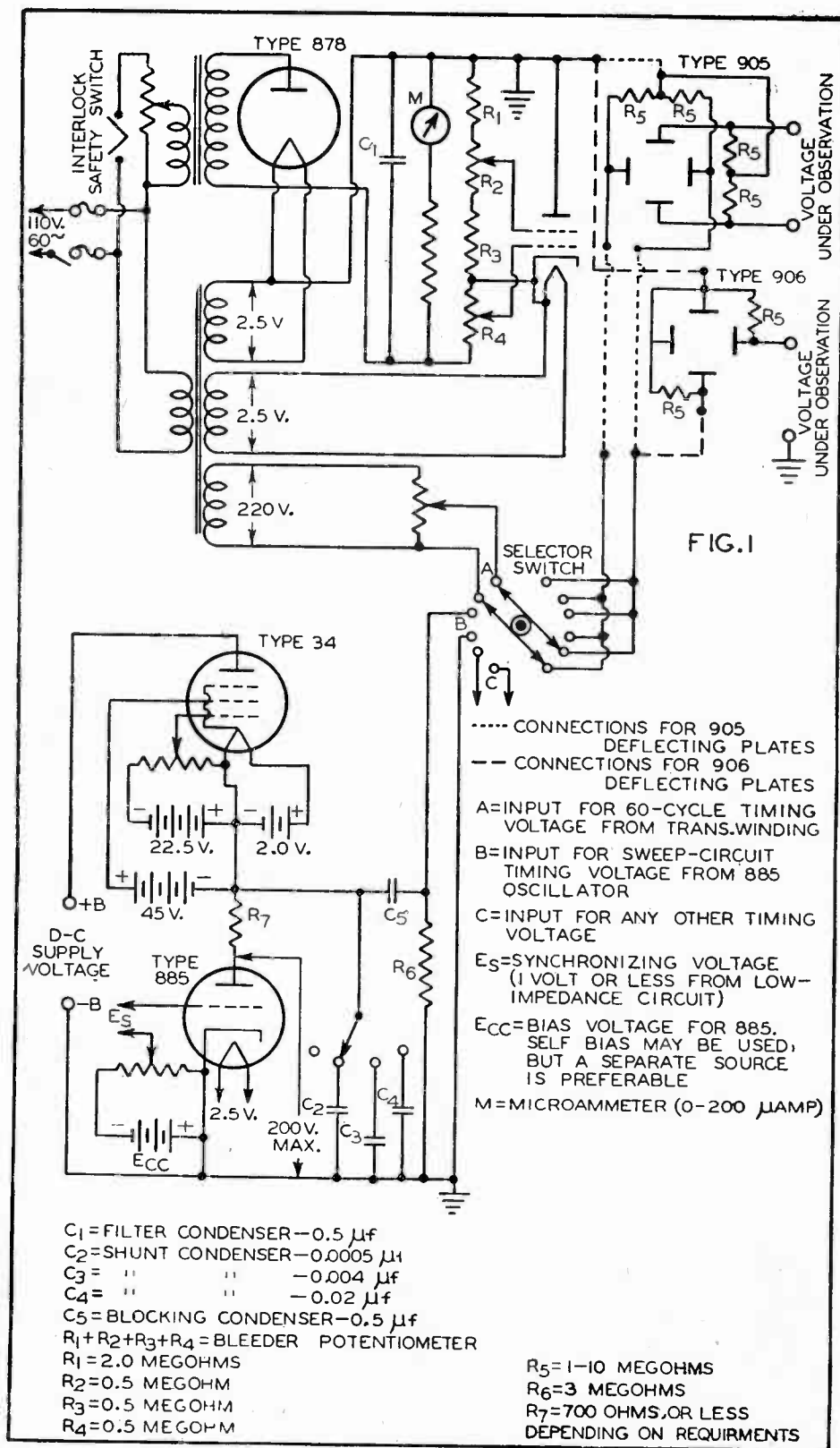

Circuits for use of the two new cathode-ray oscillograph tubes. Measurements of recurring and transient phenomena are made.

sent out on the air by the transmitter is becoming very popular, since such use provides an always present picture of the output.

Photographs may be taken by focusing a camera on the screen and exposing for a suitable length of time. The time of exposure depends on the speed of the camera lens, the kind of film used, and the intensity of illumination on the screen of the cathode-ray tube. Where transients are to be photo-

graphed, maximum brightness and a rapid exposure are required; where recurrent wave forms are to be photographed, no attempt need be made to increase the brilliance, since an exposure of the required length may easily be made. Although good results have been obtained with verichrome film, panchromatic film is more sensitive to the green coloration of the fluorescent screen so that its use reduces the time of exposure.

2-TUBE SHORT-WAVE DIAMOND OF THE AIR

SIMPLEST CIRCUIT, FEWEST PARTS, AND
RESULTS ARE SPLENDID—ADVICE ON
REGENERATION AND DETECTION

By Philip Cohen
Reliable Radio Company

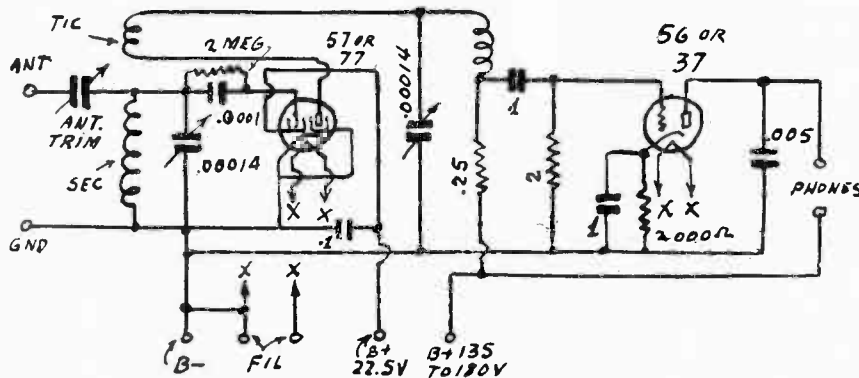

This is all there is to the circuit, so simplicity has been pressed to that extreme that marks maximum results. With such a circuit stations have been tuned in from all parts of the world.

THE fewer the parts, the better the performance, is an old rule about short-wave receivers. It isn't always true, but it does apply to the regenerative type of set almost without exception. Naturally, a superheterodyne requires more parts.

In the present boom in short-wave sets and kits no doubt many will turn to this fascinating field of entertainment who know very little about radio, and therefore anything that is fundamental and simple will appeal doubly to them. Hence the receiver herewith, which is the 2-Tube Short-Wave Diamond of the Air Detector and One-Step. The "one-step" does not mean a dance but a stage of audio-frequency amplification.

While the designation "a-c" may be applied to the circuit, that is only because the most ordinary use would be with a small B eliminator, or power supply as it is better called in these more enlightened days. The higher B voltages are then readily obtainable, and also there would be a heater winding for the 57 and 56 tubes that would be used in the tuner.

Tubes for Battery Use

However, for battery operation, with B voltages unchanged, the tubes would become the 77 detector and 37 audio amplifier. Then a 6-volt battery would supply the heaters directly, and B batteries would furnish the 22.5 and 135 volts, or, if possible, 180 volts maximum.

The circuit is intended for earphone operation, although it is true that strong stations will come in with speaker volume. However, these would be locals, and since

the constructor or possessor is interested mainly in the reception of programs, directly from foreign countries, the stage of audio renders these programs engagingly audible.

The antenna is coupled to the grid winding of the plug-in coil, or secondary, through a variable condenser. Thus the aerial is tuned, which is to the same effect as introducing proper impedance match, and then there is practically no loss in the input circuit, which becomes a sort of transmission line, and one of the best, that is, a tuned circuit. The tickler is the feedback winding, which returns part of the radio-frequency output of the detector to the grid circuit, to reinforce the voltage in the grid circuit, and thus build up the sensitivity. At the same time selectivity is increased. This is one of the unusual features of regeneration. Almost all other methods of increasing the sensitivity decrease the selectivity, although the tuned transmission line, as used in the aerial circuit, is another exception. Therefore it can be seen that high-gain methods prevail, even though the circuit is simple to the point of boyishness.

The Detector Circuit

The detector is of the grid leak and condenser type, which is more sensitive than the high-biased or so-called power detector. There would be no occasion for using a power detector here, as the signal voltage the tube is called upon to handle is entirely too small to justify that.

In fact there is negative bias on the detector, and it arises from the flow of current through the grid leak. Whenever

the tube grid is positive, or, in fact, not negative by more than 0.8 volt, there will be grid current. This means that the cathode emits electrons that not only travel to the plate but also some of them are attracted to the grid, because the grid is effectively positive. When the electrons accumulate at the grid they then tend to make the grid more negative than it was when they got there, and the rate of dissipation is determined by the value of the grid leak and the grid condenser. The higher the value of resistance of the grid leak, the greater the effect of the grid current in developing a bias because of the potential drop across the leak, but the leak resistance can not be increased without limit, as the time arrives when the electrons accumulate to such an extent at the grid that they do not leak through the resistor to grounded cathode fast enough to prevent saturation of the tube. This saturation occurs approximately when the negative bias is so high that plate current is cut off. Then of course nothing is heard.

In between there are other troublesome values of resistance, marked by a screaming or howling sound. The remedy then is, as formerly, to reduce the leak value, and in the circuit it has been selected at the optimum value for best operation, considering the wide range of wavelengths to be covered with four plug-in coils, approximately 200 to 15 meters.

Remedy for Instability

The diagram presented is an outgrowth of the battery model, where 30 tubes were used, but the present use develops greater sensitivity, and there will be a readier oscillation condition in the detector. This is in the direction of keener response, but one should not overstep the mark, for then, with too much regeneration readily present by a slight turn of the feedback control condenser, detector tube operation is erratic and noisy. The simple remedy is to remove a few tickler turns, with tuning condenser at maximum, to be sure that not so many turns are taken off so that the tube does not oscillate when the condenser is in this position.

It will occur to many who are well versed in radio that a tuner of this sort, with an audio stage, will serve admirably to feed a power pack that also includes one or two stages of audio. The connection can be made quite readily, by omitting the 'phones, and connecting plate of the 56 or 37 tube to P on primary of the first audio transformer in the power pack.

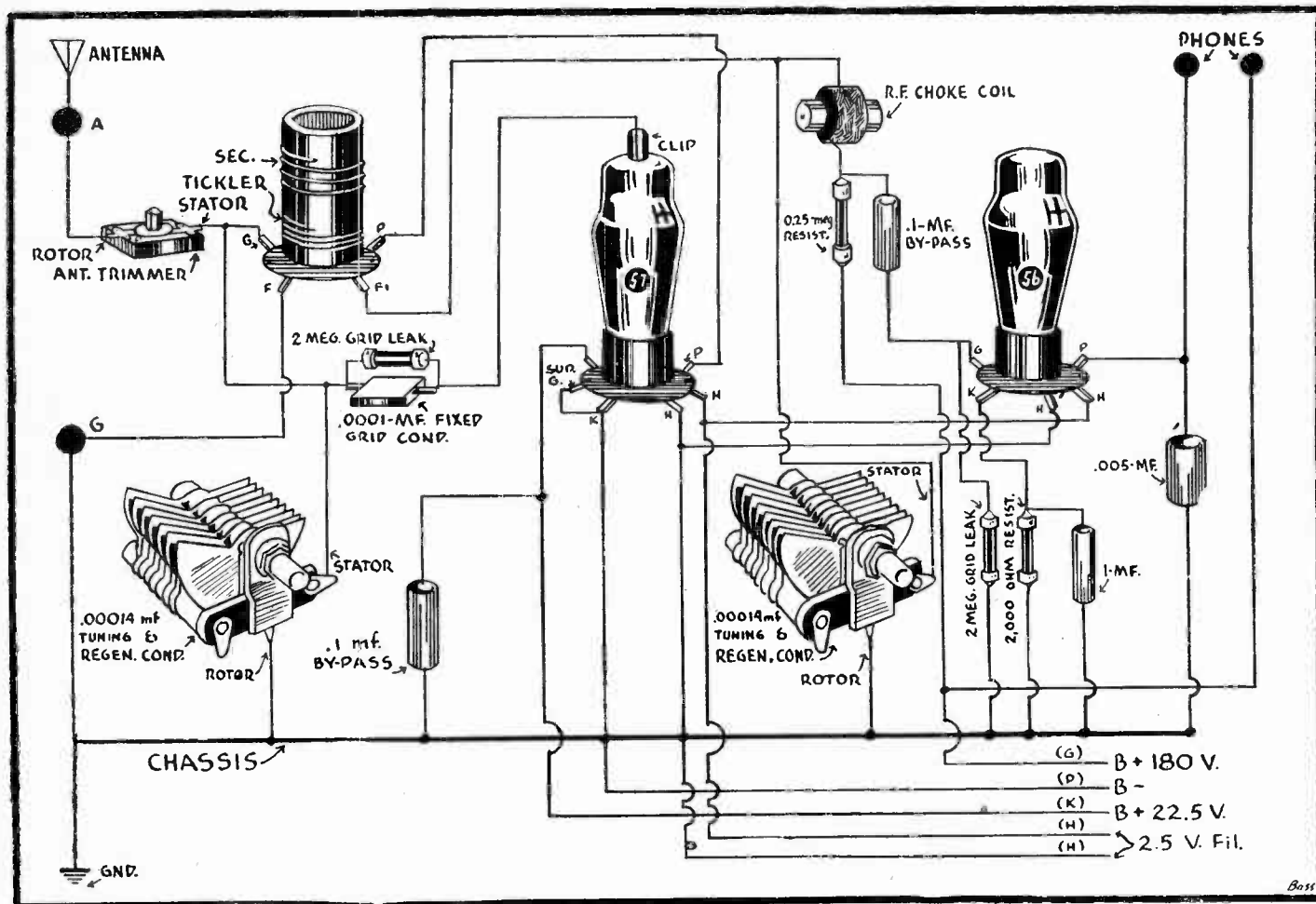

Particularly the novice will find the pictorial diagram of the wiring a splendid assistance.

Satisfactory service will result even if the power pack has only one stage of audio, which is commonly push-pull.

The detector and one-step constitute a familiar pattern to the radio old-timers, and they have been hearing about it for seven or eight years, with few changes, except those necessitated for inclusion of more sensitive tubes. Only such changes are included in the diagrams herewith, both the plain wiring diagram of the circuit, and the pictorial diagram of the wiring. For purposes of visualizing the circuit the smaller diagram is preferable. For wiring assistance the pictorial diagram will be of inestimable value to the novices and youngsters particularly.

Ratio of Tuning

The tuning condenser capacity is .00014 mfd. (microfarads), also expressible as 140 mmfd. (micro-microfarads). This yields a wavelength ratio of about 2.3 to 1, so that if any high-wavelength extreme is known, condenser at maximum, for any one or more of the four coils, the low-wavelength extreme is computable approximately. If 200 meters is the high-wavelength extreme of the largest coil, the low-wavelength extreme would be 200/2.3, or 87 meters. If the frequency method is used, then if the low end is 1,500 kc, the high end is 6,522 kc, for now the first number (1,500) has been multiplied by the factor (2.3), because the frequency increases with reduction of capacity, whereas wavelength changes in the opposite direction, hence we divided previously.

These data are given because many will want to calibrate their sets. If they do so they should bear in mind that the antenna series condenser is a tuning condenser in the strictest sense, and notation should be made of the position of the set-screw, using a different setting for each of the four coils, and drawing lines radiating from the screw, marking the

lines 1, 2, 3 and 4 for the coils intended. Of course the numerical settings of the main tuning condenser, C2, and of the feedback control, are noted. Just what position is most satisfactory for the antenna condenser will be determined from experience, and the fact should be considered also that the setting of this series condenser has an effect on regeneration. The smaller the capacity used the greater the readiness of the tube to regenerate, and this would suggest the accepted practice of using very small amount of capacity for the smallest coil.

The plug-in coils may be of the standard types as manufactured by Insuline, Sickles, Gen-win, Alden and others, with the proviso that any presence of excess tickler turns should be remedied as previously advised, in the interest of ease of operation and comfortable stability.

RFC, the radio-frequency choke, should have a high inductance and small distributed capacity. The reason is that if the capacity is relatively large the choke ceases to be a choke at the higher frequencies of tuning and becomes in point of fact a condenser, which is exactly the opposite to what is required of this constant.

“Buy RMA” Adopted

A plan to have all Radio Manufacturers Association members “Buy RMA” in their purchases was adopted unanimously by the Association’s Board of Directors at a meeting in New York City. The movement also is designed to increase RMA membership.

In buying radio parts, accessories and raw materials and when all other things are equal, RMA members are being urged to make their purchases from other RMA members. The plan was presented by W. S. Symington, of New York, chairman of the Membership Committee.

Manufacturers Hear Plea by Goldsmith for High Fidelity Receivers

A plan recently discussed by leading radio engineers for commercial development next fall or winter of high fidelity receiving sets was presented in detail to the RMA Board of Directors by Dr. Alfred N. Goldsmith, consulting engineer of New York.

Cooperation between the RMA, the Institute of Radio Engineers, the National Association of Broadcasters and, in fact, all radio interests in development and commercial presentation of a greatly improved type of receiving set was outlined to the RMA Board by Dr. Goldsmith. The plan was well received and referred for further study and action by the RMA Set Division. Dr. Goldsmith detailed the vast improvements in high fidelity receivers. The high fidelity receiver is recognized as requiring changes and improvements in broadcast transmitting apparatus as well as in sets and, therefore, requiring, in commercial presentation, co-operative action by broadcast and other interests.

FIVE NIGHTS A WEEK, TOO!

Peter Dixon said in the New York Sun the other night that if he had the power he would put Alice Remsen on the air for fifteen minutes a night, five nights a week, and would have Andre Kostelanetz direct the music. And, not so strangely, we think Mr. Dixon’s judgment would be thoroughly justified.

Miss Remsen has occupied featured spots on the air during her several years’ experience before the microphone.

Radio University

A QUESTION and Answer Department. Only questions from Radio University members are answered. Such membership is obtained by sending subscription order direct to RADIO WORLD for one year (52 issues) at \$6 without any other premium.

RADIO WORLD, 145 WEST 45th STREET, NEW YORK, N. Y.

Constant Impedance Attenuator

WILL you kindly publish a formula for computing the attenuation in a constant impedance attenuator, the one made up of two potentiometers arranged so that the same resistance is always in series with the source of voltage?—W. J. L.

The formula is no different for a constant impedance attenuator than for any other. If n is the fraction of the total resistance in series with the line and not used, and $1-n$ the fraction across which the output is taken, the attenuation is $20 \log_{10} \frac{1}{1-n}$, the attenuation is in decibels difference between two powers. This applies to any resistance in the potentiometer. If R is the total resistance, then this resistance is always in series with the voltage source and $(1-n)R$ is between the grid into which the device works and ground.

Range of Beat Note Oscillator

IS IT possible to construct a beat note oscillator that will have a frequency range covering not only the audio frequencies but also the higher frequencies up to the upper limit of the broadcast band? If so, what should the beating frequencies be and what precautions must be taken in the construction?—W. E. T.

It is possible all right, but it would be difficult to find a dial that could be calibrated to cover the whole range and have the calibration mean anything, especially at the lower beat frequencies. If the frequencies of both oscillators are varied and in opposite directions, the beat frequency will be the sum of the frequency changes of the two. If this sum is to be 1,500 kc, each would have to be changed by 750 kc. An ordinary broadcast oscillator will cover this range. Suppose then that one has a range from 1,500 to 750 kc and the other from 1,500 to 2,250 kc, the beat would be 1,500 kc at maximum. It is not recommended, however, that the frequencies of the two oscillators be so low, because when they are, the beat frequency will be higher than the frequency of one of the oscillators at certain settings. A better set of frequencies would be 1,600 kc, 2,350 kc, and 3,100 kc. If the oscillator is to be used for very audio frequencies, it would be necessary to employ the loosest possible coupling between the two circuits.

Connections of Dynatron Tube

WHEN using a screen grid tube in a dynatron oscillator circuit what should be done with the control grid? I have experimented a little with it and it appears that the oscillator works just as well if the grid is left floating. Can you suggest any way of using the grid?—R. L. W.

The grid may be left dangling or it may be connected to the cathode. It is a fact, however, that the potential on the grid does control the oscillation a little, because the potential varies the internal plate resistance (negative) of the tube. The frequency depends slightly on the plate resistance, and the amplitude of oscillation a great deal. Hence you might use the grid for controlling the amplitude, and it may be done with an audio frequency voltage and in that manner the output of the dynatron can be modulated.

Fading Remedy

MY RECEIVER is very sensitive and I can pick up distant stations any time I want

to. But on many stations there is considerable fading, which spoils programs that would otherwise be fine. Can you suggest anything that can be done to reduce the fading? What is the cause of it, the set or something else?—T. K. B.

It is the something else that cause the fading. The set is not at fault. There is no cure for fading, but there is a palliative. If you instal an automatic volume control which has a range as wide as the fluctuations in the signal strength from the fading stations, the sensitivity will go up as the signal goes down, and vice versa. The signal will be held nearly at the same volume, except for noises, which will go up and down to indicate that there is fading.

Variable Intermediate

RECENTLY you described a band spread device utilizing a variable intermediate frequency. Is it not a fact that the change in the intermediate frequency will upset any padding adjustments that may be in the radio frequency tuner? How can this be avoided when the intermediate frequency is varied?—W. H. C.

Yes, it is a fact that varying the intermediate frequency will upset the padding adjustments. But this depends on what the frequency of the signal is and how much the intermediate is varied. At high signal frequencies where the band spread arrangement would be used, there is very little padding, only tracking of the oscillator and the r-f tuners, for the two circuits are very nearly alike. The tracking of two identical circuits is not affected by the change in the intermediate frequency. Moreover, the intermediate frequency should not be changed much, relatively to the signal frequency. The scheme is very useful where it is most needed. A slight detuning of the radio frequency tuner does not matter a great deal at the very high signal frequencies. There is also an advantage in this detuning. Suppose that the circuit has not been padded very well for a given intermediate frequency. When the intermediate is variable it is possible to correct for this defect by merely turning the condenser controlling the intermediate frequency.

Tips to Service Men

CAN you suggest a good way of going about locating trouble in a receiver? I have read all kinds of service hints but it seems like they never fit the case. Perhaps the trouble is that the right hint does not come to mind at the right time.—E. N. S.

The only way to go about the job is to proceed by elimination, beginning by the most likely causes of the trouble as indicated by the symptoms. If the set does not function, the power supply should be tested first, then tubes, and other elements. In many cases almost the entire set can be eliminated by a single test. Suppose, for example, that the set works when an output meter or a head set is connected in the output of the last tube. The trouble must necessarily be in the output transformer or in the speaker. Again, suppose that the circuit works when the input is taken from the test oscillator and not when it is taken from the antenna. The trouble should be looked for in the antenna. When there is trouble in resistors the location is not easily found, because in many instances every resistor tests out all

right, yet it is one of them which is at fault. Sometimes by-pass condensers behave the same way.

Next Improvement in Radio

IN WHAT branch of radio is the next improvement likely to be, in tubes, tuners, audio amplifiers, loudspeakers, or in some other?—W. L.

It is quite possible that the next major improvement will be in the audio end of the receiver. While audio amplifiers can be built so that they introduce practically no distortion, they are not so built, largely because the demand has been for cheap receivers. The quality of radio receivers, as a whole, is not so good now as it was a few years ago. Yet better receivers in this respect can be built now, and are for those who want to pay for them. Another improvement will be in the speaker. This always has been the weakest point in a radio receiver. Good work is now being done along this line.

Number of Electrons in Current

HOW many electrons flow passed a point in a circuit per second when the current is one ampere? Or what is the charge on each electron?—N. J.

The charge on each electron is 1.50×10^{-19} coulomb. Current is the rate of change of charge, or the charge passing a point per second. One coulomb per second is one ampere. Therefore when one electron passes per second the current is numerically equal to the electronic charge. The reciprocal of this number is the number of electrons that would have to pass per second to make the current one ampere. That is, there would have to be 6.3×10^{18} electrons. Expressed in words this is 6.3 million, million, million electrons. If the current is only one microampere, the number of electrons is one millionth less. It is still an inconceivably large number.

Grid and Diode Detection

WHAT is the difference between grid leak and diode detection? The way I figure it the two are exactly the same. I am I right or wrong?—B.R.B.

As far as the detection is concerned you are quite right. Grid leak detection is diode detection. But what is usually meant grid leak detection is diode detection and diode biased amplification. If you take a 55 or similar tube and first detect by means of the diode and then amplify with the triode, using the d-c drop in the load resistance for bias on the triode, then you have the same conditions as you have in the grid leak detector. The grid leak is the load resistance, the stopping condenser is the filter condenser across this.

Buzzer Modulator

COULD a high frequency buzzer be used for modulation of a radio frequency oscillator? If so, how should it be connected to the oscillator tube to insure modulation?—T.Y.

If you get the buzzer going somewhere near the set there will be modulation. To make it more definite, you might operate the buzzer and the tube on the same filament battery. Or you can connect a small condenser between the coil of the buzzer and the plate of the tube. How not to get modulation is a bigger problem than how to get it, if the buzzer is going. Of course, it is always possible to stop the buzzer when no modulation is desired.

Straight Line Frequency Condensers

CAN straight line frequency condensers be used in a superheterodyne without padding the circuits?—B. W. M.

If the inductances in the two circuits are the same and if one condenser is offset with respect to the other by the proper amount, that is, if the rotor of one is turned on the shaft by a certain angle in respect to the

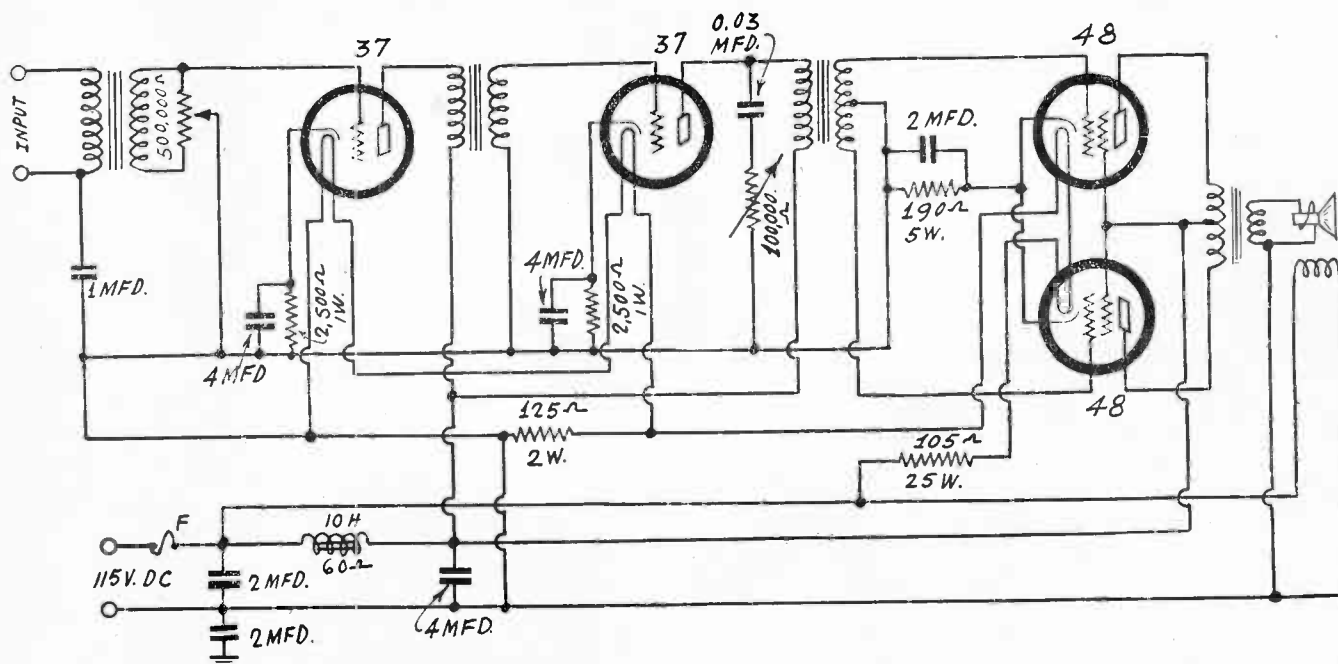

An audio amplifier powered from the d-c line. The values of constants are given on the diagram.

other rotor, then the frequency difference will be constant by an amount depending on the relative displacement of the two rotors. But this arrangement narrows the band that can be covered, and this will be larger the larger the displacement of the rotors. If the condensers turn 180 degrees and it is necessary to displace one rotor by 60 degrees with respect to the other, the net possible rotation is only 120 degrees. This arrangement will work much better on very high frequencies than on low, for then the displacement is small, assuming that the intermediate frequency is low compared with the signal frequency. If the tuning condenser originally had a range of 270 degrees, it would still be possible to have a 180-degree variation on the dial.

* * *

Faulty Diagnosis

IN January 13th issue you show a Colpitts oscillator using one of the iron dust cores. You show a grid bias resistor, R1, Fig. 2. Does this resistance not short circuit the feedback from the plate circuit? I cannot see how it could possibly oscillate.—G.B.V.
 There is no grid bias resistance in the circuit. R1 is a grid leak, C3 is the ordinary stopping condenser, and C2 is the grid to ground part of the tuning condenser. The only thing the matter with the circuit is that it has not been drawn in the orthodox manner and that the plate supply has been omitted. What is shown is the essential part of the alternating current circuit.

* * *

Best Output Tubes

WHEN first rate quality is to be combined with a great output, which tube or tubes would you recommend in the power amplification? Which is better, the 50 or the 2A3? Is there any other tube that will give a good deal of output without requiring high plate voltages?—G.H.L.
 Of all the tubes put out so far the 2A3 is the best for power handling ability. The 50 is not so good because it cannot put out so much undistorted power and it requires much higher plate voltage. A very good power tube is the 48, which operates on comparatively low plate voltage, but takes a heavy plate current.

* * *

Operation of Photoelectric Relay

SOME time ago you described a photoelectric relay utilizing a 30 tube as an amplifier. I built this and I have not succeeded

to make it work. Can you give any reason why it does not work?—W.H.N.

* * *

There are many reasons why it may not work. Perhaps the most likely is that the relay you use is not sensitive enough to operate on the current from the 30 tube. Another reason is that you may not have enough light to cause much change in the current through the cell. In other words, the phototube may not be sensitive enough. Again, the voltages on the amplifier tube may not be right. Find out what current will trip the relay and then measure the plate current in the tube to see that it is sufficient, that is, when it is maximum. Then check the photocell to see that it will swing the plate current either to maximum or to minimum, depending on which way the relay is supposed to work. If the current from the photoelectric cell flows through the grid

leak in such a direction that the grid becomes more negative when light enters the cell, the plate current should decrease as the light increases. The relay may be so adjusted that it will trip when the current decreases to a certain value, or it may be so adjusted that it operates when the current rises to a certain value. In one case it would operate when the light decreases and in the other when it increases.

* * *

D-C Audio Amplifier

KINDLY show a d-c operated power amplifier with 48 push-pull output. The input may be for microphone or radio.—E.L.S.
 The diagram is given herewith. The input transformer primary may be standard for radio, working out of a low- μ tube, but must be different for the microphone.

Join Radio World's

UNIVERSITY CLUB

And Get Free Question and Answer Service for the Coming 52 Weeks.

THIS SERVICE FOR UNIVERSITY SUBSCRIBERS ONLY

Subscribe for RADIO WORLD for one year (52 numbers). Use the coupon below or write on a separate sheet of paper, if preferred. Your name will be entered on our subscription and University Club lists by special number and you will be apprised of the number. When sending questions, put this number on the outside of the forwarding envelope (not the enclosed return envelope) and also put it at the head of your query. If already a subscriber, send \$6 for renewal from close of present subscription and your name will be entered in Radio University.

NO OTHER PREMIUM GIVEN WITH THIS OFFER

[In sending in your queries to the University Department, please paragraph and number them. Write on one side of sheet only. Always give your University Club Number.]

RADIO WORLD, 145 West 45th Street, New York City.

Enclosed find \$6.00 for Radio World for one year (52 nos.) and also enter my name on the list of members of RADIO WORLD'S UNIVERSITY CLUB, which gives me free answers to radio queries for 52 ensuing weeks, and send me my number indicating membership.

Name

Street

City and State.....

WHAT IS DOGIE? ROGERS' COYOTE IDEA ATTACKED

A lifting of eyebrows and vigorous disagreement is the answer of radio's singing cowboys to Will Rogers' broadcast definition of a "dogie" and to his assertions that no real cowboy can sing, much less yodel.

Rogers, most famous of the ex-cowboys, was all wrong in his Gulf Headliners program over NBC networks, according to former compunchers who now make their living by ululating ditties of the trail over the same national hookup. They are both hurt and astonished by Will's statement that a dogie is really a "doggie" and is in fact a coyote and now a cow, and—by his claim that said coyote is the only thing that can sing worse than a cowboy.

Quotes Live Stock Book

Jules Allen, former Texas Ranger and a member of the Trail Drivers' Association, who crossed the plains five times during the '90's, quoted from the "American Live Stock Market," published in 1922, which defines dogies as "small common-bred cattle native to the Southern States." Allen, who claims to have punched cattle before Rogers swung his first lariat, and who now sings cowboy ballads over an NBC network, also refutes the charge that trail riders can't sing by pointing to his appointment by ex-Governor Dillon of New Mexico as the official cowboy singer of that State.

John White, the "lonesome cowboy" soloist heard in the "Death Valley Days" programs, also brought unimpeachable authorities to back up his claim that Rogers is in error.

"Will's definition and pronunciation of 'dogie' are new ones on me," said White. "I think he was kidding when he said a 'dogie' is a coyote. But don't take my word for it. Let me quote two of the grand old-timers of the cow country, Will C. Barnes, former Arizona puncher, and Dominik J. White, Montana cowboy poet who wrote one of the best known of the cowboy songs, 'When the Work Is Done Next Fall.'"

The Cowboy's Falsetto

"Barnes, in a Saturday Evening Post article several years ago, explained that 'Dogies are a class of mavericks, unmarked and unbranded, whose mothers have mislaid them.' Barnes is old enough to be Will's pa, and White, who could be his big brother, wrote a poem that was printed in 1891 in which are the lines: 'Day-herding those same dogies, Out on the Dry's green plain'—obviously not referring to coyotes."

Johnnie Marvin, another NBC trail-riding soloist, who was reared in the saddle, corroborated this evidence, and then took up the cudgels for cowboy singers. "Will was speaking for himself when he said that cowboys can't sing," he declared. "There are just as many good singers and bad singers among cowboys as there are among stevedores or bank clerks or movie stars. And as for yodeling—why, every cowboy yells at the cattle in that high falsetto, and when you put that into a song—that's yodeling!"

BUTTERFIELD WITH WNEW

WNEW, Newark, N. J., which begins broadcasting in a few days, announces the appointment of Walton Butterfield as continuity and dramatic director. Mr. Butterfield has been with both major networks.

Mrs. Lindbergh's Flight Set Has Small 12-Volt Dynamotor

Radio engineers, inspecting Colonel Charles A. Lindbergh's big red and black monoplane on exhibition at the American Museum of Natural History in New York, have commented on the performance of the radio equipment under the handling of Mrs. Lindbergh. The little set, given to the museum along with the rest of the equipment carried by the Lindberghs on their recent 30,000-mile, four-continent flight, weighs less than 70 pounds and uses less current than the smallest house bulb, yet it has been heard a quarter of the way around the world.

Mrs. Lindbergh, who with her husband, received her schooling in radio from engineers of the Pan American Airways System, and who holds a third-class commercial license as a radio operator, also came in for praise for her efficient, business-like operation of the set under conditions varying from Arctic blizzards to equatorial thunder storms. Her signals, listeners reported, came at all times as sharp and clear as a professional operator's.

Her skill enabled her to communicate at will with continental European stations and North and South American stations as well. Greatest astonishment was expressed over the almost fabulous distances achieved by this set which is unknown commercially and, before its installation in the Lindbergh plane, had never been off the Pan American airlines for which it was developed by that company's engineers.

Made Good Use of Set

With it she communicated with commercial stations on Long Island and New England when the plane was in the Cape Verde Islands. Over the ice-capped wastes of Greenland she talked with ease to stations in the United States. But perhaps her greatest distances were achieved immediately after the take-off from Bathurst, Gambia, British West Africa. Within three minutes after the big plane rose from the waters of the African coast on December 6th, en route across the South Atlantic, she was in communication with the Pan American Airways communications base at Miami, Florida, approximately 5,100 miles across the sea. And thereafter through the long night her signals came in clear and strong to Pan American stations on this side of the ocean between Miami and Buenos Aires, Argentina.

The little set is a stock model of the

standard radio equipment, designed and built at the shops in Miami. It was installed in the Lindbergh plane prior to the couple's flight to China in 1931. It survived the rigors of that trip, including submersion in the waters of the Yellow River when the Colonel's plane turned over, and has functioned with unbroken regularity ever since.

A minimum service range of 600 miles was required to keep planes in the air in constant communication with at least three of the System's ground stations on the international aerial routes. It was required that the radio set perform for not less than 600 flight hours.

Use Six Frequencies

Powered by a small dynamotor operated from a 12-volt storage battery, the Lindbergh radio had a power output of 20 watts. This system of power supply made the Lindbergh plane a completely equipped radio station, for both transmission and receiving, either aloft or on the surface. It likewise made possible the use of the radio, for emergencies, for seventy-two hours of regular hourly scheduled communication. The battery is charged while the plane is in flight by means of an engine-driven generator.

Mrs. Lindbergh used all six frequencies of the set, the four short waves to communicate with stations on the western side of the Atlantic and the two long-wave frequencies to communicate with the continental European stations and with steamships. She often changed frequencies to reach different sides of the oceans or meet peculiar climatic conditions. The plane was equipped with trailing antenna which varied from 30 feet to 125 feet in length, depending upon the frequency used.

Another radio feature operated with great precision by Mrs. Lindbergh was the radio direction finder. Instead of the fixed "loops" as used on the international airliners, on the Lindbergh plane the "loop" was wound around the inside of the fuselage. By pointing the plane at the signals from any transmitting station, until the minimum intensity or "absolute zero" was reached, the Colonel could tell the exact direction from which the signals were coming. Since the location of the sending station was definitely known, the Lindberghs could plot their course and check their compass from these signals.

Speech Ruled Off Air Is Restored

A recent half-hour afternoon talk on the rights of the consumer, by Frederick J. Schlink, president of Consumers Research, Inc., sent over the Columbia Broadcasting System, was the aftermath of a heated controversy in which Mr. Schlink said he was barred from broadcasting when he spoke before the Academy of Political and Social Science in Philadelphia. William Paley, president of Columbia, wired his regrets, said that a subordinate had taken the action without authority and in violation of Columbia's principles and policies, and offering the half-hour later for Mr. Schlink to have his say.

What the economist did say amounted to an attack on the National Recovery Administration, in about the same tenor as his Philadelphia speech. The basis of his argument was that NRA has adopted the same attitude as prevailed in the Harding, Coolidge and Hoover administrations, that the first considerations are invested capital and organized labor, with disregard of the consumer as a ratable identity. So Mr. Schlink favored consumer recognition, even unto a cabinet office. Secretary of the Department of the Consumer.

When barred from the chain at first, Mr. Schlink thought that the Federal administration exercised some control over broadcasting chains, but Mr. Paley in his telegram denied this, and also denied that the Columbia exercises censorship itself.

Another point about Mr. Schlink's remarks concerned advertising in general, which he said was misinformative, and he specifically included the blurbs heard in radio programs, called "credits". He asserted that consumers have to pay dearly for the exploitation of foods and lotions and hence of themselves, so that grossly exaggerated prices are charged for the simplest concoctions, which are offered in honeyed phrases that are intended to make these products seem important and valuable, whereas they are of scant worth, he said. He mentioned the enormous expenditures by women for cosmetics, lotions, medicines and the like, most of which, he asserted, did no good whatever, and failed to perform according to the claims set forth for them. Moreover, he pointed out that the public, or consumer, is being victimized in other and more serious directions, as by the harmful ingredients put into foods.

Station Sparks

By Alice Remsen

THOSE FINE VOICES ON THE AIR

Radio has been bringing us some fine voices lately. Maude Adams, after a long retirement, came, was heard and conquered, for her sixty-two-year old voice still possesses all the magical qualities of Lady Babbie and still is as young as that ever-young character; Lily Pons, with her silvery coloratura; Tito Schipa, singing Mozart's charming music; Jane Addams, of Hull House, speaking on child labor and many other fine singers, speakers, and actors. No need to spend a boring evening with such good radio fare.

LET'S WISH JIMMY LUCK

Jimmy Kemper, who made such a hit on the Tidewater "Music on the Air" programs with his clever song characterizations, had a touch of hard luck. Pneumonia got him; he was rushed to a hospital, but last reports have it that the talented young man will be back on the air next week, just as lively as ever. . . . Jack Whiting, personable musical comedy favorite, will be starred in a new series of revue programs, entitled "Marvelous Melodies," over a WABC-Columbia network, beginning February 9th, and each Friday thereafter at 9:30 p.m. EST. A versatile performer, Whiting will be embarking on his first long-term radio contract. As the central figure of the new revues he will take part in skits and blackouts, in addition to using his baritone voice for popular songs and serving as master of ceremonies. Herbert Sanford will direct the presentations, which will utilize original material. In addition to Whiting, an orchestra, a girl singer and a supporting dramatic cast will comprise the performers. Program is under the sponsorship of the Richard Hudnut Company. . . . Raymond Scott, who wrote "You're My Lucky Charm," "Christmas Night in Harlem" and "Jungle Fever," is none other than Mark Warnow's brother Harry; Scott is merely his pen name. Harry also plays piano in his brother's orchestra. . . .

TED FAVORITE WITH OLD GOLD

Ted Fiorito is the composer of an "Unfinished Symphony," he started it at the age of nineteen and he's still working on it. Ted, by the way, has been signed by Old Gold, to take the place of Fred Waring. He opens on a nation-wide network, February 7th, at 10:00 p.m. The programs will originate in the studios of KFRC, Columbia outlet in San Francisco. The selection of the Pacific Coast maestro was made after a long series of auditions during which a number of outstanding entertainment units were heard, including groups under the direction of Ted Lewis, Buddy Rogers, Charles Previn, Phil Spitalny and others. In order to get a balanced and average reaction, a listen-board of men and women, both in and out of the radio industry, was invited to hear the various auditions. . . . And doesn't this establish a precedent? When Jimmy Kemper became sick, who do you think took his place at a moment's notice? Why, Ray Vir Den, the vice-president of the advertising agency handling the program; he was good, too; I heard him—but then, Mr. Vir Den used to be a concert and opera singer before he took up the prosaic profession of advertising; he wasn't sure whether the old vocal chords would work; just took a chance—but they did; proving that it's good to gamble once in a while. . . .

TEN-YEAR-OLD AS MAE WEST

If you heard a recent "March of Time" program in which the voice of Mae West was used you might be interested to know that Florence Halop, a ten-year-old kid, impersonated her. Little Florence won out over five actresses—and she sure sounded like Mae West. . . . Alexander Gray made his concert debut at Town Hall, New York on January 14th. . . . Jacques Fray and

Mario Braggiotti are displaying their tricky piano arrangements at the Hotel Biltmore, New York, in the Sunday night Paul White-man concerts. . . . Have you seen those wonderful "Death Valley Days" books given away by the Pacific Borax Company? They really are worth while! . . . And speaking of books, the David Ross Anthology of Poetry is getting in the best-seller class; and Edwin C. Hill will have a volume of his radio talks published very soon. . . . Elizabeth Love, who plays the part of Betty Graham in "Roses and Drums," will be seen in "By Your Leave," the new Gladys Hurl-burt-Emma Wells comedy soon to be produced in New York after a try-out in Philadelphia. . . . Another "Roses and Drums" star, John Griggs, is rehearsing in a new play, "Mackerel Skies," in which he will be seen following his appearance in the Broadway vehicle, "The Dark Tower," which closed recently. . . . Casper Reardon, eminent harpist, formerly with the Cincinnati Symphony, and heard recently over the air with Jack Denny, has joined the Camel Caravan, and will play his harp with the Casa Loma Orchestra. . . .

THE PRINCE OF WALES AND CASA

And speaking of Casa Loma, I received a letter from a Canadian reader who did not sign his name. He was very much put out because I said Casa Loma was originally built for the Prince of Wales; sorry, Mr. Canada, but that was the story I got from the Columbia Publicity Department; usually I don't run that sort of thing when it sounds far-fetched, but I adore the Prince of Wales, being English myself, and knowing he would probably smile at the story himself if he saw it; so I ran it; no offense was intended and I hope you will understand that. . . . And now it comes to light that Will Osborne is an avid collector of elephants; no, not the real thing, but tiny ones made of jade, ivory, ebony or stone; his hobby is accounted for by the fact that the ancient coat-of-arms of the Osborne family displays two elephants with trunks upraised; and also Will's middle initial stands for Oliphant, which is a family name. . . . And while I'm about it, might as well mention that the Will Osborne-Pedro de Cordoba commercial has been renewed for an extended period over WABC and network; three times weekly, Monday, Wednesday and Friday, at 10:45 a.m., EST. Sponsored by the Corn Products Refining Co. . . . Another one of those "Hollywood" programs opened this month. It's "Forty-five Minutes in Hollywood," featuring previews of the latest motion pictures and offering the music of Mark Warnow and his Orchestra, and the behind-the-scene news of Cal York, veteran film reporter; sponsored by the Borden Company; each Saturday at 8:00 p.m. EST., WABC and network. . . . And don't forget that Maude Adams may be heard each week now on WEAF, for the Pond Company. Fridays at 9:30 p.m. EST. She will be heard in the Barrie plays. So one of Peter Dixon's wishes has come true. Aren't you glad, Peter? . . . Over twenty prominent dance bands are now heard over the NBC networks. . . . Harry Stone, station manager of WSM, Nashville, has been appointed Colonel on the staff of Governor

A THOUGHT FOR THE WEEK

RACKETS, RACKETS EVERYWHERE! Now they're trying the "polishing" racket in radio. Somebody advertises for radio talents. You can whistle pretty well. You apply at the address given in a capgily worded advertisement. You whistle, and are told you are great and that a fine future awaits you before the microphone—but you need some "polishing." So, per instructions, you go to a studio where you are taught to breathe properly, to another where you are taught pitch and rhythm and to a photo gallery where you pay for pictures you don't need. Then when you've paid all the bills and report back to the "booking" office, which shares the profits on these deals, you find either that the place is closed or that there's nothing doing in the matter of bookings.

It's the cheapest, most brazen way of cheating fools out of their money. You can't get on the air that way. Keep your money and your self-respect and ask a regular broadcasting station how to go about it. There is a way—but it's not via the racket!

McAlister of Tennessee. Mr. Stone is a pioneer radio man and was Nashville's first radio broadcaster. . . . Lil and Avon Armstrong, brother and sister of the famous colored orchestra leader, Louis Armstrong, have joined the staff of WMCA, New York. . . . Pappy, Zeke, Ezra and Elton, the hill-billies who were featured for a long time over WMCA, were all set to trek back to the Ozark mountains, but NBC heard them, signed them up and now they'll be heard five times a week over national networks. . . .

TOM NOONAN CELEBRATES

Tom Noonan, the Bishop of Chinatown, recently celebrated his twenty-ninth year of service at the Chinatown Mission House, 5 Doyer Street, in the heart of New York's Chinatown. He was heard in a special broadcast over WMCA. . . . Westell Gordon, famous tenor of radio and concert, has placed himself under the exclusive direction of Norman L. Stevens, well-known concert manager. . . . The Jesse Crawfords are on tour through Texas. . . . The Boswell Sisters are stopping the show nightly at the Palais Royale, New York. . . . Skyland Scotty Wiseman, whose ballads of the North Carolina Mountains have brought him recognition as an authority on American folk songs, is now being featured on WLS, Chicago, three times weekly. . . . June Reed, who comes from Ol' Man River's home town, Memphis, and who was formerly a member of the Gus Edwards Son Revue, is now pleasing listeners over WRNY, New York, each Tuesday at 1:15 p.m. . . . and it's time for me to say toodle-oo, if I'm to get this to New York on time.

SUBSCRIBE NOW!

RADIO WORLD, 145 West 45th St., New York City. Enclosed please find my remittance for subscription for RADIO WORLD, one copy each week for specified period.

- \$10.00 for two years, 104 issues.
 - \$6 for one year, 52 issues.
 - \$3 for six months, 26 issues.
 - \$1.50 for three months, 13 issues.
- \$1.00 extra per year for foreign postage.

This is a renewal of an existing mail subscription (Check off if true)

Your name

Address

City

TRADE UNITED IN SEEKING END OF "GYP" DEALS

Through the operation of NRA codes for radio manufacturers and also wholesalers, it is hoped to wipe out many of the damaging practices prevalent in merchandising radio. With President Fred D. Williams presiding, the Radio Manufacturers Association directors discussed in detail the industry's many harmful selling practices and joined with the Radio Wholesalers Association toward development through the NRA in Washington of a code for wholesaling and retailing of radio which will eliminate widespread evils.

The proposed and revised supplemental code of the Radio Wholesalers Association, affiliated with the National Federation of Radio Associations, was presented in detail by Ben Gross, of New York, chairman of the RWA code committee. This radio merchandising code is designed as a supplement to the national basic wholesalers' code, now before General Hugh Johnson, NRA Administrator. It is a special code outlining fair trade practices for radio wholesalers and dealers.

The manufacturers' national organization pledged support of an ethical code for distribution of radio. It was decided to have the RMA represented at the hearing on the RWA code when held at Washington and to urge the adoption of proper trade practices in wholesaling and retailing. The RMA Board also will ask members to recommend that their jobbers become members of the Radio Wholesalers Association and aid in organization of local municipal radio trade bodies, to secure as wide national support of radio interests as possible for the code of merchandising practices.

A supplement to the electrical code which is now under consideration by the NRA also would prohibit many harmful merchandising practices in the radio industry. A further hearing on this supplemental code will be held in Washington January 29. Radio leaders are hopeful that from the manufacturers' code and that of the Radio Wholesalers Association there will follow a vast national improvement in radio merchandising.

THE NEW 8-TUBE PATHFINDER

(Continued from page 13)

mean, and that is just as good an intermediate as any other, as far as the i-f amplifier is concerned. In doing this, it is best to tune the plate circuits first so that they are tuned to the mean of the other two. Then the grid tuners can be adjusted, and it makes little difference which is tuned the first.

The intermediate frequency that results from this adjustment may not be exactly 175 kc, but that does not matter a great deal. The adjustment of the trimmers for high frequency tracking is done exactly as before, and it leads to just as high sensitivity. The adjustment of the padding condenser is also done in the same way as before. The only difference will be that a slightly larger or small padding capacity will be required. At other points the tracking may not be quite as good as it would have been had the intermediate tuner been adjusted exactly to 175 kc.

[Other Illustration on Front Cover]

TRADIOGRAMS

By J. Murray Barron

Another indication of the improvement in business a report comes from the Eagle Electric Mfg. Co., 59-79 Hall Street, N. Y., of further addition to its large quarters. Two additional floors have been taken in the building adjoining the two buildings now occupied by it. This will give five double floors for manufacturing. There is a new 1934 Catalog for the trade.

* * *

Those servicemen and experimenters who have built the seven-tube Thor Pathfinder will be glad to learn there is a new eight-tube kit which is the latest development and only now released after months of experimenting and testing.

* * *

A recent visit to the laboratories of a number of the smaller radio set manufacturers shows many new models under way for an early release. This applies to the midget a-c and ac-dc sets, both t.r.f. and superheterodyne.

* * *

No matter where one turns, short waves is the subject mostly discussed. That the interest is growing can hardly be denied. For the benefit of the local fans a new short-wave club held its first meeting recently in New York City.

* * *

So often servicemen and experimenters have requirements for special metal cabinets, bases and chassis and are at a loss as to where they can be made. For the made-to-order merchandise the Korrol Mfg. Co., Inc., 232 Greenwich Street, New York City, takes care of this type business.

Literature Wanted

Readers desiring radio literature from manufacturers and jobbers should send a request for publication of their name and address. Address Literature Editor, RADIO WORLD, 145 West 45th Street, New York, N. Y.

- Frank Terry, Gatun, Canal Zone.
Louis M. Swingle (W3DLC), 923 Faragot St., N.W., Washington, D. C.
William W. Brantley, Coast Artillery Armory, Water & O Sts., S.W., Washington, D. C.
Richard W. Hull, 210 Mott St., Corry, Pa.
Edward Blakeslee, R. R. No. 3, Granton, Wisc.
Lester Hale, 1916 Cleveland Ave., East St. Louis, Ill.
Dothan Radio Lab., 204 E. Powell St., Dothan, Ala.
La Verne Jacobs, Box 18, Crossville, Ill.
G. Arthur Carter, Service Mgr., Automatic Rfg. & Radio Service, 2937 Cass Ave., Detroit, Mich.
U. N. F. Labs., 69 East Logan St., Philadelphia, Pa.
C. W. Denney, R. No. 2, Box 286, Norfolk, Va.
Carl Miller, 202 Marshall St., Huntington, W. Va.
J. L. Jacobs, Box 18, Crossville, Ill.
Andrew Nutupski, Miller St., No. Wilbraham, Mass.
Carter Page, 911 Walnut St., Cincinnati, Ohio.
William S. Mullen, 8 Ivy Close, Forest Hills, L. I., N. Y.
N. N. Johnson, United Radio Eng., 708 Vaughan Hotel, Port Arthur, Texas.
I. W. Kirkwood, 829 East Maumee St., Adrian, Mich.
Chas. L. Hernde, Serviceman, 515 Oak Ave., Huntsville, Ala.
F. A. Nease (short wave parts), Nease's Barber Shop, 171 Third Ave., North, Nashville, Tenn.
G. J. Vervilos, 5681 W. Lake St., Chicago, Ill.
W. H. Melaney, 5357 Broad St., E. E., Pittsburgh, Pa.
James Louie, 153 Second St., Hoboken, N. J.
Philip Segal, Al Segal's Men's Shop, 43 Cambridge St., Boston, Mass.
Floyd E. Cates, 629 S. E. 2nd St., Minneapolis, Minn.
G. E. Gregory, Brackenridge, Penna.
W. E. McGillivray, 201 Osborne St., Winnipeg, Canada.
Aubrey E. Fales, 12 Marvin Ave., Shelby, Ohio.
D. Boillotat, 5105 Hillsboro Ave., Detroit, Mich.
Basil Bickel, 5205 Pennsylvania, St. Louis, Mo.
Donald C. Fleming, 511 17th Ave., West, Calgary, Alberta, Canada.

STUDIO CHATTER

Dave Rubinoff, violinist, doesn't play golf or bridge. . . His hobby is photography and his pet a German police dog. . . His favorite author is Tolstoy and despite all, his favorite actor is Eddie Cantor.

* * *

Elizabeth Lennox, NBC contralto, wouldn't take an engagement with the Metropolitan Opera Company if Gatticasazza offered her one on a platinum platter. "There are only two good contralto roles in all opera," says Miss Lennox. "The rest are witches and hags. I would not be a witch, I would not be a hag, even on the Metropolitan stage."

* * *

Lew White, organist, received instruction in organ playing from Dr. Alexander Matthews of the University of Pennsylvania. His first years were devoted to the violin, after which he turned to piano and theory. When still a boy he studied abroad under the German master, Heinrich Pfitzner. Returning to America, he was graduated from the Philadelphia Music Academy and later studied with Ernest Schelling.

* * *

Gene and Glenn recently observed their fourth anniversary as a radio team. . . Julian Altman, juvenile musician and actor, once won a medal as the most freckled boy in the State of New York. . . Frank Munn and Virginia Rea, once known as Paul Oliver and Olive Palmer, again singing together on NBC, made their joint debut in radio eight years ago on a program organized by Gus Haenschen.

* * *

Wilfred Glenn, basso, with a voice

ranging two octaves and a half—from the C below the bass clef to F-sharp—never knew he could sing until 20.

* * *

Wayne King, waltz music director who finds relaxation in his library, turned to the classics for the name of his daughter, born last Summer. She was christened Penelope in honor of the Penelope of Greek mythology, the wife of Ulysses, famous for wifely constancy. Mrs. Wayne King is the former Dorothy Janis, of the movies.

* * *

Allen (Wifesaver) Prescott quit the University of Pennsylvania in his junior year to become a movie actor. He supported Marion Davies in several films. . . Early in his career, Frank Black made piano player rolls. He was in such demand he produced under eight different names. . . Denied schooling in his youth, Johnny Marvin now overlooks no opportunity to urge the advantages of education. That is the keynote he sounds in answering letters from children.

* * *

"Amos 'n'-Andy, going along for quite a few years, night in and night out, have made and held more friends and listeners than any other attraction on the air. They have that human quality which gets under your skin and stays there."—Eddie Cantor.

A stock actress, a teacher of elocution, a Chautauqua musician, a piano accompanist, a vaudeville vocalist, a movie player and a radio actress of renown, Mabel Albertson, has done everything except what she longs to do. That is, to play Juliet on the stage.

**SPECIAL
GIFT
LIST**

Reliable Radio Tips

Watch for
This Special
Page Weekly

RELIABLE RADIO RUNS GIANT HOLIDAY SALE!!

FOR A PRACTICAL GIFT SUGGESTS GIVING A
RADIO—LET THE ENTIRE FAMILY ENJOY IT

Reliable Treasure Chest Receiver



A Handsome Four-Tube "Treasure Chest" model receiver which is a splendid piece of furniture and a high quality midget receiver. The beautifully designed cabinet built by craftsmen will satisfy the most critical person. Tubes used: 1-57, 1-58, 1-80 and 1-47 power pentode. Uses a full sized dynamic speaker. Price **\$9.50**
4 tubes\$1.45

4 and 5 Tube A.C. Midgets

A practical gift for the entire family. The most advanced features are embodied in these receivers. Quiet, smooth, distortionless reception.

Four-tube receiver uses 1-57, 1-58, 1-80, and 1-47 pentode; five-tube set uses 1-57, 1-58, 1-80, and 2-47's. Both models use a dynamic speaker especially designed for the output of the pentodes. The receivers are encased in a beautiful hand-rubbed walnut cabinet. Price, 4-tube A. C. receiver **\$9.95**

4 tubes\$1.45
Price, 5-tube A. C. receiver.....\$12.95
5 tubes\$1.95



Four Tube A.C. Short Wave Receiver

COMES MOUNTED INTO A BEAUTIFUL MODERNISTIC CABINET WITH BUILT-IN SPEAKER

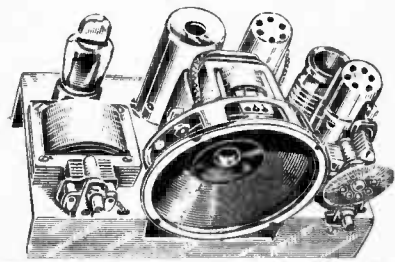

Looks like a midget broadcast receiver. Will tune in short wave stations from all parts of the world with ease. Uses four coils to cover the short wave bands from 15 to 200 meters. The built-in power supply is entirely free from hum or disturbing line noises. Uses an ultra-sensitive dynamic speaker to aid in tuning in the weaker signals. Kit of parts.....**\$17.50**

Wired and tested.....\$2.00 extra
Kit of tubes.....\$2.50 extra
Cabinet only\$1.50 extra



Stromberg-Carlson Phonograph Pickup

Makes any radio a modern up-to-date phonograph radio combination. Instruction sheet furnished with the outfit makes it simple to install. Volume control mounted on the pickup enables one to control the volume, without adjusting any part of your receiver. Special Holiday price **\$5.50**

Powertone Sending Key
The most practical gift to one who has just become interested in amateur radio. Widely used as a code practice key. Well balanced and fully adjustable. Price.. **75c**

A Handy Manual Published for SERVICEMEN AND SET DEALERS

Full of information, hookups, charts, trouble shooting hints, etc. Reg. \$1.00 **25c**

For The Beginners Rocket Two-Tube Short- Wave Battery Receiver

Economical! Uses two 2-230 tubes, which assures long battery life. Tunes from 15-200 meters. Pulls in amateurs, police calls, etc. Kit of parts

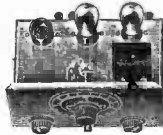

\$5.50
Wired..\$2.00 extra Tubes.....\$1.50
Batteries\$2.25

Powertone Two-Tube Bat- tery Receiver

Enclosed in a handsome crystal finished metal cabinet. Can be built by any one. Beautiful full vision modernistic vernier dial aids in logging weaker stations. Will receive all types of short-wave signals, police, amateur, ship-to-shore, airplane, etc.



\$7.95
Wired..\$2.00 extra Tubes.....\$1.95
Batteries\$2.75

A Power Pack That Converts Any Battery Operated Receiver Into an A.C. Receiver

Will convert any battery receiver to operate on a 110 volt A.C. line. All voltages terminate at binding posts on the chassis. Output; 2 1/2 volts at 10 amperes, 180 volts tapped at 135, 90, and 45. Supplies clear hum-free power regardless of circuit sensitivity. Price including 280 rectifier tube. **\$5.95**

EXTRA! SHORT-WAVE SETS

ACCLAIMED THE IDEAL GIFT FOR RADIO-MINDED FOLKS
If you really want to please your radio-minded son, father, mother, brother, sister or friend this Christmas, give a short wave receiver. On this page are several very fine receivers for both the beginner and the more advanced short wave enthusiast, yet all at extremely low prices.

For A.C. and D.C. Operation

Will work anywhere that 110 volt A.C. or D.C. is available. U. S. amateur reception is assured on loud-speaker by the use of a 43 power tube in the output.

With headphones the entire world is at your finger-tips. Chassis is completely encased in a beautiful crystal finished cabinet. Covers the short wave, band form 15-200 meters. Uses 1-78, 1-25Z5, and 1-43 tube. Price kit **\$8.95**

Wired..\$2.00 extra Tubes.....\$3.25

Beginners Twin Two-Tube Short-Wave Battery Receiver

A more advanced short-wave receiver for the beginner. Letters from builders verify foreign reception. Uses highest quality parts throughout. Complete with four plug-in coils to cover the entire short-wave band from 15 to 200 meters. Easy to build.

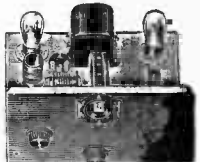

Kit of parts..... **\$8.95**
Wired..\$2.00 extra Tubes.....\$1.50
Batteries\$2.50

GIFTS FOR THE SERVICEMAN

Majestic 70 and 90 Condenser Blocks



Replacement condenser blocks for the Majestic 70 and 90 series receivers. Built to the exact specifications of the original. Absolutely guaranteed. Price\$1.35

4 and 8 mfd. Electrolytic Condensers

High quality electrolytic condensers. Can be used as a replacement in many receivers without fear of breakdown. Wet type—thus cannot be injured by slight overload or polarity. Inverted mounting.

4 mfd 35c
8 mfd 40c

RESISTORS



An assortment of 50 R.M.A. color coded resistors. Composed of 1/3, 1/2 and 1 watt resistors. All popular sizes are included in the kit ranging from 100 ohms to 10 megohms.

FREE
A beautiful bakelite case—a souvenir of the Chicago Century of Progress Exposition. Price\$2.50

Farrand Inductor Dynamic Speaker Chassis

Not to be confused with the various models now on the market and labeled Farrand Inductors. These models are genuine factory-built Inductors.

Two models are available, a 12" model and a 9" model. Mounting brackets are placed on both models.

Price, 9" model.....\$3.95 Price, 12" model.....\$5.95



Power Transformer for a BIG SET

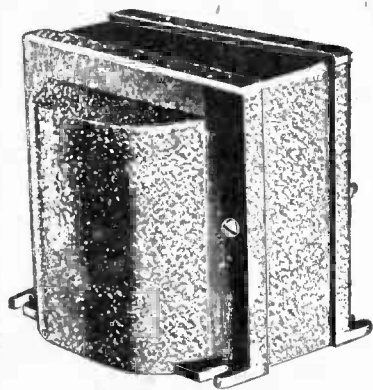

INSTEAD of using undersized, overheating, inefficient power transformers for a big set, why not use a cooling, efficient transformer and pay the little extra? The Reliable transformer, Model 104-SP, will work an 18-tube set. Provides for C bias supply through 25Z5 rectifier, for quality Class C or Class A.

Primary = 115 v., 60 cycles
 Secondary X = 14 amp., 2½ v., ct.
 Secondary Y = 6 amp., 2½ v., ct.
 Secondary R = 5 v., ct.
 Secondary HV = 400-0-400 v., 200 ma.
 Secondary Z = 25 v., 0.6 ma.
 Lug terminals at bottom

Price, \$3.95
 Shipping weight, 13 lbs.
 Immediate Delivery

RELIABLE RADIO CO.
 145 W. 45th St., New York, N. Y.

Quick-Action Classified Advertisements

7¢ a Word—\$1.00 Minimum

NEW DEVELOPED CIRCUIT. Five-tube super. Gets 3000 miles. Demonstration free. Barreto Radio, 13 Peck Slip, New York City.

TELEVISION MOTORS, Discs, Tubes, etc. Confidential prices on request. C. Denney, R. 2, Box 286, Norfolk, Virginia

"THE MODERN GASOLINE AUTOMOBILE," by Victor W. Page, M.S.A.E. "New" Revised and Up-to-date Edition. A whole library of information now complete in one large octavo volume of 1,146 (6 x 9) pages—1,000 engravings. Bound in flexible scarlet fabrikoid. Price \$5.00. Radio World, 145 W. 45th St., New York, N. Y.

"WILLCOX AUTO ELECTRICIAN'S-WIRING MANUAL."—Complete wiring diagrams for all U. S. cars made in 1928-1929-1930-1931-1932. Complete data on ignition systems, generators, starting motors, batteries and lighting. Printed on tough, wear-resisting paper that can be washed with gasoline without injury to print or paper. Loose-leaf style in sturdy covers. Size 11 x 12". 300 wiring diagrams. Price \$10.00. RADIO WORLD, 145 W. 45th St., New York City.

"SPECIALIZED AUTO RADIO MANUAL," Vol. 1, by John F. Rider—loose leaf—about 300 pages—up to the minute. Letter press printed. All diagrams clear and the figures easy to read. Covers old and new auto radio receivers, and includes recently announced auto radio installations. Price, \$3.50. RADIO WORLD, 145 West 45th Street, New York, N. Y.

"THE FORD V-EIGHT-'B'-FOUR-'BB'-TRUCK," by C. B. Manly. A New and Practical Book for Everyone Interested in the Construction, Adjustment, Upkeep and Repair of The New Fords. Over 250 pages, 125 illustrations. Complete cross index. Pocket size, flexible leatherette cover. Price \$2.00. Radio World, 145 W. 45th St., New York, N. Y.

Selected Quality Tubes FREE With Subscriptions for Radio World

Here is your opportunity to subscribe for RADIO WORLD and get just the tube or tubes you want, made by a very large, reliable, licensed tube manufacturer; picked tubes you'll appreciate. On this offer you have five days after receipt to put the tube to any logical test, and if not entirely satisfied with its performance, return it for replacement.

For an 8-week subscription (8 issues, one each week), at the regular price, \$1.00, you may select any one of the following tubes as free premium, or more at the same rate (\$2, 16-weeks subscription for two tubes, etc.), from this particular list: 01A, 01AA, 1V, 12Z3, 112A, 24A, 26, 27, 30, 31, 35, 36, 37, 38, 39, 45, 47, 51, 56, 71A, 80, 82, 199X.

With a 13-week subscription (13 issues), at the regular price, \$1.50, any one of the following tubes, or more at the same rate, from this particular list (two for a 26-week \$3.00 subscription, three for 39-week \$4.50 subscription, four for 52-weekly, yearly \$6.00 subscription, etc.), 1A6, 5Z3, 2A5, 2A6, 2A7, 2B7, 6A4, 6A7, 6B7, 6F7, 25Z5, 22, 32, 33, 34, 41, 42, 44, 46, 49, 53, 55, 57, 58, 59, 67, 75, 77, 78, 83, 83V, 84, (6Z4), 85, 89, 199V, 483, 485.

For a \$4.00 subscription, 34 weeks (34 issues), one No. 10 tube or one No. 50 tube may be obtained.

You may select any assortment of tubes desired and send in a subscription amount for the total required under the above classifications.

RADIO WORLD, 145 West 45th Street, New York, N. Y.

THE ONLY BOOK OF ITS KIND IN THE WORLD. "The Inductance Authority" entirely dispenses with any and all computation for the construction of variable or fixed condensers of any capacity, covering from ultra frequencies to the borderline of audio frequencies. All one has to do is to read the charts. Accuracy to 1 per cent. may be attained. It is the first time that any very system dispensing with computation has achieved such very high accuracy and at the same time covered such a wide band of frequencies.

A condensed chart in the book itself gives the relationship between frequency, capacity and inductance, while a much larger chart, issued as a supplement with the book, at no extra charge, gives the same information, although covering a wider range, and the "curves" are straight lines. The condensed chart is in the book so that when one has the book with him away from home or laboratory he still has sufficient information for everyday work, while the supplement, 18 x 20 inches, is preferable for the most exacting demands of accuracy and wide frequency coverage.

From the tri-relationship chart (either one), the required inductance value is read, since frequency and capacity are known by the consultant. The size and insulation of wire, as well as the diameter of the tubing on which the coil is to be wound, are selected by the user, and by referring to turns charts for such wires the number of turns on a particular diameter for the desired inductance is ascertained.

There are thirty-eight charts, of which thirty-six cover the numbers of turns and inductive results for the various wire sizes used in commercial practice (Nos. 14 to 32), as well as the different types of covering (single silk, double silk, single cotton, double cotton and enamel) and diameters of ¼, ½, 1, 1½, 1¾, 2, 2½, 3, 3½, 4, 4½, 5, 5½, 6, 6½, 7, 7½, 8, 8½, 9, 9½, 10, 11, 12, 13, 14, 15, 16, 17, 18, 19, 20, 22, 24, 26, 28, 30, 32, 34, 36, 38, 40, 42, 44, 46, 48, 50, 52, 54, 56, 58, 60, 62, 64, 66, 68, 70, 72, 74, 76, 78, 80, 82, 84, 86, 88, 90, 92, 94, 96, 98, 100, 102, 104, 106, 108, 110, 112, 114, 116, 118, 120, 122, 124, 126, 128, 130, 132, 134, 136, 138, 140, 142, 144, 146, 148, 150, 152, 154, 156, 158, 160, 162, 164, 166, 168, 170, 172, 174, 176, 178, 180, 182, 184, 186, 188, 190, 192, 194, 196, 198, 200, 202, 204, 206, 208, 210, 212, 214, 216, 218, 220, 222, 224, 226, 228, 230, 232, 234, 236, 238, 240, 242, 244, 246, 248, 250, 252, 254, 256, 258, 260, 262, 264, 266, 268, 270, 272, 274, 276, 278, 280, 282, 284, 286, 288, 290, 292, 294, 296, 298, 300, 302, 304, 306, 308, 310, 312, 314, 316, 318, 320, 322, 324, 326, 328, 330, 332, 334, 336, 338, 340, 342, 344, 346, 348, 350, 352, 354, 356, 358, 360, 362, 364, 366, 368, 370, 372, 374, 376, 378, 380, 382, 384, 386, 388, 390, 392, 394, 396, 398, 400, 402, 404, 406, 408, 410, 412, 414, 416, 418, 420, 422, 424, 426, 428, 430, 432, 434, 436, 438, 440, 442, 444, 446, 448, 450, 452, 454, 456, 458, 460, 462, 464, 466, 468, 470, 472, 474, 476, 478, 480, 482, 484, 486, 488, 490, 492, 494, 496, 498, 500, 502, 504, 506, 508, 510, 512, 514, 516, 518, 520, 522, 524, 526, 528, 530, 532, 534, 536, 538, 540, 542, 544, 546, 548, 550, 552, 554, 556, 558, 560, 562, 564, 566, 568, 570, 572, 574, 576, 578, 580, 582, 584, 586, 588, 590, 592, 594, 596, 598, 600, 602, 604, 606, 608, 610, 612, 614, 616, 618, 620, 622, 624, 626, 628, 630, 632, 634, 636, 638, 640, 642, 644, 646, 648, 650, 652, 654, 656, 658, 660, 662, 664, 666, 668, 670, 672, 674, 676, 678, 680, 682, 684, 686, 688, 690, 692, 694, 696, 698, 700, 702, 704, 706, 708, 710, 712, 714, 716, 718, 720, 722, 724, 726, 728, 730, 732, 734, 736, 738, 740, 742, 744, 746, 748, 750, 752, 754, 756, 758, 760, 762, 764, 766, 768, 770, 772, 774, 776, 778, 780, 782, 784, 786, 788, 790, 792, 794, 796, 798, 800, 802, 804, 806, 808, 810, 812, 814, 816, 818, 820, 822, 824, 826, 828, 830, 832, 834, 836, 838, 840, 842, 844, 846, 848, 850, 852, 854, 856, 858, 860, 862, 864, 866, 868, 870, 872, 874, 876, 878, 880, 882, 884, 886, 888, 890, 892, 894, 896, 898, 900, 902, 904, 906, 908, 910, 912, 914, 916, 918, 920, 922, 924, 926, 928, 930, 932, 934, 936, 938, 940, 942, 944, 946, 948, 950, 952, 954, 956, 958, 960, 962, 964, 966, 968, 970, 972, 974, 976, 978, 980, 982, 984, 986, 988, 990, 992, 994, 996, 998, 1000.

"The Inductance Authority"

By EDWARD M. SHIEPE, B.S., M.E.E.

gives the frequency ratio of tuning with any inductance, when using any condenser the maximum and minimum capacities of which are known.

The book contains all the necessary information to give the final word on coil construction to service men engaged in replacement work, home experimenters, short-wave enthusiasts, amateurs, engineers, teachers, students, etc.

There are ten pages of textual discussion by Mr. Shiepe, graduate of the Massachusetts Institute of Technology and of the Polytechnic Institute of Brooklyn, in which the considerations for accuracy in attaining inductive values are set forth. These include original methods.

The curves are for close-wound inductances, but the text includes information on correction factors for use of spaced winding, as well as for inclusion of the coils in shields. The book therefore covers the field fully and surpasses in its accuracy any and all mechanical aids to obtaining inductance values.

The publisher considers this the most useful and practical book so far published in the radio field, in that it dispenses with the great amount of computation otherwise necessary for obtaining inductance values, and disposes of the problem with speed that sacrifices no accuracy.

The book has a flexible colored cover, the page size is 9 x 12 inches and the legibility of all curves (black lines on white field) is excellent.

EACH turns chart for a given wire has a separate curve for each of the thirteen form diameters.

The two other charts are the tri-relationship one and a frequency-ratio chart, which gives the frequency ratio of tuning with any inductance, when using any condenser the maximum and minimum capacities of which are known.

The book contains all the necessary information to give the final word on coil construction to service men engaged in replacement work, home experimenters, short-wave enthusiasts, amateurs, engineers, teachers, students, etc.

There are ten pages of textual discussion by Mr. Shiepe, graduate of the Massachusetts Institute of Technology and of the Polytechnic Institute of Brooklyn, in which the considerations for accuracy in attaining inductive values are set forth. These include original methods.

The curves are for close-wound inductances, but the text includes information on correction factors for use of spaced winding, as well as for inclusion of the coils in shields. The book therefore covers the field fully and surpasses in its accuracy any and all mechanical aids to obtaining inductance values.

The publisher considers this the most useful and practical book so far published in the radio field, in that it dispenses with the great amount of computation otherwise necessary for obtaining inductance values, and disposes of the problem with speed that sacrifices no accuracy.

The book has a flexible colored cover, the page size is 9 x 12 inches and the legibility of all curves (black lines on white field) is excellent.

Send \$4.00 for 34-week subscription for RADIO WORLD and order Cat. PIA sent free, with supplement, postpaid in United States and Canada.

RADIO WORLD

143 West 45th Street

New York, N. Y.

TRY-MO RADIO BARGAIN BASEMENT

Everything in radio, from a condenser to a Broadcasting Station. Headquarters for SERVICEMEN, EXPERIMENTERS and DEALERS at lowest prices in the city. Ask for Steve. Look for the NEON SIGN BARGAIN BASEMENT in window. "BEGINNERS TWIN" (uses 2 volt tube) battery. Kit complete. \$7.95 Wired, \$2.00 extra—2-30 tubes. 1.40 SYLVANIA or ARCTURUS tubes. Using HAMMARLUND parts.

TRY-MO RADIO CO.

179 Greenwich St., Dept. R.W., New York
 WRITE FOR CATALOG

As a GIFT

with a Subscription Order—

A Test Oscillator
 Accurate to 1%!



THE new model 30-N Test Oscillator produced by Herman Bernard has been improved by custom-making each coil to an inductance accuracy of 0.01 per cent (one part in 10,000), and using a non-warping etched metal scale, so that the guaranteed frequency accuracy is better than 1%. Bernard Test Oscillators are the only low-priced ones that carry any accuracy guarantee.

The features of the Model 30-N oscillator are:

- (1)—Works on a.c. (any frequency), d.c. or B batteries, 90-120 volts, requiring no separate excitation of filament, hence is universal. Models for 180-240-volt use obtainable.
- (2)—Has frequency calibrated dial, for lining up intermediates and broadcasts, 135 to 1,500 kc.
- (3)—Contained in black crinkle finish metal cabinet, with Formica top panel having copper foil backing.
- (4)—Constantly modulated in any and all uses.
- (5)—Oscillator proper is isolated from cabinet, output is isolated from both oscillator and cabinet, and line is fused. Illustration above is one-third actual size, 5 x 5 x 3 inches. Weight only 3 lbs.
- (6)—Oscillator ready for use when received.
- (7)—Guaranteed frequency accuracy under all conditions, 1%. Calibration not disturbed by tube replacement.

The Model 30-N will be sent prepaid in United States or Canada, with tube inserted in socket, and direction booklet enclosed, on receipt of \$12.00 for a 2-year subscription for Radio World (104 issues, one each week, at regular rate), plus \$1.00 for the specially accurate calibration, total \$13.00. For 180-240-volt use, Model 30-ND, \$12.00 for subscription, plus \$2.00 extra for precision and for special voltage, total \$14.00.

RADIO WORLD

145 West 45th St., New York, N. Y.

SOLDERING IRON FREE!

Works on 110-120 volts AC or DC, power, 50 watts. A serviceable iron, with copper tip, 5 ft. cable and male plug. Send \$1.50 for 13 weeks' subscription for Radio World and get these free! Please state if you are renewing existing subscription.

RADIO WORLD

145 West 45th St. N. Y. City