

MAY 27

1933

RADIO

REG. U.S. PAT. OFF.

WORLD

15c

Per Copy

The First and Only National Radio Weekly
Twelfth Year *583d Consecutive Issue*

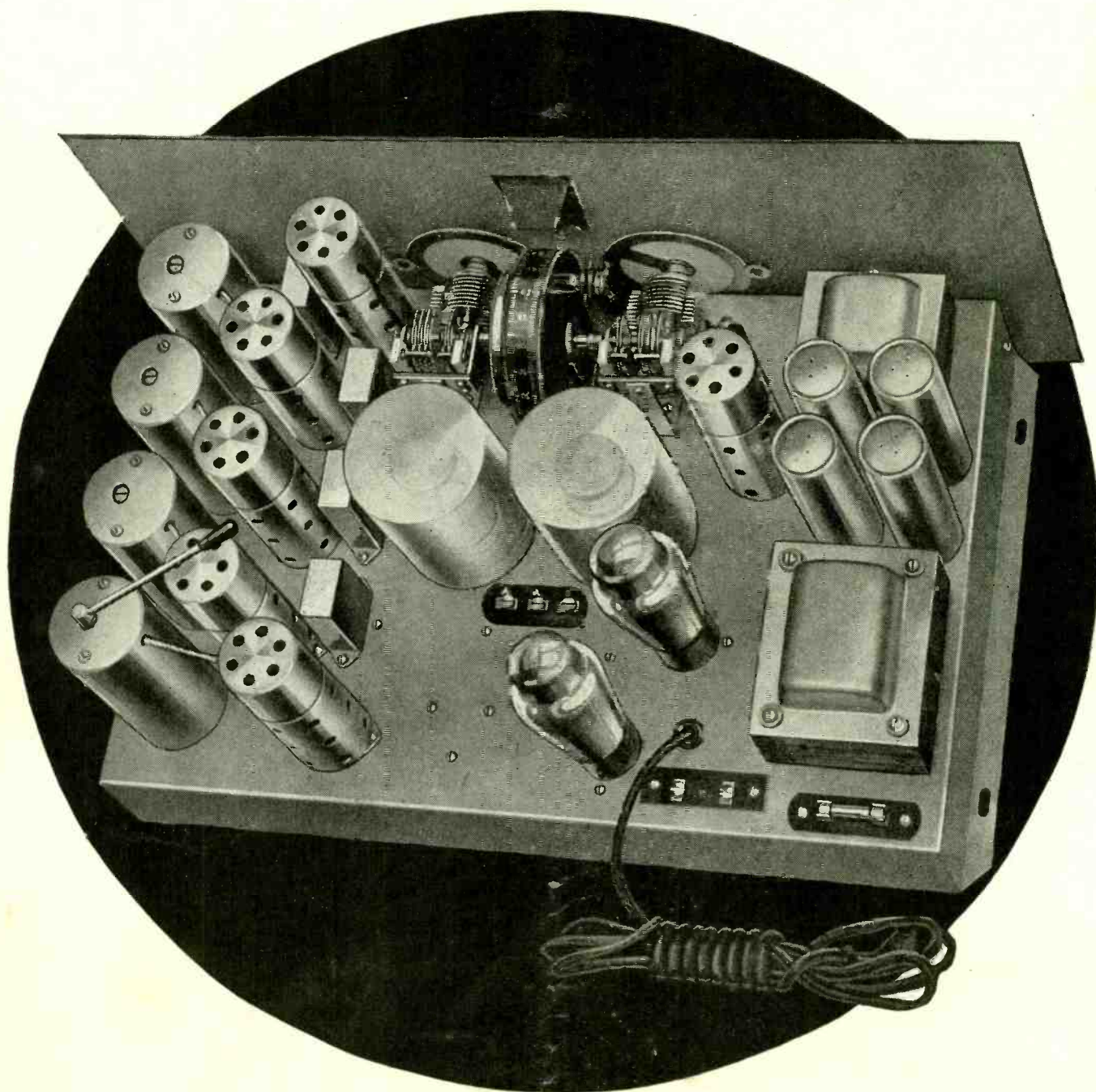

The Hammarlund Comet "Pro" has been improved by introducing air-dielectric condensers in the intermediate transformers. - See page 12.

Get the ORIGINAL IMPROVED PRIZEWINNER

When Buying an AC-DC S-W Set Look for the Following:

1. Tunable Hum Elimination
2. Proper Impedance Coupling Between 77 Detector to 43 Audio Stage (Not Resistance Coupled)
3. Pilot Light
4. Smooth Oscillation, Especially Below 80 Meters
5. Complete Loud Speaker Reception
6. Fringe Howl Elimination

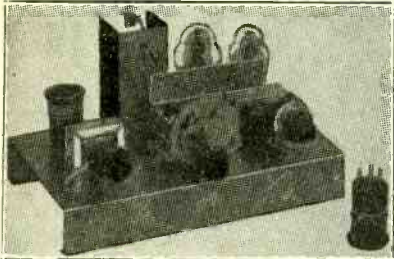

THE PRIZEWINNER is complete. No extras, such as power supply, coils, etc., to buy. Power supply is built-in and will operate on EITHER AC OR DC! Four coils included, cover all bands, 20,000 KC to 1,500 KC.

Complete kit of PRIZEWINNER parts identical in every respect with those used in built-up models, complete in every detail, including hardware, hookup wire, solder, coils, etc., and also the cabinet and dial. Price..... **\$8.95**

Set of RCA tubes containing 1-77, 1-43, 1-25-Z5 for above..... **\$3.75**

Assembled, wired, tested and enclosed in beautiful crackle finish, or Cadmium Plated, metal cabinet, ready to plug into your power line. Complete with four coils..... **\$10.95**

For extra efficiency use Octoform Coils. No add. per set.

Harness for conversion to battery operation..... **\$1.85**

RCA 41 tube required when converted to battery opp..... **\$0.95**

Adaptor for 220 v. A.C. or D.C. operation..... **\$1.90**

Mail Orders Promptly Filled

ALAN RADIO CORP.
The House of Dependable Service
83R CORTLANDT STREET
N. Y. CITY

Mr. SERVICEMAN

Take a tip! Get Rider's Volume II of the Perpetual Trouble Shooter's Manual. Buy it today. Don't wait until you cannot repair a receiver because you do not have the data.

FREE. If you are a Service Man, write for the color code chart of the resistors used in Atwater Kent receivers. Enclose 3c to cover postage.

RADIO TREATISE CO., Inc.
1440 Broadway New York City

Subscribers! Important!

Note subscription expiration date on wrapper containing your copy of RADIO WORLD. If nearing expiration date, please send in renewal so that you will not miss any copies. Subscription Dept., RADIO WORLD, 145 W. 45th St., New York City.

"FORD MODEL—'A' Car and 'AA' Truck," by Page. \$2.50. Radio World, 145 W. 45th St., N. Y. C.

Special Summer Trial Subscription Offer

FOR

NEW SUBSCRIBERS

Send \$1.00 in cash, check, P. O. money order or stamps, and receive Radio World postpaid from now until Sept. 2.

Sub. Dept., Radio World, 145 West 45th St., N. Y. City

FORDSON'S NEW SUPER LOW COST

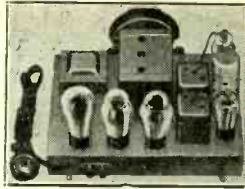

SIX TUBE
Goldentone
TRADE-MARK

Superheterodyne
\$9.95 Chassis and Dynamic Speaker

With automatic volume control using the new duplex diode triode type 55 tube and Class A power pentode, using the new seven-prong type 59 Pentode tubes.

SEND FOR FREE CIRCULAR

FORDSON RADIO MFG. CORPORATION,
11704 Livernois Avenue, Detroit, Michigan.
Send me FREE circular giving complete details and prices on the GOLDENTONE radio.
Name.....
Address.....
City.....State.....

BIG BUYS

- R.C.A. Universal ac-dc. receiver complete with 4 tubes.....\$10.95
 - R.C.A. Ltc. Super-het. Universal ac-dc. receiver with 5 tubes.....13.95
 - Standard Universal ac-dc. receiver with 4 tubes. 9.45
- FREE BOOKLET, SHORT WAVE SETS, KITS, ETC.

FANNING RADIO LABS.

377 87TH STREET BROOKLYN, N. Y.

ANDERSON'S AUTO SET

Designed by J. E. ANDERSON

FOREIGN RECEPTION ON 6-INCH AERIAL

This new auto set is the most sensitive car receiver we have ever come across. Mexican and Canadian stations were tuned in from New York City on a 6-inch aerial. The circuit, an 8-tube superheterodyne, with automatic volume control. The complete parts, including set chassis and set shield, battery box, remote control, battery cable, all condensers, resistors and coils, speaker with shielded cable; and a kit of RCA tubes (two 239, two 238, two 837, one 89, and one 85, are supplied less aerial. Cat. 898-K 9.....\$34.80
Wired model, licensed by RCA, with complete equipment, less aerial, but including RCA tubes. Cat. 898-W.....\$37.40

DIRECT RADIO CO.

143 West 45th St. N. Y. City

115 DIAGRAMS FREE

115 Circuit Diagrams of Commercial Receivers and Power Supplies supplementing the diagrams in John F. Rider's "Trouble Shooter's Manual." These schematic diagrams of factory-made receivers, giving the manufacturer's name and model number on each diagram, include the MOST IMPORTANT SCREEN GRID RECEIVERS.

The 115 diagrams, each in black and white, on sheets 8 1/4 x 11 inches, punched with three standard holes for loose-leaf binding, constitute a supplement that must be obtained by all possessors of "Trouble Shooter's Manual." to make the manual complete.

Circuits include Bosch 54 D. C. screen grid; Balkite Model F. Crosley 20, 21, 22 screen grid; Eveready series 58 screen grid; Eola 224 A. C. screen grid; Peerless Electrostatic series; Philco 76 screen grid.

Subscribe for Radio World for 3 months at the regular subscription rate of \$1.50, and have these diagrams delivered to you FREE!

Present subscribers may take advantage of this offer. Please put a cross here to expedite extending your expiration date.

Radio World, 145 West 45th St., New York, N. Y.

"SERVICING SUPERHETERODYNES," by John F. Rider. A reliable aid to the service man or to organizations in tackling superhet service problems. 161 pages, canvas cover. Price \$1.00. Radio World, 145 W. 45th St., New York, N. Y.

The World's FINEST Short-Wave RECEIVER

HAMMARLUND, for once, discards its customary modesty and asserts boldly that the new COMET "PRO" is the World's Finest Short-Wave Receiver.

The evidence is too overwhelming to permit anything less being said about this amazing custom-built superheterodyne.

With the whole world to choose from, the "PRO" holds honor position in the service of the U. S. and Canadian Governments, leading air-transport and steamship companies, police departments, and key stations of broadcasting networks—faithfully performing their most exacting tasks.

The "PRO" now uses four "58" tubes, two "57's," one "2A5" and an "80" rectifier.

New "AIR-TUNED" I.F. and oscillator units for even more sensitivity and selectivity than before—yet surprisingly easy to tune with its simple band-spread system. Full loudspeaker volume. Electron coupling gives greater oscillator stability. Shielding is more effective, and the new metal cabinet prevents stray influences. Wood cabinet optional. A.C. and Battery Models.

Mail coupon for 16-page folder describing complete details of this really GREAT receiver.



The

COMET

Custom-Built "PRO"

by
HAMMARLUND

HAMMARLUND MANUFACTURING CO.
424-438 W. 33rd St., New York

Please send your new Catalog "33,"Check here for illustrated folder describing COMET "PRO" Short-Wave Superheterodyne.

Name.....

Address.....

.....RW 5-27

ROLAND BURKE HENNESSY
Editor

HERMAN BERNARD
Managing Editor

RADIO WORLD

The First and Only National Radio Weekly
TWELFTH YEAR

J. E. ANDERSON
Technical Editor

J. MURRAY BARRON
Advertising Manager

Vol. XXIII

MAY 27th, 1933

No. 11. Whole No. 583

Published Weekly by Hennessy Radio Publications Corporation, 145 West 45th Street, New York, N. Y.

Editorial and Executive Offices: 145 West 45th Street, New York

Telephone: BR-yant 9-0558

OFFICERS: Roland Burke Hennessy, President and Treasurer; M. B. Hennessy, Vice-President; Herman Bernard, Secretary.

Entered as second-class matter March, 1922, at the Post Office at New York, N. Y., under Act of March 3, 1879. Title registered in U. S. Patent Office. Printed in the United States of America. We do not assume any responsibility for unsolicited manuscripts, photographs, drawings, etc., although we are careful with them.

Price, 15c per Copy; \$6.00 per Year by mail. \$1.00 extra per year in foreign countries. Subscribers' change of address becomes effective two weeks after receipt of notice.

THE DIAMOND GROUP

11-Tube (12 with Built-in 116.25 kc Oscillator), and 8-Tube Constitute Full Set Models, Of Equal Sensitivity, But Different Power Output, While Tuner Has Seven Tubes

By Herman Bernard

THE Super Diamonds have been altered to include the new 2A7 tube, as the frequency stability is as great as in previous models using separate oscillator and separate modulator tubes, and the gain from the mixer tube (2A7) is greater than with the two separate tubes.

Thus the 12-tube Double Push-Pull Diamond becomes an 11-tube set. There are added an 8-tube set, single-sided output, and a tuner, as many have requested that a tuner be included, for they have power packs. However, the tuner is completely self-powered, as that makes for certainty of voltages and also for elimination of inter-coupling troubles due to leads to and from tuner that would introduce truant r-f into the receiver.

All three models under discussion have the same radio frequency and intermediate frequency tuning, the same detection, and only the audio differs, save for some minor screen voltage differences.

Three Stages of Audio

Thus, the 11-tube set has three stages of audio, for one must include the non-reactive-coupled audio stage embodied in the 55. The tuner has this one stage of audio, necessary for retention of the special squelch operation, derived from the 55 besides the usual contributions of that tube, i. e., full-wave diode second detection, a.v.c. and audio stage.

Since the r-f and i-f circuits are the same, as well as the detector and a.v.c., discussion of these will be in order at this time.

There are four tuned circuits at the r-f level, including the oscillator. These are deemed necessary as the only present known means of making a super sensitive but squeal-proof. The general rule is that the circuit when built properly will have no squeals. This is so unusual in a super that many constructors believed it could not be done, and while accepting the super for its unchallenged advantages of higher sensitivity and much greater selectivity, simply took the squeals as a necessary evil. Several of the sets have been built by "outsiders," as part of the corroboration

sought before the release of the circuit to the readers of these columns, and nearly all reported utter absence of squeals, and nobody reported more than one squeal, and that a slight one.

15-Turn Primaries

As part of the design and experimental work done on this receiver the problem of squeal-elimination was tackled, and it was found that the principal reason for squeals was lack of sufficient selectivity ahead of the modulator. In almost any super, if the aerial is made short enough the squeals will disappear, but the sets are not so sensitive that they can afford the drop in input. Hence it seems necessary, in the present state of the science, to include sufficient selectivity ahead of the modulator so that squeals will be absent virtually regardless of the length (or really effective height) of the antenna. There is virtually no limit to the length of aerial that may be used.

It was not possible to achieve the desired results with large primaries. While they improve sensitivity greatly they do not permit the attainment of sufficient selectivity for riddance of squeals regardless of antenna height.

Therefore 15-turn primaries have been used, wound over the secondaries, with 0.02-inch insulation between, the form diameter being 1 inch and the coils shielded. For the 0.00041 mfd. capacity used for tuning the r-f level, the secondary inductance was 230 microhenries. For the oscillator the capacity is reduced by padding to approximately 0.0002 mfd., and the inductance is 126 microhenries for the secondary. There are two ticklers on the oscillator coil, the preferred one being shown on the coil-connection diagram, as this is the smaller one. The winding marked "not used" has 30 turns wound next to (below) the secondary. The size wire is not material. The preferred tickler has 20 turns of any fine wire wound over the secondary.

When the primaries are larger there is r-f oscillation, another source of squeals, but the present method eliminates this danger, and the sensitivity is brought up to the

desired level by the extra intermediate stage, two stages instead of one.

Police-Wave Switch

All three models are equipped with a police-wave switch, operated from the front panel, but the receiver is designed for maximum performance on the broadcast band, and the other band (1,575 — 4,500 kc) is merely incidental.

When the switch is thrown to short-wave position the first stage is untuned, as the condenser is taken out of the circuit. The frequencies are so high that when attempts were made to tune this circuit oscillation at the r-f level resulted, although the switch and coils are so made that any who desire to retain the tuning in this stage as an experimental possibility may do so, and in most instances this will work out satisfactorily.

Even though the intermediate frequency is 465 kc, the capacitive padding of the oscillator may be omitted, as the taps on the respective coils—r-f and oscillator—are such that inductive padding alone is retained, and this has proved sufficient for the police band.

The Automatic Volume Control

The a.v.c. is made to control modulator and both intermediate tubes, and thus is retained on the police band, the switching not affecting these controlled circuits. It is advisable to control the modulator because the oscillation intensity varies a bit with frequency, and as the oscillation amplitude increases, the modulator bias increases, since the increase in signal strength is communicated to the a.v.c. tube.

The additional bias voltage contributed by the a.v.c. is the maximum rectified voltage in the 55 or 2B7. The point from which a.v.c. is derived is the highest signal potential of the load resistor. (0.06 meg. potentiometer.)

The 2A7 Tube

The 2A7 is a new tube, and perhaps its connections are not familiar to some readers. A diagram includes data on the tubes in relation to the socket, while the circuit
(Continued on next page)

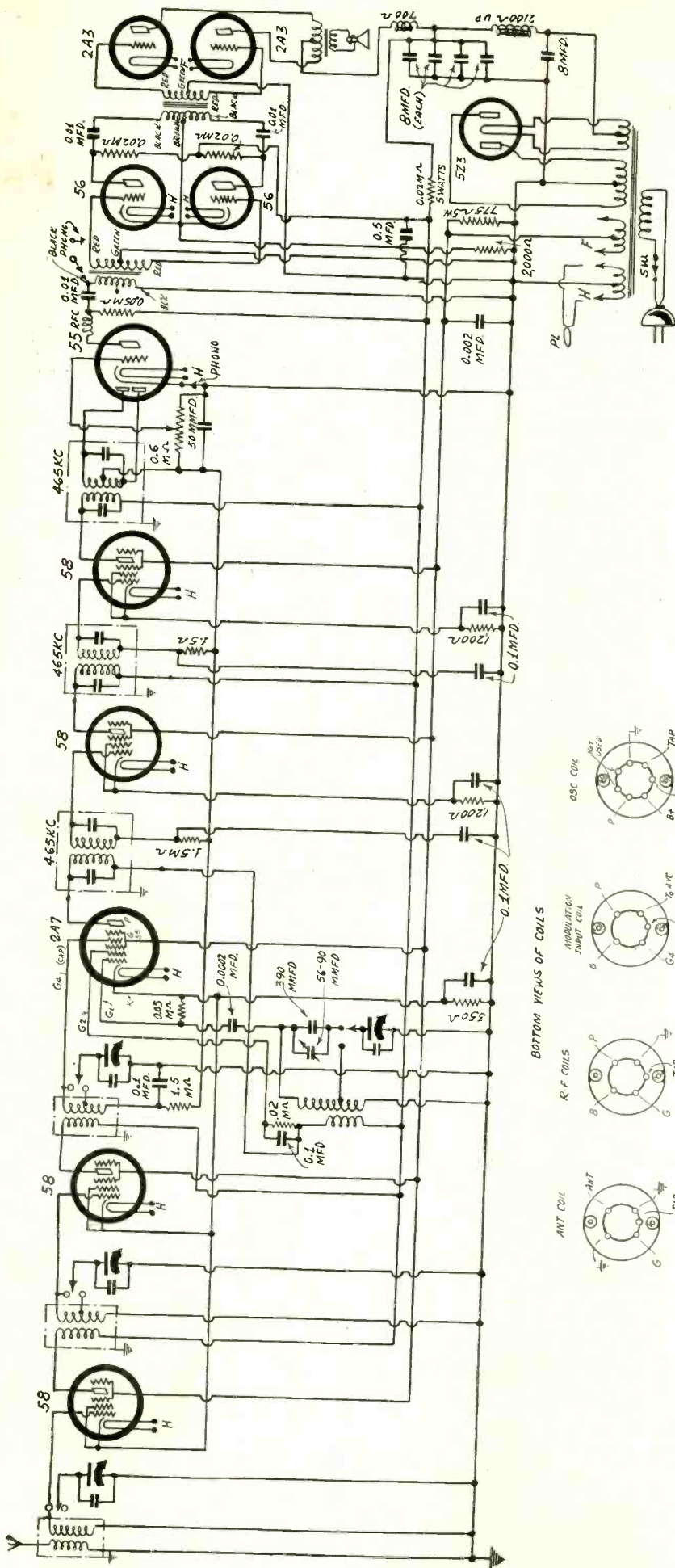

The Double Push-Pull Super Diamond, using the new 2A7 tube, total 11 tubes. The standard Super Diamond tuner is followed by a 56 push-pull stage and a 2A3 push-pull stage. The output power is 15 watts.

(Continued from preceding page)
shows the 2A7 grids as Nos. 1, 2, 3, 4 and 5, wherein No. 1 is the oscillator control grid, No. 2 is the oscillator plate, Nos. 3 and 5, joined inside the tube, are the screen, and No. 4, the overhead cap, is the control grid of the modulator.

The 2A7 is two tubes in one, with a common cathode. The oscillator is a triode, used as a grid-current type. The modulator is a pentode, used in the familiar pentode fashion. The commonness of the cathode results in the union of oscillator and modulator electrons in this branch of the circuit, hence electron coupling prevails. The effective coupling is loose, and is approximately equivalent to 2 mfd. capacity between grid of one tube and grid of the other, determined by setting up two tubes separately, using coupling capacities between oscillator in one envelope and modulator in the other, until the output was the same as in the single tube used in orthodox fashion.

Unique Connection

Of two circuits previously shown for the 2A7, and included in the official data on this tube, one provides somewhat greater frequency stability than the other, and the more stable circuit is used. Note that the primary of the first intermediate transformer is not connected directly to B plus, but instead goes to the plate side of the oscillator feedback winding. The d-c potential is the same as that of B plus, for the primary of the first i-f transformer escapes the 0.02 meg. limiting resistor, but the two frequencies pass through the feedback winding, and minimize the phase shift. Frequency instability may be expressed as a phase shift.

Looking at the 2A7, one sees three resistors associated with its circuit. One is 1.5 meg. This is simply a high resistance introduced to prevent part-shorting of the signal across the potentiometer in the second detector. To stop r-f loss due to this resistor, a condenser of 0.1 mfd. is connected between coil return and ground. The second resistor is 0.05 meg. (50,000 ohms) and is the grid leak. Connected between grid and cathode, it provides a conductive return for the grid, or path for the grid current. The value selected is a compromise, as much smaller values detract from the sharpness of the emitted oscillation frequency, and much higher values may sustain too high a voltage in the modulator circuit.

It is a fact, however, that sensitivity may be improved by using values more than 0.05 meg., and up to 0.5 meg. have been tried.

Third 2A7 Resistor

The third resistor is 0.02 meg., and is not essential. Its purpose is to limit the voltage on the plate of the oscillator (Grid No. 2), in case any use different power transformer or filter capacity or otherwise introduce much more than the normal 230 volts to the B plus feed to the tuner. If the voltage exceeds 250 volts the resistor will take care of dropping the excess. As it is, if 230 volts are fed, only a little more than 200 volts actually will be effective. Up to 250 volts are permissible for the 2A7.

The padding condenser is in lifted position (not grounded) as the sensitivity is somewhat greater that way. Moreover, the set screw is at a hot potential, and therefore the padding is not as readily done. However, it is obvious that any driver, metal or insulated, will communicate hand capacity. Therefore adjust for maximum response. When the driver is removed volume will decline sharply. This is due to capacity being less. Then increase the capacity by small amounts (fractional turns of driver) until the previously noted volume level is duplicated. Note that the driver has to be removed from the pad each time the fractional turn is made.

Squelch Circuit

The intermediate stages are standard, except that the feed to the second detector

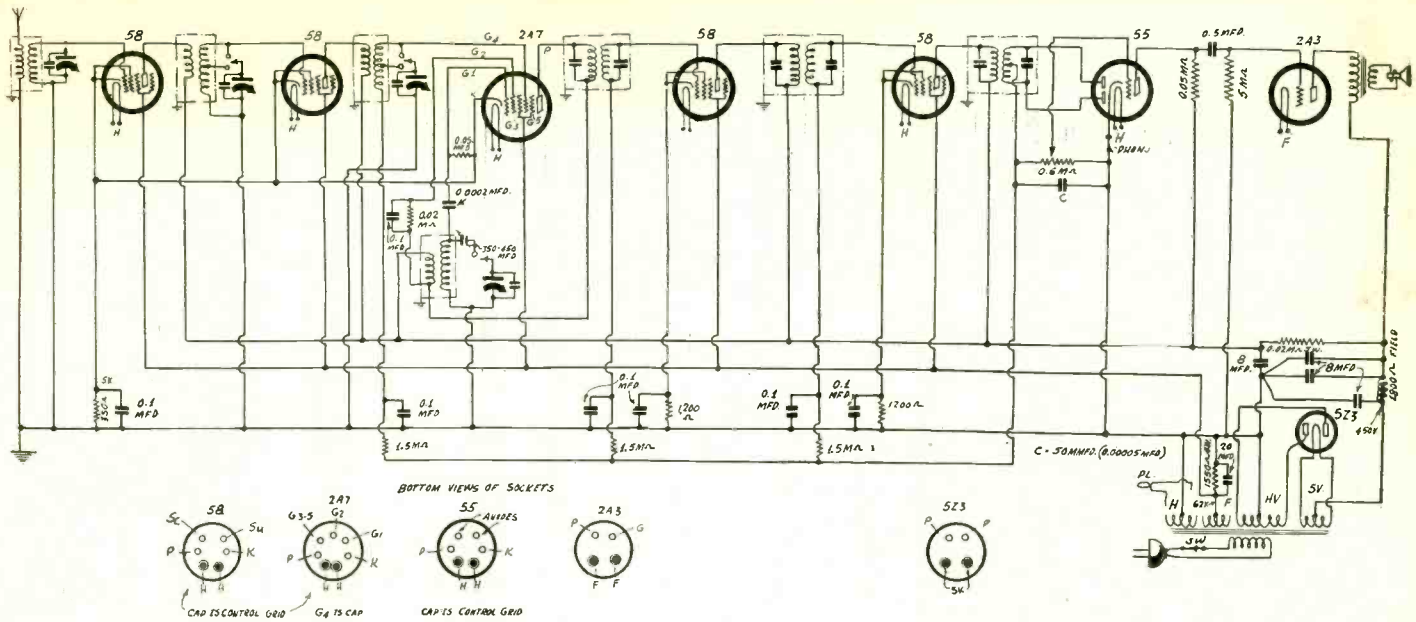

The Super Diamond 8, which has the tuner feeding a 2A3 output tube. Read the oscillator secondary as having a tap.

set's volume control is put at minimum, as then no part of any signal is introduced into the grid circuit, and the only input is from pickup in the cathode circuit.

The foregoing is common to the three circuits, since it is a discussion really of the same circuit.

The Tuner

The tuner has its own B supply, and since the B voltage at maximum would be too high, a voltage divider is used, and less than maximum is taken off for the B feed to the set. Thus 200 volts may be applied as maximum, with 100 for the r-f screens. It's enough if two i-f screens take 50 volts. A multiple-tap voltage divider is used, and the taps are selected on the voltage basis. The low resistance taps are crowded closer together, the first few being 50 ohms each. For the 50-volt tap somewhere around 200 ohms would be used, for the 100-volt tap somewhere around 600 ohms, and for the 200-volt tap, somewhere around 1,000 ohms.

The tuner output is through condensers, so that the output jack may be used with earphones, or for connection to a power pack that has its input at a positive B potential, without danger of a d-c short if the wrong one of the two jacks is picked up. Without the condenser on the grounded side this danger would exist.

The tuner has no need for a 2.5-volt power tube winding, so this winding is used for the detector.

No hum results from the tuner, so any hum introduced would have to be cured in the place of origin, the power pack.

8-Tube Receiver

The 8-tube set is substantially the 7-tube tuner, with added 2A3 output. Hence there are two stages of audio, one in the 55, the other in the 2A3. The coupling to the last tube is resistive, with a load resistor of 0.05 meg. in the plate circuit and a grid resistor of 5.0 meg. This high value of grid resistor is entirely suitable for this circuit, as there is no danger of grid current in the power tube. The 2A3 has a very small tendency to grid emission, as compared to pentode output tubes, and besides the applied voltage is 350 volts, and the bias is 60 volts. So also instead of a 3.5-watt output we have a 5-watt output. This has nothing to do with the quantity of sound which the set will produce but with the amount of power that the output stage will handle. The set has to put in enough to the power tube to enable that tube to be loaded up, if it is desired to load up the tube, although for home use 3 watts are high, and 1 watt is nearer to what most persons find comfortable.

The use of direct-coupled non-reactive

audio in the 55 results in a squelch circuit, that is, suppression of inter-channel "hash." When there is no signal, the condition when inter-channel noise arises, there is no voltage drop in the 55 load resistor (0.6 meg. potentiometer), hence no bias on the 55, for signal voltage alone constitutes the bias. Noise would result, only the 55 prevents hearing it, because the tube does not amplify at zero bias. So at no signal there is no signal heard nor any interfering substitute for a signal.

A radio frequency choke coil in the 55 plate circuit is optional, but if included should be in a shield. Its value may be 30 millihenries. The plate to cathode capacity is sufficient to complete the bypassing, and no additional condenser is needed, unless one encounters oscillation at the intermediate level, whereupon a condenser of 0.00025 mfd. may be put between plate of the 55 and ground. Another aid, to be used only if such oscillation is present, is to put two small condensers from arm to one side and the other side of the potentiometer.

Phonograph Connection

All models have provision for a phonograph pickup. The switch to cut out the pickup is on the front panel. The radio receiver is active while the pickup is used, as this is necessary for preservation of the (Continued on next page)

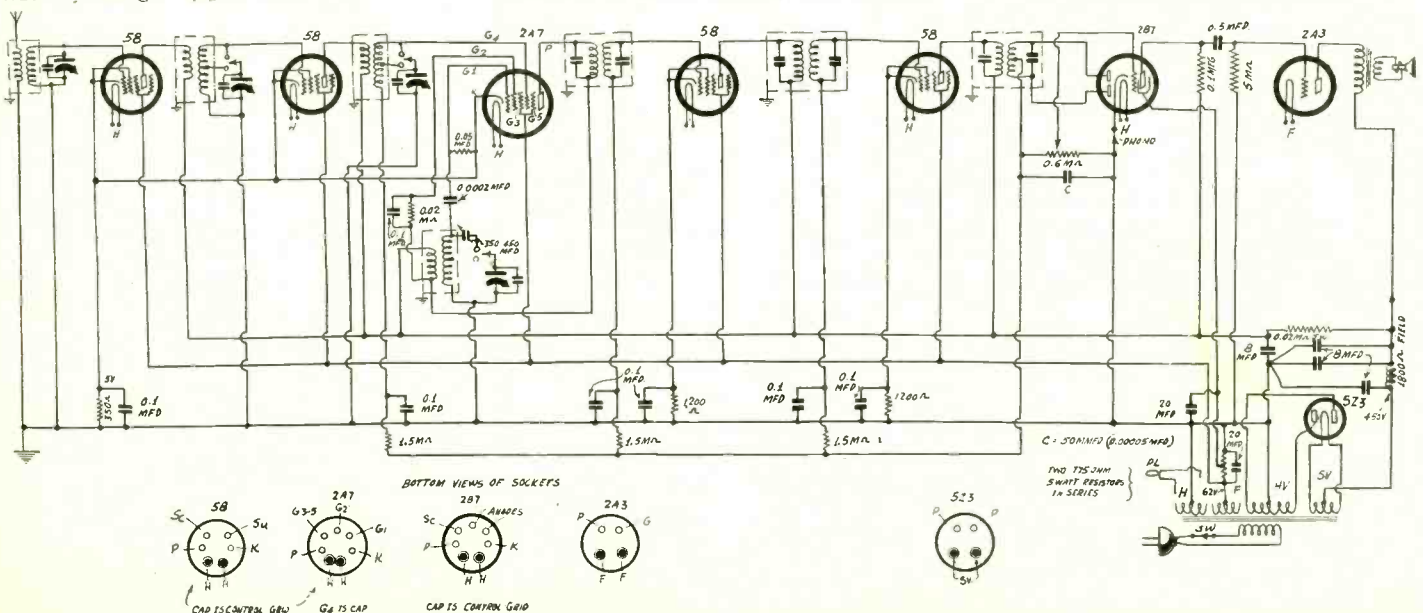

The same circuit as above, except that the 2B7 is used instead of the 55. See circuit of second tube from right.

AN S-W UNIVERSAL

Some Improvements Noted in Recent Design

By M. K. Baker

Alan Radio Company

SINCE the presentation of the data on the original Alan Prizewinner in RADIO WORLD, changes have been incorporated in the circuit which improve considerably the performance of the receiver. One change which has greatly improved the sensitivity of the circuit is the use of a 77 tube in the detector in place of the 78. Another change, necessitated by the change of the detector tube, is the introduction of a 60,000-ohm fixed resistor, in place of one of 100,000 ohms, between the high voltage and the screen voltage potentiometer. This provides for better control of the screen voltage for maximum detecting efficiency.

An improved potentiometer for controlling the regeneration has also been introduced. It is of the so-called silver contact type, and it is absolutely noiseless in its operation. This is an essential feature in a regenerative circuit, especially one designed for short waves. The potentiometer used for controlling the regeneration is smooth in its action and it makes possible to extract the highest possible sensitivity out of the set. This applies to all the frequency ranges covered by the tuner.

Tunable Hum

Tunable hum appeared in certain models of this circuit, and this was most troublesome in the 49 to 29 meter region. This difficulty was eliminated completely by putting a 0.01 mfd. condenser across the line and by rearranging the parts on the chassis. The condenser in question is shown connected between ground and the anodes of the 25Z5. The hum apparently resulted from modulation of signal frequencies coming in over the line and mixing with the hum on the line in the rectifier. The condenser, of course, prevents any signal frequencies from getting into the circuit from the B supply. The rearrangement of the parts that was most effective in eliminating tunable hum was placing the plug-in coils as far as possible from the filter chokes. A new chassis was designed to take advantage of this fact. The net result of the use of the by-pass condenser and the new placement of the parts was that no tunable hum resulting on any of the frequency ranges even when the regeneration is maximum.

Dial Light Provision

Provision has been made for a dial light by connecting the light across a portion of the filament ballast resistance. This resistance is tapped at a point 30 ohms from one end, and the pilot light is connected across this small portion.

The ballast resistor has been increased in size, although not in resistance value. This was done to insure better radiation of heat and thus to keep the temperature at a lower value. Moreover, holes have been punched in the chassis in order to improve the ventilation of the circuit.

Another and important change in the circuit is the inclusion of a special harness for converting the circuit to battery operation. This makes the set truly universal, for it is not only adaptable to a-c and d-c lines but also to batteries. When the set is to be operated on batteries the 25Z5 is removed, for it is not needed, and the 43 is replaced by a 41. After that change the battery harness is connected according to the color code on the drawing. That puts the filaments of the two remaining tubes in parallel so that they can be operated on 6 volts for the heaters and a high voltage battery for

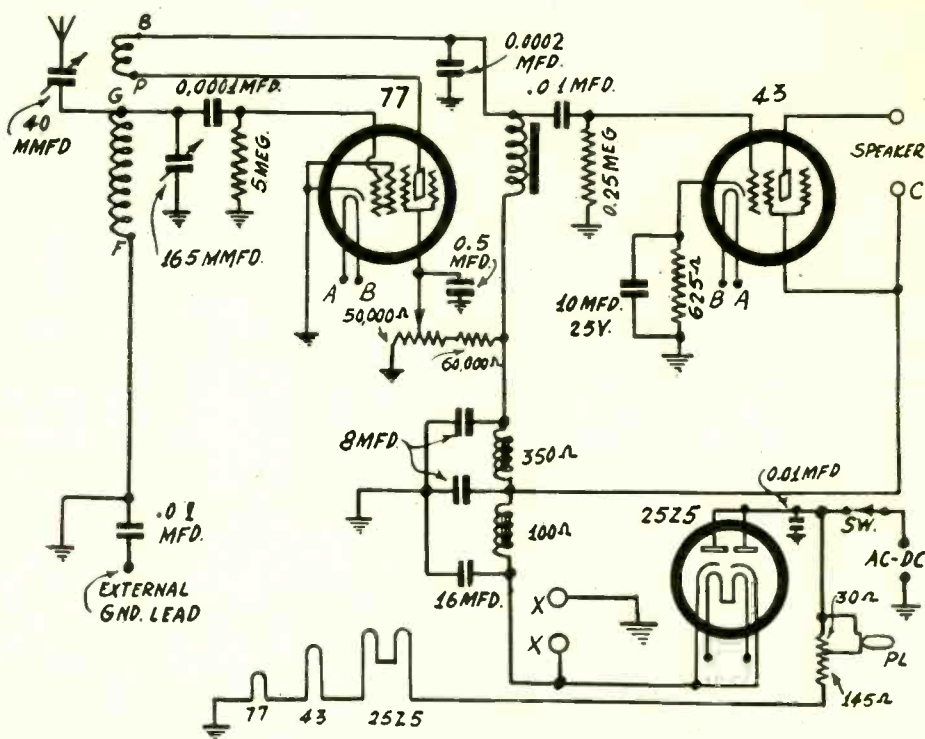

BATTERY HARNESS
COLOR CODE

A = BLACK
B = YELLOW
C = RED

X-X 4000-ohm DYNAMIC FIELD

FIG. 1

The circuit diagram of the improved Prizewinner short-wave receiver.

LIST OF PARTS

Coils

- One set of Prizewinner Octoform coils, space wound, and covering range from 15 to 200 meters
- One Prizewinner audio impedance
- One Prizewinner 25-henry, 350-ohm filter choke
- One Prizewinner 15-henry, 110-ohm filter choke

Condensers

- One 165 mmfd. Prizewinner variable condenser
- One 40 mmfd. antenna trimmer, Hammarlund
- One 0.0001 mfd. mica condenser
- One 0.0002 mfd. mica condenser
- Three 0.01 mfd. pigtail condensers
- One 0.5 mfd., 200-volt, pigtail condensers
- One 16 mfd. electrolytic condensers, Prizewinner
- Two 8 mfd., 200-volt, electrolytic condensers, Prizewinner
- One 10 mfd., 25-volt, electrolytic condenser, Prizewinner

Resistors

- One Prizewinner grid leak

- One 60,000-ohm resistor, one watt
- One 250,000-ohm resistor, 1/2 watt
- One Prizewinner series filament resistor for pilot light
- One 50,000-ohm, silver contact, noiseless potentiometer

Other Requirements

- One stamped chassis for improved Prizewinner
- One metal cabinet for improved Prizewinner
- One dial and escutcheon
- One 77 wafer socket
- One 43 wafer socket
- One 25Z5 wafer socket
- One coil wafer socket
- One special terminal strip
- One speaker, dynamic or magnetic
- One grid clip
- One pilot light socket
- One on-off switch
- One line chord
- One 25Z5 tube
- One 43 tube
- One 77 tube
- One 60 pilot light
- Two binding posts for antenna and ground connections.

the B supply. This should have a voltage of 135 volts.

The 625-ohm bias resistor serves for bias regardless of whether a 43 or a 41 is used as these tubes are practically identical except

for the filament requirements.

The receiver has been improved further by the use of space wound Octo-form coils of much larger diameter. This is an improvement (Continued on next page)

Methods of Tracking Down and Eliminating R-F INTERFERENCE

By Brunsten Brunn

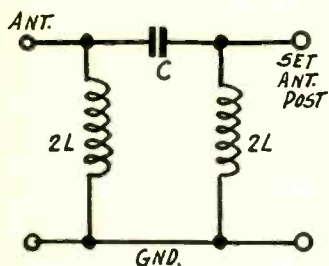

FIG. 1

A section of high pass filter with mid-shunt termination that may be used for excluding low frequency disturbances from a receiver.

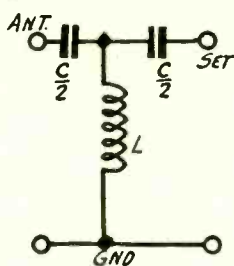

FIG. 2

This is the same filter as in Fig. 1 except that its termination is mid-series. The L's and the C's have the same values in the two.

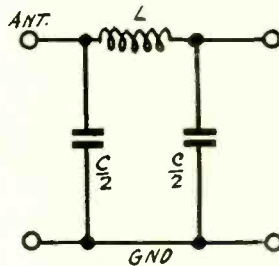

FIG. 3

A section of low pass filter with mid-shunt termination that can be used for excluding high frequency disturbances from a receiver.

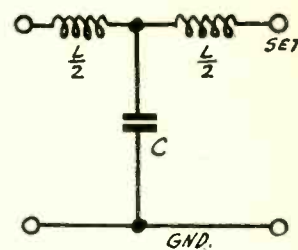

FIG. 4

This is the same filter as in Fig. 3 except that it has mid-series termination. The L's and the C's have the same values in these two.

IN CERTAIN localities there are interferences with radio reception that are extremely annoying, and at times are very difficult to eliminate. In most instances the sources of interference are local for a very short distance away another receiver will operate without the difficulty.

The difficulty of elimination is usually due to the fact that the disturbances do not occur at any particular frequency, but are of the nature of spark signals which set up oscillations in the tuned circuit of the receiver regardless of the frequency. However, sometimes it is noted that at certain settings of the tuning condensers the noise is stronger than at others, decreasing in intensity either side of the frequencies at which they occur most strongly. In other cases the desired signals will come in clearly at one end of the dial, but the strength of the interference increases as the dial is turned. There is no maximum in the strict sense although the disturbance is strongest at one extreme setting.

Harmonics

When there are several maxima the difficulty is usually due to a spark which sets up a fundamental and many harmonics in some chance tuned circuit. The maxima are the frequencies of the harmonics. If these are close together, the fundamental is comparatively low but if they are far apart, or if there is only one distinct maximum on the tuning range, the fundamental is comparable with the frequency tuned in. If the disturbance increases as the condenser is turned toward the lower broadcast frequencies, there is a fundamental or a harmonic of it just below the range of the tuner. If the disturbance increases as the condenser is turned in the opposite direction, there is a fundamental or a harmonic of it just above the range of the tuner.

Unless the tuner is extremely sharp there is no point at which the disturbance ceases entirely, due to shock excitation of the circuits. In many instances there is no practical selectivity that will be high enough entirely to suppress the disturbance between the maxima. It is because of the failure of reasonably selective circuits to suppress this disturbance that it is so annoying and difficult to remove.

The disturbances may enter the receiver in many different ways. It may get into the circuit by way of the power supply, although this is not a likely entrance when

reasonable values of by-pass condensers are employed. But this possibility must be reckoned with in tracing down the noise.

The most likely entrance of the noise is the antenna. That will be the open door if the noise consists of radio frequency disturbances.

Finding the Entrance

It is comparatively easy to determine whether the disturbance enters the receiver by way of the antenna or by some other route. If the noise disappears when the antenna is removed, or when it is shorted to ground, it is reasonably certain that the noise gets in by that route. If at the same time the primary of the power supply is shunted by a condenser of about 1 mfd. and there is no change in the intensity of the disturbance it is still more certain that the noise gets in by way of the antenna.

There is a possibility that the noise will originate in the receiver itself. There may be occasional sparks between two adjacent conductors when the voltage becomes excessive. These may, for example, occur in condensers, both dry and electrolytic, and they may also occur in transformers. Resistors have also been known to cause a good deal of trouble.

If the noise originates in the set, it will remain when the antenna is shorted or removed.

Filtering

Let us suppose that the noise comes in by way of the antenna and that it occurs mainly on a frequency lower than the lowest frequency to which the receiver tunes. It is then possible to receive some relief by inserting a high pass filter between the antenna and the receiver. This filter should be shielded except for the two input leads. It should be arranged so that it passes all frequencies higher than the lowest frequency to be received and so that it suppresses all frequencies below. For example, if the receiver is for broadcast reception the cut-off frequency might be placed at 500 kc, or at 525 kc if necessary. In Fig. 1 is a typical high pass filter of the simplest type. The cut-off frequency of this filter is determined by $f = \frac{1}{4\pi} \sqrt{LC}$, in which C is the capacity in series with the line and L is the shunt element.

In Fig. 2 is the same high pass filter with different termination. The cut-off frequency is the same as in the preceding. Of the

two, the one in Fig. 2 is probably the more easily constructed.

If these filters are to do the work expected they must be terminated correctly. But doing this properly is quite a problem in view of the fact that both the impedance and the input impedance of the set are unknown. If the cut-off frequency is not too close to the lowest frequency to be received, the terminal resistances should be equal to $(L/C)^{1/2}$, for this is the characteristic impedance of the filter for high frequencies. Even the impedances connected to the filter are not equal to the characteristic impedance the filter will discriminate against the low frequencies.

Stopping the Highs

If the disturbance comes in on a frequency higher than the highest frequency covered by the tuner of the receiver, some relief may be had by inserting a low pass filter between the antenna and the set. A simple low pass filter corresponding to the one in Fig. 1 is shown in Fig. 3, and another low pass filter corresponding to Fig. 2 is shown in Fig. 4.

The cut-off frequency of this simple low pass filter is determined by $1/\pi(LC)^{1/2}$, and the characteristic impedance well below the cut-off frequency is $(LC)^{1/2}$.

The general idea of these filters is that a condenser connected across the line will prevent the highs from passing on and a choke in series with the lines will have the same effect. A condenser in series with the line will let the high frequencies pass and a choke across the line will prevent them from attenuating. The high pass and the low pass filters are exact opposites in respect to the series and shunt elements.

Filtering the Line

When the noise enters the set by way of the power transformer, the primary may be filtered as shown in Fig. 5. Each of the condensers C may have a value of 1 mfd. and each choke L a value of one millihenry. It is essential that these coils be wound with wire that will carry all the primary current, which for an average radio set may amount to half an ampere, or more. If the wire be chosen so that it will safely carry one ampere there is ample margin. This would call for No. 20 wire or heavier. Just what a given wire will carry depends

(Continued on next page)

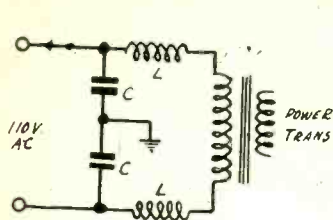

FIG. 5
When the disturbances come in over the power line a filter of this type will help to exclude the noise.

(Continued from preceding page)

on the manner in which it is wound, because if it is wound closely in many layers there is less chance for the heat to escape and therefore the wire heats up more.

Two condensers of equal, connected in series, the common side grounded. Thus it makes no difference how the plug is inserted into the socket. Grounding of the core and frame of the power transformer helps, but grounding of the transformer is usually done automatically when the transformer is mounted on the metal chassis.

Curing Trouble at Source

Sometimes it is impossible to exclude the noise entirely by treatment of the receiver. In such cases it is necessary to trace the source of the disturbance and to eliminate it there. In nearly all cases the trouble is some kind of sparking at a make and break point of a circuit. There may be a relay, a sliding contact on an elevator, a commutator on a motor or generator, a sign flasher, or just a fault in an electrical line. There are literally millions of possible sources. One unusual source of disturbance reported was a transmission belt running over wooden pulleys. Friction generated static electricity and this was discharged at regular intervals.

The source of the disturbance can often be traced by noticing the frequency of the sparks, when it does have a regular period of recurrence. This may then be compared with various electrical devices in the neighborhood. There may, for example, be a sign flasher close by. By noting whether there is a relationship between the noise in the radio set and the frequency of the flashing, the sign may either be convicted on circumstantial evidence or be acquitted of blame. A stop watch will aid in this a good deal, but the check can be made with an ordinary watch. Sometimes a rhythmic noise or vibration may be heard in a building. If there is a relation between this noise and the noise in the set, there is reason for closer investigation.

In establishing a relation it is important to note at what time of the day the noise appears. If the noise appears in the day time only it is not likely that a sign is responsible. Likewise, if the noise does not happen during business hours, many devices are eliminated by that fact. For example, if there is a dentist or doctor next door who operates an X-ray machine, this cannot be responsible if the noise occurs when the doctor is not in his office. Tracing down a source of interference, therefore, is a matter of thinking and deduction.

Use of Direction Finder

When the above methods fail to point to the source of the disturbance, a direction finding radio receiver can be employed for tracing it down. A suitable circuit is that shown in Fig. 6, which is just a one-tube regenerative receiver provided with a loop for tuning inductance instead of a small coil.

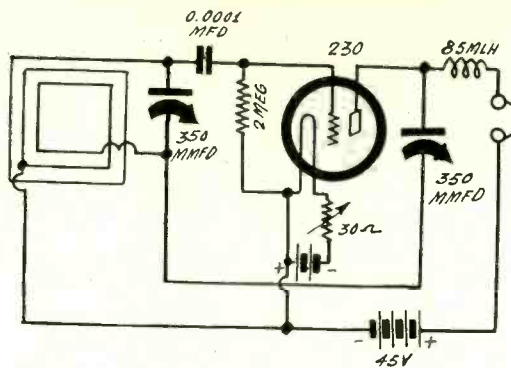

FIG. 6
A portable one-tube, regenerative, loop-operated receiver of this kind is useful in tracing down the source of interference.

This loop should be constructed so that it can easily be varied by means of taps, because the noise may be strongest on any frequency, and the tuner should be such that as wide a range as practicable can be covered. Suitable values for other parts of the circuit are given. The source of filament voltage may be two No. 6 dry cells connected in series. The 30-ohm rheostat can be used not only for the purpose of taking up the excess voltage but also for controlling the regeneration.

The main control of the regeneration is the 350 mmfd. condenser in the plate circuit. The degree of regeneration also depends on the position of the filament tap on the loop. For the best results the tap should be slightly nearer the plate than the grid, but the two regeneration controls are sufficient to control it even if the tap is placed at the center of the loop.

The actual size of the loop is of little importance, but it should not be smaller than 18 inches square or 18 inches in diameter. This size is convenient in carrying around.

Walking to the Source

When the interference is heard in the receiver it will be found that the intensity varies with the direction the loop points. If the plate of the loop passes through the source the signals are loudest. The signal disappears when the loop is at right angles to the direction from which the disturbance comes. Hence it is only necessary to turn the loop so that the noise is strongest and then walk in that direction. It is possible that this will lead directly away from the source, but this will soon be discovered because the signal will decrease in intensity.

It may be that it will be difficult at times to walk in the direction of the source, especially when the disturbance is inside a building. Observations can then be taken at different points, noting the direction at each place. All the observations will point to one location, which is the center of the noise.

It may occur that the source appears to be something that cannot possibly be the original source. For example, the loop might point unmistakably to a transmission line. In that case the line acts as a conductor and as a radiating antenna. The actual source of the trouble is then a machine of some kind operated on that line.

Treating the Source

When the spark gap has been located, it is necessary to treat it so that the spark shall cease, or so that the radiating due to it will stop. The usual spark killer is a condenser in series with a resistance connected across the gap. A condenser of from 0.1 to 1 mfd. may be required in series with a resistance of from 50 to 500 ohms. The spark killer will be most effective when the resistance and the capacity are "tuned" to the frequency of the sparking. What the best combination will be is best deter-

mined by experiment, for no two cases will be exactly alike. However, the choice of resistance and capacity is not at all critical.

In selecting the condenser it is of utmost importance to select one that has a safe voltage rating. The voltage across the spark gap may be around 110 volts, but allowance must be made for much higher voltages, say four times as high as the mean voltage.

QUESTIONS ANSWERED

Hum in Audio Amplifiers

MY receiver hums a great deal and I have been unable to trace the cause of it so far. The output tube is a 2A3 and this is preceded by a resistance coupled amplifier, a 56, which in turn is preceded by a 55 detector-amplifier. I have tried to improve the filtering but this does not seem to do any good. Please suggest something that might be the cause, and the remedy for it.—E. W. R., Reading, Pa.

All we can do with such meagre information is to guess as to the possible cause. Our guess is that the 2A3 is causing the trouble. If you replace this tube with a heater type power tube your trouble may cease. If this is not practical you might try balancing the circuit better in respect to the filament. If you have a centertap on the filament winding serving the tube, try a centertapped resistor in place of it. The tap on the winding may not be at the center. There is a better chance of getting at the exact center by means of a centertapped resistor. One of 30 ohms should be right. If this does not remove the hum you might try a resistor with a moveable tap. Somewhere there should be a point at which the hum is minimum, and at that point it may be so low that you cannot hear it at all.

Voltage Doubling Detector

IN THE April 1st issue of Radio World you had a voltage doubling detector working into a push-pull resistance coupled amplifier. Would it not be possible to use the same detector circuit with a 25Z5 instead of two 37 tubes? If so, will you kindly show the circuit diagram?—F. T., Portchester, N. Y.

Use the same circuit and treat the two parts of the 25Z5 as the two 37s are treated in the diagram referred to. The grids in the 37s take the place of the anodes in the 25Z5. The connections of the 25Z5 are shown on the next page in the same issue. See Fig. 4.

Short Wave Superheterodynes

THERE have been very few short-wave superheterodynes described, yet it seems to me that this type of receiver would be more suitable for short waves than for broadcast waves, and now there is hardly any broadcast receiver that is not a superheterodyne. There must be some reason why the superheterodyne is not used more for short waves. What is against it?—W. E. W., New York, N. Y.

Perhaps the main reason is economic. Most people who buy short-wave equipment do so for the first time just to see what there is in short-wave reception. They do not wish to spend a great deal of money until they are sure that the outlay will be worth while. Hence they buy the cheapest short-wave receiver that they can get and with which they are reasonably sure that they will get something. There are other reasons. One is the noise that a superheterodyne brings in on weak signals—and most short-wave signals from the other side of the world are weak. There are also technical reasons why superheterodynes are not used on the ultra-high radio frequencies. Transmitting stations are not constant in frequency on the very short waves. Neither are the oscillators used in receivers constant. For satisfactory reception of the ultra-high frequencies it is essential that both oscillators be constant in frequency because the intermediate frequency must be constant if it is to get through the intermediate frequency amplifier and tuner.

SMALL RESISTANCES

Measured with an Existing Ohmmeter

By Einar Andrews

SMALL values of resistances are not easily measured by means of ordinary ohmmeters because they produce such a small change in the deflection. However, there is a very simple way by which small resistance can be measured, with a little computation. We owe this method to Mr. Alan Mannion.

Let Fig. 1 be the circuit of the ohmmeter. For the moment assume that R_x is not connected. Then E is the battery built into the instrument and R is the external resistance that is always adjusted so that the deflection is full scale when the terminals X for the unknown resistance are short circuited. For the present use of the ohmmeter short circuit these terminals and adjust R , by means of the small rheostat in series with the larger resistance, until the scale reads full deflection.

Now suppose we connect an external resistance R_x across the meter as shown. This will take some of the current that previously went to the meter and the reading will decrease. Let I be the full scale deflection of the meter and I_m the deflection when R_x is connected across the meter terminals. Under these conditions it can be shown that $R_x(I/I_m - 1) = RR_m / (R + R_m)$, in which R_m is the internal resistance of the meter. From this equation the value of R_x can be computed very easily.

Range of Meter

The range of this modification of the ohmmeters covers those resistances which the original ohmmeter cannot measure accurately. Let us take an example to find out what the lowest resistance is that can be measured. Let us assume that the meter has an internal resistance of 27 ohms, that the battery in series with the circuit has a voltage of 1.5 volts and that the meter is a 0-1 milliammeter. Then the value of R is 1,500 ohms. The right hand member of the equation is then 26.5 ohms. The lowest deflection that can be read on the meter is about 1/40 of the scale of 100. Therefore the largest value of I/I_m is 40 and the coefficient of R_x is 39. Therefore $R_x = 0.68$ ohm. Such a low resistance would not have made any visible deflection on the meter with the ordinary use of the ohmmeter.

Let us take another example. Suppose the meter reading when R_x is connected is just one half scale. The I/I_m equals 2 and the coefficient of R_x is unity. Therefore the value of the resistance is 26.5 ohms. It is quite possible to read the deflection when it is within 1/40 of full scale. What is the value of the resistance R_x in that case? The value of I/I_m is 100/97.5 and the coefficient of R_x is 0.02565. Hence the value of R_x is 1,035 ohms. This value of resistance can also be measured accurately with the ordinary use of the meter. As a check a resistance can be measured by both methods. Of course, they should agree.

Approximate Formula

It will be observed that the value of R_m is very small compared with R . In the assumed case, which is taken from a typical ohmmeter, R_m is 1.8 per cent of the external ohmmeter resistance. Hence only a slight error is committed if R_m is neglected compared with R . When this is done the formula reduces to the much simpler form $R_x(I/I_m - 1) = R_m$. The error committed by using this formula is constant and is only 1.8 per cent. The result is too large by this amount.

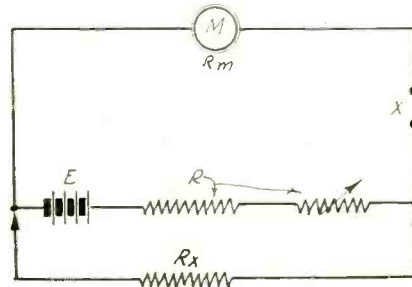

FIG. 1

This illustrates a way of measuring very small resistance with the aid of an ordinary ohmmeter. The internal resistance of the meter is supposed to be known accurately.

A knowledge of R_m is essential for all resistances are measured in terms of it. This resistance is usually stated on the dial of the meter. If it is not given, it becomes necessary to measure it, or to find out its value from the manufacturer.

An easy way to measure it is to reverse the formula, connecting a known resistance of about 25 ohms in the position R_x . In that case, however, it is necessary to know the value of R for it might appreciably affect the value of the measured resistance of R_m . R is known if the voltage E is known and the sensitivity of the meter. For example, if the sensitivity of the meter is 0-1 milliamperes, which is the most likely value in a good ohmmeter, R will be 1,000 ohms for each volt in the battery. Therefore, when the voltage is 1.5 volts, the resistance is 1,500 ohms. If the voltage is 3 volts, the value of R is 3,000 ohms.

To illustrate the reverse use of the formula suppose that the value of R is 1,500 ohms and that an external resistance of just 25 ohms gives a deflection of 0.4 of full scale. Then I/I_m is 2.5 and the coefficient of R_x is 1.5. Hence we have $25 \times 1.5 = 1,500R_m / (1,500 + R_m)$, which gives $R_m = 38.4$ ohms. There may not be such a meter but it illustrates the method of arriving at the resistance of any meter.

Increasing Accuracy

Since R is directly proportional to the voltage of the battery for any given meter, and since the accuracy is increased when R is large, when R_m is neglected in comparison with R , it is obviously desirable to use a higher voltage. This, of course, makes it more difficult to measure accurately small resistance with the regular connection of the meter, but this is offset by the fact that small resistance may be measured more easily with sufficient accuracy by the shunt method. This is not of particular interest in a ready made ohmmeter, but it is for those who assemble their own, who can select any value of voltage and hence any value of the resistance R .

This shunt method of measuring small resistance with an ohmmeter is particularly convenient in that it is applicable to any instrument, for all that is necessary is to connect the unknown resistance across the meter. In some instances it may be that both sides of the meter are not available, but one side always is, for it is connected to one of the X terminals. In any case, however, it is easy to reach both sides.

INTIMATE ASIDES

The Neil Sisters, Blondes in Blues, heard each Friday night with Phil Baker the Armour Jester, tried to improve the food which was being dished out to a gang of threshers, while they were visiting an uncle of theirs in Wyoming. The first meal they tried to serve the boys consisted of many fancy dishes. The threshers took one look at the food and fled forty miles to the nearest town and food they could recognize. The next meal served at the ranch consisted of ham and eggs.

* * *

If Jimmy Melton's guests compliment him upon his cook's skill, the tenor can afford to smile, for Melton himself often wields the skillet and turns the roast at dinner in his New York apartment. Some of Melton's favorite dishes which he prepares for guests include spaghetti (Melton style), poulet flambee a la broche, spoon bread and sausage.

Melton obtained some of his recipes from famous European chefs and others are of his own concoction.

* * *

Although it was only twenty minutes before he was to go on the air, Will Rogers was seen strolling along Fifth Avenue, his hands in his pockets, his hat tilted back, as though he had an hour or more to kill. Hundreds of Sunday night strollers along upper Fifth Avenue in the vicinity of the NBC studios were unaware of Rogers' presence as he gazed into shop windows. It was five minutes before broadcasting time when Rogers showed up at the entrance to the studio where he was to appear. He had no notes, but he had purchased an alarm clock of generous size so that when the alarm went off he would know it was time to stop talking. However, Rogers beat the clock to the end of his talk and the audience, both visible and invisible, did not hear it ring. But it was properly set and ready in case he ran over. He set it on a music rack directly in front of him.

* * *

The formal musical education of Walter Payne, of Don Bestor's orchestra, was limited to six months study of the viola. But Walter has played first saxophone for three years with Don's band and at one time had thirty saxophone pupils.

I-F IMPROVE "PRO"

Winner

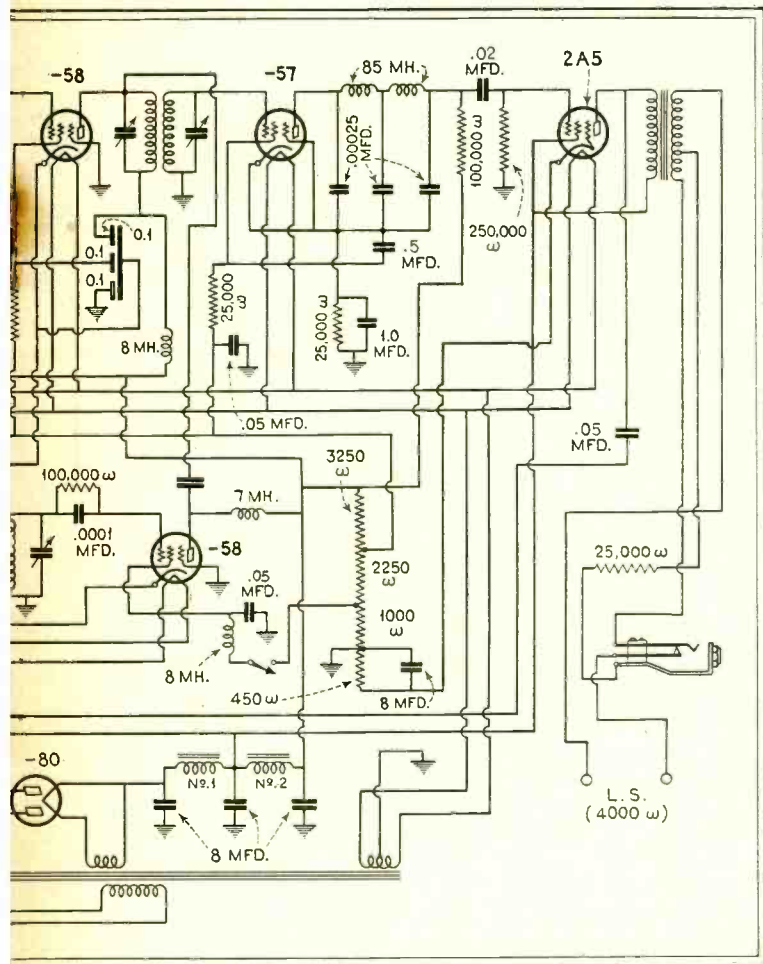

the circuit also. However, no switch is necessary, as this additional connection is automatically made when the "CC" and "DD" coils are inserted in their sockets. The fifth coil prong (which is not used in Coils "AA" and "BB") is used for this purpose in Coils "CC" and "DD". In this frequency range the band width varies from approximately 1200 kc. at 4.5 mc. to 225 kc. at 1.5 mc.

Electric-Coupled Oscillator

A further advantage of the "tank" system of tuning used in the Comet "Pro" lies in its ability to overcome "image" interference which may be encountered under certain conditions. As is well known there are two settings of the heterodyne oscillator of a superheterodyne receiver which will beat with the incoming signal to produce the desired intermediate frequency, which in this case is 465 kc. One of these is the signal frequency plus the i.f., the other is signal frequency minus the i.f. In the Comet "Pro" the design of the tuned circuits is based on the use of the higher of these two oscillator settings, that is signal frequency plus intermediate frequency. Image interference encountered at this setting may be avoided by reducing the heterodyne oscillator frequency by an amount equal to twice the intermediate frequency, or 930 kc. This is accomplished by reducing the dial reading of the left hand "tank" condenser which controls the heterodyne oscillator tuning. The

right hand, or W.L. dial should not be changed.

As will be noticed by inspection of the circuit diagram of the receiver the high-frequency or heterodyne oscillator is of the electric-coupled type. The many advantages of this type of oscillator for superheterodynes are too well known to enumerate here. A 58 tube is used with its suppressor grid grounded directly to the chassis, thus more completely isolating its plate from the oscillatory circuit. A small condenser of about 0.6 mmfd. connected to the plate of the oscillator couples a small amount of its output directly to the grid of the first detector. This type of coupling, together with the shielding of the OSC and W.L. coils, effectively eliminates all interaction between these two circuits, even at frequencies as high as 20 mc.

The first detector is a 57 screen grid pentode. Its high detector sensitivity and high output impedance make it highly suitable to work into the high impedance primary of the first i.f. transformer. A further reason for its choice lies in its high input impedance and low effective input capacity, which together reduce the damping on the tuned input (W.L.) circuit at the same time permitting a larger frequency range to be covered with a given coil and condenser.

The two intermediate amplifying stages employ 58 variable- μ pentodes, and the intermediate coupling transformers are of the twin-coil tuned plate, tuned grid

type. Since the intermediate amplifier provides most of the receiver's sensitivity and selectivity, no effort has been spared in the design and construction of the intermediate transformers. The transformer coils are wound with 10/41 Litz wire and have an inductance of 1.3 millihenries. At 465 kc. these coils have a power factor of .0087 or a Q of 115.

200 Gain Per Stage

To preserve this high efficiency the coils are accurately centered in the transformer shields and kept well away from the mounting brackets. The coefficient of coupling between primary and secondary is 0.77%. While this degree of coupling is slightly under the optimum value for two such high "Q" circuits and results in a single sharp peaked response curve with steeply sloping sides, it is sufficient to afford a voltage gain of approximately 200 per stage.

"Air-Tuned" Units

Among the outstanding features of these transformers, are the condensers used for tuning the primary and secondary coils to the intermediate frequency. They are air-dielectric variable condensers of unique design and were developed by this company specifically for this purpose. The capacity and power factor of these condensers remain substantially constant regardless of varying atmospheric conditions, and their mechanical construction is such that they are not affected by vibration or shock.

The use of these air-dielectric tuning condensers completely solves the problem of accurately maintaining the high degree of intermediate amplifier selectivity and sensitivity so necessary to high-grade superheterodyne performance. To illustrate this point the effect of the humidity and vibration on a transformer tuned by condensers of the micro-compression type was measured, and compared to the results of the same tests on one of the new air-tuned transformers. The superiority of the air-dielectric type is at once evident, and when it is realized that three transformers are generally used in a receiver, it is easy to understand why the gain and selectivity of some superheterodynes change so erratically with varying atmospheric conditions.

Smooth Control of Sensitivity

The second, or i.f. detector, is also a 57 screen grid pentode, operated as a plate rectifier. Since its plate circuit contains a large i.f. component in addition to the desired audio frequencies, a filter is necessary to remove it, otherwise undesirable feedback would result. This feedback can be very troublesome in a superheterodyne. As the tube is working as a rectifier, its plate circuit contains not only the fundamental intermediate frequency but also strong harmonic frequencies, especially the even ones. If not thoroughly suppressed these harmonics would induce voltages in the input circuit which would seriously hamper reception of signal frequencies at, or near multiples of the intermediate frequency. In the Comet "Pro" this feedback has been minimized by exceptionally thorough filtering and shielding. A two-stage filter consisting of three .00025 mfd. by-pass condensers and two 85 millihenry chokes is used. In addition each stage of this

(Continued on next page)

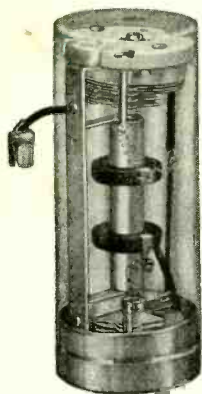

The air-dielectric type i-f transformer above. Diagram at right to be read as Fig. 3.

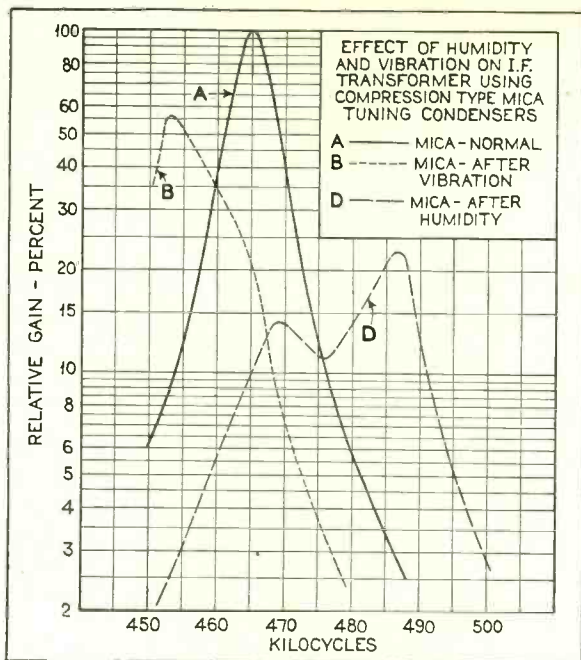

(Continued from preceding page) filter is completely enclosed in a separate shield compartment.

The output tube is a 2A5, resistance-capacity coupled from the second or intermediate frequency detector. The high amplification and great power handling capabilities of this type tube insure good loudspeaker volume even on very weak distant signals. An output transformer is mounted underneath the chassis with its secondary connected to the speaker terminal block at the rear edge of the chassis, and is designed to operate any speaker, either magnetic or dynamic (or permanent magnet dynamic), having an input impedance of the order of 4,000 ohms. A tap on the secondary of the output transformer is connected through a resistor to the jack on the front panel, thus providing head-phone reception at reduced volume and with a minimum of hum. Due to the use of a built-in output transformer there is no direct current component at either the loud speaker terminals or the phone-jack. The jack is wired so that insertion of the phone plug breaks the circuit to the speaker terminals, which can therefore be permanently connected to the loud speaker.

The volume control, or more properly, the gain or sensitivity control, consists of a variable biasing resistor in the cathode circuits of the two "58" intermediate amplifier tubes. In order to obtain wide control without using an excessively high variable resistance, a steady current of approximately five milliamperes flows through this bias control in addition to the plate and screen currents of the two tubes. This additional current has but little effect at low bias voltages where the tube current is high, but its effect increases rapidly as the tube current falls off at the higher bias voltages. The combination provides smooth as well as wide control of the overall sensitivity of the receiver.

A very important feature of the Comet "Pro" is the intermediate oscillator, which can be started and stopped by the toggle switch on the panel. It consists of a 58 tube and associated circuits permanently adjusted to oscillate at the intermediate frequency of 465 kc. Like the high-frequency oscillator, it is also of the electric coupled type. This results in great stability of oscillation and entirely eliminates the "pulling into step" effect when receiving strong C.W. signals. A small portion of its output is fed to the grid of the second or intermediate detector, thus producing an audible beat note with the incoming signal. The tuned circuit of this beat oscillator is completely shielded

in the vertical shield in the rear right-hand corner of the chassis. The circuit is tuned by means of an air-dielectric condenser similar to those used in the i.f. transformers but of greater capacity. This condenser is mounted in the bottom of the shield and is adjustable from underneath the chassis. In addition a three plate vernier condenser is mounted in the top of the shield and connected in parallel with the main condenser. This vernier condenser is adjustable by means of the lever protruding from the top of the oscillator shield. The normal is crossed during the process of tuning. By means of the zero beat method any such carrier can be quickly tuned to precise resonance after which the oscillator may be turned off. In case the carrier is that of a phone transmitter voice or music will then be heard.

C. W. Operation

The intermediate oscillator tube and its associated circuits are completely shielded from the rest of the receiver. In this way its action is entirely independent of the other receiver adjustments, especially the sensitivity control, which would not be the case if some of its output were allowed to couple with the first intermediate stage. Such independence of action is highly desirable setting of this lever for zero beat reception is the diagonal or 45° position. By moving lever through 90° angle (plus or minus 45°) the beat frequency may be changed approximately 8000 cycles. When this vernier lever is properly adjusted a considerable degree of "single signal" C.W. selectivity is possible. Using a 2,000 cycle beat note the measured attenuation of the "audio image" was found to be 25 D.B. As in the case of the i-f transformers, the use of air condenser tuning in this oscillator circuit results in such a high order of frequency stability that readjustment of the main oscillator tuning condenser is never necessary, the vernier lever alone providing all the frequency variation necessary for different operating requirements.

While this feature (the intermediate oscillator) was designed primarily for the reception of pure C.W. code signals, it is also extremely useful in other respects. When turned on, a whistle will be heard whenever any carrier wave for reliable C.W. reception, since it is substantially constant irrespective of the field strength of incoming signals. Any operator accustomed to a regenerative receiver will appreciate this advantage. In addition, adequate shielding is necessary to prevent

harmonics of the i-f oscillator from reaching the receiver input, where they might prove troublesome.

The whole question of shielding has been very carefully worked out and is culminated in an all-metal cabinet which encloses the entire receiver. Made of heavy gauge, patent levelled steel with black crinkle finish, this cabinet constitutes a handsome housing for the receiver and in addition limits all pickup to that afforded by the antenna itself. Fifteen ventilating louvres provide ample circulation of air for heat dissipation.

Performance Data

Complete sensitivity and selectivity tests of the receiver have been made by one of the best-known and best-equipped laboratories in the country. The tests were made for their own files, but a copy of their report was forwarded to the Hammarlund company. Their report on the sensitivity of the receiver was especially significant. No graph showing maximum sensitivity plotted against signal frequency was furnished, since the laboratory considers such measurements at small fractions of one microvolt unreliable. Instead they report a sensitivity for standard 50 milliwatts output, of better than one microvolt absolute (equivalent to 1/4 microvolt per meter) throughout the entire range of the receiver with a signal to noise ratio of four to one. This test was made with a carrier modulated 30% at 400 cycles. As a four-to-one signal to noise ratio corresponds to a crisp clear signal this test demonstrates conclusively both the high sensitivity and low inherent noise level of the "Pro." When pressed for an opinion the engineer in charge of the tests admitted that the sensitivity of the "Pro" would probably be rated at a few hundredths of a micro-volt per meter by ordinary test methods.

The overall selectivity of the receiver was plotted on graph paper. This curve was taken at 3750 kc. and is representative of the selectivity at all other frequencies within the tuning range of the receiver. While the input circuit does not contribute to selectivity to an extent which varies with signal frequency, its effect on the overall characteristic is negligible compared to that of the intermediate amplifier, which of course remains constant irrespective of the adjustment of the input circuits.

Installation

Fig. 6 shows one of the tuning charts of the four sets of coils, "AA," "BB," "CC" and "DD." As mentioned previously these charts are intended only as a guide to tuning, being exact only for the receiver from which they were made. However, the manufacturing variations between individual receivers are not very great, and therefore these charts will probably be correct within a few per cent for any receiver. To simplify the charts only the oscillator tank condenser tuning is shown. While the W.L. (or right hand) tank condenser setting will not track exactly, its proper setting will in general be within a few degrees of that of the oscillator. Its setting can easily be found by the rushing sound, which is loudest when the W.L. circuit is resonant to a frequency 465 kc. below (or above in some cases) that of the oscillator. The solid line curves on these charts are the calibrations of the oscillator (left hand) tank condenser when the band spreading dial is set at 50. The upper and lower dotted line curves represent the calibrations when the band spread dial is set at 100 and 0, respectively. Consequently, the vertical distance between these two dotted line curves at any given setting of the oscillator tank dial indicates directly the frequency range covered by the band spreading dial for that particular oscillator setting.

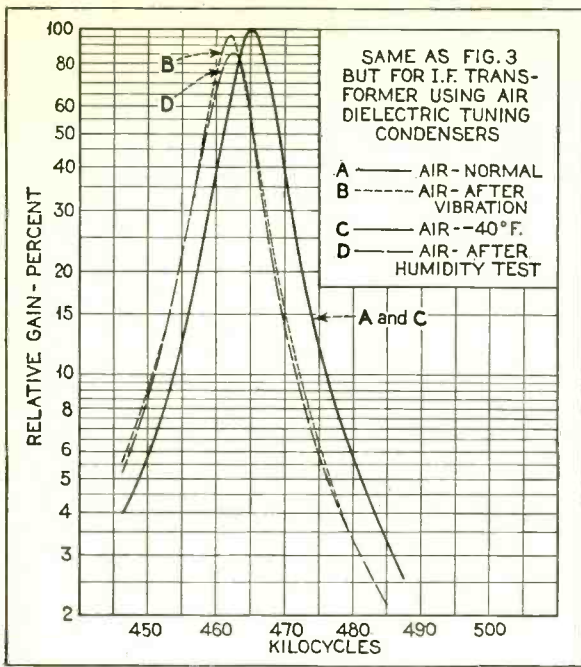

The superiority of the air-dielectric condenser is shown in chart at left, compared to results recorded on chart on page 14. At right is the selectivity curve to 10,000 times input.

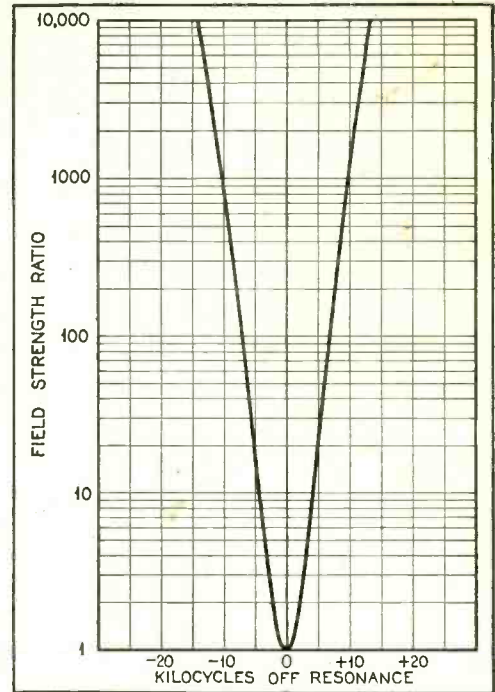

The standard Comet "Pro" is intended for use with 110 volt, 60 cycle a-c only, and should never be connected to any other source of supply. A protective fuse, rated at 1½ amperes, is mounted near the rear edge of the chassis at the left. This fuse is connected in series with the 110-volt line and should be examined in case the tubes fail to light. Where alternating current is available, but of different voltage or frequency, a suitable receiver can usually be supplied on special order. Where direct current only is available a small motor-generator of at least 110 watts capacity is recommended to supply the regular 110 volt, 60 cycle a.c.

Each socket is plainly marked with its proper tube number. The standard receiver uses eight tubes, viz., one 80, one 2A5, two 57 and four 58.

No special selection of tubes is necessary, but actually defective tubes must, of course, be avoided. This is especially true of the 58 used as the short wave oscillator (to the left of the OSC coil). Occasionally a tube will be found with an abnormally high hum level, and when used as an oscillator will modulate all incoming signals with a low pitched hum or warble.

No special type antenna is required and almost any length will prove satisfactory, except in locations where severe interference is encountered. Under such conditions a rather short antenna will generally improve matters. However, too much stress cannot be put on the need for experiment in the matter of antenna layouts for short wave reception. Each receiving location has its own peculiarities and since the receiver noise level in the Comet "Pro" is so exceptionally low, any improvement in the signal to noise ratio of the antenna system will pay big dividends in the form of improved weak signal reception. Ground connections are also a matter for experiment. All variable or high resistance joints must be carefully avoided in both antenna and ground systems.

Various types of balanced antenna systems such as doublets often provide improved reception at high frequencies. For proper operation of such a system the primary of the antenna coupler in the receiver should not be grounded. In the Comet "Pro" a three terminal "Ant-Gnd" block is used. The two "A" terminals are connected to the ends of the primary of the W.L. coil and the "G" terminal is connected to the chassis. The two leads from any balanced antenna systems may therefore be connected to the

two "A" terminals. When the conventional Antenna and Ground arrangement is used a jumper should be connected from the "G" terminal to the adjacent "A" terminal, and then to the ground wire. The remaining "A" terminal should

then be connected to the antenna. When using a balanced antenna system connected to the two "A" terminals, the "G" terminal may or may not be connected to ground depending on which condition yields better results.

All Set for Broadcast of World's Fair Opening

Chicago. — Nation-wide broadcasting from the World's Fair on the opening day, May 27th, is assured by contracts with the national chains and local stations, it was announced here today.

Seventy-two pick-up points on the Fair grounds have been established and the Fair has provided four broadcasting studios on the grounds.

Contracts have been signed by A Century of Progress, with the National Broadcasting Company, local stations WENR and WMAQ, and with the Columbia Broadcasting System, local station WBBM and other Chicago stations. WGN, KYW, WLS, WCFL, WAAE and WIBO also have signed.

Six hundred miles of line have been

laid in the Fair Grounds. Broadcasting is already being done from the Exposition and will start in a big way on the opening day, pushed forward to May 27th to make it possible for President Roosevelt to be present to open the Fair in person.

Connected with the broadcasting system will be a public address system reaching all parts of the grounds.

Four musical programs are all ready to go. Ben Bernie will broadcast from the Pabst Blue Ribbon Casino. Other broadcasts will be from Old Heidelberg Inn and the Victor Vienna Garden Cafe. The A & P Gypsies will start their regular broadcasts from their exhibit with the opening of the Fair.

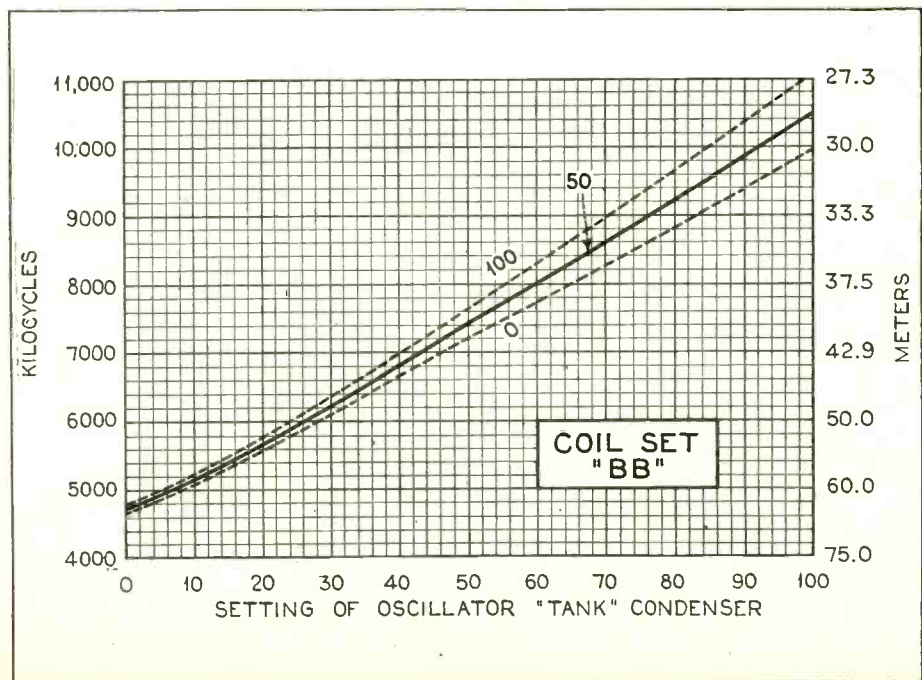

A 6-TUBE SUPER

As Commercially Produced by Fordson

By Warren Cartwright

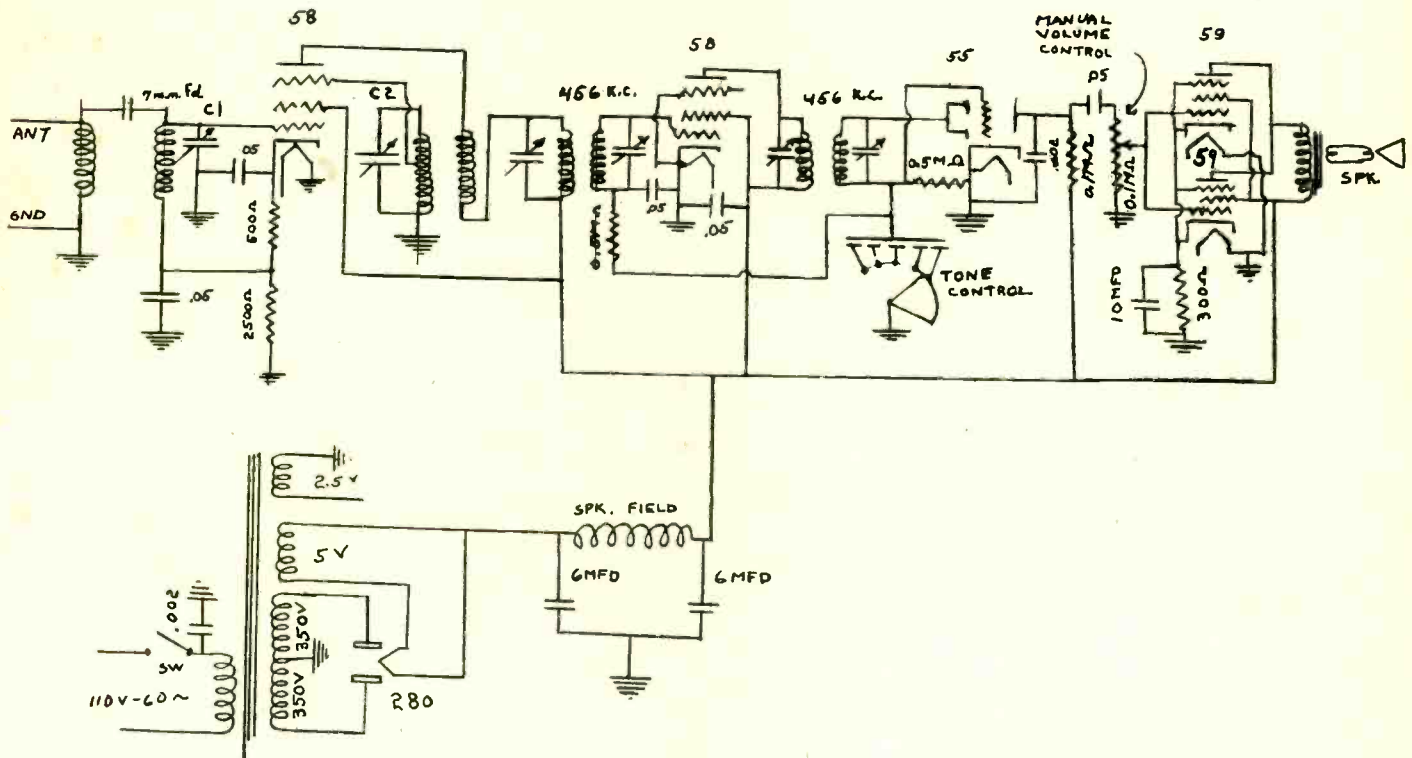

A sensitive six-tube receiver, the Goldentone, manufactured by Fordson Radio Mfg. Corp. C1 is 365 mmfd. maximum, C2 is 180 mmfd. maximum. C2 is a tracking section, specially cut for the 456 kc. intermediate frequency.

THE Goldentone 6-tube receiver, manufactured by Fordson Radio Company, is a six-tube design with the following line-up: First 58 combined detector, oscillator; second 58 single stage i.f., using a 456 kc. intermediate; 55 as second detector, using the diode as a half-wave rectifier and using a.v.c. action on the i-f. stage; and the two 59's in parallel output.

Looking at the photo, the two double-tuned i-f. coils are seen. The ones used are wound with Litz wire and have trimmers on an isolantite base. This helps to account for the selectivity.

The transformer is a half shell type large enough to take the load demanded by this set. No center tap is noticed on the 2.5-winding as this is unnecessary, for all heater type tubes are used. Incidentally, the chassis is grounded in one place only, and a bare wire used to connect one side of all filaments. All grounds are then made to this wire. This makes the set much more stable, and there is less chance of poor ground causing trouble.

The filtration is provided with a dual 6 mfd. electrolytic which is in a container beneath the chassis. A 0.002 mfd. condenser is connected from one side of the 110 a-c. line to ground to prevent resonance hum.

Tone Control Included

The audio circuit is of the conventional type with a 10 mfd. condenser by-passing the cathode resistor to bring out the low frequencies. The 55 tube is also used in the conventional manner, except that it will be noticed that a capacity type tone control is used. There are 8 condensers which are

PARTS FOR MODEL 6T GOLDENTONE SUPERHETERODYNE

Part No.	Description
6T01	Tube shield complete
6T58	Variable Condenser
6T56	Power Transformer
6T52	Intermediate Frequency Transformer
6T48	Antenna Oscillator Dowel Coil
6T28	Dual 6 Mfd. Filter Condenser
6T54	100,000 Ohm Volume Control
6T50	Tone Control and Switch
6T44	Chassis Base
6T46	Variable Condenser Cover
6T42	.05 Mfd. Tubular Condenser
6T40	.002 Mfd. Tubular Condenser
6T30	500,000 Ohm Resistor
6T32	100,000 Ohm Resistor
6T34	2,500 Ohm Resistor
6T36	300 Ohm Resistor
6T38	500 Ohm Resistor
6T26	10 Mfd.—500v. Electrolytic Condenser
6T18	Type 58 Socket
6T20	Type 55 Socket
6T22	Type 80 Socket
6T24	Type 59 Socket
6T10	Ant. Gnd. Binding Post
6T12	Connecting Cord (6 ft.)
6T08	Insulated Terminal Strip
6T14	Traveling Light Dial
6T16	Escutcheon Plate and Scale
6T06	Large Knob
6T04	Small Knob
6T60	Six-inch Dynamic Speaker
6T62	Midget Cabinet

gradually cut in on the circuit as the knob is rotated. The last section is always left in the circuit to by-pass the r-f. currents. This is accomplished by having the a-c. switch operate before the last section is cut out.

The i-f. stage is also standard except that there seems to be a cathode biasing resistor omitted. This is unnecessary as there will always be sufficient antenna voltage when tuning in-between stations to provide a minimum bias for the 58 tubes.

The oscillator circuit is slightly different from the usual cathode type, as the suppressor grid is used. On one end of a dowel about 3 inches long, there is placed the primary and secondary of the antenna coil. The antenna is of the high impedance type and the secondary is Litz-wound. Both are lattice wound. To give a better gain on the higher frequencies, a 7 mmfd. coupling capacity is used. This is done very effectively by winding about 10 turns of hookup wire on the antenna lead and connecting it to the grid terminal of the coil. The primary and secondary coils are spaced ¼-inch apart on the dowel.

Tracking Section Used

On the other end of the dowel, are two additional lattice wound coils, but these are wound on top of each other. One is a pick-up coil placed in series with the primary of the first i-f. transformer. The other coil is tuned with the oscillator section of the variable condenser. This coil is tapped in order that the oscillator will tune down low enough to get the police band.

The variable condenser is a two-gang of

The Goldentone chassis view. The square coil shields house the 456 kc. intermediate frequency transformers. The three-gang condenser has a tracking section. The autodyne tube (58) is at right front, the intermediate tube (58) behind it, and next the detector-amplifier (55). The 59's are in parallel output.

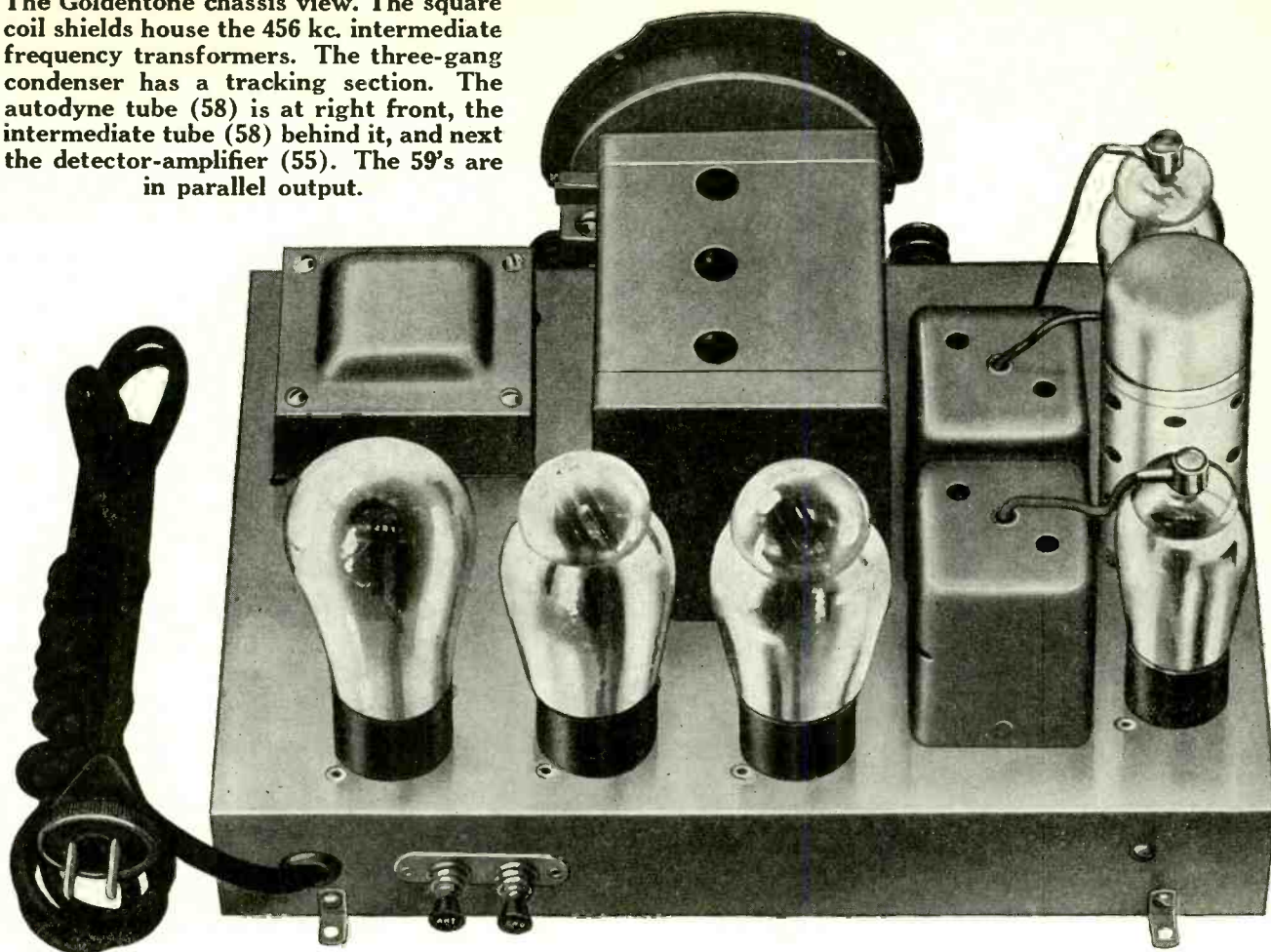

the new "baby" type with one section cut for the oscillator circuit.

Should any trouble be found with failure of the oscillator, try changing 58's as occasionally one will be found that is a poor oscillator but satisfactory in other respects.

This set was designed with one basic idea in mind: to give the best performing set possible with the simplest circuit and arrangement of parts. With a simple design such as this, there will be fewer sources of trouble that will be encountered.

As to the performance of the set, testimonial letters attest to excellent sensitivity, selectivity and tone.

Two Operator Positions Offered by Government

The United States Civil Service Commission announces open competitive examinations for assistant radio operator (airways) and junior radio operator (airways). Applications must be on file with the U. S. Civil Service Commission at Washington, D. C., not later than June 13.

Full information may be obtained from the Secretary of the United States Civil Service Board of Examiners at the post office or customhouse in any city, or from the United States Civil Service Commission, Washington, D. C.

AUDIO QUALITY TESTS

The criterion for good quality is that the signals sound like the original. For example, a man speaks. Does the reproduction sound as if a human being actually were present and talked to you, or does it sound differently? The test for high frequency tones is comparatively easy. Listen to the consonants of speech. Are they heard distinctly, or are they imagined, as they have to be in listening over a telephone? If the esses are too hissing, the high notes come through too strongly. The low notes can also be judged. If the

bull fiddle comes through all right, the low tones are there. Another test is to listen to the bass drum. If it can be heard clearly, the low tones come through.

UNIVERSAL SET

(Continued from page 8)

regeneration is also better in coils having low resistance. Therefore both the increased wire size and the space winding will increase the effectiveness of the regeneration.

The coils are of the plug-in type, which is recognized as the most efficient for short-wave reception.

An important feature in installing a short-wave set is that the antenna be suitable for short waves. A receiver that has been designed correctly in every detail will not give the best account of itself unless it is connected to the proper antenna. It should not be shielded from the incoming waves by buildings and trees. Neither should the lead-in or the antenna itself be close to any such objects for that will change the capacity and that will make the set erratic and less sensitive. Good insulation of the antenna is essential.

It will be found that different results will be obtained by running the flat-top portion of the antenna in different directions. If the main object of the receiver is to pick-up European stations, the flat-top portion should run in the opposite direction. Since most European stations are to the East and Northeast, the antenna should point West and Southwest. This should be observed wherever it is practical to do so. It may be in certain localities that stations appear to come from other directions, but that is a local condition and may not apply to all stations. When it is possible to erect several antennas they should be run in different directions and the desired one, which in any case is the one that brings in stations best, should be selected.

It is a mistake to assume that the longer and higher the antenna the better it is for short-wave reception. Usually, better re-

sults are obtained with a comparatively small antenna. In theory the antenna should be a "quarter wave" antenna, but this is not practical in a receiver that is to cover a wide range of frequencies.

The receiver has been tested in the worst reception location in New York City where skyscrapers abound, and foreign stations have been brought in with loudspeaker volume. If it will do that under such adverse conditions it certainly will do it where conditions are more favorable.

STUDIO INSIGHTS

Gene and Glenn, famous on the air-waves as Jake and Lena, are coming East soon to make a personal appearance tour. They have been on the air recently over WTAM, NBC station in Cleveland. In recent vaudeville tours they have set several house records through the Middle West.

* * *

When Jack Benny, comedian heard on the Chevrolet programs over networks each Friday, wisecracks about his "listener" when talking to his radio audience, he probably means a man across the Atlantic. Jack gets a fan letter every week from a listener on the North Coast of Ireland.

* * *

Dan Roberts, who plays the bass violin on the Three Roberts Brothers' programs, never took a lesson in his life. As a matter of fact, Dan was a painter in oils until recently. Marty and Lou, his brothers, already were working as a duet when he decided that painting didn't bring in enough money. He came East from the coast to join his brothers and to land any kind of a job. He saw Lou's bass fiddle. "I fooled around with it for three days," he said. "At the end of the third day I went out and got the Roberts Trio their first job."

Radio University

A QUESTION and Answer Department. Only questions from Radio University members are answered. Such membership is obtained by sending subscription order direct to RADIO WORLD for one year (52 issues) at \$6, without any other premium.

RADIO WORLD, 145 WEST 45th STREET, NEW YORK, N. Y.

Puttering in Amplifier

THERE is a noise in my receiver on strong stations that sounds very much like motorboating, except that it is not regular. It is a serious interference with reception. The receiver is an up-to-date circuit of the superheterodyne type and is equipped with automatic volume control, diode detection, and resistance coupling between the detector and the audio power tube. Can you give me any explanation?—F. G. W., Elmhurst, L. I.

It is easier to give many explanations than any one explanation, for there are so many possibilities. It may be that the resistance in the grid circuits of the automatically controlled tubes are too high. If they are, there would be blocking on strong signals. It is also possible that the intermediate frequency amplifier is on the verge of oscillation, or is actually oscillating. The oscillation might cause the overloading that gives rise to blocking. It may also be that the noise arises in the audio amplifier. The cause would be similar. However, if you have an audio volume control in the grid circuit of the triode of the diode detector tube, you can eliminate that possibility, or fix it as the cause, by turning the volume down. If the noise continues when the volume is very low, the trouble is ahead of the detector. The fact that the noise appears on strong signals proves that it is a type of overloading, and in such cases the grid bias voltages must be looked to.

Use of Band Pass Filters

WOULD you recommend the use of a band pass filter for a broadcast superheterodyne, or do you think that an ordinary doubly tuned coupler is just as good? If

you recommend a filter, please state what kind to use.—J. M. B., Brooklyn, N. Y.

If the receiver is to be used for broadcast reception only, and not for television, there is no need whatsoever for a band pass filter. As a matter of fact, a doubly tuned coupler like those used in most up-to-date circuits is a band pass filter, although the band is narrow. It is wide enough, however, for broadcast reception. If it were not, it would be foolish to insert a tone control to cut out the high audio frequencies.

Class B Operation

IS IT not a fact that when a tube is operated as a Class B amplifier it is really operated as a grid bias detector? If that is the case, how is it that there is not intolerable distortion? When a single tube is operated as a bias detector there is much distortion and also when two equal tubes are operated in full-wave bias detection. I have tried this and the quality is not there at all.—S. H., Springfield, Ohio.

It is a fact that each tube functions as a grid bias detector but this does not prevent distortionless amplification provided the outputs of two tubes, similarly operated, are combined correctly. If the outputs are combined improperly nothing but distortion will come through. If the circuit is to operate correctly the outputs of the two tubes must be combined as in regular push-pull. Of course, the inputs to the two tubes must also be connected in the same way.

Suppressor Grid's Function

WHAT is the function of the suppresser grid in the modern tubes? Where is it placed geometrically in the tube? Does the

placement inside the tube have anything to do with the arrangement of the terminals on the socket?—W. H. P., Rockford, Ill.

The function of the suppresser grid is to suppress secondary emission from the plate. Sometimes there is also a suppresser grid for the control grid, and its function is to suppress secondary emission from that element. It is placed near the plate when secondary emission from the plate must be suppressed. There is no particular relation between the arrangement of the terminals on the socket and the position in the tube.

Controlling Regeneration

IN THE MAY 13th issue you published a diagram of a short-wave receiver in which the regeneration is controlled by means of a variable condenser in series with a fixed tickler. I have a circuit similar to that and I find that I cannot control the regeneration. On certain dial settings the circuit oscillates at all settings of the control condenser. Can you suggest any means of varying the regeneration so that it can be stopped at all settings of the condenser?—R. W. M., Albany, N. Y.

One way to decrease the regeneration is to reduce the number of turns on the tickler or to increase the distance between the turns there are and the turns on the tuned coil. If either of these methods is unpractical, a variable resistor may be put in series with the tickler, between the control condenser and the coil. Of course, this resistor must be insulated. Or about the same result may be achieved with a fixed resistor of the proper value. This, however, has the disadvantage that it cannot easily be varied in case that becomes necessary. A certain resistance may be needed for one coil at some setting of the dial and another resistance may be needed for another combination. The variable resistor would provide a means for varying the resistance to the correct value at any setting.

Television Requirements

IT IS said that if clear television signals are to be achieved the high side band frequencies must be reproduced in full strength. What is the effect if they are not reproduced? Can you give an illustration of what happens in case the high frequencies are omitted?—B. W. R., New York, N. Y.

Suppose the picture to be transmitted contains a narrow black vertical line in a field of white. The scanning beam crosses this rapidly. The system must respond to the change instantly. But if the system is incapable of handling the high frequencies it will not respond instantly. It will take some time for the signal to build up to the full blackness required by the black band. If the system is not very fast it will not even have time to build up at all, for in an instant the demand is for whiteness. At best, the black line will become a gray. After the beam has passed over the black line it takes a certain time for the signal to return to white. Two effects, therefore, occur. One is a shift of the band in the direction of the motion of the scanning beams and the other is a reduction in the contrast. It is also important that the electrical system be slow or the broad outlines of the picture will disappear. Hence an electrical system that is to be used for television must have practically no frequency discrimination from the lowest frequencies, say 20 cycles per second, up to the highest. At present the upper limit is around 50,000 cycles per second. If the number of scanning lines per frame is increased the required upper limit will have to be raised, possibly to 250,000 cycles or higher. It is obvious that requirements are extremely severe even now.

Electrical Terminology

NOW and then unusual electrical terms are used in RADIO WORLD without any explanation of what they mean. For example,

Two for the price of One

Get, EXTRA, one-year subscription for any One of these magazines:

- POPULAR SCIENCE MONTHLY.
- RADIO-CRAFT (monthly, 12 issues).
- RADIO INDEX (monthly, 12 issues), stations, programs, etc.
- RADIO (monthly, 12 issues; exclusively trade magazine).
- EVERYDAY SCIENCE AND MECHANICS (monthly).
- RADIO LOG AND LORE. Bi-monthly; 5 issues. Full station lists, cross indexed, etc.
- AMERICAN BOY—YOUTH'S COMPANION (monthly, 12 issues; popular magazine).
- BOYS' LIFE (monthly, 12 issues; popular magazine).
- OPEN ROAD FOR BOYS (monthly, 12 issues).

Select any one of these magazines and get it free for an entire year by sending in a year's subscription for RADIO WORLD at the regular price, \$6.00. Cash in now on this opportunity to get RADIO WORLD WEEKLY, 52 weeks at the standard price for such subscription, plus a full year's subscription for any ONE of the other enumerated magazines FREE. Put a cross in the square next to the magazine of your choice, in the above list, fill out the coupon below, and mail \$6 check, money order or stamps to RADIO WORLD, 145 West 45th Street, New York, N. Y. (Add \$1.50, making \$7.50 in all, for extra foreign or Canadian postage for both publications.)

Your Name.....
 Your Street Address.....
 City State

DOUBLE VALUE!

- If renewing an existing or expiring subscription for RADIO WORLD, please put a cross in square at beginning of this sentence.
- If renewing an existing or expiring subscription for other magazines, please put a cross in square at the beginning of this sentence.

RADIO WORLD, 145 West 45th Street, New York. (Just East of Broadway)

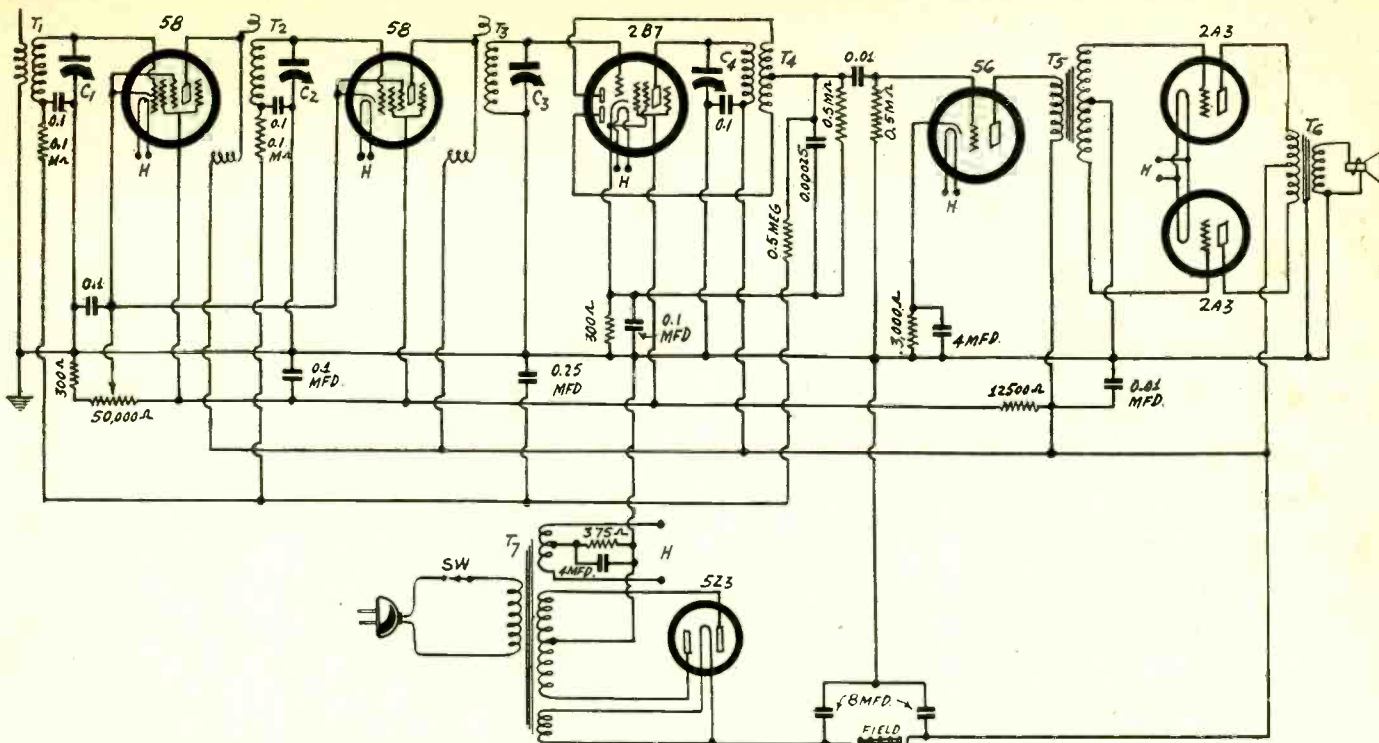

This seven-tube receiver is a t-r-f circuit. It combines selectivity, quality, and enormous output.

admittance and susceptance. What do they mean?—R. W. T., Atlantic City, N. J.

Admittance is the reciprocal of impedance. That is, if Z is the impedance of an electrical circuit, the admittance Y is defined by $Y=1/Z$. Susceptance is the reciprocal of reactance. The reactance of a condenser is $1/Cw$ and its susceptance is Cw . When the impedance is a pure resistance the reciprocal is a conductance. The reciprocal terms are not used as frequently as the direct terms, but occasionally they are convenient.

* * *

Insulating Universal Sets

RECENTLY I have serviced universal type receivers in which the chassis is not connected to the receiver except through a condenser. Even tuning condensers are insulated from the metal subpanel. What is the reason for this?—E. R. N., Chicago, Ill.

It is a matter of protection. If the chassis were connected to one side of the line, it would be "hot." This would be a danger point. It is safer to insulate the circuit from the metal chassis.

* * *

Relations in Beat Frequency Oscillator

WHAT are the relations among the beat frequency, the beating frequencies, and the coils and inductances in a beat frequency oscillator?—W. J. G., Brooklyn, N. Y.

There are many relations, but if the beat frequency is small compared with the frequency of either beating oscillator a very simple relation exists. Let f be the beat frequency, F the frequency of either oscillator when the beat is zero, C the capacity of the oscillator the frequency of which is varied, and $C1$ the capacity by which this is varied to produce the beat f , then $2f/F = -C1/C$. The minus sign only indicates that the frequency and capacity change in opposite directions. The relation holds true, very nearly, even if f is as high as 10,000 cycles provided that F is around 1,000 kc. The formula can be used for estimating the beat frequency or for determining the capacity $C1$ to produce a given beat when the other two factors are known. Suppose, for example, that F is 1,000 kc and that C is 500 mmfd. What should $C1$ be if the beat frequency is to be 10,000 cycles? We have $2 \times 10/1,000 = C1/500$. Therefore $C1 = 10$ mmfd.

A T-R-F Receiver

WILL you kindly publish a circuit of a t-r-f receiver utilizing the latest tubes? I should like to have 58s in the r-f amplifier, a 2B7 as r-f amplifier and detector, a 56 as a-f amplifier, and a pair of 2A3s in the output circuit. For rectifier in the B supply either a 280 or a 5Z3 will do. I have a four gang condenser, each section 350 mmfd., and I should like to use that if possible.—T. H. C., Fort Worth, Texas.

You will find a complete diagram of such a receiver on this page. Perhaps that is the identical circuit you had in mind. All the essential data are given on the diagram. The coils, of course, should fit the condensers you have. The first coil is a regular antenna coupler, the two are of the so-

called high-gain type, and the last is a transformer with a centertapped secondary, which is untuned.

* * *

Results of Mispadding

I FINISHED a super the other day, one I took from the pages of RADIO WORLD. From 1,500 kc to about 860 kc it works fine, but from there on to 550 kc it is not very sensitive and it squeals a great deal. Will you kindly suggest what to do to take out the oscillation and to make the set more sensitive on the low radio frequencies?—R. L. N., Jersey City, N. J.

Adjust the padding, particularly the adjustable condenser in series with the oscillator tuning condenser.

Join Radio World's

UNIVERSITY CLUB

And Get Free Question and Answer Service for the Coming 52 Weeks.

THIS SERVICE FOR UNIVERSITY SUBSCRIBERS ONLY

Subscribe for RADIO WORLD for one year (52 numbers). Use the coupon below or write on a separate sheet of paper, if preferred. Your name will be entered on our subscription and University Club lists by special number and you will be apprised of the number. When sending questions, put this number on the outside of the forwarding envelope (not the enclosed return envelope) and also put it at the head of your query. If already a subscriber, send \$6 for renewal from close of present subscription and your name will be entered in Radio University.

NO OTHER PREMIUM GIVEN WITH THIS OFFER

[In sending in your queries to the University Department, please paragraph and number them. Write on one side of sheet only. Always give your University Club Number.]

RADIO WORLD, 145 West 45th Street, New York City.

Enclosed find \$6.00 for Radio World for one year (52 nos.) and also enter my name on the list of members of RADIO WORLD'S UNIVERSITY CLUB, which gives me free answers to radio queries for 52 ensuing weeks, and send me my number indicating membership.

Name

Street

City and State.....

Station Sparks

By Alice Remsen

The Voice

(For Elsie Hitz—"The Magic Voice")

WABC, Tuesdays, 8:15 p.m., EDST

You spoke—a thousand melodies in one
Were in your voice;
My heart—enchanted by the lovely sound,
Seemed to rejoice.
Alas—your former name I did not know,
I only heard
In that one moment of extreme delight,
A spoken word.

And you—well, you were miles away from
me,

Across the wires;
To me your personality had flown,
And lit the fires
Of love—that still are fiercely burning on,
A roaring flame—
Since I first heard the magic of your
voice,
Speaking my name.

—A.R.

* * *

The magic of the sweet voice of Elsie Hitz has been well demonstrated in the popularity of her program, "The Magic Voice." She has, I believe, the most distinctive female speaking voice on the air. Her voice could not be duplicated by anybody. When she was sick with scarlet fever recently an understudy was tried with dire results. It ended by Elsie broadcasting from her sick bed.

* * *

THE RADIO RIALTO

Canada Takes Initiative

Canada has taken the initiative so far as Government supervision of radio advertising is concerned. They have limited the timing of radio blurbs to five per cent of the program time. This in itself is commendable, although I would much rather see the clients themselves taking the initiative, for, if they would only realise it, the very mention of the fact that they are sponsoring the program means more than all the high pressure salesmanship to which they now resort.

The latest news to hit us in the eye is that NBC has cancelled the programs of three women stars, Welome Lewis, Ann Butler and Bernice Claire. These girls were on a sustaining build-up basis and I suppose the powers-that-be figured an expensive build-up would be lost during the summer; too bad, for all three girls were clever in their own particular line. . . . WOR has a new series each Sunday at 10:00 p.m. EDST, featuring the New York Opera Association. . . . Ed Wynn's new chain is becoming a fact. It will begin broadcasting within a month. There will be several networks consisting of one hundred stations. The Atlantic network will use stations WBNX-WCDA-WMSG as mother stations under the call letters WMET; associated with them will be WTNJ, Trenton; WPEN, Philadelphia; WDEL, Wilmington; WCBM, Baltimore; and WOL, Washington; another component, ready to be used, is that of the Michigan network of twelve stations, with headquarters at WXYZ, Detroit. Other sections will follow. Ed Wynn and his business associates have leased commodious quarters at 501 Madison Avenue,

New York; the building will be known as the Amalgamated Broadcasting Building. . . .

Tit for Tat

Another piece of news is that the Lewisohn Stadium concerts will leave their old stand-by, Columbia, on July 1st, transferring their affections to NBC. . . . but tit for tat comes from Columbia, with the report that a former NBC commercial, a bakery program, has gone over to Columbia on a three-a-week schedule, featuring the Men About Town and Joe Green's orchestra, so that makes things almost even. . . . The Minneapolis Symphony has already inaugurated its spring series over WJZ. . . . Mrs. Franklin D. Roosevelt prefers to go to the studio when she broadcasts; says she doesn't want to put them to the trouble of a remote control line. That's what you call being a real trouper. . . . Phil Cook has a new baby, a girl. . . . So has Roger Bowers, only his is a boy. . . . In spite of the fact that Chesterfield was supposed to go NBC, it will return to the Columbia network every Friday at 10:00 P.M., beginning June 2nd, retaining Lennie Hayton's band and featuring Lou Holt. Norman Brokenshire will be the announcer. . . . Mildred Bailey has gone sustaining twice weekly over WABC, if you are an admirer of the portly songstress watch your local paper for time of programs. . . . Murmurs have often been heard against the radio crime play. Listeners arguing that crime plays have a bad effect on the younger element. Since the McMath kidnapping and the Murch murder, those murmurs have grown into shouts. Officials of the broadcasting companies do not like crime plays, but they cannot afford to offend their clients, and the clients argue that people are not compelled to listen, that the radio can always be turned off. If each crime play contained a moral lesson, showing that crime doesn't pay, it might help the situation a bit. . . . Bumped into Will Osborne at WABC the other morning. Will is doing a series of programs over the Columbia network every Monday, Wednesday and Friday morning at 10:45 EDST, with a re-broadcast at 11:45. Pedro de Cordoba is featured on the programs as The Friendly Philosopher, sponsored by the Mazola Company. . . . Newspapers are cutting up again, limiting the broadcasting of news events and demanding pay for printing radio programs. I really think they are cutting off their noses to spite their faces. Radio magazines will flourish as never before. . . .

Trouble Among the Song Folk

The Society of European Stage Authors and Composers is suing Gene Buck and E. C. Mills, of the American Society of Authors, Composers and Publishers, for \$250,000, claiming that Buck and Mills prevented the consummation of a contract between the European concern and Columbia Broadcasting Company, under which the broadcasting company were to pay \$17,850 per year as a license fee for broadcasting music controlled by the European Society. . . . Dick Robertson is now the featured singer with the George Hall and his orchestra, holding forth at the Taft Grill and broadcasting daily over the Columbia Broadcasting System. . . . Max Smolen, whom you will all remember as the maestro of the "Evening in Paris" for four years, has a gorgeous new orchestra, a brassless symphony, using two French horns in place

of cornet and trombone; a marvelous combination able to play anything from symphony to jazz. If a good commercial sponsor is looking for something new, here it is. . . . Ernie Golden, popular dance band leader, has written some two new tunes, both novelty numbers—"The Chimes in the Steeple" and "The Wedding of Punch and Judy". . . . Nelson Eddy, baritone, who formerly sang on the Hoffman program over WOR, has been signed by MGM to do a series of shorts. . . . The Woodbury program will be heard over WEAJ at 8:30 p.m. EDST each Wednesday. . . .

Moving to Chicago

Two of the best NBC commercial programs will be heard from Chicago during the new World's Fair. The Cities Service, and the A. & P. Gypsies will move bag and baggage from New York to the Windy City; they will both give daily concerts at the fair as well as their regular broadcasting schedule. . . . Bing Crosby has commenced work on six two-reelers for Paramount. . . . Victor Young and Lee Wiley open that cold cream assignment for NBC on May 26th. . . . Freddy Martin is at the Bossert Roof in Brooklyn, and is heard over WABC-CBS four times weekly. . . . Cab Calloway will be on the road until August. . . . Well, I think your girl friend has given you plenty of news this week. It's just about time to call it a day (this isn't a song title, Danny Engel, although I think I remember hearing you sing one of that name). Time for tea, so here goes for English muffins, raspberry jam and strong tea.

* * *

BIOGRAPHICAL BREVITIES

About Jeannie Lang

That vivacious little radio singer, Jeannie Lang, first made her bow to the waiting world on December 17th, 1911. It happened in St. Louis, and goodness knows she was small enough then, but her fond parents didn't realize that their tiny offspring would go through life with such name-abbreviations as "Half Pint," "Peanut" and "Spark Plug." Jeannie has three brothers, older than herself, and considerably bigger.

Jeannie's family were all dead set against her going into the theatrical profession, but Jeannie wanted to do it, and as she usually gets her own way about things—well, she is in the theatrical profession! Brooke Johns was the hand which Fate picked out to give Jeannie her first real chance; six feet tall and looking for a small feminine foil, he literally picked Jeannie up and carried her to fame. That was nearly three years ago.

Then friends introduced Jeannie to Paul Whiteman and he gave her several numbers to do in his picture. Arthur Hammerstein gave her a good part in "Ballyhoo" and when the show closed Jeannie returned to the Coast and radio work at KFI, also making movie shorts for Warner Brothers on the side. Then came a telegram from Jack Denny offering her solo work with his band, and Jeannie came East again. Now you may hear the little lady on the Pontiac program every Thursday at 9:30 p.m. over WABC, with Stoopnagle and Budd, gigantic Bill O'Neal, and Andre Kostalnetz.

A THOUGHT FOR THE WEEK

SELLING MERCHANDISE OVER THE AIR ON A PERCENTAGE BASIS? We had never heard of such a thing until a concern in Chicago wrote us and asked for a list of stations that accepted time orders on such a basis. We cannot furnish a list of this kind, but would be glad to know if some stations actually are resorting to such a makeshift method. Who can tell us if such deals are being made? The information would be an eye opener for us—and for air advertisers.

END OF INTEREST IN AIR ADS PUT AT 200 WORDS

Washington—Members of the American Association of Advertising Agencies, meeting here in their sixteenth annual session, heard the outline of an advertising policy in radio, encompassing the air, newspapers and periodicals. This proposed policy was advanced by officials of the Amalgamated Broadcasting System, the new national radio chain headed by Ed Wynn, and which includes WOL in the capital. The plan is as follows:

Elimination of offensive and lengthy trade announcements in radio advertising programs.

Inclusive national schedules for newspaper-radio advertisers, whereby each form of advertising shall be "geared in" with the other.

Co-operation, rather than hostility, between the radio and the nation's daily and periodical press.

Delegates heard the results of a survey by Frank A. Arnold, former executive of the National Broadcasting Company, and now vice-president of Albert Frank-Guenther Law, Inc., advertising agency. Mr. Arnold's survey showed that radio listeners-in are evidencing cumulative offense at long-drawn-out, intrusive and irrelevant ballyhoos in the midst of radio entertainment. Speakers at the convention here pointed to a sharp decline in advertising revenue of the two older broadcasting chains during the first quarter of 1933, and ascribed it in part to the ballyhoo tactics of some radio sponsors.

"Why does the advertiser," asked Mr. Arnold, "tell his story so well in newspaper print in 200 words, and yet require 600 words when he tells it on the air?"

He cited a 725-word commercial radio ballyhoo, adding:

"After the first 200 words all interest was lost."

The plan is to have the advertising schedules of the future, and which will govern on the Amalgamated network at once, "geared in" so that station announcements in all cities on a network shall call attention to display advertisements in the newspapers in each city. When possible, even the page numbers of the newspapers will be "geared in" with the radio announcements.

8-lb. Heindel Model Announced by Fada

A new miniature model design by Harry J. Heindel, chief engineer for Fada Radio, saw the light of day recently. This model has full-throated, dynamic loudspeaker, clarity of tone, tremendous volume, is portable (weighing only eight pounds) and is, in every sense of the word, a personal feature of the Heindel line. With chassis of classic design the "Heindelette" would list at a million dollars if it were for sale. But it isn't—it's a boy!

SANELLA BUYS LOW

Andy Sannella, guitar and saxophone virtuoso of NBC's Ingram program with Phil Cook, went shopping the other day and brought back a mandolin for \$4.98 and a jews harp thrown in. He uses both on the program.

He and Cook use ten instruments,—mandolin, harp, saxophone, guitar, wimbrola, tiple, two ukuleles, accordion and Cook's "foot" drum.

Ten Years Ago

(Harking back to Radio World of May 26th, 1923)

On the front cover was the reproduction of a photograph of the new great transmitter installed in the Edgewater Beach Hotel, Chicago. The studio was on the ground floor of the hotel and folk journeyed many miles to see what it was all about.

Carl H. Butman had a page devoted to Class A Stations, which then numbered 75. Mr. Butman later became secretary of the Federal Radio Commission.

Arthur G. Shirt told the world a lot of things in an article headed "How Radio May Unite the Languages of Europe." Has it?

The DX Nite Owls were becoming very active and increasing largely in numbers, according to the compilation of a contributor who seemed to think that the nite owls were the backbone of the whole radio structure.

C. H. Huntley devoted considerable space to an article headed "How Religious Services are Broadcast" for at that time clergymen all over the country were disturbed by the thought that radio might eventually reduce church attendance very materially. In other words, radio and golf were joined together as the foundation for many heartaches by the reverend gentlemen.

L. Bamberger & Co. had just opened the WOR studio in Newark, N. J. There were big times at the opening.

The Music Publishers Association agreed temporarily to permit the broadcasters the use of their copyrighted music—but the permission didn't continue for long. Somebody saw a great light—and then started the fee for broadcasting music that has continued until the present, when the income from this source reaches the greatest total in the history of fees to copyright owners.

Somebody offered for sale a broadcasting station which, according to the advertiser, honestly and truly had been heard in Texas, Kentucky and Missouri.

A. D. Turnbull waxed warm over a simple set that worked when taken away on a vacation and which would almost work equally well on a boat, in the mountains or on the front porch.

\$15,000 Set Demonstrated at Wholesale Radio Co.

During the broadcast of a program of organ music from the studios of the Aeolian Skinner Organ Company, through WOR, there was a demonstration recently of a new radio receiver in the auditorium of the Wholesale Radio Service Company, 100 Sixth Avenue, N. Y. City. This instrument, known as the Lanning Reproducer, uses a special amplifying system and four loudspeakers.

All tuning is accomplished by remote control. The apparatus proper being contained in a six-foot high steel cabinet intended for concealment in the owner's home. The minimum price of a complete installation is about \$15,000, making this outfit what is probably the world's most expensive radio receiver.

CORPORATE ACTIVITIES

Westinghouse Electric and Manufacturing Co.—A net loss, from operations, of \$8,903,540 is shown for the year 1932 by the preliminary report, compared with a net loss of \$3,655,659 for 1931. Sales billed totaled \$77,073,586 compared with \$115,393,082 for 1931. Obsolescence and depreciation of buildings and equipment amounting to \$5,274,857 were provided for and included in the cost of operation. In 1931 the amount for the same purpose was \$5,173,914.

Orders received by the company and its subsidiaries in 1932 amounted to \$69,082,486. In 1931 they amounted to \$128,014,820. Unfilled orders on January 1, 1933, were \$26,836,494. Cash and marketable securities at end of 1932 were \$32,851,763, compared with \$32,148,727 at end of 1931.

Rockefellers to Move Into the RCA Building

The offices of John D. Rockefeller, Sr., John D. Rockefeller, Jr., and their associates will be moved from 26 Broadway to the fifty-sixth floor of the RCA Building, Rockefeller Center, early in July.

John D. Rockefeller, Jr.'s offices have been located at 26 Broadway since he first entered business on October 1, 1897.

The new offices will cover approximately three-quarters of the fifty-sixth floor of the main 70-story structure in Rockefeller Center. A limited amount of office space, however, is still being retained at 26 Broadway for downtown conferences.

John D. Rockefeller, Jr.'s personal office will be in the southwest corner of the RCA Building, overlooking Sixth Avenue and Forty-ninth Street.

TRADIOGRAMS

By J. Murray Barron

J. Schechter, of North Radio Co., 172 Washington Street, New York City, opened his third radio store in this city at 78 Cortlandt Street under the name of Star Radio Company. They will specialize in short-wave sets, power amplifiers and parts for experimenters, servicemen and amateurs.

Jerry Gross, well known in amateur circles and who conducted a retail store at 25 Warren Street, has moved to a more central address at 51 Vesey Street, New York City, where he opened a store and will cater to the amateur and experimenter. This site is directly opposite where the New Post Office is to be built.

An item of real value to the farm or for those using 32-volt Delco systems is the newly-announced special 32-volt job put out by Postal. This new B Eliminator operates from 32 volts source and delivers 110 volts a.c. at 100 watts. This is not an adapter but a complete unit. Full detailed information can be had direct from Postal Radio Corp., 135 Liberty Street, New York City.

TEXAN IN NAME AND FACT

Margaret West, the "Texas Cowgirl," is a real Texan, and was reared on her father's ranch near the Mexican border in Zavala County. Her father's ranch is the "Rafters S" which she often mentions during her programs.

Literature Wanted

Readers desiring radio literature from manufacturers and jobbers should send a request for publication of their name and address. Address Literature Editor, RADIO WORLD, 145 West 45th Street, New York, N. Y.

- R. Fund, 181 Bay Street, Jersey City, N. J.
- Ralph Melang, Lelang Brothers, 6047 6th Avenue, N.E., Seattle, Wash.
- James R. Raymond, 24 Coeyman Avenue, Nutley, N. J.
- John Urban, 3016 Jacob Street, Hamtramck, Mich.
- M. Shuman, 3726 Ramona Blvd., Los Angeles, Calif.
- Clarence A. Storer, 61 Audubon Rd., Boston, Mass.
- John Lembke, 639 East 12th Street, New York City.
- George Silver, 1350 Clinton Avenue, New York City.
- H. Pellmann, 1439 20th Avenue, San Francisco, Calif.
- M. M. DeWitt, Panhandle Power & Light Co., Mobeetie, Texas.
- Henry N. James, 1150 1/2 N. Madison Avenue, Los Angeles, Calif.
- Paul Clem, R.R. No. 3, Monroeville, Ind.
- Robert Johnson, Silver Beach Station, Bellingham, Wash.
- Luiz Gonzaga Tegen, Rua Benjamin Constant, 173, Piracicaba, S. Paulo, Brazil.
- Howard C. Burns, 1107 Fteley Ave., Bronx, New York City.
- V. Merino, calle Sobrerroca No. 13, Manresa, Barcelona, Spain.

Bias Critical for the 2A6

If the 2A6 is a high mu tube (it is like the 55, except for high mu) and requires only a low grid bias, why is it necessary to use a high grid bias resistor? There are two reasons. First, the internal resistance of the plate is high for a tube having a high amplification constant. That limits the plate current to a low value. Second, in order to get a large output voltage from the tube, the load resistance must have a high value. This also limits the plate current to a low value. Therefore when the tube operates normally, the plate current, which is also the current through the bias resistance, has a comparatively low value, and it requires a high resistance to give the required bias.

The resistance that gives the best operation is rather critical, for the bias is critical. Moreover, all tubes are not exactly alike, so that the same resistance will not give the same bias in all instances. For that reason it is best to vary the bias resistance until it gives the best operation in each instance. It is clear that the bias can be varied not only by varying the grid bias resistance but also by varying the plate coupling resistance and the applied plate voltage. The most convenient method should always be employed for making the adjustments.

It should be remembered that the higher the load resistance the greater will be the signal output voltage for a given input. The reason for this is that there is a constant voltage, that is, for a fixed input, in the plate circuit. Part of this is dropped in the internal resistance of the tube and part

in the external resistance. The higher the external resistance the greater is the portion of the voltage that is dropped in that resistance, and it is only this that is available for use on the grid of the next tube.

While increasing the plate resistance increases the output voltage, there is a practical limit, for after the external resistance becomes about twice the internal resistance the increases in the output voltage is very slow. It is doubtful that it is of any advantage to make the external resistance more than five times the internal resistance.

Attention is called to the fact that when a triode is used in a resistance coupled circuit, it is not necessary to increase the plate supply voltage when increasing the external resistance. It is only necessary to insure that it is high enough for the signal that is to be expected. The only time it is necessary to increase the plate supply voltage is when the output signal voltage is to be increased. But merely increasing the plate supply voltage is no guarantee that the output voltage will be high enough. It is necessary to increase the bias on the tube in proportion in order to allow the grid to swing the required amount.

When the tube is a screen grid tube the case is not quite so simple. If the external resistance in the plate circuit is increased, the supply voltage must be increased in the same proportion, or else the screen voltage must be reduced greatly. But this does not apply to the 2A6, nor to the 75, 55, and 85, for they are all triodes.

DIAMOND PARTS

Tuned Radio Frequency Sets

FIVE-TUBE MODEL

A-C operated circuit, 50-60 cycles, 105-120 volts, using two 58 t-r-f stages, 57 power detector and 47 output, with '80 rectifier. Three gang shielded condenser and shielded coils in a sensitive, selective and pure-tone circuit. Dynamic speaker field coil used as B supply choke. Complete kit of parts, including 8" Rola speaker and all else (except tubes and cabinet). Cat. D5CK @.....\$15.00
Wired model, Cat. D5CW (less cabinet) @..... 17.19

Kit of five Eveready-Raytheon tubes for this circuit. Cat. D5T 4.87

FOUNDATION UNIT, consisting of drilled metal subpanel, 13 1/4 x 8 1/2 x 2 1/4"; three-gang Scovill 0.00035 mfd., brass plates, trimmers, full shield; shields for the 58 and 57 tubes; six sockets (one for speaker plug); two 8 mfd. electrolytic condensers; set of three coils. Cat. D5FU..... 6.19
Super Diamond parts in stock.

FOUR-TUBE MODEL

The four-tube model is similar, except that there is one stage of t-r-f, and a two-gang condenser is used. Tubes required, one 58, one 57, one 47 and one '80. Complete kit, including 8" Rola dynamic speaker (less tubes, less cabinet). Cat. D4CK\$13.58

Kit of four Eveready-Raytheon tubes for this circuit. Cat. 4D.TK\$3.80

FOUNDATION UNIT, consisting of drilled metal plated subpanel 13 1/4 x 2 1/2 x 7"; two-gang 0.00035 mfd. SFL condenser; full shield; two shields for 58-57; center-tapped 200-turn honeycomb coil; five sockets (one for speaker plug); two 8 mfd. electrolytics; set of two shielded coils; 20-100 mmfd. Hammarlund equalizer for antenna series condenser. Cat. D4FU\$5.48

INDIVIDUAL PARTS



Travelling light vernier dial, full-vision, 5-to-1 vernier, projected indication prevents parallax; takes 3/4" or 1/2" shaft; dial, bracket, lamp, escutcheon.

0-100 for 5-tube Diamond, Cat. CRD-0, @ \$0.91.

100-0 for 4-tube Diamond, Cat. CRD-100, @ \$0.91.

[If dial is desired for other circuits state whether condenser

closes to the left or to the right.]
8 mfd. Polymet electrolytic, insulating washers, extra lug. Cat. POLY-8 @.....\$0.00
Three 0.1 mfd. in one shield case, 250 volt d-c rating. Cat. S-31 @..... .29
Rola 8" dynamic for 47 with 1800 ohm field coil tapped @ 300 ohms. Cat. FP @..... 1.85
2 coils for 4-tube. Cat. DP @..... .90
3 coils for 5t-ube. Cat. DT @.....1.35

DIRECT RADIO CO.

143 WEST 45th STREET
NEW YORK, N. Y.

Quick-Action Classified Advertisements

7c a Word—\$1.00 Minimum Cash With Order

ALUMINUM BOX SHIELDS, 90c. Other bargains. Utah Supply Co., Box 84, Salt Lake City, Utah.

CAPACITY MULTIPLIER, over eighty different values obtainable using standard, inexpensive parts. Schematic, \$1.00. **MICRO-INSTRUMENTS**, 514-5th St., N.W., Washington, D. C.

URUGUAY STAMPS—100 different stamps, \$1.00. 200 different stamps, \$3.50. Stamps will be shipped direct from Uruguay. Heriberto Meyer, care Radio World, 145 West 45th St., New York City.

BARGAINS IN FINEST PARTS! — Highest grade, new parts, few of each on hand. National dial, flat type, modernistic escutcheon, type G, clockwise, \$2.19; Pilot drum dial No. 1285 @ \$1.89; a-c toggle switch, 19c; triple pole, four-throw Best switch, insulated shaft, \$1.62; double pole, four throw, \$1.08. Direct Radio Co., 145 West 45th St., N. Y. City.

"SOUND PICTURES," by Cameron & Rider. Over 1,100 pages, 500 illustrations. The whole question of Sound Motion Pictures treated from a new angle. A Complete Guide for Trouble Shooting. Explains in detail the construction, operation and care of sound recording and reproducing equipment. Price \$7.50. Radio World, 145 W. 45th St., New York City.

"THE CHEVROLET SIX CAR AND TRUCK" (Construction—Operation—Repair) by Victor W. Page, author of "Modern Gasoline Automobile," "Ford Model A Car and AA Truck," etc., etc. 450 pages, price \$2.00. Radio World, 145 W. 45th St., N. Y. City.

THE FORD MODEL—"A" Car and Model "AA" Truck — Construction, Operation and Repair — Revised New Edition. Ford Car authority, Victor W. Page. 703 pages, 318 illustrations. Price \$2.50. Radio World, 145 W. 45th St., New York.

NEW RADIO AMATEUR'S HANDBOOK, 180,000 words, 207 illustrations, 218 pages (10th edition, issued 1933). Price, \$1.00 per copy. Radio World, 145 West 45th Street, New York, N. Y.

"THE MODERN GASOLINE AUTOMOBILE," by Victor W. Page, M.S.A.E. New Revised and Up-to-date Edition. A whole library of information now complete in one large octavo volume of 1,146 (6 x 9) pages—1,000 engravings. Bound in flexible scarlet fabricoid. Price \$5.00. Radio World, 145 W. 45th St., New York, N. Y.

FREE with a \$1.00 8-weeks Subscription

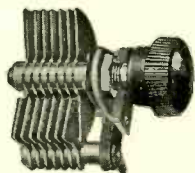

NEW STAR MIDGET CONDENSERS

Choice of 15, 25, 50 and 100 mmfd. capacities. Single hole panel mount.

Here is your opportunity to get the latest product of Hammarlund, a Star Midget condenser. Send \$1 for 8 weeks subscription and get any one condenser free. Select the desired capacity.

Any two condensers free with \$2 for 17-week subscription.

Any three condensers free with \$3 for 26-weeks subscription.

Any six condensers free with \$6 for one-year subscription (52 weeks).

RADIO WORLD

145 West 45th St., New York City

PADDING CONDENSERS



Eisher capacity, 50c

A HIGH-CLASS padding condenser is required for a superheterodyne's oscillator, one that will hold its capacity setting and will not introduce losses in the circuit, for losses create frequency instability. The Hammarlund padding condensers are of single-condenser construction on Isolantite base, with set-screw easily accessible, and non-stripping thread. For 175 kc. intermediate frequency use the 850-1350 mmfd. model. For i-f. from 460 to 365 kc., use the 350-450 mmfd.

0.0005 HAMMARLUND S. F. L. at 98c.

A sturdy, precision straight frequency line condenser, no end stops. The removable shaft protrudes front and rear and permits ganging with coupling device, also use of clockwise or anti-clockwise dials, or two either side of drum dial. Front panel and chassis-top mounting facilities. True straight line. This rugged condenser has Hammarlund's high quality workmanship and is suitable for precision work. It is a most excellent condenser for calibrated radio frequency test oscillators, any frequency region, 100 to 60,000 kc., short-wave converters and adapters and TRF or Superheterodyne broadcast receivers. Lowest loss construction, rigidity; Hammarlund's perfection throughout.

Order Cat. HO5 @.....98c net

Guaranty Radio Goods Co., 143 West 45th Street, New York, N. Y.

NEW MODEL SHIELDED TEST OSCILLATOR!

An improved modulated test oscillator, fundamental frequencies, 50 to 150 kc, enabling lining up of intermediate frequency amplifiers, t-r-f and oscillator circuits, is now ready. It is shielded in a metal box 9 1/2" wide x 8 1/2" deep x 4 1/2" high, with beautiful Japanese finish. The test oscillator is obtainable in two models, one for a-c operation, the other for battery operation. The same cabinet is used for both.

The a-c model not only is shielded but has the line blocked, that is, radio frequencies generated by the oscillator cannot be communicated to the tested set by way of the a-c line. This is a necessary counterpart to shielding, and a special circuit had to be devised to solve the problem.

The modulation in the a-c model is the a-c line frequency, 60 cycles, affected by using the line voltage on the plate of the tube. In the cabinet there is a very high resistance between the shield cabinet and the a-c, a double preventive of line-shorting and application of a-c line voltage to the user.

The oscillator is equipped with an output post. No ground connection need be used, as the circuit is sufficiently grounded through the power transformer capacity to prevent body capacity effects in tuning.

The frequencies are more accurately read than normal use requires, being never more than 2% off, and usually not more than 1% off, many readings being right on the dot (no discernible difference). The frequency stability is of a high order from 100 to 50 kc, and somewhat less from 100 to 150 kc. Zero beats are guaranteed at all frequencies.

The oscillator was designed by Herman Bernard and is manufactured under the supervision of graduates of the Massachusetts Institute of Technology.

Either model FREE with two-year subscription for Radio World (104 issues) \$12.00

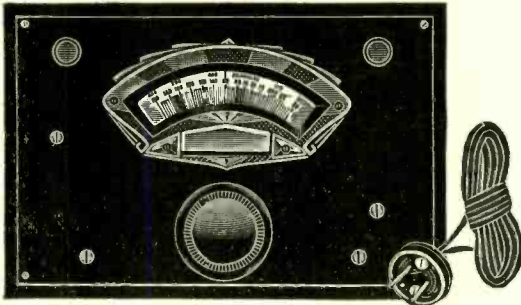

The test oscillator has a frequency-calibrated dial, 150 to 50 kc, with 1 kc separation between 50 and 80 kc and 2 kc separation between 80 and 150 kc. Intermediate frequencies are imprinted on the upper tier. Broadcast frequencies are obtainable on tenth harmonics (500 to 1,500 kc).

THE a-c model is completely self-operated and requires a 56 tube. The battery model requires external 22.5-volt small B battery and 1.5-volt dry cell, besides a 230 tube. The use of 1.5 volts instead of 2 volts on the filament increases the plate impedance and the operating stability. The battery model is modulated by a high-pitched note. Zero beats are not obtainable with the battery model.

Directions for Use

Remove the four screws and the slip cover, insert the 56 tube in its socket, restore the cover and screws, connect the a-c attachment plug to the wall socket, and the a-c test oscillator is ready for service.

For testing some particular set, follow the directions given by the designer or manufacturer. In the absence of such directions, use the following method.

Mentally affix a cipher to the registered frequencies on the lower tier (so 50 is read as 500, and 150 as 1,500), and set the dial for any desired broadcast frequency. Connect a wire from output post of test oscillator to antenna post of set. Leave aerial on for zero beats, off otherwise. At resonance the hum will be heard. Off resonance it will not be heard. For testing intermediate frequencies, connect the wire to plate of the first detector socket. The first detector tube may be left in place and bared wire pushed into the plate spring. The intermediates then are tuned for strongest hum response. If an output meter is used, tune for greatest needle deflection.

The battery model is connected to voltage sources as marked on oscillator outleads and is used the same way.

RADIO WORLD
145 West 45th St., New York, N. Y.

SHORT-WAVE COILS and FORMS



Precision short-wave plug-in coils, wound on 1 1/2" diameter Form has gripping flange. Four coils to a set for each tuned circuit. Approximate frequencies with 0.00014 mfd. are 1400-3080 kc, 3000-8600 kc, 6000-13200, 13000-30000 kc.

Two-winding coils, UX base. Cat. SWA (four coils)\$1.20
Three-winding coils, UX base (tickler interwound with part of secondary) Cat. SWB @\$1.40
UX sockets for use as coil receptacle, Cat. 5X, @ 10c each. Forms, four for 60c, either UX or 6-pin. Six-spring sockets, Cat. 8Z, @ 11c each.

SCREEN GRID COIL CO., 14 W. 45th Street, New York City

TROUBLE SHOOTER'S MANUAL, Nos. I and II

Having assembled 2,000 diagrams of commercial receivers, power amplifiers, converters, etc., in 1,200 pages of Volume No. 1 of his Perpetual Trouble Shooter's Manual, John F. Rider, noted radio engineer, has prepared Volume No. 2 on an even more detailed scale, covering all the latest receivers. Volume No. 2 does not duplicate diagrams in Volume No. 1, but contains only new, additional diagrams, and a new all-inclusive information on the circuits covered.

Volume No. 2—Perpetual Trouble Shooter's Manual, by John F. Rider, Shipping weight 6 lbs.
Order Cat. RM-VT @\$5.00
Volume No. 1 (8 lbs.). Order Cat. RM-VO @\$5.00
We pay postage in United States on receipt of purchase price with order. Canadian, Mexican and other foreign remittances must be in funds payable in New York.

RADIO WORLD
145 West 45th Street New York City

RADIO WORLD and "RADIO NEWS"

BOTH FOR ONE YEAR **\$7.00** Canadian and Foreign \$1.50 extra

You can obtain the two leading radio technical magazines that cater to experimenters, service men and students, the first and only national radio weekly and the leading monthly for one year each, at a saving of \$1.50. The regular mail subscription rate for Radio World for one year, a new and fascinating copy each week for 52 weeks, is \$6.00. Send in \$1.00 extra, get "Radio News" also for a year—a new issue each month for twelve months. Total 64 issues for \$7.00.

RADIO WORLD, 145 West 45th Street, New York, N. Y.
DICTIONARIES—STANDARD ENGLISH

3 LETTER WORDS

or 4 LETTER WORDS, 25c. by 35c. Definition Stand. Eng. Words 25c. Lists of words winning first prize in recent Gold-Medal, Princess Pat, Pathfinder, Bisquit, Magnesia or Wheaties Contest, @ 50c, 3 for \$1.00. List first-prize winners in 30 Contests, 25c. Copy of Contest Magazine, 25c. Dept. R.W.

DeLONG AGENCY, Inc., Lafayette, Indiana

BLUEPRINT

627. Five-tube tuned radio frequency. A-C operated; covers 200 to 550 meters (broadcast band), with optional additional coverage from 80 to 204 meters, for police calls, television, airplane, amateurs, etc. Variable mu and pentode tubes. Order BP-627 @25c

RADIO WORLD
145 WEST 45th ST., NEW YORK, N. Y.

PUSH-PULL DIAMOND

A dual-range receiver, 1550—535 kc, 1525—4200 kc, using a perfected superheterodyne circuit, frequency-stabilized oscillator and electron coupling between modulator and oscillator. Ten tuned circuits, four variable. Two stages of t-r-f, tuned modulator, tuned oscillator, with switch for wave-changing. Output 15 watts from 2A3's in push-pull. Full-wave second detector, with 56 driver of output. 52 mfd. of B filter capacity. Automatic volume control of two i-f tubes. Automatic inter-channel noise suppression. Selectivity enough to blot out strong locals

10 kc removed from distant station. No squeals whatever.

Tubes used: Five 58's; two 55's; one 56; two 2A3's; one 5Z3.
Wired Model of 12-Tube Push-Pull Super Diamond, including speaker, tubes and everything else, except cabinet. Lined up and padded by experts. Licensed **\$41.27**

Complete parts, speaker, tubes, everything except cabinet. **\$37.77**

Direct Radio Co.
143 West 45th Street
New York, N. Y.

A SEVEN TUBE SUPER KIT \$18.50

(complete with new type tubes)
Uses three 78's, one 37, one 75, one 42 and one 80. Employs only standard nationally advertised parts:—Thordarson power trans.; Jensen 8" speaker; Magnavox filter cond.; I.R.C. resistors; Fast bypass cond.; Meissner litz coils; General instrument variable condenser rubber mounted with special oscillator tracking section; Sylvania tubes; semi-mounted chassis of Lasalle metal; wiring cable R.M.A. coded; picture diagram actual size showing exact placement of wires and parts; real A.V.C. on three tubes. Extremely sensitive averaging less than one quarter microvolt per meter. Complete kit including tubes, speaker and all parts—\$18.50. Write for details.

BOWEN RADIO LABORATORY
526 Surf St. Chicago, Ill.

NEW \$2.65 INTERMEDIATES



Highest grade intermediate transformers, 465 kc or 175 kc, with or without secondary center tap, just released by Hammarlund, use air-core condensers for tuning.

The transformer is of the tuned primary-tuned secondary type, with both plate and grid coils being tuned by air-dielectric variable condensers of special design. These condensers are mounted on an Isolantite panel 1 1/2-16 inches in diameter. The rotor is carried in a single bearing in the Isolantite panel and consists of two circular and three semi-circular brass plates of 3/4 inch radius riveted to the rotor shaft. The stator, also of brass, consists of two circular and two semi-circular plates soldered to stator support rods which in turn are soldered in the bushings in the Isolantite panel. Contact is made to the rotor plates by phosphor bronze spring under considerable tension. No locking device is necessary, as the tension of the contact spring is sufficient to maintain the setting of the rotor even where extreme vibration is present. A screwdriver slot is provided in the end of the rotor shaft to facilitate tuning.

465 kc. model is used in 11-Tube Push-Pull Diamond

The use of these air variables practically eliminates the variations in gain and selectivity inherent in intermediate transformers in which the coils are tuned by means of adjustable condensers of the compression type using mica as dielectric. The transformers are pre-tuned to the desired frequency. List price, \$4.50; net, \$2.65 each.

Guaranty Radio Goods Co.
143 West 45th Street

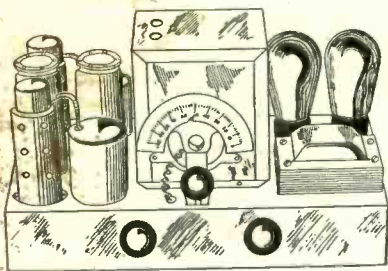

BLUEPRINTS, COILS and CHASSIS FOR THE TUNED R-F DIAMOND OF THE AIR

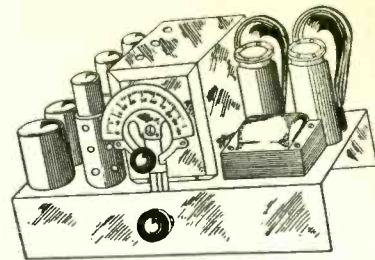

FOUR-TUBE DIAMOND

Extremely fine performance, including fetching tone quality, marks the Four-Tube A-C 1933 Diamond of the Air, blueprint of which is now available (half-scale). Many have been surprised that so much can be accomplished on a t-r-f set that costs so little to build. The circuit uses a two-gang 0.00035 mfd. condenser. Special coils are required. The chassis is metal, 13.75 x 6.75 x 2.5 inches.

Send \$3.00 for six months subscription (26 issues) and get the blueprint, two official shielded coils and the drilled metal chassis free. Order PRE-D-4-COMB.

FIVE-TUBE DIAMOND

The Five-Tube A-C 1933 Diamond of the Air provides greater sensitivity than the four-tube model, also somewhat more selectivity, as a three-gang condenser is used. An infallible method of permanently suppressing oscillation is introduced, so that besides having a sensitive and selective set one will have a stable receiver. The tone is most excellent. Send \$4.00 for 34 weeks subscription (34 issues) and get the blueprint, three shielded coils and drilled metal chassis free. Chassis is 13.75 x 9 x 3 inches. Order Cat. PRE-D-5-COMB.

Analyzer Plug and Adapters

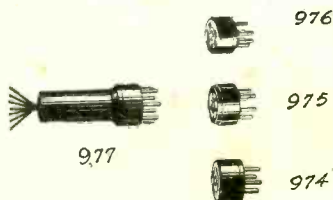

For constructing a set analyzer, an analyzer plug, to go into a receiver socket, is necessary. We offer the exclusive seven-pin analyzer plug, plain long handle as illustrated, and three adapters that enable putting the plug

connections into UX, UY and six-pin receiver sockets. The plug has 5-foot 7-lead cable. All four parts sent free on receipt of \$6.00 for one-year's subscription (52 issues). Order Cat. PRE-ANPLAD.

RADIO WORLD and } \$7.00 RADIO NEWS }

Get both of these magazines for one year for \$7.00, although the regular subscription price of RADIO WORLD alone is \$6.00 a year and that of "Radio News" alone is \$2.50 a year. Instead of paying \$8.50 you pay \$7 and you get 52 issues of RADIO WORLD (one a week) and 12 issues of "Radio News" (one a month). "Radio News" recently bought "Citizens Radio Call Book," and "Technical Review" and consolidated them with "Radio News." This offer at this combination price applies only to United States and possessions. Send \$7.00 and order Cat. PRE-RWRN. To Canadian and other Foreign subscribers the combination price offer is at \$8.50 for these two magazines. Order Cat. PRE-FOR-RWRN.

RIDER'S MANUAL

The standby of the service man is John F. Rider's "Perpetual Trouble Shooter's Manual," of which Vols. 1 and 2 have been published. Vol. 1 consists of 2,000 diagrams of commercial receivers, power amplifiers, converters, etc. Total pages, 1200. Vol. 2 contains additional diagrams on the same basis as above, but in Vol. 2 there is no duplication of any of the diagrams printed in Vol. 1. To get Vol. 1 free, send \$9.00 for 1½-year subscription (78 weeks) and order Cat. PRE-RM-1. To get Vol. 2 free, send \$9.00 for 1½-year subscription (78 weeks) and order Cat. PRE-RM-2.

PHONOGRAPH MOTOR

Allen-Hough synchronous phonograph motor, 78 revolutions per minute; takes up to 12-inch records. Works from a-c line, 50-60 cycles, 105-120 volts. Equipped with felt-covered turntable. To start the motor give it a slight impetus. Fits into 3-inch depth, hence handy for compact installations. Given free with 34-weeks subscription at \$4.00. Order Cat. PRE-PHOMO.

A-C, D-C SOLDERING IRON



A serviceable iron that works on a-c (any frequency) and d-c, 105-120 volts. Sent free on receipt of \$1.50 for three-months subscription (13 issues). Order Cat. PRE-SOLIN.

0-10,000-Ohm Resistance Meter

A 0-10,000-ohm ohmmeter and continuity tester. A rheostat is built in for correct zero resistance adjustment. The unit contains a three-cell flashlight battery. Supplied with two 5-foot-long wire leads with tip plugs. Case is 4-inch diameter baked enamel. Sent you for an order for one year's subscription for RADIO WORLD (52 weeks) at the regular rate of \$6. Order Cat. PRE-500.

We do not pay postage on resistance meter. Average postage 17c.

DOLLAR SPECIALS

R-F CHOKE COILS

These coils have 50, 100, 200, 400 and 800 turns, diameter 1 inch, and are suitable for detector plate filtering, screen filtering, grid and plate loads, etc. The 50 is for short waves, 100 for television band, 200 for broadcast band, 400 for high intermediate frequencies (450 to 300) and 800 for lower intermediate frequencies. Any four, or four of a kind, or combinations not exceeding total of four, sent free on receipt of \$1.00 for 8 weeks trial subscription. Order Cat. PRE-4-CH and state chokes desired, by quantity and number of turns.

TWO BOOKS BY ANDERSON AND BERNARD

"The Superheterodyne," by J. E. Anderson and Herman Bernard. A treatise on the theory and practice of the outstanding circuit of the day. Special problems of superheterodynes treated authoritatively.

CHOICE OF PANEL TYPE METERS

- One meter sent free with each \$1.00 trial subscription (8 weeks). Order Cat. PRE-MTR and add the number of the meter to the catalogue number. Any number of meters may be ordered on the equivalent extended subscription basis.
- 0-6 Voltmeter D.C. No. 326
 - 0-50 Voltmeter D.C. No. 337
 - 6-Volt Charge Tester D.C. No. 23
 - 0-10 Amperes D.C. No. 338
 - 0-25 Milliamperes D.C. No. 325
 - 0-50 Milliamperes D.C. No. 350
 - 0-100 Milliamperes D.C. No. 390
 - 0-300 Milliamperes D.C. No. 399
 - 0-400 Milliamperes D.C. No. 394

HANDY PACKAGE OF PARTS

One grid condenser of 0.00025 mfd., with clips; one 5-to-7 meg. fixed grid leak; one knob with ¼-inch shaft; one a-c cable and plug. All sent on receipt of \$1.00 for 8-weeks trial subscription. Order Cat. PRE-HANPKG.

SHIELDS FOR 57, 58 TUBES

Aluminium shields of the type specified by the tube manufacturers for sensitive circuits, so that the shield top fits snugly about the tube dome, are obtainable, six free on receipt of \$1.00 for 8 weeks trial subscription. Order Cat. PRE-TUBSH.

RADIO WORLD, 145 West 45th Street, New York, N. Y.
(WE PAY POSTAGE ON ALL PRODUCTS LISTED ON THIS PAGE, EXCEPT OHMMETER).