

RADIO

REG. U.S. PAT. OFF.

WORLD

The First and Only National Radio Weekly
Eleventh Year 566th Consecutive Issue

SUPER DIAMOND 7;

96 Channels Out Of 96

Latest Developments In
OSCILLATORS

Circuits of New Sets by

CROSLEY

JAN. 28

1933

15¢ Per Copy

6-TUBE D-C T-R-F RECEIVER

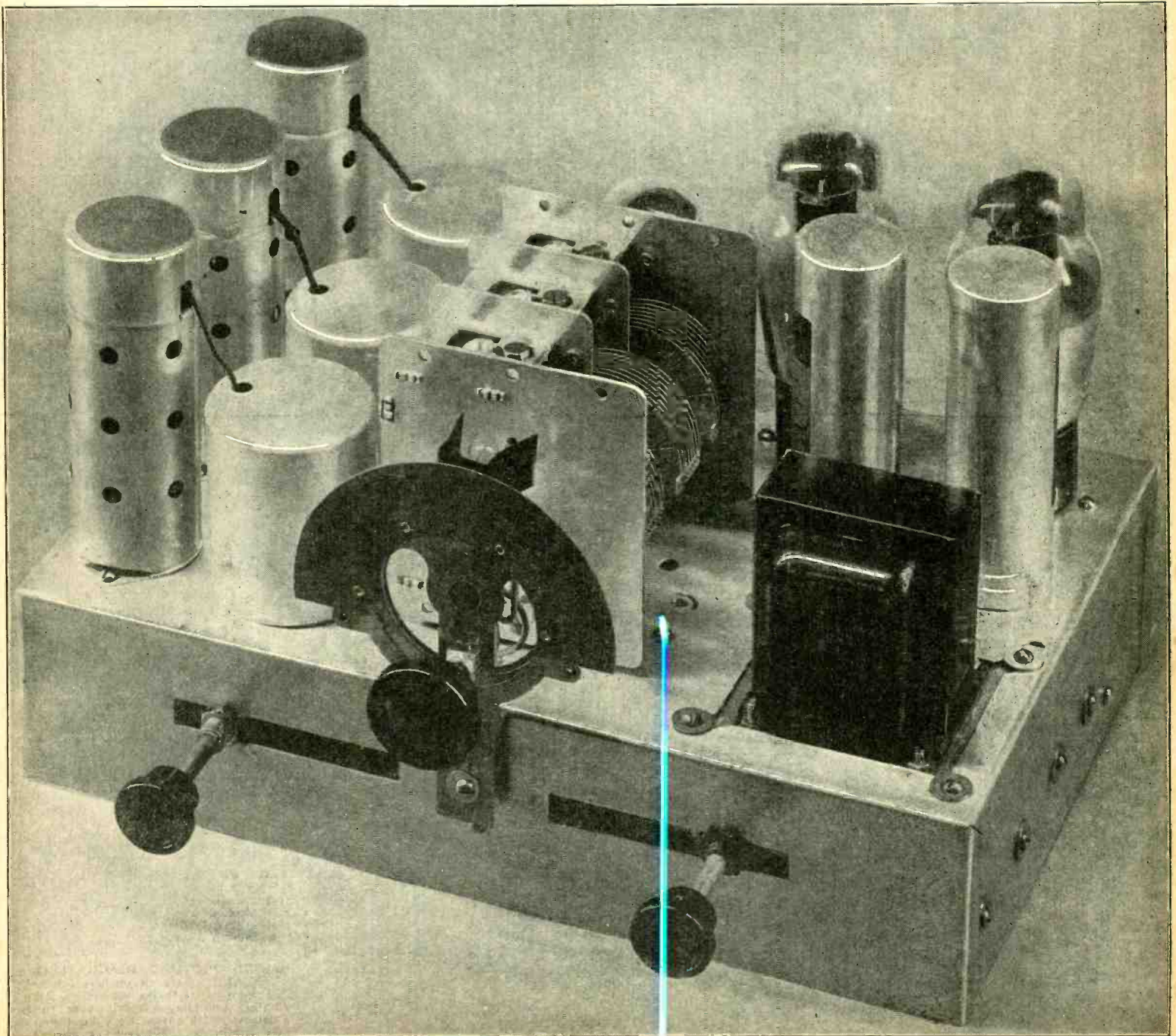

This six-tube receiver, designed by Alan Mannion for d-c operation on 110-volt line, separated distant stations 10 kc apart, and provided abundant volume with 43 push-pull output. See pages 12 and 13.

ANNOUNCING A NEW RADIO! The D-C PATHFINDER

6-TUBE TUNED RADIO FREQUENCY KIT — COMPLETE WITH DYNAMIC SPEAKER \$13.95

USING 2-39—1-36—1-37—2-48

HIGH GAIN AUDIO GIVING VOLUME WITH PURITY OF TONE
ADDED EFFICIENCY MADE POSSIBLE BY USE OF DOUBLE 48-TUBE
A GREAT ACHIEVEMENT—SETS NOW ON DEMONSTRATION
MAIL ORDERS FILLED PROMPTLY — DIAGRAM FREE. GET YOURS NOW

ANOTHER THOR NUMBER

6-TUBE A-C TUNED RADIO FREQUENCY KIT—COMPLETE WITH DYNAMIC SPEAKER \$13.95

USING 2-58—1-57—2-59—1-280

THOR'S BARGAIN BASEMENT

167 Greenwich Street, between Cortlandt and Liberty Streets, NEW YORK

Mr. SERVICEMAN

Take a tip! Get Rider's Volume II of the Perpetual Trouble Shooter's Manual. Buy it today. Don't wait until you cannot repair a receiver because you do not have the data. **FREE.** If you are a Service Man, write for the color code chart of the resistors used in Atwater-Kent receivers. Enclose 3c to cover postage.

RADIO TREATISE CO., Inc.
1448 Broadway New York City

115 DIAGRAMS FREE

115 Circuit Diagrams of Commercial Receivers and Power Supplies supplementing the diagrams in John F. Rider's "Trouble Shooter's Manual." These schematic diagrams of factory-made receivers, giving the manufacturer's name and model number on each diagram, include the MOST IMPORTANT SCREEN GRID RECEIVERS.

The 115 diagrams, each in black and white, on sheets 8 1/2 x 11 inches, punched with three standard holes for loose-leaf binding, constitute a supplement that must be obtained by all possessors of "Trouble Shooter's Manual," to make the manual complete.

Circuits include Bosch 54 D. C. screen grid; Balkite Model F. Crosley 20, 21, 22 screen grid; Eveready series 50 screen grid; Eria 224 A.C. screen grid; Peerless Electrostatic series; Philco 76 screen grid.

Subscribe for Radio World for 3 months at the regular subscription rate of \$1.50, and have these diagrams delivered to you FREE!

Present subscribers may take advantage of this offer. Please put a cross here to expedite extending your expiration date.

Radio World, 145 West 45th St., New York, N. Y.

ANDERSON'S AUTO SET

Designed by J. E. ANDERSON

FOREIGN RECEPTION ON 6-INCH AERIAL

This new auto set is the most sensitive car receiver we have ever come across. Mexican and Canadian stations were tuned in from New York City on a 6-inch aerial. The circuit, an 8-tube superheterodyne, with automatic volume control. The complete parts, including set chassis and set shield, battery box, remote control, battery cable, all condensers, resistors and coils, speaker with shielded cable; and a kit of RCA tubes (two 239, two 236, two 237, one 89, and one 85) are supplied less aerial. Cat. 898-K @ \$34.60
Wired model, licensed by RCA, with complete equipment, less aerial, but including RCA tubes. Cat. 898-W \$37.40

DIRECT RADIO CO.

143 West 45th St. N. Y. City

1-WATT PICTAIL RESISTORS @ 5c EACH
in following ohmages: 350; 800; 1,200; 20,000; 50,000; 100,000; 250,000; 2,000,000; 5,000,000. Direct Radio Co., 145 W. 45 St., N. Y. City.

TROUBLE SHOOTER'S MANUAL

Having assembled 2,000 diagrams of commercial receivers, power amplifiers, converters, etc., in 1,200 pages of Volume No. 1 of his Perpetual Trouble Shooter's Manual, John F. Rider, noted radio engineer, has prepared Volume No. 2 on an even more detailed scale, covering all the latest receivers. Volume No. 2 does not duplicate diagrams in Volume No. 1, but contains only new, additional diagrams, and a new all-inclusive information on the circuits covered.

Volume No. 2—Perpetual Trouble Shooter's Manual, by John F. Rider. Shipping weight 6 lbs. Order Cat. RM-VI @ \$5.00
Volume No. 1 (4 lbs.). Order Cat. RM-VO @ \$5.00

We pay postage in United States on receipt of purchase price with order. Canadian, Mexican and other foreign remittances must be in funds payable in New York.

RADIO WORLD, 145 W. 45th St., N. Y. City

Quick-Action Classified Advertisements

7c a Word — \$1.00 Minimum
Cash With Order

BACK ISSUES OF RADIO WORLD WANTED: Jan. 8, 1930; Mar. 1, 1930; Mar. 22, 1930. Holders please write Dr. J. M. B. Hard, 49 Wall St., New York City.

THE FORD MODEL—"A" Car and Model "AA" Truck—Construction, Operation and Repair—Revised New Edition. Ford Car authority. Victor W. Page. 708 pages, 318 illustrations. Price \$2.50. Radio World, 145 W. 45th St., New York.

"TALKING MOVIES," by James R. Cameron. A History of the Talking Movie since 1899, with an elementary explanation as to how the pictures are produced and reproduced. Paper cover, \$1.50. Radio World, 145 W. 45th St., New York, N. Y.

"MATHEMATICS FOR SELF STUDY," by J. E. Thompson, B.S. in E.E., A.M. A complete course in four inexpensive books: Arithmetic, Algebra, Trigonometry, Calculus, for the Practical Man. 1240 pages, cloth, illustrated, \$7.65. Radio World, 145 W. 45th St., New York City.

SUPER DIAMOND PICTURE DIAGRAM (6-TUBE) FULL SCALE. This circuit has proven very successful and popular, using one stage RF, autodyne oscillator, one stage intermediate frequency, diode detector with automatic volume control, 59 pentode output, and 280 rectifier. Circuit described in Radio World, issues of Dec. 17, 24, and 31, 1932, and Jan. 14, 1933. (Picture Diagram in issue of Jan. 14, 1933.) 15c each issue, or all four for 50c. Radio World, 145 W. 45th St., New York City.

BLUEPRINTS OF STAR CIRCUITS

8-TUBE AUTO SET

Sensitivity of 10 microvolts per meter characterizes the 8-tube auto receiver designed by J. E. Anderson, technical editor of Radio World, and therefore stations come in with only six feet of wire for aerial, and without ground. Most cars will afford greater aerial pickup, and besides the car chassis will be used as ground, so with this receiver you will get results. The blueprint for construction of this set covers all details, including directions for cars with negative A or positive A grounded. The circuit features are: (1) high sensitivity; (2), tunes through powerful locals and gets DX stations, 10 kc either side; (3), latest tubes, two 239 pentode r-f, two 236 screen grid, two 237 and two 238; push-pull pentodes, all of 6-volt automotive series; (4), remote tuning and volume control on steering post, plus automatic volume control due to low screen voltage on first detector; (5), running board aerial. The best car set we've published. This circuit was selected as the most highly prized after tests made on several and is an outstanding design by a recognized authority. Send for Blueprint 631, @ 50c

SHORT-WAVE CONVERTER

If you want to build a short-wave converter that costs only a very few dollars, yet gives good results, furnishing all its own power from 110 volts a-c, and uses no plug-in coils, you can do so from Blueprint 630. Price..... 25c

RADIO WORLD, 145 West 45th Street, New York, N. Y.

5-TUBE AC, T-R-F

Five-tube a-c receivers, using variable mu r-f, power detector, pentode output and 280 rectifier, are not all alike by any means. Forty circuits were carefully tested and one selected as far superior to the others. This prized circuit was the 627, and if you built it, you will always be glad you followed our authentic Blueprint, No. 627. This is the best 5-tube a-c t-r-f broadcast circuit we have ever published. Price 25c

A-C ALL-WAVE SET

An all-wave set is admittedly what many persons want, and we have a circuit that gives excellent broadcast results, and is pretty good (not great) on short waves. No plug-in coils used. Cost of parts is low. Send for Blueprint, No. 628-B, @..... 25c.

In preparation, an 8-tube broadcast superheterodyne for 110v d-c. Write for particulars.

ROLAND BURKE HENNESSY
Editor

HERMAN BERNARD
Managing Editor

RADIO WORLD

The First and Only National Radio Weekly
ELEVENTH YEAR

J. E. ANDERSON
Technical Editor

J. MURRAY BARRON
Advertising Manager

Vol. XXII

JANUARY 28th, 1933

No. 20, Whole No. 566

Published weekly by Hennessy Radio Publications Corporation, 145 West 45th Street, New York, N. Y.

Editorial and Executive Offices: 145 West 45th Street, New York

Telephone: BR-yant 9-0558

OFFICERS: Roland Burke Hennessy, President and Treasurer; M. B. Hennessy, Vice-President; Herman Bernard, Secretary.

Entered as second-class matter March, 1922, at the Post Office at New York, N. Y., under Act of March 3, 1879. Title registered in U. S. Patent Office. Printed in the United States of America. We do not assume any responsibility for unsolicited manuscripts, photographs, drawings, etc., although we are careful with them.

Price, 15c per Copy; \$6.00 per Year by mail. \$1.00 extra per year in foreign countries. Subscribers' change of address becomes effective two weeks after receipt of notice.

OSCILLATORS

Recent Developments in Field That Was Hitherto Almost Ignored

By J. E. Anderson

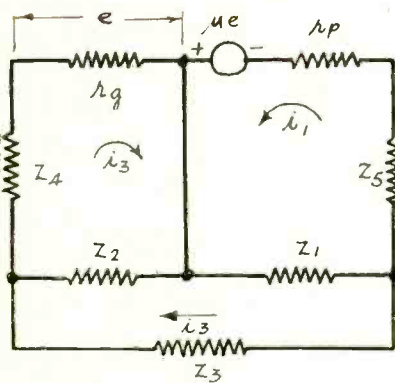

FIG. 1

A generalized oscillator of the Hartley or Colpitts types. Z1, Z2, and Z3 are the reactances in the resonant circuit.

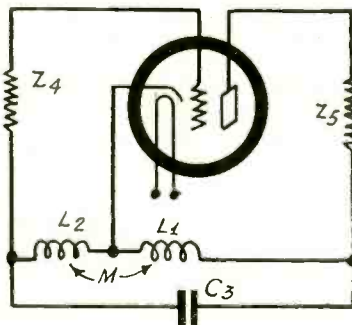

FIG. 2

A Hartley oscillator with stabilizing impedances Z4 and Z5. With proper values of these the oscillator frequency will be independent of the plate voltages.

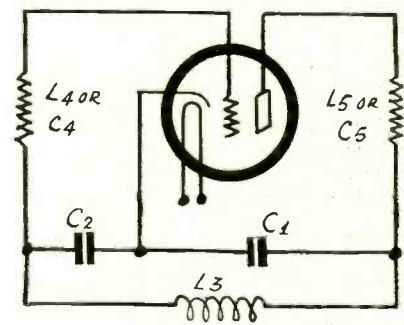

FIG. 3

A Colpitts oscillator with stabilizing reactances in the grid and plate circuits. The object of the stabilizers is to permit the resonator to be driven in phase.

INTENSE research on frequency stabilization of oscillators of different kinds has been going on the last ten years. The result is that the stability achieved has been increased from about one part in 10,000 to one part in ten million, or even better. That is worth all the work that has been expended on the problem.

But why is such high stability necessary? The crowding of communication channels on radio and wire circuits and the necessity of keeping the various signals from interfering with each other have forced the solution. Everybody who uses a radio receiver is the beneficiary of the beneficent results. For a long time the Federal Radio Commission required that all broadcast stations remain within 500 cycles of the assigned frequency. Thus the stations were allowed to stray from that frequency by as

much as half a kilocycle either up or down. But many of them strayed much farther than they were entitled to.

A time came, not long ago, when the Federal Radio Commission required that all stations remain within 50 cycles of the assigned frequencies. The rigor of the requirements was increased ten-fold in one jump. And by the time the Commission made this requirement it was easier for the stations to stay within 50 cycles of the assigned frequency than it had been before to stay within 500 cycles. The reason was that oscillators of higher stability had been developed, both for the master oscillators of the transmitters and for the monitoring oscillators used for checking the transmitter oscillators. Moreover, the government had erected a standard frequency station sending out a wave of 5 megacycles against which

any station in the country could check its oscillator or its secondary standard. This frequency sent out by the government has an accuracy of better than one in a million.

Piezo Oscillators

The greatest advance in the stabilization of oscillators came about as a result of the discovery of the quartz crystal piezo oscillator. The quartz crystal has a very low temperature coefficient of change of the natural frequency, partly because the elastic constants of quartz do not change much with changes in temperature and partly because the dimensions of the quartz do not change much. Another reason for the constancy of the quartz crystal, and perhaps the most important, is that it has extremely low internal losses. In other words, the quartz

(Continued on next page)

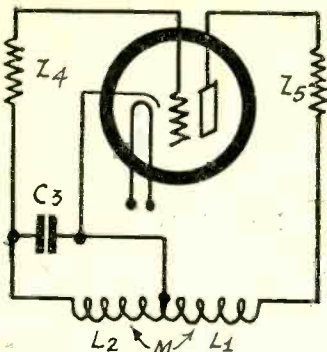

FIG. 4

A tuned grid oscillator with the positions of the stabilizers indicated.

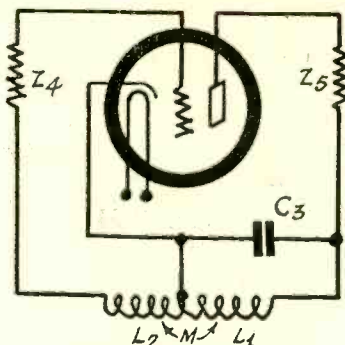

FIG. 5

A tuned plate oscillator. It is always possible to find values for Z_4 and Z_5 which will stabilize the circuit.

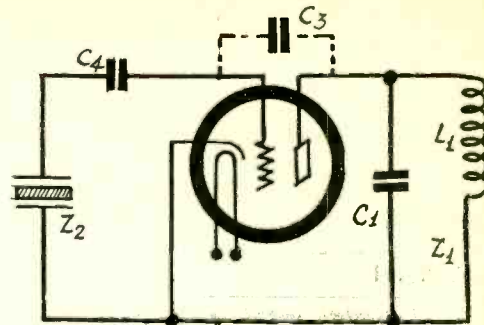

FIG. 6

The tuned grid, tuned plate oscillator may also be stabilized. In this circuit the grid tuned "circuit" is a piezo crystal.

(Continued from preceding page)

crystal is a resonant device that has an extremely high selectivity.

The stabilization of oscillators has reached the point where we no longer have any reliable means of measuring their frequencies accurately. All frequency measurements, as well as all time measurements in general, depend on the constant rate of rotation of the earth. The question now is whether or not the rate of rotation is constant enough for the purpose of measuring the frequencies of the highly stabilized oscillators. The rate of rotation would undoubtedly be constant if there were no external forces at work, but there are many such forces interfering with the earth's rotation. All the planets affect the rate to some extent, but just how much is difficult to tell.

Degree of Stability

As was stated, the constancy of the best oscillators is better than one part in a million. Indeed, an oscillator has been described that had a constancy of one part in 100 million. Let us see what this means in a practical way. A year is approximately 365.25 days long. In each day there are 86,400 seconds. If we multiply this number by the number of days in a year we get 31,557,600 seconds in a year. Let us call it 32 million in round numbers.

Suppose now we use an oscillator having a constancy of one part in 100 million for driving an electric clock, gearing this clock so that it would keep exact time if the oscillator had a given frequency, say 1,000 cycles per second. Since the oscillator is constant to one part in 100 million and there are 32 million seconds in a year, it would require 3.13 years for that clock to gain or lose one second. Indeed, it might take much longer for the uncertainty of the oscillator frequency may be either positive or negative and may be changed from one to the other throughout the years, and the average might come near to perfect accuracy. However, for radio frequency standards we are not interested in long-time averages but in accuracy all the time and at any time.

Such accuracy as was outlined above is not for radio receivers, nor even for ordinary radio laboratory standards. But for receiving short waves by means of the superheterodyne method we need a rather high stability in the oscillator. A numerical example will show this clearly. Suppose we wish to receive a signal having a frequency of 50,000 kc by means of a superheterodyne employing an intermediate frequency of 100 kc. If we detune the intermediate tuner by as much as 1,000 cycles we may notice it, if the i-f selector is sharp. Therefore we should keep the frequency constant to at least 1,000 cycles. That means 1,000 cycles out of 50 million, that is, one part in 50,000. Even that modest requirement is greater than that which could be expected of oscillators available 10 years ago.

This requirement may be all that is necessary for broadcast reception, but for c.w. code it is hardly enough. Suppose we adjust the circuit so that the audible beat frequency is 500 cycles. A variation of this frequency of 100 cycles, if rapid, would be decidedly annoying. Hence we might say that for this purpose the oscillator should be constant to one part in half a million, if the signal frequency is of the order of 50 megacycles.

Means of Stabilization

Many devices for the stabilization of the frequency have been discovered. Perhaps the first requirement is that the resonant circuit or frequency-determining resonator should be highly selective. With high selectivity the frequency is determined almost entirely by the resonator while with a lower selectivity it is affected greatly by other factors, such as voltage supply and load variations. The high stability of tuning fork, quartz crystal, and magnetostriction oscillators is due to high selectivity.

Constancy of amplitude is another condition for stability of frequency. The wider the swing, that is, the greater the amplitude, the longer is each period of vibration, and consequently the lower the frequency. This is in part due to imperfections in the resonator and partly to lack of linearity of the characteristics of the driving tube. Hence for stability of frequency the amplitude should be maintained constant.

Driving the resonator at its natural driven frequency is also an essential condition. This is a matter of phase shift. If there is a phase shift in the driving circuit this phase shift is compensated by an equal and opposite phase shift in the resonator, which means that the resonator is driven off its natural frequency. While this does not necessarily change the frequency if the phase shift remains at a given value it will produce a change if there is a change in the phase shift. The higher the selectivity the smaller the frequency change due to a given change in phase. Changes in phase may be produced by a change in the plate resistance of the driving tube, which in turn may be due to a change in amplitude or a change in the operating voltages of the tube.

Temperature Effects

Changes in temperature will produce changes in the natural frequency of the resonator. If the resonator is of the mechanical type these changes are due to changes of dimensions and changes in the elastic constants. If the resonator is electrical the changes are due to changes in the inductance and capacity, which are mostly due to changes in dimensions.

Two methods for stabilizing against temperature changes are used. The first is to maintain the temperature constant by means of thermostats and by placing the resonator inside a chamber in which the temperature is controlled. The other is based on com-

pensation, that is, the use of devices of opposite temperature coefficients. This principle is always used in clocks and watches. In a pendulum clock the length of the pendulum remains constant because as one part of the pendulum increases in length as the temperature rises another part decreases in the same degree or increases in the opposite direction. In watches the balance wheel is constructed so that its moment of inertia always remains the same.

The same principle has also been applied to piezo quartz oscillators. One crystal has a negative coefficient and another a positive coefficient of the same magnitude and the two crystals are combined so that the net temperature coefficient of the oscillator remains constant over the range of temperature the resonators are likely to fluctuate.

Invariable Material

In all cases, of course, an effort is made to find materials for the resonators which have very low coefficients. If the frequency is determined mainly by length of a rod, such as a pendulum, the choice is invar steel, which, as the name indicates, has a zero coefficient of linear expansion with temperature, or it is made of fused quartz, which has an extremely low coefficient. If the frequency is mainly determined by the elastic constants, elinvar steel is used. This is so named because it has an invariable elasticity. Tuning forks are made of this material. Another alloy, maginvar, is also used for the purpose, because this alloy has similar properties.

These materials are usually limited to mechanical oscillators, but to some extent they can also be used for electrical oscillators. For example, the inductance can be wound on a form of fused quartz to minimize the change in dimensions of the coil. Likewise the insulators in the condenser can be made of this material to minimize the change in capacity. The constant temperature chamber, of course, is equally applicable to all types of oscillators, though perhaps not of equal convenience in all cases.

Stabilization by Critical Adjustment

One method of stabilizing electrical oscillators has been investigated thoroughly by F. B. Llewellyn, of Bell Laboratories. (Proc. I. R. E., December, 1931). This is based on certain adjustments of the circuit. The object is so to choose the constants of the circuit that the grid and plate circuit resistances have no effect whatsoever on the frequency, and hence so that changes in the supply voltages on the tube have no effect.

The general arrangement for the Hartley and Colpitts types oscillator is indicated in Fig. 1. Here the impedances are generalized. The circuit comprising Z_1 , Z_2 , Z_3 , and Z_m is the frequency-determining circuit, or the resonator. Z_4 and Z_5 are the impedances to be found so that the frequency

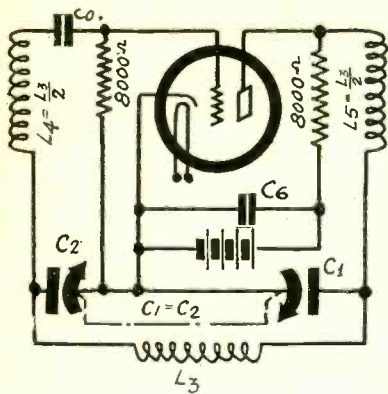

FIG. 7

This is a stabilized Colpitts oscillator arranged to make variation in the frequency possible without altering the stability.

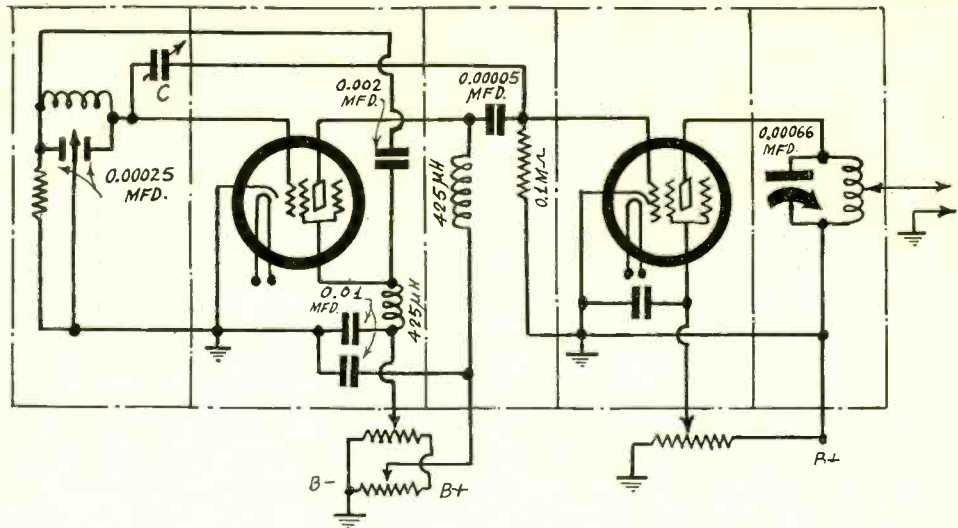

FIG. 8

The circuit of the Dow constant frequency oscillator. The oscillator is of the electrical type with the resonator in a constant temperature chamber. It is frequency stabilized in respect to changes in the load. It uses so-called electron coupling, or mixture in the space stream of a vacuum tube.

is entirely independent of the grid resistance r_g and the plate resistance r_p . Sometimes Z4 alone is needed, sometimes Z5, and sometimes both. Sometimes Z4 is an inductance, sometimes a capacity. Likewise Z5 may assume one or the other. Llewellyn assumes always that the reactance in the resonator is zero, and hence that the circuit is to be driven at the natural frequency.

When Z4 alone is used the circuit is called grid-stabilized. When Z5 alone is used the circuit is called plate-stabilized. When both are used it is, of course, both grid and plate stabilized.

Examples

In Fig. 2 the general circuit in Fig. 1 has been modified to fit the Hartley circuit. The impedances in the resonators have been replaced by the appropriate reactances, the coils being assumed to have no resistance. If Z4 is zero and Z5 alone is used for stabilization, it should be a condensive reactance and the capacity required is given by $C_5 = C_2 [L_0 / (L_1 + L_2 A^2 - 2MA)]$, in which $L_0 = L_1 + L_2 + 2M$ and $A = (L_1 + M) / (L_2 + M)$. If L_1 and L_2 are equal the value C_5 is $C_2 L_0 / (L_1 + L_2 - 2M)$.

In case Z5 is zero and Z4 is used alone for stabilization C_4 has the same value as before except that it is multiplied by A^2 . Thus if the inductances are equal the condenser has the same value whether it is put in the plate circuit or the grid circuit. Notice also that if there is no coupling between the two inductances the stabilizing condenser, in the case when the two coils are equal, has the same value as the tuning condenser.

In Fig. 3 is a typical Colpitts oscillator in which L_3 , C_1 , and C_2 constitute the resonator. If Z4 is zero and Z5 alone is used for stabilization, L_5 should be equal to $L_3 C_2 / C_1$. If the stabilizing coil is placed only in the grid circuit L4 should be equal to $L_3 C_1 / C_2$. If the two condensers in the tuned circuit are equal the two stabilizing inductances would be equal and each equal to the inductance in the tuned circuit.

Two Stabilizing Impedances

In Fig. 3 we may also put a stabilizing impedance in each circuit. If we choose an inductance L_5 for the plate circuit the stabilization may be effected either by putting a condenser C_4 in the grid circuit or and inductance L_4 . The following equations

may be used for determining the grid reactance: $L_4(C_2/C_1) + L_5(C_1/C_2) = L_3$ and $L_4 = L_3(C_2/C_1) [1 + C_2^2/C_1(C_1 + C_2)]$. From these L_4 or C_4 can be computed in terms of the other reactances as soon as L_5 has been selected.

If $C_1 = C_2$ these equations become: $L_4 = L_4 + L_5$ and $L_5 = L_3(1 + C_2/2C_1)$.

In view of the critical adjustments necessary in these stabilized oscillators they are not well suited for variable frequency generators. This applies also to the tuned grid and tuned plate oscillators that follow. However, there is one exception. If the two condensers C1 and C2 in the Colpitts oscillator are ganged and are so related that their ratio is always unity, the specialized Colpitts oscillator can be used over a range of frequencies and the adjustment will not change. The other stabilized oscillators are practical only when the frequency is to remain at a given value. There are many applications where such oscillators are useful.

Tuned Grid Oscillator

In Fig. 4 is a tuned grid oscillator in which the stabilization may be done in either the grid or the plate circuit. If Z5 is zero and a condenser C_4 is put in the grid circuit, this condenser should have the value $C_4 = C_3 k^2 / (1 - k^2)$, in which k is the coefficient of coupling between the plate and grid inductances. If Z4 is zero and Z5 only is used for stabilization, C_5 should equal $C_3 L_2 / L_1 (1 - k^2)$, in which k has the same significance.

In each of these cases it will be noted that if the coefficient of coupling is unity the stabilizing capacity is infinite, which means that none is required. If, therefore, a coil of unity coupling could be made, there would be no need of any stabilizing capacity. Of course, such a coil is not possible, but there are other means of producing the same effect. Llewellyn gives several possible arrangements whereby effective unity coupling is obtained, but they are rather complex and are not taken up here for that reason. However, the theory indicates that to obtain a stable oscillator in any case, including a variable frequency oscillator, the coupling between the tickler and grid coils should be made as tight as possible.

Tuned Plate Oscillator

Fig. 5 shows a typical tuned plate oscillator. In this case also stabilization may be

effected by reactances in the grid or the plate circuits. If it is done in the grid circuit alone, C_4 should equal $C_2 L_1 / L_3 (1 - k^2)$ and if done in the plate circuit alone C_5 should equal $C_2 k^2 / (1 - k^2)$, in which k is the coefficient of coupling between the two coils.

In either case, as for the tuned grid oscillator, greater stability may be effected by making the coefficient of coupling high, for as k increases either C_4 or C_5 increases without limit, and may be replaced by a short circuit.

Both the tuned grid and the tuned plate oscillators may be stabilized by putting suitable reactances in both the grid and the plate circuits. The formulas giving the necessary relations are complex and are not reproduced.

Tuned Grid, Tune Plate

An oscillator having one tuned circuit on the grid side and another of the same natural frequency on the plate side, and in which the only coupling is that of the grid-plate capacity, may also be stabilized. Fig. 6 is such an oscillator, except that the tuned circuit on the grid side is a piezo quartz crystal. This crystal is a highly resonant vibrator having an effective impedance Z2 and equivalent capacity C_2 and equivalent inductance L_2 connected in parallel. By varying C_1 and L_1 the piezo oscillator can be stabilized.

Suppose we have an oscillator with inductance-capacity circuits on both sides, then the relation that must exist is given by $(C_1 + C_2) L_1 = L_2 (C_2 + B)$, in which $B = (1 + \mu) C_2 C_4 / [C_1 + (1 + \mu) C_2]$. In this case for the first time the stabilization depends on the amplification factor μ of the tube. Since this may vary slightly with the voltages on the tube the accuracy of this stabilization is open to question. It will be remembered that the stabilization discussed applies only to variations in the grid and plate resistance and not to changes that may occur in the natural frequency of the resonator.

In all the foregoing oscillators only the a-c circuits have been shown. In most cases a grid leak is essential and in all cases a d-c circuit to pass the plate current is necessary on the plate side. The grid leak can be connected in the usual fashion without any change in the theory, for this leak may be considered as a part of the grid resist-
(Continued on next page)

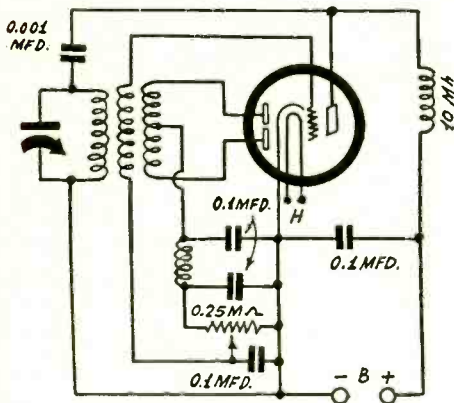

FIG. 9

In this oscillator the frequency and amplitude are held constant by means of an amplitude-controlled grid bias by the principle explained by Arguimbau. It is the plate resistance that is controlled.

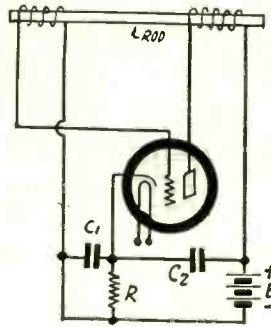

FIG. 10

The essentials of a magnetostriction oscillator in which the frequency is controlled by the mechanical properties of a metal rod of magnetostrictive material.

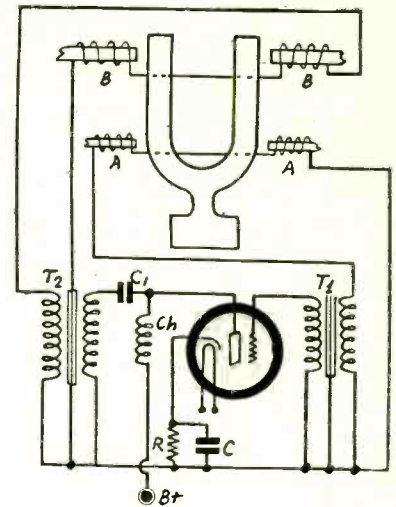

FIG. 11

This is a typical circuit of a tuning fork oscillator. The frequency is controlled by the mechanical properties of the fork.

(Continued from preceding page)
ance. The d-c circuit can be provided by using a high impedance choke coil in series with the plate battery, and if this impedance is high it will not affect the theory appreciably. If a stopping condenser is needed, either on the plate or the grid side, it should be made so large that its reactance at the frequency of oscillation is negligible.

Practical Colpitts

Fig. 7 shows how a Colpitts oscillator may be arranged so as to retain the frequency stability and at the same time permit varying the generated frequency over a wide band. Two equal condensers C_1 and C_2 are ganged with the rotor connected to the cathode of the tube. The tuning coil L_3 is connected across the two. L_4 in the grid circuit is equal to L_3 in the plate circuit, and each is equal to one-half of the tuned circuit inductance. C_3 is a stopping condenser of so large a capacity that its reactance is negligible. C_4 is a by-pass condenser across the battery, and its capacity is also so large that its reactance is negligible. In place of a plate choke in series with the plate battery an 8,000-ohm resistance is used, and to match it, an equal resistance is used for grid leak.

The significant feature of this circuit is that it contains three series tuned circuits, all adjusted to the same frequency. First we have the circuit $C_1C_2L_3$, then the circuit C_1L_4 , and then C_2L_4 . In view of the fact that these circuits are resonant to the same frequency it is difficult to see how it can oscillate at all. In the first place the voltage across C_1L_3 considered as a series tuned circuit is zero and in the second place the voltage across L_4C_2 , similarly considered, is also zero. There appears to be no input voltage and no output voltage at the resonant frequency, except such voltages as exist across the coil resistances, and these have been neglected in the theory as developed by Mr. Llewellyn. Of course, there is a voltage across C_3 and therefore there is a current through the grid leak and the grid resistance. Thus there is a voltage impressed on the grid, and it is impressed in phase. Likewise, there is a current in L_3 , and hence in C_1 . Thus there is energy fed to the resonant circuit containing L_3 . Both theory and experiment show that the circuit does oscillate.

Minimizing Effect of Load

J. B. Dow, Bureau of Engineering, Navy Department, has developed a constant fre-

quency oscillator with special attention to stability in respect to variation in the load on the oscillator. The circuit of his oscillator is shown in Fig. 8. Apparently no attempt has been made to stabilize the circuit in respect to variations in the voltage supply, except that he uses a grid leak, which always exerts a stabilizing influence in that it tends to keep the grid bias constant.

The oscillator is of the Colpitts type, as it uses a single coil and a split tuning condenser. A high inductance choke is used in the plate circuit—in this case actually the screen of the tube—and a stopping condenser. This stopping condenser may have been chosen in such a manner that the effect is plate circuit stabilization, but this point is not emphasized.

Three definite things are done to stabilize the frequency against possible variation in the load impedance. The first is thorough shielding. The resonant circuit is placed in one compartment, the one at the extreme left. The oscillator tube is placed in another, the next from the left. Certain coupling impedances are placed in a third, the power tube, or work tube, is placed in another, and the output tuned circuit in still another.

The next thing done is neutralization of the grid-plate capacity of the oscillator tube. This is a very small condenser C connected between the grids of the two tubes in the circuit, and placed in the first compartment. This condenser is naturally extremely small since it must be of the same order of magnitude as the grid-plate capacity of the tube. The plate in this case, as has already been pointed out, is the screen of the tube. Therefore the grid-plate capacity is not nearly as small as it would be if the regular plate were used as plate in the oscillator.

The third thing done to prevent feedback is the use of so-called electron coupling. The plate of the tube is connected through a small condenser and suitable plate reactance and grid leak to the grid of the power tube. There is extremely little ordinary coupling between the plate of the tube and the screen, and this is mostly capacity, which is neutralized, as was explained above.

As a further means of de-coupling the circuits two separate voltage dividers are used on the oscillator, one for the screen and one for the plate. Still another is used for the screen and the plate of the work tube. By means of these potentiometers not only is the reverse coupling reduced to a very small value but the various supply

voltages may be independently adjusted for optimum operation of the circuit. The optimum in one case might for efficiency and in the other for frequency stability.

Constant Temperature

As a means of stabilizing the frequency in respect to changes in temperature the master resonator is placed in a constant temperature compartment. The left compartment is not only the shield for the tuner, but also the constant temperature chamber.

Constant temperature chambers are very much like refrigerators except that the constancy of the temperature is greater. Extreme precautions are taken to insure freedom from radiation, convection, or conduction of heat either into or out of the chamber. Of course, there is no trouble preventing convection but radiation and conduction are not so easily prevented. As a matter of fact some loss of heat from the device is necessary and energy is always being supplied, for it takes energy to drive the device, although this is extremely small. Most of the energy is supplied by a heating device consisting of a coil carrying current. The length of time this current is allowed to flow is determined by a thermostat inside the chamber.

Since there must necessarily be some latitude in the thermostat the temperature will not remain quite constant. It is necessary for the temperature to fall to a given value before the thermostat will operate, and then it must rise to a given value before the thermostat will again stop the current. The narrower the limits the more nearly constant will the temperature be.

A Continuous Thermostat

The ideal thermostat would be one which operated continuously, that is, without any breaks whatsoever. It may be pointed out that the wire in the heating coils functions in this manner to a certain degree, for as the temperature decreases the resistance decreases and the current admitted increases. This in turn increases the heating. When the temperature rises the reverse occurs. This effect is very small but it could be increased by selecting a heating wire with a high temperature coefficient of resistance.

Another way that this could be done is to take advantage of the fact that the resistance of carbon decreases with pressure. It would be a simple matter to arrange a thermostat so that when the temperature falls a greater pressure would be exerted on the carbon.

Whether or not such a device would be adequate is another question.

If this continuous thermostat is to work the voltage supplied to the heating element should be constant. If V is the constant voltage supplied to the heating coil and R is the resistance, then the energy supplied is V^2/R . The rate of change of energy supplied as the temperature changes is $-V^2\alpha/R$. Where α is the temperature coefficient of resistance of the wire. The negative sign indicates that as the temperature increases the energy supplied decreases. The energy supplied, of course, is a measure of the heat delivered to the chamber. The value of R is the resistance of the heating coil at the normal operating temperature of the wire.

Automatic Control of Plate Resistance

In the critical methods of stabilizing the frequency as described by Mr. Llewellyn, the effects of the grid and plate resistances were neutralized. What was really done in all these cases was to impose the condition that the resonant circuit should oscillate at its natural frequency and then to determine stabilizing reactances which would allow the circuit to oscillate at this value. With these determined and inserted in the oscillator the circuit adjusted itself until the ratio of the plate and the grid resistances had the necessary value. In one sense the adjustment amounted to insuring that there should be no change of phase in the circuit as a whole, or that the tube changed the phase by 180 degrees in one direction and that the external circuit changed it by the same amount in the opposite direction, all this subject to the condition that the current in the resonant circuit should be in phase, or that there should be no reactance in that circuit.

Another method of stabilizing has been devised by L. B. Arguimbau, General Radio Company, and described in the January, 1933, issue of the Proc. I. R. E. In this method the plate resistance of the tube is automatically kept constant by means of an amplitude-controlled grid bias. It is an automatic volume control, so to speak, operating on the oscillator tube by the oscillation generated by that tube. If the amplitude of the generated oscillation increases for any reason the bias on the tube is immediately increased, decreasing the amplification and thus restoring the amplitude to its original value. This is a clever arrangement, extremely simple, and does not seem to be at all critical. It is applicable to variable-frequency oscillators and has the advantage that the amplitude of the generated oscillation is nearly the same for all frequencies. It has been shown experimentally that a change in the capacity ratio of 10 to one only changed the amplitude by two per cent. This capacity ratio is equivalent to a frequency ratio of 3.16 to one, which is considerably greater than the ratio of frequencies in the broadcast band.

Constant Plate Resistance

In Mr. Arguimbau's circuit the grid resistance was considered infinite, or that the bias was always so high that no grid current flowed. Therefore the grid resistance cannot enter into the conditions for amplitude or frequency equilibrium. Neither will there be any energy loss in the grid circuit. We can expect a more selective resonator and for that reason a more frequency-stable oscillator. However, in the oscillators shown there was no explicit attempt to drive the resonator at its natural frequency. The constancy of the frequency therefore depends on the constancy of the plate resistance.

In most non-critical oscillators the frequency is dependent on the ratio R/r , where R is the resistance of the resonator and r is the plate resistance of the tube, or the total resistance in the plate circuit. In one simple oscillator the frequency generated is to a first approximation increased by the factor $(1+R/2r)$. It is the r in this that is held constant in Arguimbau's circuit by means of the amplitude-controlled bias.

It is clear that the lower R is the more

nearly is the generated frequency equal to the natural frequency of the circuit, for any given value of r . And the larger r is for a given value of R , the smaller the change in frequency for a given change in r . This fact is taken advantage of when a high value fixed resistance is connected in the feedback circuit. When the tube resistance is small in comparison with the total resistance in the plate circuit, a given change in the plate resistance will have a small effect on the frequency. In the Arguimbau oscillator the value of r is kept high because the tube is always operated with a negative bias, and it is held constant in addition. Since R is likely to be lower and r higher in this oscillator we can expect a greater constancy of frequency, even though the resonator is driven off its natural frequency. Moreover, we can expect a small change in frequency as a result of unavoidable small deviations in the constancy of the plate resistance.

An Arguimbau Oscillator

In Fig. 9 is a diagram of an oscillator in which the Arguimbau principle is used. The circuit employs a duplex diode-triode tube, such as the 55. The circuit is of the tuned plate type. A 10 millihenry choke is used in the d-c portion of the plate circuit and a 0.001 mfd. condenser in the a-c branch.

The coil consists of three windings, a tuned winding across the tuning condenser, a grid winding, and a center-tapped winding for the rectifier.

If there were no center-tapped winding the circuit would oscillate but the bias would be zero, for the circuit would be a regular oscillator with zero bias. When the center-tapped winding and the rectifier are used there is no bias when the power is first turned on, but as soon as oscillation builds up there will be a voltage across the 0.25 megohm load resistance on the rectifier, and part or all of this voltage becomes bias on the grid. As soon as the power is turned on the oscillation builds up until the bias has assumed a value where the circuit is in equilibrium, and there it is held. The amplitude does not change appreciably.

One of the conditions for close control of the amplitude is that there should be a high ratio between the amplitude and the rectified voltage. This means that the rectifier should be of the crest type, which calls for a high load resistance on the diode and full utilization of the drop across it. And it also calls for close coupling between the oscillating coil and the center-tapped winding. If, however, the load resistance is made large and the full drop is utilized there is danger of blocking of the grid, which will give rise to a modulation. The potentiometer is used for making the optimum adjustment.

The coil in the oscillator may be a regular broadcast tuning coil suitable to the condenser employed. The large winding should be in the plate circuit and the smaller in the grid circuit. To this coil should be added the center-tapped winding.

Magnetostriction Oscillator

Fig. 10 shows the connections of a magnetostriction oscillator. There are two coils, one in the plate circuit and one in the grid circuit. Through these coils is the magnetostriction rod, such as monel metal. The rod should be supported at the exact center and it should not touch the coils or the forms on which the coils are wound.

Note the direction of the windings of the two coils. They are connected just opposite to the way they would be connected in an electrical oscillator. If this reversal is not done the rod will not be maintained in oscillation by the tube, but, on the contrary, any vibration set up by jarring or otherwise will be damped out quickly.

Because of this necessary reversal it is clear that the oscillator is not of the electrical type but depends on the properties of the rod. Suppose there exists a voltage across the grid coil of the natural frequency of vibration of the rod. This is amplified by the tube and the resulting plate current will flow through the plate coil. A stress will be applied to the rod by virtue of its mag-

netostriction properties and this will cause the rod to vibrate longitudinally. Both ends will vibrate and the vibration in the grid coil will cause a voltage to be developed therein. This voltage is impressed on the grid.

The magnetostriction oscillator is of the same order of constancy in respect to frequency as the tuning fork. However, there is not so wide a choice of magnetostrictive materials as of fork material. The fork may be chosen because it has an invariable temperature coefficient. It does not have to be magnetostrictive.

The magnetostriction oscillator has the advantage that it requires little space and therefore that it can easily be put inside a constant temperature chamber. In this respect it is nearly as convenient as the piezo quartz oscillator.

The oscillator is most suitable for high and medium audio frequencies. In order to get it to oscillate at even the lowest radio frequencies the length of the rod would be extremely short and it would be difficult to excite it.

Tuning Fork Oscillator

Many of the oscillators of highest precision are made of a tuning fork. A typical circuit of this type is shown in Fig. 11. The two coils B are electromagnets or permanent magnets with a.c. superimposed. These magnets are so placed near the ends of the prongs that when an alternating current of the proper frequency is passed through the coils the fork will vibrate.

The coils A are permanent magnets with windings of a large number of turns. The magnets are so placed near the prongs that when the prongs vibrate the reluctance is varied and this induces an electromotive force in the windings. The voltage thus obtained is impressed on the grid of the tubes, in this case after it has been stepped up by a transformer T_1 . The grid voltage results in an alternating plate current which is delivered to the primary of an output transformer R_2 . The plate is parallel fed through a high inductance choke Ch and a stopping condenser C_1 of large value is used to prevent the space current from flowing into the primary of the transformer. The secondary of T_2 is connected in series with the two driving coils B .

For greatest efficiency of the circuit the coils must be matched. That is, the windings A must match the primary of T_1 and there should be a high step-up ratio because the grid will be operated at a negative bias making the grid impedance practically infinite. The primary of T_2 must also match the plate resistance of the tube, because in this case we are interested in the greatest possible output and not in the greatest output voltage or in the greatest undistorted output. Again, the secondary of T_2 must match the impedance of the two coils B .

Harmonic Elimination

Getting rid of harmonics in the tuning fork oscillator is extremely easy. It is only necessary to treat them as non-existent. The harmonics of the fork are not simple, that is, they are not integral multiples of the fundamentals. Those generated in the tube are such multiples. But these harmonics cannot disturb the fork because they are far off from any frequency that could excite the fork. It is only necessary to consider the fundamental.

Placing of the driving magnets has been investigated with the idea of eliminating clang tones—tones generated by the fork when it is struck at an improper place. Just what is meant by clang tones and improper place can be illustrated with a baseball bat. Strike a speedy ball with the end of the bat and the batter is badly jarred, but the ball does not go far. Strike the ball at the right spot and there will be no jarring but the ball will earn the batter a home run. The proper spot is the center of gyration of the bat.

This might be an argument against placing the driving magnets near the ends of the prongs, and, indeed, it has been used. But the magnets do not strike. They merely exert a gentle, continuous back and

(Continued on next page)

(Continued from preceding page)

forth pull. Even if there were any clang tone vibrations present they would be damped out quickly.

What is needed is to place the magnets where the least force of the gentle type mentioned will produce the greatest effect. That is obviously near the end. That is just as obvious as it is that a spring board will bend the most when the diver stands at the very end of the board. That is why the driving magnets are near the ends.

When the magnets are placed there they may be placed farther from the prongs, allowing them to vibrate without striking. Moreover, when they are placed at a distance, say an eighth of an inch, the permanent pull on the ends of the prongs will be very small, which is an advantage because then the fork will vibrate very nearly about its position of equilibrium when there is no force exerted on the prongs.

Placing Pick-up Magnets

There might be some point in placing the pick-up magnets A where there will be no clang tone vibrations but it is not important. What is important is to place them so that for a given swing the change in reluctance in the magnetic circuit should be as great as possible. Therefore we must make the air gap as small as possible. This is only possible if the pick-up magnets are placed where there is little vibration, near the base of the fork.

For best effect, and for any effect at all, the phase relations must be correct. The prongs will alternately move toward and away from each other. The driving coils must be connected so that they aid in this motion. Likewise the pick-up magnets must be placed so that the electromotive forces generated in the two parts will add up.

With these details disposed of the windings in the transformers should be connected properly. If the fork will not start vibrating with one combination it is only necessary to reverse one pair of leads. There are four pairs from which to choose and no one has any particular advantage over any other.

The total phase shift around the circuit is zero. That is the only way the circuit can oscillate. However, that does not mean that there can be no phase shift in the individual parts. If there is a shift in the electrical portion of the circuit that must be compensated by an equal and opposite shift in the fork, which means that the fork will be driven off its natural frequency. There is no easy way of measuring a phase shift but it is comparatively easy to change the phase until the fork is driven at its natural frequency. This is equivalent to tuning, not of the fork or resonator, but of the driver. The adjustment should be made until the fork vibrates with a given amplitude with the least possible supply of energy, or until the amplitude is greater for a given amplification.

Amplitude

There is no means shown in Fig. 11 for varying the phase or the amplification. However, the gain can be controlled by moving either the driving or the pick-up magnets closer or farther away from the prongs. The farther they are away the less the amplitude will be. Usually it is not necessary to do anything about the phase. However, one thing that could be done is to put a condenser in series with the A circuit or with the B circuit and varying this condenser for greatest effect. A condenser could also be connected across the secondary of T_1 . This would change the phase just as it does in a tuned radio frequency transformer.

For highest precision the amplitude of the fork should be of microscopic dimensions. If the fork is in the air there should be no audible sound from it and it should require audio amplification to make it audible. The amplitude, as was stated, can be varied by varying the distances between the magnets and the fork. Another way is to vary the voltages applied to the tube. But varying these is likely to introduce a shift in phase and hence a small shift in the frequency.

Vatican City Uses Reflectors

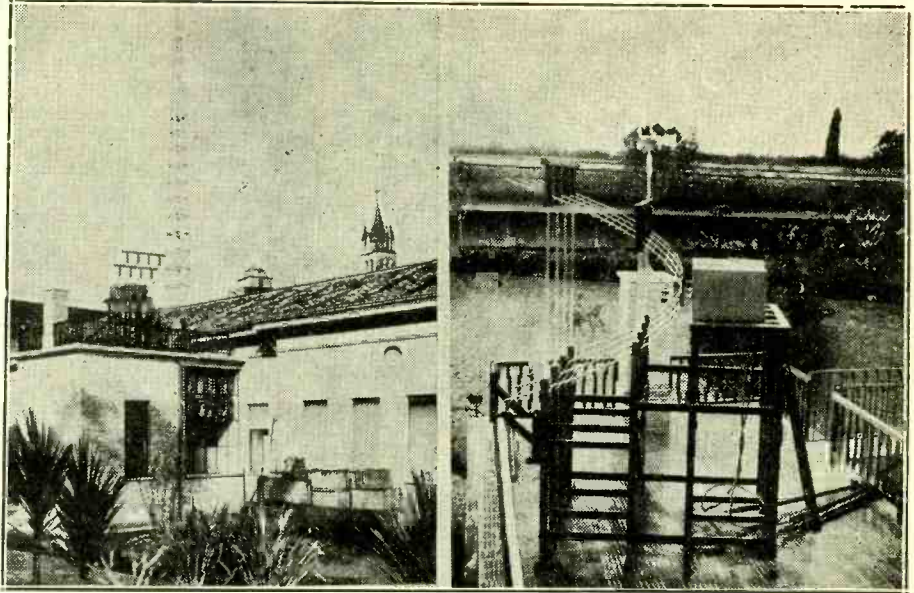

(Acme)

The parabolic reflector used at the new Vatican City ultra-short wave transmitter is shown at right while at left is a view of the Vatican City receiving and transmitting station.

Adjusting the circuit to oscillation of the fork in phase would minimize this change in frequency.

Constant Gain

At this point we might mention the possibility of employing the principle given by Mr. Arguimbau to stabilize the amplitude of the fork against changes in the supply voltages. Suppose we introduce an amplitude controlled bias in the grid circuit of the tube. If then the amplitude of the fork started to increase because of an increase in the gain of the amplifier, the bias would immediately increase and this in turn would decrease the gain. The circuit would settle down to a constant amplitude. Of course, we would have to take generated voltage from the tube and apply it to a rectifier. It would be necessary to employ a good audio filter in this rectifier. In view of the extremely low amplitude it might be necessary to amplify the signal voltage before it could be used advantageously for automatic bias.

It may be pointed out that the signal level in the tube need not be extremely low in order that the fork should be driven at an extremely small amplitude. We have a high voltage step-up between the A coils and the grid and then we have a step-down on the other side of the tube. Moreover, we are at liberty to adjust the distance between the B coils and the prongs.

Importance of Phase

If no precautions are taken to make the circuit drive the fork in phase it may take two stages of amplification, with one tube a high gain type, in order to drive a 100-cycle fork with an amplitude that can be seen and heard. With the proper phase adjustment and the proper matching, a single tube with a medium μ will do it. The actual energy required to drive a good fork is infinitesimal and the energy required in the driving coils is of the order of one microwatt.

The use of the automatic bias for controlling the amplitude has one other advantage. It requires a certain amplification to start the fork going. Thus there is a minimum amplitude. If we have automatic bias we could start with a bias giving maximum gain, or a gain sufficient to start the fork quickly. As the amplitude built up the automatic bias would come into play to limit the amplitude at which the vibration would

stabilize. This amplitude might be much lower than that which would result if it were necessary to depend on a fixed bias and coupling such that would just start the fork going of itself.

It has been found that tuning fork oscillators are influenced to a marked degree by the atmosphere. The atmosphere is a load on the fork that absorbs energy. This energy is mostly converted into sound, even though that sound is inaudibly weak. For this reason forks have been placed in constant temperature chambers in which most of the air was exhausted in which the remaining pressure was maintained constant.

There are other ways in which the frequency of the fork may be changed. If the fork is not mounted perfectly rigidly mechanical vibrations will be transmitted from the fork to its surroundings. Loss of energy and a decrease in the stability of frequency and amplitude result. There is another possibility, in theory at least, for preventing vibrations being transmitted to the surroundings of the fork, and that is to mount the fork in a perfectly non-rigid support. The two methods might be combined, mounting the fork first in a very sturdy frame, employing the same principle as that used in the seismoscope, and then mount this whole assembly in something having very low rigidity.

All such precautions, of course, have a meaning only when the accuracy of the vibration generated is of the order of one part in a million or more. The Bureau of Standards transmits on 5,000 kc with an accuracy better than 1 part in 5,000,000.

Construction Data

On New Miniature Set

Miniature radio receivers have been taking the country by storm. Now these circuits are creating an added demand from the experimenter. From many have come requests for constructional data, with values and diagram, so that the receiver may be custom built.

RADIO WORLD will run a constructional article with full information on a-c, d-c receivers in the issue of February 4th (next week). There will also be information regarding use for police signals and also for operation in autos, airplanes and motorboats.

Crosley

Model 132-1

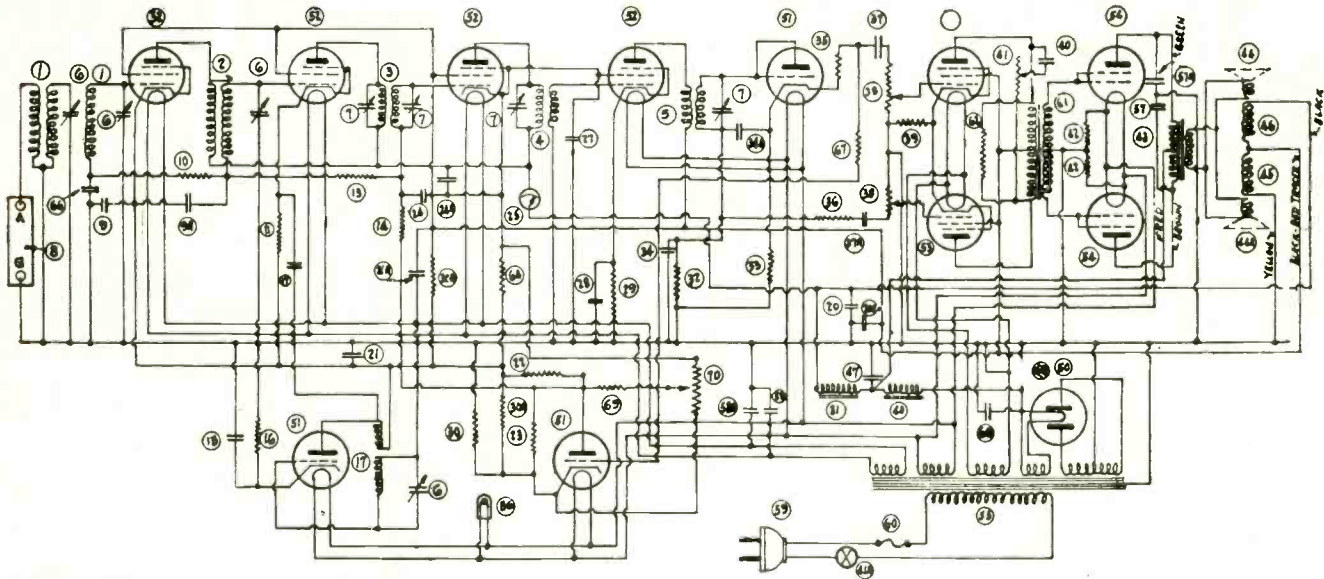

1	61-28967	PRESLECT COIL	24B	W-25438	1 MFD COND	44	MODEL	SPEAKER	67	W-26877	3 MEG RESIS.
2	W-25260	E.F. TRANS.	25	W-26091	TUNING METER	45	324	SPKR. FILD 111A	68	W-26818	0.1 MFD COND.
3	W-25444	I.F. TRANS.	26			46	MODEL	SPKR. FILD 550M	69	W-23787	500 OHM RESIS.
4	W-25445	I.F. TRANS.	27	W-25438	1 MFD COND	47	328	SPEAKER	70	W-26877	MEG. CONTROL
5	63-28448	DIODE TRANS.	28			48	W-26194A	12 MFD COND.			
6	W-26111	VAR. COND.	29	W-22514	750Ω RESIS.	49	W-24628	CHOKER			
7	W-23948	I.F. COND.	30	W-6709	600Ω RESIS.	50	W-25476	200Ω COND.			
8	W-25448	TEMP. SWITCH	30A	W-4921	10,000Ω RESIS.	51	62-12800	56 SOCKET			
9	W-25448	1 MFD COND.	30B	W-25492	700Ω RESIS.	52	62-12800	56 SOCKET			
10	W-4923	60,000Ω RESIS.	31	W-23212-C	FILTER CHOKER	53	62-12800	56 SOCKET			
11	W-23013	200Ω RESIS.	32	W-23785	500,000Ω RESIS.	54	62-12800	56 SOCKET			
12	W-25435	0.02 MFD COND.	33	W-23785	500,000Ω RESIS.	55	62-12800	56 SOCKET			
13	W-4923	60,000Ω RESIS.	34	W-26151A	0.0015 MFD COND.	56	W-23227	DIAL LIGHT			
14	W-21453	1 MFD COND.	34A			57	W-26876	0.02 MFD COND.			
15	W-25435	0.02 MFD COND.	35	W-21455	300,000Ω RESIS.	58	W-25438	1 MFD COND.			
16	W-6705	350Ω RESIS.	36	W-21455	300,000Ω RESIS.	58	W-25438	1 MFD COND.			
17	61-24996	OSCILL. COIL	37	W-23635	0.006 MFD COND.	58A		1 MFD COND.			
18	W-26118	SWITCH	37A	W-23635	0.006 MFD COND.	58	W-21451	CORBY PLUG			
19	W-26877	5 MEG RESIS.	38	W-25367	VOLUME CONTROL	65	W-7393A	FOSE 3AMP			
20	W-26118	1 MFD COND.	39	W-26049	450Ω RESIS.	61	62-12763	RADIO TRANS.			
21	W-26118	1 MFD COND.	40	W-23016	0.5 MFD COND.	62	W-26818	35,000Ω RESIS.			
22	W-26117	4 MFD COND.	41	W-25400	TONE CONTROL	63					
23	W-23403	150,000Ω RESIS.	41A			64	W-23012A	40Ω RESIS.			
24	W-26878	5 MEG RESIS.	42	W-22417A	POTENTIOMETER	65					
25	W-25438	1 MFD COND.	43			66	W-23147	82 MFD COND.			

Specifications

This is a twelve-tube superheterodyne for operation from A.C. electric circuits. It employs a -58 type R.F. amplifier tube, a -58 type first detector tube, a -56 type oscillator tube, two -58 type I.F. amplifier tubes, a -56 type diode second detector tube, a -56 type automatic volume control tube, two -42 type push-pull A.F. amplifier tubes, two -46 type push-pull output tubes, and a -82 mercury vapour rectifier tube.

Voltage Limits

The following are the approximate voltages which should be measured with the tubes in place, speakers connected, and a line voltage of 117½ (235 for 220 volt receivers). Measure plate and screen grid voltages with a high-resistance D.C. voltmeter (1000 ohm per volt) from plate or screen grid tube contact to emitter contact. Measure bias voltages as shown in table. Use a low-range A.C. voltmeter for heater voltages.

Circuit Diagram, Model 132-1

Heater Or Filament Voltages

All tubes but A. F. Amplifier and Rectifier	2.2 to 2.6
A. F. Amplifier tubes	5.2 to 6.4
Rectifier	2.4 to 2.6

Plate Voltages

R. F., First Detector, and First I. F. tubes	180 to 220
Oscillator tube	150 to 190
Second I. F. tube	200 to 240
A. V. C. tube	60 to 80
A. F. Amplifier tubes	190 to 230
Output tubes	380 to 430
Rectifier tube	390 to 440

Screen Grid Voltages

R. F., First Detector, and First I. F. tubes	50 to 70
Second I. F. tube	150 to 180
A. F. tubes	200 to 240

Bias Voltages

R. F. and First I. F. Tubes (cathode to grid)4 to .6
First Detector tube (cathode to grid)	2 to 3
Oscillator (cathode to chassis)	12 to 15
Second I. F. tube	7 to 9
A. V. C. tube (cathode to chassis)	70 to 85
Output tubes (cathode to chassis)	25 to 32
A. F. Amplifier tubes (cathode to chassis)	20 to 27

(SEE TEXTUAL DESCRIPTION ON PAGE 11)

Crosley

Model 141

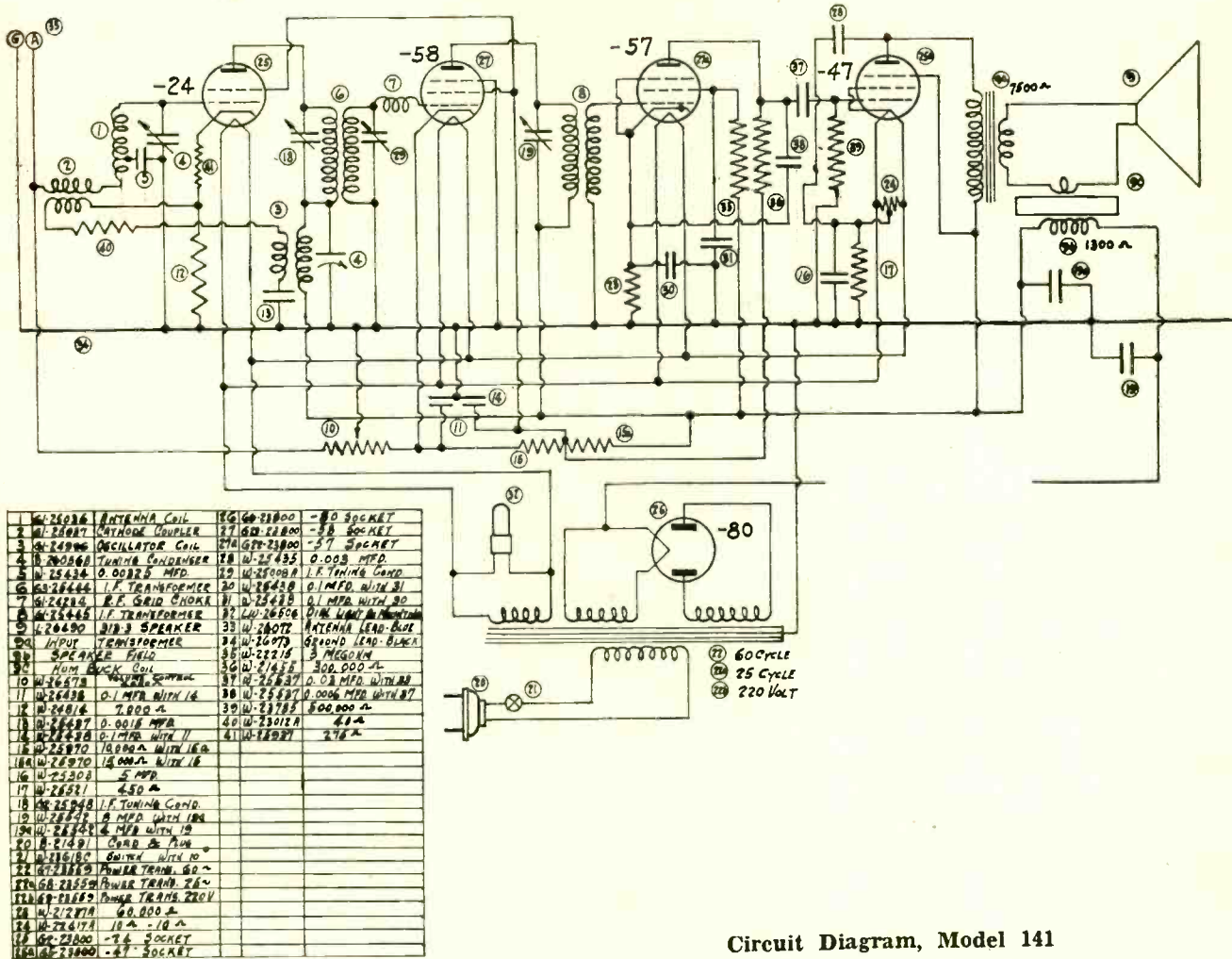

Circuit Diagram, Model 141

Specifications

Model 141 is a five-tube superheterodyne for operation from A.C. electric circuits. It employs the following tubes: a -24 type oscillating first detector, a -58 type I.F. amplifier, a -57 type second detector, a -47 type output tube, and a -80 type rectifier.

Voltage Limits

The following are the approximate voltages which should be measured with the tubes in place, speaker connected, and a line voltage of 117½ (235 for 220 volt receivers). Measure plate and screw grid voltages with a high-resistance D.C. voltmeter (1000 ohms per volt) from plate or screen grid tube contact to emitter contact. Measure bias voltages from

cathode to chassis. Use a low-range A.C. voltmeter for filament or heater voltages.

Heater Or Filament Voltages

All tubes but Rectifier	2.2 to 2.6
Rectifier tube	4.3 to 5.3

Plate Voltages

First Detector and I. F. tubes	230 to 270
Second Detector tube	30 to 50
Output tube	230 to 260
Rectifier tube	340 to 380

Screen Grid Voltages

First Detector and I. F. tubes	90 to 110
Second Detector tube	30 to 50
Output tube	235 to 265

Bias Voltages

First Detector tube	8 to 10
I. F. tube	3.1 to 3.9
Second Detector tube	9 to 12
Output tube	16 to 21

(SEE TEXTUAL DESCRIPTION ON NEXT PAGE)

CROSLY MODEL 132-1

(See diagram on page 9)

The Model 132-1 circuit is the one used in the Crosley Symphony console receiver and the Crosley Chief, also console model. The features are listed by the manufacturer as follows:

Full Class B Amplification Using the New Mercury Tube makes possible tremendous undistorted volume, eliminating overloading at high power peaks, which often occurs and causes distortion in ordinary receivers even when they are turned on at normal volume.

Manual Static Control enables you to adjust the receiver so that a proper balance is obtained between static level and signal strength. This permits quiet tuning between stations and, under normal conditions, the virtual elimination of static.

Automatic Volume Control counteracts fading of distant stations and "blasting" of local stations. Reception is automatically maintained at a uniform volume.

Meter Tuning eliminates guess work in tuning by indicating visually when the receiver is in exact tune with a station. This feature consists of a small indicator above the dial.

New Heater Type Tubes bring about new standards of tone, distance and selectivity.

Continuous (Stepless) Tone Control permits adjustment of the tone quality from bass to brilliant to meet your individual taste.

Full Floating Moving Coil Dual Dynamic Speakers — reproduce tone with startling realism. It seems just as though the performers are in your living room.

Exquisite New Cabinets—In planning, designing and executing these cabinets, furniture designers of note were consulted. The result is very attractive radio furniture for your home.

This chassis employs 12 tubes, including new 2½-volt heater type tubes as follows: one type -5 as radio frequency amplifier, one type -58 as first detector, one type -56 as oscillator, one type -58 as first intermediate frequency amplifier, one type -58 as second intermediate frequency amplifier, one type -56 as a diode second detector, one type -56 as automatic volume control tube, two type -42 in first audio connected in push-pull, two type -46 double grid class "B" amplifier tubes connected in push-pull, one type -82 mercury vapor rectifier tube. In addition to the outstanding features listed elsewhere on this folder, this chassis incorporates Four-Gang Tuning Condenser, Double Tuned Image Suppressor Pre-Selector, Manual Audio Level Control, Illuminated Hairline Shadow Dial with Vernier Drive and other modern radio refinements.

The Symphony has dual dynamic speakers. Dimensions: 41½" high, 26" wide, 14" deep.

The Chief is the same chassis but in a better grade and larger console. Dimensions: 46" high, 28" wide, 15½" deep.

CROSLY MODEL 141

(See diagram on opposite page)

This receiver is put in a jewel case or a book case cabinet.

The jewel case cabinet is a solid oak chest decorated with replicas of rich carvings, substantial beauty — a faithful reproduction of an old Italian cassone! The chest is so designed that it reflects good taste and you would never guess it to be a radio. When not in use it appears to be a chest for valuable papers, a jewel case or an attractive cigar humidor. But when the lid is raised the radio can be turned on and tuned to the desired station. The lid then is left open a few inches so that the sound is reflected into the room. The five-tube Superheterodyne Crosley chassis detailed on page 15 is incorporated in the jewel case.

Dimensions: 9" high, 14½" wide, 9" deep.

The book case model cabinet (library universal) represents a set of books with the following titles—Music, Religion, Education, News, Politics, Sport, Entertainment and Humor. It is so real in appearance that when placed on a table with book ends on either side or on a shelf among other books, no one would possibly suspect that it is anything other than a handsome set of old books. The book-

backs are covered with leatherette of antique coloring. Backs and two sides are embossed and embellished with gold. Titles are in gold and Crosley is embossed in small inconspicuous old English type lettering at the bottom of each volume. "Library Universal" is also embossed on each book and the volumes numbered from one to eight. The book backs are mounted on two doors which swing open and permit the radio to be operated in the same manner as the conventional table model receiver. The radio is the five-tube Crosley Superheterodyne receiver detailed on page 15.

Dimensions: 10¼" high, 13½" wide, 8 9/11" deep.

The cabinets are different, but the receivers are the same (see page 15). Both employ a five-tube superheterodyne chassis of modern type using the new heater type tubes which make possible better performance. Tubes used are as follows: one type -24, one type -57, one type -58, one type -47 and one type -80. Other features are: Balanced Image Suppressor Pre-Selector, Combined Volume Control and On-Off Switch; Illuminated Hairline Shadow Dial with Vernier Drive and a Crosley full-floating moving coil dynamic speaker.

A THOUGHT FOR THE WEEK

THE automobile industry is looking for an upturn of 200% in sales during 1933 over those of 1932. Why shouldn't radio sales show the same increase? Let the battle cry of the trade this year be: "Two to one over last year," and then do the things which will bring about this result.

That sounds like optimism? Of course it does. When has a pessimist ever been the life of any party?

W. PELHAM, New Harmony, Ind.—Please forgive delay in answering your letter. Have a terrific schedule ahead of me and very little time for anything else but preparing programs, broadcasting them and digging up news for "Sparks." Had to send to New York; there is still some delay at that end.

L. McCONNEL, Dayton, Ohio.—John Brewster plays the role of Jimmy Bradshaw in the Charlie Chan mystery stories. Don Becker is a native of Covington, Ky.

—ALICE REMSEN

TRADIOGRAMS

By J. Murray Barron

Paul R. Krich, Vice-President of the Krich Distributing Co., Newark, N. J., advises that all indications point to a banner year for the R.C.A. Victor Radio. Other electrical devices likewise show an increase.

A very good tip that should prove of real value to many now as an added avenue for extra business is the quick sale for the new miniature radio. It has been proven in a demonstration that a salesman carrying one of these portable radio receivers, the weight being less than six pounds, and simply walking into small business and professional offices and retail stores can gain the immediate attention of a large number and actually sell for cash. In some cases two and three sales were made on one demonstration.

A number of new tubes coming out has caused an added interest in adopting some of them in place of tubes now used, which in turn means the revamping of receivers in many instances and with the consequent purchase of the new sets of tubes. In the kit business, experimenters are keen for new tubes and are continually incorporating them in their custom-built receivers.

From various sections of the country reports are coming in of added users of Pix. It must be understood that it is not a cure-all but has a definite purpose, and for that purpose satisfaction is guaranteed. Postal Radio Corp., 133-135 Liberty Street, N. Y. City, will send some free information to out-of-town experimenters who may be interested in interference eliminating device and selectivity adjuster which Pix is.

There is now being marketed a new scanner for television, guaranteed to give satisfactory operation. It retails at moderate price. For those interested, free literature may be had by addressing Trade Editor.

BANKRUPTCY PROCEEDINGS New York

Cosmos Broadcasting Co., Inc., 100 5th Ave., New York City—No schedules filed.

RECEIVERS IN BANKRUPTCY

Mayo Instrument Corp., 21 West 18th St., New York City.

ASSIGNMENTS New York

Sheirr's Radio, Inc., 1439 St. Nicholas Ave., New York City, to George H. Weikoff, 491 Shepherd Ave., Brooklyn, N. Y.

Literature Wanted

Readers desiring radio literature from manufacturers and jobbers should send a request for publication of their name and address. Address Literature Editor, RADIO WORLD, 145 West 45th Street, New York, N. Y.

Kenneth M. Dilly, 760 W. Lincoln Blvd., Freeport, Ill.
R. O. Gandel, 2226 Scott St., Davenport, Iowa.
Joseph S. Guyda, Mgr., 591 Seneca St., Oil City, Penna.
A. L. Draper, 3304 Louisiana St., Houston, Texas.
Hartman Broom Co., Clay Center, Kansas.
Dr. Carl R. Gross, 49 Olney St., Providence, R. I.
Tony Frattaroli, Box 583, New Canaan, Conn.
Walter H. Rogers, Dames & Rogers, Sunrise Theatre, Ft. Pierce, Fla.
John S. Jarecke, 57 Ridge St., Glen Lyon, Penna.
C. N. Rich, 8 Spruce St., Brockton, Mass.
S. O. Sittinger, 2963 Poplar St., Erie, Penna.
Luther W. Martin, 801 S. New Ave., Springfield, Mo.
Smith's Piano & Radio Service, E. P. Smith, 56 St. George St., Moncton, N. B., Canada.

SHORT-WAVE CLUB

Phil Gerhardt, 210 William St., Orange, N. J.
Jack Ruhmland, 1477 New York Ave., Altadena, Calif.
Ronald R. Myers, 622 E. 5th St., Marysville, Ohio

THE D-C PA

By Alan

Thor R

THE advent of the 48 power tube has made it possible to make real d-c receivers. It is seldom that a tube comes out that receives so much praise as this tube has received. When it comes to operation on a 110-volt d-c line it is in a class by itself, and it was especially designed for this purpose. Of course, the filament voltage is such that it can also be used on 32-volt farm lighting circuits directly without any ballast resistors.

Well, here is a six tube receiver of the t-r-f type, The D-C Pathfinder, designed with these new tubes. It has excellent sensitivity and fine selectivity. As a test of its selectivity, and indirectly of its sensitivity, station WCCO was tuned in on 810 kc without any interference from WFAA on 800 kc. The reverse test was equally successful.

The sensitivity is obtained by using two 239 radio frequency amplifiers with two high-gain radio frequency coils. These coils, in addition to a high voltage gain, have the advantage that they are very nearly uniformly efficient on the entire tuning band. Stations on 550 kc come in as well as stations on 1,500 kc. While these high-gain coils are used there is no sacrifice in selectivity, as was pointed out above. The first tuner in the circuit is of the regular transformer type, which is more satisfactory between the antenna and the first tube.

Heater Circuit

Let us trace the heater circuit. Starting with the line switch in the positive side, which controls not only the heater current but also the plate and field currents, we come to a 62.5-ohm, 25-watt ballast resistor. Passing on we come to the filaments of the two 48s. Then we come to a branch, one going to a pilot light with a 40-ohm resistor across it and the other going to a 300-ohm, 5-watt resistor. The object of the 300-ohm resistor is to pass the extra 0.1 ampere required by the 48s. Only 3 watts are dissipated in this resistor so that a 5-watt resistor is entirely within the limit of safety. The object of the 40-ohm resistor across the 6-volt pilot lamp is to prevent excessive current through the lamp. The combined current through the lamp and the resistor is 0.3 ampere, which is the correct value for the tubes connected on the left of the lamp.

The plate current per tube in the push-pull stage is 50 milliamperes and the screen current per tube is 9 milliamperes. Hence the total current to the push-pull stage alone is 118 milliamperes. If this current were sent through the filament choke there would be a high voltage drop in it. Since as much of the available voltage is possible is desired on the tubes the supply to the push-pull stage is not filtered by means of a choke but only by means of an 8 mfd. condenser. That is quite sufficient in view of the fact that the line voltage is partly filtered to start with and also in view of the fact that the stage is push-pull.

The speaker field, which has a resistance of 1800 ohms, is connected directly across the line and in such manner that the field current is filtered by the first 8 mfd. condenser.

Supply to R-F Tubes

The plate supply to the r-f amplifiers, the detector, and first audio amplifier is filtered by a 400-ohm choke and another 8 mfd. condenser. The effective voltage is approximately 100 volt. The screen voltage on the

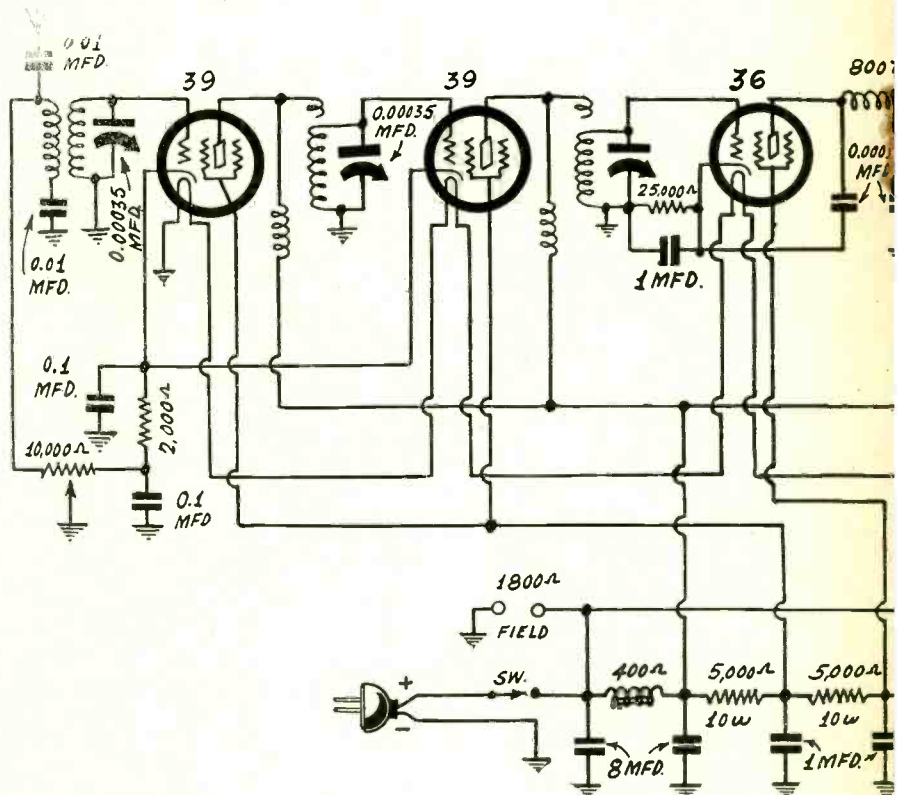

The circuit diagram of the Pathfinder six-tube, push-pull, t-r-f receiver. The tone control condenser shows

two r-f amplifiers is about 50 volts, a value that gives stable operation together with high sensitivity. The screen voltage on the detector is only 5 volts. This is an experimental value that gave best detecting efficiency combined with excellent quality of the output.

To effect the proper voltage division a 500-ohm, 2-watt resistor is placed between ground and the screen of the detector. Next a 5,000-ohm, 10-watt resistor is used between the screen of the detector and the screens of the r-f tubes, and finally another 5,000, 10-watt resistor between the screens and the choke. A one microfarad condenser by-passes each of the screen taps. These high by-pass capacities greatly help to stabilize the r-f amplifier and improve the quality of the output of the detector.

Another point where an unusually large condenser is used is across the 25,000-ohm bias resistor in the detector, which is also one microfarad. It gives the low notes a chance to come through.

R-F Filtering

In the plate circuit of the detector we have a radio frequency consisting of two 0.0001 mfd. condenser and an 800 turn r-f choke, a combination that is quite effective in keeping the radio frequency currents out of the audio amplifier.

Between the detector and the first audio tube we have a 100,000-ohm plate resistor, a 0.01 mfd. stopping condenser, and a half megohm grid leak. These are suitably chosen to give a good amplification on the lowest audio frequencies as well as on all higher essential frequencies.

In the first audio amplifier tube we again note that quality has been kept in mind. Across the 1,500-ohm bias resistance a by-pass condenser of one microfarad is used. This combination insures that there shall be

LIST OF

Coils

- One 400-ohm Pathfinder choke.
 - One antenna coil for 0.00035 mfd. condenser.
 - Two high-gain interstage coils for 0.00035 mfd. condensers.
 - One 800 turns r-f choke coil.
 - One push-pull input transformer, Pathfinder.
- ### Condensers
- One gang of three 0.00035 mfd. tuning condensers.
 - One Pathfinder condenser block consisting of four 1 mfd. and two 0.1 mfd. condensers.
 - One 0.1 mfd. condenser for tone control.
 - One 0.01 mfd. mica condenser.
 - Two 0.01 mfd. paper condensers.
 - Two 0.0001 mfd. condensers.
 - Two 8 mfd. dry electrolytic condensers.

Resistors

- One 10,000-ohm volume control potentiometer.
- One 0.5-megohm variable resistor for tone control with d-c line switch attached.

PATHFINDER

Mannion

Radio Co.

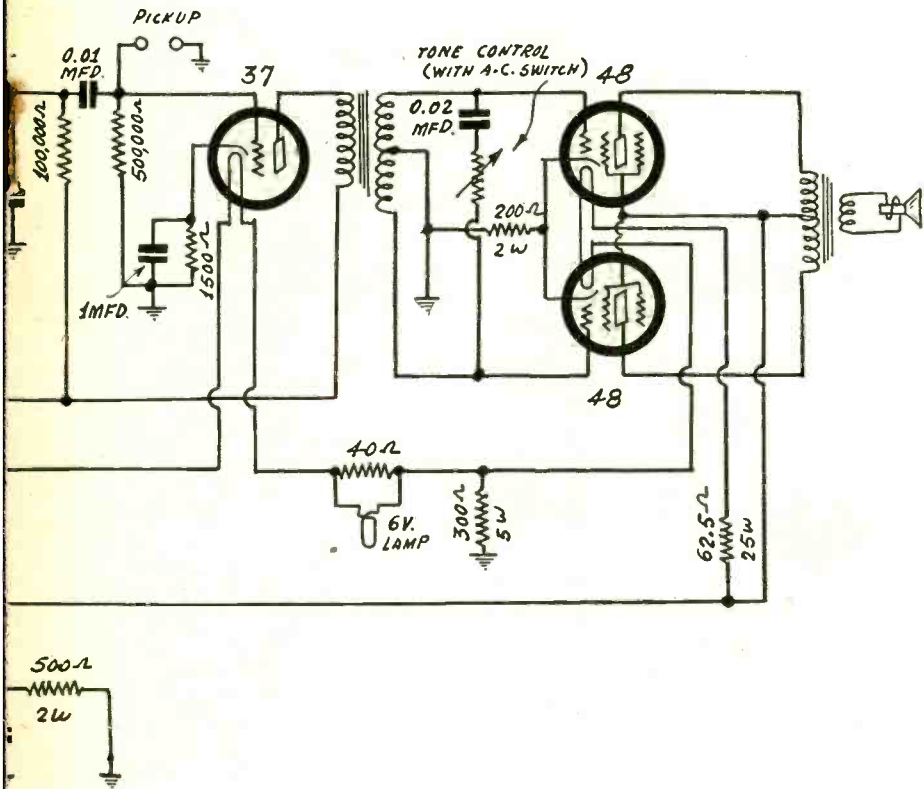

G. 1
High gain and selectivity with great output of fine quality are features. Could be 0.1 mfd. instead of 0.02 mfd.

no reverse feedback on any of the essential audio notes.

The coupling between the first audio and the push-pull stage is, of course, by means of a push-pull transformer. One of good

quality suitable to the 37 tube has been selected.

A bias resistance of 200 ohms is used in the push-pull stage, which is the correct value for two 48 tubes. This resistor is of 10-watt rating since the current through it is very high. It is not by-passed because this is not essential in a push-pull stage.

PARTS

- One 62.5-ohm, 25 watt Pathfinder ballast resistor.
- One 300-ohm, 5-watt resistor.
- One 200-ohm, 5-watt bias resistor.
- Two 5,000-ohm, 10-watt resistors.
- One 500-ohm, 2-watt resistor.
- One 25,000-ohm, 1-watt resistor.
- One 2,000-ohm, 1-watt resistor.
- One 100,000-ohm, 1-watt resistor.
- One 500,000-ohm, 1-watt resistor.
- One 1,500-ohm, 1-watt resistor.
- One 40-ohm, 5-watt resistor.

Other Requirements

- One 1,800-ohm field Rola dynamic speaker, including push-pull output transformer for 48 power tubes.
- Two six-contact sockets for 48s.
- One five-contact socket for 237.
- One five-contact socket for 236.
- Two five-contact sockets for 239s.
- One five-contact socket for speaker.
- Three grid clips.
- One spot tuning vernier dial.
- One six-tube t-r-f chassis.
- One line cable with plug attached.
- Required hardware.

Tone Control

A tone control is provided to give the operator of the set a choice of quality. This consists of a half megohm variable resistor in series with a fixed condenser of 0.1 mfd., the two connected across the entire secondary of the push-pull input transformer. When the resistance is made zero only the condenser is across the secondary and then a portion of the high audio notes are shorted out, but when the entire resistance is used there is no discrimination and the high audio notes come through together with the low. The quality is most nearly natural when the resistance is set at maximum value.

The volume of the set is controlled by means of a 10,000-ohm potentiometer between the cathode returns of the two r-f amplifiers and the antenna end of the input primary, the slider being grounded. This gives a full range of control from silence when the slider is at the antenna end to full strength when it is at the cathode end. A fixed bias resistance of 2,000 ohms is used in the common cathode lead. This is a relatively high value but its use is justified by experimental results. Moreover, the combined cathode current of the two tubes is small so that the minimum bias is not nearly as high as

the 2,000-ohm resistor would indicate. However, the choice was not based on theoretic grounds but on results. A couple of 0.1 mfd. by-pass condensers are used in conjunction with the volume control and limiting bias to by-pass signal frequencies to ground.

Protection

It will be noted that there is a 0.01 mfd. condenser in series with the antenna and another condenser of the same value in series with the ground lead. These are used for protection. Should the antenna wire become grounded for any reason, which often happens, the condenser in the antenna lead prevents a possible short and coil burnout. The condenser in the ground lead is always necessary if the low end of the antenna primary is to be connected to an external ground, for if it were not used there would be a short circuit of the line in nearly all cases. The condenser is a full protection.

In the circuit diagram ground symbols are freely used to simplify the drawing. With one exception these refer to the chassis of the set and not the external ground. In most cases the chassis cannot be grounded at all for the positive side of the line is usually grounded and the chassis must be connected to the negative. Thus there will be a voltage of 110 volts between the chassis and the external ground.

Only the low side of the antenna coil should be connected to an external ground, and this only through the 0.01 mfd. condenser as shown.

In some cases it may be desirable not to use an external ground but to depend on the grounded line. This may be done by connecting the grounded side of the 0.01 condenser to the chassis. The set will then be grounded through the first 8 mfd. condenser in the filter. Ordinarily it is preferable to use the external ground just as shown in the diagram.

There is no provision for warning against wrong insertion of the line plug in the socket. The set will only work in one way. If the insertion is made in the wrong direction the polarity of the voltage across the electrolytic condensers will be wrong. It will take a few moments to discover whether the insertion is wrong, and during this time the condensers will draw heavy current. No permanent damage will occur and it is only necessary to reverse the plug. To guard against wrong insertion the plug and the socket should be marked for polarity. It only takes a moment with the aid of a voltmeter to determine which is which, or a few moments if it is done by the cut-and-try method. Once determined it need not be repeated until the plug is inserted in an unmarked outlet.

Those who have seen and heard this set have been surprised that a d-c set could give such excellent tone and volume as this does. Many who live in d-c districts had become reconciled to the idea that no d-c set could possibly equal an a-c set but after having heard this set perform they have changed their opinion. Now they know that fine radio performance is available all regardless of the kind of electric supply available in their homes. They owe their opportunity to the development of the 48 tube and to the design of the push-pull receiver making proper use of these tubes. Much thought and experimental work went into this receiver before it met the high standard that had been set down.

Constructional Data on a Hyper-Sensitive Set SUPER DIAMOND 7

A Receiver That Tuned in 96 Channels Out of 96

By Herman Bernard

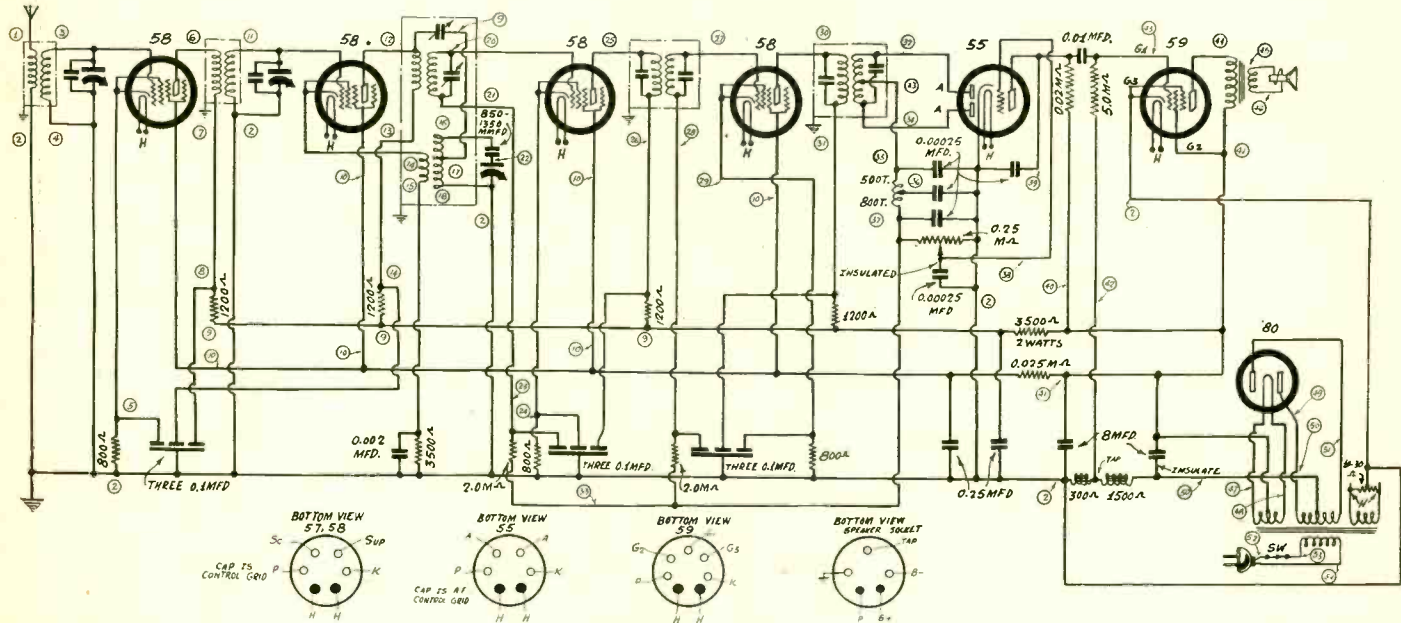

The Super Diamond 7 uses seven tubes, with 59 output. There are two i-f stages at 175 k.c., both subject to automatic volume control. The metal chassis is grounded, so the ground symbol also refers to the chassis.

SO many requests were received for a circuit that would bring in at night the entire number of broadcast channels that work was begun on this with the intention of letting nothing interrupt it until the conclusion was satisfactory. So the circuit shown in the diagram resulted.

Those who have read previous articles on the Super Diamond, a six-tube receiver, will see that the same general circuit plan was followed, but another intermediate stage was added. The sensitivity was increased so much that every possible filtration had to be included, save only in the screen leads, otherwise stability was absent. As the circuit stands, however, there is no oscillation where none is wanted, and from one end of the dial to the other ninety-six channels yielded reception. There was no interference between stations 10 kc apart, as the selectivity was high enough to afford complete separation though the power on one channel is 100 times greater at the input than the power on the other. This test was made on WOR, the most powerful local, tuned out completely to bring in WLW, Cincinnati, 700 kc, or 10 kc lower than WOR.

Automatic Volume Control

In the present circuit automatic volume control is applied to the two intermediate amplifier tubes, and it works in such a manner as to limit the voltage across the diode load resistance (the 250,000-ohm potentiometer considered as a resistance of that total) to read 10 volts on a 2,000 ohms per volt voltmeter, 300 volt scale. This is actually over 10 volts. Thus any signal strong enough to develop 10 volts input to the detector will do so, and any stronger signal will be checked by the control, whereupon no more than 10 volts will result. If a signal is weaker than the minimum that develops the 10-volt level, then the a.v.c. permits that signal to develop as much detector voltage as it can. The effect,

therefore, is that input signal voltages higher than the predetermined threshold voltage do not produce any greater output, there is no blasting when tuning through strong locals, and it is hard to distinguish a local from many distant stations, since both classes produce the same quantity of sound.

This method of using a.v.c. to prevent locals from blasting is the most popular one today, although there is another innovation, called delayed a.v.c., which tends to remove the a.v.c. effect from weak signals. However, in the present circuit it was deemed advisable not to introduce the delay, because the a.v.c. certainly is helpful on weak signals, too, since stations that otherwise fade badly get the benefit of levelled reception, and these are always weak stations. No fading of any sort was experienced with this receiver. So both benefits of a.v.c. are included: no blasting by strong locals, no fading on weak signals.

Close to Calibration on Dial

The circuit has been built, rebuilt, checked and proved, so that it is within the accomplishment of any experienced radioist to duplicate it. Moreover, the dial is calibrated in kilocycles (reading 50 to 150, representing 500 to 1,500 kc), and the actual tuning comes mighty close to the dial calibration. From 1,500 to 600 kc there was not more than 10 kc difference between the dial and the selector circuits, although at the low frequency end there was a discrepancy. With extra care taken in coinciding the two, using the method to be outlined, the coincidence may be made even better, that is, a difference of 20 kc at the low frequency end may be practically eliminated.

It may be of interest to some to know how the dial was prepared, and why the coincidence should be so good, for it exceeds in exactitude that found in commercial practice.

The first consideration was to select

the right r-f coils for the chosen capacity condenser. It was found that for absolute assurance of frequency coverage, while allowing considerable latitude in the adjustment at the high frequency end, the condenser capacity had better be 0.00041 mfd. This is a little higher than that used in the six-tube model, and the parts for both models will coincide with the new requirement.

The inductance for the tuned secondary was chosen accordingly, for use in an aluminum shield 2 1-16 inches outside diameter, and it was found that small primaries were ample, therefore 15 turns were used, wound over the secondaries, with insulation between. With this combination of coil and condenser, with adjustment made at 1,450 kc with the compensating condenser that is across the main tuning capacity, the combination tracked the dial as stated.

Oscillator Tracking

The next problem was to get the proper oscillator inductance and padding capacity, so that for the same dial settings frequencies 175 kc higher than the signal would be generated. Since the identity of the r-f settings is hidden when the set is converted to a super, the requirement resolves itself into getting the same dial settings (as per scale) to bring in the registered signal frequencies. This was done with complete satisfaction, as the real test of excellent tracking, absence of squeals as one tunes through the broadcast band, amply proved.

The absence of squeals, however, does not result only from good tracking. Poor tracking will produce a large number of squeals as well as poor tone. But even good tracking leaves some squeals, if there is stray coupling between the intermediate amplifier and the tuner. Then there may be six squeals particularly, one at 525 kc (if the set tunes that low), the others at 700, 875, 1,050, 1,225 and 1,400 kc. Of course the frequencies ending in

LIST OF PARTS

Coils

- One antenna coupler, primary wound over secondary; enclosed in an aluminum shield, for 0.00041 mfd.
 One interstage r-f coupler, primary wound over secondary; enclosed in an aluminum shield, for 0.00041 mfd.
 One combination oscillator coupler for padded 0.00041 mfd. and one 175 kc first intermediate transformer, both enclosed in one high aluminum shield.
 One 175 kc intermediate transformer enclosed in aluminum shield.
 One 175 kc intermediate transformer with center-tapped secondary; enclosed in aluminum shield.
 One tapped 20-millihenry r-f choke.
 One dynamic speaker, 1,800-ohm field coil, tapped at 300 ohms; output transformer (6,000 ohms impedance) matched to the 59 tube used as a pentode. 18 inch cable and UY plug attached, connections conforming to diagram.
 One power transformer: primary, 110 volts, 50-60 cycles; secondaries: 2.5 volts at 8 amperes; 5 volts at 2 amperes; high voltage at 350 volts a-c between center and either extreme (total 700 volts a-c across both extremes).

Condensers

- One three-gang 0.00041 mfd. tuning condenser with compensators built in and with attached screws for mounting purposes; high shield walls between sections.
 (Note: the condensers across primaries and secondaries of intermediate coils are built into these transformers.)
 One 0.002 mfd. fixed condenser.
 Five 0.00025 mfd. fixed condensers.
 One 0.01 mfd. mica fixed condenser.
 Two 8 mfd. wet electrolytic condensers, inverted mounting type; two insulating washers and extra lug for one; extra lug only for other.
 One 850-13, 50 mmfd. padding condenser, isolantite base; brass plates.
 One shielded block containing nine 0.1 mfd. condensers and two 0.25 mfd. condensers. Equipped with mounting lugs. Shield is to be grounded. Two outlets colored differently than

others are the 0.25 mfd. Rest are 0.1 mfd. Block to be fitted under tuning condenser.

Resistors

- One center-tapped resistor, 10 to 20 ohms.
 Three 800-ohm pigtail resistors.
 Four 1,200-ohm pigtail resistors.
 One 3,500-ohm pigtail resistor.
 One 3,500-ohm pigtail resistor, 2 watts (twice as thick as others).
 One 0.02 meg. pigtail resistor.
 One 0.025 meg. pigtail resistor.
 Two 2.0 meg. pigtail resistors.
 One 5.0 meg. pigtail resistor.
 One 0.25 meg. potentiometer, insulated shaft type; tapered; a-c switch attached.

Other Requirements

- One chassis, 13 $\frac{7}{8}$ in. x 8 $\frac{7}{8}$ in. x 3 in. overall, drilled for sockets, coils, tuning condenser, for electrolytics and for power transformer.
 Six insulated bushings, ends tapped for 6/32 machine screws, so that bushings may be used as if nuts on socket mounting screws, and maintain insulation for parts mounted on top of bushings by means of lugs held by short 6/32 screws.
 One dozen lugs.
 Two dozen 6/32 machine screws.
 One roll of hookup wire.
 Five aluminum tube shields for sensitive circuits requiring close shielding of 58 and 55 tubes.
 Five grid clips.
 One foot of shielded wire to be used between antenna post of set and antenna lug of antenna coupler; overall diameter $\frac{1}{2}$ inch, due to thick cotton insulation to prevent loss of signal to ground.
 One frequency-calibrated dial, travelling light type, with 2.5-volt pilot lamp (not shown in diagram) and escutcheon. Lamp goes across H and H.
 Five six-prong sockets, one seven-prong socket, one four-prong socket and one five-prong socket (the five-prong is for speaker plug).

5 are not represented in the North American continental roster, but there may be stations in Mexico, Cuba or elsewhere that result in the registration of a beat, so the entire six squeal points may exist.

Second Detector Filtration

The solution of getting rid of these squeals due to harmonics of the intermediate frequency beating with the signal frequency proved easy in this case, as a 10,000-ohm resistor in the plate circuit of the oscillator, bypassed by a condenser of 0.1 mfd., eradicated the trouble. Besides, of course, it is necessary to provide an excellent filter for the final detector circuit, or 55 diode fullwave demodulator, and this is done by using a tapped r-f choke of an inductance of 20 millihenries, with 0.00025 mfd. from both extremes and tap to ground. Also in the plate circuit of the triode unit of the 55 a condenser of 0.00025 mfd. is helpful in keeping r-f out of the subsequent audio. Besides, to insure preservation of bypassing, looking into the audio channel, a condenser is needed from moving arm of the potentiometer to ground. This may be 0.00025 mfd. or a little higher.

There is no noise suppressor tube in the circuit, although full a.v.c. is included, and therefore the question will arise: What about noise?

The Shot Effect

My theory about noise in conjunction with a.v.c. is perhaps a little different from the usual viewpoint, but it is simply that those including a.v.c. in circuits fail to make the circuit stable at the steady bias voltage value. That is, if there is really no carrier voltage, or hardly any carrier voltage, the extra bias contributed by a.v.c. may be assumed to be zero. So if the circuit is made so extremely sensitive that it is just below the oscillation point when there is some a.v.c. voltage to add to the steady bias value as obtained from the biasing resistors in the cathode legs, then when the a.v.c. bias is removed (zero carrier voltage), the circuit is at least regenerating, if not actually oscillating, and therefore the condition is ripe for modulation of each and

Saturation Remedy for the 55 Triode

The Super Diamond 7 is so sensitive that with the usual outdoor antenna it is easily possible for those living in cities where there are several strong locals to develop so high a voltage from these that the audio signal is cut off, due to the triode of the 55 being biased to almost plate current stoppage. The voltage of cutoff is around 50 volts, but it is easily possible to develop even 100 volts. This condition may not be desired.

Therefore, those so situated will reduce the input to the receiver. A shorter aerial will do the trick, or the equivalent, a condenser in series with the existing aerial, between antenna post and the leading connection at receiver end. What capacity this condenser should be is best determined by experiment, but if such saturation is experienced, try 0.00025 mfd. or thereabouts, and lesser capacity until the condition is remedied.

Some may not mind this signal cutoff, and will leave the aerial as it is, because the volume control always can be retarded, so that the bias voltage on the triode unit of the 55 is reduced, without the carrier input itself being reduced. That is, the direct coupling of the full-wave diode detector to the triode unit is from arm of the potentiometer to cathode (ground), and as the arm is slid toward ground naturally the utilization percentage of existing voltage across the total 250,000 ohms, as put into the triode, is reduced, hence the bias is reduced. The remedy is given merely for the benefit of those who desire to use it, especially where the receiver is tuned by several members of the family, some of whom would consider the cutoff condition amazing.

every tube by any disturbances, including the shot effect.

This effect is present when there are adjacent conductors carrying alternating current and consists of the transverse flight of some electrons from one conductor to the other, really an exchange bombardment. The conductors

in this instance are the live elements of the tube, and the electrons that shoot off, outside the normal path, cause noise due to their impact with one another and with the conductors and to the voltage changes they introduce. While this effect is present even at low amplification, it is not noticeable, and when the amplification is high, or voltage difference great, the effect is greater. If the tube is regenerating or oscillating, then the shot effect is very serious, for it may start and stop oscillation, which quickly starts again, and thus we have modulation.

The Biasing Voltages

So the biasing resistors are of higher value than normally encountered, and besides there are bypassed plate circuit resistors. Actually the steady value of the biasing voltage is only 3.5 volts, but the actually applied voltage in the case of the r-f, modulator and intermediate amplifier tubes is 150 volts, while the voltage on the oscillator is 100 volts. The screen voltage is taken from the maximum of the B supply, being dropped through a 25,000-ohm resistor, so that the screen voltage reads 120 volts on a 2,000-ohms-per-volt voltmeter, 300-volt scale. Making the screen voltage close to the plate voltage is accepted practice, provided the voltage of neither is too high.

The biasing voltage on the 58 is 10 volts, and the 58 was used instead of the 57 because the 10 volts were readily obtained in this fashion, and oscillation retained all over the desired range. The biasing resistor is 3,500 ohms, so the combined screen and plate currents are a little less than 3 milliamperes. If the biasing resistor is doubled the oscillator stops oscillating.

No trouble was experienced in the intermediate amplifier, for the resistor-capacity filters, and the voltage selections, resulted in full stability. Without these or substitute filters the circuit can not be kept quiet.

Sensitivity and Selectivity

When the circuit was in its final form, as diagramed, it had a sensitivity as great as could be used practically, averaging fractional microvolts per meter, and a se-

(Continued on next page)

(Continued from preceding page)
lectivity that could not be increased without serious impairment of quality due to high audio frequency attenuation by sideband-cutting. That is, both selectivity and sensitivity have been pressed to the utmost without the one hurting the other.

It is not promised that in every location the 96-channel performance will be repeated, but it is expected that if the set is built exactly as specified the constructor will tune in as great a number of channels as he really desires.

There are some drawbacks to such a sensitive and selective receiver. One of them is that nobody remembers the locations of all the stations—there are nearly 700 to keep in mind, including Canada and Mexico—but does know something about the locals. If one lives in an area close to many stations, as in Chicago or New York, he will be often misled into believing he has tuned in a local, desiring, say, to hear Eddie Cantor or Ed Wynne, only to find out he is listening to music from Mexico City or some other distant station. This is true because the dial setting has not been watched carefully and also because a hairbreadth represents the difference between two stations in terms of dial divisions, with equalized volume.

One expected fact about the circuit is that since the triode unit of the 55 is diode-biased (or depends for its grid bias on the rectified voltage) one may use too much aerial pickup, so that strong locals will cause the bias to rise to such a height that the plate current of the triode 55 is cut off. If the aerial is reduced, it should not be made so small as to cause hiss.

For the Annoying Neighbor

This is a lucky innovation for a receiver you may desire to give to a neighbor who plays his set at greatest possible volume past your bedtime, as when the volume gets to be more than enough the bias rises so high as to cut off the audio, and leave friend neighbor's set in silence. However, the device is of no

Padder Location Affects Oscillation

During experiments with the Super Diamond 7 it was found that the resistance value of 3,500 ohms was best suited for biasing the 58 autodyne tube, resulting in 10 volts negative bias, which allows for a 9-volt oscillator peak swing without danger of overloading the autodyne tube's input with oscillation voltage. This resistance value was the one applying when the padding condenser was placed as shown in the diagram, between the oscillation winding and the stator of the variable tuning condenser.

If the padding condenser is placed in the grounded position, that is, interrupting the return of the oscillation winding, the oscillator may not oscillate unless the bias resistor is reduced. Any who prefer the grounded type of padding condenser connection, because of its removal of body capacity effects when adjusting the padder, may therefore use it, but the biasing resistor must be reduced to whatever value brings back lost oscillation. This may have to be around 400 ohms. Expressed differently, the elevated position of the padding condenser (as diagrammed) permits a higher negative bias.

If for any reason oscillation is too intense, the biasing resistor always may be increased in either instance (grounded or ungrounded padding condenser connection) until the amplitude is satisfactory, consistent of course with maintenance of oscillation.

value to you personally, as it works backwards, that is, in the opposite direction from what a noise suppressor would, for it doesn't affect the noise any more than the signal.

It will be necessary to limit the aerial pickup, or length and height of aerial, to within working limits, of course with volume control full-on. A series aerial condenser outside the set will do it. Of

course there is plenty of volume left—enough perhaps to be heard outdoors quite plainly for a furlong.

The condition of signal cutoff means of course that the detector voltage has increased considerably beyond the amplification bias voltage say, to 50 volts. As stated, the detector was limited to 10 volts in the particular instance of the author's set, particularly to allow for modulation swing.

Otherwise the automatic bias, determined by the rectified component in the detector, and constituting also the input to the 55 grid, is of excellent advantage, in that it raises the bias to meet the exigencies. If a strong carrier comes along the bias is higher accordingly, also if the modulation increases. And there need be no fear about zero bias, because at zero bias nothing would be heard, moreover the high resistance potentiometers have a minimum resistance value (ones used had 175 ohms), and besides even a very weak signal will also contribute something to the bias voltage, hence zero bias may be forgotten. As to current, even if there is zero bias the current through the tube is small, for the load resistor is 20,000 ohms, the plate resistance 5,000 ohms, and not more than 10 milliamperes would flow.

Most circuits having visual tuning devices, if the devices are of relatively high current type, use them in the r-f stages, but any desiring to use a 0-10 milliammeter for this purpose may put it in series with the 20,000-ohm resistor in the 55 plate, a condenser of 1 mfd. across the meter, as audio frequencies should be removed from any visual tuning device. It is not imperative to have a visual tuning device, although helpful in finding resonance.

Motorboating

The circuit is built on a standard chassis, the same chassis used in the 6-tube model, with the speaker socket on top, between the electrolytic condensers and the '80 and 59 tubes. The speaker

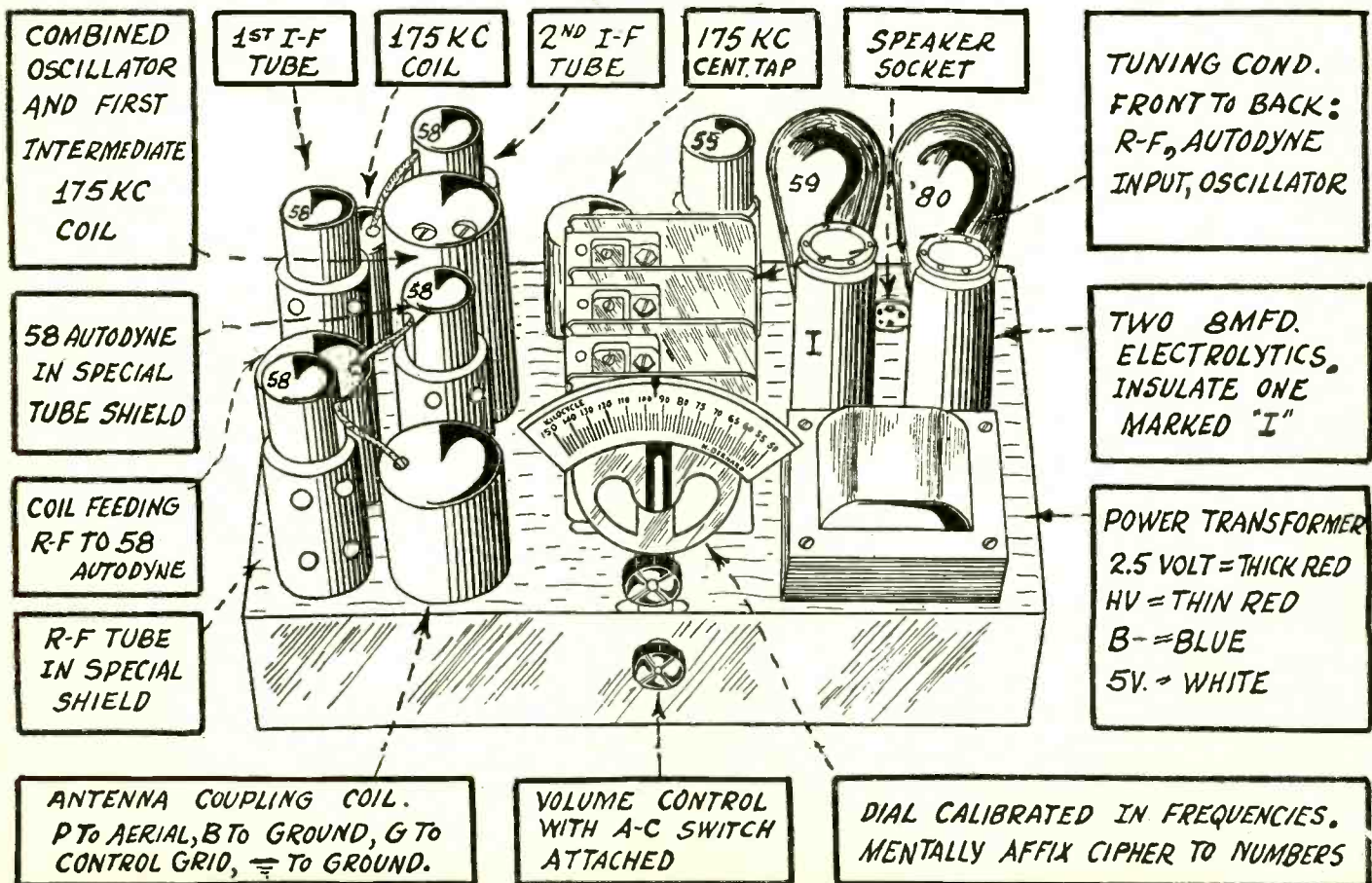

Front view of the chassis, with coils, tubes and condensers identified. The same type tube shield, for sensitive circuits, is used on the 58's and the 55. The volume control potentiometer is of the self-insulated type.

socket receives a five-pin plug, to which is attached a cable that connects to the speaker. The code is given on the circuit diagram for the standard speakers. The field coil of the dynamic speaker is the B supply choke, total resistance 1,800 ohms, with a tap at 300 ohms. The part of this field between the tap and ground, 300 ohms, develops a voltage drop of around 20 volts, and thus affords bias for the power tube when its grid is returned to the tap, since cathode is to ground, which is positive in respect to the tap.

Rat-trap Motorboating

Some who build the receiver may experience motorboating. That word is confusing, since it refers seemingly to frequencies around those of the ignition hence speed of a motorboat engine. But really motorboating is audio frequency oscillation, and the frequency may be high. The type meant here is low, and evidences itself as if a man were slowly repeating, "A rat trap, a rat trap." A fluttering type of interference, like rapid fading, should not be mistaken for the complaint now meant, as such fluttering is due to poor tracking.

Those who experience the rat-trap type of motorboating should reverse the connections to the output transformer, putting to plate what formerly went to B plus, and to B plus what formerly went to plate. If this does not cure the condition, check up on the resistance of the field coil. This should not be much more than 1,800 ohms. The 2,500-ohm type field coil will produce the rat-trap motorboating almost invariably, after the set has been running for several hours, although not at first. So after the set is built, run it for three or four hours, to determine if the motorboating is present.

Matched Impedance Necessary

As stated, the trouble has been experienced with a 2,500-ohm field. None was present with an 1,800-ohm field, although it is conceivable it would arise with an 1,800-ohm field in some instances. Any who suffer this trouble should state the exact symptoms in a letter to the author, who will send directions for curing it. Especially describe the nature and intensity of the sound and its frequency, as the remedies depend on these facts. No special advice need be sought if the field coil ohmage is too high, or if other than the recommended output tube is used with the 59 pentode type dynamic speaker, or if the 59 is used as output tube with a speaker not intended for it, though the field coil ohmage be correct for the d-c purposes of the present receiver. Simply adhere to specifications in this respect and then there is small likelihood that the trouble will be experienced. Nobody who built the six-tube model has reported any such trouble.

For Test Tables See Next Page

Grigsby-Grunow Suit Against RCA Settled

David Sarnoff, President of the Radio Corporation of America, made the following statement:

"An amicable agreement has been reached for settlement of the litigation pending in the United States District Court at Kansas City, Missouri, between the Grigsby-Grunow Company and the Radio Corporation of America, General Electric Company, Westinghouse Electric and Manufacturing Company and others.

"The Grigsby-Grunow Company has executed the standard supplemental radio receiving set license. The standard radio tube license has also been issued to the Grigsby-Grunow Company for a period of five years with an option to extend it for an additional five-year period."

The Grigsby-Grunow Company manufactures the Majestic line of receivers.

How to Adjust Circuit to Calibrated Dial

Due to the use of a frequency-calibrated dial the procedure for lining up the r-f and oscillator circuits is a little different than ordinarily recommended.

The first thing to do, of course, in any circumstance is to peak the intermediate amplifier exactly at 175 kc. This work requires an oscillator, preferably of the modulated type. An inexpensive model, with similar frequency-calibrated dial, serves the purpose excellently.

It is often impossible to get any signals through the set, when aerial is connected to the required place due to the different frequencies to which the three intermediate coils are tuned, and to get them at any one frequency (even a wrong one) by the station-tuning method alone is nearly impossible. So an oscillator may be accepted as a requisite.

Order of Procedure

Even with an oscillator it may not be easy to get the three coils at or near 175 kc when one has to adjust six variables (two condensers across each transformer). So start with the circuit feeding the demodulator. The oscillator output then may be coupled to the grid cap of the preceding tube, and the coil feeding from that tube to the demodulator (second detector) adjusted. Then move the oscillator connection ahead one tube, and tune the coil coupling the first to the second intermediate tube. Then couple the oscillator to the plate of the modulator (first detector) and adjust the coil feeding from this tube to the first intermediate amplifier. Then readjust the two other transformers, with modulator remaining coupled to the plate of the autodyne tube, which tube preferably should remain in the socket when the modulation is introduced, to duplicate the actual capacity conditions that will be present during later operation. If any confusion arises due to the oscillation in this tube (for it is also the oscillator) the cathode lead may be opened temporarily and the tube will stop functioning. It need not be functioning; it simply ought to be there.

With the intermediate at 175 kc, it may be found that the condensers across the plate coils are not highly effective, particularly the one across the primary in the autodyne's plate circuit. This is all right, as the principal tuning is in the grid circuits. There is some plate effect, of course, and principally when the capacity is too high, for then the amplification is reduced considerably by this very detuning. Indeed, the detuning affects the grid circuit, too, though done in the plate circuit, because of the coupling.

Adjusting to the Scale

Now set the dial on the condenser so that at 50 the plates of the condenser are fully enmeshed. Remember that 50 stands for 500 kc, the theoretical low frequency extreme. Actually 500 kc will not quite be reached. However, the setting should be made as if it will be reached actually.

Next turn to 60, representing 600 kc, with oscillator at 600 kc, and connected to antenna post, and ground to ground post, adjust the padding condenser until response is maximum. This may be determined by ear, even though a.v.c is included, although if you have an output meter use that. If you have no output meter, but a 0-1 milliammeter, put the 0-1 in series with the resistance of the potentiometer and watch for greatest needle deflection. There will be little deflection, but enough for the purpose.

When the padding condenser is adjusted by using an ordinary screwdriver it may be necessary to screw down the adjustment a little beyond that which prevailed when the driver was on the screw, due to removal of hand capacity when the screwdriver is taken away, but the needle or ear is still the correct guide, and the padding is not difficult even though the potential is "hot."

Compensator Adjustments

After the padding condenser has been correctly set, and it will be near maximum capacity, by the way, the trimmers on the r-f and autodyne input tuning capacities should be adjusted. This is contrary to usual sequence, but is helpful, because approximately the correct setting will be obtained this way, by watching or listening for greatest response, and much "fishing" at the high frequency end is thus avoided.

Now turn the dial to 145, representing 1,450 kc, and feed an oscillation frequency 1,450 kc to the antenna post. Adjust the oscillator compensator or trimmer now for the first time, so that maximum response obtains, and then readjust the r-f and autodyne input compensators. The condenser sections are, front to back: r-f, autodyne input, oscillator.

The reason for adjusting the r-f level trimmers to the oscillator is that the oscillator in practice is the main frequency determinant, and it is easier to follow the leader than to lead the follower.

Now some change has been made, perhaps, in all three circuits. The adjustment has come out right for the high frequency response in the broadcast band. Amateur stations and police calls should not be heard, that is, not at the 1,450 kc setting, and if they are, turn down the oscillator compensator until they are not, and until 1,450 comes in strongly at 145.

Due to possible changes made that now affect the low frequency setting, readjust the padding condenser, but only that condenser, and do not molest the compensators.

The line-up and padding are now complete, save for a checkup at around 1,000 kc, which should read that, or 990 or 1,010, that is, should not be off more than 10 kc. At this point the dial is calibrated in steps of 20 kc, so the setting should not be more than half a division off. If at 1,000 kc signal the dial reads 1,020 kc, or, if coincidence is enough here, but not close enough because reading too high in frequency at 550 kc, though the adjustment was made at 600 kc that ought to bring in 550 close to 55, it will be necessary to go through the lining up process again.

Set the condenser at full capacity. Instead of setting the dial to read 50 set it to read at or about 51. Thus when the condenser plates are entirely engaged the dial does not go entirely to its end-stop. Now turn to read 60 (for 600 kc) and feed 600 kc into the antenna post from the oscillator, pad as before, line up at the high frequency end as previously directed, and recheck at 1,000 kc or thereabouts, and it will be found that coincidence prevails.

Retarding the dial as directed has the effect of cutting down the frequency ratio slightly, as the working minimum capacity of the variable condenser is increased, but the coils and condenser are so chosen that there is leeway at this end, and 1,500 kc, and even higher frequencies, may be reached nevertheless. That is, the full broadcast band will be covered.

TABULATIONS FOR SUPER DIAMOND 7

Table No. 1—Tube Socket Data

Tube Type	Circuit	Folament Volts H to H	Plate Volts P to Gnd.	Screen Grid Volts SG to Gnd.	Cathode Volts (K to Gnd.)
58	R-F	2.5	150	120	3.5
58	1st Det.-Osc.	2.5	100	120	10.0
58	First I-F	2.5	150	120	3.5
58	Second I-F	2.5	150	120	3.5
55	Det.-1st A. F.	2.5	250	...	0
59	Output	2.5	250	250 (G ²)	(*)
'80	Rectifier	5.0		350 v. a-c between either plate and B. minus (50)	

(*) 59 cathode voltage measured between cathode and tap of field coil, 18 volts.
 Note: Control grid to cathode measurement can not be made directly with ordinary meters as to the 58 intermediate tube, the 55 triode and the 59 tube. For the 58 R-F and 58 Det.-1st A.F., control grid to ground measures 0 volts.
 Direct current voltages above 100 volts measured on 2,000-ohms-per-volt voltmeter, 300-volt scale. Low d-c voltages on 2,000-ohms-per-volt voltmeter, 30-volt scale.

Table No. 2—Resistor Data

Circuit Diagram Number	Resistance in ohms	Body	End	Dot
2 to 5	800	Gray	Black	Brown
8 to 9	1,200	Brown	Red	Red
9 to 14	1,200	Brown	Red	Red
2 to 15	3,500	Orange	Green	Red
23 to 37	2,000,000	Red	Black	Green
2 to 24	800	Gray	Black	Brown
9 to 26	1,200	Brown	Red	Red
28 to 37	2,000,000	Red	Black	Green
2 to 29	800	Gray	Black	Brown
9 to 31	1,200	Brown	Red	Red
2 to 37	250,000		Not Color Coded	
37 to 38	Variable		Not Color Coded	
2 to 38	Variable		Not Color Coded	
39 to 40	20,000	Red	Black	Orange
42 to 43	5,000,000	Green	Black	Green
10 to 41	25,000	Red	Green	Orange
9 to 40	3,500	Orange	Green	Red

Table No. 3—Resistance Values of Coils

Circuit Diagram Number	Resistance in Ohms	Circuit Diagram Number	Resistance in Ohms	Circuit Diagram Number	Resistance in Ohms
1 to 2	6	30 to 31	40	50 to 51	200
3 to 4	20	32 to 33	20	49 to 51	400
6 to 7	6	33 to 34	20	H to 2	1
11 to 2	20	32 to 34	40	H to 2	1
12 to 13	40	41 to 44	700	H to H	2
14 to 15	10	45 to 46	4	52 to 54	0 or 12
16 to 18	18	41 to 47	2	53 to 54	12
20 to 21	40	41 to 48	2	2 to 42	300
25 to 26	40	47 to 48	4	42 to 50	1500
27 to 28	40	49 to 50	200	2 to 50	1800

TABLE NO. 4

Color or Designation Code for Coils

COIL	CODE
Antenna	P to aerial, B to ground, G to control grid (cap), ground symbol to ground.
R-F Interstage	P to plate of r-f tube; B to 1200-ohm resistor leading to B+; G to control grid (cap); ground symbol to ground.
Combination Oscillator and 175 kc	Green with White Tracer to cathode; Black to 3,500-ohm resistor leading to ground; Yellow to plate of autodyne tube; Red to 10,000-ohm resistor leading to 3,500-ohm resistor leading to B+; Green to control grid of first i-f (cap); Black with Red Tracer to 2 meg. leading to 250,000-ohm potentiometer; Blue to one side of padding condenser (850 t 1,350 mmfd.); White to ground.
Standard 175 kc Transformer	Yellow to plate of the first intermediate tube; Red to 1,200-ohm resistor leading to 3,500-ohm resistor leading to B plus; Green to control grid (cap) of second intermediate tube; Black to 2 meg. resistor leading to 250,000-ohm potentiometer.
175 kc Transformer with C.T. Secondary	Yellow to plate of second i-f tube; Red to 1,200-ohm resistor leading to 3,500-ohm resistor leading to B plus; Green to one anode of the 55 diode; other Green to other anode of the 55 diode; Black to one side of the tapped r-f choke coil. No part of this coil goes to grid cap of the 55.
Power Transformer	Thick Red to H and H (2.5 volts), two wires; thin Red to respective plates of '80 rectifier, high voltage, two wires; Blue to cathode prong of speaker socket, one wire; White to filament prongs for '80 rectifier (5 volts), two wires.
Speaker Cable	Not according to any code of colors, but connections are: Plate Prong, to ground; Grid Prong to tap on field coil; Cathode to B minus; H and H interchangeably to B plus and plate; reverse H and H on speaker socket for test of less hum.

Photo-Electric Organ, New Idea, Is Demonstrated

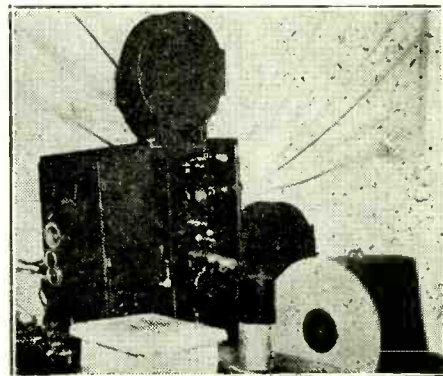

(Acme Photo)

This photo shows the photo-electric organ developed by George Reynolds. It is on exhibition in Chicago.

A new type of photo-electric organ has been developed by George Reynolds of the RCA Institute, Inc., and is now on exhibit in Chicago. Light bulbs, photo-electric cells and a spinning perforated disc are the essentials. The disc has eight rows of holes concentric with the disc. The number of holes in each ring varies according to the tone to be produced, and the holes in the rings are so proportioned that when the disc spins at a given rate the notes of an octave are produced.

In front of each ring is a flashlight lamp and on the opposite side of the disc is a photo-electric cell. When a key is pressed one lamp lights and sends a beam of light into the photo-electric cell. As the disc rotates the light beam is interrupted at a rate determined by the number of holes in the ring. This produces a tone in the loudspeaker after the impulses have first been converted to equivalent electric impulses in the photo cell and then into equivalent sound impulses in the loudspeaker. A given tone will continue as long as the light for that tone is on, and it will be on as long as the corresponding key is pressed down. The device therefore acts in the same manner as an organ.

To produce the tremulo effect the axis of the disc is offset one centimeter from the center of the disc. Some of the holes, therefore, will transmit all the light from the bulb while others will only transmit a portion. Thus as the disc rotates there will be a regular rise and fall in the intensity of the tone without a change in the pitch of the tone. There is no means for varying any one tone in respect to the others, but for tuning the instrument to a given pitch it is only necessary to vary the speed of the disc.

The music from the instrument can be broadcast without the use of a microphone.

55's Plate Resistance

KINDLY let me know the plate resistance of the 55 tube's triode unit, under operating conditions of 250 volts on the plate (through 20,000 ohms) and a negative bias of 20 volts.—I. R. W., Providence, R. I.

The plate resistance is 7,500 ohms and the plate current 8 milliamperes. This tube may be used to feed resistance coupling, as in your case, or may have the primary of a transformer in its plate circuit. However, for transformer coupling the diode-biased triode method should not be used, but separate bias provided for this tube. The 55 in some respects resembles the 112A as a functioning tube.

BETTER SPREADOUT

Applied to Anderson-Bernard Circuit

By Herman Bernard

[The Anderson-Bernard circuit, first details of which were published last week (issue of January 21st), introduces a new tuning application, especially to receivers of wide frequency coverage. This system consists of tuning the intermediate frequency variably, the same as a broadcast set would be tuned, and since the frequency spread for the broadcast band of frequencies is about 1,000 kc, the same dial and coils would be used again and again for 1,000 kc. bandspread, while the oscillator would be varied in steps, thus introducing step tuning for the first time (3,000 kc., 4,000 kc. etc.). The signal level tuning would be along orthodox lines. The foregoing supposes that the so-called intermediate channel is a t-r-f set, and used as such for direct reception of the broadcast band and for any lower frequencies desired. However, this week the idea is suggested of using a superheterodyne itself as the 500-1,500 kc. receiver-amplifier. The circuit represents an original idea, which is now being put into practice, and a report of the operating results will be rendered when the constructional articles are ready, which, it is hoped, will be within two months.—EDITOR.]

THE Anderson-Bernard circuit consists of: (a) A signal frequency selector. If wide frequency band is to be covered this will have to be along standard lines, necessitating changing coils either by plug-in or switching; (b), An oscillator for use when short waves are to be received, to change the frequencies to the ones to which the intermediate amplifier will respond; (c) An intermediate amplifier that covers some selected band, which may be the broadcast band of frequencies, say 500 to 1,500 kc, to be tuned variably, and therefore able to serve for broadcast reception direct by switching antenna to the otherwise intermediate amplifier's input.

So, to visualize the switching (assuming that a switch is used), the antenna would be connected to a 500-1,500 kc. t-r-f set, worked in usual fashion. If it is desired to receive lower frequencies this may be done also on the t-r-f basis, by putting r-f choke coils of proper inductance effectively in series with the coils used for broadcast coverage, applied to both primaries and secondaries. When short waves are desired the switch is thrown to pick up a short-wave signal selector circuit and a short-wave oscillator. While the signal selector will be of the usual type, the oscillator will be tuned not gradually but in steps of 1,000 kc, equivalent to the band width of the intermediate. Thus for all short-wave frequencies, and indeed all broadcast frequencies, too, the band spread would be 1,000 kc. For lower than broadcast frequencies it would be less, since the signal frequencies are lower. For instance, suppose 150 to 450 kc were to be covered. This is still a 3-to-1 frequency ratio, but the lower frequencies result in a band coverage of only 300 kc. However, there is no need to cover more, and the failure to cover 500 to 450 kc is not serious, as there is next to nothing of entertainment value there even in Europe.

A Super "Inside" Too

Now all the foregoing presupposes a t-r-f system for the intermediate amplifier of the short-wave receiving system and range. but it is of course possible to use a superheterodyne for the 500 to 1,500 kc coverage, just as is done in regular receiver practice. There may be trouble due to at least two

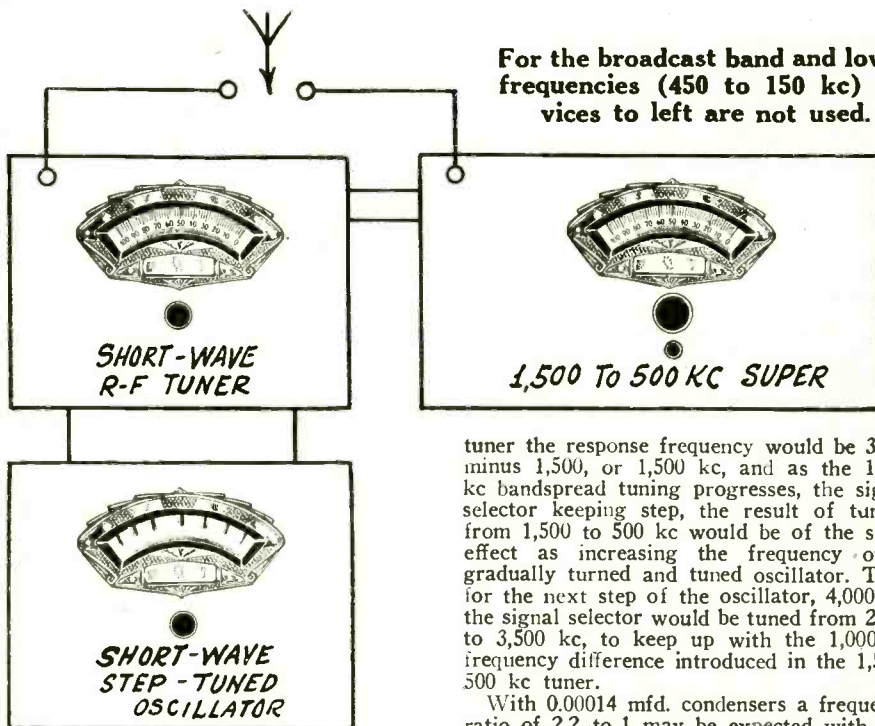

For the broadcast band and lower frequencies (450 to 150 kc) devices to left are not used.

oscillators required, although only on short waves are both working. And there may be more trouble due to a third oscillator, for one may be included at the second (fixed) intermediate level, say, 90 kc, so that c-w may be received well.

On the other hand, it is well known that t-r-f systems have their limitations, too. They use ganged condensers, and a gang of three is about as much as can be handled easily. With four condensers on the gang of a t-r-f set the problem of frequency balancing or alignment becomes much more serious, and it is difficult to get the circuits to track. Yet even more selectivity than the three tuned circuits afford could be used to advantage, and since the special band-spread method is one that makes tuning easy, though selectivity is as high as it should be, a simple superheterodyne may work out well nevertheless, particularly one like the six-tube Super Diamond. Instead of five tubes in the 500-1,500 kc outfit there would be six, but the sensitivity would be higher, and so would the selectivity. And there would be no cause for complaint on the quality score, either.

The Operation

Let us see, then, how the system would work out theoretically on the basis of a superheterodyne "inside":

Frequencies lower than broadcast frequencies may be ignored for the present, because of not much interest in them in this country, for it is in Europe that entertainment is rent out on this band.

The antenna would be switched to the first tube of the superheterodyne for broadcast coverage.

The antenna would be switched to a signal selector for short waves, and this circuit would be tuned so as to match up pretty well with the steps of the short-wave oscillator. Thus, the span is 1,000 kc, and starting at 1,500 kc one would tune the signal selector as far as 2,500 kc. During this period the short-wave oscillator would remain fixed at 3,000 kc. Then for the highest frequency setting of the 500-1,500 kc

tuner the response frequency would be 3,000 minus 1,500, or 1,500 kc, and as the 1,000 kc bandspread tuning progresses, the signal selector keeping step, the result of tuning from 1,500 to 500 kc would be of the same effect as increasing the frequency of a gradually turned and tuned oscillator. Then for the next step of the oscillator, 4,000 kc, the signal selector would be tuned from 2,500 to 3,500 kc, to keep up with the 1,000 kc frequency difference introduced in the 1,500-500 kc tuner.

With 0.00014 mfd. condensers a frequency ratio of 2.2-to-1 may be expected with any coil used for short waves. So if the signal selector starts at 1,500 kc, with a given coil it would wind up at 3,300 kc. But how about the companion oscillator? If it starts at 3,000 kc, since the frequency is so much higher, the same ratio will yield 7,260 kc, or provide for the step tuning at 3,000, 4,000, 5,000, 6,000 and 7,000 kc. Thus the oscillator far outruns the modulator, a condition that gradually declines as the frequencies increase for both, however.

Extension of Principle

In the bandspread feature the range or coverage is always 1,000 kc, no matter what the level of the signal frequency originally, and if it is advisable to spread out the tuning equally as to frequencies no matter what the original signal level, in one instance, why is it not advisable to do so in the other?

It is habitual to use 0.00014 mfd. tuning condenser, but it can be seen that the frequency difference for the lowest range of radio frequencies in the short-wave bands will be 1,500 to 3,300 kc, a difference of 1,800 kc, but in the shortest wave band, say, 15,000 to 33,000, the difference between one end of the dial and the other will be 18,000 kc, or ten times as much. So it is suggested that, even though a large capacity be needed for the lowest short-wave frequencies (highest wavelengths), that such method be adopted, and it is proposed to do so, whereby a ratio may be obtained of 3.2-to-1, yielding 1,500 to 4,800 kc for the modulator or signal level in the first instance, matching four oscillator steps, and that the oscillator capacity be less than 0.00014 mfd., so that only four steps will be used in this equivalent band. In that way when the two coils (one for modulator, the other for oscillator) may be switched on and off together, instead of being staggered in the manner depicted in the circuit diagram last week.

Of course this close companionship can not be readily carried right through, but one may continue using for tuning the signal level a condenser of 0.00041 mfd. to (Continued on next page)

Heavy-Duty Power Tube 2A3, and Rectifier 5Z3 Are Due Soon

By C. M. Bourbon

THE fifth and sixth of a series of fifteen new tubes to be "sprung" in the near future are expected to be announced soon as the 2A3 power amplifier triode and the 5Z3 rectifier, both heavy-duty tubes.

While no official announcement has been made, the report that the total of new tubes will reach fifteen within five or six weeks comes from one close to the tube manufacturing interests. Moreover, the expectation of an assortment of new tubes is raised shortly after Radio Manufacturers' Association, Inc. complained about the numerous new tubes causing trade difficulties, such as changes in receiver designs and the stocking of large numbers of tubes, due to the multifarious types, by jobbers and stores. While a committee of the association is deliberating a report on the subject, the announcements of new tubes are expected to be made.

Of the expected group of fifteen, three were discussed in last week's issue: the 25-Z-5 voltage-doubling rectifier, having a 25-volt heater, and requiring no high voltage power transformer winding, because it may be used to double the line voltage; the 43 power pentode tube, also of the 25-volt heater type; and the 42, 6.3-volt heater, of the automotive series, useful in automobile and d-c receivers. So with the two treated this week, ten more are left.

Innovation in 2A3

The 2A3 will have a multifilamentary cathode, which is an innovation in radio receiving tubes. This is a three-electrode high vacuum tube for the power output stage, capable of handling suddenly large values of volume with an undistorted output, and designed for Class A operation. The cathode is composed of a large number of coated filaments in series-parallel to provide a very large effective cathode area, and thus afford an emission commensurate with the heavy sudden demands that may be put on the tube.

This represents a new development in Class A audio amplification, since the previous method of handling large values of quantities of sound without distortion was to incorporate Class B operation, which as commonly used provides a zero bias at no signal and depends on grid current for operation. The new method, like Class B, will be useful in push-pull, but, unlike Class B, may be used single-sided as well, though with only about one-fifth the undistorted power output.

15 Watts in Push-Pull

For instance, the 2A3, as a single-sided output tube, will be capable of delivering an undistorted maximum power output of 3½ watts, at a negative bias of 42 volts, with 250 volts on the plate. But in push-pull,

with bias heightened to 62 volts, the maximum undistorted power output will be 15 watts, a new high level for tubes of the 2.5-volt filament, 300-plate-volts type. The same value of biasing resistor, 700 ohms, would be used in both instances, due to the bias difference.

The optimum operating condition for push-pull, with 15 watts output, requires that the bias be "fixed," and then the total harmonic distortion (all harmonics included) would be only 2.5 per cent., an exceedingly small harmonic content. The plate current per plate is then 40 milliamperes, and the load resistance, plate to plate, should be 3,000 ohms.

With self-bias, the same filament and plate and grid bias voltages would be used, the load resistance, plate to plate, should be 5,000 ohms, and the total harmonic distortion would be 5 per cent.

As to self-bias, the power rating is that of the momentary output average, as distinguished from the continuous average power output in the case of fixed bias. The percentage of distortion in the output is a function of the duration and magnitude of the signal which, through variations in plate current, causes a fluctuation in grid bias. A proper filter will tend to stabilize the grid bias. The duration of stabilization increases with the time constant of the filter. The longer the period as represented by the time constant the longer the power peak can be maintained.

Characteristics

The time constant may be made higher by using higher value of capacity of the filter condenser, but if the capacity next to the rectifier is very high, the peak value of the a-c voltage at this point is considerably increased, and it may be four times the average value of the a-c. The voltage from the power transformer secondary is meant.

The plate resistance of the 2A3 will be 765 ohms, the amplification factor 4.2, the mutual conductance 5,500 micromhos, the required load resistance 2,500 ohms, 42 volts negative bias and 250 plate volts, with plate current at 60 ma, on the single-sided circuit.

In the push-pull formation, since the bias is increased about one-third, plate voltage increased only 20 per cent., the plate current, as stated is 40 ma. This operation at a more negative point of the tube characteristic for no-signal test is in line with "prime" Class A amplification, which begins to partake somewhat of the virtues of Class B, in that larger power can be handled without distortion, but the low-signal values do not introduce the distortion present in a-c Class B circuits at such values, since no grid current flows then.

With modern receivers being made as

sensitive as possible ahead of the detector, and with linear detectors that are virtually proof against overload, the value of a large-power output tube, especially in the push-pull circuits to stand 15 watts without more than 2.5 per cent. total harmonic distortion, will be appreciated by home constructors and experimenters.

The New Rectifier

The 5Z3 rectifier also will be a high vacuum tube, and like the 2A3 will have a four-pin base, but will require 5 volts on the filament, the same as the 280 and the 83, drawing 3 amperes filament current. The tube will be in a dome-shaped envelope and will have a coated filament.

The plate supply, from center tap to one extreme of the high voltage winding, should not exceed 500 volts r.m.s. under any and all varying conditions of the line supply. That is, the value should not be exceeded even on those occasions when the line voltage itself increases beyond the average value, to its occasional excessive peaks, as takes place in rural communities sometimes, due to poor regulation of the line.

The positive bus of the rectifier should be well filtered. This is the lead from the filament and should be taken from a center tap on the filament winding.

Considering the input, it should be remembered that the instantaneous value of the peak a-c voltage is about 1.4 times the r.m.s. value, as measured from plate to filament on an a-c voltmeter. The peak may reach four times the load voltage. For better regulation and safety a choke input may be used, which provides a lower d-c output. Also a fuse should be in the a-c line, of half the rating of the average current.

The 44

Besides the 2A3 and the 5Z3, the 44 is to be announced. It is substantially the same as the 39. The 44 is suitable as an r-f amplifier, first detector in superheterodynes, and as intermediate amplifier, for a-c and d-c use, including line d-c sets and automotive sets. The 44 has a greater cutoff and thus extends the super control. It is expected the official announcement will admit that there is small difference between the 39 and the 44, not enough to justify a separate model receiver being made to accommodate the new tube, and indeed it may be admitted that the two tubes are interchangeable, and that the 39 will be made with 44 characteristics in the future.

The foregoing information about new tubes is well in advance of the formal announcement, and while not official will be found to tally quite closely with the official ratings when issued.

The New Bandsread Circuit

(Continued from preceding page)

second band. Then the second step of the modulator would be from 4,000 to 12,800 kc, and the oscillator's step tuning would cover the range from 7,000 to 16,300, maintaining the same frequency ratio (approximately) of 7 to 3 as prevailed in the first short-wave band of the oscillator. Thereafter the frequencies would be so high that the same capacities could be used for both modulator and oscillator.

As remarked, the spreadout would not be uniform, for with increase in frequency finally there would be quite a span of frequencies for the range of the tuning condensers, but there would be a distinct improvement over the situation that yields separation only one-tenth as great at the high end as at the low end. There would not be such a dissimilar number of steps in the oscillator tuning for the respective ranges (as the oscillator condenser capacity would

be cut down accordingly), and a system would be developed that would raise to a higher advantage the adjuncts of the hand-spread of 1,000 kc obtained by tuning through the 500 to 1,500 kc range.

[Further discussions of this circuit will be printed from time to time, prior to the publication of the constructional article and performance report, and interested readers are asked to follow these articles.—EDITOR.]

Radio University

A QUESTION and Answer Department. Only questions from Radio University members are answered. Such membership is obtained by sending subscription order direct to RADIO WORLD for one year (52 issues) at \$6, without any other premium.

RADIO WORLD, 145 WEST 45th STREET, NEW YORK, N. Y.

Zero Beat Missing

IN BUILDING a battery-operated oscillator something like one you published, to obtain modulation I used a high value of grid leak (5.0 meg.) and the usual 0.00025 mfd. stopping condenser. Modulation is present but I can not tune to zero beat when that high value of leak is in circuit. What do you suggest?—J. W. Q., Ames, Ia.

The high value of leak sometimes prevents zero beats with carriers, and therefore we suggest that you put in a switch which, when open, provides modulation, using full 5.0 meg., and when closed puts a 100,000-ohm leak in parallel with the 5.0 meg. leak. In that way also you will have a choice of modulated and unmodulated service. Commercial oscillators of the battery-operated type are made up this way.

Push-Pull Resistance

DO YOU THINK that push-pull resistance-coupled audio is practical, and if so what circuit? It seems to me that if this method can be worked out properly it will provide the scheme that will eventually be used in many receivers.—U. W. D., Bangor, Me.

Yes, it is practical, but it has not been reduced yet to that form of practice which renders it commercially feasible. A discussion of resistance-coupled push pull was printed in last week's issue (January 21st) and we suggest that you investigate the new circuit outlined in that discussion.

Lowest Wave Length

ABOUT HOW LOW in wavelength may I expect to reach with the usual set-up, that is, standard tubes, 0.00014 mfd. tuning condensers and possibly plug-in coils?—U. T., Rahway, N. J.

You should be able to get down to about 13 meters or so. Some report that they do not get down quite as far with the '35 and '24, although the fact should be in the opposite direction.

Super's Oscillator

IF A SUPERHETERODYNE oscillator coil has too little inductance, may it be used in a padded circuit nevertheless, by increasing the capacity of the padding condenser? What is the effect?—I. D., Beaumont, Tex.

If the oscillator winding has too little inductance it would be preferable to increase the inductance to the proper amount by adding more turns. Only then would you be assured of best results. It may be a commercial coil difficult to tamper with, but it is better to overcome the difficulty rather than to attack the problem in the round-about way you suggest. If the padding condenser is made larger, with coil unchanged, the tracking will be pretty good around the low radio frequency adjustment (600 kc) and also at the high frequency trimmer adjustment (1,450 kc), but will be considerably off in some places in between, and the result will be an annoying abundance of squeals. You should obtain the inductance or turns data for the oscillator coil from the sponsor or originator of the circuit, use the prescribed padding capacity and tuning capacity.

Filament Voltage Trouble

IN A BATTERY-OPERATED set, using the 2-volt tubes, I find that the sensitivity varies. It usually goes down steadily, after several weeks, but on some occasions in between will go up. Will you please let me know the solution?—C. W. H., Brooklyn, N. Y. City.

This would likely be due to the change in the filament voltage due to the exhaustion of the A supply. Possibly you are using small dry cells that will not stand the current drain very well. Sometimes the filament voltage returns to nearly normal due to the batteries having recuperated, but the fall-off soon becomes rapid again. It is necessary to operate these tubes at 2 volts. If the voltage is too high the tube life is shortened and performance impaired. This is also true if the voltage is too substantially too low, strangely enough. In any set using the 2-volt tubes, therefore, because the filament voltage is critical, it is well to include a filament voltmeter in the circuit. Then any drop in the sensitivity can be investigated right away in the filament circuit, the most logical place to look for it. If the filament resistor is a trifle smaller than necessary, and a rheostat of about twice that value is put in series, the voltage adjustment can be made properly whenever any change in filament voltage results from battery condition. The voltage drop is due to the increase in the battery resistance because of use or ageing of the battery.

Odd Values

IN CERTAIN circuits I have seen odd values used, and I am wondering why they are used. For example, I have seen plate coupling resistors of 99,000 ohms and other resistors of 51,000 ohms. Why would not 100,000 and 50,000 ohms do as well?—R. P. E., New York, N. Y.

For coupling resistors and grid leaks there is no reason why the even values should not be used, but in some cases where the resistors are used for voltage dividers values like 99,000 and 51,000 ohms might be useful. For example, suppose we have two of these connected in series with a lead running from the junction. If the same current flows through both the voltage drop is divided proportionally to the resistance. The total resistance is 150,000 ohms and the voltage drop in the smaller would be 34 per cent. of the total.

Quality from Super

IS IT POSSIBLE to get good quality out of a superheterodyne? I have heard say that it is impossible. And yet I don't see any reason why this can not be done.—K. W. C., Minneapolis, Minn.

Yes it is possible, and a good example of the practical application of this is in the Super Diamond, 6-tube model. The requirements are that the tracking be exceptionally good, otherwise tone may be wretched; that the intermediate amplifier and the tuner ahead shall not be over-selective, and that automatic volume control, if used, shall not be "too effective." Quite some DX may be received, nevertheless, but if a great DX

Strict Class B Too Distorting, Sparton Holds

In its "Bulletin Service" the Sparks-Withington Company, maker of the Sparton Radio, discusses Class B audio amplifiers, and explains why it uses Class A instead. The quotation from "Bulletin Service" follows:

"Class B amplification is not something new in theory, but is a long understood and until recently a rejected system. Class B has always had the capabilities of large power output with few tubes, but its one defect, the defect which has for many years kept it on the miscellaneous pages of the laboratory notebook, is the amount of distortion which is apparent when the system is used at low levels of output. This defect of objectionably distorted tone at low volume is not found in the well designed Class A system.

"The thirst for more power output on the part of the buying public clashes with the desire of manufacturers to keep construction costs low. Class B amplification has been revised, with some modern departures, to meet the demand for large volume. It is an economical system, as two output tubes used as Class B may be used to deliver 20 watts of understandable sound. These systems all have objectionable distortion when operated at low volume.

"Sparton has designed a large output (20 watt) amplifier which is used in the Models 28 and 27. The absence of distortion is as apparent at low volumes as at high. Four power pentodes used in Class A parallel pushpull deliver without strain the expected large volume and work normally as undistorted Class A amplifiers at the usual desired low levels. To obtain these results has necessitated design costs which are the manufacturer's problems, not the consumer's.

"At thunderous volumes admittedly four Class A tubes do the work of two Class B, providing the Class B amplifier is correctly designed, but at normal room volume these four tubes do a task which is not in the scope of Class B, a task which kept Class B on the shelf from its conception until recently dug out by manufacturers striving for additional volume with careless regard for tone quality."

set is to be built, an extra stage of i-f may be included (making two stages, using three coils), and the effect of a.v.c. extended, for its stabilizing influence, and then you have a compromise between quality and best distance-getting. The reason why quality may not be the best on a very sensitive and selective super are: a.v.c. develops a hiss; selectivity is too high; some tube or tubes overloaded (beginning with detector and ending with power tube); a.v.c. pushes bias, on many signals, too near the detecting point and thus introduces second harmonic distortion.

Hum in Receiver

A SEVERE hum has been developed in my broadcast receiver. I have tested all the tubes and they are perfect. I have also tested the speaker on another set and that, too, is all right. Many other tests I have made have been favorable. Everything seems to be all right except that the set hums. Can you suggest a cause?—E. R. W., San Antonio, Tex.

Perhaps you have electrolytic condensers in the B supply filter. If so, one of them must have gone bad. At any rate, check up on the filter and the B supply first of all. Perhaps the filter choke has become shorted. It is the filter that takes out the hum so it is logical to make the tests there.

STATION SPARKS

By Alice Remsen

A Wind Came Blowing

(For "The Romantic Bachelor")

WABC, Wednesday, 9:15 p.m.

A wind came blowing from the West,
It brought to me a cherished guest—
A lover sweet with raven hair,
All richly clad and debonair;
His ringlets tossed by wayward breeze,
A ribbon knotted at his knees.
He bent his head and kissed my hand—
Then carried me to romance land.

O blowing wind! You brought me shame!
You brought a blot to stain my name!
You brought me sorrow-laden tears,
And many anguish-ridden years!
My lover sweet with raven hair,
Has left me for a maiden fair,
With cherry lips and eyes of sloe—
I watched her come—I watched him go.

O blowing wind! I fain would flee;—
Oh, waft me to a secret sea;
Perchance I'll find an islet there
Where I may sit and comb my hair
And sing a siren melody
To draw my lover back to me;
I'll hold him ravished with delight
Within my arms so soft and white.

*A wind came blowing from the West,
It brought me a deceitful guest—
A lover false with raven hair,
So richly clad and debonair;
His ringlets tossed by wayward breeze,
A ribbon knotted at his knees.
Oh, would he had not kissed my hand—
Nor carried me to romance land.*

A. R.

* * *

LISTEN TO THE ROMANTIC BACHELOR; he will paint pictures of lovers false and true, in all countries, at all times, under all circumstances. The voice is Tommy McLaughlin's; the orchestra, Mark Warnow's, who also writes the very romantic continuity. A very intriguing program.

* * *

The Radio Rialto

Sun is shining again, and it's quite warm. I suppose you've noticed the change in our weather conditions during the last few years. I remember when we used to have real old-fashioned winters; now we have a little bit of everything, and I think we may blame the radio for that. So many bewildered air currents have changed the atmospheric condition of our fair country; in fact, of the whole world. It's the same in Europe—winters are not what they used to be. . . . Neither are radio programs; the air is now infested with a lot of out-of-date comedy—Joe Miller, Madison's Budget and the comic papers are being spread over the ether; some of the gags being used are brutal; Ed Wynn, Eddie Cantor, Jack Pearl and others are digging down deep into the past; you can hardly blame them—the old gags of yesterday are the new ones of tomorrow; the choicest one perpetrated recently was the old hunting gag, the tag line of which is: "The recoil of the gun knocked me over into the lake and I came up with my pockets full of fish, so it wasn't a bad day for hunting after all." . . . Anvhow, I give Ed Wynn credit for his delivery, Eddie Cantor for his swiftly moving panorama, Jack Pearl for his dialectical inventions, and Al Jolson for sticking to his last. . . .

By the way; at WLW there's a boy whom I have mentioned before; his name is Sidney Ten Eyck, and I think he's big-time stuff; the boy is original, with the nonchalance of Ben Bernie, the inventiveness of Walter Winchell, and his own particularly original brand of master-of-ceremonies humor; I wouldn't miss his Doodle-Sockers program, if only for his marvelous personality . . . but, here's a friendly tip, Sid: there's such a thing as too much of the "breaking-up" business. . . . Today, I heard Dorothy Paige sing "Kiss Me Again"; she did a jolly good job of it; Dorothy, by the way, sings with Seymour Simon's orchestra. . . . which also reminds me that Seymour has some new tunes, yet unpublished, that really are fine; among them are the following titles: "Foolish Pride," "Keepsakes," "Under My Skin," "Spellbound" and "I Tried So Hard"; these are torch tunes; then he has some light rhythmic numbers, a couple of which are clever: "I Just Can't Carry a Tune" and "Hook, Line and Sinker." . . .

Jack Fulton is in Cincinnati; Jack was formerly in vaudeville; I worked with him on programs when his act was known as Fulton and Burt; he's a nice lad; has been in the music business for about six weeks, working this territory for Abe Olman. . . . Got a suspicious looking envelope in the mail today marked Treasury Department; sure enough—it was the blamed old Income Tax return. . . . They flatter me. . . . Now for some good news: Joe Reis, our swankiest announcer, is back on the job, after a bout with old man "Flu"; he's added a nice dark goatee and mustache, which make him look more professorial than ever. . . .

Over at Columbia, on Madison Avenue, New York City, the Boswell Sisters inaugurated a new sustaining broadcasting schedule on January 18th; they have been busy making four vaudeville appearances per day around New York. . . . The new CBS series, "The Romantic Bachelor," shows up Mark Warnow in his true colors; he not only prepares the musical arrangements and conducts the orchestra, but writes the continuity also. . . . Billy Hillpot, one of the CBS "Smith Brothers," is a regular visitor at the studios during the new Chesterfield broadcasts; the reason: he and Lennie Hayton are old-time friends and room-mates. . . . Arnold Moss, who played the role of Chancellor von Schleicher in a recent "March of Time" broadcast, is an instructor of speech at the Brooklyn City College. . . . Several CBS artists celebrate their birthdays in January; these included Andre Kostelanetz, Freddie Rich, Helen Nugent, Marion Carley and Crane Calder; Nat Shilkret was born on New Year's Day. . . . Chief Shunatona of Cowboy Tom's Roundup, heard over Columbia, is a genuine Indian chief; he was born on the Pawnee Reservation in Oklahoma at the time of the last big buffalo hunt; hence his name, "Sunatona," which means "Charging Buffalo"; incidentally the chief is so fond of a famous Indian weed called tobacco that in his search for the perfect cigar, he frequently smokes samples of eight or ten brands in a day. . . .

Over at NBC we find that Ken Murray is the latest comedian to join the air forces of 1933; Ken is heading the cast of the Royal Vagabonds program; he's a clever lad; remember him when he first started in vaudeville as a tall, gangling youth, and it didn't take him long to reach stardom; he comes of a theatrical family, his dad being a comedian of the old

school. . . . A new program worth a listen is the Squibb dramatizations of great moments in medicine; Sundays, WEA and network at 4:30 p.m.; The Revelers and Frank Black are also on this program.

There are some things about radio that few people outside of technical men connected with the industry know: that the power required to put a program through from New York to Chicago, without the aid of repeaters or amplifiers, would be more than that given the earth by the sun; the transmitter which puts the program on the air from the studio cannot be turned on at a moment's notice, like a receiving set in a home; the power must be fed into the huge tubes gradually, for the tubes develop a terrific heat; should it be fed in full power the glass would probably break and the tubes would be ruined; the tubes, incidentally, are water cooled; stations affiliated with the National Broadcasting Company from Coast to Coast are in operation approximating a total time of 6,765 hours per year, or 405,900 minutes, or 24,345,000 seconds, and every second and fraction thereof, is accounted for in daily reports; and what do you think of that for efficient statistical figuring!

* * *

Biographical Brevities

ABOUT JULIA SANDERSON

I thought everyone knew all about sweet little Julia Sanderson, but recently I have been receiving several requests for information about her, so here goes: Born in Springfield, Mass., only child of Mr. and Mrs. Albert Sackett; her father was very well known to stage-goers in Philadelphia, as he was a fine dramatic actor. At the age of fifteen, Miss Sanderson came to New York to engage in chorus work. She studied diligently, understudying stars. Her first show was "Winsome Winnie." After her debut, opportunities came rapidly, but her first great chance came when Charles Frohman heard her sing and decided to star her in "Sunshine Girl"; she was an immediate success. Other brilliant successes followed one after the other. Then came "Tangerine." At the very first rehearsal she met Frank Crumit. He was her leading man, and from that moment on they hit it off. That was in 1922. Four years ago they were married. Their last show was "Oh, Kay."

They finally decided they were weary of travel and began to plan their home, near Julia's parents at Springfield, Mass. They chose an idyllic spot at Longmeadow, which they appropriately called "Dunrovin." It has been a happy home, for there Miss Sanderson found the peace and quiet that the road could never give. In 1928 they began their air careers with NBC and have been heard without a break ever since, having already made almost 2,000 appearances before the microphone.

Miss Sanderson is five feet, three inches tall and weighs one hundred twenty-six pounds. Her complexion is fair and her hair is golden. Her taste in dress runs to soft shades and tailored things. Her philosophy of life is that hard work and perseverance do win their reward. She admires sincerity in others and respects people who have a wholehearted love for work. One of her pet prejudices is badly dressed men and her only superstition is the possession of two-dollar bills; her favorite color is black. Her favorite author is Edward Bellamy, her uncle; her favorite playwright is George Kaufman; her favorite book "The Garden of Allah"; and her favorite poem, "Trees." Jerome Kern is her favorite composer.

DIAMOND PARTS

Tuned Radio Frequency Sets FIVE-TUBE MODEL

A-C operated circuit, 50-60 cycles, 105-120 volts, using two 58 t-r-f stages, 57 power detector and 47 output, with '80 rectifier. Three gang shielded condenser and shielded coils in a sensitive, selective and pure-tone circuit. Dynamic speaker field coil used as B supply choke. Complete kit of parts, including 8" Rola speaker and all else (except tubes and cabinet). Cat. D5CK @.....\$15.69
Wired model, Cat. D5CW (less cabinet) @.... 17.19

Kit of five Eveready-Raytheon tubes for this circuit. Cat. D5T 4.97

FOUNDATION UNIT, consisting of drilled metal subpanel, 1 3/4 x 8 5/8 x 2 1/4"; three-gang Scovill 0.00035 mfd., brass plates, trimmers, full shield; shields for the 58 and 57 tubes; six sockets (one for speaker plug); two 8 mfd. electrolytic condensers; set of three coils. Cat. D5FU..... 6.19
Super Diamond parts in stock.

FOUR-TUBE MODEL

The four-tube model is similar, except that there is one stage of t-r-f, and a two-gang condenser is used. Tubes required, one 58, one 57, one 47 and one '80. Complete kit, including 8" Rola dynamic speaker (less tubes, less cabinet). Cat. D4CK\$13.58

Kit of four Eveready-Raytheon tubes for this circuit. Cat. 4D.TK 3.89

FOUNDATION UNIT, consisting of drilled metal plated subpanel 1 3/4 x 2 1/4 x 7"; two-gang 0.00035 mfd. SFL condenser; full shield; two shields for 58-57; center-tapped 200-turn honeycomb coil; five sockets (one for speaker plug); two 8 mfd. electrolytics; set of two shielded coils; 20-100 mmfd. Hammarlund equalizer for antenna series condenser. Cat. D4FU\$5.48

INDIVIDUAL PARTS



Travelling light vernier dial, full-vision, 6-to-1 vernier, projected indication prevents parallax; takes 3/4" or 3/8" shaft; dial, bracket, lamp, escutcheon.

0-100 for 5-tube Diamond, Cat. CRD-0, @ \$8.91.

100-0 for 4-tube Diamond, Cat. CRD-100, @ \$9.91.

[If dial is desired for other circuits state whether condenser

closes to the left or to the right.]

8 mfd. Polymet electrolytic, insulating washers, extra lug. Cat. POLY-8 @.....\$8.49

Three 0.1 mfd. in one shield case, 250 volt d-c rating. Cat. S-31 @..... 29

Rola 8" dynamic for 47, with 1800 ohm field coil tapped @ 300 ohms. Cat. FP @..... 3.83

2 coils for 4-tube. Cat. DP @..... 3.90

3 coils for 5-tube. Cat. DT @..... 1.35

DIRECT RADIO CO.

143 WEST 45th STREET
NEW YORK, N. Y.

RADIO WORLD and "RADIO NEWS"

BOTH FOR ONE YEAR **\$7.00** Canadian and Foreign \$8.50

You can obtain the two leading radio technical magazines that cater to experimenters, service men and students, the first and only national radio weekly and the leading monthly for one year each, at a saving of \$1.50. The regular mail subscription rate for Radio World for one year, a new and fascinating copy each week for 52 weeks is \$6.00. Send in \$1.00 extra, get "Radio News" also for a year—a new issue each month for twelve months. Total, 64 issues for \$7.00.
RADIO WORLD, 145 West 45th Street, New York, N. Y.

SOLDERING IRON FREE!

Works on 110-120 volts AC or DC, power, 50 watts. A serviceable iron, with copper tip, 5 ft cable and male plug. Send \$1.50 for 13 week's subscription for Radio World and get these free! Please state if you are renewing existing subscription.
RADIO WORLD
145 West 45th St. N. Y. City

Modulated Oscillators

Accurate to 2 Per Cent

Offered FREE!

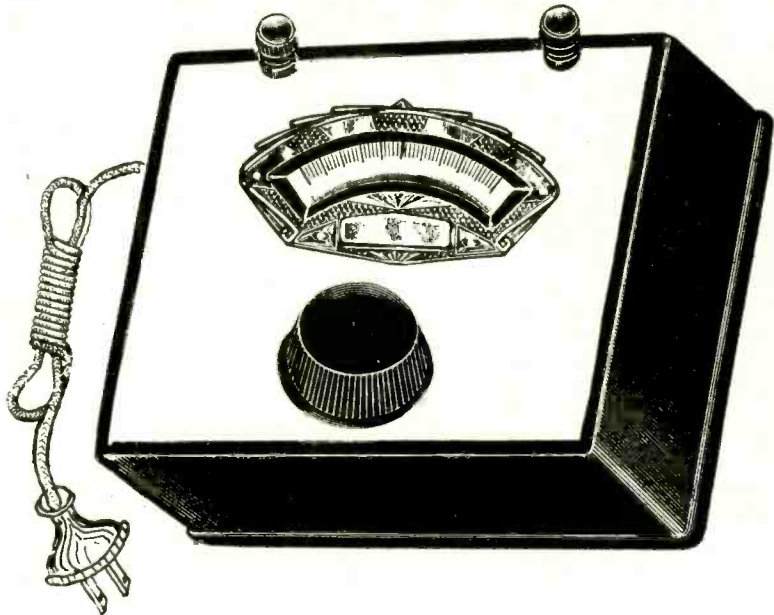

A MODULATED test oscillator is a strict necessity in service work and experimenting, and here is an oscillator in either a-c or battery-operated form that fulfills all the requirements. It permits lining up any intermediate frequency of 50 kc or higher (no limit), as well as peaking for broadcast frequencies.

This test oscillator has the fundamental frequencies imprinted right on the dial scale, 50 to 150 kc, so any tests for these frequencies should be made on the fundamental. All the commercial intermediate frequencies not found on the fundamental are registered on the upper tier of the scale, e.g., 172.5, 175, 177.5, 260, 400 and 450 kc. Any other frequency not included on the fundamental scale or the special upper tier registrations may be obtained by using a fundamental which is the result of dividing the desired frequency by the lowest whole number. Thus all intermediate frequencies are covered, either fundamentally or harmonically, and since the fundamental is 50 to 150 kc, the broadcast band is read directly by using the tenth harmonic and mentally affixing a cipher (500 to 1,500 kc). Also, by setting the test oscillator at 50 kc any receiver or other tuned circuit covering frequencies from 100 kc up may be calibrated in terms of 50 kc steps by tuning the tested circuit while leaving the test oscillator fixed at 50 kc.

Backed by Brilliant Engineering

THE a-c model uses the line frequency (60 cycles) for modulation, while the battery model uses the grid blocking principle, producing a high-pitched note. In the a-c model a 56 tube should be used, although in an emergency a '27 could be inserted. The 56 is a better oscillator and invariably permits zero beat adjustment. The tube for the battery model is the 230.

Since the modulation is of a steady average value in the a-c circuit, and of a steady absolute value in the battery model, the lining up may be done either by ear or in conjunction with an output meter.

There are two binding posts on the test oscillator panel, one (at left) for output, and the other for optional grounding. It is not necessary to use the ground post, nor for broadcast frequencies is it necessary to use any wire for coupling to the receiver, as the radiation from the test oscillator will be strong enough to effectuate coupling up to 40 feet from the receiver. For intermediate frequencies a wire from output post (left) should be connected to plate of the modulator (first detector) tube, to line up the i-f channel. Both posts are insulated from the voltage supply and therefore no fear of short-circuiting need be felt.

THESE oscillators are compact and sturdy and represent the most inviting premium ever offered to subscribers for RADIO WORLD. They were designed by Herman Bernard especially for subscribers for this publication, and utilize the Hartley oscillator as simplified by Edward M. Shiepe (Massachusetts Institute of Technology).

An extra large knob is used so that the adjustment may be closely made with convenience, while the vernier dial, of the full-vision travelling light type, combines to make possible the very closest adjustment.

In the design of the oscillator, while it was desired to avoid the nuisance of having to consult charts to determine the frequency, it was recognized that special precautions must be taken as to accuracy if the scale and the tuned circuit were to coincide. This feat has been fully and eminently accomplished by grid circuit stabilization, and while an accuracy of 2 per cent is absolutely guaranteed, one should realize that this is the maximum deviation permitted, hence at many positions the accuracy will be much greater. Indeed, there will be exact coincidence at about half the total number of subdivisions on the scale. The average accuracy is 1 per cent or better.

The battery model has a modulated-unmodulated switch. The a-c model is constantly modulated.

How to Get an Oscillator FREE!

The test oscillator, either type, is obtainable only in kit form as a premium with a one-year subscription for RADIO WORLD (\$2 issues, one each week) at the subscription price, \$6.00. The subscriber may build up the oscillator from information furnished with the kit. However, those desiring the kits wired and calibrated should send \$6.00 for the kit, and \$1.50 extra for wiring and calibration at a precision laboratory. The \$1.50 is turned over by us to the outside laboratory.

Complete parts diagram, calibration instructions, for the a-c model free with one year's subscription at \$6.00. Order Cat. PRE-ACOK and remit with order.

Wired model a-c oscillator. Send \$6.00 for one year's subscription and \$1.50 extra for wiring and calibration. Order Cat. PRE-ACOW, remit \$7.50 with order.

Complete parts, diagram and calibration instructions for battery model. Send \$6.00 for one year's subscription. Order Cat. PRE-BATOK, remit \$6.00 with order.

Wired battery model. Send \$6.00 for one year's subscription for parts and \$1.50 extra for wiring and calibration. Remit \$7.50 and order Cat. PRE-BATOW.

[Tube not included in offers. Shipments will be made express collect.]

RADIO WORLD, 145 West 45th St., New York, N. Y.

Semi-Tuned Coupler

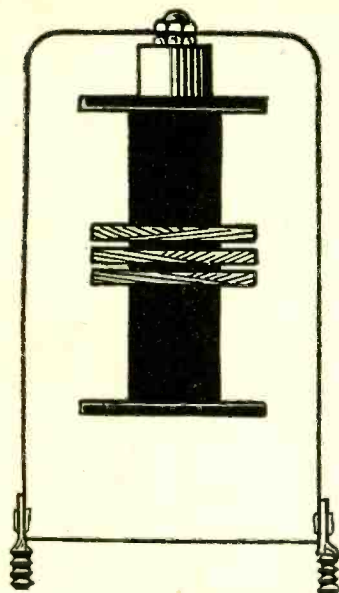

Special semi-tuned coupler, for a variety of uses. It consists of three inductively related windings in an aluminum shield, 1 3/4 inches diameter, 3 inches high overall, broadly resonant at the lower frequency extreme of the broadcast band. Secondary is center-tapped.

The semi-tuned transformer may be used as a so-called untuned stage of r-f feeding the detector, to make the amplification more nearly even throughout the band of radio frequencies by increasing the gain at the low frequency end. For general use the effected center tap on the secondary may be ignored.

If the duplex diode-triode is to be used in t-r-f sets, this transformer may be connected for full-wave detection with primary in preceding plate circuit, extremes of secondaries (green and green with white tracer) to anodes of the diode (55, 85), center (see below) to cathode through a resistor of 0.5 meg. This is one of the most practical ways of applying the diode to t-r-f sets, with or without automatic volume control, as the problem of a grounded rotor of a condenser and a return that cannot be directly grounded is avoided.

The coil also may be used for a-v-c pickup, by putting one choke winding in the plate circuit of the detector, with no condenser from plate to ground, but condenser from other end of this coil to ground, and thus using the pickup of the secondary to feed the a-v-c circuit.

The transformer may be used as antenna coupler. The windings consist of special honeycomb coils of low distributed capacity, with wire not too fine for this the intended purposes. The color code: red and yellow are primary; green and black are one secondary; green with black tracer and black with red traced other secondary. Connect black and black with red tracer for center-tapped secondary. Cat. STC @.....75c

Short-Wave Plug-in Type

- Cat. SWB—Four plug-in coils, 6-pin base; primary, secondary, fixed tickler.....\$1.70
- Cat. SZ—Six-spring wafer socket for use as coil receptacle for six-pin coils.....11c
- Cat. SWA—Four plug-in coils, UX base, primary and secondary; primary may be used for feedback if condenser connects aerial to grid....\$1.35
- Cat. SX—Four-spring (UX) wafer socket for use as coil receptacle for four-pin coils.....10c

CONDENSERS

- Cat. DJA-14—Single 0.00014 mfd. condenser with compensator built-in. 1/4-inch shaft. Supplied with bushing to take 3/8-inch dial hub. 98c
- Cat. DJA-25—Single 0.00025 mfd. feedback condenser. Useful where 0.0002 or 0.00025 mfd. is specified.....\$1.02
- Cat. DJA-14-D—Double (two-gang) 0.00014 mfd. condenser with compensators built in, 1/4-inch shaft. Supplied with bushing to take 3/8-inch dial hub.....\$1.96

SPECIALS

- Two coils for 4-tube Diamond. Cat. DP...\$.90
- Three coils for 5-tube Diamond. Cat. DT...\$1.35
- Five coils in four shields for Super Diamond. Cat. SDCK.....\$3.95
- Two r-f coils and separate oscillator coil for Anderson's Auto Super. Cat. AUSU.....\$1.45
- Two r-f coils and separate oscillator for 175 kc. supers. Cat. 175-SU.....\$1.45

Screen Grid Coil Co.

145 W. 45th St., N. Y. City

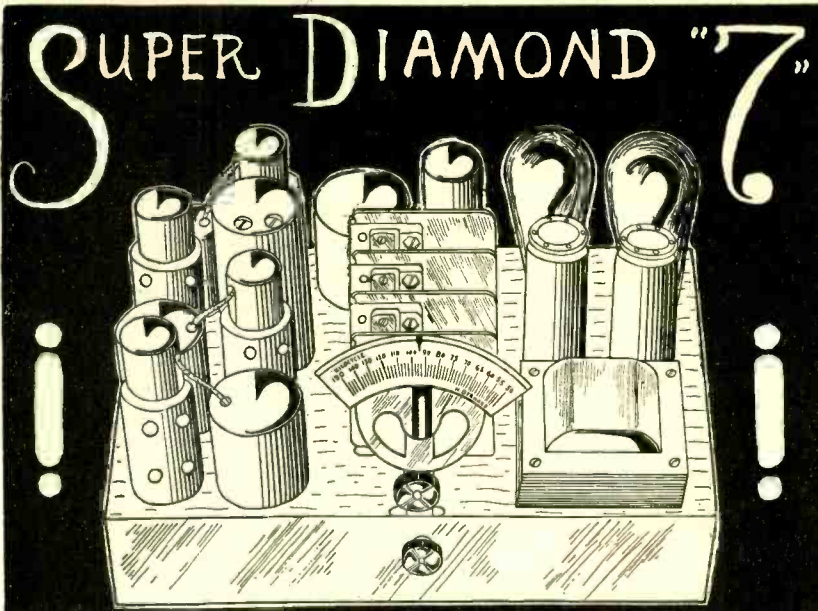

The Set That Brought In 96 Channels Out of 96!

A SEVEN-TUBE receiver, designed by Herman Bernard, with highly accurate padding, and using a frequency-calibrated dial, the Super Diamond 7 is just the thing for DX enthusiasts. The circuit has full automatic volume control, full-wave diode detection, diode-biased 55 triode, and, except for the second detector, triple-grid tubes throughout. Stations 10 kc apart sharply separated though antenna power input of one is 100 times that of other. A truly remarkable circuit. Complete kit of parts for this receiver, including everything, even speaker, except cabinet, front panel and tubes. **\$19.62** (Cat. CKSD7)

FOUNDATION UNIT

The Foundation Unit for the Super Diamond 7 consists of a shielded antenna coil, a shielded interstage r-f coil, a combination oscillator and 175 kc assembly in one high shield, a shielded regular 175 kc transformer, and a shielded 175 kc transformer with center-tapped secondary; also a 0.00041 mfd. tuning condenser, three-gang, with compensators; an 850 to 1,350 mmfd. padding condenser, a frequency-calibrated dial and a drilled chassis. **\$6.55** Cat. FU-SD7 @.....

[The coils for r-f and oscillator are wound exactly according to specifications of Herman Bernard and are of a higher order of accuracy than in commercial practice, and moreover provide for matching the tuning to the scale of the frequency-calibrated dial that bears Mr. Bernard's name.]

ADDITIONAL PARTS

- The nine 0.1 mfd. and two 0.25 mfd. bypass condensers for the Super Diamond 7 are specially made up in one shield, with mounting brackets, and is the same as used in the designer's model. Cat. CU-SD7 @ **\$1.20**
- Three-gang 0.00041 mfd. tuning condenser, compensators. Cat. TC-SD7 @ **\$1.98**
- Drilled chassis for the Super Diamond 7. Cat. CH-SD7 @..... **\$.80**
- The tubes used in this receiver are four one 55, one 59 and one '80. Total, 7 tubes. Tube kit is Cat. TK-SD7 @.. **\$5.35**
- 850 to 1,350 mmfd. padding condenser, 50c; knobs for 1/4 inch shafts, 7c each, four for 25c; Bernard's frequency-calibrated dial, 90c; electrolytic condensers, 8 mfd., 49c each.

SUPER DIAMOND 6

This is a 6-tube a-c receiver, like the "7," only there is one intermediate stage instead of two. Good sensitivity and selectivity, with finest tone yet developed in a super. Uses the same accurate padding system as the "7," same frequency dial. Gets plenty of distance, too.

Complete parts, including speaker (less tubes, less front panel, less cabinet). **\$16.22** Cat. SD-CMP @

Set of shielded coils, consisting of antenna coil, modulator input coil and combination oscillator and first 175 kc intermediate coil

- (latter two in one shield), and separate intermediate coil with center-tapped secondary. Cat. SDCK..... **\$3.95**
- Combination oscillator and 175 kc only, in one shield. Cat. OSN @.... **\$1.80**
- Three-gang 0.00041 mfd. condenser with trimmers built in; 3/8 inch shaft, 1 1/2 inches long. Cat. DJ-41-T..... **\$1.80**
- 250,000-ohm potentiometer with switch. Cat. R2SS @..... **\$.72**
- Pigtail resistors, 9c each; Rola speaker, \$3.83; tube shields, 11c each; UX, UY sockets, 10c; six-pin, 11c; 7-pin, 15c.
- The tubes required for the "6" are two 58, one 57, one 55, one 59 and one '80. Cat. TK-5D6 @

AUTHENTIC CIRCUITS

The Super Diamond series—the six-tube and seven-tube models—are most excellent circuits, carefully engineered and tested. "Everything fits." You will be amazed at what results these circuits yield. They are real "hot" and we unqualifiedly recommend them.

DIRECT RADIO COMPANY

143 WEST 45TH STREET

NEW YORK CITY