

# RADIO

REG. U.S. PAT. OFF.

# WORLD

The First and Only National Radio Weekly  
*Eleventh Year* *553d Issue*

## ALL-WAVE SUPERHETERODYNE

### FULL DETAILS OF NEW PHILCO 15

## AN AUTO SUPER

OCT. 29

1932

15c Per Copy

## 6-TUBE STAR CIRCUIT

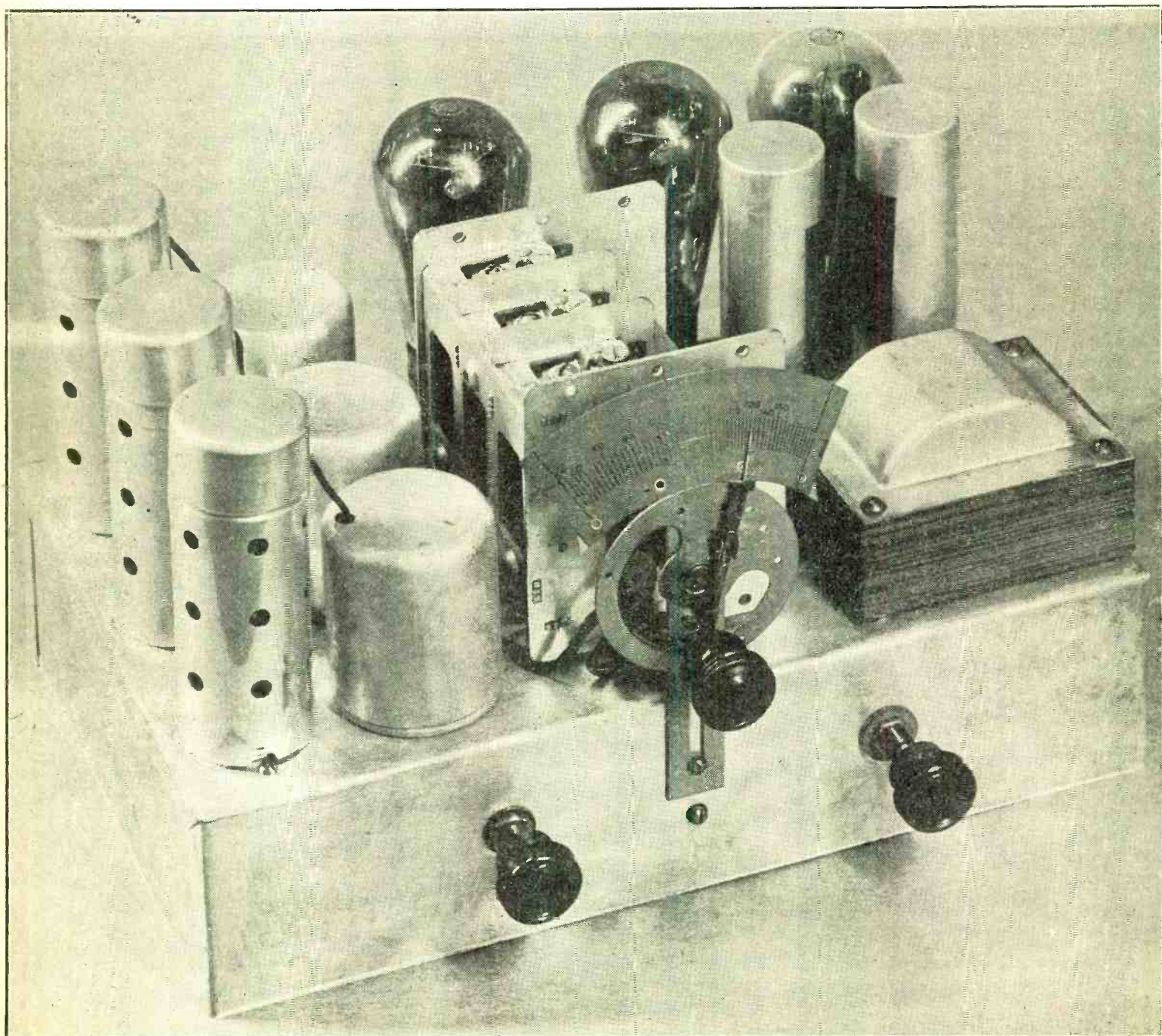

A 6-tube t-r-f set, using 58 and 57 tubes, with parallel pentode output. See page 18.



# REAL TONE QUALITY

WITH A RECORD FOR "STEPPING OUT"

## The NEW STAR "6"

6-TUBE TUNED RADIO FREQUENCY KIT—COMPLETE WITH DYNAMIC SPEAKER **\$13.95**

USING 2-58, 1-57, 2-247, 1-280

THE SENSATION OF THIS SEASON—SET NOW ON DEMONSTRATION

MAIL ORDERS FILLED PROMPTLY

DIAGRAM FREE. GET YOURS NOW

# THOR'S BARGAIN BASEMENT

167 Greenwich Street, between Cortlandt and Liberty Sts.

Telephone: Cortlandt 7-3324

**FREDRICK'S SAFETY PROTECTOR ! !**  
*The Silent Watchman—Protects Any Electric Radio*  
 Against coil and tube burn outs, short circuits, and fire hazards due to antenna circuit becoming grounded thru improved or fallen aerials, faulty materials or installation. Increases tone quality and selectivity. Increases volume and lessens static. Should be used on every electric radio. Time tested and proven for the past two years. Simple and effective. Sent postpaid by mail on receipt of check or money order. Dealers wanted!  
 Price \$1.50 each, including simple instructions  
 Satisfaction guaranteed by  
**P. R. FREDRICK'S RADIO STUDIO**  
 345 WEST 23rd ST. Tel. CHelsea 3-144 N. Y. CITY  
 (Located in this same block, nearly 10 years)

### RADIO MEN—Increase Income!

"How To Make Money In Radio Servicing," written by Zeh Bouck especially for Radio News, is the answer to the burning question of the hour! Prepared after months of effort and at great expense, it tells the radio service man how to make his business show a profit. And, what is more important in times such as the present?

Not only for the active service man, but also for the amateur and experimenter who desires to turn his knowledge and experience into practical money-making channels this book will prove indispensable. It tells you how, and when, and why to do things. It is practical—up to the minute—and complete.

For a limited time, Radio News is offering this money-making book absolutely FREE with a subscription for seven months for only \$1.00. This is a saving of 75c over the newsstand cost. Send order to Radio News, Dept. R.W., 222 West 39th St., New York, N. Y.

## RADIO WORLD and "RADIO NEWS"

BOTH FOR ONE YEAR **\$7.00** Canadian and Foreign \$8.50

You can obtain the two leading radio technical magazines that cater to experimenters, service men and students, the first and only national radio weekly and the leading monthly for one year each, at a saving of \$1.50. The regular mail subscription rate for Radio World for one year, a new and fascinating copy each week for 52 weeks is \$6.00. Send in \$1.00 extra, get "Radio News" also for a year—a new issue each month for twelve months. Total, 64 issues for \$7.00.  
**RADIO WORLD, 145 West 45th Street, New York, N. Y.**

### FINAL OFFERING! For Next to Nothing.

**UX245 Tubes at 20¢ Each**

(Five for \$1.00)

Sold on basis of remittance with order.

### RELIABLE RADIO COMPANY

143 West 45th Street New York, N. Y.

### SOLDERING IRON FREE!



Works on 110-120 volts AC or DC, power, 50 watts. A serviceable iron, with copper tip, 5 ft. cable and male plug. Send \$1.50 for 13 weeks' subscription for Radio World and get these free! Please state if you are renewing existing subscription.

### RADIO WORLD

145 West 45th St. N. Y. City

### Three 0.1 mfd. @ 29c

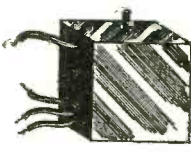

Three 0.1 mfd., in one shield; 250 v. d-c rating, mounting screw; size, 1 1/2" square x 3/8" wide. Black lead common; rods interchangeable. Cat. 8-31. @ 29c. Direct Radio Co., 143 W. 45th St., N. Y. C.

### 360-Degree Condenser

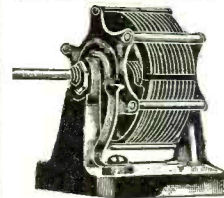

20 to 375 mmfd. capacity variation, effected over full 360 degrees, affords wide spread-out, better dial legibility. Great for test oscillators and all-wave tuning.

Price, \$3.00 net.

### DIRECT RADIO COMPANY

145 WEST 45TH STREET  
NEW YORK, N. Y.

## 115 DIAGRAMS FREE

115 Circuit Diagrams of Commercial Receivers and Power Supplies supplementing the diagrams in John F. Rider's "Trouble Shooter's Manual." These schematic diagrams of factory-made receivers, giving the manufacturer's name and model number on each diagram, include the MOST IMPORTANT SCREEN GRID RECEIVERS.

The 115 diagrams, each in black and white, on sheets 8 1/2 x 11 inches, punched with three standard holes for loose-leaf binding, constitute a supplement that must be obtained by all possessors of "Trouble Shooter's Manual," to make the manual complete. We guarantee no duplication of the diagrams that appear in the "Manual." Circuits include Boach 54 D. C. screen grid; Balkite Model F, Crosley 30, 31, 32 screen grid; Eveready series 36 screen grid; Eris 334 A. C. screen grid; Peerless Electrostatic series; Philco 16 screen grid.

Subscribers for Radio World for 3 months at the regular subscription rate of \$1.50, and have these diagrams delivered to you FREE!

Present subscribers may take advantage of this offer. Please put a cross here  to expedite extending your expiration date.

Radio World, 145 West 45th St., New York, N. Y.

### Your Choice of NINE Meters!

To do your radio work properly you need meters. Here is your opportunity to get them at no extra cost. See the list of nine meters below. Heretofore we have offered the choice of any one of these meters free with an 8-weeks' subscription for RADIO WORLD, at \$1, the regular price for such subscription. Now we extend this offer. For the first time you are permitted to obtain any one or more or all of these meters free, by sending in \$1 for 8-weeks' subscription, entitling you to one meter; \$2 for 16 weeks, entitling you to two meters; \$3 for 26 weeks, \$6 for 52 weeks, entitling you to six meters. Return coupon with remittance, and check off desired meters in squares below.

**RADIO WORLD, 145 West 45th Street, New York, N. Y.**  
(Just East of Broadway)

Enclosed please find \$.....for.....weeks subscription for RADIO WORLD and please send at free premium the meters checked off below

I am a subscriber. Extend my subscription. (Check off if true.)

- 0-6 Voltmeter D.C. .... No. 328
- 0-50 Voltmeter D.C. .... No. 327
- 0-Volt Charge Tester D.C. .... No. 22
- 0-10 Amperes D.C. .... No. 328
- 0-25 Milliamperes D.C. .... No. 328
- 0-50 Milliamperes D.C. .... No. 328
- 0-100 Milliamperes D.C. .... No. 328
- 0-300 Milliamperes D.C. .... No. 328
- 0-400 Milliamperes D.C. .... No. 328

NAME .....

ADDRESS .....

CITY STATE

## Two for the price of One

Get, EXTRA, one-year subscription for any One of these magazines:

- Q.S.T. (monthly, 12 issues; official amateur organ),
- POPULAR SCIENCE MONTHLY.
- RADIO-CRAFT (monthly, 12 issues).
- RADIO INDEX (monthly, 12 issues), stations, programs, etc.
- RADIO (monthly, 12 issues; exclusively trade magazine).
- EVERYDAY SCIENCE AND MECHANICS (monthly).
- RADIO LOG AND LORE. Bi-monthly; 5 issues. Full station lists, cross indexed, etc.
- AMERICAN BOY-YOUTH'S COMPANION (monthly, 12 issues; popular magazine).
- BOYS' LIFE (monthly, 12 issues; popular magazine).
- OPEN ROAD FOR BOYS (monthly, 12 issues).

Select any one of these magazines and get it free for an entire year by sending in a year's subscription for RADIO WORLD at the regular price, \$6.00. Cash in now on this opportunity to get RADIO WORLD WEEKLY, 52 weeks at the standard price for such subscription, plus a full year's subscription for any ONE of the other enumerated magazines FREE. Put a cross in the square next to the magazine of your choice, in the above list, fill out the coupon below, and mail \$6 check, money order or stamps to RADIO WORLD, 145 West 45th Street, New York, N. Y. (Add \$1.50, making \$7.50 in all, for extra foreign or Canadian postage for both publications.)

Your Name.....

Your Street Address.....

City ..... State .....

- If renewing an existing or expiring subscription for RADIO WORLD, please put a cross in square at beginning of this sentence.
- If renewing an existing or expiring subscription for other magazines, please put a cross in square at the beginning of this sentence.

**RADIO WORLD, 145 West 45th Street, New York. (Just East of Broadway)**

### DOUBLE VALUE!

ROLAND BURKE HENNESSY  
Editor

HERMAN BERNARD  
Managing Editor

# RADIO WORLD

The First and Only National Radio Weekly  
ELEVENTH YEAR

J. E. ANDERSON  
Technical Editor

J. MURRAY BARRON  
Advertising Manager

Vol. XXII

OCTOBER 29, 1932

No. 7, Whole No. 553

Published weekly by Hennessy Radio Publications Corporation, 145 West 45th Street, New York, N. Y.

Editorial and Executive Offices: 145 West 45th Street, New York

Telephone: BR-yant 9-0558

OFFICERS: Roland Burke Hennessy, President and Treasurer; M. B. Hennessy, Vice-President; Herman Bernard, Secretary.

Entered as second-class matter March, 1922, at the Post Office at New York, N. Y., under Act of March 3, 1879. Title registered in U. S. Patent Office. Printed in the United States of America. We do not assume any responsibility for unsolicited manuscripts, photographs, drawings, etc., although we are careful with them.

Price, 15c per Copy; \$6.00 per Year by mail. \$1.00 extra per year in foreign countries. Subscribers' change of address becomes effective two weeks after receipt of notice.

## How to Calibrate Your Own RESISTANCE METER

By Herman Bernard

MANY of the less expensive types of meters happen to have a d-c coil resistance of 500 ohms. Some of these are 0-6 volt voltmeters. No multiplier is used in the meter construction, because the resistance of the coil in the meter is purposely made just right for the voltage to be read, in this instance 6 volts.

The particular meter used in the present resistance-calibration of a new scale was a Roller Smith from an old Freed-Eisemann battery-operated receiver. Roller Smith makes excellent meters and its inexpensive meters are more accurate than the run of meters in the low-cost category. Since the voltage is 6 volts and the resistance is 500 ohms the full-scale deflection current is 12 milliamperes. If you can read the current with another meter in series, if the current is 12 milliamperes, since the voltage is 6 volts, the resistance is 500 ohms.

It does not make any difference just what type or make of meter you have, the same principle may be applied, and the meter mounted on a chassis and put in a box that also contains the dry-cell battery, and then, with calibration, you have a resistance meter. However, since the calibration work has been done on the basis of a particular meter, let us see about the procedure.

### Possibly Greater Accuracy

First the meter is removed from its case, and the scale carefully removed from the instrument. The occasion for care is that the needle is there, and the scale has to be pried off the metal disc and slid way from under the needle.

These inexpensive meters, no matter by whom made, need not to be expected to read voltages with high accuracy, because the scales are uniform and the coils in the meter may not be, and besides the fitting of scale on meter may not be perfect, the mechanical impedance non-uniform, etc., but we have our opportunity to build more accuracy into the meter, by taking the unit as it is and preparing our own scale.

Therefore, using fresh dry cells, register 0, 1.5, 3, 4.5 and 6 volt scale positions, and don't bother to be dismayed at the difference from what the meter itself would have read under previous conditions. The positions may not be exactly proportionate, although the voltages are, and don't let that worry

you, either, because the mechanical impedance of an unbalanced needle is likely to be greater at the higher voltage settings, so that the distance between 0 and 1.5 volts is greater than that between 4.5 volts and 6 volts. Bet on the battery rather than on the inexpensive meter, but know that your calibration will bring the meter into the sphere of greater accuracy.

### Resort to Protraction

When these points are registered it is quite permissible to obtain the intermediate voltages of 0.5, 1, 2, 2.5, 3.5, 4, 5, and 5.5 by protraction. If you haven't a protractor get one in the five-and-ten-cent store or in a stationary store.

Now get a compass and draw the outside circle of the scale on a piece of smooth cardboard. Also draw the pattern for the opening that permits the needle to move, and find the mounting hole points and also the needle deflection arc. You can get the

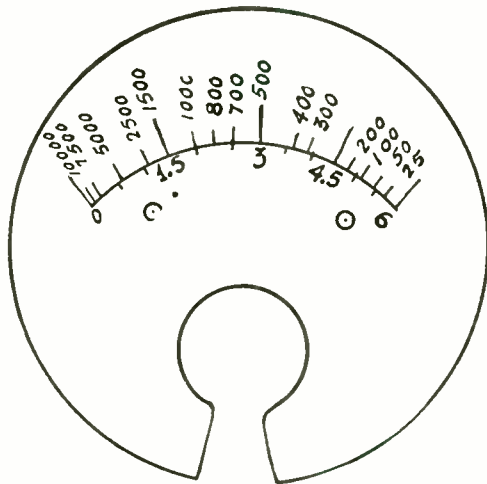

A 0-6 volt voltmeter, 12 milliamperes full-scale deflection, taken from an old battery set, was converted into a resistance meter, the scale illustrated replacing the old voltage scale. Note that voltages are recalibrated too.

length of the curved line and also the positions quite exactly by protraction, following the old scale as corrected for voltage readings.

Now the only thing you have to do is to find out the resistance gradations. This can be done by computation, using Ohm's law, which is: the resistance in ohms equals the voltage in volts divided by the current in amperes. We shall use unit ohms and decimal amperes.

The full-scale deflection is 0.012 ampere, and as the current is proportional to the voltage through an unchanged resistance, we know from our rather well established voltage reading points where certain values of unknown resistance will cause the needle to come to rest.

### Resistance Example

Let us take one example. An unknown resistance is connected in series with 6 volts  
(Continued on next page)



# A Noise-Reducing Antenna System

(From Amy, Aceves and King, Inc.)

The operation of most electric circuits, particularly if accompanied by sparking, sets up electromagnetic waves capable of interfering with nearby radio receivers.

The modern household is replete with sparking switches, motors, electric heating appliances, violet ray machines, oil burners, electric refrigerators and other devices propagating electromagnetic waves which, fortunately, travel but a very short distance. Outside the household there are electric power lines, trolley and electric railways, dial telephones, electric elevators and other devices also contributing to the high noise level or background noise experienced in average broadcast reception, particularly in these days of super-sensitive receivers.

Consequently, "static" is for the most part due to artificial rather than natural or atmospheric causes. Campaigns have been conducted in some areas, aimed at the elimination of the sources of such interference with broadcast reception. However, it is difficult and costly, if not altogether impossible, to eliminate the sources of interference in most instances. Hence the need for an inductive interference rejector or eliminator at the receiving end.

## The Two Paths

There are two paths by which inductive interference can reach and interfere with the operation of the usual broadcast receiver: first, through the power line, house wiring and into the a-c receiver via the power transformer; second, by radiation or re-radiation through space, the electromagnetic waves being picked up by the antenna system or by unshielded components of the receiver. Fortunately, most present-day a-c broadcast receivers are properly shielded, including an electrostatic shielding between primary and secondary windings of the power transformer. It is therefore the radiation or re-radiation of electromagnetic waves set up by inductive interference or man-made static that causes the noisy background. This is the point of attack upon the problem.

In the development of the multicoupler antenna system or single antenna for a plurality of radio sets, widely employed by apartments, hotels, hospitals, schools and other institutions housing many broadcast receivers, Amy, Aceves & King, Inc., were confronted with the problem of inductive interference. A study of the causes led to the development of a system, used either in combination with the multicoupler system for a plurality of broadcast receivers operating on a common antenna, or for a single broadcast receiver.

## Impedances Matched

Briefly, the system is an impedance matching device of unique design which allows the use of a shielded lead-in wire of any length, without loss of signal strength. Its use in conjunction with the shielded lead-in wire preserves the purity of the original signal intercepted by the lofty antenna, high above the zone of inductive interference, and at the same time eliminates almost to complete exclusion all the cracks, crashes, growls and other noises commonly classed as man-made static.

While the advantages derived from a shielded downlead have long been realized, it is practically impossible to achieve such shielding without resorting to this principle. Since the normal impedance of the antenna is so great with relation to the reactance between lead-in wire and shielding, it is at once apparent that, unless considerable spacing is allowed between the two, the signals would be shorted to ground via the shielding. By means of the system, however, the antenna now presents an impedance to the lead-in which is below the reactance between wire and shielding, thereby reducing the transmission loss in the shielded downlead to negligible proportions. The loss of signal pick-up by the shielded downlead is also negligible, since studies indicate that nine-tenths of the signal pick-up is by means of the antenna proper, the downlead contributing most of the remainder. Furthermore, because of the better matching of

antenna system and broadcast receiver brought about by the system, a greater transfer of energy from antenna to receiver now takes place, which is at once apparent in greater available signal strength.

The system comprises three units: first, the antenna transformer, installed at the antenna end of the downlead; second, the set transformer, installed at the receiver end of the downlead; third, the shielded downlead connecting antenna and receiver through the two transformer units. Considering each unit in turn:

The antenna transformer is a dome-shaped, weather-proof, sealed metal casing containing the antenna-downlead impedance matching unit, and provided with a screw terminal on top to fasten to the antenna wire at any convenient point, as well as screw terminals on the under side for downlead and shielding connections.

## Short-Wave Provision

Experience has proved that a transformer unit is essential at the set end of the downlead for all broadcast receivers of high impedance input. The majority of present sets are in the high impedance input category. Also, it has been found that even with low impedance input sets, when the volume control is at maximum setting the impedance becomes sufficiently high to require a transformer between downlead and the set. In order to meet the impedance requirements of any receiver, a transformer is designed with two taps or leads for high and low impedance requirements. After installation the set user can determine by actual test which of the taps or leads provides maximum signal strength.

Another feature is the incorporation of the short-wave optional feature. In other words, without any changes or additions whatsoever so far as the transformer is concerned, but merely using an alternative lead, short-wave reception down to 15 meters may be enjoyed by means of a suitable receiver.

The reduction of background noise, permitting of the greater enjoyment of any broadcast program, is at once apparent when working with the system. The reduction of the noise level also facilitates long-distance or weak-signal reception. The building up of the available signal strength by a more efficient transfer of energy between antenna and receiver is also desirable, especially for installations in which a considerable distance separates antenna and receiver.

## Plotting a Scale for Resistance Meter

(Continued from preceding page)

and the meter, whereupon the reading is "3 volts." Of course, we aren't reading voltage, so it must be current, and as 3 volts are half the total voltage, the current at this position must be half the total current, or 0.006 ampere. Therefore the resistance of the unknown is equal to (6 divided by 0.006) minus 500 ohms, or 1,000 minus 500, equals 500 ohms. Don't forget always to subtract the coil resistance (500 ohms here), as otherwise that would be accredited to the "unknown."

We find by the same process that at 1.5 volts we can register 1,500 ohms. The problem is to get the in-between resistance values, particularly as we desire even values of resistance, and not the odd values that usually obtain at most of the even current readings.

Bear in mind that the voltage in this instance is always 6 volts, or in another instance is always the maximum voltage the meter will read, and that the current is proportional to the voltage.

### Intermediate Values

Aided wonderfully by our ten-cent protractor we can determine the needle positions for the values of resistance within the

range of the meter that have even numbers and for which there is room to write down the figures. We can't write so very much, but in the present instance we can start with 25 ohms and wind up at 10,000 ohms, which isn't so bad. For instance, 10 ohms could be estimated, although any deflection beyond the 10,000-ohm mark merely would show that the resistance was more than 10,000 ohms, with no suggestion as to how much more.

Resorting to our protractor, we desire to ascertain what position is to be occupied by the needle for the 25-ohm unknown. Or, to be more accurate, this time we are making the unknown known, and trying to find out really what the current will be. The current is the unknown. The current in amperes is equal to the voltage in volts divided by the resistance in ohms, so the current is equal to 6 divided by 525, or 0.0112 ampere, or 1.12 milliamperes. No allowance need be made for the meter resistance now, because it is always a function of the current.

### Other Resistance Values

On a 100-scale protractor we can find the 11.2 position and communicate that to our scale, also by protraction, and register the scale mark as 25 ohms. And so on

with 50, 100, 200, 300, 400, 500, 700, 800, 1,000, 1,500, 2,500, 5,000, 7,500 and 10,000 ohms. Those desiring other round numbers of resistance values registered may be able to write them in, particularly 250, 450, 600, 1,200, 2,000, 3,500 and 6,000 ohms, but these values can be estimated quite readily from the scale as shown, and there is less crowding on the scale illustrated.

The integral resistance values are obtained by protraction, and we come to the conclusion that we have put to good use a meter we came near throwing away. The new scale put back on the meter, being glued down, as well as held by the two screws.

Suppose the meter is of a different type than the one discussed. Assume the meter is a 0-10 volt voltmeter. Then, we must use dry cells, and can use no more than 9 volts, we use 9 as the voltage factor and go through the process already described. We have to know the meter resistance, but we can read the current at full-scale deflection and derive the resistance value by Ohm's law.

Suppose the meter is 0-12 volts. Then again we must find the total current or the coil resistance, one giving us the other, the known one (together with the known voltage) giving us the unknown other.



# Unusual Features in an All-Wave Set

By Capt. Peter V. O'Rourke

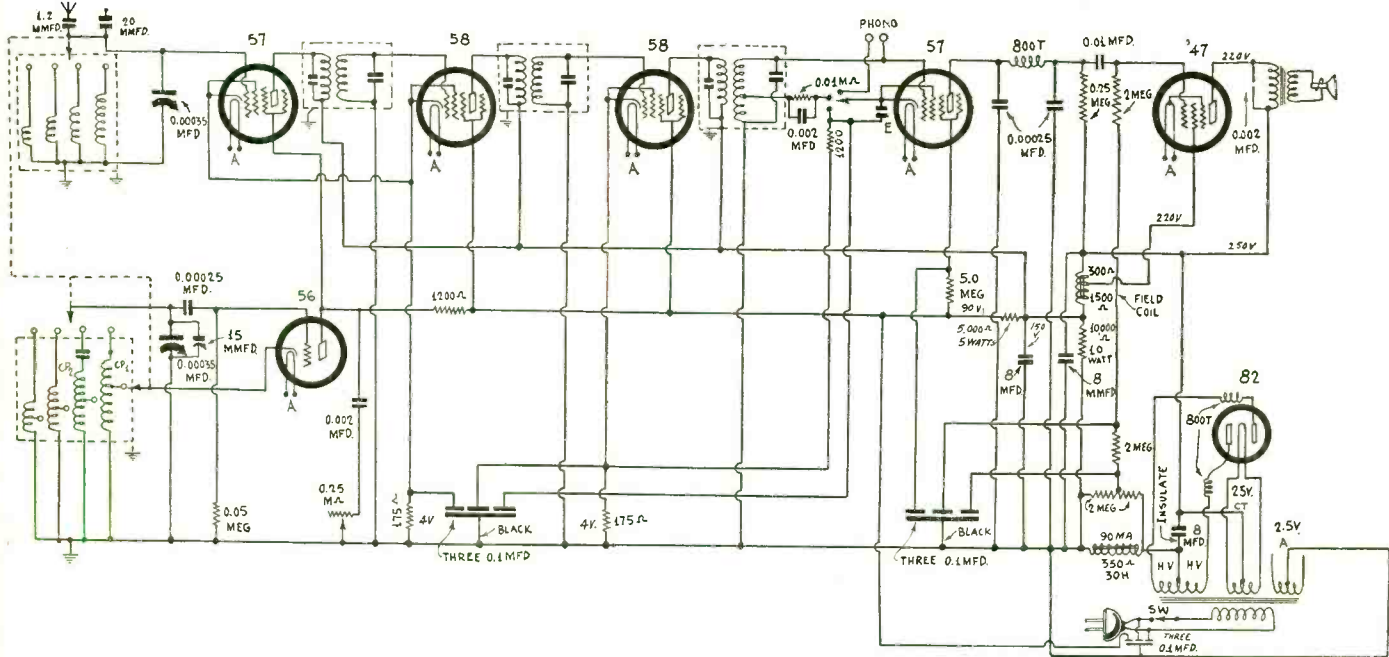

A seven-tube a-c superheterodyne for all-wave coverage (about 30,000 to 540 kc), embodying selectivity and coupling control and i-c-w switch. Wave bands are changed by switching.

**B**Y WINDING coils on somewhat larger diameter than usual, thereby enabling use of larger diameter wire, we can improve results in a receiver designed for

all-wave coverage, that is, from a little below 30,000 kc to exactly 540 kc. Such a receiver is the ultimate expectation of many, and lest it be deemed a costly af-

fair, let it be realized now that the parts (less tubes and cabinet) can be bought for about \$20, including speaker.

(Continued on next page)

## LIST OF PARTS

### Coils

- Four modulator windings on one form, four oscillator windings on another form, each form with 3 inch diameter shield, 4 7/8 inches high.
- Two shielded intermediate frequency transformers, commercial 450 kc type, adjustable from 390 to 470 kc, and to be used at 400 kc. Primary and secondary tuning condensers built in.
- One shielded intermediate frequency transformer, same as above, except that secondary is center-tapped.
- Three 800-turn honeycomb choke coils, 1 inch outside diameter.
- One 30-henry B supply choke coil, d-c resistance about 350 ohms.
- One power transformer, primary and three secondaries. Primary for 110 volts, 50-60 cycles; one secondary center-tapped, to afford about 285 volts at 90 ma d-c; another secondary 2.5 volt, center-tapped, 3 amperes, for 82 filament; third secondary, 2.5 volts also center-tapped, 2.5 volts, about 10 ampere rating.
- One dynamic speaker, 1800 ohm field coil, tapped at 300 ohms, with output transformer matched for single '47 output built in; UY plug and cable attached. Speaker cone obtainable in diameters of 6 inches, 8 inches, 10.5 inches and 12 inches.

### Condensers

- Two 0.6 mmfd. fixed condensers, to be connected in parallel to constitute 1.2 mmfd.
- Two padding condensers on isolantite bases, 350-450 mfd. capacity.
- One two-gang straight frequency line tuning condenser.
- One 15 mmfd. manual trimming condenser, with knob.
- One 0.00025 mfd. grid condenser with clips.
- Two 0.00025 mfd. fixed condensers.
- Three 0.002 mfd. fixed condensers.
- Three shielded blocks, each block containing three 0.1 mfd. fixed condensers. Black lead is common, goes to ground.

- Red leads interchangeably to destinations.
- Three 8 mfd. electrolytic condensers, one of them with insulating washers and extra connecting lug, because case is not to be grounded.
- One equalizing condenser, any small value; 20-100 mmfd. or smaller may be used. (E at demodulator cathode.)
- One 0.01 mfd. mica fixed condenser.

### Resistors

- Two 175 ohm pigtail resistors.
- Two 1,200 ohm pigtail resistors.
- One 5,000 ohm 5 watt resistor.
- One 0.01 meg. (10,000 ohm) pigtail resistor.
- One 10,000 ohm 10 watt resistor.
- One 0.05 meg. (50,000 ohm) pigtail resistor.
- One 0.25 meg. (250,000 ohm) pigtail resistor.
- One 0.25 meg. (250,000 ohm) potentiometer or rheostat with a-c switch attached; knob.
- Four 2 meg. (2,000,000 ohm) pigtail resistors.

### Other Requirements

- One chassis, 18 inches left to right, 9 inches front to back, 2-13/16 inches elevation.
- One vernier dial, 100-0, traveling light type, with lamp, escutcheon, knob; 1/4 inch hub.
- One antenna-ground binding post assembly (two antenna posts, one ground post).
- One phonograph twin jack assembly.
- Eight sockets: One UX, three UY, four six-pin type. The extra UY socket is for speaker plug.
- Four special shields for 6-prong tubes; one shield for 56 tube.
- One three-deck four-position precision switch, for band shifting; knob.
- One single pole, triple throw switch for i-c-w feature; knob.
- Tubes required: one 56, two 57, two 58, one '47 and one 82.

[Questions concerning parts should be addressed to Trade Editor, Radio World, 145 West 45th Street, New York City.]

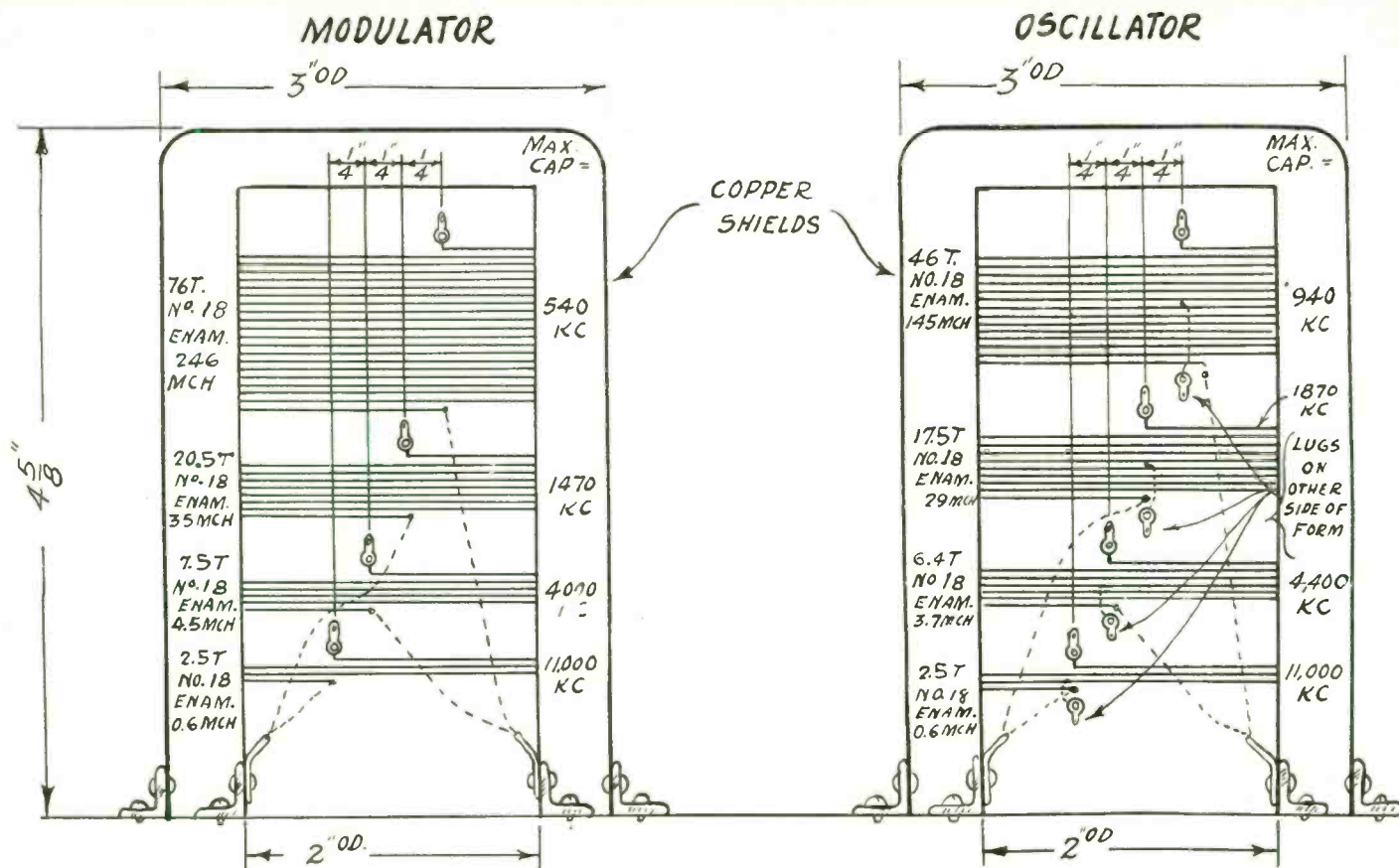

Front elevation of the coil-shield assembly, with winding data. The inductance values are given only so winding data may be computed by advanced experimenters for other form diameters and wire sizes. At maximum capacity (0.00035 mfd. for modulator and 0.00018 mfd., 0.000236 mfd. and 0.00035 mfd. twice for oscillator) the recorded frequencies should obtain.

(Continued from preceding page)

While it is generally better to use plug-in coils, because of the superior contact, if a switch of the highest caliber is used, then the contact can be just as good, and the uncertain and sometimes high resistance effect of the switch is practically eliminated, at least to the extent that contact resistance is eliminated in the plug-in coil system. This switch is the only costly item in the list of parts, and it costs more than the speaker.

#### Importance of Switch

Another requirement of the switch—and upon this item falls a plethora of responsibility—is that the capacity be low. Only by keeping the stray capacities as low as practical is it possible, first, to cover the broadcast band of frequencies in full, including the Canadian station on 540 kc, and, again, to dip to frequencies equivalent to about 10 meters at the other extreme. Fifteen meters you can rely on, but that you will reach 10 meters is not guaranteed. Uncertainties affect this end of the spectrum and they have to do with many factors, including position of wires, size of shield, condenser minimum capacity, switch capacity, etc. Hence the best switch (it is confessed) is none too good, and the one selected was the best the author ever saw.

Most of the switches intended for band shifting are quite funny, with their uncertain contacts, lack of "notification" that the contact has been made, high resistance and high capacity effects, and lost motion or play. The switch in mind is one that lacks these shortcomings, and has no play or lost motion in the switch itself, the contact snapping into place with a decisiveness that announces its completeness of conductivity. The tiny amount of lost motion that sometimes may show up in the knob is not communicated at all to the switch.

If the aerial is connected to a series condenser, then the other side of the condenser may go to grid of the modulator,

while if two different capacity condensers are used (say, 20 mmfd., being an equalizer at minimum) and 1.2 mmfd. (being two fixed condensers of only 0.000006 mmfd. in parallel), then the aerial may be moved from the larger series unit to the smaller for the two highest frequency coils.

#### Coil Information

One side of the four modulator coils is grounded, the other side goes to the tabs of the switch, while pointer is connected to the grid and to stator of the modulator

tuning condenser. All four windings are in one form, enclosed by a copper shield.

The oscillator is of the Shiepe type, which modifies the Hartley system. The plate current is passed through part of the grid coil (one-half of it in all instances here) by connecting cathode to center tap of the winding.

Thus the grid of the oscillator has to be switched, and so must the cathode, hence a three-deck, four-position switch is used, and its shaft must be insulated from everything.

The four oscillator coils are on a sepa-

## DIRECTIONS FOR WINDING COILS

Outside diameter of coil forms, 2 inches.

Length of coil forms, 4 inches.

Copper shields, 3 inch diameter, 4½ inches high.

Two coil forms and two shields required.

#### Modulator

Largest winding (top) 246 microhenries inductance, 76 turns of No. 28 enamel wire, winding space trifle more than 1 inch. Leave ½ inch space before beginning next winding.

Secondary largest winding (second from top), inductance 35 microhenries, 20.5 turns of No. 28 enamel wire, winding space about one-quarter inch. Leave ½ inch before beginning next winding.

Third largest coil (third from top), inductance 4.5 microhenries, 7-1/5 turns No. 18 enamel wire, winding space about ¼ inch. Leave ½ inch space before beginning next winding.

Smallest coil (bottom), inductance 0.6 microhenry, 2.5 turns of No. 18 enamel wire, winding space, ⅛ inch.

#### Oscillator

Largest winding (top), inductance 145 microhenries, 46 turns No. 28 enamel wire, winding space about 0.6 inch. Tap at the 23rd turn. Leave ½ inch space before beginning next winding.

Second largest winding (second from top), inductance 29 microhenries, 17.5 turns of No. 28 enamel wire, winding space little more than ¼ inch. Tap at 8¾ turns from top. Leave ½ inch before beginning next winding.

Third largest winding (third from top), inductance 3.7 microhenries, 6.4 turns of No. 18 enamel wire, winding space about ¼ inch; tapped at 3.2 turn from the top third turn from the top. Leave ½ inch before beginning next winding.

Smallest coil (bottom), inductance 0.6 microhenry, 2.5 turns of No. 18 enamel wire, winding space, ⅛ inch. Tap at 1.25 turn from the top.

Bottom of all windings is for ground connection. Ground bracket to lugs.



rate form, in a separate shield. The winding directions are given herewith.

Since the intermediate frequency selected is 400 kc, and it ought to be at least that high so that some benefit will be derived from modulator tuning at the higher frequencies, the modulator for the broadcast band tunes from 540 to 1520 kc, and the oscillator has to tune to frequencies 400 kc higher, or 940 to 1920 kc. The tuning condensers are ganged, therefore the oscillator will have to be padded. Also its inductance will have to be less than that of the modulator. The capacity actually necessary to tune in this band of frequencies is 0.00018 mfd., and as the tuning condenser is 0.00035 mfd., the padding condenser must have a minimum capacity about equal to the maximum of the tuning condenser, for if they were equal then the effective capacity would be one-half, or 0.000175 mfd. The commercial type of padding condenser, 350-450 mmfd., therefore serves the purpose.

### More Padding

The padding problem arises again in the first short-wave band, tuning range of modulator 1470 to 4150 kc, requiring oscillator frequencies of 1870 to 4550 kc. This can be accomplished by using a smaller inductance and a smaller effective capacity, values of 29 microhenries and 0.000236 mfd. having been selected, and the same type of padding condenser may be used, for at its other extreme it would result in an effective capacity of 0.000234 mfd.

These are fine differences to flirt with—too fine in fact—a micromicrofarad here, a micromicrofarad there. So a small parallel tuning condenser is placed across the oscillator capacitance, which has hardly any effect on the broadcast band, where no effect is desired, begins to have some little effect on the first band of short waves, and then becomes a really valuable adjunct on the third and fourth coils. Although we have 0.00035 mfd. tuning condensers, which would render the tuning awkward at the higher frequencies, when we have a tiny parallel condenser or manual trimmer of 15 micromicrofarads it is virtually the same as if the total tuning capacity were only that, because the main tuning condenser can be set for approximately the desired frequency, and the vernier condenser used for band-spread tuning. The surprising effect of this is to reveal the existence, indeed the reception from, stations otherwise not deemed to exist anywhere except on lists of license holders. You know, some short-wave stations do hold licenses but do not transmit, but if you have a real good short-wave set you won't believe their number is nearly so large as previous experiences might have prompted you to imagine.

### Trimmer Connection

There is no need to trim the modulator if the oscillator is trimmed, especially as the oscillator trimmer effectuates lower frequencies than would obtain without it, and the disparities between oscillator and modulator would be that the oscillator frequency was too high, rather than too low. Therefore the trimmer corrects for this condition, and the correction having been applied in one circuit, nothing need be done about the situation in the other.

It will be noticed from the coil winding data that the inductances for the two smallest coils are the same for the modulator and oscillator purposes, and this is satisfactory because at the frequencies of the signal or oscillator the difference between them (the intermediate frequency) is only a small percentage of either. At the highest frequency the difference would be 400 kc out of possible 30,000 kc, and at the lowest extreme for these two windings (third coil, condenser at maximum) the modulator is at 4,000 kc when the oscillator is at 4400 kc. That is, the padding is done for the low frequency setting, and

as higher frequencies are tuned in on that coil the percentage of difference becomes less, the oscillator runs to too high a frequency, that is, outpaces the modulator (11,280 kc compared to 12,408 kc) but the difference of 1,128 kc can be taken up by the manual trimmer, for the padding is done with this condenser at minimum setting, at which position it contributes less than 2 mmfd. of capacity.

### Electron Coupling

The coils were figured on the basis of a frequency ratio of 2.82, which is a little less than actually arises in practice, hence a fair allowance has been made because of the effect of the shield and of the necessity of starting tuning in one band at a frequency fairly well within the range of a previous or anterior band. That is, overlap is essential.

The equivalent capacity ratio is 9.4 for the modulator. The frequency ratio is the square root of the capacity ratio.

Electron coupling is used between modulator and oscillator. The common plate and screen load resistor of 1,200 ohms causes electrons in the space streams of the two tubes to intermingle.

It has been well known for several years, ever since experiments with short-wave superheterodynes became serious, that something had to be done about loosening the coupling at higher frequencies, compared to much lower ones. There are several reasons, the principal concern being to maintain the independence of the modulator tuning, which is virtually lost when coupling is too tight, as the oscillator "pulls" the modulator. A relatively low impedance for low frequencies (or loose coupling device) may become a high impedance to much higher frequencies (tight coupling device), and so the idea was conceived of having the volume control be a coupling variant.

### The Unique Control

As the particular type of oscillator used does not require a loaded plate circuit (that is, non-reactive plate circuit is permissible), we find opportunity to introduce adjustable reactance. As the screen of modulator and plate of oscillator are common, their electrons intermingling, we may put a fixed condenser from plate-screen to one side of a high-resistance rheostat (or potentiometer used as rheostat), other side, or moving arm, of rheostat to ground. Now we have a control that has its moving element at ground potential, which is highly important in any oscillating circuit, and most highly important where high frequencies are tuned. When the maximum resistance is in circuit the effect of the condenser is virtually zero, but when the control is turned to zero resistance, the full effect of the condenser results, the radio frequencies are bypassed from plate-screen to ground, and there is no coupling. The condenser, 0.002 mfd., is large enough substantially to remove the oscillator's output frequency even at 940 kc.

Another feature of this volume control—variable coupling device is that the lower the volume the higher the selectivity, so that one has a variable selectivity control as well. Any one would gladly sacrifice some volume to get rid of interference, for the interference not only spoils reception but also actually may prevent the reception of the desired station.

### Bias Values

The oscillator is not biased, and needn't be, the modulator (first detector) has the same bias as the first intermediate tube, 4 volts, the most sensitive point for the 57, while the demodulator (second detector) also has 4 volts, the same as the bias on the second intermediate tube. In fact the cathodes of these respective tubes are tied together in pairs. This reduces wobbliness in detector bias due to signal, but by no means holds detector plate current steady, for the sensi-

tivity of the detector may be measured by the change.

The demodulator has an original device, a method of changing the circuit to an oscillator, and at the same time changing the frequency enough so that a clear beat will be heard. This convenience is for those interested in receiving interrupted continuous waves, which, for clarity of reception, requires a separate oscillator, and the demodulator becomes that when the cathode is switched to the independent 0.01 meg. biasing resistor. The condition of oscillation may be used also as a means of aural tuning for all stations, if one doesn't mind the beat heard, for every time the modulator crosses a carrier the squeal is heard. Then, again, some will want to turn the dial without hearing any stations, to enjoy so-called silent tuning, and avoid blasting due to loud locals pouring in, and that service is rendered by the third position of the demodulator's cathode switch, for the plate current is cut off, and nothing is heard. Thus r-f also may be kept out if a phonograph input to the a-f channel is used.

### Switch Operation

This switch has an equalizing condenser, any one of small capacity, connected to it, other side to one side of a 1,200 ohm add-switch is set at lower position (see diagram) the equalizing condenser is shorted out, and the detector bias picked up in the manner previously explained. When the switch is at middle position the independent biasing resistor is cut in and cathode current sent through half the secondary, producing oscillation. The equalizer may be adjusted then to give just the pitch desired. There must be some detuning for the beat to arise.

The 1,200 ohm extra resistor between demodulator cathode and cathode of the second intermediate tube, while strictly speaking upsetting the condition previously described as cathodes tied together, really doesn't raise much—only 0.2 volt—and is included only because that way the demodulator did not become microphonic when a strong signal was heard, and without the resistor it did.

The wobbly detector condition when oscillation is present in the demodulator (switch as at middle position) is entirely within practical working limits, because of the removal of such reception from the sphere of highest quality of reproduction. Listeners to i.c.w. are not after quality but legibility.

### Filtration

Now, the r-f choke in the demodulator plate circuit has to be of considerable inductance, so a honeycomb coil of 800 turns, diameter about 1 inch, is used. The inductance is 10 millihenries and the distributed capacity is only a few micromicrofarads.

By no means is the B supply poorly filtered, for in short-wave work particularly there must be excellent filtration. Here we have the usual two 8 mfd. condensers affecting the negative-leg B choke coil, one of the condensers insulated from chassis, as marked on diagram, but besides we have another choke B coil, this one the field of the dynamic speaker. While it is marked as 300 and 1,500 ohms (total is 1,800, with tap at 300 ohms) almost any d-c resistance field from 1,200 to 2,500 ohms may be used, and if no tap is present, ignore it in the diagram.

It will be seen that the intermediate B voltage is derived from the total less the drop in the field coil, hence the tuner tubes have the benefit of extra filtration, and there is an 8 mfd. condenser (the third one) to augment the filtration some more.

The reason for the 300-ohm tap being connected to pentode screen ('47 tube) is to compensate for the drop in the primary

(Continued on next page)



of the output transformer, so the screen voltage will be approximately equal to the effective (rather than the applied) plate voltage. The inductance is too small to choke out the screen dynamic variations.

### Power Tube and Rectifier Dimensions

All the B current for the set flows through the negative-leg choke, which should have a low d-c resistance, to uphold the regulation of the rectifier circuit as a whole. The smaller this resistance the less the voltage differences resulting from current changes. Carrier and modulation amplitudes will change the B current, of course. Another factor toward stability is the inclusion of a fairly substantial bleeder current, about 20 ma. If the extra resistor is used (10,000 ohms, 10 watts) the total current through the negative leg choke will be about 90 ma, or the voltage drop across a choke of 350 ohms d-c resistance would be 32.5 volts, so if the pentode is biased at half this value, as may be done by including two equal resistors across the choke coil and connecting grid return to the juncture, the bias will be 16.25 volts.

The 90 ma drain is well within the limits of the 82 rectifier, but, as the diagram discloses, a 2.5 volt winding is necessary for the 82. Many may have transformers with 5 volt winding for rectifier filament, and in that instance will use the 83 tube, which stands a greater drain—indeed a greater one than is required to be served by this receiver—and in any event will have a mercury vapor rectifier that may give him a new idea of what rectifier tubes should be. However, by all means include the r-f chokes in the rectifier plate leads, or at least put high-voltage condensers of 0.05 or a little higher capacity between rectifier plates and by minus.

The line switch is built into the volume control.

### Layout of Parts

The arrangement of parts may be made on the basis of the chassis diagram, which calls for a metal chassis, the lower oblong being bent for the front flap, the large oblong being the chassis top, the next one the rear flap, and the small right-angle bend at the top mounting flap which is parallel to the top of the chassis. The diagram is purposely made for a nine-tube set, so that the same layout may be used even by others who desire to build different sets. However, for a seven-tube set one of the socket holes at right rear could be used for speaker plug, and the B choke put over the socket hole centered on the power transformer line. The 2.5 inch square cutout is for the power transformer.

The front panel parts, left to right, would be: coil switch for band shifting, manual trimming condenser, volume-coupling-selectivity control, and i.c.w.—silent switch.

The oscillator tube socket would be at left front, the modulator socket next, then four holes, for an intermediate transformer, two of them for mounting and two for bringing through leads, in one instance pairs, for in the other the grid lead (green) goes to cap of tube. Yellow is the plate lead, red B plus and black is ground.

### Grounding of Coils

To the right are the mixer coil positions, the oscillator coil forward, four leads passed through chassis, and the modulator at rear, eight leads passed through chassis. The holes for these passing purposes are on a circular formation. The ground lead need not be brought through, as the ground ends of windings are brought to lugs affixed to coil form brackets, which in turn connect to grounded chassis. In this way also the coil shields are grounded to chassis.

To the right of the mixer coils goes the shielded 0.00035 mfd. dual condenser, straight frequency line plate condensers being used,

and two of the holes being for carrying the stator leads down through the chassis to the two coil switch tabs (moving element) for band shifting.

Continuing after the first intermediate coil to the rear we find the first intermediate tube socket, then another i-f coil to right and the second i-f tube socket, and then the third coil feeding the detector.

### Shield This Lead

The lead from the switch would be long, unless a special switch with long shaft were used, and therefore if a long lead is to be present it should be of shielded wire and the shielding on the wire grounded.

The chassis is high enough, and there is room under the tuning condenser, so that most B choke coils would fit underneath, the actual height inside being  $2\frac{3}{4}$  inches (allowing  $1/16$  inch for the thickness of the chassis top.)

Left to right, rear flap, holes are provided for antenna-ground binding post assembly (two antenna posts and one ground post), and also holes for a rubber grommet to protect the a-c cable, and more holes for a phonograph twin jack assembly, mounting of three-in-one case 0.01 mfd. condensers, and speaker socket.

### Alignment of Circuits

The mixer circuit (modulator and demodulator, with switch, coils and sockets associated) may be left for the final wiring, for the circuit is operative as a 400 kc amplifier and audio amplifier without them, although the plate and screen will be a little high. The intermediate channel should be the first lined up, and for this work it is necessary to have a test oscillator, preferably a modulated one. Such an oscillator may be built for less than \$5, following data published in the October 15th issue.

If desired, the present set oscillator may have two 800-turn honeycomb coils, borrowed from the rest of the circuit, put in, one between grid condenser and cathode, other between cathode and ground, and the beat picked up with stations on 800 or 1200 kc, with the same condenser (0.00035 mfd.) The squeal would come in at about 20 on the dial and again at about 90, due to different harmonics of the oscillator beating with the selected station frequencies.

It is imperative to get the intermediate channel lined up properly.

### Padding

Do not attempt to wire in the switch and all the coils at first, but be content to get the set working satisfactorily on the broadcast band before proceeding to higher frequencies. Tune in a station at a low frequency, at or near that end of the broadcast band, not higher than 600 kc by any means, and adjust the padding condenser  $CP_1$  until the signal comes in loudest, being careful to have the manual trimmer at minimum capacity. If you have a modulated test oscillator set it for 550 kc and turn the padding condenser setscrew in a left-handed direction, for the capacity has to be nearly the minimum.

Then turn to or near the other or high frequency extreme, and if there is some reduction there in the sensitivity it is due to improper tracking, but the error is in the direction of too high an oscillator frequency, and therefore notice that the manual trimming condenser becomes helpful in clearing up this trouble.

If there is a mushy sound throughout, and generally weak reception, with many squeals, it is due to the intermediate channel oscillating.

### Oscillation Not a Killjoy

With three coils, two tubes and a high intermediate frequency, it is to be expected that there will be oscillation, although the voltages on plates and screens are a little lower than ordinarily recommended, for this very reason of aiding in getting rid of oscillation. It is not a bad sign if the inter-

mediate channel oscillates, rather it would be discouraging if it couldn't be made to oscillate no matter what was done with it, for then it would be so far below the region of most sensitive operation as to arouse suspicion.

So be prepared for the task of stabilizing the intermediate channel, which may be done by putting unbypassed resistors in the oscillating circuits, or putting resistors across the grid coil in those circuits.

The first thing to ascertain, once there is oscillation trouble in the intermediate amplifier, is what tube or tubes are oscillating. In all probability it is only one tube, and from past experience it might be supposed that this is the second intermediate amplifier. However, do not rely on assumptions. Actually ascertain. The oscillating tube will run a higher plate current than the others, and this is one indication. Another is that putting a wet finger at plate of the tube, or at grid cap, will stop the oscillation with a decided pop. So work on the tube that's oscillating, and put in the resistor. No specific values can be given, as they would depend on the severity of the oscillation, but in the grid circuit use as high a value as is consistent with total stoppage of oscillation.

### Values Suggested

For plate load resistor a value of 10,000 ohms may be sufficient (this resistor should be as low as practical, consistent with oscillation stoppage), while in the grid circuit, the value may have to be around 5,000 ohms or so.

Either of these methods, particularly the grid circuit one, positively will work, and if oscillation persists it simply proves that still another tube is oscillating, so give it the same treatment. Standard  $\frac{1}{2}$ -watt pigtail resistors will be abundantly large enough in current capacity for the plate circuit, while the grid circuit resistor will dissipate so little power that no particular rating need be given to it.

The first short-wave band windings (low frequencies) should be soldered to the switch now, and connected in circuit. The padding is done the same way as before, first on the basis of a signal frequency of 1500 to 1470 kc inclusive, representative of the low frequency end of the tuning, and then the checkup made at the other end. If you have a detecting type of test oscillator you can readily check up the set's oscillator frequencies for this band. Remember that the padding condenser  $CP_2$  must have its plates virtually as tightly together as possible for proper padding of this band.

There is no padding for the next two bands, full 0.00035 mfd. being used on oscillator as well as on modulator, but after the approximate frequency region is reached the manual trimmer is relied on for the tuning.

### Testing Frequencies

The frequency span of the little condenser of course becomes greater the higher the oscillator frequency, and for the last two coils it is really a wide-sweeping condenser on a frequency basis, despite its small capacity.

By suitable testing equipment the frequency of one circuit or another may be checked, and it is always a satisfaction to know the extreme frequencies of oscillator and modulator, including the relative effectiveness of the manual trimmer. The various methods of making such tests are rather beyond the scope of the present article, and include resonance-indicating devices of many sorts.

Some means will be suggested for using the present receiver for making such tests in the absence of more suitable equipment.

Since the oscillator is of the detecting type (due to grid leak and condenser and grid return to zero bias), we may remove the connections at oscillator plate and modulator plate, connecting the i-f primary to plate of oscillator. Using 20 mmfd. or less from aerial or other input to oscillator grid we can determine the oscillator frequencies.

(Continued on next page)



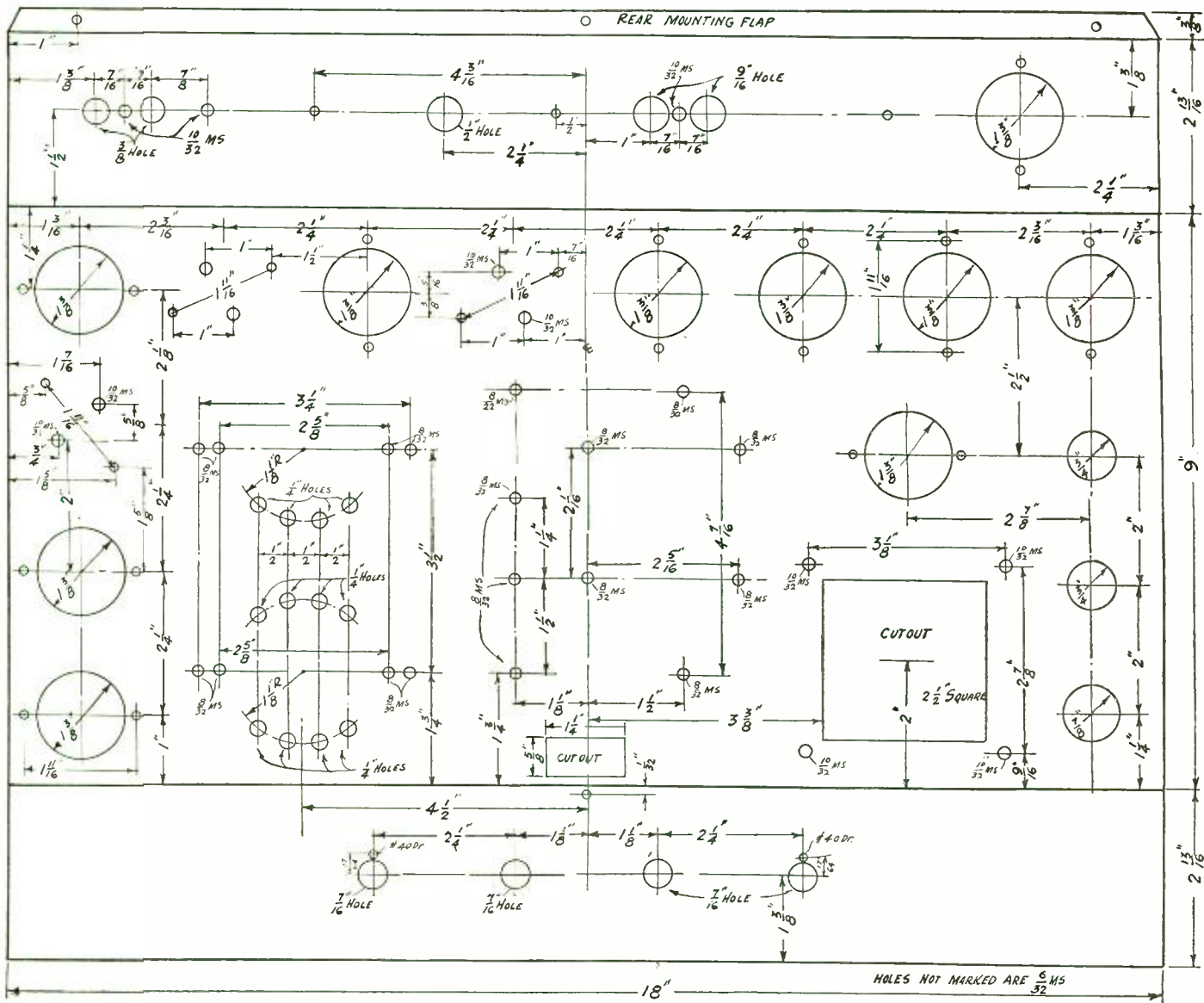

## Use of Receiver for Frequency Tests

(Continued from preceding page) because they are the input frequencies plus or minus 400 kc, and we can tell which by tuning in both, on low waves.

The coupling between aerial and the coil system may be through a small fixed condenser to grid, 20 mmfd. being all right, and we have this, but if oscillation stops, then the capacity of the series condenser is too high. Always we must know what frequencies are put in, and now we can deter-

mine the frequency span of the oscillator. If we couple the oscillator to the modulator tuning system with a turn of wire around the modulator coil to oscillator grid, and now use an independent tuning condenser on oscillator, present one disconnected, when both circuits are at same frequency the oscillator will stop oscillating. A large series capacity used as padding condenser at oscillator positions where no such condenser is shown, around 0.002 mfd. to 0.01 mfd., may

be tried, but with constants as given should not be necessary.

### STANDARD COLOR CODE

Megohms	Ohms	Body	Dot	End
0.000175	175	Brown	Brown	Violet
0.0012	1,200	Brown	Red	Red
0.005	5,000	Green	Red	Black
0.01	10,000	Brown	Orange	Black
0.05	50,000	Green	Orange	Black
0.25	250,000	Red	Yellow	Green
2.0	2,000,000	Red	Green	Black

### A THOUGHT FOR THE WEEK

**"STATIC" IS BY RUPERT HUGHES**—which means that radio is again lambasted to a fare-you-well; leave that to Mr. Hughes, who has the habit of toppling over idols and leaving a mess where there was beauty or sentiment. (Remember his book on George Washington?)

"Static" (Harper's, New York) is amusing at times and tells in an interesting manner the story of a young girl who, via the microphone, rises to fame and fortune over night and becomes the more or less blushing bride of the boy who gave her a start. She is a literary step-sister of the chief male character in "Crooner," by Rian James, but she is endurable and likable instead of being exasperating and mushy, as is Mr. James' prime idiot.

Mr. Hughes takes long jabs, right and left swings and straight-to-the-face smashes at radio, but in so doing interests even when he does not wholly convince.

### NEW INCORPORATIONS

- Reiseman Co., Inc., Newark, N. J., commercial advertisers, broadcasters—Attys., Furst & Furst, Newark, N. J.
- Yok Television-Radio Corp., New York City, radio business—Attys., Attorneys Albany Service Co., 315 Broadway, New York City.
- Atlas Television Co., New York City—Attys., Attorneys Albany Service Co., 315 Broadway, New York City.
- Paull-Pioneer Music Corp., New York City, sheet music—Att., I. A. Edelmant, 239 Broadway, New York City.
- Kornheiser Music Publishing Co., New York City, printing—Att., B. I. Shivers, 1775 Broadway, New York City.
- Utica Sales Co., Brooklyn, N. Y., electrical supplies—Attys., Sale & Sale, 551 Fifth Ave., New York City.
- Vim Electric Supply Co., New Brunswick, N. J.—Att., Morris Spritzer, New Brunswick, N. J.

### CORPORATION REPORTS

Grigsby-Grunow Company and Subsidiaries, including Columbia Phonograph Company from acquisition on Jan. 15—Six months ended June 30: Net loss after expenses, royalties, depreciation, minority interest and other charges, \$1,056,026. Net sales amounted to \$6,481,414. Comparison unavailable as company recently changed fiscal year. Balance sheet as of June 30 last shows current assets of \$4,692,882, including \$1,312,867 cash, and current liabilities of \$1,012,808. As of Dec. 31, 1931, current assets were \$4,159,918, cash \$841,179 and current liabilities \$1,079,291.

## CKOK on 540 kc Now, Outside Our Spectrum

The new Canadian station CKOK, at Windsor, Ont., operating with 5,000 watts on 540 kc, can be heard regularly in New York with receivers which go below the 550 kc American limit. The station comes in at New York City much better than WGR, Buffalo.

The distances and the frequencies are about the same in these two cases, so the difference must be due to power. WGR uses 1,000 watts. Facts of this kind point to the use of more and more power in the future to force clear signals over long distances.

### CeCo IN RECEIVERSHIP

CeCo Manufacturing Co., Providence, R. I., is in the hands of receivers. E. C. Wovry and S. J. Helsper are the co-receivers of the tube manufacturing company. Production has stopped.



# AUTO SET

## With 55, 89 and A-V-C

By Brunsten Brunn

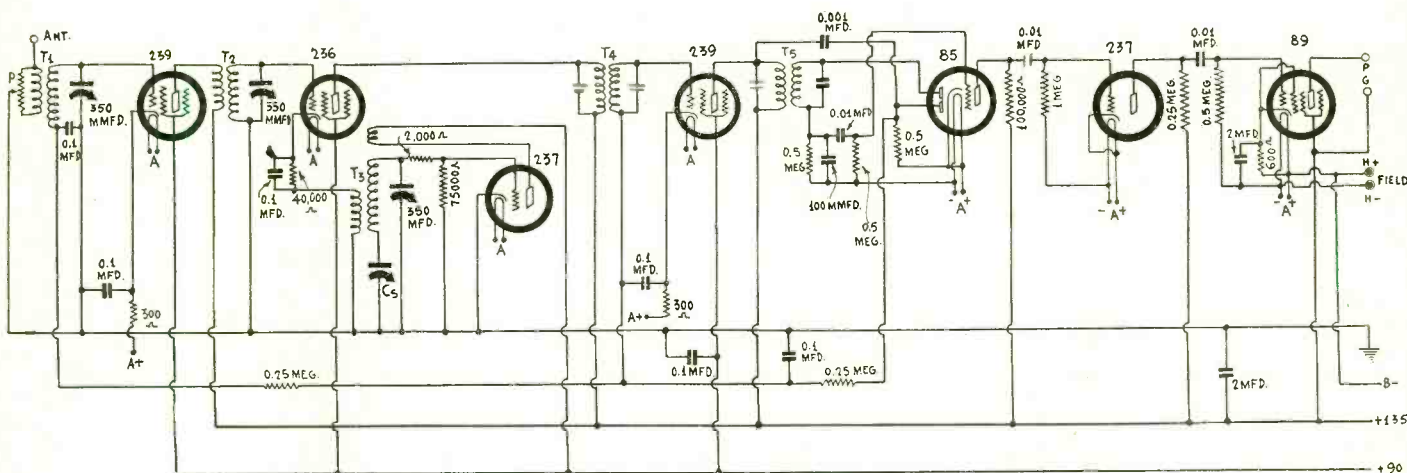

FIG. 1

In this seven tube automobile superheterodyne the 85 diode triode is used for detection, amplification and automatic volume control and the 89 is used as power tube.

THE installation of automatic volume control in an automobile receiver requires a bit of juggling if the control is to take proper effect regardless of which side of the circuit is grounded. The difficulty arises from the fact that there is only one cathode in the 85 tube and that this must be used for two functions, namely, detection and automatic control. There is danger of getting the circuit so connected that the automatic volume control does not take effect until the signal voltage on the diode exceeds the bias on the triode part of this tube. Normally, this bias is supposed to be 20 volts. There are very few circuits, indeed, in which the signal on the detector gets up to 20 volts and above. In such cases the automatic control would never be effective. Even when the bias on the triode of the 85 is only six volts, which is the case in Fig. 1, there is little chance that the signal will exceed the bias. Why? Is it because the set is so insensitive that it will never step the signal up to six volts? No, the answer is to be found in the audio amplifier.

Suppose, for illustration that the signal voltage on 89 power tube is 18 volts, which is more than it will be. The 237 tube working into a high resistance will have a gain of at least 6. Hence the voltage

on the grid of the 237 will be 3 volts. It is safe to say that the voltage gain in the triode is also 6. Then the voltage on the grid of that tube will be only 0.5 volt. That is a long way from 6 and still farther from 20. Of course, the d-c drop in load resistance on either diode will be larger than the amplitude of the audio signal, for the d-c is about equal to the mean of the carrier voltage whereas the audio amplitude is something less, depending on the degree of modulation. But even so we have a long way to go to reach 6 volts.

### Juggling Cathode Returns

We could avoid overloading of the audio amplifier and still get a high d-c voltage for automatic volume control by using only a small part of the signal on the audio amplifier. This would be easy enough if we put the manual control in the grid circuit of the 85 triode, as suggested in Fig. 2. But we still would have to have a strong signal to overcome the bias. Let us see if we cannot overcome the difficulty.

The 239 tubes in Fig. 1 are the controlled tubes. Each has a 300 ohm minimum bias resistor in the cathode lead. Now instead of connecting the low end of the resistor to the chassis let us connect it to A plus. Then

in these two tubes we start measuring the automatic bias from A plus. Let us see in what way that will help us. On the 85 detector the automatic volume control diode is connected through a half megohm resistor to the cathode, and this in turn is connected to A plus. Now we have no d-c voltage in the rectifier circuit, except that produced by the signal and the rectification. Since the low end of this resistor is connected to A plus, and it is positive end, and also since this is connected to the two bias resistors of the 239 tubes, the voltage developed across the load resistance is added to the bias on the controlled tubes. It is not subtracted from the drop in the limiting bias resistors. Therefore the automatic volume control takes hold just as soon as there is any signal voltage in the rectifier. If we wanted to delay the effect just a little bit, we could achieve that by putting in a small bias resistor in the cathode lead of the 85. If we chose this resistor so that the drop across it was one volt, for example, the signal voltage would have to be one volt before the automatic control took effect.

As the circuit stands the bias on the 85 triode is equal to the voltage of the storage battery, for the cathode is connected to the positive side and the grid return to the

### LIST OF PARTS

#### Coils

- T1, T2—Two r-f transformers for 350 mmfd. condensers, shielded.
- T3—One oscillator coil for 350 mmfd. condenser and either 175 or 400 kc intermediate frequency.
- T4, T5—Two doubly tuned i-f transformers for 175 or 400 kc.

#### Condensers

- One gang of three 350 mmfd. tuning condensers, with trimmers.
- Cs—One padding condenser (350-450 mmfd. for 400 kc and 700-1000 mmfd. for 175 kc.)
- Six 0.1 mfd. by-pass condensers.
- Three 0.01 mfd. stopping condensers.
- One 0.001 mfd. condenser.

- One 100 mmfd. condenser.
- Two 2 mfd. condensers.

#### Resistors

- P—One 10,000 ohm, or higher, potentiometer. (If audio volume control is used resistance should be half megohm.)
- Two 300 ohm bias resistors.
- One 600 ohm bias resistor.
- One 2,000 ohm resistor (Red body, red dot, black end.)
- One 40,000 ohms resistor (yellow body, orange dot, black end.)
- One 75,000 ohm resistor (Violet body, orange dot, green end.)
- One 100,000 ohm resistor (Brown body, yellow dot, black end.)

- Three 250,000 ohm resistors (Red body, yellow dot, green end.)
- Three 500,000 ohm resistors (Green body, yellow dot, black end.)
- One 1 megohm resistor (Brown body, green dot, black end.)
- One additional 500,000 ohm resistor or if audio volume control is used one 0.5 megohm potentiometer.

#### Other Requirements

- Five UY sockets.
- Two 6-pin sockets.
- One UY socket for remote control.
- One UY socket for loudspeaker, or a UX socket, depending on plug of speaker.
- Five grid clips.
- One automobile chassis.



negative side. There is no reason why only 6 volts should not be used rather than the recommended 20 volts, for the signal level is low here and the plate current is limited by the high plate load resistance of 100,000 ohms.

It is clear that either the negative or the positive of the storage battery may be connected to the chassis without any change in the operating bias or in the automatic bias.

**Bias on Other Tubes**

The bias on the first detector is not affected by the connection of the battery or by the automatic voltage for this tube is self biased. On the oscillator there is no bias other than that developed across the grid leak by virtue of grid current. The bias on the first audio tube is obtained exactly the same way as it is done on the 85 triode, by connecting the cathode to the positive and the grid return to the negative of the storage battery. It is also done in the same way on the power tube but in this case we need more bias than that afforded by the battery, and this extra bias is taken from the B supply by the usual bias resistor method. It will be noted that the 600 ohm resistor is connected between the cathode and the positive of the storage battery. Therefore the battery voltage and the drop in the resistor add up so as to give the required bias of about 16 volts. The 600 ohm resistor assumes that the supply voltage is 135 volts. If it is higher the resistance should be increased to compensate for the higher bias required.

B minus is connected to A plus in order to take advantage of the extra 6 volts. The connection between the B battery and the storage battery may be made on the car so that it is not necessary to run a separate lead. Either A plus or A minus is connected to the car chassis and when the set is mounted the chassis of the set assumes the same potential as the car chassis. It is not necessary, therefore, to run a lead for one or the other. A lead in the cable must be run for the "hot" side. If the negative of the car battery is connected to the chassis, all the A minus terminals on the set should be connected to the chassis. If the positive of the car battery is grounded all the positive terminals should be connected to the set chassis.

**Connection of Oscillator**

All who have built superheterodynes complain that it is very difficult to adjust the series padding condenser because it is "hot." This difficulty is easily overcome. It is only necessary to connect the condenser so that one side of it is grounded. This is done in Fig. 1. The series padding condenser Cs is connected between the coil and the chassis and the tuning condenser is connected across the combination. It is customary to use a stopping condenser in an oscillator. It will be noticed that the series padding condenser serves this purpose in this circuit. Hence we save a part by making the alteration and at the same time we make it easier to adjust. But these advantages are not gained without cost. The signal voltage developed on the grid of the oscillator is only the drop across the variable condenser. This drop is relatively less at the low radio frequencies than at the high. Hence the intensity of oscillation will not be as great at the low radio frequencies as at the high.

A grid leak resistor of 75,000 ohms is indicated in the oscillator circuit, and a 2,000 ohm resistor in the lead to the tuned circuit. These are subject to variation. For example, sometimes the 2,000 ohm resistor is not needed and the grid leak may be varied from 50,000 to 100,000 ohms. If there is blocking of the grid either make the leak lower or the series resistance higher.

**Intermediate Frequency**

The intermediate frequency may have any of the usual values. Either 175 or 400 kc is all right. However, due to the fact that Cs is larger when the intermediate fre-

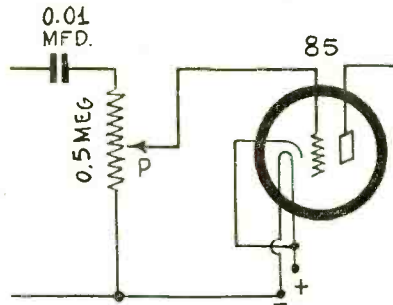

FIG. 2

**If the manual volume control is put in the audio amplifier this shows how it should be done.**

quency is lower there is a slight preference in favor of 175 kc. The intensity of oscillation, in so far as it depends on the ratio of the tuning condenser capacity and the padding capacity, will be more nearly equal at all settings of the dial. Whether 175 or 400 kc is used the oscillator transformer T3 should be wound for the frequency to which T4 and T5 are tuned.

The coils T1, T2, and T3 should also have been wound for 350 mmfd. tuning condensers. Therefore there are two conditions on the oscillator coil T3. It must have been wound for 350 mmfd. tuning and for the particular intermediate frequency that is used.

Parts not especially mentioned are specified on the diagram.

**Literature Wanted**

*Readers desiring radio literature from manufacturers and jobbers should send a request for publication of their name and address. Address Literature Editor, RADIO WORLD, 145 West 45th Street, New York, N. Y.*

- Wayne Patchen, 367-13th Street, Newark, Ohio.
- Kenneth J. Giese, 257 Dwight Street, Chippewa Falls, Wis.
- G. E. Lockerd, Radio & Sound Service, Mangum, Okla.
- Charles S. Sutton, 409 12th St., Toledo, Ohio.
- Jas. I. Brown, c/o Renwick Fuel Co. Flemington, W. Va.
- Larry A. Dowd, 111 West 84th Street, New York City.
- R. J. Sowko, 414 4th St., Monessen, Penna.
- Frank Burk, Box 88, Wadsworth, Tex.
- T. S. Branson, Box 114, Davenport, Wash.
- J. A. Brantley, 2317 Hickory St., Texarkana, Ark.
- Kenneth Hamlin, 12 Mulberry St., Clinton, N. Y.
- Clarence Erwin, Morris, Ill.
- Clay A. Large (galvanometers), 200 S. E. 26th St., Oklahoma City, Okla.
- McDaniel Radio Service, 1108 Hodges St., Lake Charles, La.
- L. A. Sunderland, 2225 Park Ave., St. Louis, Mo.
- O. Fernandez, 858 Filbert St., San Francisco, Calif.
- Juliano Infante, Hinigaran, Occ., Negros, Philippines.
- Leslie L. Clayton, Coin, Iowa.
- Richard B. Ham, Creston, Mont.
- Frederick W. Puck, 427 84th St., Brooklyn, N. Y.

**Tube List Prices**

Type	List Price	Type	List Price	Type	Price List
11	\$3.00	'31	1.65	56	1.30
12	3.00	'32	2.35	57	1.65
112-A	1.55	'33	2.80	58	1.65
'20	3.00	'34	2.80	'80	1.05
'71-A	.95	'35	1.65	'81	5.20
UV-'99	2.75	'36	2.80	'82	1.30
UX-'99	2.55	'37	1.80	'74	4.90
'100-A	4.00	'38	2.80	'76	6.70
'01-A	.80	'39	2.80	'41	10.40
'10	7.25	'40	3.00	'68	7.50
'22	3.15	'45	1.15	'64	2.10
'24-A	1.65	46	1.55	'52	28.00
'26	.85	47	1.60	'65	15.00
'27	1.05	'50	6.20	'66	10.50
'30	1.65	55	1.60		

**DX Hounds! Look Here!**

There are many more long-distance enthusiasts to-day than there were ten years ago, but they are a much smaller percentage of the total number of listeners, because that number has grown to around 75,000,000. The numerically larger quantity does not get enough attention, either from kit and set manufacturers or from the technical press.

In some few localities in the United States the reception of DX stations is practically impossible. These localities are usually in valleys. The neighboring mountains, with high ore content, act in a sense as shields. But in nearly all other localities there are many eager to sit up late at night—it's really early in the morning—to hear stations to the west of them, or who provide themselves with receivers that will bring in DX earlier from the east although locals are in active operation. Listeners in the central parts of the United States and Canada have a radial advantage, yet those on the coast lines have longer continental goals at which to shoot.

Most of those who seek DX have receivers that they themselves built, because the suitability of the receiver and aerial to the particular location, and direction of reception area to be favored, are technical problems requiring individual treatment. And the experimenters and set builders know how to give this personal touch to their work, or where to find the details in the technical press.

**Tastes Differ**

Some DX hounds seek to bring in the stations from the largest number of channels on the broadcast band, others desire to have every state in the Union, and perhaps all the station-populated provinces of Canada, on their lists, while others are interested in DX only if the station transmits on a power of 100 watts or less. Still others have a penchant for foreign station reception on the broadcast band (from which foreign category Canada is excluded in friendly and not ambitious fashion).

One of the possible annoyances, to which the DX fans become reconciled finally, is the number of chain stations, so that the same program is heard on channel after channel. But a fan who is merely seeking to build up his record in a particular direction is not so much concerned over this condition, because he isn't interested in the program, or, if he is, he will stop to listen to it. You must admit it would have to be quite a program to halt a DX hound in his quest of the far-off quarry.

**The Sixth Sense**

Virtually no assistance is given to the DX fan by the local newspapers, and therefore his standby is a lately corrected list of stations by frequencies, as with complete data given he can easily identify stations even without waiting for the call. This is especially true if he has lists of the stations attached to each of the two big chains. Then the program becomes as identifying as the call letters would be. Also, he gets to know announcers' voices, and not only that but often can recognize a station by the character of its modulation. This is the DX hound's sixth sense, and many possess it. Only some stations can be identified this way, and must have some characteristic sound.

Any DX hounds who would be interested in having a column in RADIO WORLD devoted to their activities, experiences and comments, with helpful information, have a good opportunity of getting their desire gratified. If enough such DX hounds write me they would like such a column I would be glad to conduct it. So what do you say, fellows? Address me care RADIO WORLD, 145 West Forty-fifth Street, N. Y. City

Do it now!

J. MURRAY BARRON.



# THE PHILCO MODEL 15

## Complete Circuit and Service

By Andrew

**T**HE Model 15 series Philco Radio is an eleven-tube superheterodyne, using 6.3-volt tubes (except for the rectifier), the output being pentode push-pull, feeding twin dynamic speakers. The intermediate frequency used is 175 kc. Automatic volume control, shadow tuning, and combination distance-power switch are other features. Shadow tuning consists of determining exact resonance by the narrowest shadow cast on the dial.

The front view of the highboy housing this receiver is shown herewith. As illustrated, the sounding board or baffle is tilted in characteristic individual style of the more elaborate Philco receivers. The reason for this, according to J. R. Jackson, of the Philco Service Department, is that "to purify sound it must be poured uphill."

The explanation back of this is that the waves that sound the high notes, as they come out of radio loudspeakers, travel in straight lines. They are slow to spread out and, unless directed upward, will only partly reach the ear of the listener.

### Large Baffle Area

"In fact, some of them will be absorbed and smothered in the floor covering," the explanation continues. "By tilting the sounding board and the loudspeakers as shown, these high notes are practically all carried into the field of hearing and the reproduced sound takes on the 'brilliance' of the original."

Regarding the low notes, Philco says that these waves, coming out of the loudspeaker, tend to nullify one another, so that you only partly hear them, unless the speakers are mounted on a baffle or sounding board.

"It is also a scientific fact," continues the explanation, "that up to a certain point the larger the area of the sounding board the more completely the low notes are held to their full tonal values. The large area of the sounding boards therefore is just as important in bringing you low notes with fine fidelity as the slant of the sounding boards is important in enabling the instrument to bring you the high notes."

Moreover, the mounting method is extolled for eliminating boxy tones, since the speakers are mounted directly on the inclining sounding board instead of in a sound chamber.

The tonal requirements of a radio set in respect to voice and some musical instruments are depicted in the chart herewith, showing frequency regions covered by the bass voice at one extreme, the piccolo at the other, with soprano voice and some other musical instruments in between. Performance at any point in the scale, according to Philco, can not be sacrificed without giving the effect of removing one or more instruments from the orchestra.

The data about the twin speakers are given as follows:

"You may have been told that two speakers should be used, one to carry the high notes and the other to carry the low notes. That sounds well but it isn't the proper way to use two speakers. The correct way to apply two speakers is to make two

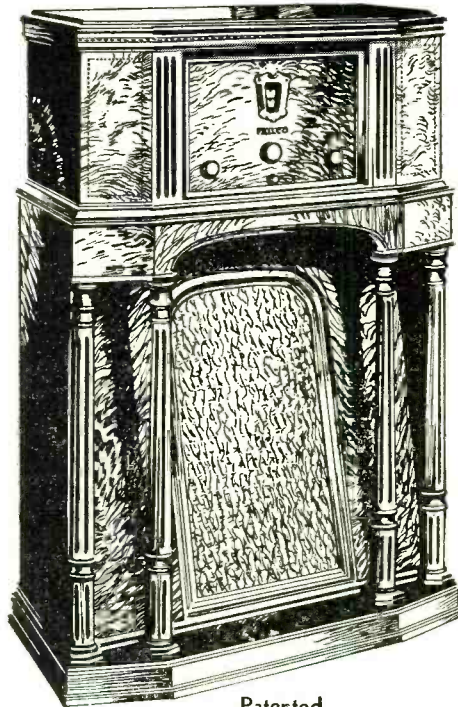

Patented

**The Philco X cabinet housing the Model 15 eleven-tube superheterodyne, with twin speakers. The knob at right operates the manual volume control. Cabinet height 42½ inches, width 27½ inches.**

speakers do for radio just what two ears or two eyes do for a human being.

"We can hear with one ear and we can see with one eye, but we need two ears for depth and fullness of hearing, and we need two eyes for depth and roundness of sight. Just so, twin speakers, properly designed, give to radio tone, fullness, roundness and relief that are impossible with a single speaker.

"Do you remember the old stereoscope? A photograph is flat until we look at it through the twin lenses of the stereoscope and then people, and trees and buildings stand right out from the background. We see the picture through both lenses and because of the twin lens arrangement the picture gains depth. However, one lens is not for the high lights while the other is for the shadows, any more than one speaker should be for high notes and the other for low notes."

The tuning silencer is combined with the power switch. With the power switch turned to the left the radio is disconnected from the line. Turning the switch to the right to the first notch places the receiver in an operating but silent or local condition. Turning the switch to extreme right releases the full power of the receiver.

A four-point tone control is included in the receiver, to enable the user to suit the tone to his taste, or to room or other conditions, including the setting of greatest reduction of high audio frequency response when there is considerable static, for then the noise caused by static is reduced.

The chassis is floating on soft rubber, and so is the gang tuning condenser. This precaution is to safeguard against acoustical feedback, which would cause grunting and howling sounds, because introducing the effect of mechanical vibration as modulation of the signal wave passing through the audio amplifier. This form of disturbance is referred to as microphonic interference.

The tubes used are made by Philco, and bear the special numerical designations used by this company. The eleven tubes are listed herewith, together with their nature and purpose and the voltage readings.

The wiring diagram at a casual glance gives the impression that it was taken from a circular issued during the financial boom, but a closer study reveals that it incorporates many ideas with which are only a few months old. A receiver of this kind has a popularity all its own—among its listeners.

There are many noteworthy features about the circuit. It incorporates shadow tuning for one thing. That's a new one! Shadow tuning is a device by which accurate tuning can be effected by the aid of a visual indicator. A shadow band is projected on the translucent dial above the dial numbers. This band varies in width according to the strength of the signal. When the signal is strongest the shadow band is narrowest and to tune accurately it is only necessary to adjust the dial until the band is as narrow as possible. Nothing elaborate is required to effect this. Suppose we have a meter which responds to the detected plate current. This current is proportional to the strength of the carrier and the deflection is also proportional to the carrier. This is greatest at exact resonance. Suppose the meter is provided with a very thin vane instead of a needle, and that the current makes this vane turn. If a light hits the face of it a wide shadow will result, but if it hits the edge only a sharp line will be projected. That is the essence of it. Examining the meter we note that there is a meter in the common plate circuit of the first detector and of the next tube.

### Automatic Volume Control

Of course, the circuit is provided with automatic volume control. We expect to find diode detection and we do. The detector tube is a 37 of the automobile series. The grid is used as anode and the cathode and the plate are tied together. The load on the diode consists of two resistors in series, one of which is a potentiometer, which is used as a manual volume control by adjusting the input signal voltage to the audio amplifier.

The voltage for the automatic volume control is taken from the d-c drop in the potentiometer for the grid returns of one r-f and one i-f amplifier are connected to the top of the potentiometer, through suitable filter condensers and resistors.

There are three stages of audio frequency amplification, two of which are resistance coupled and one a push-pull. It will be noticed that this is an even circuit although there are three stages. A certain amount of harmonic distortion is inevitably introduced by the first audio amplifier. About the same amount of distortion is introduced by the second, but in opposite phase. Hence the total distortion introduced by the first



# SUPERHETERODYNE

## Details of Latest Type Receiver

F. Fenton

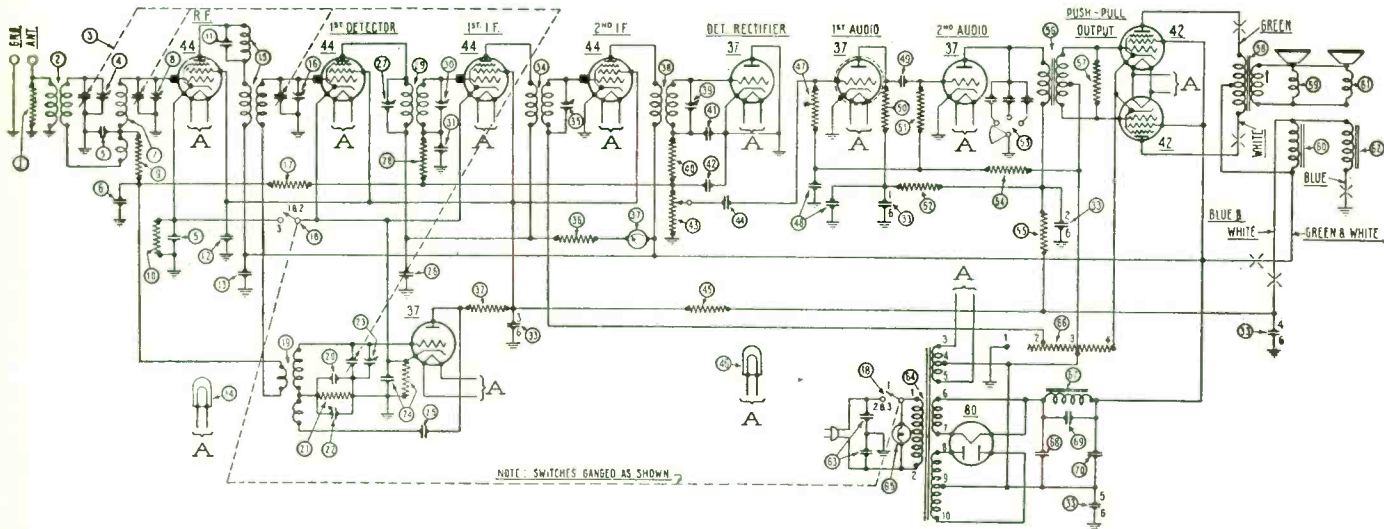

(1) Resistor (10,000 ohms) .....	4412
(2) First R. F. Coil .....	04981
(3) Tuning Condenser Assembly .....	04941
(4) Compensating Condenser—First Antenna .....	04000-E
(5) Condenser (.05 mfd.) Double .....	3615-AM
(6) Condenser (.05 mfd.) .....	3615-L
(7) Second R. F. Coil .....	04982
(8) Compensating Condenser — Second Antenna .....	04000-E
(9) Resistor (490,000 ohms) .....	4517
(10) Resistor (160,000 ohms) .....	5331
(11) Condenser (.35 mmf.) .....	4990
(12) Condenser (.09 mfd.) .....	4989-D
(13) Condenser (.25 mfd.) .....	4264
(14) Pilot Light .....	6608
(15) Detector Transformer .....	3884-V
(16) Compensating Condenser—Detector .....	04000-E
(17) Resistor (1,500,000 ohms) .....	7009
(18) Distance Switch and Power Switch .....	6438
(19) Oscillator Coil .....	04983
(20) Condenser (700 mmf.) .....	4520
(21) Resistor (51,000 ohms) .....	4518
(22) Compensating Condenser—Low Frequency .....	04000-F
(23) Compensating Condenser—High Frequency .....	04000-E
(24) Condenser (.09 mfd. and 200 ohm Resistor) .....	4989-R
(25) Condenser (.110 mfd.) .....	4519
(26) Condenser (.05 mmf.) .....	3615-J
(27) Compensating Condenser—First I. F. Primary .....	04000-J
(28) Resistor (2,000,000 ohms) .....	5872
(29) First I. F. Transformer .....	03038
(30) Compensating Condenser—First I. F. Secondary .....	04000-J
(31) Condenser (.05 mfd.) .....	3615-J
(32) Resistor (13,000 ohms) .....	3766

### KEY TO NUMERICAL DESIGNATIONS

with Official Catalogue Numbers of Replacement Parts

(33) Filter Condenser (.015, 3-5, 1. mfd.) 50-60 cycles .....	03489
Filter Condenser (.015, .5, .75, 1, 2-1 mfd.) 25-40 cycles .....	05302
(34) Second I. F. Transformer .....	04979
(35) Compensating Condenser — Second I. F. Secondary .....	04000-J
(36) Resistor (1,000 ohms) .....	5837
(37) Shadow Tuning Meter .....	6497
(38) Third I. F. Transformer .....	03345
(39) Compensating Condenser — Third I. F. Secondary .....	04000-J
(40) Resistor (99,000 ohms) .....	4411
(41) Condenser (.110 mmf.) .....	4519
(42) Condenser (.110 mmf.) .....	4519
(43) Volume Control .....	7050
(44) Condenser (.01 mfd.) .....	3903-AD
(45) Resistor (5,000 ohms) .....	5310
(46) Pilot Light (Shadow Tuning) .....	6608
(47) Resistor (1,000,000 ohms) .....	4409
(48) Condenser (.25 mfd. Double) .....	3557
(49) Condenser (.01 mfd.) .....	3903-T
(50) Resistor (25,000 ohms) .....	4516
(51) Resistor (1,000,000 ohms) .....	4409
(52) Resistor (10,000 ohms) .....	4412
(53) Tone Control .....	04787
(54) Resistor (490,000 ohms) .....	4517
(55) Resistor (5,000 ohms) .....	5310
(56) Input Transformer .....	5662
(57) Condenser (.002 Mfd.) Blue .....	6853
(58) Output Transformer .....	2565

(59) Voice Coil and Cone Assembly (Large) H-7 .....	02807
(60) Field Coil Assembled with Pot (H-7) .....	02803
(61) Voice Coil and Cone Assembly (Small) K-12 .....	02823
(62) Field Coil Assembled with Pot (K-12) .....	02803
(63) Condenser (.015 mfd. Double) .....	3793-E
(64) Power Transformer (50-60 cycles) .....	6672
Power Transformer (25-40 cycles) .....	6673
Power Transformer (50-60 cycles, 230 volts) .....	6674
(65) Cabinet Lamp .....	6600
(66) Resistor (30 ohms, 50 ohms, 205 ohms) .....	6700
(67) Filter Choke .....	3422
(68) Electrolytic Condenser (6 mfd.) 50-60 cycles .....	4916
Electrolytic Condenser (8 mfd.) 25-40 cycles .....	6707
(69) Condenser (.18 mfd.) 50-60 cycles .....	4989-K
(70) Electrolytic Condenser (6 Mfd.) .....	4916
Electrolytic Condenser (8 Mfd.) .....	6709
Knob (Large) .....	03063
Knob (Medium) .....	03064
Knob (Small) .....	03437
Knob Spring (Large) .....	4147
Knob Spring (Small) .....	5262
Tube Shield .....	04962
Grid Clips .....	4897
Four Prong Socket .....	5026
Five Prong Socket .....	4956
Six Prong Socket .....	6417
Dial Scale .....	4276
Bezel .....	6433
Pilot Bracket Complete .....	05016
Cabinet Lamp Socket .....	6584
Cabinet Lamp Socket Insulator .....	6605
Cone Retaining Ring .....	2600

two tubes is practically zero since one tube cancels the distortion by the other. The same thing happens in the push-pull stage.

In the plate circuit of the second audio amplifier is a tone control. There are four steps. In the first position there is no shunt capacity, in the second there is a small shunt, in the third still more, and so on. The use of a butterfly switch makes the capacities cumulative.

Another feature which may properly be classed as tone control is the use of two dynamic loudspeakers. One of these is mounted so that the sound is thrown forward and the other so that it is thrown downward at an angle. The object of this arrangement is to give a sense of depth to the sound just as a stereoscope gives apparent depth to a picture.

Filtering is done in the B supply to the audio tubes to prevent motorboating. Thus feedback from the power stage to the preceding stages is prevented by feeding the power tube stages directly and the other stages through one of the fields of the

speakers. Then there is a resistor in series with the lead feeding the two 37 audio tubes, with the usual condenser. In addition to that there is a resistor in series with the lead to the first audio tube, and another by-pass condenser. The result is that any stray currents from any audio to a preceding tube will have a difficult time getting through to cause instability.

A tuning silencer that prevents noise while tuning in stations is provided. This is attached to the power switch so that it does not add a control. When the switch is turned to the left the set is off. When it is turned one notch to the right it is on but in an insensitive condition. This is the position for reception of local station. When distant stations are to be received the switch is turned two notches to the right. Then the set is so sensitive that stations from coast to coast can be received.

The mixer circuit is somewhat out of the ordinary. In the first place we note that the pick-up coil is in series with the modulator tuning coil. Then the oscillator

is different. No direct current flows in the tickler coil, the tickler being connected to the plate through a condenser. Instead of a choke coil in the plate lead a resistor is used. This serves the two-fold purpose of dropping the voltage and of preventing the feedback from being short-circuited.

Both the tuning and the padding condensers are grounded on one side. The fact that the padding condenser is grounded makes adjustment easy, should this ever be required.

In the power supply there is a noise filter in the primary. This consists of two condensers in series across the line, the junction of the two condensers being grounded. Any high frequency disturbance coming in on the line will therefore be directed to ground and has no chance to enter the signal circuit. The filter in the direct current side is of the tuned type. That is, a condenser is connected across the choke and adjusted to such a value that it resonates with the principal hum frequency  
(Continued on next page)



# TABLE OF TUBES, PURPOSES, VOLTAGES

All of the readings herewith were taken with test prods from the under side of the chassis when the a-c line voltage was 115 volts. For filament voltages a suitable a-c voltmeter was connected from F to F, and for all other readings a high resistance multi-range d-c voltmeter from K to designated points, except cathode voltage, K to grid return. Volume control was at maximum and station selector turned to the low frequency end, with power switch in the middle position (silent or local reception position).

KEY TO CODE: Ef=filament voltage; Ep=plate voltage; Egs=screen grid voltage; Egc=control grid voltage; Ek=cathode voltage.

Tube	Nature	Purpose	Ef	Ep	Egs	Egc	Ek
44	Super-control variable-mu R.F. Pentode	R.F. Amplifier	6.3	165	55	15.0	20
44	Super-control variable-mu R.F. Pentode	First detector	6.3	250	90	0.85	10
37	General purpose triode	Oscillator	6.3	60	....	15.0	10
44	Super-control variable-mu R.F. Pentode	First I.F. amplifier	6.3	250	90	0.85	10
44	Super-control variable-mu R.F. Pentode	Second I.F. amplifier	6.3	275	90	3.3	10
37	General purpose triode	Second detector and automatic volume control	6.3	0	....	0.2	10
37	General purpose triode	First audio amplifier	6.3	75	....	0.4	10
37	General purpose triode	Second audio amplifier	6.3	100	....	0.2	10
42	Superpower Pentode	Superpower Push-Pull output	6.3	255	270	15.0	15
42	Superpower Pentode	Superpower Push-Pull output	6.3	255	270	15.0	15
80	Full Wave Rectifier	Supplies B and C operating voltages	5.0	320-1 plate	....	....	....

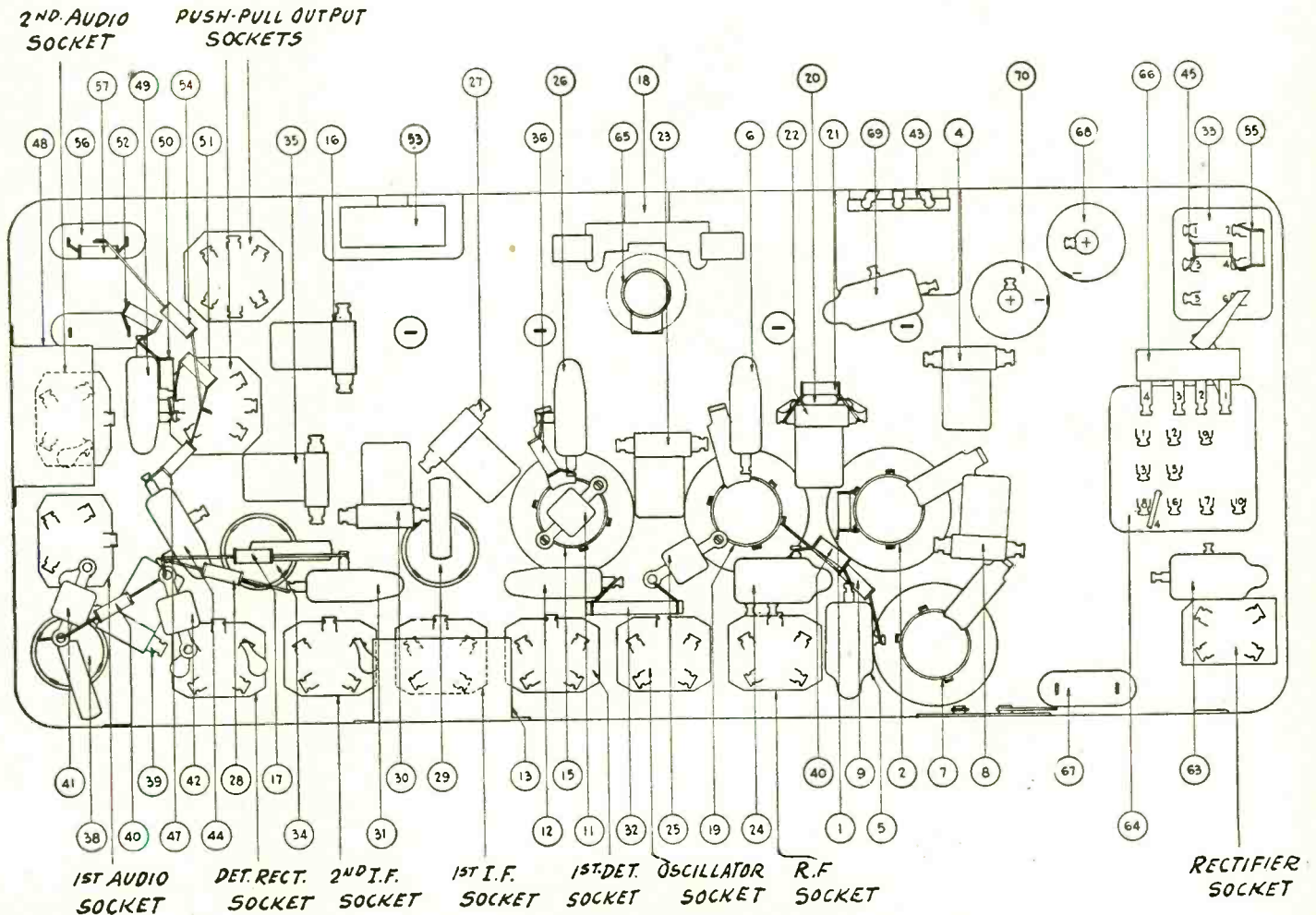

The layout of parts of the Philco set.

(Continued from preceding page) in the output. The resonant circuit offers an enormously high resistance to the hum

but very little to other frequencies or to direct current. Of course, the usual by-pass condensers are employed too. Only

this filtering is used for the radio, intermediate and the push-pull tubes. But the sup- (Continued on next page)



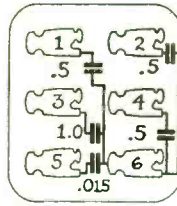
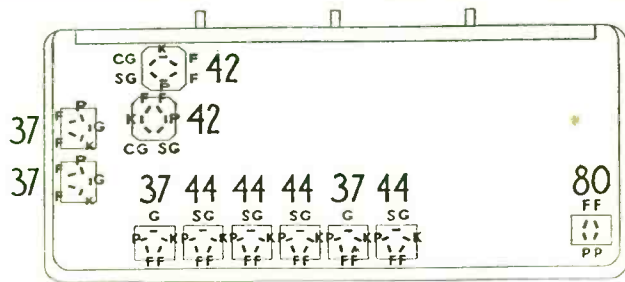

**Tube Sockets, Under Side of Chassis**  
 F Filament SG Screen Grid  
 P Plate CG Control Grid K Cathode

**Caution: Never connect the chassis to the power supply unless the speakers are connected and all tubes are in place.**

**Internal Connections**  
 Filter Condenser, 50-60 Cycles

(Continued from preceding page)  
 ply to the remaining tubes is filtered additionally in that the current must pass through one of the loudspeaker fields.

**Power Transformer Data**

Terminal Schematic Diagram	A-C Volts	Circuit
1, 2	105 to 125	Primary
3, 5	6.3	Filament
6, 7	5.0	Filament of 80
8, 10	720	Plates of 80
4	.....	Center tap of 3, 5
9	.....	Center tap of 8, 10

## Use of Beat with Converter

A good use of a short-wave converter has been suggested by Harold Scott, Lusk, Wyoming. There is always a strong short-wave signal to be had, he says. By means of the short-wave converter this can be changed to any desired frequency in the broadcast band. Thus the single frequency can be used to give any broadcast frequency for testing purposes. If it is a question of lining up the tuner when no suitable broadcast signals are present, all that is necessary is to tune the r-f portion of the converter to the strong short-wave signal and then adjust the oscillator until the desired beat frequency is obtained. This may be at either end of the tuning range of the broadcast receiver or at any point between.

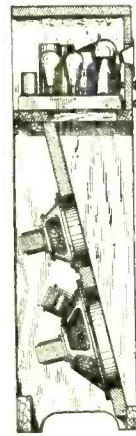

The twin speakers and chassis in phantom side view

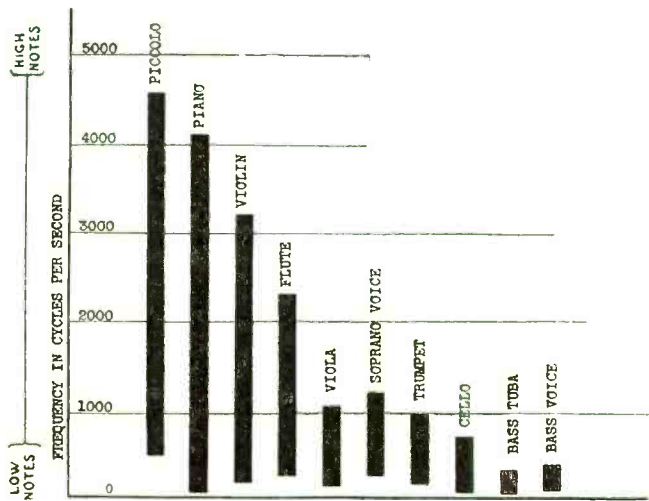

Chart of vocal and instrumental frequency ranges.

### Unknown Frequency

One disadvantage of the method is that the beat frequency is not known, unless the converter oscillator has been calibrated with the particular short-wave station that is used. However, lack of knowledge of the exact frequency of the beat only eliminates a few tests, for example, the coverage of the broadcast tuner which depends on exact knowledge of the frequency.

For lining up superheterodynes the converter could be used without trouble since it makes little difference at what two points the adjustments are made, just so long as they are made near the two extremes of the tuner. The broadcast tuner dial might first be set at 5 and then a signal at this setting can be brought in with the converter. After adjustments have been made on the trimmers the tuning condenser could be set at 90 on the dial and a signal brought in there with the converter. It would be the same signal, of course, but it would have a different frequency from what it had before.

### Distributed Tests

The broadcast set should be a t-r-f set when the signal at 90 is first brought in and then it should be changed to a super for adjusting the series padding condenser. Testing in the interior of the dial could be done after the end adjustments have been made by changing the converter oscillator a little bit and then tuning in the broadcast set with its own condenser. If desired tests could be made at every division of the broadcast set dial since by adjusting the short-wave oscillator we can get any frequency.

The speaker connections of the Philco Model 15 Receiver.

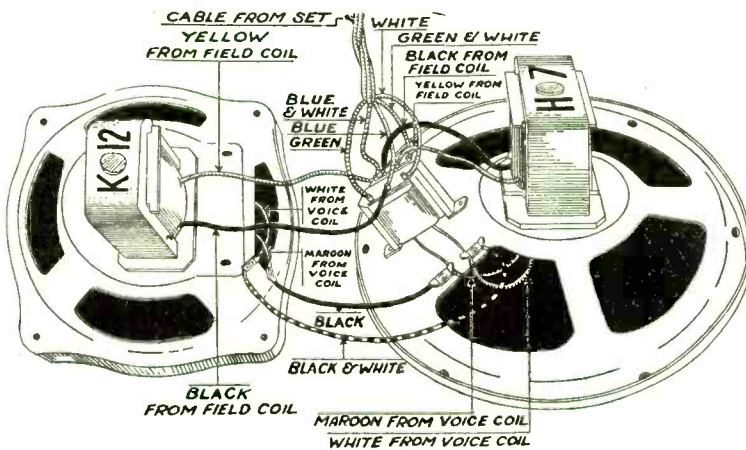

TABLE OF RESISTANCE VALUES

Numbers on Schematic Diagram	Power (Watts)	Resistance (Ohms)	Resistance			
			Body	Color Tip	Dot	
66	.....	50	1, 2	Long	Tubular	Red
66	.....		2, 3			
66	.....		205			
36	.5	1,000	.....	Brown	Black	Red
45 55	.5	5,000	.....	Green	Black	Red
1 52	.5	10,000	.....	Green	Black	Orange
32	1.	13,000	.....	Brown	Orange	Orange
50	.5	25,000	.....	Red	Green	Orange
21	.5	51,000	.....	Green	Brown	Orange
40	.5	99,000	.....	White	White	Orange
10	.5	160,000	.....	Brown	Blue	Yellow
57	.5	240,000	.....	Red	Yellow	Yellow
9 17 54 28 47	.5	490,000	.....	Yellow	White	Yellow
51	.5	1,000,000	.....	Brown	Black	Green

### COOGAN TOURS EUROPE

Walter A. Coogan, export manager of the Arcturus Radio Tube Company, Newark, N. J., sailed for Europe. He will visit his distributors, located in practically every country. The trip will cover over 15,000 miles and take more than two months. The distribution abroad covers seventy-six countries.



# PAM Connections to Tuner

By Edward C. Bridges

IT is often required to connect an audio amplifier to an r-f tuner-detector when the two have not been designed particularly to go together. Sometimes there is no difficulty in doing it so as to get results, but at other times it does not work. The signals obtained through the combination are either absent or badly distorted and weak. What are the conditions necessary to make such a combination work right?

One condition is that the one who does it should know exactly what the circuit of each component is and to act accordingly. There are other conditions. He should see to it that the tube ahead gets the right plate voltage, that the bias on his tube is not changed, that the tube gets the proper load impedance, that the bias on the first tube in the audio amplifier has the right value, that there is no short-circuit anywhere, either to the signal or the d-c voltages.

Suppose we don't know any more about the two parts than is shown in Fig. 1. We have the output terminals P and Q of the tuner and the input terminals P' and Q' of the amplifier. That is equivalent to knowing nothing. We must find out what is ahead of P and Q and what is behind P' and Q'.

## The B Supplies

Is there a separate B supply in each part? If not, must the B supply in the tuner be used for the audio amplifier or must that in the audio amplifier be used in the tuner? Or, is there a B supply in neither and must an external one be used for the two parts of the circuit? Is there a high voltage on Q or is Q grounded? Is there a high voltage on Q' or is Q' grounded? Does P go directly to the plate of the tube or is there something between. What is between, if anything? Does P' go directly to the grid or is there something between? What is between, if anything? What tube is used as detector in the tuner and how is it biased?

These questions, and others, must be answered, either by examining the diagrams of the two circuits or by tracing them out, before any decision can be made as to the proper method of coupling the two. The decision may be that it is not practical to make the connection without making some change in one part or the other.

If the detector is a screen grid tube, and if it is the last in the first part of the circuit, then a transformer should not be used as coupler because the load impedance will not be high enough. Moreover, if we do use a transformer after the detector the bias on that tube is likely to be excessive, if it is obtained in the usual way by means of a resistor in the cathode lead. This resistor has been proportioned on the basis of a high load resistance. If the detector tube is a three element tube either a resistance or transformer coupler can follow it, but even here it is necessary to look to the bias on the tube after the coupling has been made. The bias resistor may have to be increased or decreased, depending on what the value is and what the coupler demands that it should be.

## Common Mistakes

A common mistake in connecting an amplifier to a tuner is to omit making the B minus connection. This may prevent functioning if the B supply is either in the tuner or in the amplifier. That can be tested easily because if the return is not made there will not be any voltage on the tubes in one of the components, when the voltage is measured from the ground side and the plates of the same component.

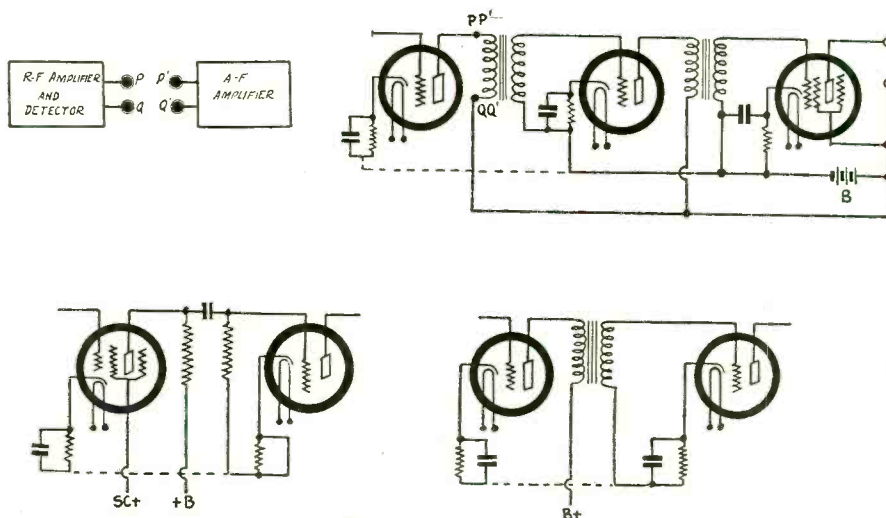

FIG. 1 (top left)

A block diagram of a radio frequency tuner-detector and an audio amplifier. In order to couple these correctly it is necessary to know what precedes PQ and what follows P'Q'.

FIG. 2 (top right)

In this case it is assumed that a triode precedes the PQ terminals and that the primary of an input transformer follows P'Q'. The connection represented by the dotted line must be made.

FIG. 3A

FIG. 3B

The coupling between the detector and the amplifier should be one of the two shown here, or an equivalent. The dotted line connection should be made to establish a return for the plate current.

The connection might be like that in Fig. 2. Here the B supply is supposed to be a part of the amplifier and the high voltage is connected to Q'. Hence in making the connections PP' and QQ' there is a continuous circuit up to the plate of the detector tube. But if a voltmeter is connected from the plate to the cathode of the detector, there is no reading because B minus is not connected. It is necessary to make the connection indicated by the dotted line.

If the B supply is in the tuner only the same connection must be made or there will not be a plate return for the tubes in the amplifier. In this case if the high voltage is on Q the plates of the amplifier will get the high voltage because of the QQ' connections. Of course, the voltage on Q must be high enough for the plates of the amplifier tubes. Otherwise some other connection must be made in addition.

## Typical Couplers

In Fig. 3A and 3B are two typical cases of couplers, resistance and transformer. If the detector is a screen grid tube the connection at the left should be used and if the detector is a three element tube the connection at the right may be used, although for this also the resistance coupler is all right. The coupler may be a part of either circuit and the B supply may also be in either. The connection by the dotted line should be made in every instance. It is usually made by connecting the two metal chasses together.

Of course, there are many variations of the couplers, but in general the two parts of the combined circuit should be joined as in Fig. 3. On the detector tube side there should be a complete circuit through the load impedance, either resistance or transformer primary, through the tube from plate to cathode, through the grid bias and through the B supply. This circuit should be traceable starting from any

point whatsoever. A similar circuit should be traceable through the screen or through any plate or screen of any other tube in the tuner. It may be necessary to go through the dotted line to complete any of these circuits. On the grid side there should be a continuous circuit from the grid through the grid leak, which may be the transformer secondary or a resistor and through the grid bias resistor to the cathode.

## Insulation Requirement

There should be an insulator between the grid and the plate, and this may either be a stopping condenser or a transformer. To test this it is only necessary to measure the plate voltage on the first tube and the grid voltage of the second. One should be positive by the right amount and the other should be negative, each measured from the cathode of the tube in question. If this test shows the circuit to be correct, the next test should be to see that the detector tube has the correct load, particularly that a screen grid tube does not have a low impedance load, such as the primary of a transformer. It is also well to check the bias on the detector tube, for this depends on the load impedance when self bias is used. It also depends on the voltage applied in the plate circuit of the tube. This may not be the same as the intended value if the voltage is taken from a B supply in the amplifier or from an external supply.

## RADIO WORLD

The First and Only National Radio Weekly  
Eleventh Year

Owned and published by Hennessy Radio Publications Corporation, 145 West 45th Street, New York, N. Y. Roland Burke Hennessy, President and treasurer, 145 West 45th Street, New York, N. Y.; M. B. Hennessy, vice-president, 145 West 45th Street, New York, N. Y.; Herman Bernard, secretary, 145 West 45th Street, New York, N. Y. Roland Burke Hennessy, editor; Herman Bernard, managing editor and business manager; J. B. Anderson, technical editor; J. Murray Barron, advertising manager.



# Practical Circuits Using New Copper Oxide R-F Rectifiers

By Nagel Wallabout

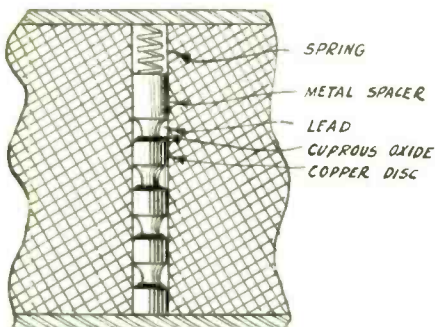

**FIG. 1**  
A cross section of a copper-oxide rectifier having four rectifying elements in series.

LAST week we discussed briefly the use of copper-oxide rectifiers for radio frequency detectors and automatic volume control. Although these rectifiers are not yet available we shall give more details and show possible circuits. We shall also show the construction of the rectifying elements in case any one should wish to try his skill making them.

In Fig. 1 is a cross section of a rectifying element. The cross-hatched area represents an insulator, such as hard rubber or bakelite. A tiny hole is drilled through this material. The slant-shaded areas at the ends are metal pieces. In the hole at the top is a compression spring. Then follows a metal spacer which fits snugly but loosely in the hole. Under this spacer is a piece of lead cut in the shape of the frustum of a cone. Following the lead is a thin layer of cuprous oxide and below that a copper disc. It looks more like a cylinder because the vertical dimension has been exaggerated. After the first series of lead-oxide-copper the same series is continued and in all there are four rectifiers in series. Several are used because the voltage across any one is limited. More of these elements could be stacked in series if it were necessary.

The object of the spring is to give some pressure on the rectifying surfaces.

### Dimensions

The dimensions of the components are exceedingly small. Thus the diameter of a copper disc is 0.08 inch, which is nearly 5/64 of an inch. The diameter of the hole is just a shade greater than this. The lead

pieces are even smaller since they are turned in the form of a frustum of a cone and the greatest diameter cannot exceed 0.08 inch. The axial dimension of the lead and copper is of very little importance and the relative dimensions shown in the figure would be all right.

Fig. 2 shows how the copper-oxide rectifier may be used in a circuit to effect detection. The signal voltage is applied across the upper and lower vertices of the bridge network and is the voltage developed across condenser C. This condenser is the tuning condenser of the circuit of which L is the

words, the current flows to the left through R at both half cycles of the signal voltage.

The left vertex is grounded whereas the right vertex is connected through a stopping condenser C3 to the top of a potentiometer P. If there is any variation in the voltage across C, due to modulation, there will be a variable current through R and there will also be a modulation frequency voltage across P. Any desired portion of this voltage is applied to the grid of the power tube.

There is no by-pass condenser shown across R because there is sufficient capacity

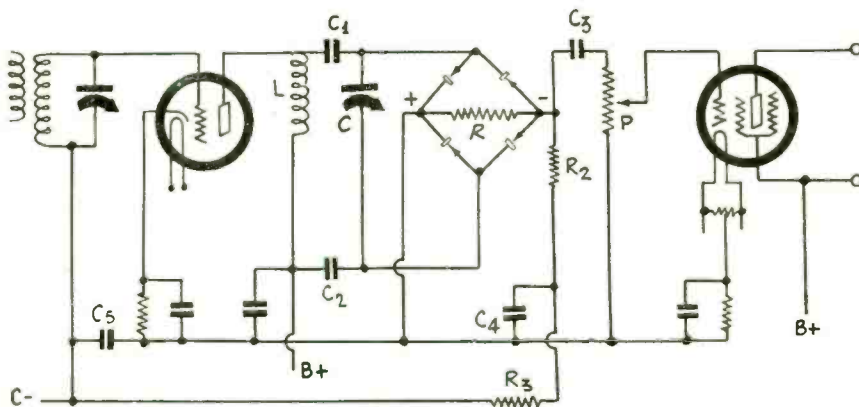

**FIG. 3**  
In this circuit a full wave copper-oxide rectifier is used as radio frequency detector and automatic volume control. The positive side of load resistance is ground and the other is used for grid returns.

inductance. C1 and C2 are stopping condensers and are so large that there is a negligible drop across them. The d-c load resistance on the rectifier is R, which is connected between the left and right vertices of the network.

Suppose the upper vertex happens to be positive. Then the current will flow down to the right vertex, then to the left through the resistance R, and finally down to the lower vertex. Thus the right vertex is positive and the left is negative. Now suppose that the lower vertex happens to be positive. Then the current flows up to the right vertex, then left through the load resistance, and finally up to the upper vertex. Thus in this case also the right vertex is positive and the left is negative. In other

in the rectifying elements to shunt the radio frequency ripple.

### Automatic Volume Control

The circuit in Fig. 3 is essentially the same as that in Fig. 2 except that it has been arranged so that the rectifier can be used to supply the bias for automatic voltage control. The first change necessary is to connect the rectifying elements so that the positive end of R is grounded and the negative is at the high potential. The only change is the reversal of two leads although the drawing shows that the rectifying elements have been reversed also.

Now we have the positive end of R connected to ground, to which also the cathodes of the controlled tubes are connected through the grid bias resistor. Every point on R is therefore negative with respect to ground, provided direct current flows through it. Therefore if we connect the grid returns of the controlled tubes to the right vertex the grids will be more negative and the more so the greater the signal, for the drop in R is directly proportional to the signal.

We have to filter the voltage used for automatic bias and we must do this so that the audio signal in R is not shorted out. Resistor R2 stops the audio frequency signal effectively and condenser C4 shunts any ripple current that may get through R2. R3 is an additional filter resistor to prevent r-f feedback. C5 is another by-pass condenser to insure that no feedback occurs. The negative lead terminates with a "C-" to indicate that other tubes may be

(Continued on next page)

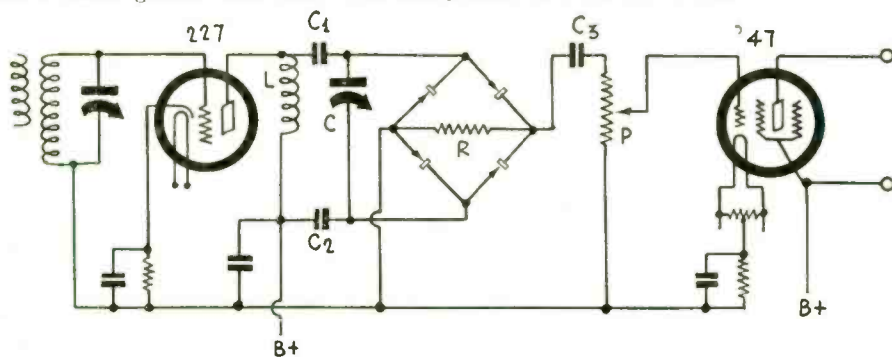

**FIG. 2**  
This shows how four copper-oxide rectifiers may be connected to make a full wave detector and how the device should be connected between two tubes.



# THE 6 TUBE STAR

## T-R-F Circuit with Two '47 Output

By Alan Mannion

Thor Radio Company

THE midget receiver has become a giant in performance. Why? Because new tubes have been developed, tubes that have enormous amplification and detection efficiency and tubes that have a high power handling capacity. We now have the 58 for radio frequency amplification, the 57 for detection, and the 47 for power amplification. All are of the high gain type. If these tubes are coupled efficiently and supplied with suitable voltages, we have the possibilities of great sensitivity and power even if we use only a few tubes.

In Fig. 1 we have a six tube midget utilizing two 58s, one 57, two 47s, and one 280. The couplers in the radio frequency amplifier are of the high gain type and the entire circuit is one of high gain.

Aside from high gain the circuit has a provision for insertion of a phonograph pick-up unit and also a provision for tone control. The tone control consists of a 0.02 mfd. condenser and a 75,000 ohm variable resistor, in series, connected between the grids of the 47 tubes and ground. When the resistance is set at zero there is a 0.02 mfd. condenser across the grid circuit and a large portion of the higher audio frequencies is shunted out, but when all of the resistance is used there is practically no discrimination against any audio frequencies.

The phonograph pick-up unit is connected in series with the ground lead of the tuned coil feeding the detector. A

closed circuit jack is inserted in this lead. When radio is to be received nothing is in the jack and the circuit is closed, but when the phono plug is in the jack the lead is opened and the pick-up winding is connected in series with the coil. This leaves the tuning condenser in shunt with the pick-up unit but this does not matter for very often it is necessary, or at least desirable to have a condenser across the unit to eliminate scratching noises. Moreover, the maximum capacity is 350 mmfd. which is a small shunt at audio frequencies. Again, the condenser can always be set at a lower value.

### Volume Control

The volume is controlled manually in the manner that has been found exceptionally satisfactory in t-r-f circuits employing variable mu tubes as radio frequency amplifiers. A 10,000 ohm potentiometer is connected between the antenna and the common cathode returns of the two 58 tubes. There is a 500 ohm fixed resistor that limits the bias. One end of this is connected to the potentiometer. The slider is grounded. The fact that 10,000 ohms are used instead of the customary value of 5,000 ohms makes the damping on the first tuned circuit low, and this increases both sensitivity and selectivity. It will be noticed that when the slider is at the antenna end there is no input to the receiver and at the same time the bias on the two 58 tubes is so high

that there is no amplification. On the other hand, when the slider is set near the cathode end the input is maximum and at the same time the amplification in the tubes is maximum. Thus the control is double acting and that is the reason it is effective.

There are two 47 pentodes in parallel in the output stage. At first thought one would suspect that these tubes would draw a very large current from the B supply. But this isn't the case. As the current increases in the plate circuit the bias on the grids increases and that in turn checks the increase in the plate current. The tubes are therefore operated at a grid bias higher than normally. Does this increase the distortion of the output? Theoretically it would do that but the fact is that the tone from a circuit like this is better than when a single tube is used and the volume is greater in addition. The best criterion of a set is its actual performance as judged by final judge, the ear.

### Elimination of Hum

Much attention has been given to the elimination of hum and noise. First we note that there is a 0.00025 mfd. condenser between ground and one side of the primary of the power transformer. This cuts out high frequency noise existing in the line. The cores of the field coil, the output transformer and the power

(Continued on next page)

## Copper Oxide Rectifier Circuits

(Continued from preceding page)

controlled automatically in the same manner.

It will be noticed that the rotors of the two variable condensers are not connected to the same potential. Hence both cannot be grounded. But that is rarely necessary. If the two condensers shown are for i-f circuits it is not necessary to ground either, and if the first is an r-f condenser its rotor may be grounded by grounding C minus.

### Possible Variations

In Figs. 2 and 3 direct coupling is shown between the tube and the rectifier because this was the recommendation of those who have experimented with the copper-oxide detector. There appears no reason, how-

ever, why transformer coupling should not be used if the proper impedance matching is done. The impedance of the rectifying element is such that it nearly fits a 227 tube directly. If a screen grid tube like the 58 were used, it would be necessary, perhaps, to use a step-down transformer.

Many interesting combinations are possible if we use a transformer between the tube and the rectifier. For one thing, it would not be necessary to ground either side of the rectifier circuit. This opens the possibility of coupling the rectifier directly to the input of a push-pull amplifier, that is, without the use of a center-tapped transformer, or any transformer. A possible circuit is shown in Fig. 4. Here T is a radio or intermediate frequency transformer,

with tuned secondary. It is connected to the a-c vertices of the network just as before. No part of the transformer nor of the rectifier is grounded. It is important that the capacity between either d-c vertex and ground should be the same as that between the other vertex and ground, or that either should be so small that it would make no difference if the capacities were not alike.

The audio voltage developed across R is divided by means of two equal resistors R1 and R2, the junction of which is grounded. The stopping condensers C1 and C2 should also be equal. Grounding the junction of R1 and R2 is equivalent to grounding the center point of R as far as audio frequency voltages are concerned. The detected voltage will be equally divided between the two push-pull tube, but the voltages applied to the grids will be in opposite phase. Of course the same thing can be done with diode rectifiers but if we use ordinary tubes the circuit will not be nearly as symmetrical as in this case because there will be more capacity to ground from one end of the load resistance than from the other.

The tuning condenser in Fig. 4 cannot be grounded. Hence this circuit is suitable only for intermediate frequency detection. But it would be possible to put the tuning condenser across the primary. In that case the condenser rotor could be grounded if the tuned circuit were completed with a large by-pass condenser. Such a condenser would be used for filtering in any case so it would not be necessary to add one to the

(Continued on next page)

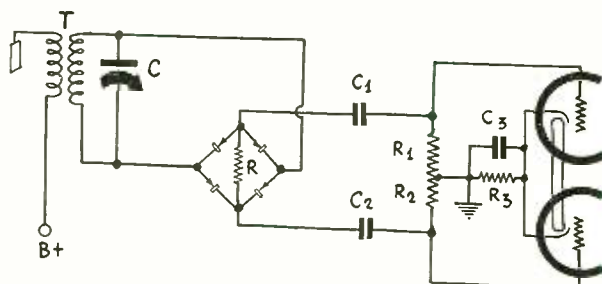
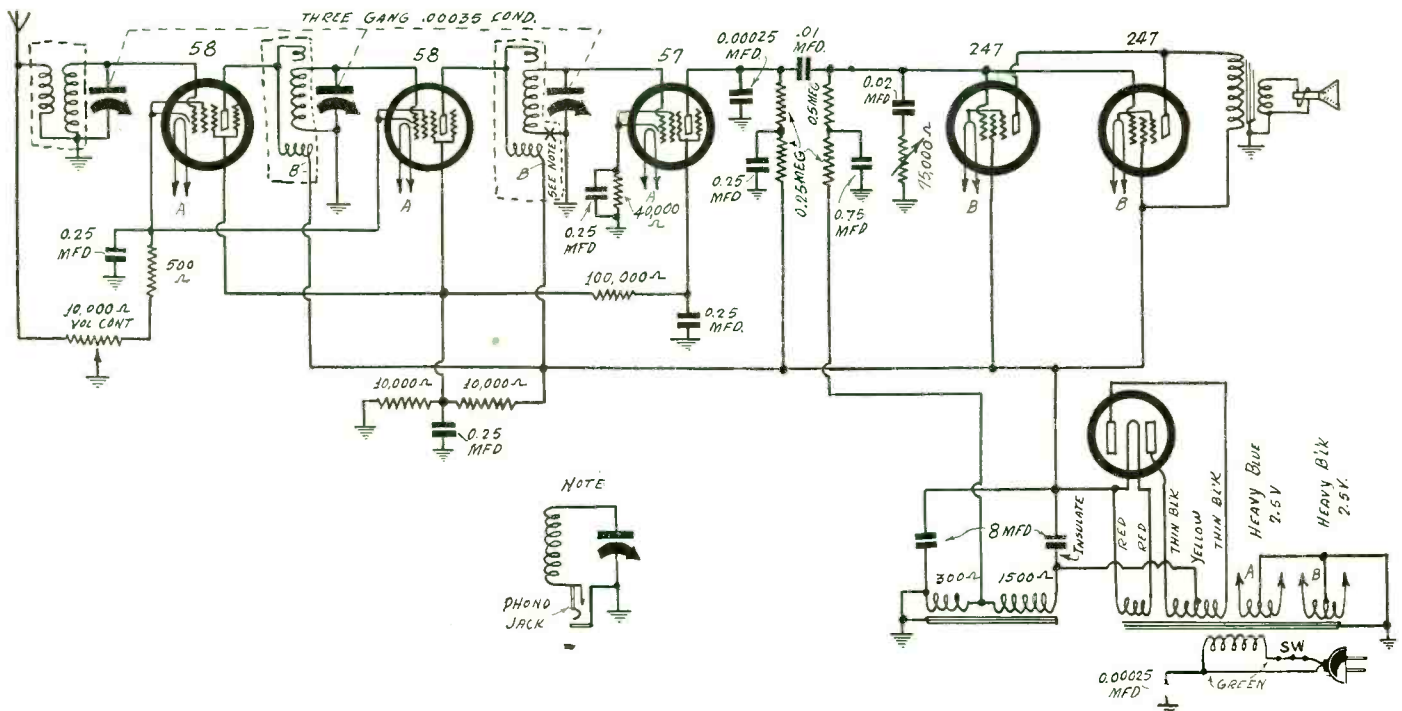

FIG. 4

A copper oxide rectifier may be connected in this manner to a push-pull amplifier without the use of a coupling transformer. No part of the rectifier circuit should be grounded.





The diagram of a six tube t-r-f receiver of exceptionally high gain and great output volume. It is a midget in size only. Provision made for adequate volume control, tone control, and phonograph attachment.

(Continued from preceding page) transformer are also grounded, which has the effect of eliminating noise and hum. One side of the voice coil is also grounded for the same purpose.

In the coupler between the detector and the power tubes we also have hum filtering. Thus there is a 0.25 megohm resistor in series with the coupling resistor, which also has the same value. A condenser of 0.25 mfd. is connected between the junction of these resistors and ground. We have a similar filter in the grid leak circuit, but the condenser here is 0.75 mfd., which is made up by connecting three 0.25 mfd. condensers in parallel. There is also a 0.25 mfd. condenser across the 40,000 ohm grid bias resistor of the detector, which serves not only in increasing the detecting efficiency but also to remove hum.

Of course, the principal hum eliminator is filter in the B supply which consists of two 8 mfd. electrolytic condensers and the field coil of the speaker.

**Voltage Distribution**

The full voltage delivered by the B supply is applied in the plate circuits of all the tubes and on the screens of the power tubes. With the power transformer used and the drop in the field coil, the maximum voltage, measured from ground with a 1,000 ohms per volt meter, is 230 volts. On the detector plate, however, the effective voltage thus measured is only 125 volts. This is when the plate current is 0.14 milliampere.

A 10,000 ohm, 10 watt resistor is connected between the 230 volt line to the screens of the two 58 tubes and another 10,000 ohm resistor, but of 2 watt rating, is connected between the screens and ground. With this voltage distributor the screen voltage is 110 volts. From the screens of the 58s to the screen of the detector is a 100,000 ohm resistor and this drops the voltage to 100 volts.

**The High Gain Coils**

Two of the couplers in the r-f amplifier are of the high gain type. There is no primary in the strict sense. Instead there is a high inductance choke not inductively coupled to the secondary, but capacitively. This insures a high gain on the low radio frequencies. For coupling at the high frequencies an open single turn winding is wound over the grid end of

the tuned winding. This type of coupler is known for its uniformly high gain over the entire tuning range. Since these two coils are equal the tracking of the two tuned circuits is satisfactory. The first coil is not of the same type but has a high impedance primary. High selectivity in this part of the circuit is not so important as the effect of the antenna would nullify the selectivity of the coil to some extent. High gain is more important. If the first tuner were as selective as the other two the overall selectivity and sensitivity of the circuit would be less because the first tuner would not track well with the other two.

**LIST OF PARTS**

**Coils**

- One antenna coil for 350 mmfd. condenser
- Two high gain interstage coils for 350 mmfd. condensers
- One power transformer
- One loudspeaker with tapped field coil

**Condensers**

- One gang of three 350 mmfd. tuning condensers
- Eight 0.25 mfd. by-pass condensers
- One 0.02 mfd. condenser
- One 0.01 mfd. condenser
- One 0.00025 mfd. condenser
- Two 8 mfd. electrolytic condensers

**Resistors**

- One 10,000 volume control potentiometer
- One 500 ohm resistor
- One 40,000 ohm resistor
- Two 10,000 ohm fixed resistors, one 2-watt and one 10-watt
- One 100,000 ohm resistor
- Three 0.25 megohm resistors
- One 0.5 megohm resistor
- One variable 75,000 ohm resistor for tone control

**Other Requirements**

- Three six-contact sockets
- Two five-contact sockets
- One four-contact socket
- Three grid clips
- One vernier dial with pilotlight socket
- One six-tube, t-r-f chassis
- One closed circuit jack

**Forum**

**Why the New Tubes?**

THERE IS NO DOUBT that although the question of new tubes has so far been the selling point of many of the newer type receivers, the Waterloo of the service man, and the cause of many new shelves in the supply houses, there is another group of half-crazed enthusiastic supporters of RADIO WORLD that should not be forgotten: the experimenter and radio bug!

You gave us the "627," a circuit highly regarded and accepted by most of us as the "best yet," then came the flood of new tubes. Headaches increased with the square of the number of grids. Methods of application were indicated and "applications" to new and old sets were theoretically set forth. With bated breath we awaited the release of these phenomena of science with their promises of automatic control of everything but the program.

After six months of suppressing oscillations, sluggish A. V. C., questionable tone compensation, and contemplated bankruptcy, we still listen in on the 627 and ask why new tubes? Has anything yet been developed including the much to be desired features of the new tubes that really gives reception comparable to or surpassing the 627?

H. M. PATRICK

**Resonance Explained**

WHAT IS RESONANCE, and how is it established?—J. E., Stafford Springs, Conn.

Generally speaking, resonance is the tuning of two or more circuits to the same frequency, and it is established in radio receivers by turning the tuning condensers until that condition prevails. If the condensers are ganged then the circuits always are resonant, within practical limits. In the case of each tuned circuit, resonance prevails when the highest impedance to any frequency is established, and this is true when the reactance of condenser and coil are equal. Of course the reactances are always opposite as between coil and condenser.



# Radio University

**A** QUESTION and Answer Department. Only questions from Radio University members are answered. Such membership is obtained by sending subscription order direct to RADIO WORLD for one year (52 issues) at \$6, without any other premium.

RADIO WORLD, 145 WEST 45th STREET, NEW YORK, N. Y.

## Oscillator Frequency Stability

MY OSCILLATOR is an inexpensive one, factory-made, with a simple knob for tuning the condenser, yet I believe it is more accurate than a more expensive one, which has a vernier dial, for the frequency seems to stay put, while the frequency of the expensive one seems to wobble.—J. R., Trenton, N. J.

Probably you are deceived by the fact that you can not set your own oscillator very closely, on account of the knob. The wobbliness is hidden by the lack of precision means of setting the condenser. A grid leak and condenser in an oscillator circuit help frequency stability. Try this combination in your own oscillator without any other changes. The condenser may be 0.00025 mfd. and the leak any value low enough to prevent grid blocking, that is, a continuous squeal. Values of 50,000 and 100,000 ohms are suggested.

## The "Ideal" Coil

CAN NOT a coil of very high impedance be wound by using resistance wire, as that kind of wire has the highest possible resistance, and an excellent coil should result?—T. D. W., Walla Walla, Wash.

Such a coil is a standing joke in laboratories when coils are discussed with beginners. The requirements for a good coil include high reactance and low resistance. The reactance is the measure of the behavior of the coil to frequency and in relationship to the coil's inductance. The impedance is the total opposition offered by the coil to the flow of alternating current and thus includes the d-c resistance. So if the d-c resistance is high (as you suggest) then the result (as you do not suggest) would be a coil of low impedance. The impedance of the coil is maximum when the combined effect of both the d-c and a-c resistance is least. Therefore you would be introducing a permanent limiting factor in a high d-c resistance.

## Condenser and Dial Couplers

LET ME HAVE some information on the adaptation of  $\frac{1}{4}$  inch condenser shafts to  $\frac{3}{8}$  inch dial hubs, also  $\frac{3}{8}$  inch condenser shafts to  $\frac{1}{4}$  inch dial hubs, also for extending the shafts without changing the diameter.—G. B. M., Chicago, Ill.

Reducing and enlarging couplers are used for accommodating one size condenser shaft to the other size dial hub, and consist of a bushing opening drilled for the proper diameter condenser shaft, and with a shaved round shaft end of the dissimilar diameter. Besides these, couplers are made that fit the same size condenser shaft and hub and serve merely to extend the length of the shaft, to accommodate an established condenser position to an established dial position, as where condensers of one make are substituted in a built set for condensers of another make. For mere coupling, providing insulation between controlled and controlling elements, there is another instrument, known as a flexible insulated coupler, which enables set-screw fixation of the coupler to the rear-protruding shaft of a condenser and to front-protruding shaft of another condenser, where ganging of singles is desired. Almost any

radio mail order house can supply you with these devices.

## D-C Voltage Increase

STATE SOME EASY WAY of increasing d-c voltage. The a-c method can not be applied, can it?—D. W., Newark, N. J.

There is no ready and inexpensive way of increasing d-c voltage. One of the theoretical methods is by condenser discharge. A practical, but rather expensive way, is by use of a special tube. The a-c method, of course, does not apply. That method consists of a step-up ratio of transformation, but direct current can not be subjected to transformation.

## Effect of A.V.C. and N.S.C.

WILL YOU PLEASE give me an insight into the effect of automatic volume control and noise suppression control on the sensitivity of a receiver? Do they improve the sensitivity considerably?—U. W. S., Rochester, N. Y.

No, they decrease the sensitivity. That, however, is nothing that need cause concern, as it is practical to start with a sensitivity that is entirely too high, whereby the noise level is equal to the signal level of a given station, and then have the two devices operate to reduce the sensitivity on received signals to somewhere in the practical region. You have probably read about the noise between stations on a-v-c receivers. This is due to the sensitivity being highest when the signal is lowest, i.e., when there is no signal. So n.s.c. has been introduced to correct this condition.

## Resistance Jump

IS THERE some definite step to take, as to current and voltage, for resistance

measurements, so that there will not be too much duplication of resistance readings on the second scale?—U. W. Q., Yoakum, Texas.

Yes, there is. We recommend that the meter be 0-100 milliamperes, in series with 15 ohms and 1.5-volt No. 6 dry cell, to measure resistance values from 1 ohm to 5,000 ohms, and that 0-1 ma in series with 50,000 ohms and 49.5 volts of dry cells (or in series with 50 volts d-c obtained from an a-c B supply) for measuring values from 1,000 to 2,000,000 or more ohms. The duplication is less than 15 per cent. of the second scale, which is small duplication, and no readings below 5,000 ohms need be taken on the second scale.

## Class B Amplifier

WILL YOU kindly publish the diagram of a Class B amplifier containing two 46 tubes and a driver stage? Can one of these be built so that high bias may be used?—F. W. R., Cleveland, Ohio.

There is such a diagram in Fig. 1035. The two tubes appearing in push-pull should be 46s with the grids so connected that they may be operated with zero bias. That is why both the grid return and the filaments are grounded. T2 must be a specially designed output transformer for these tubes and the loudspeaker that is used. T1 also must be a special input transformer, usually one that has a step-down ratio. This must be adapted to the tube that precedes, which also should be a power tube. It may be a 46 connected as a triode. In getting the transformers it should be specified that they are to work between the tubes to be used. It is possible to use the 46s, or any other power tubes, so that special transformers are not needed, but the tubes in the Class B amplifier must be operated with a high bias so that no grid current can flow. The 46 should be connected as triodes and the negative bias should be applied between the filaments and the center tap of the input transformer. The bias should be made so high that practically no plate current flows in either tube. When this is done T1 may be an ordinary push-pull input transformer and the tube ahead need not be a power tube. Self bias must not be used. Ignore R1. The B supply should have a very good regulation for Class B. It is best to use an 83 rectifier, with an r-f filter in each anode lead. The 83 requires a 5-volt filament source, same as the 280.

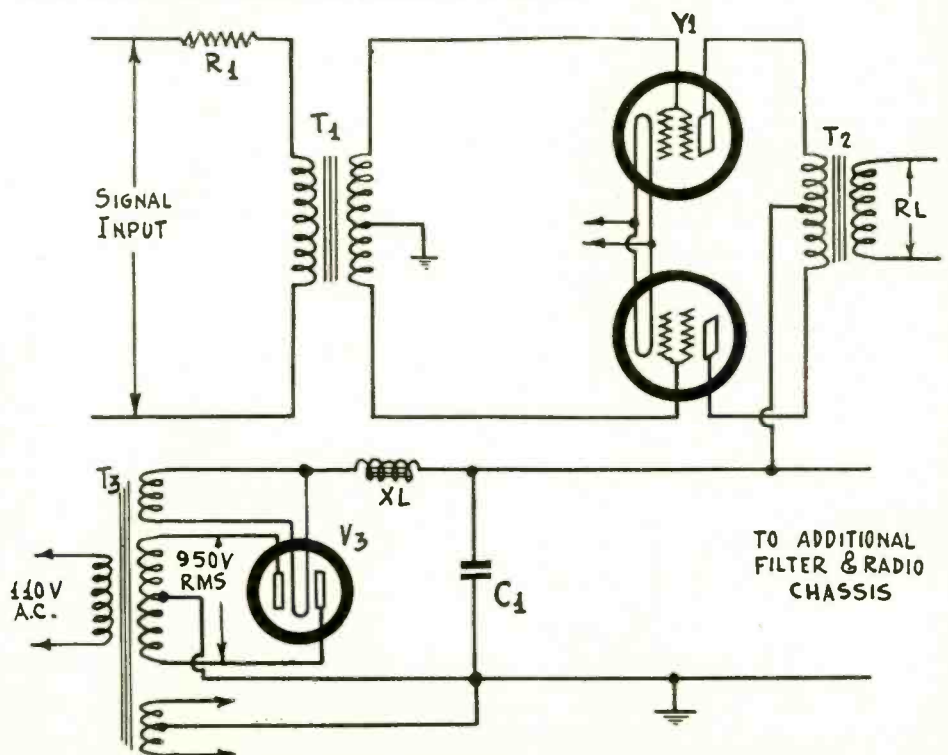

FIG. 1035



# STATION SPARKS

By Alice Remsen

## The Song Thrush

(Reprinted by request)

FOR MORTON DOWNEY

WABC Fridays, 9:30 P.M.

Oh, hear the golden-throated thrush, singing on the breeze!  
And hearken to its liquid notes trembling through the trees!  
The tall trees, the green trees, the verdant trees of spring,  
The slender trees that listen to the thrush's caroling!

The thrush is not a lovely bird, feathers bright and gay,  
But oh, the lovely song it sings on a day in May,  
A May day, a gay day, a day so green and lush,  
A perfect day to listen to the singing of a thrush.

And in the early morning light, sounding clear and strong,  
A solitary lowly thrush sings a faultless song;  
And then again at eventide cascading o'er the dale,  
The thrush is only rivaled by the graceful nightingale.

Oh, hear the golden-throated thrush singing on the breeze!  
And hearken to its liquid notes trembling through the trees!  
The tall trees, the green trees, the verdant trees of spring,  
The trees that bow whene'er they hear the lowly songbird sing.

\* \* \*

—A. R.

I have had many requests for a repetition of these verses. As Morton Downey is now featured on the "To the Ladies" program, after an absence from radio, it is particularly appropriate at this time. If you have never heard Mr. Downey, which I doubt, tune in and listen to him, you'll like him.

\* \* \*

## The Radio Rialto

It has been suggested to me that there are more radio stations outside of New York than in that great city—and of course this is true; but unless I possessed a magic carpet I couldn't visit them all; however, this morning, if you'll come right along with me, we'll take the Hudson Tube over to Jersey City and visit the promising station, WAAT. . . . So through the Tube we shoot, and here we are at Journal Square. . . . Taking the elevator upstairs to the executive offices we meet Dale Kennedy, manager of the station. . . . Mr. Kennedy is a fine, upstanding young man, simply bursting with energy and new ideas. . . . Very pleased to see us and takes us on a personally conducted tour of the station. . . . It is small, but compact and up to date. . . . Three studios and a reception room. . . .

This station is on the air from sunrise to sunset and gives some very nice programs. . . . It maintains quite a staff of artists, which includes a double mixed quartet, a string ensemble under the direction of Ina Grange, and a very good orchestra conducted by Tommy Gordon. . . . Its guiding star is Dale Kennedy, who writes, produces, announces and directs, besides managing the destinies of this progressive little station. . . . Mr. Kennedy has a flair for novelty, writes excellent continuity; his speaking voice is very pleasing and his microphonic personality has a friendly quality which makes him very popular with the air audience. . . . One of the daily features of WAAT is "Troubadour of the Stars," a young baritone, whom Harry Reser heard recently and engaged for his Cliequot Club Eskimos program; another popular feature is J. C. Ingram, radio news reporter, who has a very good delivery for that type of stuff, short and snappy. . . . Well, we must get back to the city, so we

say goodbye and Hudson Tube-it once more. . . .

Our next place of call is the NBC and a welcome bit of news is awaiting us. . . . Tom Neely, our old friend of the program department, has again become a proud father; this time it is a boy, born October 2nd; Thomas Neely, 3rd is the youngster's name; you probably remember his mother from her vaudeville days, when she was known as Gladys Fadley, a very sweet person; and so we congratulate Tom and wander on. . . . only to meet Countess Olga Albani, who tells us how very disappointed she was with her escort at her first ball game; at a crucial moment in the game she asked him what the funny wire thing over the umpire's face was and why he wore it; her ungallant escort snapped: "To keep him from biting the ball-players" . . . and there's Don Voorhees, who always looks for pearls in oyster stew, but is lucky if he even finds an oyster. . . . We can't stay here long as we have a very full day ahead of us. . . . and so we hop a cab and overturn to tea with the charming Flora Le Breton, movie and musical comedy star, whom I first saw several years ago in "Lass o' Laughter," and last saw as the little blonde waitress in "Cat and the Fiddle"—Miss Le Breton has some very wonderful ideas about radio and show business in general, which will probably be mentioned in this column at a future date—but know that we had a real English tea, and a nice long chat, and found out that you'll perhaps hear something of this clever little English actress over the air-waves very shortly.

Columbia is our next stop. . . . Come along now, don't lag behind; we'll walk over from West 45th Street and 6th Avenue to Madison and 52nd, a matter of twelve blocks. . . . On the way over we hear rumors that a third network is being formed with WOR as the key station. . . . This has been in the wind for some time and has been denied by WOR over and over again, but this time it seems there may be some truth in the rumor. A few weeks ago WOR established a branch office in Chicago, ostensibly for taking care of mid-western accounts, but now the Pan-American Broadcasting Company, backed by Eastern capital, expects to begin functioning in January, with six stations in the South, WFBR Baltimore, a Cincinnati station, and WOR in New York, with the latter's Chicago

branch on the look-out for further Western outlets. . . .

Well, here we are now at the portals of WABC. . . . So, up we go to the 22nd floor. . . . and while here we'll note a few of the idiosyncrasies of artists at the microphone: Ruth Etting stands with her hands on her hips; Georgie Price takes off his hat and coat and opens his collar; David Ross keeps his left hand cupped over his ear; Burns and Allen work behind a screen; Jay C. Flippen wears his hat; so does John Kelvin, but John removes his coat and vest; Don Ball bobs up and down on his toes; Ben Alley continually adjusts his tie and cuffs while singing; Singin' Sam uses a great deal of facial expression while singing into the "mike"; Charles Carlile always keeps a bit of chewing gum in his mouth while singing; Sid Gary never takes his eyes off the center of the "mike"; all of which are little habits which seem to help the artists put their stuff over. . . . The Three X Sisters have just finished broadcasting; hope you've heard these clever girls; if not, be sure to tune in on them. . . . We greet each other and decide to visit Singin' Sam in his studio. . . . Number seven on the 21st floor. . . . There's Sam sitting right beside Emil Seidel, his accompanist; the microphone is hanging over the piano, and Sam sits there very comfortably and sings and talks as easily as if he were at home in his own parlor. . . . Ralph Colluchio, the guitarist and violinist, rates a microphone all to himself. Old Sam starts his Barbasol refrain; now. . . . Seated around the studio are guests, quite a few of them. . . .

Ah, the program is about to begin. . . . he's talking; goodness gracious me, he's telling the audience that the 3 X Sisters are in the studio and now he turns his eye on me, but—thank goodness he doesn't introduce me. Now his mellow voice is singing; what a friendly personality this lad has. . . . I knew it would come; Sam looks at me with a twinkle in his eye and announces the fact that I'm sitting beside him and will sing a chorus of a song; can't get out of it, and so I warble the refrain of "The Girl I Left in Sunny Tennessee," enjoy doing it, too, in this impromptu fashion. . . . The program is over very quickly, fifteen minutes seem like five and we're on our way again. . . . The 3 X Sisters and Singin' Sam leave the building with us; we stand and chat for a moment, the girls telling us how much they like radio and Singin' Sam's work in particular, and Sam, who is really Harry Frankel, congratulating the girls upon their extreme versatility. . . . And now I must leave you too, for I have a date at the Astor Theatre to witness a pre-view of "The Big Broadcast" in which so many radio stars are featured. . . . I'll tell you about the picture next week. . . . So long until then.

\* \* \*

### ANSWERS TO CORRESPONDENTS

SIDNEY HYMANS, New York, N. Y.: No! The "Redheaded Sweethearts of the Air," Nell Roy and Bill Mullens, are not sweethearts in real life; in fact, Nell Roy is very interested in another man. . . . Shall run their biographies in a future issue.

O. ADAMS, New York: Johnny Hart is known by two other names, those of Jack Arthur, and his real name, Arthur Campbell.

\* \* \*

## Biographical Brevities

### ABOUT HAL KEMP

When Hal Kemp was a sophomore at the University of North Carolina he was well on his way to success as a master of jazz rhythms with the orchestra which may be heard over the WABC—Columbia network from the Black Hawk cafe, Chicago, every Friday and Sunday at 12:30

(Continued on next page)



## STATION SPARKS

By Alice Remsen

(Continued from preceding page)

a.m. E.S.T. He had gained wide recognition in his high school days with a band which he organized and entered in a B. F. Keith vaudeville contest, capturing first prize with a special arrangement of the "Song of India."

In his sophomore year at college Hal took his band to England and on the way back aboard the S. S. Berengaria he played a concert for the Prince of Wales. . . . Thus began a lasting friendship. . . . The last time he visited England, Kemp treated Wales and his brother, Prince George, and, incidentally, the British public, to a musical novelty, when his band played "Happy Days Are Here Again" on a set of whiskey bottles—full ones.

Fifty million Frenchmen had a chance to become acquainted with Kemp's band when its members played a season at Les Ambassadeurs, one of the brighter spots of Paris. His fellow Americans have danced to his rhythms at the Daffodill Club, the Hotel New Yorker, and Hotel Taft in New York, and at the William Penn Hotel, Pittsburgh, and the St. Anthony, San Antonio.

Maestro Kemp has been responsible for the introduction of many well-known English tunes to the United States. Among them are "The King's Horses," "When the Organ Played at Twilight," "My Secret Passion," "Goodnight, Little Girl," and many others.

While in Europe he studied the technique of the Continent's ace tango orchestras, and, consequently, his bandsmen do amazing things with current tango tunes.

The gentleman's complete name, just to keep the records straight, is James Hal Kemp.

\* \* \*

(If you would care to know something of your favorite radio artist, drop a card to the conductor of this page: Alice Remsen, care Radio World, 145 West 45th St., New York, N. Y.)

### Oscillator Harmonics

IN BUILDING an oscillator of the type that tunes from about 100 to about 200 kc (though over a wide enough band to establish at least a 2-to-1 frequency ratio) how is it practical to rely on harmonics for many frequencies, such as intermediate frequencies higher than the highest fundamental, and also frequencies of broadcasting stations, since there is no regular relationship between them, and one might get confused?—A. L., Winnipeg, Canada.

There is most certainly a regular relationship among them. It is the relationship of harmonics to fundamentals and it is very definite. If you calibrate for the fundamental band you certainly have an oscillator good for those frequencies. Now, the intensity of the oscillation should be great enough to enable results on harmonics up to the tenth, but assume none above the seventh is used. The intermediate frequencies may be calibrated on the basis of harmonics selected to fall

## Ten Years Ago

Ten years ago the uses of radio were spreading out, and even the ship-to-ship distress calls got considerable publicity in connection with a radio-equipped vessel in trouble at sea.

The October 28th, 1922, issue of RADIO WORLD had as its leading article one about "New Wonder of Warfare! Tanks Directed by Hidden Radio Operator." Photographs of the hidden operator, as well as the tanks descending a knoll, were shown. It was one of the early practical examples of remote control by radio applied to engines of warfare. Now we are familiar not only with tanks but battleships and airplanes directed by a remote radio operator, and many adjuncts, such as scrambled messages, beam transmission and suppressed carrier.

"How Radio Is Supplementing the Ticker in Wall Street" was illustrated, a loudspeaker being perched atop the top of an automobile. However, we still have the ticker with us, haven't we? There was not necessarily a finality to all those early gropings.

"Radio Guides Rescuers to Steamer Burning in Mid-Pacific" was another title. The ship was the City of Honolulu, and all hands were in lifeboats when the rescuing vessel arrived in response to the SOS. That situation had arisen before and has been duplicated many times since, but it is always news, always exciting, and when the result is as happy as in the City of Honolulu case (all hands saved) there is widespread rejoicing.

H. Gordon Selfridge was shown in one photograph telephoning from San Francisco to London by radio, and it was news in those days.

Another photograph showed Clara Kimball Young, the actress, as if putting together a radio set, blueprint before her, also kit of parts and tools, but the picture probably was just one of those things, you know.

On the technical side, experimenters were instructed on how to build super-regenerative receivers, although to this day there is a trickiness about them and relatively few are built any more; how to avoid interference when a 400-meter station was operating simultaneously on 360 meters, and various tube and crystal hook-ups, including superheterodynes.

in a well-ordered sequence, as well as on the basis of the fundamental. Then you could have the calibration afford results in the same ascending frequency order as applies to the fundamental calibration. With 0.00035 mfd. as tuning condenser it would be possible to have an uninterrupted sequence of harmonics representing the broadcast band, e.g., the seventh harmonic in every instance. What seems to worry

## Tradiograms

By J. Murray Barron

Servicemen and others who may have radio knowledge should prepare themselves for business that is obtainable within their own territory. There is always some business to be had in the radio service work. If one is known to attend to such work or has means of advising folk of the fact, either through advertising, or if only a sign at his headquarters, a certain amount of work will drift in. Lately it hasn't come quite so easily, yet there is some service to be done, and could be had by a fellow on the job.

Not only are there repairs and replacements to be made, but there are times when some of the new tubes could be sold for the earlier type receivers, which would be of great advantage to the owner. There is likewise a great call for receivers as colder weather approaches and there are always many who are interested in DX and are fine prospects for an excellent long-distance receiver.

There are also many outlets for public address systems and amplifiers. Within practically every territory there are many of the hard-to-hear folk who are real prospects for hearing aids. Many reliable outfits have proven beneficial to vast numbers.

When you go after business in the proper way and get your share you might be surprised to find how really important your business becomes and how much more money there is in it than you thought there was. In any fair-sized community, if you make close contacts during calls, and note the information for future reference, you will find your business contains far more prospects than you imagined. Often prospective customers will be amazed to learn that right in their own town they can get what they want.

\* \* \*

Servicemen should be interested in some informational bulletins issued by Tobe Deutschman Corporation, Canton, Mass., which deals with the elimination of man-made static.

\* \* \*

Nussbaums', 61 Cortlandt Street, N. Y. City, with branches at Forty-second Street at Sixth Avenue, N. Y. City, and 118 Flatbush Avenue, Brooklyn, N. Y. reports excellent business. At the Cortlandt Street store five men have been added to the staff since June 15th with some additional ones required to handle a new store that will open in a few days at 1508 Pitkin Avenue, Brooklyn, N. Y. This will be a very elaborate and complete store, carrying a full line of the best in radio.

you is that the frequencies may not appear in regular order, but by selection of fundamentals and of harmonics (when used) on the basis of the desired regularity, the end is achieved. The harmonic method dispenses with coil or band shifting and is well suited for test oscillators of the type you have in mind.

### R-F Amplification

To compute the amplification at radio frequency is not so simple. However, in case the coupling between the two tubes involved is a simple parallel circuit the voltage gain is easily computed. We use exactly the same formula as in the case of pure resistance except that for R we put in the equivalent value of 250 microhenries, R a resistance tuned circuit. The resistance at resonance is, very nearly,  $L/RC$ , in which L is the inductance of the tuning coil, R its effective resistance, and C the capacity across the coil. Suppose that the inductance has a value of 250 micro henries, R a resistance of 25 ohms, and C a value of 250 mmfd. Then the effective radio frequency resistance at resonance is 40,000 ohms.

## A GREAT DISPLAY COUNTER FOR YOUR GOODS

Radio World's 1932 Holiday Gifts Number

Dated Dec. 10—published Dec. 6—last form closes Nov. 30

Regular advertising Rates in force

RADIO WORLD, 145 W. 45th St., New York



## RIDER'S PERPETUAL TROUBLE SHOOTER'S MANUAL

Vol. 1 and Vol. 2

Having assembled 2,000 diagrams of commercial receivers, power amplifiers, converters, etc., in 1,200 pages of Volume No. 1 of his Perpetual Trouble Shooter's Manual, John F. Rider, noted radio engineer, has prepared Volume No. 2 on an even more detailed scale, covering all the latest receivers. Volume No. 2 does not duplicate diagrams in Volume No. 1, but contains only new, additional diagrams, and a new all-inclusive information on the circuits covered.

Volume No. 2—Perpetual Trouble Shooter's Manual, by John F. Rider. Shipping weight 6 lbs. Order Cat. RM-VT @ \$5.00

Volume No. 1 (6 lbs.). Order Cat. RM-VO @ \$4.50

We pay postage in United States on receipt of purchase price with order. Canadian, Mexican and other foreign remittances must be in funds payable in New York.

### RADIO WORLD

145 WEST 45th ST., NEW YORK, N. Y.

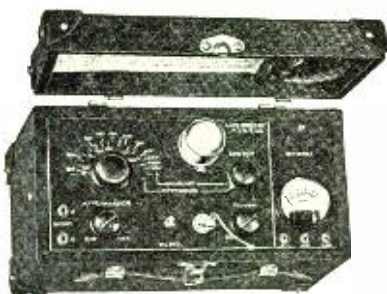

## OSCILLATOR

Licensed by A. T. & T. Co.

No. 551 \$18 Net to dealer  
\$30 list

No. 550 \$21 Net to dealer  
with output meter

A sturdy modulated instrument carefully made. Completely shielded with separate battery compartment. Furnished with 22½-v. and 3-v. batteries and one '30 tube. Direct reading broadcast band (550-1500 kc.) and intermediate band (120-185 kc.). Sharp 2nd and 3d harmonics for 260 and 475 kc. Operating instructions attached in case cover with shielded wire leads. Very compact. In leatherette case, 6x11½x5½ in. Weighs but 8 pounds. Built to high standards. Every serviceman should have the No. 550 oscillator to align r.f. gang condensers, locate defective r.f. transformers, adjust i.f. transformers, check oscillator stage and determine sensitivity of a receiver. A necessary instrument. Get yours today.

### Guaranty Radio Goods Co.

143 West 45th St. New York City

"A B C OF TELEVISION" by Yates—A comprehensive book on the subject that is attracting attention of radioists and scientists all over the world. \$3.00, postpaid. Radio World, 145 West 45th St., N. Y. City.

## ROLA SPEAKERS

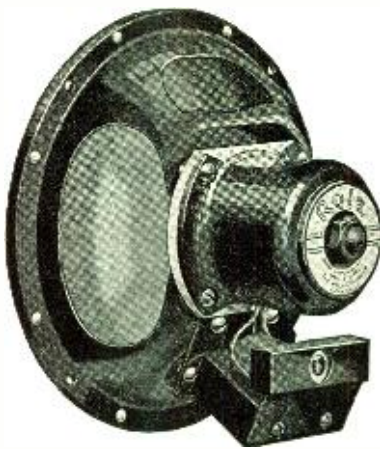

The Rola Series F speakers with 1800-ohm field coil tapped at 300 ohms are now standard in the 4-Tube and the 5-Tube Diamonds. The list of parts specifies the 8" diameter speaker, but larger diameters may be used, to fit any particular console. The small model is intended for mantel set installations.

The Rola speakers are supplied with 5-lead cable and plug. The output transformer built in is matched to the impedance of a single '47.

8" diameter (Cat. RO-8)...\$3.83

10.5" diameter (Cat. RO-105) 4.27

12" diameter (Cat. RO-12).. 5.35

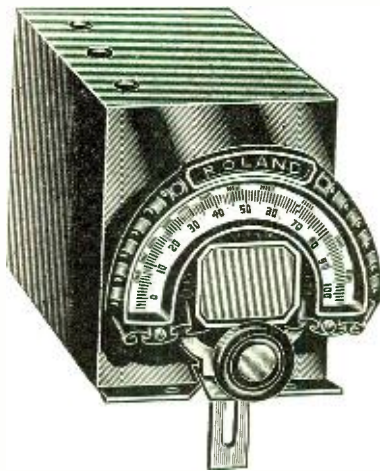

0.0005 mfd. Scovill tuning condenser, brass plates, shaft at both ends so condenser takes 0-100 or 100-0 dials and two can be used with drum dial; sectional shields built in, trimmers affixed; total enclosed in additional shield as illustrated. Access to trimmers with screwdriver. Side holes for bringing out leads to caps of screen grid tubes. Cat. SCSHC @.....\$1.95

Same as above, with ghost type dial (travelling light). Cat. SCSHC-DL @.....\$2.85

DIRECT RADIO CO., 143 W. 45 St., New York City

## GOOD RADIO BOOKS

"EXPERIMENTAL RADIO ENGINEERING," by Prof. John H. Morecroft, of the Department of Electrical Engineering, Columbia University. A companion book to the author's "Principles of Radio Communication," but in itself a text on practical radio measurements. Cloth bound, 345 pages, 6 x 9, 250 figures.....\$3.50

"FOUNDATIONS OF RADIO," by Rudolph L. Duncan. A treatise for the beginner, setting forth clearly and carefully the electrical phenomena associated with radio. Just the book to give you a firm grip on the subject.....\$2.50

"THE RADIO HANDBOOK," by James A. Moyer and John F. Wostrel, both of the Massachusetts Department of Education. Meets the need for a complete digest of authoritative radio data, both theoretical and practical. Flexible binding, 886 pages, 650 illustrations.....\$5.00  
Remit with order. We pay transportation.

RADIO WORLD, 145 W. 45th St., New York, N. Y.

25,000 OHM POTENTIOMETER, 90c. Direct Radio Co., 143 W. 45th St., N. Y. C.

## Quick-Action Classified Advertisements

7c a Word — \$1.00 Minimum  
Cash With Order

SCHEMATIC BLUEPRINT of any commercial receiver, 25c (coin). Super Engineering Lab., 1313 40th St., Brooklyn, N. Y.

25 CYCLE filament transformers, 110 v. pri., 2.5 volt c.t. secondary, 8 amperes, 96c. ea. Direct Radio Co., 145 W. 45th St., N. Y. City.

"THE CHEVROLET SIX CAR AND TRUCK" (Construction—Operation—Repair) by Victor W. Page, author of "Modern Gasoline Automobile," "Ford Model A Car and AA Truck," etc., etc. 450 pages, price \$2.00. Radio World, 145 W. 45th St., N. Y. City.

BARGAINS IN FINEST PARTS! — Highest grade, new parts, few of each on hand. National dial, flat type, modernistic escutcheon, type G, clockwise, \$2.19; Pilot drum dial No. 1285 @ \$1.89; a-c toggle switch, 19c; Aerovox dry electrolytics, bracket, 4 mfd., 500 volts, 39c; three-point, four-throw Best switch, insulated shaft, \$1.62; double pole, four throw, \$1.08. Direct Radio Co., 145 West 45th St., N. Y. City.

THE FIVE NEW TUBES, 46, 56, 57, 58 and 82, characteristics, installation data, uses, fully described and illustrated in the April 30th issue (7 pages) and in the May 7th issue. Send 30c for these two copies. Radio World 145 West 45th Street, New York, N. Y.

"SWOOP'S LESSONS IN PRACTICAL ELECTRICITY," 17th Edition, Revised by Erich Hausmann, E.E., Sc.D. Requires no previous technical knowledge; fully explains every question about the entire subject of electricity. New chapters on vacuum tubes, telegraphy, telephony and radio signalling. 709 pages, 542 illustrations, 5¼ x 8, Cloth, \$2.50. Radio World, 145 W. 45th St., New York, N. Y.

THE FORD MODEL—"A" Car and Model "AA" Truck—Construction, Operation and Repair—Revised New Edition. Ford Car authority. Victor W. Page. 708 pages, 318 illustrations. Price \$2.50. Radio World, 145 W. 45th St., New York.

### FULL SCALE PICTURE DIAGRAM OF 4-TUBE DIAMOND

This full scale diagram, together with an accompanying article on wiring, adjusting and operating the Four-Tube Diamond, appeared in Radio World dated Sept. 17. Sent for 15c a copy. First and Second installments of article on the 4-Tube Diamond appeared in issues of RADIO WORLD, dated Sept. 3 and 10. The three copies sent for 45c. Or send \$1.50 for a three months' subscription and receive these three numbers free.

Also full scale picture diagram of the 5-tube Diamond. This appeared in Radio World of Oct. 8, 15c a copy. Other issues containing information about the 5-tube Diamond are dated Sept. 24 and Oct. 1. These 3 copies, including full scale picture diagrams, mailed on receipt of 45c, or sent free with a \$1.50 subscription for three months.

RADIO WORLD, 145 W. 45th St., New York

## Subscribers! Important!

Note subscription expiration date on wrapper containing your copy of RADIO WORLD. If nearing expiration date, please send in renewal so that you will not miss any copies. Subscription Dept., RADIO WORLD, 145 W. 45th St., New York City.

### LOFTIN-WHITE AMPLIFIERS

Direct-Coupled Audio Circuits

Model 245. Uses (1) 224, (1) 280, (1) 245. @ \$10.95  
Model 247. Uses (1) 224, (1) 280, (1) 247. @ \$11.95  
Model 250. Uses (1) 224, (1) 281, (1) 250. @ \$13.95  
(Prices do not include tubes.)



Two-stage audio amplifiers with B supply built-in, for faithful reproduction. Tuner, pick-up or microphone may be connected to input.

Direct Radio Co., 143 W. 45th St., N. Y. City



## START RIGHT! Use These... Superb Condensers for Short Waves!

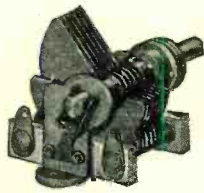

Single 0.00014 mfd. Hammarlund condenser; non-inductive pigtails; single hole panel mount and two-point base mount; Isolantite insulation; brass plates.

Single 0.00014 mfd. sent free with a 3-months subscription for Radio World (13 issues, \$1.50). Double 0.00014 mfd. sent free with a 6-months subscription (28 issues, \$3.00).

THE most popular capacity for short-wave use, and the one for which virtually all commercial short-wave coils are wound, is 0.00014 mfd. The Hammarlund condensers of this capacity, both single and double, are compact and efficient. They have Isolantite insulation and Hammarlund precision workmanship. See offer at lower left. Present subscribers may extend their subscriptions under this offer.

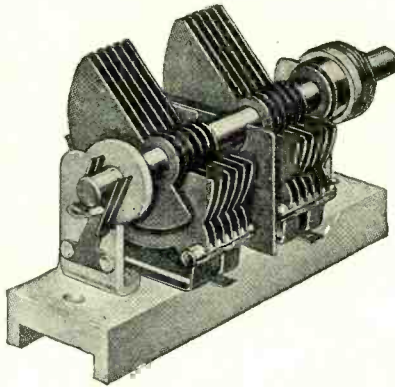

RADIO WORLD, 145 West 45th Street, New York, N. Y.

## PADDING CONDENSERS



700-1,000 mmfd. (Cat. PC-710) @ 50c net.  
350-450 mmfd. (Cat. PC-3545) @ 50c net.

A HIGH-CLASS padding condenser is required for a superheterodyne's oscillator, one that will hold its capacity setting and will not introduce losses in the circuit, for losses create frequency instability. The Hammarlund padding condensers are of single-condenser construction on Isolantite base, with set-screw easily accessible, and non-stripping thread. For 175 kc. intermediate frequency use the 700-1,000 mmfd. model. For i.-f. from 460 to 365 kc., use the 350-450 mmfd. (General Motors models).

### 0.0005 HAMMARLUND S. F. L. at 98c.

A sturdy, precision straight frequency line condenser, with end stops. The removable shaft protrudes front and rear and permits ganging with coupling device, also use of clockwise or anti-clockwise dials, or two either side of drum dial. Front panel and chassis-top mounting facilities. True straight line. This rugged condenser has Hammarlund's high quality workmanship and is suitable for precision work. It is a most excellent condenser for calibrated radio frequency test oscillators, any frequency region, 100 to 60,000 kc., short-wave converters and adapters and TRF or Superheterodyne broadcast receivers. Lowest loss construction, rigidity; Hammarlund's perfection throughout.

Order Cat. HO5 @ .....98c net

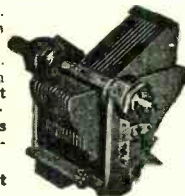

Guaranty Radio Goods Co., 143 West 45th Street, New York, N. Y.

## BLUEPRINTS OF STAR CIRCUITS

### 8-TUBE AUTO SET

Sensitivity of 10 microvolts per meter characterizes the 8-tube auto receiver designed by J. E. Anderson, technical editor of Radio World, and therefore stations come in with only six feet of wire for aerial, and without ground. Most cars will afford greater aerial pickup, and besides the car chassis will be used as ground, so with this receiver you will get results. The blueprint for construction of this set covers all details, including directions for cars with negative A or positive A grounded. The circuit features are: (1) high sensitivity; (2), tunes through powerful locals and gets DX stations, 10 kc either side; (3), latest tubes, two 239 pentode r-f, two 236 screen grid, two 237 and two 238; push-pull pentodes, all of 6-volt automotive series; (4), remote tuning and volume control on steering post, plus automatic volume control due to low screen voltage on first detector; (5), running board aerial. The best car set we've published. This circuit was selected as the most highly prized after tests made on several and is an outstanding design by a recognized authority. Send for Blueprint 631, @ .....50c

### SHORT-WAVE CONVERTER

If you want to build a short-wave converter that costs only a very few dollars, yet gives good results, furnishing all its own power from 110 volts a-c, and uses no plug-in coils, you can do so from Blueprint 630. Price.....25c

### 5-TUBE AC, T-R-F

Five-tube a-c receivers, using variable mu r-f, power detector, pentode output and 280 rectifier, are not all alike by any means. Forty circuits were carefully tested and one selected as far superior to the others. This prized circuit was the 627, and if you built it, you will always be glad you followed our authentic Blueprint, No. 627. This is the best 5-tube a-c t-r-f broadcast circuit we have ever published. Price .....25c

### A-C ALL-WAVE SET

An all-wave set is admittedly what many persons want, and we have a circuit that gives excellent broadcast results, and is pretty good (not great) on short waves. No plug-in coils used. Cost of parts is low. Send for Blueprint, No. 628-B, @.....25c. In preparation, an 8-tube broadcast super heterodyne for 110v a-c. Write for particulars

RADIO WORLD, 145 West 45th Street, New York, N. Y.

## BINDER FREE For New Yearly Subscribers

This binder is made of fine brown Spanish fabricoid and will hold 52 issues of Radio World. The year is stamped in gold on front cover. A very limited supply on hand. Sent free to new yearly subscribers who send \$4 direct to publication office. If already a subscriber, send \$6 and 52 issues will be added to present subscription. No other premium with this offer.

RADIO WORLD, 145 WEST 45th STREET, NEW YORK CITY

## SPEAKER HEADQUARTERS!

IF your dynamic speaker suffers lost insensitivity or develops rattling or buzzing sounds, it usually needs a new cone and voice coil. We have the unit cone-and-voice-coil assemblies for all the popular speakers, some listed below. Others are available. Inquire for prices.

Service men can make the cone and voice coil replacements but any who desire that the installation and adjustment be made for them on precision jigs, in the same manner as in the speaker factories, may send their speakers to us for repair. There is a 25c extra charge for this labor.

The name of the speaker is listed under the caption, "Speaker," the outside diameter in inches of the frame that holds the cone is given under the initials "O.D." and the price of cone-voice coil combination unit is given next.

Speaker	O.D.	Price	Speaker	O.D.	Price
Atwater Kent	11	\$2.75	Peerless		
Bosch	11	2.75	copper coil	10 1/4	1.95
Bosch	10	1.90	copper coil	12	2.10
Brunswick D.	9 1/4	2.25	copper coil	14 1/4	2.85
Brunswick B.	14 1/2	2.75	Peerless wire-		
Brunswick E.	14 1/2	2.75	wound coil	8 1/2	2.85
Colonial	33	12 1/4	wound coil	10 1/4	1.65
Decatur	9 1/2	1.90	wound coil	14 1/2	2.75
Eveready	10	1.90	Philco 65-90	11	1.50
Eveready	10	1.90	Philco 20	10	1.50
Earl Inductor	10	.95	RCA 106	10 1/4	2.00
Farrand	7	2.25	RCA 105	8	2.00
Farrand			RCA 104	8	2.00
Inductor	11	1.35	Symington	10	1.90
First Nat'l	10	1.90	Symington	12 1/4	2.25
Freed-Eismann			Sterling	9	2.25
NR 80-87	10	2.75	Stromberg-		
Majestic G1	9	1.80	Carlson	12 1/2	2.75
Majestic G2	9	1.80	Carlson	9	2.25
Majestic G3	11	1.80	Sparton 737	9	2.25
Majestic G5	14	2.75	Steinitz	10	1.90
Jensen			Temple	9	2.75
D9, D15	8 1/2	1.50	Temple	11	2.75
D4	9 1/2	2.25	Temple		
D7 Concert	11 1/4	2.25	Auditorium	14	3.75
Auditorium	13	4.50	Utah	9	1.90
Magnavox	9	2.25	Utah Stadium	12	2.75
Newcomb-			Victor		
Hawley	9	2.25	RE32-45	9	1.35
Oxford	9	1.95	Wright		
Oxford	8 1/4	2.25	De Costa	10	2.25
Peerless			De Costa	12	2.75
copper coil	8 1/2	1.60	Zenith	32	12 1/4
					2.25

### MAGNETIC SPEAKERS

Ready to Play, but Not Including Cabinet or Baffle  
Farrand 9" O.D., burtex cone.....\$1.50  
Timmons (as used in Philco sets) 9" O.D., burtex cone.....\$1.80  
Auto speaker, 9" O.D., burtex cone.....\$1.50

DIRECT RADIO CO.  
143 West 45th Street  
New York, N. Y.

## THREE-IN-ONE TESTER FREE!

EVERYBODY who does any radio work or for whatsover, whether for fun or for pay or for both, needs a continuity tester, so he can discover opens or shorts when testing.

A mere continuity tester is all right, but—

Often it is desired to determine the resistance value of a unit, to determine if it is correct, or to measure a low voltage, and then a continuity tester that is also a direct-reading ohmmeter and a DC voltmeter comes in triply handy.

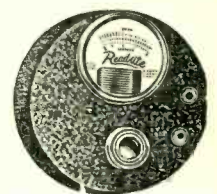

So here is the combination of all three

A 0-4 1/2-volt DC voltmeter, a 0-10,000-ohm ohmmeter and a continuity tester. A rheostat is built in for correct zero resistance adjustment or maximum voltage adjustment. The unit contains a three-cell flashlight battery. Supplied with two 5-foot-long wire leads with tip plugs. Case is 4-inch diameter baked enamel. Weight, 1 lb. Sent you with an order for one year's subscription for RADIO WORLD (52 weeks) at the regular rate of \$6. Order Cat. PR-500. Use Coupon below.

Radio World, 145 W. 45th Street, New York, N. Y.

Enclosed please find \$6 for one year's subscription for Radio World (one copy a week, 52 issues) Send Cat. PR-500 as premium.

Name .....  
Address .....  
City ..... State.....