

DEC. 24  
1932

UNIVERSAL SET A.C.  
or D.C.

15¢  
Per Copy

# RADIO

REG. U.S. PAT. OFF.

# WORLD

The First and Only National Radio Weekly  
*Eleventh Year*      *561st Consecutive Issue*

Constructional Articles  
and Plans  
on Six-Tube Super  
and a Test Oscillator

—  
The New FADA Circuit

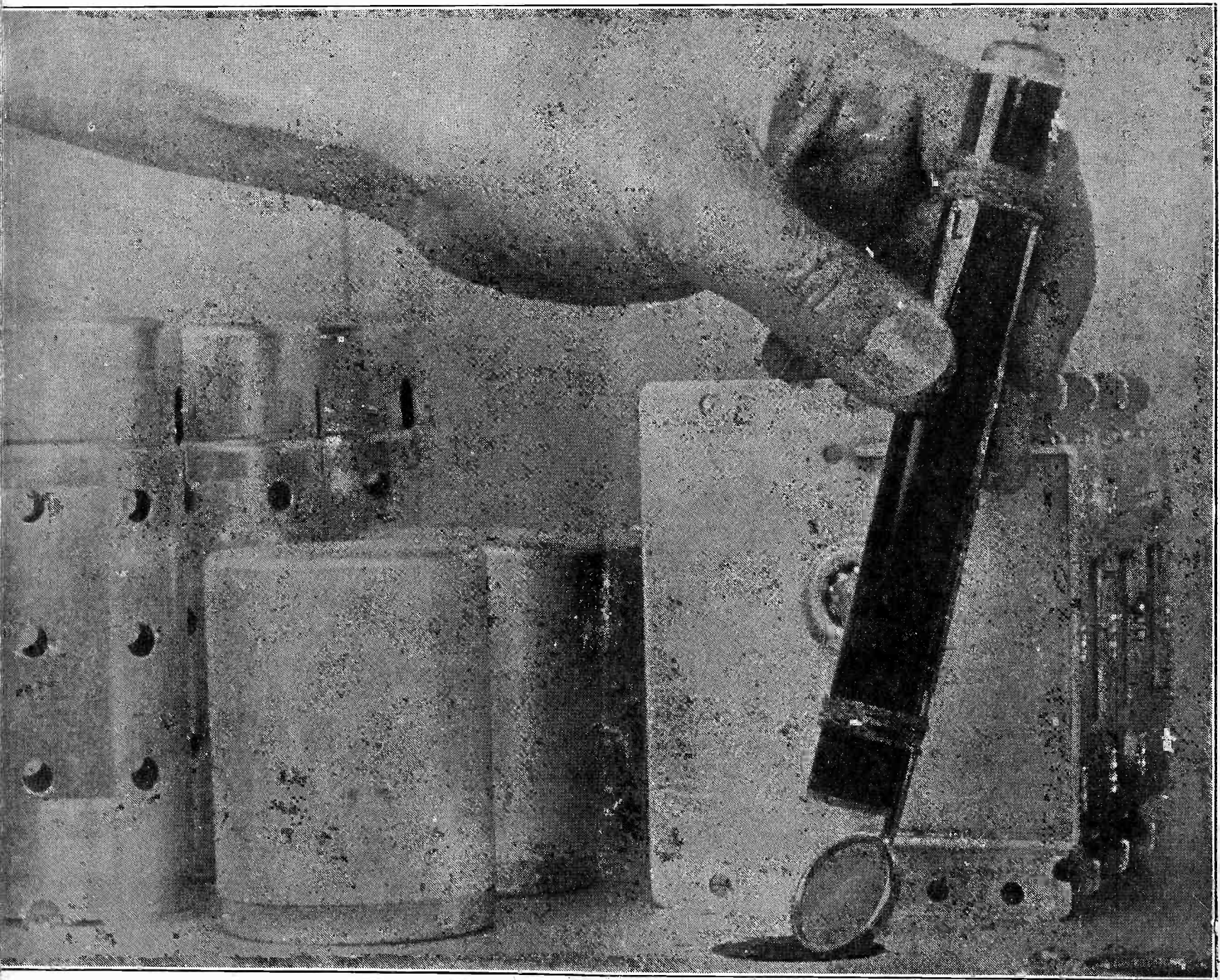

A small mirror held to a fountain-pen type flashlight often enables one to look under a chassis when troubleshooting without removing chassis from the cabinet.

**Mr. SERVICEMAN**

Take a tip! Get Rider's Volume II of the Perpetual Trouble Shooter's Manual. Buy it today. Don't wait until you cannot repair a receiver because you do not have the data. **FREE.** If you are a Service Man, write for the color code chart of the resistors used in Atwater-Kent receivers. Enclose 3c to cover postage.

RADIO TREATISE CO., Inc.  
1440 Broadway New York City

**RADIO WORLD and "RADIO NEWS"**

BOTH FOR ONE YEAR **\$7.00** Canadian and Foreign \$8.50

You can obtain the two leading radio technical magazines that cater to experimenters, service men and students, the first and only national radio weekly and the leading monthly for one year each, at a saving of \$1.50. The regular mail subscription rate for Radio World for one year, a new and fascinating copy each week for 52 weeks is \$6.00. Send in \$1.00 extra, get "Radio News" also for a year—a new issue each month for twelve months. Total, 64 issues for \$7.00. **RADIO WORLD, 145 West 45th Street, New York, N. Y.**



**AMERICAN BOSCH 10-tube Radio, \$55.95**

New 1933 New Essex Model Console, 10-tube Superheterodyne, two speakers, the best American Bosch, value at \$55.95.

Simplex long and short-wave radio, the fastest moving line in America, 5-tube superheterodyne, table model cabinet, only \$29.95.

We sell for cash with order, less 20% discount. Order from advertisement or write for folders.

McGuire Distributing Co., Doeville, Tenn.

**SHORT-WAVE BROADCAST STATIONS**—Complete list of those on air and ordinarily receivable; also, complete list of Short-Wave Commercial Stations, including Aircraft, Police and Identifying Stations, contained in Radio World issue of Dec. 3, 1932. 15c a copy. Radio World, 145 W. 45th St., New York, N. Y.

**No More Need to Calculate Inductance!**

**Correct Answer Obtained from Charts in 10 Seconds!**

**W**HILE any one of the three quantities may be determined, the chief purpose of the tri-relationship chart is to give instant reading of the inductance needed when capacity and frequency are known.

The turns charts (number of turns needed for specified inductance) are thirty-six in number, one for each of the following different wire sizes and insulations: Enamel Nos. 14, 16, 18, 20, 22, 24, 26, 28, 30; Single Silk Covered, Nos. 14, 16, 18, 20, 22, 24, 26, 28, 30; Double Silk Covered or Single Cotton Covered (same data apply to both), Nos. 14, 16, 18, 20, 22, 24, 26, 28, 30; Double Cotton Covered, Nos. 14, 16, 18, 20, 22, 24, 26, 28, 30.

Each turns chart gives the number of turns for inductance ranges well in excess of commercial uses of particular wire sizes on the specified diameters. Short waves included for larger diameter wires, very long waves for finer diameter wires.

The turns charts are Cat. CHT-TNS followed by the wire size and insulation. Thus, turns chart for No. 30 Double Cotton Covered would be Cat. CHT-TNS-30-DCC. The price is \$1.00 each. The accuracy of these charts is so high that it may be relied on in engineering practice. All charts are on a logarithmic 5x3-cycle basis.

**RADIO WORLD, 145 West 45th Street, NEW YORK, N. Y.**

**P**RECISION charts have been prepared by Edward M. Shiepe, E.E. (Massachusetts Institute of Technology) relating inductance, capacity and frequency, and giving the number of turns of different sized wires for attaining inductance values for solenoid form diameters of 3/4, 7/8, 1, 1 1/8, 1 1/4, 1 3/8, 1 1/2, 1 3/4, 2, 2 1/4, 2 1/2, 2 3/4 and 3".

The tri-relationship chart (inductance, capacity and frequency plotted, so that when any two are known the unknown may be read directly in 10 seconds) is necessary for use of the inductance table that covers any particular wire size for all the specified form diameters.

The charts are on 9 x 12" photostat sheets, white lines on a black field.

The tri-relationship chart covers inductance values of 0.1 to 10,000 microhenries, capacity values of 50 to 600 mmfd. and frequency values of from 100 to 20,000 kc.

The tri-relationship chart is Cat. CHT-TRI, @ \$1.00

**MODULATED OSCILLATORS**

Broadcast and Intermediate Frequencies

An a-c operated modulated oscillator (105-120 v., 50-60 c.), fully covering the broadcast band (1500 to 540 kc.) and all the commercial intermediate frequencies (115, 130, 172.5, 175, 177.5, 260, 400 and 450 kc.). The vernier dial has scale calibrated in broadcast frequencies, while the eight intermediate frequencies are also recorded directly on the scale. No chart references necessary. Accuracy is 3 per cent. or better, averaging better than 2 per cent. Broadcast calibration is for 5 kc. divisions at low frequency end, 10 kc. in the middle and 20 kc. at the high frequency end.

Fundamental frequencies of oscillation will be from 50.7 to 153 kc, so that some intermediate frequencies may be tested on the fundamental, others on the second harmonic, while the broadcast band is taken care of by the tenth harmonic. No switching necessary despite wide frequency coverage. Sharp tuning, clear squeals in heterodyning, and strong modulation by the 60-cycle line frequency. No hum except at resonance. Frequency stability is of a high order, due to stabilized grid circuit. Calibration is for a 56 tube.

Cat. WOSC, @ .....\$6.93 (56 tube is 87c extra)

Same as above, except for battery operation, with high audio frequency modulation, and requiring 3-volt dry battery and 22.5 volt B battery (not furnished). Tube required is the '30.

Cat. WOSCB, @ .....\$6.53 (230 tube is \$1.08 extra)

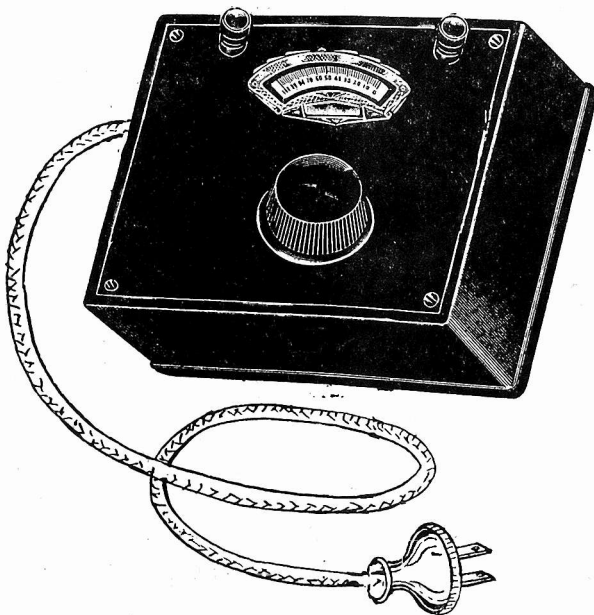

The modulated oscillator has vernier dial calibrated directly in frequencies, covering broadcasts and intermediate. The tube is inserted by removing the panel. Output post is at left, ground post at right.

**Direct Radio Co., 143 West 45th Street, New York, N. Y.**

**DIAMOND SUPER**

Set of shielded coils, consisting of antenna coil, modulator input coil and combination oscillator and first 175 kc intermediate coil (latter two in one shield), and separate intermediate coil with center-tapped secondary. Cat. SDCK. **\$3.95**

Combination oscillator and 175 kc only, in one shield. Cat. OSN @..... **\$1.80**

Three-gang 0.00037 mfd. condenser with trimmers built in; 3/8 inch shaft, 1 1/8 inches long. Cat. DJA3G ..... **\$1.80**

250,000-ohm potentiometer with switch. Cat. R25S @..... **\$.72**

Pigtail resistors, 9c each; Rola speaker, \$3.83; tube shields, 11c each; UX, UY sockets, 10c; six-pin, 11c; 7-pin, 15c.

**DIRECT RADIO COMPANY**

143 West 45th St. N. Y. City

**RIDER'S PERPETUAL TROUBLE SHOOTER'S MANUAL**

Having assembled 2,000 diagrams of commercial receivers, power amplifiers, converters, etc., in 1,200 pages of Volume No. 1 of his Perpetual Trouble Shooter's Manual, John F. Rider, noted radio engineer, has prepared Volume No. 2 on an even more detailed scale, covering all the latest receivers. Volume No. 2 does not duplicate diagrams in Volume No. 1, but contains only new, additional diagrams, and a new all-inclusive information on the circuits covered.

Volume No. 2—Perpetual Trouble Shooter's Manual, by John F. Rider. Shipping weight 8 lbs. Order Cat. RM-VT @ **\$5.00**

Volume No. 1 (8 lbs.). Order Cat. RM-VO @ ..... **\$5.00**

We pay postage in United States on receipt of purchase price with order. Canadian, Mexican and other foreign remittances must be in funds payable in New York.

**RADIO WORLD, 145 W. 45th St., N. Y. City**

**BLUEPRINTS**

**627.** Five-tube tuned radio frequency, A-C operated; covers 200 to 550 meters (broadcast band), with optional additional coverage from 80 to 204 meters, for police calls, television, airplane, amateurs, etc. Variable mu and pentode tubes. Order BP-627 @ ..... **25¢**

**628-B.** Six-tube short-wave set, A-C operated; 15 to 200 meters; no plug-in coils. Intermediate frequency, 1,600 kc. Variable mu and pentode tubes. Order BP-628-B @ ..... **25¢**

**RADIO WORLD**

145 WEST 45TH ST., NEW YORK, N. Y.

**PHONO PICKUP**

Rubber-damped phono-graph pickup, eliminating pick-up noises. Designed for full tonal range with fidelity. Price, \$4.50.



**Direct Radio Co., 143 W. 45th St., N. Y. City**

ROLAND BURKE HENNESSY  
Editor

HERMAN BERNARD  
Managing Editor

# RADIO WORLD

The First and Only National Radio Weekly  
ELEVENTH YEAR

J. E. ANDERSON  
Technical Editor

J. MURRAY BARRON  
Advertising Manager

Vol. XXII

DECEMBER 24th, 1932

No. 15, Whole No. 561

Published weekly by Hennessy Radio Publications Corporation, 145 West 45th Street, New York, N. Y.

Editorial and Executive Offices: 145 West 45th Street, New York

Telephone: BR-yant 9-0558

OFFICERS: Roland Burke Hennessy, President and Treasurer; M. B. Hennessy, Vice-President; Herman Bernard, Secretary.

Entered as second-class matter March, 1922, at the Post Office at New York, N. Y., under Act of March 3, 1879. Title registered in U. S. Patent Office. Printed in the United States of America. We do not assume any responsibility for unsolicited manuscripts, photographs, drawings, etc., although we are careful with them.

Price, 15c per Copy; \$6.00 per Year by mail. \$1.00 extra per year in foreign countries. Subscribers' change of address becomes effective two weeks after receipt of notice.

## A UNIVERSAL SET

### Superheterodyne Works on A.C. or D.C.

By J. E. Anderson

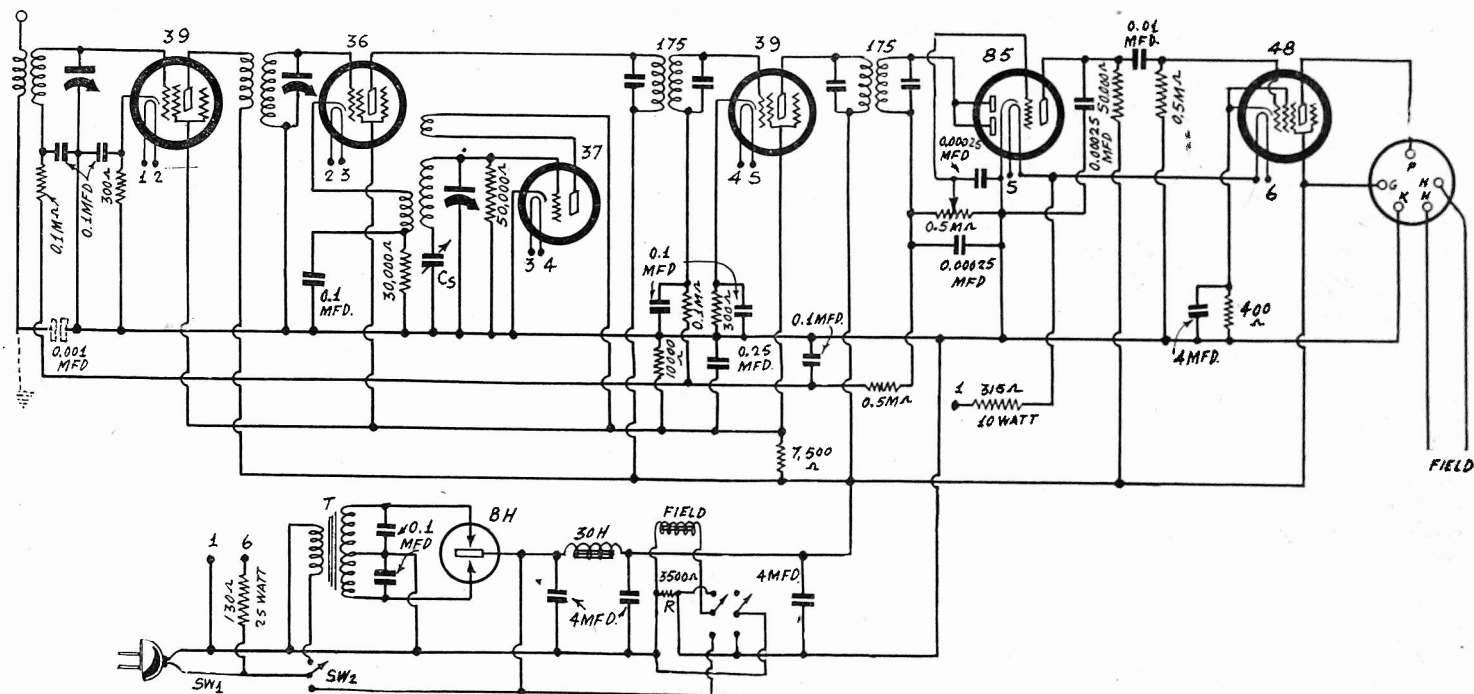

FIG. 1

This is the diagram of a six-tube d-c or a seven-tube a-c superheterodyne. It is a circuit that may be called universal because it can be used on either d-c or a-c simply by throwing a switch.

**S**O-CALLED universal receivers are being put out these days, receivers that will work when connected to a-c or d-c lines without making any changes in the connections. In these re-

ceivers the filaments are connected in series and a suitable ballast resistor is put in the line to drop the excess voltage. Since the voltage is the same regardless whether it is alternating or direct, the

same ballast will do for both cases. Now, since the a-c must be rectified and filtered before being applied to the plates and screens of the tubes, a tube rectifier  
(Continued on next page)

#### LIST OF PARTS

##### Coils

Two midget type shielded r-f tuning coils for 350 mmfd. capacity  
One midget type oscillator coil for 350 mmfd. capacity and 175 kc i-f  
Two doubly tuned 175 kc i-f transformers  
One power transformer capable of giving about 250 volts rectified  
One 30-henry choke coil capable of carrying 90 milliamperes

##### Condensers

One 0.25 mfd. by-pass condenser

One gang of three 350 mmfd. tuning condensers  
Six 0.1 mfd. by-pass condensers (eight if BH rectifier is used)  
Three 0.00025 mfd. condensers  
One 0.01 mfd. condenser  
Four 4 mfd. by-pass condensers

##### Resistors

Two 300 ohm bias resistors  
One 400 ohm bias resistor, 3 watts  
Two 50,000 ohm resistors  
One 30,000 ohm resistor  
Two 0.5 megohm resistors

One 0.5 megohm  
One 10,000 ohm resistor  
One 7,500 ohm, 3 watt resistor  
One 130 ohm, 25 watt resistor  
One 315 ohm, 10 watt resistor  
One 3,500 ohm, 5 watt resistor

##### Other Requirements

One vernier dial  
Five grid clips  
Five UY sockets  
Two six-spring sockets  
One UX socket  
One triple pole, double throw switch  
One single pole, single throw line switch.

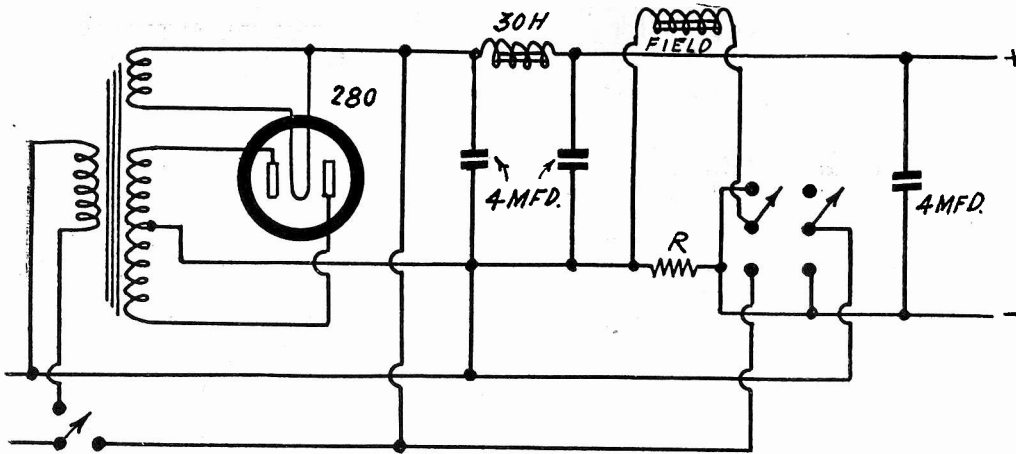

FIG. 2

If a 280 type rectifier is used in the circuit diagrammed in Fig. 1 the B supply circuit should be wired according to this arrangement.

(Continued from preceding page)

is employed, together with a suitable filter. No power transformer is used and this fact allows universality. Of course, that limits the applied voltage to the line voltage since there is no means of stepping it up.

One difficulty is encountered in connection with the field supply for the dynamic speaker. A-C cannot be applied directly to the field and if part of the available rectified voltage is used for the field comparatively little is left for the plates and the screens. Hence when the set is to work on a-c a magnetic or a permanent field dynamic speaker is the logical thing to use. This, of course, can be used when the voltage is direct, too, so that on a universal set one of these should be used.

On d-c a 110 volt speaker could be used with the field connected directly across the line. On a-c a speaker with a built-in rectifier could be used advantageously. But in neither case would the set be really universal. Only the magnetic or the permanent field dynamic would make it that.

### Use of Transformer

If we use a transformer for the a-c case it is possible to make the set universal even when a dynamic speaker is used for in that case the field could be connected directly across the line when the supply voltage is direct and in series with the plate supply when the supply voltage is alternating. To make up for the loss of voltage it would only be necessary to have a step-up transformer giving a voltage that is high enough. It is a simple matter to provide a switch that will change the set from one type to the other.

We show in Fig. 1 a diagram of a set which is universal to the extent that it may be converted from one type to the other by throwing a single triple pole, double through switch. For convenience this switch is shown in two parts. Directly under transformer T is a single pole double throw section. When this is thrown up one side of the line is connected to the primary of the power transformer. The other side of this primary is permanently connected to the other side of the line. This position of the switch, of course, is for the a-c case.

When the switch is thrown up the transformer T is excited and a high voltage is induced in the secondary. This is rectified by the tube BH and the rectified current is first filtered by means of two 4 mfd. condensers and a 30-henry choke coil. The field coil of the speaker is connected in series with the negative lead by the same movement of the switch. One side of the field is permanently connected to the negative side of the line, negative both when the supply voltage is d-c and when it is a-c.

### Additional Filtering

Since the field coil is in series with the line it acts as a choke. In order to

have a by-pass for this choke third 4 mfd. condenser is connected across the line.

When the supply voltage is d-c the switch Sw2 is thrown down. That throws the power transformer and the rectifier out of the circuit and connects the positive side of the line to the positive side of the filter circuit, that is, to the terminal of the rectifier that would be positive. Thus the filter remains in the circuit. The second part of the switch transfers the field coil from the plate supply to the line. Then the third 4 mfd. condenser is now thrown out of the circuit. The third section of the triple pole switch is used for closing the the gap in the negative line that was made when the field coil was taken out of it. That this is accomplished is clear by the fact that if the second section of the switch is thrown up and the third section down, the field coil is short circuited.

The additional filtering when a-c is used is desirable because there is much more ripple in the rectified voltage than in the voltage on the d-c line. One 30-henry choke and two 4 mfd. condensers are quite sufficient on a d-c line. Indeed, practically no hum would result if the 30-henry choke were omitted and the condensers alone were used.

### Field Coil Required

The usual field coil on d-c has a resistance of about 2500 ohms and this would take a current of 46 milliamperes when connected to a 115 volt line. Due to the use of a 48 tube in this set the normal plate current will be of the order of 85 milliamperes, which is nearly twice the current required by the 2500 ohm speaker field. That again raises a difficulty for if we connect the 2500 ohm speaker in series and forced 85 milliamperes through it, it would probably burn up. The best way out of it seems to be to put a shunt across the field when it is connected in series and adjusting this shunt so that it takes about half the total current. The voltage drop across the field must remain the same in the two positions. Suppose we allow a field current of 50 milliamperes when the coil is in series. The voltage across it should be 115 volts. This is also to be the drop across the shunt resistor. Since the total current is 85 milliamperes and the field is to take 50, the shunt will take 35 milliamperes. That means that the shunt, which is marked R, should have a resistance of 3,300 ohms. The nearest commercial size of 3,500 ohms will be all right. The wattage dissipation in it will be about 4 watts so that a 5-watt or heavier resistor should be used. It is shorted when the coil is across the line so that it will not cause any trouble.

### Rectifier Tube

The rectifier tube is of the gaseous type that requires no filament. If the power transformer T has a 5 volt filament winding a 280 type rectifier can be used

just as well. The circuit for this is shown in Fig. 2.

Regardless of which type rectifier is used the secondary voltage of the power transformer should be such that rectified voltage across the second filter condenser is 230 volts. There are midget transformers available that will give this voltage at approximately the current required by this set. They have been designed for a 280 or an 83 rectifier so that the necessary 5-volt winding is included.

All the filaments of the tubes in set proper are connected in series. The first tube is connected to the negative side of the line by joining the two points marked (1). Then the connections are made as indicated by the numbers at the ends of the heaters. The terminal on the 48 marked (6) is connected to the ballast resistor and also marked (6). Since the 48 takes 0.4 ampere and the other tubes only take 0.3 ampere a 315 ohm shunt is connected from (5) to (1). This resistor should be wire wound and should have a rating of at least 10 watts.

Between (6) and the positive side of the line is inserted the filament ballast resistor. Since there are five tubes each requiring a voltage of 6.3 volts, and one requiring 30 volts, the drop in the heaters will amount to 61.5 volts. But the line voltage is 115 volts. Hence the ballast must drop 53.5 volts when the current is 0.4 ampere, which takes nearly 130 ohms. The wattage dissipation in this circuit will be a little over 20 watts, and the resistor used should have a rating higher than this. The specified value is 25 watts but of course a heavier resistor would be better.

### Grounding of Circuit

No direct ground should be used on the circuit. On d-c one side of the line is grounded and that grounds the circuit adequately, either directly or through the filter condensers. On a-c the chassis might be grounded but it should only be done through a condenser. That is, a condenser of 0.001 mfd. or more should be connected to the chassis and then the ground connection should be made to the unused side of the condenser.

When the set is used on d-c care must be taken to see that the polarity is correct. If it is wrong the set will not work and before the tubes have a chance to warm up the filter condensers will be ruined. On a-c it makes no difference how the line plug is inserted, provided that the switch has been set for a-c first.

### Biasing of Tubes

It is necessary in a circuit of this type to bias all the tubes by means of bias resistors. For each of the 239s a 300 ohm resistor is used between the cathode and the chassis. Each is bypassed with a 0.1 mfd. condenser. The bias resistor for the 236 detector is 30,000 ohms and this also is shunted by a 0.1 mfd. condenser.

The 85 triode is diode biased, the bias voltage depending on the signal. When no signal is coming in the bias is zero, as it is when the volume control is set at zero output. To prevent excessive plate current in the triode under conditions of zero bias, a 50,000 ohm resistance is used for coupling. There is no good reason why this resistance should not be as high as 0.25 megohm.

### Automatic Bias

The power tube is biased with a 400 ohm resistor. This value is a little higher than the value obtained from the rated bias and screen and plate current but it is all right to overbias the tube a little. However, a 350 ohm resistor could be used safely. The condenser across the bias resistor is 4 mfd. A much larger value, say 25 mfd., could be used to advantage. Condensers of this value are obtainable of the electrolytic type. When one of these is used the positive ter-

minal should be connected to the cathode. Automatic bias is also used on the two 239 amplifiers. This is taken from the voltage developed across the diode load resistance through a 0.5 megohm resistor. In each grid return of the controlled tubes is a 0.1 megohm filter resistance and a 0.1 mfd. condenser across it. There is also a 0.1 mfd. condenser connecting the common return to ground.

The diode load resistance is a half megohm potentiometer which is also used as a manual volume control by controlling the amount of detected audio voltage impressed on the grid of the triode of the 85. The voltage impressed on the grid of the 85 is amplified approximately seven times and then impressed on the grid of the 48 grid. The output power is around 2 watts.

The six tube circuit is practically a standard superheterodyne. First there is an r-f tuner which is followed by a 39 r-f amplifier. This is followed by another r-f tuner after which comes the 236 first detector, which operates on the grid bias principle. The oscillator is a 37 and uses a three winding coil, the tickler, the tuned winding and the pick-up, which is put in the cathode lead of the first detector.

The intermediate amplifier-selector contains two doubly tuned i-f transformers and one 239 tube. The intermediate frequency is 175 kc.

**Padding Values**

The tuning inductance of the oscillator should have a value of about 196 microhenries, if the inductance in each of the r-f circuits is 245 microhenries. These are all standard coils that go with 350 mmfd. tuning condensers. The series padding condenser Cs should have a value of about 900 mmfd. The best way to get that is to use an adjustable condenser having a range from 700 to 1,000 mmfd. This is also a standard unit used in most 175 kc superheterodynes.

The adjustment of the padding can be done in the regular way. That is, the circuit is first adjusted at about 1,450 kc by setting the main condenser at about 6 on the dial and then tuning in the signal by means of the trimmers on the three tuning condenser sections. Then the circuit is converted to a t-r-f set by moving the grid clip from the first detector to the cap of the 85. A signal of about 600 kc is tuned in and then without touching the tuning condenser the circuit is restored to a superheterodyne and the same 600 kc signal is tuned in with the padding condenser Cs, and with nothing else.

**Precautions**

Of course, it is first necessary to tune the intermediate frequency circuit to 175 kc. This is best done by supplying a modulated 175 kc signal from a laboratory oscillator. In the absence of such an oscillator the tuning may be done on any signal that can be brought in. That may

**IMPROVING RESULTS**

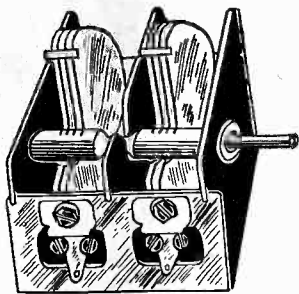

In using a short-wave dual condenser in a t-r-f circuit, if the two sections do not track after compensators have been accurately adjusted at the low capacity end, only inductance or resistance can cause the mismatching. Equalize the circuits inductively.

A microphone used with the a-f amplifier of a set works better when a d-c voltage is across it, from 1.5 to 6 volts being usual. A microphone transformer, one type for grid, another for plate coupling, aids, too.

If a wedge type dial is stiff, despite its dependence on friction, a little lubricating oil on the disc gives smoother action.



not lead to 175 kc but something near it. Warning has already been given about connecting the circuit to a ground. A serious short-circuit might occur if it is done. Care should also be taken to see that the antenna used is not grounded somewhere. The possibility of a burned-out primary in the first r-f transformer is always present.

If the set must be grounded a 0.001 mfd. condenser may be connected between the chassis and the ground terminal of the

antenna winding. If this condenser is used there is no danger of connecting the antenna post to any antenna, nor any danger of grounding the other end of the primary.

It was also said that under certain conditions the by-pass condensers in the filter might be damaged by voltage of reversed polarity. That applies only if the three 4 mfd. condensers in the filter are of the electrolytic type. If good paper condensers are used there is no danger.

**In Preparation! Radio World's Holiday Issue!**

**ROCKEFELLER CENTER NUMBER**

**(Including RADIO CITY)**

**Progress and Development of**

**World's Greatest Commercial and Amusement Achievement**

# TEST OSCILLATOR CONSTRUCTION

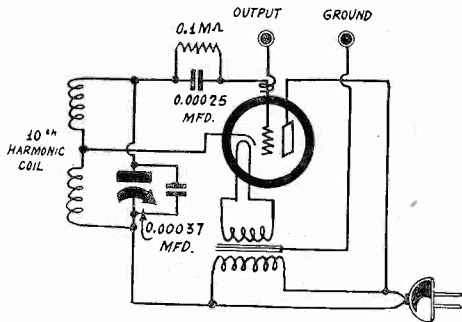

The circuit diagram of the modulated test oscillator. The output coupling is obtained by the capacity between parallel leads, one of which is the wire from grid of socket to grid condenser, and the other the wire that terminates at the output binding post. There is no conductive coupling at the other end of the output wire.

THE constructional details for building a modulated test oscillator, covering the broadcast band and all the commercially used intermediate frequencies, are given herewith on the basis of utmost compactness. The circuit is the modification of the Hartley oscillator as devised by E. M. Shiepe, and a-c is used on the plate. This of course introduces the line frequency as modulation, approximately 100 per cent. The oscillation level is high and the coupling is therefore excellent even at the lowest frequency.

The fundamental frequencies of oscillation, using a 0.00037 mfd. single condenser with compensator built in, and a "tenth harmonic" coil, will be from 152 to 50 kc, therefore the broadcast band is covered by cipher annexation, using the tenth harmonic, and a frequency-calibrated dial will read directly in terms of the fundamental and indirectly (by the cipher annex) for the broadcast band, while two intermediate frequencies, 115 and 130 kc., will be on the fundamental scale, another, 260 kc., will be a second harmonic, and the remaining intermediate frequencies third harmonics. All the popular intermediate frequencies are encompassed by the following: 115, 130, 172.5, 175, 177.5, 260, 400 and 450 kc.

## Sizes Given

The overall size of the wooden cabinet is 9 inches wide by  $5\frac{15}{16}$  inches front to back by  $4\frac{1}{4}$  inches high, the height including the mounting feet. The panel is  $8.5 \times 5.5$  inches, and is cut out for the traveling light full-vision dial.

The dimensions for the chassis are given in a drawing, and also the view of the completed test oscillator is shown in a photograph. When the test oscillator is in use, or even when it isn't, by virtue of the manner of mounting the tube the upright position for the tube is not used, but with the new heater type tubes it is entirely practical and permissible to use horizontal mounting, provided the heater prongs are vertical. The tube used is one of the new offerings, a 56, even a better oscillator than the '27, which it otherwise resembles in appearance and performance.

## LIST OF PARTS

### Coils

- One tenth harmonic coil, tapped. Total inductance 20 millihenries, tapped at 5 millihenries
- One 2.5 volt filament transformer (enamel leads are 2.5 volts)

### Condensers

- One 0.00037 mfd. tuning condenser, with compensator built in; shaft  $\frac{3}{8}$ -inch diameter,  $1\frac{1}{8}$  inches long
- One 0.00025 mfd. grid condenser with clips

### Resistor

- One 0.1 meg. pigtail resistor. Solder tails to clips of grid condenser

### Other Requirements

- One UY tube socket
- Two binding posts
- One a-c cable and plug
- One vernier dial, travelling light full-vision type; pilot bracket and lamp; scale calibrated in kilocycles, 50 to 152, with intermediate frequencies imprinted; es-cutcheon.
- One wooden cabinet, one wooden panel and one wooden chassis or base
- Hardware, consisting of nuts and bolts.

It is somewhat smaller in size, however. The circuit diagram shows how simple it is to wire up this test oscillator, since there are only a few connections. The tuning coil used is of the honeycomb type, and can be wound thus within an outside diameter of about 1 inch, even though the inductance is 20 millihenries.

Ordinarily two separate honeycomb coils have been used in the past, but after

special tests it was found that a single tapped coil could be produced with an inductance accuracy of 2 per cent., and therefore the tapped type is recommended.

The coil is so constructed that the tap is off center. There are three lugs, two for extremes of the winding and one lug for the tap. The tap lug is the central one. The question then remains, which

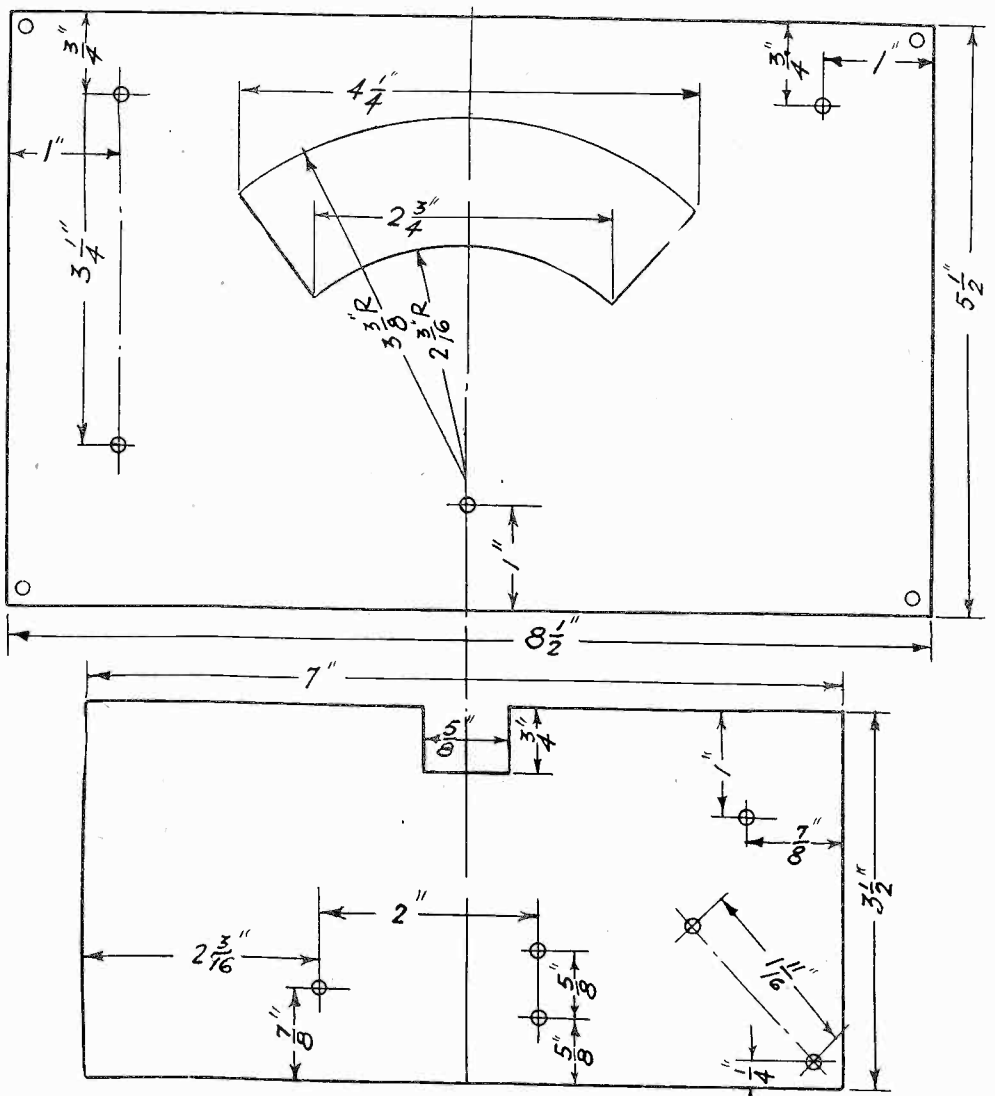

The dimensions of the top panel, with cutout for the dial escutcheon, are given at top, and the data for the wooden chassis are given below. The  $\frac{5}{8}$ -inch slot is to pass the dial bracket, but even so the dial bracket may have to be cut down.

**Internal view of the wired oscillator.** The chassis is to be turned approximately half way around, fitted onto the cabinet and screwed onto the pillars at the four corners. The filament transformer is held by two bolts and nuts. In one instance (upper) the bolt is the shaft of the ground binding post. The output binding post (lug at upper right in photograph) is coupled by its own capacity.

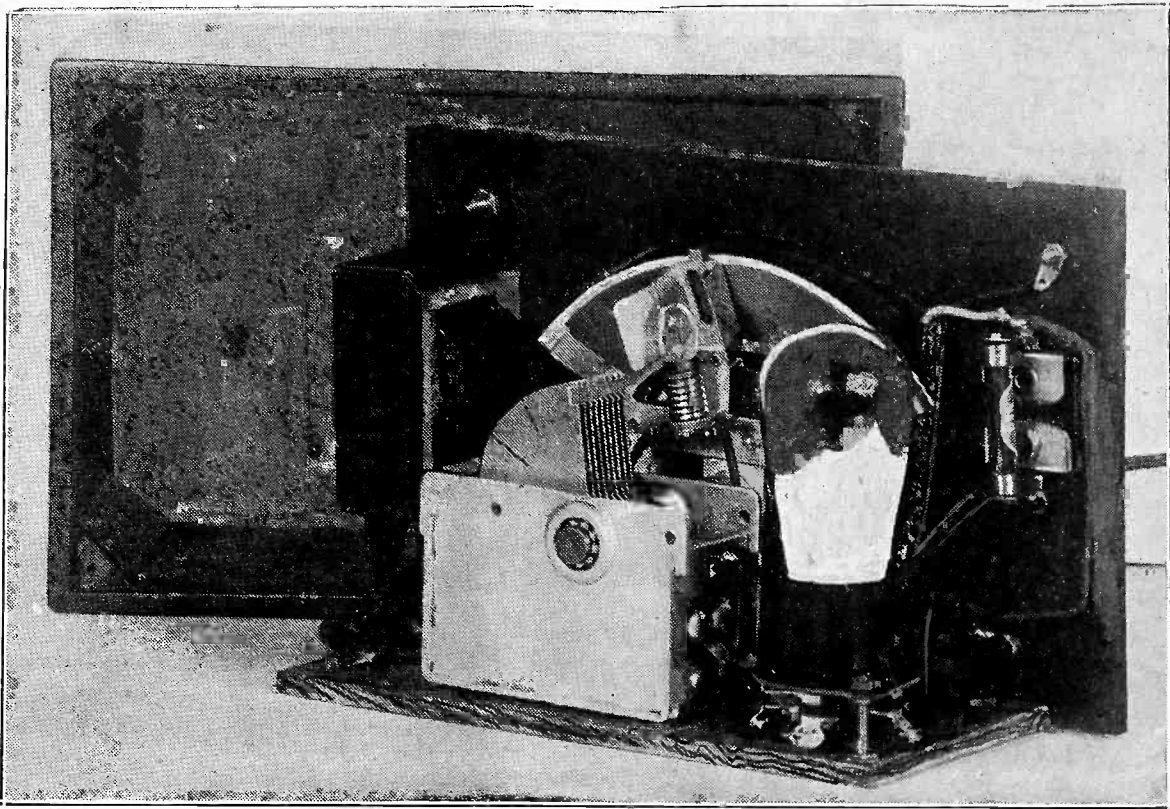

end of the winding goes to grid and which to grid return? The larger part of the inductance is to be between grid and tap, and this is between the end of the winding and the tap. The end can be seen on examination of the coil, for the lead is on the outside, being held fast by binder and brought down to the lug. This goes to grid, hence the other extreme, which may be confirmed by examination as the beginning or inside terminal, goes to grid return. If the coil is held between forefinger and thumb, base on bottom resting on the thumb, tap or central lug toward you, the grid connection is at left, tap at center and grid return at right.

### High Frequency Adjustment

The circuit will give accurate reading at the low frequency end without adjustment, but the capacity of the compensating condenser has to be adjusted for the high frequency end, and allowance has been made for this.

Of course if a numerical dial (0=100 or 100-0) is used, then no adjustment need be made, since you are going to calibrate the scale yourself, and probably draw a curve, frequency against dial setting. How to do this calibration work has been discussed fully in previous issues, including December 17th, 1932, and October 15th, 1932.

However, it is assumed for the present that a scale pre-calibrated in kilocycles will be used, as accurate ones are now obtainable commercially. Then you may select any broadcast station whose frequency is at or near the high frequency end, and adjust the compensator so that you pick up a beat or squeal when using the test oscillator with a broadcast receiver. This is the only adjustment to be made, as the coils are held to their required inductance value in manufacture. Coils with too low inductance are discarded, coils with too high inductance are reduced by removal of turns.

### Output Coupling

The intensity of oscillation is great enough so that for broadcast frequencies it is not necessary to use the coupling (output) binding post, as the radiation provides sufficient coupling. However, any who desire to use this post may do so by connecting a wire thereto and wrapping the other end of the wire a few times around the wire leading to antenna

post of the receiver. No conductive coupling to the antenna is needed, as the capacity between the outlead wire and the aerial is large enough.

For intermediate frequencies it is advisable to use the output post. Preferably connect a wire to it and then hook the bared other end of this wire to the plate spring of the modulator socket, and line up the intermediate channel on that basis. The ear test may be used even on receivers that have automatic volume control.

The other post may be grounded, as it connects only to the core or frame of the filament transformer, but this isn't necessary.

This test oscillator is so simple and effective, and also costs so little, that every experimenter and service man should have one, because work on superheterodynes is almost impossible of complete success without a test oscillator. The accuracy will be found to be 2 per cent. or better, which is entirely satisfactory, and is an improvement on the degree of accuracy previously obtained by using two 800-turn honeycomb coils and adjusting the inductance by moving the coils close together or farther apart.

### Trouble-Shooting

On the score of trouble about the only real one that need be expected is that the high frequency setting can not be made properly, because the tuning does not go high enough. And the only reason for this trouble is that you have mounted the honeycomb oscillation coil with a brass, iron or other metal screw or piece running through the core, and this increased the inductance and decreased the frequency. Therefore putting any metal through the core is taboo. The core has a hole in it that passes a 6/32 machine screw, which may be the temptation, but at the base this may be tapped for 8/32 and a brass or other metal screw only 1/4 inch long may be used for engaging this tapped thread. Put the coil in a vise so that the jaws of the vise engage the large round base of the coil without touching the winding. Then tap lightly and mount the coil as prescribed. This is a better method than hanging the coil on a socket spring.

If instead of pickup squeals you simply hear a guttural growl and the tuning condenser does not seem to change this, the condenser is not properly connected, that

is, either the grid end or rotor or both are not in circuit, or the plates of the condenser are shorted. A distinct squeal should be picked up, clear and loud, and on most stations zero beat can be registered, which means tuning to the squeal and then to that point within the squeal region on the dial for this station that registers no squeal. That is, there is no difference in frequency between the test oscillator's tenth harmonic and the fundamental of the broadcasting station.

### Grid Blocking

If besides the squeals picked up there is a steady whistle or a sound like motor-boating, the grid leak is of too high a value. The cause is grid blocking. The remedy is to use a smaller value of leak. Since the grid condenser is 0.00025 mfd., it was found by experiment that the grid would not block if the resistor were 0.1 meg.

If there is a steady hum, evidently due to vibration, then the core of the filament transformer is loose, and may be tightened by hammering a wedge between the laminations where the opening is obvious. Sometimes simply hitting the laminations with a hammer will so dispose them that the lamination rattle will disappear. A wedge, if used, need not be bulky. A strong lug or two usually will serve the purpose.

The specially calibrated scale has 1 kc separation registered from 50 to 80 and 2 kc registered from 80 to 152 kc, so that for broadcast use the equivalent separation (tenth harmonic) is 10 kc from 500 to 800 kc and 20 kc from 80 to 1520 kc. However, it is practical to set the dial in the center of two of the 20 kc separation bars for any desired 10 kc setting, except at the very high frequency end.

The intermediate frequencies are imprinted on the scale. There is then no need to concern one's self with which harmonic is being used, and that is true also of the broadcast band, by the way. For 175 kc simply set the test oscillator at the bar registered for 175, or for 1400 kc set the test oscillator at the bar registered for 140.

Since the fundamental range is 50 to 152 kc, any frequency within that range may be tested, and this includes the old superheterodynes with intermediate frequency around 70 kc (Victoreen, Magnaformer, etc.)

—Herman Bernard.

# TEST OSCILLATOR CONSTRUCTION

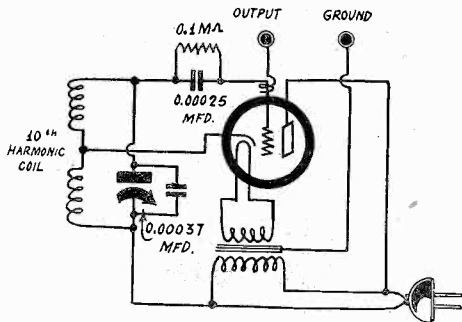

The circuit diagram of the modulated test oscillator. The output coupling is obtained by the capacity between parallel leads, one of which is the wire from grid of socket to grid condenser, and the other the wire that terminates at the output binding post. There is no conductive coupling at the other end of the output wire.

THE constructional details for building a modulated test oscillator, covering the broadcast band and all the commercially used intermediate frequencies, are given herewith on the basis of utmost compactness. The circuit is the modification of the Hartley oscillator as devised by E. M. Shiepe, and a-c is used on the plate. This of course introduces the line frequency as modulation, approximately 100 per cent. The oscillation level is high and the coupling is therefore excellent even at the lowest frequency.

The fundamental frequencies of oscillation, using a 0.00037 mfd. single condenser with compensator built in, and a "tenth harmonic" coil, will be from 152 to 50 kc, therefore the broadcast band is covered by cipher annexation, using the tenth harmonic, and a frequency-calibrated dial will read directly in terms of the fundamental and indirectly (by the cipher annex) for the broadcast band, while two intermediate frequencies, 115 and 130 kc., will be on the fundamental scale, another, 260 kc., will be a second harmonic, and the remaining intermediate frequencies third harmonics. All the popular intermediate frequencies are encompassed by the following: 115, 130, 172.5, 175, 177.5, 260, 400 and 450 kc.

## Sizes Given

The overall size of the wooden cabinet is 9 inches wide by 5 15/16 inches front to back by 4 3/4 inches high, the height including the mounting feet. The panel is 8.5 x 5.5 inches, and is cut out for the traveling light full-vision dial.

The dimensions for the chassis are given in a drawing, and also the view of the completed test oscillator is shown in a photograph. When the test oscillator is in use, or even when it isn't, by virtue of the manner of mounting the tube the upright position for the tube is not used, but with the new heater type tubes it is entirely practical and permissible to use horizontal mounting, provided the heater prongs are vertical. The tube used is one of the new offerings, a 56, even a better oscillator than the '27, which it otherwise resembles in appearance and performance.

## LIST OF PARTS

### Coils

- One tenth harmonic coil, tapped. Total inductance 20 millihenries, tapped at 5 millihenries
- One 2.5 volt filament transformer (enamel leads are 2.5 volts)

### Condensers

- One 0.00037 mfd. tuning condenser, with compensator built in; shaft 3/8-inch diameter, 1 1/8 inches long
- One 0.00025 mfd. grid condenser with clips

### Resistor

- One 0.1 meg. pigtail resistor. Solder tails to clips of grid condenser

### Other Requirements

- One UY tube socket
- Two binding posts
- One a-c cable and plug
- One vernier dial, travelling light full-vision type; pilot bracket and lamp; scale calibrated in kilocycles, 50 to 152, with intermediate frequencies imprinted; escutcheon.
- One wooden cabinet, one wooden panel and one wooden chassis or base
- Hardware, consisting of nuts and bolts.

It is somewhat smaller in size, however. The circuit diagram shows how simple it is to wire up this test oscillator, since there are only a few connections. The tuning coil used is of the honeycomb type, and can be wound thus within an outside diameter of about 1 inch, even though the inductance is 20 millihenries.

Ordinarily two separate honeycomb coils have been used in the past, but after

special tests it was found that a single tapped coil could be produced with an inductance accuracy of 2 per cent., and therefore the tapped type is recommended.

The coil is so constructed that the tap is off center. There are three lugs, two for extremes of the winding and one lug for the tap. The tap lug is the central one. The question then remains, which

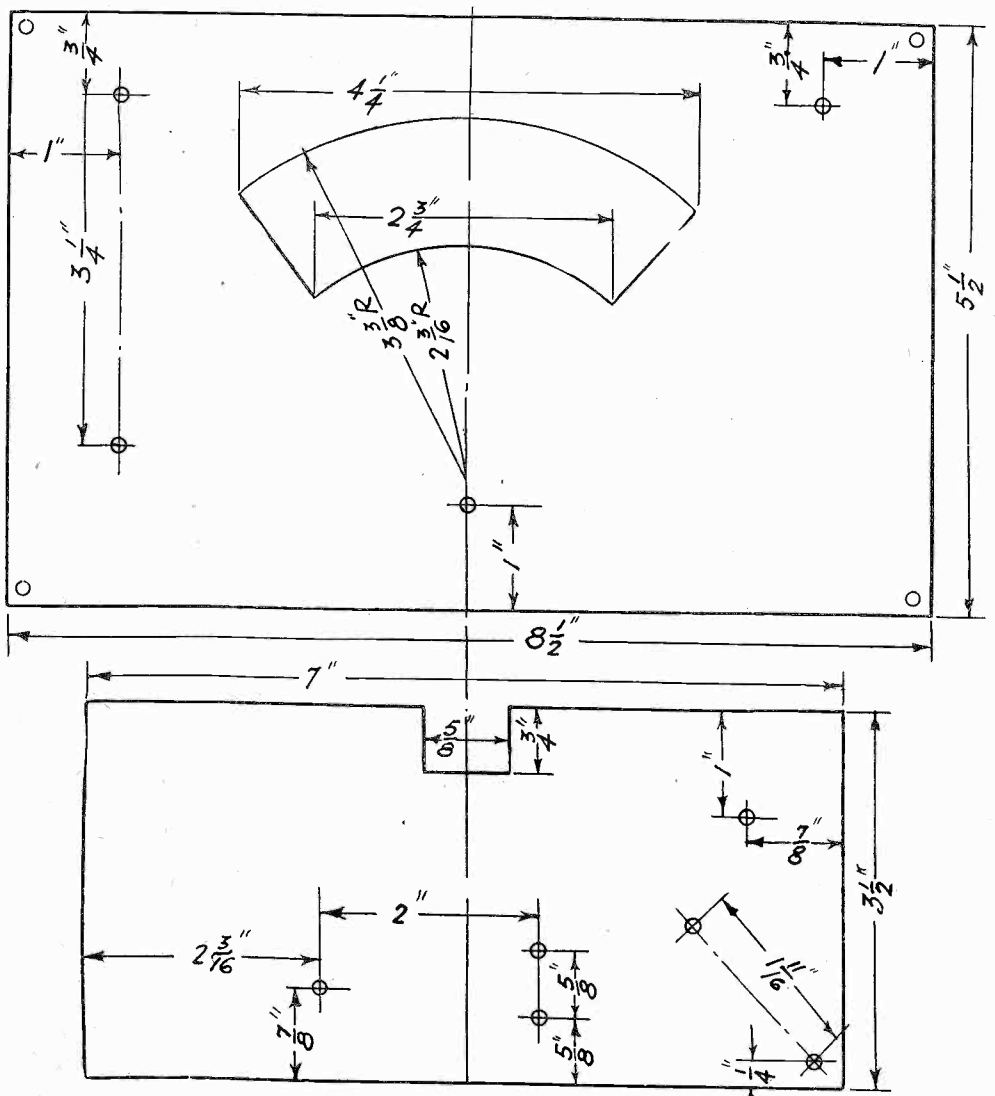

The dimensions of the top panel, with cutout for the dial escutcheon, are given at top, and the data for the wooden chassis are given below. The 5/8-inch slot is to pass the dial bracket, but even so the dial bracket may have to be cut down.



**Internal view of the wired oscillator. The chassis is to be turned approximately half way around, fitted onto the cabinet and screwed onto the pillars at the four corners. The filament transformer is held by two bolts and nuts. In one instance (upper) the bolt is the shaft of the ground binding post. The output binding post (lug at upper right in photograph) is coupled by its own capacity.**

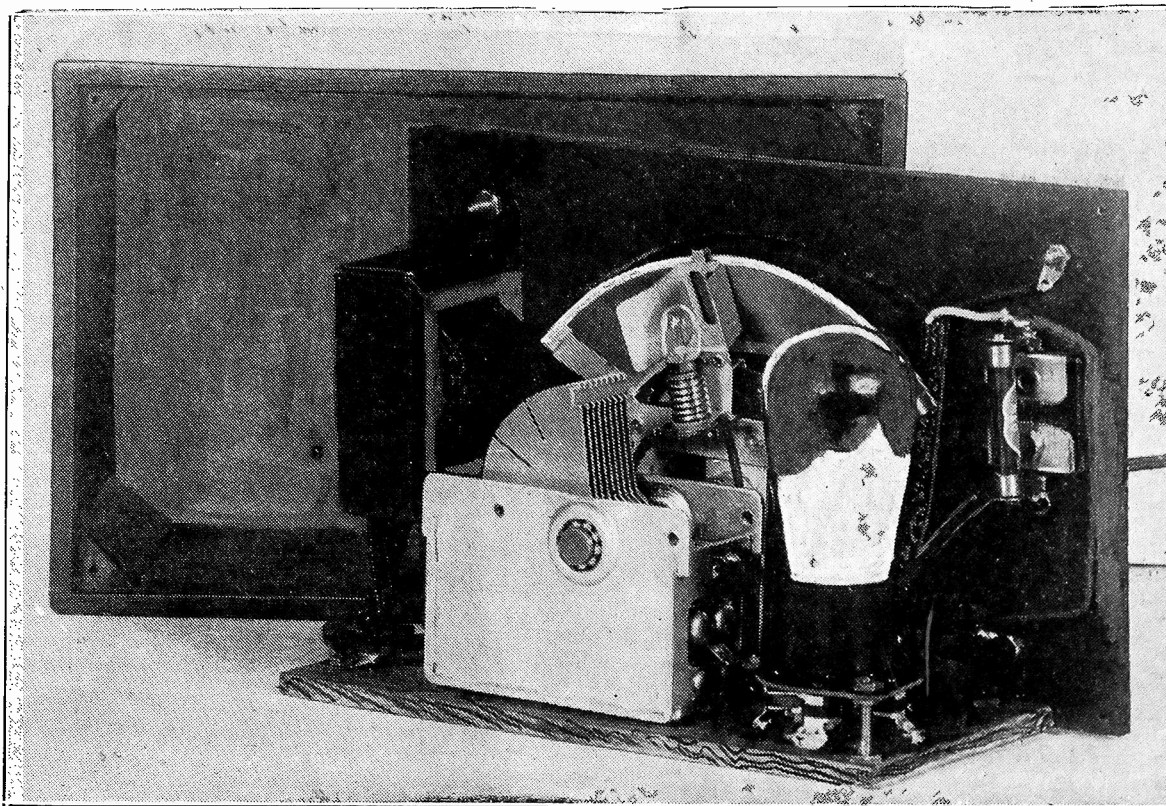

end of the winding goes to grid and which to grid return? The larger part of the inductance is to be between grid and tap, and this is between the end of the winding and the tap. The end can be seen on examination of the coil, for the lead is on the outside, being held fast by binder and brought down to the lug. This goes to grid, hence the other extreme, which may be confirmed by examination as the beginning or inside terminal, goes to grid return. If the coil is held between forefinger and thumb, base on bottom resting on the thumb, tap or central lug toward you, the grid connection is at left, tap at center and grid return at right.

### High Frequency Adjustment

The circuit will give accurate reading at the low frequency end without adjustment, but the capacity of the compensating condenser has to be adjusted for the high frequency end, and allowance has been made for this.

Of course if a numerical dial (0=100 or 100-0) is used, then no adjustment need be made, since you are going to calibrate the scale yourself, and probably draw a curve, frequency against dial setting. How to do this calibration work has been discussed fully in previous issues, including December 17th, 1932, and October 15th, 1932.

However, it is assumed for the present that a scale pre-calibrated in kilocycles will be used, as accurate ones are now obtainable commercially. Then you may select any broadcast station whose frequency is at or near the high frequency end, and adjust the compensator so that you pick up a beat or squeal when using the test oscillator with a broadcast receiver. This is the only adjustment to be made, as the coils are held to their required inductance value in manufacture. Coils with too low inductance are discarded, coils with too high inductance are reduced by removal of turns.

### Output Coupling

The intensity of oscillation is great enough so that for broadcast frequencies it is not necessary to use the coupling (output) binding post, as the radiation provides sufficient coupling. However, any who desire to use this post may do so by connecting a wire thereto and wrapping the other end of the wire a few times around the wire leading to antenna

post of the receiver. No conductive coupling to the antenna is needed, as the capacity between the outlead wire and the aerial is large enough.

For intermediate frequencies it is advisable to use the output post. Preferably connect a wire to it and then hook the bared other end of this wire to the plate spring of the modulator socket, and line up the intermediate channel on that basis. The ear test may be used even on receivers that have automatic volume control.

The other post may be grounded, as it connects only to the core or frame of the filament transformer, but this isn't necessary.

This test oscillator is so simple and effective, and also costs so little, that every experimenter and service man should have one, because work on superheterodynes is almost impossible of complete success without a test oscillator. The accuracy will be found to be 2 per cent. or better, which is entirely satisfactory, and is an improvement on the degree of accuracy previously obtained by using two 800-turn honeycomb coils and adjusting the inductance by moving the coils close together or farther apart.

### Trouble-Shooting

On the score of trouble about the only real one that need be expected is that the high frequency setting can not be made properly, because the tuning does not go high enough. And the only reason for this trouble is that you have mounted the honeycomb oscillation coil with a brass, iron or other metal screw or piece running through the core, and this increased the inductance and decreased the frequency. Therefore putting any metal through the core is taboo. The core has a hole in it that passes a 6/32 machine screw, which may be the temptation, but at the base this may be tapped for 8/32 and a brass or other metal screw only 1/4 inch long may be used for engaging this tapped thread. Put the coil in a vise so that the jaws of the vise engage the large round base of the coil without touching the winding. Then tap lightly and mount the coil as prescribed. This is a better method than hanging the coil on a socket spring.

If instead of pickup squeals you simply hear a guttural growl and the tuning condenser does not seem to change this, the condenser is not properly connected, that

is, either the grid end or rotor or both are not in circuit, or the plates of the condenser are shorted. A distinct squeal should be picked up, clear and loud, and on most stations zero beat can be registered, which means tuning to the squeal and then to that point within the squeal region on the dial for this station that registers no squeal. That is, there is no difference in frequency between the test oscillator's tenth harmonic and the fundamental of the broadcasting station.

### Grid Blocking

If besides the squeals picked up there is a steady whistle or a sound like motor-boating, the grid leak is of too high a value. The cause is grid blocking. The remedy is to use a smaller value of leak. Since the grid condenser is 0.00025 mfd., it was found by experiment that the grid would not block if the resistor were 0.1 meg.

If there is a steady hum, evidently due to vibration, then the core of the filament transformer is loose, and may be tightened by hammering a wedge between the laminations where the opening is obvious. Sometimes simply hitting the laminations with a hammer will so dispose them that the lamination rattle will disappear. A wedge, if used, need not be bulky. A strong lug or two usually will serve the purpose.

The specially calibrated scale has 1 kc separation registered from 50 to 80 and 2 kc registered from 80 to 152 kc, so that for broadcast use the equivalent separation (tenth harmonic) is 10 kc from 500 to 800 kc and 20 kc from 80 to 1520 kc. However, it is practical to set the dial in the center of two of the 20 kc separation bars for any desired 10 kc setting, except at the very high frequency end.

The intermediate frequencies are imprinted on the scale. There is then no need to concern one's self with which harmonic is being used, and that is true also of the broadcast band, by the way. For 175 kc simply set the test oscillator at the bar registered for 175, or for 1400 kc set the test oscillator at the bar registered for 140.

Since the fundamental range is 50 to 152 kc, any frequency within that range may be tested, and this includes the old superheterodynes with intermediate frequency around 70 kc (Victoreen, Magnaformer, etc.)

—Herman Bernard.

# THE LATEST METHODS

## Delayed A.V.C. and N.S.C. Examined

By Einar Andrews

RECENTLY we have had many new devices and circuit arrangements in radio. Diode detection has returned. We also have automatic volume control, noise suppression control, automatic volume control delay, and automatic tone control.

Just what are these devices? What purpose do they serve? Are sets better with them than without them?

Diode detection, of course, is not new, for it is older than the three-element vacuum tube. But the application of it now is new, especially when it is used in full-wave detection. With diode detection the tube functions only as a rectifier, just the same as the rectifier in the B supply. Detection partly occurs in the filter and load resistance associated with the rectifier. If the signal were steady, that is, unmodulated, there would be no detection, only rectification, as in the case of the B supply rectifier. When the signal is modulated or for any other reason varies, the rectified current varies with the variation in the carrier, and that variation is the audio component. In one sense there is nothing at all new about the diode detector, for the grid leak and condenser detector was nothing but a diode, the grid leak being the load resistance and the grid condenser the filter. The tube also functions as an amplifier. The improvement is due to the fact that the extra elements made it possible to use a much higher plate voltage and thus to prevent distortion and overloading on strong signals.

### A. V. C.

Automatic volume control is not strictly new either, for it has been used a few years. But the introduction of the duplex diode triode made automatic volume control simpler to apply and more practical.

The function of the a.v.c., of course, is to hold the output voltage constant regardless of the intensity of the strength of the signal at the antenna. From the nature of the a.v.c. it is not possible to hold the signal constant absolutely for the signal must increase before the a.v.c. can take greater effect. But it is an automatic check on the amplification. To expect complete automatic volume control, that is to say, complete leveling of the output regardless of the intensity of the signal at the antenna would be the same as expecting one to lift himself by the bootstraps. Perhaps that is not the best analogy, but the point is that it is not possible for the signal to hold itself constant.

Circuits have been suggested for making the effect so great that the net variation is extremely small. This is brought about by amplifying the d-c voltage used for a.v.c. before it is applied to the controlled tubes. If this voltage is amplified by a factor of 10, for example, the total variation in the output as a result of a given variation in the input signal is reduced in the ratio of 10 to one. When this scheme is used the triode part of the rectifier is employed as a d-c amplifier as well as an a-f amplifier.

### Noise Suppression Control

In a circuit equipped with an a.v.c. the sensitivity rises to maximum value when there is no carrier impressed on the diode because then the a.v.c. voltage is least. This causes a strong rise in the amount of noise in the output of the set. Indeed, there is nothing but noise, some originating in the receiver and some outside of it. The presence of noise makes operation of a set unpleasant, not because the set is noisy when

a strong station is tuned in, but because it is noisy on weak stations and on no stations at all. It is mainly noisy while tuning from one station to another.

In order to overcome the interchannel noise, the noise suppression device has been introduced. This operates so that when there is no carrier the audio amplifier is inoperative. The voltage developed across the diode load resistance is amplified by the triode part of the tube and the amplified voltage is used to bias one audio tube, called the noise suppression tube. The amplification of the d-c voltage reverses the phase of the voltage so that when the diode d-c voltage is greatest the negative voltage on the n.s.c. tube is least and the tube amplifies the audio signal, and when the diode d-c voltage is least the bias on the n.s.c. tube is greatest, and so great that the tube does not function at all. Thus the noise between stations is cut out.

A noise suppression control could be used on a set not provided with a.v.c., for the two are independent, but there would be little object of using it without the a.v.c.

### A. V. C. Delay

The a.v.c. delay is quite new. The term delay is not a good one for it has nothing to do with time. It would be more logical to call it an a.v.c. handicap, the handicap being measured in volts. We would be tempted to call it a.v.c. bias, but that would be confusing with the a.v.c. voltage itself, which is used as bias. The "delay" voltage is really a bias on the bias and therefore the term handicap seems appropriate. It might also be termed an a.v.c. limiting voltage.

Just what is the "delay?" Well, suppose the signal voltage at the antenna is such that it develops a voltage of 5 volts in the diode load resistance. If the handicap is 5 volts there would be no automatic volume control for lower signal voltages on the antenna but there would be for all higher voltages, and in proportion to the excess. The handicap can be given any desired value, and voltages as high as 50 volts have been recommended. That means 50 volts as referred to the voltage developed across the diode load resistance and not 50 volts in the antenna, for a voltage of 50 volts in the antenna would never be encountered.

It is claimed that the degree of leveling of the volume output is more nearly complete the higher the handicap on the a.v.c. The idea might be carried still further by making the handicap infinite, or 500 volts, at any rate. That would certainly level out completely all voltages that exceeded that value. That is a case of *reductio ad absurdum*. Spoofing aside, the idea has its merits. For example, we might select such values that only noise free stations would be subject to a.v.c. and then put in a noise suppression circuit such that it would cut out all the noise, including the signals below the noise level.

Another way of accomplishing about the same thing is to build a less sensitive and less costly set, eliminating all these fancy contraptions and a good many of the tubes, or if the same number of tubes must be used, to make all of them less efficient.

### Automatic Tone Control

The automatic tone control, which may also be called an automatic selectivity control, seems to have some merits in fact. The idea of it is so to arrange the circuit that the selectivity of the set becomes low on strong local signals and high on weak, dis-

tant signals. Thus the quality would be excellent on the local stations and no worse than absolutely necessary on the distant ones. That is surely as it should be.

But no set worthy of all these new devices would be complete without a manual tone control. There must be something by which the operator may spoil the excellent signals from the local stations. It would not do to shackle his freedom of choice of quality. In a free country it is unreasonable to put any constraint of this nature on an individual. And we may be sure that he will not abuse his privilege. The man who prefers nothing but the bass notes will not enter the other man's drawing room and tamper with his set, and if he himself prefers all bass and no treble, that is his concern. Moreover, there are times when bassy signals are really preferable. They have a soothing quality not possessed by signals that contain all the sparkle inherent in the original.

### Of What Use?

Well, are these new contrivances worth while in a receiver? Some of them are all the time. All of them are some of the time. Diode detection is decidedly worth while where quality of reproduction is one of the main objects of the receiver. Automatic volume control is certainly essential in an automobile, or any mobile, receiver. It is also highly desirable in any receiver that is regularly used in receiving stations in the fading zone, or any distant stations. Even in some cases of local reception there is a fluctuation in the signals that would be remedied by an automatic volume control.

A noise suppression control is a desirable feature in a receiver that is to be used regularly in receiving weak distant stations, when that receiver is equipped with an automatic volume control, but not in a receiver without an a.v.c. What is most needed is not a noise suppression control but a noise remover, a device that removes noise completely on all stations. And it should not cost more than five cents. While we are waiting for that key to the DX Utopia let us stick to the automatic noise suppression control when it is really needed.

An automatic volume control "delay" seems to be a denial of the need of a.v.c. If the "delay" is limited so that it will prevent the a.v.c. from taking effect on the weakest signals it may be all right, for it would tend to make the receiver more sensitive on those stations. This might be an advantage when the noise level is extremely low. And if it levels the output more thoroughly than the "undelayed" a.v.c. it might also help out considerably on all fading signals.

If the automatic tone control works, it might be a desirable addition to a fancy receiver, especially in view of the fact that it costs practically nothing to add it to the set. This device works on the principle that the selectivity of a tuned circuit is less the lower the resistance of the plate to which it is connected. This is true whether the primary connected to the plate is tuned or untuned, just so one or both the windings are tuned. The resistance in the plate circuit is varied by varying the suppressor voltage on the tube. The more negative this is the less the plate resistance. The less the plate resistance, the better the high frequency audio notes come through.

It would seem that the simplest way to apply automatic tone control would be to connect the suppressor grid to the a.v.c. voltage, for the voltage on the suppressor grid would then vary in the right direction.

### MICROPHONE INPUT

### SMALL SET IN EMPIRE STATE CABINET

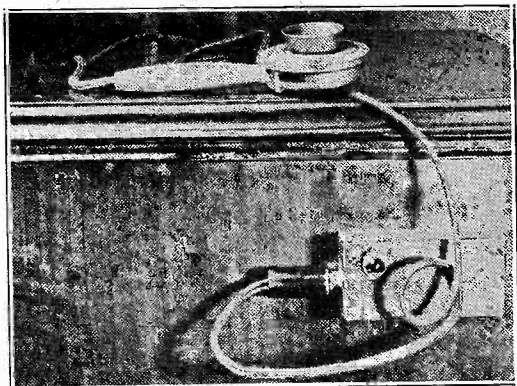

It is convenient to have a microphone jack on the side of the console, in case you want to use any of the currently popular low-priced microphones in conjunction with the audio amplifier of your receiver. The jack also can work a pilot lamp, which is fed from the 2.5 volts a. c. of the receiver, so the lamp glows when the microphone is in circuit. The microphone transformer would be inside the console.

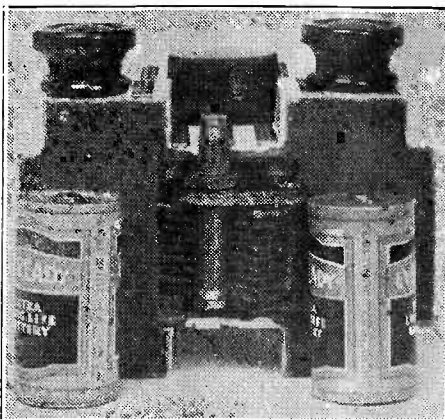

A few parts such as these were put together to constitute a small battery-operated receiver, housed in a cabinet that followed the lines of the Empire State Building, the tallest building in the world. This cabinet was made of wood by an experimenter as a Christmas present to his little son. The view shown is that of the wired set removed from cabinet shown at right.

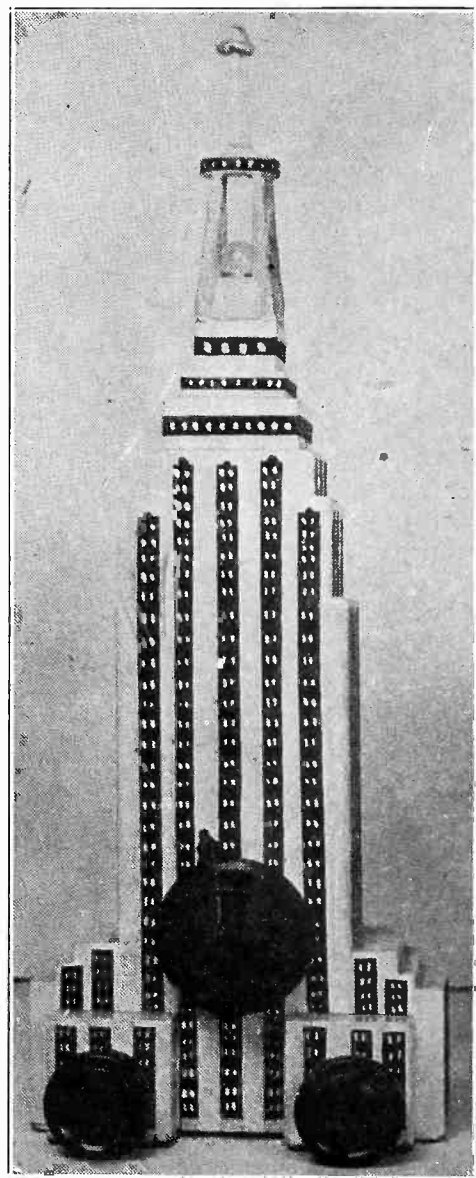

Front view of the cabinet modelled after the Empire State Building. At top an indicator pendant was placed, upside down, as it were, so that the blimp anchorage of the building was simulated, and also so that the radium coating of the indicator would cause the top to glow in a dark room. A pilot lamp of the usual type was inside, and when the set was turned on caused the paper windows of the building to light up.

### LAYOUT FOR INDUCTANCE OR RESISTOR SLIDER

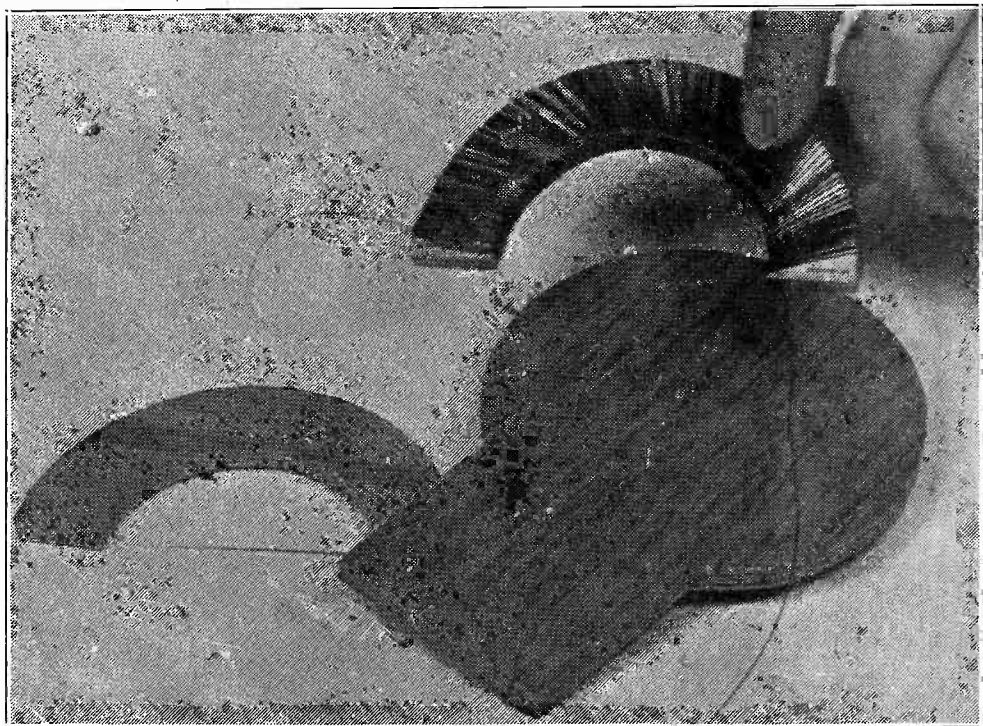

If one desires to make a loading coil or a variable resistance he may do it, using parts as shown. A moving arm travels over the wire. In the case of the inductance coil about 50 feet of No. 30 enamel wire would be used, and to provide contact the enamel insulation would be scraped off along the arc of the arm's travel. For a resistance the wire might be nichrome and hence uninsulated, but the turns should be far enough apart to prevent them from touching adjacent ones.

### FLEXIBILITY OF CONDENSER MOUNTING

Sometimes one runs across a drilled chassis that has holes that do not coincide exactly with those required by a given gang condenser one has on hand. If small right-angle brackets are used they may be so pointed, toward the front or rear, as to pick up two or more of the holes, usually. The anchorage at front is firm enough due to the dial being bracketed to the chassis and engaging the condenser shaft. See illustration at right.

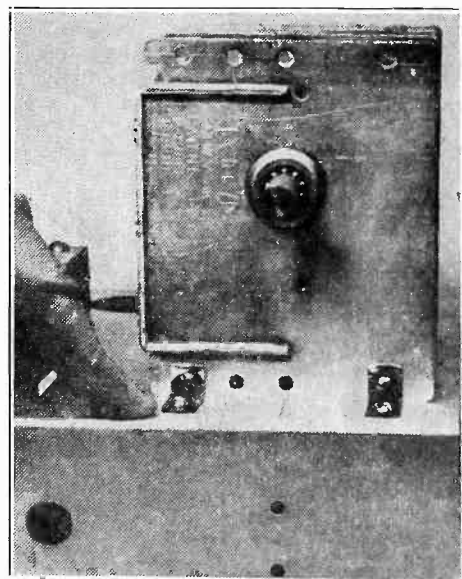



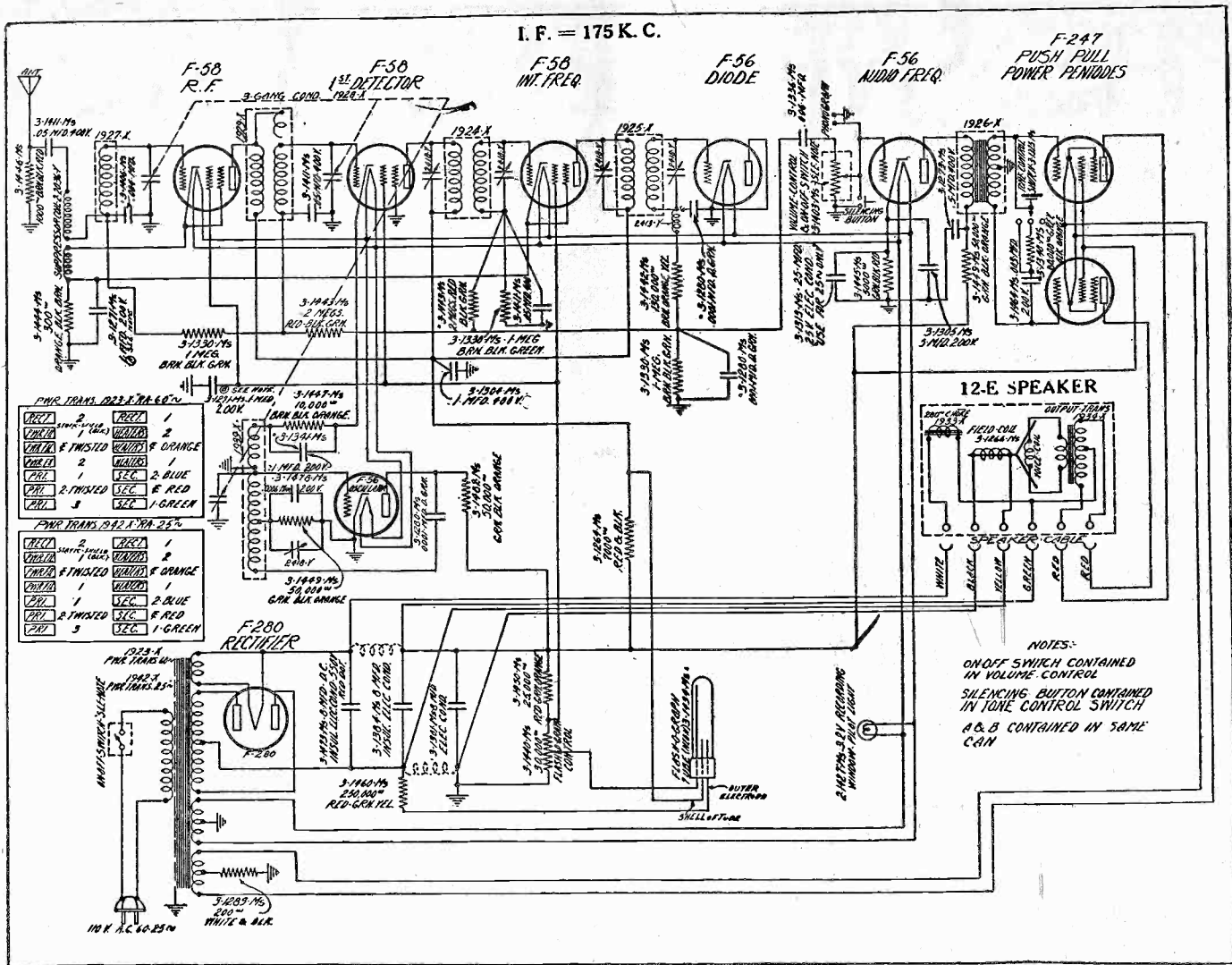

The circuit diagram of the Fada LR.

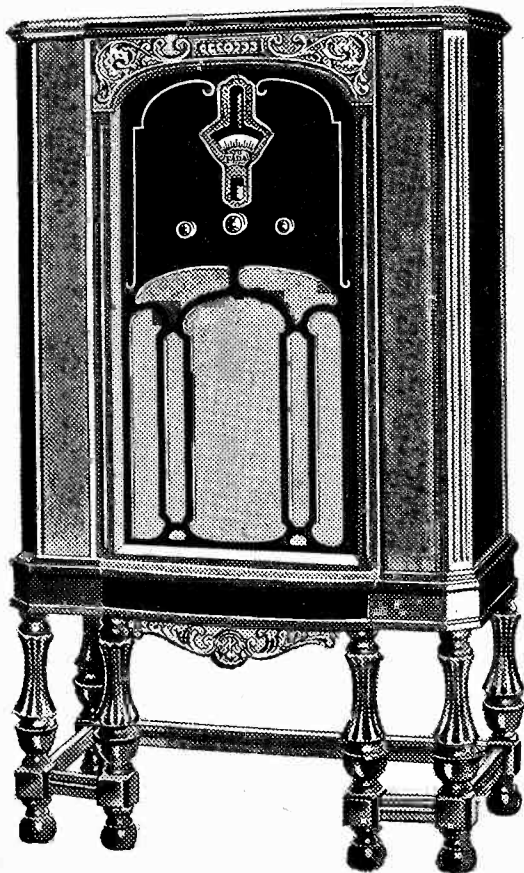

The front view of the console of the Model 97 Fada receiver. The chassis used is the RA.

(Continued from preceding page)  
meter. Do not disturb the setting of the gang condenser during these operations. Leave the volume control on full and regulate the signal output with the attenuator control of the signal generator.

**Adjustment of Oscillator Series Condensers**

The oscillator series condensers can be adjusted through the hole in the rear right hand corner of chassis (see sketch).

1st—Adjust the carrier frequency output of the signal generator to 600 kc.

2nd—Set the calibrated dial of the receiver to read 600 kc.

3rd—With the aid of a No. 4 socket wrench adjust the oscillator series condenser until a maximum output signal is indicated on the output meter. To insure perfect adjustment it is necessary to "rock" the gang variable condenser in order to follow the maximum signal output.

4th—After the oscillator series condenser is properly adjusted, turn the calibrated dial of the receiver to 1400 kc and adjust the signal generator to the same frequency, then readjust all variable condenser compensators as outlined in the foregoing instructions.

**Phonograph Pick-Up**

There is a provision for a phonograph pick-up in the grid circuit of the first audio tube. One side of the phonograph pick-up is connected to the grid and the other is grounded. There is also a provision for short-circuiting the effective portion of the manual volume control potentiometer so that no radio signals can come through to interfere with the phonograph music. The silencing switch, as it is called, is located in the tone control switch.

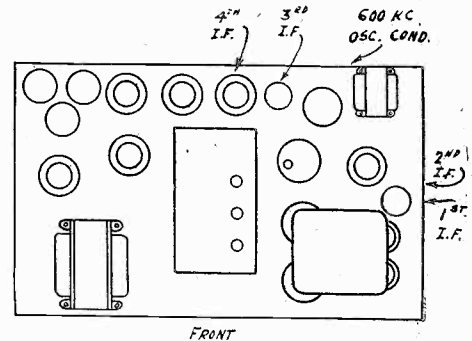

Sketch locating parts for adjustment of the LR chassis.

The tone control is located in the grid circuit of the push-pull output stage. It gives a choice of three different tone ranges. In one position of the switch there is no shunt across the secondary and the highest audio notes can come through. In the second position there is a condenser-resistor combination across the secondary, and this gives a medium tone range. In the third position only the condenser is across the secondary, and in this the high audio notes are cut out the most.

The circuit uses the nine tubes to full advantage and shows every evidence of the highest type of engineering.

\*\*\*

[ See striking views of chassis on following two pages. ]



# NEW FADA CHASSIS

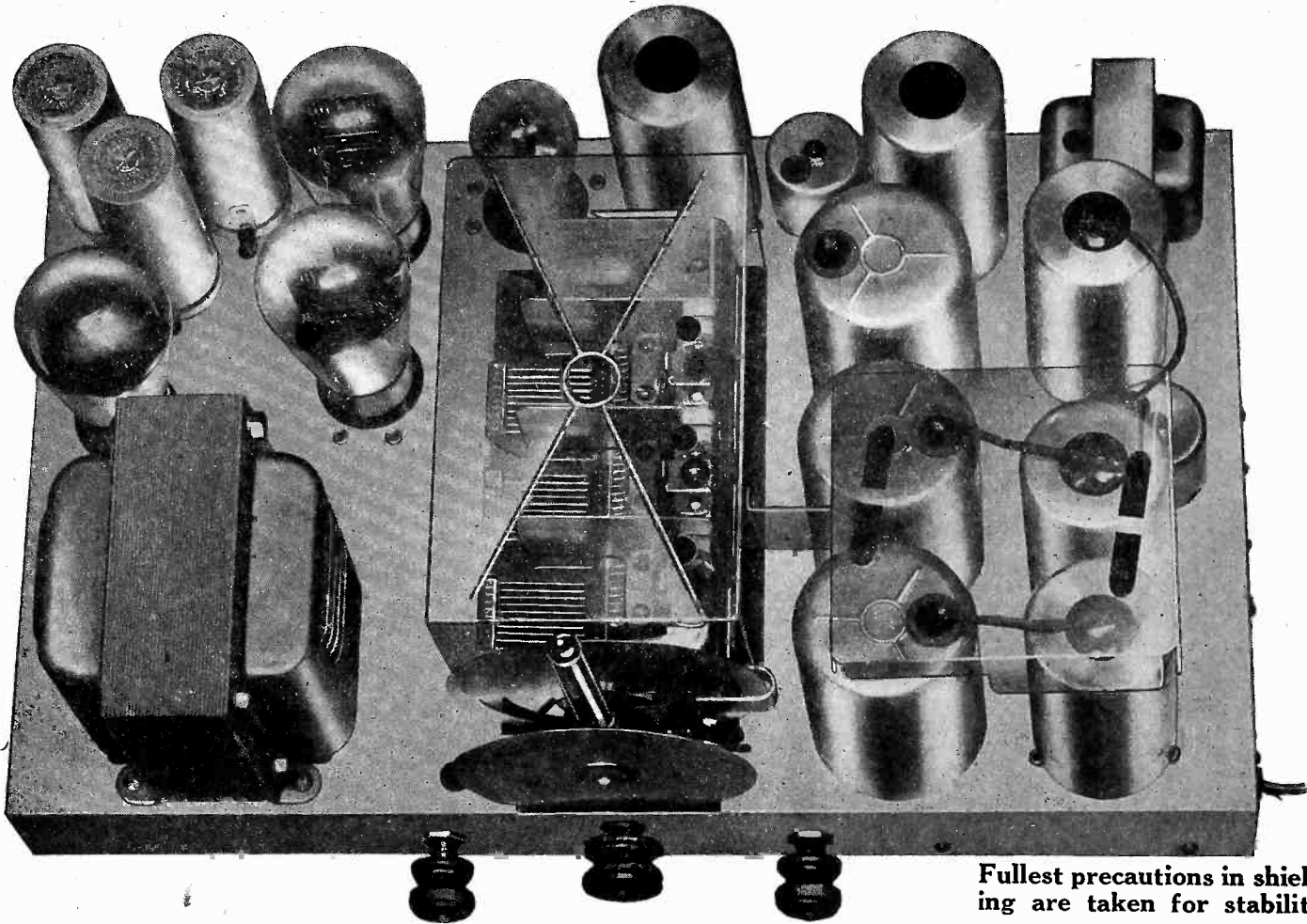

Fulllest precautions in shielding are taken for stability.

## Suppressor Grid Circuit Novelties

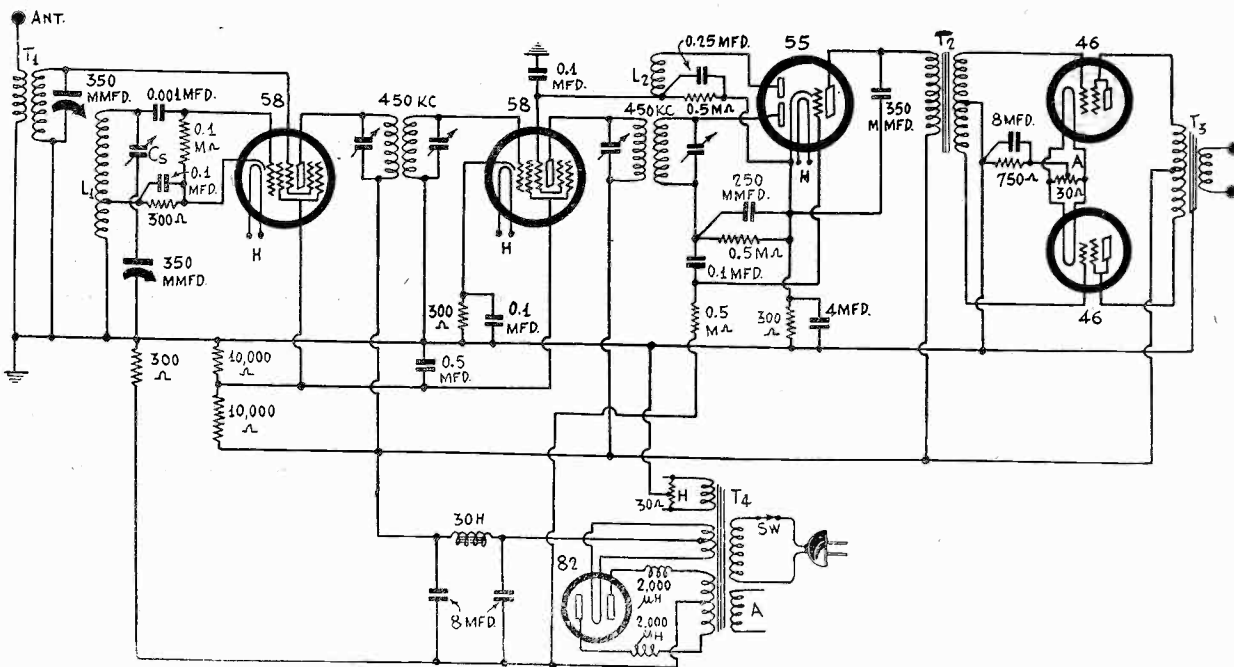

This is the circuit diagram of a six-tube set that uses suppressors in an unusual manner. The first tube's suppressor is the oscillation input, while signal is delivered to the control grid as usual. Cs is the padding condenser. This tube is therefore an autodyne, or combination modulator-oscillator. The 55 is used both as single-sided detector and automatic selectivity control. The suppressor voltage on the preceding 58 is determined by the current through the 0.5 meg. resistor on the upper anode circuit of the 55. The output tubes are Class A push-pull.





## LIST OF PARTS

### Coils

Two shielded radio frequency transformers for 0.00037 mfd. condensers.

One combination oscillator and 175 kc first intermediate transformer, in a single high shield.

One 175 kc intermediate transformer, with center-tapped secondary.

[The intermediate frequency coils have both primary and secondary tuned.]

One power transformer, primary, 105-120 volts, 50-60 cycles; secondaries, 5 volts, 2 amperes; 700 volts center-tapped, 60 ma; 2.5 volts, 7 amperes.

One dynamic speaker, with 1,800 ohm field tapped at 300 ohms, and with output transformer for 59 tube used as pentode built in; equipped with 18-inch cable and UY plug.

### Condensers

One three-gang 0.00037 mfd. tuning condenser with trimmers built in;  $\frac{3}{8}$  shaft  $1\frac{1}{4}$  inches long, mounting spaces built in on the short side.

Two 0.002 mfd. fixed condensers mica.

One 700-1,000 mmfd. padding condenser.

One 20-100 mmfd. equalizing condenser, to be used as a vernier on for the padding condenser.

One shielded block containing three 0.1 mfd. condensers.

Three 0.00025 mfd. fixed mica condensers.

One 0.01 mfd. fixed mica condenser.

Two 8 mfd. wet electrolytic condensers, inverted mounting type; two insulating washers and extra lug for one of them; nuts for both of them; peak voltage rating 435 volts d-c.

### Resistors

Two 350-ohm pigtail resistors.

One 3,500-ohm pigtail resistor.

Two 0.05 meg. (50000-ohm) pigtail resistors.

One 2 meg. (2000000-ohm) pigtail resistor.

One 5 meg. (5000000-ohm) pigtail resistor.

One 20-potentiometer.

One 250000-ohm potentiometer, insulated shaft type.

### Other Requirements

Seven socket insulating wafers and seven sockets as follows: four six-spring; one seven-spring; one four-spring; one five-spring; (U.Y.). The UY socket is for speaker plug.

One vernier dial, travelling light type, equipped with pilot bracket, lamp and escutcheon. One drilled chassis. Four tube shields. One a-c shaft type switch. Three knobs.

mediate channel is lined up by adjusting the four set-screw condensers, two on each coil, for primary and secondary are tuned in each instance. One may determine resonance by maximum response by ear alone, as the automatic volume control is not so effective as to defeat this method of line-up. If one has an output meter of course he will use that, especially if the test oscillator is of the modulated type.

As for the padding, while much general advice has been given on this subject, the present instructions have to do with this receiver alone, and dial settings will be taken as examples.

### Padding Reduced to Practice

Assuming specified coils and condensers, the trimmers on the r-f and modulator input coils should be at minimum, while the trimmer on the oscillator tuning condenser should be about half way in, or a little more. You may screw down the oscillator trimmer all the way, then turn back one complete revolution.

Turn the dial to 98 and feed a test oscil-

lator frequency of 540 kc into the antenna post, or, if that isn't within scope, tune in to receive a station at 540 kc. The station may be not be heard, for the padding condenser, Cp, has not been adjusted. Now, using an insulated screwdriver, start from nearly minimum capacity and keep on turning the padding condenser to higher capacity until the station is heard, which will be near maximum capacity of the usual 700-1,000 mmfd. padders. If the volume begins to increase, but does not come up sufficiently by the time maximum capacity of the padding condenser is in circuit, then put a smaller trimmer (20-100 mmfd.) across the padding condenser, turn out the padding condenser one turn, and then adjust this trimmer. The circuit diagram shows this trimmer across the padding condenser Cp.

### 600 and 1450 kc Points

Now a start has been made. The circuit has been tentatively padded for the lowest frequency end, for at this end the padding condenser is most effective, the trimming condensers least effective, whereas at the high frequency end the padding condenser is least effective and the trimming condensers most effective.

The tie-down points are a function of the oscillator's tuned inductance, and these points (limiting them to three) are 600, 990 and 1,450 kc. So now set the test oscillator at 600 kc and tune in the modulation to maximum strength, using the receiver dial. Make any readjustment of the padding condenser that circumstances require. This readjustment will be slight.

Now turn to 11 on the set dial and adjust the test oscillator to 1,450 kc. The sensitivity may be low, denoted by response much weaker than at the other extreme, but the circuit at this end has not been lined up. Adjust the trimmer on the oscillator until the signal comes in loudest. It may be necessary to turn down the oscillator trimmer nearly all the way.

Next adjust the trimmer across the first section only of the condenser, front to back. The oscillator section is at rear. No radio frequency level oscillation need be expected.

### Stop at 1520 kc

Now turn the dial to less capacity, and by checking with the test oscillator, determine how high in frequency the circuit tunes. There are some police stations between 1,710 and 1,560 kc, and you may be able to tune to one or two police channels at the low extreme of their span, possibly tuning to 1,580 kc. This is one reason why r-f squealing may set in, say, above 1,500 kc, but the oscillator circuit should be trimmed so that 1520 kc is not exceeded.

If the circuit is padded for police calls, the oscillator and r-f sections probably are not tracking, and this would be confirmed by squealing in the high frequency tuning, associated only with carriers tuned in.

High frequencies at relatively high numerical settings of the dial need not cause alarm. They are due to the very small change in capacity from 11 to zero on the dial.

So that the above directions shall hold true, the dial should be affixed to the condenser with the 100th division representing maximum capacity, whereupon minimum capacity setting may result in slightly less than 0 dial reading. The dial should not be set at first with condenser minimum representing zero, although by the other and recommended procedure it may turn out to be zero nevertheless.

### Final Setting

Now the third tie-down point may be used as checkup. This is 990 kc, which

## Directions for Winding the Coils

The two radio frequency coils have secondaries of 245 microhenries inductance, but have different primaries. The primary on the antenna coil is larger, and this acts automatically as a corrective of squealing at the r-f level. In the same direction the smaller primary for the interstage coil, joining r-f tube to autodyne, has fewer turns. In general, the fewer the primary turns the greater the selectivity, and as more turns were used on the antenna coupler fewer are used on the next coil without reducing the selectivity.

### Different Primaries

Therefore the antenna primary consists of 30 turns and the interstage primary of 15 turns.

The secondaries have 127 turns of No. 32 enamel wire in the commercial coils, on a diameter of 1 inch, while the primaries consist of any fine wire, and are wound over the secondaries, with insulating fabric between. The primaries are nearer the bottom of the coil and are wound in the same direction as the secondaries, but the secondaries have the grid connection from the top, while the primaries have the plate (or antenna) connections from the bottom.

Those who can not obtain No. 32 enamel wire for the secondaries may wind instead 140 turns of No. 30 enamel wire.

### The Oscillator Coil

The oscillator coil has an inductance of 190 microhenries, consisting of 115 turns of No. 30 enamel wire. This presupposes a padding condenser adjustable from 700 to 1,000 mmfd. and also that an intermediate frequency of 175 kc is used. The diameter of the tubing is again 1 inch.

The pickup winding of the oscillator, the one connected in the cathode circuit, has 40 turns of No. 30 enamel wire wound over the secondary, and insulated therefrom as previously. One end of this winding is tied to one end of the tuned winding, to constitute the outlead marked "black" on the circuit diagram.

The oscillator coil is in the same high shield as contains the first intermediate transformer, and is placed below it, with no magnetic shield between. It is not deemed practical to attempt to make this transformer, nevertheless the directions are given for the benefit of those who may desire to try.

### Intermediate Coils

The intermediate transformers can not well be built at home, either, but they may consist of 800-turn honeycomb coils, 1-inch overall diameter, for primary and secondary, centers 1 inch apart, and tuned by 20-100 mmfd. equalizers. These are not exactly the constants used in the commercial coils, but will register the same frequency at near maximum of the available capacity.

All coils are shielded, and the shields should be no less than 2 inches in diameter and no less than 2.5 inches high, while the combination coil system is in a shield about 4.5 inches high.

should come in at 45 on the dial. If it comes in somewhat lower in numerical dial reading, the capacity in the oscillator circuit is too high; if it comes in higher in numerical dial reading, the capacity in the oscillator is too low. This will be your key in the final checkup, because since trimmers have been readjusted the padding has been thrown off a little, and the padding condenser should be reset at 600 kc, on the basis of the 990 kc disclosure. When this readjustment is made the padding is completed.

If the intermediate channel is accurately  
(Continued on next page)

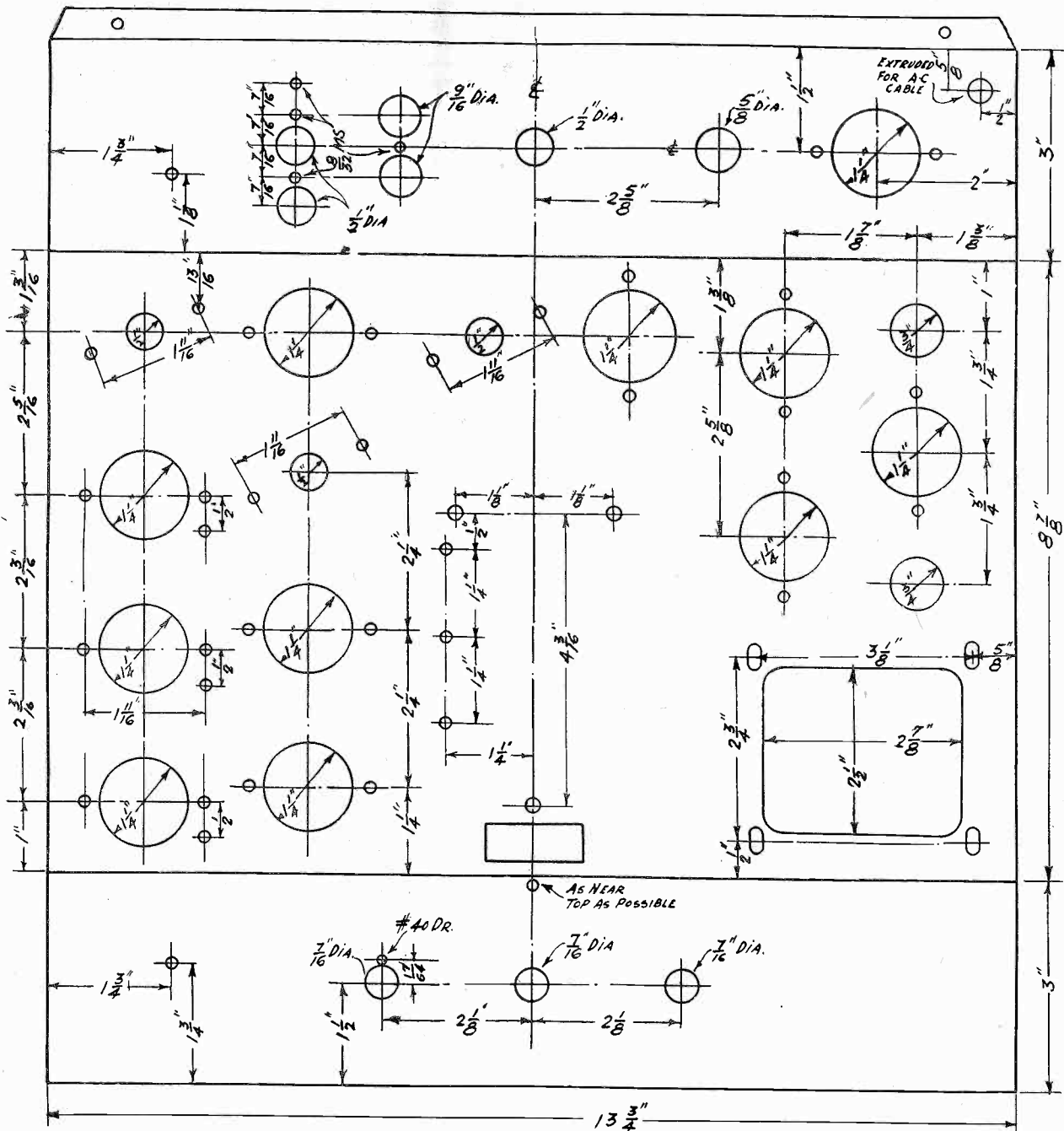

**Layout for a chassis to accommodate a set with eight tubes or fewer. This differs slightly from a commercially obtainable chassis.**

(Continued from preceding page)  
 set, the oscillation frequencies themselves may be read indirectly, by adding 175 kc to the test oscillator frequencies. Thus, at 540 kc the test oscillator frequency fed to the set, replacing aerial, the oscillator frequency is 615 kc, at 990 kc test oscillator frequency the set oscillator's frequency is 1,165 kc, while at 600 kc test oscillator frequency the set oscillator frequency is 775 kc.

Once the intermediate frequency amplifier is lined up, the second intermediate frequency coil should not be readjusted, because resonance will not change there, due to any parallel or series padding. However, realignments made at the r-f level, either t-r-f stage or input to autodyne control grid, will affect the tuning of the first intermediate transformer, the plate circuit particularly. While normally the plate circuit setting is not controlling, in that the intermediate grid tuning has the predominating effect, in this combination coil system the opposite is true. Therefore we have one intermediate coil in which the plate tuning leads in importance and another where the grid tuning leads.

**Option of Grounded Cp**

So we shall be prepared, after the set is lined up, to try a small readjustment of the plate condenser across that has one side to primary of the first intermediate. We know which one this is. It is the condenser that has caused sparks when the adjusting screw-

driver slipped against the shield during adjustment. If we didn't have that small shorting accident, we know the circuit from the grid circuit because the plate circuit is "hot" and subject to body capacity effects.

Whenever such effects are present it will be found that in any adjustment when response becomes maximum, if we remove our hand the response falls. That means we must add more capacity, a bit at a time, and retest by ear or meter until the maximum is register with hand off.

The same effect rules in the padding condenser, because it is not grounded. The coil code given is for a non-grounded type. But it would be practical to ground the padding condenser by putting it between ground the return of the oscillator secondary, using the moving plate lug connection for ground. The commercial combination coils do not provide for this, but efforts are being made to obtain such a coil (for grounded padding condenser) so that any who prefer that system may have it. The circuit would have to be changed to the previously stated—extent of relocating the padding condenser, and the total number of combination coil outlets would have to be eight. The color code would still hold, except that the return for the oscillator's tuned secondary would be the extra outlead, of a color not covered by the seven others.

**The Manual Control**

The radio-frequency section has been covered. The input to the diode detector is from

the center-tapped secondary of the second intermediate transformer. Center tap goes to one side of the load resistor of the diode. The potentiometer is the load. Thus we have direct coupled audio. To have a good manual control we connect the grip cap of the triode section of the 55 to the slider of the potentiometer, and then the volume is governed by taking off all the voltage drop to none of the voltage drop, and if the potentiometer's minimum is zero, then the signal doesn't go through at grounded position of the control.

The bias on the triode unit depends on the signal, and it is the same as the amount of bias contributed by the automatic volume control to the intermediate amplifier tube. Bias on the 55 triode really never is zero, because so long as there is a signal, it will be necessary to include some resistance of the potentiometer in circuit to hear that signal, and the bias voltage is proportional to the resistance. Also, any strong passages immediately elevate the bias, so that the bias is diode-controlled, and the audio tube is a diode-biased triode.

**Performance**

Not only has the circuit been built, but rebuilt and improved. It has been tested on the air and in the laboratory. It has proved itself well worthy of construction, having excellent tone, selectivity and sensitivity. What the sensitivity will be depends on the accuracy of the adjustments, and on the selection of loads and voltages, but as shown

the sensitivity will come close to the maximum allowable. When a set is too sensitive it is too noisy, and if ever you want to reduce the sensitivity you may increase the value of either of the biasing resistors marked 350 ohms. The general sum of such receivers is gaited to a sensitivity of 10 microvolts per meter, which is high enough, but the circuit as shown goes beyond that a little, and can be built, by most careful adjustment to just below the point of oscillation in the intermediate amplifier, so that the sensitivity is around 2 microvolts per meter at the high frequency end.

Hum is very low, but if you build the set and find that the hum is too high, reverse the connections to the primary of the speaker's output transformer, check up on the resistance of the field coil, especially as to the disposition of its 300 and 1,500-ohm sections, and see that a resistance measurement between cases of the electrolytic condensers gives a reading equal to the tap-to-ground resistance of the field coil (300 ohms).

### Phonograph Connection

The circuit provides for a phonograph pickup in an original position. As the manual volume control of the receiver is turned toward ground the signal is reduced, until a few hundred ohms before zero resistance is reached even loud signals are eliminated. Therefore to keep out the signal, turn the potentiometer to ground. The phonograph pickup's own volume control should be used for control, although the set's control will function somewhat, provided the set is turned to no signal. Since there were signals on 80 out of the 96 channels in one evening's test, maybe you'll have the same trouble in finding a quiet spot.

If no pickup is to be used, short the phonograph pickup terminals, as designated by the bracket under the word "Phono" in the circuit diagram.

## Results Obtainable With Super Diamond

If the padding has been done properly, the voltages are correct and the wiring likewise, the Super Diamond should afford excellent distance reception in nearly all localities. The limitation is placed on the statement because of occasional semi-dead spots, as encountered in some previous experiences (including Reading, Pa., where residents wanted to hear New York stations direct).

The circuit has been worked for about three weeks in New York City, and there was not the slightest difficulty in regard to selectivity, for WOR, the strongest local at this point, could be tuned out completely, and WLW, a distant station 10 kc removed, tuned in. At the low extreme of the dial, the Canadian station on 540 kc (sharing with Detroit interests) could be tuned in without interference from a Buffalo station on 550 kc, as likewise could a Philadelphia station without WMCA, 570 kc, 10 kc removed, causing any interference. These tests confirmed the condition at the low radio frequency end, while the selectivity was greater at the high frequency end due to the regenerative effects beginning to take place in the r-f stage. These effects, as explained, should not rise to the point of squealing, and if they do (which is evidenced by unholy racket), the 350-ohm r-f biasing resistor should be increased. This also will increase the selectivity. Do not put a resistor in parallel with the antenna coil to eradicate squealing, for while this will do the trick the value will have to be so low that selectivity suffers.

### Use An Outdoor Aerial

The stations at the high frequency end, on t-r-f sets in general, are subject to more interference, but on this set to less interference, for the selectivity derived from the intermediate level is constant, and the

frequency increase in the r-f section causes the increase in small values of feedback to very helpful proportions. Thus, a strong local on 1,450 kc could be tuned out and a weak distant station on 1,460 kc could be received without interference.

### Use Outdoor Aerial

In using this receiver no hesitancy need be felt about using an outdoor aerial. It is hoped that short indoor stretches of wire will not be used, as in any receiver that is sensitive (as this one is) the very short aerial, while providing results, relies too much on the amplifier ahead of the audio and here does not give the a-v-c enough of an opportunity. Thus the signal-to-static ratio is decreased, while an outdoor aerial increases the signal in relation to the static level. The static here referred to is the noise arising from various causes along the route from the sending station to the receiver, and not to the local static attendant on storms or local meteorological conditions as found in warm climates on the broadcast band.

A good ground is helpful, and it should be preferably to a cold water pipe rather than to a radiator. The length of the aerial is not specified, as it is not crucial, but any well-constructed outdoor aerial will be found in general superior to an indoor one, for DX work, particularly as with many indoor aerials the ground will prove a "better" aerial than the short antenna, therefore the desirability of a better antenna is obvious. The aerial should be at a higher radio frequency potential than the ground lead, which isn't true when the ground as aerial gives much more input than does the orthodox connection.

### Keen Response Over Dial

At almost every division on the dial there should be a station or a sign of one, if the padding is done well, and the point of reception is good. If there is little response at the high frequency end, the trimmers have not been set properly. If there is good response at the high radio frequencies but poor response at the low frequencies then the series padding is at fault, while if the receiver is insensitive throughout the dial spread, both the trimmers and series padding condenser are improperly adjusted.

## Directions for Mounting of Parts

It is preferable to solder 6-inch leads to each of the stator lugs on the condenser at the side opposite to the one where the trimmers are. The reason is that once the condenser is mounted on the chassis these lugs are not readily accessible to a soldering iron, although they can be reached that way. However, if the sockets and the tube shield bases are mounted the difficulty of reaching the lugs becomes too great. Only a small-tip soldering iron would afford access. So put on the leads before the condenser is mounted. Then pass the leads through chassis holes to the under side of the chassis and fasten the condenser and dial in place.

The circuit requires only one unit for combination manual volume control and a-c switch, and therefore this should be mounted at center. There are three holes, so that any who desire to mount the switch indethrough chassis holes to the under side of at right and the volume control at left. The center hole then would not be used. Due to cabinets available with the two holes at either side of the condenser hole, the separate method is followed by the author. The commercial chassis has the two side holes, none at center.

### Dial Bracket Detail

It often happens that the bracket of the dial hangs down too far to clear the volume control when that control is at center,

whereupon it is necessary to saw off the excess of the dial bracket. The fastening hole, through which a screw is put from panel front, is as high as practical, to require deletion of a smaller excess.

Depending on the type of condenser used, and the length of the condenser shaft, the dial may have to be mounted farther back. This may be done by putting a bushing of the desired length between the rear of the front flap of the chassis and the point where the dial is affixed. A screw through the front flap hole then passes through the bushing and then through the slot in the dial bracket, being fastened at rear by means of a nut.

### The Electrolytics

One of the 8 mfd. condensers has to be insulated. This is accomplished by using two insulating washers as follows: the one with extruded collar goes on top of the chassis, with collar pointing downward, and the condenser's threaded bolt is put through the hole. On the under side the flat insulating washer is next put on, so it is against the chassis, then the special lug is slipped over the threaded bolt of the 8 mfd. condenser and the nut finally is tightened down. The lug is wired so that it connects with B minus of the power transformer (thin black lead).

### Padding Condenser

If the padding condenser is to be mounted underneath the chassis at some point that requires that at least one of the two holes be under the tuning condenser, then it is necessary to mount the padding condenser before the tuning condenser is mounted, or at least as to the one hole affected by the tuning condenser. The screw for this padding condenser hole should be inserted so that its head is on top of the chassis, otherwise the screw, if the excess is too great, would stick upward, and might interfere with the tuning condenser.

### STANDARD RESISTOR CODE

Ohms	Megohms	Body	End	Dot
350	..	Orange	Green	Brown
3,500	..	Orange	Green	Red
50,000	0.05	Green	Black	Orange
2,000,000	2.0	Red	Black	Green
5,000,000	5.0	Green	Black	Green

## Tube List Prices

Type	List Price	Type	List Price	Type	List Price
11	\$3.00	'32	2.35	56	1.30
12	3.00	'33	2.80	57	1.65
112-A	1.55	'34	2.80	58	1.65
'20	3.00	'35	1.65	59	2.50
'71-A	.95	'36	2.80	'80	1.05
UV-'99	2.75	'37	1.80	'81	5.20
UX-'99	2.55	'38	2.80	82	1.30
'100-A	4.00	'39	2.80	83	1.55
'01-A	.80	'40	3.00	'74	4.90
'10	7.25	'41	2.85	'76	6.70
'22	3.15	'45	1.15	'41	10.40
'24-A	1.65	46	1.55	'68	7.50
'26	.85	47	1.60	'64	2.10
'27	1.05	48	2.80	'52	28.00
'30	1.65	'50	6.20	'65	15.00
'31	1.65	55	1.60	'66	10.50

### A THOUGHT FOR THE WEEK

"DISMISSED!"—and Louis Vichio walked out of Judge Feinberg's Court in Chicago. Louis had been on trial on a charge of robbery. His alibi rested on the claim that he had been listening in on station WJJD. The Court asked the prisoner what was on the air at that particular time when he was supposed to have been robbing somebody. Louis replied: "I heard Frankie 'Half-Pint' Jaxon and his band, your honor." Judge Feinberg had a court attache phone to WJJD, found that the program on that night had been broadcast at the time Louis indicated, examined witnesses who appeared for the defendant and freed the prisoner.

And now radio has one more use—it furnishes a perfect alibi at a crucial moment.

# Radio University

**A QUESTION and Answer Department. Only questions from Radio University members are answered. Such membership is obtained by sending subscription order direct to RADIO WORLD for one year (52 issues) at \$6, without any other premium.**

RADIO WORLD, 145 WEST 45th STREET, NEW YORK, N. Y.

## Getting the Lows

COULD the low frequency response be improved by tuning the output transformer to the lowest audio frequency that is desired, say 30 or 25 cycles per second?—G. J. M., Paterson, N. J.

It can, provided that the tuning is done correctly. The tuning condenser cannot be connected across the output transformer primary or secondary for that would kill everything but the low tones to which the tuning is adjusted. But it may be connected in series with the primary provided a choke is used to supply the plate with power. Tuning the primary in this manner would make the primary current much greater at and near the resonant frequency and therefore more power would be put into the secondary. This method of tuning would not appreciably alter the performance on the higher frequencies.

\* \* \*

## Padding a Trap Circuit

SOME time ago you published an article on padding a wave trap so that it would track with the r-f tuner and always be tuned to the image frequency. In this you actually padded the r-f and the oscillator circuits. Would it not be possible to use a larger tuning condenser for the trap and then pad that circuit so that it would not be necessary to tamper with the r-f circuit at all?—S. G. A., Springfield, Mass.

The padding under these conditions has not been worked out but it seems possible. It will not work with the same size condenser, for the results from the computations are negative values for both the inductance and the series capacity. In fact, the minimum capacity also turns out to be negative. While a negative minimum capacity is possible under certain conditions, since it only means a certain amount less than the capacity in the r-f circuit, a negative inductance and a negative series capacity have no direct physical significance. Such values only show that some other circuit arrangement is required.

\* \* \*

## Selection of Intermediate

WHAT is the highest intermediate frequency that can be used in a broadcast set if the second harmonic of the intermediate frequency is to lie below the broadcast band?—S. H. W., Racine, Wis.

The lowest broadcast frequency is now 540 kc, since Canada put a station on this channel. The intermediate frequency must be less than half this. One-half is 270 kc, so this is the limit. However, in order to get this station clearly it is necessary to make the intermediate frequency at least 5 kc less than this limit. That is, the lowest possible frequency would be 265 kc. In any case, divide the lowest frequency to be received clearly by two and select a frequency at least 5 kc less than this one-half.

\* \* \*

## Connecting Condensers in Series

AN electrolytic condenser is usually not rated higher than 500 volts. But in some circuits the voltage is much higher. Would it be possible to connect such condensers in series to get the required voltage rating? If so, are there any precautions to be observed?—D. B. McK., Peoria, Ill.

They can be connected in series provided that the polarity is observed and that the one on the high voltage side is properly in-

sulated. The can of one should be connected to the central cathode of the other. Or, the positive of one should be connected to the negative of the other.

\* \* \*

## Padding Short Wave Tuners

I AM about to build a short-wave superheterodyne and I wish to use ganged condensers to simplify tuning. Is that practical in short wave sets? In other words, is it possible to pad a short wave tuner so that it will always track as well as a broadcast super does?—J. A. E., Salt Lake City, Utah.

For any one band of short waves it is not difficult to pad so that the tracking will be close enough. If the receiver is to cover such a wide band that several coils are needed, either of the plug-in or the tapped type, it is necessary to pad each one independently, and the padding must be associated with the coil and not with the oscillator condenser, unless the condenser padding is changed for each band. There is one thing in favor of padding, and that is that very little is needed for the shorter waves. The intermediate frequency, though itself high, is relatively small for the higher signal frequencies. Most of the padding can be accomplished simply by making the oscillator coil slightly smaller than the corresponding r-f coil. If the radio frequency coil is very selective it becomes difficult to make the circuits track accurately and a small manual trimmer on the oscillator is desirable.

\* \* \*

## Mistaken Selectivity

MY RECEIVER is too selective on the shorter waves and it is impossible to log stations. Several stations come in inside the same division and it is not possible to tell which is which until the announcement is made. Can you suggest a method of making it less selective?—G. S., St. Louis, Mo.

The set is not too selective but the dial is too small or the plates of the tuning condensers are not cut right. If you want to spread out the stations on the high frequency end you should get a much larger dial or else a condenser with plates cut so that the capacity change is slower at the high frequency end. Better still is both to get a larger dial and a straight line frequency condenser.

\* \* \*

## Use of Small Coils

MANY years ago it was considered necessary to have the very best coils in radio sets. Much stress was laid on low loss. Now all that seems to be disregarded entirely. Were they wrong at that time or are they wrong now?—E. W., Chicago, Ill.

There has been a great change since the day of the single tube set and low power broadcast stations. Tubes especially have been improved to give a greater amplification. More tubes are used in every set. To get selectivity now many tuners are used.

\* \* \*

## Padding Long Wave Sets

IN BUILDING a superheterodyne that will receive both long and broadcast waves is it possible to pad the oscillator for both bands? If so, about how close will the tracking be? Is it practical to use the same tuning condenser for both the long and the broadcast tuners?—A. B. A., Newark, N. J.

It is quite easy to pad the oscillator for both bands and the closeness of the tracking

is about one per cent. of the intermediate frequency. That applies to the broadcast band and to the other band as well, provided that the ratio of the highest to the lowest frequency is the same as the corresponding ratio in the broadcast band. If the ratio in the long-wave band is lower the tracking can be made still better. If it were not practical to use the same tuning condensers for both bands it would hardly be practical to have a dual range circuit. The intermediate frequency in the dual range circuit should not be higher than about 115 kc, and 95 kc would be better.

\* \* \*

## Two-Volt Tubes on Six Volts

A RECEIVER I have has been designed for use on 3 volts, all the tubes being of the 2-volt type. Please tell me what changes are necessary to adapt it to 6 volts, as I want to use a storage battery of this voltage.—H. W. J., Rockford, Ill.

The easiest way is to put in a ballast resistor to drop the excess voltage. Since the tubes are of the 2-volt type and the set has been designed for three volts there is already a ballast resistor in the circuit. Increase its resistance or put another resistor in series with it. Since you gave no inkling of how many tubes or what kind of two volt tubes are in the set, it is not possible to give the value of the extra resistor needed. However, you must drop the difference between the storage battery voltage and 3 volts. If the normal voltage of the battery is 6 volts you must drop 3 volts in the extra resistor. Add up all the filament currents drawn by the set and divide 3 by this current in amperes. The result is the value of the extra resistance in ohms.

\* \* \*

## Changing Voltage

A TRANSFORMER I have gives a secondary voltage of 7.5 volts when connected to a 115 volt line. I want to drop this voltage to 5 volts. What resistor do I need?—R. V. C., San Antonio, Tex.

It all depends on the current you draw, first because the transformer winding has resistance and second because there is no drop in any resistance unless current flows, and the drop is directly proportional to current. Decide what current you are going to draw from the 7.5 volt winding and then divide 2.5 by this current, expressed in amperes. The result is the number of ohms that you must use.

\* \* \*

## Shorting Turns

MANY dual range receivers change the wave range by shorting the long wave coils. Does not this introduce serious losses and detuning in the broadcast coils?—E. F. Z., Milwaukee, Wis.

If the long wave coils are not inductively coupled to the broadcast coils there will be no appreciable loss or detuning. Even if the coils are inductively coupled the effects are small because the shorted coils are so much larger than the broadcast coil. Detuning would not matter, since the circuit is not tuned until after the change has been made.

\* \* \*

## Diode Bias Amplifier

IS IT all right to use the diode-biased amplifier with a 55 tube? When there is no signal there is no bias and it would seem that the plate current in the triode of the 55 would be extremely high when no signal is coming in. Also, is there not danger of not having insufficient bias on the triode grid when a strong signal is coming? Is it possible that the triode would become over-biased?—J. L. B., Philadelphia, Pa.

Sure, it is all right to use the diode biased amplifier. It has been used for about ten years in millions of sets, only that we used to call it grid leak detection. The danger of a heavy current in the plate circuit when no signal is coming in is real, but it may be prevented by using a high resistance load, say not less than 20,000 ohms. There is no danger of having insufficient bias, for the bias is determined by the carrier, which is always greater than the modulation on that

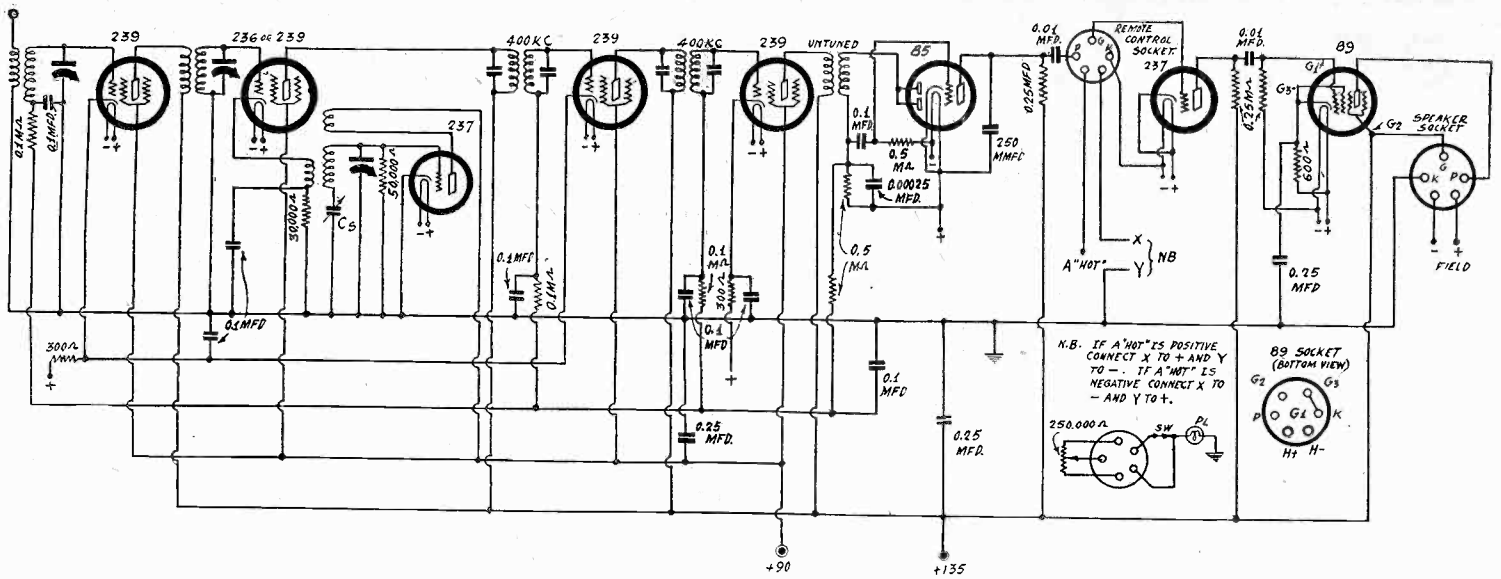

If an automobile set is wired according to this diagram it can be used on any type of car, provided the X and Y terminals are connected properly for each type.

carrier. It is quite possible that the tube might become overbiased, but that would mean that the tube was overloaded. There should be a volume control to take care of this. The bias on the tube is always fluctuating, but if the carrier remains constant this fluctuation constitutes the audio signal.

### Determining Inductance

PLEASE explain a method of measuring the inductance of an intermediate frequency coil by means of a laboratory oscillator. I understand that this is possible. I have a very good oscillator that is calibrated to the intermediate frequency band.—F. C. E., Boise, Idaho.

Measure the natural frequency of the coil and any condenser whatsoever across it. Then measure the natural frequency after a condenser of capacity C has been added to the capacity previously across the coil. Then the inductance of the coil can be computed from the formula  $L = (F_0 - F) (F_0 + F) / 4\pi^2 F^2 C$ . Since a frequency difference occurs it is well to make the two frequencies quite different by choosing a large value for C, or a very small original capacity. Possibly the self capacity of the coil would be best as the original capacity. Naturally, C must be accurately known. Let us select values for the various factors occurring in the formula by way of illustration. Let the first natural frequency,  $F_0$ , be 450 kc and let the second be 170 kc. Then  $F_0 - F = 280$  kc and  $F_0 + F = 620$  kc. Let us also assume that the condenser we added, that is, C, had a value of 250 mmfd. Substituting the values in the formula we obtain  $L = 3$  millihenries.

### Adjusting Supers

IS IT practical to line up superheterodynes without the use of an oscillator? How should it be done, if it can be done?—W. T. C., Oklahoma City, Okla.

It is quite possible to do it but it is necessary to guess at the intermediate frequency. Try to tune in a short wave station near the zero end of the dial. As soon as anything comes through tune all the intermediate circuits until the sound from the station is loudest. That tunes the intermediate to some frequency which is close to the one that is required. For example, it may be 170 kc instead of 175 kc, or it may be 180 kc. The slight deviation is not very serious. As soon as the i-f has been tuned in adjust all the trimmers for the same station until the signal is as loud as possible. Next convert the circuit to a t-r-f set by moving the grid clip from the first to the second detector. Tune in a station about 600 kc. Leave condenser set, return the circuit to a superheterodyne, and then adjust

the series padding condenser until the signal is loudest. Touch nothing else but the padding condenser at this time.

### Diode Power Detector

IS IT correct to call a diode detector a power detector or should that term be reserved for grid bias detection?—E. W. R., St. Paul, Minn.

The term power detection has not been reserved for any particular kind of detection, nor has it been defined. If it is a question of output voltage any of the detectors with the exception of the grid leak detector could be called a power detector. With a diode detector it is possible to get a very high output voltage without distortion, and that is as good a criterion as any for a power detector. There is no amplification in the diode detector and it is really for that reason that a large output without distortion can be obtained, for the distortion usually occurs in the amplifier. The so-called grid leak detector is really a diode rectifier with a diode biased amplifier following it. The reason it overloads quickly is that the plate voltage on the amplifier is low.

### Changing Auto Set

MY EIGHT TUBE automobile set was built for a car in which the negative of the storage battery is grounded but now I want to change it so that it can be used on a car having the positive grounded. Will you kindly show how it can be done? Incidentally the receiver contains automatic volume control and diode detection.—W. R. T., Akron, Ohio.

If you wire the set as shown in the accompanying drawing you can use the set on any car provided you change two connections only. You will notice that wherever essential the cathodes return to the positive side and the grids to the negative of the heater circuit. The two leads to be reversed according to the grounding of the storage battery are marked X and Y. The proper way of connecting them is given in the note on the drawing. If these connections are not made right the circuit will not work. The 300 ohm resistor terminating in the sign plus must be connected to the positive side of the heater circuit or the a.v.c. will not work the same way under the two cases.

### Cathode Ray Oscillograph

WHY are cathode ray oscillographs applicable to frequencies where ordinary mirror oscillographs fail? Are there any other devices that can be used for studying wave forms that are not so expensive as cathode ray tubes and the mirror oscillographs, and if so, can they be used on radio frequencies?—C. W. Y., Springfield, Ill.

The only reason cathode ray oscillographs can be used on radio frequencies is that they are fast enough to follow the wave. The ordinary mirror oscillograph is so slow that it is not useful above the commercial power frequencies, unless they have been especially designed to follow higher frequencies. But even so they cannot be used on the high audio frequencies. There is another instrument that has been called the Phonodeik, devised by Dayton C. Miller, for the study of musical sounds. It may be used on frequencies as high as 4,000 cycles provided that certain corrections be applied for its inability to follow the higher frequencies accurately. But it is not useful on radio frequencies. The cathode ray oscillograph is the only device so far developed that will follow radio frequencies accurately. It is so fast that it is useful on the very highest frequencies. The cost of a suitable cathode ray tube with the necessary voltage equipment is now so low that it is about the same as that of a good radio set. The entire outfit need not cost more than about \$50, and possibly can be assembled for half that amount.

### Voltage Regulation

WHY DOES the voltage output of a B battery eliminator rise when the current is reduced or when it is stopped entirely?—G. A. P., Jersey City, N. J.

It rises because the drops in the power transformer, the rectifier tube, and the filter chokes decrease. The effective voltage in the circuit is the same all the time as long as the primary voltage is constant. The change in the output voltage therefore is only a change in the distribution of the voltage drops. When the change in the output voltage with given changes in current is small the device is said to have a good regulation. That simply means that the resistance of the device, looking from the output terminals toward the transformer, is low. The same thing applies to a battery. The higher the internal resistance of the battery the lower the measured voltage is, and the measured voltage is lower the more current the voltmeter takes.

### WORTH THINKING OVER

WHO IS THE MOST POPULAR entertainer on the air? Why go to the trouble of starting a poll and getting everybody excited! Just ask one of those cocksure, can't-be-mistaken personal press representatives and he'll tell you that—well, possibly he'll select the blonde lady or the crooning chap on whose payroll he happens to be at the moment. Of course, you probably won't believe him, but that will not disturb the 1932 model P. A. He's built for hard wear!

# STATION SPARKS

By Alice Remsen

## The Footsteps

FOR "TALES OF TERROR"

WLW—Sundays and Mondays, 11:00 p. m.

One night as I sat dreaming,  
In reverie profound,  
With thoughts uncanny, teeming,  
Unconsciously I frowned;  
The night was cold and dreary,  
The evening I had squandered,  
With heart so cold and dreary  
Through shadowland I wandered—  
Until my faithful hound  
Growled at a ghostly sound.

Then I heard footsteps plainly  
Upon the oaken floor;  
The silver moon shone vainly  
Through the glass-windowed door;  
But not a shadow fell there  
The while I sat and waited;  
No, not a shadow fell there  
As I still hesitated—  
Reluctant to explore  
Beyond the fast-shut door.

The hound still growled a warning  
With ivory fangs unbarred;  
Stark terror in them dawning,  
His red-rimmed eyeballs glared;  
With hair upright and bristling  
He crouched beside me, shaking;  
With coarse red hair all bristling,  
His noise the night awak'ning;  
With noble spirit he dared—  
A challenge he declared.

There in my chair still sitting  
Chained by a ghostly whim,  
Strange terrors 'round me flitting  
From gloom obscure and dim—  
I felt the THING draw closer—  
I felt that I was dying—  
As that dread THING drew closer—  
I felt my soul was flying;  
And in that presence grim  
I could not move a limb.

My gallant hound crouched nearer—  
And then my senses fled;  
The atmosphere was clearer  
When I awoke with dread;  
I always shall remember  
That moment full of sorrow—  
That sight I shall remember  
If I should die tomorrow;  
His proud throat gushing red—  
My faithful hound lay dead.

—A. R.

\* \* \*

If You Like Your Hair to Stand Up  
Straight with horror, listen in to Don  
Becker's "Tales of Terror." You'll like  
them!

\* \* \*

## The Radio Rialto

Must tell you what a thrill I experienced last Sunday evening. Was just leaving the Netherland Plaza for rehearsal at the WLW studio, when who should I bump into but the one and only Amelia Earhart. What a sweet unaffected woman she is; did not have time for more than a very short chat, but during that time learned she was in town for a lecture and was going right away without even staying overnight. Of course, you all know what she looks like so I don't have to tell you, but she was wearing a long velvet gown, which clung to her and made her seem even more tall and slender; her resemblance to Lindy is actually remarkable. . . . A grey day today. . . . No snow yet. Not even really cold. . . . "Showboat"

is here at the Shubert and I'm going to see it tonight; wouldn't miss Helen Morgan . . . Lucky Strike program has changed from WSAI to WLW, which changes the time of my Thursday program with The Flying Dutchmen; exact time has not been settled yet. . . .

The latest piece of news to drift this way from WABC is the signing of Ruth Etting, Bing Crosby and Tom Howard for the 1933 Chesterfield program; Etting was retained by popular demand and will be heard each Monday and Thursday night; Bing Crosby each Wednesday and Saturday; the Tom Howard program will feature him together with his partner, George Shelton, and Jeanie Lang. . . . Lennie Hayton's orchestra will replace that of Nat Shilkret. . . . Of course, the irrepressible Norman Broken-shire will still continue to announce. . . . Another old feature has returned to the air, Goldy and Dusty, who for five years were a popular feature of the pioneer days of network broadcasting. They may be heard daily from 9:15 to 9:30 a. m. over a group of ten Columbia stations: Albany, Buffalo, Hartford, Philadelphia, Pittsburgh, Syracuse, Harrisburg, Rochester, Wheeling and Worcester; the program will not go out over WABC. Harvey Hindermeyer and Earle Tuckerman are "Goldy and Dusty"; they will be assisted by two little girls who will be known as the Silver Dust Twins. . . . Enoch Light and his orchestra are now located at the Plantation Gardens in Philadelphia, broadcasting locally through WCAU six times weekly. . . . Joe Haymes and his orchestra are at the Village Nut Club in New York, broadcasting over WABC three times weekly. . . . The Bohemia Club, located at 53d St. and Broadway, is a new dancing spot in New York; Ben Selvin and his orchestra make the music, which is broadcast through WABC. . . .

Are you listening to WLW nowadays? and have you heard any of your girl friend's programs? Cincinnati seems to grow on a body. I'm liking it better each week; and if it were only a little cleaner I could actually love it. . . . A new program is being inaugurated this week—dramatizing the human interest angle of big business—bringing business down so that its intricacies may be understood by the average man on the street; should prove to be a great program; it will be heard on Thursday nights I believe. Don Becker will be responsible for the continuity; this youngster is a marvel at dramatic effect—and you should hear him play a ukulele. . . . Billie Dauscha is expected to go commercial very soon. She has taken a little apartment in the downtown section of Cincinnati. . . . Barney Barnes, remote control man for WLW, and his cute little wife, have an apartment in the same building; so we play bridge, eat grapes and candy and get the cards all sticky. . . . A good program on WLW is Chime Reveries, 11:30 p. m., Mondays, and 11:00 p. m. Fridays; if you like good music, well played, be sure to tune them in. . . .

And now for some NBC news. . . . Lucky Strike will make a radical change in its program idea, canning "The Magic Carpet" and substituting three different name bands to be used permanently; Jack Pearl will stay on the job, but Walter O'Keefe will not have his contract renewed. . . . Peter de Rose and May Singhi Breen celebrated their third wedding anniversary on December 8th. . . . Jan Garber broadcasts over WJZ and the blue network on Sundays at 12:30 a. m. from the Netherland Plaza Hotel in Cincinnati; Jan has a good band and works lots of little tricks while directing. He is a friendly little person with a great audience personality. . . . Our old pal, Larry Funk, gets through to New York from the Hotel Gibson, but he is in Cincinnati for just

a short time, going from here to the Lowry Hotel in St. Paul for two weeks, then the Bellerive in Kansas City. Larry has a million fans through this part of the country and his Band of a Thousand Melodies more than lives up to its reputation as a good name band. . . . Frank Black, an earnest musician, arranger and pianist for the Revelers, a quiet, conservative man, succeeds Erno Rapee as general musical director for NBC when Rapee takes over the directorship of Radio City. . . . Rumor has it that the Stebbins Boys will be back on the air again in the near future. . . . A program I'd like to see back is Peter Dixon's "Raising Junior." . . . Understand that "Friendship Town" is going off the air, for the time being at least. . . .

As I write this Joe Emerson is singing "Home on the Range" over WLW. Joe has a mellow pleasing baritone, which comes over very well. . . . Anne Seymour, well-known Broadway actress, featured on many dramatic programs over WLW, wrote her first radio script last week, a skit on the Courtship of Miles Standish; and was Anne tickled to see her name on the production sheet—"Continuity by Anne Seymour." It was produced on the Crosley Follies program and proved to be richly humorous. . . . Paul Stewart has added announcing to his many accomplishments; Paul acts and writes. . . . Well, think I'll call it a day. Do my weekly biographical stunt and then EAT—because I'm starving—and speaking of food makes me remember that Octavia is getting married on December 10th; by the time this is in print she'll be a "Mrs."—but she'll still continue to superintend my household in Astoria.

\* \* \*

## Biographical Brevities

### ABOUT WILLIAM STOEES

William C. Stoess, musical supervisor and director of "The Nation's Station," Crosley's WLW of Cincinnati, was born exactly thirty years ago in that city and has spent practically all his life in his birthplace and yet has attained a coast-to-coast reputation as a musical director. Bill, as he is affectionately known to his friends and associates, is a post-graduate of the Cincinnati College of Music; while studying there he did considerable concertizing with the Wagnerian Quartette of the New England Conservatory of Music, and solo violin work for the concert platform and various musical organizations.

His start in radio came through disappointing Fred Smith, who was then studio director of WLW. Bill had promised to come out to the studio and play a program of violin selections; he didn't show up—in those days schedules were not adhered to as strictly as they are now; nevertheless Fred Smith was mad; he called Bill up and bawled him out—and then—at the end of the hot and heavy scolding he hired him—as assistant studio director; now Bill is the head of the musical activities of this great station.

Yes, he's married to a charming little lady named Rosemary Ellerbrock; they have one child, a girl, Betty May, seven years old. Bill's hobbies are good music and good cigars; his sports—well, he plays a bad game of golf; used to be a speed skater when a boy; I can just imagine Bill on roller skates; he drives a car these days. He has a favorite author, Theodore Dreiser; and a favorite composer, Debussy.

Goes on the air once in a while, playing violin, under the name of Elliot Brock, just to keep his fiddle fingers in good condition and to satisfy his musical cravings. His ambition is to become a really great conductor. In appearance Bill is of medium height, slender, blondish, with an impish sense of humor which shows in the twinkle of his eyes and a gorgeous grin. Usually has a cigar in his mouth. When he is conducting good music his eyes are almost closed and his sensitive fingers keep tempo on the baton; with popular music he is on his toes, swaying rhythmically and humming the tune. It is a delight to sing with him, for he has a rare sense of just what a singer needs.

## Twin Short-Wave Stations Open

The British Broadcasting Corporation has inaugurated powerful twin short-wave transmitters at the new Empire station at Daventry, England. Each transmitter has carrier output of 20 kilowatts and is capable of working on six wave lengths between 13.9 and 49.6 meters.

To provide transmissions at convenient listening times for various regions of the British Empire, five zones have been provisionally named for broadcasts and have been designated as follows: one, Australia; two, India; three, South Africa; four, West Africa; and five, Canada.

The seventeen antennas, built around a hill-top site, give the station the appearance of a giant pin cushion. Eleven of these antennas are directional and six omni-directional. Thirty thousand feet of cable are used to link up the apparatus and sixty gallons of water per minute are circulated around the transmitters for cooling.

On Christmas afternoon, the Christmas speech of H. M. King George V will be broadcast, recorded, rebroadcast and relayed to all zones by British Empire stations and by many stations in other countries. This will mean that King George will be heard by possibly 150,000,000 persons, an audience of scope and size that has never before been approached.

The apparatus for this British Empire station was manufactured and installed by Standard Telephones & Cables, Ltd., a subsidiary of the International Standard Electric Corporation, which is a company of the International Telephone & Telegraph Corporation.

### ANSWERS TO CORRESPONDENTS

MRS. THOMAS OLMSTEAD, La Crosse, Wisc.—Am sending you the information on "miniature photographs."

JUDITH KINNON, Cambridge, Ohio.—The George Hall, of the Don Hall Trio, is not the same George Hall who is maestro of the Hotel Taft orchestra. Your information as to the latter is correct. The first named artist used to be in Cincinnati at WLW.

### Literature Wanted

Readers desiring radio literature from manufacturers and jobbers should send a request for publication of their name and address. Address Literature Editor, RADIO WORLD, 145 West 45th Street, New York, N. Y.

- T. R. Morris, c/o Jones Russell & Co., Colorado, Texas.  
 Jack Perry, 42 Fairholt Road S., Hamilton, Canada.  
 Robert Robbins, 1411 Hicks Ave., San Antonio, Texas.  
 Gordon Murray, 53 Elm Grove Ave., Toronto, Ont., Canada.  
 J. K. McConomy, 37 Bougainville Ave., Quebec City, Canada.  
 Jack LeClair, 101 Eastern Ave., Fall River, Mass.  
 Hartwell Jones, 1009 Cross St., Little Rock, Ark.  
 Fred Salmar, 2615 So. Emerald Ave., Chicago, Ill.  
 Ira McMullan, 340 The Brooklands, Akron, Ohio.  
 John S. Barss, Johnson Hall, Andover, Mass.  
 Harold O. Grimsrud, R. R. 1, Wembley, Alta., Canada.  
 Frank Demoizes, Box 37, Grayn, Penna.  
 Floyd E. Cates, 629 S. E. 2nd St., Minneapolis, Minn.  
 G. A. Swinford, c/o Service Hardware Co., Sylacauga, Ala.  
 O. Burgett, Box 71C, Lima, Ohio.  
 H. W. Haile, 6570 Scanlan Ave., St. Louis, Mo.  
 John E. Helms, Jr., Daily Gazette & Mail, Norristown, Penna.  
 Wm. B. Smith, 14 Winfred St., West Haven, Conn.  
 Elmer N. Boyer, 330 N. Pine St., York, Penna.

### SHORT-WAVE CLUB

Clarence Cain, 1310 Minneapolis St., Sault Ste. Marie, Mich.

## TRADIOGRAMS Kent Audition

By J. Murray Barron

The many friends and followers of Silver-Marshall circuits will be pleased to learn that McMurdo Silver, a real pioneer in radio, has organized a company bearing his name and has brought out what is termed his latest, greatest triumph. It is an all-wave receiver manufactured under his personal supervision.

\* \* \*

Try-mo Radio Co., 85 Cortlandt Street, New York City, has stocked the replacement parts of Philco and has on display the new and unique display cards illustrating the circuits for various parts. If you are in doubt as to whether you can use a particular part for other than a Philco, the circuit cards will aid you.

\* \* \*

Thor's Bargain Basement has a complete new window dressing of unusual design featuring small parts and much needed essentials of radio. Downstairs the kits and parts department is running to full capacity. Even in these days of very efficient factory-built receivers at reasonable prices there are still thousands of folk who want their receiver as they want it and therefore prefer to build their own, hence the demand for an efficient kit at reasonable price.

\* \* \*

Lansing Mfg. Co., Los Angeles, Calif., announces it has brought suit in the U. S. District Court of Arizona against the Magnavox, Fort Wayne; Utah Products Co., Chicago; Jensen Radio Mfg. Co., Chicago, and the Lektophone Corp., Jersey City, through John H. Klenke, patent attorney for the plaintiff. It is understood the purpose of the suit is to ask restraint on the four companies from mailing further letters to the trade, from filing any patent action against individual Lansing customers and retail trade until and unless they bring suit against Lansing Mfg. Co., itself.

\* \* \*

There is an interesting and helpful tube chart that assists greatly in giving data on the new tubes. It gives all the data and shows the pin arrangement. It is for free distribution and issued by the Postal Radio Co. Copies may be had by addressing Trade Editor, RADIO WORLD.

\* \* \*

Philco Radio & Television Corp. has a complete parts catalogue for the serviceman which gives valuable information. Send your name to Trade Editor, RADIO WORLD, for one.

## NEW INCORPORATIONS

International Television & Broadcasting Corp., Wilmington, Del.—Atty., Corporation Fiscal Co., Dover, Del.  
 Radio Center, New York City, realty—Atty., M. Paxson, 64 West 52nd St., New York City.  
 Radio Sales, New York City, broadcasting—Atty., Rosenberg, Goldmark & Colin, 165 Broadway, New York City.  
 Dynamic Acoustical Products, New York City, sound amplifying horns, etc.—Atty., E. A. Stern, 120 Wall Street, New York City.  
 S. & S. Electric Products Co., Lynbrook, L. I., N. Y.—Atty., L. Weinstein, Lynbrook, N. Y.

### ASSIGNMENTS

In Kings County, New York City  
 Atlantic Radio Corp., radio parts, etc., 1072 Atlantic Ave., Brooklyn, has been assigned to Aaron L. Palmer, 26 Court St., Brooklyn, N. Y.  
 In New York County  
 Penn Electric Co., at 22 Dey St., New York City, to Harry Smith, 80 Broad St., New York City.  
 William Vance Co., Inc., plumbing, 301 West 127th St., New York City, has assigned to Irene Naiman, 6201 Bay Pkwy., Brooklyn, N. Y.

### CORPORATIONS REPORTS

Pilot Radio and Tube Corporation—November: Net sales, \$134,263, compared with \$108,587 for the corresponding month last year. I. Goldberg, President, said November was the fifth consecutive month in which the company's sales had shown an increase over last year's.

## Prizes Awarded

The winners of the national audition of the Atwater Kent Foundation were Wilson Angel, 19, basso, Winston-Salem, N. C., and Lydia Summers, 25, contralto, New York. They receive \$5,000 each.

Second places were awarded to Thomas L. Thomas, 21, baritone, Scranton, Pa., and Frances de Voice, 23, Minneapolis. They receive \$1,000 each.

The remaining six of the first ten selected by the judges receive \$500 each. They are Peggie Jo Lobb, 23, coloratura soprano, Concord, N. C.; Robert Miller, 23, baritone, Dallas, Texas; William Felix Knight, 24, tenor, Santa Barara, Cal.; Laura Lodema, 19, mezzo-soprano, San Francisco, Clyde F. Kelly, 24, baritone, St. Louis, and Edythe Hoskinson, 23, mezzo-soprano, Hutchinson, Kan.

The judges were Maria Jeritza, Rosa Ponselle, Lawrence Tibbett, Richard Bonelli and Tito Schipa, all of the Metropolitan Opera Company; Reinald Werrenrath, Marcella Sembrich, teacher, and Marshall Bartholomew, director of music, Yale University.

## Bellows Assigned by C.B.S. to Washington

Henry A. Bellows, vice-president of the Columbia Broadcasting System, has been assigned to Washington, D. C., where he will be in charge of Columbia's activities within the Capital district. He will assume his duties in Washington on January 1.

Mr. Bellows, one of the pioneer broadcasters in the north central states, will continue to supervise the operation of WCCO, in Minneapolis, and will spend a part of his time in that city.

## DX CORNER

Just why it is that so many DX-ers repeatedly pull in the "hard-to-get" stations and yet rarely ask for a verification? Of course there are a great many who have the verifications, but nowhere near the number that has not. It isn't because the station has not been heard, because we know of too many cases that offset that opinion. It cannot be lack of interest, for the same stations are pulled in repeatedly, sometimes for the purpose of listening to definite features at stated periods. It may be that there are a great many more verifications received than the DX-ers admit, and possibly they do not want to let them out of their possession, or go to the trouble of sending them in. That will work both ways, for if all felt that way, then there would not be any exchanging of ideas. We will publish verified reception records.

We want to publish lists from all over the country, and while we have received fine support in the way of letters of good-will and also a large number giving lists of stations received, the big list of verified stations has not come along, so please bear this in mind when writing.

From Oak Forest, Ill., comes a report from W. E. Smith, with verification cards, showing reception of VK2ME, "The Voice of Australia," 31 meters; also a card showing reception from "The Voice of the Tropics," Honduras, C. A., on 1370 kc.

Readers interested in DX should address the condition of this column, J. Murray Barron, c/o RADIO WORLD, 145 West 45th St., N. Y. City.

# 6-Pin Plug-In Coils 200 to 15 Meters with 0.00014 mfd.

**SHORT-WAVE** plug-in coils with three separate windings for detector circuit produce best results as they avoid the broadness of plate-circuit tuning or the losses of r-f choke load on plate circuit due to damping. The lower winding is for r-f plate circuit, if t-r-f is used, or for aerial otherwise, the center winding is the tuned secondary, while the top winding is for feedback. The coils are accurately wound on 1.25 inch diameter Bakelite and have a 3/8 inch flange for gripping. Thus the actual winding need never be touched when you're handling the coils, and they are suitable for calibration.

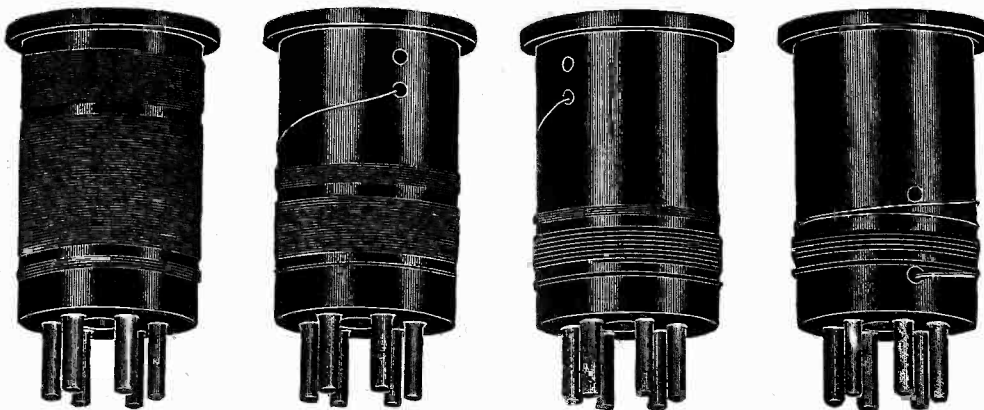

- Cat. SWB—Four plug-in coils, 6-pin base; primary, secondary, fixed tickler.....\$1.70
- Cat. SZ—Six-spring wafer socket for use as coil receptacle for six-pin coils.....\$1.35
- Cat. SWA—Four plug-in coils, UX base, primary and secondary; primary may be used for feedback if condenser connects serial to grid.....\$1.14
- Cat. SX—Four-spring (UX) wafer socket for use as coil receptacle for four-pin coils.....\$1.35
- Cat. H-14—Hammarlund junior midline 0.00014 mfd. condenser with Isolantite insulation.....\$1.20
- Cat. H-20—Hammarlund junior midline 0.0002 mfd. condenser with Isolantite insulation. Used as feedback control.....\$1.04

**THE** secondary is to be tuned with 0.00014 mfd. capacity. Using four coils, there will be sufficient overlapping of bands, also assured coverage to above 200 and below 15 meters. Also, 0.00015 mfd. may be used instead for tuning, with slightly greater overlap. Regeneration may be controlled by a 0.0002 mfd. variable condenser from detector plate to ground, or by a plate voltage rheostat or other means. The standard six-pin tube socket may be used for coil receptacle. For antenna stage tuning only two windings are needed, where no stage of t-r-f is included, when use SWA.

## HOW TO USE THE COILS FOR HIGHEST EFFICIENCY AND SMOOTHEST OPERATION

In building short-wave receivers using our plug-in coils be careful to locate the coils so that the centers of their cores are at least 6 inches apart, otherwise in sets with t-r-f the r-f tube may oscillate. Even if a volume control in the r-f stage controls any oscillation present the recommended separation should be maintained, otherwise a critical circuit results.

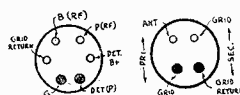

The connections to make are diagrammed herewith. Bottom views of sockets are shown. For the 6-pin coil P-B RF goes to aerial and ground if there is no r-f. For UX coil primary is ant. and gnd.

## HIGH-GAIN SHIELDED-COILS FOR T-R-F

### DIRECTIONS FOR BEST RESULTS

**THE** shielded coils for tuned radio frequency sets are supplied in matched sets of three or four, with secondary inductance equalized (plus or minus 0.6 microhenry). Thus any lack of sensitivity due to mismatched secondaries is avoided. As inductive discrepancies could not be compensated for by parallel capacity trimming, this high degree of inductive accuracy is important. Complete coverage of the wave band with the specified capacity condensers is absolutely guaranteed.

The coils may be used (set of three) for t-r-f, and with minimum value of negative bias for r-f tubes may oscillate a little at the very highest frequencies, say 1500 to 1580 kc, as they will be tuned below the broadcast band about that much. The negative bias should be increased until oscillation completely stops. Thus also selectivity is improved by heightened permanent or limiting bias.

In using four coils (three stages of t-r-f and tuned detector) each screen and plate lead should be carefully filtered, using 300-turn honeycomb coils and 0.002 mfd. or higher capacity in the filter, and the coil centers placed at least 4 inches apart.

The diameter of the form is 1 inch, the aluminum shield 3/8 inch diameter, 2 1/2 inches high.

The shield has a small protected opening at top so the lead for the grid cap may be brought through. The opening is bevelled. This constitutes the protection against fraying the insulation of leadout wire to grid cap.

In the four-coil system, reversing connections to primary of second coil often stops oscillation in poorly filtered sets.

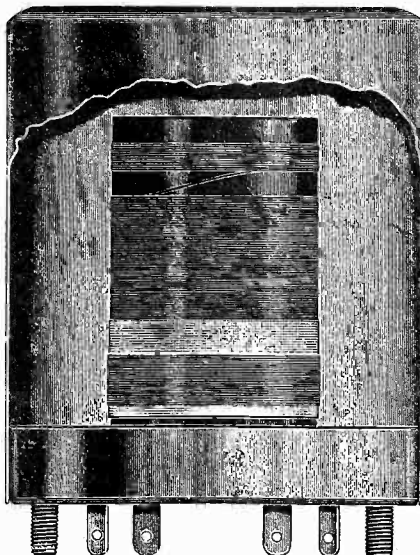

- Cat. No. 1—Three t-r-f coils for 0.00035 mfd., 80-meter tap.....\$1.35
- Cat. No. 1-F—Four coils, 0.00035 mfd.....\$1.80
- Cat. No. 3—Three t-r-f coils for 0.0005 mfd., 80-meter tap.....\$1.35
- Cat. No. 3-F—Four coils, 0.00035 mfd.....\$1.80
- Cat. DCH—Diode r-f choke, center-tapped, \$ .40
- Cat. 3DS—Three-deck long switch for above coils, to utilize 80-meter tap.....\$2.50

### 80-METER TAP PROVIDED

**E**ACH coil for the t-r-f sets has secondary tapped, so that if desired a long switch may be used to shift the tuning condenser stators to extreme of winding (200-555 meters) or to tap (80-200 meters). The tap is represented by a ground symbol stamped on the shield base. Please note ground is not to be connected to ground symbol. Grid return is the side lug inside the shield. P, B represent primary, G and side lug secondary. The 80-meter tap does not have to be used, but is advantageous to those desiring to tune in television, amateurs, police calls, some relay broadcasting and other interesting transmissions in a band of frequencies replete with novelties for the usual broadcast listener.

High impedance primaries are used, the number of turns chosen so that the same coils may be used for antenna coupler and interstage couplers. For diode t-r-f circuits, either full-wave or half-wave detector, a diode choke may be inserted inside the detector form. This choke has three terminals, with outleads: two extremes and center. For full-wave use two extremes to anodes of 55 or 85, center to cathode resistor. For half-wave use two extremes and ignore center tap.

Except in rare hookups the diode circuit requires an input free from grounding, and as the tuning condenser rotor and frame are grounded the choke pickup affords any potential output.

T-R-F sets using the 55 or 85 should have three stages of resistance audio, e.g., first stage the triode unit of the 55 or 85, second stage screen grid audio, third stage power tube or tubes (output).

COILS FOR 4-TUBE DIAMOND (CAT. DP) @ 90c—COILS FOR 5-TUBE DIAMOND (CAT. DT) @ \$1.35

## MIXER AND INTERMEDIATE TRANSFORMERS

### PADDED SETS

For circuits using 175 kc. or 400 kc. intermediate frequency we have two coils for a stage of t-r-f and first detector, and accurately chosen inductance for the padded oscillator for these intermediate frequencies. There is no 80-meter tap provided on these mixer coils.

The coils are of the same type of mechanical construction as the t-r-f coils. Since there is no secondary tap, the code for connecting the t-r-f coils of the superheterodyne combination is different: P and B, primary; G and ground symbol, secondary. P would go to plate or antenna, G to grid cap, while B and ground symbol are the returns.

The oscillator has a smaller inductance secondary, for padding, and moreover is a three-winding coil. The three windings are: pickup, secondary and tickler. The pickup winding consists of 10 turns, and is brought out to two side lugs. The polarity of its connections unusually is of no importance. The secondary is represented by G and ground symbol, G going to grid and ground symbol to grid return usually ground. The tickler connections for oscillation usually require that the lug at B be connected not to B plus but to plate, hence the P lug goes to B plus. In any case, if no oscillation results, reverse the tickler connections.

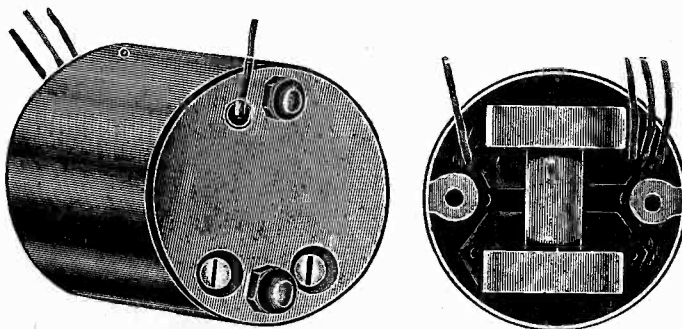

- Cat. No. 4—Three mixer coils, for 0.00035 mfd. Intermediate frequency in-tended, 175 kc. Price includes padding condenser, 700-1000 padder.....\$1.80
- Cat. No. 5—The mixer coils for 0.0005 mfd., 175 kc., 700-1000 padder.....\$1.80
- Cat. No. 7—Three mixer coils, for 400 kc; padding condenser included is 350-450 mfd. ....\$1.80

### INTERMEDIATE TRANSFORMERS

The intermediate transformers consist of two honeycomb coils, wound with low resistance wire, coils spaced 1 inch apart, and thus affording loose coupling, stability and high selectivity. Primary and secondary tuned.

- Cat. FF-175—Shielded intermediate frequency transformer, 175 kc.....\$1.10
- Cat. FF-175CT—Same as above, center-tapped secondary, for full-wave diode detector.....\$1.25
- Cat. FF-450—Shielded intermediate frequency transformer, affording choice by condenser adjustment of frequencies from 380 to 480 kc.....\$1.30
- Cat. FF-450CT—Same as above, center-tapped secondary.....\$1.45

**Padding Condensers @ 45c Each**  
 Cat. PC-710—For 175 kc intermediate. Put in series with oscillating tuning condenser. Capacity 700-1000 mmfd. Hammarlund, Isolantite base.  
 Cat. PC-3545—Same as above, except 350-450 mmfd. for 380-480 kc intermediate.

**SCREEN GRID COIL CO.**  
 145 WEST 45TH STREET, NEW YORK CITY

- Cat. CH-300—A 300-turn r-f choke, inductance 1.3 millihenries.....\$0.30
- Cat. CH-800—An 800-turn r-f choke, inductance 10 millihenries.....\$0.35



# ROLA SPEAKERS

**R**OLA dynamic speakers with output transformers matched for the specified type of output tubes built-in, single-sided or push-pull, and affording three different diameter sizes, 8, 10.5 and 12 inches, are offered as premiums for the first time. Besides there is a 6-inch diameter speaker offered (not made by Rola), so that a full range of sizes and types is afforded to those now subscribing for RADIO WORLD.

The Rola speakers are equipped with output transformer, 1800-ohm field coil (tapped as designated), cable leads, plug and terminal cover. They are grouped below as to outside diameters of cone rings.

**8-inch Diameter; sent free with one-year subscription, \$6.00 (52 issues).**

Single pentode, '47 or '89, tapped at 300 ohms. Order Cat. PRE-F-P.  
 Single 59, new heater power tube model, tapped 300 ohms. Order Cat. F-P-59.  
 Push-pull pentodes, '47 or '89, tapped at 125 ohms. Order Cat. PRE-F-P-2.  
 Push-pull 59's, tapped at 125 ohms. Order Cat. PRE-F-P-2-59.

**10.5-inch Diameter; sent free with 60-week subscription, \$7.00 (60 issues).**

Single pentode, 47 or 89, tapped at 300 ohms. Order Cat. PRE-K-7-P.  
 Single 59. Order Cat. PRE-K-7-P-59.  
 Push-pull pentodes, tapped at 125 ohms. Order Cat. PRE-K-7-P-2.  
 Push-pull 59's, tapped at 125 ohms. Order Cat. PRE-K-7-P-2-59.

**12-inch Diameter; sent free with 68-week subscription, \$8.00 (68 issues).**

Single pentode, 47 or 89, tapped at 300 ohms. Order Cat. PRE-K-9-P.  
 Push-pull pentodes, 47 or 89, tapped at 125 ohms. Order Cat. PRE-K-9-P-2.  
 Single 59, tapped at 300 ohms. Order Cat. PRE-K-9-P-59.  
 Push-pull 59's, tapped at 125 ohms. Order Cat. PRE-K-9-P-2-59.

(Speaker for any other type output tubes, single or push-pull, obtainable on the same subscription basis, determined by outside diameter of speaker as listed above).

Above speakers shipped express collect.

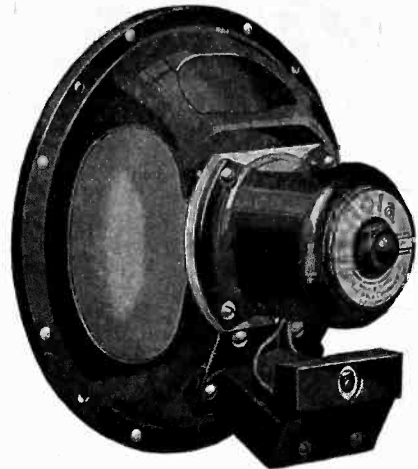

Besides the Rola speakers (illustrated above) we offer a 6-inch diameter speaker, 1800 ohm field, bias through built-in resistor apportionment; single 47 or 89 output only. Free with six-months subscription @ \$3.00 (26 issues). Order Cat. PRE-AKMS. Shipped express collect.

## POWER TRANSFORMERS

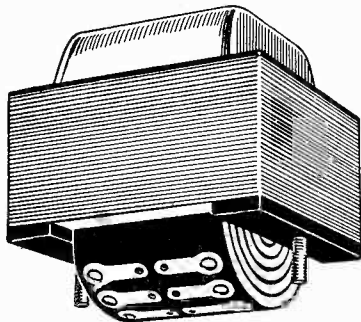

No. 508 or No. 509 winding bulge fits into a panel cutout of 2 1/4 x 1 11/16 inches, two mounting holes 2 3/8 inches apart, at center, across the shorter side of opening. Laminations 3/4 inch extra all around.

**I**N the construction of small a-c receivers in general two types of power transformers are used, and we offer both types. These are distinguished mainly by their B current carrying capacity and the capacity of the heater winding of the receiver tubes. The classification is generally narrowed down to B current comparison, 50 ma and 60 ma.

The two types, 508 for the smaller load (50 ma) and 509 for the larger load (60 ma), are in the same style case.

The specifications are as follows:

**No. 508**, for four-tube receivers, including rectifier; primary, 110 volts, 50-60 cycles, high voltage secondary, 330-330 volts a-c (660 volts, center-tapped); heater secondary, 2.5 volts, 7 amperes, center-tapped; rectifier filament secondary, 5 volts, 2 amperes, not center-tapped. On 1800 ohm field supplies about 275 volts d-c.

**No. 509**, for five, six and seven-tube receivers, including rectifier; primary 110 volts, 50-60 cycles; high-voltage secondary, 330-330 volts ac-c (660 volts, center-tapped); heater secondary, 2.5 volts, 9 amperes, center-tapped; rectifier filament secondary, 5 volts, 2 amperes, not center-tapped. On 1800 ohm field supplies about 275 volts d-c.

**No. 508** sent free on receipt of \$3.00 for six months' subscription (26 issues). Order Cat. PRE-508.

**No. 509** sent free on reception of \$4.00 for 34-weeks' subscription (34 issues). Order Cat. PRE-509.

Above transformers shipped express collect.

### 3-Gang Condenser, Dial

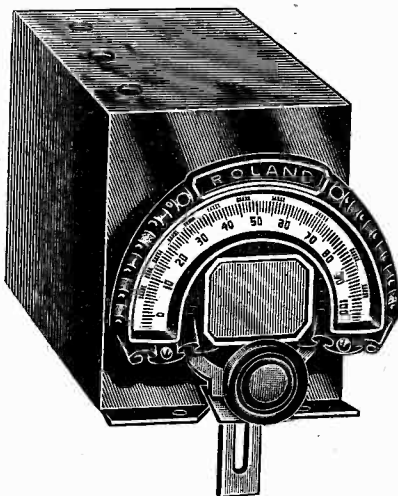

Three-gang 0.00035 mfd. tuning condenser, low minimum capacity, exceptionally wide frequency coverage. The condenser has brass plates, trimmers, and sturdy shield. Condenser, shield and trimmers free on receipt of \$4.00 for 34-week subscription (34 issues) Order Cat. PRE-SHSCO.

Above with dial and knob sent free with 39-week subscription (39 issues) at \$4.50. Order Cat. PRE-SHSCO - DL. Shipped express collect.

RADIO WORLD, now in its eleventh year, is the first and only national radio weekly, and publishes the latest, up-to-the-second news of circuits, both of kit types and of 1933 commercial receivers, as well as news of happenings in the broadcasting field. Lists of broadcast and short-wave stations are published regularly. You get your information weekly—which means quickly—and you get it accurately, so be sure to become or remain a subscriber for RADIO WORLD. We are able to offer now specially attractive premiums, and ask you to make your choice from the variety of parts offered herewith. When order-

### CABINET

A cabinet for a 12-inch speaker only. A beautiful walnut, hand-rubbed, artistic creation, with steel back cover in imitation cane, beautiful front grille, marqueterie up and down the front sides, and a luxurious general appearance. Stands 32 inches high and 19 inches wide. Room in the back also for a small set to be tuned by remote control, but not for knob control from the front. This cabinet, with speaker, listed at \$175. Given free (with-out speaker) with three-year subscription (156 issues) on receipt of \$15.00. Shipped express collect.

### CHASSIS

Chassis can be supplied for four, five, six, seven and eight-tube receivers. The general size is 14 inches wide, 3 inches high, 8.5 inches front to back, for five, six, seven and eight-tube sets, whereas the four-tube chassis is smaller. Any of these chassis sent free on receipt of \$2.00 subscription on 16 issues (16 weeks). Order Cat. PRE-CHAS-4, 5, 6, 7 or 8 (specify which by correct number at end.) Shipped express collect.

### BLOCK

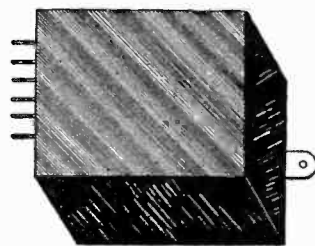

A paper condenser block that stands the gaff and provides abundant capacity for excellent filtration for those who desire the utter absence of hum from a receiver. Stands up to 350 volts d-c on any section. The highest quality paper condensers are inside the block (not electrolytics). The capacitances are 8.0 mfd., 6.0 mfd., 1.0 mfd., 1.0 mfd. and 0.5 mfd. Of the many condenser blocks of this group we have supplied, not one has given dissatisfaction. Send \$3.00 for six months subscription (26 issues) and get this free. Order Cat. PRE-FLHCB. Shipped express collect.

ing, please remember that we do not pay shipping charges on any products listed on this page. See footnotes on pages as to whether we pay cartage.

The regular subscription rates are: \$6 for one year, 52 issues, one each week; \$3 for 6 months (26 weeks); \$1.50 for three months (13 weeks); \$1 for 8 weeks; 15c per single copy. All copies postpaid. Present subscribers may take advantage of any of our offers by stating they are subscribers already. Subscription will be extended.

# RADIO WORLD

145 WEST 45th STREET, NEW YORK, N. Y.

We DO NOT pay the postage, express or freight on any products listed on this page, but will ship express collect on receipt of the subscription prices mentioned. If other shipping directions are to be followed, please advise us.

# DIAMOND PARTS

## FIVE-TUBE MODEL

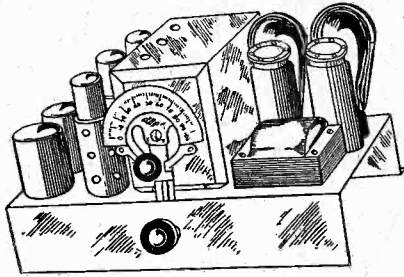

A-C operated circuit, 50-60 cycles, 105-120 volts, using two 58 t-r-f stages, 57 power detector and 47 output, with '80 rectifier. Three gang shielded condenser and shielded coils in a sensitive, selective and pure-tone circuit. Dynamic speaker field coil used as B supply choke. Complete kit of parts, including 8" Rola speaker and all else (except tubes and cabinet). Cat. D5CK @.....\$15.00  
Wired model, Cat. D5CW (less cabinet) @.... 17.19

Kit of five Eveready-Raytheon tubes for this circuit. Cat. D5T ..... 4.97

FOUNDATION UNIT, consisting of drilled metal subpanel, 13 3/4 x 8 3/4 x 2 3/4"; three-gang Scovill 0.00035 mfd. brass plates, trimmers, full shield; shields for the 58 and 57 tubes; six sockets (one for speaker plug); two 8 mfd. electrolytic condensers; set of three coils. Cat. D5FU..... 6.19  
*Super Diamond parts in stock.*

## FOUR-TUBE MODEL

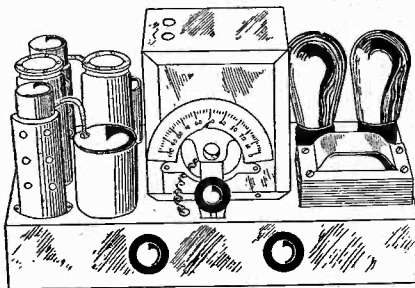

The four-tube model is similar, except that there is one stage of t-r-f, and a two-gang condenser is used. Tubes required, one 58, one 57, one 47 and one '80. Complete kit, including 8" Rola dynamic speaker (less tubes, less cabinet). Cat. D4CK .....\$13.99

Kit of four Eveready-Raytheon tubes for this circuit. Cat. 4D.TK ..... 3.89

FOUNDATION UNIT, consisting of drilled metal plated subpanel 13 3/4 x 7 1/2 x 7"; two-gang 0.00035 mfd. SFL condenser; full shield; two shields for 58-57; center-tapped 200-turn honeycomb coil; five sockets (one for speaker plug); two 8 mfd. electrolytics; set of two shielded coils; 20-100 mmfd. Hammarlund equalizer for antenna series condenser. Cat. D4FU .....\$5.48

## INDIVIDUAL PARTS

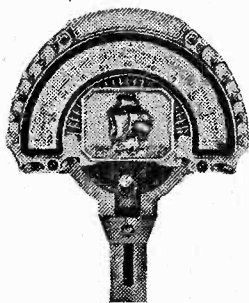

Travelling light vernier dial, full-vision, 6-to-1 vernier, projected indication prevents parallax; takes 1/4" or 3/8" shaft; dial, bracket, lamp, escutcheon.

0-100 for 5-tube Diamond, Cat. CRD-0, @ \$0.91.  
100-0 for 4-tube Diamond, Cat. CRD-100, @ \$0.91.

[If dial is desired for other circuits state whether condenser

closes to the left or to the right.]  
8 mfd. Polymet electrolytic, insulating washers, extra lug. Cat. POLY-8 @.....\$0.49  
Three 0.1 mfd. in one shield case, 250 volt d-c rating. Cat. S-31 @..... .29  
Rola 8" dynamic for 47, with 1800 ohm field coil tapped @ 300 ohms. Cat. FP @..... 3.83  
2 coils for 4-tube. Cat. DP @..... .98  
3 coils for 5-tube. Cat. DT @..... 1.35

## DIRECT RADIO CO.

143 WEST 45th STREET  
NEW YORK, N. Y.

# Quick-Action Classified Advertisements

7c a Word — \$1.00 Minimum Cash With Order

**WANTED TO BUY**—One or more Silvertone Neutrodyne radio sets, models 106, 108, 110 or 95. Purchased from Sears, Roebuck & Co., between June, 1930, and June, 1931. Need not be in operating condition but must have manufacturer's nameplate. Will pay commission to service man locating required set, if satisfactory. Box 1724, Radio World, 145 West 45th Street, N. Y.

**"THE CHEVROLET SIX CAR AND TRUCK"** (Construction—Operation—Repair) by Victor W. Page, author of "Modern Gasoline Automobile," "Ford Model A Car and AA Truck," etc., etc 450 pages, price \$2.00. Radio World, 145 W. 45th St., N. Y. City.

**BARGAINS IN FINEST PARTS!**— Highest grade, new parts, few of each on hand. National dial, flat type, modernistic escutcheon, type G, clockwise, \$2.19; Pilot drum dial No. 1285 @ \$1.89; a-c toggle switch, 19c; triple pole, four-throw Best switch, insulated shaft, \$1.62; double pole, four throw, \$1.08. Direct Radio Co., 145 West 45th St., N. Y. City.

**"TALKING MOVIES,"** by James R. Cameron. A History of the Talking Movie since 1899, with an elementary explanation as to how the pictures are produced and reproduced. Paper cover, \$1.50. Radio World, 145 W. 45th St., New York, N. Y.

**THE FORD MODEL—"A" Car and Model "AA" Truck**—Construction, Operation and Repair—Revised New Edition. Ford Car authority. Victor W. Page. 708 pages, 318 illustrations. Price \$2.50. Radio World, 145 W. 45th St., New York.

## 8 MFD. CONDENSER Four for Only \$1.47



We are able to offer brand-new 8 mfd. wet electrolytic condensers, with insulating washers, mounting nut and lugs at four for \$1.47. These condensers are freshly made for us in quantity by Polymet Manufacturing Co. and are highly recommended by us for assurance of full capacity and for their ruggedness. They are of the inverted mounting type. Single condenser, lugs, washers, nuts. Cat. Poly-8 @.....49c  
Four for the price of three, i.e., \$1.47

DIRECT RADIO CO.

143 West 45th St. New York City

## SOLDERING IRON FREE!

Works on 110-120 volts AC or DC, power, 50 watts. A serviceable iron, with copper tip, 5 ft. cable and male plug. Send \$1.50 for 13 weeks' subscription for Radio World and get these free! Please state if you are renewing existing subscription.

RADIO WORLD

145 West 45th St. N. Y. City

"A B C OF TELEVISION," by Yates, \$3.00. Radio World, 145 W. 45th St., N. Y. C.

# Magnetic Pickup Outfit

## Stromberg-Carlson

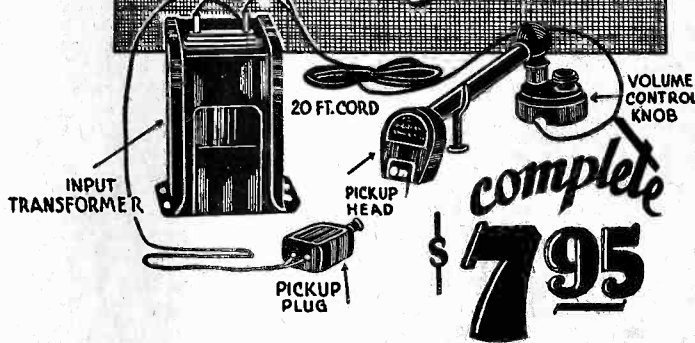

A phonograph pickup made by Stromberg-Carlson, equipped with volume control knob, with matched input transformer, a connecting cord and jack plug, for using the audio amplifier of your set, to play phonograph records. Outfit was listed @ \$30.00.

OUR PRICES:

Cat. SC-3A, for grid circuit connection, \$7.95

Cat. SC-3B, for plate circuit connection, 7.95

Three different weights, for choice in using bead for recording, Cat. SC-W @ 1.00

GUARANTY RADIO GOODS CO. 143 WEST 45th STREET  
NEW YORK, N. Y.

# Two for the price of One

Get EXTRA, one-year subscription for any One of these magazines:

- Q.S.T. (monthly, 12 issues; official amateur organ),
- POPULAR SCIENCE MONTHLY.
- RADIO-CRAFT (monthly, 12 issues).
- RADIO INDEX (monthly, 12 issues), stations, programs, etc.
- RADIO (monthly, 12 issues; exclusively trade magazine).
- EVERYDAY SCIENCE AND MECHANICS (monthly).
- RADIO LOG AND LORE. Bi-monthly; 5 issues. Full station lists, cross indexed, etc.
- AMERICAN BOY—YOUTH'S COMPANION (monthly, 12 issues; popular magazine).
- BOYS' LIFE (monthly, 12 issues; popular magazine).
- OPEN ROAD FOR BOYS (monthly, 12 issues).

Select any one of these magazines and get it free for an entire year by sending in a year's subscription for RADIO WORLD at the regular price, \$6.00. Cash in now on this opportunity to get RADIO WORLD WEEKLY, 52 weeks at the standard price for such subscription, plus a full year's subscription for any ONE of the other enumerated magazines FREE. Put a cross in the square next to the magazine of your choice, in the above list, fill out the coupon below, and mail \$6 check, money order or stamps to RADIO WORLD, 145 West 45th Street, New York, N. Y. (Add \$1.50, making \$7.50 in all, for extra foreign or Canadian postage for both publications.)

Your Name.....

Your Street Address.....

City ..... State .....

- If renewing an existing or expiring subscription for RADIO WORLD, please put a cross in square at beginning of this sentence.
- If renewing an existing or expiring subscription for other magazines, please put a cross in square at the beginning of this sentence.

RADIO WORLD, 145 West 45th Street, New York. (Just East of Broadway)

DOUBLE  
VALUE!