

APRIL 4
1931

A MIDGET SUPER

Price
15 Cents
Per Copy

RADIO

REG. U.S. PAT. OFF.

WORLD

The First and Only National Radio Weekly
471st Consecutive Issue—TENTH YEAR

HOW TO OBTAIN B VOLTAGES FOR CONVERTERS

REVIEW OF MARCH "PROCEEDINGS"

ASSEMBLY OF INTERMEDIATE COILS



An intermediate transformer may be built in a small aluminum can, with screw cover, adjusting condensers accessible. See pages 5 and 6.

HOW TO COMPUTE BALLAST RESISTORS

FILTER TYPE DETECTOR FOR SUPERHETERODYNES

Selectifier

The Supertone Selectifier
Makes Any Set Selective

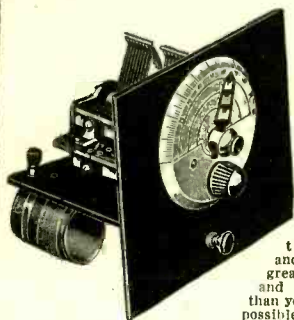

This device is a band pass filter with 10 kc. band width and enables you to separate any station from any other, build up the volume of weak stations, subdue powerful locals so they are no longer troublesome, and bring in far greater distance, and more of it, than you ever thought possible with your set.

Price, Wired in Cabinet, \$10
On 10-day money-back guarantee

175 KC TRANSFORMER

Supertone 175 kc. transformer, for screen grid tubes, with tuning condensers across primary and secondary, both accessible; in aluminium shield 2 1/4 inch diameter, 2 1/4 inches high, with removable bottom, both horizontal and upright mounting facilities. Sold on 10-day money-back guarantee. Order Cat. FP-175 @ \$3.00
For other than screen grid tubes (secondary alone is tuned to 175 kc.; ratio is 1 to 4). Order Cat. FP-175-G @ \$2.65

Supertone Products Corp.
216 Wallabout Street, Brooklyn, N. Y.

NEW...
SMALLER—LIGHTER
A CARDWELL QUALITY
CONDENSER AT A
LOWER PRICE!

For receiving, up to 365 MMF.
For transmitting, up to 150 MMF.

THE CARDWELL
MIDWAY
FEATHERWEIGHT
SEE IT!

SOLD IN NEW YORK CITY BY

LEEDS RADIO 45 VESEY STREET
SUN RADIO 64 VESEY STREET
WM. EGERT 179 GREENWICH ST.

LITERATURE ON THESE AND OTHER CONDENSERS ON REQUEST.

THE ALLEN D. CARDWELL
MFG. CORP.

95 Prospect Street, Brooklyn, N. Y.

DEALERS AND SERVICEMEN SEND FOR IT

Write for your FREE Copy of this Big Catalog 40 PAGES OVER 2000 ITEMS OF REPLACEMENT PARTS FOR ALL STANDARD SETS

Federated Purchaser
18E Hudson Street New York City

DEALERS and SERVICE MEN! STANDARDIZE ON!

LYNCH METALLIZED RESISTORS

For Permanent Replacement—Accurate—Guaranteed
Write for descriptive catalogue "W"
LYNCH MFG. CO., INC., 1775 Broadway, New York

RADIO WORLD and "RADIO NEWS"
BOTH FOR ONE YEAR @ **\$7.00**

You can obtain the two leading radio technical magazines that cater to experimenters, service men and students, the first and only national radio weekly and the leading monthly, for one year each, at a saving of \$1.50. The regular mail subscription rate for Radio World for one year, a new and fascinating copy each week for 52 weeks, is \$6.00. Send in \$1.00 extra, get "Radio News" also for a year—a new issue each month for twelve months. Total, 64 issues for \$7.00.
RADIO WORLD 145 West 45th Street, New York, N. Y.

Multi-Tap Voltage Divider

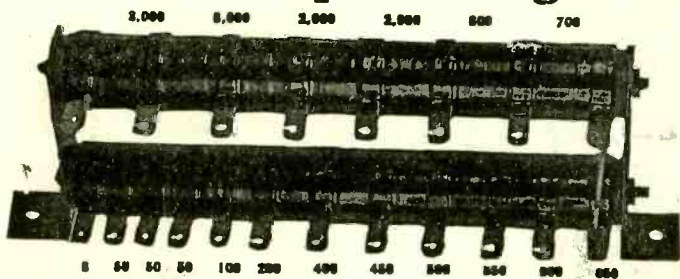

The resistance values between the twenty taps of the new Multi-Tap Voltage Divider are given above. The total is 17,100 ohms and affords nineteen different voltages.

The Multi-Tap Voltage Divider is useful in all circuits, including push-pull and single-sided ones, in which the current rating of 100 milliamperes is not seriously exceeded and the maximum voltage is not more than 400 volts. Higher voltages may be used at lesser drain. Conservative rating, 40 watts.

GUARANTY RADIO GOODS CO.

143 W. 45TH ST., NEW YORK, N. Y.

The expertness of design and construction will be appreciated by those whose knowledge teaches them to appreciate parts finely made. When the Multi-Tap Voltage Divider is placed across the filament output of a B supply which serves a receiver, the voltages are in proportion to the current flowing through the various resistances. By making connection of grid returns to ground, the lower voltages may be used for negative bias by connecting filament center or, in 237 and 224 tubes, cathode to a higher voltage. If push-pull is used, the current in the biasing section is almost doubled, so the midspan of the power tubes' filament winding would go to a lug about half way down on the lower bank.
Order Cat. MTTVD.

List price \$4.50
set price.. **\$2.95**

Two for the price of One

Get a FREE one-year subscription for any ONE of these magazines:

- CITIZENS RADIO CALL BOOK AND SCIENTIFIC DIGEST (quarterly, four issues).
- RADIO LOG AND LORE. Quarterly. Full station lists, cross indexed, etc.
- RADIO (monthly, 12 issues; exclusively trade magazine).
- RADIO ENGINEERING (monthly, 12 issues; technical and trade magazine).
- RADIO INDEX (monthly, 12 issues) Stations, programs, etc.
- SCIENCE & INVENTION (monthly, 12 issues; scientific magazine, with some radio technical articles).
- AMERICAN BOY—YOUTH'S COMPANION (monthly, 12 issues; popular magazine).
- BOYS' LIFE (monthly, 12 issues; popular magazine).

Select any one of these magazines and get it FREE for an entire year by sending in a year's subscription for RADIO WORLD at the regular price, \$6.00. Cash in now on this opportunity to get RADIO WORLD WEEKLY, 52 weeks, at the standard price for such subscription, plus a full year's subscription for any ONE of the other enumerated magazines FREE! Put a cross in the square next to the magazine of your choice, in the above list, fill out the coupon below, and mail \$6 check money order or stamps to RADIO WORLD, 145 West 45th Street, New York, N. Y. (Just East of Broadway)

Your Name

Your Street Address

City State

- If renewing an existing or expiring subscription for RADIO WORLD, please put a cross in square at beginning of this sentence.
- If renewing an existing or expiring subscription for other magazine, please put a cross in square at the beginning of this sentence.

RADIO WORLD, 145 West 45th Street, New York, N. Y. (Just East of Broadway)

DOUBLE VALUE!

Short-Wave Converter Series

In the November 8th issue of RADIO WORLD there began a remarkable series of articles dealing with the construction of short-wave converters that really do work, and that work well. Besides, the cost of parts is low. One model, 30 to 110 meters, no plug-in coils, may be built of parts costing less than \$5, for battery operation, or for AC with extra filament transformer external, while another model, 10-200 meters, two plug-in coils, using somewhat superior parts, filament transformer built-in, can be made up by you for less than \$10. Surely these are prices within the reach of all.

Low price and high achievement go hand in hand in these designs by Herman Bernard.

The series ran in the November 8th, 15th, 22nd and 29th, and December 6th, 13th, and 20th issues. Send \$1 and we will forward these seven issues and a blue-print of the AC \$5 model. Or send \$3.00 for 6 months' subscription and these copies and blue print will be sent FREE.

RADIO WORLD, 145 West 45th Street, New York, N. Y.

Enclosed please find \$1.00 for which send me the November 8th, 15th, 22nd and 29th, and Dec. 6th, 13th and 20th issues, containing the series of articles on short-wave converters of extremely low price, and a blueprint of the AC \$5 model.

Name

Address

City State

The New Jiffy Tester

Chromium-Plated Case and Accurate Meters

A NEW and improved Jiffy Tester, improved in both performance and appearance, is Model JT-N. The meters are of the moving iron type. Tested on precise batteries, they show errors not exceeding 2%. As for appearance, the case is first copper plated, then nickel plated, then chromium plated, giving a lustrous, permanent, non-peeling non-rusting finish. It is the same finish found on hardware in fine automobiles. The handle and lock strap are genuine leather.

Jiffy Tester, Model JT-N, consists of three double-reading meters, with cable plug, 4-prong adapter, test cords and screen grid cable, enabling simultaneous reading of plate voltage, plate current and filament or heater voltage (DC or AC), when plugged into the socket of any set. The ranges are filament, heater or other AC or DC: 0-10 v, 0-140 v; plate current: 0-20, 0-100 ma; plate voltage: 0-60, 0-300 v. It makes all tests former models made. Each meter is also independently accessible for each range. The entire device is built in a chromium-plated case with chromium-plated slip-cover. Instruction sheet will be found inside. Order Cat. JT-N.

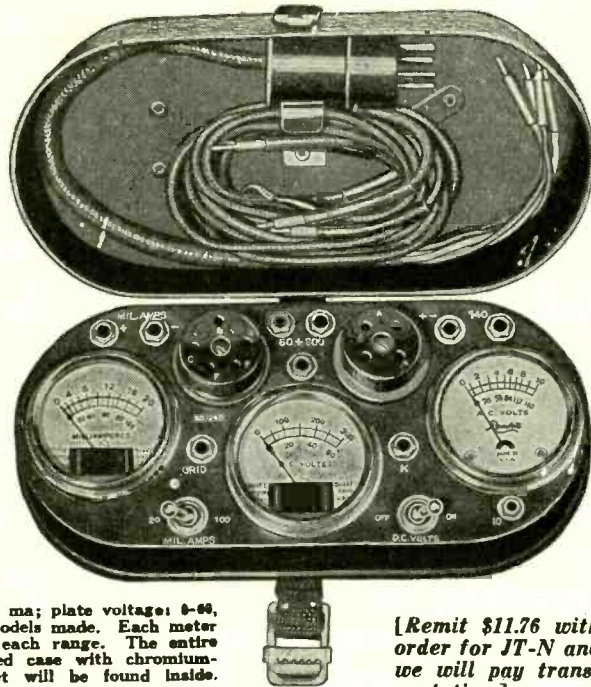

[Remit \$11.76 with order for JT-N and we will pay transportation.]

GUARANTY RADIO GOODS CO.

143 WEST 45th STREET (Just East of Broadway) NEW YORK, N. Y.

NEW VARIABLE MU TUBE

T remedy cross-modulation and cross-talk, without circuit changes, a new AC screen grid tube has been developed, the G-51. In AC circuits where the volume control varies the grid bias or the screen voltage, or in which there is an automatic volume control, the new tube works wonders. This is the sensational tube developed by Stuart Ballantine. Price, \$3.80.

RELIABLE RADIO CO.
143 WEST 45th St., N. Y. City

115 DIAGRAMS FREE!

115 Circuit Diagrams of Commercial Receivers and Power Supplies supplementing the diagrams in John F. Rider's "Trouble Shooter's Manual." These schematic diagrams of factory-made receivers, giving the manufacturer's name and model number on each diagram, include the MOST IMPORTANT SCREEN GRID RECEIVERS.

The 115 diagrams, each in black and white, on sheets 8 1/2 x 11 inches, punched with three standard holes for loose-leaf binding, constitute a supplement that must be obtained by all possessors of "Trouble Shooter's Manual," to make the manual complete. We guarantee no duplication of the diagrams that appear in the "Manual." Circuits include Bosch 54 D. C. screen grid; Balkite Model F, Crosley 20, 21, 22 screen grid; Eveready series 50 screen grid; Erla 224 A. C. screen grid; Peerless Electrostatic series; Philco 76 screen grid.

Subscribe for Radio World for 3 months at the regular subscription rate of \$1.50, and have these diagrams delivered to you FREE!

Present subscribers may take advantage of this offer. Please put a cross here to expedite extending your expiration date.

Radio World, 145 West 45th St., N. Y. C.

FOUR-GANG .00035 MFD. WITH TRIMMERS BUILT IN!

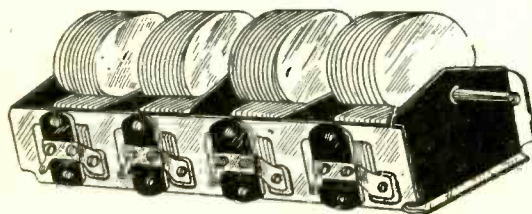

This condenser, each of four sections .00035 mfd., has aluminum plates that are removable and adjustable, also a 1/4" diameter steel shaft that is removable. It is sturdy and is suitable for popular four-circuit screen grid tuners. Trimming condensers are built in. The condenser may be mounted on its bottom or side. Total overall length, including shaft, 1 1/2". Overall width, 4". The frame is steel Order Cat. 4-G @..... **\$3.95**

RELIABLE RADIO COMPANY
145 W. 45th St., N. Y. C.

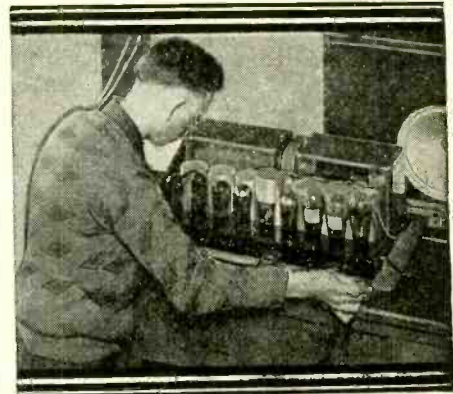

Learn RADIO, TELEVISION, TALKING PICTURES

Don't spend your life slaving away in some dull, hopeless job! Don't be satisfied to work for a mere \$20 or \$30 a week. Let me show you how to make REAL MONEY in RADIO—THE FASTEST-GROWING, BIGGEST MONEY-MAKING GAME ON EARTH!

Jobs Leading to Salaries of \$60 a Week and Up

Jobs as Designer, Inspector and Tester, paying \$3,000 to \$10,000 a year—as Radio Salesman and in Service and Installation work, at \$45 to \$100 a week—as Operator or Manager of a Broadcasting Station, at \$1,800 to \$5,000 a year—as Wireless Operator on a Ship or Airplane, as a Talking Picture or Sound Expert — HUNDREDS of Opportunities for fascinating BIG PAY Jobs!

Without Books or Lessons in 10 Weeks

By Actual Work in Great Coyne Shops

Coyne is NOT a Correspondence school. We don't teach you from books or lessons. We train you on the greatest outlay of Radio, Broadcasting, Television, Talking Pictures and Code Practice equipment in any school. You don't need advanced education or previous experience. We give you—right here at Coyne—all the actual practice and experience you'll need. And because we cut out all useless theory, you graduate as a Practical Radio Expert in 10 weeks.

TELEVISION Talking Pictures

And Television is already here! Soon there'll be a demand for THOUSANDS OF TELEVISION EXPERTS! The man who gets in on the ground-floor of Television can make a FORTUNE in this new field. Learn Television at COYNE on the very latest Television equipment! Big demand in TALKING PICTURES and SOUND REPRODUCTION! Hundreds of good jobs for WIRELESS OPERATORS! Learn ALL branches of Radio at Coyne—the one school that has been training men for 32 years.

Earn as You Learn

You get FREE EMPLOYMENT HELP FOR LIFE! And if you need part-time work while at school to help pay expenses, we'll gladly help you get it. Coyne Training is tested—proven beyond all doubt. You can find out everything absolutely free. Just Mail Coupon for MY BIG FREE BOOK!

H. C. LEWIS, President
Radio Division, COYNE ELECTRICAL SCHOOL
500 S. Pauline St., Dept. 41-2K, Chicago, Ill.

Send me your Big Free Radio Book and all details of your Special Introductory Offer. This does not obligate me in any way.

Name.....
Address.....
City.....State.....

Subscribers: watch the date line on your wrapper

If the expiration date line on your wrapper indicates that your subscription has expired or is about to expire, please send in renewal so that you will not miss any copies of the paper. Subscription Dept., Radio World, 145 W. 45th St., N. Y.

+ RADIO BOOKS +

SERVICE MANUAL RAMSAY HAAN RADIO MANUAL

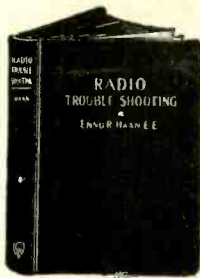
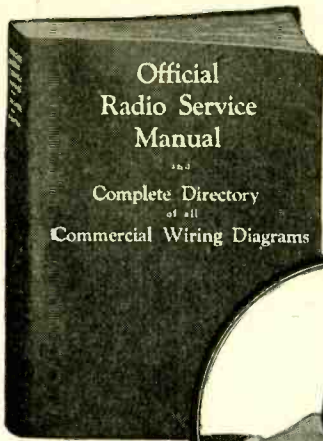

"Official Service Manual" by Gernsback and Pritch, 1,000 illustrations; diagrams of commercial receivers and power amplifiers; 352 pages; includes course on servicing. Weight, 2 1/2 lbs. Complete 8-page index. Flexible leatherette cover, loose-leaf binding. Order Cat. ORSM @ \$3.50



The index to the commercial wiring diagrams takes up five pages alone. The index is an alphabetical array of the manufacturers' names, with model names and numbers stated.

"Radio Trouble Shooting," by E. R. Haan, passes over theory, tells what to do to cure troubles. 300 illustrations, flexible binding 381 pages 6x9". Order Cat. HAAN... @ \$3.00

"Experimental Radio" by E. R. Ramsey, Ph.D., Prof. Physics, Indiana University. 255 pages, 186 illustrations. Cloth cover. Order Cat. REX... @ \$2.75

"Fundamentals of Radio," by Ramsey. 374 pages, 402 illustrations. Order Cat. RFM @ \$3.50

The new edition of "The Radio Manual" answers questions about the principles, methods, or apparatus of radio transmitting and receiving. A complete course in radio operation in a single volume. 20 big chapters include: Elementary Electricity and Magnetism; Motors and Generators; Storage Batteries and Charging Circuits; The Vacuum Tube; Circuits Employed in Vacuum Tube Transmitters; Modulating Systems and 100% Modulation; Wave-meters; Piezo-Electric Oscillators; Wave Traps. Nearly 900 pages, 369 illustrations; flexible-fabrikoid cover. Order Cat. MAN @ \$6.00

BOOKS BY JOHN F. RIDER

Two new books by Rider are:
 (1) "Practical Radio Repairing Hints," a handbook for the radio worker. Replete with facts and figures, hints and kinks. No Theory. No Formulae. In it you will find explanations of the modern radio systems, automatic volume control circuits, new forms of voltage distribution... automobile radio sets, public address systems, etc. Order Cat. PRRH @ \$2.00
 (2) "Practical Testing Systems," the first complete collection of accurate and practical testing circuits of interest to the service man, professional builder and experimenter. Among the many testing systems described in this book are tube testers, capacity measuring systems, signal generators, radio frequency oscillators, audio oscillators, vacuum tube voltmeters, resistance testers, continuity testers, etc. Material for the man who wants a simple test unit or desires a laboratory arrangement. Order Cat. PTS @ \$1.00
 Other books by Rider are:
 "Trouble Shooter's Manual," the first comprehensive volume devoted exclusively to the topic. It is not only a treatise for service men, telling them how to overcome their most serious problems, and diagramming the solutions, but it is a course in how to become a service man. It gives details of servicing and includes more than 100 actual factory-drawn diagrams of commercial receivers. 240 pages, 8 x 11". 200 illustrations. Order Cat. TSM @ \$3.50

"Supplement No. 1," containing 115 diagrams of commercial receivers, supplementing the diagrams in "Trouble Shooter's Manual," but not duplicating any. These 115 diagrams are supplied loose. They are a necessary adjunct to those in "Trouble Shooter's Manual." Order Cat. SUPP-1 @ \$1.20
 "Mathematics of Radio," by Rider, 128 pages, 8 1/2 x 11", 139 illustrations, bridges the gap between the novice and the college professor. It gives a theoretical background so necessary for a proper understanding of radio and audio circuits and their servicing. Formulas for capacity, inductance, impedance, resistance, etc., are explained. Flexible cover. Order Cat. MOR @ \$2.00

TWO MASTERPIECES BY PROF. MORECROFT

"Principles of Radio Communication," by Prof. John H. Morecroft, second edition. Prof. Morecroft, of the Electrical Engineering Department of Columbia University and past president of the Institute of Radio Engineers, is a noted authority. Prior electrical and mathematical knowledge required. 1,001 pages and 831 illustrations. Cloth-bound. Order Cat. M-PRIN @ \$7.50

"Elements of Radio Communication," written in plain language, requiring little foundation knowledge of radio, is another fine Morecroft book. The book is a complete course on the elements of radio, containing much material never before published. 226 pages, 170 illustrations and a complete index. Cloth bound. This is one book you must have in your library. Order Cat. M-ELEM @ \$3.00

THREE BOOKS BY MOYER AND WOSTREL

The need for an up-to-date book on radio tubes that answers all the important questions has been filed by James A. Moyer, Director of University Extension, and John F. Wostrel, instructor in radio engineering, Division of University Extension, Massachusetts Department of Education. This book is a complete discussion of tube principles, functions and uses. The essential principles underlying the operation of vacuum tubes are explained in a non-technical manner as is consistent with accuracy. The book covers the construction, action, reactivation testing and use of vacuum tubes as well as specifications for vacuum tubes and applications for distant control of industrial processes and precision measurements. 297 pages, cloth bound. Order Cat. MWT @ \$2.50

"Practical Radio," including the testing of radio receiving sets. 378 pages, 223 illustrations. Cloth bound. Order Cat. MWP @ \$2.50
 "Practical Radio Construction and Repairing," 819 pages, a companion volume to the above. New edition. New price. Order Cat. MWC @ \$2.50

Radio World, 145 West 45th Street, New York, N. Y.
 Enclosed please find \$..... for which please send at once, postpaid, books indicated by my crosses

<input type="checkbox"/> Cat. ORSM @ \$3.50	<input type="checkbox"/> Cat. TSM @ 3.50
<input type="checkbox"/> Cat. HAAN @ 3.00	<input type="checkbox"/> Cat. SUP-1 @ 1.20
<input type="checkbox"/> Cat. REX @ 2.75	<input type="checkbox"/> Cat. MOR @ 2.00
<input type="checkbox"/> Cat. RFM @ 3.50	<input type="checkbox"/> Cat. M-PRIN @ 7.50
<input type="checkbox"/> Cat. MAN @ 6.00	<input type="checkbox"/> Cat. M-ELEM @ 3.00
<input type="checkbox"/> Cat. DRA @ 6.00	<input type="checkbox"/> Cat. MWT @ 2.50
<input type="checkbox"/> Cat. FRK @ 3.50	<input type="checkbox"/> Cat. MWP @ 2.50
<input type="checkbox"/> Cat. PRRH @ \$2.00	<input type="checkbox"/> Cat. MWC @ 2.50
<input type="checkbox"/> Cat. PTS @ 1.00	<input type="checkbox"/> Cat. RTT @ 7.50

Name.....
 Address.....
 City..... State.....
 Check here if C. O. D. is desired.

Remit with
 Order for
 Books and
 We Pay Postage

- SPECIALS -

Five-lead cable, 2 ft. long, with plug to fit a five-prong (UY) socket. The cable is connected at the factory so that following wires represent the respective prongs of the socket: Blue with white marker—G post of socket; Red—plate of socket; Green—cathode of socket; Yellow—heater adjoining cathode; Black with yellow marker—heater adjoining plate. Net 65c
 MARCO black bakelite vernier dials. Read 0-100 with a supplementary scale reading 0-10 between figures on large scale. Takes a 1/4" shaft. Net 50c
 Parts for "A" battery eliminator: Dry rectifier, \$2.10; 0-10 ammeter, 75c; 20-volt filament transformer, \$2.50. Will handle up to 2 amperes filament current.

GUARANTY RADIO GOODS CO.
 143 West 45th St. New York, N. Y.

BARGAINS in High-Grade Standard Parts

"A" ELIMINATOR PARTS

Choke coil, to filter out the hum. Wound with No. 16 wire on secondary. Husky choke. Only one needed. Will pass 3 amperes. In shielded case. Cat. AECH @ \$5.50
 Westinghouse Rectox metal disc rectifier, to pass 2 amperes, or connect rectifiers in parallel to pass 4 amperes; mounting brackets. Cat. WRX @ \$1.95
 Jefferson transformer, 110 v. 50-60 cycle primary; 12 volts, no load; 9 volts when used full load on Rectox rectifier; DC voltage at full load, 7 volts. Cat. J-12V @ \$1.65
 Dry electrolytic condenser, 1,500 mfd. (two required). Cat. DRL @ \$3.25
 Steel cabinet, 12" long x 9" front to back x 9" high; cutout for bakelite binding post strip. Cat. SCAB @ \$1.25

TESTOLIGHT

Neon lamp in bakelite housing with two test prods. Tells whether voltage is AC or DC, and if DC which side is negative. Finds shorts and opens. Full directions. Cat. TSTL @ 99c

CABLE AND PLUG

Five-lead cable with 5-prong plug attached that fits into UY socket. Useful as a connector of set voltages or for short-wave adapters. Cat. CPG @ 62c

HOOKUP WIRE

10-strand genuine copper wire (not steel or alloys), with rubber insulation above which is ornamental fabric insulation. Best hookup wire for sets. Insulation good for 1,000 volts or more. Available in five different types: blue, brown, red with black marker, blue with white marker, green. Cat. HW (specify color). 12 ft. lengths @ .41c

RESISTORS

Grid leaks 5 meg., 2 meg., 1/2 meg., 1 meg., 5,000 ohms (specify which). Cat. CGL @ 11c
 Filament ballasts: 4 ohm for one 201A, 112A, 200A, 240A, 171A; 2 ohm for two 201A, 112A, 200A, 240 or 171A, or for one 171 or 112 Mounting supplied. (Specify which.) Cat. FB @ 11c
 Wire-wound resistors: 1 ohm, 1-3/10 ohm, 6-5/10 ohms; 30 ohms; 50 ohms. (Specify which.) No mounting supplied or needed. Cat. WWR @ 16c
 30-ohm rheostat with battery switch attached. Cat. 30RH @ 65c
 75-ohm rheostat with battery switch attached. Cat. 75RH @ 65c
 25,000 ohm potentiometer, wire-wound; Electrad Tonatrol. Will pass 30 ma. Excellent volume control or for tone control in series with .3 mfd. condenser. Cat. ELTT @ 99c
 30,000 ohm wire-wound clarostat potentiometer with AC switch attached. Cat. CLSA @ \$1.25
 Variable voltage divider; 10,000 ohms; will pass 100 ma; eight sliders and fixed terminal connections; mounting bracket. Cat. VVD @ \$1.49

CONDUCTORS

2 ampere fuse, cartridge type, for fusing AC line entering receiver; with fuse holder. Cat. 2AFH @ 25c

GRID CLIPS

Grid clip for connection to control grid of screen grid tube. Cat. GC @ \$0.4

GUARANTY RADIO GOODS CO.
 143 West 45th Street, New York, N. Y.
 (Just East of Broadway)

Enclosed find \$.....for which ship at once:

<input type="checkbox"/> Cat. AECH @ \$5.50	<input type="checkbox"/> Cat. FB @ 11c
<input type="checkbox"/> Cat. WRX @ 1.95	<input type="checkbox"/> Cat. WWR @ 16c
<input type="checkbox"/> Cat. J12V @ 1.65	<input type="checkbox"/> Cat. 30RH @ 65c
<input type="checkbox"/> Cat. DRL @ 3.25	<input type="checkbox"/> Cat. 75RH @ 99c
<input type="checkbox"/> Cat. SCAB @ 1.25	<input type="checkbox"/> Cat. ELTT @ 99c
<input type="checkbox"/> Cat. TSTL @ 99c	<input type="checkbox"/> Cat. CLSA @ 1.25
<input type="checkbox"/> Cat. CPG @ 62c	<input type="checkbox"/> Cat. VVD @ 1.49
<input type="checkbox"/> Cat. HW @ 41c	<input type="checkbox"/> Cat. 2AFH @ 25c
<input type="checkbox"/> Cat. CGL @ 11c	<input type="checkbox"/> Cat. GC @ 4c

*Specify which.....

Name.....
 Address.....
 City..... State.....



Vol. XIX No. 3 Whole No. 471
 April 4th, 1931
 [Entered as second-class matter, March 1922, at the Post Office at New York, N. Y., under act of March, 1879] 15c per Copy, \$6.00 per Year

TENTH YEAR
 Technical Accuracy Second to None
 Latest Circuits and News

A Weekly Paper published by Hennessy Radio Publications Corporation, from Publication Office, 145 West 45th Street, New York, N. Y. (Just East of Broadway) Telephone, BRyant 9-0558 and 9-0559

RADIO WORLD, owned and published by Hennessy Radio Publications Corporation, 145 West 45th Street, New York, N. Y. Roland Burke Hennessy, president and treasurer, 145 West 45th Street, New York, N. Y.; M. B. Hennessy, vice-president, 145 West 45th Street, New York, N. Y.; Herman Bernard, secretary, 145 West 45th Street, New York, N. Y.; Roland Burke Hennessy, editor; Herman Bernard, managing editor; J. E. Anderson, technical editor.

A Midget Super

By H. G. Cisin

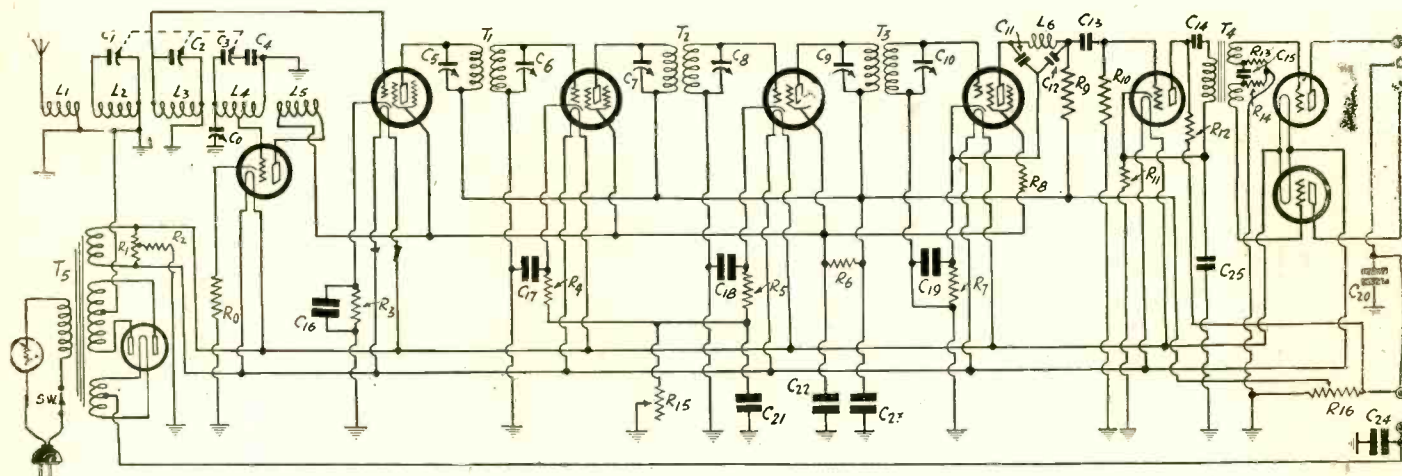

Fig. 1

The circuit of a compact superheterodyne for AC power supply with specially designed tuning inductance and ganged tuning control.

HERE is a midget superheterodyne circuit involving eight tubes for amplification and detection and one for the B supply. Careful attention has been given to the selection in front of the first tube in order to suppress interference, especially of the image type. At first we have a small antenna coil L1 coupled loosely and inductively to a tuned circuit consisting of L2 and C1. This circuit in turn is coupled to another and similar circuit consisting of L3 and C2, which is connected across the input of the modulator or first detector.

The oscillator is a typical of modern oscillators and consists of a tuned coil L4 with the condensers C3 and C4 and a tickler coil L5. Only a part of the voltage developed across L4 is impressed on the grid of the oscillator tube, which is the first in the circuit. The grid is connected to the tap in order to minimize the intensity of oscillation and thus to prevent the generation of harmonic frequencies.

Condensers Are Ganged

The tuning condensers are ganged as is customary in up-to-date superheterodynes and the ganging is made possible by the use of a condenser C4 in series with the oscillator tuning condenser C3 and a small trimmer condenser C5 across the two condensers in series.

The coupling between any two coils is obtained in the proper degree by placing the windings on one piece of tubing with the correct distance between them. This applies not only to the signal couplers but also the pick-up between the oscillator tuned circuit and the input circuit to the modulator.

The diameter of the tubing on which all the coils are wound is 1.5 inches and the number of turns is as follows: L1, 12; L2, 82; L3, 82; L4, 82; L5, 41 turns. The distance between the nearest turns on adjacent coils are as follows: L1 L2, 1/8 inch;

L2 L3, 3/4 inch; L3 L4, 1/2 inch; L4 L5, 1/8 inch. All the windings are wound with No. 29 enameled wire. The total length of the tubing is 6 inches, which gives about 1/2 inch space at each end for mounting purposes.

The Modulator

The modulator or first detector operates on the negative bias principle, but the bias resistor R3 is only 2,000 ohms. This is quite satisfactory since utmost detecting efficiency is not essential in view of the fact that the oscillator impresses a strong signal on it and the output is proportional to the oscillator pick-up. Moreover, the low bias makes the tube a good amplifier of the intermediate frequency signal generated. There are other advantages. For example, modulation hum and harmonic generation are minimized.

The Audio Amplifier

There are two intermediate frequency amplifier tubes in the receiver, and three doubly tuned intermediate frequency transformers. There are therefore six tuned circuits, all tuned to a frequency of 175 kilocycles. The construction of the intermediate transformers is similar to that of the transformers described in a preceding issue of Radio World. Each winding is an 800 turn duolateral wound coil and the two of each transformer are loosely coupled to produce a band pass effect.

The detector following the intermediate frequency amplifier operates on the bias principle like the modulator, but in this case the bias resistance R3, is 6,000 ohms. The detector works first into a filter consisting of two .0005 mfd. condensers C11 and C12 and an 800 turn choke coil L6. This coil may be one just like the coils in the intermediate frequency tuner. Note

How to Build a Midget

that the common side of the condensers goes to the cathode of the detector tube. Following the filter is a 250,000 ohm coupling resistance R9, a 0.02 mfd. stopping condenser C13 and finally a one megohm grid leak R10.

The first audio amplifier tube is a 227, the plate of which is fed through a 250,000 ohm resistor R12 which is connected to the highest voltage tap in the B supply. The grid bias resistor R11 should be 2,000 ohms.

The first audio stage and the output stage are coupled by means of an audio transformer T4 which is connected between the plate and the cathode, with a 2 mfd. condenser C14 in series to keep out the direct current.

The output stage contains two 245 tubes. The secondary of the input transformer is split and a 2mfd. condenser C15 is connected between the low potential terminals. Two 20,000 ohm resistors R13 and R14 are connected across the condenser and the junction of the two is joined to the ground lead.

The Power Supply

A power supply is built into the circuit and consists of the power transformer T5 and a rectifier. There is one 2.5 volt winding which serves all the tubes in the circuit with the exception of the rectifier. R1 across the 2.5 volt winding is a Humdinger and is used to balance the circuit for the elimination of hum and R2 is the bias resistor for the output tubes. Its proper value is 750 ohms.

The total rectified voltage maintained by this B supply is

300 volts, sufficient for the bias and plate voltage for the 245 power tubes. The voltage for the plates of the screen grid tubes is lowered to the desired value by a potentiometer R16, which has a total resistance of 250,000 ohms. The voltage for the screens and the plate of the oscillator is dropped to the proper value by resistance R6, which has a value of 15,000 ohms. A resistance R8 of 10,000 ohms is put in the screen lead to the detector to prevent this voltage from being too high.

Volume Control

Two means are provided for controlling the volume. First there is the 250,000 ohm potentiometer controlling the plate voltage on the screen grid tubes and then there is the variable resistance R15, a Tonatrol, by means of which the grid bias on the two intermediate frequency amplifiers may be varied.

There is no choke coil shown in the B supply filter but terminals are provided for the insertion of a choke or two or a complete filter. These terminals are found at the extreme right lower corner of the diagram, Fig. 1.

Compactness was the keynote in the design of this circuit, compactness without crowding. It is built on a chassis measuring 3.5 inches high, 12 inches long, and 10 inches deep. Most of the apparatus is mounted under the sub-panel, only the tubes, the tuning condensers, and the power transformers being mounted on top. Besides the model illustrated, there is another one, using only one push-pull audio stage.

Short-Wave Stations, Additional to List Published Last Week

Frequency	Power	Call Letters	Location	Time	Time	Time	Time	Time	Time	Notes
19,780	15.14	WMI	Deal, N. J.							Phone to GBU, Rugby
19,700	15.2	EAQ	Madrid, Spain							Phone
19,600	15.3	DFA	Nauen, Germany							Phone
19,400	15.45	FRO	St. Assise, France							Phone
19,320	15.5	PCP	Kootwijk, Holland							Phone
19,250	15.57	PPU	Rio de Janeiro, Brazil	4-11 P.M.	3-10 P.M.	2-9 P.M.	1-8 P.M.	12-7 P.M.		Phone
19,100	15.68	PCO	Kootwijk, Holland							Phone
18,900	15.85	XDA	Mexico City, Mexico	5 P.M.	4 P.M.	3 P.M.	2 P.M.	1 P.M.		Phone
18,600	16.12	PDM	Kootwijk, Holland							Phone
18,350	16.32	FZA	Saigon, Indo-China	7-9 P.M.	6-8 P.M.	5-7 P.M.	4-6 P.M.	3-5 P.M.		Phone to St. Assise
18,050	16.6	PCS	Kootwijk, Holland							Sunday
17,520	17.10	G2IV	S.S. "Majestic"							Phone
17,380	17.25	J1AA	Tokyo, Japan							Phone
16,550	18.1	G2AA	London, England							Phone to Ships
16,380	18.3	G2GN	S.S. "Olympic"							Phone
15,760	19.0	EAJI	Barcelona, Spain							Phone to Buenos Aires
15,250	19.67	W2XAL	Coytesville, N. J.							Phone to Ships
13,620	22.14	F8BZ	Paris, France							Phone
13,200	23.00	S.S. "Hamburg"							Phone to Ships
12,830	23.35	Buenos Aires, Arg.							Phone to Spain
12,490	24	G2GN	S.S. "Olympic"							Phone
12,200	24.57	Transfer only							
12,000	24.98	FZR	Saigon, Indo-China	6-7 A.M. 12-1 P.M.	5-6 A.M. 11 A.M.-12	4-5 A.M. 10-11 A.M.	3-4 A.M. 9-10 A.M.	2-3 A.M. 8-9 A.M.		
12,000	24.98	PCR	Kootwijk, Holland							
11,750	25.5	PK6KZ	Makassar, Celebes	7:40-10:40 A.M.	6:40-9:40 A.M.	5:40-8:40 A.M.	4:40-7:40 A.M.	3:40-6:40 A.M.		Phone
11,430	26.52	DDDX	S.S. "Bremen"							
11,100	27.0	Leiningrad, U. S. S. R.							
11,100	27.0	OUIH	Vienna, Austria	6:30-8 P.M.	5:30-7 P.M.	4:30-6 P.M.	3:30-5 P.M.	2:30-4 P.M.		Mon., Thurs.
11,000	27.27	Pozan, Poland	12:30-5:30 P.M.	11:30 A.M.- 5:30 P.M.	10:30 A.M.- 4:30 P.M.	9:30 A.M.- 3:30 P.M.	8:30 A.M.- 2:30 P.M.		
10,800	27.5	PCP	Kootwijk, Holland							
10,700	28.00	VAS	Glace Bay, Nova Scotia							
10,420	28.75	VS6WX	Singapore, Straits Sett.	6 A.M.-3 P.M.	5 A.M.-2 P.M.	4 A.M.-1 P.M.	3-12 A.M.	2-11 A.M.		Phone
10,400	28.8	PLR	Malabar, Java	7-11 A.M.	6-10 A.M.	5-9 A.M.	4-8 A.M.	4-8 A.M.		Phone
10,330	29.0	PCT	Kootwijk, Holland							Phone
10,160	29.47	DHC	Nauen, Germany							Phone
9,840	30.15	RTL	St. Assise, France							Phone
9,860	30.4	EAQ	Madrid, Spain							Phone
9,360	32.0	XDA	Mexico City, Mexico	5 P.M.	4 P.M.	3 P.M.	2 P.M.	1 P.M.		Phone
9,360	32	HB9XD	Zurich, Switzerland							
9,170	32.71	WND	Ocean Township, N. J.							
9,130	32.85	HB9OC	Berne, Switzerland	7:30 A.M.-6 P.M.	6:30 A.M. 5 P.M.	5:30 A.M.-4 P.M.	4:30 A.M.-3 P.M.	3:30 A.M.-2 P.M.		
9,090	33.00	VK3ME	Melbourne, Australia							
8,900	33.70	Poznan, Poland							
8,440	35.54	G2AA	London, England	5-7 A.M. 12:30-6 P.M.	4-6 A.M. 11:30 A.M.-5 P.M.	3-5 A.M. 10:30 A.M.-4 P.M.	2-4 A.M. 9:30 A.M.-3 P.M.	1-3 A.M. 8:30 A.M.-2 P.M.		Sund., Wed. Phone to Ships
8,100	37.0	RV19	Tomsk, Siberia							
7,775	38.56	F8BZ	Paris, France							Phone to Ships
7,500	40.0	EK4ZZZ	Danzig, Free State							
7,310	41.0	PBF5	Hilversom, Holland							
7,190	41.7	VK6AG	Perth, Australia	6 A.M.-12:30 P.M.	5-11:30 A.M.	4-10:30 A.M.	3-9:30 A.M.	2-8:30 A.M.		
6,850	43.75	Paris, France							
6,625	45.21	WSBN	S.S. "Leviathan"							
6,510	46.0	EAR96	Barcelona, Spain							
6,510	46.0	EAR113	Viscaya, Spain							
6,430	46.6	PCM	The Hague, Holland	4-7 P.M. 5-8 P.M.	3-6 P.M. 4-7 P.M.	2-5 P.M. 3-6 P.M.	1-4 P.M. 2-5 P.M.	12-3 P.M. 1-4 P.M.		Sunday Mond., Sat.
6,200	48.3	LON	Buenos Aires, Argen- tina							
6,100	49.17	VQ7LO	Nairobi, Kenya	12-3 P.M.	11 A.M.-2 P.M.	10 A.M.-1 P.M.	9-12 A.M.	8-11 A.M.		Daily exc. Sund.
6,075	49.34	W9XAA	Chicago, Ill.							WCFL
6,075	49.34	W2XCX	Kearny, N. J.							Daily exc. Sund. WOR
6,050	49.5	VE9CL	Winnipeg, Manitoba	7:30 P.M.	6:30 P.M.	5:30 P.M.	4:30 P.M.	3:30 P.M.		CJRW
6,000	50.0	PK2AF	Djocjarta, Java	7:40-10:40 A.M.	6:40-9:40 A.M.	5:40-8:40 A.M.	4:40-7:40 A.M.	3:40-6:40 A.M.		
5,875	51.0	CN8MC	Casablanca, Morocco							Sund., Tues., Wed., Sat.
5,450	55.0	F8BP	Rugles, France	8 A.M.-4 P.M.	7 A.M.-3 P.M.	6 A.M.-2 P.M.	5 A.M.-1 P.M.	4-12 A.M.		

Ballast Resistor Values

By Einar Andrews

Fig. 1
Four different combinations of filaments illustrating the computation of ballast resistors.

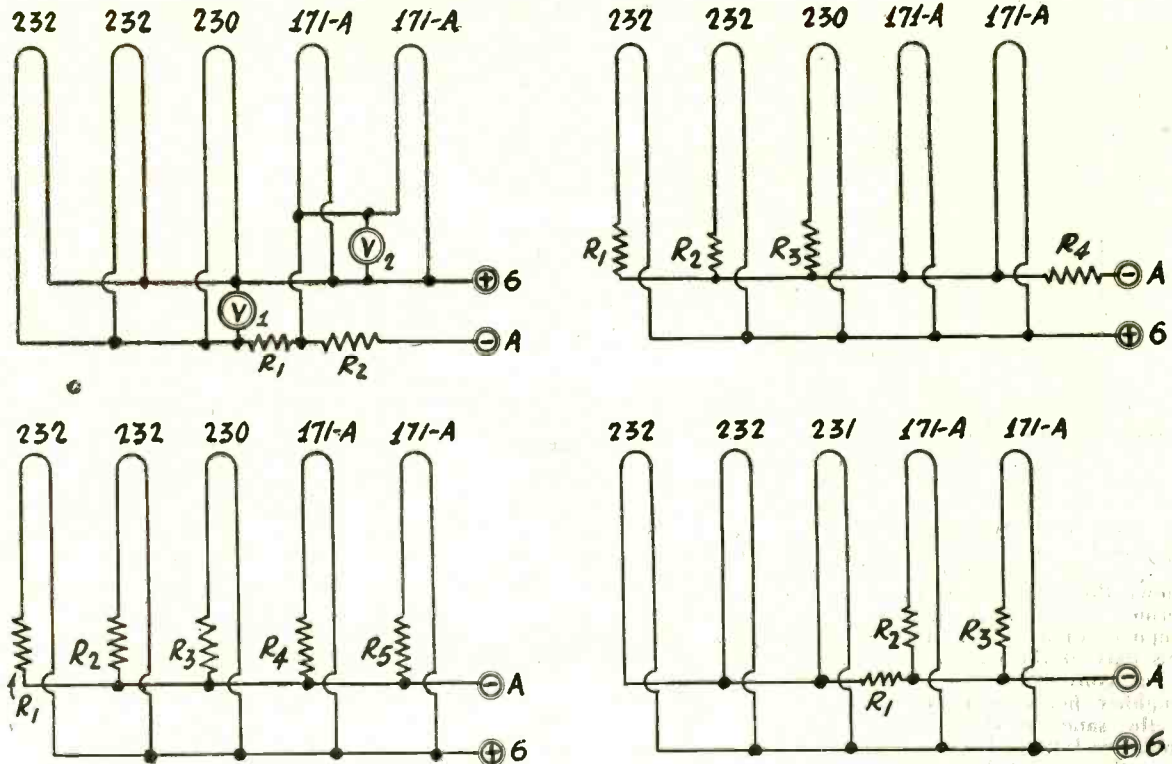

THE computation of ballast resistors for different tubes and combinations of tubes, is somewhat of a problem and many have requested a discussion of the method used for determining the values. When all the tubes are the same with respect to filament voltage, or when each tube has its own ballast, the problem is very simple, but when combinations are used some thought is required to get the right values.

The best way to discuss the problem is to explain typical examples, and therefore we give a number of combinations in Fig. 1. Of the four circuits represented there the first, or the upper left, is the most complex. Here we have three 2 volt tubes, each drawing 60 milliamperes, on one ballast R1, and then we have two 171A tubes on a second ballast R2, through which the current of all the tubes flows. Suppose now that the filament battery voltage is six volts, what should the resistance of R1 be and what should that of R2 be?

We start by determining the current that should flow through R2. Since the current of all the tubes flows through it, and no other current, we get the total by adding up the currents required by the five tubes. The two 171A tubes take 0.5 ampere, one-quarter each, and the three 2 volt tubes take 0.18 amperes, 0.06 each. Hence the total current through R2 is 0.68 ampere.

Next we have to determine what the voltage drop in R2 must be. We know that the 171A tubes require 5 volts across the filaments, and we have assumed that the voltage of the battery is 6 volts. Hence the drop in R2 must be one volt. By Ohm's law we find the resistance of R2 by dividing the voltage to be dropped by the current flowing through the resistance, or $R_2 = 1/0.68$ ohms. This gives 1.47 ohms.

When this has been determined we go to R1. As before we first determine the current flowing through it. We just found it to be 0.18 amperes. Next we have to find the voltage drop in R1. We know that the first three tubes require 2 volts across the filaments, and we also know that the voltage across the 171A filaments is 5 volts. Since these are connected across the same points as the resistance R1 and the other filaments, the drop in R1 must be 3 volts, the difference between the filament voltages of the two different types of tubes, that is, 5 less 2. Hence resistance R1 is $3/0.18$ ohms, or 16.67 ohms.

If these resistances are connected in the circuit voltmeter V1 should read 2 volts and V2 should read 5 volts, provided that the currents drawn by the voltmeters are so small that they are negligible in comparison with the filament currents.

The upper right circuit in Fig. 1 gives a different combination of the filaments of the same tubes. In this case R4 should be determined first. As before the voltage drop in this should be one volt and since the same current flows through it in this circuit as in the preceding, the resistance value should be the same. That is, R4 should be 1.47 ohms, obtained as before by dividing unity by 0.68.

The 2 volt tubes have individual ballast resistances, and since all take the same current and the same terminal voltage,

the ballasts R1, R2, and R3 are the same. The current in each tube is 0.06 ampere and the voltage that must be dropped is 3 volts. Therefore each of these resistances should be $3/0.06$, or 50 ohms. That is just three times as much as resistance R1 in the preceding case.

In the lower left circuit all the tubes have individual resistances and therefore each must be treated separately. However, there are only two different resistances, because there are only two different tubes. The voltage drop in R1 must be 4 volts, the difference between the battery voltage and the filament terminal voltage, and the current is 0.06 ampere. Hence R1 should be $4/0.06$, or 66.7 ohms. R2, and R3 are the same as R1. R4 is also the same as R5, and either is obtained by dividing unity by 0.25 ampere. Thus each of this is 4 ohms.

In the final circuit in Fig. 1 the three 2 volt tubes are put on resistance R1 and the other two are put on individual resistances. R1 in this case is one-third as great as R1 in the preceding circuit, or 22.22 ohms, for the voltage to be dropped in the resistance is 4 volts and the current is 0.18 ampere. R2 and R3 for this circuit are the same as the ballasts for the same tubes in the preceding circuit, namely, 4 ohms each. If the two 171A tubes were placed on the same ballast, the resistance should be 2 ohms.

The 171A tubes can be replaced by any other 5 volt, 0.25 ampere tubes without changing the ballast resistors. These tubes are 201A, 200A, 240, and 112A.

Sometimes it is convenient to connect filaments in series or in series parallel in order to economize on filament power and to avoid a lot of ballast resistors. One method of doing this is illustrated in the upper left of Fig. 2. Here we have the filaments of two 232 tubes in parallel and again the filaments of two 230 tubes, the two groups being connected in series. Then we have a filament of a 231 in series with the others. Each of these tubes requires 2 volts across the filaments and since we have three in series, the total required voltage is 6 volts, which may be supplied either by a 6 volt storage battery or a dry cell battery consisting of four cells in series. No ballast is required in series, since the voltage is just enough.

However, there is a complication. The current required by the 231 tube is 0.13 ampere, while that required by two 230 or two 232 is only 0.12 ampere. If we don't do something about this the four 60 milliamper tubes will get more current than they should have. The excess is very small in this particular case but we might as well provide for it, for in another case, using different tubes, it may be so large as to endanger the small tubes. The excess in this case is 0.01 ampere. We use the resistance R1 to pass this around the other tubes. The value of this resistance is determined by the fact that the voltage across it is 4 volts and the current that should pass through it. We have $4/0.01$, or 400 ohms.

In the upper right circuit of Fig. 2 is a combination in which no resistance at all is needed. Two 222 tube filaments are

(Continued on next page)

Filter Detector

By J. E.

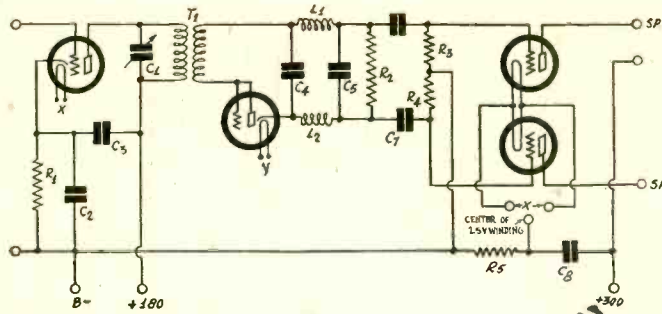

Fig. 1

The circuit of a special type of detector by means of which it is possible to couple it to a push-pull amplifier with a resistance coupler. This is especially suitable for use in a superheterodyne.

LAST week we discussed a 175 kc superheterodyne tuner and showed the construction of the doubly tuned intermediate frequency transformers. Previously we had shown the resonance characteristics of the doubly tuned transformers. Last week we also suggested a possible detector-amplifier of a somewhat different type. We shall now discuss this part of the circuit in detail.

For convenience we reproduce the circuit of the detector-amplifier herewith in Fig. 1. The first tube in this circuit is the same as the final circuit in the tuner of the circuit published last week but in this case it is not used as a detector, as in that circuit, but as an amplifier. For this reason the grid bias resistor R1 should be 2,000 ohms, since the tube is a 227. This resistor is by-passed by a condenser C2, which should be 0.1 mfd. or larger. If the tube is used as detector it should be 2 mfd. or larger. The plate supply is by-passed by a condenser C3, the connection being made to the cathode of the tube.

Tune Primary

The coupling transformer T1 is similar to the doubly tuned transformers except that only the primary is tuned and that the coupling between the two windings is as close as it can be made practically. The tuning condenser C1 is of the midget type just like those used in the doubly tuned transformers, and it has a maximum capacity of 100 mmfd.

The detector in this circuit is of the diode rectifier type, the secondary of T1 being connected in the circuit to supply the signal to be rectified. The object of this rectifier is to permit the use of resistance coupling between this tube and a push-pull audio amplifier, which is made possible by the fact that neither side of the output circuit is grounded, as in the case of other detectors. Ripple of the signal frequency is removed by a filter consisting of two radio frequency chokes, L1 and L2, one in each side of the line, and two by-pass condensers across the line, one on each side of the chokes. The condensers should be of the order of .00025 mfd., while the coils may be ordinary radio frequency chokes, anywhere from 5 to 100 millihenries. If the inductance of each be made high, the high notes will be suppressed from the audio signal, and if they be made small the detecting efficiency will not be so good. Two coils similar to those used in the intermediate frequency tuners are satisfactory.

The Output Magnitude

R2 is a load resistance on the rectifier tube and serves the same purpose as the voltage divider, or rather as the bleeder resistance, in a B supply unit. The principle of this rectifier is exactly the same as that of the half wave B supply rectifier. But R2 also serves as load on the rectifier and thus takes the place of the plate circuits of the receiver connected to the B supply.

The principle of detection by means of this circuit is illustrated in Fig. 2. At top is represented the radio frequency signal wave, assumed to be unmodulated and having an amplitude E. This is impressed on the rectifier tube and results in pulses of current with amplitude I, shown in the second row of Fig. 2. During the half cycles when the plate is negative with respect to the cathode, no current flows through resistance R2. The two condensers C4 and C5 convert the current to the jagged line shown in the third row of Fig. 2. The condensers charge up during the current pulses and discharge during the inactive half-cycles. Hence current flows

all the time through the resistance R2 and always in the same directions.

Chokes Level Current

The chokes level the current still more. That is, they prevent the condensers from charging up and discharging as rapidly or as completely as if the condensers alone were used. With the condensers and the chokes in the circuit, the rectified current through R2 is virtually a steady direct current. This is represented in the last row of Fig. 2, in which the straight line represents the steady current. There may be some ripple present but it will not do any harm, for it is superaudible.

It may be argued that a rectifier that turns out ripple-free direct current is not a detector, since the detected component must contain the current fluctuations of which the audio signal is composed. But we started out by assuming an unmodulated signal. When a modulated signal is impressed on the rectifier the "steady" direct current will fluctuate just as the ampli-

Computing

(Continued from preceding page)

connected in parallel and then in series with the filament of a 120 power tube. The 222 tube takes just half as much current as the 120 and both types may be operated satisfactorily on 3 volts. Therefore the series may be connected across a 6 volt battery without any ballast or shunt.

Line Ballast Computation

In the lower left circuit of Fig 2 a series of quarter milli-ampere tubes have been put on a 110 volt line. Of course, here a ballast is essential. The resistance R of this ballast may be obtained in the following way: Add the filament terminal voltages of the tubes in the series. Then subtract the sum from the voltage of the line, and divide the difference by the current. There are five 5 volt tubes in the circuit and therefore the sum of the voltages is 25 volts. Suppose the line voltage is 110 volts. The difference is 85 volts. Therefore the value of R should be $85/.25$, or 340 ohms.

Tubes cannot be connected in series this way unless all the tubes require the same current. They may have different filament voltages, however. If the current requirements are not the same it is necessary to use shunts to pass the excess current around a tube or tubes drawing less than the others.

6 Advantages Listed

The Type 551 variable mu tube is announced by Arcturus Radio Tube Company, Newark, N. J. This screen-grid tetrode, designed to eliminate to a large extent the defects of the conventional '24 type tube, reduces by a large factor modulation distortion, cross talk and association modulation troubles, and permits partly or wholly dispensing with the precautions necessary to overcome these faults. Double pre-selectors, dual volume controls and the local distance switch are rendered unnecessary when designing a circuit around the 551.

It is claimed that the variable mu permits distortionless operation with signal input voltages approximately 25 times greater than with present-day tubes and extends the range of automatic and manual volume controls by this factor.

Advantages of Tubes

It divides maximum cross talk by 500, and effects a marked reduction in receiver hiss.

Tests conducted with the 551 variable mu in standard receivers have indicated the following advantages:

- (1)—Increase of maximum allowable input voltage for distortionless operation by a factor of about 20.
- (2)—Extension of the range of automatic volume control by a factor of about 20.
- (3)—Reduction of crosstalk by a factor of several hundred times.
- (4)—Improvement in uniformity of control over the entire range of volume control.
- (5)—Reduction of hum on carrier (modulation of carrier in RF tubes) due to incomplete power pack filtering.
- (6)—Reduction in receiver noise. This is brought about in-

r for Supers

Anderson

tude of the signal. The current line in the last row of Fig. 2 will be wavy or undulating.

The effect of the modulation is the same as the effect of gradually rising and falling voltage impressed on the power transformer of a power supply. When the input voltage is 110 volts, the steady direct current in the power supply may be 100 milliamperes, say, and when it is 120 volts the current may rise to 110 milliamperes, and when it falls to 100 the current may be 90 milliamperes. The output rises and falls according to the rise and fall of the input voltage. So with the current put out by the rectifier-detector when the input voltage is modulated.

The useful output voltage is the drop in the resistance R2 caused by the rectified current. If this resistance is high, say one megohm, the voltage across it will be almost equal to the peak of the signal voltage impressed in the circuit by the secondary of T1. This is because the current that flows is extremely small and the resistance is nearly all the impedance

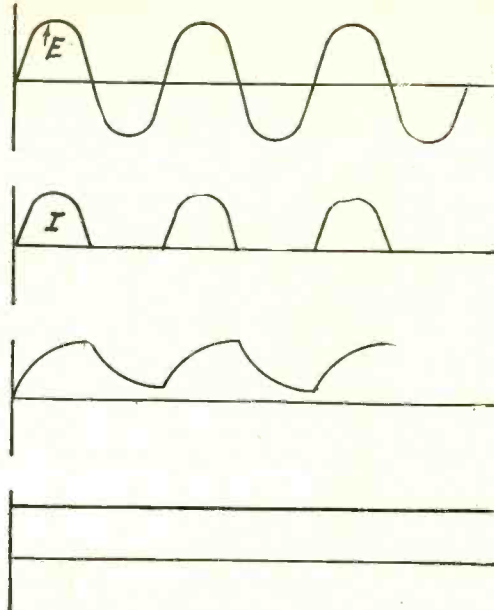

Fig. 2

This shows how the detector in Fig. 1 works and how the filter converts the signal to a direct current, which fluctuates at audio frequency when the signal is modulated.

Ballast Resistors

Suppose, for example, that a 222 tube be substituted for the 240 tube in the series circuit. The 222 takes a current of 132 milliamperes when the voltage across the terminals is 3.3 volts. The difference between .25 amperes and .132 ampere is .118 ampere. A resistance should be connected across the 222 tube filament such that it will pass the .118 ampere. Now the voltage across the tube, and hence across the resistance, is 3.3 volts. Hence the shunt should be $3.3/.118$, or 28 ohms.

In this case the voltage of the series will be less than it was before, since it has been reduced by the difference between 5 and 3.3 volts. Additional resistance should be added to the ballast R and the amount to be added is 6.8 ohms, which is obtained by dividing the difference between 5 and 3.3 by $\frac{1}{4}$. Of course this is so small in comparison with the total ballast resistance that it is not essential to add it, for without it the current would be only 2 per cent greater.

Combining 2 and 5 Volt Tubes

At the lower right in Fig. 2 is a circuit containing the filaments of three 2 volt tubes connected in series across the 6 volt battery and one 112A in parallel. A ballast R1 of 4 ohms is used for the quarter ampere tube and none for the others. The others need no ballast.

for Variable Mu Tubes

directly. In receivers employing double pre-selectors (two tuned circuits between antenna and the first tube) for the purpose of reducing crosstalk the gain in voltage between antenna and first grid is comparatively low with the result that the hiss noise is high compared with the signal. The 551 tubes permit the replacement of the double pre-selector by a single tuned circuit with an increase in gain between antenna and first grid which reduces the hiss noise.

Walter L. Krahl, chief engineer of the Arcturus Radio Tube Company, Newark, N. J., discussing the new 51 tube, said:

"By a special construction of the grid, or controlling element, of this new tube, it compensates for the difference between strong and weak signals. Prior to this, two screen-grid tubes would have been necessary to perform the same function.

Properties Depend on Structure

"The grid is so constructed that the amplification factor of this tube automatically varies with the intensity of the signal.

"It has been found that this tube permits a far greater degree of realistic reproduction than any other tube heretofore developed. Distortion and crosstalk effects caused by high-powered local stations are practically eliminated. Loud signals are received with the same tonal clarity as weaker ones, and the unpleasant garbling of the reception gives way to smooth, distortionless reproduction.

"The type 51 tube is uncanny in its automatic variation of amplification power. Preliminary reports from radio engineers indicate that the variable-mu principle is the most versatile contribution in the art of vacuum radio tubes."

The 551 may be used for a 224.

in the circuit. Incidentally, the high resistance makes the filter more effective because of the low current.

There is a strong direct current component in the current through R2 and only the fluctuations are needed on the audio amplifier that follows. For this reason two condensers of 2 mfd. are placed in the circuit, one on each side of the line. Then two one megohm resistors, R3 and R4, are connected in series across the line and the junction of these resistors is grounded. If it were not for the two series condensers the direct current component would flow through the grid leak resistors and it would not be possible to get the same bias on the two push-pull tubes without complex arrangements.

Due to the high values of the capacities and the high grid leak resistances there is practically no frequency discrimination even as far down as 10 cycles per second.

Signal is Split

The audio signal voltage drop in R3 and R4 is the same in magnitude but opposite in phase, due to the fact that the center is grounded. The grids of the push-pull tubes are connected to the opposite ends so that one-half of the output of the detector is put on one tube and half on the other. Thus we have a means of coupling a push-pull amplifier to a detector by means of a resistance coupler.

The bias for the power tubes is obtained in the usual manner by means of a bias resistor R5, which is not by-passed, connected between ground and the center tap on the filament transformer. For 245 tubes the resistance should be 750 ohms.

No loudspeaker or output transformer is shown because if full advantage is to be taken of the relatively distortionless amplifier and detector, the output should be fed directly to a push-pull speaker, such as the inductor dynamic. It may also be that the output is to be delivered to a neon tube for television reception. If a dynamic speaker is to be used, the output transformer built in should be used. If this has only two leads it will be necessary to use two high inductance chokes for feeding the plates, one being connected on each side of the circuit.

While the bias resistor in the push-pull stage is not by-passed, the plate circuit is, and the condenser C8, which should be not smaller than 2mfd., is connected from the plate return to the midtap of the filament transformer, that is, to the cathode, or positive end of the bias resistor.

It will be noticed that the heaters of the first and the last tubes are marked X, signifying that the same 2.5 volt winding may be used for these three tubes. The rectifier heater is marked Y to signify that a separate winding should be used for this tube, or even a separate transformer. A separate winding is necessary because the voltage between the heater and the cathode would be of the order of 50 volts when the power amplifier is operated to the limit. This might break down the insulation.

A very strong signal is needed to produce a detected signal strong enough to load up the two push-pull tubes when they are of the 245 type. It is for this reason that the first tube in Fig. 1 is used as an amplifier.

A detector of the type illustrated in Fig. 1 is especially suitable for use with a superheterodyne, because the coupling between the last RF amplifier and the detector may be tuned once for all. In a broadcast receiver it would be necessary either to use an untuned transformer or an additional tuning condenser, which would complicate the circuit.

The March "Proceedings"

By Brunsten Brunn

"A RADIO Method for Synchronizing Recording Apparatus," is described by T. Parkinson, University of Michigan, and T. R. Gilliland, Bureau of Standards, in the March, 1931, issue of the Proceedings of the Institute of Radio Engineers. The object of the method is to drive two fading recorders synchronously when one of them is portable and located far away from the other, and when it is not practical to interconnect the two by a wire line. The recorders are operated by clock type synchronous motors on 60-cycle power. One is driven directly from a 60-cycle power line and the other from the received and amplified power of 60 cycles obtained from a lower power transmitter, the carrier of which is modulated by the same 60-cycle power that drives the first motor.

The authors suggest that the scheme may be used in other fields of research, and a similar scheme has already been applied to synchronizing the scanning discs of television transmitters and receivers.

* * *

European Aviation Radio

Gerald C. Gross, Federal Radio Commission, reports on "European Aviation Radio" in a paper which is the result of an inspection trip over the major European airways. European aviation radio may be divided into three major classes, according to the author, (1) Communication from ground to plane and from plane to ground; (2) Point-to-point communications in connection with the traffic dispatching of aircraft, and, (3) Meteorological communications relating to safe flying conditions. The paper describes the type of equipment used for receiving and transmitting on ground and on aircraft and the power and frequencies used are discussed. The present methods of direction finding is given in detail. Short wave communication is still in a highly experimental stage.

* * *

Greenleaf W. Pickard, RCA-Victor Co. of Massachusetts, Boston, contributes a "Note On the Fifteen-Month Period in Solar Activity, Terrestrial Magnetism, and Radio Reception." This contains more evidence for the close relationship that exists among radio reception, terrestrial magnetism and sun spot numbers.

* * *

"Ten Years of Broadcasting," by C. W. Horn, General Engineer, National Broadcasting Co., is a review of the development of radio broadcasting during the decade that has just passed. It begins with the original KDKA transmitter, which opened on November 2, 1920, to announce the election returns in the Harding-Cox contest, and ends with the 200 kilowatt transmitter of the General Electric Co. It points out that improvement in broadcasting services in the future will be in the direction of increasing power of the broadcast stations. Network broadcasting, studio development, outside pick-up, tube development, and other phases of radio are discussed.

* * *

Power and Efficiency of Transmitters

"Measurement of Power and Efficiency of Radio Transmitting Apparatus," by G. Pession and T. Gorio, Rome, Italy, is a paper discussing various methods and results of the measurement of power and efficiency in radio transmitting apparatus. The methods used for measuring the high frequency power are classified as wattmeter, ammeter, calorimeter, and indirect. The direct and indirect calorimeter methods are favored by the authors because of their advantages, which are mentioned.

* * *

Herbert J. Reich, University of Illinois, has developed "A New Method of Testing for Distortion in Audio-Frequency Amplifiers," which he reports in this issue of the Proceedings. "A periodic voltage wave consisting of a series of straight lines is distorted into a series of curves when it passes through an amplifier which gives nonuniform amplification. As such distortion can very readily be detected visually with an oscillograph, it affords a means of testing for uniformity of amplification." The claim for the method is that a falling off in the amplification of less than 1/2 per cent can be detected without difficulty. The method is applicable to any type of amplifier and may be constructed out of parts that are usually found in laboratories. One of the chief instruments is a vacuum tube oscillograph.

* * *

F. B. Llewellyn, Bell Telephone Laboratories, contributes a note on "A Rapid Method of Estimating the Signal-to-Noise Ratio Gain Receiver." It is shown that the limit to be attained in signal-to-noise ratio in a radio receiving set by design of the set is the ratio of the signal to the thermal noise of the input circuit.

"Oscillation in Tuned Radio Frequency Amplifiers" is considered in detail by B. J. Thompson, General Electric Co. "The wide use of screen-grid tubes renders an understanding of the conditions for stability of tuned radio-frequency amplifiers important. In this paper the relation between the feed-back capacity and the other circuit and tube parameters at the threshold of instability is computed for one, two, three, and four stages." A simple relation is worked out for the various cases and the conditions under which it is applicable specified. The mathematical deductions are supported by experimental data.

* * *

"The Design of Radio-Frequency Signal Generators," by J. R. Bird, Massachusetts Institute of Technology, deals with certain factors involved in designing signal generators free from stray voltage errors. The importance of accounting for all circuit details, particularly of wiring elements, is stressed. The impedances of certain connections, particularly of the output connections from the generator to measured receiver, are shown to be important and shielding is considered in some detail.

* * *

High Frequency Impedances

Another contribution from General Electric Co. is a paper on "Measurement of Resistance and Impedances at High Frequencies," by J. W. Labus. The paper is mathematical and deals largely with resistances and impedances of transmission lines at very short wavelengths where ordinary methods of measurement fail. The theory worked out has been tested on grid leaks and units in decade resistance boxes and the results obtained agreed with expectations.

* * *

From Telefunken-Gesellschaft, Berlin, comes a mathematical treatment on the "Calculation of Electric and Magnetic Field Strengths of Any Oscillating Straight Conductors," by R. Bechman. The expressions that have been derived make possible simple calculation of the radiation conditions near the conductor, and are of practical importance in the calculation of radiation characteristics and radiation resistances of any linear antenna arrangements.

* * *

Hajime Inuma, Electrotechnical Laboratory, Ministry of Communications, Tokyo, contributes a paper on "Resonant Impedance and Effective Series Resistance of High-Frequency Parallel Resonant Circuits." Results are given on measurements in the band of high frequencies from 6,300 to 26,300 kilocycles.

* * *

Wave Propagation

"Some Details Relating to the Propagation of Very Short Waves," by R. Jouaust, deals with the laws governing propagation of very short waves and shows they are the same as those governing the propagation of luminous vibrations. However, because of the difference in frequencies, the absorption is less for very short waves than for light, which explains the very great distance traveled by these waves. Communication by means of very short waves have been carried on between points not in direct line of vision and the phenomena of atmospheric refraction seem to account for this to some extent, according to the author.

* * *

James R. Nelson, Raytheon Production Corp., Newton, Mass., contributes a paper on "Grid Circuit Power Rectification." This important paper is of special interest to radio fans and others who design and build radio receivers. Grid circuit power rectification is investigated by studying the ideal rectifier and applying the results obtained to the case of a tube rectifier. Characteristic curves are used in this study to obtain the optimum conditions for rectification and the order of the output voltage is obtained. Conditions for minimum loading of the circuit preceding the detector and audio-frequency discriminations as a function of grid circuit impedances are discussed and experimental evidence is adduced.

Facts that Determine Operation of a Tube

Scientific information about radio tubes which enables radio manufacturers to utilize numerous different forms of tubes successfully are learned through regular laboratory tests of tubes to determine the tube characteristics.

Among the important facts obtained by these are these: amplification factor, or the number of times an impulse is amplified by the action of the tube; plate impedance and mutual conductance.

Midget for Short Waves

By Henry B. Herman

A SHORT-wave midget receiver-adaptor, for ear-phone use or for plugging into a set, was described last week, issue of March 28th. Herewith the battery model is diagrammed.

It was explained that it is necessary to mount the condensers to the sub-panel independent of the dial mounting, unless one drills a center hole through a bracket that is on the condenser. Preferably use a No. 30 drill and tap for 6/32. Otherwise it might be difficult to fasten a nut inside the condenser; in fact, there would be danger of the nut touching the stator plates. Even if the screw is too long this condenser would be thus short-circuited. Therefore if the screw is excessively long, cut off the excess, which may be done by estimating, before the screw is inserted.

Three 0.1 mfd. condensers are used. All three are in one shield case. There are three red leads, each representing an individual capacity. The black lead is common and goes to B minus, while the red leads go to the respective destinations, cathode of RF tube, screen of RF tube and screen of detector tube.

The shielded short-wave coils are regular inductances wound on tube-base type forms. Since the shield has a removable screw top, this top is taken off. A hole is drilled through the center of the coil form at bottom (if a hole isn't there already), so that a screw may be put through this hole and through the shield cover.

It is necessary to drill four or five holes in the removable top, to clear the prongs of the plug-in coil form. If you have UY type forms, with four prongs, use them for the antenna input.

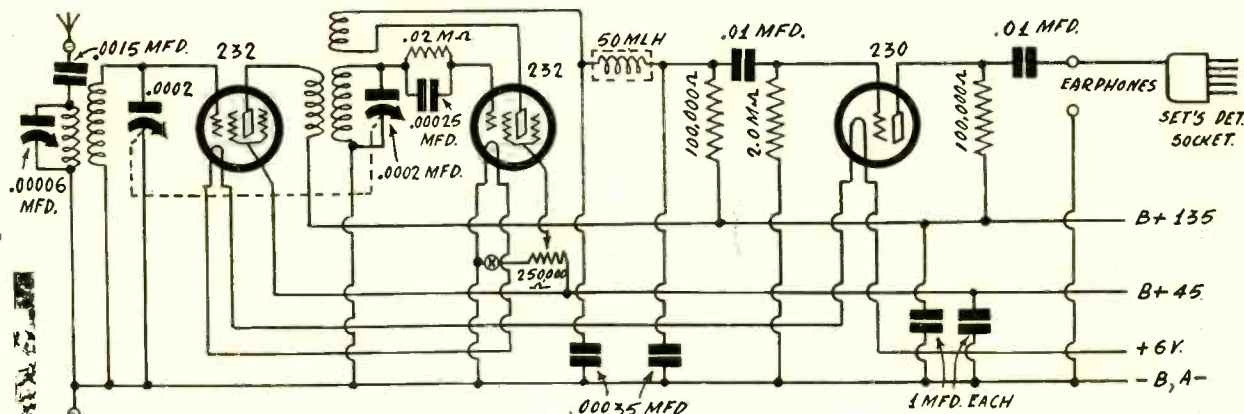

In the UY type follow this code: aerial to cathode prong of coil form; end of primary and end of secondary to heater prong next to the cathode; grid connection of the secondary to grid prong of the coil form.

The winding may be done so that primary starts at top, end of primary adjoins end of secondary, and extreme of secondary, near bottom, goes to grid.

For the other coil, using five-prong type bases, the shield may be used as ground, since a metal chassis is used, therefore only five connecting points are required of the plug or socket, and these may be: cathode of coil prong to plate of RF tube, heater next to cathode to B plus; low end of secondary to the shield, other end of secondary to the grid prong; plate of detector to the plate prong and heater next to plate to the 50 mlh. choke coil.

To effectuate this system, care should be taken that the shield is grounded to the metal chassis. In any circuit the shield must be grounded if it is to be a shield. Here, in the AC model, B minus is ground, as explained, and no external ground connection is to be made. Two phosphor bronze spring clips on the chassis, to grid either side of the shield, will serve connection purpose very nicely.

Plug-in Coils Are Popular

THE plug-in coil system is extensively used on wavelengths under 200 meters. It is convenient for receiving television signals, short-wave broadcasting, amateur code and phone stations and other signals found in the higher frequencies (shorter waves).

The plug-in coil is wound on a suitable form or tubing that is attached to a plug that fits a receptacle. In this way one coil may be withdrawn and another one inserted at will.

This system avoids the need for a separate receiver for each section of the short-wave band. Home radio builders display great ingenuity in the construction of plug-in coils. The bases of old radio tubes are the most popular units for the plug-in system, because a regular tube socket may be utilized as the coil holder.

The glass part of the tube is broken and removed. For the smallest size coils, for 15 to 35 meters or so, the wire may be wound right on the tube base remaining, and small holes drilled into the material serve to pass the ends of the wire through. Contact is made to the prongs very easily by pushing the wire as far as possible into the prong, touching the tip with a hot soldering iron to melt the solder and allow the wire to break through. Then the wire is pulled through tightly before the iron and solder are again applied.

For larger size coils, special wooden, cardboard or composition forms are attached in various ways to the tube bases.

Usually the circuit calls for two windings on the single form or a single coil of wire with a tap or connection near one end, so that only three wire ends are brought down to the base.

One winding is for the tuning, while the other is for the feedback or regeneration.

When still larger coils are made, as for broadcast waves or above, another winding usually is added as an antenna coupling coil, thus using all four of the prongs on the base.

Generally, however, this plan is not suitable for broadcast

work, since the selectivity is not good enough, and unless the set is operated with extreme care, whistling interference will be caused to annoy listeners nearby. Some day, when short-wave reception is as common as broadcast reception today, special sets will have to be developed to avoid the same sort of interference that broadcast reception got into a number of years ago through the wide use of regenerative sets.

So do not look on the short-wave plug-in coil system as a universal receiving system, even though it may be used to some degree of success for broadcast waves.

The larger sizes of tuning condenser required for broadcast waves in itself interferes with the spread of this method of receiving much above 200 meters, for large condensers call for too critical adjustments on short waves.

The above remarks about tuning in broadcast waves refer to short-wave receivers, not to converters, as converters are selective enough in broadcast work.

The April Special!

Next week's issue of RADIO WORLD, dated April 11th, will be The April Special. It will contain 32 pages of most interesting articles on circuits, also latest news of stations, studios and personalities, besides highly interesting advertising, and will have the complete list of broadcasting stations in the United States, by frequencies. This list will give full details, including frequency, wave, call, owner, location, power and time sharers. It requires a weekly magazine to furnish you with an up-to-date list. Tell your newsdealer to reserve a copy for you, or send in your subscription to us, beginning with the April 11th issue, @ \$6.00 for 1 yr., \$3 for 6 mos. or \$1.50 for 3 mos.

The May Special, also of absorbing content, will be dated May 2d. Radio World, 145 West 45th Street, New York, N. Y.

How to Get B Vol

By Her...

FIG. 1
 (A)—B voltage obtained for a converter from the screen of an RF tube in the set.
 (B)—Use of power tube's filament.
 (C)—Plate voltage of first RF tube used, requires killing that stage.
 (D)—Matched coupling with method (C).
 (E)—Rectifier circuit.

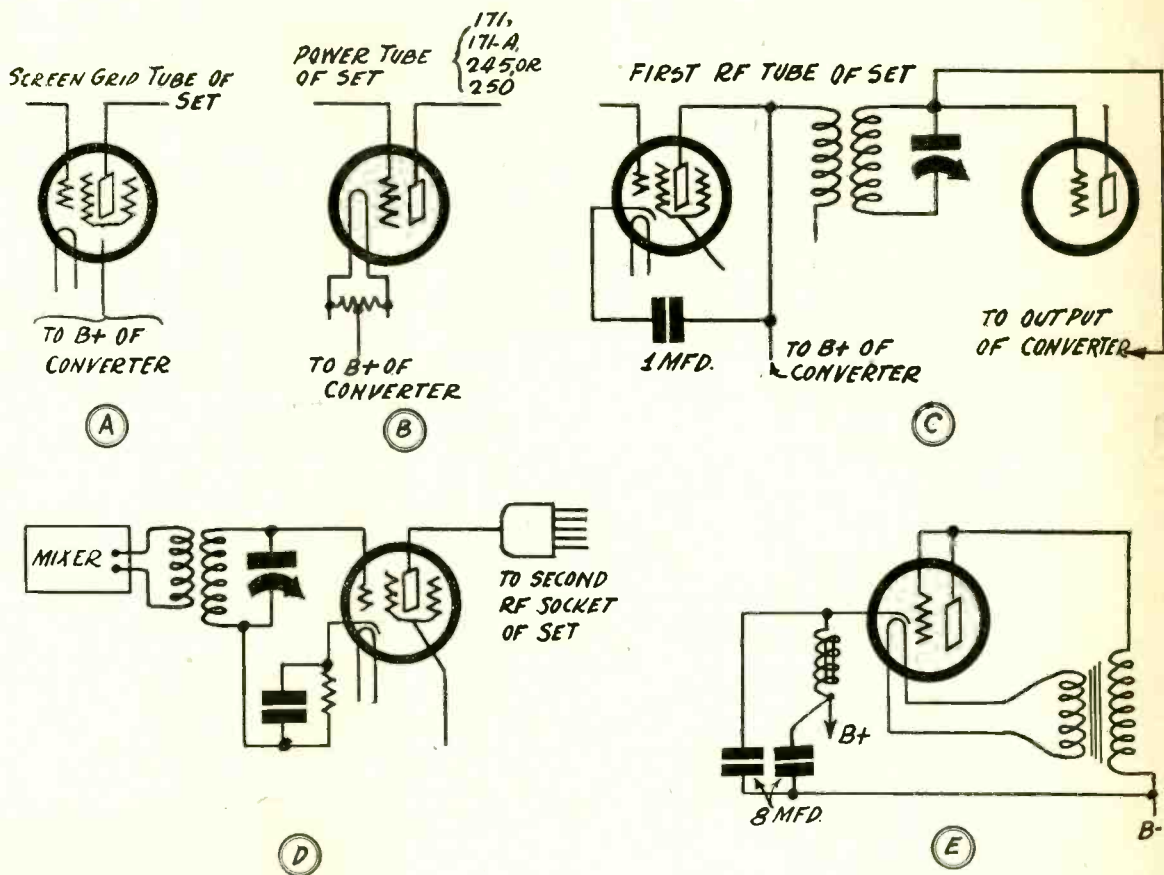

THE problem of obtaining the B voltage from a receiver in connection with which a short-wave converter is worked resolves itself into tapping into the receiver somewhere. Otherwise one has to use independent B batteries or a converter with rectifier built in.

If the receiver itself is battery-operated, of course the B voltage problem is solved, since the batteries are accessible. But in many AC receivers, the sealed-in shield type of construction is used, and one can not readily get at the voltage divider.

Methods Outlined

Then the voltage would have to be obtained from one of the tube connections. The principal methods follow:

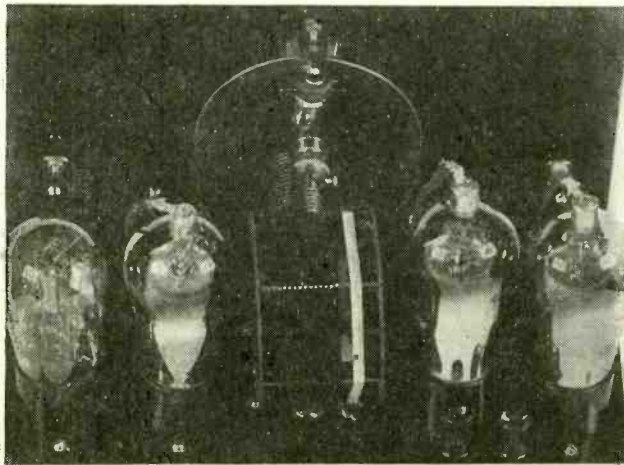

FIG. 2
 The DX-4, an all-wave converter (10 to 600 meters at any intermediate frequency), built according to panel plans published last week.

A. Connection to the screen of a radio frequency tube. This presupposes the presence of screen grid tubes in the receiver. If a series resistor drops some higher voltage to the voltage required for the screens, the system will not work well, if at all, because the converter's B current would flow through the resistor, and the voltage not only to the converter but to the screens of tubes in the set would be too low. Some sets have such a series resistor, but it does not include in the circuit the tube just ahead of the detector, so favor that tube. Loop the bared end of the B plus lead from the converter slip the loop over the screen prong of the tube removed from the set and reinsert the tube in the set.

B. Connection to the center of the power tube's filament. Since all power tubes have a negative grid bias, the filament is positive in respect to ground, or grounded B minus, hence if you pick up the filament center and ground, you pick up the positive voltage. This method is workable only with 171, 171A, 245 and 250 tubes, and the positive B voltage for the converter is equal but opposite in polarity to the negative grid bias voltage of the power tube. The reason for the limitation to these four tubes is that the converter B current (which would include screen current, if any) must flow through the power tube, and other tubes than these will not stand the extra current. In fact, if the converter draws more than 8 milliamperes, the 171, 171A and 245 should be ruled out also, while the 250 will stand 20 milliamperes increase. The bared looped wire method of connection may be used, or a wafer adapter that establishes the same connections. A center-tapped resistor of 30 ohms to 100 ohms, is used, with center serving as B plus. The converter must have a bypass condenser of at least 0.1 mfd. from B plus to B minus, so that the oscillator will oscillate.

C. A new method is one that requires "killing" the first radio frequency amplifying stage in the receiver. The plate has a positive B voltage, and a high one, so that may be used for the converter. However, the plate also has a load on it, usually the primary of a radio frequency transformer. It is well to kill the effect of the primary, and a 1.0 mfd. condenser serves effectively as a short-circuit for this load. Now the plate may be used as the B plus lead to the converter, by the looped bare wire method. The output of the converter now goes to the grid circuit of the second radio frequency tube of the set, which becomes the first effective tube in the receiver.

D. The same method as outlined in (C) may be used with a properly chosen method of coupling, to get rid of any troubles due to poor coupling methods. The mixer is followed by a stage

Stage for Converters

an Bernard

tuned radio frequency amplification built into the converter assembly. The B voltage for the converter is obtained as in (C), but instead of connecting to the grid of the first RF tube in the receiver, a stage of TRF is built into the converter to atone for the stage killed in the receiver, and a cable connector is used to plug into the second radio frequency socket, picking up the plate lead only.

On the other hand, a rectifier may be built into the converter, whereby the primary of the filament or heater transformer is connected with either side to the joined grid-plate elements of a 227 tube, with the other side of the primary serving as B minus. A B supply choke coil may be used, and if it is a small one, then the capacities used for filtration may be large. Electrolytic condensers of 8 mfd. are suggested. In using this rectifier, a series condenser should be in the aerial circuit of the converter, of any capacity from .00025 mfd. up, while no ground connection is made to the converter, since the AC line is itself grounded, and this rectifier system simply requires connection of the AC line across the rectifier and converter.

B Minus in Other Instances

In all converters that do not have this type of rectifier, the ground lead from the set is the B minus lead for the converter. Therefore when the converter ground post is connected with a wire to the receiver ground post, B minus is thus picked up from the receiver by the converter.

Therefore there are only four methods of obtaining the voltage from the receiver: one is by direct connection to receiver's B batteries or voltage divider, and the three other methods by the indirect process of gaining access through the receiver tube sockets. These three are screen of screen grid tubes, plate of the first RF tube, and center of power tube filament.

If you have a converter that requires that the B voltage be supplied, and you have no method of furnishing that voltage from the receiver, since it is an AC set with inaccessible voltage divider, and you don't want to use any of the three substitute methods outlined, you may always connect B batteries, with negative to ground of the receiver, and positive to the B plus lead of the converter. Use two batteries of 45 volts each, in series, for 227 tubes in the converter, and three batteries of 45 volts each, in series, for converters using screen grid tubes. The screen grid models will work from about 50 volts up, but the higher voltage will furnish more kick.

The lower voltage for the screens of screen grid tubes need not prove troublesome, as models embodying these tubes usually have a resistor to drop the maximum voltage to the desired voltage, so the reduction is automatic. The proportion will remain substantially the same, although the applied B voltage may be different in various installations.

Boon to Novices

If the B voltage can not be obtained from the receiver the converter can not be worked, unless external B batteries are used, or a rectifier is built to furnish the B voltage.

If the B voltage is satisfactorily obtained, the converter will work just as well with the supply as furnished, as if a rectifier were built in. However, only with the rectifier type can you be absolutely certain that persons unfamiliar with radio technique you will have no B voltage trouble, since the circuit of the receiver used may not be known to the possessor. A copy of the circuit diagram, however, will be found in one of the service manuals that publish these circuits. If you can gain access to a voltage divider, and are doubtful as to where to tap in, you will have to get one of these books, and be guided by the circuit diagram.

The simple rectifier shown is one that works very well. If the choke coil is of fairly high inductance, say, 15 henries actually, then the filter capacities may be smaller than 8 mfd. each, but it is well to bear in mind that the average converter draws about 15 milliamperes, and that for every 100 ohms of resistance at this current flow the voltage drop is 15 volts. Of course, with all resistance values of this choke coil, as compared with omission of the choke, the total drain will be less, because of the extra resistance, but the choke always drops only a little voltage, and if it has a DC resistance of 400 ohms, you can rely on the drop being not more than 8 volts, which certainly is not too severe.

Converters requiring an external B voltage have been featured in these columns, including the following models: 3-A, for about \$5, requiring also an external filament transformer; no plug-in coils; 3-B, for about \$5, the equivalent battery model, using no transformer; FS, for about \$10, with built-in filament transformer, using tube base type plug-in coils; RC, for about \$10, with built-in filament transformer, no plug-in coils; RC-B, the equivalent battery model; 1-A, for about \$20, using de luxe parts, and three screen grid tubes, with built-in filament transformer and precision plug-in coils; DX-4, for about \$27, using three screen grid tubes and a 227 rectifier, with de luxe parts throughout. Only the 1-A Unit uses two tuned circuits, all the remainder one tuned circuit. Only the 1-A and the DX-4 use screen grid tubes.

Last week diagrams showed the DX-4 front and subpanel dimensions, while text outlined constructional details (issue of March 28th). Herewith is published a photograph of the DX-4, built according to those plans. Four precision type plug-in coils are used in the coil socket, one at a time, to cover from 10 to 600 meters, no matter what intermediate frequency is used (that is, no matter what frequency the receiver itself is tuned to), so full coverage of bands is assured.

Covers 10 to 600 Meters

In regard to the higher frequencies, it is assumed by some that converters as described in these columns work fine over part of the smaller coils, but the oscillator ceases to function over the lower capacity settings of the condenser tuning it. This is a mistake. The oscillator oscillates at all frequencies to which it can be tuned, but as most persons listen in at night, they hear virtually nothing on these higher frequencies (15,000 kc up), because reception is usually obtainable in this region only during daylight. It is one of the short-wave phenomena.

The presence of only one tuned circuit need trouble nobody, since the function of the oscillator is simply to generate frequencies that, when mixed with the desired incoming frequency, produce the intermediate frequency. Hence the oscillator, strictly speaking, has no selectivity. It is simply a frequency generator. The selectivity is derived from the intermediate channel.

Any set, even if only fairly selective for broadcast purposes, will be sufficiently selective for conversion purposes, because for broadcast work it has to meet a situation often demanding 10 kc separation, whereas on short waves a separation of 100 kc is the more likely requirement, and there are a few stations on short waves that transmit a band even 1,000 kc wide.

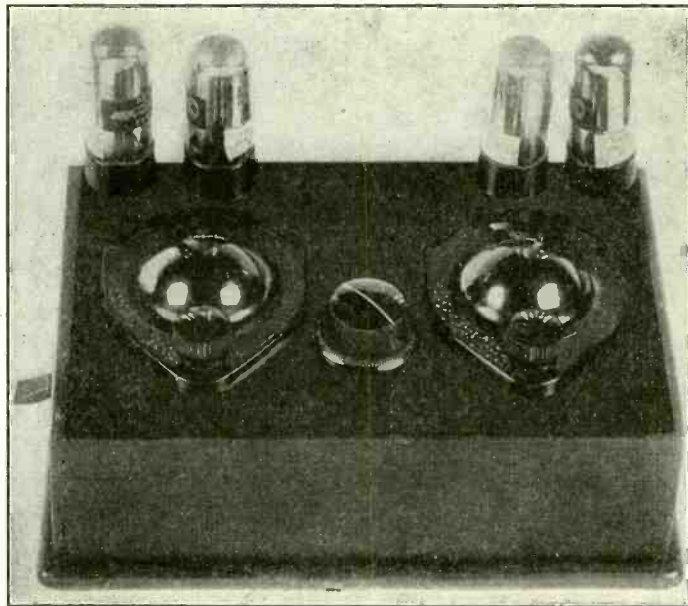

Fig. 3
View of a battery-model converter, using no plug-in coils.

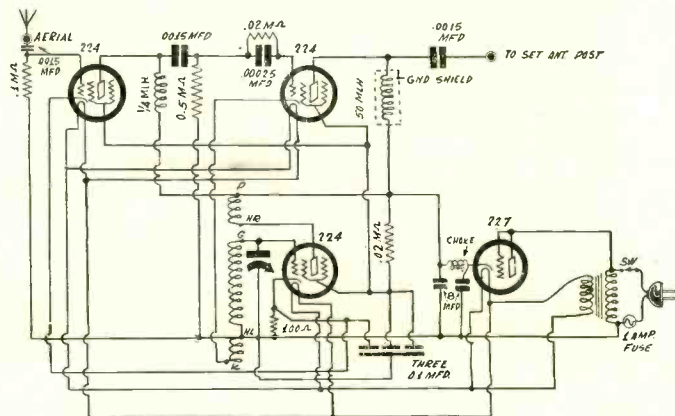

Fig. 4
Diagram of the DX-4, with rectifier built in.

is to be 45 volts, the proper bleeder current to choose is 10 milliamperes, because 45 volts divided by 4,500 ohms gives 10 milliamperes. The next section is determined by adding the current into the 45 volt tap to the bleeder current. Suppose the current to the 45 volt tap is 5 milliamperes. The current in the second section is then 15 milliamperes. If the second tap is to be at 90 volts, the drop in the second resistance section is 45 volts and the resistance should be $45/.015$, or 3,000 ohms. For the third section we have to add the current that flows into the 90 volt tap to the sum of the preceding two, that is, to 15 milliamperes, and so on to the top of the voltage divider. In making the computation care should be taken that some grid bias resistance is not mistaken for the first resistance section. Sometimes the voltage divider unit is split up so that the lowest section is used for grid bias for a power stage. This should not be taken as the first but the count should be from B minus.

* * *

Modulated Oscillator

I AM planning to build a modulated oscillator consisting of two tubes, one for radio frequency and one for audio frequency. The circuit should be such that coils of different inductance can be plugged in for covering a wide band of frequencies. Will you kindly publish a suitable circuit, either in an article or in the University columns?—W. H. G.

In Fig. 905 is a modulated oscillator of this kind. C1 is an ordinary tuning condenser provided with a good dial and T1 is the oscillation transformer which may be of the plug-in type. It has three windings but it may be put on a UX type base since it has only four independent terminals. Ch1 is a radio frequency choke of 50 millihenries and Ch2 is an audio choke of 30 henries. C2 should be a condenser of 2 mfd. or larger and the transformer on the right is an ordinary audio frequency transformer. The circuit is arranged so that the oscillation may be modulated with a microphone, phonograph pick-up, or by oscillation in the second tube.

* * *

Combination of Capacities

HOW do you figure the capacity of three condensers connected so that two are in series and the third is connected across the two? These three condensers are in the tuned circuit and one is a tuning condenser, another is a fixed condenser in series with the tuning condenser, and the third is a trimmer condenser connected across the other two.—J. W.

First find the capacity of the two condensers connected in series by multiplying the two capacities together and then dividing the product by the sum of the two. Then add the capacity of the condenser connected across the two and the result is the capacity of the combination.

* * *

Condensers for Short-wave Converters

ARE midget tuning condensers just as good for short-wave converters as ordinary large condensers as used in broadcast receivers?—V. M.

A midget condenser is just as good as a large condenser of the same capacity. Indeed, it is better because it takes less room and serves the purpose of tuning just as well. As a rule, for short-wave reception a small capacity tuning condenser is better than a large capacity tuning condenser because it makes the tuning less critical. However, a small condenser requires more plug-in coils to cover the short-wave region from 1,500 kc to 20,000 kc or higher.

* * *

Ratio Versus Volume

IN buying audio transformers to modernize my set, would a ratio of 2-to-1 be much worse in volume than one of 4-to-1? It is queer, also, that the higher ratio is less costly.—S. F.

The lower ratio is perhaps the better choice. A high ratio usually means that the primary coil is skimped and has too low an impedance. This may theoretically furnish less amplification, but in actual practise the 2-to-1 of a better type will prove not only better in tone but greater in volume. In modernizing a set, be sure to select good audio transformers, with a wide frequency range.

* * *

Ten Kilocycle Selectivity

HOW can you tell whether or not your set is capable of 10 kc selectivity or a greater selectivity? Is there any meter by which the selectivity may be measured?—L.M.

Take a transmission curve of your set and see whether or not it meets with your definition of 10 kc selectivity. Ten kilocycle selectivity, or any other selectivity expressed in that manner, has no significance. That is why you have to use your own definition of selectivity. There is no meter that measures selectivity directly, but there is a decrement meter, which is nearly the same thing. The proper way is to take the transmission curve.

* * *

Cross Modulation

I AM troubled with cross modulation in my superheterodyne and I should like to know what can be done about it. I can tune in any station with good volume but as I detuned the station disappears and then reappears about 10 divisions away. It is this second response I should like to get rid of if possible.—H. V.

This is not due to cross modulation but is a normal behavior of a superheterodyne. It results from the beating of harmonics.

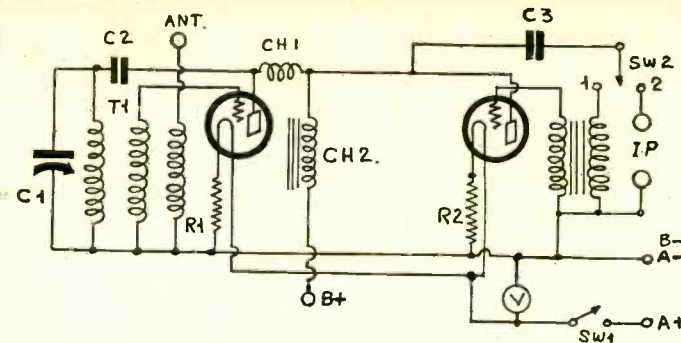

FIG. 905

This circuit consists of a radio frequency oscillator and another tube which may be used either as an audio frequency or oscillator for modulating the output of the radio frequency oscillator.

To eliminate it, reduce the coupling between the oscillator and the modulator, reduce the intensity of the oscillation in the oscillator tube, or reduce the intensity of the input to the modulator from the radio frequency amplifier. Don't attempt to reduce the intensity of the oscillation by reducing the plate or filament voltages on the oscillator, for this will make it worse. Reduce it by reducing the tickler turns or by using a potentiometer across the tuned circuit and putting only half of the total voltage on the grid. Cross modulation manifests itself in the following way: When a given station is tuned in the signal comes in strongly but in the background a second station is heard, usually a strong local. As you tune out the desired station both go out together. The undesired station comes through in the same manner as modulation hum. That is, the disturbance appears only when there is a carrier present and the circuit is tuned to it. The cause of cross modulation is detection in the radio frequency amplifier, usually in the first tube, and the remedy is to tune the circuit sharply ahead of the first tube. Adjusting the bias so that the tube does not detect also helps.

* * *

Use of a Baffle

IS a baffle board always required with a dynamic loud speaker?

No, not when the speaker is purchased already assembled in a cabinet, as that serves as a baffle. If you mean the chassis only, then a cabinet or a baffle board is required to obtain satisfactory tone qualities. Without the baffle or cabinet, only the higher tones will be heard.

* * *

Extending the Range of a Tuner

IHAVE built a radio receiver which is very satisfactory in all respects but one. It does not cover the broadcast band. WMCA comes in at 96 on the dial but the lowest I can go is 230 meters. There are many stations below this that I should like to get once in a while. What can you suggest?—T. M. R.

You either have too small tuning condensers or you have overdone the shielding of the tuning coils. If the condensers are smaller than .0005 mfd. it is practically impossible to cover the broadcast band, especially when the coils are well shielded. Hence if you have .00035 mfd. condenser they are the cause of your trouble. If you don't want to change the condensers you have to extend the range of the tuner by using larger shields over the tuning coils or by partly removing them.

* * *

Screen Grid Versus Space Charge

KINDLY explain the difference between a straight screen grid tube and a space charge tube.—J. Z.

The difference is in the use. The four-electrode tube has a filament, two grids and a plate. In the screen grid system, the control grid (connected to cap at top of tube), is connected as the grid of a three-element tube, and it is the grid nearer the filament. The extra grid, which is nearer to the plate, is connected to a positive tap on the B battery or eliminator or to an adjustable resistor so this voltage may be changed. In the space-charge system, the two grid connections are reversed, providing a system sometimes useful for detection and other uses.

* * *

Result from Screen Grid Tube

I NSTALLLED a screen grid tube in my set instead of a 201A amplifier. The result is not good, because of very bad interference, although the stations come in with fine volume.—C.F.

This is characteristic of screen grid tubes. They are not adapted to circuits intended for 201A tubes, because of the much greater amplification, the circuit not having the selectivity. Use a band pass filter pre-tuner. Screen grid tubes require a succession of stages to obtain satisfactory selectivity and realize on the volume of which they are capable.

SYNCHRONIZED SENDING HELD VAST BENEFIT

Synchronization points the way to the practical solution of major difficulties in broadcasting, said C. W. Horn, general engineer of the National Broadcasting Company, commenting on the synchronization of WJZ, New York, with WBAL, Baltimore, and WEA, New York, with WTIC, Hartford. Part of each day the synchronization is effected, WBAL and WTIC operating on their own wave the rest of the time.

Synchronization, as now constituted in these instances, means the simultaneous operation of two stations on the same wavelength. "The move is revolutionary, since hitherto a separate broadcasting channel has been required for each transmitter, and the knotty problem the new system may eventually clear up is the congestion on American wavelengths," said Mr. Horn.

"There are more than 600 radio stations in the United States," he added, "and only ninety practical wavelengths to divide among them. Part-time operation, regional assignments, limitation of power, and a congested dial for the listener have resulted from the necessity of parcelling out only ninety waves among 600 transmitters.

Each Has Full Time Now

"Synchronization presents a natural solution for this problem. Inauguration of our synchronized schedules with WTIC and WBAL, however, is only the starting point. It will take much further development and adaptation to local conditions to bring synchronization into general use."

Meanwhile, another more immediate advantage has been gained by the synchronization schedule begun last week. WTIC and WBAL, which have hitherto been heard in their respective areas on a part-time basis, are now able to give their listeners full-time service by alternating in synchronization with one of NBC's key stations in New York.

WTIC synchronizes with, and receives programs from WEA, while WBAL broadcasts independently on the wave length of 1,060 kilocycles, which it shares with WTIC by Federal allotment. Then when WTIC ceases synchronizing and takes over the 1,060 kilocycle channel, WBAL, instead of remaining silent, continues to operate by synchronizing with WJZ in New York. In other words, WTIC synchronizes for half the broadcasting day, while WBAL operates independently, and then WTIC broadcasts on the separate channel for the remainder of the day, while WBAL synchronizes.

First Benefit to Regional Stations

The stations which are now operating on the regional wavelengths, Horn believes, may well be the first to benefit from the development of synchronization. At the present there are certain stations throughout the country which operate on the same wavelength because they are spaced far enough apart geographically to permit some sort of service locally. These are the regional stations. To allow such service on the same wavelength without synchronization, their power must be restricted to very low values.

Electron Called Diamond Rater

After a piece of willemite stone has been placed under a Lenard ray tube and bombarded with millions of tiny electrons, it glows and emits light.

This tube is used by Dr. H. M. Eley to make a rough check on the fluorescent quality of new synthetic minerals created by H. M. Kraner, noted ceramist of the Westinghouse Electric and Manufacturing Company.

It is said that an indication of the quality of diamonds may also be obtained in this way.

BAGLEY PASSES 6TH AIR YEAR

The Tower Health Exercises, directed by Arthur Bagley, entered its seventh year recently.

While establishing a record of more than 2,300 broadcasting hours, the equivalent of 12,000 station hours, Bagley has built up a following estimated at 4,000,000 people, who have mailed more than 1,000,000 fan letters.

Bagley reads 400 letters daily. He keeps a force of fifteen secretaries to handle his 14,000 letters each month.

A majority of the mail contains requests for exercise charts, 806,000 of which have been sent out since 1925. More than 890,000 copies of health pamphlets were also mailed during that period, the most popular being "Overweight," with the "Cook Book" running close second and "Rheumatism" third.

Many requests are for exercises designed to reduce the abdomen and hips.

Bagley says he has interviewed more than 10,000 visitors since his broadcasts began.

His day begins with the exercises, followed by breakfast. Then he reads letters during the morning and generally is a luncheon speaker about town. In the afternoon he schedules his "bicycle itinerary" and poems.

Westinghouse's 1930 Business \$180,283,579

The annual report of the Westinghouse Electric & Manufacturing Company shows the following income account for the year ending December 31st, 1930, as compared with the previous year:

	1930	1929
Gross earnings		
Sales billed	\$180,283,579	\$216,364,588
Cost of sales	171,971,118	194,371,987
Net manufacturing profit	8,312,461	21,992,601
Gross income from all sources	11,886,205	27,316,344
Net income available for dividends and other purposes...	11,881,705	27,062,611

Reduction in sales and income in 1930 reflects removal of manufacture of radio sets and tubes, as well as decrease in general business. The net earnings per share were \$4.45. As of December 31st, 1930, unfilled orders amounted to \$40,208,181, which compares with \$62,025,399 for the preceding year. During the year, four quarterly dividends were declared on the common and participating preferred stocks, each at the rate of 2½ per cent. (\$1.25 per share), a total for the year of 10 per cent. (\$5.00 per share).

TUBE CARILLON DEMONSTRATED TO ENGINEERS

The electric carillon, a new musical device which can boom out bell tones louder than the largest bells in Christendom or can tone down these same notes to the tinkle of the chimes in a boudoir clock, was demonstrated by Dr. Alfred N. Goldsmith, vice-president and general engineer of the Radio Corporation of America in an address on "The New Music of Electric Vibrations," before the New York Electrical Society in the Engineering Auditorium, 29 West 39th Street, New York City.

This device, developed under the supervision of C. J. Young, of the RCA Victor Company, Inc., consists, Dr. Goldsmith explained, of a series of small steel chimes, not unlike those of a household clock. These chimes are struck by tiny electric hammers actuated by a keyboard like that of a piano. The tiny tones thus produced are audible only a few inches away but the vibration of the steel chimes is made to create small electric currents in devices like the familiar pick-up used on electric phonographs. These feeble currents then are amplified millions of times by a vacuum tube amplifier and are played to an auditorium audience or from a church tower by means of giant loudspeakers.

Can Be Heard Miles

The operator of this electric carillon not only controls the notes to be played but can vary the volume of the tone from a faint sound, audible only a few feet away, to intensities loud enough to be heard for miles. The device, Dr. Goldsmith said, is a "flexible lion which can be made to sound like a lamb." Runs or trills can be played even more rapidly than on a piano, something never before possible with chimes. These notes may start softly and then be swelled to enormous volumes, another impossibility on any other kind of bell instrument. No great physical effort is required from the operator, as it is for example, when ordinary bells are rung by levers or ropes.

The electric carillon is but one example, Dr. Goldsmith believes, of the enormous possibilities of electric music. The variation of volume is so great, for example, that a flute tone may be played as loudly as a trombone or an organ. By electric control of overtones the instrument can change the tone quality also. "If the musician of the future," Dr. Goldsmith said, "desires to get violin effects but happens to have special ability in playing on a piano keyboard, there is no reason why he should not produce violin tones by this latter means. If, on the other hand, he prefers the technique of bowing a string or pressing buttons or waving his hands and yet desires to produce the tone quality of a trombone, electricity will enable him to satisfy his desires. Even entirely new sounds of kinds previously unknown on earth will be available, Dr. Goldsmith predicted, to increase the richness and flexibility of the electric music of future ages."

Artist Survives This Invention

Dr. Goldsmith disagrees emphatically with those who believe that these electric developments mean the elimination of the artist. On the contrary, he insisted, "the artist and musician will become more important in the future because of the advent of electric music."

FIRST REGULAR RADIO TALKIES SOON TO BEGIN

Eyes are being provided for the heretofore blind radio audience, with the early inauguration of regular programs from the first sight and sound broadcasting studio in New York City. The Jenkins Television Corporation's television transmitter W2XCR and the General Broadcasting System's station WGBS, are co-operating as outlets for the sight and sound studios.

With a corps of electricians and mechanics completing their work on the radiovision studios and television transmitter at 655 Fifth Avenue, New York City, entertainment and enlightenment will soon be projected by sight and sound to the homes of the metropolitan area as well as to other parts of the country.

How to Tune in Both

The W2XCR television transmitter is located in the same building, while the WGBS sound transmitter is located at Astoria, L. I.

Performers will face the radiovision camera in the studio, so that their image may be sent to the television transmitter, while the microphone nearby will pick up the voice or other sound for transmission over wires to the WGBS control room from that point to the transmitter.

Lookers-in will employ a special radiovision receiver for tuning in the pictures, while the standard broadcast receiver, tuned in to WGBS, will bring in the synchronized sound for the complete radio talkies.

Television transmitter W2XCR will operate on a frequency of 2035 kilocycles, or 147.5 meters. It is licensed for an output up to 5,000 watts, so as to cover not only the New York metropolitan area, but also a good portion of the United States.

Starts Early This Month

The new television transmitter will go on the air experimentally early this month. The regular program service will be announced later. In the near future the first combined sight and sound studios in New York City will be on the air each day from 3 to 5 p. m., and for a period during the evening, with regular and entertaining programs, following the short period of experimentation.

The studios will bring leading personalities of the entertainment world, as well as leading men in the public eye, before the combined television camera and broadcast microphone.

Caldwell is Worried Over Low-price Sets

Dangers threatening the entire radio industry, as well as entertainment of the listening public, were the subject of a warning in a talk by O. H. Caldwell, former Federal Radio Commissioner, broadcast over the WEA network.

Mr. Caldwell was deeply concerned over a tendency on the part of some radio manufacturers to sacrifice tone values, and high quality generally, to cater to a low-price market. He holds that this tendency is likely to nullify the great progress made in broadcasting and to deprive listeners of the full benefit of fine, artistic programs.

Television Plan for Opera House

Leopold Stokowski, conductor of the Philadelphia Symphony Orchestra, said: "Television would enable me to offer opera, ballet and drama to all American radio listeners. Modernistic music is often complicated and difficult to understand. Television would smooth the way for popularity of the works of present-day composers. By television I could bring entire operas to the radio audience and synchronize impressions of eye and ear."

Stokowski indicated that plans for the proposed Philadelphia Grand Opera House, to be erected on the new Parkway, include provision for television broadcasting of stage productions, with special lighting effects and radio facilities.

TAYLOR GIVES OPERA COURSE

A series of Sunday afternoon broadcasts to acquaint Americans with grand opera is being undertaken by Deems Taylor, American author-composer, in cooperation with the National Broadcasting Company.

The opera appreciation course, to be known as the Deems Taylor Musical Series, will continue through ten weekly programs with leading opera singers and conductors assisting the composer in chronological explanations and musical illustrations. The programs will be broadcast at 2:00 p. m., Eastern Standard Time, except the last one. Arias will be sung in English.

"My talks are not directed to the opera audience we have today," said Taylor, "but are planned for the average American who never has seen grand opera on a metropolitan stage, nor wanted to, and probably never will see such opera."

The composer of the two most successful American operas, "The King's Henchman" and "Peter Ibbetson," says appreciation of grand opera, in this country, should spread beyond the diamond horseshoe to city apartment, farm, ranch house and tenement.

Opening and closing programs will require forty-five minutes each, all others being half an hour. The time will be divided between Taylor's talks and the musical demonstrations, consisting of excerpts from operas under discussion.

As America's leading opera composer, and as an author and former newspaperman Taylor was selected as eminently qualified to arrange, direct the series and give verbal illustrations in descriptive language intelligible to all.

The complete schedule, after the opening broadcast, follows:

March 29, "Opera in America Today"; April 5, "How Opera Started"; April 12, "Opera is Taken up Socially"; April 19, "The First Reformation and the Two Schools"; April 26, "The Ten-Twenty-Thirty Period of Opera"; May 3, "The Second Reformation"; May 10, "The Revolution"; May 17, "Verdi, Before and After Wagner"; May 24, "Opera After Wagner"; May 31, "American Composers and American Opera."

HOLMES JOINS STEVENS

Harry Holmes, former general sales manager of the DeForest Radio Company, has joined the Stevens Manufacturing Corporation, 42 Spring Street, Newark, N. J., as general sales manager. The Stevens Corporation manufactures Burtex diaphragms for loudspeakers, complete loudspeakers, direct-coupled amplifiers and other sound-reproducing equipment.

ESTIMATE PUTS LISTENER GAIN AT 10,000,000

Despite the wide use of radio and tremendous growth of broadcasting, an estimate today of the Radio Manufacturers Association is that 10,000,000 or more persons will be added during 1931 to the already enormous army of radio listeners.

"Recent surveys," said Bond Geddes, executive vice-president of the association, "indicate prospective sales in 1931 of between 3,500,000 and 4,000,000 new receiving sets. Of these probably 1,000,000 will replace antique radio sets. Calculating four listeners to each radio set, according to the average of recent Government Census Bureau and broadcasters' figures, there will be 2,500,000 to 3,000,000 new purchasers of modern receiving sets and thus about 10,000,000 new listeners.

Midgets An Important Factor

"Many of these will be in rural communities, especially if the Federal Radio Commission, as it is hoped, grants applications of broadcast stations for high power with consequent opening of new markets, especially in the Southern States, and improved reception for other listeners.

"The new and popular midget radio set is an important factor in replacement of antique radios. Late last year a large proportion of radio sales was of midget sets. With business conditions improving, the proportion of console sales is expected to increase, although possibly 50 per cent. of 1931 sales may be of the midget type.

"In the new 1931 radio development, with better sets at lower cost to the public, a popular price receiving set selling under \$100, promises to be an important factor this year.

Wants Modern Sets Used Throughout

"Preliminary Census Bureau figures estimate that about 14,000,000 American families now possess receiving sets. Of these only about 11,000,000 AC, or light-socket operated sets, are estimated to be in use.

"Those radio listeners who do not know the enjoyment of modern radio and modern broadcasting, it is hoped will be induced to discard their apparatus and join the millions enjoying modern radio."

Optimism in Trade

L. P. Naylor, sales manager of Arcurus Radio Tube Company, Newark, N. J., returned from a four weeks' trip to the Middle West and South.

"It is gratifying to note," says Mr. Naylor, "the decided optimism prevailing among jobbers and dealers. This attitude is in sharp contrast to the conditions existing this time last year, when I took a similar trip.

"In the Middle West, the employment situation has considerably improved. This, together with a renewed tendency on the part of the listening public to once again become radio-conscious, is beginning to make itself felt among the radio trade.

"The South, with its textile mills opening up and stepping up capacity, is in a highly optimistic mood. Jobbers and dealers seem to have a new lease on radio life. The consensus stresses the return of good radio business in 1931."

A THOUGHT FOR THE WEEK

ARE crooners over the air at the height of their popularity and success? Some say they are and others assert that the crooned song will be with us just so long as the public attention is not attracted to something more original or of better artistic value. There's one thing to be said for crooning—many a singer has become a high-salaried entertainer in spite of the fact that he hasn't any voice, no musical culture and is expert at nothing except croonology. Give the devil his due, however; the crooner wakes up fewer sleeping infants than do the more talented and lusty-voiced singers before the mike. Proving, perhaps, that every dark cloud has its silver lining. But is everybody interested in clouds?

RADIO WORLD

The First and Only National Radio Weekly
Tenth Year

Owned and published by Hennessy Radio Publications Corporation, 145 West 45th Street, New York, N. Y. Roland Burke Hennessy, president and treasurer, 145 West 45th Street, New York, N. Y.; M. B. Hennessy, vice-president, 145 West 45th Street, New York, N. Y.; Herman Bernard, secretary, 145 West 45th Street, New York, N. Y. Roland Burke Hennessy, editor; Herman Bernard, managing editor and business manager; J. E. Anderson, technical editor; L. C. Tobin, advertising manager.

Remedies for Troubles

THE modern, electrically-operated radio set is a well-made instrument in almost all cases, and as a rule it is comparatively troublefree and dependable. There are, however, certain difficulties that may arise, and it is well for the set owner to know about them, and what he can do to improve his reception.

The troubles ordinarily encountered are hum, interference, noise, insensitivity, poor reproduction.

Hum, quite often noticed, may be caused by one or more defective tubes. In fact, one defective tube is likely to cause a lot of trouble, and a set owner should keep on hand at least one new and tested tube of each of the kinds used in the set. Then he will always have a dependable tube that he can substitute for each of the others, in turn, and prove instantly by this comparison which one, if any, of the tubes has gone bad.

Another cause of hum may be a defective rectifier tube or unit. Where a separate B eliminator is used, hum is often caused by locating this accessory too close to the set. In many cases where hum is due to a poorly filtered eliminator, the addition of extra filter condensers externally will greatly improve matters.

Having electric lamps and wiring too close to the set sometimes causes hum, as would a defective dynamic speaker, which is usually remedied by adding an A filter condenser to the field coil of the speaker.

If the aerial is too large, stations will conflict with each other. Make the aerial as short as will provide you with satisfactory volume from the stations you ordinarily wish to receive. Where the

volume is too great, tone quality will not be good. Another remedy for this is to use a series condenser between the aerial post and the aerial.

Where you live within a couple of miles of a powerful broadcasting station you will have considerable difficulty in listening to other stations. A wave trap will be needed in such cases. Often the broadcasting company recommends these devices, especially within a limited area of the transmitter, so that such listeners may enjoy better radio reception. The improved band pass filter type of wave trap, with two tuned circuits, is especially effective.

Noise is perhaps the most common problem with any radio receiving outfit. If your set is noisy, disconnect the aerial. If the noise stops, you've proved that the source of the noise is outside. If the noise continues, it's in your set or speaker, as a rule.

A common form of noise is a scraping and rasping sound. This is sometimes due to a defective grid leak, which is easily replaced. The volume control device is a very frequent source of noise, because of worn and defective contacts. The noise, in such cases, is always noted when you adjust the volume knob, or even press on it. The remedy here is a new volume control device, easily installed.

Bad contacts are generally noise-causers. Tubes may make poor contact in the sockets, as evidenced by noise when they are moved.

Where the noise is evidently from an outside source, first examine the antenna. Loose joints in the aerial or ground, a bad contact on the water pipe, aerial wire swinging against any object whatever, even other wires touching each other near your aerial, may cause noise. A quite common experience in radio homes is scraping and rattling sounds caused by the BX cable used in the house wiring, touching at various places. The BX cables may cross one another, especially in the cellar, and the touching of the metal casings causes a radio noise, though of course not causing any difficulty as to the electric wiring itself. Such noises are generally loudest when someone walks across the floor.

Noises due to electrical machinery, electric contacts, etc. present a problem. Household devices that cause noise, such as refrigerators, oil burners, vibrators, heating pads, fan motors, etc., may be provided with special filters that will effectively stop such interference. No one should give up on the radio noise problem and imagine that nothing can be done.

Insensitivity is generally controlled in the manufacture of the set, although the user can influence the sensitivity by his choice of tubes for the radio frequency and detector positions. Good tubes have great importance in amplifying the weak radio impulse to a point of understandability. The aerial exerts a considerable effect, too. Make it as high as you can—not too long, however—and keep it well away from other objects like building roofs or walls, trees, signs, wiring and the like. Greater volume will reward such changes.

A power tube that is in good condition, a loudspeaker in good condition, and B voltage of the correct values will help you get better tonal qualities.

RADIO WORLD'S APRIL SPECIAL

and will be dated April 11, 1931. (Out next week). It is planned to publish the May Special during the first week in the month, and to date it May 2.

Thus RADIO WORLD will afford an opportunity to advertisers who use only monthly magazines to be represented in the RADIO WORLD SPECIAL with the added advantage of a twelve-time rate. Those desiring to take advantage of the regular fifty-two time discount of 20% can do so by running a one-inch rate holder for the other weeks of the month.

Our regular rate card in force—and we believe these rates are the lowest in this field. RADIO WORLD at \$150.00 a page and \$5.00 an inch is a wonderful buy.

RADIO WORLD, 145 West 45th St., New York City.

Forum

Tickled With His MB-29

THE effectiveness of RADIO WORLD advertisements has a range without limits, and unaffected by static. In December over the signature of my assistant we ran an ad relative to the sale of my MB29 tuner. Letters came from the North, South, West, and East, and they are still coming. We decided not to sell the tuner, however.

In checking up the tuner, and after making several changes, the peak efficiency was so much increased that the functioning is about all a man would wish in a tuner. Some of the changes made in tuner were: the 60 ohm resistor across the heater filament was replaced by one of 20 ohms, the choke in screen grid circuit was increased to three chokes, the two added ones being bypassed by two .01 mfd., and instead of using a common biasing resistor of 100 ohms, individual ones of 300 ohms, each bypassed by 1 mfd. were used. Now I get KFI at 8.45 p. m.

Easy to Install

The installation of the bypasses is easy, but mounting of the 1 mfd. will require a little study. I finally solved the problem of location by drilling the chassis and strapping the extra 1 mfd. on top of the three condenser housings braded to chassis. The other change made was in the cathode circuit of detector. The auxiliary resistor was removed, using straight power detection. The powers say that the resistor should be 20,000 ohms. J. E. Anderson rightly said that there cannot be any orthodox rule laid down in this respect. I found best results with a resistor of less ohmage.

If this tuner develops a hum when used with the Velvetone, spot the electrolytic condenser in the amplifier.

Fine Sports

I might say that I have found the National group a bunch of fine sports. Dana Bacon of the engineering department is most co-operative in regards to any troubles that may develop with their line of sponsored goods.

I have noted with interest your features of short-wave adapters and converters. The article by Mr. Bacon in December 13th issue was most constructive to the experimenter. I have been successful in short-wave work, and for several years been able to reach stations across the big pond. But I use a full set.

The adapters will cause a great deal of interest, and at less money. I have found out that the whole family as a rule is not interested in the thrill band. They want to listen to the regular broadcasts.

DR. A. S. HUNTER,
Box 311, Durham, N. C.

* * *

Good Results from Converter

IBUILT one of your 4 tube converters and that on the afternoon of March 17th from 2 to 4 p. m. I listened to G5SW, Chelmsford, England. Good speaker volume. The items were a short play; an Irish monologue, a quartette singing Irish songs; and announcing programs for March 18th from Brooklands to be broadcast from London and Manchester; and an hour of dance music from the Winter Garden signed off with the chimes of Big Ben 12 p. m. (4 p. m. here).

H. CROWTHER,
1889 Stride Ave.

New Westminster, B. C., Canada.

HALF OF WORLD SETS IN USE IN UNITED STATES

Washington.

There are about 30,000,000 receiving sets in the world. The United States has about half of them.

There are 1,255 broadcasting stations in the world. The United States has about half of them.

There are about 2,028,000,000 persons in the world. The United States has 122,000,000 of them.

So the United States population is about 10 per cent. of the world's population, but the set and station "population" here is about 50 per cent. of the world's.

These comparisons are drawn from a report by Lawrence D. Batson, radio specialist of the Department of Commerce.

605 Licensed Stations Here

Statistics compiled by Mr. Batson show that there were approximately 650 licensed broadcasting stations outside the United States. Records of the Federal Radio Commission show 605 licensed stations in the United States, with several other stations under construction.

"The position of the United States in station strength is much more effectively presented when population figures are considered," declared Mr. Batson. "This country, with a population of but 122,000,000, has nearly as many stations as the rest of the world, with a population of 1,906,000,000.

Within the United States it is estimated there are some 15,000,000 receiving sets, with other nations together probably having about the same number."

Mr. Batson pointed out that only a year ago records showed that the United States accommodated more stations than were in operation in all other nations. The tendency, he declared, has been toward reducing the number of American stations to alleviate congestion in the broadcast band and eliminate interference to reception. Other nations, which have only begun to appreciate the advantages of broadcasting, now are installing more and more stations.

380,000,000 Sets for Coverage

"To make radio programs available to every human being on earth," said Mr. Batson, "more than 380,000,000 receiving sets would be necessary. There are now, roughly, 30,000,000 sets in use, based on best available information. This estimate is made on the assumption that there are five listeners to each set. Thus, about 150,000,000 people are now equipped with radio receiving facilities.

Along with the world-wide activity in broadcasting, Mr. Batson asserted reports to the Department show a "definite trend" toward the use of high power as the most effective means of reaching the remote listener. In tropical countries, he said, where static is at its worst, strong signals are necessary.

He pointed out that several of the large American broadcasting stations transmit simultaneously on short-wave their regular evening programs for reception in tropical areas. These short-wave programs are received in widely separated areas of the world.

Reports from Germany, England, and Russia, particularly, disclose that more super powered stations, ranging up to as high as 500,000 watts, are being installed, he said. In other European countries, central high-powered transmitters are being installed either to replace or supplement existing stations.

Capital District Leads in Sets

Washington

With an average of more than one radio receiving set to two families, the District of Columbia has a greater "radio population" than any other portion of the country for which statistics have been compiled, the Bureau of the Census, Department of Commerce, states.

Results of the preliminary count, the Bureau states, show that 53.9 per cent of the total number of families have sets. The number of families reporting sets was 67,880.

Similar figures for seven States have been compiled so far by the Bureau. When the analysis is completed, the total "radio population" of the country as of April 1, 1930, will be available, with an approximation of the number of radio listeners.

STATIONS STICK WELL TO WAVE

Washington.

Broadcasting stations are improving in their efforts to keep within the broadcasting bands allotted to them by the Federal Radio Commission, according to W. D. Terrell, Director of the Commerce Department's Radio Division. He commented on the increase in January, 1931, over December, 1930, in the number of stations which have deviated less than 100 cycles from the allotted mark. The Radio Commission ruling permits deviation up to 500 cycles.

The Division, during January, measured at different localities throughout the country the frequencies of 365 United States broadcasting stations. The frequencies of these stations were measured for an aggregate of 7,934 times.

The measurements were taken at various times during day and night and it was ascertained that 54 stations at no time deviated 100 cycles or over and 104 deviated less than 200 cycles. The deviation of 207 stations therefore exceeded 200 cycles.

In comparison with the measurements made during December, the figures for January show a decided improvement. During December 10½ per cent of the stations measured deviated less than 100 cycles, whereas in January 15 per cent deviated under this mark. Those deviating under 200 cycles in December amounted to 19½ per cent, against 28½ per cent during January. The percentage of those deviating over 200 cycles for December was 70 per cent, while January showed a decrease to 56½ per cent.

Each of 800 Rooms Is Wired for Radio

Radio engineers who installed the radio equipment in Cincinnati's new hotel, the Netherland Plaza, introduced innovations. By the equipment in the hotel guests have the choice of four programs from noon to 12 p. m. in any and all of the 800 rooms. The master receiving set in the radio control room in the pent house may be used at will for broadcasting as well as receiving.

The loudspeaker is built into the wall in each guest room, and in the ceiling in the private dining rooms and various public rooms. There is a dial and volume control in each room.

VISION SET AND STENODE TO BE AT TRADE SHOW

Washington

Home television receivers, new types of radio tubes designed to afford increased fidelity of reproduction, and the Robinson "Stenode Radiostat" which, it is claimed, eliminates interchannel interference, probably will be displayed at the radio trade show, at Chicago in June, Federal Radio Commissioner Harold A. Lafount stated on the basis of reports from the industry.

Despite the experimental restriction on television broadcasting, Mr. Lafount said several of the manufacturers are concentrating on the development of a moderately-priced television receiver. Development in the visual art is making rapid strides, the Commissioner declared, and it is predicted by some engaged in the experimental work that television will be practical within a year.

Pentode Coming Forward

The pentode, a five-element tube which has been the subject of much discussion in the industry, may be displayed by certain manufacturers at the show, Mr. Lafount asserted. In the past two years, he said, claims have been made that this tube has been perfected, but it has never been generally introduced in this country. Less tubes per set, with vastly improved quality, are recited as the advantages of the pentode.

More and more superheterodyne receivers are being manufactured, Mr. Lafount declared. He emphasized, however, that the tuned radio frequency type of receiver has by no means been abandoned, and that production for 1931-32 models, is going forward in both lines.

Reports from the industry are to the effect that one or two manufacturers may introduce sets equipped with the "Stenode Radiostat," invented by Dr. James Robinson, British scientist.

With this device it is claimed that existing broadcast channels can be increased threefold at this time, without interference, and that ultimately all channels can be increased a hundred-fold. With the stenode, according to its sponsors, a band only 100 cycles wide is needed for broadcasting, whereas the band now used is 10,000 cycles wide (10 kilocycles), Mr. Lafount said.

Most Engineers Doubt Stenode

Stenode receiving sets, he said, even without realignment of broadcasting station assignments, would permit "sharp tuning" and eliminate interchannel interference, if they measure up to the claims of their sponsors. Engineering opinion is divided, he said, and there is a tendency on the part of most American engineers to discount the theory of the inventor.

As to television, the Commissioner declared that difficulties have been encountered in the manufacture of receivers because there is no standard process of television transmission. Consequently a particular type of receiver is adapted only for the reception of visual transmissions from a particular type of station. In other words, he explained, a television receiver of today, would not be capable of receiving programs of all of the experimental television stations on the air.

Regarding superheterodyne sets, Mr. Lafount, says "The United States Daily," alluded to a statement by Kenneth B. Warner, secretary of the American Radio Relay League, the organization of radio amateurs, warning against indiscriminate buying of such types, and calling attention to the trouble that may result from the purchase of a poorly designed superheterodyne.

VISION FAR OFF, ANDREA FEELS

"Intense public curiosity about television has led to premature hope of its arrival in a practical, commercial form," said Frank Andrea, president of the Fada Radio Company, Long Island City, N. Y.

"Radio owners or prospective owners are particularly susceptible to rumors about the arrival of television," continued Mr. Andrea, "for they are led to believe that television will be a part of the new radio sets. The best technical opinion is quite the contrary, of course—that when and if television does arrive it will of necessity operate in the short-wave spectrum and require separate receiving apparatus. In other words, the sound and sight spectrums will be separate and distinct with different receiving apparatus required for each.

"Translated into common sense this simply means that no one should hesitate to purchase a good radio set now or delay the enjoyment of a fine radio in the vain hope of getting a set next year with television too in the same box.

"While experimental television is already the hobby of a few amateurs who are not critical of results obtained, this is not to be compared with television that would be acceptable to the mass of radio owners as entertainment. As soon as radio surpassed the phonograph in fidelity of reproduction, it achieved enormous popularity, but the public has learned to demand high quality in visual reproduction because of the motion picture and will not be satisfied with crude or inferior reproduction."

DX Reception Fine—in Alaska

Washington.

Alaska is a real paradise for radio fans, according to a report recently received at the National Park Service from Harry J. Lick, Superintendent of Mount McKinley National Park, in that far north territory.

Mr. Lick reports to the Department of the Interior ideal radio reception at park headquarters, situated at an altitude of approximately 3,000 feet. Each day after darkness sets in, it is possible to get stations from all parts of the United States, and Honolulu and Japan are picked up quite frequently. Broadcasts from all these stations are reported as very clear and distinct.

Studio Personalities

Amos In a Real Court

Freeman F. Gosden, the Amos of Amos 'n' Andy, got a real thrill out of a crime suspect "showup" one morning when he visited the Chicago police headquarters.

During the questioning of an assorted line of suspects a colored fellow was signalled out by Chief of Detectives John Norton, who asked his name.

"Amos," replied the suspect.

"Occupation?" continued the detective.

"Ah'm in business with a fellow named Andy," he rejoined.

"What are you here for?"

"Ah stole a fellow's girl," confessed the chap.

None was more astonished than Gosden. However the "show" proved to be a put-up job on the comedian.

* * *

All Amos 'n' Andy

One of the invited men in radio in the eyes of many people is Bill Hay, announcer for Amos 'n' Andy. Fans often say they envy Hay because he knows what's going to happen, but Hay doesn't know any more about it than does the radio audience. Each evening just before going on the air, Amos 'n' Andy hand him the synopsis of the previous day's episode, which he reads—but he never sees the manuscript for the program being broadcast.

Correll and Gosden always write every word of their episodes. No one but themselves ever has been heard in their broadcasts.

* * *

Host Is Timekeeper to Guests

The constant necessity of keeping his watch before him, even at meals, recently caused a bit of embarrassment and much merriment at the home of Alois Havrilla, announcer. The Havrillas had guests for dinner. As they entered the dining room the announcer, by force of habit, took his watch from his pocket and placed it by his plate.

* * *

Stebbens Hears Again

It had been thirty years since George Stebbens had been able to hear any of the many popular hymns he has composed until one morning recently, when he was a studio visitor during the Morning Devotions program conducted daily over a National Broadcasting Company network. As the guest of Arthur Billings Hunt, conductor of the presentations, the octogenarian was given a seat in the control booth. With his ear close to the loud-speaker, Stebbens could hear distinctly the strains of his own music, and a bright smile lighted up his face. Hunt, during

the course of the program, came into the booth to see how his guest was faring, but the composer waved him away. The elderly hymn writer did not want his host to interrupt his complete enjoyment of the songs.

Among the numerous hymns Stebbens has written are: "On a Green Hill Far Away," "Face to Face" and "An Evening Prayer."

* * *

Composes, Babe In Arms

Madame Lolita Cabrera Gainsborg, pianist, whose programs are broadcast over networks, composed her well-known "Lullaby" for the right hand only, with her youngest child in her arms.

"Tommy," says Madame Gainsborg, "cried a great deal when he was a baby. I had to hold him much of the time, and it was practically impossible for me to play."

One day while sitting at the piano with the baby, she had the inspiration for a lullaby for the right hand alone. On a recent radio program she played the number. Letters were received from all parts of the country saying that it was one of the most exquisite selections heard over the radio.

* * *

Signs Dual Personalities

Phillips Lord, interpreter of Seth Parker, recently visited a Buffalo hotel. He put two signatures in the hotel guest book: Phillips H. Lord, New York City, and Seth Parker, Jonesport, Me.

* * *

Writer May Be in Earnest

Raymond Knight, who plays Ambrose J. Weems in the Cuckoo program, believes he is being kidded by the writer of the following letter:

Professor Ambrose J. Weems.

Dear sir (?)

Enclosed find five (5) cents in stamps for which please send me your autographed photograph sworn to before a notary public.

Enclosed in the letter were found two 2-cent stamps intact and one 2-cent stamp cut in half.

* * *

\$10,000 Fiddle a Makeshift

Lou Raderman, violinist, often heard during National Broadcasting Company programs, strolled into the studio recently with a \$10,000 Guarnerius violin tucked under his arm. Raderman's \$25,000 Stradivarius violin was being repaired by a violin trouble-shooter who loaned Raderman the \$10,000 fiddle.

FREE AID TO A NEW JOB!

SITUATIONS WANTED AND HELP WANTED ADVERTISEMENTS WITHOUT COST!

Address: Industrial Dept., RADIO WORLD, 145 W. 45th St., N. Y. C.

SITUATIONS WANTED

YOUNG MAN, 21 YEARS OF AGE, desires position in experimental laboratory, factory or in the broadcasting field, with chance of becoming Radio Operator, commercial class. Over 5 years' experience in radio work, graduate of Carnegie Institute of Technology, Pittsburgh. Will work anywhere in U. S. Start at reasonable salary. Robert Warren Myers, 1911 Carson St., S.S., Pittsburgh, Pa.

YOUNG MAN SINGLE, age 28, free to go anywhere. Two years technical college. Associated with radio since 1921. Short wave and television experience. References and additional information gladly furnished. Jack Fink, 1200-4 Ave. S.E., Cedar Rapids, Ia.

WANTED—Connection with Radio, Radio Tube, Electrical or Sound Equipment manufacturer. Electrically inclined. 5 years' experience servicing Radios. A1 references. With chance for advancement. Address E. C. H., P. O. Box 823, Freehold, N. J.

RESEARCH OR LABORATORY POSITION WANTED by 1929 graduate, BS in EE. Thesis, Vacuum Tubes, used as basis of college lab. manual. Formerly, head instructor in Radio School. Engineer in tube plant, experimental department. Hold radio operator's license, broadcast class. Experienced on motion picture sound apparatus. All references of highest order. Age 25. W. A. Woehr, Geneseo, Ill.

TWENTY-TWO YEARS OLD, graduate of one of country's largest technical radio schools, two years' actual experience in handling receiving and transmitting equipment; also a wireless operator. Have excellent business references. W. H. Carter, Radiotrician, Martin, Tenn.

RADIO SERVICE MAN, AGE 25, with several years experience, and complete modern equipment, would like position as helper to install or service sound motion picture equipment, and public address systems. Have had some experience in this line. Willing to go anywhere. R. M. Turner, P. O. Box 144, Okmuigece, Okla.

Hammarlund's New Intermediate Condensers

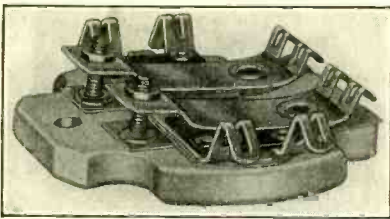

Intermediate tuning condensers, in both dual and single style, for superheterodyne and other similar circuits, are now being manufactured by The Hammarlund Manufacturing Company, 424 West 33rd Street, New York City. These condensers, which are made specially for manufacturers' use, in the single style are known as the "ICS," and in the dual style as the "ICD" type.

The duals are made in two sizes, 1 15/16" for a shield 2" in diameter, and 2 3/8" for a larger size shield. The single condenser base is 1 15/16" by 1 3/4". They are made in capacity ranges of 10 to 70 mmf.; 70 to 140 mmf., and 140 to 220 mmf.

To afford absolute stability, specially conditioned Isolantite bases are used. This material is treated immediately after withdrawal from the kilns, making it impossible to absorb any moisture. Each base is individually tested for volume resistance and only those showing infinity resistance are acceptable. The mica dielectric films are of the best quality obtainable. About four out of every five are rejected in the rigid inspection required in the selection of films of the necessary quality.

The temper of the phosphor bronze flexible plate is controlled by scleroscope to insure uniformity of minimum, maximum and rate capacity increase.

The adjusting screws are not the usual rolled thread machine screws. Instead, they have cut threads and a tapered self-aligning head. There are, therefore, no "thin at the top" threads to "give" under tension or vibration and upset the capacity adjustment.

Two eyelets prevent shift and permanently fix the position of the brass plate.

New Corporations

Traul Radio Co.—Atty. S. I. Shapiro, 51 Chambers St., New York, N. Y.
Premier Radio Corp.—Atty. C. Planick, 19 Cedar St., New York, N. Y.
West Radio Co.—G. J. Cohen, 258 Broadway, Brooklyn, N. Y.
Radio Spot Time, radio broadcasting—Attys. Rosenberg, Goldberg & Colin, 165 Broadway, New York, N. Y.

50-Cycle Limitation Proposed by Board

Washington.

Reduction in the permissible frequency deviation of broadcasting stations from the present limit of 500 cycles to 50 cycles, as a means of reducing interference, is proposed by the Federal Radio Commission.

Before acting on the proposal, the Commission designated an informal hearing for April 20th to obtain information as to whether existing regulation should be repealed.

The Commission also announced that oral arguments in the high-power case, requested by a number of the parties to the controversy for the maximum power of 50,000 watts, would be heard on April 14th before the Commission. Argument will be heard by zones.

Literature Wanted

Readers desiring radio literature from manufacturers and jobbers concerning standard parts and accessories, new products and new circuits, should send a request for publication of their name and address. Send request to Literature Editor, RADIO WORLD, 145 West 45th Street, New York, N. Y.

Henry H. Esterly, Sally Ann Furnace, Pa.
Jos. P. Hiatt, Radio, 1315 North "A" Street, Richmond, Ind.

Frank Novak, 2401 S. Troy St., Chicago, Ill.
Albert Minder, Box 134, Pawnee, Ill.
Reed Barton, 1718 Ridge Ave., Coraopolis, Pa.
Maurice Cantin, 516 Gordon Ave., Verdun, P. Q., Canada.

Geo. W. Lowry, New & Used Radios & Repairs, 1863 Harrison Ave., Butte, Mont.
Fred Kellerman, 204 Grove St., Brooklyn, N. Y.
Henry C. Cassidy, Wakefield, N. Y.

Kenneth M. Rouse, 325 University Ave., N. E., Minneapolis, Minn.
John F. Stroben, Exeter, Calif.

R. D. McDonald, P. O. Box 442, Trail, B. C., Canada.

S. N. Olson, 1326 W. 102nd St., Cleveland, Ohio.

A. S. Adler, 334 Cherry St., W. Homestead, Pa.
William Dennison, 250 Aberdeen Ave., Wayne, Pa.

Hayes Electric Works, 6 E. Cucharras, Denver, Colo.

Hayward MacDonald, 202 Caledonia Mines, Glace Bay, N. S., Canada.

Geo. H. Dannett, 4501 Park Heights Ave., Baltimore, Md.

H. C. Shaw, 630 Douglas Ave., Portsmouth, Va.
Don La Fleur, 46 Williams St., Northampton, Mass.

Charles Cord, 33 College St., Danville, Ill.

N. J. Young, 619 Cedar St., Allentown, Pa.

W. H. Melaney, 5357 Broad St., Pittsburgh, Pa.

Louis A. Storm, 3200 Linwood Blvd., Kansas City, Mo.

Jolley's Radio Shop, R. B. Jolley, Prop., Box 323, Valdosta, Ga.

D. W. Mooney, 2572-14 West, Seattle, Wash.

F. W. Fox, 1332 Burrard St., Vancouver, B. C., Canada.

Frank H. Watson, Coffee, Trinity Co., Calif.

H. M. Goodrich, Graduate Radiotician, Box 1301, Ft. Lauderdale, Fla.

L. A. Bisbing, 723 North St., E. Mauch Chunk, Pa.

Arthur E. Lowe, 814 Hereward Road, Victoria West, Victoria, B. C., Canada.

Elmer L. Warner, Export, R. No. 2, Pa.

E. Alcock, 609-9th St., Lyndhurst, N. J.

P. B. Kehoe, Kehoe Electrical Co., 818 W. 2nd St., Fort Myers, Fla.

Irving Cohen, 2746 W. 5th St., Brooklyn, N. Y.

J. M. Zalkind, P. O. Box 615, Oklahoma City, Okla.

Reed Barton, 1718 Ridge Ave., Coraopolis, Pa.

Roy S. Lamson, Wadena, Minn.

A. L. Rohl, 4640 North Colfax Ave., Minneapolis, Minn.

Frs. Coupal, Brebeuf, Co. Terrebonne, P. Q., Canada.

James Burdett, 527 Hood St., Waco, Tex.

Wm. H. Bockman, 1586 O'Farrell St., San Francisco, Calif.

Andrew Gilmore, 3871 1/2 Lankershim Blvd., North Hollywood, Calif.

Robert P. Millan, 2615 Clifton Ave., St. Louis, Mo.

David Dodson, Eldorado, Pa.

Israel Horowitz, 555 Dahill Road, Brooklyn, N. Y.

Sr. Luis del Pozo, Necochea 1396, San Fernando, Argentina.

Utah Counts, Cleveland, Va.

H. E. Dansereau, 5153 Music St., New Orleans, La.

J. Thos. Pitts, 2124 Kenmore Ave., Charlotte, N. C.

Wm. H. Kurtz, Newside, Pa.

Everett Sound Machine Works, 2802 Norton, Everett, Wash.

H. Caldwell, 920-58th St., Brooklyn, N. Y.

C. F. Dunmore, Route 17A, No. Postal Annex, Boston, Mass.

Dr. C. W. Smith, 509 Savings & Trust Bldg., Butler, Pa.

K. C. Stewart, 401 E. Goodwin Ave., Victoria, Tex.

N. J. Voorhees, 58 High Ave., Terryville, Conn.

C. E. Darrow, 4228 Westminster Pl., St. Louis, Mo.

Jas. B. Hager, 215 Ind. Ave., Wichita Falls, Tex.

A. Van Derbeek, 3 Verdun St., Plainfield, N. J.

E. R. Renfro, Box 43, Farmersville, Tex.

Albert E. Savoy, First Nat'l Bank Bldg., Cincinnati, Ohio.

John B. Daniels, 68 Richdale Ave., Cambridge, Mass.

Forest W. Horton, U. S. Engr. Dept., aboard Col. A. M. Miller, Pier No. 18, Galveston, Texas.

Alger Johnson, 2807 Bay Avenue, Hoquiam, Wash.

Readrite Announces New Set Analyzer

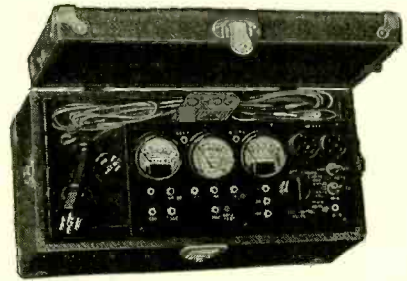

A new set analyzer, which meets the requirements of the average service man, has just been placed on the market by the Readrite Meter Works, Bluffton, Ohio. The model 700 Readrite Set Analyzer is an extremely compact device. The outside dimensions of the carrying case are only 10 3/4 in. by 7 3/4 in. by 3 3/4 in. The analyzer contains a DC voltmeter, an AC voltmeter and a milliammeter. The DC voltmeter has three ranges: 0 to 60, 0 to 300 and 0 to 600 volts. Normally, the instrument is connected on the 300 volt range. By pressing a push-button, it can be changed to the 60 volt range, or by flipping a toggle switch, it can be transferred to the 600 volt range.

The AC voltmeter has three ranges of 0 to 10 volt, 0 to 140 volts and 0 to 700 volts. The normal operating range is 0 to 140 volts. A push-button switch is provided for the 10 volt range. The 700 volt range, for external measurements, is obtained through a conveniently market jack. The milliammeter has two ranges, one for a 20 mil reading and the other for 100 mls. Either range may be obtained as desired, depending upon the position of a double-throw toggle switch.

The new Readrite Set Analyzer is equipped with a six-position bi-polar selector switch, by means of which readings may be obtained of C volts, C volts reversed, K volts, K volts reversed, plate voltage, and screen grid control voltage. A 4 1/2 volt battery is supplied with the analyzer for providing C bias, for grid tests, continuity tests, etc.

There are two sockets on the panel of the analyzer, one for four-prong tubes and the other for five-prong tubes. There are two grid test buttons. One of these is for screen grid tubes and one for other types of tubes. Pin jacks are available for the individual use of all meters, externally, in every range. There is a screen grid jack and there are two other pin jacks for connecting the external 4 1/2 volt battery.

The No. 600 contains the same equipment as No. 700. The carrying case is larger with leatherette covering and equipped with lock. Room is provided for carrying tubes, tools and supplies. The test equipment and panel is in a removable tray in the top of the case. The tray equipment may be used separately as a complete test panel for shop purposes. Size 14 1/2 x 7 x 7 1/2.

NEW SYMPHONY ORCHESTRA

Already a noted musical center, Rochester, N. Y., has added another symphony orchestra to its roster of musical groups. Samuel Sherman A. Clute organized the new group especially for broadcasting. The Rochester Concert Orchestra makes its bow, under the direction of Clute, in a special Good Friday program, over an NBC-WJZ network from Rochester, Friday, April 3, at 5:15 P. M., Eastern Standard Time.

RADIO WORLD'S MONTHLY SPECIAL

The publishers of RADIO WORLD, believing that the time is ripe for such a move, this conclusion resulting from a careful survey of the radio publishing field, have decided to issue each month a special magazine edition. It will not be an additional or separate issue, but will be published as a unit of RADIO WORLD'S regular series of fifty-two issues a year.

The first in this monthly series will be

POLO

SHORT-WAVE CONVERTERS

All parts for DX-4, triple screen grid, with 227 rectifier (less tubes, less cabinet), order Cat. DX-4 @ \$26.00
 All parts for two-tube model, RC (less 227 tubes, including cabinet), order Cat. RC @ \$10.00

POLO ENGINEERING LABORATORIES
 125 West 45th St., New York City

Bristol Double Button Microphone Transformers

An excellent input transformer for all standard microphones. Primary impedance is 100 ohms per button. Use one side for single button mikes. This un-cased transformer is equal in efficiency to others selling at many times our special low price of..... **\$1.95**

FREE Send NOW for a copy of our latest Bargain Bulletin **FREE**
HARRISON RADIO CO.
 189 Franklin St., Dept. "W," N. Y. City

Three 0.1 mfd. in One Case

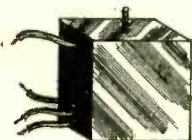

Three Supertone non-inductive fixed condensers of 0.1 mfd each, (250 v.) in steel case, provided with a 6/32 mounting screw, built in. The black lead is common to the three condensers, the three red leads are the other sides of the respective

capacities. Size, 1 1/2" square by 3/8" wide. Order Cat. SUP-31, list price, \$1.00; net price, 57c.

GUARANTY RADIO GOODS CO.
 143 West 45th St., New York, N. Y.

Save Money on Tubes!

Get a Guarantee Just the Same!

QUANTITY tubes at enormously reduced prices enable you to save money and obtain full satisfaction. Any tube will be replaced on request within thirty days of its sale!

These tubes are made by a manufacturer of national reputation and are not "distress merchandise." No tube is shipped until it is carefully checked on a Readrite No. 9 Radio Test Kit.

Type	List Price	Your Cost	Type	List Price	Your Cost	Type	List Price	Your Cost
<input type="checkbox"/> 201A	\$1.25	49c	<input type="checkbox"/> WD-12	\$3.00	59c	<input type="checkbox"/> 245	\$2.00	59c
<input type="checkbox"/> 226	1.75	49c	<input type="checkbox"/> 171A	2.25	59c	<input type="checkbox"/> 280	1.90	59c
<input type="checkbox"/> 199-UX	2.50	59c	<input type="checkbox"/> 171AC	2.25	59c	<input type="checkbox"/> 224	3.30	59c
<input type="checkbox"/> 199-UV	2.75	59c	<input type="checkbox"/> 112A	2.25	59c	<input type="checkbox"/> 222	4.50	95c
<input type="checkbox"/> 120	3.00	59c	<input type="checkbox"/> 227	2.20	59c	<input type="checkbox"/> 281	7.25	95c

250, List \$11.00, your cost, 95c.

[Remit with order for tubes and we pay postage]

DIRECT RADIO CO.

143 West 45th St., New York, N. Y.

DOUBLE RANGE POTENTIOMETER; made by Centralab, designed for volume control. 10,000 and 20,000 ohms. Price, \$1.05. Guaranty Radio Goods Co., 143 W. 45th St., New York.

"RADIO TROUBLE SHOOTING," E. R. Haan. 328 pages, 300 illustrations, \$3. Guaranty Radio Goods Co., 143 W. 45th St., New York.

PARTS FOR BERNARD'S DIAMOND MIDGETS

3-tube AC tuner, less B supply, complete parts as specified by Herman Bernard. Pre-selector tuning, space-wound shielded coils, aluminum chassis drilled for socket holes. High sensitivity. No cross-modulation. Adequate selectivity. All parts (less tubes, less front panel) order Cat. DHST @ \$17.28

AC tuner, with B supply built in, using 227 as rectifier; two 224 RF tubes, 227 detector. Same circuit as DHST, except that special rectifier circuit is added, so that tuner may be worked with audio power amplifier that provides no external voltage. All parts (less tubes, less front panel) order Cat. DHBT @ \$21.82

Complete AC receiver, with the same tuner as the others, but with three-stage audio, with 245 output. All parts fit on a 12" wide x 9 1/2" front-to-back chassis, with elevating flap 3" high. Filtration perfect (24 mfd. used). Requires two 224, three 227, one 245, one 280. All parts (less tubes, less front panel) order Cat. DACR @ \$31.09

Battery-operated tuner, using two 232 RF and one 231 tube (new 2-volt type), affording same sensitivity and selectivity as either model AC tuner. Just the thing for those whose homes have no electricity. Supplied with cable connector plug for extreme convenience in connecting batteries. All parts (less tubes, less front panel) order Cat. DBTU @ \$16.94

The complete battery-operated receiver, six tubes (two 232, three 230, one 231). All parts (less tubes, less front panel) order Cat. DBB @ \$23.91
 Note: All models use same front panel. Supplied in bakelite, 7 x 12 inches, drilled for REL dial, volume control and switch, to coincide with chassis. Order Cat. DFP-Black, or DFP-Walnut @ \$1.62

GUARANTY RADIO GOODS COMPANY, 143 WEST 45th STREET, NEW YORK, N. Y. (Just East of Broadway)

Quick Action Classified Ads

Radio World's Speedy Medium for Enterprise and Sales

7 cents a word—\$1.00 minimum—Cash with Order

TRANSFORMERS—700 V. C. T. secondary; 2-2.5 V.; 1-5 V. windings \$6.00. Special made. Radio Power, 1028 Forest Road, Schenectady, N. Y.

FILAMENT TRANSFORMERS, 1 1/2, 2 1/2, 5, 7 1/2 volt, center tapped. State voltage wanted. \$1.15 each. V. C. Cook, 3406 Frederick, Detroit, Mich.

ATWATER-KENT HORN UNIT, \$1.95 postpaid. For use in home or portable, 108-inch tipped cord; 1 1/2 lbs. weight; size 3-inch height; 1-inch diameter. Guaranty Radio Goods Co., 143 West 45th St., N. Y. C.

SHORT WAVE STATIONS BY FREQUENCIES—with schedule of hours on the air given for the five time zones. This valuable information appeared in Radio World dated March 28, 1931; mailed on receipt of 15c in stamps or coin. Or send your subscription starting with this issue. Radio World, 145 W. 45th St., N. Y. City.

"A B C OF TELEVISION" by Yates—A comprehensive book on the subject that is attracting attention of radioists and scientists all over the world. \$3.00, postpaid. Radio World, 145 West 45th St., N. Y. City.

"FORD MODEL 'A' CAR." Its Construction, Operation and Repair. By Victor W. Pagé, M.E. 545 Pages, 251 Specially Made Engravings. \$2 postpaid. Radio World, 145 W. 45th St., N. Y. City.

A-B-C- POWER PACKS 110 volt, 60 cycle, for sets using 1 1/2, 2 1/2 and 5 volt tubes or for electrifying battery sets. Packs are well made, filtered with Potter Condensers and are remarkably free from hum. Complete with 280 tube, \$6.25. Cash Radio, 1013 N. McDonel St., Lima, Ohio.

FILAMENT TRANSFORMER FOR SERIES OPERATION, new Radio World circuits, \$2.50. Apfelbaum, 2711 Girard Ave., Philadelphia, Pa.

NEW PHILCO 96, 1931, A.C. 9 Tubes, Highboy. Cost \$189.00. Sell \$85.00. E. A. Fountain, 436 E. 138th Street, Apt. 5L, New York.

BARGAINS in first-class, highest grade merchandise. Phono-link pick-up with vol. control and adapter, \$3.32; four-gang .00035 mfd. with trimmers built in, \$1.95; .00025 mfd. Dubilier grid condenser with clips, 18c. P. Cohen, Room 1214, at 143 West 45th Street, N. Y. City.

"HANDBOOK OF REFRIGERATING ENGINEERING", by Woolrich—Of great use to everybody dealing in refrigerators. \$4. Book Dept., Radio World, 145 W. 45th St., N. Y. City.

SOUND PICTURES TROUBLE SHOOTER'S MANUAL, by Cameron and Rider, an authority on this new science and art. Price \$7.50. Book Dept., Radio World, 145 W. 45th St., N. Y. City.

"MATHEMATICS OF RADIO"—A great help to everybody interested in radio. \$2 postpaid. Radio World, 145 W. 45th St., N. Y. City.

BALKITE A-5 RECEIVER, eight-tube, three stages of Neutrodyne RF and two stages audio with push-pull output. Good distance-getter and very sensitive. Has post for external B voltage for short-wave converters. Brand new in factory case. Berkey-Gay walnut table model cabinet. Price \$35 (less tubes). Direct Radio Co., 143 West 45th St., New York.

MAJESTIC, RADIOLA, etc. Drum Dial Cable by foot or mile. Service men's test prods, 50c, 75c, \$1.00. Blan, the Radio Man, Inc., 89 Cortlandt St., New York.

"A DISCUSSION OF RADIO TUBES FOR THE LAYMAN," a copyrighted article by L. G. Mason will help you sell radio tubes in competition with mail order and chain store houses. \$1.00 per hundred, \$7.50 per thousand. Mason-Radio, 6212 Florida Ave., Tampa, Florida.

MILLION PARTS. Replacements for Freshman, Earl, etc. Radio hardware, small and big stuff. Price list just out for out-of-town experimenters, repair men. Experimenters Radio Shops, 129 West St., N. Y. C.

SHORT-WAVE NUMBERS OF RADIO WORLD. Copies of Radio World from Nov. 8, 1930 to Jan. 3, 1931, covering the various short-wave angles, sent on receipt of \$1.00. Radio World, 145 W. 45th St., N. Y. City.

RADIO WORLD AND RADIO NEWS. Both for one year, \$7.00. Radio World, 145 W. 45th St., N. Y. City

The New 2-Volt Tubes at \$1.00

THE new 2-volt tubes are the 230 general purpose tube, the 231 power tube and the 232 screen grid tube. They are principally for battery operation. Due to low current drain they are a boon to all who use battery-operated receivers. The Rextron 2-volt tubes are subject to a money-back guarantee as stated below, and are priced at only \$1.00 each.



231 Power Tube

The 230 and 232 draw .06 ampere filament current each (60 milliamperes), and each requires about 65 ohms to drop a 6-volt source to 2 volts for filament, or 15 ohms to drop a 3-volt source to 2 volts. The characteristics follows:

230 General Purpose Tube
 Filament voltage 2 volts
 Filament current06 amp.
 Plate voltage90 volts
 Plate current (amplifier) 2 m. a.
 Amplifier bias 4 1/2 volts
 Detector bias9 volts
 Amplification constant. 8.8
 Output resistance 12,500 ohms

232 SCREEN GRID TUBE

Filament voltage 2 volts
 Filament current06 ampere
 Plate voltage 135 volts
 Plate current (amplifier) 1.5 milliamperes
 Screen voltage 45 volts
 Amplifier bias 3 volts
 Detector bias 6 volts
 Amplification constant 440
 Plate resistance 800,000 ohms

231 POWER TUBE

Filament voltage 2 volts
 Filament current13 ampere
 Plate voltage 135 volts
 Plate current 8 m. a.
 Amplifier bias 22.5 volts
 Plate resistance 4,000 ohms
 Amplification constant 3.5

Money - Back Guarantee on All Rextron Tubes

THE economic depression and resultant predicament of some tube manufacturers have resulted in the dumping on the market of tubes of inferior calibre, tubes that failed in the factory test for "firsts," and were sold to distress merchandise operators "as is" at a few cents apiece. These tubes often are in private brand cartons, but do not bear the name of the real manufacturer.

Rextron tubes are made by Rextron. The estimate a manufacturer places on his tubes in the present chaotic tube market is well measured by the guarantee that backs up the tube. Replacement guarantees are encouraging but not conclusive. Nothing less than "money-back" will do now. Rextron tubes are sold on a 10-DAY MONEY-BACK GUARANTEE. Use them ten days. If not fully satisfied, return the tubes and your money will be refunded at once.

Each tube is packed in an especially rugged and secure carton with "Holed-Tight" safety wrapper inside, as precaution against damage in transit. We - NOT YOU - run the damage risk.

List of Tubes and Prices

230	1.00	224	1.00
231	1.00	227	1.00
232	1.00	245	1.00
222	2.10	210	2.85
171A	1.00	250	2.95
171 (for AC)	1.00	226	1.00
112A	1.00	280	1.00
112 (for AC)	1.00	281	2.95
201A	1.00		
240	1.00		
UX-199	1.00		
UV-199	1.00		
120	1.00		
200A	1.00		
WD-12	1.00		

RELIABLE RADIO CO.

143 West 45th Street, New York, N. Y.

Enclosed please find \$..... for which ship at once, on 10-day money-back guarantee, the following tubes:

<input type="checkbox"/> 230	<input type="checkbox"/> 240	<input type="checkbox"/> 226	If C.O.D. is desired please put a cross in square at left.
<input type="checkbox"/> 231	<input type="checkbox"/> UX-199	<input type="checkbox"/> 280	
<input type="checkbox"/> 232	<input type="checkbox"/> UV-199	<input type="checkbox"/> 222	
<input type="checkbox"/> 171A	<input type="checkbox"/> 120	<input type="checkbox"/> 210	
<input type="checkbox"/> 171	<input type="checkbox"/> WD-12	<input type="checkbox"/> 250	
<input type="checkbox"/> 112A	<input type="checkbox"/> 200A	<input type="checkbox"/> 281	
<input type="checkbox"/> 112	<input type="checkbox"/> 224	<input type="checkbox"/> Telson	
<input type="checkbox"/> 201A	<input type="checkbox"/> 245	<input type="checkbox"/> Photo cell	

Name

Address

City

State

SCREEN GRID SHIELDED COIL, \$1.50

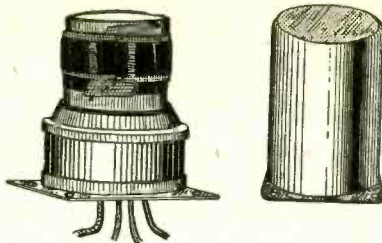

THESE shielded coils are especially suitable for screen grid circuits, but are adaptable also to other circuits.

They consist of a secondary wound on a 1 1/2" diameter bakelite tubing, a layer of moisture-proof insulating fabric, and primary wound over the secondary. The bakelite tubing is firmly embedded in a veneered base, to which an aluminum plate is attached at bottom, punctured to pass outlets and to coincide with mounting holes of the aluminum shield. The shield size is 3 11/16" x 2 11/16" x 3 3/4". The mounting method keeps the walls of the shield equi-distant from the coil. The outlets are: shielded wire lead to plate, red lead to B plus, dark blue lead to grid and yellow to ground. When the coil is used as antenna coupler a fixed condenser of .00025 mfd should be in series with the aerial. The connections would be: shielded wire to fixed condenser, red and yellow both to ground and dark blue to grid. The coils are packed in matched sets of four. Thus they are of precision type, necessary for fully effectiveness from gang tuning.

The primaries are of high impedance and the coupling to the secondary is very tight. These features are desirable for high gain in multi-stage screen grid circuits. However, for circuits using other tubes, the primary turns may be easily reduced by the user to 10 turns, by cutting the primary wire near where it enters the insulating cloth, and unwinding all but 10 turns, cutting and then soldering the two wires together.

For .0005 mfd. tuning order Cat. 40-70..... @ \$1.50
 Matched set of four for .0005 mfd. Cat. 40-70MF \$5.00
 For .00035 mfd. tuning order Cat. 40-80..... @ \$1.50
 Matched set of four for .00035 mfd. Cat. 40-80MF \$5.00

DYNAMIC TUNER ASSEMBLY, \$1.25

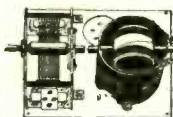

A TUNING condenser with a dynamic coil to match, mounted on an aluminum base that has socket built in. The condenser shaft goes in a dial (not furnished). The tuned circuit includes a fixed and a movable winding (rotor coil) in series. The moving coil is used as a trimmer, set once and left thus, so two separate tuning dials are made to read alike, or gang tuning is made practical. No equalizing condensers needed. Do not couple the adjoining shafts.

For antenna circuit input to any tube fitting four-prong UX socket, or for interstage coupling for 228, 201A, 199, 240 or 230, but NOT interstage for 232 or 222, order cat. BT-L-DC @ \$1.25
 For interstage coupling for 232 and 222, order cat. BT-B-DC @ \$1.25
 For antenna circuit, as RF input to any five-prong tube, order cat. BT-L-AC @ \$1.25
 For interstage coupling for 224, order cat. BT-R-AC @ \$1.25

DYNAMIC RF COIL, 75c

THE dynamic coil for either .0005 mfd. or .00035 mfd. tuning. The same coil serves either capacity, as the series rotor may be set in position to increase or reduce the total secondary inductance. For antenna coil, all circuits, and interstage coupling for all tubes except screen grid, order cat. BT-3A... @ 75c
 For interstage coupling from plate circuit of screen grid tube order cat. BT-3B @ 75c

DIAMOND PAIR COILS, \$1.20

The Diamond of the Air is a popular circuit using an antenna coil and a three-circuit tuner. For this circuit the standard Diamond pair of coils consists of two, wound on 3" diameters, except for rotor on smaller form. The standard pair may be obtained for .0005 or .00035 mfd. tuning. Ticker coil has single hole panel mount.

For .0005 mfd. order SDP-5..... @ \$1.20
 For .00035 mfd. order SDP-35..... @ \$1.20
 These coils will give extreme satisfaction and are excellent for the Diamond of the Air, being specified by Herman Bernard, the designer of the circuit.

OTHER COILS

(Cat. 5-HT)—Special three-circuit tuner for .0005 mfd tuned primary in plate circuit of a screen grid tube; untuned secondary..... \$.95
 (Cat. 3-HT)—Same as Cat. 5-HT, except that it is for .00035 mfd. tuning..... \$.95
 (Cat. T-5)—Standard 3-circuit tuner for .0005 mfd. where primary is for any type of tube other than plate circuit of screen grid tube..... \$.80
 (Cat. T-3)—Same as T-5, except for .00035 mfd. condensers instead of for .0005..... \$.80
 (Cat. 2-R5)—Radio frequency transformer for .0005 mfd. condenser where high impedance untuned primary is in plate circuit of a screen grid tube, and secondary is tuned by .0005 mfd..... \$.60
 (Cat. 2-R3)—Same as 2-R5, except that it is for .00035 mfd. tuning..... \$.60
 (Cat. 5-TP)—Radio frequency transformer for use where primary is tuned and placed in plate circuit of screen grid tube, while secondary is not tuned. For .0005 mfd..... \$.55
 (Cat. 3-TP)—Same as Cat. 5-TP, except that it is for .00035 mfd. tuning..... \$.55
 (Cat. RF-5)—Radio frequency transformer for .0005 mfd. tuning, where untuned primary is in plate circuit of any type tube except screen grid. Useful also as antenna coupler..... \$.55
 (Cat. RF-3)—Same as Cat. RF-5, except that it is for .00035 mfd. tuning..... \$.55

Remit with order for coils and we pay transportation. C.O.D. orders filled.

SCREEN GRID COIL CO.

143 WEST 45TH STREET
 NEW YORK, N. Y.

'BINDER' TO HOLD 52 ISSUES OF RADIO WORLD

Loose-leaf binder made of fine brown Spanish grain fabric. Built to stand heavy use. Purchase of binder includes template showing proper place for punching holes in magazine, Radio World, and year 1931-32 printed in gold on front cover. Binders for previous years also on hand.

Alphabetical Index of articles in issues from Mar. 29, '30, to Mar. 21, '31, incl. Index shows the title of article as it appeared in Radio World, author, date and page.
 Loose-leaf binder and template—\$2.00.
 Alphabetical Index, Mar. 29, '30, to Mar. 21, '31—\$.75.

Kindly remit with order

SUPER CO.

1313 - 40th ST. BROOKLYN, N. Y.

REPLACEMENT CONDENSER BLOCKS

A. K. 37 (Chokes & Condensers)..... \$3.75
 Majestic Master "B"..... \$2.25

REPLACEMENT POWER TRANSFORMERS

R. C. A. 17, 18, 33, 51..... \$3.75
 R. C. A. 44, 46..... \$3.90
 Zenith, all models 52 up to 77..... \$4.50

Write for price list of replacement parts.

BRONX WHOLESALE RADIO CO.

7 W. Tremont Ave. New York, N. Y.

SEND FOR FREE RADIO CATALOG LOWEST PRICES!

COAST TO COAST RADIO CORPORATION

HEADQUARTERS: ALL RADIO REPLACEMENT PARTS

142 W LIBERTY ST. NEW YORK



Your Choice of NINE Meters!

To do your radio work properly you need meters. Here is your opportunity to get them at no extra cost. See the list of nine meters below. Heretofore we have offered the choice of any one of these meters free with an 8-weeks subscription for RADIO WORLD, at \$1, the regular price for such subscription. Now we extend this offer. For the first time you are permitted to obtain any one or more or all of these meters free, by sending in \$1 for 8-weeks' subscription, entitling you to one meter; \$2 for 16 weeks, entitling you to two meters; \$3 for 26 weeks, \$6 for 52 weeks, entitling you to six meters. Return coupon with remittance, and check off desired meters in squares below.

RADIO WORLD, 145 West 45th Street, New York, N. Y. (Just East of Broadway)

Enclosed please find \$..... for..... weeks subscription for RADIO WORLD and please send as free premium the meters checked off below.

I am a subscriber. Extend my subscription. (Check off if true.)

- 0-6 Voltmeter D.C. No. 326
- 0-50 Voltmeter D.C. No. 337
- 6-Volt Charge Tester D.C. No. 23
- 0-10 Amperes D.C. No. 338
- 0-25 Milliamperes D.C. No. 325
- 0-50 Milliamperes D.C. No. 350
- 0-100 Milliamperes D.C. No. 390
- 0-300 Milliamperes D.C. No. 399
- 0-400 Milliamperes D.C. No. 394

NAME

ADDRESS

CITY

STATE

BUY NOW
While Prices Are Lowest!

BIGGEST BARGAINS!

Now all the fans who build their own sets or service men who are making replacements are using the dry electrolytic condenser. It affords high, lasting capacity in compact form. The lug at top represents the anode and goes to the positive side (B+ or C+), while the aluminum case is to go to the negative side, usually ground. The capacity of the condenser is 8 mfd. The condenser, a product of Aerovox, is admirably suited for use in filter circuits, for use on rectified AC or pulsating DC. The condenser must not be used on raw AC. Maximum peak voltage, 500 volts DC. Normal operating voltage, 450 volts DC. Dry, self-healing, high capacity, low leakage, unaffected by moisture. Size, 1-5/16" diam. x 4 1/4" overall. Mounts in any position. Brackets supplied. Order Cat. AV-8 @ \$1.42

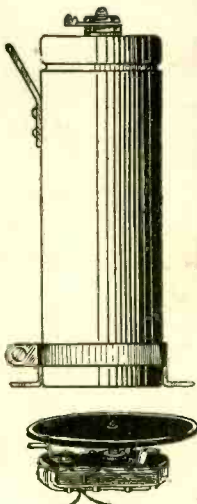

An outstanding example of the vastly popular midget receiver, not very much larger than any good speaker, yet it contains a very sensitive, efficient and powerful AC radio set, AC power pack and a speaker that would do justice reproducing the output of the most elaborate AC receiver! Startling statements, yes, but they are undeniable facts! Imagine, not even as large as most battery operated portable sets, and lighter in weight! The set will duplicate in performance (considering selectivity, sensitivity and volume) that of its much larger and more costly brother! One dial tuning control, also switch and volume control knob (not illustrated.) Uses six tubes: three 224, one 227, one 245 and one 280. Perfect reproduction! Combined weight of entire set, speaker and tubes less than 20 lbs.! Entirely self-contained! 3 gang tuning condenser. Uses power tubes and push-pull electro-dynamic speaker! Durably built in handsome walnut case. For 110-120 volts, 50-60 cycle AC. Complete set, with the six tubes, cabinet, speaker—nothing else to buy! Order Cat. MDST @ \$39.95

Peerless Dynamic In Sonora Consolette

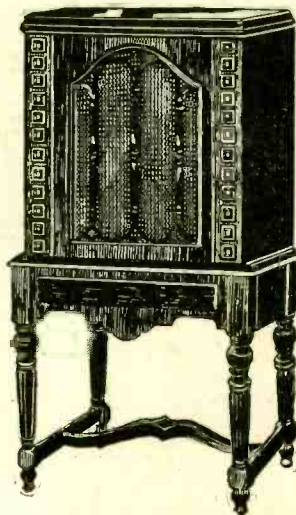

Positively the last word in the most efficient and powerful reproducer made! A fitting companion, it is housed in a truly exquisite deep two-tone walnut console, of rare beauty and craftsmanship! To properly baffle the ultra-powerful Peerless chassis, a chamber 15" deep, 17 1/4" wide and 18" high houses same. Front baffle of 3/4" thickness! Size of opening, 10 inches. Ideal for use with the most powerful public address amplifier. NO RATTLING, NO DISTORTION—JUST PERFECT REPRODUCTION! For that matter it is equally suited with ordinary sets, employing the average type of audio amplification systems. Order Cat. SSC @ \$24.95 [If cabinet only is desired (less speaker) order Cat. SC0 @ \$13.44]



New Speakerrelay for connecting two speakers to it and playing either one (position No. 1, left); or the other (position No. 1 right); or both at once (position No. 2); by turning the knob. Built into an attractive black moulded bakelite case, with 18-inch connecting cords to go to the output posts of the receiver or amplifier. The speakers' cords are connected to the relay by plugging into built-in jacks. This device can be used also for switching from "phonograph pickup" to "radio." Order Cat. 131 @ \$1.10

Synchronous motor for 60-cycle lines, 105 to 125 volts, with turntable, producing 80 turntable revolutions per minute. Takes up to 11-inch records. Sturdy and compact, this motor is only 1 1/2 inches thick. Not affected by line voltage fluctuations. The compactness permits installation in consoles or any other available space. Made by Allen-Hough, makers of the Phono-link pickup. Shipping weight, 7 lbs. Order Cat. SYN-M (with turntable) @ \$4.25

PHONOGRAPH \$3.32 PICK-UP

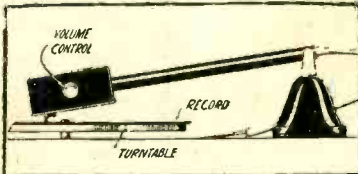

The famous Phono-link, made by Allen-Hough, enables playing phonograph records electrically, on your set. Volume control is built in. Adapter, free with each order, enables immediate connection to your set. Instruction sheet enclosed. Order Cat. PHL @ \$3.32.

Temple Dynamic \$15.34 Beautiful Carved Wood Grille Front



This is one of the finest dynamic speakers ever made, and is highly recommended by us. AC switch is provided. A knob is built in for adjusting the speaker impedance to that of your set. An output transformer and dry rectifier are built in. Connect plugged AC cable to 110 volts AC, 50 to 60 cycles and connect tipped cords to speaker post of receiver. This remarkable speaker is The Temple 16 chassis in the fascinatingly decorative walnut cabinet, with carved grille ornament, as illustrated; both front and back finished. (Cabinet not sold separately.) Order Cat. TEM @ \$15.34

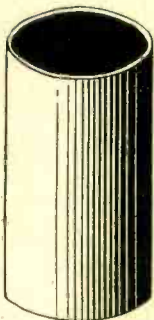

Natural bakelite tubing, made by Spaulding, in two diameters, 1 1/4 inches and 2 inches, outside diameters. One will fit inside the other even after wire is wound on the smaller diameter.

Length	Diam.	Price
1 1/4"	1 1/4"	\$0.09
2 1/4"	2"	.12
3 1/4"	2"	.40

The 1 1/4" length, 1 1/4" diameter, can be used for winding a primary, and be inserted.



Here is the best buy of the year: A 15" diameter 110 volt D.C. dynamic chassis, with two field coil resistances, 800 ohms AND 4,000 ohms. Contains push-pull output transformer. Designed for use with any super-power amplifier—for auditorium reproduction. Shipping weight, 25 lbs. Order Cat. 1100 @ \$18.95

We also offer the following Peerless dynamic chassis:

Cat.	No. Size	Type	Price
	719, 14"	110 v. D.C.	\$14.95
	720, 12"	110 v. A.C.	15.95
	721, 12"	110 v. D.C.	9.95
	1020, 12"	6 v. D.C.	9.95
	1021, 10"	110 v. A.C.	11.95
	1022, 9"	110 v. A.C.	9.95
	1023, 9"	110 v. D.C.	7.95
	1024, 9"	6 v. D.C.	7.95

0-600 Voltmeter Reads Both AC and DC

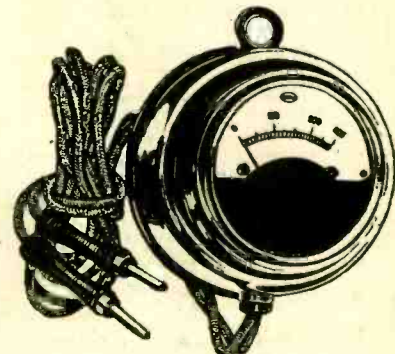

0-600 volts, high resistance; AC and DC (same meter reads both types). DC readings accurate to 2%, also AC readings 2% at 50-60 cycles, but accuracy is less on AC at substantially different frequencies. Order Cat. F-600 @ \$3.75

0-300 volts, high resistance. Accuracy, 2%. Case is full nickel finish. Long connecting cords have especially ornamental tip holders. Meter should be read in perpendicular position. Order Cat. F-300 @ \$2.25

0-500 volts, same as above in appearance, but the range is greater. Order Cat. F-500 @ \$3.00

Special "Buy-Now" Bargain Coupon!

GUARANTY RADIO GOODS CO., 143 West 45th Street, New York, N. Y. (Just East of Broadway)

- Please ship at once the following:
- | | | |
|--|--|--|
| <input type="checkbox"/> Cat. AV-8 @ \$1.42 | <input type="checkbox"/> Cat. SC0 @ \$13.44 | <input type="checkbox"/> Cat. 1021 @ \$11.95 |
| <input type="checkbox"/> Cat. MDST @ \$39.95 | <input type="checkbox"/> Cat. 1100 @ \$18.95 | <input type="checkbox"/> Cat. 1022 @ \$9.95 |
| <input type="checkbox"/> Cat. 121 @ \$1.10 | <input type="checkbox"/> Cat. 719 @ \$14.95 | <input type="checkbox"/> Cat. 1023 @ \$7.95 |
| <input type="checkbox"/> Cat. SYN-M @ \$4.25 | <input type="checkbox"/> Cat. 720 @ \$15.95 | <input type="checkbox"/> Cat. 1024 @ \$7.95 |
| <input type="checkbox"/> Cat. PHL @ \$3.32 | <input type="checkbox"/> Cat. 721 @ \$9.95 | <input type="checkbox"/> Cat. TEM @ \$15.34 |
| <input type="checkbox"/> Cat. SSC @ \$24.95 | <input type="checkbox"/> Cat. 1020 @ \$9.95 | |

- METERS
- | | | |
|--|--|--|
| <input type="checkbox"/> Cat. F-600 @ \$3.75 | <input type="checkbox"/> Cat. F-300 @ \$2.25 | <input type="checkbox"/> Cat. F-500 @ \$3.00 |
|--|--|--|

- EXTRA-SPECIAL SPECIALS!
- | | | |
|---|---|---|
| <input type="checkbox"/> Cat. SPEC-1 @ \$9.00 | <input type="checkbox"/> Cat. SPEC-3 @ \$7.35 | <input type="checkbox"/> Cat. SPEC-7 @ \$9.11 |
| <input type="checkbox"/> Cat. SPEC-2 @ \$7.87 | <input type="checkbox"/> Cat. SPEC-5 @ \$7.16 | <input type="checkbox"/> Cat. SPEC-8 @ \$7.50 |
| <input type="checkbox"/> Cat. SPEC-4 @ \$7.11 | <input type="checkbox"/> Cat. SPEC-6 @ \$7.11 | |

Name

Address

City

State

EXTRA-SPECIAL SPECIALS!

- (Cat. SPEC-1)—Eria DC dynamic chassis, 9-inch cone, for operation from 6-volt storage battery. *Connect speaker-tipped cords to output of set, and connect twisted pair to 6-volt storage battery. Draws 1/2 amp. from battery. Price.....\$9.00
- (Cat. SPEC-2)—Wave trap, for cutting out interference. Connect aerial to one side of the trap, other side to antenna post of receiver from which aerial was removed, and tune out interfering stations. A great selectivity booster. Price.....\$7
- (Cat. SPEC-3)—Rider's Supplement No. 1, containing diagrams supplemental to those in Rider's "Trouble Shooting Manual," and an invaluable addition, for completeness, to any who possess Rider's manual. Price.....\$7.35
- (Cat. SPEC-4)—Dubilier .01 mfd. fixed mica condenser.....\$7.11
- (Cat. SPEC-5)—Dubilier .0025 mfd. mica fixed condenser, with clips for grid leak mounting.....\$7.11
- (Cat. SPEC-6)—Dubilier .001 mfd. Dubilier fixed condenser, for connection in series with aerial to improve selectivity.....\$7.11
- (Cat. SPEC-7)—Power transformer, with two chokes built in for B filtration. Primary, 105-125 volts, 50-60 cycles; secondaries, all center-tapped with red leads, are for high voltage for 280 to work 245 tubes, single or push-pull, and rest of tubes in set up to 100 mba; 300 volts DC output; 2 1/2 volts 2 amps. for 245s, single or push-pull; 2 1/2 volts 14 amperes, for 227s and 224s, up to 8 of these; 5 volts for filament of 280. All, including chokes, in one cadmium plated steel case. Leads identified. Chokes are 30 henries each.....\$7.50