

NOV. 22d

1930

15c
Per
Copy

RADIO

REG. U.S. PAT. OFF.

WORLD

FREE

Radio Situations Wanted and Help Wanted Ads. RADIO WORLD will publish, **FREE**, under the heading of Radio Situations Wanted or Help Wanted, advertisements for those who are seeking radio situations or for employers who are adding to their working forces. Address: Industrial Dept., RADIO WORLD, 145 W. 45th St., N. Y. C.

The First and Only National Radio Weekly
452nd Consecutive Issue—NINTH YEAR

Diagrams of
Latest Brunswick
and
Stewart-Warner
Receivers



A shack at Babylon, N. Y., recently was identified by Major Edwin H. Armstrong as the first Marconi wireless station in the United States, erected thirty years ago. Major Armstrong is shown in front of the shack, which has been removed to Rocky Point, N. Y.

RADIO WORLD, Published by Hennessy Radio Publications Corporation. Roland Burke Hennessy, editor; Herman Bernard, managing editor and business manager, all of 145 West 45th Street, New York, N. Y.

**PHONOGRAPH \$3.32
PICK-UP Only**

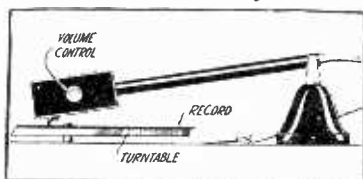

The famous Phono-link, made by Allen-Hough, enables playing phonograph records electrically, on your set. Volume control is built in.

Adapter, free with each order, enables immediate connection to your set. Instruction sheet enclosed. Order Cat. PHL @ \$3.32.

RELIABLE RADIO COMPANY
Room 504, at 1562 Broadway, N. Y. City
(Between 46th and 47th Streets)

**HAMMARLUND
100 MMFD. EQUALIZER**

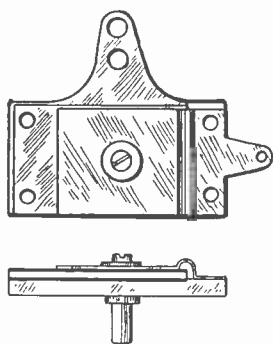

The most precise and rugged equalizing condenser made, with 20 mmfd. minimum and 100 mmfd. maximum, for equalizing the capacity where gang condensers are used that are not provided with built-in trimmers. Turning the screw alters the position of the moving plate, hence the capacity. Cross-section reveals special threaded brass bushing into which screw turns, hence you can not strip the thread. If you turn the screwdriver down with accidental excess of force the screw simply stops, no injury results, as this special equalizer does not rely on the delicate thread

in bakelite. The screw receptacle is strong brass. Useful in all circuits where trimming capacity of 100 mmfd. or less is specified. Maximum capacity stamped on the condenser.

Order Cat. EQ-100, List Price 60c. Net Price 35c

GUARANTY RADIO GOODS CO.
143 West 45th Street
N. Y. City (Just East of Broadway)

BRACH RELAY

ONLY 99c

List price, \$4.50

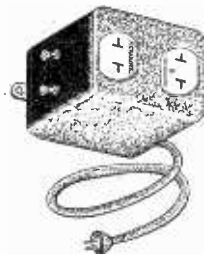

Connect relay's cable plug to 105-125 volt AC line. Connect B eliminator cable plug to relay socket so marked; connect trickle or other charger's plug to relay socket so marked; connect one side of A battery to binding post, other side to A set. Then turning on your set turns on B eliminator and turns off charger, turning off set turns on charger and turns off B eliminator.

GUARANTY RADIO GOODS CO.
143 W. 45th St., New York, N. Y.

NATIONAL

Velvet B Eliminator \$16.13
180 Volts (280 Tube Free)

Latest Model National Velvet-B, Type 3530, in handsome crackle finish black metal casing, for use with sets up to and including six tubes. Input 105-120 volts AC, 50 to 60 cycles. Output, 180 volts maximum at 35 milliamperes. Three variable output intermediate voltages. (Det., RF, AF). Eliminator has excellent filter system to eliminate hum, including 80 henry choke and 12 mfd. Mershon condenser. No motorboating!
(Eliminator Licensed under patents of the Radio Corporation of America and associated companies.)

Guaranty Radio Goods Co.

143 W. 45TH STREET
(Just East of Broadway)
NEW YORK CITY

BARGAINS!

We are able to offer the lowest prices on merchandise due to our tremendous purchasing power of surplus material. Dealers and service men, take advantage now!

**SILVER MARSHALL 250 Super Power
Auditorium Amplifier**

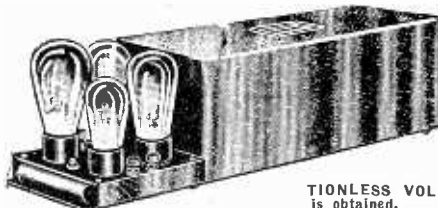

CONTAINS 2 STAGES SUPER POWER
A. F. AMPLIFICATION

Ideal for theatres seating approximately 3,000 people, dance halls, schools lectures, hospitals, hotels, auditoriums, outdoor gatherings, etc., etc. The gigantic power is at all times within control—for that matter it can be used in any home, as the volume can be regulated down to a whisper! But most important of all, the QUALITY OF REPRODUCTION IS AS NEAR PERFECT AND LIFE-LIKE AS POSSIBLE! ITS POSSIBILITIES CAN BE SUMMED UP IN THREE WORDS: ABSOLUTELY DISTORTIONLESS VOLUME! The full benefit of the 450 volts produced is obtained.

A PHONOGRAPH AMPLIFIER—PUBLIC ADDRESS AMPLIFIER SYSTEM—RADIO TUNER AMPLIFIER. When you remove it from its shipping crate, all you need do is to insert the necessary tubes. PLUG INTO ANY 60 CYCLE A.C. 110 VOLT ELECTRIC SOCKET and connect input binding posts. Either a radio set tuner output, a phonograph pick-up, "phono-movie" or microphone arrangement can be easily adapted to this amplifier.

TUBES REQUIRED

Self-contained unit. Supplies all necessary A, B and C power to its own tubes. Operation requires one type X250 power tube, one X226 A.C. tube (permits amplifier to be in immediate operation not subject to a 7 to 30 second delay if a 227 were used!) and two type X281 rectifier tubes. Attractive crystalline finish metal cabinet. 21"x5 1/2"x5 1/2". Shpg. wt., 38 lbs. You can very easily obtain "B" plate voltages from this amplifier for the tubes in any tuner. Use a RELIABLE 2 1/2 volt filament transformer to light the 2 1/2 volt A.C. tubes in a Radio tuner, to which this amplifier will be coupled.
No. 438. FULLY GUARANTEED. Shipped in original cases. List \$150.00. (\$5.00 additional with FULLY GUARANTEED TUBES!) **\$22.50** YOUR PRICE, without tubes.

R-C-A Magnetic Speaker Chassis

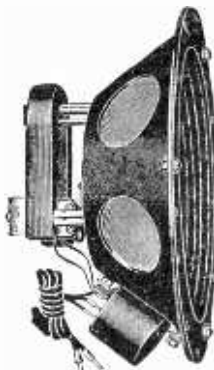

This chassis is the identical one used in the RCA Model 100A and 100B and 103 Speakers, WHICH LIST FOR AS HIGH AS \$30.00. Note built-in OUTPUT TRANSFORMER—permits use of 450 volts, without distortion, rattling or blasting. GENEROUS OVER-SIZED MAGNETS. The thick armature is ACCURATELY CENTERED. The STURDY METAL FRAME IS LINED WITH A SPECIAL SELF-BAFFLING FABRIC, greatly improving the acoustic properties of this sensational speaker! NOTE THE CORRUGATED SURFACE OF THE CONE, AN EXCLUSIVE FEATURE — ENHANCES PERFECT TONAL REPRODUCTION QUALITIES CONSIDERABLY. MOST COMPACTLY MADE: 9 INCHES OUTSIDE DIAMETER, 4 1/2 INCHES DEEP OVERALL. IDEAL FOR AUTOMOBILE INSTALLATION! Shpg. wt., 4 lbs.

YOUR PRICE..... **\$3.75**

**BOSWORTH 250 TWO-STAGE POWER
AMPLIFIER**



Connects to any radio-tuner output (detector plate lead), microphone or phonograph pick-up. Supplies 450 volts to 250 plate, "C" bias and filament voltage. Requires two 281 rectifiers, one 226 (permits instantaneous use) and one 250. Produces auditorium volume—no blasting—no distortion. Ideal for home installation: 11" long, 10 1/2" deep, 6" high. Output characteristics suited for any dynamic speaker. For 110-120 volt, 50-60 cycle A.C.

\$17.87

SEND FOR OUR FREE CATALOG NOW!

Surplus Radio Corp.

56-W Vesey Street
New York, N. Y.

FOUR-GANG .00035 MFD. WITH TRIMMERS BUILT IN!

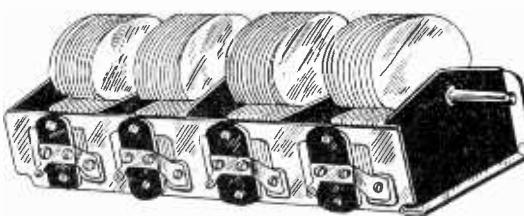

This condenser, each of four sections .00035 mfd., has aluminum plates that are removable and adjustable, also a 1/8" diameter steel shaft that is removable. It is sturdy and is suitable for popular four-circuit screen grid tuners. Trimming condensers are built in. The condenser may be mounted on its bottom or side. Total overall length, including shaft, 11 1/2". Overall width, 4". The frame is steel Order Cat. 4-G @.....

\$3.95

(Between 46th and 47th Streets)

RELIABLE RADIO COMPANY
Room 504, at 1562 Broadway, N. Y. City

Three 0.1 mfd. in One Case

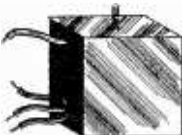

Cat. SUP-31

Three Supertone non-inductive fixed condensers of 0.1 mfd. each, (250 v.) in steel case, provided with a 6/32 mounting screw, built in. The black lead is common to the three condensers, the three red leads are the other sides of the respective

capacities. Size, 1 1/2" square by 3/4" wide. Order Cat. SUP-31, list price, \$1.00; net price, 57c.

GUARANTY RADIO GOODS CO.
143 West 45th St., New York, N. Y.

SHIELDED LEAD-IN WIRE

No. 18 solid wire, surrounded by a solid rubber insulation covering, and above that a covering of braided copper mesh wire, which braids is to be grounded, to prevent stray pick-up.

Also used to advantage in the wiring of receivers, as from antenna post of set, to antenna coil, or for plate



This wire is exceptionally good for antenna lead-in, to avoid pick-up of man made static, such as from electrical machines.

leads, or any leads, if long. Order Cat. SH-LW. List 9c. net, 5c per ft.

GUARANTY RADIO GOODS CO.
143 West 45th St., New York, N. Y.

Orders - Inquiries

60 pages
Send for FREE COPY
Can be Secured by MAIL

POLK'S REFERENCE BOOK and Mailing List Catalog

Gives counts and prices on over 8,000 different lines of business. No matter what your business, in this book you will find the number of your prospective customers listed. Valuable information is also given as to how you can use the mails to secure orders and inquiries for your products or services.

Write for Your FREE Copy
R. L. POLK & CO., Detroit, Mich.
Largest City Directory Publishers in the World
Mailing List Compilers—Business Statistics
Producers of Direct Mail Advertising

Slightly Used Amer-tran Transformers



We have on hand some Amer-tran audio transformers, both first stage de luxe and push-pull input No. 151, which have been used by us only in experimental work. They are slightly used, therefore, but are in first-class condition. Five-day money-back guarantee. There is not a mark or scratch on the case or anywhere else except on the terminal lugs. These lugs have a trace of solder on them, showing where we removed the connection made to the test circuit, and this solder trace is the only difference between our stock and brand-new merchandise. We have even put the transformers back in their original boxes.

First stage de luxe, list (when new) \$8.00; slightly used @ \$3.90
Push-pull input, list (when new) \$12.00; slightly used @ \$5.90

RELIABLE RADIO COMPANY
Room 504, at 1562 Broadway, N. Y. City
(Between 46th and 47th Streets)
5-DAY MONEY BACK GUARANTEE!

AMER-TRAN'S NEW POWER AMPLIFIERS



The American Transformer Company, makers of superb power amplifiers and components, has a new and marvelous line of push-pull power amplifiers, known as the "Series 80."

The six-tube power amplifier illustrated above is a three-stage system, with 227 first and second audio, and 250 push-pull output. Two 281 rectifiers are used, full wave. The first stage is transformer coupled, the second impedance coupled and the third transformer coupled. It is not intended this, or any other "Series 80" power amplifier, supply any voltage to any other device, e.g. a tuner. The five binding posts are two each for input and output and one for ground. The other posts are test jacks. The input or primary of the first transformer has an impedance of 500 ohms, for general use, including microphones input. Input impedance of 2,000 or 4,000 ohms can be furnished instead, on request. The final output has an impedance of 15 ohms, for dynamic speaker voice coils, but 500-ohm impedance for line transformers and 4,000-ohm impedance for magnetic speakers can be furnished instead, on request.

The three-stage 250 push-pull power amplifier is Cat. PA-86 and lists for \$195, wired, less tubes. Net price, \$114.66.

The three-stage product, with 245 push-pull output, has the same general appearance, audio circuit and impedance factors at input and output, but five tubes instead of six, due to the use of a 280 rectifier. This is Cat. PA-84, list price, \$160, wired, less tubes; net price, \$94.08.

The five-tube two-stage amplifier with 250 push-pull output, is Cat. PA-85, list price, \$180, wired, less tubes; net price, \$105.84.

The four-tube two-stage 245 PP output is Cat. PA-83, list price, \$145, wired, less tubes; net price, \$85.26.

These power amplifiers are highly suitable for theatres, auditoriums, clubs, public address and home use. They are licensed by RCA and associates.

Two types of power transformers by Amer-tran for those who want to build their own power amplifiers are Cat. PB-250 for 250 output, single or push-pull; and Cat. PB-245 for 245 output, single or push-pull. Cat. PB-250 furnishes power for two 281s and for two 250s. Two B supply chokes are built in. No filament voltage for tuner is supplied. Cat. PB-250 lists @ \$35; net, \$20.58. Cat. PB-245 furnishes power for a 280 and two 245s, besides 2 1/2 volts AC for heaters of five tubes. Two B chokes are built in. List price, \$32.50; net, \$19.11.



Amer-Tran AF Transformers
First stage, de luxe, primary, in detector circuit, has 200 henrys inductance at 1 ma; turns ratio, 1-to-3. Cat. DL-1, list price, \$8.00; net \$4.70. Push-pull input transformer; turns ratio, 1-to-2 1/2; single primary; two separate windings for secondary; Cat. 151, list price \$12; net, \$7.05.

National Co. Velvetone Power Amplifier

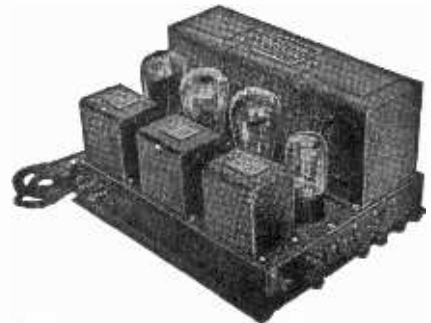

A 245 push-pull power amplifier especially suitable for powering AC tuners is the new model Velvetone. Uses one 280, one 227 and two 245. Furnishes 2 1/2 volts AC for up to five other tubes, also plate voltages for tuner. Two stages of transformer coupling with output transformer. Cat. PPPA, list price, wired, \$97.50, less tubes; net, \$57.33. [Velvetone is licensed by RCA and associates.]

Guaranty Radio Goods Co.
143 West 45th St., N. Y. City

Enclosed please send \$..... for which ship

| | |
|--|--|
| <input type="checkbox"/> Cat. PA-86 @ \$114.66 | <input type="checkbox"/> Cat. PB-245 @ \$18.11 |
| <input type="checkbox"/> Cat. PA-84 @ 84.08 | <input type="checkbox"/> Cat. DL-1 @ 4.70 |
| <input type="checkbox"/> Cat. PA-85 @ 105.84 | <input type="checkbox"/> Cat. DL-2 @ 4.70 |
| <input type="checkbox"/> Cat. PA-83 @ 85.26 | <input type="checkbox"/> Cat. 151 @ 7.05 |
| <input type="checkbox"/> Cat. PB-250 @ 20.58 | <input type="checkbox"/> Cat. PPPA @ 57.33 |

Name

Address

City State.....

The New Jiffy Tester
Chromium-Plated Case and Accurate Meters

A NEW and improved Jiffy Tester, improved in both performance and appearance, is Model JT-N. The meters are of the moving iron type. Tested on precise batteries, they show errors not exceeding 2%. As for appearance, the case is first copper plated, then nickel plated, then chromium plated, giving a lustrous, permanent, non-peeling non-rusting finish. It is the same finish found on hardware in fine automobiles. The handle and lock strap are genuine leather.

Jiffy Tester, Model JT-N, consists of three double-reading meters, with cable plug, 4-prong adapter, test cords and screen grid cable, enabling simultaneous reading of plate voltage, plate current and filament or heater voltage (DC or AC), when plugged into the socket of any set. The ranges are filament, heater or other AC or DC: 0-10 v, 0-140 v; plate current: 0-20, 0-100 ma; plate voltage: 0-60, 0-300 v. It makes all tests former models made. Each meter is also independently accessible for each range. The entire device is built in a chromium-plated case with chromium-plated slip-cover. Instruction sheet will be found inside. Order Cat. JT-N.

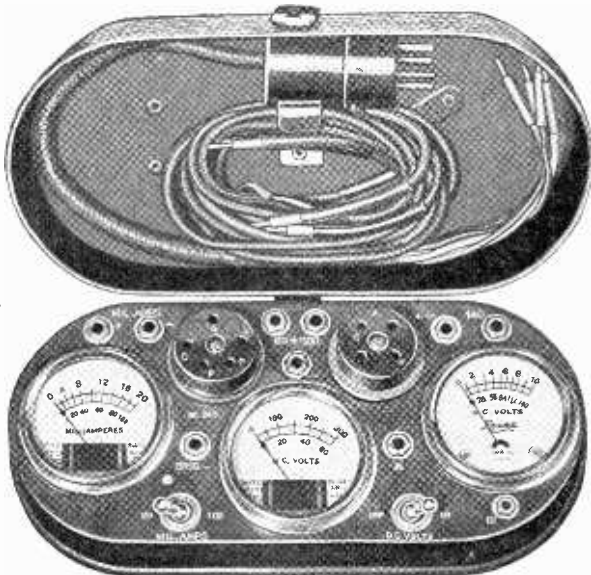

[Remit \$11.40 with order for JT-N and we will pay transportation]

GUARANTY RADIO GOODS CO.
143 WEST 45th STREET (Just East of Broadway) NEW YORK, N. Y.

Experimental Model

4-tube screen-grid set, battery operated requiring outdoor antenna. Ideal where economical operation is desired, sensitive and selective, but not in a cabinet.

Price, \$20.50

GUARANTY RADIO COMPANY
143 West 45th Street, New York City

"A" BATTERY SWITCH

A push-pull switch for battery-operated sets. Made by Benjamin. Firm, sure contact, extremely long life. Special price, only13c

GUARANTY RADIO GOODS CO.
143 West 45th St., New York, N. Y.

THREE-GANG SCOVILL .0005 MFD. WITH BRASS PLATES

One of the best three-gang condensers made. Plates, utterly rigid and expertly aligned, are of brass, the most expensive metal used for this purpose. Capacity of each section, .0005 mfd. Shaft, 3/16" diameter, of genuine steel, protrudes at both ends. For 3/4" diameter dial use an extension shaft. (Cat. X5-4 @ 12c extra). Trimming condensers not built in, but mounting holes are provided for them. Condenser should be mounted on narrow side for drum dial operation. Rotor tension adjusters are built in. Frame is steel. Total shaft length 8 1/2", total frame width overall 4 1/2". Order Cat. 8-G **\$3.20**

RELIABLE RADIO COMPANY
Room 504, at 1562 Broadway, N. Y. City
(Between 46th and 47th Streets)

A Complete Line of Radio Books!

SERVICE MANUAL RAMSAY HAAN RADIO MANUAL ANDERSON and BERNARD

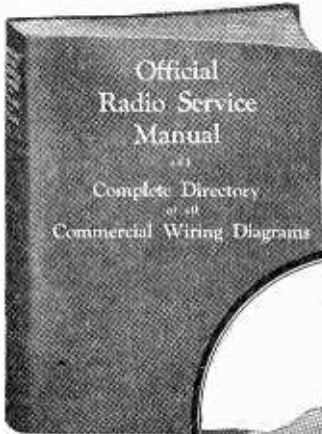

"Official Service Manual," by Gerns-bach and Fitch, 1,900 illustrations; diagrams of commercial receivers and power amplifiers; 352 pages; includes course on servicing. Weight, 2 1/2 lbs. Complete 5-page index. Flexible leatherette cover, loose-leaf binding. Order Cat. ORSM @ \$5.50



"Radio Trouble Shooting," by E. R. Haan, passes over theory, tells what to do to cure troubles. 300 illustrations, flexible binding 361 pages 6x9" Order Cat. HAAN... @ \$3.00



"Experimental Radio" by R. R. Ramsey, Ph.D., Prof. Physics, Indiana University. 255 pages, 168 illustrations. Cloth cover. Order Cat. REX..... @ \$2.75

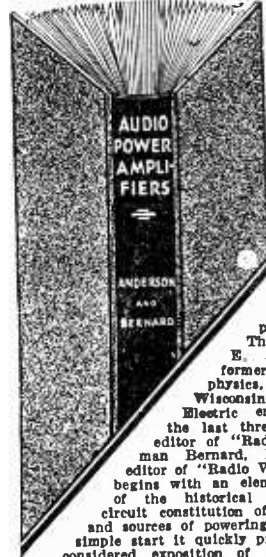

An understanding of audio amplifiers of all types, and of the use of tubes in audio channels, is a prerequisite today, when audio amplification is to the fore in radio, in public address systems and in the talks. "Audio Power Amplifiers" is the first and only book on the important subject. The authors are J. E. Anderson, M.A., former instructor in physics, University of Wisconsin, former Western Electric engineer, and for the last three years technical editor of "Radio World"; Her-mann Bernard, LL.B., managing editor of "Radio World." The book begins with an elementary exposition of the historical development and circuit constitution of audio amplifiers and sources of powering them. From this simple start it quickly proceeds to a well-considered exposition of circuit laws, including Ohm's laws and Kirchhoff's laws. The determination of resistance values to produce required voltages is carefully expounded. All types of power amplifiers are used as examples: AC, DC, battery operated and composite. But the book treats of AC power amplifiers most generously, due to the superior importance of such power amplifiers commercially. Tube characteristic tables and curves profusely included. Cloth cover, 193 pages. Order Cat. APAM.... @ \$3.50



The index to the commercial wiring diagrams takes up five pages alone. The index is an alphabetical array of the manufacturers' names, with model names and numbers stated.

BOOKS BY JOHN F. RIDER

Two new books by Rider are: (1)—"Practical Radio Repairing Hints," a handbook for the radio worker. Replete with facts and figures, hints and kinks. No Theory. No Formulas. In it you will find explanations of the modern radio systems, automatic volume control circuits, new forms of voltage distribution, automobile radio sets, public address systems, etc. Order Cat. PRRH..... @ \$2.00 (2)—"Practical Testing Systems," the first complete collection of accurate and practical testing circuits of interest to the service man, professional se builder and experimenter. Among the many testing systems described in this book are tube testers, capacity measuring systems, signal generators, radio frequency oscillators, audio oscillators, vacuum tube voltmeters, resistance testers, continuity testers, etc. Material for the man who wants a simple test uni or desires a laboratory arrangement. Order Cat. PTS..... @ \$1.00

Other books by Rider are: "Trouble Shooter's Manual," the first comprehensive volume devoted exclusively to the topic. It is not only a treatise for service men, telling them how to overcome their most serious problems, and diagramming the solutions, but it is a course in how to become a service man. It gives details of servicing and includes more than 100 actual factory-drawn diagrams of commercial receivers. 240 pages, 8 x 11," 200 illustrations. Order Cat. TSM..... @ \$3.50



"Supplement No. 1," containing 115 diagrams of commercial receivers, supplementing the diagrams in "Trouble Shooter's Manual," but not duplicating any. These 115 diagrams are supplied loose. They are a necessary adjunct to those in "Trouble Shooter's Manual. Order Cat. SUPP-1..... @ \$1.20

"Mathematics of Radio," by Rider, 128 pages, 8 1/2 x 11," 119 illustrations, bridges the gap between the novice and the college professor. It gives a theoretical background so necessary for a proper understanding of radio and audio circuits and their servicing. Formulas for capacity, inductance, impedance, resistance, etc., are explained. Flexible cover. Order Cat. MOR..... @ \$2.00

TWO MASTERPIECES BY PROF. MORECROFT

"Principles of Radio Communication," by Prof. John H. Morecroft, second edition. Prof. Morecroft, of the Electrical Engineering Department of Columbia University and past president of the Institute of Radio Engineers, is a noted authority. Prior electrical and mathematical knowledge required. 1,001 pages and 831 illustrations. Cloth-bound. Order Cat. M-PRIN..... @ \$7.50

"Elements of Radio Communication," written in plain language, requiring little foundation knowledge of radio, is another fine Morecroft book. The book is a complete course on the elements of radio, containing much material never before published. 228 pages, 170 illustrations and a complete index. Cloth bound. This is one book you must have in your library. Order Cat. M-ELEM..... @ \$3.00

THREE BOOKS BY MOYER AND WOSTREL

The need for an up-to-date book on radio tubes that answers all the important questions has been filed by James A. Moyer, Director of University Extension, and John F. Wostrel, instructor in radio engineering. Division of University Extension, Massachusetts Department of Education. This book is a complete discussion of tube principles, functions and uses. The essential principles underlying the operation of vacuum tubes are explained in a non-technical manner as is consistent with accuracy. The book covers the construction, action, reactivation testing and use of vacuum tubes as well as specifications for vacuum tubes and applications for distant control of industrial processes and precision measurements. 297 pages, cloth bound. Order Cat. MWT..... @ \$2.50

"Practical Radio," including the testing of radio receiving sets. 378 pages, 223 illustrations. Cloth bound. Order Cat. MWP..... @ \$2.50

"Practical Radio Construction and Repairing," 319 pages, a companion volume to the above. New edition. new price. Order Cat. MWC..... @ \$2.50

The SUPERHETERODYNE

This is a new volume by Anderson and Bernard dealing with the principles and practice of the Superheterodyne method of receiving. It explains the function of the oscillator, the modulator, the pre-modulator selector, and the intermediate frequency amplifier. It explains the cause of repeat points and gives methods for avoiding them or minimizing their effect. It expounds the relative advantages and disadvantages of high and low intermediate frequencies, and shows the effect of selectivity on the quality. It illustrates various forms of oscillators and tells of the advantages of each. Different types of modulators and pick-up systems are explained and their advantages stated. Different methods of coupling in the intermediate frequency amplifier are shown. Image interference is discussed in detail and methods given by which it may be reduced. A special method of ganging the oscillator to the radio frequency condensers is explained, a method which allows either the high or the low oscillator setting to be selected by means of a varactor in the oscillator circuit. One section is given over to coil design for the radio frequency tuners, the oscillator, and the intermediate frequency filter. Audio amplifiers suitable for Superheterodynes are also described. These include transformer, resistance, and push-pull amplifiers both for AC and DC.

While the book is primarily intended to expound the principles of the Superheterodyne, the practical phase has not been neglected. Detailed descriptions of AC and DC Superheterodynes, designed in conformity with best practice and sound applications of the principles, have been included. These descriptions are well illustrated. Order Cat. ABSH..... @ \$1.50

FOOTHOLD ON RADIO

In simple English that any one can understand, the technical side of radio is presented by Anderson and Bernard in their book, "Foothold on Radio." Any one who can read English can understand this book. It is intended for the sheer novice. The treatment is non-mathematical. The origin of the broadcast wave, its radiation, reception, amplification are set forth in clear language. Side bands are explained simply. The types of receiving circuits are illustrated, described and contrasted. A chapter is devoted to loudspeakers, explaining the different kinds and the principles of their operation. Performance is compared. Audio coupling is fully explained, also the action of the vacuum tube, with a special analysis of plate current and its behavior. Those who have been thirsting for a book that readily reveals the marvels of the radio science will appreciate this little volume. Paper cover 60 pages, fully illustrated. Order Cat. For..... @ \$1.00

"A B C OF TELEVISION"

"A B C of Television, or Seeing by Radio," by Raymond Francis Yates, editor of "Television," formerly editor of "Popular Radio." 210 pages (5 1/2 x 8 1/2"). 100 illustrations. Cloth bound. This book is not a dull, technical treatise. Rather, it is a popular, easily understood and practical book containing descriptions of television systems, and also detailed information concerning many fascinating television experiments that may easily be conducted with modest equipment. It is not a book for engineering "high-brows" nor is it a superficial treatise written merely to entertain and amaze the novice. It is an intensely practical volume written for those who want to do things. It stresses the "how" of the art as well as the "why." In its essence, it is an academic treatise brought down to the level of the lay mind. Engaging in its simplicity, penetrating and wide in its scope, it stands as the first popular American book devoted to television and telephotography. The book contains two hundred fifty pages profusely illustrated. The reading matter is arranged in simple stepping stones dealing with the problems of scanning, amplification of light modulated signals, photo-electric cells and neon lamps. The book has been written especially for those who wish to build and use television receivers and transmitters for entertainment and research purposes. It is written for amateurs and experimenters who crave action and results rather than high-sounding theory. Order Cat. TEL..... @ \$3.00

"Drake's Encyclopedia," new edition, 2 1/2" thick, weighs 3 1/2 lbs., 920 pages, 1,025 illustrations. Order Cat. DRA..... @ \$6.00

"Principles of Radio," by Keith Henney, M.A., former director, laboratory, Radio Broadcast. 477 pages, 304 illustrations. Order Cat. PRK..... @ \$3.50

"Radio Telegraphy and Telephony," by Rudolph L. Duncan and Charles E. Drew, of Radio Institute of America. Order Cat. RTT..... @ \$7.50

Radio World, 145 West 45th Street, New York, N. Y.

Enclosed please find \$..... for which please send at once, postpaid, books indicated by my crosses

- | | |
|---|---|
| <input type="checkbox"/> Cat. ORSM @ \$3.50 | <input type="checkbox"/> Cat. PRRH @ \$2.00 |
| <input type="checkbox"/> Cat. HAAN @ 3.00 | <input type="checkbox"/> Cat. PTS @ 1.00 |
| <input type="checkbox"/> Cat. REX @ 2.75 | <input type="checkbox"/> Cat. TSM @ 3.50 |
| <input type="checkbox"/> Cat. RFM @ 3.50 | <input type="checkbox"/> Cat. SUP-1 @ 1.20 |
| <input type="checkbox"/> Cat. MAN @ 6.00 | <input type="checkbox"/> Cat. MOR @ 2.00 |
| <input type="checkbox"/> Cat. APAM @ 3.50 | <input type="checkbox"/> Cat. M-PRIN @ 7.50 |
| <input type="checkbox"/> Cat. FOR @ 1.00 | <input type="checkbox"/> Cat. M-ELEM @ 3.00 |
| <input type="checkbox"/> Cat. ABSH @ 1.50 | <input type="checkbox"/> Cat. MWT @ 2.50 |
| <input type="checkbox"/> Cat. TEL @ 3.00 | <input type="checkbox"/> Cat. MWP @ 2.50 |
| <input type="checkbox"/> Cat. DRA @ 6.00 | <input type="checkbox"/> Cat. MWC @ 2.50 |
| <input type="checkbox"/> Cat. PRK @ 3.50 | <input type="checkbox"/> Cat. RTT @ 7.50 |

Name

Address

City

State

Check here if C. O. D. is desired.

Remit with Order for Books and We Pay Postage



Vol. XVIII, No. 10 Whole No. 452
 November 22nd, 1930
 [Entered as second-class matter, March, 1922, at the Post Office at New York, N. Y., under act of March, 1879]
 15c per Copy, \$6.00 per Year

NINTH YEAR
 Latest Circuits and News
 Technical Accuracy Second to None

A Weekly Paper published by Hennessy Radio Publications Corporation, from Publication Office, 145 West 45th Street, New York, N. Y. (Just East of Broadway) Telephone, BRyant 0558 and 0559

RADIO WORLD, owned and published by Hennessy Radio Publications Corporation, 145 West 45th Street, New York, N. Y. Roland Burke, Hennessy, president and treasurer, 145 West 45th Street, New York, N. Y.; M. B. Hennessy, vice-president, 145 West 45th Street, New York, N. Y.; Herman Bernard, Secretary, 145 West 45th Street, New York, N. Y.; Roland Burke Hennessy, editor; Herman Bernard, business manager and managing editor; J. E. Anderson, technical editor

The Stenode's Comeback

By J. E. Anderson

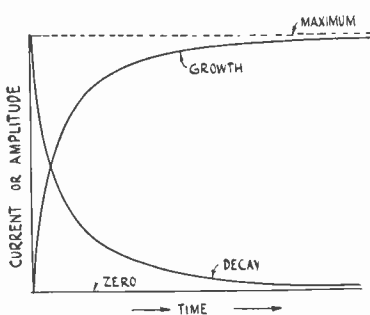

FIG. 1. CURVES SHOWING THE EXPONENTIAL GROWTH OR DECAY OF CURRENT IN A CONDENSER OR COIL CHARGED OR DISCHARGED THROUGH A RESISTANCE, AND ALSO THE GROWTH AND DECAY OF AMPLITUDE OF A RESONANT SYSTEM.

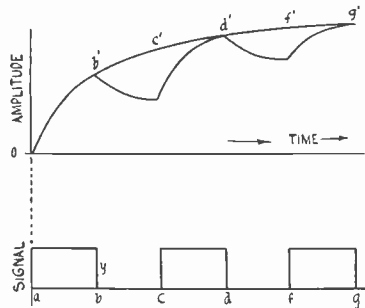

FIG. 2. A CURVE ILLUSTRATING THE GROWTH OF AMPLITUDE IN A RESONANT SYSTEM WHEN IT IS DRIVEN BY GROUPS OF CONSTANT AMPLITUDE WAVES, SEPARATED BY PERIODS OF CESSATION THE AMPLITUDE GRADUALLY ATTAINS MAXIMUM.

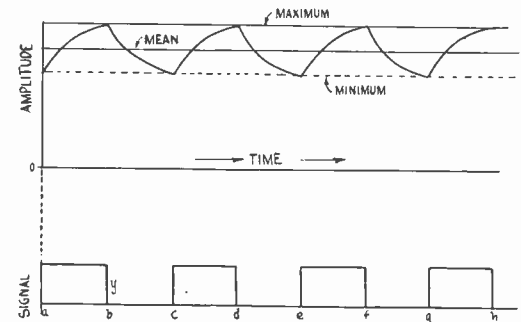

FIG. 3. A CURVE SHOWING THE VARIATION OF AMPLITUDE ABOUT A MEAN VALUE WHEN DASHES AND SPACES HAVE BEEN CONTINUED FOR A CONSIDERABLE TIME. THESE VARIATIONS ARE USED IN THE STENODE RADIO-STAT RECEIVER.

LAST week we reported on the results of a public demonstration of the Stenode Radiostat, the invention of Dr. James Robinson, of England. The unfavorable tone of that report was the result of entirely unsatisfactory results. The sponsors of the new device realized the failure of the demonstration and knew that adverse criticism was inevitable. Therefore they arranged with certain engineers and newspaper men for a private demonstration of the device and for an opportunity for discussion of its principle with Dr. Robinson and his assistant, Mr. Percy Harris.

The first demonstration was made under the most unfavorable conditions. The private test was made under average conditions, when, it must be admitted, the quality of the Stenode Radiostat receiver was not bad. Indeed, it compared very favorably with that from a modern radio receiver of more conventional make-up.

The Demonstration

Moreover, the test and the discussion brought forth the fact that Dr. Robinson has been misrepresented in published discussions of the new system. Dr. Robinson does not discard the sideband theory but accepts it as it is, together with its consequences. He maintains that the sideband theory has been carried as far as it can be and that there is another way of receiving by means of resonant devices which the sideband theory does not bring out.

During the private demonstration the Stenode Radiostat receiver was set up in a laboratory in the top story of a tall building in New York City, not in the interior of a maze of steel, as in the case of the public demonstration, and it did bring in signals of good quality. Possibly the quality was not quite as good as the quality obtainable with a modern conventional receiver, but the difference was not necessarily the fault of the new system. At any rate, the quality was much

better than that obtained with many conventional broadcast receivers.

As to selectivity, there is no question about the superiority of the Stenode Radiostat. A laboratory transmitter, modulated with the output of a phonograph pick-up, was set up about 20 feet from the Stenode receiver. The carrier of this transmitter was adjusted to differ by about 2,000 cycles from that of the station to which the Stenode receiver was tuned.

By means of a control on the Stenode receiver it was possible to shunt the quartz crystal so as to convert the test receiver to a standard Superheterodyne. When this was done the 2,000 cycle beat frequency was clearly heard above the signal as a loud whistle. But when the crystal was cut in, restoring the selectivity, this whistle was entirely cut out as far as the ear could tell, and this without any appreciable change in the quality.

While the laboratory oscillator was modulated with phonograph music there was no trace of this music in the signal heard on the Stenode receiver. Yet the degree of modulation of this interfering carrier was of the same order of magnitude as that used in broadcasting.

Selectivity Amazing

The fact that the Stenode Radiostat receiver could tune out completely an interfering modulated carrier differing by only 2,000 cycles shows that the new receiver is amazingly selective, and that it could do this and still retain the quality is still more amazing to adherents of the sideband theory.

The high degree of selectivity is emphasized by the tuning arrangement necessary to bring in the desired station. The main tuning condenser had a capacity of 500 mmfd. In shunt with this was a trimmer condenser of a few mmfd., consisting of a single small movable and one fixed plate. The movable

(Continued on next page)

New System Explained

(Continued from preceding page)

plate was geared to the knob in the ratio of five-to-one, so that it was necessary to turn the knob through 2.5 revolutions to turn the condenser rotor one-half revolution. By turning this condenser it was possible to tune from silence to silence through the signal.

The selectivity is so great that either WOR or WLW, 10 kc. apart, may be tuned in and leave a space of dead silence between them. That this should be so is obvious when it was possible to tune out a carrier differing by only 2,000 cycles from the desired carrier.

Principle of Stenode Radiostat

On the face of it the theory of the Stenode Radiostat is very simple. Mathematically it is rather complex, and this writer has not yet seen a satisfactory expression of the theory. Let us attempt to explain the working of the new receiver on a qualitative basis.

When voltage is impressed on a condenser the charge on that condenser does not assume full value instantly but the charge grows gradually according to an exponential law. The charge on the condenser, or the voltage across it, would grow like the "growth" curve in Fig. 1, and the current into the condenser would vary as the "decay" curve. Both of these curves are exponential and one is just the complement of the other.

When a charged condenser is discharged through a resistance, the current varies, as the "decay" curve and the voltage across it varies in the same manner.

Theoretically it takes an infinite time for a condenser to charge or discharge but practically either process takes place in an extremely short time, the actual time depending on the capacity of the condenser and the resistance in series with it.

The growth of current in a coil after a DC voltage has been impressed is similar to the "growth" curve, and the decay of current in a circuit consisting of an inductance and a resistance is similar to the "decay" curve.

Resonant Systems

When a resonant system is involved the situation is somewhat different but the law of growth and decay of amplitude is the same as the curves in Fig. 1.

Suppose we impress an alternating force on a tuning fork, the frequency of which is exactly equal to the resonant frequency of the fork. The fork will begin to vibrate and it quickly gains a wide amplitude. The rate of growth of amplitude is that shown in the "growth" curve. If the fork is highly resonant, that is, has very low losses, the given force will make the maximum amplitude very large after a very short time. If the losses in the fork are higher, the maximum amplitude will not be so great and it will take a longer time to reach it.

When the driving force is suddenly removed, the fork will continue to vibrate, and the amplitude will die down according to the "decay" curve. If the fork is highly resonant, it will take a very long time for it to die down to zero, and if the losses are great it will stop quickly.

What applies to a tuning fork driven by an alternating force equal in frequency to the natural frequency of the fork, also applies to any other resonant device whatsoever, such as a tuned circuit, a quartz crystal, a pendulum, or a steel rod vibrating laterally or longitudinally. Some of these devices are highly resonant, and others are feebly resonant. Those that are highly resonant, like a quartz crystal and a tuning fork, keep on vibration for some time, while those feebly resonant come to rest quickly.

It might be mentioned that the frequency of the vibrator is not quite the same while it is dying down and while it is being driven. There is a slight difference between the natural frequency of a freely vibrating resonator and the natural frequency of a driven resonator. If the resonator is highly resonant, the difference between these two frequencies is extremely small, so that for practical purposes the two frequencies may be called exactly equal.

Application to Code

As another step in the explanation of the Stenode Radiostat let us assume that we impress dashes of driving force to a highly resonant vibrator, each dash consisting of a certain number of waves of equal amplitude having a frequency equal to the natural frequency of the vibrator. We represent the amplitude of the dashes by y in Fig. 2 and the duration by ab , cd , and fg . The time between the dashes represents silent periods when no driving force is applied to the vibrator.

Above the signal curve in Fig. 2 is a representation of the growth of the amplitude of the vibration. The driving force is applied at a when time is zero. The amplitude grows according to the exponential law explained above and reaches a value b when the dash is at an end. The amplitude then begins

to decay, but the decay is slow because the system is highly resonant, by assumption. Hence when the next dash begins at c the amplitude is not zero but has an appreciable value.

When the second dash begins the system is again being supplied energy and the amplitude begins to grow, so that at the end of the second dash the amplitude has reached a value d' . When the second dash is ended and the energy supply is withdrawn, the decay sets in again and as before the decay is slower than the growth. Hence by the time the third dash begins the amplitude is considerably greater than it was at the beginning of the second dash. During the third dash the amplitude grows to g' .

If the process continues a long time, and by long may mean a small fraction of a second, the amplitude of the vibrator will be near the maximum, that which it would have attained had the driving force not been interrupted once it started. Then we have a situation such as is represented in Fig. 3, which may be called the steady state condition attained after a considerable time. Fig. 2 is supposed to lie far to the left of the beginning of Fig. 3.

Variation in Amplitude

The growth and decay sections of the curve in Fig. 3 have to be exaggerated greatly just to show the effect. In a highly resonant vibrator the mean amplitude would be considerably greater in proportion variation in the amplitude.

During a dash period when driving force is being supplied the amplitude grows to the maximum, which is determined by the value of the amplitude y of the driving force and the losses in the vibrating system.

During the spaces the amplitude decays because no energy is being supplied, but energy is continually being lost. As long as the dashes and spaces occur successively, the rises and falls in the amplitude continue, and it is clear that a rise must be equal to a fall, for otherwise the vibrator would either attain a higher amplitude, which is not possible as long as the driving force is constant, or it would decay, which is not possible as long as the spaces remain of the same duration with respect to the duration of the dashes. Hence after the vibrator has been subjected to alternate dashes and spaces for some time, the amplitude will vary about a mean position slightly less than the amplitude that would result if there were no dead spaces between the active dashes.

It is clear that the variation in amplitude occurs at the same rate as the dashes and that the dashes are receivable by observing the variation in the amplitude in some manner and by some suitable device. That the variations in amplitude of the vibrator do not constitute clearly defined dashes and spaces is obvious. It is also obvious that the shorter the dashes and spaces, the less the variation in amplitude will be. Thus the higher the rate of signalling, the smaller the variations will be. This conclusion is also arrived at by considering the problem from the point of view of the side-band theory. That is, a highly resonant circuit responds slowly to changes in amplitude of the impressed force of resonant frequency.

An Inverse Ratio

It appears from elementary considerations that the variation in amplitude, for a given impressed force and a given degree of sharpness of resonance, that the variation in amplitude is inversely proportional to the dash-space frequency. For equal speed of signalling, then, it would be necessary to amplify the variations in the amplitude of the vibrator in direct proportion to the frequency. This means that after detection the audio frequency would have to be amplified in a manner directly proportional to the frequency of the dashes and spaces.

Moreover, to get dashes reasonably well-defined it would be necessary to devise a special type of detector, and it appears that Dr. Robinson and his co-workers have done this successfully, for they have succeeded in carrying on 200 word per minute telegraphy by means of tuning fork resonators spaced only 50 cycles apart.

Problem of Broadcast Reception

The principle of the Stenode Radiostat has been explained above on the basis of equal dashes and spaces in which the driving force continues for a definite time at constant amplitude and then is zero for a definite period.

In broadcasting this is not the case, for the amplitude of the carrier never drops to zero. Modulation only varies the amplitude, increasing and decreasing with respect to a mean value, the amplitude of the unmodulated carrier.

The theory as worked out for the dashes and the spaces applies only in a qualitative way to the case of continuously variable amplitude of the carrier as met with in broadcasting.

For the dashes and spaces the mathematical treatment of the problem is simple but an adequate theory for the broadcasting case seems to be much more complex, and this writer has not yet seen one other than the familiar side-band theory.

(Continued on page 14)

A New SW Invention

Fig. 1.

Diagram of an all-wave receiver, embodying a new principle. Two three-gang condensers are used on either side of a drum dial. The same tuning operation tunes all sections of the gang at the same time, of course. Short or broadcast waves are brought in by simple switching.

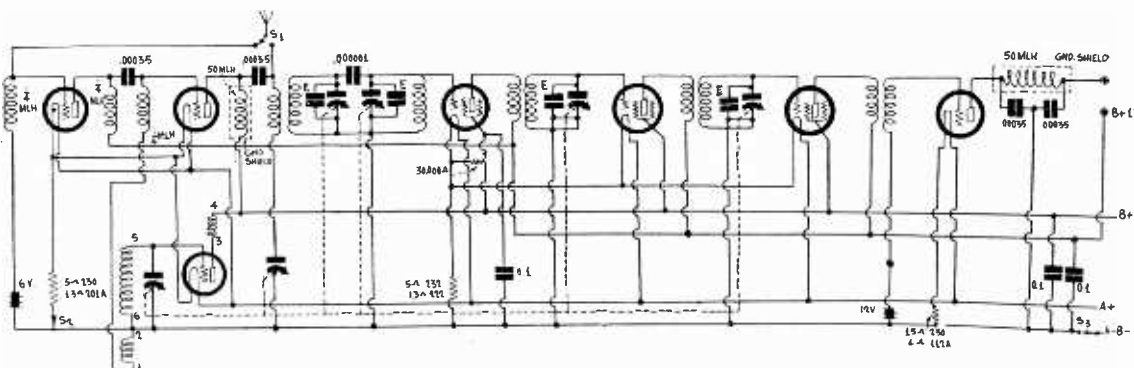

THE fact that interest is so great in reception of short waves does not, of course, infer that interest in regular broadcast waves has been robbed to fatten the other. Rather the short-wave enthusiasm is simply additional.

If this is true it certainly must be acceptable to have a receiver that tunes in both the short waves and the broadcast waves. Several plans of doing this have been suggested, but never have I noted even a suggestion of the present method. Indeed, there is no hint anywhere in radio literature of any such plan of achieving this highly desirable result.

Equal Sensitivity

In brief, the plan consists of building a sensitive tuned radio frequency receiver that discriminates very little, if at all, in the amplification over the broadcast spectrum. To insure this result of equal sensitivity throughout, a tuning condenser is placed in series with the antenna coil and ground, to cut down the input on the higher frequencies, since the capacity of this condenser then is decreased. The action is automatic as a part of the regular tuning process, since this condenser is simply one section of a gang.

As a supplementary aid to uniformity, an untuned radio frequency transformer is used to couple to the detector tube (extreme right). This transformer is broadly peaked around 500 meters, to build up the response at the lower radio frequencies. Such a transformer may be built of 700 turns on primary and secondary, each, by using any spool with about $\frac{3}{8}$ -inch hub or thereabouts, that permits slot winding. The wire may be No. 36.

A battery-operated tuner is illustrated, and the operation for dual purposes will be explained now.

Operation Explained

When the switch S1 in the antenna circuit is thrown to the left the aerial is connected to a radio frequency choke coil of $\frac{1}{4}$ millihenry inductance. The same action also may throw the switch S2, so that when the aerial is connected to the first tube in the chain of seven, the first three tubes are lighted. These are the short-wave performers. At the same time the equal amplification of the regular broadcast part of the receiver is utilized.

To receive broadcast a wavelength, the antenna switch is thrown in the opposite direction, and the filament supply of the first three tubes is cut off, the antenna input being made in usual fashion.

The condensers used for tuning are six in number and mechanically are two three-gangs. There is only one dial to tune them. Hence whenever one section is tuned, all six sections are tuned.

A Changing Second Frequency

The question now arises, how are you going to tune in short waves with a device that keeps changing the frequency of the broadcast part of the receiver all the while it is attempting to bring in short waves? Well, that's one place where the invention comes in. Instead of using a fixed second frequency, as is commonly done, a gradually varying second frequency is used, changing from 1,500 to 550 kc, a total change of 950 kc.

To enable successful operation in this fashion, it is necessary that there should be no direct pickup of broadcasts by the broadcast part of the receiver when short waves are tuned in. The remedy is to use $\frac{1}{4}$ millihenry radio frequency chokes, which virtually by-pass broadcast wavelengths, and to resort to shielding and to short leads. Even a sensitivity of 7 microvolts per meter will result in no stray pickup as close as one mile from a 50,000-watt broadcasting station, if the prescribed precautions are taken.

This plan for an all-wave receiver is submitted with the assurance that it works well and meets a real need now felt by experimenters and soon to be felt by set manufacturers and others, as the public demand for short-wave reception, in addition to usual broadcast reception, steadily grows, as it will.

Tube Options

The circuit, if used with the new 2-volt tubes, 230 general purpose and 232 screen grid, should have filament resistance values as stated, but a 6-ohm rheostat should be connected between A minus (3 volts) and the switch S3. Also it would be advisable to have a voltmeter across any one of the filaments. However, if 201A and 222 tubes are used, the resistance values would be as stated for them on the diagram; no rheostat would be necessary and no voltmeter, either.

A different voltage source, 6 volts, would constitute the source of filament supply. Where the 201A and 222 tubes are used in the other sockets, a 112A may be used for detection, instead of a 210A, without changing the filament resistor's value. The negative bias for detection with the 112A should be around 12 volts, supplied by C batteries.

Plug-in coils may be used with the system outlined, or a fixed coil, if a band of from 48 to 110 meters is sufficient. A fixed coil of $2\frac{3}{4}$ inch diameter would consist of 8 turns for the grid winding, 8 turns for the plate winding and 2 turns for the pickup winding. The wire may be No. 25, 24, or 22 silk covered.

Plug-in Directions

If the tube base type of form is used, for plug-in, double the number of turns specified, due to the smaller diameter. A five-prong plug is needed. The tuning capacity may be .00035 mfd., or .0005 mfd. of any value in between, which will depend, of course, on the capacity of the section of the gang that tunes this extra circuit.

It must be realized that one operation tunes everything—all rotors move whenever any one moves—and that the system is successfully operative because of the precautions taken against broadcast pickup when short waves only are tuned in.

The circuit shown is one that has great sensitivity, but it is not necessary to have such a high-gain broadcast amplifier to insure the working of the dual-system. Indeed, it has been worked successfully when using a radio frequency chain consisting of three tuned and one untuned stages, i. e., three stages of TRF and an untuned input to the detector.

This particular model, using the three-stage TRF arrangement, thus accounted for four tubes in that channel, plus three in the short-wave dipision, plus two audio and one rectifier, since this was an AC-operated design. The total number of tubes was ten, of which seven were used when broadcast wave lengths were tuned in, and ten when short waves were tuned in. The statement of the number of tubes, in all instances, includes the 280 rectifier.

An Open Invitation

It is the purpose of this article to present the theory, and to reveal the diagram for the first time. The proposition has been worked on for a long time. It is expected that soon a receiver embodying the principle will be ready for discussion from a constructional angle, including battery and AC operation, and also including the audio amplifier, omitted now, since there is no novelty in that. Any who are interested in using this system on a receiver to be newly built, or to be rebuilt from any existing receiver, may address questions to me care RADIO WORLD, 145 W. 45th Street, New York, N. Y., or come in to see me any Thursday, Friday or Saturday.

—Herman Bernard.

Installation and Operation

By Herman

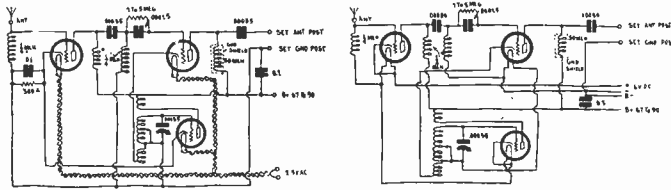

FIGS. 8 AND 9, REPRINTED FROM PREVIOUS ISSUES, SHOW THE AC AND BATTERY MODEL CONVERTERS, USING THE BERNARD SYSTEM OF MODULATION.

[In the November 8th and 15th issues the construction of a good short-wave converter, the parts for which cost \$5 or less, was described. The converter may be built for AC operation, with an external 2½-volt filament transformer (not included in the \$5 price), or for battery operation. In either instance three 227 tubes are used. The battery model uses a 6-volt storage battery with heaters in series, affording 2 volts to each tube, which is sufficient. This week installation and operation are discussed. EDITOR.]

THE same directions for installation and operation apply to both the AC and the battery-operated models of the three-tube short-wave converter, except that for the battery model a 6-volt storage battery is connected across the heater leads, while in the other instance the 2½ volts of a filament transformer are connected to these outlets.

Four connections are made to the converter, as previously explained, and as repeated herewith:

1. The aerial is removed from the antenna post of the receiver and is connected instead to the antenna lead of the converter.
2. The ground lead of the converter is connected by a wire to the ground post of the receiver. The ground is left connected to the ground post of the receiver.
3. The output of the modulator (marked "Set Ant. Post" on the diagram) is connected by a wire to the vacated antenna post of the receiver.
4. Positive B voltage is connected to the B plus of the converter. This voltage need be only high enough to insure oscillation, and may be from 67 volts to 90 volts.

When Aerial is Left on Set

If the aerial is left connected to the antenna post of the receiver, and the lead from the converter marked "Set. Ant. Post" is connected also to the receiver's antenna post, signals will be heard, but usually not as loud as if the connection were split up as recommended. The segregation of the connections, whereby aerial alone goes to the converter, and the converter's output alone goes to the set antenna post, utilizes the stage of short-wave radio frequency amplification in the converter, which the other method of connection cuts out of circuit.

Unlike the split connection in the aerial circuit, the ground connection is undivided. The ground lead is left at the ground post of the receiver and in addition the ground lead of the converter (marked "Set. Gnd. Post") is joined to the set ground post.

"Finding" the B Plus Voltage Source

The foregoing disposes of the first, second and third paragraphs of the tabulated installation directions. But as to the fourth one, connection of the B plus lead of the converter to a positive voltage of from 67 to 90 volts or more, this requires some voltage source within this range be found in your receiver.

Assuming the worst conditions, of a factory-made set with which you are not familiar and in which the parts are surrounded by metal casings and also are placed inaccessibly, if the receiver is of the screen grid type, this voltage nearly always is obtainable properly from the screen grid itself. Bare the looped end of the insulated converter lead intended for this positive voltage, so that the loop fits snugly over one of the screen grid tubes removed from a receiver radio frequency socket. Replace the tube in the same socket, pressing firmly in place. The contact of the looped end of the wire with the screen prong of the tube will introduce the screen voltage into the adapter. If you have a standard lug, you may fit this, instead of the looped wire, over the screen prong, and solder the converter wire to the free end. Usually the last RF screen grid tube will afford a constant B voltage from the screen.

In the battery-operated sets, using 222 tubes, this voltage will be around 45 volts, while in AC receivers, using 224 tubes, it will be from 50 to 75 volts, and in most instances the voltage is governable, as the volume control is a potentiometer that permits

variation of the screen voltage. If so, put the volume control at or near maximum volume position for working the converter, or connect to the last RF screen, usually independent of a series resistor.

Insurance of Oscillation

Should the receiver provide its screens with a voltage dropped through a series resistor, since the converter draws about 10 milliamperes plate current, this current will flow through the series resistor, lowering the effective voltage. The voltage scarcely will be lower than 40 (this extreme example of resultant reduction is taken from the Hi-Q 31). The oscillator will function, as well as the detector and RF tubes in the converter, on 40 volts, provided the screen lead is adequately bypassed by a condenser in the receiver. For instances of low voltages around 40 volts, and absence of oscillation, assume inadequate bypassing and connect an extra condenser of 1.0 mfd. from the B plus lead of the converter to ground.

If under no circumstances you can pick up an adequate B voltage from your receiver (and I have not come across any receiver from which such pickup could not be obtained), then you may introduce a 45-volt B battery, connecting negative to ground and extreme positive to the B plus lead of the converter.

The voltage to use is not critical, as the foregoing intimates. The main object is to attain oscillation. What the voltage is on the detector plate is unimportant, especially as 45 volts usually is recommended as a good detecting or modulating voltage, when the cathode is returned for zero bias, as it is in the AC and battery converters.

The actual work of installation takes only a few minutes, but the incidental factors should be understood, hence the explanation of installation and its sidelights has been given rather fully. It must not be assumed from the extensiveness of the explanation that there is anything difficult about it.

Theory of Operation

As for the operation of the converter, here is the theory:

All waves are introduced into the first tube, which is in a stage of untuned radio frequency amplification, but the input choke is of such small inductance, around ¼ millihenry, that short waves are greatly favored. The amplified untuned, or, one might say roughly, semi-tuned waves, are introduced into the modulator, again without tuning. The oscillator is coupled to the modulator by a small winding in the modulator tube's cathode lead inductively related to the oscillator's tuned secondary. Tuning the oscillator, with the only tuning condenser used, varies the frequency of oscillation, and in such a manner that the resultant admixture of the oscillator frequency and the incoming frequencies, in the modulator, comprises another, but lower, frequency. This frequency is to be the same all the time, representing a standard setting you use on your broadcast receiver, preferably about as high a frequency (low wavelength) as your broadcast receiver will reach. Hence selection is attained solely by turning the dial in the oscillator circuit of the converter, and the selectivity, as previously pointed out, is simply the selectivity of your own receiver. The composite operation constitutes a Superheterodyne.

Due to the great difference in performance of various receivers it is not possible to standardize the results attainable, but it is rational to state that short waves can be brought in when the converter, either model, is worked in conjunction with any receiver that satisfactorily brings in broadcast waves. Nearly all receivers are more sensitive at the higher frequency settings, and this applies particularly to tuned radio frequency receivers, which is one reason for preferring a high broadcast frequency as the intermediate frequency. But if sensitivity is greater elsewhere, use the most favorable setting.

Tendency is to Overload the Set

The tendency will be to press the receiver itself to its condition of maximum amplification, as thus the sensitivity is usually increased. In fact, that very condition was incidentally recommended when it was said the volume control should be advanced to or near the setting for maximum volume. However, the principal consideration at first is to bring in some short-wave stations, to make one feel that, after all, the \$5 was well spent, and it was not a case of paying \$5 just to satisfy one's curiosity as to what is inside of a dubious package.

So we shall address ourselves now to the pleasant act of tuning in some short-wave stations. We shall not consider whether code or voice is received, but be content simply with reception of some kind.

The choice of a high frequency in the receiver for intermediate amplification gives us, of course, a Superheterodyne with an intermediate channel of, say, 1,500 kc. The waves we desire to

of the \$5 SW Converter

Bernard

tune in will be much shorter, their frequencies much higher, so 1,500 kc is only a small fraction of the frequency of reception. Hence the ratio is high, as it should be.

As only one condenser is used in tuning, our pleasure is simplified considerably.

Tuning In

Turn on the switch of the receiver and also see that the tubes in the converter are lighted. Press in the coil switch at rear of the converter. Then, after waiting for the tubes to heat up, which should not take more than one minute even with slow-heating tubes, listen carefully to your broadcast receiver, for the familiar rushing sound in the loudspeaker. If this sound is not present, turn up the volume control of your receiver. If this does not cause the sound to appear, then turn the volume control in the opposite direction, for if the receiver itself can oscillate at the high frequency to which it is tuned, only a quiet hiss will be audible, and indeed you may not be able to tune in a short-wave signal. Be sure that the receiver is not oscillating. If possible, operate it just under the point of oscillation, or, if it is a stabilized receiver, at or near maximum volume position of the volume control.

Now very slowly rotate the tuning dial of the converter. If you have had no previous experience with short-wave reception, recognize right now the well-established fact that it is easier to pass over short-wave signals that are within sensitivity range of your receiving system than it is to tune them in. The loudest short-wave station receivable will come in strong at a given position of the converter's dial, and possibly be tuned out completely by a movement of that dial equal to only one-eighth of a division.

The converter is not equipped with a vernier dial, but when you pick up a carrier, hearing its swish, you may resolve this into reception either by careful adjustment of the converter dial, or by a slight adjustment of your receiver dial. It is preferable to use the receiver dial, as this is in itself vernier in its action, and likewise the vernier effect is communicated to the converter at an increased ratio (much finer adjustment).

Repeat Tuning Points

After having tuned in a strong signal at one position of the converter dial, try to tune it in at another position of the same dial. About one-third the number of strong stations you can receive will come in at two settings of the oscillator dial. If interference is suffered, either use the alternative setting, whereupon this interference may disappear, but if it does not, another remedy is to change the setting of the receiver dial ever so slightly (thus barely altering the intermediate frequency), and retune the converter. The form of interference usually cured by this intermediate frequency alteration is peculiar to Superheterodyne reception. It is known as image interference.

Should no signals be receivable, and no indication be obtained that the converter or set is functioning, turn the dial of the set to bring in regular broadcasts, which come in even with the converter hooked up. In fact, the converter acts as a damper for the set in tuning in broadcasts, since it constitutes two stages of "detuned" radio frequency amplification (the oscillator being ineffective) in this regard, and the modulator being utilized for its amplification properties alone. If stations come in, then the set itself is all right, so look to the connections to or in the converter as the source of your trouble.

Make the Oscillator Oscillate

The principal fault to be expected is the wrong connection of the windings in wiring the converter, since if the directions for installation are followed, no mistake can be made here. Check up to determine that the single coil used in the converter has one end of the secondary (10-turn winding) going, **not** to ground as is usually the case, but to the **cathode of the modulator**, and that the next tap up from this cathode connection goes to ground, while the other extreme of the secondary goes to oscillator grid. The remaining connection, a tap for the switch, is incidental. If the connections are right, the only other mistake will be that the plate winding in the oscillator tube is misconnected as to phases, so simply reverse the connections so that the lead that went to plate now goes to B plus, and the one that went to B plus now goes to plate, or follow exactly Fig. 12, published last week, as this is one of the two methods of connection that produce oscillation.

If all directions are followed as given, and the receiver is functioning, nothing can prevent the converter from working, except failure to connect aerial, or use of poor tubes in the converter. Particularly must a tube be used in the oscillator socket that will oscillate. If you have any half-dead tubes and

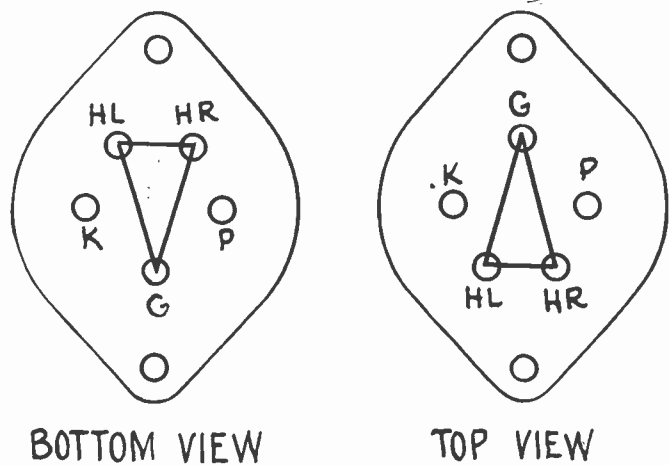

FIG. 14

CODE FOR IDENTIFYING SOCKET CONNECTIONS. VISUALIZE THE TRIANGLE FORMED BY THE LINES FROM HEATERS AND GRID. VIEWED FROM BOTTOM, GRID TOWARD YOU, OR TOP, GRID AWAY FROM YOU, THE RELATIVE RIGHT-AND-LEFT POSITIONS ARE THE SAME. FOLLOW THIS CODE IN WIRING.

must use them, though they won't oscillate, put them in the modulator and radio frequency sockets. By all means get a tube for the oscillator that positively will oscillate. Your dealer will test a 227 for oscillation if you so request. If in doubt about your tubes, have the dealer test all of them for you.

Peculiarities of Reception

Assuming that you get reception now, let us investigate the peculiarities.

You may experience fading. This is something associated with short-wave reception, and particularly the reception of certain stations, and is due to wave behavior in space, a condition beyond your power to remedy. But if you have a receiver equipped with an automatic volume control, this device will compensate to a great extent for the fading, since dissimilar values of input create a relatively uniform output.

When you tune in a station it may not be as loud as you desire, therefore you turn up the volume control of your receiver, and at once you hear a gong-like sound, resembling the microphonic performance of tubes in the days when tube manufacturers were not so exacting. This sound is due to coupling between converter and receiver, causing overloading of the receiver's detector. The remedy is to retard the volume control of the receiver until the interfering sound disappears. Be careful in this adjustment, for if you retard the control a little too much, the effect in reducing volume will be great. When you get as much volume as is possible, without working the receiver to the hilt and causing howling, you should not try to exceed this limit.

High Level of Oscillation

The oscillator tube should be regarded as one that has a large output, compared to the amplitude and even the capacity of the modulator, so that the ratio of oscillator to modulator amplitude may be as great as 1,000-to-1. Hence it is always a good plan to include radio frequency amplification ahead of the modulator, one stage being used in the present converter. Thus the ratio is about 250-to-1. Nevertheless, if you press the receiver too hard, making it amplify more than the conjunctive system permits, you are bound to overload it.

Remember, also, that even with no signal impressed, it is possible to overload a receiver, due simply to the intensity of the oscillator voltage. Be circumspect, therefore, as to the amount of receiver amplification used, and when you have reached the working limit, stop. A very strong signal will overload the modulator as well as the receiver's detector, so stay within limits.

The intensity of the oscillator voltage has been stressed, also the desirability of radio frequency amplification ahead of the modulator, as included in the two designs for \$5 converters, and these facts lead to the conclusion that a long aerial is greatly to be desired.

Many modern receivers operate on short aeriels, even on short wires indoors, or from screen mesh built into a console, but for short-wave work use an outdoor aerial, 100 feet or more total.

The Brunswick and Ste

By Leonard

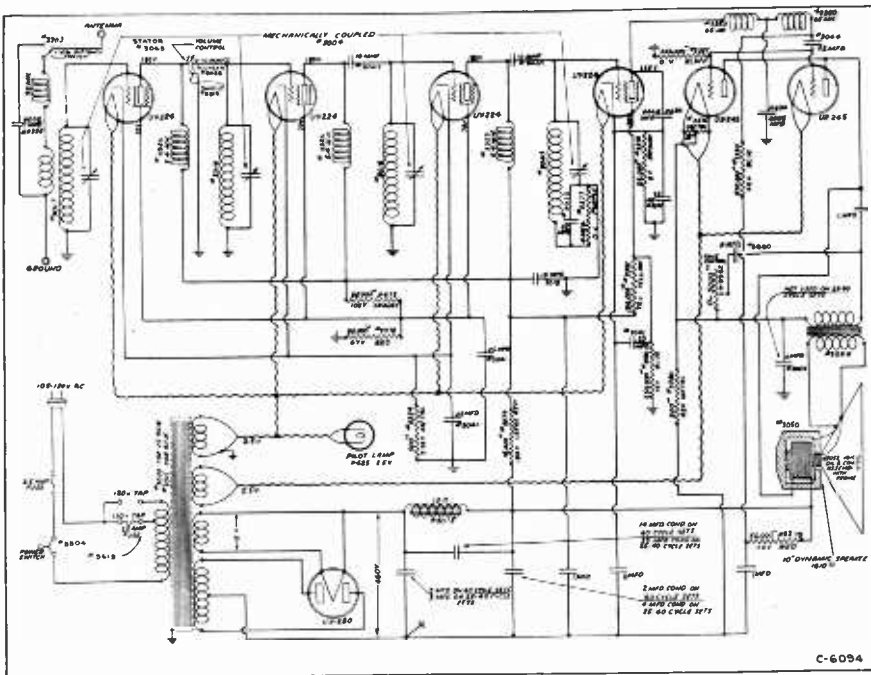

FIG. 1.
THE COMPLETE CIRCUIT DIAGRAM OF THE BRUNSWICK MODELS 15 AND 22 RECEIVERS. THE OUTPUT STAGE OF THESE MODELS CONTAIN TWO 245 TUBES IN PARALLEL. AN INGENUOUS METHOD OF CONNECTING THE FIELD WINDING OF THE DYNAMIC SPEAKER IS EMPLOYED.

THE circuit diagram of the Brunswick Models 15 and 22, as shown in Fig. 1, reveals the fact this is not a conventional receiver, for it has many distinct features of design. In the first place it utilizes a screen grid tube as detector and in the second it utilizes two 245 tubes in parallel in the last stage, not in push-pull. This two-tube power stage is the only audio amplifier in the circuit and it is coupled to the detector by means of resistance capacity.

Another feature is the coupling between the radio frequency tubes. A 5.4 millihenry choke coil is used in each plate circuit for feeding the plates. Between the plate of one tube and the grid of the next is a 10 mmfd. condenser, the first of which is variable between zero and 10 mmfd., the others being fixed. In the grid circuit of each of these tubes is a tuned circuit. Loose coupling between the tubes is established by means of these small condensers.

Grounding of Heater Circuit

The small variable 10 mmfd. condenser, which follows the first tube, is also used as a volume control. In addition to this volume control there is a Local-Distance switch in the antenna circuit. For local stations the regular antenna is cut out and the primary is connected in series with a .0002 mfd. condenser. In series with

the primary in either position of the Local-Distance switch is a 0.95 millihenry choke which acts as a loading coil.

It is customary to ground the mid-tap of the 2.5 volt heater circuit, either directly or through a resistance, but in the Brunswick Model 15 and 22 one side is grounded. Obviously, grounding one side of this circuit will give less hum than grounding the other, and in some instances less than if the center of the winding is grounded.

The B supply filter is also somewhat unconventional, although the type is used in other receivers. There is a single 15 henry choke in the filter, but this choke is tuned to hum frequency by a condenser of a value suitable to the frequency of the line voltage. This type of filter is very effective in suppressing the main hum component while it permits the higher, and weaker, components to get through. However, condensers across the line are provided to cut out these as well as to aid in the suppression of the principal hum component.

The loudspeaker is coupled to the two power tubes by means of an output transformer but the heavy plate current is kept out of the primary by means of a 1 mfd. condenser and a choke coil, and this choke is the field winding of the dynamic loudspeaker. This is an ingenious arrangement. The field serves as a choke and an impedance coupler in addition to its service as a field coil, and it permits the use of the heavy plate current to energize the field. By suit-

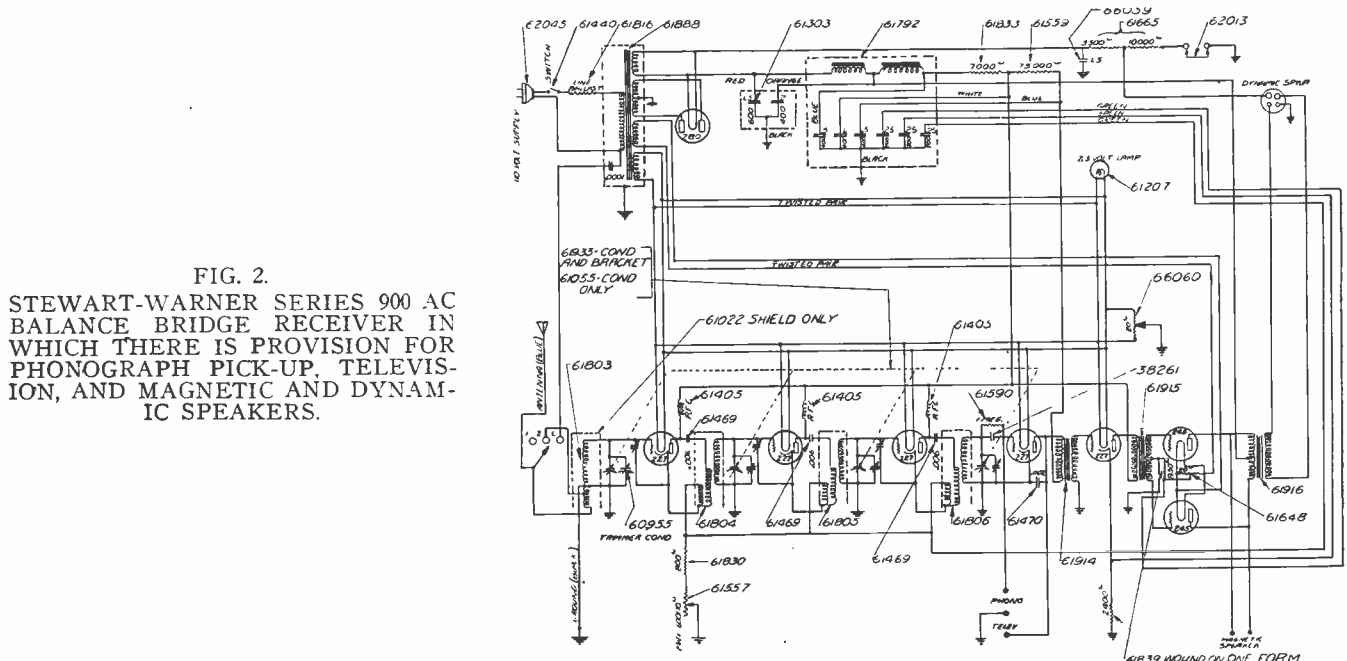

FIG. 2.
STEWART-WARNER SERIES 900 AC BALANCE BRIDGE RECEIVER IN WHICH THERE IS PROVISION FOR PHONOGRAPH PICK-UP, TELEVISION, AND MAGNETIC AND DYNAMIC SPEAKERS.

Stewart-Warner Receivers

Watkins

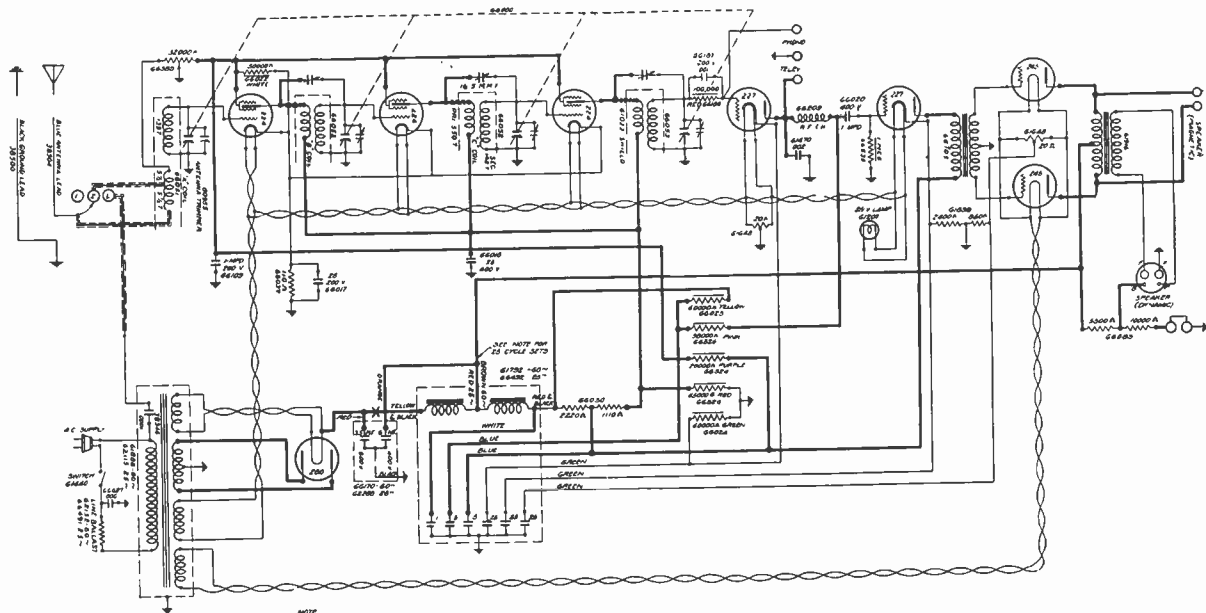

FIG. 3

STEWART-WARNER SERIES 950-960 SCREEN GRID TUBE RECEIVER. IN MANY OF THE SPECIAL FEATURES THIS IS LIKE THE SERIES 900 BUT IT DOES NOT CONTAIN THE BALANCED BRIDGE ARRANGEMENT, THIS BEING UNNECESSARY WITH THE SCREEN GRID TUBES.

ably connecting the leads of the field winding and those of the transformer it is possible to eliminate a large proportion of the hum, and this is another advantage of the arrangement.

Tone Control

There is also a tone control associated with this output arrangement. It consists of a 0.4 mfd. condenser in series with a variable resistance of 5,000 ohms maximum value connected from the high side of the transformer primary to the mid-tap of the filament circuit of the power tubes, as well as to the low side of the primary. Thus by varying the 5,000 ohm resistance it is possible to put a condenser of 0.4 mfd. across the primary to reduce the intensity of the high notes or to put 0.4 mfd. and 5,000 ohms across it for normal reception.

Grid bias detection is used, the bias being supplied by a 25,000 ohms resistance between the cathode and ground. This is shunted by a 0.25 mfd. condenser. The plate coupling resistor is 250,000 ohms and the grid leak ahead of the power tubes is half megohm. The plate resistance goes to a 50,000 ohm resistor, shunted to ground by a 1 mfd. condenser, which is used to drop the plate voltage on the detector by 11.3 volts and also to prevent audio frequency oscillation.

Radio frequencies are prevented from reaching the power tubes by means of a .00015 mfd. condenser from the plate to the cathode of the detector, a 65 millihenry choke in series with the output lead, another .00015 mfd. condenser to ground, and finally another 65 millihenry choke in series with the lead to the coupling resistance and the .02 mfd. stopping condenser. The effective plate voltage on the detector tube is 225 volts.

Stewart-Warner Series 900

This is known as the A. C. balanced bridge receiver because of the special arrangement of the couplers between the radio frequency tubes, all of which are 227 type tubes. A small adjustable condenser is connected from the grid of each tube to the cathode, and a small coil coupled to the tuned circuit following the tube is connected in series with the cathode lead to ground. A certain amount of reversed feed-back may therefore be arranged for controlling the radio frequency oscillation.

Provision is made for both dynamic and magnetic speakers. The field current for the dynamic speaker is taken from the B supply circuit. The current for the field is not filtered other than by a 1.5 mfd. condenser. The magnetic speaker is connected from plate to plate of the push-pull amplifier.

A unique feature is that provision is made for both television signals and phonograph pick-up. The terminals for the pick-up unit are so arranged that the detector becomes an amplifier, the unit being connected between the grid and ground. The terminals for the television signals are between the plate of the detector and ground.

Volume is controlled by a switch in the antenna circuit and by a variable resistance which controls the bias on the radio frequency amplified tubes. The antenna switch contains three stops. One stop throws the entire primary in series with the antenna and this is

for long distance and weak stations. The second stop short-circuits a portion of the primary, and this is for medium distant stations. The third stop connects the antenna to a condenser one side of which is connected to the 110-volt supply line. This is for local stations since the connection is such that most of the signal energy is shunted by the primary to ground through the condenser.

Stewart-Warner Series 950 and 960

In many respects this series of receivers is like that previously discussed but it contains three screen grid radio frequency amplifiers and it does not contain the bridge balancing feature. The output arrangement is essentially the same, being provided with terminals for both dynamic and magnetic speaker. There is also the same provision for phonograph pick-up and for television. The coupling between the detector and the first audio frequency amplifier is resistance-capacity, whereas in the other it was by transformer.

A by-pass condenser of .002 mfd. is connected from the plate of the detector to ground and a radio frequency choke is in series with the output lead of the detector for the purpose of suppressing radio frequencies. The coupling resistor has a value of 38,000 ohms and the grid leak one megohm. The stopping condenser has a value of 0.1 mfd. Since the time constant of the stopping condenser and the grid leak is as high as 0.1 second, it is clear that the amplifier is effective on very low audio frequencies.

A grid bias resistor of 40,000 ohms is used with the 227 detector. This is in addition to the .001 mfd. grid condenser and 100,000 ohm grid leak. The method of detection is primarily that of strong signal, grid bias type.

Radio Frequency Coupling

In addition to the inductive coupling between the primary and secondary of each RF transformer there is a 16.5 mfd. condenser between the plate and the grid, the two types of energy transfer being used to equalize the amplification in the tuning range. The small condensers are adjustable so that the degree of capacitive coupling may be adjusted. These condensers together with the trimmer condensers also help to line up the ganged tuning condensers.

There are two sets of volume control in the circuit, the switch arrangement described under the previous model and a 32,000 ohm potentiometer by means of which the voltage on screens can be varied.

The heater circuit is balanced by means of a 20 ohm potentiometer connected across the 2.5 volt winding supplying the heater tubes and with its moving arm connected to ground. This adjustable feature permits adjustment for no hum or minimum hum.

In these receivers there are directions for changing the filter for use with 40 or 25 cycle current. In every case when the frequency of the current is less than 50 or 60 cycles, the filter condensers required are larger, the aim being to keep the impedance approximately the same. For example, if a condenser is specified at 2 mfd. for use with 60 cycle current, it would be specified at about 4 mfd. for 25 cycles.

Affinity of Gas and

By John C

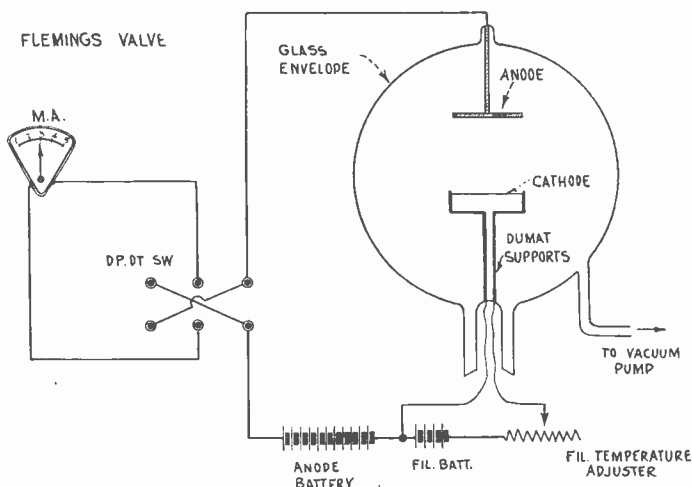

FIG. 1.

THE FLEMING VALVE, THE EARLIEST FORM OF VACUUM TUBE THAT COMPARES TO THE PRESENT-DAY TUBE WE KNOW. IT IS A DIODE, OR RECTIFIER.

[The following article is the seventh of a series dealing with the historic aspect of the development of the radio transmission and reception art. The first article appeared in the October 11th issue, and presented a condensed resumé of important scientific steps that culminated with the successful commercial experiments of Guglielmo Marconi, 1899-1901. The second article appeared in the October 18th issue and consisted of a brief review of early telegraphic systems, including data on the first photo-electric work, and short-wave transmissions with concave and parabolic mirrors, also early stages in the development of the beam transmission system. Progress was traced from the sixteenth century to the eighteenth century. The October 25th installment traced the development of the Leyden Jar, whence the first oscillatory currents were obtained, and also told of the manner in which short wave radiations were concentrated by lenses, as compared to reflection methods. The article in the November 1st issue dealt with interference in short wave transmissions, and showed how the experiments of Dr. Thomas Preston established the identity between luminous and electromagnetic radiation, a prediction of Dr. James Clerk Maxwell, made nearly a hundred years previously. The fifth installment, in the November 8th issue, dealt with the early history of the vacuum tube, detailing the methods used to make the first correct estimation of the velocity of light, and also described the first efforts to register the effects of negative radiation from hot platinum. The November 15th issue, last week, continued with early radiation experiments, and showed how the study of tube discharges aided the design of electrodes. The following is a continuation of the study of radiation experiments.—EDITOR.]

SIR AMBROSE FLEMING made three experiments of note with the vacuum tube. The first and second experiments of this distinguished Briton have been described.

The third experiment with the Fleming valve was the determination of the maximum anode current obtainable after the increase with reduced pressure was stationery. After this point was reached the cathode heating potential was increased, and the result was an increase of anode current, but it was a small change as compared to the result of the first experiment. Another stationery point was found beyond which the anode current did not increase. It was assumed that this point represented the maximum radiation output of the cathode, a fact that was later substantiated when an increase of anode potential produced no further increase of anode current.

The cathode electrode supports originally were of platinum, because this metal has coefficient of expansion similar to the glass of which the tube envelope is made, but the later Fleming valves used the alloy called dumat, which serves the same purpose. This alloy is used today in lamps and vacuum tubes.

As a direct result of the work of Fleming at the University College Laboratory, Cambridge, England, the study of the characteristics of various types of radiation was begun in earnest by scientists on both sides of the ocean.

The researches of Dr. Karl K. Compton, now of the Massachusetts Institute of Technology, in the field of X-rays, is only one of the offshoots of the study of the science of radiation. The relatively small company of roentgenologists who have added

to the stock of knowledge of which this particular branch of physics is daily assuming greater importance to mankind.

Positive Charge Suspected on Surface

We have reviewed the highlights of the theoretical and experimental progress of the earlier steps incidental to the determination of the nature of the behavior of ionized gases, first in air, then in vacuo, and this led to the first form of the radio receiving tube, the Fleming Valve.

Experiments by Dr. Compton were made during 1915-1920, with the object of confirming that a positive charge existed on the surface of a glass envelope that enclosed a source of negative radiation. It was found that this was not exactly the case, the setup as here depicted being used, with the single exception of the type of galvanometer, which is of the telescope and mirror reflected scale variety. The one shown is merely for convenience.

Here is one historic experiment that the reader who is experimentally inclined can copy. The essential apparatus is a standard 50-volt lamp (10 watts), a hundred ohm resistor of the variable type, and four dry cells to afford anode voltage. The galvanometer may be of inexpensive design, say one of a sensitivity of five microamperes per scale division, or so. The lamp may be heated from AC.

The Compton Experiment

The purpose of this experiment, at first consideration, seems to overlap the work already done, if the existence of the effect of the negative radiation is the only objective, but if you will remember a previous remark concerning the deflection observed in the second experiment of Fleming, it will be realized that there is a difference.

One of the outstanding characteristics of all vacuum tube research is that you have to have an alert mind, eye, and ear, to observe small effects, which may easily have big consequences.

The evacuated glass envelope contains a tantalum or tungsten filament, and the metallic coating is of heavy tin foil, closely conforming to the shape of the envelope, and from the surface of this coating at the top, as shown, a wire lead goes to the reversing switch, and from the other terminal of the switch a lead goes to the potential battery positive terminal. The negative terminal is common with the positive filament voltage source which may be the power main, AC or DC.

Here the situation is somewhat different to the preceding cases, since the plate or anode electrode is external to the rest of the tube elements, especially the source of negative radiations.

Test of Polarity

According to theory, the velocity of emission of the negative charges will be high enough, if the temperature of the cathode is sufficiently high, to enable the negative charges to bombard the inside surface of the envelope. This results in the outside

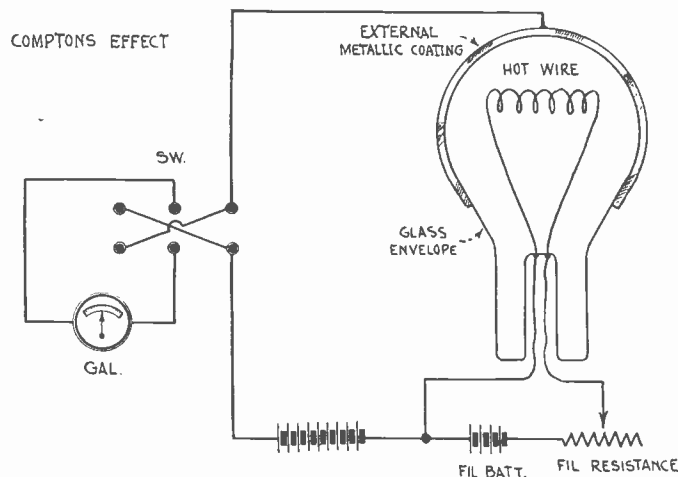

FIG. 2.

THE COMPTON EXPERIMENT, MADE WITH AN ORDINARY TUNGSTEN FILAMENT LAMP, GAVE THE FIRST INDICATION OF THE EFFECT OF SPACE CHARGE.

Electronic Discharge

Williams

surface of the glass envelope acquiring a positive charge by induction. The existence of this state of affairs should result in a current through the glass.

The polarity of this surface charge was tested, by connection to an electrometer, and found to be positive. Following this the circuit was closed through a galvanometer, as shown, but without the left-hand potential battery. The deflection was found to be zero, despite the connection to the positive filament voltage source.

So the previous experiment was repeated, and the electrometer test again showed the metallic coating to be positive.

But it was also found that the degree of positive charge coincided with the potential drop between the ends of the hot cathode wire, taking into account the potential necessary to transfer unit charge from the plane of the cathode to the plane of the coating. It was further found that if the load conditions imposed by the external circuit, namely, those of a resistive equivalent, are less than that of the path through which the charge passes, the required potential must be maintained with an external source of potential, such as the battery shown in Fig. 2.

Thus it was found that there was a gradient of radiation along the hot cathode, from the positive end to the negative end. It was at first thought that this inequality in the emissivity of the cathode would result in the exhaustion of a portion of it first, but it was later found that the total number of charges that negotiated the distance between the cathode and the external anode by far the greatest number fell back on the cathode again, this effect being proportional, roughly, to the square of the applied voltage.

Experiments with a variety of radiators gave different results, so finally it was possible to tabulate the emissivity of a number of substances. This line of investigation led to the development of the present-day filament, and ceramic coating materials.

How Gas Molecules Behave

What is the structure of gaseous molecules whose behavior under the influence of an electric field, even a weak one, as in the case of the Compton experiment, is involved?

Theories of molecular and atomic structure have undergone changes, due to new concepts of the electrical constitution of matter. If explanation were made of the relatively historic effects observed years ago, in terms of modern concepts, the result would be a complicated sequence.

The structure of gaseous molecules is held intact by a mutual electric attractive force that is exercised wholly within the sphere of the individual molecule. The application of an electric field under the right conditions results in the disruption of the molecule's structure. If these particles can be projected along a definite path without the influence of the force that disintegrated them, the mutual attractive forces tend to reassert themselves, especially if the particles are close enough together, so that the ratio of the center to center distance of the particles to the attractive force is small. This results in recombination of the molecules.

This is well illustrated in an experimental observation of Fleming in connection with research on the Edison incandescent lamp filament, made of carbonized bamboo fibre, fashioned in the form of a loop, the terminals of which are clamped by two small copper tubes pinched together, and the whole being then copper plated, after which the assembly is placed within the envelope and sealed off, after exhaustion.

Copper Deposit Appears

During the exhaustion process, the lamp was dimly lighted to help to drive off occluded gases, and finally the tube was sealed off.

But during the life of the lamp, it was noticed that a copper deposit appeared on the interior of the lamp, and it grew thicker as time went on. There was at the same time a well-defined line along which there was no deposit of copper.

This was a *shadow* of the filament, and it was most noticeable when the ordinary carbon deposit was a minimum. But even when the copper coating reached its maximum density, the additional carbon coating did not affect it, and after the lamp finally burned out the copper coating's thickness was measurable.

This copper deposit exhibited the characteristic behavior of a molecular radiation between two points, and though no special significance was attached to the observed fact at that time, it is now seen to parallel the Compton effect. This effect observed

A CASE OF MOLECULAR RADIATION

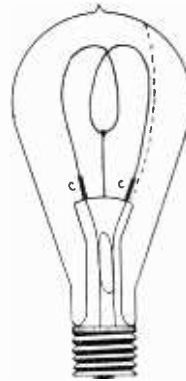

FIG. 3.

THE EDISON LAMP AS AN EARLY CASE OF MOLECULAR RADIATION, NOW APPLIED TO THE FRONT SURFACING OF MIRROR SURFACES.

by Fleming, with the Edison filament, was really the forerunner of the electron radiation phenomenon of Compton.

Refer to Richardson and Bishop, "Radiation from Metals in Vacuo," Proceedings, Royal Society, Cambridge, 1898-1904.

Fig. 3 represents the first commercial form of the Edison lamp, and the clear line above referred to is represented by the dotted line in the sketch. This dotted line is not one that is in any way irregular in appearance. It is manifested in each and every case, and because the effect constituted a *defect*, it led to the substitution of a different method of fastening the filament wires to the supporting structure, which were finally made of dumet alloy. The joint was secured with a kind of carboniferous paint, which solidified in the form of a small ball on drying.

Positive Charge Established

The precipitation of solid copper on the inner walls of the lamp is directly due to the establishment of a positive charge on this inner surface of the lamp, coupled with the velocity of emission of the particles. The potential available for doing all this is furnished by the potential difference between the opposite ends of the filament, which is 110 volts, the shadow being on the same side of the bulb as the negative end or side of the filament occurs.

One side of the filament acted as a cathode, while the other side was the anode, but it must be borne in mind that the effect was a differential one, as all parts of the filament that were incandescent were at the same temperature, since the cross-section was uniform. Thus it is seen how this effect parallels the Compton experiment, except that the precipitation of a metal in molecular form was not involved in Compton's work.

Study of Gas Discharges

Of the development of the vacuum tube it can be truly said that progress depended on the degree of adaptability of the tube with which you worked, for before the glass-blowing art approached the degree of present-day accomplishment the physicist in many cases was dependent upon his own ability as a glass blower, when it became necessary for him to make alterations to his glassware. This hazarded many a failure, but of all this work there was born a new knowledge which became part and parcel of the tube making industry.

Fig. 4 may not seem to be very much unlike the low pressure tube previously discussed but in reality it is very different, the former being for the purpose of demonstration, while the present tube's form fits it for qualitative work.

Another curious fact about vacuum tubes is that the effects observed in one tube often help to answer the question which the nature of the discharge in another indicated, and thus it is glimpsed how a part of the vacuum tube research rests upon the observations of the discharges in the earlier tubes.

What is important now is the presentation of the form of tube in which the ionization potential of different gases is measured.

(Continued next week)

A Standard

By Stewart

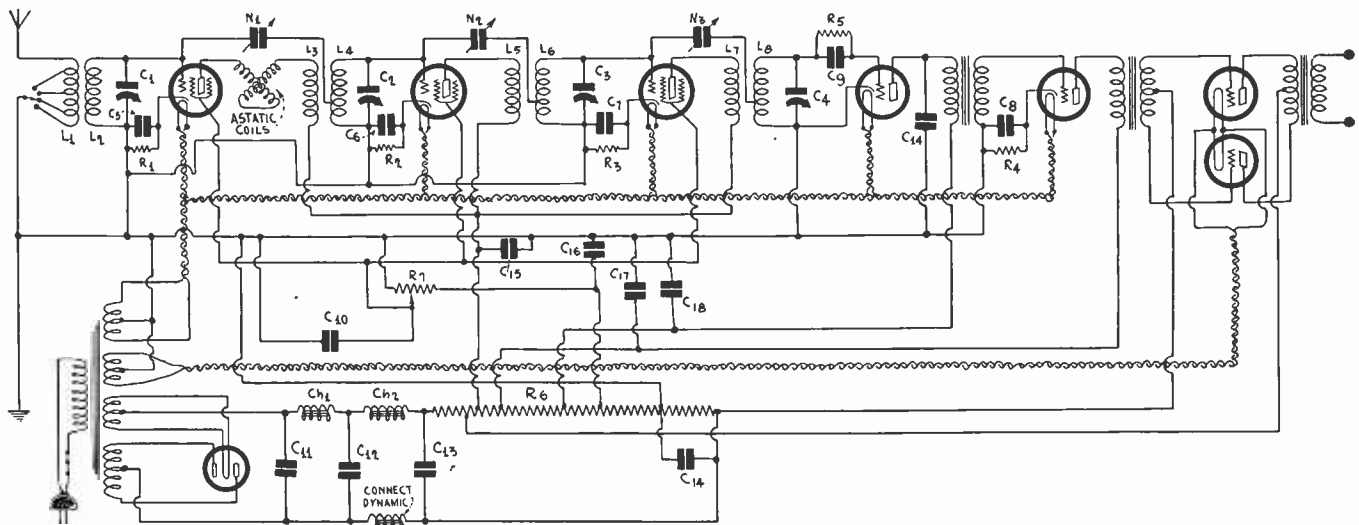

FIG. 1. A NEUTRALIZED TUNED RADIO FREQUENCY SET, PROVIDED WITH A STATION SELECTING INPUT FILTER, IN LINEAR FREQUENCY RELATIONSHIP TO AN ASTATIC COIL BUILDS UP THE VOLUME OF THE FOLLOWING THREE-STAGE TUNED RF CIRCUITS. DISTANT STATION WITHOUT INTRODUCING THE CUSTOMARY DISTORTION.

THERE are by now certain standard sets which, though they may differ superficially, nevertheless are very much the same. These sets not only sell, but stay sold and continue to give satisfactory reception year after year.

Therefore why not write up a descriptive article about a set like this?

One of the advantages of this circuit is that a chassis may be built to fit a wide variety of cabinets. A design reasonably trouble free is what is under discussion. The assembly of a standard circuit is simple to the average set constructor, who will have no trouble with it.

Uses Screen Grid Tubes

The assembly is of a variety not strange to the majority of readers.

The input circuit is one of the station selecting type, and its function is that of a modified filter, enabling the first stage to be made more nearly resonant to the desired signal frequency than it is usually with the untuned type of first stage antenna coupler.

The control for this adjustable filter is a small knob of the same size and finish as the usual volume control and switch knob and is located at the left-hand side of the center of the lower part of the front panel. The tuning is accomplished with a four-gang, .00035 mfd. variable condenser, whose plates are carefully aligned.

The radio frequency coils are mounted mutually at right angles to each other. There is a small neutralizing condenser for each coil.

The three coils mount right under the radio frequency tubes, with sufficient clearance to enable the connecting wires to be laid in the manner to be prescribed later on.

Detection Circuit

The tubes plug into the tube sockets, which are mounted underneath the panel, so that the tube prongs will project through the panel. This necessitates the drilling of five tube prong holes. You may use a dummy socket as template.

In those circuits with high detector plate voltage a power detector may be used. The circuit will contain suitable means, as well as apparatus for cutting in a phonograph record pickup, regardless of its impedance, the scheme being to regulate the speaker output by means of the usual volume control, and in addition the input to the audio amplifier is by means of two push-pull tubes, a circuit arrangement that follows the detector output, the change-over being made by a small separate switch directly under the main dial, which you rotate to the right for the phonograph record connection and to the left for the reception of broadcasting.

Connections, and the Battery Cable

The audio amplifier consists of an arrangement whereby three tubes follow the detector tube. The output is 245 push-pull.

This hasty resume of the sets just concluded omitted the usual connections and it might be surmised that all that you have to do is to complete the antenna and ground connection, also the A B & C voltage leads and the job is done. In general this is true but there may easily be the odd case where this is not the only slant on the proposition, and this is specially true in the case of the AC model, where the actual placement of the lead by-pass condensers influences the working of the circuit. Here is where the interpretation of the wiring diagram is likely to go wrong, if at all, and the general rule to follow is that if the diagram calls for the placement of a by-pass condenser at the end of the particular lead, and particularly if you are to by-pass a certain piece of apparatus, do so at the point closest to the part in question, always, unless there as a good reason for using it at some other point.

245 Push-Pull Output

The original model of this circuit appeared in two forms, one of them used a single 171, while the other one used two of them in push-pull. Here we are going to use push-pull, but substitute 245s.

The power transformer is provided with two 2.5 volt windings, one of 16 amperes capacity, the other of 3 amperes capacity. The large-wire winding is loaded with the heaters of five tubes, or a total of 8.75 amperes.

The mid-connection of the two filament windings goes to ground. The 3-ampere winding supplies the filaments of the 245s. The radio frequency coils that follow the first stage tapped coil are the ones that are placed at mutual right angles

Analysis of the

(Continued from page 6)

When the modulation increases the amplitude of the carrier the energy supplied to the resonant vibrator is continually increasing and the theory for a constant amplitude for a definite period does not hold. But the increasing amplitude of the driving force obviously increases the amplitude of the vibrator, but not as rapidly as the driving force, because part of the driving force is not in phase with the vibrator. It is held back a little. Likewise, when the modulation decreases the amplitude of the carrier, the amplitude of the vibrator obviously decreases also, but not in the same manner as when the carrier stops entirely, because carrier continues.

It appears that the variation in the amplitude resulting from a driving force modulated with a pure tone would be quite different from the variation shown in Fig. 3. The rise in the amplitude would more clearly follow a sine curve than the exponential curve shown in Fig. 3. Also, the fall in amplitude of the resonant vibrator would more nearly follow a sine curve than the decay exponential curve shown in Fig. 3. Of course this is just what is desired to produce a pure tone from a carrier

TRF Receiver

McMillin

to one another. The tapped coil is placed at a distance from the others so that its coupling effect on them is very small.

Use With a Short-Wave Converter

The scope of usefulness of a broadcast receiver is not complete these days if it does not include that of a suitable source for an intermediate frequency for a short-wave converter, and is highly adaptable for an intermediate frequency source.

When you use the short-wave converter the procedure is to tune the broadcast receiver to 1500kc. or higher, unless the set is more sensitive at a lower frequency.

A model similar to the one herein described was tested by the author on both local and distant stations, when the local stations were plentiful on the air, with very gratifying results. An indoor antenna of bell wire was used. Later on for short-wave reception, with a converter, the same set was tested on the regular outdoor antenna, against a loop-operated Super-heterodyne. The TRF set was more sensitive.

From a glance at the drawing, the crossed inductances might seem to indicate a variometer of the old bulky type. The present coil is quite small, not quite two inches in diameter, and occupies about 3/8 inch behind the front panel, being mounted at the left-hand side of the tuning condenser center. L₁ and L₂ are two windings and need not be shielded. The inductance switch is mounted directly under the tuning condenser's dial knob, and the volume control, which is the screen grid voltage potentiometer, is mounted at the right of the tuning condenser center at the same level as the astatic variometer's horizontal axis.

Controls

The occurrence of three control knobs might seem at first blush to presage a degree of complication that some of the contemporaneous sets apparently do not possess, but that impression would soon be dispelled if the reader could but see behind the works of some of the modern sets, as compared to the one depicted here.

In reality the tuning condenser control knob is a kind of volume control, although really a detuner in the strict sense. The principal control is the screen grid potentiometer, the astatic coil's mutual inductance variation affecting principally the sensitivity of the circuit, an adjustment that in this case does not act to spoil the quality either with local or long distance reception. Adjustment is not required usually for the reception of local stations.

Most fans will want to use black-finished surface bakelite for the front panel, if for no other reason than the fact that it is easy to look at, but if you have the means at hand to put an artificial finish on either brass or aluminum, such as a grained wood effect, there is no reason why you should not use a front panel of either of these two metals, provided you remember to keep the radio frequency coils at least three inches away from the front panel.

Ground Power Transformer Frame

As usual, the heater wiring is to be of ample cross-section, not smaller than No. 18 B & S. equivalent of the resistance of solid copper wire, and that the soldered joints shall be of low resistance, as any tendency toward low heater voltage

Stenode Radiostat

modulated by a pure tone. There is no doubt, however, that the variation in the amplitude of the vibrator is reduced considerably by the tendency of the vibrator to remain in the status quo, for if it did not we would have to modify Newton's laws of motion.

Audio Compensation

That the modulation is reduced is recognized by the inventor of the Stenode Radiostat and also that this reduction is inversely proportional to frequency. For this reason he has introduced an audio compensator into his receiver by which the high audio frequencies are amplified more than the low in direct proportion to the frequency. It is this compensation which in part accounts for the good quality obtainable with the super-selective receiver.

It should be remembered that when the highly resonant vibrator is driven by a modulated carrier it is never vibrating freely but is forced all the time. Hence we have no periods of exponential decay such as in the case of the dash-space type of signal. The continuance force is steadily either increasing the amplitude of the vibrator or it is decreasing it.

is usually due to these two things. Also general neatness in the wiring layout is a factor not to be ignored.

And finally the core, or rather the case of the power transformer is to be grounded, simply by connecting a short lead soldered to the case directly to the ground lead, preferably close to the point where the regular ground binding post is connected. The transformer is the Polo 245 PT.

Simply because there is an indication that a dynamic speaker field coil is to be connected to the B voltage supply system, in place of the choke coil, is no reason to suppose that any other kind would be overloaded. A reserve of output power is always an asset, because it usually means that the otherwise hard-to-raise station is readily rendered decently audible.

The author has been experimenting with adjustments on the inductor dynamic speaker lately, and has found that of a total of ten units for repair, four had too close an air gap between the armature and the pole faces. This observation is directly at variance with the accepted practice in the case of the regular magnetic unit, which was subject to increasing volume with decreasing air gap distance. The optimum distance for the inductor unit is .010 of an inch.

[More about this circuit will be published in an early issue.—EDITOR.]

Bias Resistance Requirements

WHAT should the grid bias resistor be in a 245 tube push-pull amplifier? I have seen different values specified. If they are all correct the value cannot be very critical.—L. C. R.

One 245 tube requires a bias resistor of 1,500 ohms. Two tubes, either in push-pull or in parallel, both on the same filament winding, require a bias resistor just half this value, or 780 ohms. Since the nearest commercial resistors are 1,000 and 750 ohms, these are used. The value in either case is not critical within 100 ohms, or even 200 ohms. If widely different values are used, there is either an error in the design or there is some special reason for the difference. For example, they may be connected in the circuit so that more than the plate current of the 245 tubes flows through the resistor. In any case the proper resistance is that which when multiplied by the current, in amperes, flowing through it, gives the desired voltage drop. In case the plate voltage is 250 volts, the bias should be 50 volts. When the voltage on the plate, or plates, is 250 volts and the bias on the grid, or grids, one tube draws 32 milliamperes and two draw 64 milliamperes. Hence we have for one tube 50/.032 equals 1,560 ohms and for two tubes, 50/.064 equals 780 ohms. If the resistor is connected so that more than the plate current of the tube, or tubes, flows, we have to add the extra current, and in each case we get a lower resistance.

ADVERTISERS

Cash in on Radio World's GIFTS NUMBER!
Dated December 6. Out December 3.

Readers of RADIO WORLD, now in its ninth year, will buy radio goods to the value of hundreds of thousands of dollars during the coming Holiday Season. Get your share of this business by having your announcement appear in the widely distributed Radio Gifts Number.

RADIO WORLD's advertising rates are the lowest in the radio periodical field, considering circulation and pulling power. Our readers generously patronize our advertisers.

Regular advertising rates for Radio Gifts Number as follows:

| | 1 Inscr. | 4 consec. Inscr. (each) 10% | 13 consec. Inscr. 12 1/2% | 26 consec. Inscr. 15% | 52 consec. Inscr. 20% |
|-----------|----------|-----------------------------|---------------------------|-----------------------|-----------------------|
| 1 page | \$150.00 | \$135.00 | \$131.25 | \$127.50 | \$120.00 |
| 1/2 page | 75.00 | 67.50 | 65.62 | 63.75 | 60.00 |
| 1/4 page | 50.00 | 45.00 | 43.75 | 42.50 | 40.00 |
| 1/8 page | 37.50 | 33.75 | 32.81 | 31.87 | 30.00 |
| 1/16 page | 25.00 | 22.50 | 21.87 | 21.25 | 20.00 |
| 1/32 page | 18.75 | 16.87 | 16.41 | 15.94 | 15.00 |
| 1 inch | 5.00 | 4.50 | 4.37 | 4.25 | 4.00 |

Classified advertisements, 7 cents a word; \$1.00 minimum; must be paid in advance.

Write, wire, phone or call now for preferred positions in Radio World, 145 West 45th St., New York, N. Y.

281 Char

By J. E.

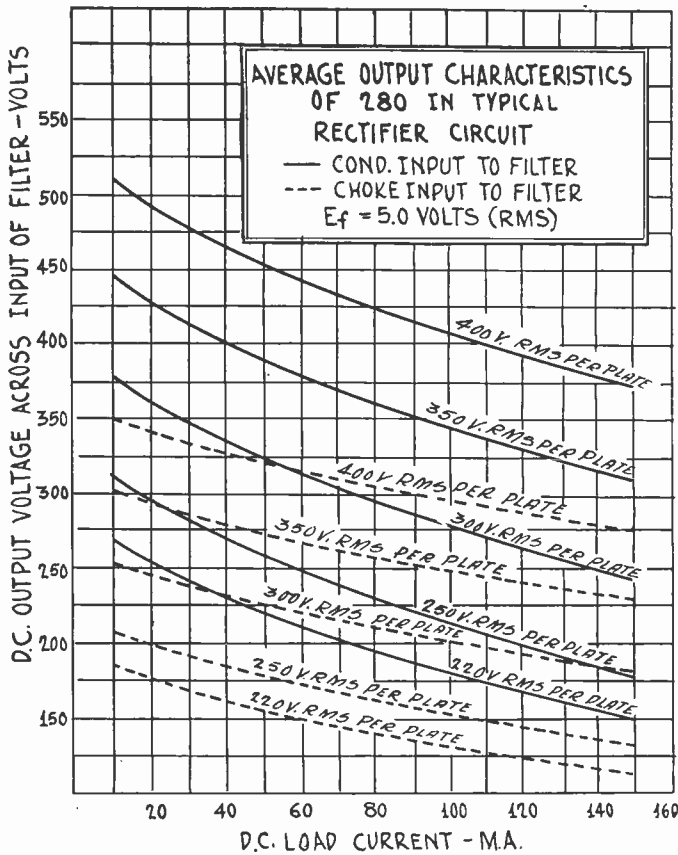

FIG. 2
AVERAGE OUTPUT CHARACTERISTICS OF THE 280 TUBE, SHOWING THE VARIATION IN THE RECTIFIED VOLTAGE WITH CHANGES IN THE LOAD CURRENT. CURVES ARE SHOWN FOR BOTH CHOKE AND CONDENSER INPUT TO THE FILTER

[This is the continuation of the article published last week on rectifier tubes and circuits. The installment last week contained the characteristics of the 280 full-wave rectifier tube.—EDITOR.]

THE 281 tube is a half-wave rectifier which is used when higher voltages than those obtainable with a rectifier employing the 280 are desired. This half-wave rectifier is rated at 700 volts and 85 milliamperes. Two of these tubes must be used if a full-wave rectifier is desired, and then the output current may be as high as 170 milliamperes.

CHARACTERISTICS OF 281 RECTIFIER

| | |
|---|-------|
| Filament voltage..... | 7.5 |
| Filament current, amperes..... | 1.25 |
| Maximum AC plate voltage (RMS)..... | 700 |
| Maximum DC load current, milliamperes.... | 85 |
| Maximum length, inches..... | 6 1/4 |
| Maximum diameter, inches..... | 2 1/8 |
| Socket, standard UX. | |

In this tube the two heavy prongs are the filament terminals and the small, right-hand prong, looking down, is the plate terminal. The small, left-hand prong has no connection in the tube.

The filament is of the oxide coated type and should show a red color when the rated voltage of 7.5 volts is applied across

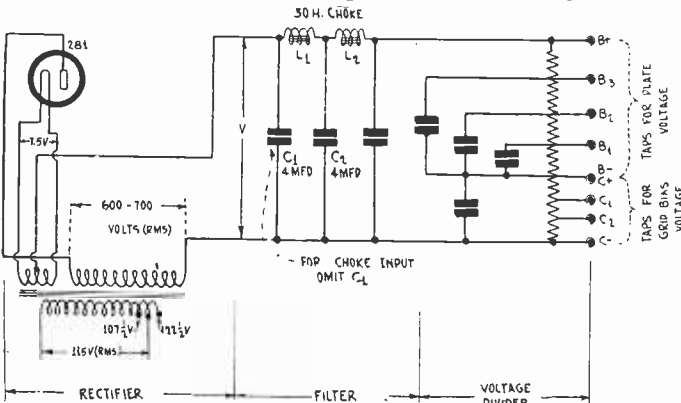

FIG. 3
ATYPICAL DIAGRAM OF A HALF-WAVE RECTIFIER UTILIZING THE 281 TUBE, WITH FILTER AND VOLTAGE DIVIDER.

the terminals. Since the filament current is comparatively heavy, the leads from the supply transformer should be of heavy wire and should be as short as practical and all joints should be carefully soldered.

Before removing the tube from the socket the power should be turned off and it should not be turned on until after the tube has been inserted in the socket. These precautions are to avoid surges and excessive voltages.

It is advisable to make certain that the line voltage across the primary of the power transformer does not exceed that for which the transformer has been designed, before the tube is inserted into the socket. This can be ascertained by means of a good AC voltmeter reading from zero to 150 volts. If the line voltage is higher than the voltage for which the transformer has been designed, it is advisable to insert a resistance of suitable value in the line and adjusting this resistance until the voltage across the transformer terminals reads the proper value. If the transformer primary contains taps for different line voltages, the appropriate tap should be used in place of the resistance. Some transformers are tapped for 105, 110, 115, 120, and 125 volts for cases when the nominal voltage of the line is 115 volts.

Half-Wave Rectifier

When one of these tubes is used as a half-wave rectifier, the power transformer should have one 7.5 volt secondary, preferably center tapped, and one high voltage winding without a center tap. A typical circuit diagram of a half-wave rectifier with filter and voltage divider is shown in Fig. 3. The primary of the transformer in this case is tapped for 107.5, 115, and 122.5 volts, while the high voltage secondary is marked for either 600 or 700 volts, root mean square value.

Two choke coils are shown in the filter, each of 30 henries. These chokes should be designed for a current of about 100

Right or

QUESTIONS

- (1)—A choke coil having an inductance of about 1/4 millihenry is not effective in a short-wave converter because its impedance is so low that it is inefficient as a coupler.
- (2)—A choke coil of 50 to 100 millihenries is not effective in a short-wave converter, except in the output, because the distributed capacity is so high that the high frequency currents are by-passed.
- (3)—When a short-wave converter does not bring in anything but a roar, the trouble is that the detector tube is overloaded and the remedy is to reduce the pick-up between the oscillator and the detector tube.
- (4)—The purpose of a baffle board in conjunction with a loudspeaker is to put a load of air on the moving cone.
- (5)—A resistance in series with the primary of the transformer following the detector stops motorboating because the plate voltage on the detector is lowered.
- (6)—A vernier is a device by means of which a dial may be moved very slowly, or a device which changes the capacity in a tuned circuit at a very slow rate.
- (7)—The core of a dynamic speaker must be made of the highest permeability material, in order to get a sufficiently high field strength.
- (8)—A bi-resonator is a dual tuner, or a type of filter in which there are two tuned circuits.
- (9)—A high impedance speaker, such as most magnetic speakers, may be connected from plate to plate of the tubes in a push-pull amplifier without loss of coupling efficiency.

ANSWERS

- (1)—Wrong. At high frequencies such a choke coil is more effective than a choke designed for use in the broadcast band. At 1.5 megacycles the impedance of a quarter millihenry choke is 2,357 ohms. At higher frequencies the impedance is proportionately higher. A 50 millihenry choke may have a much lower effective impedance at some of the high frequencies because of the high distributed capacity.
- (2)—Right. Take a choke having an inductance of 50 millihenries and a distributed capacity of 10 mmfd. It has a natural frequency of 225kc. and therefore any short-wave frequency

Characteristics

Anderson

milliamperes. The first three by-pass condensers should be designed for voltages of about 1,000 volts to provide a safety factor. Electrolytic condensers cannot be used in this circuit unless they be connected in series, because the working voltage will be higher than the break-down voltage of these condensers.

When more current than given by a single 281 tube is needed, it is necessary to use two of them in a full-wave rectifier circuit, as shown in Fig. 4. The power transformer required in this case should have one 7.5 volt winding, preferably center-tapped, and capable of carrying more than 2.5 amperes. The high voltage secondary should be center-tapped and the effective voltage across each half should be from 600 to 700 volts. That is, the total effective voltage across the secondary should be from 1,200 to 1,400 volts.

This circuit is capable of delivering up to 170 milliamperes and therefore the 30 henry choke coils in the filter should be designed to carry this current or a higher current. The requirements of the condensers in this circuit are exactly the same as those of the condensers in the half-wave rectifier provided the voltage across each half of the high voltage winding is no higher than the voltage across the untapped winding in the half-wave circuit.

Regulation Curves of Full-Wave Rectifier

In Fig. 5 are shown some regulation curves of full-wave and half-wave rectifiers utilizing the 281 tube. For the full-wave rectifier curves are shown for both condenser and choke input to the filter but for the half-wave rectifier curves are shown for only condenser input.

It will be noticed that the regulation is considerably better for the full-wave rectifier, since the curves are not nearly so steep, and also that the output voltage for condenser input is considerably higher than that of choke input.

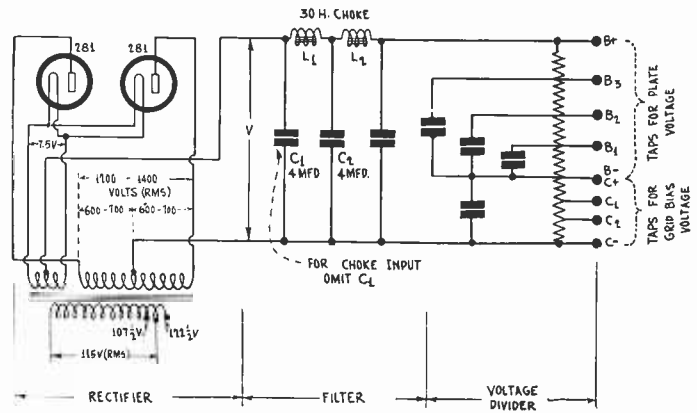

FIG. 4
A TYPICAL DIAGRAM OF A HALF-WAVE RECTIFIER UTILIZING THE 281 TUBE, WITH FILTER AND VOLTAGE DIVIDER.

These curves show nothing about the thoroughness of the filtering in the different cases. For a given filter, the output of the full-wave rectifier will contain less ripple than the other rectifier, and for a similar filter, insofar as similarity is possible, the choke input gives less ripple than the condenser input. The lower output voltage from the choke input filter is a disadvantage which offsets any advantage in thoroughness of filtering. The main advantage of the choke input is that it protects the rectifier tubes.

If breakdown of the filter condensers is to be avoided it is necessary to choose condensers that are guaranteed to withstand the peak value of the high voltage on each plate of the rectifier tube. The peak value is 1.41 times the RMS or effective value. Hence if the voltage per plate is 700 volts, the peak value is 987.5 volts. This value of voltage will occur when the load current is zero. As an additional precaution against excessive voltage the voltage divider resistance should be chosen so that there is always some bleeder current, say 20 milliamperes. If this is done the maximum voltage will never reach peak value because the load current cannot be less than 20 milliamperes. The regulation curve for 700 volts on the plates at 20 milliamperes shows a voltage of approximately 890 volts, which is well within the working range of a condenser rated for continuous service at 1,000 volts.

Wrong?

would be far above the natural frequency. Much off resonance, the impedance of the coil is equal to that of the capacity alone, and at 10 megacycles this is 1,592 ohms.

(3)—Right, at least in most cases. Overloading takes place even when the detector operates on the grid bias principle. Sometimes this overloading may be in the modulator of the converter and at other times it may be in the detector of the broadcast receiver. The remedy in most instances is to loosen the coupling between the oscillator in the converter and the modulator.

(4)—Right. The effect is the same, essentially, as attempting to cut butter with the side of the knife. When there is no baffle, the armature moves through the air just like the knife through butter when the edge is used for cutting. A better analogy, perhaps, is to move a board in water. Moving edge-wise is easy because the board cleaves the water. Moving it sideways is difficult because much water has to move with the board. The object of the loudspeaker is to move the air back and forth, and as much air as possible.

(5)—Wrong. This effect may in some instances increase the motorboating. It stops it because it prevents feed-back from backing up through the transformer primary.

(6)—Wrong. A vernier is a device by which a dial may be read closer than the finest division, and read accurately. The usual vernier is such that it permits reading to one-tenth of the smallest division.

(7)—Wrong. While it would be desirable to use high permeability material for the core, it is not necessary, for the same field strength may be obtained with the cheapest cast iron core, provided that sufficient magnetizing force is used. It would be cheaper to operate a speaker with a high permeability core, but it would require a higher initial investment.

(8)—Right. This is a name given to a filter circuit designed so as to pass a narrow band of frequencies when the filter consists of two loosely coupled resonant circuits.

(9)—Right. Indeed, the matching may be improved, but whether or not it is, depends on the matching existing between the power tubes and the speaker as well as on the impedance of the speaker and the type of tubes. A magnetic speaker usually has high impedance, which is comparable with the impedance of two ordinary power tubes in push-pull.

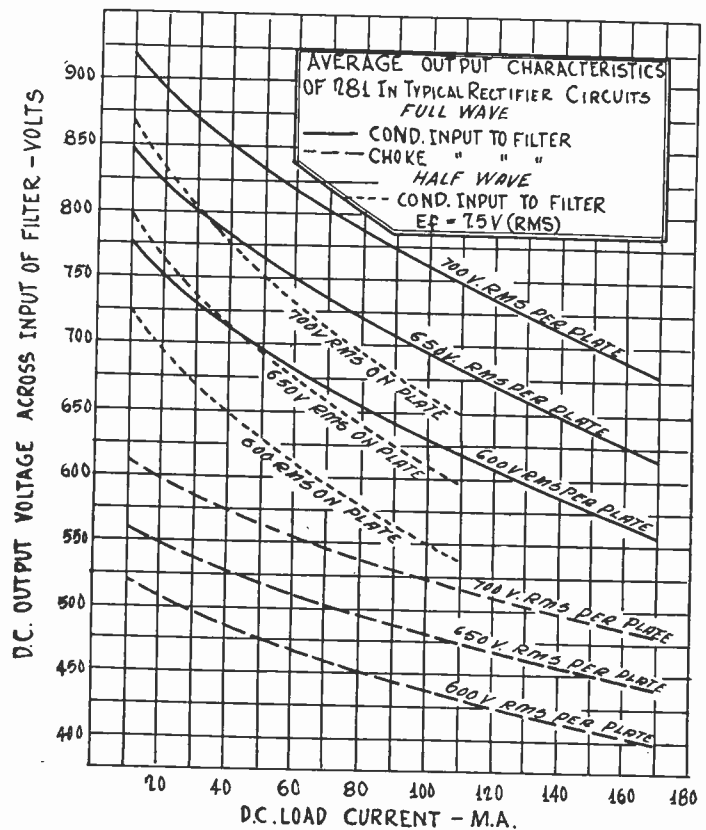

FIG. 5
REGULATION CURVES OF FULL-WAVE AND HALF-WAVE RECTIFIERS UTILIZING THE 281 TUBE. THE FULL LINES ARE FOR FULL-WAVE RECTIFIER WITH CONDENSER INPUT, THE DOTTED LINES FOR HALF-WAVE RECTIFIER WITH CONDENSER INPUT, AND THE DASHED LINE FOR A FULL-WAVE RECTIFIER WITH CHOKE INPUT.

A Question and Answer Department conducted by Radio World's Technical Staff. Only Questions sent in by University Club Members are answered. Those not answered in these columns are answered by mail.

RADIO UNIVERSITY

Annual subscriptions are accepted at \$6 for 52 numbers, with the privilege of obtaining answers to radio questions for the period of the subscription, but not if any other premium is obtained with the subscription.

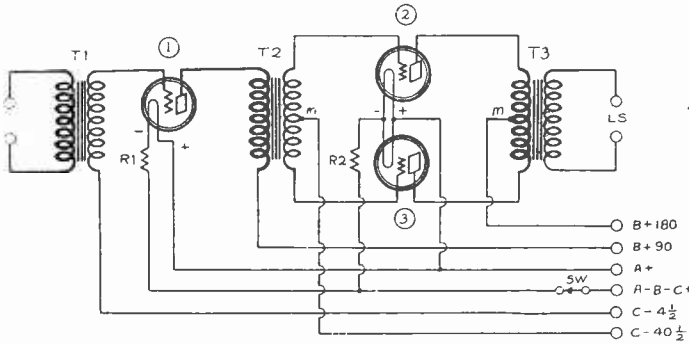

FIG. 863

A TWO-STAGE, PUSH-PULL AMPLIFIER IN WHICH THE NEW 2-VOLT TUBES CAN BE USED WITH FEW ALTERATIONS IN THE VOLTAGES. THIS CIRCUIT IS CAPABLE OF GIVING OUT 340 MILLIWATTS OF UNDISTORTED OUTPUT.

Two Stage Push-Pull Amplifier

IF you have a circuit of a two-stage amplifier which can be used with the new 2-volt tubes, will you kindly publish it? If any changes are necessary please point them out.—B. L.

In Fig. 863 is such a circuit. It was intended for use with 201A and 171A tubes but it can be changed very easily to fit the 2-volt tubes. The first tube would be a 230 and the tubes in the push-pull should be 231. The filament voltage should be changed from 6 to 3 and may be supplied by two No. 6 dry cells in series. With 3 volts on the filament battery terminals, ballast resistor R1 should be between 16 and 17 ohms and ballast resistor R2 should be slightly under 4 ohms. The bias on this tube should be changed to 3 volts and the plate voltage may remain at 90 volts. The bias on the power tubes should be changed to 22.5 volts and the plate voltage to 135 volts. These are the only changes necessary.

* * *

Photo-Cell Characteristics

IS it a fact that photo-electric cells give the same output current for all anode voltages, provided that the amount of light that enters is constant? If this is not a fact, how does the current vary? Also, is it a fact that if the anode voltage is kept constant the current varies in direct proportion to the amount of light?—G. M. S.

It is not a fact that the current is independent of the anode voltage. For constant light flux entering the cell, the current increases in much the same manner as it increases in an ordinary vacuum tube when the voltage increases. The manner of change depends on the type of photo-cell, that is, whether it is of the high vacuum or the gaseous types. It is true that the current varies in direct proportion to the light flux, provided that the spectral composition remains constant as well as the anode voltage. By spectral composition is meant the proportion of the various colors in the light. The current varies with the wavelength of the light or with the color. In gaseous cells the current is not strictly proportional to the illumination.

* * *

Overloading the Modulator

I HAVE built a four tube converter along the lines described by Brunsten Brunn in the Nov. 15th issue and I have noticed some peculiar effects, which are not at all pleasant. When the signals are tuned in with both the oscillator and the radio frequency dials there is a loud roar in the speaker, or a very shrill whistle. I have been unable to remove this. Can you suggest a remedy? I can receive signals with it the way it is but I cannot tune in the signals with the RF tuner, and therefore I am not getting as high sensitivity as I would if I could suppress the roar and still tune sharply with the RF tuner.—L. W. C.

The roar and the shrill whistle are undoubtedly due to overloading of the detector tube. This may be due to the pick-up from the oscillator alone or to the combination of this and the signal. The oscillator contributes most of the voltage that overloads. The thing to do is to loosen the coupling between the oscillator tuned circuit and the pick-up coil, which may

be done either by moving the pick-up coil farther away or by reducing the number of turns on it. This was explained in the article by Mr. Brunn and the explanation applies equally well to his set and yours. The same phenomenon occurs also in broadcast superheterodynes.

* * *

Design of High Frequency Choke

I WISH to construct choke coils of about one millihenry each for a short-wave converter. I have wooden rods about $\frac{3}{8}$ inch and am wondering if it would be all right to wind the coil on these. If it is all right how many turns should I use?—W. H. J.

It is all right and you need about 250 turns of No. 36 double silk covered wire. This will make a winding 2.25 inches long. These coils can be used for antenna impedance in case the input is untuned, or for chokes in series with screen and plate leads, or as RF chokes in the plate circuit of a detector for the purpose of forcing the high frequency currents through the tickler. A coil of this diameter has a distributed capacity around one micromicrofarad and a natural wavelength of about 59.5 meters. However, it remains effective for shorter waves.

* * *

Short-Circuiting Turns

YOU have published circuits lately in which you have provided a switch in the tuned circuits whereby turns on the coils may be short-circuited for the purpose of extending the range of the tuners. Is it not a fact that short-circuited turns reduce the efficiency of the tuned circuits? We have been led to believe this by innumerable statements in technical articles. Will you kindly explain?—F. W. C.

It is a fact that shorted turns reduce the efficiency, especially when one or two turns on the coil are shorted. But when a large part of the coil is shorted the loss is not nearly as great and is negligible. It has been found that in some instances it is better to short-circuit a part of the coil than to leave dead-end turns. For this reason when a coil is tapped so as to go from broadcast frequencies to higher frequencies, or from any frequency band to a band of higher frequencies, it is better to short-circuit the superfluous turns than to leave them open. The reason for this is that when a part of the coil is shorted a circuit is formed which consists of an inductance in series with a resistance and the inductance is so high that no current of appreciable magnitude can flow in the circuit and hence there will be no loss. When the turns are left open the distributed capacity of the shorted turns and the inductance of the turns form a circuit which may resonate with some frequency in the band the active part of the coil is supposed to cover. Shorting one or two turns on the coil is bad, but shorting a third or a half of the coil is permissible.

* * *

Improving a Center Tap

I HAVE a filament transformer having a five volt secondary which I wish to use for heating the filaments of a couple of 171A tubes. But there is no center tap on the winding and I suppose that without one the hum will be excessive. Can you suggest a way of using this transformer for the purpose I mentioned without introducing a lot of hum?—C. L. K.

There is a very simple way. Just get a center tapped resistance of about 30 ohms and connect this across the filaments of the 171A tubes and use the tap on the resistance in place of the center tap on the transformer. If you get a resistance with an adjustable tap it is possible to balance out practically all the hum. This method of reducing hum is often used even when there is a center tap on the filament winding because it has many advantages.

* * *

Blue Glow in Rectifier Tube

I HAVE a push-pull amplifier and power supply utilizing two 245 tubes and one 280. For a while this circuit worked all right but now as soon as I turn on the power the rectifier tube turns blue and operation is not satisfactory. What is the cause of the blue glow and what can I do to prevent it?—R. B. H.

The voltage on the rectifier tube is too high or the current drawn from it is too high. This may be due to a defect in the tube, a defect in the amplifier or in the filter, or to lack of bias

on the power tubes. Most likely you have a defective rectifier tube. Try one that you know to be good, and if that too turns blue cut down on the line voltage by putting in the variable resistance in series with the primary. Use 20 or 30 ohms and adjust it until the total voltage across the voltage divider is 300 volts. Also check over the parts in the circuit to make sure that no condenser or resistor is shorted and also check the bias voltage on the power tubes. A gaseous tube will turn blue at much lower voltages than high vacuum tubes, and it may be that your rectifier tube has more gas in it than is good for it. It may also be that your power transformer has been designed for 281 and 250 tubes.

* * *

Calibrating a Short-Wave Converter

IS it practical to calibrate a short-wave converter, and if so how can it be done? I have built one and I find that the same station never comes in the same place on the oscillator dial twice in succession. If I record the dial settings of the stations I log one day, I don't get the stations at the recorded readings the next day. What is the cause of the variation?—S. G.

The variation in the oscillator dial settings is due to the fact that you don't use the same intermediate frequency. Every time you change the tuning of the broadcast receiver you change the intermediate frequency. If you want to calibrate the oscillator dial on the short-wave converter you must always use the same setting of the broadcast receiver tuner, not approximately but exactly the same. A change of one-tenth of a division on the broadcast tuner may be equivalent to a change of 10 divisions on the oscillator dial. Select some point on the broadcast tuner dial where the receiver is very sensitive and where there is no interference from local stations and then use that setting every time. While you may use the broadcast tuner as a vernier for the oscillator control, you should always know where its normal position is with respect to the calibration of the oscillator dial.

* * *

Making a Vernier

I WISH to make a vernier to attach to my tuning dial so that I may be able to read fractions of the finest division on the scale. Can you tell me how to do it and how to read it when it has been done?—F. W.

Make a short scale having 10 divisions, these ten divisions being exactly equal to 9 divisions on the dial. If the dial moves, attach the small scale in place of the index and mount it so that there is as little clearance between the two scales as possible. When zero on the small or vernier scale is opposite one division on the dial, say 50, the tenth division on the vernier scale should be exactly opposite 59 on the dial. If zero on the vernier scale is a little past 50 but not a whole division past, look along the vernier scale for the first division line that is exactly opposite one of the dial divisions. If the first is opposite 51 on the dial, the exact reading is 50.1, or the second is exactly opposite 52 on the dial, the reading is 50.2, and so on.

* * *

Power Supply Design

IN your Nov. 15th issue you published a diagram in connection with the characteristics of the 280 rectifier tube. I wish to build this circuit and would appreciate if you would give the constants of the condensers and the resistances. Also, could I use the Polo 245 power transformer and the Polo chokes—C. D. F.

Condensers C1 and C2, Fig. 1 of the circuit in question should be designed to stand 600 volts or more. The first unspecified condenser next to L2 should have a capacity of 4 or 8 mfd. and it, too, should be designed to stand 600 volts or more. An electrolytic condenser of 8 mfd. could be used in this position. This, however, will stand only a little over 400 volts. This is high enough because this condenser is self-healing in case it should receive an over-voltage for a short time. The other condensers may be one or two mfd. each and need not be rated at higher than 400 volts. The Polo 245 power transformer has been designed for a job just like this and the Polo chokes can be used to good advantage.

* * *

High-Low Switch Arrangement

IN most receivers there is now a switch by which the volume may be changed from high to low or vice versa. Most of these are in the RF amplifier. Would it not be possible to put this switch in the audio frequency amplifier so that the RF amplifier would be left intact? That is, would it not be possible, for example, to arrange the switch so that the loudspeaker would be transferred to the tube ahead of the power amplifier and at the same time kill the power tubes so that the power used by them would be saved?—L. M. C.

While this could be done, complications would result. For example, when the power tubes are cut off the voltage rises, due to the decreased load on the B supply, and the rise might be so great as to endanger the remaining active tubes. Then there would be unmatching of the tube and the loudspeaker because

the speaker coupling transformer has been designed to work from power tubes, while the arrangement suggested would throw the speaker transformer into the plate circuit of a high impedance tube. In some instances the speaker would be transferred to the detector because many receivers have only one audio amplifier stage. In cases where there is an intermediate stage of audio it might be better to arrange the switch so as to cut out this stage. Commercial sets have been designed so that the high-low switch accomplishes the desired result in the most practical manner, taking all the factors into consideration.

* * *

Getting Distant Stations

MODERN receivers have been designed so that they are more sensitive than is required for ordinary reception, and supposedly so sensitive that they should be able to pick up foreign stations, such as those in Cuba and Mexico. But they don't do it. Can you suggest a reason for this lack of agreement between laboratory sensitivity and field sensitivity? Also, can you suggest methods whereby the distant stations could be received with better regularity?—W. J. F.

Modern receivers have been designed to have a certain sensitivity, say four or five microvolts per meter. It is only necessary to insure that the field strength is that or more around the receiver. If a given receiver is in good operating condition and it does not bring in the foreign stations, you may be sure that the field strength is not as high as field strength required. This lack of field strength may be due to great distance between the transmitter and receiver, to a high attenuation of the signals due to atmospheric conditions, or to local shielding of the antenna. It is also possible that the antenna used is not in effect equal to the standard antenna. It may have no effective height at all or it may have too much capacity to ground, so that the signals are grounded long before they reach the receiver. The best way, and about the only way, to receive remote stations with an up-to-date receiver is to provide a first-class antenna and the very best ground. This offers little trouble in the country or in suburban localities but great trouble in apartment houses. As an example, a certain commercial receiver with built-in antenna just barely brought in local high power stations in a certain apartment house. When an indoor antenna of about 10 feet of wire running up to the picture moulding was installed, stations up to 1,000 miles came in regularly. When a wire 20 feet long was run from the antenna post and dropped out of the window, stations in Cuba, Mexico, and California came in strong and clear, the receiver being in New Rochelle, N. Y. To bring in the remote stations it was necessary to tune extremely carefully, for half a division on the dial was sufficient to throw the signals out completely.

Join

Radio World's

UNIVERSITY CLUB

And Get Free Question and Answer Service for the Coming 52 Weeks. This Service for University Subscribers Only

Subscribe for RADIO WORLD for one year (52 numbers). Use the coupon below. Your name will be entered on our subscription and University Club lists by special number. When sending questions, put this number on the outside of the forwarding envelope (not the enclosed return envelope) and also put it at the head of your queries. If already a subscriber, send \$6 for renewal from close of present subscription and your name will be entered in Radio University.

NO OTHER PREMIUM GIVEN WITH THIS OFFER

[In sending in your queries to the University Department please paragraph and number them. Write on one side of sheet only. Always give your University Club Number.]

RADIO WORLD, 145 West 45th Street, New York City. Enclosed find \$6.00 for RADIO WORLD for one year (52 nos.) and also enter my name on the list of members of RADIO WORLD'S UNIVERSITY CLUB, which gives me free answers to radio queries for 52 ensuing weeks, and send me my number indicating membership.

Name

Street

City and State.....

FIRST MARCONI STATION FOUND; NOW LANDMARK

A little shack near Babylon, Long Island, New York, has been identified as the first commercial wireless station built by Guglielmo Marconi in the United States. It is to be preserved for historical exhibit through the efforts of Major Edwin H. Armstrong, radio inventor and engineer.

Marconi erected the station in the late Autumn of 1900 or the early Winter of 1901. This gives it a date in radio history prior to the inventor's experiments in transoceanic radio communications, and previous to flashing the letter "S" across the Atlantic.

10 Words Versus 150 Words

Marconi located his Long Island sending post near the coast, where he could reach incoming ships while they were within 60 miles of New York. The station was operated by the Marconi Wireless Transmission at the rate of about 10 words a minute. Present transmission to all parts of the world is at the rate of 150 words a minute.

After Major Armstrong recently identified the shack he purchased it and offered it to the Radio Corporation of America, the successor to the American Marconi Company.

Major Armstrong went to Babylon, loaded the little building on a truck and removed it to Rocky Point, Long Island, where he placed it beneath the transmitting and receiving towers of the RCA Communications, Inc., station.

Formal acceptance of the gift was made by David Sarnoff, President of the Radio Corporation of America.

How It Was Located

Discovery of the existence of the station and verification of the part it had played in early American radio came about partly by coincidence.

The coincidence was that Captain H. I. Round, one of the leading radio engineers of the British Marconi Wireless Company and an associate in Marconi's early work, happened to mention the Babylon station while visiting Major Armstrong at Bayport, Long Island, and expressed curiosity as to what happened to it.

Captain Round and Major Armstrong drove over to the town. They found and identified the shed.

[Picture on front cover]

One-Third of Music On Air Is Jazz Type

From the result of a recent survey of the distribution of radio time, it is found that of the total of 52.9% devoted to the broadcast of musical entertainment, the broadcasting of jazz occupied the 33.9%, the remaining being devoted to the dissemination of artistic works.

Despite the apparent plethora of advertising, this analysis shows that it occupies only 8.64% of the total broadcast time, while the churches lag slightly behind.

This survey was conducted by the White House Conference on Child Health and Protection, and covered 75 stations. The use of the radio facilities by churches is said to be on the increase.

TRADIOGRAMS

CAPTAIN SPARKS RETURNS FROM EUROPE

Captain Sparks, of the Sparks-Withington Company, returned from Europe on the Leviathan. During a two months' tour of Europe, as an official representative of the Radio Manufacturers Association, Captain Sparks gleaned information he submitted to the RMA at a meeting of its Board of Directors. Captain Sparks attended several radio shows and exhibitions in Europe.

* * *

D. W. May, President of the May Radio & Television Corp., Radio Distributors in Metropolitan New York, New Jersey, and New England, announced that the quarterly dividend of twenty-five cents (.25) per share was authorized by the Board of Directors, payable November 15th. Sales for the period up to October 31st, 1936 were \$3,079,283.45 as compared with \$2,342,177.17 for the same period in 1929, or an increase of \$737,106.28. A gain on the last quarterly period starting with August 1st, to October 31st, was shown, as the sales this year for that period were \$1,844,105.49 as compared with \$1,332,899.05 for the same period in 1929, or an increase of \$511,206.44.

Oregon's Wildcat Guilty of Profanity

Washington

The Federal Radio Commission has announced the first conviction for profane broadcasting, in the case of Robert Duncan, of Portland, Oregon, known as the Oregon Wildcat. The violation concerns, section 29 of the Radio Act, which provides that no person within the jurisdiction of the United States shall utter any obscene, indecent or profane language by means of radio communication.

The conviction is the outcome of speeches by Duncan, who purchased time over KVEP during the course of his campaign for Congress, for which he was defeated.

Previously to the conviction KVEP was removed from the air by the Federal Radio Commission, last June.

The station was owned by William B. Shaeffer, who, it was testified, operated his station beyond the assigned hours of operation, was not a citizen at the time he obtained the station license, and lastly, there was great frequency variation.

The counter claim was made that as the transmission power was only 15 watts the station could not be heard far outside of Portland.

N.B.C. Adds WBEN of Buffalo to Chain

WBEN, Buffalo, N. Y., will become associated with the National Broadcasting Company effective Saturday morning, November 15th.

WBEN uses 1,000 watts, and has an assigned frequency of 900 kilocycles (333.1 meters).

A THOUGHT FOR THE WEEK

READERS, take advantage of the Free Situations Wanted and Help Wanted announcement on our front page this week. Tell your friends about it. This is a small part of our bit to aid in the present successful national effort to get back to normalcy. Help some one out of work by telling him of this offer. Yours for more jobs for the jobless!

Transmission Tested by Highway Police

The use of radio communication apparatus for the transmission of intelligence from a divisional headquarters is being experimented with by a variety of interests. The latest news of this activity comes from the Division of Motor Vehicles of the State of California, which is carrying out a series of trials of an experimental nature with a special type of light-weight radio telephone receiving equipment which has a useful operative range of over 200 miles.

Preliminary tests show that this equipment enables the chief to get in touch with members of the patrolling force on the highway, regardless of how they are scattered, in the minimum of time.

The preliminary plans call for the establishment of a 200-watt transmitter at the highway department traffic school, where the tests are to be continued. The present tests are being made to determine the location of dead spots within the reception range of the transmitter. It is the opinion of the chief of the Division of Motor Vehicles, Frank G. Snook, that highway law enforcement will be revolutionized when the system is finally operative.

Literature Wanted

Readers desiring radio literature from manufacturers and jobbers concerning standard parts and accessories, new products and new circuits, should send a request for publication of their name and address. Send request to Literature Editor, RADIO WORLD, 145 West 45th Street, New York, N. Y.

Frank Kutcher, 709 Catherine St., Perth Amboy, N. J.

Fred Abraham, Offenbach Elec. Co., 1452 Market St., San Francisco, Calif.

Geo. Hetzel, 866 E. End Ave., New York, N. Y.

Richard L. Ahrens, 21-15-93rd St., N. Jackson Hghts, N. Y.

J. H. Sheridan, Central Radio Sales & Service, 36 Lafayette St., Salem, Mass.

Charles W. McCollum, 665 West St., Reno, Nev.

H. S. Hope, 133 S. Main St., Darlington, S. C.

Reynold Nelson, Route 1, Spicer, Minn.

Howard F. Anderson, 28 Maple St., Torrington, Conn.

T. G. Hewitt, Box 154, Gloucester Heights, N. J.

John D. Springer, 6163 Pine St., Philadelphia, Pa.

Joseph H. Bond, 55 Blackstone St., Boston, Mass.

William A. Hudson, 303 So. Olive St., Peabody, Kans.

Albert C. Birch, Clerk's Box, Winnipeg, Man., Canada.

Albert J. Boudreau, 80 Margaret St., Pawtucket, R. I.

Harold Gile, Kent Hill, Maine.

Elmer O. Noble, P. O. Box 642, Borger, Texas.

Chas. O. Bietau, 3014 Auburn St., Rockford, Ill.

Alfred Kunze, 1181 Sherman Ave., Bronx, New York City.

Raymond Rozell, 826 N. Main St., Chariton, Iowa.

Henry Hall, Rigaud, P. Q., Canada.

The Radio Shop, Box 3803, Santurce, P. R.

Samuel J. Cohen, 4203 So. Grand Ave., Los Angeles, Calif.

Ben Stone, 3019 S. Irvington Ave., Huntington Park, Calif.

P. W. Paladin, 92 Greenwood Ave., Bridgeport, Conn.

Geo. Durbeck, 37 Great Bend Rd., So. Weymouth, Mass.

M. M. Sullivan, 304 W. 3rd St., Port Clinton, Ohio.

Russell Cassidy, Harbor Springs, Mich.

James R. Stewart, 1420 Glenn St., Newberry, S. C.

Barton C. Albert, 367 Hanover St., Fall River, Mass.

S. H. Gatty, 304 N. 8th St., Philadelphia, Pa.

Rogelio Garcia, 128 Adriatic Ave., Tampa, Fla.

H. F. Hollwitz, Box 312, Urbana, Ohio.

M. L. Glazner, R. F. D. No. 1, Summerdale, Ala.

Paul Humphreys, Jr., 2210 Bloomington Ave., Minneapolis, Minn.

C. C. Clark, Weatherford, Okla.

Bernard Croy, 410 E. Douglas, Bronson, Mich.

D. E. Wills, 28 Glenside Ave., Eagerstown, Md.

Wm. F. Parker, Parker Eng. Co., 125 S. 11th St., St. Louis, Mo.

Thos. Gladwin, Jr., 250 El Bosque Rd., Santa Barbara, Calif.

Einar Anderson, 300 Gramatan Avenue, Mt. Vernon, N. Y.

Bertram Reinitz, 18 East 23d Street, Brooklyn, N. Y.

Harvey Wood, care Post Office, East Rockaway, L. I.

John C. Williams, 12 Dart Street, East Rockaway, L. I.

William B. Johnston, Hartford, Conn.

MANSON LISTS ART'S ADVANCE IN ONE DECADE

By **RAY H. MANSON**
Chief Engineer, Stromberg-Carlson Tel. Mfg. Co.

In the ten years that have elapsed since KDKA at Pittsburgh put out the first regular broadcast programs in November, 1920, vast strides have been made in the technique both of broadcasting and of reception. In transmission both the quality of broadcasting and the area served by stations have increased steadily.

Whereas 1,000 watts was considered a powerful station in the twenties, 50,000 is no longer considered extraordinary. Use of higher power has been made possible largely through the use of improved vacuum tubes as amplifiers.

High Percentage Modulation

Improvements in microphone design and construction have aided greatly in improving the tone quality of the programs sent on the air. Another technical improvement in broadcasting is "high modulation" by which the program is more "deeply impressed" upon the station's carrier wave and is carried to a greater distance.

Advances in radio receiver performance have been equally startling. Crystal sets gave way to battery receivers; battery receivers to sets operated by eliminators; and these in turn to full A. C. operating receivers—with amazing rapidity. Tube developments have also aided greatly in perfecting radio receivers.

Fading Minimized

Advances in construction have given tubes greater amplifying power and greater stability together with lower current drain, while mass production has enabled manufacturers to reduce prices substantially.

Automatic volume control, which will reduce the effects of fading signals and "full dial efficiency," giving virtually equal sensitivity and improved selectivity at all points of the dial, are a few more of the many radio advances made in the past decade, all adding to the pleasure which one can get from owning a good radio receiver.

Mr. Gruen Proves He's Broad-minded

Cincinnati.

Every Thursday night at 8:45 E. S. T., the radio station of the Gruen Watch Makers Guild (WKRC) becomes a part of the Columbia Broadcasting System network which spends 30 minutes extolling the virtues of the Hamilton watch.

Thus far, the Gruen advertising department has just grinned and borne it.—From "Advertising Age."

WORTH THINKING OVER

NOW they're swearing over the air. At any rate, a person bearing—and, they say, deserving—the sobriquet of "the Oregon Wildcat," was convicted in Oregon recently for calling some well-known citizens out of their names. He also used other language that never came out of a Sunday school. The Federal Government closed the station which gave the hot-tongued violator his chance to tell an interested and frequently perturbed public his idea of certain fellow-beings. Now all is quiet along the Oregon borders. Cuss Uncle John in private if you want to but look for trouble when Uncle Sam listens in.

What Results Does Television Offer?

A Conservative's Report

EDITOR RADIO WORLD:

AT my location, half a block from street cars, television reception is fair to good. My two main stations are W3XX, at Washington, on 102 meters, and W2XCR, Jersey City, N. J., on 107 meters. W2XR, Radio Pictures, New York, on around 140 meters, is too weak to use. These three stations use 48 lines per picture, 15 pictures per second, but with slightly different height to width ratios. The RCA station, as I believe, New York, on around 145 meters, and another recent so far unidentified station on 106 meters, using different line characteristics, come through with sufficient strength to resolve their pictures, but at present I have not made other discs to enable me to see them. Other stations are heard occasionally, but generally weak.

My present receiver consists of two screen grid RF, screen grid plate circuit linear detector, resistance coupled to screen grid audio, resistance coupled to 245 tube, with neon lamp in series with plate. All filaments are AC fed, and plate voltage of two audio tubes is taken from power unit. Whole set specially constructed for this work. Television consists of 1/12 H.P. universal motor, home made 17-inch diameter aluminum 48 1/48-inch holes, disc one to one ratio. Aerial 65 feet long, average height above ground 35 feet.

Following is a summary of results I am obtaining: W3XX, Washington, 102 meters, silhouettes only, generally very strong. Most nights bad and fairly rapid fading. Local harmonic interference makes this station unusable for half of their program three or more nights a week. When clear, pictures are generally fair to good, figures and movements clear for periods only, although fairly understandable most of the time. Occasionally a complete film can be followed with ease. Writing is generally readable. Some nights double images and "part frame" phase changing is bad.

W2XCR, Jersey City, N. J., 107 meters, half tones. Generally strong. Some nights very strong, usually rapid fading. Until a month ago was very clear of interference. Lately badly jammed by harmonics and other television stations. However, results on the whole are surprisingly good. The half-tones for quite long periods, five minutes or more, are quite recognizable, and at times as good as a photograph. Accompanying speech has not been tried yet. Interference, so long as it is not periodic, such as heterodyne or violet ray, etc., or too continuous, has less effect than one would expect. Pictures can be resolved from the signal when the speech is drowned out by noise.

I have endeavored here to give you a true account of my results to date, and they may border slightly on the conservative side. With possibly a closer station, or more power from the present ones, results should be tremendously improved.

ROLAND PRICE (VE3DE),

299 Waverly Road, Toronto, Canada.

* * *

Perfers Technique to News

PLEASE allow me to express my preference for more technical matter in your magazine, more constructional matter on the Superheterodyne, and more short-wave stuff. I don't care much about the news, for I can get news enough in other magazines and the newspapers, but not the technical stuff.

EDWARD W. CHAMBERLIN,
Box 42, St. Albans, Vermont.

Two-Way Phoning on Mail Planes

America can now claim the most comprehensive aeronautical radio installation, as Boeing System has notified the Post Office Department all of its fifty planes flown on the Chicago-San Francisco and Seattle-San Diego air mail routes are equipped for two-way voice communication and twenty-two ground stations have been completed in nine states. These stations are owned by Boeing System and operated under a federal permit. Communication between the pilots and the ground stations and between pilots of planes in flight is now possible over 3,144 miles of airway.

Under this system it is possible for travelers in Boeing passenger transports on the San Francisco-Chicago and Seattle-San Diego airways to talk to city numbers by calling a terminal station and asking to be connected with a house or any other number. This is not done, however, as the Department of Commerce permit stipulates that only messages dealing with operation of planes and "protection of life and equipment" shall be sent.

Four Stations Get Order to Quit Air

Washington.

The following stations were ruled off the air for failure to apply for license renewal in time, and were warned that any attempt to broadcast would be punishable:

WMAV, Kings Highway Presbyterian Church, St. Louis, Mo.

WCSO, The WGAR Broadcasting Co., Springfield, Ohio.

KFHA, Waldo L. Hawkins and Dr. A. R. Craig, Hawkins-Craig Syndicates, care Western State College, Gunnison, Colo.

KZM, Leon P. Tenney, Hayward, Calif

Fixed Condensers

Dubilier Micon fixed condensers, type 642, are available at following capacities and prices:

| | | | |
|------------------|-----|--------------------------|-----|
| .0001 mfd. | 10c | .005 | 20c |
| .00025 mfd. | 10c | 00025 with clips | 20c |
| .0003 mfd. | 10c | All are guaranteed | |
| .00035 mfd. | 15c | electrically perfect and | |
| .001 | 17c | money back if not | |
| .0015 | 17c | satisfied within five | |
| .002 | 18c | days. | |

Order Cat. MICON .0001 etc. at prices stated.

GUARANTY RADIO GOODS CO.

143 West 45th St., New York, N. Y.

Set of SOCKET WRENCHES FREE



FOR turning nuts down or up there is nothing as efficient and handy as a socket wrench. Here is a set of three wrenches for hexagonal nuts, enabling use with 5/32, 6/32, 8/32 and 10 32 nuts. Fit the nut into the proper socket and turn down or up. The three different size sockets, one size on each wrench, enables use of three different outside diameters of nuts, but at least ten different sizes of threads. Send \$1.00 for eight weeks subscription for RADIO WORLD and get this set of three wrenches FREE!

RADIO WORLD, 145 W. 45th St., New York, N.Y.
Enclosed \$1.00 for 8 weeks. Send wrenches.

Name

Address

City State

Cross here if extending existing subscription.

Multi-Tap Voltage Divider

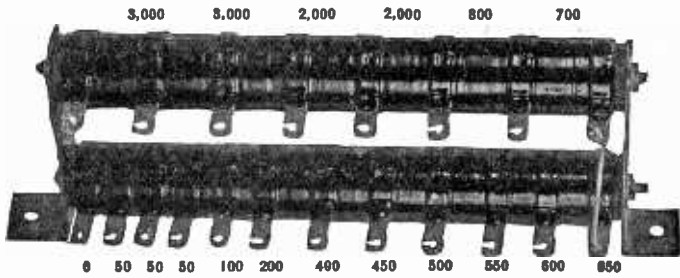

The resistance values between the twenty taps of the new Multi-Tap Voltage Divider are given above. The total is 17,100 ohms and affords nineteen different voltages.

The Multi-Tap Voltage Divider is useful in all circuits, including push-pull and single-sided ones, in which the current rating of 100 milliamperes is not seriously exceeded and the maximum voltage is not more than 400 volts. Higher voltages may be used at lesser drain. Conservative ratings, 40 watts.

GUARANTY RADIO GOODS CO.

143 W. 45TH ST., NEW YORK, N. Y.

The expertness of design and construction will be appreciated by those whose knowledge teaches them to appreciate parts finely made.

When the Multi-Tap Voltage Divider is placed across the filtered output of a B supply which serves a receiver, the voltages are in proportion to the current flowing through the various resistances. By making connection of grid returns to ground, the lower voltages may be used for negative bias by connecting filament center, or, in 227 and 224 tubes, cathode to a higher voltage.

If push-pull is used, the current in the biasing section is almost doubled, so the midspan of the power tubes' filament winding would go to a lug about half way down on the lower bank.

Order Cat. MTRD.
list price \$3.25
\$0.50, net price..

Parts for the Best Circuits

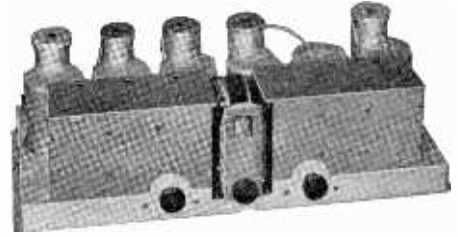

NEW NATIONAL DE LUXE MB-30 SCREEN GRID TUNER—This is one of the most sensitive tuners ever developed, averaging 1 microvolt per meter, and at some frequencies attaining 1/4 microvolt per meter. Its selectivity is most remarkable, and without material sideband cutting, due to use of Vreeland band pass filter and pre-selector circuits. Six tuned circuits, perfectly aligned and tested with laboratory equipment that cost more than \$1,000. The circuit, which is for AC only, uses four 224 and one 227 tubes and requires a power amplifier that will power the heaters as well. All parts mounted on chassis, ready for wiring. Steel chassis, 2 1/4 x 10 1/2 x 1 1/2". Order Cat. MB-30-P, list price \$85 less tubes; net price.....\$48.97
WIRED MODEL, Cat. MB-30-W, list price \$95 less tubes; net price.....\$54.86

MB-29-A TUNER, a smaller version of the MB-30, using four instead of six tuned circuits, but including also the pre-selector and band pass filter circuits. Uses three 224 and one 227. Aluminum chassis 1 5/8 x 10 1/2 x 1 1/2". Order Cat. MB-29-AP, list price \$69.50 less tubes; net price.....\$40.88

WIRED MODEL, Cat. MB-29-AW, list price \$79.50, less tubes; net price.....\$46.74

NATIONAL VELVETONE Push-Pull Power Amplifier, using one 227, two 245's and one 280; two stages of transformer coupling, with output transformer; heater voltage for five extra tubes; plate voltage for tuner. A matched unit for the MB-30 or MB-29-A. Phonograph jack built in. Velvetone comes completely wired. Licensed by RCA. Order Cat. PPPA, list price \$97.50, less tubes; net price.....\$57.33

HAMMARLUND HI-Q-31—The latest development in custom-set building, a 9-tube circuit, using a 3-stage band-pass filter pre-selector, three stages of 224 RF, 224 power detector, 227 first audio, two 245's for push-pull output, and a voltage regulator tube. Chassis is 2 5/8 x 12 3/4". Order Cat. AC-31-B, list price of complete parts, \$159.80, less tubes; net price.....\$91.06

WIRED MODEL HI-Q-31—Order Cat. AC-31-BW, list price, \$184.80, less tubes; net price.....\$111.05

HI-Q AC TUNER WITH POWER SUPPLY (less audio)—Order Cat. AC-31-TPS, list price \$148.55, less tubes; net price.....\$82.78

HI-Q AC TUNER ONLY (for use with external power supply)—Order Cat. AC-31-T, list price, \$107.20, less tubes; net price.....\$61.09

HI-Q-31 FOR BATTERY OPERATION—Order Cat. BAT-31-B, list price, \$119.55, less tubes; net price.....\$68.14

HI-Q-31 TUNER FOR BATTERY OPERATION (less audio)—Order Cat. BAT-31-T, list price \$102.95, less tubes; net price.....\$58.69

Short Waves

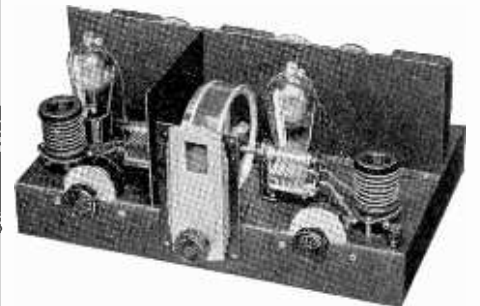

NATIONAL 5-TUBE THRILL BOX—A remarkably sensitive short-wave outfit, noted for reception of foreign stations. Uses 224 RF, 224 detector, 227 first audio, 227 push-pull second audio. A separate A and B supply is required. See below. Standard set of four pairs of coils included (21.2 to 2.61 megacycles). Humless operation, even on earphones. Single tuning control. No grunting, no backlash, no hand capacity. Order Cat. AC-SW-5, list price, less tubes, less B supply, \$79.50; net price.....\$46.74

NATIONAL SW POWER UNIT—Furnishes heater voltage and B voltage for the AC Thrill Box. Uses 280 rectifier. Comes in wired form only. Licensed under RCA patents. Order Cat. 5880, list price, less tube, \$34.50; net price.....\$20.28

BATTERY MODEL THRILL BOX—This uses the new 2-volt tubes; two 232 screen grid, three 230 and one 231, in same general circuit. Order Cat. DC-SW-5, list price \$75; net price.....\$44.10

WIRED MODEL AC THRILL BOX—Order Cat. AC-SW-5-W. List price, \$89.50, less tubes, less power unit; net price.....\$52.62

WIRED MODEL BATTERY THRILL BOX—Order Cat. DC-SW-5-W. List price, \$85, less tubes; net price.....\$49.88

HAMMARLUND SW HAWK—For one stage of RF and detector; battery operation; uses two 230 tubes or any other pair of battery-operated general purpose tubes. Coils cover 15 to 105 meters. Order Cat. SWR-2, list price \$86, less tubes; net price.....\$21.15

Guaranty Radio Goods Co.

143 West 45th Street,
New York, N. Y.

Trouble-Finding Dial FREE!



Here is an 8" diameter dial that you slide around to shoot trouble in an audio circuit or B supply or power amplifier. Trouble is divided into five groups; distortion, howl, dead amplifier, weak signals and hum. By sliding the dial to one of fifty different positions the cause of the trouble is read in the slotted opening. Invented by John F. Rider. Send \$1.00 for eight weeks subscription for Radio World and get a Trouble-Finding Dial free with instructions on back. If extending an existing subscription please so state.

RADIO WORLD

145 West 45th Street, New York, N. Y.

ERLA-DYNAMIC CHASSIS, WEST-INGHOUSE RECTIFIER. Sensitive and efficient dynamic speaker chassis. List price, \$25; our net price, \$12.50. Guaranty Radio Goods Co., 143 W. 45th St., New York.

Songwriters Service Co.

6719 Hollywood Boulevard, Dept. R. W.
Hollywood, California

Talking Pictures offer new opportunities. Your songs personally submitted to Picture Studios, revised for publication by Hit Writers. Words, Music, Arranging, everything pertaining to songs.

Ansonia Gothic Speaker - - \$3.95

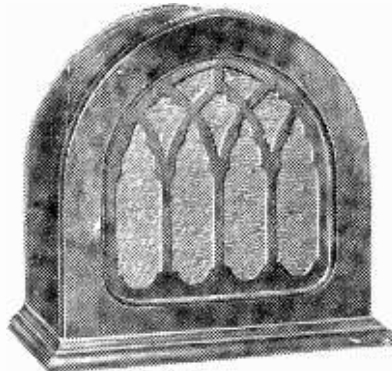

Magnetic speaker in genuine, beautiful walnut cabinet. Order Cat. AN-G at \$3.95.

Square Model (same unit and cone) Cat. AN-S at \$3.67

Guaranty Radio Goods Co.

143 West 45th St., New York, N. Y.

FILL OUT AND MAIL NOW

SUBSCRIPTION BLANK

RADIO WORLD

RADIO WORLD

145 West 45th Street, New York City

Please send me RADIO WORLD for..... months, for which

SUBSCRIPTION RATES:

Single Copy.....\$.15
Three Months..... 1.50
Six Months..... 3.00
One Year, 52 Issues..... 6.00

Add \$1.00 a Year for Foreign Postage; 50c for Canadian Postage.
 If this is a renewal, put cross in square at left.

please find enclosed

Subscribers: watch the date line on your wrapper
If the expiration date line on your wrapper indicates that your subscription has expired or is about to expire, please send in renewal so that you will not miss any copies of the paper. Subscription Dept., Radio World, 145 W. 45th St., N. Y.

RF Choke in Copper Shield



A 50-millihenry radio frequency choke coil, in a copper shield, with mounting screw and bracket attached. This choke is excellent for the plate lead of a detector, placed in series with the plate and the load impedance, for keeping RF out of the audio channel, broadcast receivers. Also excellent for RF plate lead, between the end of the plate load and B plus, and for screen grid leads, between screen grid plus, and screen grid plus, between and stabilizing. This choke will pass 25 ma. In all cases ground the shield. Order Cat. SH-RFC. List price, \$1.00; your price.... **57c**

For short waves, an unshielded RF Choke, ¼ millihenry, with mounting lugs. Order Cat. SW-CH. List price 80c; your price.... **47c**

GUARANTY RADIO GOODS CO.
143 West 45th St., New York, N. Y.

AMER-TRAN AUDIOS



First stage, de luxe (illustrated), primary, in detector circuit, has 200 henrys inductance at 1 ma; turns ratio, 1-to-3. Cat. DL-1, list price, \$8.00 net \$4.70.

Push-pull input transformer. Turns ratio, 1-to-2½; single primary; two separate windings for secondary; Cat. 151, list price, \$12; net, \$7.05.

[Remit with order and we pay transportation.]

GUARANTY RADIO GOODS CO.
143 West 45th Street, New York, N. Y.

Deepest Cut Prices!

- .00035 mfd. single Scovill variable condenser; brass plates; shaft extending front and rear. Built-in brackets permit subpanel mounting. Order Cat. S-SIN @.....\$0.30
- .00015 mfd. tuning condenser for short waves. Order Cat. SWC-15 @..... .60
- .00025 mfd. tuning condenser for regeneration in short-wave circuits. Order Cat. SWC-25 @..... .60
- Flexible insulated coupler for uniting coil or condenser shafts of ¼ inch diameter. Provides option of insulated circuits on both sides. Order Cat. FL-C @..... .26
- Brach relay for making the switch in a set with battery-operated filaments turn on the trickle charger when set is turned off, and turn charger off when set is turned on; also will make set switch turn B eliminator off when set is turned off. Order Cat. BR-REL @..... .90
- Antenna coil for .0005 mfd. Order Cat. ANT-5 @..... .45
- Three-circuit tuner for .0005 mfd. Order Cat. 3-CT-5 @..... .75
- Antenna coil for .00035 mfd. Order Cat. ANT-3 @..... .47
- Three-circuit tuner for .00035 mfd. Order Cat. 3-CT-3 @..... .79
- Screen grid RF transformer, for .0005 mfd., to couple screen grid tube to next tube. Order Cat. SG-5 @..... .45
- Screen grid RF transformer, for .00035 mfd., to couple screen grid tube to next tube. Order Cat. SG-3 @..... .47
- AC electric motor and turntable, for playing phonograph records. A synchronous motor, 60 cycles; 80 turntable revolutions per minute. Order Cat. SYN-M @..... 4.45
- A battery switch (Benjamin). Order Cat. A-SW @..... .13
- A eliminator or dynamic speaker transformer (Jefferson), 20-volt secondary. Will pass 2½ amps. Order Cat. 20-V-T @..... .40
- 30-henry shielded choke for B supply filtration or filtered speaker output. Will stand 100 ma. Order Cat. OS-30HS @..... 1.05
- 60-henry shielded center-tapped choke (30 each side of center) for B supply filtration or filtered output of push-pull tubes. Will stand 100 ma. Order Cat. OS-60HCT @..... 1.95

GUARANTY RADIO GOODS CO.
143 WEST 45TH STREET, NEW YORK, N. Y.
(Just East of Broadway)

Official Parts for Popular Circuits

- Universal Short-Wave Converter, using three 227 tubes; five de luxe precision short-wave air dielectric coils, condensers, chokes, 7"x14" panel, cabinet, etc. Cat. UN-SWC @.....\$24.73

GUARANTY RADIO GOODS CO.
143 West 45th Street
New York City

Horn Unit \$2.25



Fidelity Unit, Cat. FDU, price \$2.25

The Fidelity unit is pre-eminent for horn type speakers such as exponential horns. The faintest word from a "whispering tenor" or the tumultuous shout of the crowd or highest crescendo of the band is brought out clearly, distinctly. Stands up to 450 volts without filtering.

Works right out of your set's power tube, or tubes requiring no extra voltage source. Standard size nozzle and thread. Works great from AC set, battery set or any other set, push-pull or otherwise. The casing is full nickel finish, highest polish.

This unit can be used in a portable without any horn attached and will give loud reproduction.

Order Cat. FDU, with 50-inch tipped cord; weight, 2½ lbs.; size, 2¼-inch diameter, 2¾-inch height. (This is the large size). Price..... \$2.25

GUARANTY RADIO GOODS CO.
143 West 45th Street, New York City

Two for the price of One

Get a FREE one-year subscription for any ONE of these magazines:

- CITIZENS RADIO CALL BOOK AND SCIENTIFIC DIGEST (quarterly, four issues).
- RADIO (monthly, 12 issues; exclusively trade magazine).
- RADIO ENGINEERING (monthly, 12 issues; technical and trade magazine).
- RADIO INDEX (monthly, 12 issues) Stations, programs, etc.
- SCIENCE & INVENTION (monthly, 12 issues; scientific magazine, with some radio technical articles).
- AMERICAN BOY-YOUTH'S COMPANION (monthly, 12 issues; popular magazine).
- BOYS' LIFE (monthly, 12 issues; popular magazine).

Select any one of these magazines and get it FREE for an entire year by sending in a year's subscription for RADIO WORLD at the regular price, \$6.00. Cash in now on this opportunity to get RADIO WORLD WEEKLY, 52 weeks, at the standard price for such subscription, plus a full year's subscription for any ONE of the other enumerated magazines FREE! Put a cross in the square next to the magazine of your choice, in the above list, fill out the coupon below, and mail \$6 check money order or stamps to RADIO WORLD, 145 West 45th Street, New York, N. Y. (Just East of Broadway).

Your Name

Your Street Address

City State.....

- If renewing an existing or expiring subscription for RADIO WORLD, please put a cross in square at beginning of this sentence.
- If renewing an existing or expiring subscription for other magazine, please put a cross in square at the beginning of this sentence.

RADIO WORLD, 145 West 45th Street, New York, N. Y. (Just East of Broadway)

DOUBLE

VALUE!

SOLDERING IRON FREE!



Works on 110-120 volts, AC or DC; power, 50 watts. A serviceable iron, with copper tip, 5 ft. cable and male plug. Send \$1.50 for 13 weeks' subscription for Radio World and get these free! Please state if you are renewing existing subscription.

RADIO WORLD
145 West 45th St., N. Y. City

Quick Action Classified Ads

Radio World's Speedy Medium for Enterprise and Sales

7 cents a word—\$1.00 minimum—Cash with Order

MAJESTIC, RADIOLA, etc. Drum Dial Cable by foot or mile. Blan, the Radio Man, Inc., 89 Cortlandt St., New York.

H.F.L. MASTERTONE. List \$195. Sell \$85. World's finest radio. W. J. Reed, Aurora, Ill.

NEW TUBES 50c, 276-227-224-245-280. For particulars write, R. B. Jolley, Valdosta, Georgia.

MICROPHONE LIGHTERS—For cigars or cigarettes, with button switch at top. Press switch, and lighter acts instantaneously. \$1.00. Model B lighter on tray, \$1.50. Radio World, 145 W. 45th St., N. Y. C.

MEN WANTED

Earn \$22 to \$30 a week while learning Electric and Acetylene Welding in all branches and \$10 to \$14 a day after short period of training. This is the best and fastest growing trade in America. Big demand for trained men. Learn this big pay trade in the finest equipped shops in America. Union card when finished. Act now! Write Mr. Flint, Superintendent of Shop.

ILLINOIS WELDING WORKS
514 N. La Salle St. Chicago, Ill.

EXPERIENCED RADIO SERVICE MAN wants position. Write Thomas E. Martin, Keota, Iowa.

HORN UNIT, \$2.25—This is the Fidelity Unit and has stood the test of time. Guaranty Radio Goods Co., 143 W. 45th St., New York.

PERMACHARGE: New permanent battery charger for motor cars. Easily installed on any car. Will keep your battery up under all weather conditions by simply plugging into light socket. A real help to automobile radio. For particulars write, Permcharge, Inc., 4394 Pearl Road, Cleveland, Ohio.

GOOD VOLUME, 4 tube, loop Auto Radio blue print 50c; parts cost \$12 complete. Write me. C. C. Burge (Radio Engineer), 301 E. Park Blvd., Villa Park, Ill.

"A B C OF TELEVISION" by Yates—A comprehensive book on the subject that is attracting attention of radioists and scientists all over the world. \$3.00, postpaid. Radio World, 145 West 45th St., N. Y. City.

Save Money on Tubes!

Get a Guarantee Just the Same!

QUALITY tubes at enormously reduced prices enable you to save money and obtain full satisfaction. Any tube will be replaced on request within thirty days of its sale!

These tubes are made by a manufacturer of national reputation and are not "distress merchandise." No tube is shipped until it is carefully checked on a Readrite No. 9 Radio Test Kit.

| Type | List Price | Your Cost | Type | List Price | Your Cost | Type | List Price | Your Cost |
|---------------------------------|------------|-----------|--------------------------------|------------|-----------|------------------------------|------------|-----------|
| <input type="checkbox"/> 201A | \$1.25 | 40c | <input type="checkbox"/> WD-12 | \$3.00 | 59c | <input type="checkbox"/> 245 | \$2.00 | 50c |
| <input type="checkbox"/> 226 | 1.75 | 40c | <input type="checkbox"/> 200A | 4.00 | 59c | <input type="checkbox"/> 280 | 1.90 | 50c |
| <input type="checkbox"/> 199-UX | 2.50 | 50c | <input type="checkbox"/> 171A | 2.25 | 50c | <input type="checkbox"/> 224 | 3.30 | 50c |
| <input type="checkbox"/> 199-UV | 2.75 | 50c | <input type="checkbox"/> 171AC | 2.25 | 50c | <input type="checkbox"/> 222 | 4.50 | 95c |
| <input type="checkbox"/> 120 | 3.00 | 50c | <input type="checkbox"/> 112A | 2.25 | 50c | <input type="checkbox"/> 281 | 7.25 | 95c |
| <input type="checkbox"/> WD-11 | 3.00 | 50c | <input type="checkbox"/> 227 | 2.20 | 59c | <input type="checkbox"/> 210 | 9.00 | 95c |

250, List \$11.00, your cost, 95c.

[Remit with order for tubes and we pay postage]

DIRECT RADIO CO.

Room 504, at 1562 Broadway, New York, N. Y.
(Between 46th and 47th Streets)

RADIO AND OTHER TECHNICAL BOOKS At a Glance

- "Audio Power Amplifiers," by Anderson and Bernard\$3.50
- "Drake's Radio Cyclopeda," by Manly..... 6.00
- "The Electric Word," by Shubert 2.50
- "Elements of Radio Communication," by Morecroft 3.00
- "Experimental Radio," by Ramsey 2.75
- "Foothold on Radio," by Anderson and Bernard 1.00
- "Fundamentals of Radio," by Ramsey 3.50
- "Mathematics of Radio," by Rider 2.00
- "Practical Radio," by Moyer & Wostrel... 2.50
- "Practical Radio Construction and Repairing," by Moyer & Wostrel 2.50
- "Principles of Radio," by Henney 3.50
- "Principles of Radio Communication," by Morecroft 7.50
- "Radio Blueprint Library"—AC Hook-ups.... .35
- "The Radio Manual," by Sterling 6.00
- "Radio Receiving Tubes," by Moyer & Wostrel 2.50
- "Radio Telegraphy & Telephony," by Duncan 7.50
- "Radio Trouble Shooting," by Haan..... 3.00
- "The Superheterodyne," by Anderson & Bernard 1.50

TELEVISION

- "A B C of Television," by Yates..... 3.00

AVIATION

- "A B C of Aviation," by Maj. Page..... 1.00
- "Aerial Navigation and Meteorology," by Capt. Yancy 4.00
- "Everybody's Aviation Guide," by Maj. Page 4.00
- "Ford Model 'A' Car," Its Construction, Operation and Repair—by Maj. Page.... 2.00
- "Modern Aircraft," by Maj. Page..... 5.00
- "Modern Aviation Engines," by Maj. Page.. 9.00

RADIO WORLD

145 West 45th Street
New York, N. Y.

(Just East of Broadway)

Hammarlund SFL



Hammarlund's precision .0005 mfd. condenser, with removable shaft; single hole panel mount. Excellent for calibrated radio frequency oscillators, short-wave converters and adapters and TRF or Superheterodyne broadcast receivers. Lowest loss construction; rigidity; Hammarlund's perfection throughout.

Order Cat. HAM-SFL, list price \$5.50; net price.....\$3.00

GUARANTY RADIO GOODS CO.

143 West 45th St., New York, N. Y.

DEALERS and SERVICE MEN
STANDARDIZE ON

RESISTORS
For Permanent Replacement—Accurate—Guaranteed
Write for descriptive catalogue "W"
LYNCH MFG. CO., INC., 1775 Broadway, New York

SHORT WAVES FOR \$4.87

Real results are obtained from the Supertone Short-Wave Converter. Single tuning control. No body capacity, no squeals. Works with any broadcast receiver. Parts, as specified by Herman Bernard (Cat. SUP-3A), less filament transformer, less 227 tubes, only \$4.87. Battery model (Cat. SUP-3B) same price. Remit with order and we pay postage.



Supertone Products Corporation
216 Wallabout Street Brooklyn, N. Y.

The inductor dynamic offers high sensitivity and true tonal response. It requires no exciting field current, unlike other dynamics. Order model R for 112 or 112A, and Model G for all other output tubes.

- Cat. 9-G (9" extreme outside diameter) \$8.49
- Cat. 9-R\$8.49
- Cat. 12-G (12" extreme outside diameter)\$10.03
- Cat. 12-R\$10.03

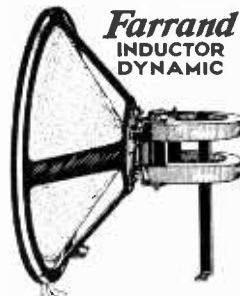

GUARANTY RADIO GOODS CO.
143 W. 45th St., New York, N. Y.

RADIO WORLD and "RADIO NEWS"

BOTH FOR ONE YEAR @ \$7.00

You can obtain the two leading radio technical magazines that cater to experimenters, service men and students. The first and only national radio weekly and the leading monthly, for one year each, at a saving of \$1.50. The regular mail subscription rate for Radio World for one year, a new and fascinating copy each week for 52 weeks, is \$6.00. Send in \$1.00 extra, get "Radio News" also for a year—a new issue each month for twelve months. Total, 64 issues for \$7.00.
RADIO WORLD, 145 West 45th Street, New York, N. Y.

RADIO MAP

OF NORTH AMERICA

22 x 22 inches, printed in two colors, bound in cover.

Shows every city from Balboa to Edmonton which has a broadcasting station.

Indexed by states, provinces and cities with key for instant location on map.

Call letters, power and frequency given for each station.

Accurate; up-to-date

Scale in miles gives distances between any two cities. Time zones correctly marked.

Just what you have been wanting.

25 cents

THE RADEX PRESS

1368 E. 6th St. Cleveland, Ohio



Your Choice of NINE Meters!

To do your radio work properly you need meters. Here is your opportunity to get them at no extra cost. See the list of nine meters below. Heretofore we have offered the choice of any one of these meters free with an 8-weeks subscription for RADIO WORLD, at \$1, the regular price for such subscription. Now we extend this offer. For the first time you are permitted to obtain any one or more of all of these meters free, by sending in \$1 for 8-weeks' subscription, entitling you to one meter; \$2 for 16 weeks, entitling you to two meters; \$3 for 26 weeks, entitling you to three meters; \$4 for 35 weeks, entitling you to four meters; \$5 for 44 weeks, entitling you to five meters; \$6 for 52 weeks, entitling you to six meters. Return this offer with remittance, and check off desired meters in squares below.

RADIO WORLD, 145 West 45th Street, New York, N. Y. (Just East of Broadway)

Enclosed please find \$.....for.....weeks subscription for RADIO WORLD and please send as free premium the meters checked off below.

- I am a subscriber. Extend my subscription. (Check off if true.)
- 0-6 Voltmeter D.C.No. 326
- 0-50 Voltmeter D.C.No. 337
- 6-Volt Charge Tester D.C.No. 325
- 0-10 Amperes D.C.No. 328
- 0-25 Milliamperes D.C.No. 325
- 0-50 Milliamperes D.C.No. 350
- 0-100 Milliamperes D.C.No. 390
- 0-300 Milliamperes D.C.No. 390
- 0-400 Milliamperes D.C.No. 394

NAME

ADDRESS

CITY..... STATE.....

DOUBLE RANGE POTENTIOMETER; made by Centralab, designed for volume control. 10,000 and 20,000 ohms. Price, \$1.05. Guaranty Radio Goods Co., 143 W. 45th St., New York.