

JAN. 25th
1930

NON-REACTIVE AMPLIFIERS

15 CENTS
PER COPY

RADIO

REG. U.S. PAT. OFF.

WORLD

409th Consecutive Issue—EIGHTH YEAR

Cures for Repeat Tuning

**Coil, Resistor and Con-
denser Action Analyzed**

List of Stations by Calls

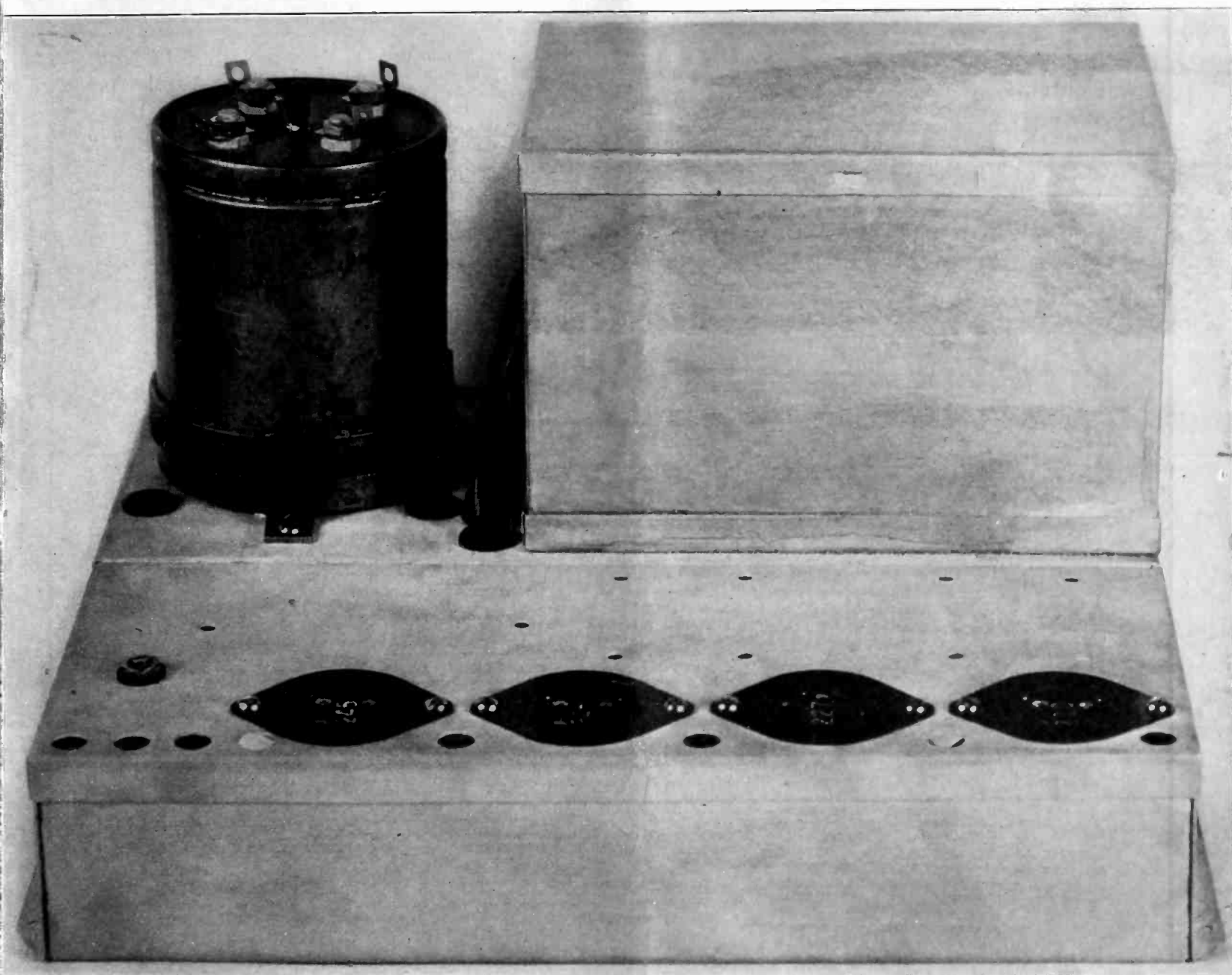

A 245 Push-Pull Power Amplifier—See Pages 16 and 17

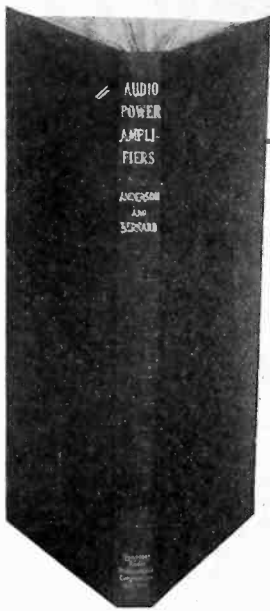

"Audio Power Amplifiers," 193 pages, 147 Illustrations; Maroon Cloth Bound Cover, Lettering in gold. Price, \$3.50.

"AUDIO POWER AMPLIFIERS"

By J. E. ANDERSON and HERMAN BERNARD

The First and Only Book on This Important Subject—Just Out

IN radio receivers, separate audio amplifiers, talking movies, public address systems and the like, the power amplifier stands out as of predominant importance, therefore a full and authentic knowledge of these systems is imperative to every technician. "Audio Power Amplifiers" is the book that presents this subject thoroughly. The authors are

J. E. Anderson, M.A., former instructor in physics, University of Wisconsin, former Western Electric engineer, and for the last three years technical editor of "Radio World."

Herman Bernard, LL.B., managing editor of "Radio World." They have gathered together the far-flung branches of their chosen subject, treated them judiciously and authoritatively, and produced a volume that will clear up the mysteries that have perplexed many.

What are the essentials to the reproduction of true tone values? What coupling media should be used? What tubes? How should voltages be adjusted? These are only four out of 1,400 questions raised and solved in "Audio Power Amplifiers." The book begins with an elementary exposition of the historical development and circuit constitution of audio amplifiers and sources of powering them. From this simple start it quickly proceeds to a well-considered exposition of circuit laws, including Ohm's laws and Kirchhoff's laws. The determination of resistance values to produce required voltages is carefully expounded. All types of power amplifiers are used as examples: AC, DC, battery operated and composite. But the book treats of AC power amplifiers most generously, due to the superior importance of such power amplifiers commercially.

Rectification theory and practice in all the applied branches, grid bias methods and effects, push-pull principles, power detection, reproduction of recordings and methods of measurements and testing are set forth. And besides there is a chapter on the subject of motorboating, with which one of the authors is probably better familiar than any other textbook author. Then, too, there is a chapter on tubes, with essential curves and a full list of tables of tube data. Every tube that will be used in an audio amplifier—therefore virtually all tubes—is clearly diagnosed, classified and tabulated! These data on tubes should be at every radio engineer's hand.

"Audio Power Amplifiers" is a book for those who know something about radio. It is not for novices—not by a mile. But the engineers of manufacturers of radio receivers, power amplifiers, sound installations in theatres, public address systems and phonograph pickups will welcome this book. Engineers—even chief engineers—of the Bell Telephone Laboratories, Radio Corporation of America, Westinghouse Electric & Mfg. Co., Western Electric, Photophone, Vitaphone and the like needn't be afraid they won't learn something from this little book.

Table of Contents

	Page
Chapter I	
General Principles	1
Chapter II	
Circuit Laws..	20
Chapter III	
Principles of Rectification	35
Chapter IV	
Practical Voltage Adjustments ..	62
Chapter V	
Methods of Obtaining Grid Bias..	72
Chapter VI	
Principles of Push - Pull Amplifier ..	90
Chapter VII	
Oscillation in Audio Amplifiers	98
Chapter VIII	
Characteristics of Tubes	118
Chapter IX	
Reproduction of Recordings	151
Chapter X	
Power Detection	161
Chapter XI	
Practical Power Amplification	121
Chapter XII	
Measurements and Testing ...	183

The book consists of 193 pages in type the size used in printing these words, known as 8 point, and therefore a great deal of text is contained in these 193 pages, and the book is small enough to be carried conveniently in the side pocket of a sack coat. It was purposely printed that way because busy engineers and other experimenters will want to consult this precious volume while riding in conveyances, as well as when in the laboratory, and compactness was therefore desirable.

The edition is strictly limited to 1,000, and the publishers recognize that the field of distribution is necessarily small, hence the price is \$3.50. Those to whom such a volume is of any value would not be without it at any price.

The device of presenting no more information or greater number of illustrations, but of using larger type, and thicker and often cheaper paper, to present a bulkier appearance, was purposely avoided. The paper is finest super stock and the size of the page is 5 x 8".

Detailed Exposition of Chapter Contents

Chapter I. General Principles, analyzes the four types of power amplifiers, AC, DC, battery-operated and composite, illustrates them in functional blocks and schematic diagrams, and treats each branch in clear textual exposition. Audio coupling media are illustrated and discussed as to form and performance: transformer, resistance-resistance, impedance-impedance, impedance-resistance, resistance-autotransformer, autotransformer-resistance and non-reactive. Push-pull forms are illustrated, also speaker coupling devices. Simple audio amplifiers are illustrated and analyzed. Methods of connection for best results are stressed.

Chapter II. Circuit Laws, expounds and applies Ohm's laws and their special form known as Kirchhoff's laws. Direction of current flow in tube circuits is revealed in connection with the application of these laws to several circuits, including a DC 110-volt A, B and C supply, and series and parallel filaments in general. Special diagrams are published for Ohm's and Kirchhoff's laws.

Chapter III. Principles of Rectification, expounds the vacuum tube, both filament and gaseous types, electrolytic and contact rectifiers, and explains why and how they work. Full-wave and half-wave rectification are treated, with current flow and voltage derivation analysis. Regulation curves for the 280 tube are given. Voltage division, filtration and stabilization are fully illustrated and dissected.

Chapter IV. Practical Voltage Adjustments, gives the experimental use of the theoretical knowledge previously imparted. Determination of resistance values is carefully revealed.

Chapter V. Methods of Obtaining Grid Bias, enumerates, shows and compares them.

Chapter VI. Principles of Push-Pull Amplifier, defines the push-pull relationship, with keys to the attainment of desired electrical symmetry.

Chapter VII. Oscillation in Audio Amplifiers, deals with motorboating and oscillation at higher audio frequencies, explaining why it is present, stating remedies and giving expressions for predetermination of regions of instability. The trouble is definitely assigned to the feedback through common impedance of load reactors and B supply, and in some special instances to the load's relationship to the C bias derivation as well. The feedback is shown as negative or positive and the results stated.

Chapter VIII. Characteristics of Tubes, tells how to run curves on tubes, how to build and use a vacuum tube voltmeter, discusses hum in tubes with AC on the filament or heater, and presents families of curves, plate voltage—plate current, for the 240, 220, 201A, 112A, 171A, 227 and 245, with load lines. Also, plate-screen current characteristics of the 224, at five different control grid biases, at plate voltages 0-250. Then Table I gives the Average Characteristics of Amplifier and Detector Tubes 220, 200A, 201A, 112A, 171A, 222, 240, 226, 227, 224, 245, 210 and 250, stating use, plate current, plate AC resistance, mutual conductance, mu, maximum undistorted power output, physical size. There is a composite table (II) of characteristics of Rectifier and Voltage Regulator Tubes, and individual tables, giving grid voltage, plate current characteristics over full useful voltage ranges for the 220, 201A, 112A, 171A, 222, 240, 227, 245 and 224.

Chapter IX. Reproduction of Recordings, states coupling methods and shows circuits for best connections.

Chapter X. Power Detection, explains what it is, when it should be used, and how to use it. A rectifying detector, designed by one of the authors, is expounded also.

Chapter XI. Practical Power Amplifier, gives AC circuits and shows the design of a sound reproduction system for theatres. A page is devoted to power amplifier symbols.

Chapter XII. Measurements and Testing, discloses methods of qualitative and quantitative analysis of power amplifier performance. A scale illustrates the audio note oscillator is described. Thirteen causes of hum, with remedies, are stated, also the estimation of power required for output and preliminary tubes.

You may safely order "Audio Power Amplifiers," either enclosing your remittance or ordering the book mailed C.O.D. Examine it for five days. If you are not completely satisfied with it for any reason, or for no reason, send it back in five days with a letter asking for a refund. A check refunding the purchase price will be sent to you immediately. We can not send the book on approval, without payment before receipt, so please do not ask us to do so.

What Is Not As Well As What Is

SOMETIMES it is more important to expose a fallacy than merely to state the fact. A crop of technical weeds has grown into the garden of audio amplification, and the authors have gone to the pains of exposing these.

The book "Audio Power Amplifiers" is free from traditional errors, except in citing them as fallacious conclusions. Each attack on a fallacy is abundantly supported by proof of the REAL facts.

As an example, take the theory that motorboating is due to grid blocking. The authors say: "Many explanations for this oscillatory condition (motorboating) have been made, some of which are wholly untenable. One of these is that the oscillation is due to blocking of the grids of the amplifiers. If blocking of the grid were the cause of the phenomenon, the wave form of the oscillation would be very irregular, but an oscillograph shows that it is very nearly of a sinusoidal form."

Then follows an exposition of motorboating, and oscillation at other frequencies, with expressions for predetermining the instability, or stability of audio circuits.

Send in This Coupon Now!

Hennessy Radio Publications Corporation,
145 West 45th Street, New York, N. Y.
(Just East of Broadway).

Please send at once postpaid copies of "Audio Power Amplifiers," by J. E. Anderson and Herman Bernard, for which please find enclosed \$3.50 per copy.

Please send copies C.O.D. I will pay \$3.50 plus Post Office charges.

Name

Address

City..... State.....

Highest Grade Speakers at Lowest Prices!

T - E - M - P - L - E F - A - R - R - A - N - D

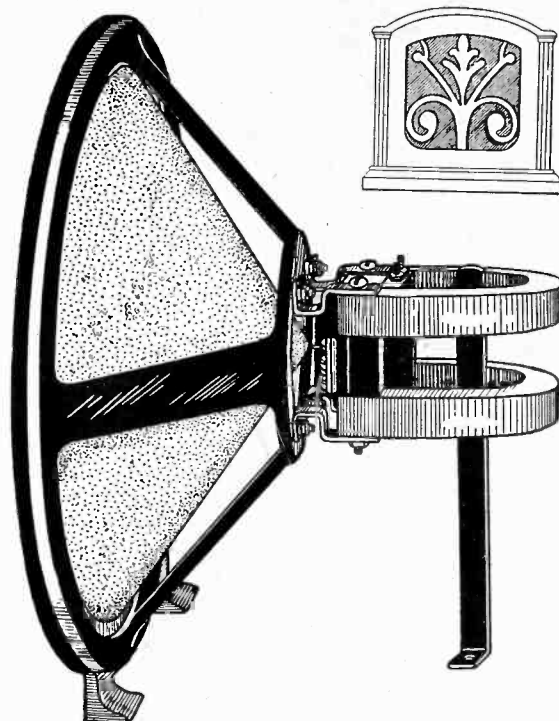

Farrand Inductor Chassis, consisting of the unit, cone, spider, bracket, assembled, but not in a cabinet.

Model 6-G, 10" extreme diameter of cone front rim \$8.00

Model 10-G, 12" extreme diameter of cone front rim \$10.00

Model 10-G-PP for connection to push-pull, requiring no output device, because unit is constructed as a center tapped output impedance. Center tap is yellow and goes to B+. Tipped cords go direct to plates. Outside diameter 12"..... \$11.00

Brookfield cabinet, No. 10 or No. 6 for those speakers, \$6.50

Temple AC Dynamic Model 10, in a beautiful cabinet. The speaker chassis is one of the finest made. There are an output transformer and dry rectifier built in. The cabinet has decorated walnut front and back, with carved grille ornament. An AC switch is accessible underneath cabinet. Rear is removable for adjustment of resistor knob to match the impedance of your receiver's output tube. Connect plugged AC cable to 110 volts AC, 50 to 60 cycles, and connect tipped cords to speaker post of receiver. This remarkable speaker Cat. TEM-10 at only.....

\$15.34

R - O - L - A

Rola Model D-10 dynamic chassis, less cabinet, for 110 volts 50-60 cycles AC. Dry rectifier and output transformer built in. The fine workmanship of this chassis is shown in the illustrations of the front and rear views. Extreme diameter of rim 9 inches but baffles with cutouts down to 7 inches may be used.

This is the biggest dynamic chassis bargain we have ever offered and enables you at low price to obtain one of the best chasses made. Tone is most excellent.

Order Cat. No. RO-10 at

\$11.34

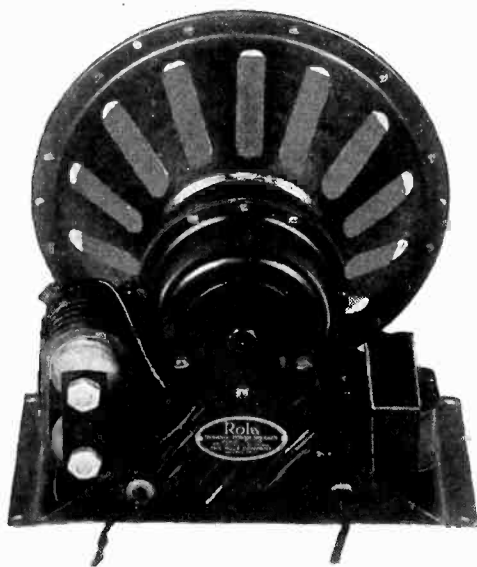

Rear view of the Rola chassis

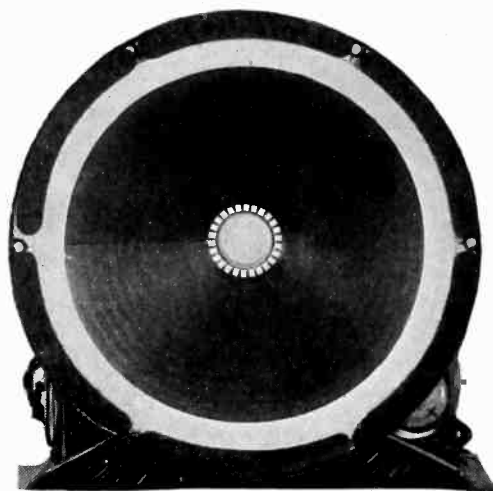

Front view of the Rola chassis. Holes are provided for attachment to your own baffle. The rim is protected by a lining of felt. The voice coil (center) is firmly mounted.

The Temple, Rola and Farrand speakers are highly recommended by us for true tone and high volume. They are extremely sensitive as well. The chasses (Farrand and Rola) will work without a baffle, but it is preferable to provide one. The Temple requires no extra baffle, as the cabinet is itself a baffle box.

All three speakers are sold in factory-sealed cartons. Immediate delivery.

Model 10-G-PP Farrand may be used in push-pull without any output device. Connect yellow lead to B+, tipped leads to power tube plates. May be used on single output by ignoring yellow lead.

Acoustical Engineering Associates
143 West 45th Street, New York City. (Just East of Broadway)
Gentlemen: Enclosed please find money order check for \$ for which please send me at once

<input type="checkbox"/> One Model 6-G Farrand Inductor	\$8.00
<input type="checkbox"/> One Model 10-G Farrand Inductor	10.00
<input type="checkbox"/> One Model 10-G-PP Farrand Inductor	11.00
<input type="checkbox"/> One Model 10 Brookfield cabinet	6.50
<input type="checkbox"/> One Model 6 Brookfield cabinet	6.50
<input type="checkbox"/> One TEM-10 Temple Dynamic in cabinet	15.34
<input type="checkbox"/> One RO-10 Rola dynamic chassis	11.34

For C. O. D. shipment put cross here

Name
Address
City State
[Prepaid orders shipped same day as received. Canadian remittance must be by postal or express money order.]

NEW J-245-X TROUBLE-SHOOTING JIFFY TESTER

Illumination Continuity and Polarity Tester FREE with Each Outfit!

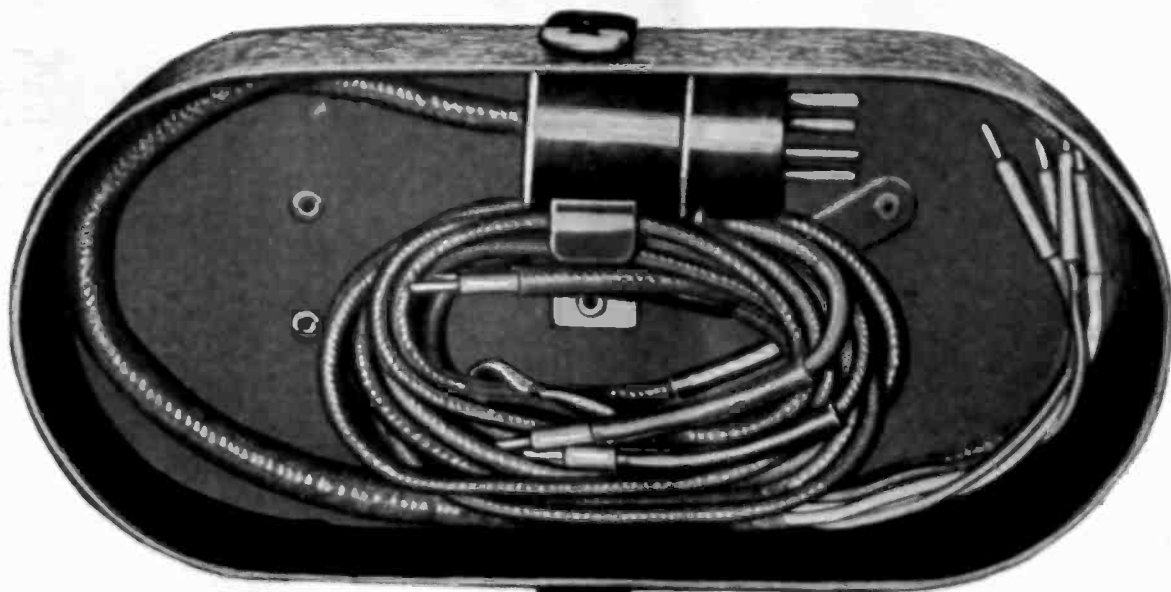

Your Price
\$15.82

Complete



Illumination Tester. Vest Pocket Size. Shows Shorts and Opens Visually, also polarity of DC line. A Neon lamp is built in.

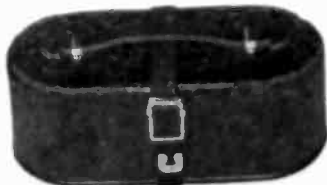

The three-meter assembly, in the crackle-brown finish carrying case, with slip-on cover and a cable plug. There are ten adapters. It is vital to have the complete outfit so you can meet any emergency.



Illustration above is 2/3 scale.

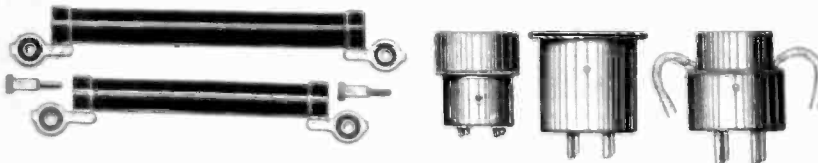

J-111 Multiplier, upper left, with tip; below it, J-106 Multiplier with tip; plugs, left to right, J-18, conforms UV socket to UX plug; J-24, conforms UX tester socket to UV199 tube; J-24, to test Kellogg and old style Arcturus tubes.

Makes All Necessary Tests in a Jiffy and Simplifies Service Work!

THE new Jiffy Tester, J-245-X, is a complete servicing outfit. It consists of a three-meter assembly in a metal case, with slip-on cover and a cable plug. There are ten adapters. It is vital to have the complete outfit so you can meet any emergency.

With this outfit you plug the cable into a vacated socket of a receiver, putting the removed tube in the tester, and using the receiver's power for making these tests: plate current, up to 100 milliamperes; plate voltage up to 300 volts; filament or heater voltage (AC or DC), up to 10 volts.

Each meter may be used independently. One of the adapters—a pair of test leads, one red, the other black, with tip jack terminals—serves this purpose. Multiplier J-106 extends the range of the DC voltmeter to 600 volts, but this reading must be obtained independently, as must readings on the 0-50 scale of the DC voltmeter. Independent reading of the AC voltmeter for line of voltage is necessary; also to use 0-140 scale while Multiplier J-111 extends the AC scale to 560 volts for reading power transformer secondaries.

The other adapters permit the testing of special receiver tubes, so that tests may be made, in all, of 22 different tubes: 201A, 200A, UX199, UV199, 124, 240, 171, 171A, 112, 112A, 245, 224, 222, 228, 280, 241, 227, 224, 210, 250, Kellogg tubes and old style Arcturus tubes.

WHEN servicing a radio set, power amplifier, speech amplifier or sound reproduction or recording equipment, the circuits and voltages are almost inaccessible, unless a plug-in tester is used.

The Jiffy 245-X plugs in and does everything you want done. It consists of:

- (1)—The enclosed three-meter assembly, with 4-prong (UX) and 5-prong (UY) sockets built in; changeover switch built in, from 0-20 to 0-100 ma.; ten vari-colored jacks, five of them to receive the vari-colored tipped ends of the plug cable; grid push-button, that when pushed in connects grid direct to the cathode for 224 and 227 tubes, to note change in plate current, and thus shorts the signal input.
- (2)—4-prong adapter for 5-prong plug of cable.
- (3)—Screen grid cable for testing screen grid tubes.
- (4)—Pair of Test Leads for individual use of meters.
- (5)—J-106 Multiplier, to make 0-300 DC read 0-600.
- (6)—J-111 Multiplier, to make 0-140 AC read 0-560.
- (7)—Two jack tips to facilitate connection of multipliers to jacks in tester.
- (8), (9), (10)—Three adapters so UV199 and Kellogg tubes may be tested.
- (11)—Illumination Tester.

The illumination tester will disclose continuities and opens and also the polarity of DC house mains. It is as handy as a pencil and fits in your vest pocket. It works on voltages from 100 to 400. There are two electrodes in a Neon lamp in the top of the instrument. On AC both electrodes light. On DC only one lights, and that one is negative of the line, the light being on the same side as the lead. Hence the illuminator shows whether tested source is AC or DC, and if DC, which side is negative.

Even the output of the speaker cord will show a light. Also, the device will test which fuses are blown in fused house lines, AC or DC. Besides it tests ignition of spark plugs of automobiles, boats and airplanes, also faulty or weak spark plugs.

Just flash on the illumination tester momentarily. It will last about 4,000 flashes.

GUARANTY RADIO GOODS CO.
145 West 45th Street, Just East of Broadway,
N. Y. City.

Please send me on 5-day money-back guaranty your J-245-X Jiffy Tester, complete, with all 10 adapters, and with illuminated Tester FREE with each order. Also send instruction sheet, tube data sheet and receiver tube testing information.

Enclosed please find \$15.82 remittance. Slip at your expense. (Canadian must be P.O. or Express M.O.)

Please ship C. O. D. @ \$15.82 plus cartage and P.O. fee.

NAME

ADDRESS

CITY STATE

5-DAY MONEY-BACK GUARANTY

Power Amplifier Equipment

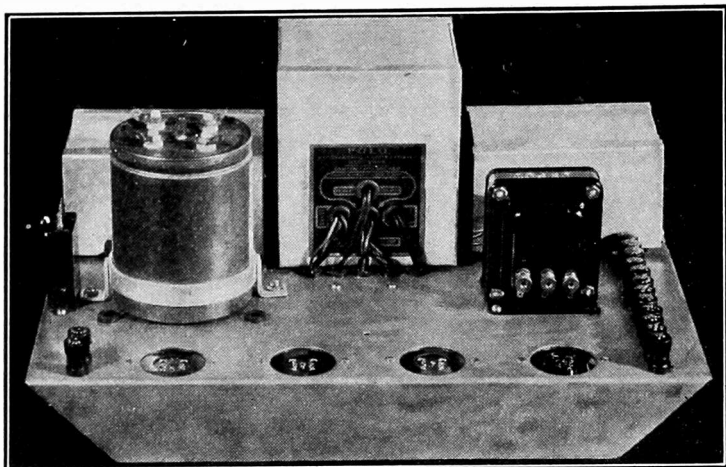

At left is illustrated a push-pull power amplifier, using a first stage of resistance coupled audio, 280 rectifier and two 245s in push-pull, as described in the November 2d issue of Radio World. Abounding volume and faithful tone reproduction are assured. The Polo Filament-Plate Supply, two Polo center-tapped audio chokes and a Multi-Tap Voltage Divider are used, with a Q 2-8, 2-18 Mershon condenser, an input push-pull audio transformer and auxiliary equipment. The total parts, including cadmium-plated steel sub-panel, come to \$43.57 net, the best power amplifier for that modest amount. Provision is made for phonograph pickup plug insertion. Thirteen output voltages are provided, including 300, 180, 75, 50 and an assortment of nine different voltages under 50 available for bias. All A, B and C voltages are provided for the power amplifier and for a tuner to be used with it employing 227, 224 or 228 tubes. Order Cat. PO-245-PA @ \$43.57 net,

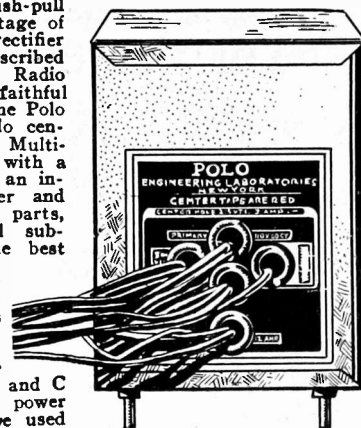

POLO 245 Filament Plate Supply (less chokes) has four windings, all save primary center-tapped (red), is 4 1/4" wide, 5" high, 4" front to back. Weight, 9 lbs. Filament windings, 2.5 v. at 12 amps., 2.5 v. at 3 amps. (for 245 filaments), 5 v. at 2 amps. for 280 rectifier, and 724 v. @ 80 m.a., center-tapped. Order Cat. PFFS @ \$7.50. [For 25 cycles order Cat. PFFS-25 @ \$12.00.] [For 40 cycles order Cat. PFFS-40 @ \$10.00.]

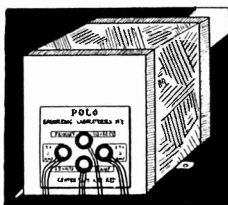

Polo Filament Transformer Only, four windings, consists of 50-60 cycles, 110 v. winding, 2 1/2 v. at 12 amps., 2 1/2 v. at 3 amps., 5 v. at 2 amps. All windings, save primary, are center-tapped (red). Size, 4 1/4" high x 3 3/4" wide x 3" front to back. Weight, 6 lbs. Order Cat. PFT @ \$4.25. [For 25 cycles order PFT-25 @ \$7.00; for 40 cycles order PFT-40 @ \$6.25.]

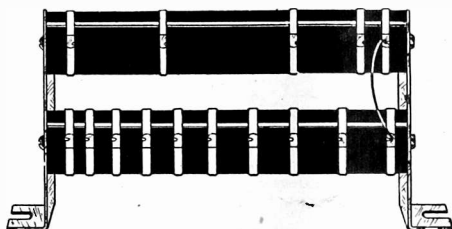

Two rugged, expertly engineered wire-wound, enamelled resistors, mounted in series, one atop the other, with fourteen useful lugs, providing all necessary choice of voltages without the uncertainty of adjustable variable resistance.

The Multi-Tap Voltage Divider has a total resistance value of 13,850 ohms, in the following steps: 3,000, 4,500, 2,000, 800, 700, 600, 550, 500, 450, 400, 200, 100 and 50 ohms. With the zero voltage lug (at lower left) the total number of useful lugs is fourteen. The resistance stated are those between respective lugs and are to be added together to constitute 13,850 ohms total.

A conservative rating of the Multi-Tap Voltage Divider is 50 watts, continuous use. The unit is serviceable in all installations where the total current drain does not exceed 125 milliamperes.

Extreme care has been exercised in the manufacture of the Multi-Tap Voltage Divider. It is mounted on brackets insulated from the resistance wire that afford horizontal mounting of the unit on baseboards and subpanels.

There long has been a need for obtaining any necessary intermediate voltage, including all biasing voltages, from a Multi-Tap Voltage Divider, but each lug has to be put on individually by hand, and soldered, so that manufacturing difficulties have left the market barren of such a device until now.

The Multi-Tap Voltage Divider is useful in all circuits, including push-pull and single-sided ones, where the current rating of 125 milliamperes is not seriously exceeded and the maximum voltage is not more than 400 volts. If good ventilation is provided, this rating may be exceeded 15 per cent.

The expertness of design and construction will be appreciated by those whose knowledge teaches them to appreciate parts finely made.

When the Multi-Tap Voltage Divider is placed across the filtered output of a B supply which serves a receiver, the voltages are in proportion to the current flowing through the various resistances. If a B supply feeds a receiver with two-stage audio amplifier, the last stage a single-sided 245, then the voltages would be 250 maximum for the power tube, 180, 135, 75, 50, 40, 35, 30, 25, 16, 10, 6 and 3. By making suitable connection of grid returns the lower voltages may be used for negative bias or even for positive voltage on the plates.

If push-pull is used, the current in the biasing section is almost doubled, so the midtap of the power tubes' filament winding would go to a lug about half way down.

Order Cat. MTVD at \$3.95.

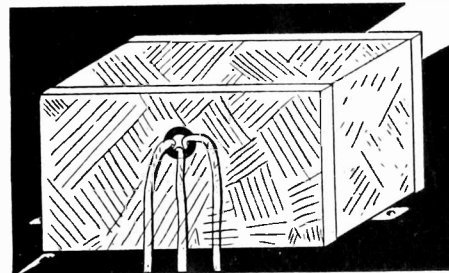

Center-tapped double choke, 125 m.a. rating, 30 henrys in each section. Used for filtering B supply or for a push-pull output impedance, where speaker cords go directly to plates of tubes. Center tap is red. Order Cat. PDC @ \$3.71.

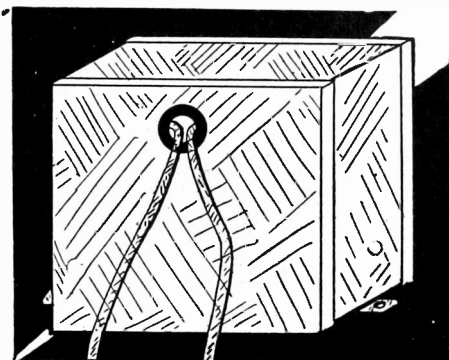

Single 30 henry 100 m.a. choke for filtered output (where condenser is used additionally) or for added filtration of a B supply. Order Cat. PSC @ \$2.50.

By-pass Condensers
For by-passing B+ leads to ground or C minus from 200 v. post or less, where current is less than 10 m.a., 1 mfd. paper dielectric condensers are useful. Order LV-1 @ \$0.50 ea.

Filter Condensers
For high voltage filtration next to the rectifier, use 1 or 2 mfd. The 2 mfd. makes the output voltage a little higher.
Order Cat. HV-1 (1,000 v. DC, 550 v. AC) @ \$1.76
Order Cat. HV-2 (1,000 v. DC, 550 v. AC) @ \$3.52

Filament-Plate-Choke Block
Same as Filament-Plate Supply, except that two 50 henry chokes are built in. Six windings: primary, 110 v., 50-60 cycles; 2.5 v. at 12 amps.; 2.5 v. at 3 amps.; 5 v. at 2 amps.; 724 v. at 80 m.a.; choke All AC windings center-tapped (red), except primary. Connect either end of a choke to one end of other choke for midsection. Order Cat. P-245-FPCH @ \$10.00 [For 40 cycles order P-245-FPCH-40 @ \$13.50.] [For 25 cycles order P-245-FPCH-25 @ \$14.50.]

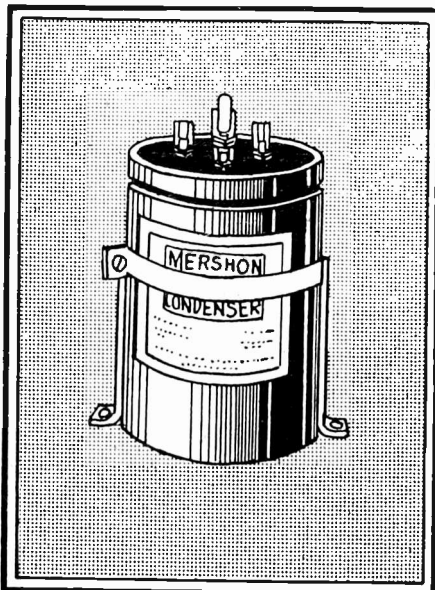

The Mershon electrolytic condenser, 415 volts DC, for filtering circuits of B supplies. Q 2-8, 2-18 has four capacities in one copper casing: two of 8 mfd. and two of 18 mfd. The copper case is negative. The smaller capacities are nearer the edge of the case. The vent cap should not be disturbed, and the electrolyte needs no refilling or replacement.

Mershon electrolytic condensers are instantly self-healing. Momentary voltages as high as 1,000 volts will cause no particular harm to the condenser unless the current is high enough to cause heating, or the high voltage is applied constantly over a long period.

High capacity is valuable especially for the last condenser of a filter section, and in by-passing, from intermediate B+ to ground or C+ to C-, for enabling a good audio amplifier to deliver true reproduction of low notes. Suitably large capacities also stop motor-boating.

Recent improvements in Mershons have reduced the leakage current to only 1.5 to 2 mils total per 10 mfd. at 300 volts, and less at lower voltages. This indicates a life of 20 years or more, barring heavy abuse.

In B supplies Mershons are always used "after" the rectifier tube or tubes, hence where the current is direct. They cannot be used on alternating current. Rated 415 v. DC.

The Mershon comes supplied with special mounting bracket. Order \$5.15 Q 2-8, 2-18 B @

ACOUSTICAL ENGINEERING ASSOCIATES,
143 West 45th St., N. Y. City.
(Just East of Broadway.)

Please ship at once the following:

Quantity	Cat. No.	Product	Price
<input type="checkbox"/>	PO-245-PA	Power amp. parts, 50-60 c.	\$43.57
<input type="checkbox"/>	PO-245-PA-40	Same, 40 cycles	46.07
<input type="checkbox"/>	PO-245-PA-25	Same, 25 cycles	48.57
<input type="checkbox"/>	PFFS	Fil. plate supply, 50-60 c.	7.50
<input type="checkbox"/>	PFFS-40	Same, 40 cycles	10.00
<input type="checkbox"/>	PFFS-25	Same, 25 cycles	12.00
<input type="checkbox"/>	PFT	Fil. trans., 50-60 e.	4.25
<input type="checkbox"/>	PFT-40	Same, 40 cycles	6.25
<input type="checkbox"/>	PFT-25	Same, 25 cycles	7.00
<input type="checkbox"/>	P-245-FPCH	Power-filter block	10.00
<input type="checkbox"/>	P-245-FPCH-40	Same for 40 cycles	13.50
<input type="checkbox"/>	P-245-FPCH-25	Same for 25 cycles	14.50
<input type="checkbox"/>	PDC	Single choke	2.50
<input type="checkbox"/>	PSC	Multi-tap volt. div.	3.95
<input type="checkbox"/>	MTVD	Double c.-t. choke	3.71
<input type="checkbox"/>	Q2-8, 2-18B	Mershon with bracket	5.15
<input type="checkbox"/>	LV-1	200 v., 1 mfd. by-pass cond.	.50
<input type="checkbox"/>	HV-1	1,000 v., 1 mfd. filter cond.	1.76
<input type="checkbox"/>	HV-2	1,000 v., 2 mfd. filter cond.	3.52
<input type="checkbox"/>	SPO	Subpanel	3.50

Enclosed please find check—money order—for the above. [Note: Canadian remittance must be by postal or express money order.]

Please ship C.O.D.

NAME.....

ADDRESS.....

CITY..... STATE.....

5-DAY MONEY-BACK GUARANTEE!

The Latest in Tuning Equipment

SHIELDED COIL

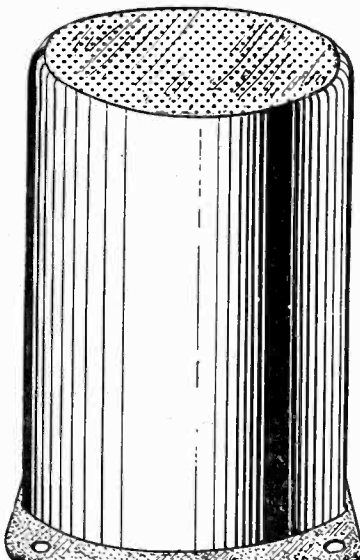

RF transformer in aluminum shield 2 1/2" square at bottom, 3 1/2" high. If metal sub-panel is used no extra base is needed. Coils have brackets on. You must assemble in shield yourself and solder winding terminals to built-in lugs. For all circuits and stages, including screen grid tubes.

Cat. No. SH3 for .00035 mfd.\$0.95
 Cat. No. SH5 for .0005 mfd.\$1.00
 Cat. SHB (extra base)\$0.10

BERNARD TWO-TUBE TUNER ASSEMBLY

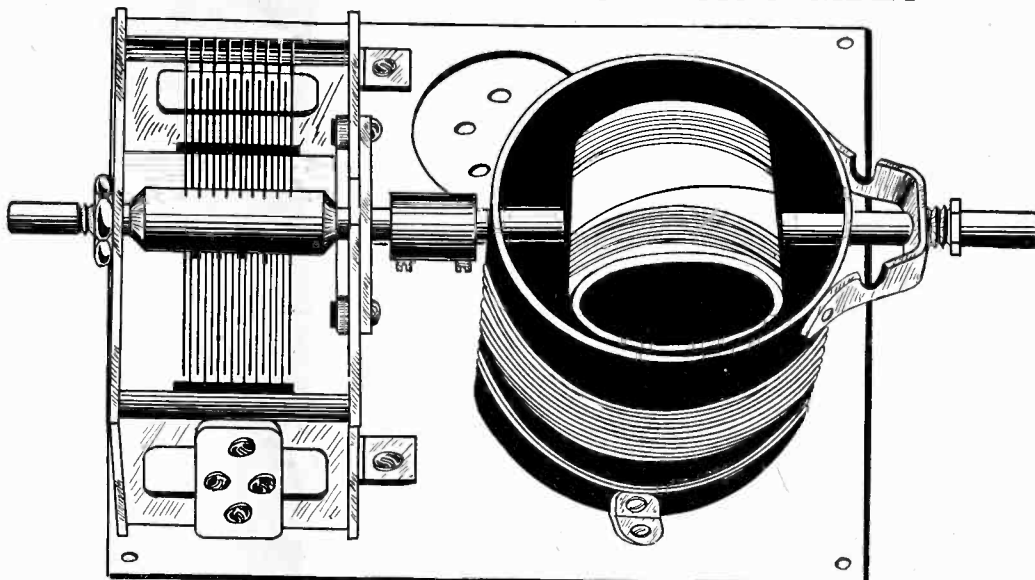

For building a tuner consisting of a stage of screen grid radio frequency amplification and a detector, AC or battery-operated, use the Bernard two-tube tuner assembly. Suitable for single control with one drum dial or separately tuned stages with two flat-type dials. The assembly consists of antenna stage (BTL-AC or BTL-DC) having Bernard Tuner BT3A, a .00035 mfd. condenser, socket, link and aluminum base. The detector input stage (BTR-AC or BTR-DC) consists of the same parts, but the coil has a tuned primary with untuned input to detector. Assemblies are unwired but are erected.

The condenser has shaft protruding at rear, so if two dials are used coil is put at front panel in either instance and condenser at front panel for the other.

For AC operation, 224 RF and 224, 227 or 228 detector, order Cat. No. BTL-AC and BTR-AC at \$6.00 for both.

For battery operation of filaments, 222 RF and 222, 240, 201A or 112A detector, order Cat. No. BTL-DC and BTR-DC at \$6.00 for both.

[Note: for drum dial single control an 80 mmfd. equalizing condenser is necessary. This is extra at \$0.35. Order Cat. EQ-80.]

ANTENNA COUPLER

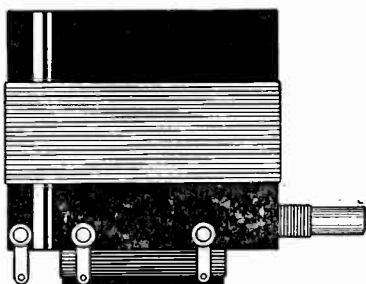

Cat. No. VA5—\$0.85
 FOR .0005 MFD. CONDENSER

Moving primary and fixed secondary, for antenna coupling. Serves as volume control.
 Cat. No. VA3 for .00035 mfd.\$0.90

BERNARD TUNERS

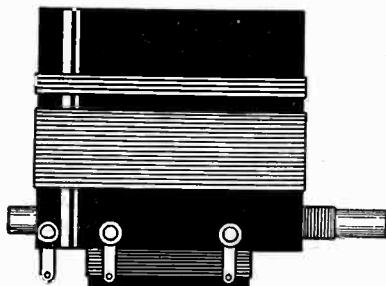

Cat. No. BT5A—\$1.35
 FOR .0005 MFD. CONDENSERS

Bernard Tuner BT5A for .0005 mfd. for antenna coupling, the primary being fixed and the secondary tuned. This coil is used as input to the first screen grid radio frequency tube. Secondary has moving coil.

Cat. No. BT3A for .00035 mfd. ..\$1.35

Bernard Tuner BT5B for .0005 mfd. for working out of a screen grid tube, tuned primary, untuned secondary. Primary has moving coil.

Cat. BT3B for .00035 mfd. ..\$1.35

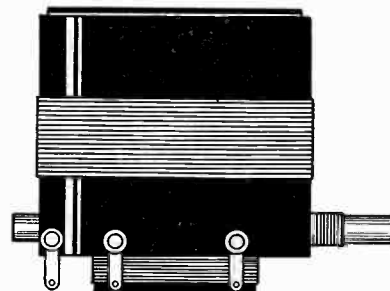

Cat. No. BT5B—\$1.35
 FOR .0005 MFD. CONDENSER

SG TRANSFORMER

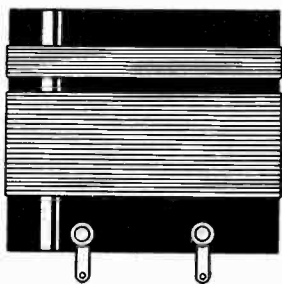

Cat. No. SGS5—\$0.60
 FOR .0005 MFD. CONDENSER

Interstage radio frequency transformer, to work out of a screen grid tube, primary untuned.

Cat. No. SGS3 for .00035 mfd.\$0.65

DIAMOND PAIR

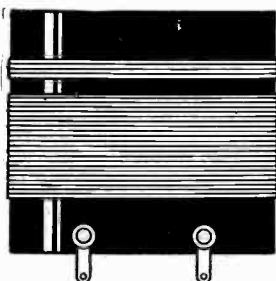

Cat. No. RF5—\$0.60
 FOR .0005 MFD. CONDENSER

Cat. No. RF5—\$0.60
 FOR .0005 MFD. CONDENSER

Antenna coil for any standard circuit, and one of the two coils constituting the Diamond Pair.

Cat. No. RF3 for .00035 mfd.\$0.65

Cat. No. SGT5—\$0.85
 FOR .0005 MFD. CONDENSER

Interstage 3-circuit coil for any hookup where an untuned primary is in the plate circuit of a screen grid tube.

SGT3 for .00035 mfd.\$0.90

Order the Diamond Pair, Cat. DP5 for .0005 mfd. at\$1.45
 Order the Diamond Pair, Cat. DP3 for .00035 mfd. at\$1.55
 [Note: These same coils are for AC or battery circuit.]

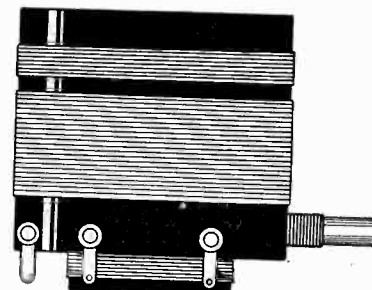

Cat. No. SGT5—\$0.85
 FOR .0005 MFD. CONDENSER

STANDARD TUNER

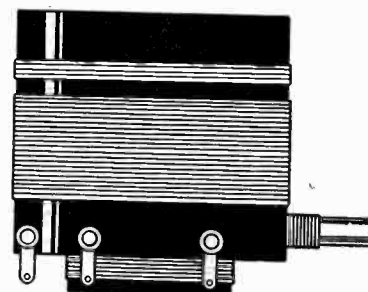

Screen Grid Coil Company,
 143 West 45th Street,
 New York, N. Y. (Just East of Broadway.)

Enclosed please find \$..... for which please send at once the following parts:

- Cat. No. at \$
- Cat. No. at \$
- Cat. No. at \$
- Please ship C. O. D.

Name

Address

City State

FL4 \$0.30
 Flexible insulated coupler for uniting coil or condenser shafts
 Order Cat. FL4 at\$0.30
 Equalizing condenser, 80 mmfd., for connection across any tuning condenser where ganging is resorted to, or for equalizing independently tuned circuits to make dials track.
 Order Cat. EQ80 at\$0.35

The standard three-circuit tuner is used with primary in the plate circuit of any RF tube, AC or battery type, excepting only screen grid tube. For .0005 mfd. order T5 at\$0.85
 For .00035 order Cat. T3 at\$0.90
 All coils have 2 1/2" diameter, except the shielded coil, which is wound on 1 1/2".
 The coils are wound by machine on a bakelite form, and the tuned windings have identical inductance for a given capacity condenser, i. e., .0005 mfd. or .00035 mfd. Full coverage of the wave band is assured.

All coils with a moving coil have single hole panel mounting fixture. All others have base mounting provision. The coils should be used with connection lugs at bottom, to shorten leads.

Only the Bernard Tuners have a shaft extending from rear. This feature is necessary so that physical coupling to tuning condenser shaft may be accomplished by the insulated link.



Your Choice of These Nine Meters FREE!

- 0-5 Voltmeter D.C. No. 328
0-50 Voltmeter D.C. No. 337
0-Volt Charge Tester D.C. No. 23
0-10 Amperes D.C. No. 338
0-25 Milliamperes D.C. No. 325
0-50 Milliamperes D.C. No. 326
0-100 Milliamperes D.C. No. 328
0-500 Milliamperes D.C. No. 329
0-400 Milliamperes D.C. No. 324

Equip Yourself Now With Necessary Meters!

To do your radio work properly you need meters. Here is your opportunity to get them at no extra cost. See the list of nine meters at left. Heretofore we have offered the choice of any one of these meters free with an 8-week subscription for RADIO WORLD at \$1 the regular price for such subscription. Now we extend this offer. For the first time you are permitted to obtain any one or more or all of these meters free, by sending in \$1 for 8-week's subscription, entitling you to one meter; \$2 for 16 weeks, entitling you to two meters; \$3 for 24 weeks, entitling you to three meters; \$4 for 32 weeks, entitling you to four meters; \$5 for 40 weeks, entitling you to five meters; \$6 for 48 weeks, entitling you to six meters. Return this offer with remittance, and check off desired meters in squares at left.

RADIO WORLD will help you in your radio work, so you will be able to use the meters most valuably. Keep abreast of all the new circuits, intimate details on perfecting existing sets, and get inside track on sensitivity, distance reception, tonal quality, and news of radio, technical and non-technical. Enjoy the writings of Dr. Leo De Forest, Mackurda Silver, J. E. Anderson, Herman Bernard and a host of other radio engineers who contribute their knowledge to you through the medium of RADIO WORLD, the first and only illustrated national radio weekly. You can find no magazine that better caters to your needs than RADIO WORLD. Short waves! RADIO WORLD will tell you all about them. Extremely sensitive broadcast receivers! Their construction and operation are fully discussed with attendant regularity. Power supplies—push-pull or otherwise! AC receivers? Screen grid tubes? Large receivers that give a super-abundance of performance—small, economical receivers that give performance out of all comparison to their size? Are you interested in these? Then you're interested in RADIO WORLD.

Present mail subscribers may renew their subscription under this remarkably generous offer. Put a cross in square.

RADIO WORLD

145 W. 45th St., N. Y. City—Published Weekly. All Newsstands, 15c per copy—\$3. six months—\$8 a year

Component Parts for 245 Push-Pull Power Amplifier

(as described and specified by Herman Bernard) Check off which parts you desire. All parts sold separately.

- C1—One .00025 mfd. mica condenser. .21
C2—One .01 mfd. mica fixed condenser. .35
C3—One Flechtheim 1 mfd. filter condenser, 1,000 volts DC continuous working voltage rating, 550 volts AC (root mean square) continuous voltage rating. 1.78
C4, C5, C6, C7—Four Marshon condensers in one copper casing, two of 8 mfd. and two of 18 mfd. with low bracket, Cat. Q2-8, 2-18B. 5.15
C8, C9, C10, C11, C12, C13, C14, 15, C16—Nine 1 mfd. bypass condensers, 200 volts DC continuous working voltage rating. 4.50
T1—One Polo Filament-Plate Supply transformer: 110 volt 50-60 cycle primary, 724 volt secondary center-tapped, 5 volt 2 amp. secondary center-tapped; 2.5 volt 3 ampere secondary center-tapped, and 2.5 volt 12 ampere secondary center-tapped. Cat. PFPS. 7.50
FC, PPOC—Two center-tapped chokes for high current one used as filter choke, other as push-pull output choke. 7.42
PPIT—One push-pull input transformer. 3.41
SW—One AC pendant through-switch, with 12-ft. AC cable and main plug. 1.10
F—One 2 ampere fuse, with holder. .50
CO—One convenience outlet (for dynamic speaker AC cable). .50
P3, P3S—Phonograph Jack with automatic switch and plug. 1.42
R1—One resistor, 0.1 meg. .30
R2—One grid leak, 5.0 meg. .30
R3—One multi-tap voltage divider, 50 watt rating; fourteen taps affording thirteen different voltages; 13,850 ohms. 3.95
Two resistor mountings.
Roll of heavy insulated hookup wire for power work.
Fifteen binding posts. 1.50
One 15x3 1/2 cadmium plated steel subpanel, with self-bracketing flanges, one five-prong and three four-prong sockets built in; sockets marked to identify tubes that go in them; subpanel drilled and insulated where necessary; flat insulating washers; hardware. 4.00
All parts. \$43.57
Ferranti AF5CC push-pull input instead of above input transformer. 9.60

[Note: For 40 cycles 110v. order Polo P40 FPS at \$10; for 25 cycles 110v. order Polo P25 FPS at \$1]

Guaranty Radio Goods Co.

143 West 45th Street Just East of Broadway NEW YORK CITY

Blueprint of the New One-Dial

Push-Pull Battery Model SG DIAMOND

Full-sized picture diagram of the wiring, with list of parts. This 5-tube receiver is really superlative. It gives you screen grid radio frequency amplification and push-pull output, most economically.

Send \$1.00 today for this blueprint or order it shipped C. O. D.

RADIO WORLD

145 West 45th Street Just East of Broadway New York City

One Tube? Two Tubes? Three Tubes? Four Tubes?

Circuits for Schoolboys—Easy to Build, Very, Very Inexpensive!

- A One Tube Receiver, parts costing \$4.28!
A Two Tube Audio Amplifier, parts costing \$5.23!
A Three Tube Speaker—Operating Circuit, parts costing \$11.10!
A Four Tube Speaker—Operating Circuit, parts costing \$12.72!

The construction of these circuits, with a pictorial diagram as one of the illustrations, was described by Jack Tully, himself a schoolboy, in RADIO WORLD. See list below.

- Sept. 21st and 28th issues, One-Tube DX Set, by Jack Tully; two-part article.
Oct. 5th, Three-Tube Single Dial Speaker Set, by Jack Tully.
Oct. 12th, Two Stage Transformer, Coupled Audio Amplifier, by Jack Tully.
Oct. 19th, Four-Tube DX Speaker Set, by Jack Tully. 15 cents a copy Order at once while these copies are available.

RADIO WORLD, 145 W. 45th St., New York

LACAULT'S BOOK

GIVES YOU A FINE UNDERSTANDING OF THE SUPER-HETERODYNE

R. E. LACAULT, E.E., I.R.E., who died recently, was one of the outstanding authorities on the Super-Heterodyne. He wrote a book, "Super-Heterodyne Construction and Operation," that explains in a non-technical manner the phenomena associated with a Super-Heterodyne. More, it gives a clear outline of the way such a receiver functions, and naturally gives the clues to solving virtually all the troubles that may arise in a Super.

So thoroughly did Lacault do his work that he covered associated topics, thus making his book a sidelight on radio in general, including advice on trouble-shooting.

Therefore the service man, the home experimenter, the custom set builder and the student will welcome this book.

It consists of 103 pages and includes 68 illustrations. It is bound in maroon buckram.

There are three valuable tables in the book, also. One classifies harmonics into groups, e.g., sound, radio, short waves, heat, light, chemical rays, X-rays and "unknown." Another is a trouble-shooting chart, classifying "trouble experienced" and "causes" and referring to the text for specific solutions. The third is a table for converting broadcast frequencies to wavelengths (accurate to .1 of a meter) or for converting the wavelength into frequency.

THE book begins with a comparison of alternating and direct current and proceeds to a discussion of the relation of wavelength to frequency. Then tuning is explained.

Condensers, coils, induction, vacuum tube operation and testing, earphones and speakers, rectification, oscillation, grid condenser action, modulation, grid bias detection, regeneration, beat notes, frequency changing, audio amplification, batteries, aeriels, loops, wiring, sockets, and shielding are only some of the other important topics covered.

Besides, there is an entire chapter on the construction of a Super-Heterodyne receiver, with list of parts, front, top and rear views of set, front panel layout, shield dimensional drawings, schematic diagram of wiring and picture diagrams of the top and bottom views of the subpanel.

You Can Get This Book At Once!

You will want this book not only for present reading but also for future reference. It is authoritative and highly informative. Send for it now! It's free with each order for an eight weeks' subscription for RADIO WORLD. Present subscribers may renew under this offer. Their subscriptions will be extended eight weeks. Please use coupon.

RADIO WORLD, 145 W. 45th St., N. Y. City (Just East of Broadway)

Gentlemen: Enclosed find \$1.00. Please enter my subscription for RADIO WORLD for eight weeks at \$1.00 and send me at once one copy of R. E. Lacault's "Super-Heterodyne Construction and Operation," FREE!

I am a subscriber at present. (Check off if true.)

Name
Address
City State

5-DAY MONEY-BACK GUARANTEE If C. O. D. desired, put cross here.

Component Parts

for ONE-DIAL

PUSH-PULL BATTERY DIAMOND

[Check off parts you want. Each part is sold separately.]

- L1L2—Antenna coil RF3 @ .65
L3L4L5—3-circuit SG coil SGT3 @ .90
L6—Push-pull output transformer. 2.50
T1—Push-pull input transformer. 2.50
CT—80 mfd. equalizer .35
C1, C2—Two .00035 mfd. ext. shafts @ 98c 1.96
C3, C5—Two .01 mfd. mica condensers. .70
R—One 6.5 ohm filament resistor. .25
R1, Sw—One 75 ohm switched rheostat. .80
R2, C4—2 meg. Lynch leak, grid clip condenser. .51
R3—One .25 meg. .30
R4—One 5.0 meg. .30
R5—One 1.3 ohm filament resistor. .20
Ant., Gnd., Sp. (+) Sp. (-)—Four posts @ .10. 40
One drilled front panel 7x18" 1.85
One socketed, self-bracketing metal sub-panel, all holes drilled. 3.50
One National new modernistic drum dial with color wheel, pilot bracket, 6v. lamp, hardware, knob. 3.13
Two matched knobs for rheo. and tickler @ .18. 36
Five vari-colored cable leads @ .07. 35
Metal link and insulated shaft. .22
One screen grid clip. .06
All parts (including blueprint). \$21.89

GUARANTY RADIO GOODS CO., 143 W. 45th St., N.Y.C. (Just East of Broadway)

Enclosed please find \$..... for which please mail at once the parts for the Push-Pull Battery Model Diamond of the Air as checked off above.

If ordering C.O.D. put check mark here.

Name
Address
City State

TRIAL SUBSCRIPTION, 8 WEEKS, \$1.00. Send \$1 and we will send you Radio World for 8 weeks, postpaid. RADIO WORLD, 145 West 45th St., N. Y. City.

"MODERN AIRCRAFT," By Maj. Pagé, \$5. postpaid; and "Everybody's Aviation Guide," By Maj. Pagé, price \$2. postpaid. Latest and best up-to-date aviation books. Radio World, 145 W. 45th St., N. Y. City.

Highest Grade Key Tubes at Defiant Prices!

Screen Grid Tubes
224 at \$1.43
222 at 1.88

Power Tubes
245 at 1.28
112A at .78
171A at .78

Other Tubes
227 at .90
226 at .68
280 at 1.13
201A at .53

The above constitute the nine most popular tubes used in radio today. Despite the severely low prices the Key tubes are firsts of the very first quality. Besides, there is a five-day money-back guaranty! The above tubes are manufactured under licenses granted by the RCA and its affiliated companies.

All prices are net and represent extreme discount already deducted.

228 HIGH-GAIN DETECTOR

Increase the sensitivity of modern AC-operated circuits by substituting the new 228 AC high mu tube (large amplification), for the 227 tube otherwise used as detector in up-to-date circuits. The result is immediately obvious in the greatly increased volume. Then the weak, distant stations come in stronger and tone quality is improved. Simply substitute the 228 for the 227 in the detector socket only. No wiring change of any kind is required. Price, \$1.88.

GUARANTY RADIO GOODS CO., 143 West 45th St., N. Y. City. (Just East of Broadway).

- Enclosed please find \$..... for which ship at once tubes marked below:
- 228 AC high mu. \$1.88
 - 224 AC screen grid \$1.43
 - 245 AC power tube \$1.28
 - 226 AC amplifier .68
 - 227 AC det.-amp. .90
 - 280 AC rectifier \$1.13
 - 222 battery screen grid \$1.88
 - 112A power tube .78
 - 171A power tube .78
 - 201A battery tube .53
 - Matched pair of 245s for push-pull (for both) \$2.56
 - Matched pair 171As for AC push-pull (for both) \$1.80
 - Matched pair of 112As for push-pull (for both) \$1.80

Name

Address

City State

Put cross here if C. O. D. shipment is desired.
Canadian remittance must be by postal or express money order.

5-Day money-back guaranty



A Topping Coil Antenna
Is the answer to the aerial problem. Designed to meet the requirements of powerful A.C., Screen Grid & Short Wave Radios.
Selective—Non-Directional—
Low Capacitive
Shipped Complete \$7.00 Prepaid
TOPPING RADIO COMPANY
2205 Taraval St. San Francisco, Cal.

RADIO TONIC

When it comes to making sick radios well, or good radios better, just remember—

CLAROSTAT

the name of a line of products dedicated to better radio results.
Clarostat Mfg. Co., 291 N. 6th St., B'klyn, N. Y.

Polk's Reference Book and Mailing List Catalog

Gives counts and prices on over 8,000 different lines of business. Valuable information also given as to use of mails to secure orders for your products or services.

Write for Your FREE Copy
R. L. POLK & CO., Detroit, Mich.

EVERY WEEK in RADIO WORLD appears a feature article of intense interest to schoolboys. Parents and other relatives will bring great delight to youngsters by sending \$3 for a 6 months' subscription for RADIO WORLD (26 issues) in the youngster's name.—RADIO WORLD, 145 West 45th Street, New York City.

LACAULT'S BOOK, "Superheterodyne Construction and Operation," and Radio World for 8 weeks for \$1. Radio World, 145 W. 45th St., N. Y. City.

NEWEST BOOK ON VACUUM TUBES

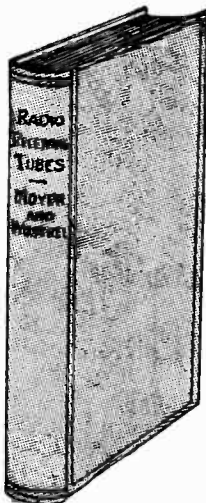

"RADIO RECEIVING TUBES," by James A. Moyer and John F. Wostrel, first edition just off the press. No radio service man, experimenter or student of radio should be without this authoritative book on the principles and applications of vacuum tubes. It answers all your questions relating to receiving, amplifying and rectifying tubes. It is a complete discussion of tube principles, functions and uses, thoroughly up-to-date.

In this book the essential principles underlying the operation of vacuum tubes are explained in as non-technical a manner as is consistent with accuracy. The book covers the construction, action, reactivation, testing and use of vacuum tubes as well as specifications for vacuum tubes and applications for distant control of industrial processes and precision measurements.

Price \$2.50

RADIO WORLD
145 West 45th Street, New York City
(Just East of Broadway)

LOOK AT YOUR WRAPPER

You will see by the date thereon when your subscription for Radio World expires. If the subscription is about to run out, please send us renewal so that you will not miss any copies. Subscription Department, RADIO WORLD, 145 West 45th St., N. Y. City.

PUBLISHERS CAN SUPPLY ALL 1929 COPIES OF RADIO WORLD

Excepting issues of Jan. 5, Feb. 23, and May 11

If you have missed any copies of Radio World for the year 1929 and want to complete your file, let us know what issues you are short and we will mail what we can at 15c a copy, or any seven issues for \$1.00, mailed postpaid.

Circulation Dept., Radio World, 145 W. 45th St., N. Y. City.

SECURITY DEALER

Wants Attractive Stock Issue

Send full particulars
**W. E. A. WHEELER
& COMPANY**
90 Wall Street
NEW YORK CITY

BROADWAY-HOLLYWOOD

World's most intriguing places. Where famous stage, screen, radio stars live their lives. Intimate stories of their stage and personal doings in

NEW STAR National Illustrated Amusement Weekly
Edited by Roland Burke Hennessy. Clever writers cover comedy, tragedy, fascination of professional life. Portraits and unusual pictures of favorites. 10c copy \$5 year (52 issues). SPECIAL: 12 issues \$1 and experts answer your questions. FREE. STAR, 1562 Broadway, New York.



Fourteen Circuits

Each Shown in Colored Picture Diagram, Colored Schematic Diagram and Front Panel Layout

Get This FREE Book!

Complete AC electric receivers, with B eliminators included, also AC receivers without B eliminators, also battery operated models, all easy-to-build circuits, using your own parts.

RADIO WORLD, 145 W. 45th St., N. Y. City. (Just East of Broadway)

Gentlemen: Enclosed please find \$1.00 for which please send me Radio World each week for eight weeks (regular price, \$1.20) and besides send me a FREE copy of the 1929 edition of The Radio Blueprint Library of AC and Battery Hookups.

Name

Address

City State

Note: Present mail subscribers may take advantage of this offer by putting a cross in this square. Your subscription will be extended eight weeks.

[Canadian remittance must be by postal or express money order, due to high discount rate on cashing Canadian checks in New York.]



Vol. XVI, No. 19 Whole No. 409
 January 25th, 1930
 15c per Copy, \$6.00 per Year
 [Entered as second-class matter, March, 1922, at the Post Office at New York, N. Y., under act of March, 1879.]

Technical Accuracy Second to None
 Latest Circuits and News
EIGHTH YEAR

A Weekly Paper published by Hennessy Radio Publications Corporation, from Publication Office, 145 West 45th Street, New York, N. Y.
 (Just East of Broadway)
 Telephone, BRyant 0558 and 0559

RADIO WORLD, owned and published by Hennessy Radio Publications Corporation, 145 West 45th Street, New York, N. Y. Roland Burke Hennessy, president and treasurer, 145 West 45th Street, New York, N. Y.; M. B. Hennessy, vice-president, 145 West 45th Street, New York, N. Y.; Herman Bernard, secretary, 145 West 45th Street, New York, N. Y. Roland Burke Hennessy, editor; Herman Bernard, business manager and managing editor; J. E. Anderson, technical editor.

Practical NR Circuits

Methods to Pursue in Non-Reactive Operation

By Randolph MacNamara

A PRACTICAL non-reactive detector and one-stage audio diagram is shown in Fig. 1. It is assumed there is a tuner available for connection thereto, the connection being made to the points marked "input."

The circuit was built of parts the author had on hand. The power transformer was intended for 112A output tubes in push-pull, and in full-wave rectification afforded 150 volts direct current, at the end of the filter system, but as can be seen this was changed, so that the 280 rectifier was used in half-wave fashion instead. This doubled the voltage. It was necessary to obtain higher voltage, since the total voltage is used in series distribution.

It can be seen from the diagram that the voltage drop across the total of the resistance chain is the full 300 volts. The apportionment of the voltages is one of the problems of this type of circuit. In other circuits the voltages are, in general, in parallel.

FAMILIAR CIRCUIT MADE TO WORK

The tuner to be connected to this detector-amplifier circuit may be fed in the usual way, from the B supply shown, but the power transformer should have the filament winding for the 224 tube and for other tubes in the tuner. Otherwise a separate filament transformer for the 224 and 227 or other RF tubes used would have to be provided for total AC operation. Of course battery-operated filament tubes in the tuner could be used, with the B voltages for the tuner taken from the present B supply through drops in suitable resistors connected to the 300-volt post in one instance and to the plate returns and screen grid returns in the other. However, only two or three tubes should be used in the tuner, as the B supply depicted is not designed to carry high current and still retain satisfactory filtration. It is better for the present to obtain B voltages independent of this B supply.

The idea embodied in the present circuit is a familiar one, as non-reactive circuits have been under discussion for years, but certain troubles have been encountered in them. Messrs. Loftin and White have been studiously engaged on the elimination of these troubles, and have demonstrated circuits to the satisfaction of discerning engineers.

HOW MUCH VOLUME IS OBTAINED

As to performance, the circuit as shown amplifies much the same, in quantity, as other forms of one-stage audio following a detector. Therefore local stations may be tuned in with sufficient volume, if the RF amplification consists of two stages. The quality is good.

Hum is low, and is reduced considerably as the capacity of the reservoir condenser C4 is increased. In the experimental model 1 mfd. for C4 proved wholly inadequate, while 4 mfd. was a good value. Next to the rectifier is C3, which should be 1 mfd.

Note that the voltage is twice that which would be present in a full-wave rectifier, using the same high-voltage secondary. This doubling is obtained by use of the full winding, and disuse of the midtap. The plates of the rectifier are connected together, which improves regulation. If you intend to convert an existing full-wave B supply to the present use, it is necessary to have

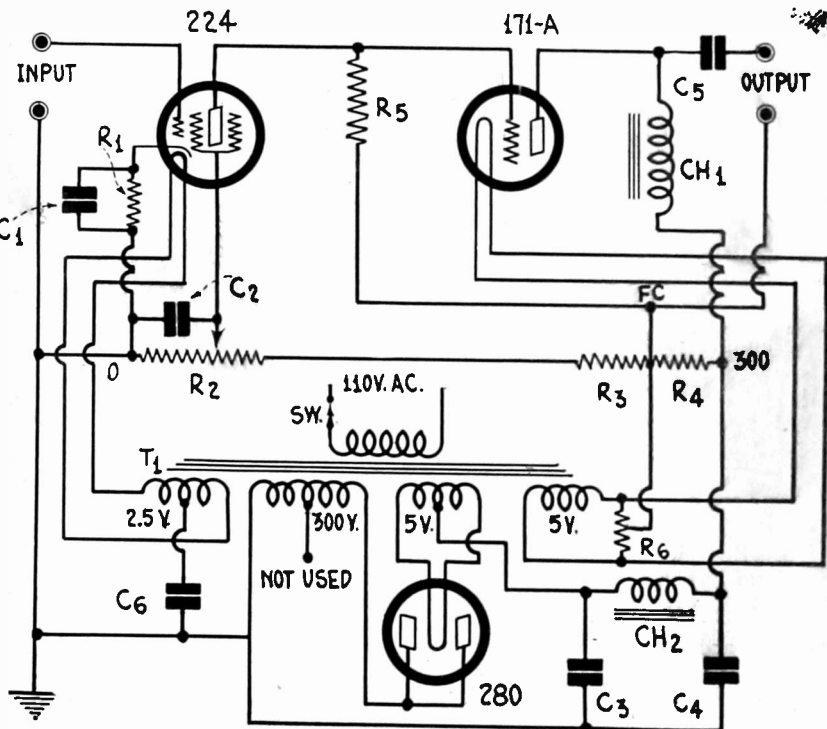

NON-REACTIVE CIRCUIT CONSISTING OF DETECTOR AND ONE STAGE OF AUDIO, BUILT AS A POWER AMPLIFIER. BY SLIDING THE POTENTIOMETER AND MAKING ANOTHER ADJUSTMENT THE 224 TUBE MAY BE CONVERTED FROM DETECTOR TO AMPLIFIER.

LIST OF PARTS

- R1—One .05 meg. resistor with mounting.
- R2—One 5,000 ohm potentiometer, 5 watts or more.
- R3—One 2,000 ohm resistor, 5 watts or more.
- R4—One 13,000 ohm resistor, 1 watt or more.
- R5—One 5 meg. leak with mounting.
- R6—One 30 ohm center tapped resistor (not needed if power tube filament winding is center-tapped).
- C1, C2—Two 1 mfd. condensers 200 volt DC type.
- C3, C5—Two 1 mfd. filter condensers, 400 volt AC type or higher voltage rating.
- C4—One 4 mfd. filter condenser, 400 volt AC type or higher voltage rating.
- C6—One .01 mfd.
- T1—One power transformer with full secondary wound to give 300 volts DC.
- Ch1, Ch2—Two 30 henry choke coils.
- Input, output—Four binding posts (two "input," one speaker plus, one speaker minus).
- One UY and two UX sockets.
- One 224, one 171A and one 280 tube.

Pointers for Getting Results

Last Tube Should Be Regulated First, Then Its

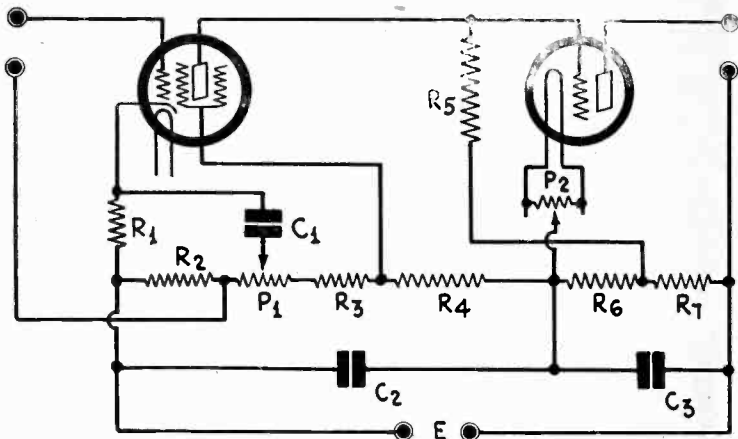

FIG. 2
THE CIRCUIT OF A TWO-TUBE NON-REACTIVE AMPLIFIER WHICH ILLUSTRATES HOW THE RESISTANCES MAY BE SELECTED FOR PROPER VOLTAGE DISTRIBUTION.

condensers that will stand the higher voltage. In many instances, however, the previously used filter condensers will stand 400 volts AC, so note the rating and act accordingly.

GOOD DETECTION

The 224 is worked as a high gain detector. As is well-known, a detector tube will amplify, and an amplifier tube will detect. Nevertheless a tube must be worked primarily as a detector or as an amplifier, and its operation is on the basis of a selected point on its characteristic curve. So soon as an attempt is made to compromise between detection and amplification, so that there will be some action of both types, there is not much of either. Nevertheless some types of tubes are better detectors than others, also provide higher gain besides better quality. The choice in the present instance is of a power detector of the high-gain type for this sort of detection. The action is all in the direction of better detection, rather than being an attempt to compromise between detection and amplification.

As was said, the problem is to obtain the correct voltages. Those familiar with standard hookups may find it difficult to work with direct coupled amplifiers, because while the basis of reckoning is the same, the application is different. Hence an analysis of the circuit is interesting.

Bear in mind that the plate voltage is that between cathode and plate return or between filament center and plate return, each tube to be reckoned independently.

Let us start from the point of zero potential and work along toward the maximum voltage of 300.

FIRST CRITICAL RESISTOR

First we have the 224 tube. Between its cathode and ground is connected a resistor, probably the most important resistor in the circuit, and surely one which, if improperly chosen, will defeat results. Low values will insure failure of operation. High values are necessary, because the higher the value, the higher the bias, the less the plate current through R5, and the lower the bias on the last tube, since its bias is derived from the voltage drop in R5. So if the drop is too much, the plate voltage on the last tube goes way up, while the current is reduced to almost zero, sometimes actually zero. This also upsets all the other voltages. For R1 use 50,000 ohms (.05 meg.).

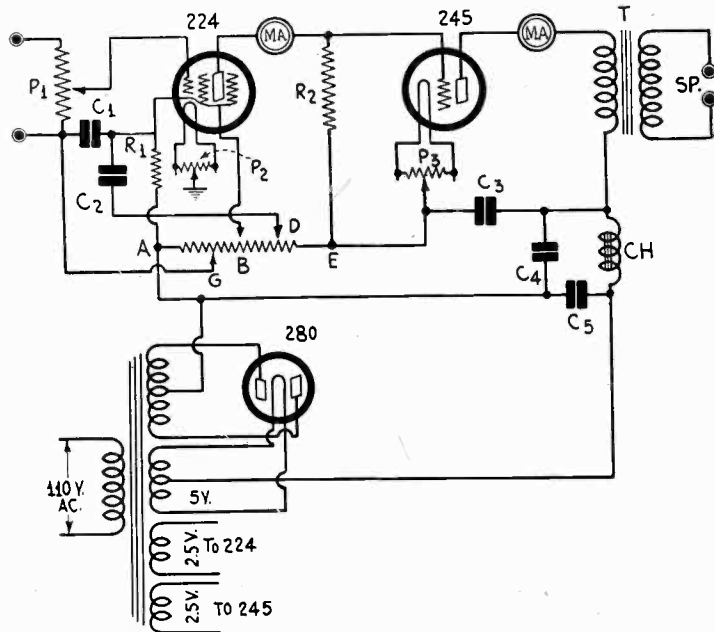

FIG. 3
A TWO-TUBE NON-REACTIVE AMPLIFIER USING ONE 224 AND ONE 245 TUBE.

R2 is a potentiometer, used for apportioning the screen grid and plate voltages of the 224 tube. It may be 5,000 ohms, while R3 is 2,000 ohms. R4 is 13,000 ohms, but is not critical, and may be generously more, or somewhat less than 13,000 ohms.

The total resistance across the chain composed of R2, R3, and R4 is 20,000 ohms, and the voltage across this total resistance is 300, therefore the bleeder current is 15 milliamperes.

The bleeder current flow through the chain is, of course the same at all points, but the plate current of the last tube does not flow through R4 but only through the power tube's filament center (FC) to zero, or through 7,000 ohms. If the plate current of the last tube is 20 milliamperes, then R4 carries 15 milliamperes and R2 and R3 carry the power tube's plate current and the bleeder current, or 35 milliamperes. An exception exists, however, since the 224 tube is in parallel with R2 and R3 and the same current therefore is diverted according to the rule of parallel resistors.

It will be seen that the plate current of the last tube is utilized throughout the circuit, being diverted for use in the 224.

Now, to inquire about the voltages.

SECOND CRITICAL RESISTOR

The bias on the first tube being the voltage drop in R1, and the screen grid voltage being adjustable, the degree of bias may be regulated by the potentiometer, since the screen current must flow through R1, and it will change according to the screen voltage. This potentiometer requires critical adjustment, since detection is attained by proper adjustment, and no signals, only a hum, will be heard otherwise. However, if you desire to feed a detector into the 224, you may convert the 224 to an amplifier by adjustment of the potentiometer R2.

The very high detecting bias being required for keeping the current low through R5, it still must be maintained low if the tube is used as an audio amplifier, and one solution in that case

How to Adjust Non-Reactive Circuits for Operation

Due to unfamiliarity with non-reactive (NR) circuits the experimenter may find difficulty in obtaining any results whatsoever. He will succeed in getting the filaments to light and the maximum voltage to register, easily enough, but that is no solution by a long shot. Hence follow these directions:

Test the output tube first. Get it to produce the rated plate current at rated plate voltage.

If the maximum voltage registers, increase the bias on the preceding tube, also increase the value of the coupling resistor. In this way plate current can be made to flow at the desired value in the last tube. Too high voltage and no current mean too low bias.

Next turn to the preceding stage and adjust the screen grid voltage or increase the bias on the tube to obtain detection.

From Non-Reactive Circuits

Predecessor to Obtain Detection or Amplification

is to use a lower value for R5 than 5 meg., and another is to move the end of R5, whatever value is used, even if 5 meg. is retained, to the right, to the power tube's filament center tap. This decreases the bias on the last tube and increases the plate voltage on the 224.

Regarding the effectiveness of the voltages: the full 300 volts is effective nowhere except across the voltage divider itself, this divider consisting of the resistor units already discussed. Read on a tube tester, or other meter servicing equipment plugged into the socket, the voltage on the last tube will be lower than the applied voltage by the drop in the choke coil Ch1. On the 224 the effective voltage is too low to give a reading and so is the current.

The first tube as a detector draws very little plate current, so little that you probably have no meter sensitive enough to measure the current, unless you have a 0-1 milliammeter. The plate current would be about .6 of a milliampere and the screen current about .2 milliampere, so the total would be less than 1 milliampere if rated voltages are used, which may be done, but the rated voltages do not give the best results in this circuit in connection with the screen grid tube. If any bias experiments are to be conducted in connection with this tube, the return of R1 may be moved over to the right, being tied to the potentiometer arm, or put at the right-hand end of R2 or at the power tube's filament center. The stated values in the list of parts are practical not experimental, in connection with Fig. 1.

Only one filter choke, Ch2, is used, as the current is so low, not exceeding 35 milliamperes under correct operating conditions. Ch is a standard choke coil, 35 to 50 henrys, and all such will pass 35 mils.

APPORTION VOLTAGES PROPERLY

Last week were published data on the non-reactive circuits that certainly started a great deal of interest in radio circles. Here is some additional information on the fundamental circuit.

There are many variations of this circuit, depending on the type and number of tubes used and on the voltages available. In Fig. 2 is shown a two tube circuit in which the tubes are supposed to be one 224 and one 245. To make a circuit of this type function satisfactorily it is essential that the voltages be distributed properly. This statement can not be made too convincing. In ordinary circuits voltages are not critical but in this type some of them are.

Let us take the circuit in Fig. 2 as a basis for discussion of the circuit and to show how the various voltages are interrelated and how they can be adjusted for satisfactory operation. It is well to state now that any particular values of resistors are not essential but the proper relation of them is necessary.

INTERRELATION OF VOLTAGES

One thing that must be remembered in this circuit is that the voltages applied to the second tube are dependent on the grid, screen grid, and plate voltages on the first tube, and that it is this fact which makes it important to adjust the circuit properly. For example, suppose the screen grid voltage on the first tube is decreased from a certain value, keeping the grid and the applied plate voltages constant. This change causes an increase in the plate current and therefore an increased drop in the coupling resistor R5. The increased drop is equivalent to an increase in the grid bias of the second tube, and it may be that the new grid bias on that tube is so great that the plate current in the second tube is entirely stopped. On the other hand, if the screen grid voltage is increased the screen takes most of the current and the plate gets very little. Hence the drop in R5 is small and it may then be that the total effective bias on the second tube is so slow that the plate current is excessive. Indeed, the plate current may be so large that the plate of the tube turns bright red.

It is clear that changes in the grid bias on the first tube will have similar effect, for if it did not the circuit would not function when the grid voltage on that tube is varied by the signal. But the grid must have a definite fixed bias about which the signal voltage will fluctuate.

When only a moderate total voltage is available it is not possible to give the elements of the first tube as high values as in rated voltages, since most of the voltage should be applied to the power tube if any appreciable volume is to be obtained.

DESIGNING THE CIRCUIT

Let us see how the various resistors in Fig. 2 may be determined so as to bring about the correct adjustment. Let us assume that we have a total available voltage of 450 volts. Of this voltage 250 volts should be applied to the plate of the 245 tube. This means that the voltage drop in R6 and R7 should be 250 volts. Now we are at liberty to choose almost any current through these resistors as long as we stay within the limits of the current supply. Let us choose a value of 10 milliamperes. This is convenient because the sum of R6 and R7 will be just 25,000 ohms.

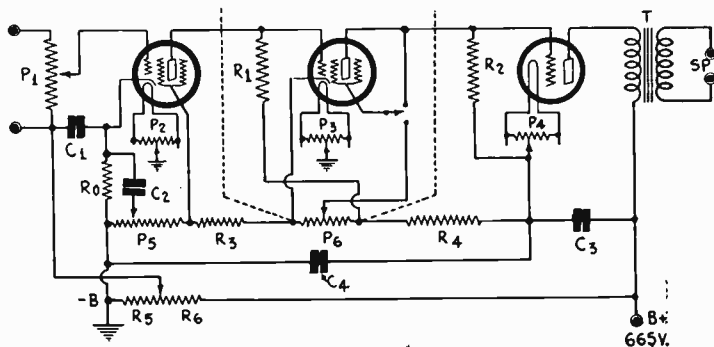

FIG. 4
A THREE-TUBE NON-REACTIVE CIRCUIT FEATURED BY A VOLUME-CHANGE SWITCH WHICH CONVERTS THE MIDDLE TUBE FROM A SCREEN GRID TO A THREE-ELEMENT TUBE.

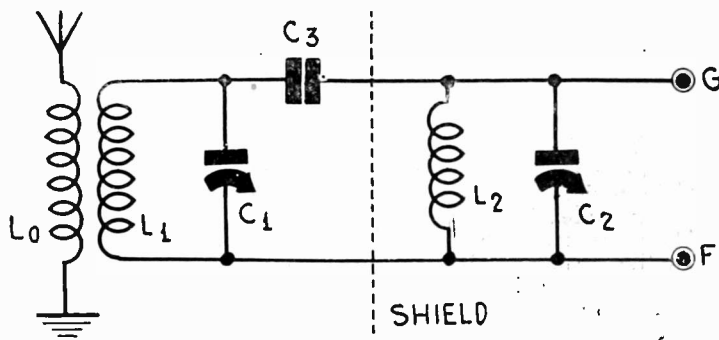

FIG. 5
A SIMPLE TUNER FOR AMPLIFIER. THIS TUNER HAS TWO EQUAL TUNED CIRCUITS COUPLED TOGETHER WITH A SMALL CONDENSER.

It is true that more current flows through R7 than through R6, but the difference is only the plate current of the first tube, which is negligible in comparison with the assumed current of 10 milliamperes.

We have used 250 volts of our available supply so that we have 200 volts left. This, however, does not mean that the plate voltage on the first tube is limited to something less than 200 volts. We can use more as we shall see. Now the question may arise as to the need of a higher voltage on the plate of the screen grid tube. Readers of RADIO WORLD who have followed articles concerning screen grid tubes in resistance coupling will know why it is desirable to use much higher applied plate voltages, as the need for high voltage has been pointed out repeatedly. It is also discussed at length in "Audio Power Amplifiers" by Anderson and Bernard. It is a fact that in non-reactive circuits it is sometimes necessary to compromise regarding that need.

QUESTION OF BIAS

Suppose the plate resistance R5 in Fig. 2 is 1 meg. and that the voltages on the first tube have been adjusted so that the plate current in the tube is 100 microamperes. The drop in R5 will then be 100 volts, 50 volts more than required for the bias on the second tube. But if the low end of R5 be returned to a point on R6R7 50 volts higher than voltage at the filament of the power tube, the effective value of bias on the second tube will be 50 volts, the correct value. This return not only adjusts the grid bias on the second tube but it adds 50 volts to the plate voltage on the first. Now, then, we have 250 volts for the plate of the first tube. This is all right, although it could be much higher if more voltage were available.

We shall now skip to the other end of the circuit. There is a resistance R1 in the cathode lead, used for bias, for stability, and for a hum-bucking arrangement. We have assumed that the plate current in this tube is 100 microamperes. When the tube is operating properly we may assume that the screen current is one-third of this value. Both of these currents flow through R1. Hence if R1 is 50,000 ohms the drop in it will be 6.65 volts. This would probably be too high a bias for the screen grid tube under best operating conditions, but the bias needed depends on the screen grid voltage applied to the tube, the other values being as assumed and as deduced. If the screen grid voltage is too high for the plate voltage and plate load resistance used, the only thing that will make the first tube function is to increase the grid bias. But then the tube functions more as a grid bias detector than as an amplifier. True, it amplifies but it does so with a good deal of distortion.

(Continued on page 15)

Reactance Explai

Why a Condenser is Like a Rubber Band;

By J. E.

Technical

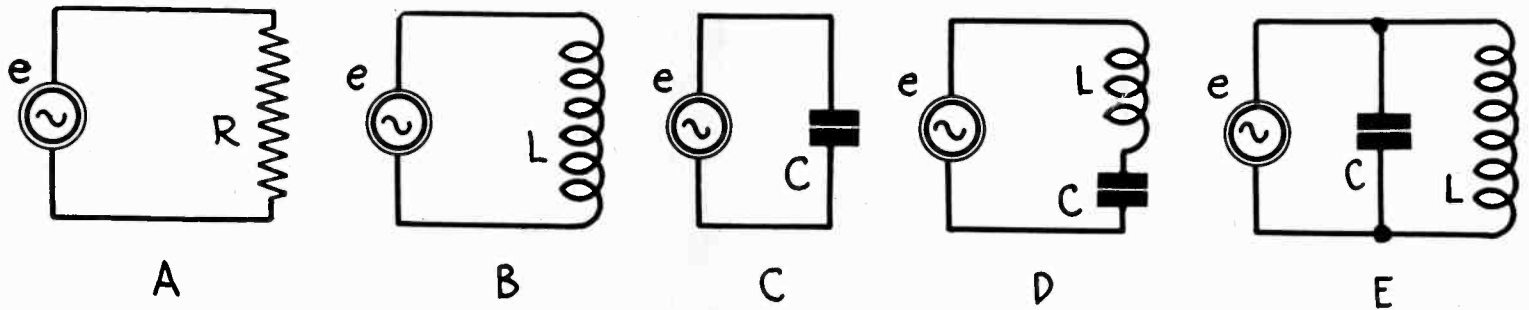

FIG. 1

FIVE DIFFERENT SIMPLE CIRCUITS. (A) IS A NON-REACTIVE CIRCUIT, (B) A CIRCUIT HAVING INDUCTIVE REACTANCE, (C) ONE HAVING CAPACITIVE REACTANCE, (D) A CIRCUIT HAVING BOTH INDUCTIVE AND CAPACITIVE REACTANCE WITH THE COIL AND THE CONDENSER CONNECTED IN SERIES, AND (E) IS A CIRCUIT HAVING BOTH TYPES OF REACTANCE BUT IN WHICH THE CONDENSER AND THE COIL ARE CONNECTED IN PARALLEL.

THE present interest in non-reactive, direct-coupled amplifiers has brought up the question as to when a circuit is reactive and when non-reactive. We shall try to explain under what conditions a circuit is non-reactive, that is to say, when it has no reactance.

There are two types of reactance, inductive and capacitive. Inductive reactance is akin to inertia reactance and is due to electrical inertia. Capacitive reactance is akin to compressive reactance or elastic reactance and is due to electric elasticity.

These statements are scarcely explanatory since the analogous concepts may not be any better understood by some than the electrical concepts. But let us try to expatiate on the statements.

Inertia is that property of a massive body by which that body tends to remain in its present state of motion or immobility when acted on by a force of any kind. Consider, for example, a person riding on a train. The person has mass and therefore inertia. When the train is at rest the person also is at rest and tends to remain in that state of immobility. If the train suddenly starts the person tends to remain stationary and therefore will tend to fall in the direction opposite to that in which the train started.

Now suppose the train has been speeding at a constant rate for some time. The person has been moving at the same speed. But if the train should suddenly stop the person moves forward in the direction he was going. The inertia tends to keep him going with the same speed and only force can prevent him from continuing. Sometimes this force may be fatal to the person.

RESISTS CHANGE OF VELOCITY

Inertia does not enter only when the train starts and stops but whenever there is any change in the speed of the train or in the direction in which the train travels. For example, whenever the train slows down the person lurches forward and whenever the train accelerates he lurches backward. Likewise when the direction of the train changes one way or the other the person lurches sidewise in the direction opposite to the new direction of the train. In every case the person tends to remain in his original state of motion or immobility. This statement includes changes of direction as well as absolute motion.

What is true of a person is true of every other body, living or dead, that has mass, or that weighs something when put on a balance.

Inductance in electricity is analogous to mass in mechanics, and electric current is analogous to velocity. If there is inductance in a circuit it requires a force, or electromotive force, to start or stop a current in that circuit. It also requires an electromotive force to change the direction, or the intensity, of the current. The greater the inductance (electric mass) the greater the electromotive force required to produce a given change in the intensity of the current.

If the electromotive force is alternating rapidly, that is, acting first in one direction and then in the other, and there is an inductance in the circuit, the intensity of the alternating current resulting will be small because of the electric inertia. The larger the inductance the smaller the current.

THE MECHANICAL ANALOG

We might take a mechanical analog for illustration of this

effect. Suppose we take a heavy ball or other body and swing it back and forth. The force exerted by the hand in swinging the body corresponds to the alternating electromotive force and the resulting motion of the body corresponds to the electric current. The heavier the body, that is, the more massive, the more difficult it is to swing the weight. If an attempt be made to swing the weight rapidly to and fro a distinct reaction is felt, and the reaction is the greater the more rapidly it is attempted to shake the weight or the greater the weight. The rapidity with which the weight is shaken corresponds to the frequency of the electrical current.

ELASTIC REACTANCE

Capacitive reactance was likened to elastic reactance. Elasticity is the property of a body by which it resists changes in shape or volume provided that after the body has been deformed by a force it returns to its original shape or volume after the deforming force has been removed. A well known example of an elastic body is a rubber band. It may be stretched to several times its normal length by exerting a force, and when the force is removed it returns to its normal length. A steel wire helix is another well known elastic body. If the turns of the helix are close, the spring may be stretched and it will return to its normal form as soon as the stretching force is removed. If the spring is not wound closely it may also be compressed, and after the compressing force has been removed the spring will lengthen to its normal length.

Even a straight steel wire may be stretched by exerting a force, and as soon as the force is removed the wire will assume its original length, provided that the stretching has not been overdone. Steel and other elastic substances also resist bending, twisting, and compression. When one of these bodies has been deformed by force in any one of these ways, within limits, it will return to its original shape or volume after the deforming force has been removed.

ELECTRIC ANALOGY

Gases are well known examples of substances which resist change of volume. It takes force to put more air, for example, into a confined space, such as an automobile tire. After the compression has taken place and the compression force is removed the excess gas in the confined space will immediately escape so that afterwards the gas occupies the same volume as it originally did.

An electric condenser is a device into which electricity may be forced or compressed. It is a sort of vessel for storing electricity, but electric charge has the property of elasticity. It requires an electric force to charge a condenser or to force more electricity into it than would normally be contained therein if there were no electric force. The amount that can be forced into the condenser depends directly on the intensity of the force, that is, voltage, and on the capacity of the condenser, its electric dimensions.

One who has pumped up an automobile tire by hand will know that at the beginning the work is easy. There is very little reactance. But as the pumping proceeds and the pressure increases in the tire, more force is required at each stroke. The amount of air that can be pumped in depends on the volume of the tire and on the force that is exerted. The analogy between the pneumatic and the electrical cases is

ed by Analogies

Resistance, a Brake, a Coil, a Weight

Anderson

Editor

very close. If electricity is regarded as a gas the two become practically identical.

FURTHER SIMILARITY

Suppose air has been pumped into a bottle and the cork is suddenly removed. There is a pop which has a more or less definite pitch. That is, a sound of a certain frequency is produced a short period. This would not be possible were not the air also possessed of inertia or mass. The air rushes out when the cork is first pulled out. The inertia of the moving air keeps the air flowing after the pressures inside and outside have become equalized. It keeps flowing outward until the pressure inside is less than the pressure outside. Then it begins to rush in again. This inward and outward motion of air keeps up for a moment, giving use to the musical quality of the pop. This oscillation is only possible because the air possesses both elasticity and inertia.

An electrical circuit comprising capacity and inductance behaves in the same way. The current rushes in and out of the condenser for a moment after the first discharge and it keeps up for a time depending on the amount of resistance in the circuit. The greater the resistance the shorter the time of oscillation.

SIMPLE CIRCUITS

In the figure above are five different simple electrical circuits. In each there is a source of alternating electromotive force e . This electromotive force drives a current through each circuit, but in each case the current has a different intensity because the reactances of the circuit are different.

In (a) we have a non-reactive circuit because there is only a pure resistance in series with the electromotive force. There is no reactance in the circuit since there is neither inductance (inertia) or capacity (elasticity). The energy is all dissipated in the resistance R and for that reason a non-reactive circuit is called a dissipative circuit.

In (b) we have an inductance in series with the electromotive force. This circuit has inertia reactance, the coil resists any changes in intensity or direction of current. For this reason the current will be small and it will be smaller the higher the frequency and the higher the inductance. It is the fact that the current is dependent on the frequency, which makes reactive circuits undesirable in audio frequency amplifiers.

In (c) we have a simple reactive circuit comprising a condenser in series with the electromotive force. Since there is elastic reactance in this circuit the current will depend on the intensity and frequency of the alternating electromotive force. The larger the condenser the larger the current will be and also the higher the frequency the higher the current. Direct current will not flow at all and currents of very high frequency will flow just as if the condenser were not in the circuit. Since the current depends on the frequency a circuit having condensive, or elastic reactance, is not desirable in an audio frequency amplifier.

MIXED CIRCUITS

The circuit in (d) contains both capacity and inductance in series with the electromotive force. What the current will be in this circuit depends on the frequency, the inductance and the capacity. For low frequencies the current will be mainly determined by the condenser, since the coil will not offer much reactance compared with the reactance of the condenser. At high frequencies the current will be mainly determined by the inductance, since the condenser will offer very little reactance.

When the frequency is such that the inductive reactance is equal to the capacitive reactance resonance will obtain and the current will be determined by the electromotive force and any resistance which may exist in the circuit, especially in the coil. At resonance the circuit is non-reactive and dissipative. The current will be very large in comparison with the current at frequencies off resonance.

A circuit like that in (d) is used for tuning, that is, for selecting a current of one frequency and rejecting currents of all other frequencies. It cannot be used in audio frequency circuits where all audible frequencies are to be received with the same intensity. In the ordinary tuned circuit of this kind the electromotive force is usually introduced by induction in-

to the coil L rather than as indicated. In either case the response of the current is practically the same.

PARALLEL RESONANCE

The circuit in (e) is known as the parallel tuned circuit when the capacity and the inductance are so related to the frequency of the electromotive force that the inductive reactance is equal to the capacitive reactance. When this condition obtains the current through the source of electromotive force is zero or minimum and the current in the condenser and the coil maximum. The impedance presented by the condenser and the coil to the source of electromotive force is a pure resistance of exceedingly high value. The voltage across either the condenser or the coil is very high.

The reason the currents in the coil and the condenser can be very large and the current in the source of electromotive force very small is that the currents in the coil and the condenser are out of phase. They neutralize each other as far as the current through the generator is concerned.

The circuit in (e) is used frequently in radio receivers. In fact it is used in all tuners, either in the primary of the secondary. Suppose e is the effective signal voltage in the plate circuit of an amplifier tube. Then the circuit represents the tuned plate method of coupling in receivers. If e represents the voltage developed across the secondary of a radio frequency transformer and if the secondary is connected to the grid circuit of a tube, the figure represents the ordinary tuned circuit in most receivers.

EXAMPLES OF REACTANCES

Tuning in radio receivers is done exclusively by reactances. In every case an inductive reactance is balanced against a capacitive reactance, and in most cases the capacitive reactance is varied to bring about resonance. If the receiver contains many tuners in tandem there are also many pairs of reactances that must be equalized to effect tuning. This is sometimes done by adjusting the capacitive reactances one at a time and sometimes all at once, as in gang controlled receivers.

In audio frequency amplifiers there should not be any reactances of either kind, because any reactance will introduce frequency discrimination which will mar the quality. Yet in nearly all cases some reactances must be used to make the circuits practical.

There should, for example, be a small by-pass condenser in the plate circuit of the detector. This lowers the output at the high audio frequencies to some extent. Then in many circuits stopping condensers are used between the plate of one tube and the grid of the next, or between the plate of the power tube and the loudspeaker. These condensers lower the output of the low frequencies. The smaller these condensers the more do they suppress the low notes. In some circuits now being popularized most of the stopping condensers are eliminated with considerable gain of the low note output.

When choke coils and transformers are used for coupling, additional reactances are introduced into the amplifier, both inductive and capacitive, the capacitive reactances being due to stray capacities across the windings. The coupling reactances discriminate against the low notes and the distributed capacity reactances against the high. The effect is much the same as tuning, only that the selectivity, that is to say, the discrimination, is not so great.

BY-PASS CONDENSERS

Even in the so-called non-reactive circuits by-pass condensers should be used for best results, but these introduce reactance which is discriminatory to some extent. But it is better to use them and suffer the discrimination than to omit them and have a circuit that does not amplify well. It is well to remember then the larger any condenser the lower is its reactance.

The condensers and chokes in the B supply have reactance and consequently affect the frequency characteristics of any amplifier connected to it. These reactances have much to do with the frequency at which a circuit motorboats or at which it blasts in case the feedback is not sufficient to sustain oscillation.

Repeat Tuning on TRF

Amplifiers Act as Stray Detectors and Sensitive

By Neal

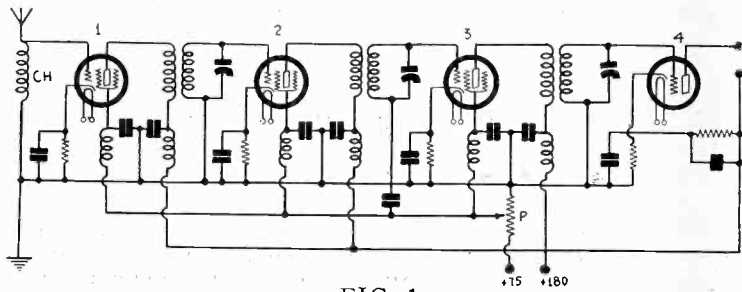

FIG. 1
A RADIO FREQUENCY TUNER AND AMPLIFIER IN WHICH THE ANTENNA IS COUPLED TO THE CIRCUIT BY MEANS OF A CHOKE COIL Ch. RECEPTION OF THE SECOND HARMONIC MAY BE QUITE STRONG.

THOSE who have operated Superheterodyne receivers are familiar with repeat tuning. They know that every station usually comes in on at least two different points on the tuning dial, and frequently at a larger number of different points scattered over the dial.

Tuned radio frequency receivers are not supposed to be subject to this difficulty and operators of such receivers do not expect dual or multiple response. But the fact is that many modern receivers do pick up stations at two points on the tuning dial, one point where the station is normally expected, and another near the low wave-length end of the scale.

"I receive WGY at two points on the dial," is a common complaint. "What can be done about it?"

Of course, all do not complain for receiving WGY at two settings, for any station that has high field strength about the receiving antenna is likely to come in at two points. Naturally the station that sends out a strong wave in the first place will come in rather than a weak station at two different points, and any station close to the receiver is likely to come in strong at two different points.

THE CAUSE OF REPEATS

What is the cause of the dual reception? Certainly we cannot ascribe it to the oscillator as is done in the Superheterodyne, because receivers which do not oscillate at all are subject to the condition just as often as receivers which contain an oscillator as a nessesential or incidental part. There must be another explanation for the phenomenon.

The fact is that every receiver brings in most of the stations in two places on the dial. The only question is how strong the signal is at the abnormal point. If the signal is weak the second tuning point is not noticed. If the signal is strong it is received audibly on most receivers, provided that the volume control is turned up high and the circuit tuned accurately to the point where the second point happens to be.

It has been observed that in receivers in which the input circuit is untuned the signal at the second point is stronger than in those circuits which have a sharply tuned input. Apparently there is some relation between the selectivity of the receiver and the intensity with which any station is received at the abnormal point. But many who have noticed the phenomenon have also noticed that extremely selective receivers are subject to the trouble. Indeed, in this respect the circuit behaves like a Superheterodyne, the most selective circuit of all, and the one that is most subject to repeat tuning. Hence lack of selectivity alone does not explain the situation.

THE EXPLANATION

As a matter of theory there are two possible explanations for the dual reception. It is known that all broadcast stations send out some energy on the second harmonic of the carrier frequency. This energy is contained in a wave exactly like the carrier except that its frequency is twice as great. Therefore if any receiver is tuned accurately to a frequency twice as great as that of the carrier of any station, the signal of that station should come in, provided that the receiver is sensitive enough. It has been found that it is only on the most sensitive receivers that the dual tuning is noticed and only when the sensitivity is turned up to maximum.

If the second harmonic transmitted by the station were alone accountable for the dual tuning there would be no difference between those receivers which have sharply tuned input circuits and those which have untuned input circuits. If any-

thing, the receiver with the tuned input should be more subject to the trouble than the other type of receiver.

Moreover, the energy sent out on the second harmonic by the better broadcast stations, which include stations that cause most of the trouble, is so small that not even the most sensitive receiver made will pick it up and make it audible, except possibly when the receiver is very close to a broadcast station. Therefore there must be another effect which gives a better explanation. And there is.

We know that every amplifier tube, no matter how well it has been adjusted to amplify without distortion, causes a certain amount of detection. Whenever there is detection there is frequency doubling—harmonic generation. Therefore the amplifier tubes operating at radio frequencies take the carrier frequency of a station and double it. If the tuner is adjusted to the double frequency the second harmonic is singled out and amplified by the tubes just as if the receiver were tuned to the carrier. Therein lies the explanation of most of the trouble.

TRACING THE CAUSE

Suppose the input circuit of the receiver is untuned. All carrier frequencies are then impressed on the grid of the first tube with practically the same intensity that exists about the antenna. Since the first tube detects a little, besides amplifying considerably, there will be a current of the second harmonic frequency in the plate circuit of the tube.

Now for the first time does the tuner come into play, but now it is too late, since the harmonic frequency already has been generated.

When the receiver is tuned to the second harmonic it receives this just as if the plate circuit of the first tube were the antenna. The first tuner singles out the second harmonic and the second tube amplifies it. The second tuner continues the selection and the third tube the amplification. And so the process continues until the detector tube, where the second harmonic is detected in the usual way and sends an audio frequency signal on through the amplifier to the speaker.

It is not to be supposed that the first tube alone is responsible for the frequency doubling. Every tube, including the detector, contributes to the process, and every tuner helps in the selection.

So there is no wonder that by the time the signal gets to the audio amplifier the second harmonic of a strong station is loud enough to be comparable with the first harmonic or fundamental of other station. Naturally the first tube contributes most to this condition, since it is placed so that its output is magnified by all the succeeding radio frequency tubes.

SCREEN GRID TUBES DETECT

It has been asserted that receivers incorporating several screen grid tubes are more subject to the dual response effect than receivers having an equal number of three-element tubes and the same number of tuned circuits. That this assertion is well-founded is clear from the fact that screen grid tubes are normally operated as amplifiers so that the stray detection is prolific. Then, again, screen grid tubes amplify more, so that any second harmonic component that may have gotten into the circuit will attain a much higher intensity than in a circuit of three-element tubes.

Just what broadcast stations may be expected on two points on the dial? The lowest broadcast frequency is 550 kilocycles and the frequency of its second harmonic is 1,100 kilocycles. Thus this should appear not far from the center of the dial, the center being on an average at about 930 kilocycles. If the receiver tunes up to 1760 kilocycles, which it well may, the second harmonic of a station operating on 880 kilocycles will be received at the extreme end of the dial, since twice 880 is 1,760.

RECEPTION ON THIRD HARMONIC

It is quite possible to receive some broadcast stations on the third harmonic as well as on the second, for the third is often more intense than the second. Suppose, for example, that the tuning range of the receiver is from 550 to 1,770 kilocycles. One-third of 1,770 is 590 and therefore there are no less than five channels which could be picked up on the third harmonic if the sensitivity of the receiver and the intensity of the carrier are great enough. However, few tuners can go up to 1,770 kilocycles. But even if a set tunes up to only 1,650 kilocycles one broadcast channel could be tuned in on the third harmonic.

The second tuning point on the ordinary receiver is not likely to cause much interference unless it should happen that

Receivers and Its Cures

Circuits Pick Up Odd Interference

W. H. T. Zalon

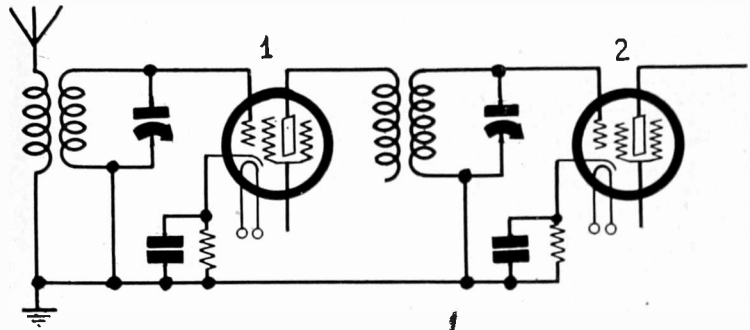
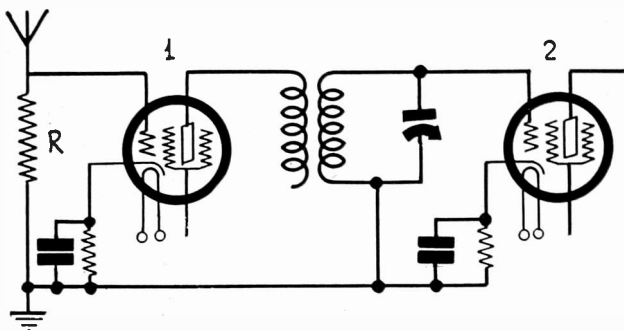

FIG. 2

LEFT: THE FIRST PART OF A CIRCUIT SIMILAR TO THAT IN FIG. 1 EXCEPT THAT A RESISTANCE IS USED FOR COUPLING THE ANTENNA TO THE SET. FREQUENCY DOUBLING IS QUITE STRONG.
RIGHT: THIS SHOWS TUNED INPUT FOR MINIMIZING DOUBLING.

two stations, one operating on the second harmonic of the other, should operate in the same locality. When such is the case there may be a heterodyne whistle on both stations.

In a receiver subject to double tuning of the type discussed it is possible that code stations operating on wavelengths longer than the broadcast waves will interfere with broadcast reception. Take, for example, the 600 meter wave on which many ships' stations transmit continually. The frequency of the signal of these stations is 500 kilocycles, the second harmonic of which is 1,000 kilocycles. This lies almost in the middle of the broadcast band and much interference can be expected. Interference of this kind might be expected from stations operating on wavelengths as low as 273 meters.

EXAMPLES OF CIRCUITS

In Fig. 1 is a diagram of screen grid tube radio frequency amplifier and detector in which the input circuit is untuned. The coupling to the antenna is effected by means of a radio frequency choke coil Ch. This is a typical circuit when the tuning condensers are ganged. The object of the untuned input is to insure that all the tuned circuits be alike by the removal of the effects of the antenna constants on the first tuned circuit. This type of circuit is subject to dual reception.

The first part of a similar circuit is shown in Fig. 2, left. Here a non-reactive resistance is used for coupling the antenna to the set. As far as operation is concerned this is in no way different from the circuit in Fig. 1. The first tube detects some and the detected, or doubled frequency, results in dual response.

In Fig. 2, right, is the first part of a receiver in which the antenna input is tuned. In this circuit there is so much discrimination between the desired frequency and the harmonic that very little interference will result from frequency doubling. This kind of input circuit is to be preferred whenever it is practical to use it. It is difficult, however, to gang the condensers in a receiver of this kind except by the use of an ac-

cessible trimmer in the first tuned circuit. When such a trimmer has to be used it is just as well to provide a knob for the main tuning condenser. A control is a control whether it is called a trimmer or something else.

The advantage of single control is so great that any trouble caused by dual reception which may result from the use of an untuned input is insignificant. In nearly all cases there is really no interference between stations. The objection to dual reception hinges on the belief that the st, which is supposed to be very sharp, is not selective enough to separate two stations widely apart in the frequency scale, and that belief leads to annoyance. But the remedy is simply the realization that the circuit performs normally and that it does not lack selectivity.

BEHAVIOR OF SUPER

In the Super-heterodyne repeats are not alone due to frequency multiplication but arises also from the fact that the intermediate frequency can be produced both by setting the oscillator above and below the frequency of the desired carrier by an amount equal to the intermediate frequency. There is frequency doubling and trebling in the Super-heterodyne, too, and every frequency produced gives one chance for bringing in a signal at a point on the dial where that signal does not normally belong. This property of the Super-heterodyne is well known and most fans expect this behavior.

There are exceptions. There has been so many claims for "one-spot" Super-heterodynes that a few fans have been led to believe that repeats can be eliminated completely. Now most of these "one-spot" supers have been nothing more than ordinary supers with the oscillator condenser tied to the same shaft as the other tuning condensers. Of course this does not make a circuit a "one-spot." It merely eliminates half the chances of getting the stations free of interference.

There is no "one-spot" super, although there are circuits which approach the condition quite closely.

Adjustments to Make in Non-Reactive Circuits

(Continued from page 11)

Just as the grid bias was reduced on the second tube to a value which would put that tube in the best operating condition so the bias on the first tube may be reduced in the same manner voltage divider higher than the negative end of R1. Hence in Fig. 4 is returned to the high point of R2.

The value of R2 in Fig. 2 can be determined approximately by assigning a desired grid bias and using the known current in the resistor. Suppose we want a bias of 1.5 volts. The drop in R2 must then be 6.65 less 1.5, or 5.15 volts. Now the current through R2 is practically the current in the plate circuit of the power tube plus the current through R6 and R7, that is, 42 milliamperes. The currents diverted by the plate and the screen of the first tube is negligible. Hence the value of R2 should be about 12 ohms.

The voltage on the screen is the sum of the drops in R2, P1 and R3 diminished by the drop in R1, or according to the figures derived above, it is less by 1.5 volts than the sum of the drops in R3 and P1. We may assume a screen grid voltage one-third the effective voltage on the plate, and this voltage is about 150 volts. Hence the screen voltage should be 50 volts or somewhat less. Let us call it 45 volts. For simplicity we can call the sum of the drops in P1 and R3 45 volts also. From this and

the current flowing through the resistors we can determine the values of P1 and R3. The current, as we have assumed, is 42 milliamperes. Therefore the sum of these two resistors should be 1,071 ohms, or 1,000 for simplicity. The potentiometer P1 can account for 200 volts of this resistance and R3 the rest.

It now remains to determine the value of R4. We know that the voltage drop across R2, P1, R3 and R4 is 200 volts, and we have assumed a total current of 42 milliamperes. Hence the sum of all these resistors should be 4,762 ohms. But we have found the sum of R2, P1 and R3 to be 1,012 ohms. Hence R4 should be 3,750 ohms.

Now it is a reasonable certainty that when these resistors are put into the circuit the adjustment will not be perfect but it will fairly close and they will give a good start toward experimental adjustment. Difference in tubes will make such adjustment necessary in any case, and possibly the best two values to adjust experimentally are those of R3 and R6, that is to say, those that determine the screen grid voltage on the first tube and the grid bias on the second.

While the screen is shown to return to a fixed point it should preferably be returned to a potentiometer slider, just as C1 is returned. Likewise R6 and R7 could be two sections of a 25,000 ohm potentiometer with R5 returned to the slider.

The Popular PPPA

Chassis Construction Lends Beau

By Capt. Pe

Cont

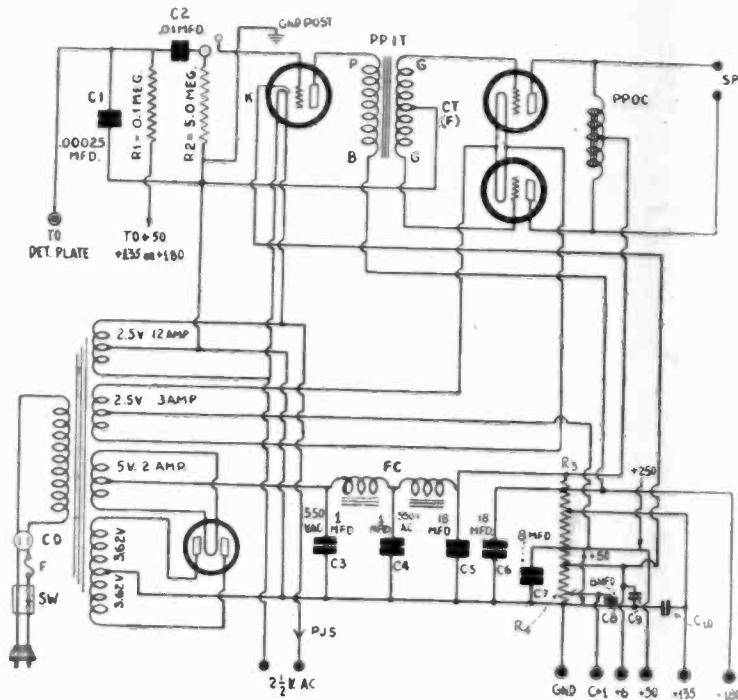

FIG. 1
THE CONNECTIONS DIAGRAM OF THE PPPA AMPLIFIER AND POWER SUPPLY

THE standard push-pull power amplifier using a resistance coupled first stage of audio and a transformer-coupled 245 push-pull output is shown in a new physical dress. The circuit is an A, B and C supply of well-established authenticity, and the dress is made good-looking at last.

LIST OF PARTS

- C1—One .00025 mfd. mica condenser.
- C2—One .01 mfd. mica fixed condenser.
- C3, C4—Two 1 mfd. filter condensers, 1,000 volts DC continuous working voltage, rating, 550 volts AC (root means square) continuous working voltage rating.
- C5, C6, C7, C8—Four Mershon condensers in one copper casing, two of 8 mfd. and two of 18 mfd., with low bracket. Cat. Q2-8, 2-18B.
- C9, C10—Two 1 mfd. bypass condensers, 200 volts DC continuous working voltage rating.
- T1—One Polo Filament-Plate-Choke Supply; 110 volt 50-60 cycle primary, 724 volt secondary center-tapped, 5 volt 2 amp. secondary center-tapped; 2.5 volt 3 ampere secondary center-tapped, and 25 volt 12 ampere secondary center-tapped. Cat. PFPCH. Note, for 25 cycles use Cat. PFPCH-25, for 40 cycles use PFPCH-40).
- PPOC—One Polo output choke for push-pull (Cat. PPOC).
- PPIT—One push-pull input transformer (select one you prefer).
- SW—One AC pendant through-switch, with 12-ft. AC cable and male plug.
- F—One 2 ampere fuse, with holder.
- CO—One convenience outlet (for dynamic speaker AC cable).
- PJ, PJS—Phonograph pick-up jack with automatic switch.
- R1—One Lynch metallized resistor, 0.1 meg.
- R2—One Lynch metallized grid leak, 5.0 meg.
- R3—One Multi-Tap Voltage Divider, 13,850 ohms, fourteen taps.
- R4—One 30 ohm Clarostat Humdinger.
- Two resistor mountings.
- Six binding posts (Det., five blanks).
- Speaker output jacks in bakelite assembly.
- One cadmium plated steel chassis, with self-bracketing flanges, one five-prong and three four-prong sockets built in; sockets marked to identify tubes that go in them; subpanel drilled and insulated where necessary.
- One base cover for chassis, with six bolts and six nuts.
- Four tubes one 280, one 227, two 245.

The height is 7 inches, the width or direction in which the sockets run, is 12 inches, and the depth is 10 inches. These are overall dimensions.

On top are the power transformer, Mershon condenser of two 8 mfd., and two 18 mfd., the sockets, output device and binding posts. Beneath are the filter and bypass condensers, and voltage divider.

Thus the assembly is decidedly attractive to the eye, and the tone quality will be no less attractive to the ear, provided a good push-pull input transformer is used. This transformer you are asked to select for yourself, or you may use one you have.

Five Voltages Selected

Five positive voltage binding posts are provided, and these may be used for bringing out the voltages you need, since the voltage divider provides a plentiful assortment. Of the group, 3, 6, 10, 16, 22, 50, 75, 90, 135 and 180, ten different voltages, the diagram suggests 3, 6, 50, 135 and 180 as the five, since these are most suitable for high-gain screen grid receivers.

The bias of 3 volts is really 1 to 3, being taken care of by a resistor adjustable from the top of the subpanel with a screwdriver. This resistor is a Clarostat "humdinger," one terminal connected to the low end of the voltage divider, the other Clarostat terminal to grounded B minus. This bias is used for 224 RF tubes.

Advantages Listed

The PPPA has the following features:

- (1)—Filament voltage for 245s in push-pull and for 280 rectifier; heater voltage for 224s and 228s, up to six such tubes, including the 227 in the PPPA.
- (2)—Plate voltage of 250 for the power tubes, with 50 volts bias to spare, total 300 volts at 80 wa., with intermediate B voltages.
- (3)—All the bias voltages you will require.
- (4)—Phonograph pick-up jack.
- (5)—Post for detector (input) and two posts for speaker (output).
- (6)—About 60 mfd. of filter and bypass capacity.
- (7)—As good an audio channel as can be built in a reactive circuit, with large undistorted power output.
- (8)—Good appearance.

Right or

- (1)—In the Loftin-White direct-coupled circuit the grid of the second tube is positive because it is connected to the same point as the plate of the preceding tube.
- (2)—When a screen grid tube is used in resistance coupling with a moderately high voltage on the plate the screen grid voltage should be high in order to make up for the difference.
- (3)—In a screen grid tube the voltage drop in the coupling resistor is of no practical importance, the applied voltage alone being important.
- (4)—AC hum in a receiver can be balanced out, under certain conditions, by introducing a suitable amount of hum into the grid circuit.
- (5)—A hot soldering "iron" is the best assurance of good soldered joints.
- (6)—Overheating of the soldering "iron" is one of the chief reasons why melted solder will not flow into the joint.
- (7)—Equality of all inductance coils and equality of rate of change of all condenser capacities are essential for successful ganging of several tuned circuits.
- (8)—To make ganging of several tuned circuits really effective there should be one capacity trimmer and one inductive trimmer in each circuit.
- (9)—In order to check the frequencies of broadcast stations against a standard piezo oscillator it is necessary to have one standard for each channel.

ANSWERS

- (1)—Wrong. The grid is negative by the amount of steady drop in the coupling resistor or by a less amount depending on the return of the plate of the first tube relative to the cathode of the second.
- (2)—Wrong. The screen grid voltage must be lowered rather

a New, Pretty Dress

to A, B, C, Supply for 245 Output

V. O'Rourke

Editor

(9)—Compactness, enabling installation in "tight" consoles or even in a table model receiver that has 12 inch cabinet depth (front to back) or accommodation to 10 inch cabinet depth if there is room to put the 12 inch stretch in the direction of the front panel.

(10)—Economy.

The filter system uses a 1 mfd. paper dielectric condenser of 1,000 volts DC continuous working voltage rating, 550 volts AC, root mean square, next to the rectifier and another at the midsection of the filter chokes FC. The first condenser has an effect on the output voltage, and only 1 mfd. is used here because the voltages are satisfactory under the circumstances and the hum is less. Anyone desiring to increase the voltage applied to the push-pull pair may put another 1 mfd. condenser in parallel with the prescribed capacity, making certain, however, that it is of the same high voltage rating. Do not put a 200-volt DC bypass condenser in this position, as it will break down at once.

Chassis Ground and Negative B

The filter chokes, two windings to be interconnected to constitute the mid-section, is inside the power transformer case.

As the chassis should be grounded, this connection is most easily made by putting a lug on the machine screw that holds down one side of the bracket of the Mershon condenser, and connecting a wire from one of the terminals of the paper condenser to the lug.

The Mershon condenser provides almost all of the capacity used in the filter. This particular Mershon is the one having two anodes of 8 mfd. each and two of 18 mfd. each. The catalogue number, including bracket, is Q 2-8, 2-18B.

The different capacities of the Mershon condenser may be distinguished easily. The smaller capacity is nearer the edge of the copper casing. In all instances the copper casing is negative. The anodes, represented by lugs on the insulated top of the casing, are positive. Attachment of the bracket to the chassis, which is steel, takes care of grounding the Mershon properly to negative, provided negative of the B supply is connected to the chassis.

One 8 mfd. section is used as the condenser across the B bias (1 to 3 volts), one 18 mfd. as the "reservoir" condenser at the filter output, the other 18 mfd. to bypass 180

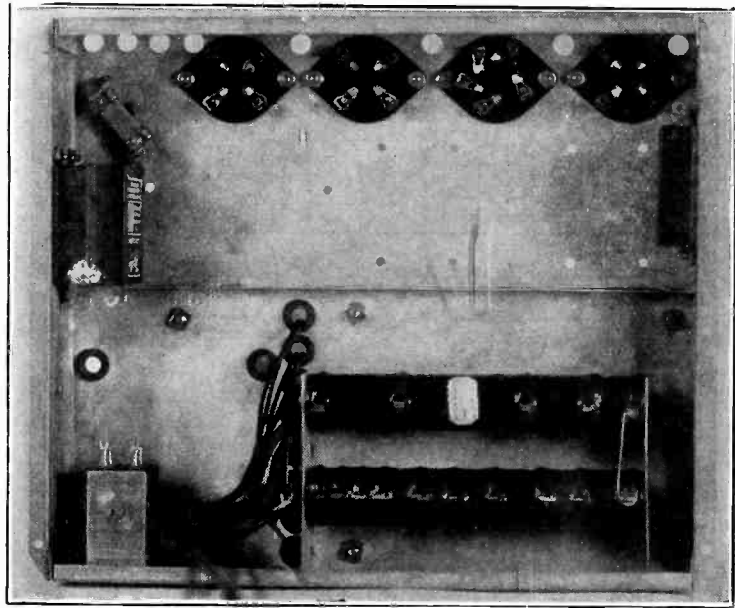

FIG. 2
UNDER-THE-PANEL VIEW OF THE PPPA AMPLIFIER
AND POWER SUPPLY

volts and the remaining 8 mfd. across the 50-volt bias section. This same voltage of 50, used negatively for biasing these particular tubes, is available as a positive screen voltage for screen grid tubes, or for plate voltage for the grid-leak-condenser detector tube. This seeming double utility arises from the fact that the heater circuits are independent of the cathode, grid and plate circuits of the 227, 224 and 228 tubes, and of course are independent of the filament circuit of the two 245s.

The intermediate voltages (other than 50) are bypassed by 1 mfd. 200 volt condensers, of which four are used. If substitute intermediate voltages are preferred, move the bypass condenser over to the next section of the divider, or if additional output voltages are required, bypass each of such with 1 mfd., also, obtaining the extra condensers and binding posts additionally.

Voltage Determinations

By using a high resistance voltmeter you may determine the voltages by simple measurement, and without calculation of voltage drop on the basis of known values of resistance and the current flowing through each section of the divider. The values of current are different in each section. Through all sections flows the bleeder current, a little less than 22 milliamperes, when the power amplifier is worked with an average tuner.

If the bleeder current is measured when there is no load on the rectifier except the Multi-Tap Voltage Divider itself, the reading will be in excess of 22 milliamperes, because the voltage is higher than 300 across the divider. This is due to the low total current. The more current drawn, the lower the voltage, principally because of the regulation of the rectifier tube, the resistance of which increases with increase in current.

When the plate current of the audio amplifier tubes or of the audio and radio amplifier tubes and detector is drawn from the power amplifier, it is impossible to read the bleeder current separately, as there is only one current flowing through each section of the voltage divider. This is the sum of the bleeder current and plate currents.

However, with the voltage across the two extreme terminals known, and the total resistance of the Multi-Tap Voltage Divider being 13,850 ohms, the current is calculated as 300 divided by 13,850, or about .022.

The Multi-Tap Divider consists of two enamelled wire-wound resistors, on separate cores, mounted one above the other on supporting end-brackets, and connected in series. This connection is made at the factory. The entire unit is tapped in resistance steps as follows: 3,000 ohms, 4,500, 2,000, 800, 700, 600, 550, 500, 450, 400, 200, 100 and 50. The zero lug is the fourteenth and goes to the Clarostat. The "low" end is therefore the one where the tops are closer together.

Wrong?

an increased. If the screen grid voltage is high it may be higher than the effective value on the plate, and when it is the case does not function.

(3)—Wrong. This is true in a three-element tube but not in a screen grid tube. In a screen grid tube the screen voltage must always be considerably less than the effective voltage on the plate of the tube.

(4)—Right. One way of doing this is to use a grid bias resistor and adjusting this as is done when measuring the amplification constant of a tube. Any hum introduced in the plate circuit is also introduced in the grid circuit but in opposite phase as far as the effect is concerned. It can also be done as in the oftin-White circuit.

(5)—Wrong. The "iron" may be too hot. If the "iron" is hot and at the same time clean and well tinned the high heat is advantageous, but when the "iron" is too hot it is difficult to keep it tinned.

(6)—Right. Oxide of tin forms on the surface of the iron in the form of a film and this prevents solder from flowing readily.

(7)—Right. Equality of the inductances is essential in order that matching may be done throughout the tuning range and equality of rate of change of capacities is essential in order that matching may be done at all.

(8)—Right. The capacity trimmers are used to bring about equality of capacity at the low setting of the tuning control and inductive trimmers are useful in equalizing the inductances.

(9)—Wrong. It is possible to use one frequency standard and harmonics for checking many different broadcast frequencies. Even if an exact harmonic is not available it is possible to interpolate and thus get a very close measure on the broadcast frequency.

A Question and Answer Department conducted by Radio World's Technical Staff. Only Questions sent in by University Club Members are answered. Those not answered in these columns are answered by mail.

RADIO UNIVERSITY

Annual subscriptions are accepted at \$6 for 52 numbers, with the privilege of obtaining answers to radio questions for the period of the subscription, but not if any other premium is obtained with the subscription.

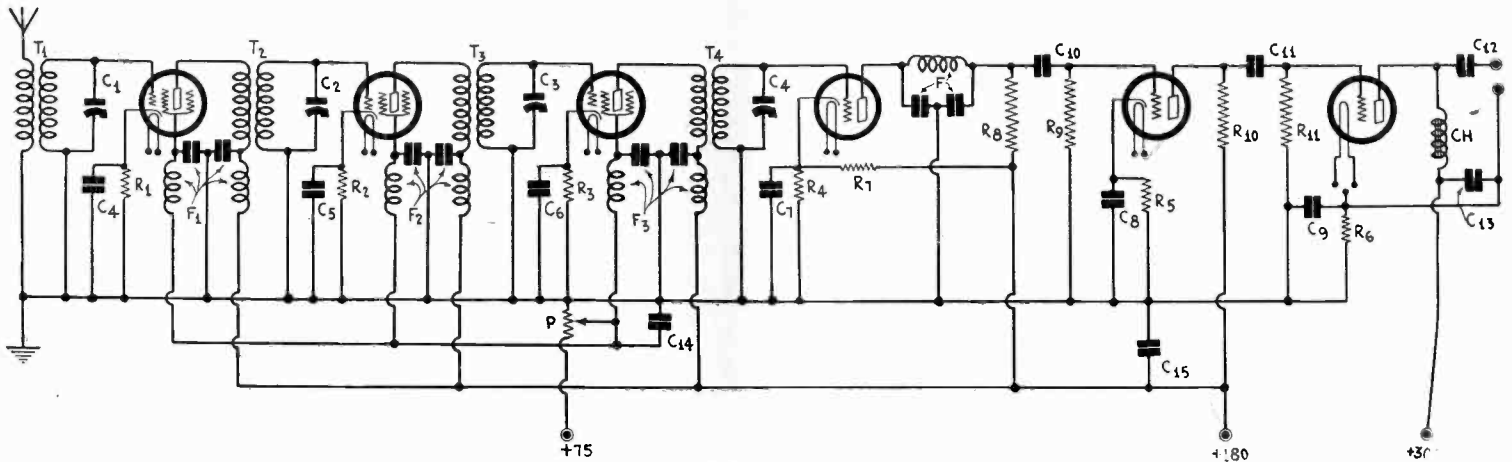

FIG. 824

WHEN SEVERAL STAGES OF SCREEN GRID TUBES ARE USED IN A RECEIVER THOROUGH FILTERING IS DESIRABLE AND THIS CIRCUIT SHOWS HOW IT SHOULD BE DONE TO BE EFFECTIVE

KINDLY SHOW a circuit diagram illustrating how radio frequency chokes and by-pass condensers should be connected when it is desired to take utmost precautions in isolating the several stages with respect to feedback—A. M. C.

The circuit in Fig. 824 illustrates a case of thorough filtering to prevent feedback both at radio and audio frequencies. This might serve as a model.

DIVERGENCE OF OPINION

IREAD RECENTLY in a book on radio that resistance coupled amplifiers are the most stable of all audio amplifiers. Also I have read on numerous occasions that the resistance coupled amplifier is the most unstable. It does not seem to me that both statements, which are diametrically opposed, can be true. What is your opinion?—V. O. S.

Possibly you read a statement that resistance coupled circuits are *probably* the most stable because the coupling resistors are non-reactive. The other, and opposing, statements were undoubtedly more positive and based on experimental evidence. There is scarcely a resistance coupled amplifier that does not oscillate at some frequency, unless special precautions have been taken. Transformer and impedance coupled amplifiers are quite often stable without special treatment. It is assumed that all the amplifiers are operated by the same B supply, one at a time, in making this comparison. So the conclusion would seem to be that resistance coupled amplifiers are the most unstable. This conclusion is not based on the probable effect of a reactance but on general experience.

CAPACITY BETWEEN WINDINGS

IHAVE BEEN informed that the capacity between the primary and the secondary of a radio frequency transformer reduces the amplification and that only when this capacity is negligibly small can full gain be obtained. If that is true, will you kindly tell how to reduce the capacity between the windings?—J. A. F.

It is true, as was abundantly proved by a well-known radio frequency transformer. Since the capacity depends on the dimensions of the conductors involved, one way of reducing the capacity between the windings to make the primary, if untuned, of very fine wire. Since capacity also depends on the distance between conductors and decreases with the distance, another way of reducing the capacity is to put the two windings far apart. This is limited practically by the fact that the farther the windings are apart the more is the amplification reduced by virtue of loose coupling. One way is to bunch the primary wires in a slot in such a manner that each turn is coupled inductively most effectively to the secondary, that is, putting the primary near the center of the secondary, with an appreciable distance between the turns of the two. Still another way is to put the primary turns in a flat coil, pancake form, and placing it in the middle of the secondary.

CONSTRUCTION OF C BATTERY ELIMINATOR

WOULD it be worth while to build a C battery eliminator operating on the same principle as the ordinary B supply unit for a receiver using 245 power tubes? Would it be worth while when using 250 power tubes?—W. C. K.

The only object of building a C supply would be to obtain the C potential required without robbing the plate circuits of voltage. For example, suppose the total available voltage is only 250 volts

and 245 power tubes are used. These tubes should have 250 volts on the plates and 50 on the grids. Obviously, a total of 250 will not supply both. In this case it would be worth while to build a C supply, provided that the 250 volt power supply is large enough to handle the circuit. Otherwise it would be necessary to get another B supply, one which gave a total of 300 volts. With this it would not be necessary to use a separate C supply. The situation is somewhat the same with 250 power tubes. These require 450 volts on the plates and 84 volts on the grids, a total of 534 volts. Few B supply units give this voltage, so when the total voltage available is less than 500 volts it would pay to use a separate C supply. It should be noted that it costs practically nothing to operate a C supply giving 84 volts or more and it costs an appreciable amount to get 84 volts from the regular high power B supply. For example, suppose the receiver contains two 250 tubes, which draw a plate current of 110 milliamperes. Since the bias required is 84 volts the power consumption for the C supply alone is 9.24 watts. The same voltage could be obtained from a C supply with less than a watt.

REDUCING STATION INTERFERENCE

IN MY PRESENT location on Long Island I am troubled considerably by interference from a local high power station. Can you suggest how to get rid of it?—H. B. G.

If it is the station you want to get rid of, you have two courses open, move the station or move the set. If neither is practical you might try to eliminate the signal from the station. One way of doing this is to get a more selective set. Possibly the simplest remedy in the case is to install a wavetrap in the antenna circuit. Wind some heavy magnet wire on a 3-inch bakelite tube, or other insulating tube, and connect a .0005 mfd. condenser in series with the coil. Connect this in the antenna circuit and tune the trap to the interfering signal. An alternative connection is to put a second winding of about 10 turns on the form and connect this small winding in series with the antenna, tuning the trap to the interfering signal. Close tuning is necessary. The trap will help a great deal. You should use about 40 turns.

EFFECT OF LONG FILAMENT LEADS

THE MEASURED voltages across the terminals of my filament transformer is slightly over the rated values but the voltages across the same leads measured at the tubes is much below normal, and for that reason the performance of my set is not satisfactory. What is the cause of the difference in the voltages and how can it be remedied?—N. L. W.

The difference, of course, is due to the voltage drop in the leads between the transformer and the tubes and the remedy is to reduce the resistance in these leads. This reduction may be effected either by making the leads of heavier wire or by making them shorter. Making both of these changes would be desirable.

SPEAKER HUM REMOVED

RECENTLY I bought a receiver in which there was provision for the field of a 90-volt dynamic speaker. I connected a Jensen dynamic to the binding posts provided and the result is a terrific hum which can be heard even above loud signals. I had used the same speaker before, taking the field current from a special B supply unit, and there was hardly any hum. What little there was could only be heard close to the speaker. What is the trouble and how can it be remedied?—H. A. D.

The field current supplied by the new receiver is not filtered well enough. It may be that the filter in the B supply becomes overloaded when the extra current is taken. The remedy is to provide additional filtering. A large by-pass condenser across the field winding may be sufficient, but it may be that you also have to use a choke coil in series with the field winding. Why not continue to use the B supply unit that did provide adequately filtered field current?

COMBINING AC AND DC

IS IT POSSIBLE to build a receiver so that DC is used on the filaments of the radio frequency amplifier and the detector and AC on the filaments of the audio frequency tubes? Would there be any advantage in arranging a circuit in this way?—W. H. C.

It is perfectly feasible to arrange a circuit that way, and many receivers are so built. Using DC up to and including the detector may make it easier to eliminate hum, but otherwise there is no advantage. It would be much simpler to use AC throughout.

POLARITY TESTS

CAN YOU SUGGEST any methods of testing the polarity of voltage sources, such as that of the DC power supply?—W. J. S.

One of the simplest polarity testers is a glass of water in which a small quantity of salt has been dissolved. Put the two terminals in the water, as far apart as practicable. Bubbles will appear around both terminals but there will be twice as many around the negative. Another simple test is one involving the use of a raw potato. Cut a potato in two and insert the terminals into one of the cut surfaces. Around the positive terminal a green spot will form. There is also a tester available which works on the principle of the neon cell. The device has two neon cells, and it is arranged so that when the device is connected across a DC voltage source one cell lights up, indicating the polarity. If the device is connected across an AC voltage both cells light up. This is one of the handiest devices gotten out.

RESISTANCE-COUPLED RF

WOULD IT BE practical to use resistance coupling and screen grid tubes in the radio frequency amplifier? I am desirous of building an amplifier of this type provided that it would be satisfactory.—E. A. B.

It would not be satisfactory. In the first place even screen grid tubes do not work efficiently in resistance coupled circuits at high frequencies and in the second there would be no selectivity. There would be a good deal of detection in the RF amplifier which would give rise to repeat tuning.

IMPEDANCE-COUPLED AMPLIFIER

IS IT POSSIBLE to get as good quality with impedance-coupled audio amplifiers as with resistance coupled circuits? Are there any advantages of impedance aside from quality over resistance couplers?—W. C. C.

There is very little difference between the quality of output of the two types of couplers provided that the impedances of the impedances are high. The quality from a resistance coupler is slightly better at the low frequencies. Impedance couplers have no advantages. Both types of amplifiers are subject to the same disadvantages, and impedance coils cost much more than resistances. They also occupy more space in the set and an impedance coupled circuit takes more plate current.

THE MORGAN AMPLIFIER

SOME TIME AGO you published a type of circuit which you call the Morgan amplifier. Have you tested this amplifier thoroughly and is it as good as claimed? Have you had any reports on the circuit, favorable or otherwise?—J. J. R.

The circuit was developed by Prof. Morgan who knows his subject thoroughly. The circuit is correctly designed. We have had no unfavorable reports whatsoever, but we have had some very enthusiastic reports. One who built the circuit reported that before he could get satisfactory results he had to make minor changes in the voltages but after he had made these changes the circuit was by far the best he had ever listened to. That changes are necessary at times is clear from the fact that tubes are not equal. It is necessary to make small changes in the voltages to compensate for these differences. But they are easily made.

GET A NEW B SUPPLY

I HAVE A B supply unit which I used with an old five-tube receiver. It gave good service on the old set and I am now wondering whether it will work the MB-29 tuner and an audio frequency amplifier using two 245s in the last stage. What do you say?—A. B. Q.

Since you said nothing as to what B supply unit you had we can only guess as to its adequacy in the new receiver. Our guess is that it will be sadly lacking in power and that the results with the new combination will not be as good as those with the old. By all means get a B supply which is able to handle the MB-29 and the power amplifier. Since you have the old B supply, you might try it on the new combination before you get the new B supply. Undoubtedly you will find that a substantial B supply is a good investment.

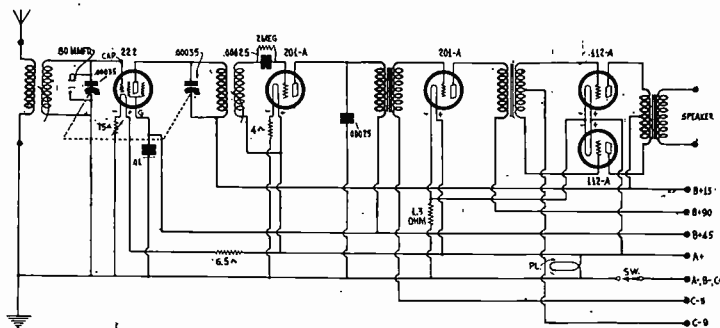

FIG. 825 A SIMPLE FIVE-TUBE RECEIVER EMPLOYING SCREEN GRID AMPLIFICATION IN THE FIRST STAGE AND PUSH-PULL IN THE OUTPUT. GANG CONTROL OF THE TWO TUNED CIRCUITS IS A FEATURE.

GANG TUNING DESIRED

WILL YOU PLEASE publish a diagram of a circuit as follows: One screen grid tube of the 222 type, one 201A detector, one 201A amplifier, one stage of push-pull with 112A tubes, transformer coupling, and gang control of the two tuned circuits.—J. A. J.

See Fig. 825 above for the circuit you request.

BEST INSULATORS

WILL YOU KINDLY name some of the best insulators for radio purposes? Also please name some of the best conductors.—A. G. M.

Fused quartz and ceresin wax are two of the best insulators known, each having a resistivity of 5 billion ohms per centimeter cube. Next comes hard rubber with a resistivity one-fifth as great. Colorless mica and sulphur come next. Rosin and paraffin also rank high as insulators.

The best conductors are silver, copper, aluminum and gold and are good conductors. The poorest conductors of the metals or alloys are bismuth, Nichrome, mercury, cast iron and German silver, in the order named.

Join

Radio World's

UNIVERSITY CLUB

And Get Free Question and Answer Service for the Coming 52 Weeks. This Service for University Subscribers Only

Subscribe for RADIO WORLD for one year (52 numbers). Use the coupon below. Your name will be entered on our subscription and University Club lists by special number. When sending questions, put this number on the outside of the forwarding envelope (not the enclosed return envelope) and also put it at the head of your queries. If already a subscriber, send \$6 for renewal from close of present subscription and your name will be entered in Radio University.

NO OTHER PREMIUM GIVEN WITH THIS OFFER

[In sending in your queries to the University Department please paragraph and number them. Write on one side of sheet only. Always give your University Club Number.]

RADIO WORLD, 145 West 45th Street, New York City.

Enclosed find \$6.00 for RADIO WORLD for one year (52 nos.) and also enter my name on the list of members of RADIO WORLD'S UNIVERSITY CLUB, which gives me free answers to radio queries for 52 ensuing weeks, and send me my number indicating membership.

Name

Street

City and State.....

If renewing subscription, put cross here.

The Popular PPPA

Chassis Construction Lends Beau

By Capt. Pe

Contri

The height is 7 inches, the width or direction in which the sockets run, is 12 inches, and the depth is 10 inches. These are overall dimensions.

On top are the power transformer, Mershon condenser of two 8 mfd., and two 18 mfd., the sockets, output device and binding posts. Beneath are the filter and bypass condensers and voltage divider.

Thus the assembly is decidedly attractive to the eye, and the tone quality will be no less attractive to the ear, provided a good push-pull input transformer is used. This transformer you are asked to select for yourself, or you may use one you have.

Five Voltages Selected

Five positive voltage binding posts are provided, and these may be used for bringing out the voltages you need, since the voltage divider provides a plentiful assortment. Of the group, 3, 6, 10, 16, 22, 50, 75, 90, 135 and 180, ten different voltages, the diagram suggests 3, 6, 50, 135 and 180 as the five, since these are most suitable for high-gain screen grid receivers.

The bias of 3 volts is really 1 to 3, being taken care of by a resistor adjustable from the top of the subpanel with a screwdriver. This resistor is a Clarostat "humdinger," one terminal connected to the low end of the voltage divider, the other Clarostat terminal to grounded B minus. This bias is used for 224 RF tubes.

Advantages Listed

The PPPA has the following features:

- (1)—Filament voltage for 245s in push-pull and for 280 rectifier; heater voltage for 224s and 228s, up to six such tubes, including the 227 in the PPPA.
- (2)—Plate voltage of 250 for the power tubes, with 50 volts bias to spare, total 300 volts at 80 wa., with intermediate B voltages.
- (3)—All the bias voltages you will require.
- (4)—Phonograph pick-up jack.
- (5)—Post for detector (input) and two posts for speaker (output).
- (6)—About 60 mfd. of filter and bypass capacity.
- (7)—As good an audio channel as can be built in a reactive circuit, with large undistorted power output.
- (8)—Good appearance.

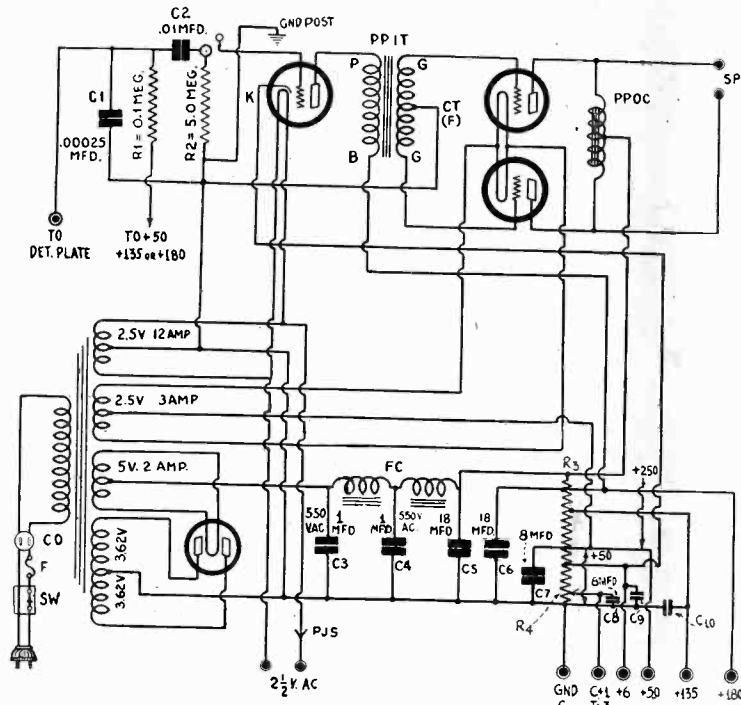

FIG. 1

THE CONNECTIONS DIAGRAM OF THE PPPA AMPLIFIER AND POWER SUPPLY

THE standard push-pull power amplifier using a resistance coupled first stage of audio and a transformer-coupled 245 push-pull output is shown in a new physical dress. The circuit is an A, B and C supply of well-established authenticity, and the dress is made good-looking at last.

LIST OF PARTS

- C1—One .00025 mfd. mica condenser.
 C2—One .01 mfd. mica fixed condenser.
 C3, C4—Two 1 mfd. filter condensers, 1,000 volts DC continuous working voltage, rating, 550 volts AC (root means square) continuous working voltage rating.
 C5, C6, C7, C8—Four Mershon condensers in one copper casing, two of 8 mfd. and two of 18 mfd., with low bracket. Cat. Q2-8, 2-18B.
 C9, C10—Two 1 mfd. bypass condensers, 200 volts DC continuous working voltage rating.
 T1—One Polo Filament-Plate-Choke Supply; 110 volt 50-60 cycle primary, 724 volt secondary center-tapped, 5 volt 2 amp. secondary center-tapped; 2.5 volt 3 ampere secondary center-tapped, and 25 volt 12 ampere secondary center-tapped. Cat. PFPCH. Note, for 25 cycles use Cat. PFPCH-25, for 40 cycles use PFPCH-40).
 PPOC—One Polo output choke for push-pull (Cat. PPOC).
 PPIT—One push-pull input transformer (select one you prefer).
 SW—One AC pendant through-switch, with 12-ft. AC cable and male plug.
 F—One 2 ampere fuse, with holder.
 CO—One convenience outlet (for dynamic speaker AC cable).
 PJ, PJS—Phonograph pick-up jack with automatic switch.
 R1—One Lynch metallized resistor, 0.1 meg.
 R2—One Lynch metallized grid leak, 5.0 meg.
 R3—One Multi-Tap Voltage Divider, 13,850 ohms, fourteen taps.
 R4—One 30 ohm Clarostat Humdinger.
 Two resistor mountings.
 Six binding posts (Det., five blanks).
 Speaker output jacks in bakelite assembly.
 One cadmium plated steel chassis, with self-bracketing flanges, one five-prong and three four-prong sockets built in; sockets marked to identify tubes that go in them; subpanel drilled and insulated where necessary.
 One base cover for chassis, with six bolts and six nuts.
 Four tubes one 280, one 227, two 245.

Right on

- (1)—In the Loftin-White direct-coupled circuit the grid of the second tube is positive because it is connected to the same point as the plate of the preceding tube.
- (2)—When a screen grid tube is used in resistance coupling with a moderately high voltage on the plate the screen grid voltage should be high in order to make up for the difference.
- (3)—In a screen grid tube the voltage drop in the coupling resistor is of no practical importance, the applied voltage alone being important.
- (4)—AC hum in a receiver can be balanced out, under certain conditions, by introducing a suitable amount of hum into the grid circuit.
- (5)—A hot soldering "iron" is the best assurance of good soldered joints.
- (6)—Overheating of the soldering "iron" is one of the chief reasons why melted solder will not flow into the joint.
- (7)—Equality of all inductance coils and equality of rate of change of all condenser capacities are essential for successful ganging of several tuned circuits.
- (8)—To make ganging of several tuned circuits really effective there should be one capacity trimmer and one inductive trimmer in each circuit.
- (9)—In order to check the frequencies of broadcast stations against a standard piezo oscillator it is necessary to have one standard for each channel.

ANSWERS

- (1)—Wrong. The grid is negative by the amount of steady drop in the coupling resistor or by a less amount depending on the return of the plate of the first tube relative to the cathode of the second.
- (2)—Wrong. The screen grid voltage must be lowered rather

a New, Pretty Dress

to A, B, C, Supply for 245 Output

V. O'Rourke

Editor

(9)—Compactness, enabling installation in "tight" consoles or even in a table model receiver that has 12 inch cabinet depth (front to back) or accommodation to 10 inch cabinet depth if there is room to put the 12 inch stretch in the direction of the front panel.

(10)—Economy. The filter system uses a 1 mfd. paper dielectric condenser of 1,000 volts DC continuous working voltage rating, 550 volts AC, root mean square, next to the rectifier and another at the midsection of the filter chokes FC. The first condenser has an effect on the output voltage, and only 1 mfd. is used here because the voltages are satisfactory under the circumstances and the hum is less. Anyone desiring to increase the voltage applied to the push-pull pair may put another 1 mfd. condenser in parallel with the prescribed capacity, making certain, however, that it is of the same high voltage rating. Do not put a 200-volt DC bypass condenser in this position, as it will break down at once.

Chassis Ground and Negative B

The filter chokes, two windings to be interconnected to constitute the mid-section, is inside the power transformer case.

As the chassis should be grounded, this connection is most easily made by putting a lug on the machine screw that holds down one side of the bracket of the Mershon condenser, and connecting a wire from one of the terminals of the paper condenser to the lug.

The Mershon condenser provides almost all of the capacity used in the filter. This particular Mershon is the one having two anodes of 8 mfd. each and two of 18 mfd. each. The catalogue number, including bracket, is Q 2-8, 2-18B.

The different capacities of the Mershon condenser may be distinguished easily. The smaller capacity is nearer the edge of the copper casing. In all instances the copper casing is negative. The anodes, represented by lugs on the insulated top of the casing, are positive. Attachment of the bracket to the chassis, which is steel, takes care of grounding the Mershon properly to negative, provided negative of the B supply is connected to the chassis.

One 8 mfd. section is used as the condenser across the RF bias (1 to 3 volts), one 18 mfd. as the "reservoir" condenser at the filter output, the other 18 mfd. to bypass 180

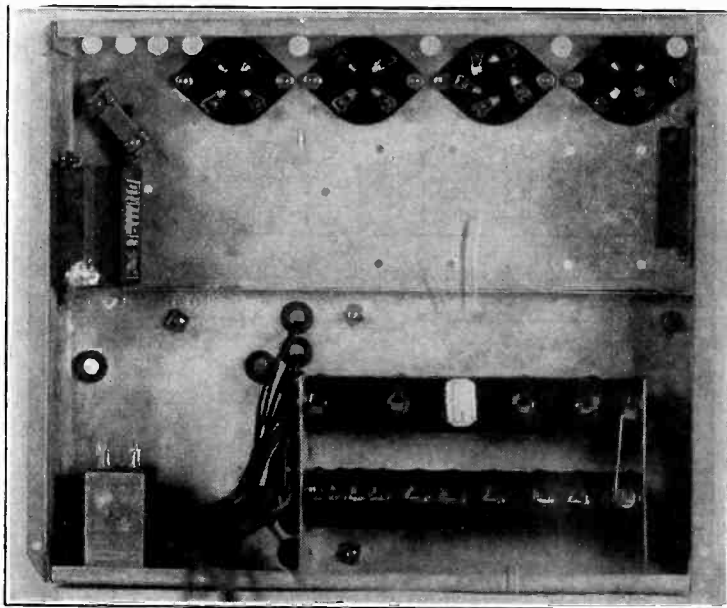

FIG. 2
UNDER-THE-PANEL VIEW OF THE PPPA AMPLIFIER AND POWER SUPPLY

volts and the remaining 8 mfd. across the 50-volt bias section. This same voltage of 50, used negatively for biasing these particular tubes, is available as a positive screen voltage for screen grid tubes, or for plate voltage for the grid-leak-condenser detector tube. This seeming double utility arises from the fact that the heater circuits are independent of the cathode, grid and plate circuits of the 227, 224 and 228 tubes, and of course are independent of the filament circuit of the two 245s.

The intermediate voltages (other than 50) are bypassed by 1 mfd. 200 volt condensers, of which four are used. If substitute intermediate voltages are preferred, move the bypass condenser over to the next section of the divider, or if additional output voltages are required, bypass each of such with 1 mfd., also, obtaining the extra condensers and binding posts additionally.

Voltage Determinations

By using a high resistance voltmeter you may determine the voltages by simple measurement, and without calculation of voltage drop on the basis of known values of resistance and the current flowing through each section of the divider. The values of current are different in each section. Through all sections flows the bleeder current, a little less than 22 milliamperes, when the power amplifier is worked with an average tuner.

If the bleeder current is measured when there is no load on the rectifier except the Multi-Tap Voltage Divider itself, the reading will be in excess of 22 milliamperes, because the voltage is higher than 300 across the divider. This is due to the low total current. The more current drawn, the lower the voltage, principally because of the regulation of the rectifier tube, the resistance of which increases with increase in current.

When the plate current of the audio amplifier tubes or of the audio and radio amplifier tubes and detector is drawn from the power amplifier, it is impossible to read the bleeder current separately, as there is only one current flowing through each section of the voltage divider. This is the sum of the bleeder current and plate currents.

However, with the voltage across the two extreme terminals known, and the total resistance of the Multi-Tap Voltage Divider being 13,850 ohms, the current is calculated as 300 divided by 13,850, or about .022.

The Multi-Tap Divider consists of two enamelled wire-wound resistors, on separate cores, mounted one above the other on supporting end-brackets, and connected in series. This connection is made at the factory. The entire unit is tapped in resistance steps as follows: 3,000 ohms, 4,500, 2,000, 800, 700, 600, 550, 500, 450, 400, 200, 100 and 50. The zero lug is the fourteenth and goes to the Clarostat. The "low" end is therefore the one where the tops are closer together.

Wrong?

man increased. If the screen grid voltage is high it may be higher than the effective value on the plate, and when it is the tube does not function.

(3)—Wrong. This is true in a three-element tube but not in a screen grid tube. In a screen grid tube the screen voltage must always be considerably less than the effective voltage on the plate of the tube.

(4)—Right. One way of doing this is to use a grid bias resistor and adjusting this as is done when measuring the amplification constant of a tube. Any hum introduced in the plate circuit is also introduced in the grid circuit but in opposite phase so far as the effect is concerned. It can also be done as in the oftin-White circuit.

(5)—Wrong. The "iron" may be too hot. If the "iron" is hot and at the same time clean and well tinned the high heat advantageous, but when the "iron" is too hot it is difficult to keep it tinned.

(6)—Right. Oxide of tin forms on the surface of the iron in the form of a film and this prevents solder from flowing readily.

(7)—Right. Equality of the inductances is essential in order that matching may be done throughout the tuning range and equality of rate of change of capacities is essential in order that matching may be done at all.

(8)—Right. The capacity trimmers are used to bring about equality of capacity at the low setting of the tuning control and inductive trimmers are useful in equalizing the inductances.

(9)—Wrong. It is possible to use one frequency standard and harmonics for checking many different broadcast frequencies. Even if an exact harmonic is not available it is possible to interpolate and thus get a very close measure on the broadcast frequency.

A Question and Answer Department conducted by Radio World's Technical Staff. Only Questions sent in by University Club Members are answered. Those not answered in these columns are answered by mail.

RADIO UNIVERSITY

Annual subscriptions are accepted at \$6 for 52 numbers, with the privilege of obtaining answers to radio questions for the period of the subscription, but not if any other premium is obtained with the subscription.

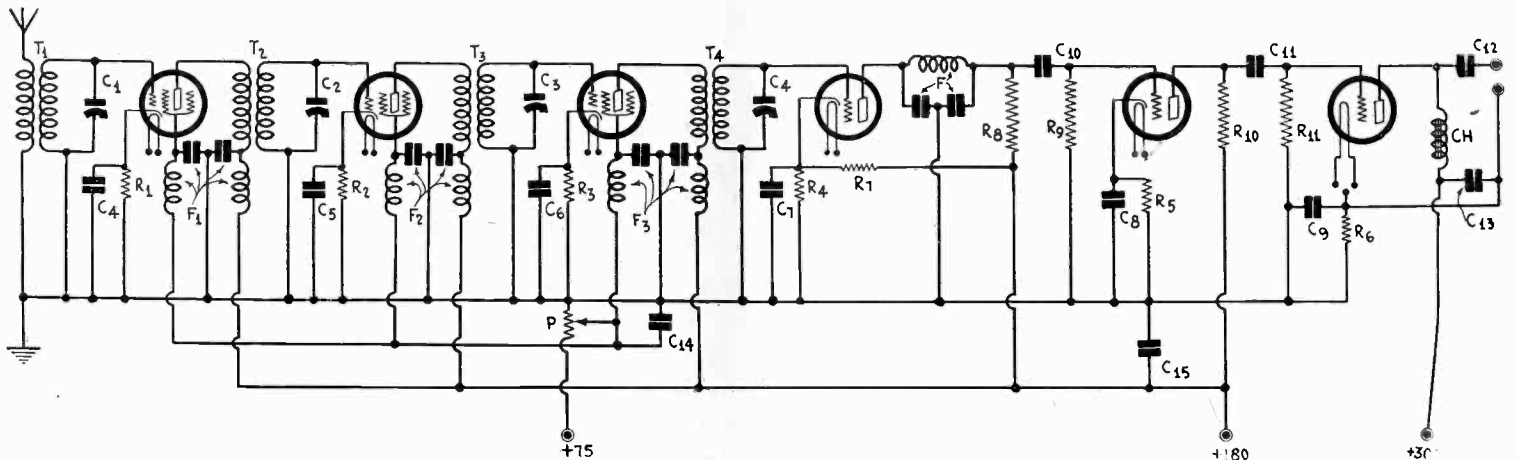

FIG. 824

WHEN SEVERAL STAGES OF SCREEN GRID TUBES ARE USED IN A RECEIVER THOROUGH FILTERING IS DESIRABLE AND THIS CIRCUIT SHOWS HOW IT SHOULD BE DONE TO BE EFFECTIVE

KINDLY SHOW a circuit diagram illustrating how radio frequency chokes and by-pass condensers should be connected when it is desired to take utmost precautions in isolating the several stages with respect to feedback.—A. M. C.

The circuit in Fig. 824 illustrates a case of thorough filtering to prevent feedback both at radio and audio frequencies. This might serve as a model.

DIVERGENCE OF OPINION

IREAD RECENTLY in a book on radio that resistance coupled amplifiers are the most stable of all audio amplifiers. Also I have read on numerous occasions that the resistance coupled amplifier is the most unstable. It does not seem to me that both statements, which are diametrically opposed, can be true. What is your opinion?—V. O. S.

Possibly you read a statement that resistance coupled circuits are probably the most stable because the coupling resistors are non-reactive. The other, and opposing, statements were undoubtedly more positive and based on experimental evidence. There is scarcely a resistance coupled amplifier that does not oscillate at some frequency, unless special precautions have been taken. Transformer and impedance coupled amplifiers are quite often stable without special treatment. It is assumed that all the amplifiers are operated by the same B supply, one at a time, in making this comparison. So the conclusion would seem to be that resistance coupled amplifiers are the most unstable. This conclusion is not based on the probable effect of a reactance but on general experience.

CAPACITY BETWEEN WINDINGS

IHAVE BEEN informed that the capacity between the primary and the secondary of a radio frequency transformer reduces the amplification and that only when this capacity is negligibly small can full gain be obtained. If that is true, will you kindly tell how to reduce the capacity between the windings?—J. A. F.

It is true, as was abundantly proved by a well-known radio frequency transformer. Since the capacity depends on the dimensions of the conductors involved, one way of reducing the capacity between the windings to make the primary, if untuned, of very fine wire. Since capacity also depends on the distance between conductors and decreases with the distance, another way of reducing the capacity is to put the two windings far apart. This is limited practically by the fact that the farther the windings are apart the more is the amplification reduced by virtue of loose coupling. One way is to bunch the primary wires in a slot in such a manner that each turn is coupled inductively most effectively to the secondary, that is, putting the primary near the center of the secondary, with an appreciable distance between the turns of the two. Still another way is to put the primary turns in a flat coil, pancake form, and placing it in the middle of the secondary.

CONSTRUCTION OF C BATTERY ELIMINATOR

WOULD it be worth while to build a C battery eliminator operating on the same principle as the ordinary B supply unit for a receiver using 245 power tubes? Would it be worth while when using 250 power tubes?—W. C. K.

The only object of building a C supply would be to obtain the C potential required without robbing the plate circuits of voltage. For example, suppose the total available voltage is only 250 volts

and 245 power tubes are used. These tubes should have 250 volts on the plates and 50 on the grids. Obviously, a total of 250 will not supply both. In this case it would be worth while to build a C supply, provided that the 250 volt power supply is large enough to handle the circuit. Otherwise it would be necessary to get another B supply, one which gave a total of 300 volts. With this it would not be necessary to use a separate C supply. The situation is somewhat the same with 250 power tubes. These require 450 volts on the plates and 84 volts on the grids, a total of 534 volts. Few B supply units give this voltage, so when the total voltage available is less than 500 volts it would pay to use a separate C supply. It should be noted that it costs practically nothing to operate a C supply giving 84 volts or more and it costs an appreciable amount to get 84 volts from the regular high power B supply. For example, suppose the receiver contains two 250 tubes, which draw a plate current of 110 milliamperes. Since the bias required is 84 volts the power consumption for the C supply alone is 9.24 watts. The same voltage could be obtained from a C supply with less than a watt.

REDUCING STATION INTERFERENCE

IN MY PRESENT location on Long Island I am troubled considerably by interference from a local high power station. Can you suggest how to get rid of it?—H. B. G.

If it is the station you want to get rid of, you have two courses open, move the station or move the set. If neither is practical you might try to eliminate the signal from the station. One way of doing this is to get a more selective set. Possibly the simplest remedy in the case is to install a wavetrap in the antenna circuit. Wind some heavy magnet wire on a 3-inch bakelite tube, or other insulating tube, and connect a .0005 mfd. condenser in series with the coil. Connect this in the antenna circuit and tune the trap to the interfering signal. An alternative connection is to put a second winding of about 10 turns on the form and connect this small winding in series with the antenna, tuning the trap to the interfering signal. Close tuning is necessary. The trap will help a great deal. You should use about 40 turns.

EFFECT OF LONG FILAMENT LEADS

THE MEASURED voltages across the terminals of my filament transformer is slightly over the rated values but the voltages across the same leads measured at the tubes is much below normal, and for that reason the performance of my set is not satisfactory. What is the cause of the difference in the voltages and how can it be remedied?—N. L. W.

The difference, of course, is due to the voltage drop in the leads between the transformer and the tubes and the remedy is to reduce the resistance in these leads. This reduction may be effected either by making the leads of heavier wire or by making them shorter. Making both of these changes would be desirable.

SPEAKER HUM REMOVED

RECENTLY I bought a receiver in which there was provision for the field of a 90-volt dynamic speaker. I connected a Jensen dynamic to the binding posts provided and the result is a terrific hum which can be heard even above loud signals. I had used the same speaker before, taking the field current from a special B supply unit, and there was hardly any hum. What little there was could only be heard close to the speaker. What is the trouble and how can it be remedied?—H. A. D.

The field current supplied by the new receiver is not filtered well enough. It may be that the filter in the B supply becomes overloaded when the extra current is taken. The remedy is to provide additional filtering. A large by-pass condenser across the field winding may be sufficient, but it may be that you also have to use a choke coil in series with the field winding. Why not continue to use the B supply unit that did provide adequately filtered field current?

COMBINING AC AND DC

IS IT POSSIBLE to build a receiver so that DC is used on the filaments of the radio frequency amplifier and the detector and AC on the filaments of the audio frequency tubes? Would there be any advantage in arranging a circuit in this way?—W. H. C.

It is perfectly feasible to arrange a circuit that way, and many receivers are so built. Using DC up to and including the detector may make it easier to eliminate hum, but otherwise there is no advantage. It would be much simpler to use AC throughout.

POLARITY TESTS

CAN YOU SUGGEST any methods of testing the polarity of voltage sources, such as that of the DC power supply?—W. J. S.

One of the simplest polarity testers is a glass of water in which a small quantity of salt has been dissolved. Put the two terminals in the water, as far apart as practicable. Bubbles will appear around both terminals but there will be twice as many around the negative. Another simple test is one involving the use of a raw potato. Cut a potato in two and insert the terminals into one of the cut surfaces. Around the positive terminal a green spot will form. There is also a tester available which works on the principle of the neon cell. The device has two neon cells, and it is arranged so that when the device is connected across a DC voltage source one cell lights up, indicating the polarity. If the device is connected across an AC voltage both cells light up. This is one of the handiest devices gotten out.

RESISTANCE-COUPLED RF

WOULD IT BE practical to use resistance coupling and screen grid tubes in the radio frequency amplifier? I am desirous of building an amplifier of this type provided that it would be satisfactory.—E. A. B.

It would not be satisfactory. In the first place even screen grid tubes do not work efficiently in resistance coupled circuits at high frequencies and in the second there would be no selectivity. There would be a good deal of detection in the RF amplifier which would give rise to repeat tuning.

IMPEDANCE-COUPLED AMPLIFIER

IS IT POSSIBLE to get as good quality with impedance-coupled audio amplifiers as with resistance coupled circuits? Are there any advantages of impedance aside from quality over resistance couplers?—W. C. C.

There is very little difference between the quality of output of the two types of couplers provided that the impedances of the impedances are high. The quality from a resistance coupler is slightly better at the low frequencies. Impedance couplers have no advantages. Both types of amplifiers are subject to the same disadvantages and impedance coils cost much more than resistances. They also occupy more space in the set and an impedance coupled circuit takes more plate current.

THE MORGAN AMPLIFIER

SOME TIME AGO you published a type of circuit which you call the Morgan amplifier. Have you tested this amplifier thoroughly and is it as good as claimed? Have you had any reports on the circuit, favorable or otherwise?—J. J. R.

The circuit was developed by Prof. Morgan who knows his subject thoroughly. The circuit is correctly designed. We have had no unfavorable reports whatsoever, but we have had some very enthusiastic reports. One who built the circuit reported that before he could get satisfactory results he had to make minor changes in the voltages but after he had made these changes the circuit was by far the best he had ever listened to. That changes are necessary at times is clear from the fact that tubes are not equal. It is necessary to make small changes in the voltages to compensate for these differences. But they are easily made.

GET A NEW B SUPPLY

IHAVE A B supply unit which I used with an old five-tube receiver. It gave good service on the old set and I am now wondering whether it will work the MB-29 tuner and an audio frequency amplifier using two 245s in the last stage. What do you say?—A. B. Q.

Since you said nothing as to what B supply unit you had we can only guess as to its adequacy in the new receiver. Our guess is that it will be sadly lacking in power and that the results with the new combination will not be as good as those with the old. By all means get a B supply which is able to handle the MB-29 and the power amplifier. Since you have the old B supply, you might try it on the new combination before you get the new B supply. Undoubtedly you will find that a substantial B supply is a good investment.

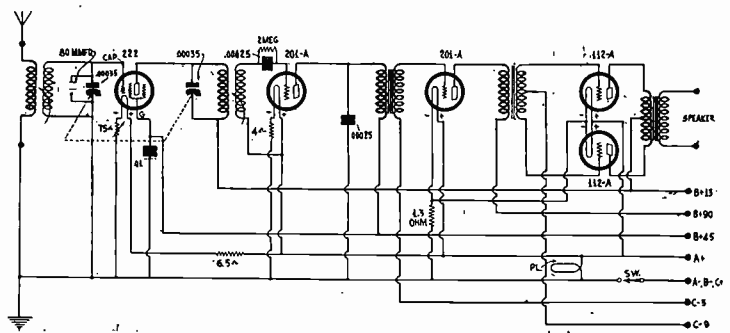

FIG. 825
A SIMPLE FIVE-TUBE RECEIVER EMPLOYING SCREEN GRID AMPLIFICATION IN THE FIRST STAGE AND PUSH-PULL IN THE OUTPUT. GANG CONTROL OF THE TWO TUNED CIRCUITS IS A FEATURE.

GANG TUNING DESIRED

WILL YOU PLEASE publish a diagram of a circuit as follows: One screen grid tube of the 222 type, one 201A detector, one 201A amplifier, one stage of push-pull with 112A tubes, transformer coupling, and gang control of the two tuned circuits.—J. A. J.
See Fig. 825 above for the circuit you request.

BEST INSULATORS

WILL YOU KINDLY name some of the best insulators for radio purposes? Also please name some of the best conductors.—A. G. M.

Fused quartz and ceresin wax are two of the best insulators known, each having a resistivity of 5 billion billion ohms per centimeter cube. Next comes hard rubber with a resistivity one-fifth as great. Colorless mica and sulphur come next. Rosin and paraffin also rank high as insulators.

The best conductors are silver, copper, aluminum and gold and are good conductors. The poorest conductors of the metals or alloys are bismuth, Nichrome, mercury, cast iron and German silver, in the order named.

Join

Radio World's

UNIVERSITY CLUB

And Get Free Question and Answer Service for the Coming 52 Weeks. This Service for University Subscribers Only

Subscribe for RADIO WORLD for one year (52 numbers). Use the coupon below. Your name will be entered on our subscription and University Club lists by special number. When sending questions, put this number on the outside of the forwarding envelope (not the enclosed return envelope) and also put it at the head of your queries. If already a subscriber, send \$6 for renewal from close of present subscription and your name will be entered in Radio University.

NO OTHER PREMIUM GIVEN WITH THIS OFFER

[In sending in your queries to the University Department please paragraph and number them. Write on one side of sheet only. Always give your University Club Number.]

RADIO WORLD, 145 West 45th Street, New York City.

Enclosed find \$6.00 for RADIO WORLD for one year (52 nos.) and also enter my name on the list of members of RADIO WORLD'S UNIVERSITY CLUB, which gives me free answers to radio queries for 52 ensuing weeks, and send me my number indicating membership.

Name

Street

City and State.....

If renewing subscription, put cross here.

EQUALITY LAW IS EVADED AS 'IMPOSSIBLE'

Washington.

Strict adherence to the Davis amendment to the radio law for the equal distribution of radio facilities among the zones and states is a "physical impossibility" if satisfactory reception for all listeners is to be provided, Federal Radio Commissioner Harold A. Lafount told the Senate Committee on Interstate Commerce.

After Senator Dill (Dem.), of Washington, and co-author of the amendment, again had criticized the Commission for its failure to observe the requirements of the law, Commissioner Lafount said reception would be "ruined" if the Commission attempted to follow it to the letter.

Despite the inherent difficulties of the amendment, he said, the Commission has accomplished a virtual equality in the distribution of stations and wavelengths among the five zones into which the Nation is divided, based on population, but has been unable to do so in the case of power distribution.

Calls Board a Violator

Although Senator Dill admitted that the Davis amendment is not satisfactory in every detail, and that some other yardstick for the distribution of facilities should be provided, he declared this does not alter the fact that the Commission has violated the intent of the law.

"The Commission has evaded the law and has not adhered to it to the letter," declared the Senator. "The Commission has taken it upon itself to readjust the law when it should have followed it."

"I am not satisfied with the Davis amendment, and I never have been, but the public demand that something be done about the then chaotic radio conditions forced its enactment," Senator Dill continued. "I do not believe that both houses of Congress would agree to its repeal, but want a substitute for it first." They do not trust the Commission."

Commission Replies

Commissioner Lafount called attention to the fallacies of the Davis amendment. The zones are so disproportionate in size, he declared, that the smallest of them, the first or eastern zone, does not cover a geographical area as large as the state of Montana, which is only about one-fiftieth of the entire fifth or western zone. Yet, he declared, under the law, the geographically great fifth zone may have no more radio facilities than the compact first zone.

Moreover, he said, when the Davis amendment was passed, the eastern and middlewestern zones, in which the greatest centers of population—New York and Chicago—were located naturally had the largest number of stations. It was natural, he said, that they should have had more broadcasting power, and although there has been a sweeping reallocation, this same power situation obtains today.

Commissioner Lafount said that atmospheric and other physical conditions which have the tendency either of absorbing or accentuating radio signals, which prevail in different localities, also

prevent a mathematical allocation of facilities.

Granite Plays Its Part

For example, he declared, along the Mississippi Valley reception is excellent, while a station broadcasting with the same power and on the same wavelength in New England will not be heard over a range even approaching that of the transmitter in the Mississippi Valley. This, he said, is because of the granite absorption in New England.

Asked by Senator Dill what a proper system of regulating broadcasting should be, Commissioner Lafount said such a proposition should be left to the judgment of the Commission. It is a continuous problem, he said, needing almost day to day attention and revision, and should be kept fluid, without restrictive laws which do not recognize the engineering problems.

A discussion of the chain program problem, and of reports of duplication of such programs on the listeners' dial was precipitated by Senator Brookhart (Rep.), of Iowa, according to "The United States Daily." The Senator said that in his state a listener reported that he received the same program 20 places on his dial.

Finds Distance Appetite Wanes

Commissioner Lafount said few complaints of duplication are received by the Commission. People today, he said, are content to listen to stations in close proximity to the point of reception which offer chain or other programs, and do not attempt to pick up distant stations as they formerly did when it was a novelty.

Senator Dill asked why the Commission did not limit the broadcasting of chain programs on cleared channels, used by high-powered stations, so there would be a minimum of duplication. He suggested that the Commission might restrict the use of chain programs on certain of the eight cleared channels assigned to each of the five radio zones.

Questioned as to the proposal to impose license fees upon broadcasting stations with a view to defraying the cost of administering radio in the United States, Commissioner Lafount said he was not definitely opposed to such a system, but that it would be extremely difficult to handle.

Rates Under Secretary

At the outset of the hearing, the chairman of the Commission, Ira E. Robinson, resumed his testimony, begun the preceding day. Senator Kean (Rep.), New Jersey, interrogated the witness as to the existing conditions in the New York metropolitan area, wherein certain high-powered broadcasting stations, accredited to the New York quota, have their transmitters located in New Jersey. He said these transmitters "blanket out" reception of New Jersey stations, and should not be permitted under the law which recognizes such conditions.

Mr. Robinson said the Commission, in administering radio, looks upon it from the broad national viewpoint, and how the American public generally may be served to the maximum extent. He said the Commission has had the New Jersey controversy aired before it.

Advertising rates of broadcasting stations were the basis of further examination of Commissioner Lafount by Senator Dill. He asked why WOR, in Newark, N. J., of only 5,000-watt power, received greater compensation for use of its station than some 50,000-watt stations. Commissioner Lafount said the New Jersey station is so situated and so equipped that "it can reach more people than some of the 50,000-watt stations."

BOARD PROBES BAD RECEPTION IN ALLEGHENIES

Washington.

The Allegheny Valley delegation in the House, with Representative Estep (Rep.) of Pittsburgh, Pa., as spokesman, conferred with the Federal Radio Commission with a view to getting better radio reception facilities.

There is interference between WJAS and WCAE, it was stated by the delegation. The Radio Commission announced it would make an investigation of the situation through its engineers.

There were five members of the House at the conference. They were Mr. Estep, as spokesman; Representatives Kelly (Rep.), of Edgewood, Pa.; Porter (Rep.), of Pittsburgh, Pa.; Campbell (Rep.), of Grafton, Pa., and Sullivan (Rep.), of Pittsburgh.

Speaks for Pittsburgh

After the conference, Representative Kelly said that Pittsburgh has four broadcasting stations, "perhaps fewer," he said, "than any other city of its size in the United States."

He added:

"Complaints are being heard from radio listeners-in that there is great interference and a generally unsatisfactory condition within the city proper. The delegation at its conference urged better radio reception facilities for the Pittsburgh section of the country. Under the Radio Commission act of 1928, the so-called Davis amendment called for equitable allotment of power channels. Five zones were established and certain channels allocated to each one of them. The Pennsylvania territory comes within Zone 2.

Not Given Quota

"At the present time this zone has not yet been given its equitable portion of the national and regional channels. Three zones have been given more than the channels to which they are entitled.

"Our state is under the disadvantage of having less than the quota facilities it is entitled to. The same is true, particularly, of our Zone 2, while other sections of this country enjoy more than their just quota.

"The conditions have been growing worse in our zone than anywhere else since the reallocation of 1928. Our people have been hoping that the Federal Radio Commission would make the necessary readjustments in the interest of better radio reception in our zone. Ever since the 1928 reallocation, we have been deprived in the Pittsburgh section of one cleared channel, the 1,020 channel.

"The Federal Radio Commission now, I believe, will make the necessary readjustments as the result of the promised engineering investigation of our present unfortunate situation."

LOOK AT YOUR WRAPPER

You will see by the date thereon when your subscription for Radio World expires. If the subscription is about to run out, please send us renewal so that you will not miss any copies. Subscription Department, RADIO WORLD, 145 West 45th St., N. Y. City.

RCA EXTORTER, SENATE HEARS; DEMANDS CITED

Washington.

Having obtained licenses for trans-ocean radioing of news, Press Wireless, Inc., sought apparatus from the Radio Corporation of America and was met with extortionate demands, said Joseph Pierson, president, addressing the Senate Committee on Interstate Commerce.

Tells of Demands

Here is what Mr. Pierson said RCA demanded:

"Communication must be between points 'within the continental United States' only.

"Will rent, but not sell, apparatus to Press Wireless, Inc., and (a) Press Wireless must pay RCA the General Electric Company's price for building the apparatus plus 45 per cent profit for the RCA; and (b) Press Wireless must pay as royalty or rental 5 per cent of the gross receipts to the RCA.

"Use can be for press messages only.

"Press Wireless must charge its clients 'with a view to earning a reasonable profit,' and not as a mutual company.

"Press Wireless must allow RCA to inspect its apparatus and its accounts at will.

"Press Wireless, Inc., must surrender to RCA without any charge whatsoever all patents or patent rights it now has or will ever have."

No Chance to Live

"RCA wants," said Mr. Pierson, "not only high tribute indefinitely prolonged, but they even would force us to give up to them use of these valuable frequencies which the Federal Radio Commission licensed only to us."

He explained that Press Wireless, Inc., is authorized by the Federal Radio Commission to create a trans-oceanic radio-telegraph network for the transmission of news dispatches for the American press. It has been granted 20 trans-oceanic frequencies for such a service, which later will be augmented by 20 domestic frequencies for continental transmission of press dispatches.

RCA has refused to sell it equipment for such a service, Mr. Pierson said, but offered to "lease" the necessary apparatus, under "extortionate" conditions.

Eight Experimental Frequencies

Press Wireless, Inc., has been granted authority by the Federal Radio Commission to maintain experimental operation on eight frequencies in the trans-oceanic band, preparatory to its establishment of a press communications system. Stations in Chicago and Los Angeles were licensed to maintain the communications.

WANTS VOLTAGES STATED

JUST a word in regards to your magazine. I think it is one of the most complete magazines on the subject of radio that I can or any one else can purchase, and I hope you continue with the fine articles found within its covers.

There is one thing I think would be of help to me as a novice and that is when you diagram a circuit please mark the voltages which the tests you made show to work the best.

JAS. BROWN,
Flemington, W. Va.

74 Stations Now in Northern Europe

Washington.

Broadcasting stations in northern Europe, comprising Norway, Sweden, Denmark, Iceland, Finland, Estonia, Latvia, Lithuania, Danzig, and Czechoslovakia, have been increased to 74, according to an announcement of the Department of Commerce after a check-up of the stations in these countries.

Among these countries Sweden leads with 32 stations. Norway is second with 12 and Finland third with 9 stations. Denmark has 6 stations, Danzig 5, Czechoslovakia 4, Iceland and Estonia 2 each and Latvia and Lithuania 1 each.

The highest powered station listed is in Lahtis, Finland, which operates with 40,000 watts on a wavelength of 1,552.8 meters. The second strongest station is SBG in Motala, Sweden, which operates with 30,000 watts on a wavelength of 1,348 meters. The remaining 72 stations range in power from 50 to 12,500 watts.

WMAK STARTS NEW WAVE SUIT

Washington.

A new appeal in the Buffalo broadcasting case, involving the Buffalo "Evening News" and WMAK, of that city, was filed with the Court of Appeals of the District of Columbia by WFBL, at Syracuse.

The Syracuse station appeals from the action of the Commission removing it from half-time operation on the 900-kilocycle channel, and placing it full time on the 1490-kilocycle channel. It contends that the Commission did not act directly on its application for increased time and power on the 900-kilocycle channel.

The Commission, in its decision, issued a construction permit to the newspaper for a station to operate full time on the 900-kilocycle channel, which now is shared by WMAK and WFBL. Previously, WMAK filed an appeal from the action.

Coincident with the filing of the new appeal, the Commission filed with the court its statement of facts and grounds for decision in the Buffalo case. Asking that the appeal of WMAK be dismissed, because the reasons cited are not specific, the Commission states it granted the Buffalo "Evening News" appeals because the Buffalo Broadcasting Corporation, controlling WMAK, has a virtual monopoly of broadcasting facilities in Buffalo.

This corporation, it states, controls the four leading broadcasting stations in Buffalo, namely, WKBW, WMAK, WKEN and WGR.

NEW DRAKE'S ENCYCLOPEDIA

1,680 Alphabetical Headings from A-battery to Zero Beat; 1,025 Illustrations, 920 Pages, 240 Combinations for Receiver Layouts. Price, \$6.00. Radio World, 124 W. 45th St., N. Y. C

READ OUR CLASSIFIED ADS

And use this department if you have anything to sell. 10c a word, \$1 minimum. Radio World, 145 W. 45th St., N. Y. City.

NO DANGER NOW OF TUBE TRUST, RCA MAINTAINS

Washington.

"There is no danger whatever of a monopoly in the radio tube field," John W. Davis, as counsel for the Radio Corporation of America, told the Federal Trade Commission in asking the Commission to discuss its tube monopoly complaint against RCA.

The Trade Commission had charged that Clause 9 of patent licenses granted by RCA to set manufacturers violated Section 3 of the Clayton act and Section 5 of the Federal Trade Commission act, "on that the RCA" required the licensees to use, for initial installation in manufacturing the patented electrical circuits licensed thereby, radio tubes purchased from the corporation."

Licensing Competitors

Mr. Davis declared in his motion that "Clause 9 has not been enforced by the Radio Corporation for over a year and a half past" and that the RCA "has also been permanently enjoined by a United States court."

"The Radio Corporation," his motion continued, "is, in fact, actually aiding its tube competitors by licensing them under its tube patents."

Now Oppose Policy

"Clause 9 of the patent license to the set manufacturers was in effect for approximately one year," added Mr. Davis. "During that time the sales department of the Radio Corporation became thoroughly convinced that, wholly apart from its legality or illegality, the policy embodied in Clause 9 was very undesirable from a purely merchandising standpoint."

Press Exploration Licenses Renewed

Washington.

The licenses held by the New York "Times" and the San Francisco "Examiner" for high frequency radio communication with scientific expeditions in remote areas of the globe have been extended for a period of six months by the Federal Radio Commission.

The "Times" station maintains direct communication with the Byrd Antarctic expedition and uses a power of 1,000 watts on high frequencies in the international band. The "Examiner's" station has been used for communication with the expedition of Sir Hubert Wilkins and with various airplane flights in the Pacific territory.

When Louis M. Loeb, of New York, attorney for the "Times," applied for the extension he supported his claim by quoting Admiral Byrd as follows:

"No group of men ever appreciated the advantages of radio more than the members of the Antarctic expedition. It has been invaluable. I think it would be fair to say that it would have been impossible to have carried out the operations of an expedition of so many units without radio."

Commissioner Sykes advised Mr. Loeb that the Radio Commission had no intention of cutting off radio communication with the Byrd exploration party.

BILL BARS ALL UTILITIES FROM STATION RIGHTS

Washington. Legislation which would prohibit the ownership or operation of broadcasting stations by public utilities or their subsidiaries will be offered by Senator Brookhart (Rep.), of Iowa, he announced.

At a hearing of the Senate Committee on Interstate Commerce relative to the Couzens bill to create a commission on communications, which also would control radio, Senator Brookhart declared he believed public utilities should not be accorded channels. He also deplored the use of channels and ownership of broadcasting stations by newspapers, but said he would offer an amendment to the pending bill to exclude utilities.

The announcement was made by the Senator when the Chairman of the Federal Radio Commission, Ira E. Robinson, was on the witness stand. Robinson had called to the Committee's attention the recent decision of the Court of Appeals of the District of Columbia, overruling a decision of the Commission respecting WENR, at Chicago, a 50,000 watt station, owned by the Insull public utility interests.

Thirteen Utilities Stations

The Commission had denied the station an increase in broadcasting time from two days per week to at least one-half time. The court overruled this decision, granting to the Insull station one-half time on the channel in question, ordering that this time be taken away from WLS, also of Chicago, operated by "The Prairie-Farmer."

An analysis recently prepared by the stations on the air operated by public power utilities.

In his testimony, Robinson disclosed that the Commission shortly expects to take action on the case of KWKH at Shreveport, La., owned by W. K. Henderson, who, it is alleged, uses indecent and profane language over his station.

Congress Distrusts Board

Senator Dill criticized the Commission sharply for its failure to carry out the terms of the Davis equalization amendment to the radio law, which requires the equal distribution of radio broadcasting facilities among the five radio zones into which the country is divided. He said that Congress cannot trust the Commission to distribute the facilities equally as the Davis amendment requires, and that he will endeavor to have a formula worked out by Congress, which will be "ironclad" and not give the Commission any leeway so that it will not misinterpret the intent of the law.

In the course of his testimony, Chairman Robinson was questioned as to license fees for broadcasting stations and other users of the ether; high power and cleared channels for broadcasting stations; whether broadcasting stations should be considered public utility common carriers, open to all, and other general broadcasting questions now in controversy.

The witness favored the imposition of license fees as a means of defraying the costs of administering radio. He opposed higher power and cleared channels generally, saying he did not go along with the Commission in its interpretation of the Davis amendment.

Dill Asks Arrest of Air Profaner

Washington. Senator Dill (Dem.), of the State of Washington, again addressed the Senate on the use of profanity over the radio, declaring that if KWKH, at Shreveport, La., continues to disregard the law in this respect, its owner should be arrested and the station discontinued.

Mr. Dill, co-author of the radio act, took the floor to explain that, in objecting to the use of obscene language over the Shreveport station, which is owned by W. K. Henderson, he did not wish to be interpreted as objection to Mr. Henderson's policy of attacking chain stores. Some independent merchants have wrongly made this interpretation, he said, while he has been opposed only to the use of profane language.

"As I have said before, I took up this matter with the Commission, and the Commission said it had no affidavits as to the indecency and obscenity being used," declared Senator Dill. "I think it now has some and will have many more."

Senator Walsh (Dem., of Montana, inquired whether the matter had been referred to the Attorney General, and whether the existing law, in the opinion of Senator Dill, is adequate to meet the situation. Senator Dill said he thought existing law fully adequate to cover the case.

"I have written a letter to the Attorney General calling his attention to statements I have made and to sections of the law, and have suggested that he refer the matter to the United States attorney in that district, so that the use of profanity may be stopped or the owner prosecuted under the criminal provisions of the act," concluded Senator Dill.

Two Cities Obtain Radio Police Permits

Washington. The police departments of two cities have been granted authority by the Federal Radio Commission to use short waves for the creation of crime detection and criminal apprehension services. The cities are Minneapolis, Minn., and Tulare, Calif.

Construction permits were also granted to these police departments for stations to use channels in the continental high frequency spectrum. Many other cities have already established such service and many more now hold construction permits for the erection of stations of this character.

All Parts for the ABC Supply

as described by Capt. Peter V. O'Rourke

Provides filament and heater voltages for 227, 224, 245 push-pull and 280, and fourteen B voltages.

These parts are complete less push-pull input transformer and are already mounted on steel chassis at...

\$30.00

[Order C. O. D. or remit with order.]

Guaranty Radio Goods Co.
143 West 45th Street,
New York, N. Y.
Just East of Broadway

DEFOREST SAYS AIR IS FULL OF "AD" AVARICE

By DR. LEE DeFOREST
Newly Elected President of Institute of Radio Engineers

The insidious influence of the avaricious advertiser and his stupid insistence on direct advertising have, I regret to observe, become increasingly effective and devastating.

As the so-called "Father of Radio Broadcasting" I wish again to raise my voice in most earnest protest against this revolting state of affairs.

The present all too marked tendency of the broadcast chains and of many individual stations to lower their bars to the greed of direct advertising will rapidly work to sap the life-blood and destroy the greatest usefulness of this magnificent new means of contact which we engineers have so laboriously toiled to upbuild and to perfect.

Public Flareback

In all seriousness I attribute a part of the present undeniable slackening in radio sales to the public as actually due to this pernicious advertising. The radio public is, I believe, becoming nauseated by the quality of many of the present programs. Short-sighted greed of the broadcasters, station owners and advertising agencies, is slowly killing the broadcasting goose, layer of many golden eggs.

Too long has this perilous situation continued without earnest protest from our organization. We members of this institute must be jealous of its good name, regardless of a wise supervision of this broadcast institution.

We should, I maintain, take active steps to get rid of the stupid avarice which is killing the most splendid and potent means of entertainment, culture and education which mankind has yet devised.

Foreign Relish by Domestic

If we anticipate the day of the international broadcast, when American programs are interchanged with those from Europe, you may rest assured that any foreign programs of high-class music will be relished in this country in preference to much of the stuff which American audiences are now compelled to hear.

This factor, the international broadcast, is at hand. The sterling work of radio communication engineers the world over in the fascinating field of short-wave transmission is rapidly bringing it to pass. And this development will eventually mean mutual acquaintanceship among people, international amity, an end of war, and finally the blessings of one common tongue.

TRIAL SUBSCRIPTION, 8 WEEKS, \$1.00. Send \$1 and we will send you **Radio World** for 8 weeks, postpaid. **RADIO WORLD, 145 West 45th St., N. Y. City.**

ARISTOCRAT FLOOR SPEAKER
With Molded Wood Horn and Horn Motor built in. Good value. \$12.00.
Acoustical Engineering Associates, 143 W. 45th St., N. Y. C.

RECEIVER FOR KOLSTER ASKED ON \$17,000,000

Paterson, N. J.

A receiver for the Kolster Radio Corporation, was asked by David Schiffman of Passaic, N. J., as owner of 200 shares of common stock. Vice Chancellor Lewis, signed an order, returnable, directing the Kolster officers to show cause why a receiver should now be appointed. Meanwhile the corporation was enjoined from collecting or contracting any further debts.

Executives of the \$17,000,000 corporation were in conference following filing of the petition. Ellery W. Stone, president of the corporation, said that on advised counsel, executives of the corporation would make no statements.

Cites \$916,233 Loss

Mr. Schiffman said he found the corporation sustained a loss of \$916,233 in 1929, its financial statement listing assets of \$7,011,758 in certain patent rights, "which your complainant alleges are fictitious and of no value." The statement showing such assets, according to the petition, was made "as part of a scheme to sell stock to the stockholders of record as of April 30th, 1928," at \$22 a share. The same stock, according to Mr. Schiffman's petition, was being quoted in the market at \$5 a share at the time his petition was filed.

Kolster Radio shares were selling on the New York Stock Exchange at 4¼ just before the receivership application, then dropped to 2½. In 1929 the high was 78¾.

Sales Grow, Profits Drop

Mr. Schiffman alleged that while the company in 1928 showed gains in sales, its net profits declined 75 per cent, due to increased cost of manufacturing and to competition.

The Kolster Radio Corporation was incorporated in Delaware on July 1st, 1926, as Federal-Brandes, Inc., and changed its name on April 9, 1928. As of Nov. 1, 1926, it purchased the entire capital stock of the Brandes corporations in Newark, Toronto and London. Later it acquired the capital stock of the Federal Telegraph Company by exchanging share for share of its A common stock for the \$10 par value shares of the Federal Company.

Rudolph Spreckels, head of the Spreckels Sugar Corporation, is chairman of the board

WABC Testing New Site for 50 kw. Plant

WABC, key station of the Columbia Broadcasting System, which has been seeking a site for its proposed 50 kw transmitter, is testing field strength near Jones Beach, L. I., twenty-five miles out of New York City.

The company telegraphed the Federal Radio Commission for permission to test for 10 days and obtained it.

The station will use the call letters W2XAN, the WABC short wave transmitter, but will operate on the WABC frequency of 860 kilocycles. Granting of the license is another step in the Columbia's effort to find a suitable location for its high-power transmitter, which it wants to locate where it will not interfere with other stations. The original intention to locate the station at Columbia Bridge, N. J., was abandoned because of opposition in New Jersey.

Literature Wanted

THE names and addresses of readers of RADIO WORLD who desire literature on parts and sets from radio manufacturers, jobbers, dealers and mail order houses are published in RADIO WORLD on request of the reader. The blank at bottom may be used, or a post card or letter will do instead.

RADIO WORLD,
145 West 45th St., N. Y. (147).
I desire to receive radio literature.

Name

Address

City or town

State

- W. V. Bozzelle, 529 Newton St., Gretna, La.
- Bruce Adams, St. Onge, So. Dak.
- Walter Magamol, 19 N. Fourth Ave., Highland Park, N. J.
- Nicholas Lalli, 19 No. Iowa Ave., Atlantic City, N. J.
- John J. Martin, 1711 Stanwood St., Phila., Pa.
- H. B. Wyatt, 288 Main St., Room 308, Worcester, Mass.
- F. E. Broadhurst, 6394 Trumbull Ave., Detroit Mich.
- Benjamin Berger, 1443 Wilkins Ave., Bronx, N. Y. City, N. Y.
- W. G. Schoettler, Box 501, Atlantic City, N. J.
- Wm. Kaiser, 1610 Blue Is. Ave., Chicago, Ill.
- Raymond P. Mahoney, 1303 Divinity Place, Phila., Pa.
- Elmo L. Barrett, Jr., P. O. Box 23, Morgantown, W. Va.
- C. L. Sowder, 1502 Melrose Ave., N. W., Roanoke, Va.
- Wm. R. Sewell, 6192 Hecla Ave., Detroit, Mich.
- B. C. Brewton, Claxton, Ga.
- Emil De Legien, 1104 Carroll Pl., Apt. E. 4, Bronx, N. Y. City.
- Fred Buettner, 1333 Wilmerding Ave., E. McKeesport, Pa.
- A. G. Chiginski, 716 7th St., S. W., Washington, D. C.
- Lee Deane, R. No. 3, Kingsville, Mo.
- Wm. C. Ogle, 1759 2nd St., San Diego, Calif.
- L. D. Orr, Box 306, New Bethlehem, Pa.
- Bob Lamb, c/o Leesburg Radio Amateurs Assoc., Leesburg, Fla.

STATION RATES UNRESTRICTED

Washington, D. C.

The Interstate Commerce Commission has no authority over rates charged to advertisers by broadcasting stations and chains, Commissioner Joseph B. Eastman told a Senate committee, as he recorded himself in favor of a communications commission.

Broadcasting stations, the Interstate Commerce Commissioner explained, are not regarded as being engaged in the transmission of intelligence as common carriers. No complaints have been made as to broadcasting rates, he added, and only one request for an investigation, which was received two years ago from the C. K. MacAlpine Company, 50 Church Street, New York City, had ever been received by the commission.

A THOUGHT FOR THE WEEK

HERE'S an idea that may appeal to a lot of listeners-in: organize a "National Shiver Week" and, at one fell stroke, get rid of those strong-meat dramalets of mystery, racketeering and gang life that are now sending the young ones scurrying off to bed, there to cover up their head and dream of murderous goings-on all night? If we can get these garish things off our chests in a seven-day period perhaps the country can spend fifty-one weeks in normal living and thinking again. Noise, the other name is radio melodrama!

WILBUR ASKS RADIOS TO HELP THE ILLITERATE

By RAY LYMAN WILBUR
Secretary of the Interior

Independent private institutions with sufficient funds for educational and cultural experiments could render the same great service in the field of radio education that they have in all American education. We do not yet know what the best methods are in education by the radio. We do not know how to discover them except by experimentation, nor how to choose the proper teachers for this special work except by trial.

We do not know how best to handle drama, literature, etc. We have already discovered that there is much interesting broadcasting possible in the field of political science, history and music.

Literacy Experiment

My hope is that we can continue the work that is now going forward and inaugurate under conditions of great freedom with adequate funds further experimentation under the guidance of those who cannot be considered as having a commercial viewpoint.

Personally, I should like to see just what could be done for several thousand illiterate families by providing them with a radio and a special service for a period of months. It would be a novel experience to become literate without being able to write or read, using literate in the sense of becoming informed and able to follow what is going on in the world about one. Here is an opportunity for some one to unite his interest, enthusiasm, and financial resources with some university which has a well developed department of sociology.

What People Want

I have indicated the significance of the radio and the necessity of some means of checking results as well as devising experiments in educational procedure. Control can not come through any individual or institution or any governmental agency alone. It must evolve from the experience of the industry and the creation of controlling ideals and principles.

There is a gratifying tendency to cleanse the air of unsavory broadcasts of all sorts. The Commonwealth Club of San Francisco recently reported a study in which over 7,000 people returned answers to 20 leading questions. Seventy-six per cent asked for educational programs, 84 per cent asked for more semi-classical music; 57 per cent reported that they listened to book reviews, and, says the report, "We found a tidal wave of indignation against jazz." It is important that the truth be presented over the radio. You have often heard individuals say: "I saw it in print," as if that were a finality.

NEW CROSLY SALES MANAGER

Cincinnati, O.

R. H. Woodford, for the past five years general sales manager of the radio division of the Stewart-Warner corporation, has been appointed general sales manager of the Crosley Radio corporation. He succeeded Neal Newman, resigned.

REVISED LIST OF STATIONS BY CALL LETTERS

With Location, Power, Frequency and Wavelength

74 ADDITIONS, DELETIONS, NEW WAVE ASSIGNMENTS, COMPARED WITH LIST PREVIOUSLY PUBLISHED

[The transmitter location of each station is given, but where the studio is located in some other city or town, the studio location is given also, designated by the letter "S." Where two different powers are given, the larger is usually for daylight use only. "Kc" stands for frequency in kilocycles, "kw" for power in kilowatts, "M" for wavelength in meters.]

Station	Transmitter	Power	kc.	M.
WAAF	Chicago, Ill.	500	920	325.9
WAAM	Newark, N. J.	1&2kw.	1250	239.9
WAAT	Jersey City, N. J.	300	1070	280.2
WAAW	Omaha, Nebr.	500	660	454.3
WABC	WBOQ—Queens Co. N. Y.			
	S—New York City	5,000	860	348.6
WABI	Bangor, Me.	100	1200	249.9
WABO	WHEC—See WHEC-WABO			
WABZ	New Orleans, La.	100	1200	249.9
WADC	Tallmadge, Ohio	1kw.	1320	227.1
WAGM	Royal Oak, Mich.	50	1310	228.3
WAIU	Columbus, Ohio	500	640	468.5
WAPI	Birmingham, Ala.	5kw.	1140	263
WASH	Grand Rapids Twp., Mich.	500	1270	236.1
WBAA	W. Lafayette, Ind.	500	1400	214.2
WBAK	Harrisburg, Pa.	500	1430	209.7
WBAL	Glen Morris, Md.			
	S—Baltimore, Md.	10kw.	1060	258.5
WBAP	Fort Worth, Texas	50kw.	800	374.8
WBAX	Wilkes-Barre, Pa.	100	1210	247.8
WBBC	Brooklyn, N. Y.	500	1400	214.2
WBBL	Richmond, Va.	100	1370	218.8
WBBM	WJBT—Glenview, Ill.			
	S—Chicago, Ill.	25kw.	770	389.4
WBBR	Rossville, N. Y.	1kw.	1300	230.6
WBBY	Charleston, S. C.	75	1200	249.9
WBBZ	Ponca City, Okla.	100	1200	249.9
WBCM	Hampton Twp., Mich.			
	S—Bay City, Mich.	500	1410	212.6
WBIS	WNAC—See WNAC-WBIS			
WBMS	Hackensack, N. J.	250	1450	206.8
WBNY	New York, N. Y.	250	1350	221.1
WBOQ	WABC—See WABC-WBOQ			
WBOV	Terre Haute, Ind.	100	1310	228.3
WBRC	Birmingham, Ala.	1kw.&500w.	930	322.4
WBRE	Wilkes-Barre, Pa.	100	1310	228.3
WBRL	Tilton, N. H.	500	1430	209.7
WBSO	Wellesley Hills, Mass.	250	920	325.9
WBT	Charlotte, N. C.	5kw.	1080	277.6
WBZ	E. Springfield, Mass.			
	S—Springfield, Mass.	15kw.	990	302.8
WBZA	Boston, Mass.	500	990	302.8
WCAC	Storrs, Conn.	500	600	499.7
WCAD	Canton, N. Y.	500	1220	245.8
WCAE	Pittsburgh, Pa.	500	1220	245.8
WCAH	Columbus, Ohio	500	1430	209.7
WCAJ	Lincoln, Nebr.	500	590	508.2
WCAL	Northfield, Minn.	1kw.	1250	239.9
WCAM	Camden, N. J.	500	1280	234.2
WCAO	Baltimore, Md.	250	600	499.7
WCAP	Asbury Park, N. J.	500	1280	234.2
WCAT	Rapid City, S. D.	100	1200	249.9
WCAU	Byberry, Pa.			
	S—Philadelphia, Pa.	10kw.	1170	256.3
WCAX	Burlington, Vt.	100	1200	249.9
WCAY	Carthage, Ill.	50	1070	280.2
WCBA	Allentown, Pa.	250	1440	208.2
WCBD	Zion, Ill.	5kw.	1080	277.6
WCBM	Baltimore, Md.	250	1370	218.8
WCBS	Springfield, Ill.	250&100	1210	247.8
WCCO	Anoka, Minn.			
	S—Minneapolis, Minn.	7½kw.	810	370.2
WCDA	Cliffside Park, N. J.			
	S—New York City, N. Y.	250	1350	221.1
WCFL	Chicago, Ill.	1kw.	1280	234.2
WCGU	Coney Island, N. Y.	500	1400	214.2
WCKY	Crecent Springs, Ky.			
	S—Covington, Ky.	5kw.	1480	202.6
WCLO	Kenosha, Wis.	100	1200	249.9
WCLS	Joliet, Ill.	100	1310	228.3
WCMA	Culver, Ind.	500	1400	214.2
WCOA	Pensacola, Fla.	500	1340	223.7
WCOG	Meridian, Miss.	1kw&500	880	340.7
WCOD	Harrisburg, Pa.			
	(formerly WPRC)	100	1200	249.9
WCOH	Greenville, N. Y.			
	S—Yonkers, N. Y.	100	1210	247.8
WCRW	Chicago, Ill.	100	1210	247.8
WCSH	Portland, Maine	500	940	319.0
WCSO	Springfield, Ohio	500	1450	206.8
WDAE	Tampa, Fla.	1kw.	1220	245.8
WDAF	Kansas City, Mo.	1kw.	610	491.5
WDAG	Amarillo, Texas	250	1410	212.6
WDAH	El Paso, Texas	100	1310	228.3
WDAY	W. Fargo, N. D.	1kw.	940	319
WDBJ	Roanoke, Va.	250&500	930	322.4
WDBO	Orlando, Fla.	1kw.	1120	267.7
WDEL	Wilmington, Del.	250&350	1120	267.7
WDGY	Minneapolis, Minn.	1kw.	1180	254.1
WDOD	Chattanooga, Tenn.	2½&1kw.	1280	234.2
WDRU	New Haven, Conn.	500	1330	225.4
WDSU	New Orleans, La.	1kw.	1250	239.9
WDWF	WLSI—Cranston, R. I.	100	1210	247.8
WDZ	Tuscola, Ill.	100	1070	280.2
WEAF	Bellmore, N. Y.			
	S—New York, N. Y.	50kw.	660	454.3
WEAI	Ithaca, N. Y.	500	1270	236.1
WEAN	Providence, R. I.	250&500	780	384.4
WEAO	Columbus, Ohio	750	570	526
WEAR	Cleveland, Ohio	1kw.	1070	280.2
WEBC	Superior, Wis.			
	S—Duluth, Minn.	2½kw.	1290	232.4
WEBE	Cambridge, Ohio	100	1210	247.8
WEBQ	Harrisburg, Ill.	100	1210	247.8
WEBR	Buffalo, N. Y.	200&100	1310	228.3
WEBW	Beloit, Wis.	500	560	535.4
WEDC	Chicago, Ill.	100	1210	247.8
WEDH	Eric, Pa.	30	1420	211.1
WEEL	Weymouth, Mass.			
	S—Boston, Mass.	10kw.	590	508.2
WEHC	Emory, Va.	100	1370	218.8
WEHS	Evanson, Ill.	100	1420	211.8

Station	Transmitter	Power	kc.	M.
WELK	Phila., Pa.	100	1370	218.8
WEMC	Berrien Springs, Mich.	1kw.	590	508.2
WENR	WBCN—Chicago, Ill.	50kw.	870	344.6
WEVD	Forest Hills, N. Y.			
	S—New York City	500	1300	230.6
WEW	St. Louis, Mo.	1kw.	760	394.5
WFAA	Grapevine, Tex.	50kw.	800	374.5
WFAN	Philadelphia, Pa.	500	610	491.5
WFBC	Knoxville, Tenn.	50	1200	249.9
WFBE	Cincinnati, O.	100	1200	249.9
WFBG	Atoona, Pa.	100	1310	228.3
WFBJ	Collegeville, Minn.	100	1370	218.8
WFBM	Syracuse, N. Y.	1kw.	1490	201.2
WFBP	Indianapolis, Ind.	1kw.	1230	243.8
WFBT	Baltimore, Md.	250	1270	236.7
WFDL	Flint, Mich.	100	1310	228.3
WFDV	Rome, Ga.	100	1370	218.8
WFDW	Tallegada, Ala.	100	1420	211.8
WFI	Philadelphia, Pa.	500	560	535.4
WFIW	Hopkinsville, Ky.	1kw.	940	319
WFJC	Akron, Ohio	500	1450	206.8
WFKD	Wissinoming, Pa.			
	S—Philadelphia, Pa.	50	1310	228.3
WFLA	WSUN—Clearwater, Fla.	1-2½kw.	900	331.1
WFLG	Lancaster, Pa.	15	1310	228.3
WGBB	Freeport, N. Y.	100	1210	247.8
WGBC	Memphis, Tenn.	500	1430	209.7
WGBF	Evansville, Ind.	500	630	475.9
WGBI	Scranton, Pa.	250	880	340.7
WGBS	Astoria, L. I., N. Y.			
	S—New York City	500	600	499.7
WGCM	Gulport, Miss.	100	1210	247.8
WGCP	Newark, N. J.	250	1250	239.9
WGES	Chicago, Ill.	500	1360	220.4
WGH	Newport News, Va.	100	1310	228.3
WGHP	Fraser, Mich.			
	S—Detroit, Mich.	1kw.	1340	223.7
WGL	Fort Wayne, Ind.	100	1370	218.8
WGMS	WLB—See WLB-WGMS			
WGN	WLIB—Elgin, Ill.			
	S—Chicago, Ill.	25kw.	720	413
WGR	Amherst, N. Y.			
	S—Buffalo, N. Y.	1kw.	550	545.1
WGST	Atlanta, Ga.	250	890	336.9
WGTB	Columbia, S. C.	500	1010	296.9
WGY	S. Schenectady, N. Y.	50kw.	790	379.5
WHA	Madison, Wis.	750	940	319
WHAD	Milwaukee, Wis.	250	1120	267.7
WHAM	Victor Twp., N. Y.			
	S—Rochester, N. Y.	5kw.	1150	260.7
WHAP	Carlstadt, N. J.			
	S—New York City	1kw.	1300	230.6
WHAS	Jeffersontown, Ky.			
	S—Louisville, Ky.	10kw.	820	365.6
WHAT	Phila., Pa.	100	1310	228.3
WHAZ	Troy, N. Y.	500	1300	230.6
WHB	Kansas City, Mo.	500	860	348.6
WHBC	Canton, Ohio	10	1200	249.9
WHBD	Mt. Orab, Ohio	100	1370	218.8
WHBI	Hattiesburg, Miss.	100	1370	218.8
WHBF	Rock Island, Ill.	100	1210	247.8
WHBL	Sheboygan, Wis.	500	1410	212.6
WHBO	Memphis, Tenn.	100	1370	218.8
WHBU	Anderson, Ind.	100	1210	247.8
WHBY	West De Pere, Wis.			
	S—Green Bay, Wis.	100	1200	249.9
WHDF	Calumet, Mich.	100	1370	218.8
WHDH	Gloucester, Mass.	1kw.	830	361.2
WHDI	Minneapolis, Minn.	500	1180	254.1
WHDL	Tupper Lake, N. Y.	10	1420	211.8
WHFC	WABO—Rochester, N. Y.	500	1440	208.2
WHFD	Cicero, Ill.	100	1420	211.8
WHIS	Bluefield, W. Va.	100	1420	211.1
WHK	Cleveland, Ohio	1kw.	1390	215.7
WHN	New York, N. Y.	250	1010	296.9
WHO	Des Moines, Iowa	5kw.	1000	299.8
WHP	Lemoine, Pa.			
	S—Harrisburg, Pa.	500	1430	209.7
WIAS	Ottumwa, Iowa	100	1420	211.1
WIBA	Madison, Wis.	100	1210	247.8
WIBG	Elkins Park, Pa.	50	930	322.4
WIBM	Jackson, Mich.	100	1370	218.8
WIBO	Desplaines, Ill.			
	S—Chicago, Ill.	1&1½kw.	560	535.4
WIBR	Steubenville, Ohio	50	1420	211.1
WIBS	Jersey City, N. J.	250	1450	206.8
WIBU	Poynette, Wis.	100	1310	228.3
WIBW	(near) Topeka, Kan.	1kw.	580	516.9
WIBX	Utica, N. Y.	100-300	1200	249.9
WICC	Easton, Conn.			
	S—Bridgeport, Conn.	500	1190	252
WIL	St. Louis, Mo.	100-250	1200	249.9
WILL	Urbana, Ill.	250-500	890	336.9
WILM	Wilmington, Del.	100	1420	211.1
WIOD	WMBF—Miami Beach, Fla.	1kw.	560	535.4
WIP	Philadelphia, Pa.	500	610	491.5
WISN	Milwaukee, Wis.	250	1120	267.7
WIAC	Johnstown, Pa.	100	1310	228.3
	(Formerly WHBP)			
WJAD	Waco, Texas	1kw.	1240	241.8
WJAG	Norfolk, Nebr.	1kw.	1060	282.8
WJAK	Marion, Ind.	50	1310	228.3
WJAR	Providence, R. I.	250-400	890	336.9
WJAS	North Fayette Twp.			
	S—Pittsburgh, Pa.	1kw.	1290	232.4
WJAX	Jacksonville, Fla.	1kw.	900	331.1
WJAY	Cleveland, Ohio	500	610	491.5
WJAZ	Mt. Prospect, Ill.	5kw.	1480	202.6
WJBC	La Salle, Ill.	100	1200	249.9
WJBI	Red Bank, N. J.	100	1210	247.8
WJBK	Ypsilanti, Mich.	50	1370	218.8
WJBL	Decatur, Ill.	100	1200	249.9
WJBO	New Orleans, La.	100	1420	211.1
WJBT	WBBM—See WBBM-WJBT			
WJBU	Lewisburg, Pa.	100	1210	247.8
WJBW	New Orleans, La.	30	1200	249.9
WJBY	Gadsden, Ala.	50	1210	247.8
WJDX	Jackson, Miss.	500-1kw.	1270	236.1
WJJD	Mooseheart, Ill.	20kw.	1130	265.3
WJKS	Gary, Ind.	500-1½kw.	1360	220.4

Station	Transmitter	Power	kc.	M.
WJR	Sylvan Lake Village, Mich.			
	S—Detroit, Mich.	5kw.	750	399.8
WJSV	Mt. Vernon Hills, Va.	10kw.	1460	205.4
WJW	Mansfield, Ohio			
	(Formerly WLBV)	100	1210	247.8
WJZ	Bound Brook, N. J.			
	S—New York City, N. Y.	30kw.	760	394.5
WKAQ	San Juan, P. R.	500	890	336.9
WKAR	E. Lansing, Mich.	1kw.	1040	288.3
WKAU	Laconia, N. H.	100	1310	228.3
WKBB	Joliet, Ill.	100	1310	228.3
WKBC	Birmingham, Ala.	100	1310	228.3
WKBF	Indianapolis, Ind.	500	1400	214.2
WKBH	La Crosse, Wis.	1kw.	1380	217.3
WKBI	Chicago, Ill.	50	1420	211.8
WKBN	Youngstown, Ohio	500	570	526
WKBO	Jersey City, N. J.	250	1450	206.8
WKBP	Battle Creek, Mich.	50	1420	211.1
WKBS	New York, N. Y.	250	1350	221.1
WKBS	Galesburg, Ill.	100	1310	228.3

Station	Transmitter	Power	kc.	M.
WOR	Kearny, N. J.			
	S-Newark, N. J.	5kw.	710	422.3
WORC	Auburn, Mass.			
	S-Worcester, Mass.	100	1200	249.9
	(formerly WKBE)			
WORD	Batavia, Ill.			
	S-Chicago, Ill.	5kw.	1480	202.6
WOS	Jefferson City, Mo.	500-1kw.	630	475.9
WOV	Secaucus, N. J.			
	S-New York City	1kw.	1130	265.3
WOW	Omaha, Neb.	1kw.	590	508.2
WOWO	Ft. Wayne, Ind.	10kw.	1160	258.5
WPAP	WQAO-See WQAO-WPAP			
WPAW	Pawtucket, R. I.	100	1210	247.8
WPCC	Chicago, Ill.	500	560	535.4
WPCB	Hoboken, N. J.			
	S-New York City	500	810	370.2
WPEN	Philadelphia, Pa.	100-250	1500	199.9
	(formerly WPSW)			
WPG	Atlantic City, N. J.	5kw.	1100	272.6
WPOE	Patchogue, N. Y.	100	1370	218.8
WPOR	WTAR-See WTAR-WPOR			
WPSC	State College, Pa.	500	1230	243.8
WPTF	Raleigh, N. C.	1kw.	680	440.9
WOAM	Miami, Fla.	1kw.	560	535.4
WOAN	Scranton, Pa.	250	880	340.7
WQAO	WQAO-Cliffside, N. J.			
	S-New York City, N. Y.	250	1010	296.9
WQBC	Utica, Miss.	300	1360	220.4
WQBZ	Weirton, W. Va.	60	1420	211.1
WQDM	St. Albans, Vt.	5	1370	218.8
WRAF	LaPorte, Ind.	100	1200	249.9
WRAC	Erie, Pa.	50	1370	218.8
WRAP	Reading, Pa.	100	1310	228.3
WRAX	Philadelphia, Pa.	250	1020	293.9
WRBI	Tifton, Ga.	20	1310	228.3
WRBJ	Hattiesburg, Miss.	10	1500	199.9
WRBL	Columbus, Ga.	50	1200	249.9
WRBO	Greenville, Miss.	100	1210	247.8
WRBT	Wilmington, N. C.	100	1370	218.8
WRBU	Gastonia, N. C.	100	1210	247.8
WRC	Washington, D. C.	500	950	315.6
WREC	Whitehaven, Tenn.			
	S-Memphis, Tenn.	500&1kw.	600	499.7
WRN	Lawrence, Kans.	1kw.	1220	245.8
WRHM	Fridley, Minn.			
	S-Minneapolis, Minn.	1kw.	1250	239.9
WRIN	Racine, Wis.	100	1370	218.8
WRK	Hamilton, Ohio	100	1310	228.3
WRNY	Coytesville, N. J.			
	S-New York City, N. Y.	250	1010	296.9
WRR	Dallas, Texas	500	1280	234.2
WRUF	Gainesville, Fla.	5kw.	830	361.2
WRVA	Mechanicsville, Va.			
	S-Richmond, Va.	5kw.	1110	270.1
WSAI	Mason, Ohio			
	S-Cincinnati, Ohio	500	1330	225.4
WSAJ	Grove City, Pa.	100	1310	228.3
WSAN	Allentown, Pa.	250	1440	208.2
WSAR	Fall River, Mass.	250	1450	206.8
WSAZ	Huntington, W. Va.	250	580	516.9
WSB	Atlanta, Ga.	1kw.	740	405.2
WSBC	Chicago, Ill.	100	1210	247.8
WSBT	South Bend, Ind.	500	1230	243.8
WSDA	WSGH-See WSGH-WSDA			
WSFA	Montgomery, Ala.	500	1410	212.6
WSGH	WSDA-Brooklyn, N. Y.	500	1400	214.2
WSIX	Springfield, Tenn.	100	1210	247.8
WSJS	Winston-Salem, N. C.	100	1310	228.3
	(formerly WJZ)			
WSM	Nashville, Tenn.	5kw.	650	461.3
WSMB	New Orleans, La.	500	1320	227.1
WSMK	Dayton, Ohio	200	1380	217.3
WSOA	Deerfield, Ill.			
	S-Chicago, Ill.	5kw.	1480	202.6
WSPD	Toledo, Ohio	500&1kw.	1240	241.8
WSSH	Boston, Mass.	500	1360	220.4
WSUI	Iowa City, Iowa	500	880	340.7
WSUN	WFLA-See WFLA-WSUN			
WSVS	Buffalo, N. Y.	50	1370	218.8
WSYR	Syracuse, N. Y.	250	570	526
WTAD	Quincy, Ill.	500	1440	208.2
WTAG	Worcester, Mass.	250	580	516.9
WTAM	Brecksville Village, Ohio			
	S-Cleveland, Ohio	50kw.	1070	280.2
WTAQ	Township of Washington, Wis.			
	S-Eau Claire, Wis.	1kw.	1330	225.4
WTAR	WPOR-Norfolk, Va.	500	780	384.4
WTAW	College Station, Texas	500	1120	267.7
WTAX	Streator, Ill.	50	1210	247.8
WTBO	Cumberland, Md.	50	1420	211.1
WTFI	Toccoa, Ga.	250	1450	206.8
WTIC	Avon, Conn.			
	S-Hartford, Conn.	50kw.	1060	282.8
WTMJ	Brookfield, Wis.			
	S-Milwaukee, Wis.	1kw.&2 1/2 kw.	620	483.6
WTNT	Nashville, Tenn.	5kw.	1490	201.2
	(formerly WBAA)			
WTOC	Savannah, Ga.	500	1260	238
WWAE	Hammond, Ind.	100	1200	249.9
WWJ	Detroit, Mich.	1kw.	920	325.9
WWL	New Orleans, La.	5kw.	850	352.7
WWNC	Asheville, N. C.	1kw.	570	526
WWRI	Woodside, N. Y.	100	1500	199.9
WWVA	Wheeling, W. Va.	5kw.	1160	258.5
WBTM	Paragould, Ark.	100	1200	249.9
KCRC	Enid, Okla.	100&250	1370	218.8
KDB	Santa Barbara, Calif.	100	1500	199.9
KDFN	Casper, Wyo.	100	1210	247.8
KDKA	Wilkins Township, Pa.			
	S-Pittsburgh, Pa.	50kw.	980	305.9
KDLR	Devils Lake, N. D.	100	1210	247.8
KDYL	Salt Lake City, Utah	1kw.	1290	232.4
KECA	Los Angeles, Calif.	1kw.	1430	209.7
KEJK	Beverly Hills, Calif.	500	1170	256.3
KELW	Burbank, Calif.	500	780	384.4
KEX	Portland, Ore.	5kw.	1180	254.1
KFAB	Lincoln, Neb.	5kw.	770	389.4
KFBB	Great Falls, Mont.	1kw.	1360	220.4
KFBK	Sacramento, Calif.	100	1310	228.3
KFBL	Everett, Wash.	50	1370	218.8
KFDM	Beaumont, Texas	500	560	535.4
KFDY	Brookings, S. D.	500&1kw.	550	545.1
KFEL	Denver, Colo.	500	920	325.9
KFEO	St. Joseph, Mo.	2 1/2 kw.	560	535.4
KFGO	Boone, Iowa	100	1310	228.3
KFH	Wichita, Kans.	1kw.	1300	230.6
KFHA	Gunnison, Colo.	50	1200	249.9
KFI	Los Angeles, Calif.	5kw.	640	468.5

Station	Transmitter	Power	kc.	M.
KFIF	Portland, Ore.	100	1420	211.1
KFIO	Spokane, Wash.	100	1230	243.8
KFIU	Juneau, Alaska	10	1310	228.3
KFIZ	Fond du Lac, Wis.	100	1420	211.1
KFJB	Marshalltown, Iowa	100	1200	249.9
KFJF	Oklahoma City, Okla.	5kw.	1470	204
KFJJ	Astoria, Ore.	100	1370	218.8
KFJM	Grand Forks, N. D.	100	1370	218.8
KFJR	Portland, Ore.	500	1300	230.6
KFJY	Fort Dodge, Iowa	100	1310	228.3
KFJZ	Fort Worth, Texas	100	1370	218.8
KFKA	Greeley, Colo.	500&1kw.	880	340.7
KFKB	Milford, Kans.	5kw.	1050	285.5
KFKU	Lawrence, Kans.	1kw.	1220	245.8
KFKX	KYW-See KYW-KFKX			
KFLV	Rockford, Ill.	500	1410	212.6
KFLX	Galveston, Texas	100	1370	218.8
KFMX	Northfield, Minn.	1kw.	1250	239.9
KFNF	Shenandoah, Iowa	500&1kw.	890	336.9
KFOR	Lincoln, Neb.	100&250	1210	247.8
KFOX	Long Beach, Calif.	1kw.	1250	239.9
KFPL	Dublin, Texas	15	1310	228.3
KFPM	Greenville, Texas	15	1310	228.3
KFPW	Siloam Springs, Ark.	50	1340	223.7
KFPY	Spokane, Wash.	1kw.	1340	223.7
KFQA	KMOX-See KMOX-KFQA			
KFQD	Anchorage, Alaska	100	1230	243.8
KFOU	Holy City, Calif.	100	1420	211.1
KFOW	Seattle, Wash.	100	1420	211.1
KFQZ	Hollywood, Calif.			
	S-Los Angeles, Calif.	250	860	348.6
KFRC	San Francisco, Calif.	1kw.	610	491.5
KFRU	Columbia, Mo.	500	630	475.9
KFSD	San Diego, Calif.	500&1kw.	600	499.7
KFSG	Los Angeles, Calif.	500	1120	267.7
KFUI	Juneau, Alaska	10	1310	228.3
KFUL	Galveston, Texas	500	1290	232.4
KFUM	Colorado Springs, Colo.	1kw.	1270	236.1
KFUO	Clayton, Mo.	500&1kw.	550	545.1
KFUP	Denver, Colo.	100	1310	228.3
KFVU	Culver City, Calif.	250	1000	299.9
KFVS	Cape Girardeau, Mo.	100	1210	247.8
KFWB	Hollywood, Calif.	1kw.	950	315.6
KFWF	St. Louis, Mo.	100	1200	249.9
KFWI	San Francisco, Calif.	500	930	322.4
KFWM	Richmond, Calif.	500&1kw.	930	322.4
KFXD	Jerome, Idaho	50	1420	211.1
KFXF	Denver, Colo.	500	920	325.9
KFXK	Denver, Colo.	250	630	475.9
KFXJ	Edgewater, Colo.	50	1310	228.3
KFXM	San Bernardino, Calif.	100	1200	249.9
	(formerly KFWC)			
KFXR	Oklahoma City, Okla.	100	1310	228.3
KFFXY	Flagstaff, Ariz.	100	1420	211.1
KFYO	Abilene, Texas	100&250	1420	211.1
KFYR	Bismarck, N. D.	500	550	545.1
KGA	Spokane, Wash.	5kw.	1470	204
KGAR	Tucson, Ariz.	100	1370	218.8
KGB	San Diego, Calif.	250	1330	225.4
KGBU	Ketchikan, Alaska	500	900	331.1
KGBX	St. Joseph, Mo.	100	1310	228.3
KGBZ	York, Neb.	500&1kw.	930	322.4
KGCA	Decorah, Iowa	50	1270	236.1
KGCI	San Antonio, Texas	100	1370	218.8
KGCR	Watertown, S. D.	100	1210	247.8
KGCU	Mandan, N. D.	100	1200	249.9
KGCX	Wolf Point, Mont.	100&250	1310	228.3
KGDA	Dell Rapids, S. D.	50	1370	218.8
KGDE	Fergus Falls, Minn.	50	1300	249.9
KGDM	Stockton, Calif.	250	1100	272.6
KGDY	Oldham, S. D.	15	1200	249.9
KGEF	Los Angeles, Calif.	1kw.	1300	230.6
KGEK	Yuma, Colo.	50	1200	249.9
KGER	Long Beach, Calif.	1kw.	1360	220.4
KGEW	Fort Morgan, Colo.	100	1200	249.9
KGEZ	Kaisepell, Mont.	100	1310	228.3
KGFF	Alva, Okla.	100	1430	211.1
KGFG	Oklahoma City, Okla.	100	1370	218.8
KGFI	Corpus Christi, Texas	100	1500	199.9
KGFI	Los Angeles, Calif.	100	1200	249.9
KGFK	Hallock, Minn.	50	1200	249.9
KGFL	Raton, N. Mex.	50	1370	218.8
KGFW	Ravenna, Neb.	50	1310	228.3
KGFX	Pierre, S. D.	200	580	516.9
KGGC	San Francisco, Calif.	50	1420	211.1
KGGF	Picher, Okla.	500	1010	296.9
KGGM	Albuquerque, N. Mex.	250&500	1230	243.8
KGHF	Pueblo, Colo.	500	1320	227.1
KGHI	McGehee, Ark.	50	1310	228.3
KGHI	Little Rock, Ark.	100	1200	249.9
KGHL	Billings, Mont.	500	950	315.6
KGIO	Twin Falls, Idaho	250	1320	227.1
KGIR	Butte, Mont.	250	1360	220.4
KGIV	Trinidad, Colo.	100	1420	211.1
KGIX	Las Vegas, Nev.	100	1420	211.1
KGJF	Little Rock, Ark.	250	890	336.9
KGKB	Brownwood, Texas	100	1500	199.9
KGKL	San Angelo, Texas	100	1370	218.8
KGKO	Wichita Falls, Texas	250&500	570	526
KGKX	Sandpoint, Idaho	100	1420	211.1
KGKY	Scottsbluff, Ark.	100	1500	199.9
KGMB	Honolulu, Hawaii	500	1320	227.1
KGMC	Jerome, Ark.	100	1310	228.3
KGMD	Roswell, N. Mex.	100	1500	199.9
KGO	Oakland, Calif.	7 1/2 kw.	70	379.5
KGRC	San Antonio, Texas	100	1370	218.8
KGRS	Amariillo, Texas	1kw.	1410	212.6
KGU	Honolulu, Hawaii	500	940	319
KGW	Portland, Ore.	1kw.	620	483.6
KGY	Lacey, Wash.	100&50	1200	249.9
KHJ	Los Angeles, Calif.	1kw.	900	331.1
KHO	Spokane, Wash.	1kw.	590	508.2
KICK	Red Oak, Iowa	100	1420	211.1
KID	Idaho Falls, Idaho	500	1320	227.1
KIDO	Boise, Idaho	1kw.	1250	239.9
KIT	Yakima, Wash.	50	1310	228.3
KITS	San Francisco, Calif.	100	1070	280.2
KTR	Seattle, Wash.	5kw.	970	309.1
KLCN	Blytheville, Ark.	50	1290	232.4
KLO	Ogden, Utah	100&200	1370	218.8
KLP	Minot, N. D.	100	1420	211.1
KLRA	Little Rock, Ark.	1kw.	1390	215.7
KLX	Oakland, Calif.	250	1440	208.2
KLX	Oakland, Calif.	500	880	340.7
KLZ	Denver, Colo.	1kw.	560	535.4
KMA	Shenandoah, Iowa	500&1kw.	930	322.4
KMBC	Independence, Mo.			
	S-Kansas City, Mo.	1&2 1/2 kw.	950	315.6
KMED	Medford, Ore.	50	1310	228.3

Station	Transmitter	Power	kc.	M.
KMIC	Inglewood, Calif.			

High Gain at Low Cost

HB44 - - - \$45.59

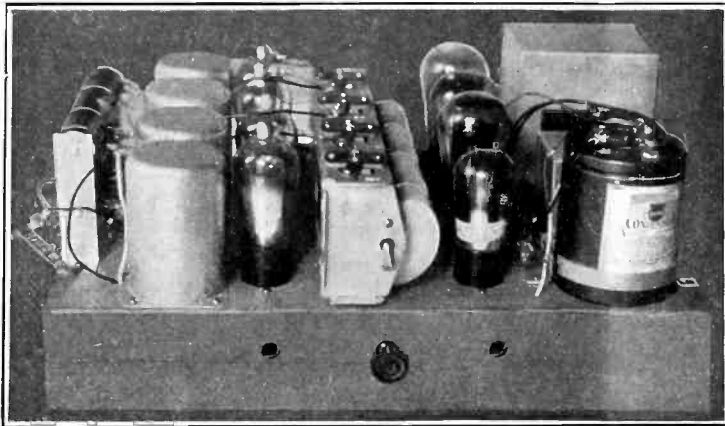

The HB44, assembled, presents in compact form, on a 17½ x 11½" steel chassis, a completely AC operated shielded receiver, using four 224 screen grid tubes, one 227, two 245s in push-pull, and a 280 rectifier, eight tubes all told. Here is the circuit that will bring 'em in from all over the country—and at a price you can afford—\$45.59. This price includes EVERYTHING except speaker, cabinet and tubes.

It's the Real Thing!

- (a) Three stages of tuned R.F., using 224 screen grid tubes.
- (b) Tuned input to 224 power detector.
- (c) Audio, consisting of first stage resistance coupled, second stage 245s in push-pull.
- (d) Four totally shielded R.F. coils.
- (e) A chassis all drilled for necessary parts.
- (f) A four gang condenser, guaranteed accurate, with equalizing condensers built in.
- (g) 61 mfd. of filter and bypass capacity.
- (h) Thirteen different fixed voltages available from the output.
- (i) Single dial control.

LIST OF PARTS FOR THE HB44

<input type="checkbox"/> SL1, SL2, SL3, SL4—Four stage individually shielded coil cascade for .00035 mfd. (Four Cat. SH-3 of Screen Grid Coil Co.).....	\$ 3.80
<input type="checkbox"/> C1, C2, C3, C4—One four gang .00035 mfd. condenser with equalizers E1, E2, E3, E4 built in.....	3.95
<input type="checkbox"/> C5—One .01 mfd. mica condenser.....	.35
<input type="checkbox"/> C6, C7, C13, C14—Four 1 mfd. 200 volt DC bypass condensers....	2.00
<input type="checkbox"/> C8—One 1 mfd. 550 volt AC filter condenser.....	.85
<input type="checkbox"/> C9, C10, C11, C12—One Mershon, consisting of four condensers, two of 8 mfd. and two of 18 mfd. with bracket (Cat. Q-2-8, 2-18-B).	5.15
<input type="checkbox"/> R1—One Electrad 25,000 ohm potentiometer with knob and two insulators.....	1.60
<input type="checkbox"/> R2—One 50,000 ohm Lynch metallized resistor (.05 meg.), with mounting.....	.45
<input type="checkbox"/> R3—One Lynch 5.0 meg. metallized grid leak, with mounting.....	.40
<input type="checkbox"/> R4—One 5,000 ohm resistor with mounting.....	.50
<input type="checkbox"/> VD—One Multi-Tap Voltage Divider, 13,850 ohms, 14 taps.....	3.95
<input type="checkbox"/> T1—One push-pull input transformer.....	2.50
<input type="checkbox"/> OPC—One center-tapped output choke.....	2.50
<input type="checkbox"/> T2—One Polo filament-plate supply (Cat. PFP5).....	7.50
<input type="checkbox"/> Ch—One double filter choke coil, 30 henrys each section, 100 ma..	3.71
<input type="checkbox"/> SW—One pendant AC switch with 12 ft. cable.....	.80
<input type="checkbox"/> PL—One 2.5 volt pilot lamp and bracket.....	.70
<input type="checkbox"/> Speaker (+), (-), Ant., Gnd.—Four binding posts with insulators.	.40
<input type="checkbox"/> One Clarostat Humdinger, 30 ohms.....	.50
<input type="checkbox"/> One subpanel 17½" x 11½", with five UY and three UX sockets..	3.00
<input type="checkbox"/> One vernier dial.....	.50
<input type="checkbox"/> Four National grid clips.....	.24
<input type="checkbox"/> Hardware.....	.24
<input type="checkbox"/> All parts (less cabinet, tubes and speaker).....	\$45.59
<input type="checkbox"/> Tubes: four 224, one 227, two 245, one 280.....	9.51

GUARANTY RADIO GOODS CO.,
143 West 45th Street, New York, N. Y.
(Just East of Broadway.)

- Please ship all parts for HB44 @.....\$45.59
- Eight tubes for HB44..... 9.51
- Please ship C.O.D.
- Enclosed find \$..... remittance.
(Canadian must be P. O. or Express M. O.)

NOTE: If only some (not all) parts are desired, check off on list at left and tear out and send in this entire page.

NAME.....

ADDRESS.....

CITY..... STATE.....

FIVE DAY MONEY-BACK GUARANTY

TELEVISION FOR HOME CONSTRUCTORS

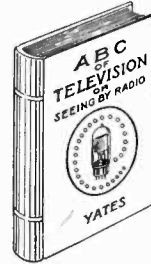

Full explanation of the theory and practice of television is contained in the new 210-page book (5¼ x 8¾"), with 100 illustrations.

ABC of Television

By Raymond Francis Yates.
Students and Experimenters alike will glory in the possession of this masterful volume. Popularly written, easily understood.

TABLE OF CONTENTS

CHAPTER I—TELEVISION—THE NEW CONQUEST OF SPACE
How the Principles of Television were Invented in 1884 and what the Future Holds for this Promising New Child of Science—A Description, in Narrative Form, of the Television of the Future.

CHAPTER II—TELEVISION SYSTEMS
Complete and Elementary Explanation of the Fundamental Principles of Television As They Are Applied Today in Both Transmitting and Receiving—Methods of Synchronization, Scanning and the Function of Photoelectric Cells.

CHAPTER III—TELEGRAPHING PICTURES
An Outline of the Various Successful Methods Employed Today in the Transmission of Facsimiles and Photographs by Wire and Wireless Systems—Practical Description of Telephotographic Receivers for Home Use With Practical Instruction Concerning Their Operation.

CHAPTER IV—PHOTOELECTRIC CELLS
How Photoelectric Cells Serve as "Light Microphones" in Modulating Radio Waves With Light Impulses—Elementary Outline of the Theory of Photoelectric Phenomena.

CHAPTER V—AMPLIFYING PICTURES
Theory and Practice of the Amplification of Picture Signals Together With Data for the Construction of Television Amplifiers That Will Function With a Minimum of Picture Distortion.

CHAPTER VI—THE AGILE NEON LAMP
Theory, Operation and Practical Application of Neon Tubes in Television Reception—How the Neon Tube Functions as a "Light Loud Speaker" in Television Reception.

CHAPTER VII—SELENIUM CELLS
Theory of Selenium Cells Together With a Description of the Popular Types of Cells and Practical Data Concerning Their Construction by Home Experimenters.

CHAPTER VIII—THE PROBLEM OF SCANNING
The Function of the Scanning Disc With Complete Instructions for the Design and Construction of Different Types of Scanning Devices Including Drums and Moving Belts.

CHAPTER IX—SYNCHRONIZING TELEVISION
An A B C Outline of the Synchronizing Methods Now Employed by the Television Broadcasters of Today—Problems of Synchronizing Television Scanning Discs Treated in a Popular Way.

CHAPTER X—TRANSMITTING TELEVISION AT HOME
How the Experimenter Can Construct and Operate Both a Television Transmitter and Receiver for Home Use—This Equipment Makes Possible the Transmission of the Outline of Simple Objects From One Room to Another.

CHAPTER XI—HOW TO MAKE A TELEVISION RECEIVER
Practical Application of the Principles of Television in the Construction of a Television Receiver Involving a Special, Highly Efficient Short-Wave Receiver.

RADIO WORLD, 145 West 45th Street, New York City
(Just East of Broadway)

Enclosed please find \$3.00 for which send at once at your expense one copy of "A B C of Television, or, Seeing by Radio," by Raymond Francis Yates, as advertised.

NAME.....

ADDRESS.....

CITY..... STATE.....

FULL EXPOSITION OF HB COMPACT, BATTERY MODEL

Complete details on the theory and construction of the HB Compact were published in a four-part article in Radio World, written by Herman Bernard, designer of the circuit and inventor of the Bernard Dynamic Tuners used in the circuit. Full details on how to wind your own coils. Full-sized pictorial diagram of the wiring. Order the August 24th, 31st, September 7th and 14th issues, 60¢—

RADIO WORLD, 145 West 45th Street, New York, N. Y.

MORECROFT wrote a great book when he turned out "Principles of Radio Communication." Second edition now ready. Price \$7.50. Radio World, 145 W. 45th St., N. Y. City.

"AERIAL NAVIGATION and METEOROLOGY." By Capt. Yancey, \$4.00 postpaid. Radio World, 145 W. 45th St., N. Y. City.

RADIO AND OTHER TECHNICAL BOOKS At a Glance

- RADIO**
- "Audio Power Amplifiers," by Anderson and Bernard\$3.50
 - "Elements of Radio Communication," by Morecroft 3.00
 - "Foothold on Radio, A," by Anderson and Bernard 1.00
 - "Mathematics of Radio," by Rider..... 2.00
 - "Practical Radio," by Moyer & Wostrel..... 2.50
 - "Practical Radio Construction and Repairing," by Moyer & Wostrel..... 2.00
 - "Principles of Radio Communication," by Morecroft 7.50
 - "Radio Blueprint Library"—AC Hook-ups..... 35
 - "Radio Cyclopaedia," by Drake..... 6.00
 - "Radio Receiving Tubes," by Moyer & Wostrel 2.50
 - "Superheterodyne Construction and Operation," by Lacault25
 - "Thermionic Vacuum Tube, The," by Van der Bijl 5.00
 - "Trouble Shooter's Manual," by Rider..... 3.50
- TELEVISION**
- "A B C of Television," by Yates..... 3.00
- AVIATION**
- "A B C of Aviation," by Maj. Page..... 1.00
 - "Aerial Navigation and Meteorology," by Capt. Yancy 4.00
 - "Everybody's Aviation Guide," by Maj. Page 4.00
 - "Ford Model 'A' Car," Its Construction, Operation and Repair—by Maj. Page..... 2.00
 - "Modern Aircraft," by Maj. Page..... 5.00
 - "Modern Aviation Engines," by Maj. Page... 9.00

RADIO WORLD
145 West 45th Street
New York, N. Y.
(Just East of Broadway)

NEW Morecroft

"Elements of Radio Communication," by Prof. John H. Morecroft, of the Engineering Department of Columbia University, is the latest book on radio by this outstanding authority.

This book is entirely new and contains matter which never before has been published. It is written in plain language so that every radio novice can understand it, yet it is a complete course in the elements of radio.

It contains 266 pages, 170 illustrations and a complete index. Price \$3.00.

RADIO WORLD

145 West 45th St., New York, N. Y.

TELEVISION and all about it in "A B C of Television," by Raymond Francis Yates. \$3 post-paid. Radio World, 145 W. 45th St., N. Y. City.

4-GANG CONDENSER

With Trimmers
Built in

\$3.95

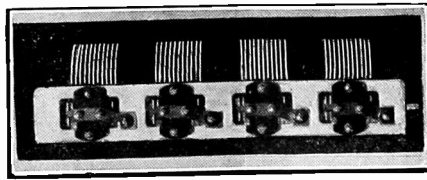

Capacity of each of the four sections is .00035 mfd. Overall length 11". Accurate capacity and precise alignment. Used in HB33 and HB44.

GUARANTY RADIO GOODS CO.
143 West 45th Street New York
[Just East of Broadway]

New DRAKE'S ENCYCLOPEDIA

A reference work that has subjects classified in alphabetical order.

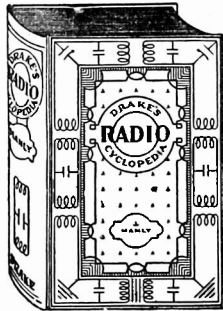

Each rule, fact, method, plan, layout and diagram is instantly picked out and separated from everything else by placing all subjects in alphabetical order with cross references for every imaginable name under which the information might be classed.

This alphabetical arrangement lets the experienced worker refer directly to the one thing in which he is interested at the moment without hunting through non-essentials. The needs of the beginner are cared for.

The important articles deal primarily with receivers and reception. They do not stop with the electrical end, but go also into the mechanics of construction.

Every new thing in radio is covered in detail.

BOOK IS 2 1/2" THICK,
WEIGHS 3 1/4 LBS., 1,025
ILLUSTRATIONS.

1,680 Alphabetical Headings from A-battery to Zero Beat
1,025 Illustrations, Diagrams, Layouts and Graphs
920 Pages, Each 8 by 9 inches
240 Combinations for Receiver Layouts
OF THE PRINCIPAL ARTICLES

159 Concern service men, 129 help the set builder, 182 help the experimenter, 155 interest the student, 75 assist in sales work, 73 interest set owners.

PRICE, \$6.00

Remit with order and we pay cartage. Canadian remittance must be by postal or express money order Order C. O. D. and you pay cartage.

RADIO WORLD, 145 W. 45th St., N. Y. City

MICROPHONE LIGHTERS

for cigars or cigarettes, with button switch at top. Press the switch and light up!

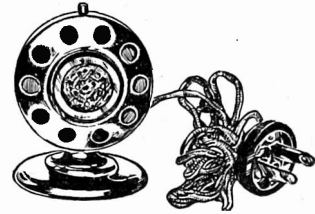

Model A lighter, microphone design, with 5-ft. AC cable and plug. Works on 110 volts, AC any frequency and on direct current. Price \$1.00



Model B lighter, microphone design, on tray, with 5-ft AC cable and plug. Works on 110 volt AC, any frequency, and on direct current. Exactly the same lighter as the other, only tray is added. Price.....\$1.50

This lighter is instantaneous. Hold button down only long enough to light a cigar or cigarette. The two models are furnished in attractive sprayed finish. Both are very compact! For instance, the tray is only 4 1/2" in diameter. Use these lighters in your home and for holiday gifts.

he heater element is renewable. Price 35 cents.

RADIO WORLD, 145 West 45th St., N. Y. City
 Please send me Model A Microphone Lighter at \$1.00.
 Please send me Model B at \$1.50.
 Enclosed is remittance [Canadian must be P.O. or express money order.]
 Ship C. O. D.

Name:
Address
City..... State.....

NATIONAL SCREEN GRID TUNER

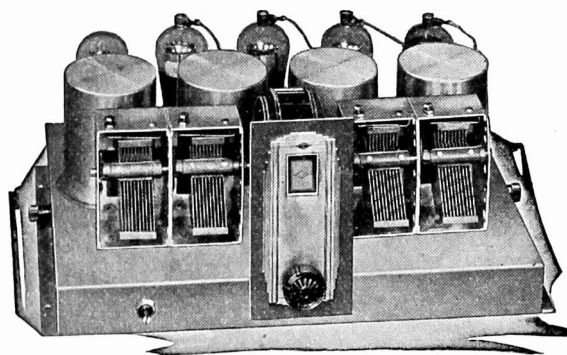

The most sensitive tuned radio frequency tuner so far developed, the MB-29 is long on distant reception, and penetrates seemingly unsurmountable barriers to reception. On the MB-29 the stations come in no matter where you are. The MB-29, designed by James Millen and Prof. Glen H. Browning, is the choice of the most discriminating. It is designed only for AC operation, uses four stages of screen grid RF and a power detector (227). Use 135 to 180 volts on the detector. Testimonials from radio's hardest-boiled experts prove this is the circuit of circuits. Buy the parts and find fullest radio delight. You will be sure nobody else has a tuner as good as yours, unless he too has an MB-29. Complete component parts for National Screen Grid Tuner MB-29, mounted on frosted aluminum chassis, including rainbow modern-istic drum dial HC. Order catalog No. MB-29-K list price, less tubes \$69.50. Your price

WRITE FOR WHOLESALE PRICES

143 WEST 45TH STREET

GUARANTY RADIO GOODS CO.

NEW YORK CITY

RADIO WORLD, a weekly paper published by Hennessy Radio Publications Corporation, from Publication Office, 145 West 45th Street, New York, N. Y. Vol. XVI, No. 18. Whole No. 408. January 18th, 1930. 15c per copy, \$6.00 per year. [Entered as second-class matter, March, 1922, at the Post Office at New York, N. Y., under act of March, 1879.] Roland Burke Hennessy, president and treasurer; M. B. Hennessy, vice-president; Herman Bernard, business manager and managing editor; J. E. Anderson, technical editor.

MB-29

Push-Pull Amplifier

The National Velvetone Push-Pull Power Amplifier (shown at right) consists of an AC-operated filament-plate supply, with two stage transformer audio amplifier and output transformer built in. Made only for 110-V., 50-60 cycles. Sold only in completely wired form, licensed under RCA patents.

The new Power Amplifier has been developed and built to get the very most out of the MB-29. It is a combination power supply and audio amplifier, using a 280 tube for a rectifier, one stage of transformer audio with a 227 tube and a stage of push pull amplification with two 245s. It furnishes all power for itself and for the MB-29, as well as the audio channel. Order catalog PPPA, list price, completely wired and equipped with phonograph jack, (less tubes) \$97.50. Your price.

WRITE FOR WHOLESALE PRICES

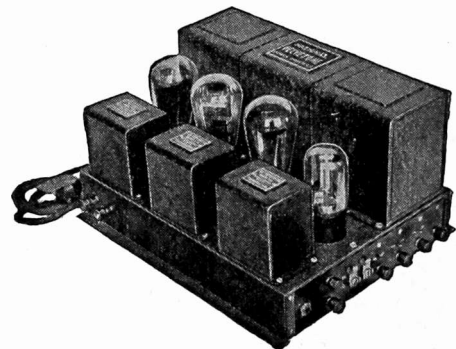

View of National Velvetone Push-Pull Power Amplifier, an expertly made A, B and C supply and audio amplifier, producing marvelous tone quality.

O-1 MA, \$5.95

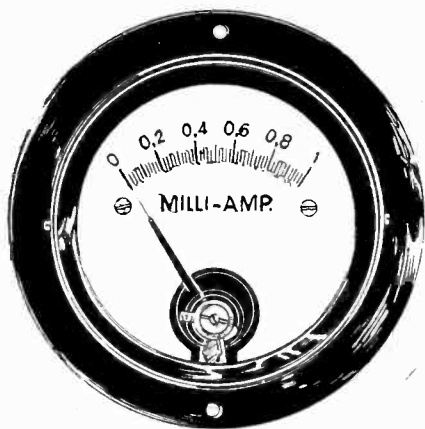

Here is a 0-1 milliammeter, accurate to plus or minus 1% clearly legible to two-one hundredths of a milliampere at any reading (20 microamperes). This expertly made precision instrument is offered at the lowest price so far for a 0-1 ma. Order Cat. FO-1 at \$5.95. C. O. D. orders accepted.

Guaranty Radio Goods Co.
143 West 45th Street,
New York City

AERIAL TUNER

Improves Your Reception

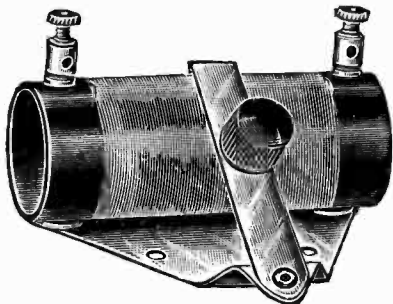

Remove aerial lead from set. Connect aerial instead to one of the binding posts of the Aerial Tuner. Connect the other binding post of the Aerial Tuner to antenna post of your set. Then move the lever of the Aerial Tuner until any weak station comes in loudest. The lever need not be moved for every different frequency tuned in. The Aerial Tuner acts as an antenna loading coil and puts the antenna's frequency at any frequency in the broadcast band that you desire to build up. Price, 85c.

GUARANTY RADIO GOODS CO.
143 West 45th Street
New York City
(Just East of Broadway)

BRILLIANT, NEW
NATIONAL
MODERNISTIC PROJECTION DIAL
WITH RAINBOW FEATURE

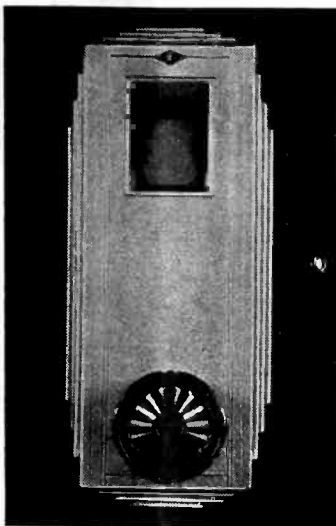

Modernize the appearance of your receiver by installing the brilliant new National dial, with color wheel built in, so that as you turn the dial knob one color after another floods the screen on which the dial numbers are read. On this screen the numbers are projected, so that you get the same dial reading from any position of the eye. This is just what DX hunters want—laboratory precision of dial reading.

The escutcheon is of modernistic design. The Velvet Vernier mechanism drives the drum superbly. Order today. Remit with order and we pay cartage. Shipments day following receipt of order.

GUARANTY RADIO GOODS CO.

143 W. 45th St., N. Y. City (Just E. of B'way)
Enclosed please find \$3.13 for which please send me dial marked below:
 Cat. HC6, National modernistic drum dial, with color wheel built in, pilot bracket, 6-volt pilot lamp for storage battery or A eliminator sets; hardware; instructions \$3.13
 Cat. HC2½, same as above, but with 2½-volt AC pilot lamp \$1.13
 Order C.O.D. and I pay cartage.

NAME

ADDRESS

CITY STATE

Hi-Q 30
Wholesale
Prices!

Write or wire!

Guaranty Radio Goods Co.
143 West 45th St.,
New York City

NATIONAL

Velvet B Eliminator \$16.13
180 Volts (280 Tube Free)



Latest Model National Velvet-B, Type 8580, is handsome crackle finish black metal casing, for use with sets up to and including six tubes. Input 105-120 volts AC, 50 to 60 cycles. Output, 18½ volts maximum at 35 milliamperes. Three variable output intermediate voltages. (Det., R.F., A.F.) Eliminator has excellent filter system to eliminate hum, including 30 henry choke and 18 mfd Marshon condenser. No motorboating!
(Eliminator Licensed under patents of the Radio Corporation of America and associated companies.)

Guaranty Radio Goods Co.
143 W. 45TH STREET
(Just East of Broadway)
NEW YORK CITY

New Junior Model
POLO UNIT \$4

The famous twin magnet principle for double sensitivity, large magnets for great flux, permanently adjusted armature, all are in the new junior model Polo Unit. Weight, 2¼ lbs. Stands 150 volts unfiltered. Stands up to 250 push-pull filtered. Works any output tube, power or otherwise. Supplied with 10-ft. cord. Order unit now. Five-day money-back guarantee Shipped C. O. D. if desired.

Acoustical Engineering
Associates
143 West 45th Street
New York City
(Just East of Broadway)

Blueprint FREE!

Get a free blueprint of either circuit listed on the coupon below, by sending \$1.00 for eight weeks' subscription for RADIO WORLD, or send \$1.50 for 13 weeks' (quarter of a year) and get both blueprints free!
RADIO WORLD, 145 W. 45th St., N. Y. City
Enclosed please find:
 \$1 for which send RADIO WORLD for 8 weeks and send free blueprint of the battery model 4-tube Screen Grid Diamond of the Air.
 \$1 for which send RADIO WORLD for 8 weeks and send free blueprint of the 4-tube AC Screen Grid Diamond of the Air.
 \$1.50 for which send RADIO WORLD for 13 weeks and send both blueprints free. (If renewing a subscription put cross here.)

NAME

ADDRESS

CITY..... STATE.....

Quick Action Classified Ads

Radio World's Speedy Medium for Enterprise and Sales

10 cents a word — 10 words minimum — Cash with Order

ARISTOCRAT FLOOR SPEAKER—With Molded Wood Horn and Horn Motor built in. Great value. \$14.00. Acoustical Engineering Associates, 143 W. 45th St., N. Y. C.

POLO 245 POWER SUPPLY. Read all about it on another page of this issue. Polo Engineering Laboratories, 57 Dey St., N. Y. City.

EDISON STORAGE BATTERIES—100 volts \$6.50; ¼ Horsepower Alternating Motors \$7.00. Hoffmann Electrical Shops, 904 North Fifth. Philadelphia, Pa.

BE SURE TO READ the advertisement on another page of this issue about the HB Compact Guaranty Radio Goods Co., 143 W. 45th St. N. Y. City

"MATHEMATICS OF RADIO."—A great help to everybody interested in radio. \$2 postpaid. Radio World, 145 W. 45th St., N. Y. City.

DISTON ELIMINATORS \$6.95. Edison Batteries \$1.95. Audio Transformers 95c. Western Electric Amplifier \$14.00. Get our big bargain list sets and parts. Quality Radio Shop, Richmond, Indiana.

USED RADIO PARTS. Very low prices. Mack Gamble, Hannibal, Ohio.

TWO FOR ONE. Radio World for 52 weeks and Radio News twelve months at the combination rate of \$7. Radio World, 145 W. 45th St., N. Y.

WORLD'S BEST AVIATION BOOKS: "A B C of Aviation," \$1.00; "Modern Aviation Engines," \$9.00 postpaid. Both by Maj. Page. "Aerial Navigation and Meteorology," By Capt. Yancey. \$4.00 postpaid. Radio World, 145 W. 45th St., N. Y. City.

OUTDOOR WORK—Get Outdoor Govt. Jobs; \$1,860 year. Patrol forests; protect game. Write for details. Bradley Institute, All, Denver, Colo.

"AUDIO POWER AMPLIFIERS," by J. E. Anderson and Herman Bernard, the first and only book on the subject. \$3.50. Hennessy Radio Publications Corporation, 145 West 45th St., N. Y. City.

A. C. TUBES—Manufactured by licensed R.C.A. manufacturer. UX250—.95 UX224—.85 UX245—.85 UX227—.80 UX280—.75 UX226—.65. Charles Blackmore, Windsor, Missouri.

"EVERYBODY'S AVIATION GUIDE." By Maj. Page. \$2 postpaid. Also "Modern Aircraft" by same author. \$5. postpaid. Radio World, 145 W. 45th St., N. Y. City.

Short Wave Circuit

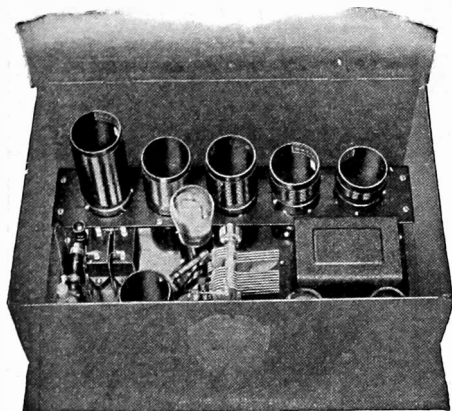

National Thrill Box, 4-tube short wave circuit, 15 to 535 meters, battery-operation of filament; B supply, either batteries or eliminator.

Get a real kick out of listening to foreign stations on a real short-wave circuit, the National Thrill Box. Uses one 222 screen grid RF amplifier, one 200A detector, one 240 first audio and one 171A or 112A output. Single control. Buy the parts and build the circuit in two hours. Data sheet shows dial settings where foreign stations come in. Cat. SW4EF, all parts, including decorative brown steel cabinet, all six plug-in coils, list price \$51.90 (less tubes). Write for wholesale prices.

Guaranty Radio Goods Co.
143 West 45th Street New York City

Horn Unit \$2.25

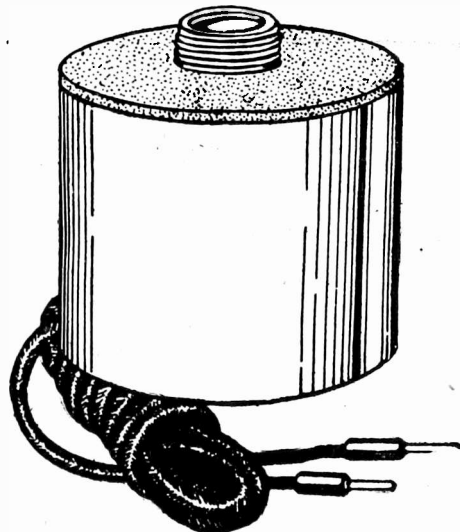

This unit is pre-eminent for horn-type speakers such as the exponential horns or other long tone travel horns. The faintest word from a "whispering tenor" or the tumultuous shout of the crowd or highest crescendo of the band is brought out clearly, distinctly. Stands up to 450 volts with out filtering. Works right out of your set's power tube, requiring no extra voltage source. Standard size nozzle and cap are die-cast aluminum, one piece, with milled platinum-like finish. The casing is full nickel, of highest possible polish. Works great from AC set, battery set or any other set, push-pull or otherwise.

For Portable Use

This unit can be used in a portable without any horn attached and will give loud reproduction. Order Cat. 225, with 4 1/2 ft. cord attached. (Shipping weight, 2 lbs.) \$2.25

Air-Column Horn

8-ft. tone travel molded wood horn (less unit No. 225) is obtainable already mounted in a baffle box. Outside overall dimensions of baffle box, 21 1/4" high, 18" wide, 15" front to back. Shipping weight, 27 lbs. Order Cat. 596 @ \$8.00.

Acoustical Engineering Associates,
145 W 45th St., N. Y. City (Just E. of Bway).

Please ship C. O. D.
 Cat. No. 225 @ \$2.25 Cat. No. 596 @ \$8.00

Name

Address

City State

FIVE-DAY MONEY-BACK GUARANTEE

Tone That Thrills!

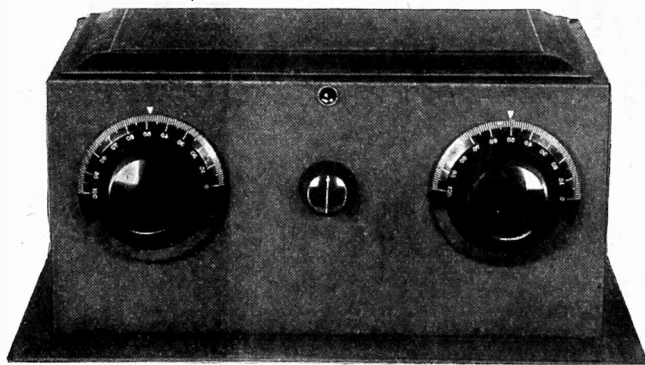

Build the
HB Compact
(Battery model)

\$18.55

Front view of the HB Compact, battery model, the simple 4-tube receiver that works a speaker at high volume and produces tone that is of the very purest kind. Cabinet is only 15" wide, 9 1/2" front to back, 7" high.

Everybody is delighted with the exquisite tone of the HB Compact, battery model. "Never heard anything like it," is the usual comment. The receiver uses a 222 screen grid tube for RF, 240 bias detector, 222 first audio and 112A power tube. Draws only .75 ampere filament, 18 milliampere plate current. Very economical to run. B batteries last 6 months or more. Plentifully selective and sensitive. Build it now!

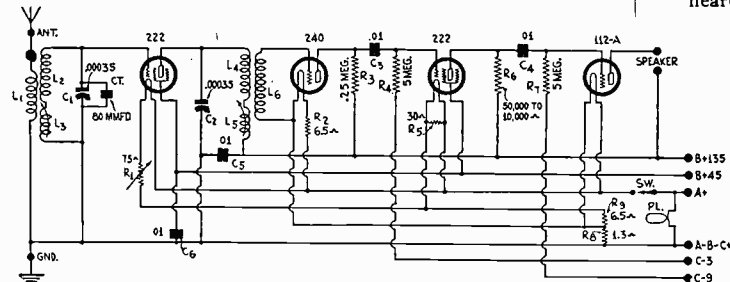

Follow this diagram of the HB Compact, battery model, when building this tone-marvelous receiver.

LIST OF PARTS

[Check off what parts you want]

- L1L2L3—Antenna coil, BT3A..... 1.35
- L4L5L6—Interstage coil, BT3B..... 1.35
- C1, C2—Two .00035 mfd., brackets..... 2.00
- CT—Hammarlund 80 mmfd..... .35
- C3, C4, C5, C6—Four .01 mfd. mica fixed..... 1.40
- R1, SW—75 ohm switch rheostat..... .80
- R2, R9—Two 6.5 ohm filament resistors..... .50
- R3, R4, R6, R7—0.25, 5.0, 0.05 and 5.0 meg. with 4 mounts..... 1.65
- R5—30 ohm filament resistor..... .45
- R8—1.3 ohm filament resistor..... .20
- Ant., gnd., Sp. (+), Sp. (—)—Four posts..... .40
- PL—Pilot lamp 6v. and bracket..... .70
- Drilled, socketed steel subpanel 9 1/2 x 14 1/4"..... 2.00
- Crinkle brown steel cabinet, 7x9 1/2 x 15"..... 3.50
- Two metal links..... .20
- Seven leads for battery cable..... .70
- Two Dials..... 1.00
- All parts..... \$18.55
- Tubes: two 222, one 240, one 112A..... \$ 5.79

The HB Compact, battery model, designed by Herman Bernard, has tone quality second to none. All who appreciate music will revel in the delightful tone of this amazing circuit.

Send in your order for parts today to Guaranty Radio Goods Co., 143 West 45th Street, New York, N. Y., just E. of B'way. Use Coupon.

Name

Address

City State

Guaranty Radio Goods Co., 143 West 45th St., New York.

Two for the price of One

Get a FREE one-year subscription for any ONE of these magazines:

- CITIZENS RADIO CALL BOOK AND SCIENTIFIC DIGEST (quarterly, four issues).
- RADIO (monthly, 12 issues; exclusively trade magazine).
- RADIO ENGINEERING (monthly, 12 issues; technical and trade magazine).
- SCIENCE & INVENTION (monthly, 12 issues; scientific magazine, with some radio technical articles).
- AMERICAN BOY—YOUTH'S COMPANION (monthly, 12 issues; popular magazine).
- BOYS' LIFE (monthly, 12 issues; popular magazine).

Select any one of these magazines and get it FREE for an entire year by sending in a year's subscription for RADIO WORLD at the regular price, \$6.00. Cash in now on this opportunity to get RADIO WORLD WEEKLY, 52 weeks, at the standard price for such subscription, plus a full year's subscription for any ONE of the other enumerated magazines FREE! Put a cross in the square next to the magazine of your choice, in the above list, fill out the coupon below, and mail \$6 check, money order or stamps to RADIO WORLD, 145 West 45th Street, New York, N. Y. (Just East of Broadway).

Your Name

Your Street Address

City State

If renewing an existing or expiring subscription for RADIO WORLD, please put a cross in square at beginning of this sentence.

RADIO WORLD, 145 West 45th Street, New York, N. Y. (Just East of Broadway)

A GREAT ADVERTISING MEDIUM
That describes Radio World. Rates on application. Radio World, 145 W. 45th St., N. Y. City.

HIGH RESISTANCE PHONES \$1.65
You can't beat them at the price. Send now. Guaranty Radio Goods Co., 143 W. 45th St., N. Y. C.

DOUBLE

VALUE!

RADIO WORLD BOOK SERVICE

AS the first and only national radio weekly, now in its eighth year, RADIO WORLD publishes the most timely, up-to-date news of radio circuits and events in the set-building and broadcasting fields. Technical accuracy second to none. Get a copy at your news-stand today, 15c. RADIO WORLD advises impartially on all radio topics, including what text books to buy, and helps you to read the books properly. Every book advertised on this page is essential to your radio library.

Five New Volumes Offer Short-Cut to Knowledge!

MORECROFT

"Elements of Radio Communication"

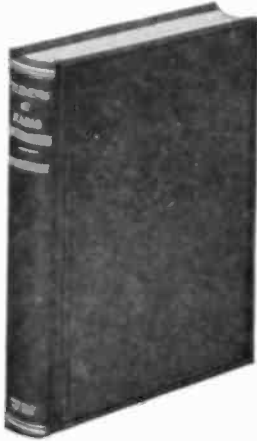

The latest book by Prof. John H. Morecroft, of the Engineering Department of Columbia University, and past president of the Institute of Radio Engineers, is his "Elements of Radio Communication," a book for the novice to enjoy. We regard this as the best elementary book to inform you authoritatively on the technical phases of radio in plain language, without requirement of mathematical knowledge. The book is a complete course on the elements of radio, containing much material never before published. It has 226 pages, 170 illustrations and a complete index. Just out, it is the book of the year in radio. Cloth bound. Order Cat. ME @\$3.00

By the same author: "Principles of Radio Communication," second (new) edition. This book is for advanced students. It is the standard of excellence in its field. It covers much the same ground as the later book, only much more fully and more technically. Contains 1,001 pages, 831 illustrations. Cloth bound. Order Cat. MP @ \$7.50

MOYER and WOSTREL

"Radio Receiving Tubes"

The need for an elementary book on radio tubes that answers all the important questions has been filled by James A. Moyer, Director of University Extension, Massachusetts Department of Education, and John F. Wostrel, Instructor in Radio Engineering, Division of University Extension, Massachusetts Department of Education.

This new book is a complete discussion of tube principles, functions and uses, thoroughly up-to-date. In this book the essential principles underlying the operation of vacuum tubes are explained in as non-technical a manner as is consistent with accuracy. The book covers the construction, action, reactivation, testing and use of vacuum tubes as well as specifications for vacuum tubes and applications for distant control of industrial processes and precision measurements. 297 pages, cloth bound. Order Cat. MWT @\$2.50

By the same authors: "Practical Radio," including the testing of radio receiving sets. 376 pages, 223 illustrations. Cloth bound. Order Cat. MWPE @\$2.50
"Practical Radio Construction and Repairing," 319 pages, a companion volume. Order Cat. MWPEC @\$2.00
[NOTE: The standard book on tubes for advanced students: "The Thermionic Vacuum Tube," by Hendrik Van der Bijl. Order Cat. VDB @\$5.00]

ANDERSON and BERNARD

"Power Amplifiers"

Here is the first book to be published on the subject of "Power Amplifiers." Now printing, it is certain to fill a void in radio literature. The whole subject is fully covered in a masterful theoretical discussion of audio amplifiers and power supplies, supplemented by constructional chapters, with complete wiring diagrams and specification of parts. Learn while you build! J. E. Anderson, M. A., technical editor of RADIO WORLD, and Herman Bernard, L. L. B., managing editor of RADIO WORLD, both of the Institute of Radio Engineers, have explained fully the phenomena of power amplifiers. Learn all about motorboating and its cures, push-pull theory and practice, grid bias methods and effects, vacuum tubes in audio circuits, AC and battery type AF amplifiers, phase relationships, common impedance, filter systems, by-pass condenser effects, necessities for tone quality, values of coupling constants, and a host of other topics associated with power amplification, including speech amplifiers and "talkie" installations.

More than 200 pages and more than 100 illustrations are devoted to an analysis of this outstanding radio subject. "Power Amplifiers" is authoritative, original and comprehensive. It is free from the traditional errors that have crept into this subject. The theoretical part of the book can be understood by most novices, while the constructional part, that capitalizes the previously imparted knowledge, is thoroughly understandable by anybody. There is virtually no mathematics in the book. Cloth bound. Order Cat. PAM @\$3.50

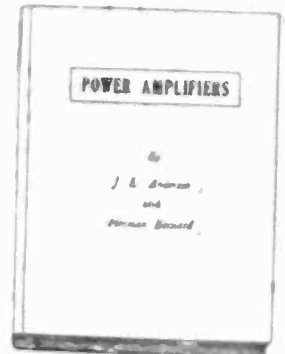

RIDER

"Service Man's Manual"

Two new books by John F. Rider, M. E., Member, Institute of Radio Engineers, constitute the series grouped by him under the heading "Service Man's Manual." Part I is "Mathematics of Radio." Part II is "Trouble Shooter's Manual."

The value of one of these books is more than doubled by the possession of the other.

"The Mathematics of Radio," 128 pages, 8 1/2" x 11", 119 illustrations, bridges the gap between the novice and the college professor. It gives a theoretical background so necessary for a proper understanding of radio and audio circuits and their servicing. Flexible cover. Order Cat. MOR @\$2.00

The first comprehensive volume devoted exclusively to the topic uppermost in every service man's mind is "Trouble Shooter's Manual," just published. It is not only a treatise for service men, telling them how to overcome their most serious problems, and fully diagramming the solutions, but it is a course in how to become a service man. It gives all the details of servicing as they have never been given before. Finding the right mode of attack, applying the remedy promptly and obtaining the actual factory-drawn diagrams of receivers always have been a big load on the service man's chest. But no more. Rider, expert on trouble shooting, has produced the outstanding volume on servicing, and has taken the load off the service man's chest!

This book is worth hundreds of dollars to any one who shoots trouble in receivers—whether they be factory-made, custom-built or home-made receivers. The home experimenter, the radio engineer, the custom set-builder, the teacher, the student—all will find this new book immensely informative and absolutely authoritative.

MORE THAN 100 WIRING DIAGRAMS OF RECEIVERS MADE BY MORE THAN FORTY DIFFERENT SET MANUFACTURERS ARE PUBLISHED IN THIS BOOK, INCLUDING OLD MODELS AND LATEST MODELS! RCA, ATWATER KENT, CROSBLEY, MAJESTIC, ZENITH, STROMBERG CARLSON, KOLSTER, FEDERAL, FADA, Etc. 340 pages, size 5 1/2" x 11"; 200 illustrations. Imitation leather cover. Order Cat. TSM @\$3.50



Read Radio World Every Week

RADIO WORLD will help you in your radio work, so you will be able to use meters most valuably. Keep abreast of new circuits, intimate details on perfecting existing sets, get inside track on sensitivity, distance reception, tone quality, and news of radio, technical and non-technical. Enjoy the writings of McMurdo Silver, J. E. Anderson, Herman Bernard, John F. Rider and a host of other radio engineers in RADIO WORLD. You can find no magazine that better caters to your needs than RADIO WORLD. Short waves? RADIO WORLD is fully discussed with consistent regularity. Power supplies—push-pull or otherwise? AC receivers? Screen grid tubes? Large receivers that give a super-abundance of performance—small, economical receivers that give performance out of all comparison to their size? Are you interested in these? Then you're interested in RADIO WORLD.

See the list of nine meters at left. Obtain one or more of these meters free, by sending in \$1 for 8-weeks' subscription, entitling you to one meter; \$2 for 16 weeks, entitling you to two meters; \$3 for 26 weeks, entitling you to three meters; \$4 for 35 weeks, entitling you to four meters; \$5 for 44 weeks, entitling you to 5 meters; \$6 for 52 weeks, entitling you to six meters.

Present RADIO WORLD mail subscribers may renew their subscription under this remarkably generous offer. Put a cross in square.

RADIO WORLD

145 W. 45th St., N. Y. City—Published Weekly.
All Newsstands, 15c per copy—\$3. six months—\$6 a year

Gentlemen: Enclosed find \$..... for which please send items checked on coupon. (R-10)

- 0-6 Voltmeter D.C. Cat. 326
- 0-50 Voltmeter D.C. Cat. 337
- 6-Volt Charge Tester D.C. Cat. 23
- 0-10 Amperes D.C. Cat. 338
- 0-25 Milliamperes D.C. Cat. 325
- 0-50 Milliamperes D.C. Cat. 350
- 0-100 Milliamperes D.C. Cat. 390
- 0-300 Milliamperes D.C. Cat. 399
- 0-600 Milliamperes D.C. Cat. 394

- CAT. ME @\$3.00
- CAT. MP @\$7.50
- CAT. PAM @\$3.50
- CAT. MWT @\$2.50
- CAT. MWPR @\$2.50
- CAT. MWPRC @\$2.00
- CAT. MOR @\$2.00
- CAT. TSM @\$3.50
- CAT. VDB @\$5.00

- CAT. 326 Name
- CAT. 327
- CAT. 23
- CAT. 338
- CAT. 325 Address
- CAT. 350
- CAT. 390
- CAT. 399
- CAT. 394 City

State.....

TRIAL SUBSCRIPTION, 8 WEEKS, \$1.00. Send \$1 and we will send you Radio World for 8 weeks, postpaid. RADIO WORLD, 145 West 45th St., N. Y. City.

TWO FOR PRICE OF ONE!
Radio World, 52 issues, and Radio News, 12 issues, in combination for special \$7 subscription price. Radio World, 145 W. 45th St., N. Y. City.

RECENT NUMBERS
for the late last year are procurable at the rate of 15c a copy, or 7 copies for \$1.00. RADIO WORLD, 145 West 45th St., N. Y. City.

Parts for BERNARD TWO-TUBE TUNER

Using 222 and 201A for Battery Operation—Order what parts you desire.

- L1L2L3, C1, socket, link, base, .00035 mfd. tuning condenser—One Bernard tuner assembly for left-hand position when using a drum dial, socket for DC screen grid tube 222 (Cat. BT-L-DC)..... \$3.00
- L4L5L6, C2, socket, link, base, .00035 mfd. tuning condenser—One Bernard tuner assembly for right-hand position when using drum dial; socket for four-prong DC tube, 201A, 240, 112A, etc. (Cat. BT-R-DC)..... 3.00
- R1—One 75 ohm. rheostat..... .67
- R2—One 6.5 ohm. filament resistor..... .25
- R3—One 5 meg. grid leak..... .30
- R4—One 4 ohm. filament resistor..... .20
- C3, C4—Two .01 mfd. mica dielectric fixed condensers..... .70
- C5—One .00025 mfd. mica dielectric fixed condenser with clips..... .95
- C6—One .00025 mfd. mica dielectric fixed condensers..... .20
- SW—One A battery switch..... .40
- Ant., Gnd., A minus, A plus, B plus 45, B plus 135 and P, seven binding posts..... .70
- One National Velvet Vernier Modernistic dial, with rainbow feature and pilot light and bracket. 3.13
- One drilled front panel, 7x18", black bakelite. 1.80
- All parts \$17.60
- All parts for AC Tuner, including fil. trans..... \$22.10

Your Name

Your Address

- If C.O.D. is desired put cross here.
- If remittance enclosed put cross here. Canadian remittance must be express or P.O. money order.

GUARANTY RADIO GOODS CO.,
143 West 45th Street, N. Y. City
Just East of Broadway.

CONE ASSEMBLY WITH DOUBLE MAGNET UNIT

\$4.95



An excellent magnetic type speaker for installation in any cabinet. The unit is a double-magnet Paratone, with two magnet coils, for utmost sensitivity. Each horseshoe magnet is 3/4" thick. The magnet coils are forever protected against dust and other foreign, injurious substances, by special bakelite housings. The pin is reverse-drive. The cone frame is metal. The 9" cone is specially treated buckram.

All assembled, with long cord, ready to play. Shipping weight 6 lbs. \$4.95 (Cat. CAS) Net

The unit alone (cord included). It will operate any type sounding surface, including paper, cloth, wood, etc. Shipping weight 4 lbs. (Cat. UA). \$2.95 Net

Guaranty Radio Goods Co.
145 West 45th St., New York City

MORECROFT

New second edition of "Principles of Radio Communication," by Prof. John H. Morecroft, of the Electrical Engineering Department of Columbia University and past president of the Institute of Electrical Engineers. This is an outstanding and authoritative book on the subject.

This large book on radio principles and practice is something that you must not be without. Every set builder, every designer, every engineer, every service man, simply must have this book. Ready reference to all intricate problems makes this volume invaluable. Set builders, experimenters, distributors, dealers, salesmen and teachers, students and operators, all find Morecroft their standby, and now the new second edition awaits you. 1,001 pages and 83 illustrations in this cloth-bound volume.

Price \$7.50

RADIO WORLD
145 West 45th Street
New York City
(Just East of Broadway)

MICROPHONE LIGHTERS

For cigars or cigarettes, with button switch at top. Press switch, and lighter acts instantaneously. \$1.00. Model B lighter on tray, \$1.50. Radio World, 145 W. 45th St., N. Y. C.

Aristocrat Floor Speaker

With Molded Wood Horn of 8 ft. \$12.00
tone travel (exponential type) with baffle and horn motor built in. Extraordinary bargain.

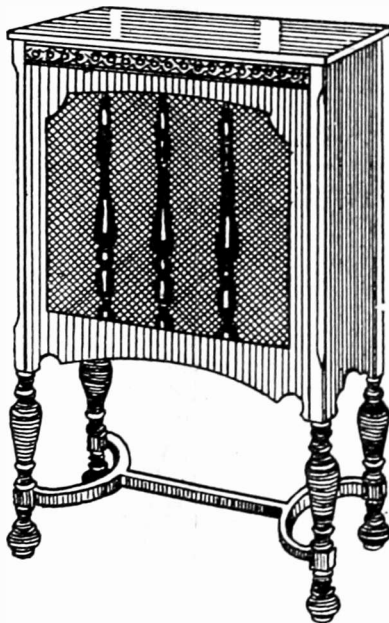

The speaker cabinet is walnut finish, 33" high, 24 1/2" wide, 17 1/2" deep, with carved legs. Golden cloth grille covers front opening. Built inside is No. 595 molded wood horn with baffle and No. 203 driving motor unit that stands 250 volts without filtration. Horn and motor removable. Table alone is worth price asked. Shipped C.O.D. if desired.

Acoustical Engineering Associates
143 WEST 45th STREET NEW YORK CITY

0-60,0-300

HIGH RESISTANCE

DC VOLTMETER

With three 28" tipped leads built in



A portable type, high resistance meter, 2 1/2" outside diameter, for close reading of direct current voltages up to 60 volts, and for reading DC voltages up to 300 volts. Three vari-colored 28" insulated leads, with jack tips, are built in. Black is minus, yellow is 0 volts maximum and red is 300 volts maximum. These voltages are marked at the meter outlets. Cat. J-246. Net price, \$2.28.

J-246 Voltmeter, for measuring all direct current voltages, including B eliminators. 0-60, 0-300 (double range).

Multiplier, with jack terminals, to increase range 0-300 range to 0-600. Cat. J-106JT (with jack terminals), net price, \$1.18.

GUARANTY RADIO GOODS CO.

143 West 45th St., N. Y. City

RADIO WORLD and "RADIO NEWS"

BOTH FOR ONE YEAR @ \$7.00

You can obtain the two leading radio technical magazines that cater to experimenters, service men and students. The first and only national radio weekly and the leading monthly, for one year each, at a saving of \$1.00. The regular mail subscription rate for Radio World for one year, a new and fascinating copy each week for 52 weeks, is \$6.00. Send in \$1.00 extra, get "Radio News" also for a year—a new issue each month for twelve months. Total, 64 issues for \$7.00.

If renewing Radio World subscription, put cross square.
RADIO WORLD, 145 West 45th Street, New York, N. Y.



GUARANTY RADIO GOODS CO.
143 West 45th Street, New York, N. Y.

SUBSCRIBERS!

Look at the Expiration Date on Your Wrapper

Please look at the subscription date stamped on your last wrapper, and if that date indicates that your subscription is about to expire, please send remittance to cover your renewal.

In this way you will get your copies without interruption and keep your file complete.

SUBSCRIPTION DEPARTMENT
RADIO WORLD
145 WEST 45TH ST., N. Y. CITY

SEPARATE TESTER COMBINATION

Consists of two-meter assembly in neat black metal case, with an external high resistance meter. The two meters in the case read (a) 0-20, 0-100 milliamperes; (b) 0-10 volts, AC or DC, same meter reads both. The external high resistance meter reads 0-600 volts, AC or DC (same meter reads both). Thus you can test any plate current up to 100 ma., any filament voltage, AC or DC, up to 10 V., and any plate voltage, or line voltage or other AC or DC voltage, up to 600 volts. Five-prong plug, screen grid cable, and 4-prong adapter included. Order Cat. ST-COMB @ \$11.00 2-meter assembly, cable plugs, Cat. 215 @ \$7.06 0-600 AC-DC meter alone, Cat. M600 @ \$4.95

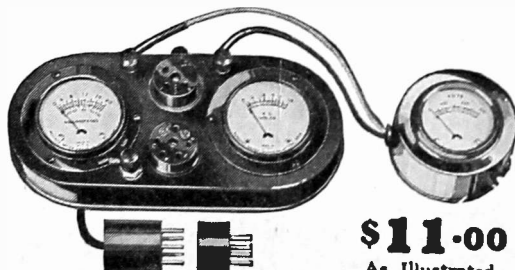

\$11.00
As Illustrated

Guaranty Radio Goods Co., 143 West 45th St., N. Y. City

THREE IMPORTANT BOOKS FOR SERVICE MEN!

"Trouble Shooter's Manual" *The most popular and fastest-selling book in radio today. Wiring diagrams of commercial receivers are contained in this outstanding book.*

"Mathematics of Radio" *A sure route to a good grasp on radio technique. Radio theory outlined so that anybody can understand it.*

"Testing Units for Service Men" *Circuits and Methods of Testing Equipment, particularly use of individual meters and of meters united in combination testers.*

These Three Books by John F. Rider Constitute an Outstanding Asset to All Possessors!

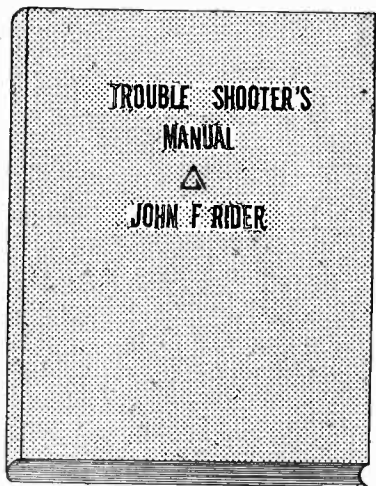

"Trouble Shooter's Manual"

is the first comprehensive volume devoted exclusively to the topic. The 240 pages include 200 illustrations devoted to wiring diagrams of factory-made receivers, besides other illustrations. It is not only a treatise for service men, telling them how to overcome their most serious problems, and fully diagramming the solutions, but is a course in how to become a service man. *This book is worth hundreds of dollars to any one who shoots trouble in receivers—whether they be factory-made, custom-built or home-made receivers.*

Besides 22 chapters covering thoroughly the field of trouble shooting, this volume contains the wiring diagrams of models, as obtained direct from the factory, a wealth of hitherto confidential wiring information released for the first time in the interest of producing better results from receivers. You will find these diagrams alone well worth the price of the book. The wiring diagrams are of new and old models, of receivers and accessories and as to some of the set manufacturers, all the models they ever produced are shown in wiring diagrams! Here is the list of receivers, etc., diagrams of which are published in this important and valuable book:

Wiring Diagrams of All These Receivers

- | | | |
|--|---|--|
| <p>R. C. A.
60, 62, 20, 64, 30, 105, 51, 16, 32, 50, 25 A.C., 28 A.C., 41, Receptor S.P.U., 17, 18, 33.</p> <p>FEDERAL
Type E series filament, Type E series filament, Type D series filament, Model K, Model H.</p> <p>ATWATER-KENT
10B, 12, 20, 30, 35, 48, 32, 33, 40, 38, 36, 37, 40, 42, 52, 50, 44, 43, 41 power units for 37, 38, 44, 43, 41.</p> <p>CROSLEY
XJ, Trirdyn 3R3, 601, 401, 401A, 608, 704, B and C supply for 704, 704A, 704B, 705, 706.</p> <p>STEWART-WARNER
300, 305, 310, 315, 320, 325, 500, 520, 525, 700, 705, 710, 715, 720, 530, 535, 750, 801, 802, 806.</p> <p>GREBE
MU1, MU2, synchrophase 5, synchrophase AC6, synchrophase ACT, Deluxe 428.</p> <p>PHILCO
Philco-electric, 82, 86.</p> <p>KOLSTER
4-tube chassis used in 6 tube sets, tuning chassis for 7 tube sets, power amplifier, 7 tube power pack and amplifier, 6 tube power pack and amplifier, 6 tube power pack and amplifier, rectifier unit K-23.</p> | <p>ZENITH
39, 39A, 392, 392A, 40A, 35PX, 35APX, 352X, 352APX, 37A, 35P, 35AP, 352P, 352AP, 34P, 342P, 33, 34, 35, 35A, 342, 352, 352A, 362, 31, 333, 353A, power supply ZE17, power supply ZE12.</p> <p>MAJESTIC
70, 70B, 180, power pack 7BP3, 7P6, 7P3 (old wiring) 8P3, 8P6, 7BP6.</p> <p>FRESHMAN
Masterpiece, equaphase, G, G-60-S power supply, L and LS, Q15, Q, K60-S power supply.</p> <p>STROMBERG-CARLSON
1A, 2B, 501, 502, 523, 524, 635, 638, 403AA power plant, 404 RA power plant.</p> <p>ALL-AMERICAN
6 tube electric, 8 tube 80, 83, 84, 85, 86, 88, 6 tube 60, 61, 62, 65, 66, u and 8 tube A.C. power pack.</p> <p>DAY FAN
OEM7, 4 tube, 5-5 tube 1925 model, Day Fan 8 A.C., power supply for 6 tube A.C., B power supply 5524 and 5525, motor generator and fletir, 6 tube motor generator set, 6 tube 110 volt D.C. set, 6 tube 32 volt D.C. set.</p> | <p>FADA
50/80A receivers, 460A, Fada 10, 11, 30, 31, 10Z, 11Z, 30Z, 31Z, 16, 17, 32, 18Z, 32Z, 18, 18, special, 192A-192S, and 192BS units, R30A, 480A, and SF 50/80A receivers, 460A receiver and R60 unit, 7 A.C. receiver, 475 UA or CA and SF45-75 UA or CA, 50, 70, 71, 72, C electric unit for special and 7 A.C. receivers, ABC 6 volt tube supply, 88V and 82V, E180Z power plant and E 420 power plant.</p> <p>FREED EISEMANN
NR5, FE18, NR70, 470, NR57, 457, NR11, NR80 D.C.</p> <p>COLONIAL
26, 31 A.C., 31 D.C.</p> <p>WORKRITE
8 tube chassis, 6 tube chassis.</p> <p>AMRAD
70, 7100, 7191 power unit.</p> <p>SPARTON
A.C. 89.</p> <p>MISCELLANEOUS
DeForest F6, D10, D17, Super Zenith Magnavox dial, Thermodyne, Grimes 4DL inverse duplex, Garod neotrodne, Garod EA, Ware 7 tube, Ware type T, Federal 102 special, Federal 59, Kennedy 220, Operadio portable, Sleeper RX1, Amrad inductrol.</p> |
|--|---|--|

HERE ARE THE 22 CHAPTER HEADINGS

- | | |
|--|--|
| <p>Service Procedure
Practical Application of Analysis
Vacuum Tubes
Operating Systems
Aerial Systems
"A" Battery Eliminators
Troubles in "A" Eliminators
Trouble Shooting in "A" Eliminators
"B" Battery Eliminators
Troubles in "B" Battery Eliminators</p> | <p>Trouble Shooting in "B" Battery Eliminators
Speakers and Types
Audio Amplifiers
Trouble Shooting in Audio Amplifiers
Troubles in Detector Systems
Radio Frequency Amplifiers
Trouble Shooting in RF Amplifiers
Series Filament Receivers
Testing, and Testing Devices
Troubles in DC Sets
Troubles in AC Sets</p> |
|--|--|

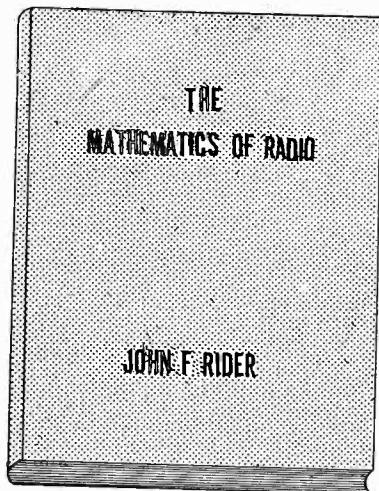

"Mathematics of Radio"

TABLE OF CONTENTS:

- OHM'S LAW.**
RESISTANCES: Basis for resistance variation, atomic structure, temperature coefficient, calculation of resistance variation, expression of ampere, volt and Ohm fractions, application of voltage drop, plate circuits, filament circuits, filament resistances, grid bias resistances.
- DC FILAMENT CIRCUITS:** Calculation of resistances.
- AC FILAMENT CIRCUITS:** Transformers, wattage rating, distribution of output voltages, voltage reducing resistances, line voltage reduction.
- CAPACITIES:** Calculation of capacity, dielectric constant condensers in parallel, condensers in series, voltage of condensers in parallel, in series, utility of parallel condensers, series condensers.
- VOLTAGE DIVIDER SYSTEMS FOR B ELIMINATORS:** Calculation of voltage divider resistances, types of voltage dividers, selection of resistances, wattage rating of resistances.
- INDUCTANCES:** Air core and iron core, types of air core inductances, unit of inductances, calculation of inductance.
- INDUCTANCE REQUIRED IN RADIO CIRCUITS:** Relation of wavelength and product of inductance and capacity, short wave coils, coils for broadcast band, coupling and mutual inductance, calculation of mutual inductance and coupling.
- REACTANCE AND IMPEDANCE:** Capacity reactance, inductance reactance, impedance.
- RESONANT CIRCUITS:** Series resonance, parallel resonance, coupled circuits, bandpass filters for radio frequency circuits.
- IRON CORE CHOKERS AND TRANSFORMERS:** Design of chokes, core, airgap, inductance, reactance, impedance, transformers, half wave, full wave windings.
- VACUUM TUBES:** Two element filament type, electronic emission, limitations, classifications of filaments, structure, two element rectifying tubes, process of rectification, tungar bulb.
- THREE ELEMENT TUBES:** Structure of tube, detector, grid bias, grid leak and condenser, amplifiers, tube constants, voltage amplification, resistance coupling, reactance coupling, transformer coupling, variation of impedance of load with frequency, tuned plate circuit.
- POWER AMPLIFICATION:** Square law, effect of load, calculation of output power, undistorted output power, parallel tubes, push-pull systems, plate resistance.
- GRAPHS AND RESPONSE CURVES:** Types of paper, utility of curves, types of curves, significance of curves, voltage amplification, power amplification, power output, radio frequency amplification.
- MULTIPLE STAGE AMPLIFIERS:** Resistance coupling, reactance coupling, tuned double impedance amplification, underlying principles, transformer coupling, turns ratio, voltage ratio, types of cores, late current limitation, grid current limitation.
- ALTERNATING CURRENT TUBES:** Temperature variation hum, voltage variation hum, relation between grid and filament, filament circuit center tap, types of AC tubes.
- SCREEN GRID TUBE:** Structural design, application, amplification, associated tuned circuits, radio frequency amplification, audio frequency amplification.

"Testing Units for Service Men."

A 43-page, liberally illustrated book on testing units and circuits. Tells what equipment a service man should have and how to use it most effectively and quickly. Rapidity of operation is one of the points stressed throughout this valuable book. A service man's time is his chief stock in trade.

CONTENTS

- Tube Reactivator and Voltages
- Calibrated Vacuum Tube Bridge
- General Utility Tube Tester
- AC-DC Receiver Tester
- Eliminator Testers
- Signal Generator for Receiver Testing
- Oscillators
- Cathode Ray Oscillograph
- Indefinite Systems
- Tube Voltmeters
- Measurement of Inductance, Impedance, Capacity, DC Resistance
- Multi-Range Meters
- Service Station Test Bench

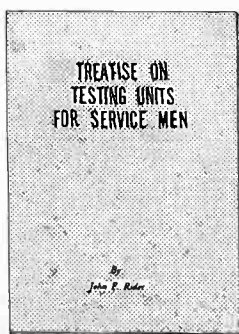

RADIO WORLD, 145 West 45th St., New York, N. Y.
(Just East of Broadway)

Enclosed please find:

- \$3.50 for which please send me postpaid "Trouble Shooter's Manual" (Cat. TSM), by John F. Rider, 240 pages, 8 1/2 x 11", more than 200 illustrations, including wiring diagrams of commercial receivers as advertised; imitation leather cover, gold lettering.
- \$2.00 for which please send me postpaid "Mathematics of Radio" (Cat. MOB), by John F. Rider, 128 pages, 8 1/2 x 11", 119 illustrations, flexible cover.
- \$1.00 for which please send me postpaid "Treatise on Testing Units for Service Men" (Cat. TU), by John F. Rider, 43 pages, 6 1/2 x 9 1/2".
- If ordering C.O.D., put cross in this square.

NAME.....

ADDRESS.....

CITY..... STATE.....
[Canadian remittances must be made by postal or express money order.]