

RADIO



















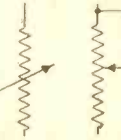
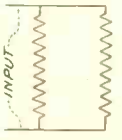
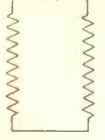
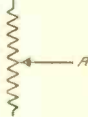
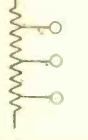
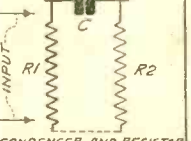

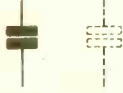

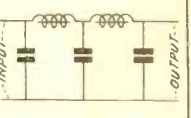







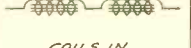

REG. U.S. PAT. OFF.

WORLD

The First and Only National Radio Weekly

375th Consecutive Issue—Eighth Year

POWER AMPLIFIER SYMBOLS FOR NOVICES

 BATTERY SHORT BAR NEGATIVE LONG BAR POSITIVE	 LINE PLUG	 SWITCH	 PILOT LIGHT	 GROUND
 CHOKE COIL	 AUDIO TRANSFORMER	 POWER TRANSFORMER WITH THREE SECONDARIES, ALL MULTAPPED	 RESISTOR	 ADJUSTABLE RESISTORS
 RESISTORS IN PARALLEL	 RESISTORS IN SERIES	 POTENTIOMETER (ADJUSTABLE)	 POTENTIOMETER (FIXED)	 CONDENSER AND RESISTOR (C & R2) IN SERIES. C, R2 IN PARALLEL WITH R1
 CONDENSER	 REQUIRED OPTIONAL DOTTED SYMBOL OF A PART DENOTES OPTION	 CONDENSERS IN PARALLEL	 CONDENSERS IN SERIES	 FILTER (CHOKE-CONDENSER TYPE)
 FILAMENT 2-ELEMENT TUBE	 FILAMENT 3-ELEMENT TUBE	 FILAMENT SCREEN GRID 4-ELEMENT TUBE (SCREEN GRID)	 CATHODE K HEATER AC TUBE (HEATER TYPE)	 CATH. K HEATER SCREEN GRID AC TUBE (HEATER TYPE, SCREEN GRID)
 FULL WAVE RECTIFIER TUBE (FILAMENT TYPE)	 FULL WAVE RECTIFIER TUBE (GASEOUS TYPE)	 GLOW TUBE	 VOLTAGE REGULATOR TUBE	 COILS IN SERIES
 PHONOGRAPH PICKUP	 VOLTMETER	 EARPHONES	 MICROPHONE	 LINE FUSE
	 AMMETER	 SPEAKER		 WIRES JOINED
	 MILLIAMMETER			 WIRES NOT JOINED

HAMMARLUND CONDENSERS

Midline and Junior

selected again for their superior qualities and rugged construction by the designer of the

"UNIVERSAL 250"

Your Dealer Sells Them



"BRUNO" COILS

Wound on quartzite glass; low-loss construction; high gain per stage.

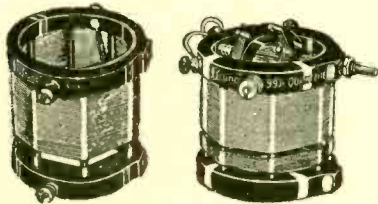

99RF
\$2.50

99 TUNER
\$3.75

99RF is useful as an antenna coil where high selectivity is desired and as an inter-stage coupler for all tubes, battery or AC, except screen grid tubes. Tunes with .0005 mfd. only.

99 Tuner is a three-circuit coil for any standard circuit using a rotatable winding. Tunes with .0005 mfd. only.

Guaranty Radio Goods Co.

145 West 45th Street, New York City

SCREEN GRID COILS

for the

4-tube SG Universal

- Antenna coil, Model RF5 for .0005 mfd. \$1.50
- Antenna coil, Model RF3 for .00035 mfd. 1.75
- Coupler, Model TP5, for .0005 mfd. 3.00
- Coupler, Model TP3, for .00035 mfd. 3.25

SCREEN GRID COIL CO.

143 West 45th Street
New York City
Immediate Delivery and
10-Day Money-Back Guarantee

Front Panel and Subpanel for the

Screen Grid Universal

- Bakelite front panel alone, drilled.... \$2.35
 - Drilled aluminum subpanel alone, with self-bracketing feature, built-in sockets, extra washers and hardware 3.00
 - Both front and subpanel together.... 5.00
- GUARANTY RADIO GOODS CO.**
145 West 45th Street, New York City
(Just East of Broadway)

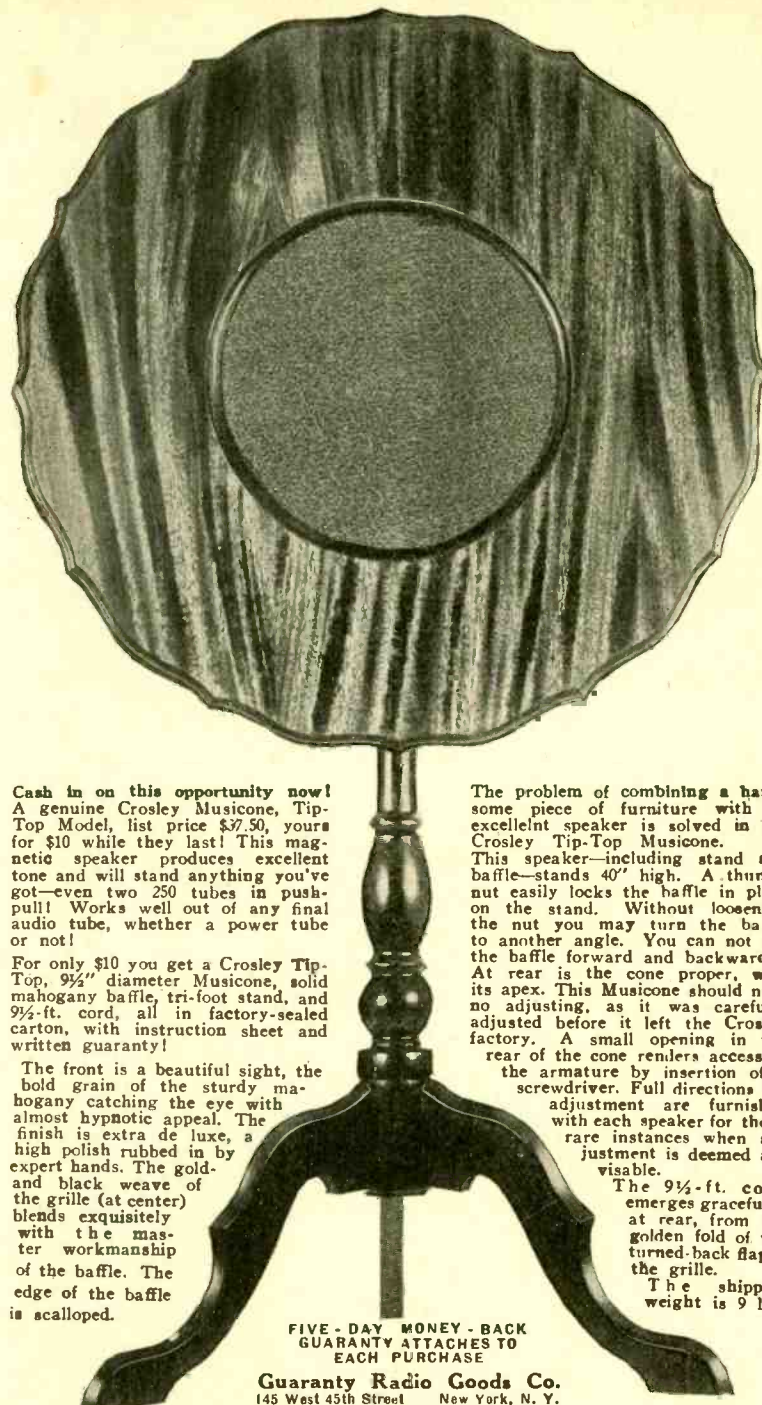

Cash in on this opportunity now! A genuine Crosley Musicone, Tip-Top Model, list price \$37.50, yours for \$10 while they last! This magnetic speaker produces excellent tone and will stand anything you've got—even two 250 tubes in push-pull! Works well out of any final audio tube, whether a power tube or not!

For only \$10 you get a Crosley Tip-Top, 9 1/2" diameter Musicone, solid mahogany baffle, tri-foot stand, and 9 1/2-ft. cord, all in factory-sealed carton, with instruction sheet and written guaranty!

The front is a beautiful sight, the bold grain of the sturdy mahogany catching the eye with almost hypnotic appeal. The finish is extra de luxe, a high polish rubbed in by expert hands. The gold- and black weave of the grille (at center) blends exquisitely with the master workmanship of the baffle. The edge of the baffle is scalloped.

The problem of combining a handsome piece of furniture with an excellent speaker is solved in the Crosley Tip-Top Musicone.

This speaker—including stand and baffle—stands 40" high. A thumb-nut easily locks the baffle in place on the stand. Without loosening the nut you may turn the baffle to another angle. You can not tilt the baffle forward and backward. At rear is the cone proper, with its apex. This Musicone should need no adjusting, as it was carefully adjusted before it left the Crosley factory. A small opening in the rear of the cone renders access to the armature by insertion of a screwdriver. Full directions for adjustment are furnished with each speaker for those rare instances when adjustment is deemed advisable.

The 9 1/2-ft. cord emerges gracefully at rear, from the golden fold of the turned-back flap of the grille. The shipping weight is 9 lbs.

**FIVE-DAY MONEY-BACK
GUARANTY ATTACHES TO
EACH PURCHASE**

Guaranty Radio Goods Co.
145 West 45th Street New York, N. Y.
(Just East of Broadway)

Most Selective Diamond

Follow Blueprint

THIS IS THE BATTERY MODEL

Here is the circuit of circuits—the design that makes a neighboring cleared-channel, high-power broadcaster snap out of audibility at a slight turn of the dial.

No need to worry about the selectivity requirements imposed on receivers by the reallocation.

Volume "to fill the house"—even on distance. Tone quality excellent.

Get the official blueprint of the laboratory model of the new SG 4-tube Diamond, exactly as built by Herman Bernard, the designer.

RADIO WORLD
145 W. 45th St., N. Y. City
(Just E. of B'way)

- Enclosed please find \$1.00 for which please send at once the official blueprint of the new, highly selective 4-tube screen grid Diamond of the Air battery model.
- 60 cents extra for the February 9th, 16th, 23rd and March 2nd (1929) issues of Radio World, containing Bernard's articles on the construction of this receiver.
- \$3.00 for 6 months (26 numbers) subscription for Radio World. Send Diamond blue print and four Diamond issues FREE, in addition to 26 current issues.

Name

Address

City State

NOTICE TO SUBSCRIBERS

Look at the date of the label pasted on the wrapper containing your subscription copies. If this date on wrapper is older than the date of the issue received, then your subscription has expired and should be renewed.



Vol. XV., No. 11 Whole No. 375
 June 1st, 1929
 15c per Copy, \$6.00 per Year
 [Entered as second-class matter, March, 1922, at the Post Office at New York, N. Y., under Act of March, 1879.]

Latest News and Circuits
 Technical Accuracy Second to None

EIGHTH YEAR

A Weekly Paper published by Hennessy Radio Publications Corporation, from Publication Office, 145 West 45th Street, New York, N. Y.
 Phone BRyant 0558 and 0559 (Just East of Broadway)

Power Amplifiers

An Authoritative Exposition of their Construction and Operation

By J. E. Anderson and Herman Bernard

Technical Editor

Managing Editor

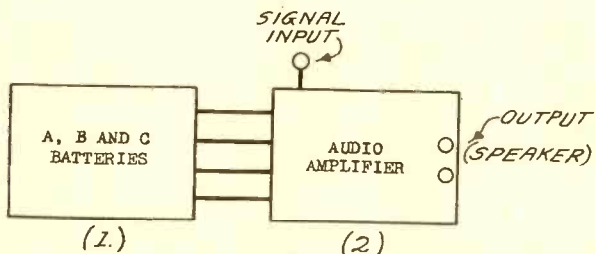

FIG. 1.

A BATTERY-POWERED AUDIO AMPLIFIER, SHOWN IN FUNCTIONAL BLOCKS.

[Herewith begins a notable contribution to the literature of power amplifiers, written so that the novice can grasp the situation, while even the expert will find meat in the subject-matter. The exposition of this fascinating subject by the authors will continue in Radio World from week to week for several months. Don't miss an issue! A big instalment every week!—Editor.]

THE advent of alternating current tubes, including power tubes, brought about the development of power amplifiers.

In general the term applies to an audio frequency amplifier that provides a large undistorted output and which supplies its own power for the operation of the tubes it contains. It is essentially an alternating current design, operable from the wall socket or lamp socket, because greater power handling capacity is more conveniently provided for in that way.

Power amplifiers operating from direct current lighting circuits are feasible, multiple output tubes being used to provide adequate power, because the maximum plate voltage is relatively low. This type is called a DC power amplifier.

A battery-operated power amplifier is another form, although not economical in the attainment of large values of undistorted power output. While it is direct current all the way through, it is called a "battery" type to distinguish it from a "DC" power amplifier which derives its voltages and currents from the DC lighting circuit.

A battery power amplifier consists of (1) A, B and C batteries; (2), audio amplifier.

A DC power amplifier comprises (1) a source of DC power, usually 110 volts, occasionally 220 volts, obtained from the wall outlet or lamp socket; (2), a filter; (3), a voltage divider, and (4), an audio amplifier.

The AC power amplifier consists of (1), a source of AC power, usually the 105-110 volt 50-60 cycle AC line; (2), a

means of increasing and decreasing the power supply to desired voltages, often consisting of only a single power transformer with several windings; (3), a rectifier, which is at least one tube; (4), a filter, comprising chokes and condensers; (5), a divider of the rectified output voltage; (6), an audio amplifier.

Sometimes an A battery is used to heat the tubes and an AC or DC B supply to furnish the plate voltages and currents, thus constituting a composite power amplifier.

Many receivers have modest power amplifiers built into them, such as AC console or AC table model receivers, but among experimenters a separate tuner and a separate power amplifier are popular.

Originally, experimenters left their complete receivers as they found them, but added an extra stage of audio in a B eliminator design, heating the filament of the last tube alone with AC. This type was called a power pack, but soon after the AC tubes became popular a complete audio channel, with AC tubes, was found preferable.

With separate power amplifiers, undistorted reproduction at high volume is readily attained, since the tendency is to use large power tubes. Greater volume than any home would require is within easy reach, but the real object is tone quality, rather than fatiguing volume.

What the tone quality will be depends on the audio amplifier. Its function is to preserve the quality obtained from the detector output, while amplifying that output to large values. The possession of abundant audio amplification is a virtuous asset. Distant stations may be brought in with as much volume as an ordinary amplifier would produce from an average local station, while a volume control is used to cut down the volume of local stations to whatever degree is found most enjoyable. You can tune through the dial scale, for instance, from distant to local reception, and although the locals come in momentarily with too much volume, this is unaccompanied by overloading of the last tube of the amplifier. Also, quality is served most propitiously by proper balance between loudspeaker and the output tube or tubes.

It is relatively easy to have a tuner that does not discriminate injuriously up to the detector output, but from the detector onward it is necessary to observe strict precautions, particularly as problems may arise that assume not only serious proportions but which are novel and soluble only by special study. However, all the problems are soluble, and the construction of a power amplifier for use in home, auditorium or theatre, requires only adherence to recommended constants and faithful duplication of authenticated design. Tone quality then becomes what it really should be: a faithful reproduction of the original.

The power amplifier, however, is not restricted to use with a radio frequency tuner, but may be used to amplify the elec-

FIG. 2.

The components of an electric power amplifier, worked from a 110 volt DC source. The filter eliminates extraneous noises, ripples, hum, etc.

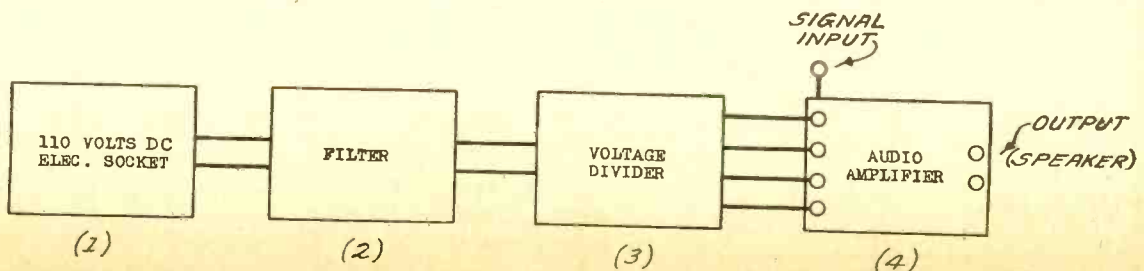

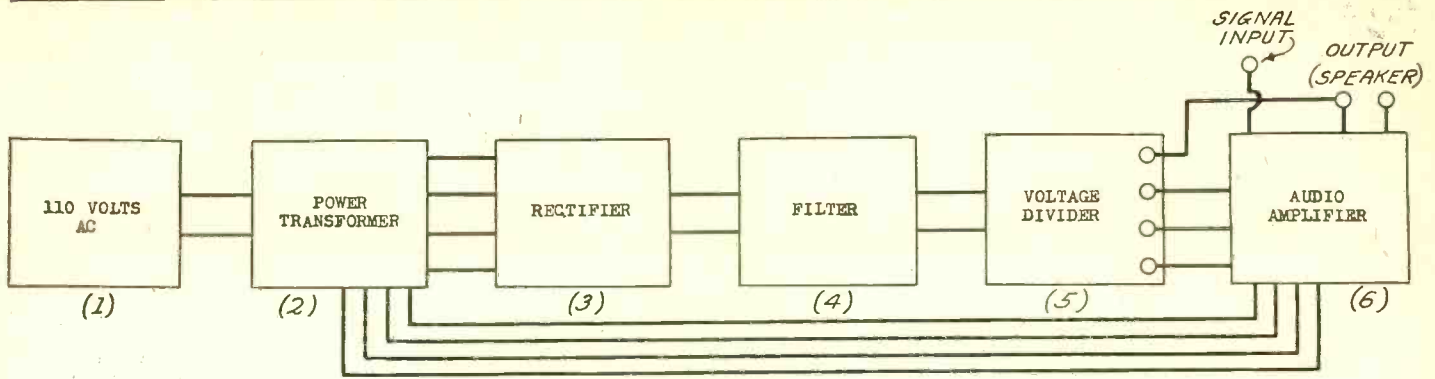

FIG. 3.

FUNCTIONAL CHART OF AN AC POWER AMPLIFIER. THE 110 VOLTS AC ARE DELIVERED TO THE POWER TRANSFORMER, WHICH STEPS THE VOLTAGE UP AND DOWN, TO SUIT REQUIREMENTS. A RECTIFIER TUBE CHANGES THE AC TO DC. THE FILTER TAKES OUT THE HUM, THE DIVIDER APPORTIONS THE OUTPUT VOLTAGES, AND THE AUDIO AMPLIFIER MAGNIFIES THE SIGNAL.

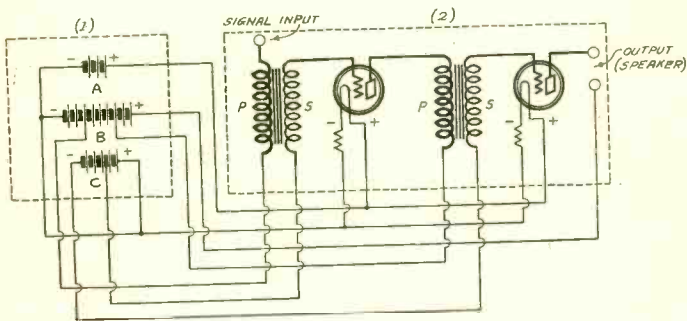

FIG. 4.

A SCHEMATIC DIAGRAM OF THE BATTERY-POWERED TWO-STAGE AUDIO AMPLIFIER. THE COMPONENTS (1) AND (2) ARE AS IN FIG. 1, WHICH THE ABOVE DIAGRAM PARTICULARIZES.

trical impulses provided by a pickup actuated by a phonograph record or by any other recording, such as a film. Talking movies are practical only because power amplifiers are practical. Public address systems are simply power amplifiers with microphones at input and loudspeakers at the distributed output.

In ordinary amplifiers two stages of transformer coupled amplification are used, but in power amplifiers a third stage is often included.

Two-stage transformer coupled amplifiers are shown in the schematic diagrams, Figs. 4, 5 and 6, for simplicity. The three types of power amplifiers—battery, DC and AC—are also represented in block formation. The schematic diagrams expose the components of the block diagrams. In both these groups of illustrations it is assumed a radio receiver is used and that it derives its filament, plate and biasing voltages from the same supply as does the power amplifier. Hence the signal input is made to a solitary post, which picks up the detector plate lead of the receiver. The plate circuit is completed to B plus through the primary P of the first audio transformer.

Types of Audio Couplers

Many types of couplers for transferring the signal voltage from one tube to the next in audio frequency amplifiers have

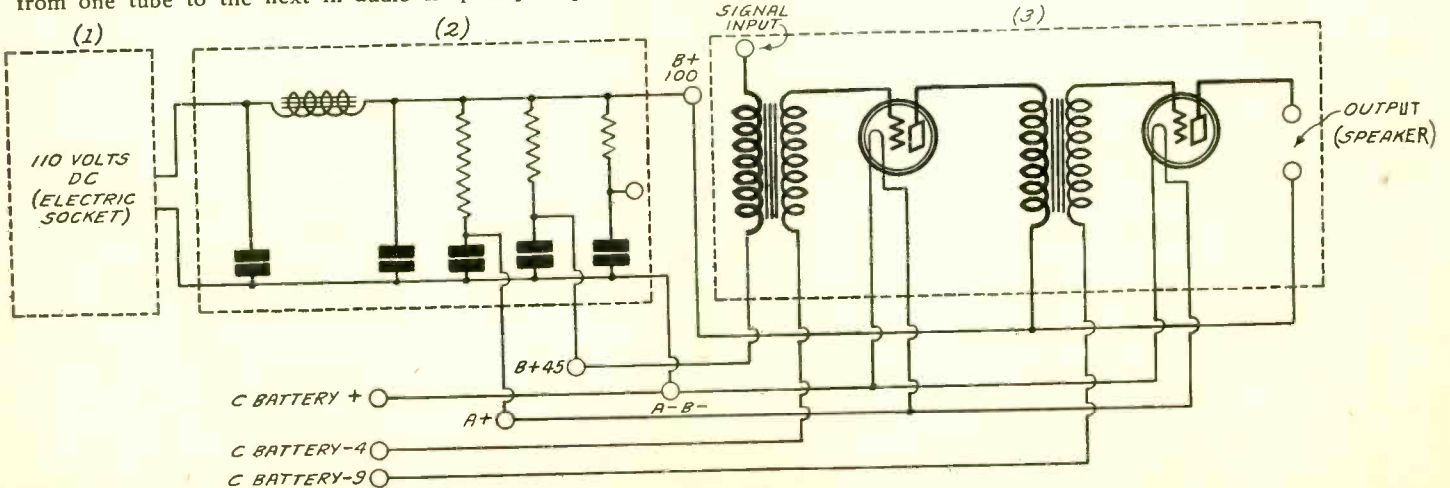

FIG. 5.

A DC POWER AMPLIFIER IN SCHEMATIC DETAIL IS SHOWN. THE 110 VOLTS ARE DROPPED TO SUITABLE VOLTAGES FOR FILAMENTS AND PLATES OF TUBES BY THE RESISTORS. DUE TO THE VOLTAGE DROP IN THE CHOKE COIL THE MAXIMUM OUTPUT VOLTAGE IS ABOUT 100 VOLTS. THE ABOVE DIAGRAM IS AN EXTENSION OF FIG. 2.

been devised, but all come under one of two principal types, namely, transformers or direct couplers, or in various combinations of these main types.

The direct coupler comes in many different variations, and some of the transformer couplers partake of the characteristics of the direct coupler.

Reduced to the simplest terms, the transformer coupler contains two independent windings on an iron core. One of these windings, usually the smaller, is connected in the plate circuit of a tube and the second winding is connected in the grid circuit of the next tube. The signal is transferred by mutual induction from the primary, or first winding, to the secondary, or second winding. If the secondary contains more turns than the primary the voltage is stepped up in proportion to the ratio of turns.

The simplest form of direct coupler is an impedance, either a choke coil or a resistance. This is connected between the plate of a tube and B+, for the plate circuit. The stopping condensers, grid leaks or grid impedances are simply adjuncts to this coupler which make the coupling practical. It is possible to arrange the circuit so that these adjuncts may be entirely omitted.

The Simple Transformer

The simplest transformer arrangement, and possibly the most popular, is shown symbolically in Fig 7A. It has four terminals, two for each of the independent windings. There are four possible connections of these terminals to the tubes, corresponding to the four possible combinations, subject to the condition that the primary terminals remain connected to the first tube and the secondary terminals remain connected to the second tube. For any given connection of the primary, the secondary may be connected in two ways. Similarly for any given connection of the secondary, the primary may be connected in two ways.

All of these connections lead to different results, especially in multi-tube receivers served by the same plate voltage source. It has been found experimentally and theoretically that one of these connections gives the best results, particularly with respect to stability, and manufacturers of transformers mark the terminals for this connection. The terminal marked P is connected to the plate of the first tube, that marked B plus, or HT in British transformers, to the positive plate voltage, that marked G to the grid of the second tube, and that marked C minus, or F minus, to the negative of the grid voltage source, or to the filament of the tube. In any amplifier these connection should be main-

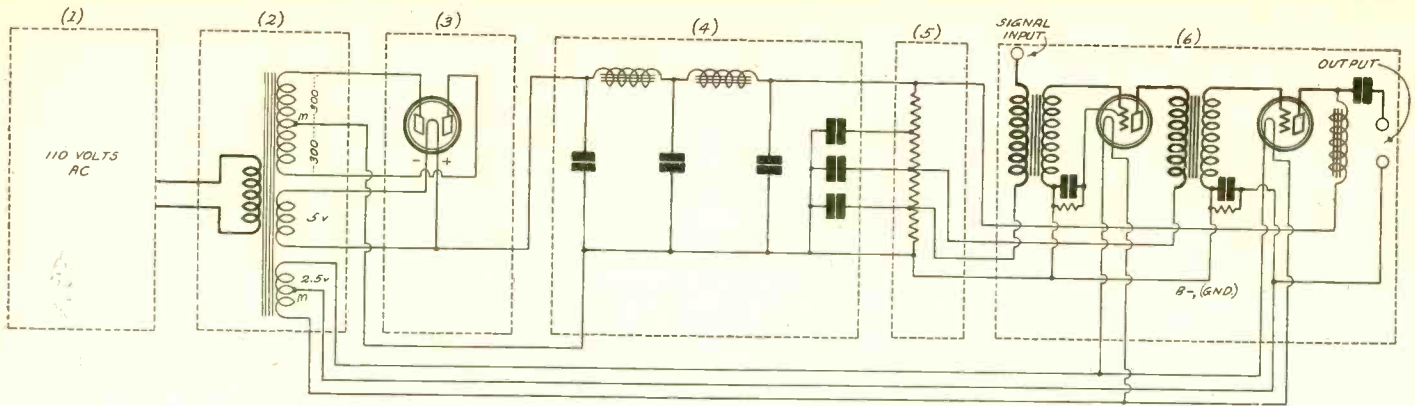

FIG. 6
SCHEMATIC DIAGRAM OF AN AC POWER AMPLIFIER. THE NUMBERED SECTIONAL BLOCKS CORRESPOND TO THOSE IN FIG. 3.

tained, unless for some special reason it should become desirable to reverse a pair of leads.

Direct Couplers

The simplest direct coupler is shown symbolically in Fig. 7B. In this R1 is the coupling resistance, which is connected between the plate of the first tube and the plate voltage source. C is the stopping condenser, which is connected between the plate of the first and the grid of the second tube. R2 is the grid leak, which is connected between the grid of the second tube and the grid bias intended for that tube.

The only object of the stopping condenser is to prevent the high positive voltage on the plate of the first tube from being applied to the grid of the second tube. It does not couple two circuits. R2 becomes necessary as soon as C is used, for without it the grid could not be maintained at the proper negative potential with respect to the filament or the cathode.

While R1 is the coupling resistance, C and R2 must also be considered when designing a coupler of this type, because the plate and grid resistors are in parallel, while C is in series with the leak. The actual impedance presented to the plate of the first tube is determined by the R1 shunted by the condenser and the grid leak connected in series. If R2 is large compared with R1, the impedance presented to the first tube may be taken, for design purposes, as the resistance of R1 alone.

Impedance Coupling

The impedance coupler is like the resistance coupler, as shown in Fig. 7C, the only difference being that the coupling resistance takes the form of a high inductance choke Ch1 and the grid leak the form of a similar or higher inductance choke Ch2. The functions of these chokes are exactly the same as the functions of the resistors. But there is some difference in the result. A higher amplification can be obtained with the impedance coupler, although for both the limit is the amplification constant of the first tube.

A disadvantage of the impedance coupler is that the low notes cannot be amplified as much as the higher frequencies. All

three of the elements, namely, Ch1, Ch2 and C, contribute to cutting down the amplification of the low notes. Another disadvantage is that for very high audio frequencies the distributed capacities of the choke coils tend to cut down the amplification. The condenser does not contribute any of this suppression.

A Variant of Impedance Coupling

In one particular impedance coupler the stopping condenser C and the choke coil Ch2 are proportioned so that the capacity resonates with the inductance at a selected low frequency. This resonance increases the amplification at that frequency and therefore overcomes the principal disadvantage of double impedance coupling. By selecting suitable circuit constants a practically flat amplification curve can be obtained from 10,000 to well below 100 cycles. This is the Hiler method of coupling.

Another variation of the direct coupler is shown in Fig. 7D, in which the plate coupling impedance is a choke coil Ch1 and the grid leak is a resistance R2. It has no advantage over either of the two previous couplers.

The Clough System

In Fig. 7E is shown a combination of direct and transformer coupling. On the plate side of the stopping condenser is a high resistance R1 through which the direct plate current flows. On the grid side of the condenser is an auto-transformer T. This arrangement has the advantage, first, that the direct current is kept out of the primary of the transformer and hence eliminates core saturation, second, that a voltage step-up may be obtained in the transformer, and third, that grid leak resistance is low.

If the capacity of the condenser C and the inductance of the primary of T be chosen so as to form a tuned circuit at some low frequency, this is known as the Clough coupling system. In this form the coupler is capable of exceptionally faithful amplification as well as of a high step-up. The frequency of resonance can be placed at any desired value. Below this frequency the amplification cuts off rapidly. Thus by this method the low

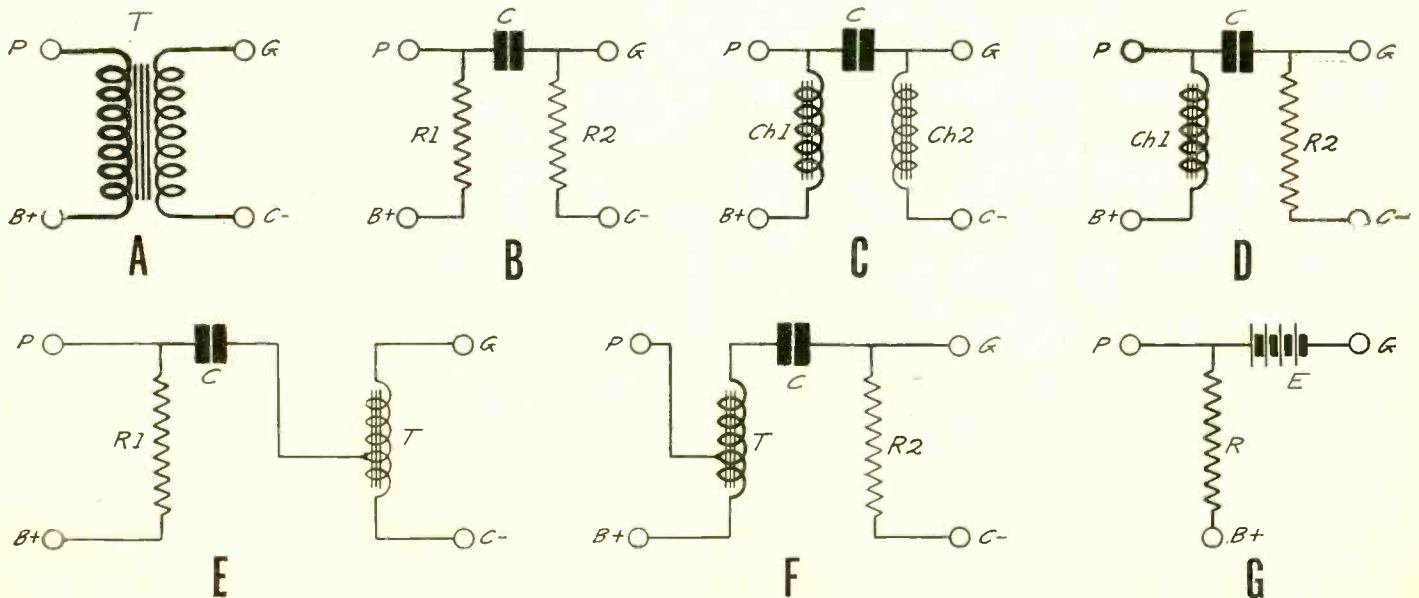

FIG. 7.
SEVEN DIFFERENT TYPES OF COUPLERS USED IN AUDIO AMPLIFIERS: (A), AUDIO TRANSFORMER; (B), RESISTANCE-RESISTANCE; (C), IMPEDANCE-IMPEDANCE; (D), IMPEDANCE-RESISTANCE; (E), RESISTANCE AND AUTO-TRANSFORMER; (F), AUTO-TRANSFORMER AND RESISTANCE; (G), NON-REACTIVE DIRECT COUPLER.

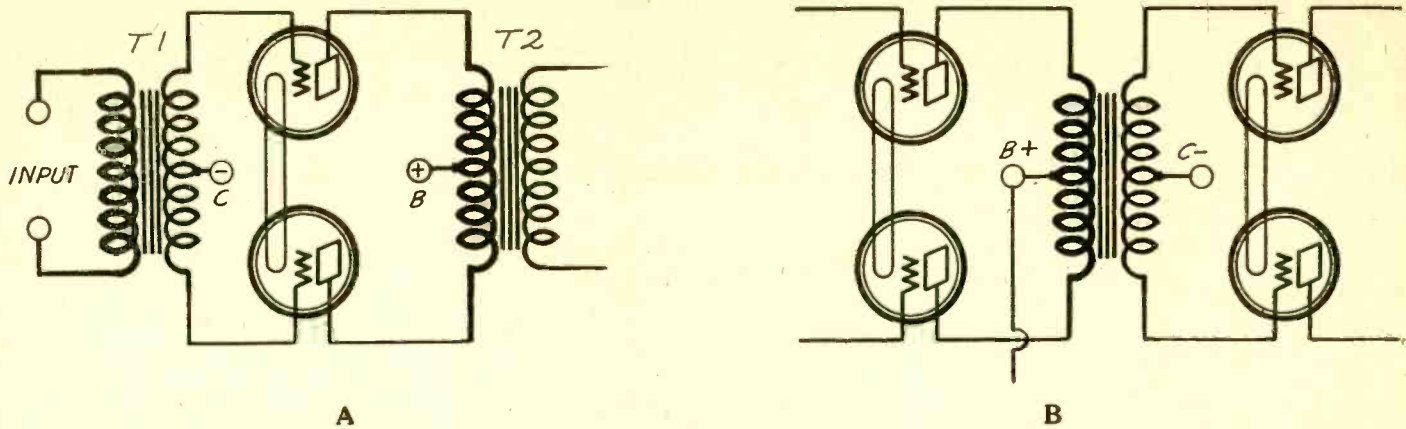

FIG. 8

A—PUSH-PULL COUPLERS FOR SYMMETRICAL AM PLIFIERS. T1 IS THE INPUT AND T2 THE OUTPUT TRANSFORMER.
 B—PUSH-PULL INTERSTAGE COUPLER USED WHEN TWO OR MORE STAGES IN THE AMPLIFIER ARE MADE SYMMETRICAL.

notes can be amplified fully without introducing instability on the sub-audible frequencies.

The Auto-Transformer Coupler

The auto-transformer can also be placed in the plate circuit, as shown in Fig. 7F. When it is so placed it is necessary to use the stopping condenser and a grid leak. This coupler is not so satisfactory as the one shown in Fig. 7E, because the plate current can saturate the core, the transformer cannot be tuned to bring out the low notes and the grid leak is not so effective as the transformer winding in maintaining the grid at the proper negative potential.

In Fig. 7G is shown a true direct coupler, which is the simplest of all as far as the impedances are concerned. Only one coupling resistance R is used, which serves both as coupling impedance and grid leak. In application this is not so simple because it requires additional voltage sources, or independent voltage sources for each stage. It is the only type of coupling that can be used for amplifying direct voltages, and it has a straight amplification curve over a wider frequency range than any other type of coupler.

The battery E in the grid circuit of the second tube is employed to counteract the positive voltage applied at B plus. The negative of E must be toward the grid. If the plate battery were placed between P and the top of R, the polarity of E would have to be reversed because the steady voltage drop in R would be greater than the bias required for the second tube.

The Push-Pull Coupler

The push-pull coupler is a modification of the transformer method. There are three types of push-pull transformers, first, the input transformer, second the interstage transformer, third, the output transformer.

The input transformer has a two-terminal primary wound to fit the plate circuit of a single amplifier or detector tube, and a three-terminal secondary wound so as to step up the voltage as high as practical. The third terminal is put at the center of this winding so that the voltages induced in the two sides are equal. In well-constructed transformers the two extreme terminals are balanced with respect to capacity as well as to resistance and inductance against the center tap. T1 in Fig. 8A illustrates the input transformer.

The interstage push-pull transformer has a center-tap on each of the primary and the secondary windings. The primary is designed to work from a push-pull stage and the secondary to work into another. This coupler is illustrated in Fig. 8B.

The push-pull output transformer has a center-tapped primary each half being wound to match the output impedance of a given power amplifier tube, and a single output winding, which is wound to match a given speaker. Sometimes the secondary of the output transformer is provided with taps for matching it to different speakers. T2 in Fig. 8A illustrates the push-pull output transformer.

The chief advantages of push-pull are that greater undistorted power output is made possible and clearer tone. The object, is not to produce more volume, but to be able to handle greater volume without distortion. The amount of volume depends on the circuits that precede the push-pull stage, since this stage is almost universally the output or power tube stage.

The input is made to the push-pull stage by connecting the two grid terminals to the respective grids of the two tubes (2) and (3) in Fig. 12. Then the output is taken through a center-tapped primary. The secondary of this step-down or one-to-one ratio transformer is connected to the loudspeaker.

A significant feature about push-pull is that the input to the last stage is thereby made at a phase difference between tubes (2) and (3) in Fig. 12 of 180 degrees. The voltages and currents are said to be equal but opposite at any given instant.

That is, when tube (2) is 20 volts positive, tube (3) is 20 volts negative. This phenomenon balances out the even order of harmonics and tends to eliminate extraneous noises and instability.

The plate circuits of the push-pull stage are likewise 180 degrees different in phase. The tube in each instance turns the phase around 180 degrees, so that the output phase is exactly opposite to the input phase, but as this reversal applies equally to the two tubes, the relative angle is the same.

While for a single-sided circuit, like the one shown in Fig. 10, the general run of transformers may work fairly well, for a push-pull stage accurately wound and high-class transformers become a virtual necessity, particularly because of the balance that must be struck. This requires special pains in the winding and testing of the transformer.

Another reason for choosing high-grade transformers for push-pull is that the selection of push-pull is on a quality basis only, as the desire is to get the best and clearest tone. Cheap transformers would not produce this. Actuated by a desire for clear tone, the constructor who has bought first-grade push-pull input and output transformers would not want to saddle them on a circuit that had a distorting stage of audio ahead of the fine push-pull. Therefore the three transformers in a two-stage push-pull circuit should be as good as you can afford.

Some experimenters wonder whether a push-pull stage has its tubes in series or in parallel. The tubes are in series. Therefore the plate impedances add up. Two tubes in parallel have approximately half the impedance of a single similar tube, while tubes in series (e. g., push-pull) have approximately twice the impedance of one tube alone.

The plate current drawn by two tubes in a push-pull stage is approximately twice as much as that which a single tube of the same type would draw under the same voltage and load conditions.

Push-pull has proven popular because its virtues have been popularly demonstrated. Technicians knew for many years that push-pull had fine advantages, but in the early days these advantages were hard to capitalize, because the transformers themselves afforded such distorted frequency response that their service in the cause of push-pull was of little value. Nowadays there are several high-grade push-pull and single-sided transformers on the market.

Combination of Couplers

While the tendency is strongly in favor of using a given form of audio coupling throughout the amplifier, some experimenters lean to a combination of media, for instance two stages of resistance coupling with a push-pull transformer output. In an instance like that the desire to embody push-pull accounts for the deviation, since there is no generally available means of successfully working resistance coupled push-pull.

For special acoustical purposes sometimes a uniform design is avoided, the audio channel being so fashioned as to attempt to atone for distortion arising in the tuner or in the speaker.

As the characteristics of the tuner and the speaker affect the tone quality, so combinations are sometimes introduced in an effort to compensate for shortcomings that arise outside of the AF amplifier. Such circuits are special ones, designed to meet a particular condition, and at best are compromises. The goal should be the attainment of quality in the performance of each function—selection of the desired radio frequency wave by tuning, detection, audio amplification and speaker reproduction.

Besides these considerations, others lead experimenters to use combinations of types of audio couplers, because a particular fancy has been nursed, the scientific value of which is not always confirmed by meters, oscillographs and other reliable informants.

[Part II next week, June 8th]

Using Power Detector Largest Power Tube

into a Standard 7x21x8 $\frac{1}{2}$ " Cabinet—
at Auditorium Volume

V. O'Rourke

Editor

LIST OF PARTS

L1—One RF5 antenna coil for .0005 mfd. tuning (Guaranty Radio Goods Co.).

L2—One tuned primary transformer (TP5 for .0005 mfd. tuning).

CT—One Hammarlund 70 mmfd. Equalizer.

C1, C2—One Hammarlund two-gang condenser, each section .0005 mfd. (MLD 23).

C3—One Hammarlund junior condenser, 50 mmfd.

C, C4, C5, C6, C8, C9, C10—Six Aerovox .02 mfd. condensers.

C7—One Aerovox .00025 mfd. condenser.

C11, 1 mfd.; C12, 4 mfd.; C13, 1 mfd.; C14, 2 mfd. 1,000 volts AC; C15, C16, 2 mfd. each, 800 volts AC—One Aerovox condenser bank.

T1—One National A100 audio transformer.

T2—One power transformer, with choke and fuse holders built in; secondaries approximately 2.5v., 1 $\frac{1}{2}$ v., 1 $\frac{1}{2}$ v., 7.5v., 7 $\frac{1}{2}$ v., 450v. (Guaranty Radio Goods Co.)

1, 2—Two UY sockets (five prong).

3, 4, 5, 6—Four UX sockets (four prong).

PL—One Yaxley pilot light bracket with colored window.

SW, R1—One Electrad 5,000 ohm Royalty variable resistor with 110-volt AC switch affixed.

R2, R9, R11—Three Lynch 0.1 meg. metalized resistors, with mountings.

R3, R4—One Electrad 20,000 ohm wire-wound resistor, type B, with extra slider.

R5, R6—Two Electrad 2,000 ohm resistors (suppressor type).

R7—One 1,500 ohm Aerovox Pyrohm.

R8, R10—Two Lynch 1 meg. fixed metalized resistors, with mountings.

R12—One Aerovox Pyrohm 4,500, 4,500 ohms (9,000 ohms center tapped).

RX—One Clarostat humdinger, 20 ohms.

Ant., Grid., Sp. —, Sp. + —. Four binding posts.

One 8 $\frac{1}{2}$ x20 in. baseboard.

One 7x21 in. front panel.

One flat type dial.

One dial indicator.

One cabinet.

One National grid clip for SG tube.

One roll of Corwico Braidite.

One 2 ampere to 6 ampere cartridge fuse.

Tubes:

(1) One 224; (2), one 227; (3) and (4), two 226; (5), one 250; (6), one 281.

volume to serve an auditorium capable of seating 500 persons. So there is plenty of leeway for home use, and the keen desire for a high-powered receiver is easily met.

The transformer T1 has a ratio of about

1 to 3 $\frac{1}{2}$, primary to secondary. Disregarding the mu of the last tube, as the calculation is made from the grid circuit of this tube, the swing on the preceding tube must be permitted to exceed 10/35 of 75, or about 20, divided by 8, the mu

to B plus 180 volts, the intermediate tap to the cathode of the detector tube. The other extreme terminal connects to B minus, so that the relatively large plate current independent of the tube, which flows through R4, is passed through the portion of the resistor (from cathode to B minus) in addition to the tube's small plate current. In this way high bias is attained without causing diminution of the detector tube's plate current to be

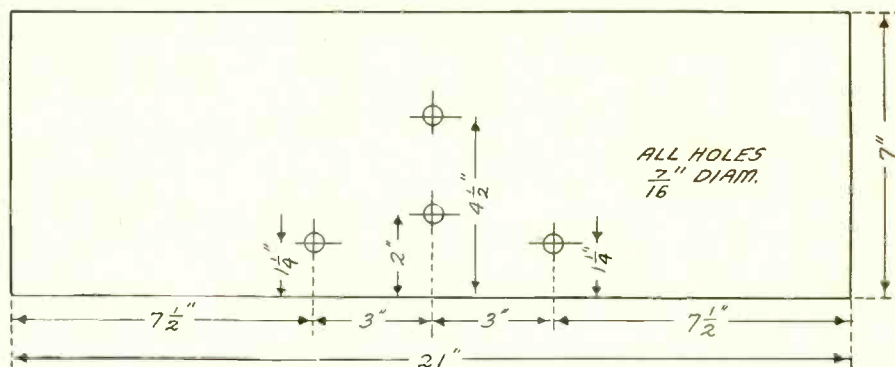

DIMENSIONS FOR THE FRONT PANEL. THE BASEBOARD DIMENSIONS WILL BE GIVEN IN A DIAGRAM NEXT WEEK.

of the 226 second audio tube, equals 2 $\frac{1}{2}$. With 5 milliamperes flowing in tube 4, the bias through the 2,000 ohm resistor R6 is 10 volts, so there is an ample safety factor of 7 $\frac{1}{2}$ volts to prevent distortion arising in the audio channel from under-bias of this tube.

In the preceding stage, first audio, the same value of biasing resistor is used, but the current is about quarter as much, so the bias is about 5 volts negative. This is nearly 100 per cent. excess safety factor.

The detector depends for its distortionless operation on the grid bias principle also, for it is a power detector, and is worked at a bias of about 18 volts. A single resistor accomplishes this by having a third terminal. One extreme goes

vanishing point. As this current is at best very low, easily under 1 milliampere, to obtain the requisite bias by the usual means of having the biasing resistor carry only tube's plate current, a resistor of about 50,000 ohms would be required.

The method of shooting through some extra current to prevent reduction of the plate current in the detector tube to the point where there isn't enough of it to support a loud signal without distortion was contrived by Prof. Glenn H. Browning during his work for the National Company on the new MB29.

[Part II, the conclusion of this article, will be published next week, issue of June 8th. The layout of parts will be shown pictorially.]

Right or Wrong?

(Answers on page 12)

1. The impedance of a choke coil to alternating current is the same as the AC resistance of the winding.

2. The impedance of a condenser to alternating current is equal to the reciprocal of the product of the capacity, the frequency and the factor 6.283.

3. Tubes like the -71A, 245 and 250 are true power amplifiers, that is, they amplify power.

4. The plate current in a vacuum tube can be increased indefinitely by increasing the voltage applied, just as in the case of resistors.

5. If the wattage and voltage ratings of a commercial resistor are known, the resistance can always be found from Ohm's law. The resistance is obtained by dividing the square of the voltage by the wattage.

6. A parallel tuned circuit is a pure resistance at the resonant frequency, and the resistance is very high.

7. A series tuned circuit is a pure resistance at the resonant frequency, and the resistance is very low.

8. An inductance and a capacity have reactances of opposite sign so that when a coil and a condenser are connected in series the total reactance is less than that of either alone.

9. As a rule, a lower selectivity will be obtained with a screen grid tube than with a three-element tube even with the best design of coupling transformer.

10. A higher amplification is obtainable from a screen grid tube with resistance coupling than with any other type of coupling.

Now—Power Detection

Great Volume Is Easily Handled Without Distortion

By James H. Carroll

Contributing Editor

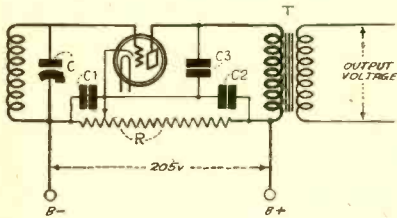

FIG. 1

A DIAGRAM OF A TYPICAL PLATE BEND, POWER DETECTOR IN WHICH THE GRID BIAS AND PLATE VOLTAGE ARE OBTAINED FROM THE SAME SOURCE.

PLATE bend detection is rapidly gaining in favor with designers of receivers. This method is less sensitive than the grid leak and condenser method of detection, but permits a far greater input without overloading.

Several advantages accrue from the use of plate bend detection. First, there will be less frequency distortion because the plate bend detector detects high frequencies as well as the low. Second, there will be less harmonic distortion on large signal voltages because the plate bend detector can handle several times as high signal voltages without overloading as the grid leak detector. Third, there will be less microphonic noise. Fourth, there will be less tube and battery noises because the possible high output of the plate bend detector makes it feasible to eliminate one or more audio tubes.

Power Detection

When the plate bend detector is operated so that very large signal output voltages may be obtained it is called a power detector. The adjustment of the detector circuit required for this is a high grid bias and a high plate voltage. For example, on a 227-type detector tube the grid bias may be 25 volts and the plate voltage 180 volts. With this adjustment of the circuit the detected output is very nearly directly proportional to the input voltage up to an input of about 30 volts, peak value. The detected voltage across the primary of transformer following the tube is then about 10 volts, peak value.

If the transformer has a step-up ratio of 1-to-4 the voltage on the grid of the first audio amplifier will be nearly 40 volts, which is sufficient to load up a -71A power tube, and very nearly enough to load up a 245 power tube. Thus with a power detector it is quite feasible to design a receiver in which there is only one audio tube, the power amplifier. It is clear that the elimination of one or two audio tubes will also eliminate all the noises and distortion which the extra tubes would introduce.

Securing Sensitivity

But a peak signal voltage of 30 volts cannot be obtained from ordinary radio frequency amplifiers. It is obvious that when a power detector is used a far greater radio frequency amplification must be used than when a grid leak detector and two or three stages of audio are used. Ordinarily it is not necessary to use more

than one additional radio frequency tube.

The reason for this is that the efficiency of a detector tube is proportional to the square of the input voltage. If a radio frequency amplifier having a step-up of 10 is used the detected signal will be 100 times as great. Thus one stage of radio frequency amplification not only makes up for the lower detecting efficiency of the plate bend detector, but also for the loss of amplification resulting from the omission of one of the audio frequency amplifiers.

Long Known Factors

The advantages of power detection have been known for a long time. The reason this type of detector has not been employed to any great extent in the past is that it has been difficult to design and build stable radio frequency amplifiers of high gain. The advent of the screen grid tubes, especially the 224, has changed this condition. It is now possible to secure a very high, selective amplification with stability. Indeed, it is no longer a great engineering feat to design an amplifier which will pick up signals originating two or three thousand miles away and build them up to the point of loading up a power detector. It is almost a matter of engineering routine.

A typical power detector circuit is shown in Fig. 1. A high radio frequency voltage is induced in the coil L by the primary supposed to be coupled to that coil. By selective tuning this voltage is magnified many times and then impressed on the detector tube, between the grid and the cathode.

This is detected by virtue of the unsymmetrical nature of the grid voltage, plate current characteristic of the tube. The radio frequency component of the signal current in the plate circuit of the tube goes through condenser C3 directly to the cathode and the audio frequency component is forced through the primary of the transformer T.

The Voltage Divider

A total voltage of 205 volts is impressed on the grid and the plate of the tube. This voltage is divided in the ratio of 25 volts for the grid and 180 volts for the plate by the potentiometer R, or in any other ratio which might give better results. Two condensers, C1 and C2, are connected across the two sections of the potentiometer resistor. The total voltage available can be apportioned to the grid and plate at will by merely sliding the contact on the potentiometer. If the total resistance of R is 25,000 ohms the contact should be approximately 3,000 ohms from the B minus end. If the drop in the left-hand portion is adjusted to 25 volts the plate voltage will be 180 volts, provided that the total applied voltage is 205 volts. The voltage divider may be a 25,000 ohm wire-wound instrument, which can be obtained in every well-equipped radio store.

Voltages Apportioned

Note that if the grid and plate voltages are measured with ordinary voltmeters, even those of high resistance per volt, the readings will be less than the actual values. Allowance should be made for this, which is easy for the ratio of the

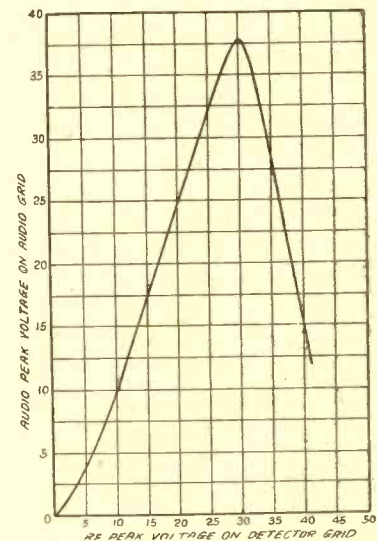

FIG. 2

A RESPONSE CURVE OF A POWER DETECTOR GIVING THE RELATIONSHIP BETWEEN THE PEAK RF VOLTAGE IMPRESSED ON THE GRID AND THE PEAK AUDIO VOLTAGE ACROSS THE SECONDARY OF THE FIRST AUDIO TRANSFORMER.

readings is nearly the same as the ratio of the true voltages.

Response Curves of Power Detector

In Fig. 2 is shown a response curve of a 227-type tube used as a power detector with 25 volts on the grid and 180 on the plate. The curve gives under these conditions the relationship between the peak RF input voltage to the peak audio voltage across the secondary of the transformer.

An interesting feature of this curve is that the output voltage increases almost directly as the input up to 30 volts, after which the output drops rapidly. It is not advisable to increase the input voltage above 30 volts, because for greater inputs the output will be distorted. If an output greater than the maximum afforded by this detector is required, it will be necessary to use an extra stage of audio, or to increase both the grid bias and the plate voltage on the power detector.

Effect of Grid Current

The rapid decrease in the amplification above 30 volts is due to the grid current which flows when the grid is positive, and therefore if the grid bias is increased a greater output voltage can be obtained before grid current begins to flow. The limit to the increase in grid and plate voltages is determined by the insulation of the detector tube. In most tubes it is possible to increase the voltages considerably above those given before ionization takes place. But there is no object of increasing the voltages unless there is sufficient RF amplification to deliver a signal voltage in excess of 30 volts.

Ways of Regeneration

How Weak Signals Are Built Up Much More Than Strong Ones

By Herbert E. Hayden

THE two principal ways of using regeneration in a broadcast receiver are by the capacity and the inductive methods. They are so called because one uses a condenser for variation of feedback and the other uses a coil. But in reality both use both capacity and inductance. The paradox presented is that the constant that is varied gives the method its name.

A third method also works well. That consists of variation of the amount of resistance in the circuit, while the inductance is not changed.

The inductive method is the most popular, because regeneration is readily assured and control is good. A sturdy coil is required, because it is constantly rotated, and if not durable will work lose. Also good flexible connections from the tickler coil are required. The tickler setting has to be changed for almost every 10 kilocycles, provided the circuit is worked at or near maximum practical regeneration. That point is just below the oscillatory breaking point. Of course, no matter in what way you obtain regeneration, if you are considerably under the allowable maximum you may turn the tuning dial over hundreds of kilocycles in the broadcast range without having to disturb the tickler or feedback coil.

Spreads Out Less

Greater rigidity usually is obtained by the capacitive method, and besides the connections to the regeneration control do not have to be pigtail leads or equivalent. The arc of practical use is usually narrower with capacity, that is, the regeneration required for the highest wavelength and for the lowest wavelength are represented by fewer degrees of a circle. The regeneration range is the same, but is crowded on the knob. As a compensatory feature, it is possible to obtain good regenerative effect over a much wider band of frequencies without having to disturb the regeneration condenser's setting. The very condition of crowding the total useful sweep of the knob into a smaller space partly explains this. The ratio is about 6-to-1. That is, for 180 degrees through which a tuning dial is turned, the capacity controlling regeneration is turned through 30 degrees.

Resistance control affords the widest separation. The resistor may be placed across a fixed tickler or it may be connected in series. If in parallel, then the resistor does not change the plate current. If in series it materially reduces the

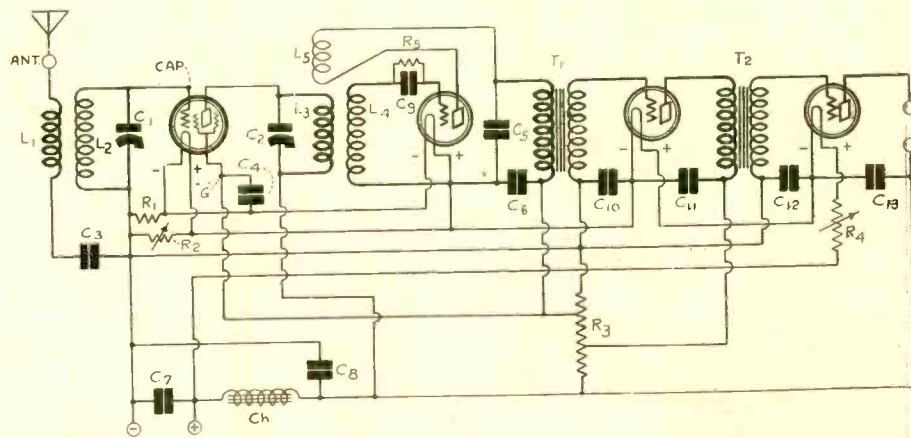

INDUCTIVE REGENERATION, CONSISTING OF A ROTATABLE COIL L5. THE TICKLER ALSO IS INDUCTIVE RELATIONSHIP TO THE PRIMARY L3, THEREFORE IF INSTABILITY ARISES IT MAY BE CURED IN MANY INSTANCES BY REVERSING CONNECTIONS TO L3 TO MAKE THE RELATIONSHIP BETWEEN THE TWO PLATE COILS OPPOSITE IN PHASE.

plate current as greater damping or resistance is introduced. In many circuits it is inadvisable to change the flow of plate current that way, as the impedances are unbalanced.

Remedies for Spillover

If too much regeneration is obtained by the coil method, a variable resistor may be placed across the tickler coil, and the resistor's knob turned until regeneration is controllable by the tickler coil at the lowest receivable wavelength. Then the tickler will provide regeneration up to the highest wavelength. Or, the tickler coil may be removed from the front panel and the variable resistor placed there instead, connected in parallel with the tickler. A range of 0-25,000 or 0-50,000 ohms is suitable.

Permanent reduction of the plate voltage in the regenerated circuit to a voltage that renders stability easily attainable is another way out, if too much regeneration is present. This is true no matter how regeneration is obtained. Reversal of the primary connections of a three-circuit tuner often helps too.

Hardly a factory-made receiver on the market to-day uses regeneration, in the sense of deliberate introduction of manual control of positive feedback. The Super-Heterodyne is no exception, as re-

generation is used there for a different purpose, that of producing oscillation for the intermediate carrier frequency, and there is no manual control of the regeneration.

In fact mercantile receivers are designed in just the opposite direction: elimination of all possibility of squeals and feedback. This often accounts for low sensitivity in multi-tube factory-made sets.

Regeneration is not for everybody. It is a great sensitivity asset, but it requires a little practice before its proper use comes easy. How effective regeneration is, can hardly be stated, since its effect is proportionate to the weakness of the signals. The louder the signals the less effective is regeneration, the weaker the signals the more effective it is. Therefore it is most effective where effect is most needed. It permits a four-tube regenerative receiver to be as sensitive as a six or seven-tube receiver. Therefore it is economical indeed.

A slight detuning effect is introduced by all forms of regeneration. The inductive method and the capacity method are about equal in this respect, while the resistance method introduces the least amount of detuning. The tuned circuit regenerated is the one detuned. For instance, if the grid-to-filament circuit is tuned, as is usual, then pressing to greater regeneration by adding capacity will require reduced capacity for resonance in the tuned circuit.

Inductively varied regeneration works in the opposite direction, since the secondary's inductance is lowered when the tickler is "tightened" or made more nearly parallel with the secondary. This is due to absorption. Where there is mutual inductance, as between tickler and secondary, it is equivalent to fields in parallel.

Regeneration is a subject not fully investigated even yet. Much about it is a mystery. But its effectiveness has been gauged. In the required technical terms it is expressed thus: regeneration varies directly in proportion to the two-thirds power of the grid space. [The grid space is the grid bias change necessary to change the plate current from zero to saturation.]

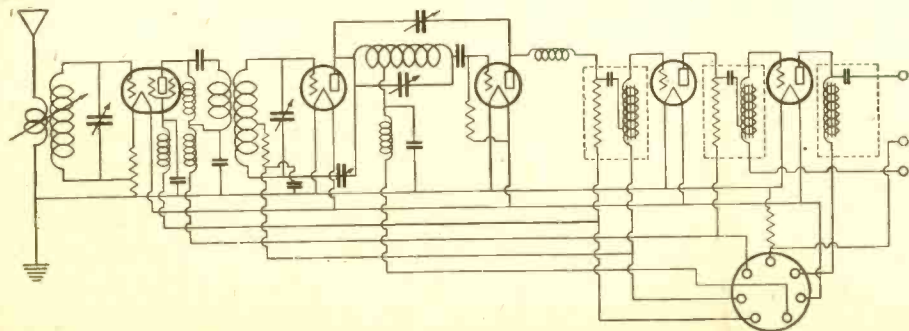

THE CAPACITY METHOD OF REGENERATION IS USED IN THIS CIRCUIT. THE CONDENSER FROM PLATE TO PLATE PRODUCES THE REGENERATION IN THIS CIRCUIT. THERE ARE OTHER METHODS OF CONNECTING SUCH A CONDENSER

New Modernistic Dial Beautifies

THE response to the first instalment of the article on the National MB-29 receiver, published in the May 18th issue, demonstrated that radio fans and custom set builders all over the country are eagerly looking for an outstanding receiver. The recognition of the

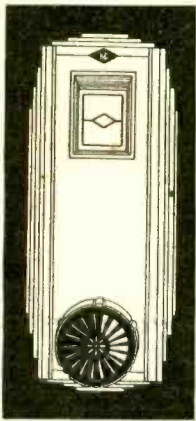

The National modernistic dial which is used on the MB-29 radio frequency amplifier.

merits of this receiver was instantaneous, and the response was overwhelming in volume. Few other receivers in recent times created such interest as this. Scarcely had the issue containing this instalment reached the readers before requests for additional details began to deluge the office. Part II, in the May 25th issue, contained further interesting details.

No doubt the keen interest in the receiver was due to the prominence of the two designers, James Millen and Prof. Glenn H. Browning, a prominence well deserved by past outstanding successes. But that alone did not account for the interest displayed, for, judging by the written and oral inquiries received, those interested are capable of judging a good receiver by its schematic form and by its electrical design. Some, undoubtedly, were attracted to it by the trans-continental reception credited to it by the designers—nine coast-to-coast reception feats on the speaker in one night!

Substituting Parts

Some readers have asked what parts are used in the MB-29, although a list of parts was given in the first instalment. It is suspected that many of these readers wanted to make substitutions of parts rather than to use the parts recommended

and designed for the receiver. It cannot be denied that substitutions of parts can be made, but if they are the receiver will no longer be that designed by Millen and Browning.

It would not be fair to the designers to wire up a medley of parts in accordance with the MB-29 schematic diagram and then blame them for any unsatisfactory results.

Points of Interest

One of the points which has elicited much comment is the method introduced by Mr. Browning for obtaining a high grid bias on the detector without using an excessively high bias resistor. One man who tried it out found it no better than a simple grid bias resistor. For example, he asserted that the resistor R4 may be inserted or taken out without the slightest change in the results. But this observation is at variance both with the experiments of members of the RADIO WORLD staff and with the theory. The method works just as theory indicates and as Mr. Browning asserts.

Indeed, it works so well that there is no doubt that shortly it will not only be applied to all plate bend detectors, but also to all resistance coupled amplifiers employing AC tubes. It is of advantage in all AC circuits in which the plate current is very low.

No Side Band Cutting

Questions have been received as to the quality of the output of this receiver or tuner. How can these be answered? The quality of any receiver is almost entirely dependent on the kind of audio amplifier that is used. The tuner has very little to do with it. There are three factors, however, which have some bearing

Five-Tube AC Tuner, Constitutes High

By J. E.

Techni

on the quality, namely, selectivity, stability and detection.

If the selectivity is too great the high audio frequencies will not be reproduced as strongly as the low and the middle frequencies. But it is rather difficult to design a radio frequency amplifier and tuner, without using maximum regeneration, which is so selective that the high frequencies will suffer appreciably. In the MB-29 no regeneration is used. Sensitivity is obtained by straightforward amplification, and selectivity by using four tuned circuits.

Instability in a circuit usually introduces noises into the signal, which, of course, mar the quality. But this radio frequency amplifier has been stabilized by shielding, filtering and by the use of screen grid tubes. Stabilization is one of the features of the circuit.

The third factor which results in poor quality is faulty detection. This means essentially overloading of the detector tube. The plate bend detector, which is used in the MB-29, is recognized as the best when loud signals are to be detected. It gives the greatest fidelity, the least harmonic distortion, and the least noise. It is called power detection.

So the quality of a receiver incorporating the MB-29 radio frequency amplifier and power detector depends on the fidelity of the audio amplifier that is used with it.

Modernistic Dial

Those who have read the second instalment of this article, which appeared in

Right or Wrong?

(Questions on page 9)

1. Wrong. The impedance of a choke coil is equal to the square root of the sum of the squares of the AC resistance and the reactance. In most good choke coils the reactance is so large compared with the resistance that the impedance of the coil may be taken as equal to the reactance.

2. Right. This is the reactance of the condenser, and since in nearly all condensers the resistance is negligible, the reactance is the impedance.

3. Wrong. No tube is a power amplifier, because no power is put into it. Every tube is a voltage amplifier, but the so-called power tubes are designed so that the volt-ampere output is large.

4. Wrong. There is a definite limit to the current, depending on the temperature of the filament. The limiting current is called the saturation current, present during severe overloading.

5. Right. The current flowing in the resistor is equal to the voltage across it multiplied by the resistance and the power is the product of the current and the voltage. Hence the resistance is equal to

the voltage squared divided by the wattage rating.

6. Right. Strictly, it is only true when the resistance of the coil is negligibly small, or when the resistance in the coil is equal to that in series with the condenser. Practically it is true for all radio frequency tuned circuits.

7. Right. This is strictly true. The resistance is simply the total AC resistance in the circuit.

8. Right. The reactance of the coil is positive, which means that the current lags behind the voltage. The reactance of the condenser is negative, which means that the current leads the voltage.

9. Wrong. As a rule, if the transformer is designed properly, the selectivity will be greater, provided conditions are similar.

10. Right. The screen grid tube requires a very high load impedance, and it is not possible to get as high impedance with a tuned circuit as with a resistance. But no selectivity can be obtained with a resistance, and therefore a tuned circuit has to be used.

LIST OF PARTS

L, L5, L6, L7—Four National radio frequency choke coils.

L1, L2, L3, L4—Four National SG RF transformers with by-pass condensers and RF chokes inside shields.

C1, C2, C3, C4—Four National tuning condensers for the SG RF transformers.

C5, C6, C8, C9—Four 1.0 mfd. by-pass condensers.

C7—One .001 mfd. by-pass condenser.

R1—One 100 ohm resistor.

R2—One 60 ohm, center-tapped resistor.

R3—One 1,800 ohm grid bias resistor.

R4—One 20,000 ohm resistor.

R5—One 50,000 ohm wire wound potentiometer.

One National drum dial with modernistic escutcheon and color wheel; scale calibrated in frequencies.

One National aluminum MB-29 chassis.

Four 224 type screen grid tubes.

One 227 type detector tube.

One 7x18" front panel.

Radio with Color Wheel MB-29

with Screen Grid Tubes,
Specially Sensitive Circuit

Anderson

Editor

favorite station on the blue network when the window is blue. No doubt each individual can think of a station for which yellow is the most appropriate color. The kaleidoscopic feature of the dial lends a bit of color which gives a charming effect.

The Choice of Audio Amplifier

Already requests for specific recommendations of audio amplifier and loud-speaker to use with this radio frequency

inductor-dynamic and there soon will be condenser speakers.

It might be said truthfully that a radio receiver, including radio and audio frequency amplifiers, is no better than the power supply. A common mistake is to employ a power supply designed for a smaller receiver than the one for which it is used. When this is done the regulation of the voltage will be very poor, amplification will be uncertain and there will be considerable noise in the output. It is never a mistake to use an oversized eliminator.

When a combination amplifier and power supply is used, it is advisable to use a separate B battery eliminator for the radio frequency circuit because amplifier and power supply have been de-

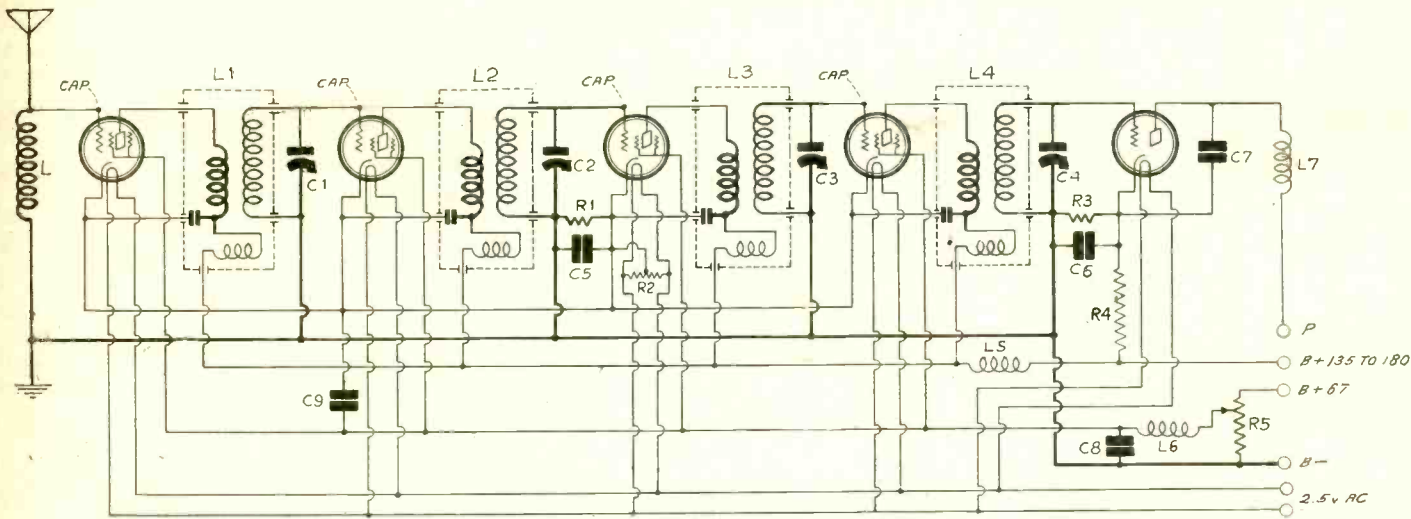

CIRCUIT FORMATION OF THE MB-29, SHOWING THE SPECIAL METHOD OF INTRODUCING EXTRA CURRENT THROUGH THE POWER DETECTOR'S BIASING RESISTOR R3. THE EXTRA CURRENT IS BLED FROM THE B SUPPLY BY R4, SO THAT THE BIASING RESISTOR R3 WILL NOT HAVE TO BE SO LARGE AS TO FRITTER AWAY PRECIOUS PLATE CURRENT OF THE DETECTOR (TUBE AT EXTREME RIGHT).

the May 25th issue, no doubt noticed the attractive modernistic escutcheon with the drum dial, which appeared on the photograph of the amplifier. The artistic lines of this escutcheon cannot fail to please the discerning eye. The new National dial represents a distinct departure from common practice, and a pleasing one. The escutcheon is reproduced herewith.

Aside from the modernistic appearance of this escutcheon, there is a novel feature which cannot be seen in the illustration. The scale on the drum is printed on a transparency and the dial light is inside the scale so the numerals are projected on the square, translucent window. In the center of the window is a diamond-shaped indicator, inside of which the frequency to which the circuit is tuned appears. This greatly facilitates exact tuning of the circuit.

There is still another point of novelty. The light is surrounded by a polyhedral cylinder, the sides of which are transparent films of many colors. As the drum turns the cylinder also turns, and the window assumes kaleidoscopically all the colors of the rainbow.

The order of succession of the colors can be changed so that some of the stations can be recognized by the colors that appear on the window. For example, the colors can be arranged so that the favorite station on the red network will tune in when the window is red, and the

amplifier have been received. The only recommendation that can be made is that a first class amplifier and the best speaker available should be used. The National Company has an admirable 245 push-pull power amplifier it uses with this circuit. The speaker used should be suited to the power tube or tubes employed in the final stage.

There are many good amplifiers available. There are resistance coupled, impedance, dual impedance, transformer and push-pull coupled amplifiers. There are amplifiers for medium power tubes and for power tubes. Many fans already have good amplifiers, others have parts for good amplifiers, and still others now want to buy the best amplifiers that can be had.

Good Eliminator Essential

There are also many good loudspeakers available. There are magnetic, dynamic,

signed to work well together and the balance may be upset by any extra load.

The MB-29 radio amplifier requires a total current of about 30 milliamperes at a maximum voltage of 180 volts. Part of this current is taken by the two potentiometers, namely R5 and R3R4. If a separate eliminator is used for the amplifier it should be able to maintain a voltage of 180 volts when 30 milliamperes are flowing. This is not a severe requirement. If a common voltage supply is used it should be able to supply the extra 30 milliamperes without appreciably reducing the voltage or without increasing the ripple in the current supplied.

The filters used in the radio frequency amplifier are not effective in reducing the ripple because their only purpose is to filter at radio frequency, and the ripple frequency is practically all 120 cycles.

(Continued next week)

Literature Wanted

- Anthony Friscia, 5918 Fort Hamilton Ave., Brooklyn, N. Y.
- John H. Gross, 213 No. 25th, Apt. 10, Omaha, Neb.
- A. F. Stankus, 1942 W. 119th St., Chicago, Ill.
- Geo. T. Dayton, 114 Bronx Ave., Bridgeport, Conn.
- Karno Radio Sales, 1671 Boston Road, Bronx, N. Y.
- Leo H. Johnston, Rutland, Ohio.
- Roy D. Penbeathy, Houghton, Mich.

- Elmer Field, 408 4th St., S. W., Little Falls, Minn.
- Archie D. Bartlett, Galax, Va.
- F. G. Dauble, 65 Wilson Place, Irvington, N. J.
- L. C. Risenburg, 1495 Lee, Detroit, Mich.
- Geo. C. Schneider, 700 W. Erie Ave., Phila., Pa.
- Southern States Radio Supply Co., 2306 3d Ave. North, Birmingham, Ala.
- Fred Hultstrand, Park River, No. Dak.
- John O. Hooks, P. O. Box 167, Parsons, Kans.
- Melvin Olroyd, 902 S. Richard St., Joliet, Ill.

Radio University

QUESTION and Answer Department conducted by RADIO WORLD, by its staff of experts, for University members only.

When writing for information give your Radio University subscription number.

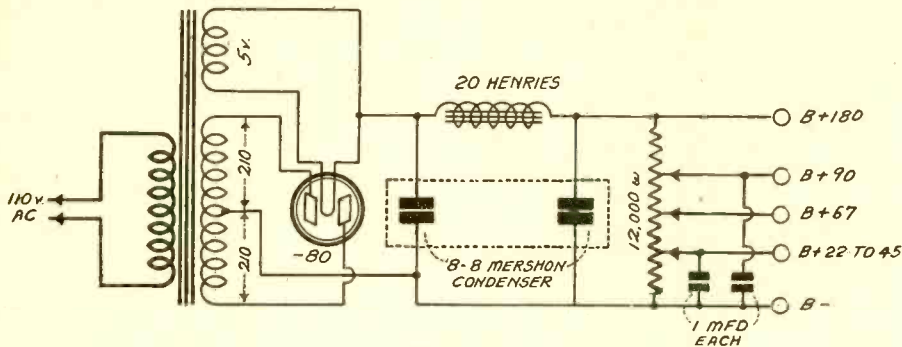

FIG. 754

A FULL WAVE RECTIFIER EMPLOYING ELECTROLYTIC CONDENSERS AND A SINGLE 20-HENRY CHOKE COIL IN THE FILTER.

I WISH TO BUILD an eliminator supplying 180 volts maximum and a current of about 65 milliamperes. I want to use an -80 rectifier tube and electrolytic condensers. Please show a diagram.

(2)—Will it be necessary to use more than one 20 henry choke? I have one.
(3)—What type of resistance do you recommend for the voltage divider?

ERIC OLAND, Rockford, Ill.

(1)—See Fig. 754.

(2)—Not if you use electrolytic condensers of very large capacity. But the wire on the coil used should be large enough to carry the 65 milliamperes without saturation.

(3)—Use a wire-wound resistance strip having movable taps. This will allow you to adjust the various output voltages, except the highest, to any value required. A total resistance of about 12,000 ohms will do.

THERE IS A hissing noise in my receiver whenever the volume is loud, but reception is all right on weak volume. It seems to be directly due to the signal. What do you suppose is the cause of this noise? My set is resistance coupled and I have used the same tubes for about a year.

(2)—The noise is more frequent on low notes than on high, which makes me think it is a case of overloading.

JOSEPH MEYER, Bronx, New York.

(1)—It is difficult to locate the source of such a noise because it does not continue and because there are so many places where it could be. Undoubtedly, it is a case of overloading of some kind. It may be a condenser which breaks down partly on high signals, or the insulation at some point in the circuit. It may be due also to a defective resistor. It may pass a certain amount of current but when the demand exceeds this there may be arcing. Again, it may be due to faulty adjustment of the grid bias. It may be that the bias is too great so that when the signal increases beyond a certain value the plate current is entirely cut off. The same effect might be obtained if the tubes are exhausted.

(2)—Yes, everything seems to point to a type of overloading.

PLEASE SHOW a simple AC receiver employing one 224 tube, two 227s and one -71A.

(2)—Would it be possible to build such a receiver with a single tuning control without using any trimmer condensers? If not, please show where to put the trimmers.

AARON METZGER, Cleveland, Ohio.

(1)—See Fig. 755 for such a receiver.
(2)—While it is possible it is not ad-

visable because it is very difficult to make the set selective. The circuit diagram shows on trimmer across the first tuning condenser.

HOW HIGH signal voltage can be applied to a push-pull stage with two 245 tubes before the tubes are loaded up to the limit, assuming 250 volts on the plates and 50 volts bias?

(2)—If the transformer feeding this stage has a total step-up ratio of 4-to-1 and if it is preceded by a 227 tube, how much should the bias on that tube be, assuming that for low notes the primary is such that two-thirds of the voltage in the plate circuit is dropped across the transformer?

(3)—Would it be necessary to employ two stages of audio ahead of the push-pull stage, or will a single stage be enough?

(4)—In a resistance coupled amplifier of three stages and a 250 tube in the final stage and two 240 type tubes, what will the signal voltage drop across the first coupling resistor be when the 250 is loaded up to the limit, assuming that the bias on that tube is 84 volts?

JUDAH C. FEINBERG, Brooklyn, N. Y.

(1)—It is safest to figure on twice the input voltage for a single tube, that is, 100 volts peak value. Actually, the voltage may be much higher before serious overloading occurs in the push-pull stage. But the object of the push-pull stage is not to

get more volume with a given amount of distortion, but to get a given volume with the least possible distortion.

(2)—4½ volts.

(3)—It is better to use two stages ahead of the power tube, unless the detector is of the power type. If the grid leak method of detection is used, with only two audio stages, the detector is the first to overload. If power detection is used a single stage ahead of the push-pull is enough, provided that there is enough radio frequency amplification.

(4)—It will be approximately .093 volt.

WHAT IS the purpose of the small by-pass condenser in the plate circuit of the detector? I have a receiver which seems to work just as well without this condenser as with it.

(2)—My receiver at times give out unearthly shrieks. Recently I installed a glass panel in place of a bakelite panel. No other change was made. Since the noise was not present before the change I wonder if the glass panel could be the cause of the noise. What do you think? There are several frequencies of this noise.

(3)—What is the power required to operate the filament of a 245 type tube?

(4)—What is the power required to operate the heater in a 227 or a 224 tube?

GILBERT EDWARD, Covington, Ky.

(1)—The purpose of the by-pass condenser in the plate circuit of the detector is to provide a low impedance path for the radio frequency currents in the output of the tube. For best detecting efficiency the impedance to radio frequency currents should be as low as possible and that to audio frequency currents as high as possible. A detector tube works fairly well without the condenser when the primary of the transformer or other plate load has a high distributed capacity.

(2)—You seem to have a brand new type of trouble. It is quite possible that the noise is a type of microphonic howl, induced by the vibrations of the panel. The glass panel may be set in vibration at one or more of its natural periods by vibrations from the loudspeaker or the audio transformers, and these vibrations may be communicated to the elements of the tubes. The glass panel can be set into vibration very easily and it can vibrate in any one of several natural modes, both flexural and longitudinal.

(3)—The power required by the 245 tube is 3.75 watts.

(4)—The power required by either of these heater tubes is 4.375 watts.

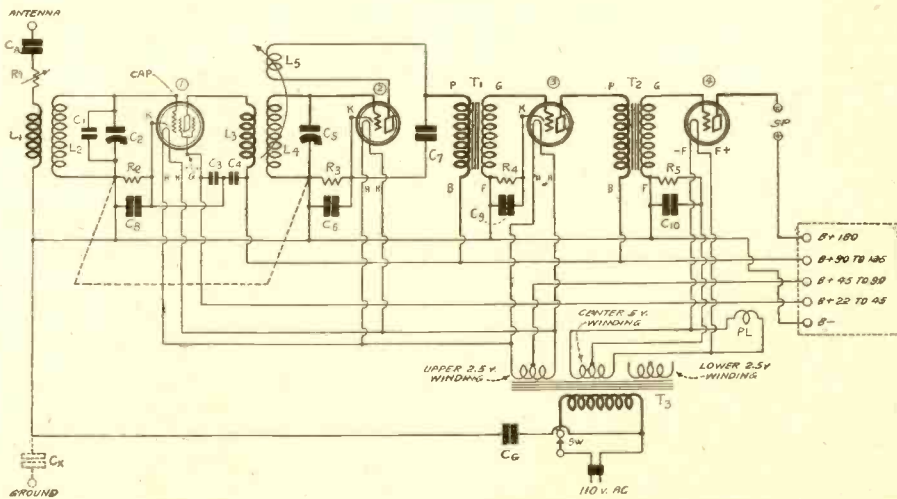

FIG. 755

A FOUR-TUBE AC RECEIVER, USING THE NEW 224 SCREEN GRID TUBE AS RF AMPLIFIER. CA AND CG ARE .0005 MFD., R1 IS 0-5,000 OHMS; R2, 1,000 OHMS; R3, 50,000 OHMS; R4, 1,000 OHMS; R5, 1,500 OHMS FOR 171A. THE BYPASS CONDENSERS ARE AS LARGE AS YOU HAVE, EXCEPT THAT C10 MUST BE AT LEAST 4 MFD. C1 IS 70 MMFD., LEFT IN POSITION AFTER IT IS SET TO MAKE THE DIALS TRACK.

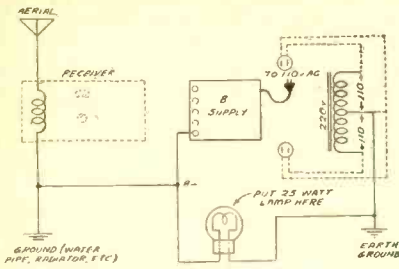

FIG. 756
HOW TO CONNECT A 25-WATT LAMP FROM GROUND OF SET TO GROUND OF AC LINE.

IS THERE any advantage in using two stages of push-pull over a single stage? If so, what?

(2)—If a push-pull stage is used ahead of the power stage, should another amplifier be used between the detector and the push-pull, or can the detector deliver enough undistorted output to load up the final stage?

(3)—Could push-pull be used to advantage in the intermediate amplifier of a Super-Heterodyne? If so, what would the advantage be?

(4)—Please explain the production of squeals in a Super-Heterodyne, that is, cross-talk between two stations widely separated in the frequency scale.

LESTER HOLMES,
 Lincoln, Nebraska.

(1)—There is about as much advantage in using a push-pull stage ahead of the power stage as to use push-pull in that stage. A push-pull amplifier prevents the generation of harmonics no matter where it is. The only question is whether it is necessary to prevent the harmonics which a single-sided stage would produce. It is, because no matter how feeble they are, they will be amplified in the final stage, not as harmonics but as fundamentals.

(2)—That depends on the type of detector and the power handling capacity of the final stage. If a power detector is used, it is not necessary to use an additional stage of amplification. Neither is it necessary to use it if the final push-pull stage contains a couple of 112A or 171A tubes.

(3)—There is no advantage at all in using push-pull in the intermediate frequency stages. Any harmonic distortion introduced by the tubes is tuned out by the intermediate frequency filter.

(4)—The squealing is due to the fact that any two stations separated by twice the intermediate frequency come in at the same point on the oscillator dial and hence simultaneously produce a beat frequency which will get through the intermediate filter. The only way to eliminate this squealing is to tune out the undesired station at radio frequency. This is facilitated by using a high intermediate frequency.

* * *

I RECENTLY READ an article which stated that if a certain number of transmission units (TU) is impressed on a loudspeaker the armature will move a certain distance. What does that mean?

(2)—What is the meaning of TU? I have seen it defined at 10 times the common logarithm of a ratio of currents or voltages and I have also seen it defined as 20 times a ratio of powers. Which is right, if either is?

(3)—Please illustrate the meaning of the TU with numerical examples.

WALLACE KIRK,
 New York, N. Y.

(1)—The only meaning that can be attached to that statement is that the writer had a hazy understanding of the TU.

(2)—Both of these definitions of the TU are correct, provided that they are applied correctly. For voltages and currents the definition contains the factor 10 and for power the factor 20. The reason

for doubling the factor for power is that power is proportional to the square of current or voltage, or that it is proportional to the product of current and voltage.

(3)—Suppose the signal voltage at the input of one tube is E volts and the signal voltage at the input of the next tube is k times greater, that is, kE. The ratio of these voltages is kE/E, or k. The amplification in terms of transmission units is then $10 \log k$, the common logarithm being used. The value of k may be 25, for example. The common logarithm of 25 is 1.398. Hence the amplification is 13.98 TU. The amplification of currents would be determined the same way, wherever that would have any meaning. If the amplification at one frequency is compared with that at another the amplification at one of these can be taken as the "zero level." The amplification at the other, in comparison, would then be either "up" or "down," depending on whether it was greater or less. Suppose the amplification at 400 is 60 TU and that it be taken as "zero" level. Then if the amplification at some other frequency, say 10,000 cycles, is 40 TU, it is 20 TU down. If the voltage amplification at 400 cycles is 10,000, that is 40 TU, and at 10,000 cycles 100, that is, 20 TU, the relative power outputs at these two frequencies is $20 \log (10,000/100)$, or 40 TU. Thus the power output at 10,000 cycles is 40 TU down at 10,000 cycles as compared with the output at 400 cycles. The correct name for the transmission unit is the decibel (DB).

* * *

PLEASE SHOW how to connect a lamp from ground cold water pipe to reduce hum in an AC set.

(2)—How is maximum power output obtained in audio transformer coupling?

JAMES BLACK,
 Superior, Wisc.

(1)—See Fig. 756.

(2)—In Fig. 757 R1 is the resistance in primary and R2 that in secondary. Maximum power output obtains when $L2R1 = L1R2$.

* * *

WHAT TYPE of meter would you recommend for measuring the plate current in a resistance couple amplifier using 240 type tubes?

(2)—What type of meter do you recommend for measuring the plate voltage in such circuit? I have a high resistance

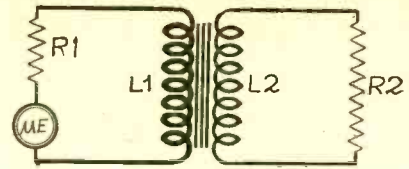

FIG. 757
SIMPLIFIED REPRESENTATION OF A TRANSFORMER CIRCUIT WITH RESISTOR REPRESENTING THE R2 LOAD.

meter and when I connect it between the plate and the filament I get such a low reading that I am sure I either have the wrong meter or that I am not using it in the right way.

(3)—Are heater type tubes (227) good amplifiers in resistance coupled circuits? What voltage step-up per stage can be expected with such tubes?

(4)—Is it better to use high coupling resistances than low ones from the point of view of stability of the circuit?

JOHN MORENO,
 Fort Worth, Tex.

(1)—It depends on the voltages and the coupling resistors as well as on the tubes. Perhaps the safest is to use a milliammeter having a range of 0-5 milliamperes. In some instances the current will be less than one milliamper, but the 0-5 meter can measure accurately down to less than half a milliamper.

(2)—A vacuum tube voltmeter or any other non-current drawing voltmeter. No ordinary voltmeter, even one of high resistance, will measure, accurately the plate voltage of such a circuit. But it is not necessary to measure the voltage at the plate. Connect any voltmeter of suitable range from the filament to the B plus post on the coupling resistor. If that voltage is correct, and if any current at all flows through the resistor, the tube gets enough voltage for proper operation.

(3)—These tubes are fair amplifiers in resistance coupled circuits. A step-up per stage of 7.5 can be obtained by using high plate coupling resistors.

(4)—As a rule, greater stability, as well as higher amplification, can be obtained if high value coupling resistors are used. It is practical to go as high as half a megohm.

Join RADIO WORLD' University Club

And Get Free Question and Answer Service for One or Two years.
 This Service Only for Those Who Subscribe by Filling out
 This Coupon and Sending Remittance.

Subscribe for RADIO WORLD for one year (52 numbers, one each week) at \$6, or two years at \$10 (104 numbers) by filling out this coupon and enclosing remittance. You will then become a member of RADIO WORLD'S University Club and receive a secret number.

Put this number on the outside of the forwarding envelope (not the enclosed return envelope) and also put at the head of your letter. If already a subscriber, send \$6 or \$10 for renewal from close of present subscription and your name will be entered in Radio University. No other premium given with this offer.

RADIO WORLD, 145 West 45th Street, New York City.

Enclosed find \$6.00 for RADIO WORLD for one year (52 nos.); or \$10.00 two years (104 nos.) and also enter my name on the list of members of RADIO WORLD'S University Club, which gives me free information in your Radio University Department for the period of this subscription, and send me my secret number indicating membership.

Name

Street

City and State

WHAT ZONE DO YOU LIVE IN? WHO IS THE COMMISSIONER?

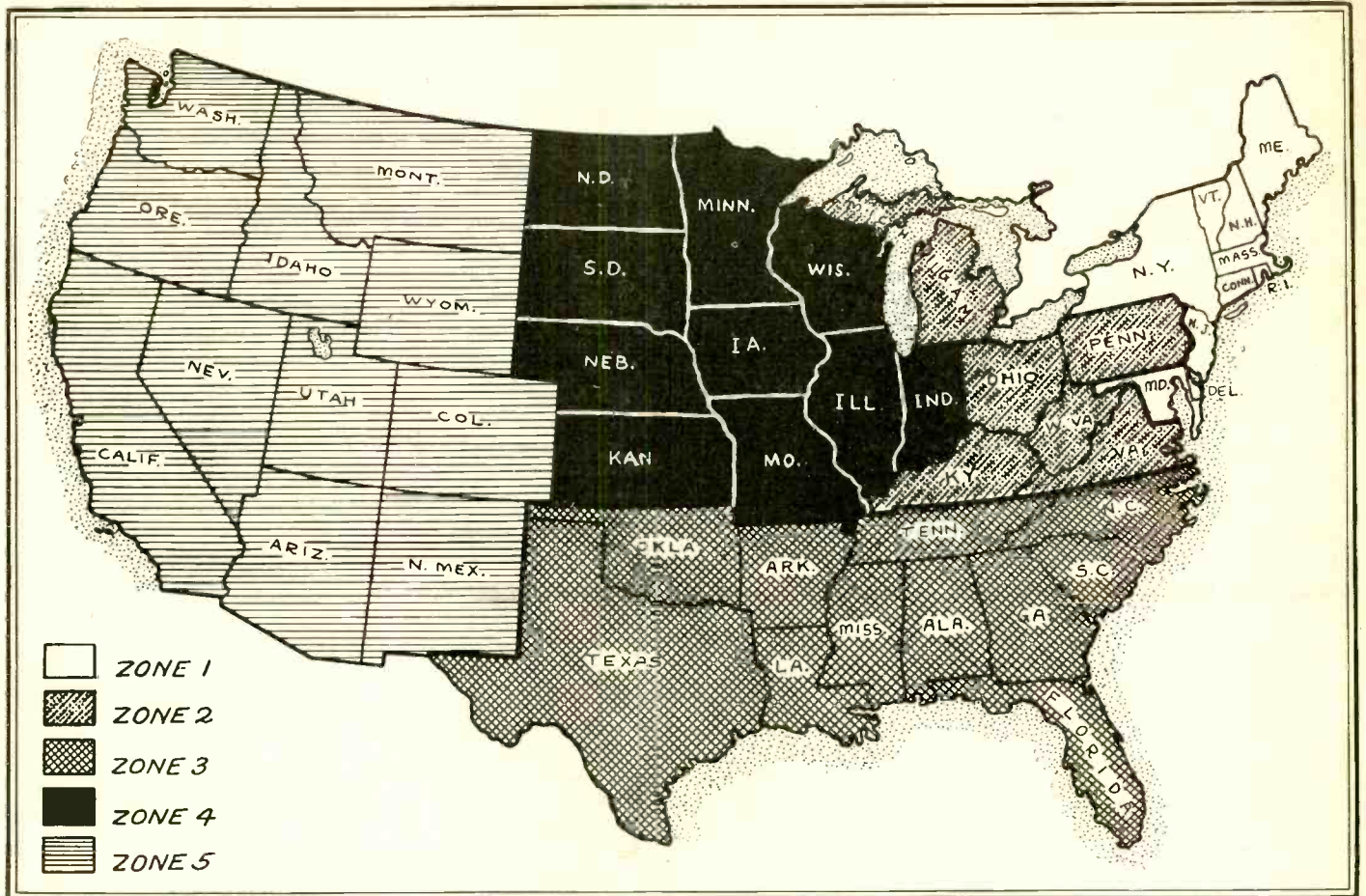

THE FIVE ZONES INTO WHICH THE FORTY-EIGHT STATES ARE DIVIDED. THERE IS A FEDERAL RADIO COMMISSIONER APPOINTED FROM EACH ZONE



Wm. D. L. Starbuck
First Zone



Ira E. Robinson
Second Zone



Eugene O. Sykes
Third Zone



Chas. McK. Saltzman
Fourth Zone



Harold A. Lafount
Fifth Zone

Ford Starts Radio Message Corporation

Detroit. A request before the State Utilities Commission at Lansing for the approval of a \$100,000 stock issue by the Ford Communications Company, a Delaware corporation, disclosed the formation of a radio service company backed by the Ford interests.

The company is headed by Edsel Ford, as president and treasurer. Other officers of the corporation are: Peter E. Martin, vice-president, and B. J. Craig, secretary. The original directors are Henry Ford, A. V. Line, C. S. Peabbles, and L. E. Grey, the last three of Wilmington, Del.

The company plans to engage in national and international radio and cable communication.

Weir Made Manager of Canadian Stations

The Canadian National Railways has placed at the head of its eleven broadcasting stations E. A. Weir, who for four years has been the company's publicity agent in London.

He was born on a Canadian farm. He is a graduate of a Canadian agricultural college and has been a lecturer in veterinary science, a judge of livestock, a bank manager, a Government land surveyor, an advertising expert, a magazine editor and a newspaper contributor.

VAN HORNE ENLARGES

The Van Horne Tube Company, of Franklin, Ohio, one of the oldest in the business, has undergone an expansion. Another large factory has been purchased. The president is David M. Kasson. John S. Van Horne, scientist, is vice president.

Why No Telephones On Trains? Dill Asks

Washington. Senator Dill, of the State of Washington, said the United States is backward in not having radio telephones on railroad trains, although it leads the world in other branches of radio.

He promised to bring up this subject in the Senate.

"Television" New Act On Vaudeville Stage

Atlantic City. "Television," a vaudeville act that constitutes a demonstration of television, has been booked for ten weeks at the Steel Pier. Actors under floodlights outside the stage are televised and the result screened for the benefit of the audience.

AC OUTSELL BATTERY SETS NEARLY 9-TO-1

The average value of each radio receiving set sold through the United States during the first quarter of 1928 was \$165 compared with a value of \$158 per set in the last quarter of 1928 and \$167 for the months of July, August and September, 1928, according to a statement made public by the Department of Commerce. The sale of AC sets compared with battery sets was almost 9 to 1. The statement follows in full:

Replies from 7,581 radio dealers in the United States indicated a retail volume of business amounting to \$25,540,245, during the first quarter of this year, according to results of the April 1st, 1929, quarterly survey of radio stocks in dealers' hands, compiled by the Department in cooperation with the Radio Division of the National Electrical Manufacturers Association.

Figures Compared

This figure compares with \$20,508,666 worth of business by 6,766 reporting dealers the third quarter and \$37,975,15 by 6,569 dealers the fourth quarter of last year. The fourth quarter's business is believed to have been substantially influenced by holiday trade. The dealers reported 139,347 electric and 15,623 battery sets sold during this period; this number divided into the total volume of business amounts to an average of \$165 per set, as compared with \$158 per set for the last three months of 1928, and \$167 per set for the period of July, August, and September, 1928.

The average volume of business per dealer was \$3,370 for the initial three months of 1929, whereas the corresponding figures for the third and fourth quarters of 1928 were \$2,470 and \$5,790, respectively.

Dealers Had 30,153 Dynamics

Forms were sent to 39,159 dealers on April 1, 1929, to 32,159 on January 1, 1929, and to 31,573 on October 1, 1928 and replies received were 7,581, 6,569, and 6,766, respectively.

Sixty per cent. of the total replies, which originated in the New England, Middle Atlantic and East North Central States, showed that 59 per cent of the total business reported for the United States was consummated there.

Stocks of electric sets held by the dealers replying amounted to 62,190, with the number of battery sets held about one-fifth as large; 30,153 dynamic speakers were held by these dealers, and a new item was added to the survey, covering stocks of separate radio cabinets, which amounted to 17,136 on April 1st, 1929. This shows that on an average one out of every four sets held by these dealers is stocked in a cabinet that did not originate with the set.

NEW HAMMARLUND PARTS

The three new Hammarlund parts shown in the May 25th issue of RADIO WORLD are made primarily for manufacturers' use, although they may be used to advantage by amateur and custom-set builders. The neutralizing condenser strip described was erroneously catalogued in one line. The proper designation should be, catalog number EC-35-KW3 for the strip.

Vorzimer's Career at New Height

From a tiny radio store started in a small room in the Yorkville section of Manhattan seven years ago, with small capital, to probably the largest individual radio store in New York City, is the business miracle performed by "Sid" Vorzimer, head of the Yorkville Radio Company. This company, now settled in its new location, 149 East 86th Street, does a yearly business of over \$750,000 in radio sets, parts and accessories.

The little business started by Mr. Vorzimer grew rapidly from the start, necessitating three removals to larger quarters. The new store has set-back display windows, a mezzanine floor and a subway store. The space covered is seven times that of the former store.

Believing that home movies are a natural auxiliary to radio as the best form of home entertainment, the new store houses a special home movie department with leading standard equipment, also a camera department.

Mr. Vorzimer bears the honorary title of Mayor of Yorkville.

SOUND OF DERBY AIR-RECORDED

Pathe Sound News photographed the Kentucky Derby at Churchill Downs with cameras operating in synchronism with radio receivers which recorded the sound on film running through a machine in New York, step by step with the cameras.

The films bearing the pictures came the 900 miles away from Kentucky to join their sound film mates, and matched well.

The only connection between the sound recording devices in New York and the cameras at the race track in Kentucky was through the radio waves, which not only bore the words and cries of the cheering throngs as Van Dusen scampered to victory, but also the impulses which kept the two tiny whirring motors running turn for turn with each other.

The result was used to supplant the Kentucky-made sound track in the release of Pathe Sound News.

This "remote recording" of sound and picture had never been done save under perfected laboratory conditions at short range. Pathe engineers are now engaged in setting up devices for the performance of a similar recording between Culver City, California, and New York.

NEW CORPORATIONS

- Good-Will Radio Stores, Brooklyn, N. Y.—Atty. Becker & Fink, 15 Park Row, New York, N. Y.
- Lyons Radio Sales, Inc., Philadelphia, Pa.—Corporation Trust Co. of America, Wilmington, Del.
- Musical Radio Corp.—Atty. Buchdahl, Males & Lempel, 276 5th Ave., New York.
- Aladin Radio Laboratory—Atty. H. X. Blum, 18 East 41st St., New York.
- Radio Systems, publish pamphlets—Atty. A. H. Goodman, 1482 Broadway, New York, N. Y.
- Almark Radio Company, Rochester—Atty. S. D. Cohen, 8 West 40th St., New York, N. Y.
- W. I. Borenstein, radios—Atty. B. Jaffe, 50 Court St., Brooklyn, N. Y.
- Mellaphone Corporation, Rochester, sound devices for theatres—Atty. W. Eber, Rochester, N. Y.
- May Radio and Television Corp.—Prentice-Hall, Inc. of Delaware, Dover.
- Hillside Radio Shop, Newark, N. J.—Atty. William Osterwill, Newark, N. J.
- Walbert Radio Corp., Dover, Del.—U. S. Corp. Co.
- Sylvania Radio Co., Inc., Wilmington, Del.—Corp. Service Co.
- Coin Radio Corp., Jackson Heights, L. I.—Delaware Registration Trust Co.

EVEREADY SOLE SALES UNIT FOR RAYTHEON TUBE

The National Carbon Company assumed control of the production and distribution of the Raytheon Manufacturing Company's entire output of radio tubes. The product will be marketed under the brand "Eveready-Raytheon."

The tubes are manufactured under patents owned exclusively by the Raytheon Manufacturing Company and under licenses granted by the Radio Corporation of America. The Raytheon Company also owns a number of patents covering tubes, lamps and photo-electric cells used in connection with television.

The capital stock of the Raytheon Manufacturing Company was increased from 100,000 to 200,000 shares without par value, and substantially all the property and assets of the company were transferred to a newly formed subsidiary, the Raytheon Production Corporation, a manufacturing organization. The National Carbon Company is given an option to purchase the entire capital stock of this new corporation on or before October 15th, 1938, on a cumulative price basis. To facilitate increased production National Carbon has agreed to invest \$500,000 in the production corporation. General Electric is behind the National Carbon Co.

Byrd Hears KDKA via Australian 2ME

Commander Richard E. Byrd and his companions at Little America, Antarctica, got a big surprise one morning recently when they listened to a program through station 2ME, Sydney, Australia. The program originated at KDKA, Pittsburgh, and was radiated on short waves and finally was rebroadcast by the powerful Australian station. The surprise program followed the regular Saturday broadcasting, at the conclusion of which Commander Byrd was requested to stand by, as a special treat had been prepared for him. A few minutes later the Sydney station went on the air with an orchestral number, "A Chinese Temple Garden."

Following the program, Howard F. Mason, one of the radio operators with the Byrd Expedition, sent the following message to KDKA:

"Your special broadcast received O.K. and enjoyed very much by all. Thanks." The program from Pittsburgh traveled a distance of 21,000 miles before it reached the men at Little America.

Warrant with Photo Radioed to Steamers

The first photograph ever to be sent from Germany by radio in connection with a warrant for the arrest of a person was sent recently to all steamers bound for America.

The warrant, including the subject's photograph, was to be served on a man wanted by the State Attorney of Berlin on a charge of fraud involving about \$180,000.

The German police assumed that he had sailed for America, where he had spent some time previously, and that he was traveling with forged passports.

Grid Tube \$3.00

240 High Mu Tube \$1.25

Great for Detector or in audio channels where a resistor or impedance coil is in the plate circuit. Fil. 5 volts DC, plate 90 to 180 volts.

POWER TUBES

250.....\$6.00	210.....\$4.50
171A.....1.50	112A.....1.50

OTHER TYPES

280.....\$2.50	281.....\$3.50
227.....2.25	226.....1.25
201A.....1.00	199.....1.25

KELLY TUBE COMPANY
Walter J. McCord, Manager
57 DEY STREET, NEW YORK CITY
Suite 6 Tel. BARclay 6659

GUARANTY RADIO GOODS CO.
145 West 45th Street, N. Y. City.
(Just East of Broadway)

Please ship at once one 0-600 volts AC and DC high resistance voltmeter, accurate to 1% plus or minus (Cat No. 600); meter equipped with 8-ft. cord, moulded tip receptacles, tips and hanger.
[Put cross in proper square below.]

\$7.00 enclosed
 I will pay Postman \$7.00 plus few cents extra for postage.

Name
Address
City State.....

DYNAMIC BAFFLE

Completely built up, for any type dynamic chassis. State what make dynamo you want it for. Cans sides, open back De luxe finish. Size, 24x24 inches..... **\$12.00**

GUARANTY RADIO GOODS CO.
145 West 45th Street, New York City

GUARANTY RADIO GOODS CO.
145 West 45th Street, New York City.
Just East of Broadway

Send me the following individual meters (quantity in square):

Cat. No. Cat. No. Cat. No.
 Cat. No. Cat. No. Cat. No.

NAME

ADDRESS

CITY..... STATE.....

TEN-DAY MONEY-BACK ABSOLUTE GUARANTY!



VICTOREEN Super Coils

Write for Free Blueprints of New Victoreen Circuits

Geo. W. Walker Co.
2825 Chester Avenue
Dept. B Cleveland, O.

New Style DeLuxe Leatherette Carrying Case FREE with each Jiffy Tester!

This combination of meters tests all standard tubes, including the new AC screen grid tubes and the new 245 tube, making thirteen tests in 4½ minutes! Instruction sheet gives these tests in detail.

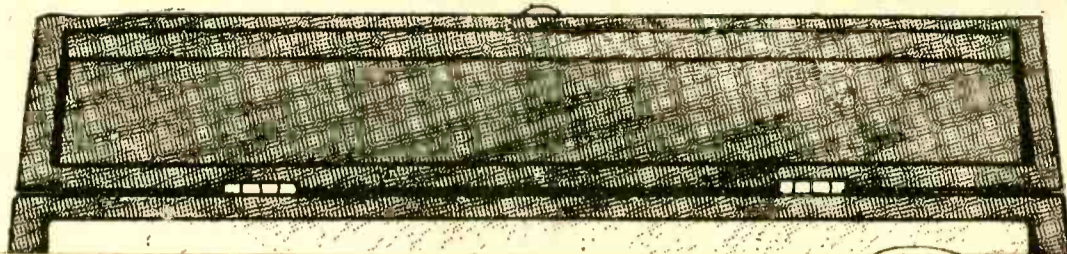

All Parts for MB-29

as described and specified by J. E. Anderson

Also for

H. B. Herman's
Resistance—Coupled Power Amplifier

GUARANTY RADIO GOODS CO.
145 West 45th Street
N. Y. City

ARISTOCRAT FLOOR SPEAKER

With Molded Wood Horn of 8 ft. tone travel (exponential type) with baffle and horn motor built in. Extraordinary bargain. **\$20.00**

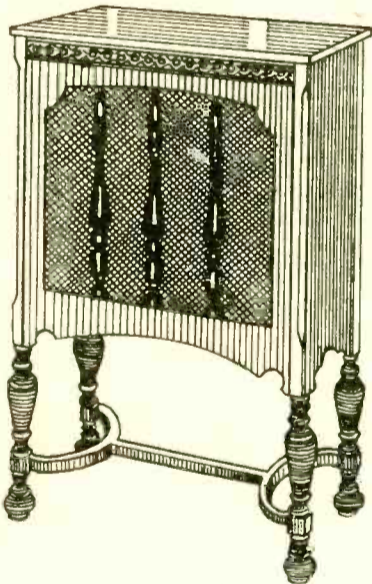

The speaker cabinet is walnut finish, 33" high, 24½" wide, 17½" deep, with carved legs. Golden cloth grille covers front opening. Built inside is No. 595 molded wood horn with baffle and No. 203 driving motor unit that stands 250 volts without filtration. Horn and motor removable. Table alone is worth price asked. Remit with order and we pay cartage on Aristocrat Floor Speaker.

Acoustical Engineering Associates
143 WEST 45th STREET
NEW YORK CITY
(Just East of Broadway)

Filament Transformer

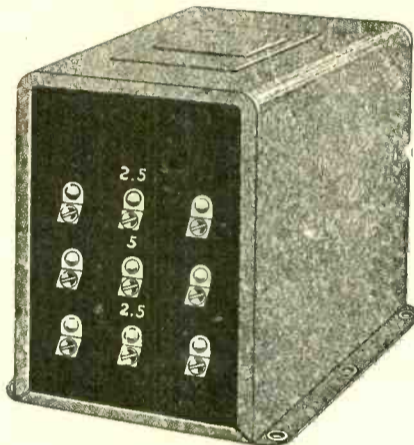

The heater type tube draws 1.75 ampere at 2.5 volts. If several such tubes are used a heavy-duty filament transformer is necessary. The top 2.5-volt winding of this filament transformer easily carries NINE AMPERES, or enough current for five heater type tubes. The bottom 2.5-volt winding stands four amperes, or enough current to heat TWO MORE such tubes, a total of SEVEN TUBES! The power tube, if of the 5-volt type, may be heated from the 5-volt central winding. 5-volt power tubes in push-pull may be heated from this winding.

All three windings are fapped at the exact electrical center. This precision location, made with the aid of an impedance bridge, accounts for absence of hum otherwise caused by the last tube when heated directly with AC. The heater type tubes are indirectly heated by AC, since the filament that glows is fed by AC but communicates heat to the cathode or electron emitter.

The heater type tube is represented by the 227, excellent as radio amplifier and audio amplifier, and the exclusive type of AC detector tube. Also the new AC screen grid tubes, with the same filament voltage and current, are of the heater type.

The transformer is beautifully finished in cracked glossy black, with bakelite front, and comes equipped with 52-inch AC cable with plug. Six riveted mounting holes for baseboard or subpanel. Size, 3¾ in. high, 2¾ in. wide, 3 in. deep. Shipping weight, 6 lbs.

Cat. F226A, for 50-to-60 cycles, 105-to-120 volts AC, Net Price\$6.00

Guaranty Radio Goods Co.
145 West 45th St.
N. Y. City

BLUEPRINT of the
New, Highly Selective
Screen Grid DIAMOND
(AC MODEL)
\$1.00

RADIO WORLD
145 West 45th Street New York City
Few Doors East of Broadway



Factory-Built. Ready to Plug Into Your Present Set. Operates perfectly without motorboating, by an auxiliary filter system control. This amazing radio instrument now makes it possible for you to reach 'round the world—England, Germany, Holland, Australia, Panama, Java and many foreign stations are some that are tuned in regularly on short wave. Permits you to enjoy programs that your regular receiver cannot get. What a thrill! No change or wiring required. All complete, ready to operate. Neat, golden brown, compact metal cabinet in crackle finish. Size, 9x5½x2¼ in. The only converter we know of that really works on all sets. Two models—A.C. and D.C. Write for Catalog and literature, or send \$25 and name of your dealer.

AERO PRODUCTS, INCORPORATED
4611 E. Ravenswood Ave., Dept. 1589, CHICAGO, ILL.

Reallocation Requires Greater Selectivity

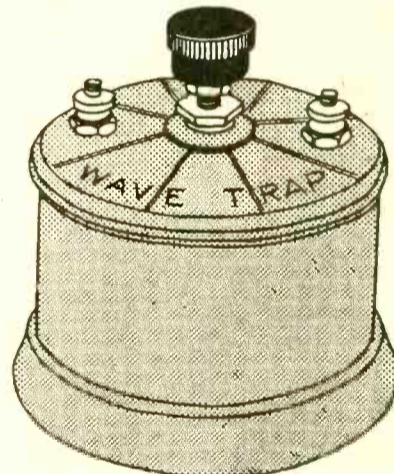

Use a Wave Trap. Spend \$1.50 to get clear reception.

How to hook up wave trap: disconnect aerial lead from set. Connect aerial to either post of the trap, other trap post to "Ant." post of set. Turn trap knob until interference disappears. Each different wave requires a different adjustment.

GUARANTY RADIO GOODS CO.,
145 West 45th Street, New York City
(Just East of Broadway)

Front and Subpanel for the

AC4

Front panel, drilled for National Drum Dial, volume control switch, and for "dummy". \$2.35

Subpanel, 6x19", cut milk ladel shape, to permit room for B eliminator; 4 sockets built into subpanel; other holes drilled.....\$3.65

SPECIAL: We carry National Velvet B (type 3580) in stock, also 280 tube. Get our prices on these. Blueprint for AC4.....\$1.00

GUARANTY RADIO GOODS CO.
143 W. 45th St., N. Y. City

Quick Action Classified Ads

Radio World's Speedy Medium for Enterprise and Sales
10 cents a word — 10 words minimum — Cash with Order

REDUCE STATIC: The Phantom increases selectivity, chokes out static. No lightning danger, no aerial, no holes to dig. Completely shielded. Hook up in three minutes. Guaranteed fifteen years. Price \$7.50 postpaid. Brighton Radio Lab., Brighton, Iowa.

ARTISTS and Art Students are printing 250 signs or pictures an hour without machinery. Sample and particulars 10c. Straco, 1014 Mulberry, Springfield, Ohio.

ELIMINATE AERIAL. Greater distance, volume, selectivity with "Little Black Box." Rosens Shop, 616 Plant St., Utica, N. Y.

RADIO RECEIVING TUBES, by Moyer and Wostrel, first edition just off the press. No radio service man, experimenter or student of radio should be without this authoritative book on the principles and applications of vacuum tubes. It answers all your questions relating to receiving, amplifying and rectifying tubes. Price postpaid, \$2.50 Radio World, 145 W. 45th St., New York.

DYNAMIC SPEAKER

Build your own with our castings. Set of machined castings, \$8.00; not machined, \$5.00. Full set blue prints and instructions included. Prices of complete parts on request.

IMPERIAL RADIO SPEAKER CO.
1453 East 174th St., Cleveland, Ohio

DIAMOND Pair

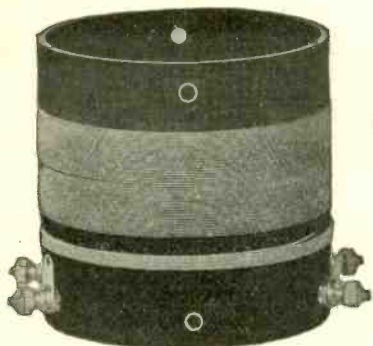

AC5 \$1.50

Highly selective antenna coil for any circuit, and interstage coil for AC circuits. Step-up ratio, 1-to-8. Tunes with .0005 mfd. Model AC3, for .00035 mfd. . . . \$1.75

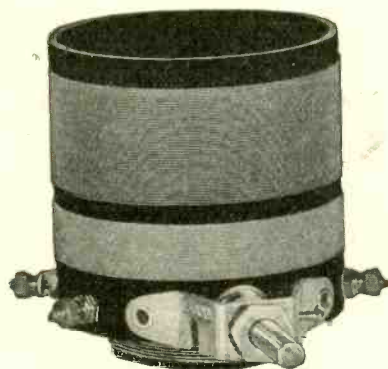

SGT5 \$2.75

Tuner to work out of a screen grid tube. The large primary is fixed and is connected in the plate circuit of the screen grid tube. Tunes with .0005 mfd. Model SGT3, for .00035 mfd. . . . \$3.00

UNIVERSAL Pair

TP5 \$3.00

Interstage coupler to work out of a screen grid tube, where the primary in the plate circuit is tuned, the secondary, in the next grid circuit, untuned. Tunes with .0005. Model TP3, for .00035 mfd. . . . \$3.25

RF5 \$1.50

Excellent selective antenna coil for any circuit, and interstage coil for any battery operated receiver, excepting output of screen grid tube. Tunes with .0005 mfd. Model RF3, for .00035 mfd. . . . \$1.75

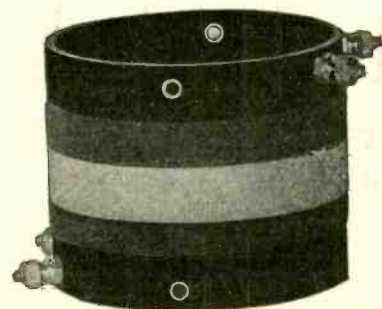

A5 \$1.75

Conductively coupled antenna coil, for maximum pickup, where selectivity is not the main consideration. Continuous winding in two colors. Tunes with .0005 mfd. Model A3, for .00035 mfd. . . . \$2.00
Screen Grid Coil Co., 143 W. 45th St., N. Y. City

CONE ASSEMBLY WITH DOUBLE MAGNET UNIT

\$6.00



An excellent magnetic type speaker for installation in any cabinet. The unit is a double-magnet Paratone, with two magnet coils, for utmost sensitivity. Each horseshoe magnet is 3/4" thick. The magnet coils are forever protected against dust and other foreign, injurious substances, by special bakelite housings. The pin is reverse drive. The cone frame is metal. The 9" cone is specially treated buckram.

All assembled, with long cord, ready to play. Shipping weight 6 lbs. (Cat. CAS) Net \$6.00

The unit alone (cord included). It will operate any type sounding surface, including paper, cloth, wood, etc. Shipping weight 4 lbs. (Cat. UA) Net \$3.50

Guaranty Radio Goods Co.
145 West 45th St., New York City

175 Varick St., New York, N.Y.

ELECTRAD INC.

Put Your Voltage Control Problems up to Electrad.

Write Dept. RW3. for useful data

COMPLETE PARTS
for the New, Highly Selective

SCREEN GRID DIAMOND

(Four-Tube Battery Model)

Exactly as Specified by **\$29.00**
Herman Bernard Net

Guaranty Radio Goods Co.
145 West 45th Street
New York City

Just East of Broadway

LYNCH

Filament Equalizer. Use it in filament circuit to keep filaments at their best operating points. All sizes. Complete with mountings, \$1.00. Without mount, 75c.

ARTHUR H. LYNCH, INC.
1775 Broadway New York City
Send for free book on Resistance in Radio

Recent Issues of RADIO WORLD, 15 cents each. Any number published in 1928 available for a short while. Six issues 75 cents, 10 issues \$1.00. Send stamps, coin or money order NOW, before the issues are sold. RADIO WORLD, 145 West 45th Street, New York City.

HBH Unit

ALL acoustical and radio engineers agree that the balanced armature type of loudspeaker unit is the best, the most sensitive and the most faithful of all magnetic units. But it is only in the HBH unit that superior designing skill, scrupulous care in the selection of the best materials, and extreme accuracy of manufacture have been combined and co-ordinated so as to bring out all the possibilities of the principle of the balanced type unit.

Any magnetic speaker requires a strong permanent magnet for its operation. The strength of the HBH unit is assured by the use of a long magnet of large cross-section, made of specially selected, high coercive-force steel, forged under the lowest heat possible, scientifically tempered in oil and aged.

The making of a permanent magnet requires a highly specialized skill. It must be forged, cut and tempered with as few heatings as possible, and no heating must exceed a certain temperature. If the magnet is to retain its strength and permanence. Another important feature of the magnet which enhances its strength and permanence is that NO HOLES ARE CUT IN IT. The magnet is one solid piece of steel and the pole pieces are clamped firmly to the steel by screws in the die cast harness holding the pole pieces and the armature.

The sensitivity and efficiency of the unit are enhanced by the use of laminated, properly tapered silicon steel pole pieces. Eddy current losses are thus reduced to a vanishing minimum and all the force is concentrated on the ends of the armature.

The armature itself is made of carefully annealed soft iron, thus eliminating any residual magnetization and reducing eddy currents and hysteresis losses to a very small percentage of the energy involved in the operation of the unit. The armature is made short and heavy to enhance its effectiveness in translating electro-magnetic energy into sound.

Nobody ever returned an HBH unit because of dissatisfaction with its performance! It stands up and delivers and continues to deliver. You can put 150 volts right through the magnet coils, steadily, without danger of the coil breaking. You don't need any extra power to operate this unit—as you do with dynamics—but get full efficiency at lowest cost and greatest economy.

Put this unit in your cone or cloth speaker in place of the unit now there and marvel at the difference! You will then recognize the technical superiority of this unit in terms of tone value and volume. It produces so much more volume than most other units that it makes distant stations sound like locals.

Order a unit today! Send \$4.00. Try the unit ten days. If not overjoyed, return it for full refund. Otherwise take 90 days to pay the extra \$1.95.

10-day money back guaranty!
90 days to pay in full!

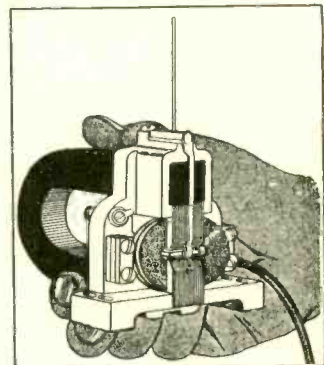

The HBH Unit, representing the most skillful and sturdiest magnetic unit design. Mfgd. under BBL License.

Price \$5.95
Moulded bracket (extra) 65c

Guaranty Radio Goods Co.,
145 West 45th St.,
N. Y. City (Just East of Broadway)

Please ship one HBH Unit only on 10-day money-back guaranty; at \$4.00 down, balance of \$1.95 in 90 days, unless I return the unit in 10 days for full refund of \$4.00.

Please ship moulded bracket also at 65c.

Name
Address
City
State

NEWEST BOOK ON VACUUM TUBES

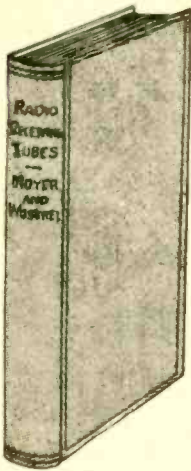

"RADIO RECEIVING TUBES," by James A. Moyer and John F. Westrich, first edition just off the press. No radio service man, experimenter or student of radio should be without this authoritative book on the principles and applications of vacuum tubes. It answers all your questions relating to receiving, amplifying and rectifying tubes. It is a complete discussion of tube principles, functions and uses, thoroughly up-to-date.

In this book the essential principles underlying the operation of vacuum tubes are explained in as non-technical a manner as is consistent with accuracy. The book covers the construction, action, reactivation, testing and use of vacuum tubes as well as specifications for vacuum tubes and applications for distant control of industrial processes and precision measurements.

Price \$2.50

RADIO WORLD
145 West 45th Street, New York City
(Just East of Broadway)

LACAULT'S BOOK

"Super-Heterodyne Construction and Operation," giving the master's most masterful exposition of the theory, performance and construction of this fascinating type of circuit, is a necessity to every serious radio experimenter. More than 100 pages and more than 50 illustrations. Burckman cover. This book by B. E. Lacault, FREE if you send \$1.00 for an 8-weeks subscription for Radio World. Present subscribers may accept this offer. Subscription will be extended.

RADIO WORLD 145 W. 45th St., N. Y. City
Just East of B'way

PLUG AND CABLE for any SHORT WAVE ADAPTER

May also be used as a 5-Lead Battery Cable and Plug, in conjunction with a 5-prong (AC227) socket.

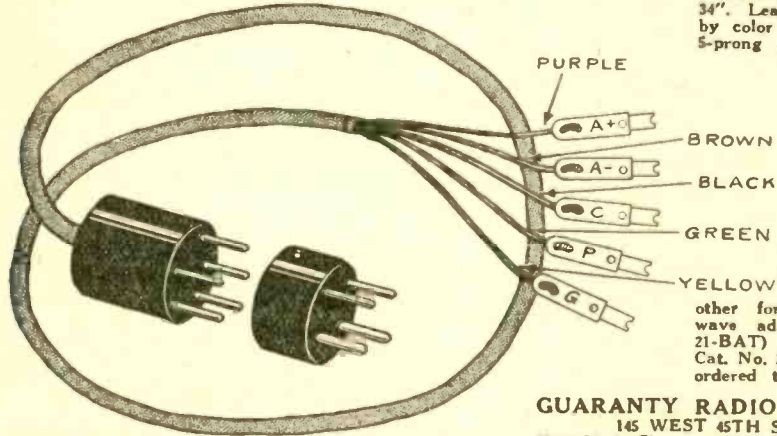

Handiest thing for ANY short-wave adapter. Put detector tube of your present set in socket of any short-wave adapter you build, put plug in detector socket of your broadcast receiver. Cable 34". Leads identified both by color scheme and tags 5-prong plug and 5-lead cable for AC short wave adapter. May be used as 5-lead battery cable plug with UY socket (Cat. No. 21AC) \$1.50 4-prong extra plug only necessary addition to other for battery short-wave adapter (Cat. No. 21-BAT) \$0.50. Cat. No. 21AC and 21-BAT ordered together \$1.75.

GUARANTY RADIO GOODS CO.
145 WEST 45TH STREET
New York City Just East of Broadway

RADIO WORLD, published every Wednesday, dated Saturday of same week, from publication office Hennessy Radio Publications Corporation, 145 West 45th Street, New York, N. Y., just east of Broadway. Roland Burke Hennessy, President; M. B. Hennessy, Vice-President; Herman Bernard, Secretary. Roland Burke Hennessy, Editor; Herman Bernard, Managing Editor; J. E. Anderson, Technical Editor.

FILL OUT AND MAIL NOW SUBSCRIPTION BLANK RADIO WORLD

RADIO WORLD

145 West 45th Street, New York City
(Just East of Broadway)

Please send me RADIO WORLD for _____ months, for which

SUBSCRIPTION RATES:

Single Copy.....\$.15
Three Months.....1.50
Six Months.....3.00
One Year, 52 Issues.....6.00
Add \$1.00 a Year for Foreign Postage; 50c for Canadian Postage.

please find enclosed

Aluminum Subpanel for the New, Highly Selective SG Diamond

Battery or AC Model (specify which)

The best appearance of the New Diamond of the Air results from using the official aluminum sub-panel, 10 x 20 inches, with the four sockets built in, and with self-bracketing front. Hardware and insulating washers supplied with each sub-panel. The aluminum sub-panel is exactly the same as the one used in the laboratory models of the battery operated and the AC Screen Grid Diamonds. Holes are drilled for mounting parts, but as this aluminum drills like bakelite you can drill any holes you want.

RADIO WORLD, 145 W. 45th St., N. Y. City.
(Just East of Broadway)

Enclosed please find \$3.00 for which please send one aluminum subpanel 10x20" for the new battery model 4-tube SG Diamond of the Air, with sockets built in, and with self-bracketing front and side and rear supports; also send hardware and insulating washers.

Enclosed please find \$2.35 for which please send 7x21" drilled Bakelite front panel for the new battery model Diamond.

Enclosed please find \$3.25 for the 10x20" aluminum subpanel, etc., for the new AC Screen Grid Diamond.

Enclosed please find \$2.35 for the 7x21" drilled Bakelite front panel for the new AC Screen Grid Diamond.

Enclosed please find \$5.00 for both the aluminum subpanel, etc., and the drilled Bakelite front panel of the battery model.

Enclosed please find \$5.25 for both the aluminum subpanel, etc., and the drilled Bakelite front panel of the AC model.

Name

Address

City..... State.....

New Diamond (AC or Battery Model)

PARTS FOR THE AC DIAMOND

CA, CG, C7—Three Aerovox .0005 mfd. mica fixed condensers, moulded, @ .25.....	\$0.75
CS, C4, C8—Three Aerovox .006 mfd. mica fixed condensers, moulded, @ 50.....	1.50
C6, C9—Two Aerovox .02 mfd. mica fixed condensers, moulded, @ \$1.00.....	2.00
C10—One Electro 4 mfd. condenser.....	2.50
C1—One Hammarlund Equalizer 70 mfd.....	.48
C2, C5—One Hammarlund Midline double condenser, each section .0005 mfd. (MLD21).....	6.00
R1, SW—One Electrad Royalty volume control (0 5,000 ohms) with 110-volt Hart & Hegeman AC switch built in.....	1.50
R2—One Electrad 900-ohm resistance strip (grid suppressor type).....	.20
R3—One Lynch 50,000-ohm resistor, with clips.....	.20
R4—One Electrad 2,000-ohm resistance stub.....	.20
R5—One Electrad 2,000-ohm type B resistor (B20).....	.20
T1, T2—Two National A100 audio frequency transformers @ \$5.70.....	11.40
T3—One filament transformer; one winding 2.5 volts at 9 amperes or more, one winding 2.5 volts at 3.5 amperes or more, one winding 5 volts at 2 amperes or more (merchandise by Guaranty Radio Goods Co.).....	6.00
PL—One Yaxley pilot light bracket with green jewel and lamp.....	.55
Ant., ground, speaker —, speaker +, four binding posts @ .10.....	.40
One roll Braidite wire.....	.30
One 7 x 21-inch front panel.....	2.35
One 10 x 20-inch official AC Diamond aluminum subpanel, self-bracketing, with three five-prong sockets and one four-prong socket built in.....	3.25
Front and subpanel together.....	5.25
Porcelain AC socket, screw plug 3-way plug, cable (lamp cord) and wall plug.....	.75
One dial.....	.90
Two knobs (one for tlecker, the other for volume control) @ .20.....	.40
Note: The optional condenser, CX, is .006 mfd. @ .50	

PARTS FOR BATTERY MODEL DIAMOND

C1—Aerovox .0005 moulded fixed.....	.25
C2—Hammarlund .0005 mfd. Midline.....	3.30
CS, C4—Two Aerovox moulded .006 mfd. @ .50 ea.....	1.00
C5—Hammarlund .0005 mfd. Midline.....	3.30
C6—Aerovox .00025 moulded fixed with clips.....	.30
C7—Aerovox .0005 moulded fixed.....	.25
A1—622 Amperite with mount.....	.85
A2, A3, A4—Three 1A Amperites, three mounts @ .85.....	2.55
R1—50-ohm front rheostat.....	1.40
R2—5-meg. Lynch metallized leak.....	.40
T1, T2—Two National A100 audios @ \$5.70 ea.....	11.40
Ant., Gnd., Sp. —, Sp. + posts @ .10 ea.....	.40
P1—Yaxley jewel window bracket .35 with pilot lamp.....	.20
SW—Yaxley No. 10 A battery switch.....	.35
7 x 21-inch front panel.....	2.35
10 x 20-inch official battery Diamond subpanel, self-bracketing, with four sockets affixed; subpanel hardware, insulated bushings, washers.....	3.00
Front panel and subpanel together.....	5.00
Two dials with pointers.....	2.00
Two knobs @ .20.....	.40
One roll stranded Braidite.....	.30
Hammarlund 70 mmfd. Equalizer.....	.40
Four Kelly tubes: one 222, two 201A, one 112A or 171A.....	7.00

GUARANTY RADIO GOODS CO.
145 WEST 45TH STREET
(Just East of Broadway)
NEW YORK CITY

SUBSCRIBERS!

Look at the Expiration Date on Your Wrapper

Please look at the subscription date stamped on your last wrapper, and if that date indicates that your subscription is about to expire, please send remittance to cover your renewal.

In this way you will get your copies without interruption and keep your file complete.

SUBSCRIPTION DEPARTMENT

RADIO WORLD

145 WEST 45TH ST., N. Y. CITY

SET Builders **FREE** LATEST RADIO GUIDE

Elections have brought back Custom Set building. Business is booming. Thousands of old-timers are clearing up. Let Barawik show you the way to bigger profits, more sales. Send today for Barawik's Big Bargain Book — the radio man's bible.

BARAWIK CO. 136 Canal St., CHICAGO, U. S. A.

Gothic Polo Speaker, \$15.00

Housed in a beautiful Gothic structure of genuine walnut; hand-rubbed to an attractive finish, the Polo driving mechanism and cone combine best quality reproduction with finest appearance. The grille is specially constructed for two-tone effect, so popular in walnut these days. The Polo Speaker in the Gothic housing is an adornment, besides being an outstanding speaker in performance. The design of the cabinet is exclusive. The height is 12 1/4". Shipping weight, 10 lbs. Cat. No. T.M.P.G.....

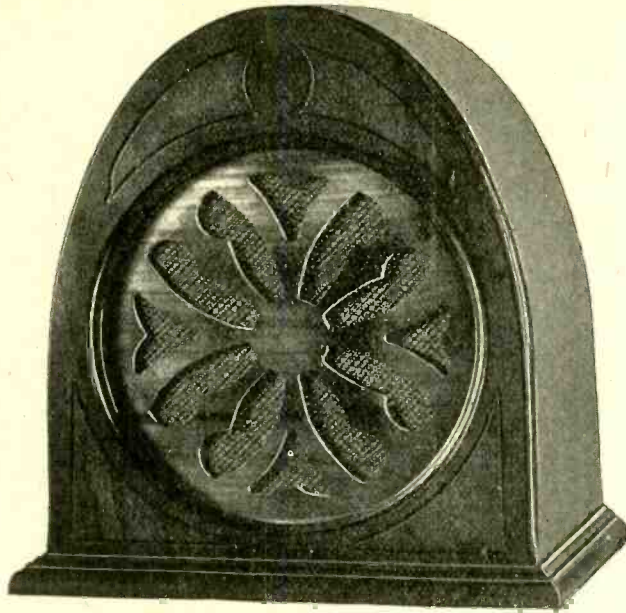

Guaranty Radio Goods Co.
145 West 45th Street
New York City

Troubled with A-C Hum?

The most likely cause is an unbalanced grid return to the A-C operated tubes. Center-tap transformers do not compensate for filament or circuit imbalance. Install a HUM-DINGER across filament terminals, adjust with screwdriver, and you'll clear up that hum in A-C sets. Ask your dealer to show you the HUM-DINGER, as well as other items of the CLAROSTAT line. Or if you prefer, write for literature.

CLAROSTAT MFG. CO., Inc.
Specialists in Radio Aids
291 N. 6th St., Brooklyn, N. Y.

CLAROSTAT

FAMOUS NATIONAL

Velvet B Eliminator \$16.13
180 Volts (280 Tube Free)



Latest Model National Velvet-B, Type 3580, in handsome crackle finish black metal casing, for use with sets up to and including six tubes. Input 105-120 volts AC, 50 to 60 cycles. Output, 190 volts maximum at 35 milliamperes. Three variable output intermediate voltages. (Det. RF, AF). Eliminator has excellent filter system to eliminate hum, including 30 henry choke and 18 mfd. Mersham condenser. No motorboating! (Eliminator Licensed under patents of the Radio Corporation of America and associated companies.)

Guaranty Radio Goods Co.
145 W. 45TH STREET
(Just East of Broadway)
NEW YORK CITY

GUARANTY RADIO GOODS CO.,
145 W. 45th St., N. Y. City

Please send C. O. D. on 5-day money-back guaranty, one National Velvet B (180 volts maximum with three variable intermediate voltages), 280 tube free, at \$16.13.

Enclose find \$16.13. Please send above. You are to pay cartage.

Name
Address

City State

5-DAY MONEY-BACK GUARANTY

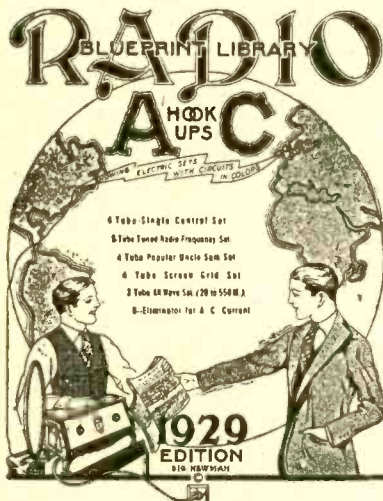

Fourteen Circuits

Each Shown in Colored Picture Diagram, Colored Schematic Diagram and Front Panel Layout

Get This FREE Book!

Complete AC electric receivers, with B eliminators included, also AC receivers without B eliminators, also battery operated models, all easy-to-build circuits, using your own parts.

RADIO WORLD, 145 W. 45th St., N. Y. City.
(Just East of Broadway)

Gentlemen: Enclosed please find \$1.00 for which please send me Radio World each week for eight weeks (regular price, \$1.20) and besides send me a FREE copy of the 1929 edition of The Radio Blueprint Library of AC and Battery Hookups.

Name

Address

City State

Note: Present mail subscribers may take advantage of this offer by putting a cross in this square. Your subscription will be extended eight weeks.

Recent Issues of RADIO WORLD, 15 cents each. Any number published in 1928 available for a short while. Six issues 75 cents, 10 issues \$1.00. Send stamps, coin or money order NOW, before the issues are sold. RADIO WORLD, 145 West 45th Street, New York City.

AGENTS AND SALESMEN WANTED
Sell \$5.00 Men's Daily Necessity for 50c. Cost quantities 20c. Sample postpaid 30c. Catalog hundreds household articles free. Mills Sales Co., 901 Broadway, New York.

HIGH RESISTANCE VOLTMETERS

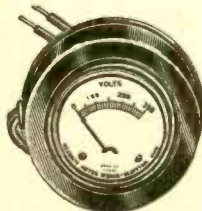

0-300 v., in portable type, full nickel finish, 30" tipped cord (illustrated at left). (Cat. No. 346) \$4.50

0-500 v., Tests ALL power packs, B eliminators, etc. Same casing as above. (Cat. No. 347) \$5.00
Just the thing for service men, custom set builders, home experimenters.

GUARANTY RADIO GOODS CO.
145 W. 45th St., N. Y. City



Your Choice of Any One of These Nine Meters FREE!

- 0-6 Voltmeter D.C. No. 326
- 0-50 Voltmeter D.C. No. 337
- 6-Volt Charge Tester D.C. No. 23
- 0-10 Amperes D.C. No. 338
- 0-25 Milliamperes D.C. No. 325
- 0-50 Milliamperes D.C. No. 350
- 0-100 Milliamperes D.C. No. 390
- 0-300 Milliamperes D.C. No. 399
- 0-400 Milliamperes D.C. No. 394

Equip Yourself Now With Necessary Meters!

To do your radio work properly you need meters. Here is your opportunity to get them at no extra cost. See the list of nine meters at left. Heretofore we have offered the choice of any one of these meters free with an 8-weeks subscription for RADIO WORLD, at \$1, the regular price for such subscription. Now we extend this offer. For the first time you are permitted to obtain any one or more or all of these meters free, by sending in \$1 for 8-weeks subscription, entitling you to one meter; \$2 for 16 weeks, entitling you to two meters; \$3 for 26 weeks, entitling you to three meters; \$4 for 35 weeks, entitling you to four meters; \$5 for 44 weeks, entitling you to 5 meters; \$6 for 52 weeks, entitling you to six meters. Return this offer with remittance, and check off desired meters in squares at left.

RADIO WORLD will help you in your radio work, so you will be able to use the meters most valuably. Keep abreast of all the new circuits, intimate details on perfecting existing sets, and get inside track on sensitivity, distance reception, tonal quality, and news of radio, technical and non-technical. Enjoy the writings of Dr. Lee De Forest, McMurdo Silver, J. E. Anderson, Herman Bernard and a host of other radio engineers who contribute their knowledge to you through the medium of RADIO WORLD, the first and only illustrated national radio weekly. You can find no magazine that better caters to your needs than RADIO WORLD. Short waves? RADIO WORLD will tell you all about them. Extremely sensitive broadcast receivers? Their construction and operation are fully discussed with confident regularity. Power supplies—push-pull or otherwise? AC receivers? Seven grid tubes? Large receivers that give a super-abundance of performance—small, economical receivers that give performance out of all comparison to their size? Are you interested in these? Then you're interested in RADIO WORLD.

Present mail subscribers may renew their subscription under this remarkably generous offer. Put a cross in square.

RADIO WORLD

145 W. 45th St., N. Y. City—Published Weekly.
All Newsstands, 15c per copy—\$3, six months—\$6 a year

Every Ten Kilocycles

In Comes a Station—When You Turn the Dial on the NATIONAL MB-29

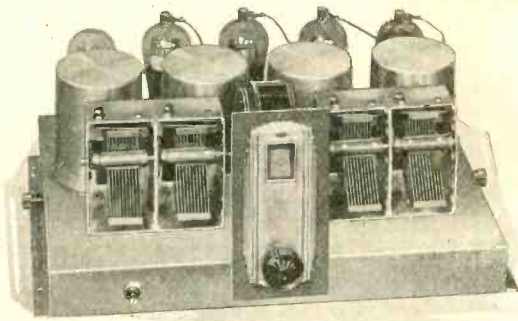

Ask to see the MB-29 or write us for full particulars today.

James Millen, and Glenn H. Browning of Browning-Drake fame, certainly have produced a masterpiece in their latest design—the MB-29 Five Tube Screen-Grid Tuner. The range of this ultra-sensitive, highly-selective receiver is amazing, even on a short indoor antenna. Every detail of the design is in advance of the times:—beautiful polished aluminum, shielded chassis; A.C. operation; and when used with the NATIONAL Velvetone Push Pull Power Amplifier (employing two 245's), rich full tone that fully measures up to 1930 standards.

Made under exclusive license under patents and applications of James Millen and Glenn H. Browning.

NATIONAL

MB-29 FIVE TUBE TUNER

NATIONAL CO., INC., Malden, Mass.

Est. 1914

Wholesale Prices

—for Dealers, Agents and Set Builders

RASCO HAS IT—PROMPT DELIVERY



Our huge Wholesale Radio catalog No. 19 (2ND EDITION) is a valuable encyclopedia—a liberal Radio education. Mailed immediately on request—absolutely

FREE

1500 illustrations and 6000 articles

From many years in the Radio Mail Order Business, we have learned how an organization can be efficiently run and retain the good will of our customers. Radio Specialty

Co. ships orders promptly!—offers you 100% quality merchandise on a strict money-back basis if not thoroughly satisfied and sells at rock-bottom net prices.

Our catalog contains the largest assortment of completely assembled all-electric AC Receivers at amazingly low prices, and other Radio Merchandise including such lines as Pilot—Silver—Marshall—Carter—Aero—Yaxley—Tobe—Hammarlund—Amer Tran—Cunningham—Dongan—Thordarson—Muter, etc., etc. The latest improvements in Radio are listed and thoroughly described in this great catalog: AC All-Electric Sets with self-contained ABC power supply—Public Address Amplifier systems—AC Set Converters—A and B eliminators—Dynamic Speakers and Units—Magnetic Speaker Chasses—250 Tube Amplifiers—Airplane Cloth Speakers—Push-Pull Power Amplifiers—Electric Phonograph Turn-Tables—Combination Radio and Electric Phonograph Consoles—Speaker Tables—Short Wave Sets and Adapters—Shield Grid Tube Kits—Television Parts—Electric Household Appliances, Vibrators, Tools, Workshops—Cameras, etc., etc. Logically, how can you afford to be without our catalog. Send for one now!

RADIO SPECIALTY CO.

100R Park Place New York, N. Y.
Radio's Oldest Mail Order House

HAVE AN EXPERT PUT YOUR SET IN SHAPE!

If your receiver or amplifier, no matter of what kind, is not giving proper results, send it to us, prepaid. We will test it FREE and let you know what's wrong, telling you cost of repairs. Our charges are very reasonable. Six years' experience. Loudspeakers and units repaired. Burnt-out coils replaced. Jaynson Laboratories, 57 Dey Street, New York City.

RADIO INFORMATION

Reliable, prompt, accurate, in every-day language, 25c per question. Radio Information Bureau, 1426 South Clifton Park, Chicago.

SOCKET WRENCH

FREE

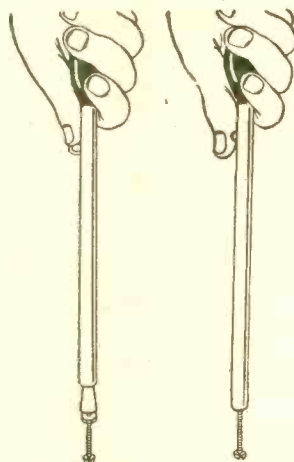

Push out control lever with knob (as at left) and put wrench on nut. Push down on handle only (at right), then turn nut left or right.

ONE of the handiest tools for a custom set builder, service man or home constructor is a BERNARD socket wrench.

It consists of a 6 1/2" long metal tubing in which is a plunger, controlled by a knob. The plunger has a gripping terminal (called a socket, hence the name "socket wrench") that may be expanded or contracted to fit 6/32, 8/32 and 10/32 nuts, the most popular sized nuts in radio.

Use the knob to push out the plunger, press down on the handle to grip the nut, then turn the nut to left for removal or to right for fastening down. Total length, distended, including stained wooden handle, 10". Gets nicely into tight places. Send \$1 for 8 weeks' mail subscription for RADIO WORLD and get this wrench FREE.

No other premium with this offer. Present subscriber may extend subscription by stating he is one, and entitle himself to this FREE premium, making \$1 remittance.

RADIO WORLD

145 WEST 45TH ST., N. Y. CITY

PROTECT your RADIO

USE THE

LIGHTNING ARRESTER

\$1

\$100 GUARANTEE

The Corwico Vulcan Lightning Arrester not only protects your radio set against lightning, but also dissipates accumulated static charges.

Any radio protected by Corwico Vulcan Lightning Arrester that is damaged by lightning will be repaired by us up to a cost of \$100.

Why take chances with storms and lightning when you can have guaranteed protection for \$1.00 with a Corwico Vulcan Lightning Arrester.

At All Dealers
Or Direct Upon Receipt of Price

CORNISH WIRE COMPANY
32 Church Street, New York City

MAKERS OF
CORWICO BRAIDITE HOOK UP WIRE

CONTROLS THE TRAFFIC THRU YOUR TUBES

Like the corner cop directing traffic, AMPERITE controls tube voltage. Self-adjusting, dependable, accurate. A type for every tube—A. C. or D. C. \$1.10 with mounting (in U. S. A.) at all dealers.

Radiall Company
50 FRANKLIN ST., NEW YORK

FREE "Amperite Blue Book"
of modern circuits and valuable construction data.
Write Dept. R. W.-11

This symbol in a radio diagram means—

AMPERITE

REG. U. S. PAT. OFF.
The "SELF-ADJUSTING" Rheostat

BUILD A 36-INCH CONE—LOWEST COST FOR FINEST TONE!



**NEW
POWERTONE
UNIT**

with 5-ft. cord
Designed Front Sheet
Plain Rear Sheet
Radio Cement
Mounting Bracket
Apex
Chuck
Nut
Tri-Foot Pedestal
Instruction Sheet
ALL FOR ONLY

\$6.00

24" KIT, SAME PRICE.

Build the speaker. If not overjoyed at results, return the built-up speaker in five days and get ALL your money back!

GUARANTY RADIO GOODS CO.

145 WEST 45TH STREET
N. Y. City Just East of Broadway