

TWO NEW TUBES ANALYZED

January 19th, 1929

15 Cents

RADIO

REG. U.S. PAT. OFF.

WORLD

The First and Only National Radio Weekly
356th Consecutive Issue—Seventh Year

How Loudspeakers Were Developed

New Chains
Under Way

Board Bars
Injunctions

Reallocation
Held Failure

S. R. O. Sign On
Useful Waves

THE NEW AC4

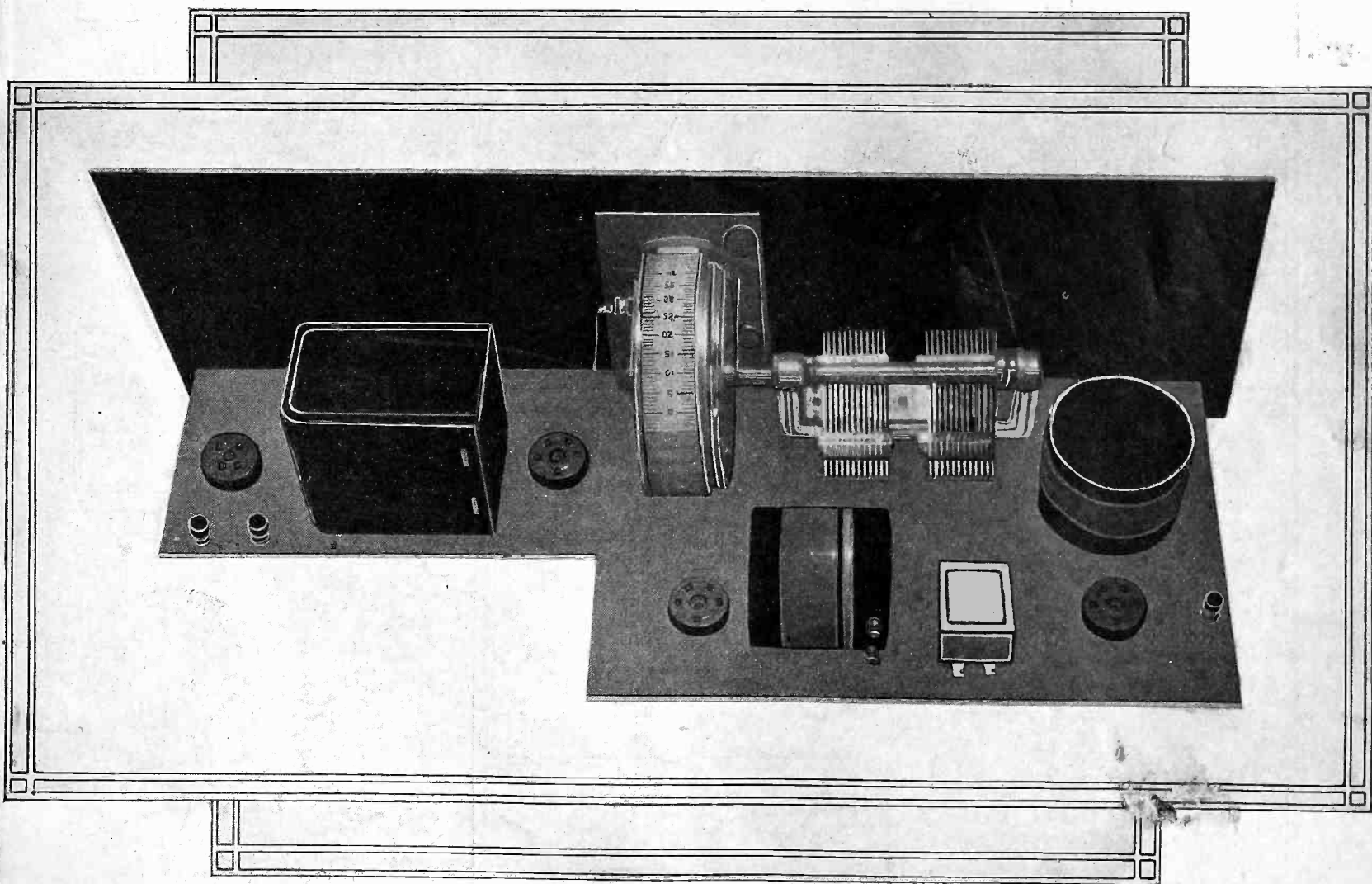

This subpanel is cut milk-ladle shape to make room for a factory-built B eliminator in the AC4. See pages 12 and 13.

New HBH Unit Sets World Standard!

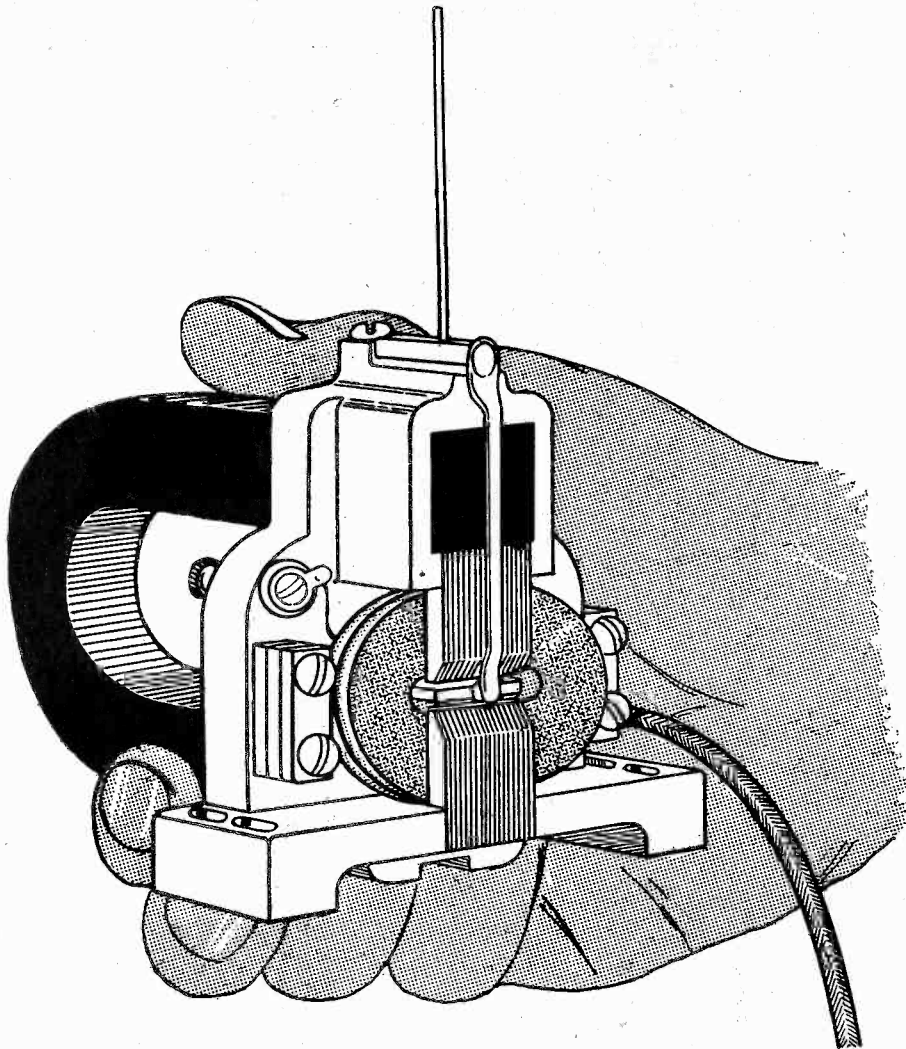

Any degree of volume is kept well in hand by the new HBH loudspeaker unit, for cones, cloth diaphragm speakers, etc. The unit is shown full size.

TWO years' intensive investigation of the minute details of construction that lend superiority to a magnetic type Unit have resulted in the combination of all the known assets into the new HBH unit. The result is something so far superior to anything you have ever heard or dreamt of, that we sum it up in six words: The finest unit in the world. Get one *now*—try it for ten days—money right back if you're not overjoyed!

This unit has won the enthusiastic acclaim of leading acoustical experts. There are eleven secret reasons for its uncanny performance. And now these advantages are yours at last!

Unheard-of Performance
at an Unheard-of Price

\$5.50
NET

Manufactured Under BBL
License

GUARANTY RADIO GOODS CO.,
143 West 45th Street, N. Y. City.
(Just East of Broadway)

Check off proper squares below:
 Please find \$5.50 enclosed, for which ship
AT ONCE on 10-day money-back guarantee
one HBH unit with 10-ft. cord.
 65c extra for moulded mounting bracket.

NAME.....
ADDRESS.....
CITY.....STATE.....

PARTS FOR THE AC 4

Complete Kit of Parts for the AC4, less
B eliminator\$36.75
Complete Kit of Parts for AC4, with
National B eliminator (180 v.) including
280 tube\$54.75
Complete Kit of Parts for AC4, with
National B eliminator, 280 tube, cabinet,
three 227 tubes, one 171A tube and Table
Model Polo Speaker (nothing else to
buy)\$75.00

GUARANTY RADIO GOODS CO.
143 West 45th Street
New York City

Front and Subpanel
for the

AC 4

Front panel, drilled for National Drum Dial,
volume control switch, and for "dummy". \$2.35
Subpanel, 6x19", cut milk ladel shape, to per-
mit room for B eliminator; 4 sockets built into
subpanel; other holes drilled.....\$3.65
SPECIAL: We carry National Velvet B
(type 3580) in stock, also 280 tube. Get our
prices on these. Blueprint for AC4.....\$1.00

GUARANTY RADIO GOODS CO.
143 W. 45th St., N. Y. City

COILS FOR THE NEW AC 4

Two AC5 (for .0005 mfd.)
@ \$1.50 each....\$3.00
Two AC3 (for .00035 mfd.)
@ \$1.75 each.... 3.50

SCREEN GRID COIL CO.
143 West 45th Street
N. Y. City
(Just East of Broadway)

Blueprint of the

AC 4

Price \$1.00

RADIO WORLD
145 W. 45th St., N. Y. City

SPEAKERELAY

Cat. No. 121

\$2

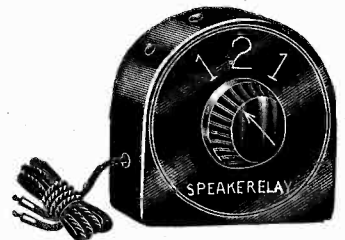

For connecting two speakers by turn of
knob so that at No. 1, left, you operate
one speaker alone; at No. 2 you operate
both speakers together; at No. 1, right,
you operate the other speaker alone. Ex-
cellent for store demonstrations or home
use. Earphones may be substituted for
one speaker.
Cat. 1234 for connecting 4 speakers, one to play
at a time.....\$2.50

GUARANTY RADIO GOODS CO.
145 WEST 45TH STREET
NEW YORK CITY Just East of Broadway

SOCKET WRENCH

**F
R
E
E**

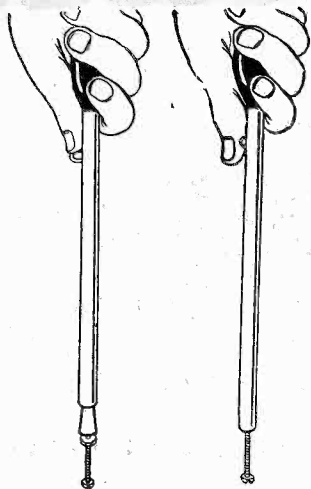

Push out control lever with knob (as at left) and put wrench on nut. Push down on handle only (at right), then turn nut left or right.

ONE of the handiest tools for a custom set builder, service man or home constructor is a BERNARD socket wrench.

It consists of a 6½" long metal tubing in which is a plunger, controlled by a knob. The plunger has a gripping terminal (called a socket, hence the name "socket wrench") that may be expanded or contracted to fit 6/32, 8/32 and 10/32 nuts, the most popular sized nuts in radio.

Use the knob to push out the plunger, press down on the handle to grip the nut, then turn the nut to left for removal or to right for fastening down. Total length, distended, including stained wooden handle, 10". Gets nicely into tight places. Send \$1 for 8 weeks' mail subscription for RADIO WORLD and get this wrench FREE.

No other premium with this offer. Present subscriber may extend subscription by stating he is one, and entitle himself to this FREE premium, making \$1 remittance.

RADIO WORLD

145 WEST 45TH ST., N. Y. CITY
A few doors east of Broadway

BUILD A 24-INCH CONE—LOWEST COST FOR FINEST TONE!



**NEW
POWERTONE
UNIT**
with 5-ft. cord
Designed Front Sheet
Plain Rear Sheet
Radio Cement
Mounting Bracket
Apex
Chuck
Nut
Tri-Foot Pedestal
Instruction Sheet
ALL FOR ONLY

\$6.00

REMARKABLE GUARANTY!

This 24" Cone Speaker Kit is sent complete, as listed, carefully packed. Order one sent C. O. D.

SEND NO MONEY!

Build the speaker. If not overjoyed at results, return the built-up speaker in five days and get ALL your money back!

GUARANTY RADIO GOODS CO.
145 WEST 45TH STREET
N. Y. City Just East of Broadway

New Ivory Finish POLO SPEAKER

The Most Beautiful Reproducer on the Market!

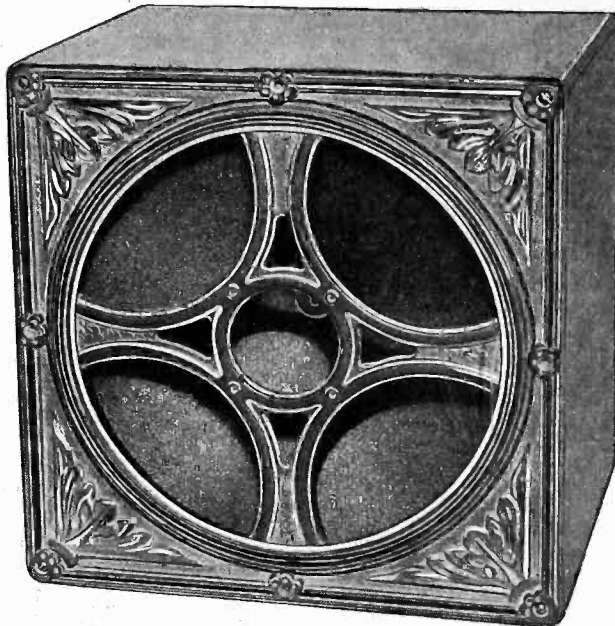

The polished tusk of an elephant is one of the choicest substances for the production of art objects, including precious carved trinkets. This ivory effect is now obtainable in the Polo Speaker (shown 1-3 scale). A new spraying process gives the real ivory effect—as entrancing as anything you've ever seen.

THE table Model Polo Speaker (illustrated) in a de luxe ivory finished housing, with moulded metal front piece, makes an outstanding table model speaker. It will stand the heaviest load—even two 250 tubes in push-pull without rattling—yet it is so sensitive it will work well from any output tube, even a 201A! The super-sensitive Twin Magnet Polo Unit is used, with a Burtex cone. Order one today at \$13.50, on 10-day trial. Pay \$9.00 C.O.D., rest in 90 days. You will receive the factory-built speaker, all ready to play.

The Polo Twin Magnet Unit is furnished with bracket, apex and 10-ft. cord, at \$10.00. Pay \$6.00 C.O.D., balance in 90 days.

A characteristic of the Polo Unit and the Polo Speaker is full, rich rendition of the low notes, due to even frequency response over the entire audible scale.

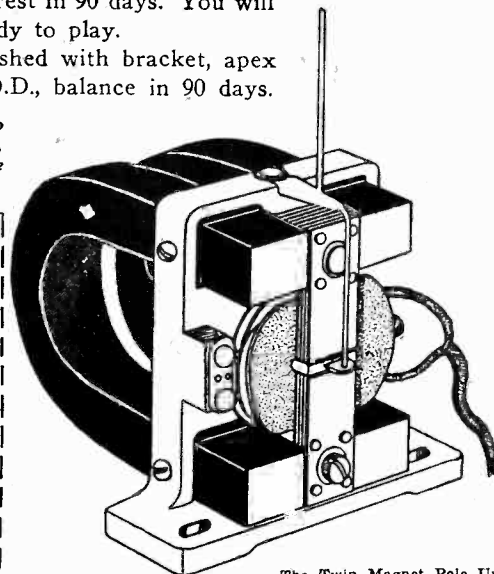

The Twin Magnet Polo Unit

Acoustical Engineering Associates,
143 West 45th Street, N. Y. City.
(Just East of Broadway)

Please ship at once:

- One Ivory Finish Polo Speaker, at \$13.50; \$9 payable C. O. D., rest in 90 days.
- One Polo Unit with bracket, apex, chuck, nut and 10 ft. cord, at \$10.00; \$6.00 payable C. O. D., rest in 90 days.

[Put cross in proper square above.]

Name

Address

City..... State.....

TEN-DAY MONEY-BACK GUARANTEE

DYNAMIC BAFFLE

Completely built up, for any type dynamic chassis. State what make dynamic you want it for. Cone slides, open back. De luxe finish. 8 1/2", 24x24 inches..... **\$12.00**

GUARANTY RADIO GOODS CO.
145 West 45th Street, New York City

TAKE Your Choice of 4 Other Publications for New Radio World Subscribers Ordering Now. Radio World has made arrangements to offer, with one year's subscription for Radio World, a year's subscription for any one of the following publications, FREE: Radio News or Science and Invention or Boys' Life or Radio (San Francisco) or Radio Engineering. Send \$6.00—now. State which other listed publication you desire. Radio World, 145 W. 45th St., N. Y. City.

RADIO WORLD, published every Wednesday, dated Saturday of same week, from publication office, Hennessy Radio Publications Corporation, 145 West 45th Street, New York, N. Y., just east of Broadway. Roland Burke Hennessy, President; M. B. Hennessy, Vice-President; Herman Bernard, Secretary; Roland Burke Hennessy, Editor; Herman Bernard, Managing Editor; J. E. Anderson, Technical Editor; Anthony Sodaro, Art Editor.

**For A-C Set
Volume Control—**

To control volume without distortion—that's the trick! It's simple, however, with the TABLE TYPE CLAROSTAT. Just connect it to antenna and ground binding posts—that's all. You can control the volume from a whisper to a roar. Also, you can control the sensitivity and the selectivity for compensating between loud local signals and weak distant signals.

Write us for literature on how to improve your radio set, no matter what type it may be. Or ask your radio dealer for Clarostat data.

CLAROSTAT MFG. CO., Inc.
Specialists in Variable Resistors
291 N. 6th St. Brooklyn, N. Y.

Pat. Off. **CLAROSTAT** Reg. U. S.

LYNCH

resistance-coupled amplifier kit for quality television reception. \$9.00

ARTHUR H. LYNCH, INC.

1775 Broadway New York City

Send for free Lynch radio manual

**VICTOREEN
Super Coils**

Write for Free Blueprints of New Victoreen Circuits

Geo. W. Walker Co.

2825 Chester Avenue
Dept. B Cleveland, O.

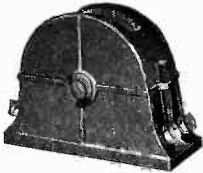

BLUEPRINT FREE!

4-Tube Screen Grid Diamond of the Air Blueprint, full sized picture wiring diagram; also schematic diagram and panel layout.

At 15c per copy RADIO WORLD costs you but for four weeks. But if you send 50c NOW you get the first and only national radio weekly for four consecutive weeks and this handsome official blueprint FREE!

This blueprint is life-sized and shows in easy picture diagram form how to mount parts and wire this super-sensitive receiver. One screen grid tube is used as radio frequency amplifier. The rest of tubes are two—01A and one 112A.

This circuit gives you distance, tone quality, ease of performance. No shielding, no neutralizing required!

Radio World, 145 West 45th Street, New York City

Enclosed please find 50 cents (stamps, coin, check or money-order) for which send me RADIO WORLD for four weeks, and free Diamond S. G blueprint.

Name

Address

City State.....

Renewal.

If you are already a mail subscriber for RADIO WORLD you may extend your subscription four weeks and get free blueprint, but put a cross in the square.

Please look at the subscription date stamped on your last wrapper, and if that date indicates that your subscription is about to expire, please send remittance to cover your renewal.

In this way you will get your copies without interruption and keep your file complete.

Subscription Department, Radio World, 145 West 45th St., N. Y. City.

KILLS NOISES

In Your Electric Radio



**Eliminates Hum!
Stops Interference
from all
Electrical Sources**

The SI-LEN-SER makes any electric or any electrified set play as quietly and free from hum as any battery operated receiver. The SI-LEN-SER silences all stray power line noises which enter the receiver through the power packs of electric sets and eliminators. The SI-LEN-SER eliminates absolutely all hum from powerhouse generators, and all bothersome knocks and noises that emanate from such electrical sources as nearby power lines, such electrical devices as electric refrigerators, vacuum cleaners, oil burners and other noise-breeding electric household apparatus.

CAN BE USED ON ANY VOLTAGE

Either Alternating or Direct Current

The SI-LEN-SER is absolutely universal. It works efficiently on either alternating or direct current and on any voltage or cycles, with any eliminator, either old style or new. The SI-LEN-SER is the device that all radio engineers have been seeking to make the electric set perfect. With the SI-LEN-SER, the clear and noiseless reception of a battery-driven receiver is now possible with the convenience of an electric radio.

Easy to Hook Up

All that's necessary is to plug the SI-LEN-SER into your wall or light socket, plug your set into the SI-LEN-SER, then make a ground connection. That's all there is to it. The SI-LEN-SER is small and compact, being 3 1/2 inches in diameter and 5 inches high. In addition to eliminating hum and other noises the SI-LEN-SER also prolongs the life of your A.C. tubes and enables you to use them at their maximum efficiency.

Sold by All Dealers

If your local dealer cannot supply you with a SI-LEN-SER, write us direct. The SI-LEN-SER is approved by radio engineers and fully guaranteed against electrical and mechanical defects.

\$12.50 List

JOBBER AND DEALERS—WRITE FOR DETAILS.

Manufactured and Guaranteed by

TRUTONE RADIO SALES CO.

Makers of the famous Philharmonic A.C. RECEIVERS

114-116 WORTH ST.

Phone: Worth 5573

NEW YORK, N. Y.

Sold Throughout Greater New York by all

CITY RADIO STORES

BRONX
224 E. F'dham Rd.
DOWNTOWN
63 Cortlandt St.

TIMES SQUARE
110 West 42nd St.
DOWNTOWN
42 Cortlandt St.

59TH STREET
744 Lexington Ave.
NEWARK
183 Market St.

BROOKLYN
924 Flatbush Ave.
JAMAICA, L. I.
163-24 Jamaica Ave.



Your name will be put on the mailing list free of charge on request.

A COMPLETE CATALOG with illustrations and detailed descriptions may be obtained free of charge on request.



NEWS to Set Builders

LATEST RADIO GUIDE

Barawik offers set builders bigger bargains — bigger opportunities to make money this season. New sets, new kit ideas, all the leading parts, dynamic speakers, supplies, etc. Lowest rock-bottom prices. Bigger stocks, quicker service. Send for Big Barawik Book today—free.

BARAWIK CO., 1311B Canal Sta., CHICAGO, U. S. A.

Vol. XIV, No. 18 Whole No. 356
 JANUARY, 19, 1929
 15c per Copy, \$6.00 per Year
 [Entered as second-class matter, March
 1922, at the Post Office at New York,
 N. Y., under Act of March, 1879]

RADIO WORLD

Latest News and Circuits
 Technical Accuracy Second to None

Publication Office, 145 West 45th Street,

A Weekly Paper published by Hennessy
 Radio Publications Corporation, from
 New York, N. Y.
 (Just East of Broadway)
 Phone: BRyant 0558 and 0559

INDEPENDENT CHAINS TRYING FOR BIG LISTS

Despite the enormous cost of maintaining a good key station and serving a chain of stations by land wire for rebroadcasting, several attempts are being made to establish rather important chains. The latest effort has the backing of the Gimbel family, owners of Gimbel Bros. department stores in three cities.

The New York store operated WGBS, but the General Broadcasting Company took this over, and the studio was removed from the store to the Hotel Lincoln on Forty-third street. The transmitter remained at Astoria, L. I.

Paskman Heads Company

WGBS was given reduced time and a higher frequency under the reallocation. It then applied for half time on WABC's wave, just before the announcement that WABC had been bought by the Columbia System to be used as the main key, as WOR will quit as such.

Dailey Paskman, formerly manager of WGBS, when it was run by the store, is president of the General Broadcasting Co. He spent a good part of his active life in the theatrical business, as executive assistant to Morris Gest, producer. His theatre contracts enabled him to draw exceptionally good talent to WGBS until the chains made payment of good talent the rule, and the theatrical booking agents and actors' "Union" sided with view.

Hence Paskman is turning to the formation of a chain of real importance. With Gimbel money behind his project he is endeavoring to line up stations, to bolster his application before the Commission.

Others Try for Long List

Paskman is meeting with considerable success, despite his difficult task, and the Gimbel interests are greatly pleased with his work.

In the West two new chains are gaining in strength, while the National Broadcasting Company, through its Red and its Blue net work, and the Columbia System, are getting bigger almost weekly.

WJAX Joins N. B. C.

WJAX, Jacksonville, Fla., joined the coast-to-coast network of stations regularly associated with the National Broadcasting Company. Before it had been a special network addition.

The station, which is owned by the City of Jacksonville, has a 1000-watt transmitter, operated on a frequency of 1260 kilocycles, or a wavelength of 238 meters. Thomas C. Imeson is Commissioner in Charge for the city.

The Columbia Broadcasting System is now operating a chain including 47 stations from New York to Los Angeles. The wire link and wire monitoring system is more than 100,000 miles long, said William S. Paley, president.

The Red and Blue networks of the National Broadcasting Company, not classed as "independent chains, have 58 stations on their list.

Brief Asks Ouster Of WGY's Appeal

Washington.

The Federal Radio Commission filed with the Court of Appeals of the District of Columbia a reply brief in support of its four motions to dismiss the appeal of the General Electric Company, in the case of the Commission's reallocation order, placing WGY, at Schenectady, owned by that Company, on part time operation.

Louis G. Caldwell, as counsel for the Commission, in the brief said that "examination of counsel's arguments discloses that substantially the only contention made is that a decision denying an application for renewal of license is the same as a decision revoking a license." He added:

"Argument hardly seems necessary to show that the very opposite is intended by the radio act of 1927."

WRIT PARADE GETS LARGER

Washington.

The list of stations that want to air their grouch over their reallocation assignment in the Court of Appeals of the District of Columbia is growing fast. The way having been paved by WGY, Schenectady, N. Y., the others hope WGY will emerge victorious, so they, too, may look forward to success.

Actual commencement of action against the Commission, or notice of appeal preparatory to such action, has come from the following:

WENR, Chicago, owned by public utilities interests, headed by Samuel Insull.
 WLS, Chicago, the "Prairie Farmer" station.

WCBD, Zion City, Ill., owned by Wilbur Glenn Voliva. Portable owned by C. L. Carroll, of Chicago.

WNYC, the municipal station of New York City.

WGY, owned by the General Electric Company, Schenectady, N. Y.

The three Illinois stations whose call letters are given are engaged in a three-cornered fight.

Washington Convention is Now in Full Effect

Washington.

The International Radiotelegraph Convention, signed in Washington in November, 1927, is now in effect.

The following countries have deposited their ratifications in the Department of State: United States and Canada, with respect to the convention and the general regulations.

The following have deposited ratifications of the convention and the general and the supplemental regulations relating

BOARD STRIVES TO PUT A STOP TO INJUNCTION

WASHINGTON.

Efforts to circumvent any legal obstructions to its orders and allocations are being made by the Federal Radio Commission.

WGY, in its suit for a permanent injunction restraining the Board from denying it a cleared channel on 790 kc., maintained it had a property right in that assignment, by virtue of long enjoyment, equivalent to the possession of a trade mark. Charles Evans Hughes, for WGY, made the argument.

The Commission is now inserting "saving clauses" in its assignments, so that any license issued or extended is conditioned on acceptance with a waiver of any claim of "vested property right."

WNYC Takes Same Stand

The argument that such a right is acquired by use was not only made by WGY, the General Electric Co. station at Schenectady, N. Y., which was given daylight assignment under the reallocation, but is being put forward also by WNYC, the New York City municipal station. WNYC wants full time, also.

In recently extending short wave licenses for one month the Commission joined that acceptance shall be deemed a consent to the conditions imposed. One of the provisions in these new extensions shows the Board's attempt to circumvent the plea that a change in assignment violates the Constitution safeguard against taking property without compensation.

Wording of "Safeguard"

This provision follows:

"The Commission reserves the right to change the frequency assignment of any station, the license of which is affected by this order, during the extension herein provided if, in the opinion of the Commission, such changes are advisable."

The WGY case is still before a Federal Court in the District of Columbia, while WNYC is threatening to seek an injunction in the same manner, but is awaiting the outcome of the other case.

thereto: Austria, Belgium including the Belgium Congo Colony and the Mandated Territory of Ruanda-Ruandi, The Netherlands including the Dutch East Indies, Suriman and Curacao, Great Britain, British India, Norway and Denmark.
 The Department of State has been officially informed that the following have ratified, but ratifications have not yet reached the State Department: Italy, Finland and Morocco. The receipt is expected daily.

NO TELEVISION AT ALL UNTIL PAST MIDNIGHT

Washington.

Television and still picture broadcasting, which heretofore have been permitted experimentally within the broadcast band, but under "rigid regulation," have been ruled out of that band, the Federal Radio Commission announced. No television or still picture transmission is to be permitted at all except between midnight and 6 a. m.

It was stated at the Commission that because of the noises and interference caused by visual transmission, disturbing regular broadcasting, it has decided to place this phase of radio in the short wave spectrum, or outside of the area where it would interfere with broadcasting. Heretofore, it was explained, the Commission has permitted visual broadcasting on the same frequencies as the audible, because it would not entail the purchase of the public of short wave radio equipment, which is intricate and difficult to operate.

Two Licensed in Band

There are only two stations licensed for visual broadcasting within the broadcast band, WGY at Schenectady, and WIBO, Chicago, and approximately 20 operating on short waves. Several other stations, however, it was explained, have been operating within the broadcast band during early morning hours without express Commission authorization.

On October 31st the Commission adopted a General Order (No. 50) specifying that picture broadcasting and television broadcasting will be permitted in the short wave spectrum, the exact frequencies, or band of frequencies to be determined at a later date. These, it was stated, have not yet been determined.

Disturbs Programs

It has been found, it was stated, that visual broadcasting disturbs audible broadcasting to the extent that it should not be permitted on the broadcast band, even experimentally.

Extra Weight Reduced By Exercises at Radio

Chicago.

Pat Flanagan, physical director, WBBM, received letters from men and women in all walks of life who told of improvement after faithfully following out the director's orders in his morning broadcasts.

One woman said she reduced her weight from 216 to 126 pounds by a six months' faithful adherence to exercises after diets were unable to bring about permanent improvement. A man in Tennessee who tried for four years to reduce, sent a letter offering Flanagan a new hat if his exercises would reduce his weight to 285 pounds. Flanagan won the hat.

Flanagan was physical director in the Y. M. C. A. for four years followed by an experience as physical director for a battalion in the 132nd. infantry and a number of years on the radio at WOC and WBBM. The exercises take place every morning except Sunday over the WBBM from 10:45 to 11:00 A. M., C. S. T.

Public Hearings Set for Television

Washington.

A public hearing on television and picture broadcasting, to ascertain whether it will be permitted within the broadcast band of frequencies, will be held this month, the Federal Radio Commission announced.

It was decided to invite all interested parties to attend the meeting to discuss the advisability of allowing visual broadcasting within the broadcast band from 500 to 1,500 kilocycles, limited, however, to 10-kilocycle operation.

"It was further decided," the Commission announced, "that all transmission of television or pictures in the broadcast band be prohibited except between the hours of 12 midnight and 6 a. m."

Recently the Commission issued an order removing all visual broadcasting from the broadcast band, because of interference caused by regular broadcasting. Since October the Commission had permitted such transmission on a limited basis.

BILL SEEKS END OF RADIO BOARD

Washington.

A Federal Communications Commission, taking over and enlarging the activities of the Federal Radio Commission, would be established by a bill (S. 5104), introduced in the Senate by the chairman of the Senate Committee on Interstate Commerce, Senator Watson (Rep.), of Indiana.

"I do not contemplate any action on this measure at the current session," declared Senator Watson as he introduced the measure. "I am submitting this bill as a basis of discussion for the creation of such a Commission."

The Federal Communications Commission outlined in the Watson bill would consist of seven members serving seven-year terms at a compensation of \$10,000 per annum. The commission would regulate and control the transmission of intelligence by telegraph, telephone, cable and radio.

The Federal Radio Commission is abolished by the act, and its work taken over by the new Commission. The bill also transfers to the Commission all functions of the Interstate Commerce Commission relating to communications and relating to common carriers engaged in the transmission of intelligence by telegraph, telephone, cable and radio.

Certain functions of the Postmaster General over such communications are also given to the new independent executive body, as well as the functions of the President relating to submarine cables.

Cuba Gets Television On WGY Wavelength

Tuinucu is tuning in on television, according to Frank Jones reported reception of WGY's television transmission at Tuinucu, Cuba.

The image he saw was that of A. O. Coggeshall, one of the announcers of WGY. The voice of Mr. Coggeshall was very familiar to Tuinucu listeners, but this was the first opportunity to view his face.

ARTISTS' COST FOR N.B.C. PUT AT \$5,000,000

By M. H. Aylesworth

President, National Broadcasting Co.

It costs money to run radio stations. During 1928 the presentations from the National Broadcasting Company studios have represented an expenditure of \$5,000,000 for talent alone, and it cost \$2,000,000 more just for rental of wires to carry these programs to our associated stations. Also, we have about 600 business employees who insist upon being paid every two weeks. All this money has to come from somewhere.

Britain's Case

Our financing is sometimes contrasted with that of the broadcasting business in Great Britain. In England they meet expenses by the licensing of receiving sets and every person who listens-in has to pay a yearly fee to the Government—just as he does his water taxes or his automobile taxes.

Last year the British listeners paid something more than \$5,500,000 in license fees to support their twenty-one broadcasting stations—or about \$250,000 per station. In America we have something like 700 radio stations. If they were to be financed on the British license basis—it would cost the listeners of America approximately \$192,000,000 in radio taxes or from \$15 to \$20 a year tax on every owner of a radio set.

Painless Extraction

As a matter of fact, in this country we try to raise the money painlessly. The radio listener does not pay a single cent in taxes or licenses to the Government or the broadcasting stations or anyone else for the privilege of using his radio.

In America, we obtain our financial support in the same way as does our sister industry—the publication business. That is, by making available a certain proportion of space or time for the printed or spoken messages of commercial concerns. In other words—advertising.

Correct Resistance Sharpens Television

Fans who are experimenting with television have many troubles in this early stage of the art. One of their chief difficulties is in obtaining a clear, sharp image. Many of them may not be aware that in television reception precise resistance in the Kino-lamp circuit is necessary. In this instance it amounts to the same thing as the focusing arrangement in the camera where, without precise adjustment the picture is a failure.

It is therefore necessary that a suitable variable resistor, of absolute precision, such as the standard clorostat be inserted in the Kino-lamp circuit so that the applied voltage may be delicately adjusted until the desired contrast is obtained. The current may then be so exactly adjusted that on strong negative impulses the light goes out, while with positive impulses the glow intensifies accordingly. At this point of adjustment of current, the tone and contrast are most distinct and realistic in accordance with the television signals received. In other words, the image is in focus.—J. H. C.

AIR CHANNELS SCARCE EVEN TO 23,000 KC.

By Dr. John H. Dellinger

Chief Engineer, Federal Radio Commission

New problems facing the Federal Radio Commission arise from the rapid development in many phases of radio: transoceanic telegraphy and telephony, airplane communication, emergency and special uses of every conceivable kind.

Most of the new projects involving radio contemplate the use of the high frequencies above broadcasting. These high frequencies have the advantages of carrying to great distances with moderate power, and of less susceptibility to static than the low frequencies, but are subject to irregular variations with time.

Above 23,000 Kc. Impractical

They extend from 1,500 to about 23,000 kilocycles. Below 1,500 kilocycles lies the broadcasting band, and above 23,000 the frequencies have not so far been demonstrated to be of practical use.

In this band of high frequencies there are available about 1,900 communication channels. This number may be increased in the future, as engineering progress permits simultaneous signals to be more and more closely crowded together in frequency.

Of these 1,900 channels at present available approximately 1,300 are in the band 6,000 to 23,000 kilocycles, in which any signal may be heard all over the world. There are already some 2,400 stations in the world operating on these frequencies, an average of about two per channel. This frequency band is therefore already more than occupied.

Danger of Interference

Whenever more than one station is operated on a channel there is a potential source of interference. Additions can be made only in special cases by consideration of the areas affected, times of operation, differing capacities of the various frequencies at different parts of the diurnal period and engineering expedients like directional reception or transmission.

The real nature of the congestion is apparent from the fact that the commission has in the past been forced to deny hundreds of applications for licenses in this frequency band.

There remains the 1,500 to 6,000 kilocycle band. These frequencies are continental rather than worldwide in their effects. There are 639 communication channels in this band in the present state of the art. These are all available for use on this continent, as there will not in general be interference between their uses here and in Europe or other continents.

Their most effective use will be promoted by understandings between the several North American countries, and for this reason discussions are now in progress on this subject between this country, Canada, Mexico and Cuba.

How Choice Is Made

The Commission has about 850 applications pending for frequencies in the continental band. These are for all sorts of uses, such as ship telephone and telegraph, airplane telephone and telegraph, freight train communication, geophysical exploration, power line emergency service, television transmission, point-to-point commercial message service, broadcasting

International Parley Is Set

Washington.

Canada, Mexico, Cuba and the United States will resume consideration of the distribution of continental short waves among these countries at a conference to be held at Ottawa probably beginning on January 21st.

The conference is for the purpose of consummating a "gentleman's agreement" as to the wavelengths that will be allocated for commercial use by these countries, so that interference in communication may be avoided.

Delegates Mentioned

The American delegation, it was said, probably will consist of three Radio Commissioners, O. H. Caldwell, Sam Pickard and Harold A. Lafount, and William R. Vallance, Assistant Solicitor, Department of State, and Lieut. Commander Tunis A. M. Craven, U. S. Navy, technical adviser to the Commission.

It was explained at the Federal Radio Commission that the tentative agreement reached with the other North American nations as to the division of the short wave spectrum, at a conference in Washington in August, was to have been consummated at a conference in Ottawa during November. Canada, however, requested that it be granted 50 per cent of the channels and informed the Department of State that it would not negotiate until the principle of 50-50 division as between the United States and Canada was agreed to. An agreement subsequently was made, however, it was added, under which the conference will be held.

70 Channels Awarded

Since this agreement, the Federal Radio Commission has allocated 70 of the 639 channels in the short wave band between 1,500 and 6,000 kilocycles, for commercial use on an unshared basis by the United States. Forty of these were assigned to the Universal Wireless Communications Company of Buffalo, a new concern, for the purpose of establishing a radio point-to-point communications network linking 110 cities, and accepting message business on a public service basis.

The Commission assigned 20 short wave channels to the American News Traffic Corporation, and its associated news gathering organizations for the distribution of news dispatches on a public service basis. These channels will be used in connection with the 20 transoceanic channels allocated the press organization recently.

pickup, relay broadcasting, police signaling, general experimentation, etc.

It will be by no means possible to grant all these applications. Even though several stations at suitable distances may operate simultaneously on one channel, the total number will be definitely limited.

In this band, just as in the higher frequencies, the Commission will be under the necessity of denying some applications, since their number exceeds the transmission opportunities on the channels available.

The choice among the applicants is made on the basis of public convenience, interest or necessity.

The Commission brings this to the notice of the public in order to warn prospective users of radios of possible disappointment. Many a business man has worked out excellent communication plans involving radio, only to learn to his sorrow that channels are hard to obtain. The Commission hopes that it is rendering a public service by now hanging out the S. R. O. sign.

PLEA TO STOP SUNDAY JAZZ TURNED DOWN

Washington.

The Federal Radio Commission has no authority to establish a "radio Sunday blue law" as is requested by the Lord's Day Alliance, the Commission's General Counsel, Louis G. Caldwell, declared.

The opinion is expressed in a letter to Linn A. E. Gale, secretary of the National Association Opposed to Blue Laws, Inc., which previously had protested to the Commission against the demand of the Alliance.

"Your letter to Commissioner Robinson on the question of the Commission prohibiting broadcasting on Sundays of anything but purely religious music and oratory, has been referred to the legal division for reply," General Counsel Caldwell wrote.

No Authority

"In this connection you are advised that under the radio act of 1927, as amended, the Commission is without authority to censor programs which are broadcast over the air, or to take any regulation interfering with the right of free speech by means of radio communication.

"I see no reason to believe that the Commission will take the position which the organization you mention in your letter is reported to intend to urge upon the Commission."

Wanted Jazz Banned

The Rev. Harry L. Bowley, Secretary of the Lord's Day Alliance, recently filed with the Commission a resolution asking that "Sunday jazz over the radio" be ruled against.

The Association Opposed to Blue Laws subsequently asked the Commission to retain the present situation, under which stations are permitted to broadcast in their own discretion.

Kiley Appoints New BBL Jobber

Pat Kiley, director of sales in the vast metropolitan territory for the BBL units and magnetic pickups, manufactured by the Best Manufacturing Company of Irvington, N. J., announces the appointment of the Wolfe Radio Company, 26 Warren Street, New York City, as jobbers.

This concern will handle the territory covering New Jersey, Brooklyn, Long Island and in Manhattan north of Chambers street. The original jobbers, Sanford Radio Company, 122 Greenwich street, known for the notable success which they have achieved in distributing this product, will continue to serve their territory, which is south of Chambers street, and covering the entire downtown radio district. Mr. Kiley reports the BBL unit as going stronger than ever, the factory working night and day to supply the growing demand.—J. H. C.

NEW BOOK BY DUNLAP

Orrin E. Dunlap, Jr., radio editor of "The New York Times," has written a new book, "Advertising by Radio." He discusses the appeal of the sponsored broadcast and its place in advertising. The book has just been brought out by the Ronald Press Company.

REALLOCATION HELD FAILURE BY ROBINSON

Washington. That the reallocation, put into effect November 11th, is a failure, and conditions are now worse than what they were previous to that date, was the assertion made before the House Committee on Merchant Marine and Fisheries, by Chairman Ira E. Robinson, of the Federal Radio Commission. He said he voted against the reallocation.

Chairman Robinson's declarations were made at a hearing on the White bill to extend the life of the Commission one year from March 15th, 1929, the date on which its life expires under the Radio Act of 1927.

Has Shunned Participation

Chairman Robinson said he also was opposed to the provision of 40 cleared channels for exclusive use of high-powered stations. He explained that he has not participated in any of the Commission activities incident to the reallocation because of his original dissent.

Chairman Robinson endorsed the White bill, saying that there is much work yet to be done in all phases of radio, including broadcasting, television and radio communications.

Replying to a question by Representative Briggs (Dem.) of Galveston, Tex., he said:

"There have been so many complaints against the reallocation that this is one of the grounds for the continuance of the Commission. If it has made a mistake it must correct it."

Bill Gets Right of Way

Opening the hearings the Committee's chairman, Representative White (Rep.) of Lewiston, Me., stated there were several bills pending for Committee consideration.

By unanimous consent it was agreed that the White bill first should be considered because of the urgent nature of the legislation which, if not enacted at this session, would let the Commission advert to a quasi-judicial body, and vest in the radio division of the Department of Commerce the administration functions of the Commission.

Aerovox Continues Growth

Aerovox Wireless Corporation, 70-72 Washington Street, Brooklyn, makers of Aerovox condensers and filters, J. I. Cole announced, has added another 15,000 square feet to its quarters in the building. This is in addition to the 10,000 feet of space added to the factory last July. Special machinery has been added to speed up production and extra shifts are being worked to keep up with orders. A complete list of the parts manufactured by this concern will be sent for the asking. Mention RADIO WORLD.—J. H. C.

A THOUGHT FOR THE WEEK

IT is evident that those stations that have been put out of the running by the Radio Commission do not think that it is a case of "survival of the fittest." The threatened suits demanding reinstatement should add a little zest to the job of Radio Commissioner—described reverently by one of the halibuts as "a feather duster without a handle."

Taylor Is Elected Institute President

At a regular meeting of the Institute of Radio Engineers, Dr. Alfred N. Goldsmith, retiring president, announced that Dr. A. Hoyt Taylor had been elected president of the Institute for 1929, and that Dr. Alexander Meissner, of Germany, had been elected vice-president.

Meissner studied in Technical School, from which he received the degree of Doctor of Technical Science.

Dr. Taylor is director of the United States Naval Research Laboratory and was the recipient of the Morris Liebmann Memorial Prize for 1927 for meritorious work in radio, particularly in the field of piezo electric frequency control.

He was commissioned a Lieutenant in the Naval Reserve in 1917 and was promoted to Lieutenant Commander in 1918. He has been in charge of the Naval Radio Research Laboratory since 1922, when he was promoted to Commander and placed on the inactive list. He has been a member of the Institute for thirteen years.

LAW IS ASKED TO END PIRACY

Some telephone companies are pirating broadcast programs, the Radio Division of the National Electrical Manufacturers charged, and demanded amendment of the radio law specifically to cover such offenses.

The manufacturers assert that certain telephone companies receive broadcast programs without obtaining the permission of the stations where these programs originate, or of the sponsors of these programs, or of the copyright owners, and send the programs over the telephone company wires at a fixed charge to subscribers. This technical method is known as a form of "wired wireless."

Another charge by the manufacturers is that some other companies are habitually making phonograph records of broadcasts, and commercializing them, without authority.

A bill was drawn up by Louis B. F. Raycroft, vice-president of the N. E. M. A., in charge of the radio division, in cooperation with association's law and legislative committee.

"While the spirit of the statute is clear," said Mr. Raycroft, "and it is quite plain what the legislators intended to forbid, certain practices have grown up and others have threatened, which contravene the spirit but do not seem to be covered by the letter of the law."

Section 28 of the radio act of 1927 says: "* * * nor shall any broadcasting station rebroadcast the program or any part thereof of another broadcasting station without the express authority of the originating station."

To state specifically the prohibitions intended the new bill would introduce the following wording: "nor shall any such person, firm, company or corporation intercept in the process of transmission and rebroadcast in any manner restraint by wire or wireless or by any means record for the purpose of reproduction the program or any part thereof of another station without the express authority of the originating station."

The proposed amendment is said to have been favorably received by broadcasters, and many of the stations are expected to support the measure.

ANIMAL PETS ENJOY MUSIC BY DAMROSCH

The old epigram to the effect that "music hath charms" is being given a modern slant in connection with Walter Damrosch's weekly radio concerts.

From his human listeners have come numerous letters testifying that mammals and birds in great numbers are enjoying the series he is giving for the Radio Corporation of America and the National Broadcasting Company.

These revelations as to the strange make-up of his audience were given an impetus by Mr. Damrosch himself when at his first broadcast with the National Orchestra he read a telegram from Maumee, Ohio, announcing that a flock of birds had assembled on a windowsill for the concert.

Birds and Dog Enjoy It

M. J. Haglund, of Maumee, sent the message:

"There are a lot of birds in this vicinity who frequently come and perch on the windowsill for a few moments during the musical programs and listen to my loud-speaker. Tonight instead of just staying for a moment, they are remaining right through, gathering in constantly increasing numbers."

Capping this came a letter from Charles Kloehn of Washington, D. C.

"My Airdale is becoming extraordinarily musical. You know, most dogs howl at music. Bramble-Son-of-Briar, with a prodigious pedigree, lies in front of the radio entranced at things melodious, cocking an ear when a flute or violin predominates and thoroughly enjoying himself."

Cat Likes It, Too

Foremost among the cats in the Damrosch audience is Mitzi, of Arcadia, California. Mitzi's owner, W. McGarr, writes:

"Our living room in which we sat is of the old English farm type with high raftered ceiling. There was no light in the room except the embers of a slowly dying fire in the grate. Seated on the hearth was our orange Persian kitten, Mitzi, a gentle, intelligent animal. During one of your numbers Mrs. McGarr pointed to her. I looked and knew what she meant. Mitzi was enjoying your music. Her tail was moving back and forth in perfect time with the music, and the expression on her face showed plainly that her finely artuned nervous organism was sweetly in accord with the melody. Sir, I have seen her react entirely differently to music of another type. At the sound of jazz her eyes flash, her fur stands on end and she dashes off from the offensive noise."

Another Cat Fan

Another regular cat listener, also of California, is reported to have exterminated a cricket who interrupted a Damrosch number. From F. J. Wilmington, of Mar Vista, comes this disclosure.

Gershwin Rights Sold

The Godfrey Wetterlow Company, program producer, has bought the rights for the first radio presentation of George Gershwin's "An American in Paris," on behalf of the W. S. Quinby Company, which will sponsor the broadcast.

THE AIR COLUMN

Fifty cleared channels or bust!

* * *

Federal Radio Commissioner Lafount says that after hearing the appeals of stations dissatisfied under the reallocation he finds every aggrieved station is the best on the air. Too bad he wasn't a Judge of the Court of Appeals of the District of Columbia, when he would have learned from Charles Evans Hughes how truly magnificently great is a station that is better than the average.

* * *

Birds, dogs and cats enjoyed Walter Damrosch's broadcast symphonic music, thus shaming human beings.

* * *

Anti-injunction clauses are being inserted in licenses and renewals issued by the Federal Radio Commission, while the law under which the Board acts is slowly turning injunctive itself, as the Board's life ebbs.

* * *

The argument that it isn't legal to change a station's frequency assignment or hours on the air raises the question whether it's legal to tune a station out. At any given time we always tune all stations out save one. Our set is more selective than the Commission supposed.

* * *

Dr. Alfred N. Goldsmith, vice-president of the R. C. A. and its chief broadcast engineer, remarks that he tuned in station after station, from the East Coast to the outer fringe of the Middle West, and about all he heard was "Sonny Boy" all the time and heterodyne whistles half the time. His set evidently wasn't selective enough to tune out the song.

* * *

Stations quarreling with their reallocation position are flocking to the same court in Washington, all singing the same song, too, only it isn't "Sonny Boy." WGY started the injunction songfest. Pretty soon no station will be complete without an injunction.

* * *

One injunction is better than good program talent any day.

* * *

Jazz on Sunday, for which a ban was asked by those who wanted religious and inspiring programs exclusively, on the day of rest, can't be prohibited by the Radio Commission, says the Board's counsel. Now listen to the stations get back at the Blue Law advocates by jazzing even the hymns.

* * *

Fat persons dropped much superfluous weight, exercising before their radio sets, to the commands of the WBBM physical director. Anguish will exact its toll.

* * *

All useful waves are overcrowded, says Dr. Dellinger, the Federal Radio Commission's engineering expert. As frequencies go, since those above 23,000 kc. are unmanageable commercially, there's plenty of room at the useless top, as in business.

* * *

The first Hudson-Essex Hour was marked by the announcement it was "a fortunate coincidence" that this start was made just as a new model car was being introduced by the Hudson-Essex group. Sponsors of programs should take out accident insurance.

* * *

THE DESIGN WAS PERFECT BUT THE FINESSE WAS RAW.

* * *

American Academy is trying to ascertain which announcer has the best truly American diction. Easy problem to solve. Ask any announcer.

* * *

Listeners scatter their choice all over the dial night after night. Nothing less than a

\$100,000 program bunches the listeners on one program nowanights. Yet some stations are proud when they intersperse jazz phonograph music with red seal records.

* * *

The Radio Commission requires stations to identify the fact that they are playing record music, but leaves the method to the station. One phonographic station announces: "We have just completed a program of copy music." That would apply to almost any of the popular music of the day. No expert is needed to discover the original.

* * *

Talks by the presidents of companies that sponsor programs are unfailingly dull, but vanity must be appeased. Shop talk falls flat on sharp ears.

* * *

On behalf of a New Jersey manufacturer a publicity "release" was sent out stating the company was about to put on the market a television receiver, and that television is an accomplished commercial fact. A statement issued for a Brooklyn radio set manufacturer asserted television was overrated, and was in the experimental stage only. The same publicity man sent out both "releases." He was right.

* * *

The "signature music" of the sponsored programmarians is getting more tiresome. Composers get real money for stopping the advertising manufacturers from bothering them.

* * *

Television is restricted until after midnight, local time. If an Eastern "looker-in" wants to tune in a Pacific Coast station's television transmission he has to wait until 3 a. m., E. S. T. For the present the television receiver market must be restricted to sleepwalkers.

* * *

It was foolish of the Commission to rule television off the broadcast band day and night, on account of interference with programs. It could have had a good alibi for heterodynes.

* * *

KILO—Did anybody else ever say your home receiver has the finest tone he ever heard?

WATT—Nobody who owes me that much money ever dared visit my home at night.—H. B.

BERLINER, OF SONATRON, WEDS

Sidney Berliner, New York City salesman for the Sonatron Tube Company, 16 Hudson Street, New York City, and Miss Annetta Shapiro were married recently. The ceremony took place at the home of the bride, 1115 Avenue T, Brooklyn.

Berliner started as shipping clerk with the Sonatron Company, when it went into business. His marked ability led him up from laboratory tester to contact man to the New York City salesmanship, where he has made good in the hardest selling territory in the country. Here, he has made a record, and modestly attributes much of his success to the able guidance of Lew Newman, sales manager of the Sonatron Company, the largest independent tube manufacturing company in the country.—J. H. C.

NEW CORPORATIONS

The Veteran Wireless Operators Association, Inc., New York.
 Mitchell-Storck Radio Corp.—B. Haas, Nyack.
 Chalmers Radio Service, Newark—Kessler & Kessler, Newark, N. J.
 Cincrow Corp., Radio equipment—Atty., M. E. King, 1564 Broadway, New York.
 Mayflower Radio Renting Corp.—Atty., L. Feuerman, 9 Park Place, New York.
 Square Radio Stores—Atty., D. J. Joltes, 26 Court St., Brooklyn, N. Y.
 Cornell Radio Stores, Brooklyn, N. Y.
 Van Wickland Products Co., Jersey City—Atty., Corporation Trust Co., Jersey City, N. J.

NO ELECTRICITY IN 10,000,000 HOMES IN U. S.

There are more than 10,000,000 homes in the United States not wired for electricity, hence cannot use AC radio sets. Few are not potentially a market for radio receivers deriving their current from batteries. Many have overlooked the extent of the battery set field.

The latest statistics of the Government reveal that Washington, D. C., is regarded as one of the most urban communities in the country. A large part of the District of Columbia is solidly built up as a city. Yet there are no fewer than 28,300 homes in the capital of the nation which are unwired for electricity. Ohio has 342,000 unwired homes; Kentucky 418,700; Pennsylvania 852,500; North Carolina 514,900. The total for the United States, according to the latest official estimate, is 10,559,510. In many States it is estimated that the market for battery sets is 70 per cent. of the total.

Recently National Carbon Company, Inc., sent agents into representative rural communities in several populous states. Consultation with rate engineers of power companies showed that these companies, although making every effort to keep down costs to the consumer, were facing a difficult problem. They had reached the point where they could not give farmers current where there are three farms or less to the mile.

It was found that where farms were concentrated 2.5 to 2.9 per mile the minimum charge was \$8.50. A lesser concentration per mile brought a minimum charge of \$10. In all cases the farmer received 50 kilowatt hours for the prices quoted. Several of the communities in which the survey was made are in regions where the generating cost of electricity from water power is relatively low.

First New Product of 1929 Is Si-len-ser

The first radio apparatus of 1929 has made its appearance. It is the Si-len-ser, a product of the Trutone Radio Laboratory engineers, under the direction of Julien J. Proskauer, head of the Trutone Company, makers of the famous Philharmonic AC receivers and other radio products.

The Si-len-ser is a device designated to eliminate disturbances from all electric sources on all types of receivers, AC or DC electric sets or sets working on eliminators or power packs. It is said to kill all stray power line noises, all knocks and clicks from push buttons, defective sockets, power house and power line noises, noises generated by electric trolley and elevated lines and such electrical devices as vacuum cleaners, fans, X-ray machines, etc.

It is a small, compact, sturdily made device working on an entirely new principle and is thoroughly guaranteed. The list price is low for an apparatus of this kind and it should prove a boon to all radio users troubled by electrical interference. Fans and dealers may obtain details by addressing Julien J. Proskauer, Trutone Radio Sales Co., 114-116 Worth Street, New York City. Mention RADIO WORLD.—J. H. C.

How the Loudspeakers

By J.

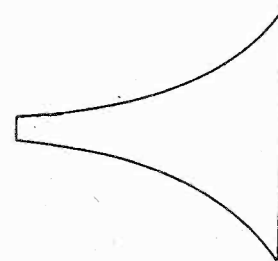
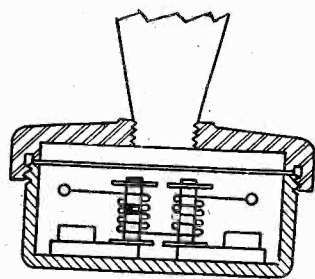
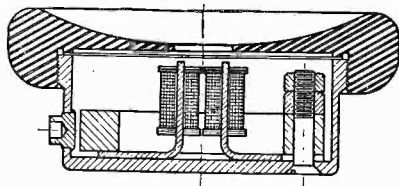
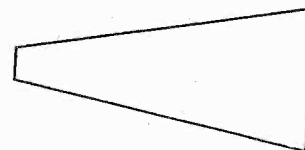
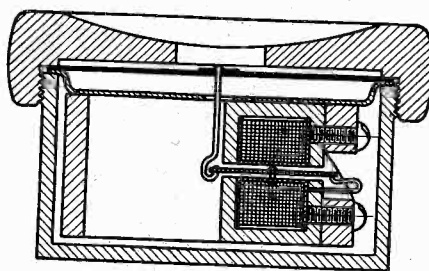
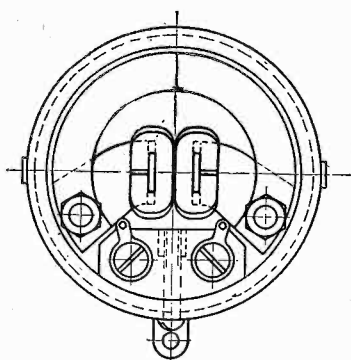
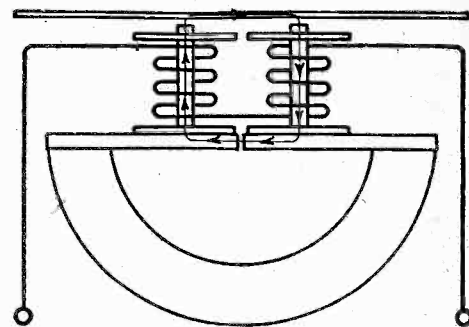
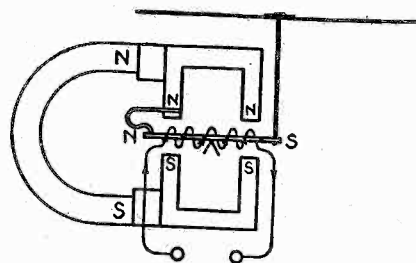
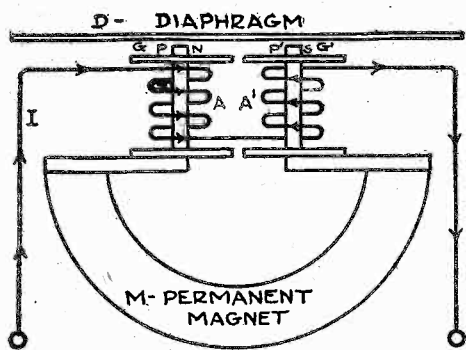

FIG. 1
FIG. 1A

FIG. 2
FIG. 2A
FIG. 3

FIG. 4
FIG. 5
FIG. 6

FIGS. 1 AND 1A ILLUSTRATE THE BI-POLAR TYPE EARPHONES. FIGS. 2 AND 2A SHOW THE BALANCED ARMATURE TYPE, AND FIG. 3 THE FIRST LOUDSPEAKER. FIG. 4, THE SEGREGATION OF THE TWO CURRENTS, FIG. 5 THE CONICAL HORN, AND FIG. 6 THE EXPONENTIAL HORN.

RADIO'S success has depended much upon the quality and faithfulness of reproduction from the sound producing device, whether it came from the first headsets, or our latest dynamic loud speakers of to-day. Radio reception to-day is quality reception and this faithfulness of reproduction is the result of intensive and exhaustive studies and development of acoustical devices.

The first acoustical device used in radio was the headset, and for years the principle employed in headset units was used in loudspeaker devices. Even to-day the principle used in one of the old standard headsets is still used in speakers.

Acoustical devices for radio broadcast reception should be distinctly classified into two groups—telephone headsets and loudspeakers or reproducers. The loudspeaker of to-day is the result of careful study and development of the ordinary headset, and, for this reason, consideration must be given to the types, theory and performance of the telephone headset.

The Two Earphone Types

The telephone headset is known as headphones, earphones, or headsets. Before the era of broadcasting these devices were used by wireless operators on ships and land stations.

There are two important types of tele-

Advance Traced From Earphone with Horn to the Shell Type Dynamic; Bi-polar and Balanced Armature Motors Distinguished.

phone headsets, bi-polar and balanced armature. The bi-polar type is illustrated in Figs. 1 and 1A, and the balanced armature in Figs. 2 and 2A.

In Fig. 1 you will notice A and A' represent the pole pieces; which consist of bobbins with many thousands of turns of wire, and the iron pole pieces P and P'; D the diaphragm; G and G' the air gaps between pole pieces and diaphragm and M the permanent magnet.

As current I passes through the winding, as indicated, the pole pieces P and P' become north and south respectively, setting up a magnetic field around the pole pieces, which magnetic field passes through the diaphragm.

The diaphragm is attracted to the pole pieces, depending upon the strength of the magnetic field around the pole pieces.

The current that passes through the bobbins, being a pulsating current, that is, always in the same direction, but varying in strength from a minimum to a maximum, the diaphragm is attracted to the pole pieces when the current is maximum and returns to its neutral position when the current is zero.

Current Determines Strength

The strength of the magnetic field around the pole pieces is directly proportional to the amount of current passing through the bobbins, the number of turns in the bobbins, and the quality of steel in the pole pieces.

The product of the number of turns and the current in the bobbin is known as the ampere turns of the bobbin, that is, current times number of turns (NI), and this should be a maximum.

In telephone headsets, three to five thousand turns of very small enamel wire, generally No. 40 to No. 42 B. & S. gauge, are used in bobbins. Since the quality of iron in the pole pieces plays a very important part, only the best grades of iron are used, such as high grade Swedish iron, very carefully treated pure soft iron free from impurities, or the good grades of silicon steels having 3 to 5% silicon content.

The magnetic field above the pole pieces passes through the diaphragm D, and the

Speaker Was Developed

Smith

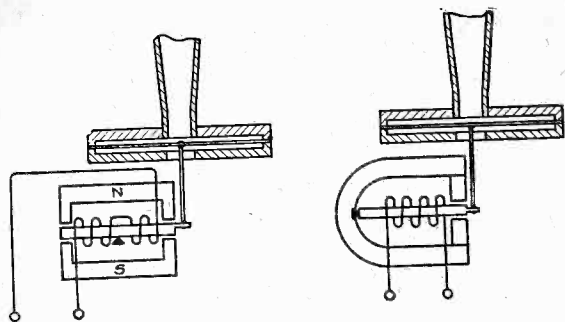

FIG. 7

FIG. 8

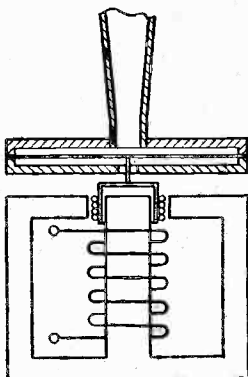

FIG. 9

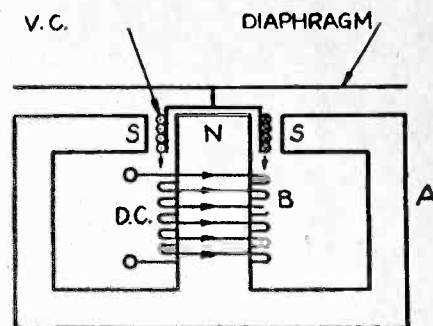

FIG. 10

FIG. 7 AND 8 SHOW BALANCED ARMATURE TYPE COIL UNITS, FIG. 9 IS THE ORIGINAL MOVING COIL TYPE. FIG. 10 ILLUSTRATES THE PRINCIPLE OF THE MOVING COIL SPEAKER WITH SHELL TYPE CASTING. THIS WAS THE FORERUNNER OF THE DYNAMIC SPEAKER OF TODAY.

quality of this diaphragm metal is of the best, such as soft iron or silicon steel. In headsets, where the ear piece comes in contact with the air and ear, the diaphragm is lacquered or japanned to prevent rusting.

The length of the air gaps G and G¹ is dependent only upon the amount of maximum vibration of the diaphragm, the gaps being so adjusted that the diaphragm will not touch the pole pieces.

Permanent Magnet is "Starter"

The permanent magnet M is of sufficient size and strength initially to magnetize the pole pieces P and P¹. This magnet is so designed that it will not lose its magnetism in time. Chrome and tungsten magnets are generally employed. In the high grade units tungsten magnets are used because they hold their magnetism for a much longer time than chrome magnets.

The theory of a telephone headset unit is expressed as follows:

In the balanced armature type of unit, a soft iron armature is placed in the center of a coil, mechanically fulcrumed at the middle, and the diaphragm is connected to one end of the armature by a connecting link.

Tips of two sets of pole pieces are located at both ends of the armature, and these pole pieces are magnetized by the permanent magnet M.

As the current passes through the single winding as indicated, the respective ends of the armature become north and south and the armature is thus caused to pivot at the fulcrum.

The attraction or repulsion of the armature by the pole pieces is governed by the same laws as in the bi-polar unit, the pivoted movement of the armature depending upon the amount of current passing through the coil, the number of turns in the coil, the quality of the iron of the armature and pole pieces and the strength of the magnetic field at the pole pieces.

The Era of Big Production

With the proper design of pole pieces, diaphragm, magnets, etc., very efficient telephone headsets were developed and manufactured in great quantities, especially during the first years of broadcasting. During 1922, 1923 and 1924 manufacturers were producing great quantities of these headsets and one manufacturer produced as high as 8,000 headsets a day.

Soon after broadcasting seriously gripped the country many headsets were

used in a single home, several persons sitting around a radio receiver, each with a headphone clamped on his or her head, listening to the broadcasting. It was not long before everyone realized the necessity of an acoustical device that enabled everyone to hear the reception of music or speech from the radio receiver without the inconvenience and uncomfotableness of a telephone headset. This was seriously appreciated as early as 1923 and all important engineering departments began on this most important development the loudspeaker.

The first loudspeaker was a horn placed on a telephone receiver unit, as shown in Fig. 3.

Quality Was Lacking

These first loudspeakers served the purpose for a time, because they eliminated the use of headsets, but the quality of reproduction was not good. During those days, it was often remarked:

"Yes, I like your loudspeaker, but for good quality reception I still use my headset."

Engineers soon found that pole pieces and component parts designed for telephone headset units were not correct for a loudspeaker device.

Referring again to Fig. 1, it was brought out that there were two kinds of magnetic fields in the magnetic circuit, the permanent magnetic field as produced by the permanent magnet and the varying or fluctuating magnetic field as produced by the pulsating current passing through the bobbin coils. Following both of these fields through the magnetic circuit, one finds both have the same path, that is, from one pole piece through air gap G, through diaphragm D, across diaphragm D, across air gap G¹ to other pole piece and through the permanent magnet back to the first pole piece.

The high reluctance or magnetic resistivity of the permanent magnet to this varying magnetic flux required that some other path be provided and it would be stronger at the pole piece tips P and P¹. Such a path was made available in the improved horn speakers as shown in Fig. 4.

Fig. 4 shows the redesign of pole pieces of a telephone unit for a horn type loudspeaker. R is a very small reluctance gap between 1/5,000 and 1/10,000 of an inch, to prevent magnetic short circuit of the permanent flux, from the permanent magnet, but which allows a very good path for the varying magnetic flux. This

not only increased the magnetic force upon the diaphragm but increased the efficiency of the loudspeaker unit at the lower frequencies.

Laminated Pole Pieces Used

In ordinary telephone headsets the energy passing through the unit was so small that laminating the pole pieces did not appreciably help its efficiency, but in loudspeaker units, with energy coming from first and second stage audio amplifiers, it was found that laminating the pole pieces increased its efficiency tremendously. As is appreciated, laminating iron decreases the iron losses, such as eddy currents and hysteresis, and in laminating the pole pieces in loudspeaker units, the principal iron losses prevented were the eddy currents otherwise induced in the solid pole pieces.

Larger and thicker diaphragms of silicon steel, bigger and better magnets, redesign and introduction of a reluctance gap in the pole pieces, replaced those of the ordinary telephone improved horn type loudspeaker.

The types or horns were first used on loudspeaker devices, conical and exponential. In the conical horn, the area varies directly per unit length and in the exponential horn the area varies exponentially per unit length as shown in Figs. 5 and 6.

Control of Pressure

The correct type of horn for a loudspeaker is one which places a sufficient air pressure upon the diaphragm, this air pressure to be gradually released through the horn.

The taper of the horn controls the air pressure in the horn, and it is important that this air pressure be not suddenly released until towards the free end of the horn. For this reason the exponential horn is far superior to the conical horn, as, by examining the above illustrations, the rate of change of areas at the beginning in the respective horns is very much greater in the conical horn than in the exponential.

The length of the horn determines the range of response from the loudspeaker. the longer the air column in the horn, the better will be the response of the lower frequencies. As in the case of organ pipes, the longer the air column in an organ tube, the lower the response. [In next week's issue, dated January 26th, Mr. Smith will compare the performance of various types of speakers as to tone and power.]

The AC4 for Volume

By Her
Manag

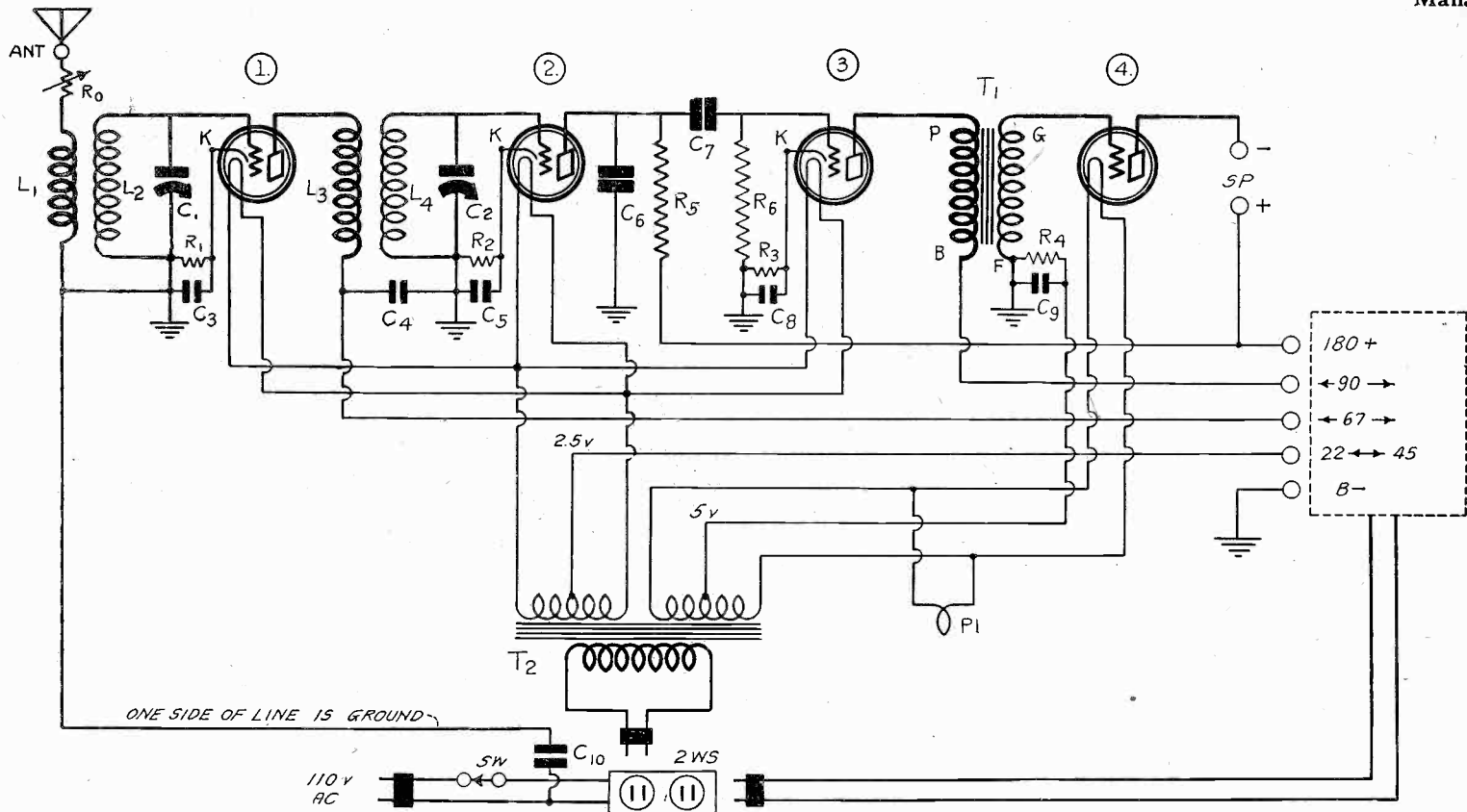

FIG. 1. REMARKABLE PERFORMANCE WAS OBTAINED FROM THIS FOUR TUBE AC ELECTRIC RECEIVER, BOTH IN SELECTIVITY AND TONE REALISM. THE SELECTIVITY WAS OBTAINED WITHOUT ADJUSTABLE REGENERATION DUE TO THE SPECIAL WINDING, PLACEMENT AND CONNECTION OF COILS, SO THAT STEADY FEEDBACK WITHOUT POSSIBILITY OF SQUEALS WAS ESTABLISHED. THREE HEATER TYPE TUBES AND ONE -71A POWER TUBE WERE USED. NOTE THAT GROUND WAS ESTABLISHED ON ONE SIDE OF THE AC LINE THROUGH C10. THE TRIANGULAR GROUND SYMBOLS REPRESENT THE SIDE OF C10 OTHER THAN THE ONE CONNECTED TO THE LINE. THE SWITCH SW IS ON THE "HIGH" SIDE OF THE LINE. THE DOTTED OBLONG REPRESENTS THE B ELIMINATOR.

"ALL-ELECTRIC" is the catch-phrase of the day. This year just closed—1928, to betray a confidence—marked the development of the all-electric receiver to the point of dependability.

It is now not only safe for the home-constructor to rally to the AC receiver, so that in a single cabinet are contained the receiver, B supply and alternating current filament supply, but all the volume one needs for home reproduction is readily supplied distortionlessly. The tubes in the receiver and a compact 180-volt B supply of the factory-built type enable this result to be attained simply, and no objectionable hum will be present

THIS is Herman Bernard's first article on the construction of an AC receiver. He chose a four-tube design as being wholly adequate for sensitivity and selectivity, providing abundant volume without distortion. Three type 227 tubes are used, as these are superior from several viewpoints, particularly more amplification at less hum. The output tube is a 171 or 171A. Mr. Bernard experimented with AC receivers for almost a year before presenting the AC4, which he now does. It is a receiver well worth building, and capable of a performance that its modest cost of construction and maintenance do not even remotely suggest.—EDITOR.]

even at maximum signal volume. And for all this four tubes are enough. Such a design is shown in Fig. 1—the AC4.

Without some measure of feedback it would be impossible to attain sufficient selectivity, with only two tuned circuits, so it was deemed necessary to devise some method of accomplishing this, without adjustable regeneration.

Convenience is Served

The AC receiver is essentially something for convenience, since there are no batteries of any sort, not even C batteries; single tuning control is the rage for this type of receiver; hence adjustable

LIST OF PARTS

L1, L2, L3, L4—Two Model AC5 coils for .0005 mfd. tuning (mfgd. by Screen Grid Coil Co.).
C1, C2—One Hammarlund Midline Double Condenser, each section .0005 mfd. (Model MLD 23).
R0—One Elecrad Royalty variable high resistance, 5,000 ohms (Type K), with 110-volt AC switch.
R1—One Electrad wire fixed resistances, 1,500 ohms each (Model B15).
R2—One Electrad wire fixed resistance, 50,000 ohms (Model B500).
R3—One Electrad wire fixed resistor, 500 ohms (Model B5).
R4—One Electrad wire fixed resistance, 2,000 ohms (Model B20).
R5—One Lynch metallized fixed resistor, 0.25 meg,

R6—One Lynch metallized fixed resistor, 5.0 meg.
C3—One Aerovox mica fixed condenser, .006 mfd. (Type 1350).
C4, C5, C7, C8—Three Aerovox mica fixed condensers, .02 mfd. (Type 1350).
C9—One Tobe bypass condenser, 4 mfd. (400 volt test).
C6, C10—Two Aerovox mica fixed condensers, .00025 mfd. each. (Type 1350).
T1—One National audio transformer, type A100.
T2—One filament transformer, with one 2.5 volt midtapped winding at 7 amperes, one 5 volt midtapped winding at 2 amperes.
2WS—One two-way socket with cord and plug.

Ant., SP.—Three binding posts (Ant. Speaker+, Speaker—).
One National drum dial, type F, with pilot light PL.
One 7x21-inch bakelite front panel drilled for National dial, for dummy and for volume control.
One 19x6-inch subpanel, with 8x3" cut out at right rear; sockets 1, 2 and 3 (five prong) and socket 4 built into subpanel; holes drilled for mounting other parts.
One National B eliminator (180 volts) Model 3580.
Flexible Corwico Braidite for wiring; miscellaneous hardware.
One 7x21x12-inch cabinet.
Three type -27 tubes, one -71 or -71A.

DX and Superb Tone

Bernard

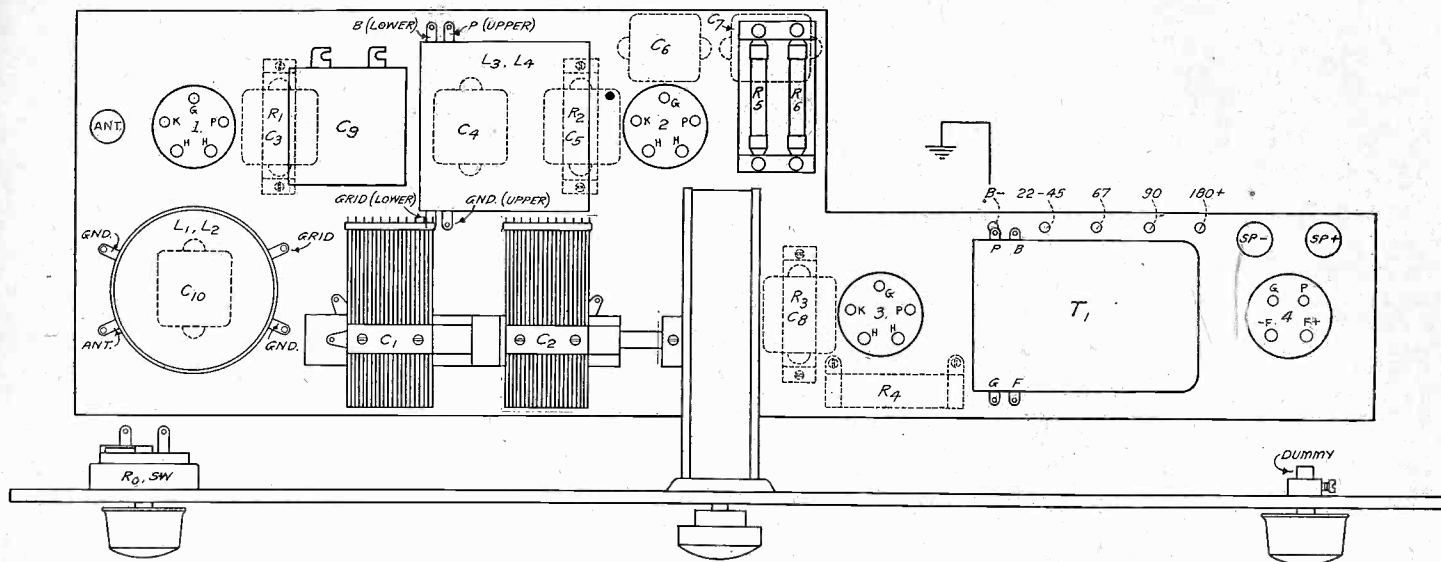

FIG. 2. THE SUBPANEL SHOWN ONE-THIRD SCALE. DO NOT DEVIATE FROM THIS LAYOUT! NOTE THE AUDIO TRANSFORMER LOOKS STRANGE. IT IS MOUNTED WITH ITS BOTTOM AS THE LEFT SIDE, ANGLE BRACKETS BEING USED. THIS AVOIDS COUPLING TO THE POWER TRANSFORMER IN THE B SUPPLY AND REDUCES HUM.

generation should be avoided if utter convenience (the completion of the uniform requirement) is to be achieved.

Proper construction of the coils and their placement in respect to each other solved two problems at once. Small primaries were used, so that the reduction of the antenna circuit, as ever, increased the tendency toward oscillation, due to lower antenna resistance, but fewer turns decreased this tendency in the plate circuit, because of the diminished inductive load.

The antenna resistance is something inherent in the antenna, and is augmented by the radio frequency resistance of the primary in the antenna-ground circuit.

Even a single radio frequency stage, ahead of a tube detector, will oscillate if the antenna winding is greatly attenuated, so that little more resistance is left than that contributed directly by the antenna itself, and the small reflected resistance contributed by the secondary. The effect of R_0 is not considered, as for DX it is zero, hence shorted out.

Coil Data

After many experiments, all with the type 27 tube, which has a heater, powered by AC, but an independent electron emitter, the cathode, the number of primary turns selected was six in each instance.

Therefore for .0005 mfd. tuning the coils should consist of six turns on the primary, $\frac{1}{4}$ inch separation, and 48 turns on the secondary, using No. 24 single silk covered wire for the secondaries and No. 21 wire for the primaries, on a tubing $\frac{1}{2}$ inches in diameter and $2\frac{1}{2}$ inches long.

By placing these coils at right angles—the antenna coil upright, the in-stage coil horizontal—stray coupling was reduced to a minimum, but some existed, as an exploration of the flux lines conclusively proved. Also some coupling resulted from the proximity of the two coils to the tuning condensers (the

two condensers being on a single shaft). The wiring itself added some coupling.

No Squealing

But the object was not the total elimination of back coupling. Indeed, the coils were so connected as to have their voltage fields in phase, so there would be some back coupling or regeneration. This was so established that the frequency of self-oscillation, with the RF plate voltage high, was at 1,700,000 cycles, a frequency above the broadcast maximum. As the capacity-inductance combination will not tune above 1,600,000 cycles, complete stability is achieved.

With high efficiency established, it was easy to tune in distant stations without any trimmer, including large numbers of stations in Chicago and points East, when the location of reception was New York City. A steady distance range of 1,000 miles at night, with abundant speaker volume, was enjoyed for the three weeks that the AC4 was under rigid test.

The dial was turned over to a housewife, one not radio-wise in any particular, and the distant stations still came rolling in, (only a few skipped silently by) proving that getting DX was no trick even to one who did not know what "DX" stood for.

Some DX Loud as Locals

Sensitivity and selectivity, therefore, by actual operating test on the air, was adequate. Some of the distant stations came in with actual local volume, particularly WRVA, Richmond, Va.; KDKA, East Pittsburgh, Pa.; WBBM, Chicago; WTAM, Cleveland; WLW, Cincinnati (when WOR had signed off); etc.

Volume and tone quality are the other outstanding considerations. Volume refers to the quantity of sound, but as we have long since passed the day when that alone is satisfactory, volume must now be discussed as distortionless volume.

The distortion test was made visually,

by connecting a Raytheon Kino-lamp across the B supply, with a limiting resistor in series. Since distortion would change the current drain of the receiver in the B supply to a considerable extent, hence the voltage, from moment to moment, this change would show up in the contracted width and extended length of the lamp's glow, besides in the shimmering of the orange field of the illuminated plate and in the introduction of a coruscating light blue, almost lavender, spray that danced in a manner to delight the eye while the audible result from the speaker would annoy the ear.

Pure Tone Preserved

Only by deliberate mis-selection of biasing resistors was it possible to bring about a condition of overload, so that distortion showed up, and the resistances therefor were selected of such values as to preserve pure tone. The result was realism of the finest sort, for the additional reasons that negative grid bias detection was used, and the audio channel consisted of resistance coupling working out of the detector and a high-grade transformer, the new National A-100, working into the last audio tube.

The Last and Vital Tube

The final or output tube must be watched carefully, and the design surrounding it must be carried out thoughtfully, else the quality made possible by the preceding stages will be distorted in the last tube. The proper value of biasing resistor, high enough to keep the Kino-lamp glowing steadily, and also a bypass condenser across this resistor of sufficient capacity to avoid volume loss and production of distortion due to the impedance of the resistor being insufficiently by-passed are necessary. The bypass condenser to use here is 4 mfd. (C9 in Fig. 1).

The output tube used was a 171 or 171A, these being interchangeable in
(Continued on next page)

Novel Ground in AC4

(Continued from preceding page)
AC circuit. The National Velvet-B, type 3580, was used, and the subpanel so cut as to make room for this B supply.

Despite the grid bias voltage drop in resistors in four tubes, the output voltage measured 185 volts, although 55 milliamperes were being drawn, the high drain being due to the inclusion of a DC model dynamic speaker field coil across the 90 volts of the B supply, draining 30 milliamperes. Any other type speaker may be used in this set. The power tube drew 17 milliamperes and the three other tubes a total of only 8 milliamperes, because the grid biased detector drew one milliamperere or less.

How Ground is Obtained

An unusual feature of the receiver is the indirect use of one side of the AC line as ground. A fixed condenser of .00025 mfd. capacity is connected to one side of the line, and the other side of that condenser is used as ground. The triangular symbols made up of parallel, shortening lines, in Fig. 1, refer therefore to the receiver side of this condenser, C10, and not to the AC line side.

Any method of producing this connection to the line may be used. The one shown is that of any accessible AC switch of the panel type, with one side of C10 connected to the "low" side of the line.

Another method would be the connection of a lamp socket antenna, by inserting its plug into an AC convenience outlet or multiple socket, the binding post on the plug being ground. In any event the signals will be louder when C10 is connected to the "low" side, while the switch, for safety reasons, should be in the "high" side of the line, two points that will be discussed fully, and directions will be given for establishing the proper connections.

An Insight Into the AC Line

The AC-line ground reduces hum, since there is no potential difference, as there might be between a cold water pipe or radiator ground, and the ground on the power company's transformer in your yard or on a pole outdoors.

Usually an AC line has a stepdown transformer, the secondary of which carries 220 volts, but since the secondary is center-tapped, one group of consumers is served from one-half of the secondary, another group from the other half, the line voltage supplied thus being 110 volts. The difference in RF voltage between the center-tapped side, common to both groups of users of this secondary, may be small, in fact often is too small to permit a lamp socket antenna serving adequately as an aerial. Several tests in different locations in New York City confirmed this.

In rural districts the answer might be different, due to the distance of the company's step-down transformer from the point of consumer use.

Therefore one side of the AC line is "net ground," while the other side is little bit "higher" than ground, equivalent to a short aerial only a few feet high. The difference is too small to insure good results when the grounded side is used as ground and the higher side as antenna, in fact it was impossible to make this receiver work in that manner, although persistent attempts were made to get results from such an "antennaless" system.

Use an Outdoor Antenna

Hence an outdoor aerial should be used, while the AC line may serve as ground. The aerial may be a long one—100 feet is

not too long, although good results are obtainable on a short outdoor aerial, minimum 50 feet. The linear dimensions include lead-in.

The two-way socket shown at the bottom of Fig. 1 may be of any type, that has outlet leads, or a three-way socket may be used, and into one of the openings a male plug with wire leads is inserted, the other end of the leads terminating in another plug that goes into the wall socket or lamp socket. The switch is in one of these cable leads. Then there are still two places left—one for the filament transformer plug, the other for the B eliminator plug. Of course the leads from the AC cables of these two devices may be cut so that as to be no longer than necessary to make the connection.

The Five Components

In physical construction, the receiver is built independently on a subpanel shaped like a milk-ladle, the "handle" part affording room for the B supply, in a cabinet 12 inches deep, as most cabinets are, when intended for a custom-built or home-constructed AC receiver.

The B supply may be laid on the floor of the cabinet, or may be secured to that floor. Especially is this security rendered easy by use of the National B Supply, since the four casing screws at the corners may be removed, and a small angle bracket fastened on as the screws are **driven home again**. Wood screws through bracket holes anchor the B supply. Likewise the filament transformer is independent and this may be simply screwed to the baseboard through the transformer's mounting holes.

There is room at rear, beside the filament transformer, for the plug receptacle, or this may be placed against the side of the cabinet.

Close Quarters

The front panel is the other component. So there are five independent units to consider. The subpanel is 6x19 inches, until the piece is cut out for the B supply, and since cutting bakelite is not a popular indoor sport with those not supplied with circular electric saw, it will be advantageous to obtain a commercial subpanel, already cut, with the four sockets built in, in their proper places.

The entire receiver construction is designed for close quarters, so there must be no deviation from the constructional plan. Follow the dimensions of Fig. 2, which is scaled to one-third. Hence multiply by three to get the actual dimensions. Or, better still, get a blueprint.

The front panel will appear next week in dimensional form in Fig. 3. Unless you have a panel cutter you had better have the circular hole cut by the concern from which you obtain the front panel.

A Thing of Delight

This receiver will prove a delightful possession, something that delivers ample volume, unusually realistic tone, and provides simplicity and convenience in the extreme. It should be built exactly as shown. No attempt should be made to use an AC screen grid tube as the radio frequency amplifier, such a tube not having been considered for the circuit because of the indifferent showing made by makes now available.

The prescribed list of parts should be followed, but if you have a B eliminator or a filament transformer of your own, you may incorporate that, using only the designated windings of the filament transformer.

You should not, however, try to press

a cheap double condenser into service. Multiple condensers must be accurate to be worth using, and accuracy in manufacture is expensive.

Also, please note, the circuit works with unmarred efficiency without the use of trimmers, due to the small primaries and to the accuracy of the double condenser. And the high amplification at low frequencies—high wavelengths—is due to the high plate voltage and the 227 tube that permits both this voltage and the small primary in the plate circuit with genuine effectiveness.

Looked Complicated Then

As soon as the AC receiver popped up before the anxious eyes of radio enthusiasts the circuit diagrams began to appear complicated, even those of tuned radio frequency circuits. And as a rule it is a rather exacting task to build an AC receiver.

But in the present instance the work has been reduced to a minimum, so that it is really as easy to build the AC4 as to build a battery model four-tube set. And besides, when the pleasant work is proudly finished, you have in the concentrated area of the cabinet everything necessary for the operation of a fine circuit—excepting only the loudspeaker, which is better situated outside of the receiver cabinet.

This ease of construction arises from the simplicity of the layout and the incorporation of a compact factory-made B eliminator, the National velvet-B, type 3580, especially made compact for ready insertion in an AC electric receiver. And that use has brought about a great popularity for this B supply, which is conservatively, almost Puritanically, rated at 180 volts at 35 milliamperes. You may safely expect the full 180 volts maximum even though the biasing voltages for the four tubes are obtained through voltage drops in independent resistors (usually diminutants).

The Five Components

The five components of the installation may be reiterated here as follows: (1) the front panel, (2) the subpanel, (3) the filament transformer, (4) the B supply and (5) the AC multiple socket. These will be discussed constructionally in that order.

Easy indeed to prepare is the front panel, the dimensions of which are 7x21 inches, the layout to be published next week. At left is the combination volume control and AC switch, a product of Electrad, Inc. A type Royalty (0 to 5,000 ohms) is the volume control, while a Hart & Hegeman 110-volt AC switch is built in.

In the center of the front panel is the National drum dial, type F, the drilling dimensions for which will be given next week, but will be found in template size on the circular supplied by the National Company with each dial.

["The Five Components of the AC4" is the title of Part II of this absorbing article by Herman Bernard on his compact, efficient receiver design. The front panel has been discussed, but the four other components possess points of interest that require plain definition. Follow Mr. Bernard through in this series on the AC4, because much interesting data are contained in the series, and surely you will want to build this receiver, if you have AC. This is the simplest AC circuit ever presented, as well as being truly worth while.—Editor.]

The Universal for DC

Screen Grid Model Worked from Line

By Hemstreet Foster

THERE are many sections both in this country and in Canada where the electric power is supplied as direct current at 110 volts. Calls for means of electrifying radio receivers come from these sections constantly. The writers want to do away with the batteries and use the power from the line directly.

Is this practicable? If so, why has this phase of radio been almost completely neglected when there are millions of people interested?

The scheme is practicable all right but it is subject to many limitations. In the first place the available voltage is only 110 volts. This at once limits the undistorted volume that may be obtained from the set. Still it is possible to get moderate loudspeaker volume of good quality with a voltage no higher than this. The second disadvantage is that it takes considerable power from the line for a given set. A receiver drawing a filament current of 1 ampere takes about as much power from the line as a 100-watt light, which means that it would cost less than one cent an hour to operate the set. This is small, if you look at it quickly, but large compared to the cost of running an equal AC set.

Electrified Universal Receiver

Let us see how it is possible to electrify the Screen Grid Universal so that it can be attached to a 110 volt DC line. The filaments are in parallel, three of which take .25 ampere each and one which takes .132 ampere. Thus the total filament current is .882 ampere.

It will not be practical to filter this current by any choke coil, for the coil would have to be too large and costly. It will be necessary to filter it with a condenser across the line. This may well be an electrolytic condenser of high capacity. An 18 mfd. condenser of this type placed as C10 is suitable.

When placed in this position the condenser does not only filter the filament current but also the plate current, and it serves effectively also to reduce other line noises.

The filament terminal voltage is to be 5 volts on three of the tubes and 3.3 volts on the screen grid tube. To bring the voltage down from 110, resistors and rheostats are used. R0 is a 15 ohm resistor tapped so as to divide it in 5 and 10 ohm sections. The 5 ohm section is put next the tube and the grid return is connected to the tap. Rheostat Rh1 is used for volume control and it should have a resistance of 25 ohms.

Resistance R1 is put in the filament circuit to furnish a bias for the audio amplifier tubes. Six ohms is about right for the plate voltages available. It may well be a six ohm rheostat so that the bias can be varied.

Value of Main Rheostat

The voltage drop in the filaments and in R1 is 11 volts, or less, if a lower bias than six volts is used.

Since the line voltage is about 110 volts the difference should be dropped in Rh2. And since the current is normally .882 ampere, the value of Rh2 should be 112 ohms. It may be that the line voltage is as high as 120 volts and also it may be that the voltage drop in R1 is

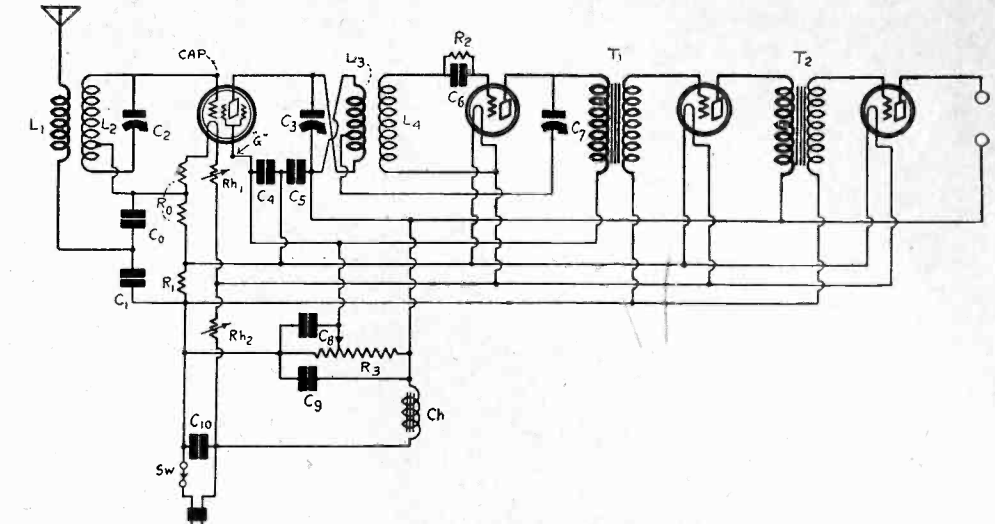

FIG. 1. A CIRCUIT DIAGRAM OF THE SCREEN GRID UNIVERSAL MODIFIED FOR DIRECT OPERATION FROM A 110-VOLT DC LINE. THE CIRCUIT IS COMPLETE WITH RESPECT TO A, B AND C VOLTAGES.

only 4 volts, for example. Rh2 must be large enough to take care of this possibility. That is, it may be required to

drop 111 volts, which would require a value of 126 ohms for Rh2.

This main rheostat should be able to carry at least one ampere without excessive heating. Of course such rheostat is not available and must therefore be improvised. A 660 watt heating resistor such as is used in electric heaters has a resistance of about 20 ohms. This will carry 6 amperes but at that current it is too hot for use in a radio set. At one ampere it will only be a little warm. Five of these in series would give a resistance of 100 ohms, approximately. Ninety-ohm resistors are available in the lavite type.

Combination Possible

One of these can be used for it will carry about an ampere. A 100-watt light has a resistance of about 121 ohms and will carry .9 ampere.

It is always possible to find a combination of resistors commercially available which will give approximately the resistance required in any one case. As a final adjustor a small rheostat, say one of 6 ohms, can be used for obtaining the exact resistance required.

As an example suppose the voltage of the line measures 115 volts and that R1 is a six ohm rheostat all of which is used. The total drop in R1 and Rh2 is then 110 volts. The drop in the six ohm R1 when .882 ampere is flowing is 5.3 volts. Then the drop in Rh2 should be 104.7 volts, which requires a resistance of 104.7/.882, or 118.7 ohms.

Proper Combination

A 100 watt lamp has too much resistance. A 90 ohm lavite has too low. But a 90 ohm lavite and a 660 watt heater have a resistance of 110 ohms, approximately. Still 8.7 are required. A ten-ohm rheostat will not carry the current. A six-ohm rheostat will but its resistance is not high enough. Hence two six-ohm rheostats in series may be used to make up the necessary 8.7 ohms. These two will provide a suitable range for current adjustment.

A voltmeter or an ammeter should be used for making the adjustment. A volt-
(Continued on page 17)

LIST OF PARTS

- L1L2—One Screen Grid two-winding RF transformer, with center-tapped secondary, Model 5RF.
- L3L4—One Screen Grid high impedance interstage coupler, with center-tapped primary, Model 5TP.
- C0—One .001 mfd. Aerovox condenser.
- C1—One mfd. Tobe condenser.
- C2,C3—Two Hammarlund Midline .0005 mfd tuning condensers.
- C4,C5—Two .01 mfd. Aerovox condensers.
- C6—One .00025 mfd. Aerovox condenser, with resistor clips.
- C7—One Hammarlund Junior condenser, Cat. No. MC11 MC9, 50 mmfd. 1, or 32 mmfd.
- C8,C9—Two Tobe 2 mfd. by-pass condensers.
- C10—One Mershon electrolytic condenser, 18 mfd.
- T1,T2—Two National A100 audio frequency transformers.
- Ch—One 30 henry filter choke, National.
- R0—One 15 ohm resistor tapped 10-5.
- R1—One 6 ohm rheostat.
- R2—One Lynch metallized grid leak, 2 megohms.
- R3—One wire-wound 25,000 ohm potentiometer.
- Rh1—One 25 ohm rheostat.
- Rh2—One heavy duty resistor as described.
- Sw—One filament switch.
- Two dials.
- One knob.
- Three binding posts (Ant., Speaker Plus, Speaker Minus).
- One 10x20-inch aluminum self-bracketing sub-panel, with sockets affixed, and including hardware and insulating washers.
- One 7x21-inch drilled bakelite front panel.
- One plug and cord to plug into nearest outlet.
- Four Kelly tubes as follows: One 422 screen grid, two 401A and one 412A.
- Cabinet and speaker.

Two New Tubes

By Herbe

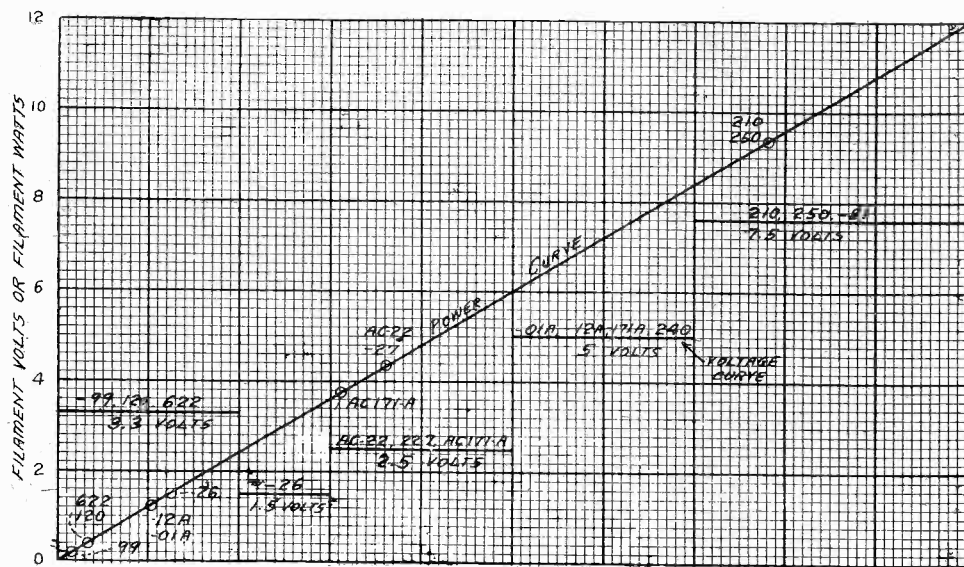

FIG. 1
GRAPHS WHICH SHOW AT A GLANCE THE FILAMENT POWER AND FILAMENT VOLTAGE OF SOME OF THE MORE POPULAR TYPES OF RECEIVING TUBES.

AC Power Valve, Due About April 1st, Will Be Equivalent to Present 210, but Requires Only 250 Volts on Plate — AC Screen Grid Tube is the Other, Due Later

ANOTHER power tube has been announced. It will be on the market about April 1st. This new tube is an improved 171A tube especially designed for AC operation. It has a rugged filament requiring a voltage of 2.5 volts and a current of 1.5 amperes, a wattage of 3.75 watts.

The old 5-volt 171A tube has worked very well in AC circuits when used in the last stage. However, it has not been entirely free from hum, nor has it given all the undistorted power that most people now require for dynamic speakers. The new tube is an improvement in these directions.

The fact that the terminal voltage is only half as great as that in the older tube will reduce hum considerably because the voltage drop in either half of the filament will only be 1.25 volts and any unbalance will have a proportionately smaller effect in producing hum. The sturdier filament and the heavier current also work in the same direction.

The maximum undistorted output power of the new tube is 1.6 watts, whereas the maximum output of the old tube is only .7 watt. Thus the output of the new tube is 2.3 times greater than that of the older tube. In fact it is nearly as great as that of the 210 tube, which is 1.7 watt. And this high output power is obtained with lower voltage than required for the 210 tube.

The maximum voltage for the new tube is 250 volts while that for the 210

in 450 volts. Therefore the new tube can be operated with B battery eliminators having moderately high voltage, requiring filter condensers of considerably lower voltage ratings, than in the case of the 210 output tube. Hence the filters will be cheaper and they will last longer than when higher voltages are used.

Plate Impedance the Same

The plate output impedance of the new power tube is the same as that of the old tube, and only slightly higher than that of the 250 tube. Hence the new tube can be used with the same output transformers and speakers as the old tube, or with those designed for the 250 tube.

Another advantage of the new tube is that its amplification factor is a little higher, being 3.5 against slightly less than 3 for the old tube. Thus extra volume will be obtained for a given signal input. Less amplification ahead of the tube will be required for a given output voltage, or for a given amplification ahead of the tube the output voltage will be greater.

The practical results of the combination will be a more sensitive set with much greater output power.

Those who have concluded that the 250 tube is too powerful will hail the new 171A tube for it will give ample loudspeaker volume without the necessity of resorting to the 250 with its expensive power plant.

Of course, there will be many who will want to use the new tube in push-pull circuits. For this purpose it is excellent. One such push-pull stage with the new tubes will give a maximum undistorted output power of about 6.5 watts. But this will require a signal voltage of 100 volts peak value. With transformer coupling and suitable DC voltages this signal voltage can be obtained from a 227 heater type tube.

Uniformity of Voltages

An AC screen grid tube has also been announced. This tube is similar to the DC screen grid tube so far as amplification characteristics are concerned but like the 227 with respect to the heating arrangement. That is, it has a five-prong base and a terminal voltage of 2.5 volts. This tube can be used as a radio frequency amplifier or as a detector. It will be available some time after the new power tube.

It is interesting to note the filament and heater voltages for both of these new tubes are the same, and also that they are the same as for the 227 tube. Thus a complete set can be built with tubes, all of which require 2.5 volts for heating the cathodes, and only one secondary winding on the filament transformer will be necessary. This is a desirable simplification.

One of these receivers might consist of one AC screen grid RF amplifier, one AC screen grid detector, one 227 type audio amplifier and one AC type 171A tube. Since the AC screen grid tube has a high output impedance a special coupling device will be necessary. For the coupler between the RF tube and the detector devices are already available because they have been developed for the DC screen grid tube.

Between the detector and the first audio tube resistance, impedance or trans-

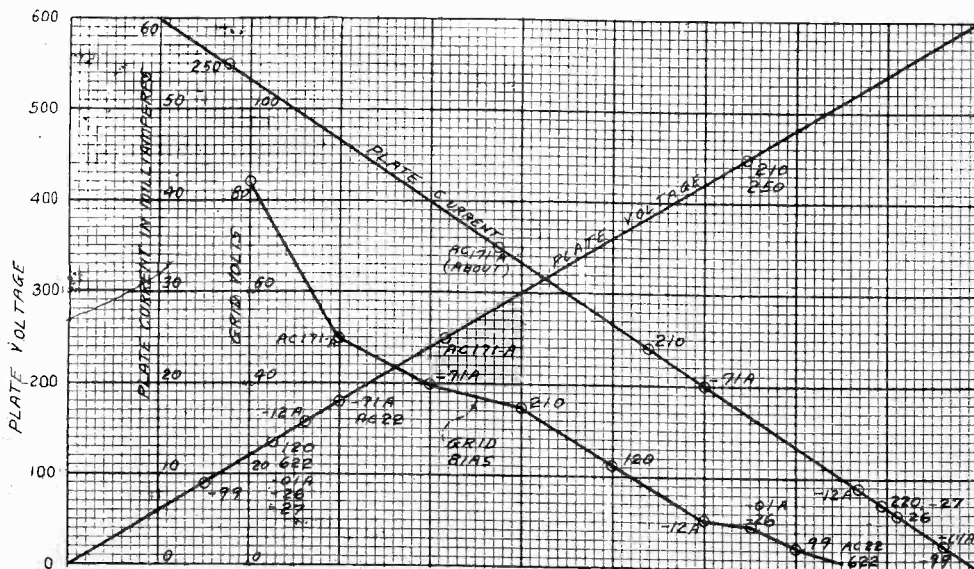

FIG. 2
GRAPHICAL REPRESENTATION OF THE PLATE VOLTAGE, PLATE CURRENT AND GRID VOLTAGE REQUIREMENTS OF VARIOUS POPULAR RECEIVING TUBES.

Are on the Way

E. Hayden

former coupling may be used. Although the present audio devices have not been developed especially for the screen grid tube, they may be used because modern transformers have very high primary impedances, which is the necessary condition.

The property of a tube which more than any other tells the value as an amplifier is its mutual conductance. This is higher for the new power tube than for any of the other tubes. Hence it is a more effective tube than the others. The nearest competitor is the 250 tube. The mutual conductance of the new power tube is 1,750 micromhos, which means that one volt in the grid circuit will produce 1.75 milliamperes in the plate circuit when there is no load in that circuit.

The higher the mutual conductance for the tube alone, the greater the efficiency of the tube will be, that is, the greater will be the power developed in the load to that expended in the plate.

If the internal plate resistance of the tube and the mutual conductance are known, the maximum undistorted output power for any given input can be determined approximately. Suppose that the internal plate resistance of the tube is r ohms and the mutual conductance is g micromhos. The maximum undistorted power output is then $\frac{2}{9}$ of $r(gE)^2$, where E is the effective value of the input voltage. The power is given in milliwatts.

Let us apply this to the new power tube. The internal plate resistance is 2,000 ohms and the mutual conductance is 1,750 micromhos. The maximum peak voltage that can be impressed on the grid of the tube is 50 volts, or $.707 \times 50$ effective volts. Putting these values into the formula the result is 1,700 milliwatts, or 1.7 watts, which is the rated power for the tube.

Another Example

Now let us apply the formula to the present 171A tube. The mutual conductance of that tube is 1,500 micromhos and the plate resistance is 2,000 ohms. The peak voltage that may be impressed on the grid is 40.5 volts, or $.707 \times 40.5$ volts effective. Putting these values in the formula there results 820 milliwatts. The rated power is 700 milliwatts. The difference is due to the use of a higher input voltage than the rated, and also to the use of a higher mutual conductance than the actual value.

In estimating the maximum undistorted output power of a tube it is inconvenient to convert the peak voltage impressed on the grid to effective volts. This may be avoided if the factor $\frac{1}{9}$ is used in the formula instead of $\frac{2}{9}$, and the grid bias in place of the effective signal voltage. It is assumed that the maximum peak signal voltage is equal to the grid bias. The formula then takes the form of $r(gC)^2/9$, where C is the grid bias.

Let us check this formula on the 250 power tube. Its plate resistance is 1,800 ohms, its mutual conductance is 1,670 micromhos and the highest grid bias is 84 volts. Hence the power output is 3,920 watts, which checks out fairly well with the rated value.

Whenever this formula is used the load resistance should be twice the value of the internal resistance of the tube, because the formula has been worked out on that basis and that is the condition for maximum undistorted power output.

The various constants of the more im-

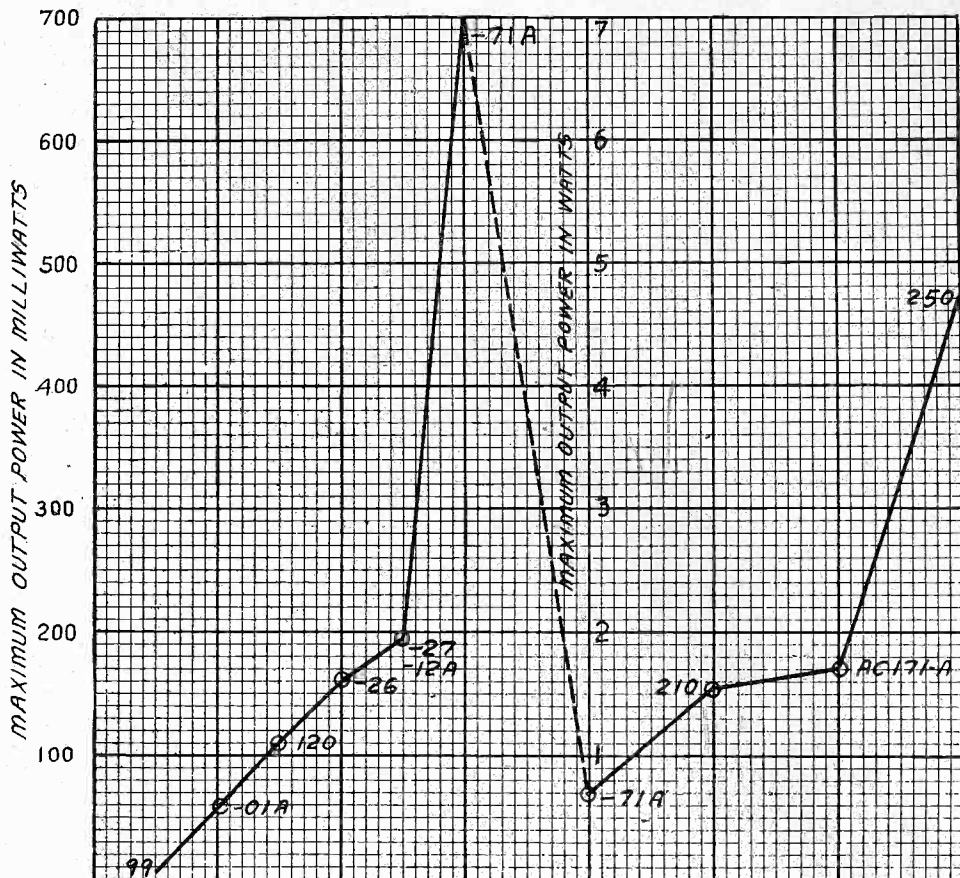

FIG. 3 GRAPH WHICH SHOWS THE MAXIMUM UNDISTORTED POWER OUTPUTS OF SOME OF THE MORE POPULAR TYPES OF RECEIVING TUBES.

portant tubes are shown in the accompanying graphs. In Fig. 1 are shown the power required to heat the filaments or heaters and the filament or heater terminal voltages. Since no regular curves can be drawn to illustrate the different values the code names for the tubes are placed by the dots which represent the filament power or filament terminal voltages. The higher up the dots on the graphs the higher is the power or filament voltage required for the tube.

Fig. 2 shows three graphs. One is the plate current, another the plate voltage and a third the grid bias. Different scales are used for all the graphs, but each scale is labeled to correspond with the graph.

Fig. 3 shows the maximum undistorted output power for each tube. This power is not only the maximum for a given plate voltage but it is also for the maximum plate voltage that should be used.

In the accompanying table are shown the mutual conductance in micromhos, the internal plate resistance, the grid bias and the plate voltage corresponding to the maximum power for each tube. The values under the heading "power" have been calculated with the simplified formula given above, and they give the maximum undistorted power in milliwatts.

TABLE 1. Characteristics of Popular Receiving Tubes.

Tube	G	R	C	Plate voltage	power
—99	425	15,500	4.5	90	6.3
120	525	6,300	22.5	135	66.4
—01A	800	10,000	9.0	135	57.6
—12A	1,700	4,700	10.5	157	166.4
—71A	1,500	2,000	40.5	180	820
AC71A	1,750	2,000	50.0	250	1,700
210	1,600	5,000	35.0	425	1,740
250	1,670	1,800	84.0	450	3,920

The DC Electric Universal

(Continued from page 15)

the receiver side of the line to aid the filtering.

The voltage divider R3 may be a 25,000 ohm wire wound potentiometer, which can be obtained in any radio store. The slider on this unit is connected to the screen grid and to the plate return of the detector. A 2 mfd. condenser C8 is connected across the lower portion of this potentiometer.

The radio receiver is the Screen Grid Universal which was described in the December 1st. issue of Radio World. The few additions shown in the present circuit are made desirable because of the changed

conditions of power supply. C0 is a .001 mfd. condenser to by-pass the 10 ohm section of R0. C1 is a 1 mfd. condenser to by-pass the grid bias resistor R1 to prevent the hum from entering the amplifier by way of the grid circuits. C4 and C5 are .01 mfd. condensers to steady the screen grid voltage and to ground the rotor of C3.

It is not necessary to use a ground on the receiver because one side of the power line is grounded, usually the positive. The ground end of the antenna circuit is connected to this ground through the condensers C1 and C10.

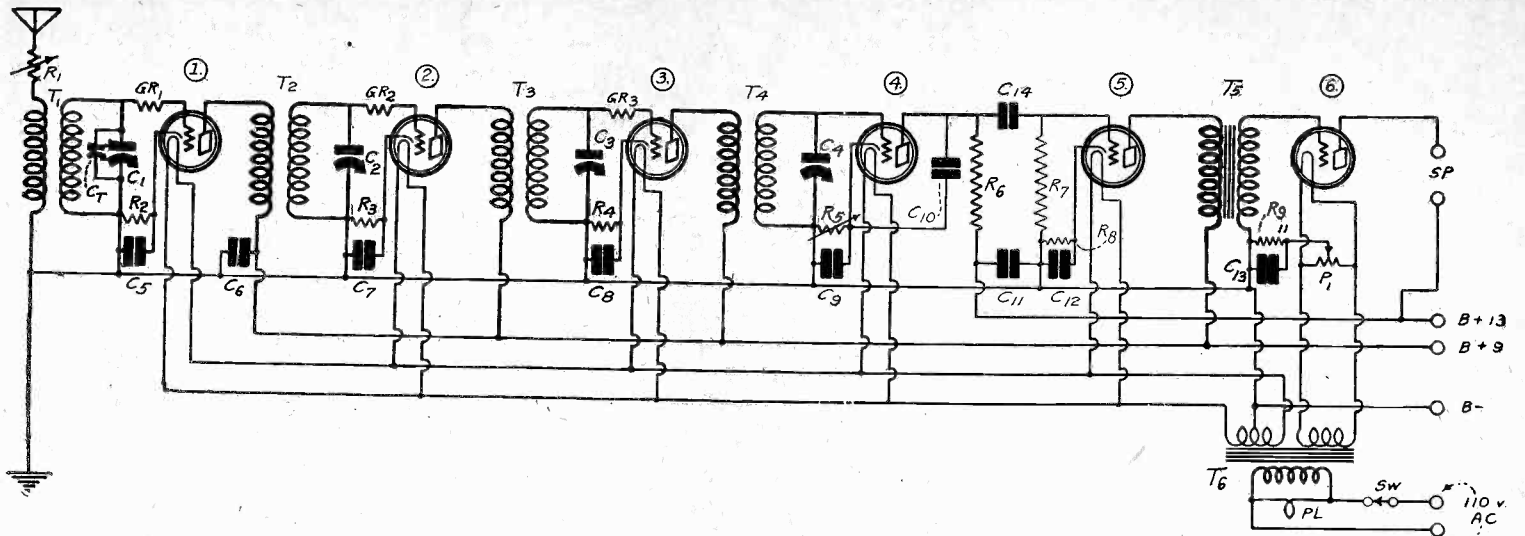

FIG. 725. THE CIRCUIT DIAGRAM OF A SIX TUBE AC RECEIVER USING FOUR TUNED CIRCUITS AND FIVE -27 TYPE TUBES. REQUESTED BY PAUL INGALLS.

Radio University

A FREE Question and Answer Department conducted by RADIO WORLD for its yearly subscribers only by its staff of Experts. Address Radio University, RADIO WORLD, 145 West 45th St., New York City.

I WISH to construct a short wave set using a screen grid tube for RF amplification and a 201A tube for detector. Is this practical?

(2)—Is it possible to tune both stages?

(3)—Can the circuit be used for picking up short wave code without regeneration?

(4)—If regeneration is necessary what type of feedback is best?

WILFRED ALLRED,
Harrisburg, Pa.

(1)—Yes.

(2)—It is, provided that the two tuned circuits are carefully shielded from each other. It is necessary to isolate the circuits completely so that there can be no feedback from the detector to the screen grid tube.

(3)—It can only be used for picking up modulated signals, and this includes spark signals. It cannot be used for continuous wave telegraphy without oscillation.

(4)—The condenser method of feedback is usually considered more suitable for short wave work.

IS IT POSSIBLE to construct a short wave receiver operating with a loop, and if so would such a receiver be effective in picking signals?

(2)—Could a loop be made regenerative so that continuous wave signals could be received on such a set?

(3)—How large should the loop be to be most effective?

HOWARD WILLIAMS,
Racine, Wisc.

(1)—A loop is more effective on short wave signals than on long, and such a receiver should be very efficient.

(2)—It may be made regenerative by arranging it in a Hartley circuit. But a regenerative loop will radiate as well as receive. It would undoubtedly cause interference.

(3)—A loop which is half a wavelength across is most effective. It would probably be necessary to have several loops of different inductances in order to cover the entire band of so-called short waves, just as it is necessary to have a set of short wave tuning coils.

CAN A TRICKLE CHARGER designed for charging a 6 volt battery at the rate of 1/2 ampere be used for charging a 4 volt battery? If so, what change is necessary without any charger?

(2)—What will happen if the charger is connected across the 4 volt battery directly without any charger?

FRANK MORLEY,
Cleveland, Ohio.

(1)—Connect a four-ohm resistor in

series with the charger, a resistor that is capable of carrying 1/2 ampere or more.

(2)—The battery will charge more rapidly than at the 1/2 ampere rate. In some instances nothing else would happen, but in other instances the charger would get hot.

I HAVE HAD a four-tube Diamond of the Air which has given fine results for two years, that is, as long as I used batteries. Now I use a B battery eliminator and can get no clear signals. There is a terrific squeal. What is wrong?

(2)—Will by-pass condensers help?

(3)—Would there be any advantage in using radio frequency choke coils in the detector and RF plate leads?

EDWARD SIMMONDS,
Newark, N. J.

(1)—It is probable that the B battery eliminator gives too high plate voltages. The values indicated on the binding posts are not reliable. It may also be that there is too much feedback through the eliminator to the first tubes. The squeal may arise in the AF amplifier.

(2)—Yes, the more and larger the better. Put them across the plate voltage taps to the filament.

(3)—Yes, it will be advantageous to put RF chokes in the plate leads of the detector and RF tubes and AF chokes in the plate leads of the detector and the AF tubes. If chokes are used, by-pass condensers must be connected from ground or filament to the plate side of each of the chokes. Use .01 mfd. for the RF and 1 mfd. for the detector and the AF tubes.

I HAVE a B battery eliminator which gives too high voltage. Is there any simple way of reducing the voltage?

(2)—Will a resistor in the rectified current line do the trick?

(3)—What resistance is necessary to cut out the voltage by 50 volts?

JACK LITTLE,
Memphis, Tenn.

(1)—If the B battery eliminator has no filament windings the simplest way is to put a resistor in the primary of the supply transformer. A variable resistor from 0 to 50 ohms which will carry about 1/2 ampere will do. This method will not work if there is a filament winding in the secondary, whether this is used for the rectifier tube or the power amplifier.

(2)—The resistor in the secondary will not cut the voltage in the secondary but it will cut the effective voltage applied to the plates of the tubes provided that current passes through the resistor.

(3)—What resistance is required de-

pends entirely on how much current passes through that resistor. The voltage drop is equal to the resistance used multiplied by the current flowing through it.

I HAVE a two dial receiver which I have built. It gives very good results both as to volume and selectivity, but the dials don't tune right. At the higher wave lengths the two dials are together but at about 240 meters they are 25 degrees apart. The right hand dial is then set at zero. What causes this?

(2)—Can I make the dials read alike by shielding the coils?

(3)—Will a condenser across the right hand tuning coil help?

ALFRED PETERSON,
Brownsville, Texas.

(1)—The cause of the divergence of the two dials is the high distributed capacity across the right-hand tuning coil. This capacity is partly due to the distributed capacity of the coil itself, partly to the high zero setting capacity of the condenser you use, and partly to the capacity between the windings of the coil.

(2)—Shielding of the coils will probably make the situation worse. It will not enable you to tune any lower on the right hand dial.

(3)—Another condenser across the tuning coil is just what you don't want. A small condenser across the first tuning coil will make the two dials read alike, but it will not enable you to tune any lower. Reduce the capacity across the right hand coil. This may require a new coil or a change in the position of the coil.

I HAVE five-tube regenerative receiver which I operate with a storage A battery and a dry cell B battery. There is a very loud hum in the loudspeaker which seems to come from the AC lighting line. It is of a constant pitch although it varies in intensity with the tuning. It is loudest when the set is adjusted for critical regeneration. What do you suppose is the cause of it?

(2)—Do you suppose that the hum is picked up by the antenna? It is near some power lines running parallel with the antenna.

LESTER JONES,
Jacksonville, Fla.

(1)—There are conditions in a radio receiver which might make it possible for the antenna to pick up the hum, but it is probable that there is AC near the detector or audio amplifier in the set. This AC might be picked up by condenser coupling between the grids of the tube and the power line. Once the signal has been picked up it may modulate with the radio frequency current and so show up louder when the set is tuned and regenerated.

(2)—The antenna may pick up the noise if there is a condenser between the

ground on the set and the actual ground. If there is no condenser in the antenna circuit there is little chance of picking up the hum, even if the antenna and the power lines are parallel. Try shielding the entire receiver and ground the shield.

* * *

WHAT IS the advantage of using an aluminum sub-panel over a wooden base-board?

(2)—Will the set be more selective if a metal sub-panel is used?

(3)—What is the best material for shields in a radio receiver?

AMOS FRANKLAND,
Terra Haute, Ind.

(1)—The metal sub-panel makes a much better looking set, takes less room, furnishes a convenient ground and A minus connection and partly shields the receiver from outside disturbances. It also forms one side of the shield when the stages are shielded from each other.

(2)—It does not help the selectivity any, except in so far as it helps to isolate tuned circuits from each other.

(3)—Copper is the best material for shielding, but aluminum is a close second. Aluminum has the advantage of being lighter. Also because it is lighter, it costs less than copper, even if it costs more per pound.

* * *

I BUILT a five-tube Diamond of the Air exactly as you described it, but I cannot get a sound out of it. Each of my tuning condensers has seven rotor and seven stator plates. Can you tell me what is wrong?

(2)—I use an eliminator on this set which works very well on another receiver. Cannot the five tube Diamond be worked on an eliminator?

(3)—Could I use a 171A power tube on this circuit?

ROY MILLER,
Michigan City, Ind.

(1)—You are using midget condensers for tuning. The specifications called for .0005 mfd. tuning condensers.

(2)—If you have a good B battery eliminator it can be used with the Diamond.

(3)—You can use a 171A power tube provided you give the proper grid and plate voltages. This tube should have an output transformer or output filter between the tube and the speaker.

* * *

WHEN I USE no grid bias whatever on my first audio tube I get even a little more volume than when I include the recommended bias. I therefore do not understand why the bias should be recommended.

(2)—I tried two 201A tubes in parallel in the output of my receiver, replacing the 112 I had been using, and volume increased. It seems that the two parallel tubes work better than the single power tube.

ADOLPH FRIED,
Seattle, Wash.

(1)—The object is not maximum volume regardless of distortion but maximum power handling, i. e., signal strength without distortion. If you placed a milliammeter in series with the plate lead of the first audio tube you would note (a) that with zero bias the plate current would be higher and (b) the needle would wiggle badly, disclosing distortion. The main consideration being operation without distortion, the diminished plate current is merely incidental, even if B batteries are used. Restore the bias.

(2)—There will be a little more volume, but again mere volume is not the goal. The 112 and 112A have a greater undistorted power output than the two parallel 201As. Only novices compare tubes by bare volume, disregarding the really important consideration of purity of tone. Perhaps your ear does not readily disclose the tonal difference, but on loud passages that difference must be obvious.

Literature Wanted

THE names and addresses of readers of RADIO WORLD who desire literature on parts and sets from radio manufacturers, jobbers, dealers and mail order houses are published in RADIO WORLD on request of the reader. The blank at right may be used, or a post card or letter will do instead.

RADIO WORLD,
145 West 45th St., N. Y. City.
I desire to receive radio literature.

Name

Address

City or town

State

- Jos. Einhaus, 756 No. Chicago St., Pontiac, Ill.
- C. W. Stewart, 55 E. 28th St., Portland, Ore.
- H. P. Willis, 431 No. Humphrey Ave., Oak Park, Ill.
- J. K. Moore, 6148 Master St., Phila., Pa.
- W. L. Beckman, 85 Prospect Pl., Brooklyn, N. Y.
- J. C. Weimer, 1417 Kelsey Ave., Toledo, Ohio.
- D. Franklin Fisher, 3326 College Ave., Indianapolis, Ind.
- Jiffy Supply Co., H. S. Johnson, 2118 Dupont Ave., So., Minneapolis, Minn.
- H. E. Clark, 676 View Ave., Ocean View, Va.
- C. A. Isham, Box 314, Hyattsville, Md.
- Howard Roix, 471 Gratton St., Aldenville, Mass.
- Chas. J. Leibman, 61 Whitehall St., New York, N. Y.
- Fred Ponn, Stop 31, Euclid Ave., Wickliff, Ohio.
- W. A. Bond, c/o Mr. L. Marshall, Medford, Ont., Can.
- Robert Davies, 796 Broad St., Providence, R. I.
- Geo. N. Hulter, 207 Wells, S.W., Canton, Ohio.
- O. P. Bouland, 843 Viger Ave., Montreal, Can.
- M. W. Stoner, L. Box 47, Mt. Holly Springs, Pa.
- Harry Goodchild, R. No. 1, Garden City, Pa.
- O. J. Glaubitz, 380 Broadway, Albany, N. Y.
- Harry C. Deemer, 1629 N. 12th St., Phila., Pa.
- W. H. Mitchell, 503 E. Jackson St., Sterling, Kans.
- J. S. McGraw, Tolleson, Ariz.
- M. C. Goldstein, Southern Pacific Co., 77 Market St., San Francisco, Calif.
- Lee A. Myers, 65 13th Ave., Columbus, Ohio.
- E. J. Christ, 101 Clinton St., Hempstead, N. Y.
- S. Larmour, Master Mechanic, Norfolk Navy Yard, Portsmouth, Va.
- Thomas Tooner, 5852 N. Nurvine St., Phila., Pa.
- L. S. Forsythe, 515 5th St., Portsmouth, Va.
- Fred J. Dean, 114 Charlton St., Southbridge, Mass.
- Herbert Cane, Box 84, Plainville, Ill.
- H. E. Traver, 237 Cannon St., Syracuse, N. Y.
- L. M. Hanes, R. R. No. 3, Cainsville, Ont., Can.
- H. H. Schwalenberg, Jr., 128 Barney St., Wilkes-Barre, Pa.
- Mrs. A. Utemoff, Pascadero, Calif.
- Arnold Schultz, 302 E. Fifth St., Cincinnati, Ohio.
- Riley Henry, Hoxie, Ark.
- Clyde Taylor, Richland, Mo.
- Norris L. Brown, Newton Square, Pa.
- A. G. Donnick, 501 5th & Logan Sts., McMechen, W. Va.
- Ga vane Flournoy, R. D. 1, Edmonds, Wash.
- S. P. Virek, 4839 So. 24th St., Omaha, Nebr.
- Donald Hunt, 119 Main St., Conemaugh, Pa.
- Edward Bauer, 3024 Sevilla Ave., Lawndale, Ohio.
- Edward Bishop, Gananoque, Ont., Can.
- N. T. Irons, 617 North St., Oil City, Pa.
- John W. Starie, The Parsonage, Fairview St., Greenfield, Mass.
- I. N. Woodward, 1536 Vine St., Phila., Pa.
- Henry W. Woodward, 15 Winchester St., Springfield, Mass.
- Jesse I. Seward, Palmyra, N. Y.
- Corp. W. F. Hansen, U. S. M. C. Signal Sch., Marine Barracks, Quantico, Va.
- F. T. Hix, 556 So. 6th St., Pocatello, Idaho.
- Harry Helmke, Box 63, Whittetore, Iowa.
- Edwin Wicklund, R. No. 3, Kensington, Minn.
- Allen C. Lovejoy, 100 East St., Fitchburg, Mass.
- Russell Dennison, 466 1/2 Dufferin Ave., London, Ont., Can.
- J. H. Wells, 1468 E. 204th St., Euclid Village, Ohio.
- John Cavette, 11556 122nd St., Richmond Hill, N. Y.
- Jules F. Swan, Hillsdale, N. J.
- Harold Lewis, 239 Lake St., Newark, N. J.
- Dr. Albert A. Ripperger, 25 East 86th St., New York, N. Y.
- Harold W. Duley, Upper Dam House, Upper Dam, Oxford Co., Maine.
- Harold D. Rissler, 638 Tire & Vulcanizing Co., Springfield, Tenn.
- Fred W. Nutting, 1 Dexter Ave., Waltham, Mass.
- K. A. Offerman, 24 Sheridan Ave., Brookfield, Ill.
- Shumway's Office Service, 2824 North 24th St., Philadelphia, Pa.
- Wm. A. Kelley, 8 So. Texas Ave., Atlantic City, N. J.
- L. G. Reeves, 518 Summit Ave., Charlotte, N. C.
- Frank Crawford, Star Route, Gig Harbor, Wash.
- Thos. A. Keegan, 1724 N. Howard St., Phila., Pa.
- R. D. Dickson, 686 31st St., Oakland, Calif.
- W. Jasioskowski, 534 Manitoba St., Milwaukee, Wis.
- William Beel, 252 Prospect Pl., Brooklyn, N. Y.
- H. P. Dahlen, 1700 N. Sixth St., Terre Haute, Ind.
- Arielle Mig. Co., 2207 Pearl St., Phila., Pa.
- H. W. Woodward, M. D., 2039 New Hampshire Ave. N. W., Washington, D. C.
- Oscar Wray, R. F. D. No. 4, Lewistown, a.
- C. M. Rogers, Box 111, Topeka, Kans.
- Moreland & Tilton, M. Moreland, 203 So. Second St., Greenfield, Ohio.
- General Sales Co., 606 Iowa Bldg., Sioux City, Ia.
- J. F. Brownlee, Ridgway, Pa.
- Ikey Enlow, Mayfield, Ky.
- H. Brook, 1930 Cabot St., Detroit, Mich.
- G. H. McIntler, 2541 Babe, Kansas City, Mo.
- T. L. M. Wray, 538 Chrysler Ave., Schenectady, N. Y.
- G. E. Gage, Helena, Mo.
- J. F. Roworth, Hollister, Mo.
- Printis McGinnis, 2731 E. 27th Ave., Denver, Colo.
- H. H. Chalkley, Box 785, Norfolk, Va.
- M. B. Farris, 1819 Avenue B, Scotts Bluff, Nebr.
- A. E. Dyer, 2121 So. Ninth St., St. Joseph, Mo.
- J. A. McNicholas, 105 William St., New York, N. Y.
- F. N. Wilcox, Lakewood, Ohio.
- S. Jalenak, 4300 Forest Park Blvd., St. Louis, Mo.
- Geo. L. Webster, 426 Seaview Ave., Bridgeport, Conn.
- B. Roberts, care Mrs. T. McLaughlin, 40 Elizabeth St., River Rouge, Detroit, Mich.
- E. L. Roberts, 97 E. 154th St., Harvey, Ill.
- D. George, 155 Meeting St., Charleston, S. C.
- G. K. Harrington, Manette, Wash.
- H. B. Jones, Box 578, White River Jct., Vt.
- L. A. Bickel, 143 E. 63rd St., Los Angeles, Calif.
- F. Yindrock, 421 4th Ave., Dayton, Ky.
- Willett Naumann, 824 W. Morgan St., Kokomo, Ind.
- R. ayHindenach, 2200 Briggs Ave., Parsons, Kans.
- W. H. Irwin, 329 E. Main St., Chattanooga, Tenn.
- W. T. Hale, 519 Mass. Ave., Boston, Mass.
- P. Dohse, West Side, Iowa.
- H. W. Sturgis, 3424 Edison Ave., Wesleyville, Pa.
- J. J. Ball, Lake Arthur, La.
- Jerome Wechsler, 40 Thayer St., New York, N. Y.
- Ben Friedman, 319 E. 46th St., Brooklyn, N. Y.
- A. E. Gaisunas, 50 Riverside St., Newton Upper Falls, Mass.
- C. G. Townsend, Bolckow, Mo.
- Hemoral Products Co., J. W. Robinson, 33 W. Jackson Blvd., Chicago, Ill.
- Adam Kubar, Oxford Radio Service, 18th and Oxford Sts., Philadelphia, Pa.
- C. W. Stewart, 55 E. 26th St., Portland, Ore.
- H. N. Edmonston, 525 Crittenden St. N. W., Washington, D. C.
- Wm. H. Cook, 431 Myrtle Ave., Clearwater, a Fl.
- Sam Hanson, Ada, Minn.
- J. F. Newell, R. D. No. 2, Box 45, Bound Brook, N. J.
- Jos. E. Hogarth, 255 Berkley St., Germantown, Philadelphia, Pa.
- W. J. Wirick, 214 Dewet St., Lakemont Terr., Altoona, Pa.
- Robert R. Dietz, Broomall, Pa.
- B. Anderson, The Canadian Bank of Commerce, Toronto, Ont., Can.
- Bruce Dragon, 3022 Russell Ave., Parma, Ohio.
- J. G. Dozier, P. O. Box 438, Harrisville, R. I.
- M. Wm. Guerin, 4220 Ivanhoe, Baltimore, Md.
- J. L. Hill, 1036 E. State St., Rockford, Ill.
- Frank E. White, Frazee, Minn.
- L. Culker, 34 Cozeler's St., St Henry, Montreal, P. Q., Can.
- H. S. Stanbery, Mgr., Nat'l. Audiphone Co., 706-9th Ave., N., Fort Dodge, Iowa.
- Thos. Capo, Jr., 718 Weiblen Place, New Orleans, La.
- H. Frazier Sheffer, 124 E. Athens Ave., Ardmore, Pa.
- Walter E. Latham, Ft. Trumbull Branch, Milford, Conn.
- J. Robertson, U. S. Radio Laboratory, 879 Hutchins Ave., Cincinnati, Ohio.
- Henry Roling, 3545-A Nebraska Ave., St. Louis, Mo.
- Donald Cameron, 62 Palmer Ave., E., Detroit, Mich.
- Donald Whittaker, 415 W. 13th St., Sioux Falls, So. Dak.
- T. P. Hodges, Fresno, Calif.
- Clyde Taylor, Richland, Mo.
- C. O. Neikirk, 6602 Sunnyside Ave., Seattle, Wash.
- Steve Horvath, 92 Ely Ave., S. Norwalk, Conn.
- John Gravella, 31 Kilhoffer St., Buffalo, N. Y.
- E. C. Baker, Yarmouth South, Nova Scotia, Can.
- E. H. Braaten, 415 James St., Turtle Creek, Pa.
- J. F. Fox, 6631 Chew St., Germantown, Phila., Pa.
- J. L. Anderson, 558 Main St., Kansas City, Mo.
- O. S. Harvey, 16 Avon St., Portland, Me.
- D. R. Vogelsang, 1623 Elizabeth Lane, So. P. O., Baltimore, Md.
- W. E. Fraser, P. O. Box 448, Chilliwack, B. C., Can.
- I. S. Christy, S. M. Service Station, Revere, Mo.
- Newton M. Baul, 39 Woodrow, Bedford, Ohio.
- Townsend's Garage, H. S. Townsend, Cheriton, Va.
- Madison Cooper, Jr., Calcium, N. Y.
- P. D. Henson, Rome, Pa.
- R. M. Anderson, 2715 Webb Ave., Bronx, New York, N. Y.
- W. E. Maunula, 1377 Grand Ave., Astoria, Ore.
- H. F. Sheffer, 124 E. Athens Ave., Ardmore, Pa.

De Luxe Carrying Case **FREE**

With Each Jiffy Tester Combination!

This Meter Outfit Makes Thirteen Vital Tests in Only 4½ Minutes!

INSTRUCTION SHEET GIVES FULL DETAILS OF THESE THIRTEEN TESTS

The Jiffy Tester in its Case is a Testing Laboratory All by Itself. Leave the meters in the case. Simply lift out the plug, attaching the four-prong adapter, if testing a four-prong tube. Put plug in socket of receiver to be tested; put tube in Tester socket. The B voltmeter automatically connects to the proper points when its tipped leads are inserted in the two binding posts at rear.

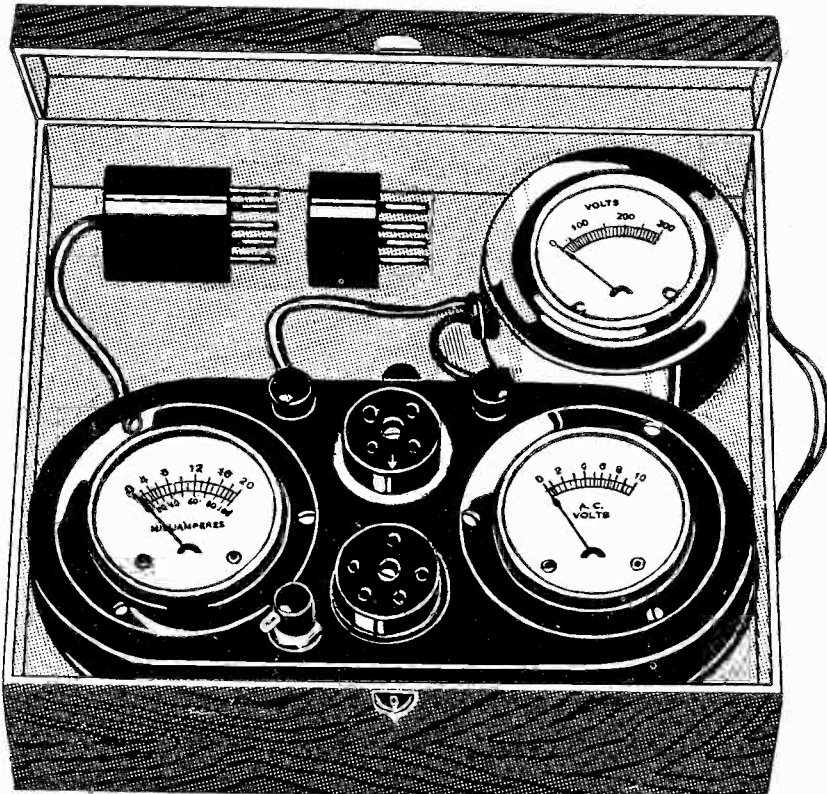

This housed Jiffy Tester, with high resistance voltmeter for measuring B voltages, including those of eliminators, is a service kit of the highest value. The case is furnished in a de luxe finish, with handle. A patented snaplock makes it impossible for the lid to open accidentally. The Tester and high resistance meter fit so snugly in place that they will not jar in transportation. A 5-day money-back guaranty attaches to each sale.

Jiffy Tester Combination, shown one-third size, includes 0-10 voltmeter reading AC or DC (same meter reads both); 0-20, 0-100 milliammeter, with change-over switch; cord and plug with 4-prong adapter; 0-300 high resistance voltmeter. Price \$13.50. Complete instruction booklet and de luxe carrying case FREE with each order.

Jiffy Tester a Scientific Trouble Shooter

Every service man, custom set builder, home experimenter, student or teacher needs one of these Jiffy Tester Combinations. Ample accurate for this class of work. You will be well satisfied with assured 5% plus or minus accuracy. Jiffy Tube and Set Tester, consisting of 0-20, 0-100 combination milliammeter, 0-10 AC and DC voltmeter and 0-300 high resistance voltmeter. De luxe carrying case and instruction booklet FREE with each order. Jiffy Tester Combination A.

\$13.50

The 0-300 high resistance voltmeter in "Jiffy Tester Combination A" is accurate to 5% plus or minus, so that at maximum reading it is not more than 15 volts off. Those desiring a more accurate 0-300 high resistance meter, never more than 3 volts off, at maximum reading, should order "Jiffy Tester Combination B," which has a 0-300 meter accurate to 1%, at a cost of \$1 extra. Order "Jiffy Tester Combination B." De luxe carrying case and instruction booklet FREE.

\$14.50

Here Are the Thirteen Vital Tests!

- (1) to measure the filament voltage, up to 10 volts, of AC and DC tubes;
- (2) to measure the plate current of any one tube, including any power tube, from less than 1 milliamperer up to 100 milliamperes;
- (3) to measure the total plate current of a receiver or amplifier, up to 100 milliamperes. (Hardly any set draws more);
- (4) to measure the B voltage applied to the plate of tube; the voltage across B batteries or B eliminators, up to 300 volts;
- (5) to determine the condition of a tube, by use of the grid bias switch;
- (6) to measure any tube's electronic emission;
- (7) to regulate AC line, with the aid of a power rheostat, using a 27 tube as guide;
- (8) to test continuity of resistors, windings of chokes, transformers and circuits generally;
- (9) to find shorts in bypass and other condensers, as well as in inductances, resistors and circuits generally;
- (10) to read grid bias voltages, including those obtained through drops in resistors;
- (11) to determine the presence of distortion and overloading;
- (12) to test for correct bias;
- (13) to determine starting and stopping of oscillation.

[Note—Instruction booklet fully informs you how to make each and every one of these tests in a jiffy.]

Note All That You Get!

- For \$13.50 you receive:
- (1) One Two-in-One 0 to 10 voltmeter for AC and DC. Same meter reads both. Scale especially legible at 1½ to 7½ volts. This meter reads the AC and DC filament voltages.
 - (2) One DOUBLE reading DC milliammeter, 0 to 20 and 0 to 100 milliamperes, with changeover switch. This reads plate current, which is always DC in all sets.
 - (3) One 0-300 volts high resistance voltmeter, No. 346, with tipped 30" cord to measure B voltages.
 - (4) One 5-prong plug with 30" cord for AC detector tubes, etc., and one 4-prong adapter for other tubes.
 - (5) One grid switch to change bias.
 - (6) One 5-prong socket.
 - (7) One 4-prong socket.
 - (8) Two binding posts.
 - (9) One handsome molre metal case.
 - (10) One instruction sheet.
 - (11) One de luxe carrying case.
- If 0-500 volt 5% accuracy high resistance meter is preferred to 0-300 volts, add \$1.00, and order Combination C at \$14.50.
If 0-500 volt 1% accuracy high resistance meter is preferred to 5% accuracy 0-500 voltmeter, add \$2.00, and order Combination D at \$15.50.
[Note—A pair of adapters for UV199 tubes, Cat. No. 999, at \$1.00 extra. These are not sold except with Jiffy Tester Combination.]

GUARANTY RADIO GOODS CO.,
145 West 45th Street, New York City.
(Just East of Broadway.)

- Please ship at once your Jiffy Tester Combination for which I will pay post-man advertised prices, but no shipping charges. (Check off below.)
- One Jiffy Tester Combination A (0-10 v., 0-20, 0-100 m. a., 0-300 v., carrying case, instruction booklet FREE. Price \$13.50
 - One Jiffy Tester Combination B (same as above, but with 0-300 voltmeter accurate to 1%). Price.....\$14.50
 - One Jiffy Tester Combination C (same as A, except 0-500 voltmeter replaces 0-300). Price.....\$14.50
 - One Jiffy Tester Combination D (same as C, except 0-500 voltmeter is accurate to 1%). Price.....\$15.50
 - Set of 199 adapters. Price.....\$1.00

NAME.....
ADDRESS.....
CITY..... STATE.....

5-DAY MONEY-BACK GUARANTY

Individual METERS
For Portable or Panel Use

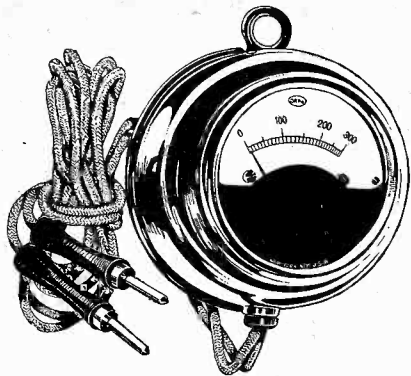

High resistance 0-300 Voltmeter, accurate to 1%. Measures any DC voltage to 300, including B eliminators. Provided with 30" cord, with luxurious jack tips and hanger. Meter full nickel de luxe finish. No. 348F. **\$4.50**
No. 347F, same as above, but 0-500 volts, \$8.00

POCKET AND PORTABLE VOLTMETERS

- No. 8—For testing A batteries, dry or storage, 0-8 volts DC scale.....\$1.00
- No. 10—For testing A batteries, dry or storage, 0-10 volts DC scale.....1.00
- No. 13—For testing A batteries, dry or storage, 0-16 volts DC scale.....1.00
- No. 50—For testing B batteries, dry or storage, but not for B eliminators, 0-50 volts DC scale.....1.00
- No. 39—For testing B batteries, dry or storage but not for B eliminators, 0-100 volts DC scale.....1.25
- No. 40—For testing A and B batteries, dry or storage, but not for B eliminators; double reading, 0-8 volts and 0-100 volts DC scale.....1.75
- No. 42—For testing B batteries, dry or storage, but not for B eliminators; 0-150 volts DC scale.....1.50
- No. 348—For testing AC current supply line, portable, 0-150 volts.....4.00

PANEL AC VOLTMETERS

- (Panel meters take 2-5/8" hole)
- No. 351—For reading 0-15 volts AC.....\$2.25
 - No. 352—For reading 0-10 volts AC.....2.25
 - No. 353—For reading 0-6 volts AC.....2.25
- (See No. 348 under "Pocket and Portable Voltmeters.")

PANEL VOLTMETERS

- No. 335—For reading DC voltages, 0-8 volts, \$1.00
- No. 310—For reading DC voltages, 0-10 volts, 1.00
- No. 316—For reading DC voltages, 0-18 volts, 1.00
- No. 326—For reading DC voltages, 0-6 volts, 1.00
- No. 337—For reading DC voltages, 0-50 volts, 1.00
- No. 339—For reading DC voltages, 0-100 volts, 2.25
- No. 342—For reading DC voltages, 0-150 volts, 2.25
- No. 340—For reading DC voltages, double reading, 1-8 volts, 0-100 volts.....1.50

VOLTMETERS

- No. 18—For testing amperage of dry cell A batteries and voltage of dry or storage A batteries, double reading, 0-8 volts, and 0-40 amperes DC.....\$1.25
- No. 35—For testing amperage of dry cell A batteries and voltage of B batteries (not B eliminators); double reading, 0-50 volts, 0-40 amperes DC.....1.50

PANEL MILLIAMMETERS

- No. 311—For reading 0-10 milliamperes DC..\$1.75
- No. 325—For reading 0-25 milliamperes DC..1.00
- No. 350—For reading 0-50 milliamperes DC..1.00
- No. 390—For reading 0-100 milliamperes DC..1.00
- No. 899—For reading 0-300 milliamperes DC..1.00
- No. 394—For reading 0-400 milliamperes DC..1.00

VOLTAGE REGULATOR

- No. 218—For preventing excess voltage on the filament and cathode of AC tubes, by compensating for excess line voltage.....\$5.00

POCKET AMMETER

- No. 1—For testing dry cells, 0-50 ampere DC scale pocket meter.....\$.75

6-VOLT A BATTERY CHARGE TESTER

- No. 23—For showing when 6-volt A battery needs charging and when to stop charging; shows condition of battery at all times.....\$1.00

PANEL AMMETER

- No. 338—For reading amperage, 0-10 amperes DC.....\$1.00

Immediate Shipment

GUARANTY RADIO GOODS CO.,
145 West 45th Street, New York City.
Just East of Broadway

Send me the following individual meters (quantity in square):

- Cat. No. Cat. No. Cat. No.
- Cat. No. Cat. No. Cat. No.

NAME

ADDRESS

CITY..... STATE.....

TEN-DAY MONEY-BACK ABSOLUTE GUARANTY!

O-600 V. AC and DC High Resistance Meter

Same Meter Reads Both
Accurate to 1 per cent. **\$7**

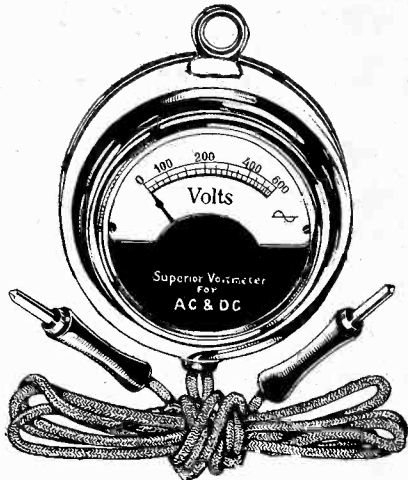

The O-600 volt AC and DC meter (Cat. No. 600), with 3-ft. cord, de luxe tips and hanger \$7.00.

THE output voltages of all B eliminators, the voltages of all B batteries, as well as the house current line voltage, whether AC or DC, and the voltage across power transformer secondaries, can be accurately measured by this meter. The full scale is 0-600 volts, and this same meter measures both AC and DC. Since it is a high resistance meter, of extraordinary range, and accurate to 1% plus or minus, it is advisable to get this meter for your testing purposes, since it is like two meters in one—AC and DC. You can find trouble more quickly. Without it you can't tell if a power transformer secondary is delivering voltage. 10-day money-back guaranty.

GUARANTY RADIO GOODS CO.,
145 West 45th Street, N. Y. City.
(Just East of Broadway)

Please ship at once one O-600 volts AC and DC high resistance voltmeter, accurate to 1% plus or minus (Cat. No. 600); meter equipped with 3-ft. cord, moulded tip receptacles, tips and hanger.

- \$7.00 enclosed
- I will pay postman \$7.00 plus few cents extra for postage.

Name

Address

City State.....

HBH SPEAKER AT \$17.00

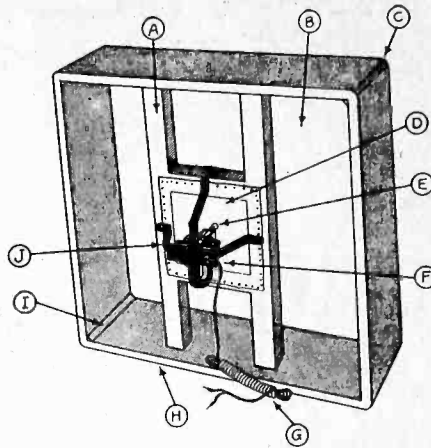

The HBH Speaker has imported Irish sheer linen front diaphragm for best tone and an HBH unit that is the most sensitive.

FOR unsurpassed tone quality, high sensitivity and rugged construction the HBH Speaker at \$17.00 offers the best buy on the market. Those who relish purity of tone want just such a speaker as this. No matter what your audio output is, this speaker will take care of it faithfully and unflinchingly.

The construction consists of an upright support (A), imported Irish sheer linen front diaphragm (B), metal-sprayed wooden decorated frame with rounded corners (C), airplane cloth rear diaphragm (D), rigid apex (E), HBH high-sensitivity, non-rattling unit (F), 10-ft. cord (G), 1-inch thick wood all around (H), splice joints (no nails) I, moulded metal bracket (J).

The speaker is shipped in a special "Safe-T" carton, all ready to play.

GUARANTY RADIO GOODS CO.
145 West 45th Street, N. Y. City.
(Just East of Broadway)

Please ship at once C.O.D. one HBH Speaker for which I will pay \$17 plus a little extra for cartage.

Name

Address

City State.....

Ten-Day Money Back Guaranty

Cash in on This Offer Now!

ONE full year's subscription for any TWO of the following magazines given to you—RADIO NEWS or SCIENCE AND INVENTION or RADIO (San Francisco) or BOYS' LIFE.

Select any TWO of these four publications, each of which will be sent to you (at only one address, however) each month for twelve months—in other words, 24 issues—if you will send in now your subscription for RADIO WORLD for two years (104 numbers) at \$10.00. RADIO WORLD'S subscription price for one year is \$6.00, so you gain the extra 2 dollars by taking advantage of the liberal offer for two-year subscriptions; and, besides, you get a subscription for each of the TWO other magazines selected from the enumerated list, making a total of 128 numbers for \$10.00.

If you want to select only one from among the four other magazines, you may obtain this one for TWO years, so that you will be subscribing for RADIO WORLD for two years and for the other magazine for TWO years, all for only \$10.00 (both mailed to one address only).

These offers are rightly regarded as among the most liberal ever made, but as they are limited as to expiration date (see notice below) you must act now.

Please use the attached coupon.

SPECIAL TWO-FOR-PRICE-OF-ONE COUPON

RADIO WORLD, 145 West 45th Street, New York City (Just East of Broadway):
Enclosed please find \$10.00, for which send me RADIO WORLD each week for two years (104 numbers), and also send me, without extra cost, each month for one year each of the following TWO magazines—total, 24 issues—grand total, 128 numbers:

- RADIO NEWS RADIO (San Francisco)
- SCIENCE AND INVENTION BOYS' LIFE

If you want one of each, put a cross in a square next to the name of each of the two other magazines. If you want a two-year subscription for ONE of the above magazines, with the two-year subscription for RADIO WORLD (same grand total of 128 numbers), put two crosses before the name of one magazine.

If you prefer to pay \$6.00 for only one year's subscription for RADIO WORLD (52 numbers) and get one of the other magazines for one year, without extra cost, put one cross in one square in front of the name of one magazine.

Present RADIO WORLD subscribers may renew under this offer. If renewing, put a cross here

Name.....

Street Address.....

City..... State.....

THIS OFFER EXPIRES AT NOON ON FEBRUARY 15TH, 1929

KELLY TUBES

Prescribed for the
Screen Grid Universal

One screen grid 422.....\$3.50
Two 410A at \$1.00 each..... 2.00
One 412A (for 135 volts)..... 2.00
or One 471A (for 180 volts)..... 2.00
Send \$7.50 for set of four tubes for this receiver.
Specify whether power tube wanted is 412A or 471A

KELLY TUBE COMPANY
57 Dey Street New York City
10-Day Money-Back Guarantee

SAVE THOSE TUBES!



Many persons have sets with Navy type sockets—the kind with the collar on and the bayonet hinge for the pin on the base of the tube. If you put a UX 199 tube in a Navy type socket a short may blow out all the tubes. Play safe and have fine contact besides. Use an adapter that fits UX 199 into Navy sockets (Cat. No. UX). Price 30 cents each.

GUARANTY RADIO GOODS CO.
145 West 45th St., N. Y. City

SCREEN GRID COILS

for the
4-tube SG Universal

Antenna coil, Model RF5
for .0005 mfd.....\$1.00
Antenna coil, Model RF3
for .00035 mfd..... 1.25
Coupler, Model TP5, for
.0005 mfd. 2.00
Coupler, Model TP3, for
.00035 mfd..... 2.25

SCREEN GRID COIL CO.
143 West 45th Street
New York City
Immediate Delivery and
10-Day Money-Back Guarantee

Complete Kit of Parts for the Four-Tube Screen Grid Universal

As Specified by Herman Bernard

What You Get L1, L2—One Screen Grid two-winding RF transformer, with center-tapped secondary; Model 5RF for .0005 mfd. L3, L4—One Screen Grid high impedance interstage coupler, with center-tapped primary; Model 5TP for .0005 mfd. C1—One .00025 mfd. Aerovox grid condenser, with clips. C2, C3—Two Hammarlund Midline .0005 mfd. tuning condensers. C4—One Hammarlund Junior condenser; Cat. No. MC11 (50 mmfd.). R1—One Lynch metallized grid leak, 2 meg. R2—One No. 622 Amperite, with mount. R3, R4, R5—Three No. 1A Amperites with three mounts. Rh—One 50-ohm rheostat. T1, T2—Two National new audio transformers. SW—One filament switch. PL—One pilot light bracket with lamp. Two dials with two dial pointers. Two knobs. Four binding posts (Ant., Gnd., Speaker plus, Speaker minus). One 10x20-inch aluminum self-bracketing subpanel, with sockets affixed, and including hardware and insulating washers. One 7x21-inch drilled Bakelite front panel. One nine-lead battery cable. One Peewee clip.

\$35.00
NET

Blueprint Free With Each Kit Order

CUSTOM SET BUILDERS SUPPLY CO.
57 Dey Street, New York City
Tel. Barclay 8659 Corner Greenwich Street

BLUEPRINT OF SCREEN GRID 4-TUBE UNIVERSAL - - \$1.00

Connections Doubly Clear Because Wiring Done on Top of the Subpanel is Shown Separately, and wiring done underneath the subpanel is shown separately. All leads shown in the same direction in which they are physically connected. You don't have to reverse the blueprint mentally to visualize the practical connections. Crystal-clear blueprint safeguards against error. Order your print today. Prompt delivery. Price of complete kit, \$35.00 (less tubes, cabinet and speaker).

CUSTOM SET BUILDERS SUPPLY CO., 57 Dey St., New York City

McARTHUR'S SHELL TALLIES for scoring at bridge parties or for bridge favors. A beautiful, dainty, unusual and useful gift utterly unlike anything else you have ever seen. When you use them at your next bridge party, all your friends will want to know where you got them. \$3.00 a dozen (for twelve place cards and tallies), postpaid. C. McArthur, 620 Plaza Place, St. Petersburg, Florida.

Recent Issues of **RADIO WORLD**, 15 cents each. Any number published in 1928 available for a short while. Six issues 75 cents, 10 issues \$1.00. Send stamps, coin or money order NOW, before the issues are sold. **RADIO WORLD**, 145 West 45th Street, New York City.

AIR COLUMN HORNS ARE SPLENDID!

Especially Those Made of Molded Wood

EVERYBODY who uses a horn loud speaker of the latest type, consisting of an air column design, with long tone travel, agrees that the tone is splendid. Our Model 595 has a travel distance of 8 feet from the unit to the large end of the "bell." If you must economize on space, use Model 570, with a 6-foot tone travel, with not quite as strong reproduction of low notes. But No. 595 is better and, if you've the room (21 1/4" high, 18" wide, 15" deep), choose that one. Every purchaser is a delighted customer. Order one of these specially moulded wood horns. Try it for 90 days. If not delighted, return it and get back your money, including any shipping charges you paid! (Note: Not a single one of these horns has ever been returned to us, though we've sold many hundreds!)



Model 595 (illustrated above) Baffle board (not shown) FREE with each order. List price \$18.00. Our price (40% and 2% off list price) — **\$10.58**



Model 570, size 15" high by 12" wide by 12" deep, 6-foot tone travel. FREE baffle board. List price \$13.00. Our price (40% and 2% off list price).....\$7.64

Model 112 horn motor stands 250 volts without filtering (illustrated at right). List price \$6.00. Our price (40% and 2% off list price).....\$3.53

ACOUSTICAL ENGINEERING ASSOCIATES,
143 West 45th St., New York City.
(Just East of Broadway)

Please ship me at once the following (check off):

One No. 595 at \$10.58, plus a little extra to defray shipping costs; send it already mounted in FREE baffle board.

One No. 570 at \$7.64, plus a little extra to defray shipping costs; send it already mounted in FREE baffle board.

One No. 112 horn motor (universal nozzle) at \$3.53, plus a few cents extra for shipping.

NAME.....
ADDRESS.....
CITY..... STATE.....

90-DAY MONEY-BACK GUARANTEE!

RADIO BLUEPRINT LIBRARY

A C HOOKUPS



1929 EDITION
DIX NEWMAN

6 Tube Single Control Set
5 Tube Tuned Radio Frequency Set
4 Tube Popular Uncle Sam Set
4 Tube Screen Grid Set
3 Tube All Wave Set (250 to 550 Mc.)
B-Eliminator for A. C. Current

Fourteen Circuits

Each Shown in Colored Picture Diagram, Colored Schematic Diagram and Front Panel Layout

Get This **FREE** Book!

Complete AC electric receivers, with B eliminators included, also AC receivers without B eliminators, also battery operated models, all easy-to-build circuits, using your own parts.

Colors Prevent Error

Red lines are used in all the diagrams to denote filament leads, light blue lines for grid connections, green lines for plate leads and heavy and light black lines for the rest. You can't make a mistake if you let the colors be your guide.

The Radio Blueprint Library of AC and Battery Hookups, one volume, in FOUR COLORS, is a veritable encyclopedia of tested DX hookups, with 45 illustrations of fourteen different circuits, and a textual explanation of each circuit. Besides, the booklet contains the Story of Radio, lists of parts for all fourteen circuits, and a Station Log Chart on which to record the stations you receive and the dial settings.

This is the very volume you've been wanting for a long time, and you can get a copy of the latest edition (1929), just off the press.

RADIO WORLD, 145 W. 45th St., N. Y. City.
(Just East of Broadway)

Gentlemen: Enclosed please find \$1.00 for which please send me Radio World each week for eight weeks (regular price, \$1.20) and besides send me a **FREE** copy of the 1929 edition of The Radio Blueprint Library of AC and Battery Hookups.

Name.....
Address.....
City..... State.....

Note: Present mail subscribers may take advantage of this offer by putting a cross in this square. Your subscription will be extended eight weeks.

POWERTONE SPEAKER \$7.50

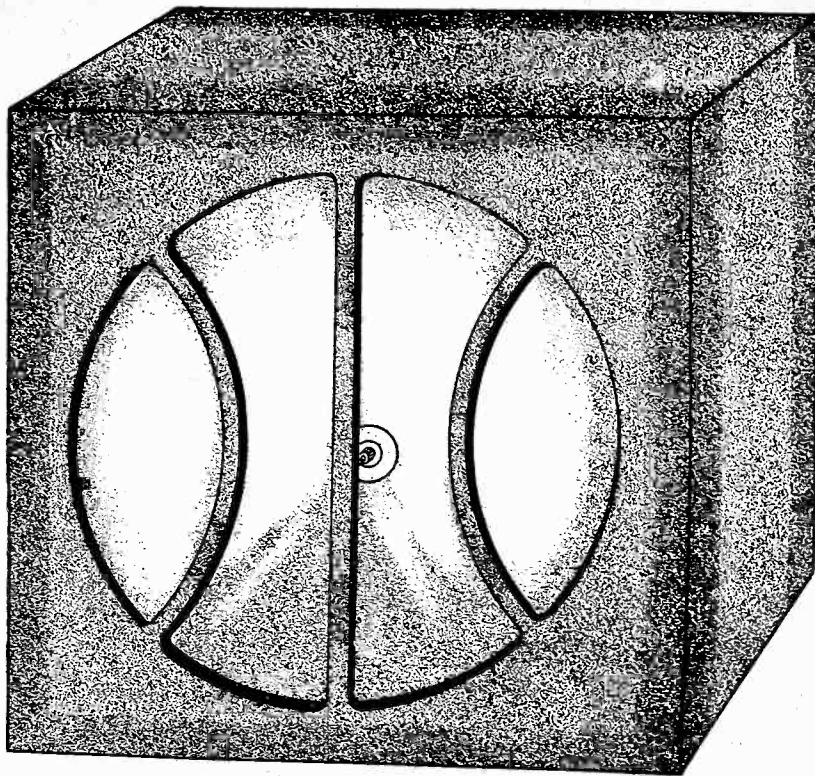

The New Powertone Speaker, shown one-third scale. All built up, ready to play \$7.50

GUARANTY RADIO GOODS CO.
145 West 45th Street, New York City
(Just East of Broadway)

Enclosed please find \$7.50, for which please ship at once one new Powertone Speaker, using new Powertone Unit, 1929 model; speaker all built up, ready to play. You will pay cartage.

Please send speaker C.O.D. I will pay \$7.50 plus postage.

[Check off proper square above.]

The 1929 model Powertone Unit, built into a decorative brown sprayed finish box, two-tone; with sturdy cone and adjustable armature, makes a dandy speaker. At \$7.50 you get more than your money's worth. The speaker stands 150 volts without need of an output filter. Works well out of any final audio tube. Tone is excellent; volume is high. Order one today.

Name.....
Address.....
City..... State.....

TEN-DAY MONEY-BACK GUARANTY

FILL OUT AND MAIL NOW

SUBSCRIPTION BLANK

RADIO WORLD

RADIO WORLD

145 West 45th Street, New York City
(Just East of Broadway)

Please send me RADIO WORLD for months, for which please find enclosed.....

SUBSCRIPTION RATES:
Single Copy \$.15
Three Months 1.50
Six Months 3.00
One Year, 52 Issues 6.00
Add \$1.00 a Year for Foreign Postage; 50c for Canadian Postage.

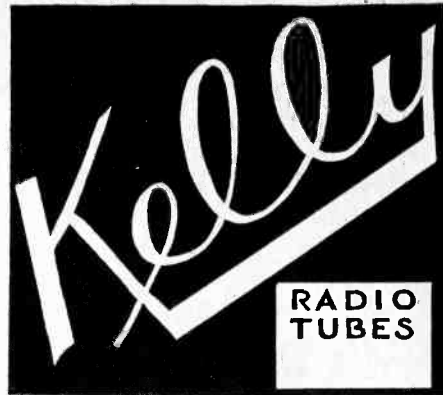

LONGER LIFE BETTER TONE MORE VOLUME

A guarantee slip is contained in each carton. Fill this out and earn FREE tube insurance. Built to excel, KELLY TUBES open new vistas of radio reception.

401A	\$1.00
4X Special Detector	2.00
412A	2.00
471A	2.00
UX499	1.25
428AC	2.00
427AC	3.50
440 (high mu)	1.50
422 (screen grid)	3.50
480	3.50

422 SCREEN GRID

Our 422 stands up.

440 HIGH MU

great for resistance or Impedance audio

KELLY TUBE COMPANY
57 Dey Street, New York City

HIGH RESISTANCE VOLTMETERS

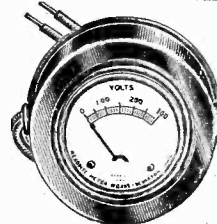

0-300 v. in portable type, full nickel finish, 80" tipped cord (illustrated at left). (Cat. No. 346) \$4.50

0-500 v. Tests ALL power packs, B eliminators, etc. Same casting as above. (Cat. No. 347) \$5.50

Just the thing for service men custom set builders, home experimenters.

GUARANTY RADIO GOODS CO.
145 W. 45th St., N. Y. City

Quick Action Classified Ads

Radio World's Speedy Medium for Enterprise and Sales

10 cents a word — 10 words minimum — Cash with Order

I HAVE twelve dynamic chassis speakers—AC models—fine speakers, brand new. Be one of the lucky dozen to get these at \$17.50. Guaranty money back in 5 days. P. Cohen, R 1214, at 143 W. 45th St., N. Y. C.

ARTISTS and Art Students are printing 250 signs or pictures an hour without machinery. Sample and particulars 10c. Straco, 1014 Mulberry, Springfield, Ohio.

EIGHTEEN microfarads of capacity, using Mershon condensers that will not ruin, because they're self-healing in case of puncture. This large capacity gives stability and humless quality in a marvelous new B eliminator, using the -80 full-wave rectifier tube on 50-60 cycle 105-120 v. AC maximum output voltage at 35 milliamperes is full 180 volts for -71 or -71A power tube, or lower voltage may be used for -12 or -12A power tube. The voltages are (B-) (B+22

to 45 variable) (B+67 to 85 variable) (B+90 to 135 variable) (B+180). Size 6 1/4 inches high by 7 inches wide. Equipped with finger-tip adjusters and insulated binding post strip. Price, all built up in de luxe metal housing with crackled gloss finish, including tube, \$18.00. Immediate shipment. Send remittance and we pay cartage. Order C.O.D. and you pay cartage—Custom Set Builders Supply Co., 57 Dey Street, N. Y. City. Tel. Barclay 8659.

HOW TO USE SCREEN GRID COILS

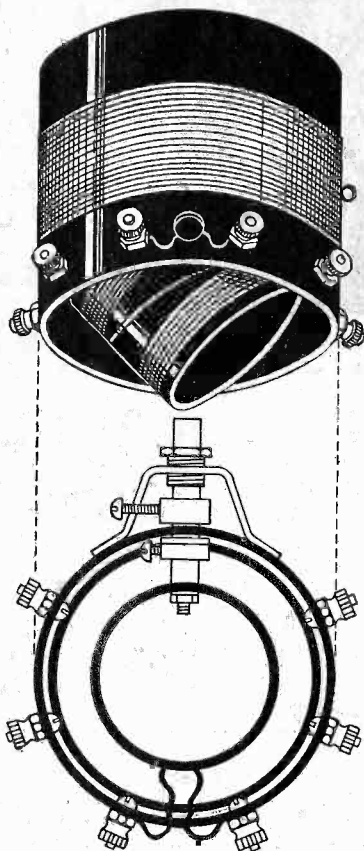

Model 5HT. High impedance 3-circuit tuner, to work out of a screen grid RF tube. For .0005 mfd. \$3.00
 Model 3HT. Same as above, but for .00035 \$3.25

WHEN a screen grid tube is used as a radio frequency amplifier, the maximum gain, the best amplification, the most volume and the most DX are obtained by tuning the plate circuit. Then this enormous amplification is itself doubled by providing a secondary with twice as many turns as the primary has. The secondary is not tuned. The high impedance 3-circuit tuner at left (Model 5HT) is an example, as is the two-winding coil (Model 5TP) at lower left. The primary in these two instances is the outside winding and the tuning condenser goes across it. The secondary is wound on a separate form that is riveted inside the primary form. Preferably mount coils with binding posts at bottom for short leads. Then the connections for Models 5HT, 3HT, 5TP and 3TP are, from right to left as you look at the back of the coil: B+135; near front panel; plate of screen grid tube; two rotary leads (for tuner only); grid and (next to panel) grid return.

The antenna coil to use in screen grid circuits is 5A or 3A (upper right), because it is so designed as to equalize tuning. The low, almost zero, capacity between grid and filament of the tube is compensated by extra turns of wire, so that if the tube following the screen grid is of another type, for instance a regular detector, the elemental capacity difference is nullified. The antenna coupler has a continuous winding in shaded colors. The end with the larger number of distinctive turns goes to grid, the opposite end to ground. Either of the two remaining binding posts goes to antenna.

For single control screen grid sets the inductive trimmer type of antenna coupler (Model 5AS or 3AS, at right) should be used. The inductive trimmer coil for interstage coupling is Model 5TPS or 3TPS (not illustrated), but its connections are shown in the diagram at lower right. An inductive trimmer adds to or subtracts from the reactance, which is very important for resonance in single control sets. Trimming condensers only increase reactance, hence fail where decrease is needed.

Model 5TPS Interstage coupler to screen grid tubes, with inductive trimmer. For .0005 mfd. \$2.25
 Model 3TPS, same as above, except it is for .00035 \$2.50

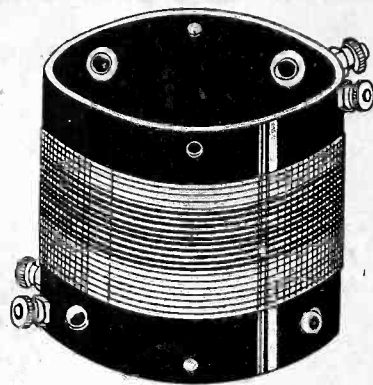

Model 5A. Conductively coupled antenna coil for input to screen grid radio frequency amplifier. For .0005 mfd condenser. Price \$1.75
 Model 3A. Same as above, but for .00035 \$2.00

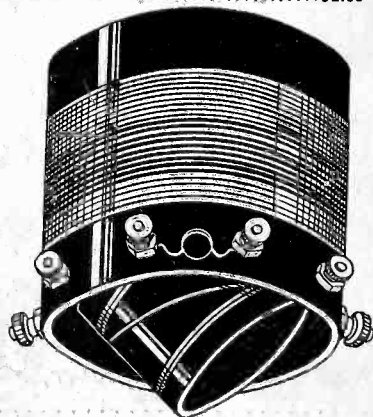

Model 5AS. Conductively coupled antenna coil for single tuning control screen grid sets. Rotor is an inductive trimmer. For .0005 mfd. \$2.75
 Model 3AS, same as above, but for .00035 \$3.00

ALL ROTOR COILS HAVE SINGLE HOLE PANEL MOUNTING FIXTURE

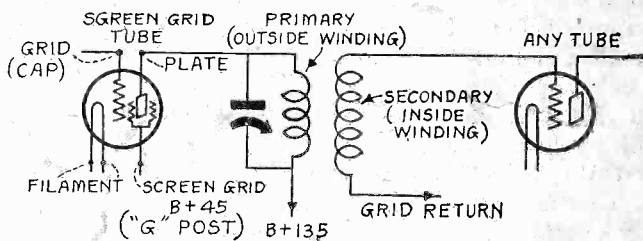

How tuned primary in plate circuit is wired for a screen grid tube. This illustrates the use of Model 5TP or 3TP, also Model 5HT and 3HT, except for the rotor coil connections.

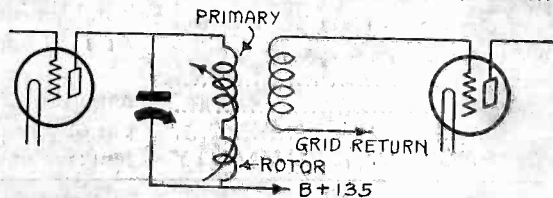

In single control circuits Model 5TPS is used as shown, for interstage coupling. The rotor is an inductive trimmer. The tube at left is a screen grid.

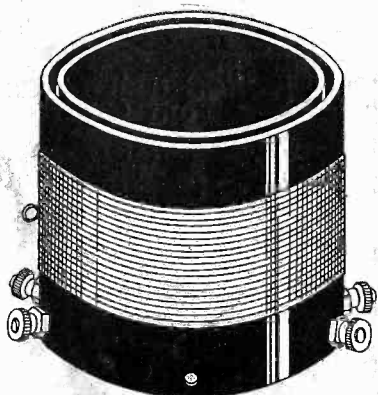

Model 5TP, the wiring of which is shown in the diagram directly above, is an interstage coupler for screen grid tubes. For .0005 mfd. \$2.00
 Model 3TP, same as above, but for .00035 \$2.25

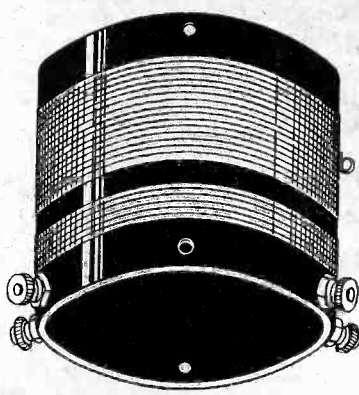

Model R5, interstage coupler for replacing present coil in existing receiver when screen grid tube is substituted. For .0005 \$1.50
 Model R3, same as above, but for .00035 \$1.75

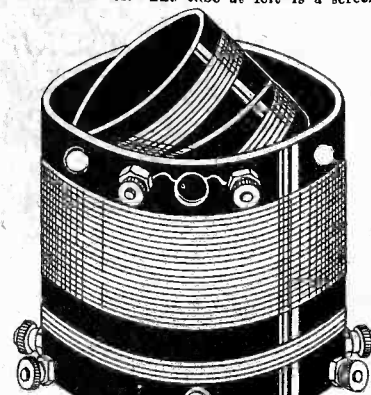

Model T5, standard 3-circuit tuner, not for screen grid tubes, but for all others. For .0005 \$2.50
 Model T3, same, but for .00035 \$2.75

Coils for Other Than Screen Grid Tubes

When any tubes other than screen grid tubes are used as radio frequency amplifiers, standard coils are used, for instance Models T5 and T3, the three-circuit tuner shown above at right.

For the antenna coil in such a circuit use one with two separate windings, the familiar radio frequency transformer, with about 14 turns on the primary. This RF transformer is therefore used as antenna coil and as an interstage coil.

The resultant loose coupling of antenna reduces the capacity effect of the antenna and thus the standard TRF coils, with 201A, 112A, 226, 227, 199 or 240 tubes, providing the same RF tubes are used throughout, may be used in single control sets without trimming devices. This is true if the coils are absolutely matched, as Models RF5 and RF3 are.

The small winding (primary) is connected in the antenna-ground circuit, or, for interstage coupling, in the plate circuit. The large winding (secondary) is tuned and is put in the grid circuit.

Model RF5. Antenna coil or interstage coupler for any and all tubes, excepting only screen grid tubes. For .0005 \$1.00
 Model RF3, same as above, but for .00035 \$1.25
 Model T5, standard 3-circuit tuner for .0005 \$2.25
 Model T3, standard 3-circuit tuner for .00035 \$2.50
 Model 5AC. \$1.50 Model 3AC. \$1.75

USE THIS COUPON

Screen Grid Coil Co., 143 W. 45th St., N. Y. C. (Just East of Broadway)

(Specify Quantity in the Squares)

Please mail me at once your following coils, for which I will pay postman the advertised prices, plus a few cents extra for postage.

Model..... Model..... Model..... Model..... Model.....

Name

Address

City State

SEND NO MONEY!