

# INSIDE FACTS ABOUT NBC

Feb. 9th, 1929

15 Cents

# RADIO

REG. U.S. PAT. OFF.

# WORLD

The First and Only National Radio Weekly

359th Consecutive Issue—Seventh Year

Radio to Run Autos,  
Motor Head Expects

Can Men Float in  
Air Like Bubbles?

Getting Rid of Hum

Bias Riddles Solved

## NEW SCREEN GRID DIAMOND

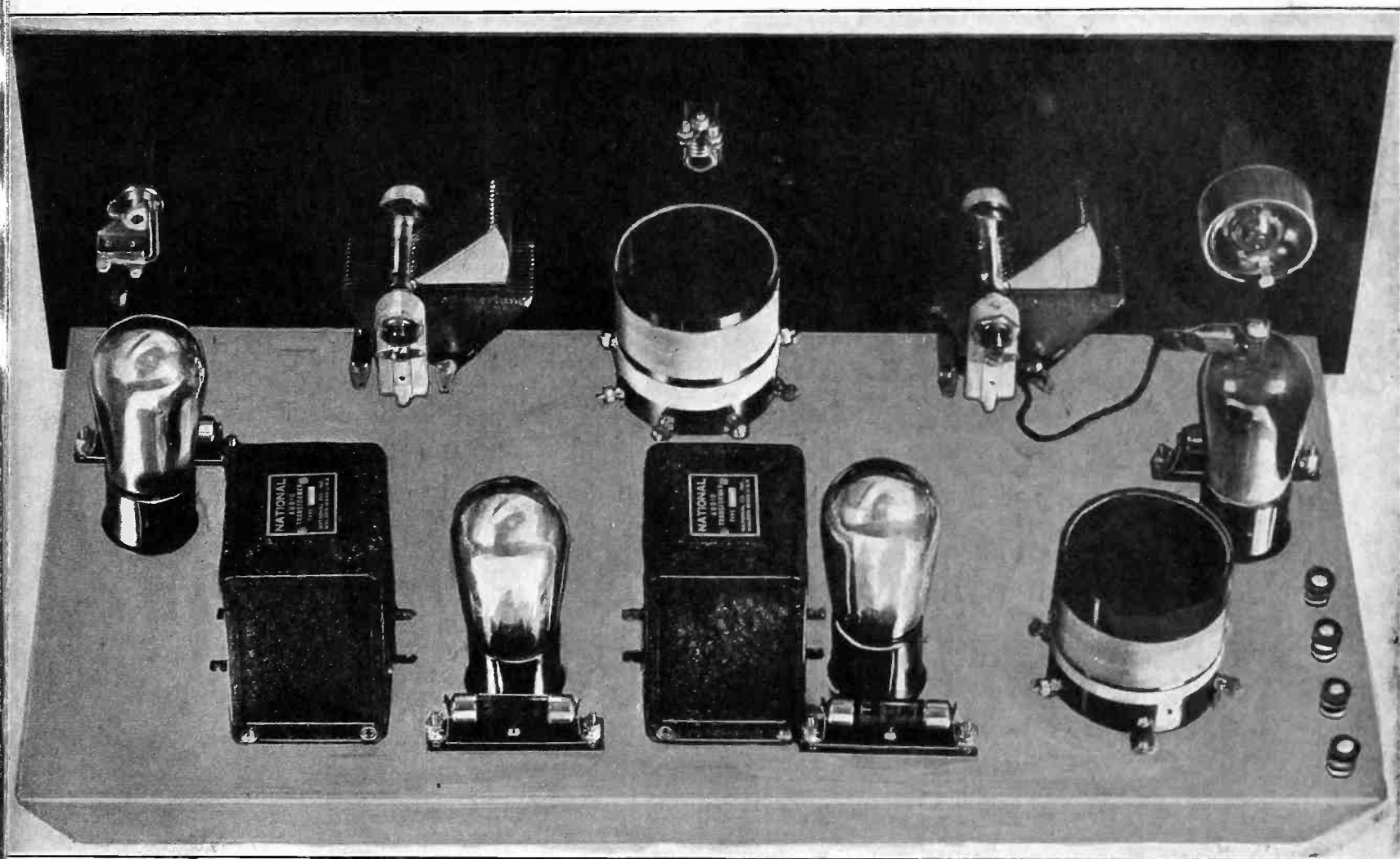

Much greater selectivity is obtained from the new model of the Four-Tube Screen Grid Diamond of the Air. See pages 18 and 19

# PARTS FOR THE AC 4

Complete Kit of Parts for the AC4, less B eliminator .....\$36.75  
 Complete Kit of Parts for AC4, with National B eliminator (180 v.) including 280 tube .....\$54.75  
 Complete Kit of Parts for AC4, with National B eliminator, 280 tube, cabinet, three 227 tubes, one 171A tube and Table Model Polo Speaker (nothing else to buy) .....\$75.00

GUARANTY RADIO GOODS CO.  
 143 West 45th Street  
 New York City

# COILS FOR THE NEW AC 4

Two AC5 (for .0005 mfd.) @ \$1.50 each....\$3.00  
 Two AC3 (for .00035 mfd.) @ \$1.75 each.... 3.50  
**SCREEN GRID COIL CO.**  
 143 West 45th Street  
 N. Y. City  
 (Just East of Broadway)

Front and Subpanel for the **AC 4**

Front panel, drilled for National Drum Dial, volume control switch, and for "dummy". \$2.35  
 Subpanel, 6x19", cut milk label shape, to permit room for B eliminator; 4 sockets built into subpanel; other holes drilled.....\$3.65

SPECIAL: We carry National Velvet B (type 3580) in stock, also 280 tube. Get our prices on these. Blueprint for AC4.....\$1.00

**GUARANTY RADIO GOODS CO.**  
 143 W. 45th St., N. Y. City

Blueprint of the **AC 4**

Price ..... \$1.00

**RADIO WORLD**  
 145 W. 45th St., N. Y. City

TAKE Your Choice of 4 Other Publications for New Radio World Subscribers Ordering Now. Radio World has made arrangements to offer, with one year's subscription for Radio World, a year's subscription for any one of the following publications FREE: Radio News or Science and Invention or Boys' Life or Radio (San Francisco) or Radio Engineering.  
 Send \$6.00 —now. State which other listed publication you desire. Radio World, 145 W. 45th St., N. Y. City.

# BUILD A 24-INCH CONE—LOWEST COST FOR FINEST TONE!

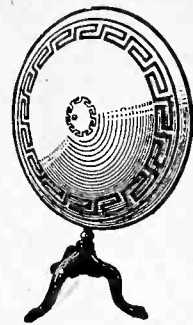

NEW **POWERTONE UNIT**  
 with 5-ft. cord  
 Designed Front Sheet  
 Plain Rear Sheet  
 Radio Cement  
 Mounting Bracket  
 Apex  
 Chuck  
 Nut  
 Tri-Foot Pedestal  
 Instruction Sheet  
**ALL FOR ONLY \$6.00**

**REMARKABLE GUARANTY!**  
 This 24" Cone Speaker Kit is sent complete, as listed, carefully packed. Order one sent C. O. D.  
**SEND NO MONEY!**  
 Build the speaker. If not overjoyed at results, return the built-up speaker in five days and get ALL your money back!

**GUARANTY RADIO GOODS CO.**  
 145 WEST 45TH STREET  
 N. Y. City Just East of Broadway

# SOCKET WRENCH

**FREE**

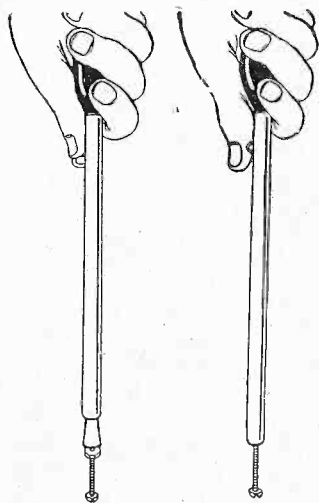

Push out control lever with knob (as at left) and put wrench on nut. Push down on handle only (at right), then turn nut left or right.

ONE of the handiest tools for a custom set builder, service man or home constructor is a BERNARD socket wrench.

It consists of a 6 1/2" long metal tubing in which is a plunger, controlled by a knob. The plunger has a gripping terminal (called a socket, hence the name "socket wrench") that may be expanded or contracted to fit 6/32, 8/32 and 10/32 nuts, the most popular sized nuts in radio.

Use the knob to push out the plunger, press down on the handle to grip the nut, then turn the nut to left for removal or to right for fastening down. Total length, distended, including stained wooden handle, 10". Gets nicely into tight places. Send \$1 for 8 weeks' mail subscription for RADIO WORLD and get this wrench FREE.

No other premium with this offer. Present subscriber may extend subscription by stating he is one, and entitle himself to this FREE premium, making \$1 remittance.

**RADIO WORLD**  
 145 WEST 45TH ST., N. Y. CITY  
 A few doors east of Broadway

Please look at the subscription date stamped on your last wrapper, and if that date indicates that your subscription is about to expire, please send remittance to cover your renewal.

In this way you will get your copies without interruption and keep your file complete.  
 Subscription Department, Radio World, 145 West 45th St., N. Y. City.

# FILL OUT AND MAIL NOW SUBSCRIPTION BLANK

# RADIO WORLD

RADIO WORLD

145 West 45th Street, New York City  
 (Just East of Broadway)

Please send me RADIO WORLD for ..... months, for which

**SUBSCRIPTION RATES:**  
 Single Copy .....\$ .15  
 Three Months ..... 1.50  
 Six Months ..... 3.00  
 One Year, 52 Issues..... 6.00  
 Add \$1.00 a Year for Foreign Postage; 50c for Canadian Postage

please find enclosed.....

# YOU MUST GET THIS BOOK!

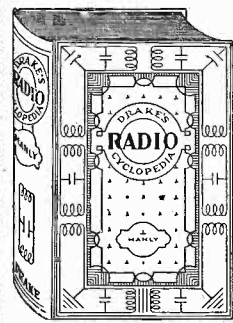

## DRAKE'S RADIO CYCLOPAEDIA (New Edition)

has been developed to answer the questions of service men, custom set builders and home constructors, of experimenters, students, salesmen and operators of receiving equipment and to allow all these to have instant access to the information they want. The author, Harold P. Manly, has collected and translated into plain English the material formerly obtainable only from dozens of scattered sources.

BOOK IS 2 1/2" THICK, WEIGHS 3 1/2 LBS., 1,025 ILLUSTRATIONS.

Each rule, fact, method, plan, layout and diagram is instantly picked out and separated from everything else by placing all subjects in alphabetical order with cross references for every imaginable name under which the information might be classed.

This alphabetical arrangement lets the experienced worker refer directly to the one thing in which he is interested at the moment without hunting through non-essentials. The needs of the beginner are cared for.

The important articles deal primarily with receivers and reception. They do not stop with the electrical end, but go also into the mechanics of construction. Every new thing in radio is covered in detail.

1,680 Alphabetical Headings from A-battery to Zero Beat  
 1,025 Illustrations, Diagrams, Layouts and Graphs  
 920 Pages, Each 6 by 9 inches  
 240 Combinations for Receiver Layouts

**OF THE PRINCIPAL ARTICLES**  
 159 concern service men, 129 help the set builder, 162 help the experimenter, 155 interest the student, 75 assist in sales work, 73 interest set owners.  
 Radio World: "The most suitable volume for those who want the facts stripped as far as possible of intricacies. Useful addition to any library."  
 Radio Broadcast: "The reviewer does not believe that a more satisfactory addition to the experimenter's library in any one volume can be made."  
 QST: "The information is so put as to be of most immediate use to the constructor and repair man, and, remarkably enough, includes apparatus of most recent origin."  
 Radio: "Seldom is any subject so comprehensively and practically explained."

**GUARANTY RADIO GOODS CO.**  
 145 W. 45th St., New York, N. Y. (Just E. of Broadway)  
 Gentlemen: Please mail me at once the new (second) edition of "Drake's Radio Cyclopaedia," by Harold P. Manly, just published, with all the latest technical information in it. I will pay the postman \$6.00 plus a few cents extra for postage. If I am not delighted, I may return the book in five days and you will promptly refund my purchase money.

Name .....  
 Address .....  
 City ..... State .....

**5-DAY MONEY-BACK GUARANTY!**

### KELLY TUBES

Prescribed for the  
**Screen Grid Universal**

One screen grid 422.....\$3.50  
Two 410A at \$1.00 each..... 2.00  
One 412A (for 135 volts)..... 2.00  
or One 471A (for 180 volts)..... 2.00  
Send \$7.50 for set of four tubes for this receiver.  
Specify whether power tube wanted is 412A or 471A

**KELLY TUBE COMPANY**  
57 Dey Street New York City  
10-Day Money-Back Guarantee

### Front Panel and Subpanel for the Screen Grid Universal

Bakelite front panel alone, drilled....\$2.35  
Drilled aluminum subpanel alone, with self-bracketing feature, built-in sockets, extra washers and hardware ..... 3.00  
Both front and subpanel together.... 5.00

**GUARANTY RADIO GOODS CO.**  
145 West 45th Street, New York City  
(Just East of Broadway)

### NEWS to Set Builders

**LATEST RADIO GUIDE**

Barawik offers set builders bigger bargains—bigger opportunities to make money this season. New sets, new kit ideas, all the leading parts, dynamic speakers, supplies, etc. Lowest rock-bottom prices. Bigger stocks, quicker service. Send for Big Bargain Book today—free.

**BARAWIK CO.,** 1312A Canal Sta., CHICAGO, U. S. A.

### Complete Kit of Parts for the Four-Tube Screen Grid Universal

As Specified by Herman Bernard

**What You Get** L1, L2—One Screen Grid transformer, with center-tapped secondary; Model 5RF for .0005 mfd. L3, L4—One Screen Grid high impedance interstage coupler, with center-tapped primary; Model 5TP for .0005 mfd. C1—One .00025 mfd. Aerovox grid condenser, with clips. C2, C3—Two Hammarlund Midline .0005 mfd. tuning condensers. C4—One Hammarlund junior condenser; Cat. No. MC11 (50 mmfd.). R1—One Lynch metallized grid leak, 2 meg. R2—One No. 622 Amperite, with mount. R3, R4, R5—Three No. 1A Amperites with three mounts. Rh—One 50-ohm rheostat. T1, T2—Two National new audio transformers. SW—One filament switch. PL—One pilot light bracket with lamp. Two dials with two dial pointers. Two knobs. Four binding posts (Ant., Gnd., Speaker plus, Speaker minus). One 10x20-inch aluminum self-bracketing subpanel, with sockets affixed, and including hardware and insulating washers. One 7x21-inch drilled Bakelite front panel. One aluminum battery cable. One Peewee clip.

**\$35.00**

NET  
Blueprint Free With Each Kit Order

**CUSTOM SET BUILDERS SUPPLY CO.**  
57 Dey Street, New York City  
Tel. Barclay 8659 Corner Greenwich Street

### SCREEN GRID COILS for the 4-tube SG Universal

Antenna coil, Model RF5 for .0005 mfd.....\$1.00  
Antenna coil, Model RF3 for .00035 mfd..... 1.25  
Coupler, Model TP5, for .0005 mfd. .... 2.00  
Coupler, Model TP3, for .00035 mfd..... 2.25

**SCREEN GRID COIL CO.**  
143 West 45th Street  
New York City  
Immediate Delivery and  
10-Day Money-Back Guarantee

### SAVE THOSE TUBES!



Many persons have sets with Navy type sockets—the kind with the collar on and the bayonet hinge for the pin on the base of the tube. If you put a UX 100 tube in a Navy type socket a short may blow out all the tubes. Play safe and have fine contact blades. Use an adapter that fits UX 100 into Navy sockets (Cat. No. UX). Price 30 cents each.

**GUARANTY RADIO GOODS CO.**  
145 West 45th St., N. Y. City

### New Powertone

Cone or Cloth Diaphragm Speaker

### Unit

With 5-foot cord, less bracket, apex, chuck and nut. Cat. PA. **\$3.00**

### BLUEPRINT OF SCREEN GRID 4-TUBE UNIVERSAL - - \$1.00

Connections Doubly Clear Because Wiring Done on Top of the Subpanel is Shown Separately, and wiring done underneath the subpanel is shown separately. All leads shown in the same direction in which they are physically connected. You don't have to reverse the blueprint mentally to visualize the practical connections. Crystal-clear blueprint safeguards against error. Order your print today. Prompt delivery. Price of complete kit, \$35.00 (less tubes, cabinet and speaker).

**CUSTOM SET BUILDERS SUPPLY CO., 57 Dey St., New York City**

### Bakelite Front and Aluminum Subpanel for the 4-Tube Screen Grid Universal; also

### \$5.00

### DIAMOND OF THE AIR - -

Five-Day Money-Back Guaranty

Finest eye appeal results from construction of the 4-tube Screen Grid Diamond of the Air when you use the official panels. The front panel is bakelite, already drilled. The subpanel is aluminum, with sockets built-in, and is self-bracketing. Likewise it has holes drilled in it to introduce the wiring, so nearly all of it is concealed underneath set. Make your set look like a factory job.

Front panel alone, bakelite, drilled.....\$2.35  
Aluminum subpanel alone, drilled, with sockets built-in..... 3.00

**GUARANTY RADIO GOODS CO.**  
145 WEST 45TH STREET NEW YORK, N. Y.

### PLUG AND CABLE for any SHORT WAVE ADAPTER

Handiest thing for ANY short-wave adapter. Put detector tube of your present set in socket of any short-wave adapter you build, put plug in detector socket of your broadcast receiver. Cable, 34". Leads identified both by color scheme and tags. 5-prong plug and 5-lead cable for AC short wave adapter. May be used as 5-lead battery cable plug with UY socket. (Cat. No. 21AC) \$1.50. 4-prong extra plug only, necessary addition to other for DC short-wave adapter (Cat. No. 21DC) \$0.50. Cat. No. 21AC and 21DC ordered together \$1.75.

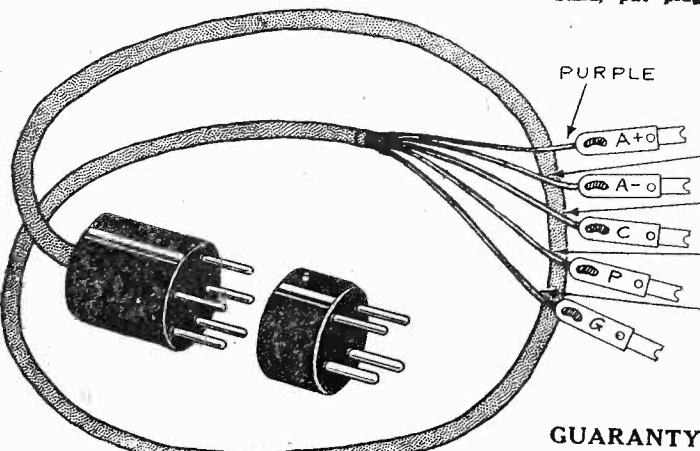

**GUARANTY RADIO GOODS CO.**  
145 WEST 45TH STREET  
New York City Just East of Broadway

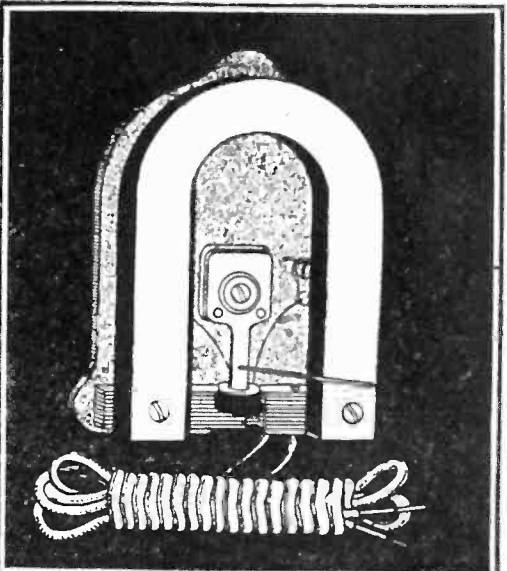

New Moulded tri-foot bracket, fits Powertone, Polo, B.B.L., Brielle, Paratone and other units. Cat. BA.....65c  
Apex, Thumbscrew and Chuck. Cat. AA.....10c  
(Note: Cat. AA not sold alone.)

### You Cannot Buy a Better Unit at Anywhere Near This Price!

The 1929 Model Powertone Unit, that drives any cone or similar type speaker, is an extremely sensitive and faithful reproducer. The magnet coil (the black ring under the pin in illustration) is wound to higher impedance than is ordinarily encountered. Volume is greater. The unit has an adjustable armature. Both the tone and the appearance are brilliant! You may order a new model Powertone Unit with perfect safety. It's a pippin, say those who use it. If you don't agree with that, return the unit ten days after receipt and get your money back promptly. No questions asked—but all questions gladly answered. Immediate shipment guaranteed.

**Guaranty Radio Goods Co.**  
145 West 45th Street, N. Y. City  
(Just East of Broadway)

Please mail me at once C.O.D. (Check off).  
 One Powertone Unit alone, Cat. PA. @ \$3.00.  
 One Tri-foot Bracket, Cat. BA @ 65c.  
 One Apex, one Chuck, one Thumbscrew, Cat. AA. @ 10c.

Name .....  
Address .....  
City ..... State .....

**COMPLETE KIT OF PARTS**  
for the New, Highly Selective  
**SCREEN GRID**  
**DIAMOND**

(Four-Tube Battery Model)

Exactly as Specified by **\$29.00**  
Herman Bernard Net

WHAT YOU GET:

- R1—50 ohm Frost rheostat.
- R2—5 meg. Lynch metallized leak.
- T1, T2—Two National A100 audios.
- Ant. Gnd., Sp. —, Sp. + posts.
- P1—Jewel window and lamp.
- Sw—A battery switch.
- 7 x 21 inch front panel.
- 10 x 20 inch subpanel, self-bracketing, with four sockets affixed; subpanel hardware, insulated bushings, washers.
- Two dials with pointers.
- Blueprint.
- Two knobs.
- L1L2—Antenna coil (AC5).
- L2L3L4—Screen grid tuner (SGT5).
- C1—Aerovox .0005 fixed.
- C2—Hammarlund .0005 mfd. Midline.
- C3, C4—Two Aerovox .006 mfd.
- C5—Hammarlund .0005 mfd. Midline.
- C6—Aerovox .00025 mfd. with clips.
- C7—Aerovox .0005 mfd. fixed.
- A1—622 Amperite with mount.
- A2, A3, A4—Three 1A Amperites, three mounts.

**Guaranty Radio Goods Co.**  
145 West 45th Street  
New York City  
Just East of Broadway

**BLUEPRINT of the**  
New, Highly Selective  
**Screen Grid DIAMOND**  
(Four Tubes)

**\$1.00**

**RADIO WORLD**  
145 West 45th Street New York City  
Few Doors East of Broadway

Recent Issues of **RADIO WORLD**, 15 cents each. Any number published in 1928 available for a short while. Six issues 75 cents, 10 issues \$1.00. Send stamps, coin or money order NOW, before the issues are sold. **RADIO WORLD**, 145 West 45th Street, New York City.

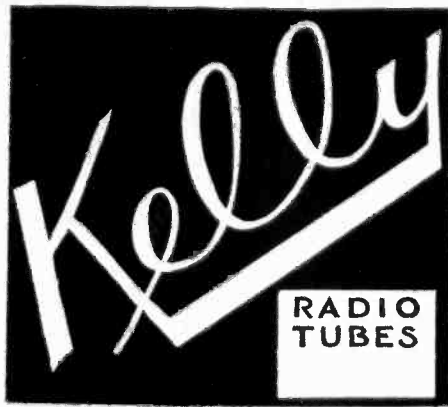

**LONGER LIFE**  
**BETTER TONE**  
**MORE VOLUME**

- 401A .....\$1.00
- 4X Special Detector ..... 2.00
- 412A ..... 2.00
- 471A ..... 2.00
- UX499 ..... 1.25
- 428AC ..... 2.00
- 427AC ..... 3.50
- 440 (high mu) ..... 1.50
- 422 (screen grid) ..... 3.50
- 480 ..... 3.50

**422 SCREEN GRID**

Our 422 stands up.

**440 HIGH MU**

great for resistance or Impedance audio

**KELLY TUBE COMPANY**  
57 Dey Street, New York City

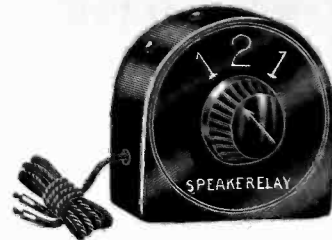

Cat. No. 121

**\$2**

**SPEAKERELAY**

For connecting two speakers by turn of knob so that at No. 1, left, you operate one speaker alone; at No. 2 you operate both speakers together; at No. 1, right, you operate the other speaker alone. Excellent for store demonstrations or home use. Earphones may be substituted for one speaker.  
Cat. 1234 for connecting 4 speakers, one to play at a time.....\$2.50

**GUARANTY RADIO GOODS CO.**  
145 WEST 45TH STREET  
NEW YORK CITY Just East of Broadway

**O-600 V. AC and DC**  
**High Resistance Meter**

Same Meter Reads Both  
Accurate to 1 per cent.

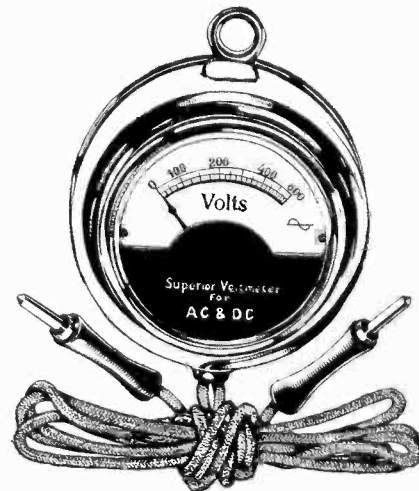

The O-600 volt AC and DC meter (Cat. No. 600), with 3-ft. cord, de luxe tips and hanger \$7.00.

THE output voltages of all B eliminators, the voltages of all B batteries, as well as the house current line voltage, whether AC or DC, and the voltage across power transformer secondaries, can be accurately measured by this meter. The full scale is 0-600 volts, and this same meter measures both AC and DC. Since it is a high resistance meter, of extraordinary range, and accurate to 1% plus or minus, it is advisable to get this meter for your testing purposes, since it is like two meters in one—AC and DC. You can find trouble more quickly. Without it you can't tell if a power transformer secondary is delivering voltage. 10-day money-back guaranty.

**GUARANTY RADIO GOODS CO.**  
145 West 45th Street, N. Y. City.  
(Just East of Broadway)

Please ship at once one 0-600 volts AC and DC high resistance voltmeter, accurate to 1% plus or minus (Cat. No. 600); meter equipped with 3-ft. cord, moulded tip receptacles, tips and hanger.

[Put cross in proper square below.]

- \$7.00 enclosed
- I will pay postman \$7.00 plus few cents extra for postage.

Name .....

Address .....

City ..... State .....

**DYNAMIC BAFFLE**

Completely built up, for any type dynamic chassis. State what make dynamic you want it for. Cone slides, open back. De luxe finish. Size, 24x24 inches.....**\$12.00**

**GUARANTY RADIO GOODS CO.**  
145 West 45th Street, New York City

**Cash in on This Offer Now!**

ONE full year's subscription for any TWO of the following magazines given to you—**RADIO NEWS** or **SCIENCE AND INVENTION** or **RADIO** (San Francisco) or **BOYS' LIFE**.

Select any TWO of these four publications, each of which will be sent to you (at only one address, however) each month for twelve months—in other words, 24 issues—if you will send in now your subscription for **RADIO WORLD** for two years (104 numbers) at \$10.00. **RADIO WORLD'S** subscription price for one year is \$6.00, so you gain the extra 2 dollars by taking advantage of the liberal offer for two-year subscriptions; and, besides, you get a subscription for each of the TWO other magazines selected from the enumerated list, making a total of 128 numbers for \$10.00.

If you want to select only one from among the four other magazines, you may obtain this one for TWO years, so that you will be subscribing for **RADIO WORLD** for two years and for the other magazine for TWO years, all for only \$10.00 (both mailed to one address only).

These offers are rightly regarded as among the most liberal ever made, but as they are limited as to expiration date (see notice below) you must act now.

Please use the attached coupon.

**SPECIAL TWO-FOR-PRICE-OF-ONE COUPON**

**RADIO WORLD**, 145 West 45th Street, New York City (Just East of Broadway):  
Enclosed please find \$10.00, for which send me **RADIO WORLD** each week for two years (104 numbers), and also send me, without extra cost, each month for one year each of the following TWO magazines—total, 24 issues—grand total, 128 numbers:

- RADIO NEWS**   **RADIO** (San Francisco)
- SCIENCE AND INVENTION**   **BOYS' LIFE**

If you want one of each, put a cross in a square next to the name of each of the two other magazines. If you want a two-year subscription for ONE of the above magazines, with the two-year subscription for **RADIO WORLD** (same grand total of 128 numbers), put two crosses before the name of one magazine.

If you prefer to pay \$6.00 for only one year's subscription for **RADIO WORLD** (52 numbers) and get one of the other magazines for one year, without extra cost, put one cross in one square in front of the name of one magazine.

Present **RADIO WORLD** subscribers may renew under this offer. If renewing, put a cross here

Name.....

Street Address.....

City..... State.....

**THIS OFFER EXPIRES AT NOON ON MARCH 15TH, 1929**

# RADIO BLUEPRINT LIBRARY

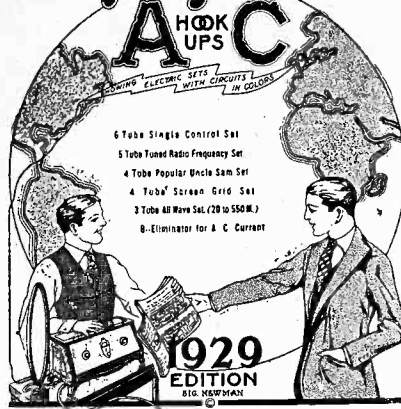

## Fourteen Circuits

Each Shown in Colored Picture Diagram, Colored Schematic Diagram and Front Panel Layout

Get This FREE Book!

Complete AC electric receivers, with B eliminators included, also AC receivers without B eliminators, also battery operated models, all easy-to-build circuits, using your own parts.

## Colors Prevent Error

Red lines are used in all the diagrams to denote filament leads, light blue lines for grid connections, green lines for plate leads and heavy and light black lines for the rest. You can't make a mistake if you let the colors be your guide.

The Radio Blueprint Library of AC and Battery Hookups, one volume, in FOUR COLORS, is a veritable encyclopedia of tested DX hookups, with 45 illustrations of fourteen different circuits, and a textual explanation of each circuit. Besides, the booklet contains the Story of Radio, lists of parts for all fourteen circuits, and a Station Log Chart on which to record the stations you receive and the dial settings.

This is the very volume you've been wanting for a long time, and you can get a copy of the latest edition (1929), just off the press.

RADIO WORLD, 145 W. 45th St., N. Y. City.  
(Just East of Broadway)

Gentlemen: Enclosed please find \$1.00 for which please send me Radio World each week for eight weeks (regular price, \$1.20) and besides send me a FREE copy of the 1929 edition of The Radio Blueprint Library of AC and Battery Hookups.

Name .....

Address .....

City....., State.....

Note: Present mail subscribers may take advantage of this offer by putting a cross in this square.  Your subscription will be extended eight weeks.

RADIO WORLD, published every Wednesday, dated Saturday of same week, from publication office, Hennessy Radio Publications Corporation, 145 West 45th Street, New York, N. Y., just east of Broadway. Roland Burke Hennessy, President; M. B. Hennessy, Vice-President; Herman Bernard, Secretary, Roland Burke Hennessy, Editor; Herman Bernard, Managing Editor; J. E. Anderson, Technical Editor; Anthony Sodaro, Art Editor.

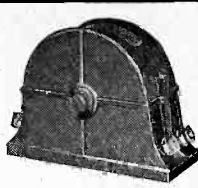

## VICTOREEN Super Coils

Write for Free Blueprints of New Victoreen Circuits  
Geo. W. Walker Co.  
2825 Chester Avenue  
Dept. B Cleveland, O.

# LYNCH

Tubadapta for Better Tone  
Installed in ONE minute. Small cost.  
ARTHUR H. LYNCH, INC.  
1775 Broadway New York City  
Send for free Lynch radio manual

# HBH Unit

Partial Payment Plan and Money-Back Guaranty!

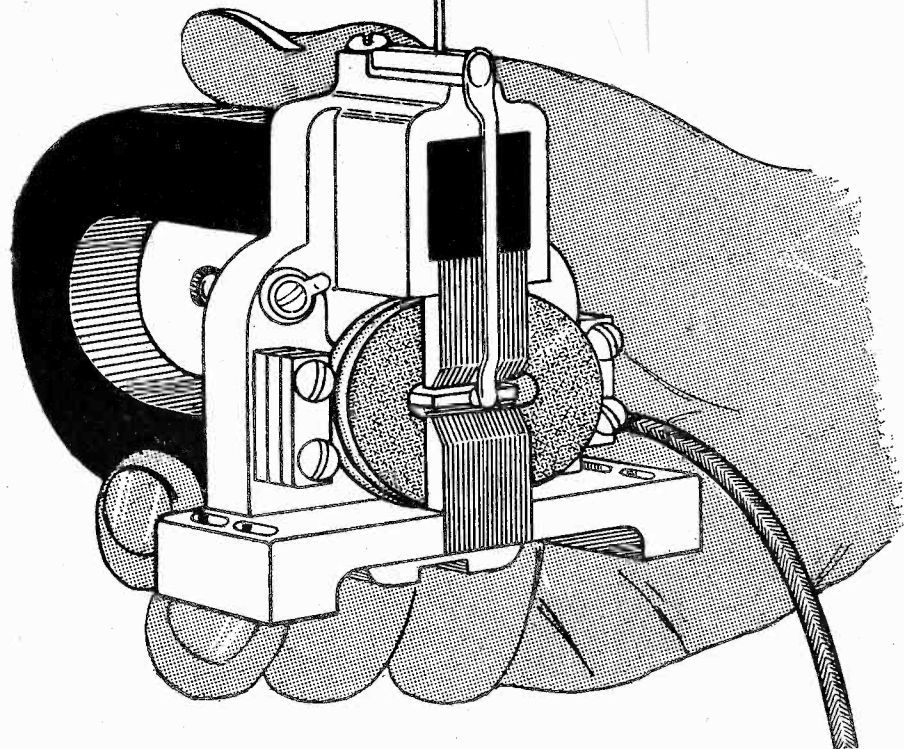

Manufactured Under BBL License

GUARANTY RADIO GOODS CO.,  
143 West 45th Street, N. Y. City  
(Just East of Broadway)

Check off proper squares below:

- Please ship AT ONCE on 10-day money-back guaranty one HBH unit with 10-ft. cord.
- 65c extra for moulded metal tri-foot mounting bracket.

NAME .....

ADDRESS .....

CITY..... STATE.....

IF you are looking for a unit that gives you MOST volume, NO trouble, FINEST frequency response and MOST rugged construction, order an HBH Unit (illustrated). This is supplied with 10-ft. cord. Price \$5.95. Pay postman only \$4, plus little extra for postage. Try this unit for 10 days. If not delighted, return it in that time and get your \$4 back promptly. If you keep the unit pay the balance of \$1.95 in 90 days.

10-DAY MONEY-BACK GUARANTY

# Quick Action Classified Ads

Radio World's Speedy Medium for Enterprise and Sales

10 cents a word — 10 words minimum — Cash with Order

### DAVEN TELEVISION KITS

With Motor, Neon Lamp, Two Scanning Discs, Daven Television Amplifier. Special price \$34.00.

MARTIEN RADIO SHOP  
Galion, Ohio

### SEEDS FOR SALE

ALFALFA SEEDS, hardy common varieties \$8.40, \$10.20, \$12.60, bushel; Grimm variety Alfalfa seed \$18. Scarified sweet clover \$3.90, \$5.20; Alsike or red clover \$15. Bags Free. Send for samples and catalogue. Kansas Seed Co., Salina, Kan.

SHIELD GRIDS. AC, \$4.00; DC, \$3.50; Raytheon Kino-Lamp, \$6.00; 1929 kits. Write H. Davis, 230 So. Adams, Glendale, Calif.

ARTISTS and Art Students are printing 250 signs or pictures an hour without machinery. Sample and particulars 10c. Straco, 1014 Mulberry, Springfield, Ohio.

EIGHTEEN microfarads of capacity, using Mershon condensers that will not ruin, because they're self-healing in case of puncture. This large capacity gives stability and humless quality in a marvelous new B eliminator, using the —80

full-wave rectifier tube on 50-60 cycle 105-120 v. AC maximum output voltage at 35 milliamperes is full 180 volts for —71 or —71A power tube, or lower voltage may be used for —12 or —12A power tube. The voltages are (B—) (B+23 to 45 variable) (B+67 to 85 variable) (B+90 to 135 variable) (B+180). Size 6 1/4 inches high by 7 inches wide. Equipped with finger-tip adjusters and insulated binding post strip. Price, all built up in de luxe metal housing with crackled glass finish, including tube, \$18.00. Immediate shipment. Send remittance and we pay cartage. Order C.O.D. and you pay cartage—Custom Set Builders Supply Co., 57 Dey Street, N. Y. City. Tel. Barclay 8659.

**GORWICO**  
**Braidite**  
 HOOK-UP WIRE  
 "THE BRAID SLIDES BACK"

Safe as insulated wire and as convenient as bare wire. You cannot scorch or burn Braidite with a soldering iron. Use Braidite in your next set.

At All Dealers  
 25 Feet Stranded.....35c  
 25 Feet Solid.....30c

Red, Green, Yellow, Blue, Black  
**FREE** Send us the name and address of your dealer and we will send you a sample package of Braidite FREE. Include 10c for Postage.

**CORNISH WIRE CO.**  
 30 Church St. : : New York City

**For That Blasting Loud Speaker—**

Would you like to control it from a whisper to any volume to fit the occasion? If so, the **TABLE TYPE CLAROSTAT** is the answer. Can be applied to any set or loud-speaker. No fussing. No tools. No alterations. No special knowledge of radio. Provides remote control for your radio entertainment—just like the monitor control in the broadcast studio. All for \$2.50.

Your dealer will gladly show you the Clarostat line and give you a copy of "Radio Etiquette." Or, if you prefer, address—

**CLAROSTAT MFG. CO., Inc.**  
 Specialists in Variable Resistors  
 291 N. 6th St. Brooklyn, N. Y.

**CLAROSTAT**

**CONTROLS THE TRAFFIC THRU YOUR TUBES**

Like the corner cop directing traffic, **AMPERITE** controls tube voltage. *Self-adjusting, dependable, accurate.* A type for every tube—A. C. or D. C. \$1.10 with mounting (in U. S. A.) at all dealers.

*Radiall Company*  
 50 FRANKLIN ST., NEW YORK

**FREE—"Amperite Blue Book"** of modern circuits and valuable construction data. Write Dept R W 3

This symbol in a radio diagram means—

**AMPERITE**  
 The "SELF-ADJUSTING" Rheostat

**1813 Worked! 9 Failed!**

**SI-LEN-SER**  
 A TRUTONE PRODUCT

**Not every electric set needs one—but the—**

SI-LEN-SER makes any electric or any electrified set play as quietly and free from hum as any battery operated receiver. The SI-LEN-SER silences all stray power line noises which enter the receiver through the power packs of electric sets and eliminators and not from aerial pick-up!

The SI-LEN-SER eliminates absolutely all hum from powerhouse generators, and all bothersome knocks and noises that emanate from such electrical sources as nearby power lines, such electrical devices as electric refrigerators, vacuum cleaners, oil burners and other noise-breeding electric household apparatus.

**USED ON ANY VOLTAGE FOR ANY CURRENT**

The SI-LEN-SER is absolutely universal. It works efficiently on either alternating or direct current and on any voltage or cycles, with any eliminator, either old style or new. The SI-LEN-SER is the device that all radio engineers have been seeking to make the electric set perfect. With the SI-LEN-SER, the clear and noiseless reception of a battery-driven receiver is now possible with the convenience of an electric radio.

Sold by All Dealers  
 If your local dealer cannot supply you with a SI-LEN-SER, write us direct. The SI-LEN-SER is approved by radio engineers and fully guaranteed against electrical and mechanical defects.  
 Positively no C.O.D.'s unless accompanied by 20% of the price.

**JOBBERS AND DEALERS—WRITE FOR DETAILS**  
 Manufactured and Guaranteed by

**TRUTONE RADIO SALES CO.**  
 114-116 WORTH ST. Phone: Worth 5573 NEW YORK, N. Y.

**METROPOLITAN AND WHOLESALE DISTRIBUTORS**  
 Stanley & Patterson, Inc. Times Appliance Co., Inc.  
 150 Varick St., New York City 33 West 60th Street, New York City

**WEST COAST DISTRIBUTORS**  
 Wedell & Co. Pacific Motor Supply Co.  
 520 Second Avenue 1438 Market Street  
 Seattle, Washington San Francisco, Cal.

**100% Guaranteed**

**\$12.50** List

**AC DYNAMIC CHASSIS** \$23.52

**110 volt 50-60 Cycle Model, with Built-in Rectifier and Output Transformer**

YOU simply must get a dynamic speaker. There's nothing more important to your radio installation. Everybody's getting one. Why deny yourself the advantages of most superior tone realism? Your set can't overtax a dynamic speaker. You can't buy anything at anywhere near our prices that will give you such satisfaction.

All you need is the chassis. It plays splendidly just as it is. You may put it in a baffle box, or in a cabinet, if you like.

If your home is wired for electricity of the alternating current type, 110 volts, 50 to 60 cycles, then get the AC model at \$23.52. It has a plugged cord for connection to the lamp socket or convenience outlet. The two extra leads, with tips on, go to the output posts of your receiver—the speaker posts.

The AC model has a built-in rectifier that changes the AC (alternating current) to DC (direct current) and filters it. The rectifier is shown at right in the illustration. Also there is a built-in output transformer, (at left in illustration). Your receiver therefore needs no output transformer—there is one in the dynamic chassis.

For best results use as the output tube of your receiver any of the following power tubes—120, 171, 171A, 210, 250, or two in push-pull. If your set has a 112 power tube put in a 171 and increase the negative grid bias. If your set has a 112A or a 201A for the output tube, put in a 171A and increase the negative grid bias. No other changes are necessary.

Remember that the dynamic is this year's supreme contribution to radio, and you must share in this fine advantage to enjoy the best and be thoroughly up-to-date.

**6-VOLT MODEL** \$17.64

If you have a 6-volt storage battery to heat the filaments of your tubes you may use the 6-volt model dynamic chassis with equal results. The current drain is low. But if you have AC house supply of electricity, even if you use a storage battery, the AC model dynamic chassis is recommended, because if you decide at any time to have an AC set you'd have to retain the storage battery just to run the 6-volt model. If you have no electricity in your home, then you must use the 6-volt model. It looks exactly like the other model, except that the rectifier is omitted as unnecessary. The current used is already direct. The output transformer is built-in, however. Both models perform alike.

The AC model, 110 volts, 50 to 60 cycles, is illustrated. It has built-in rectifier and filter and built-in output transformer. Price, \$23.52

Name.....  
 City..... State.....  
 Address.....

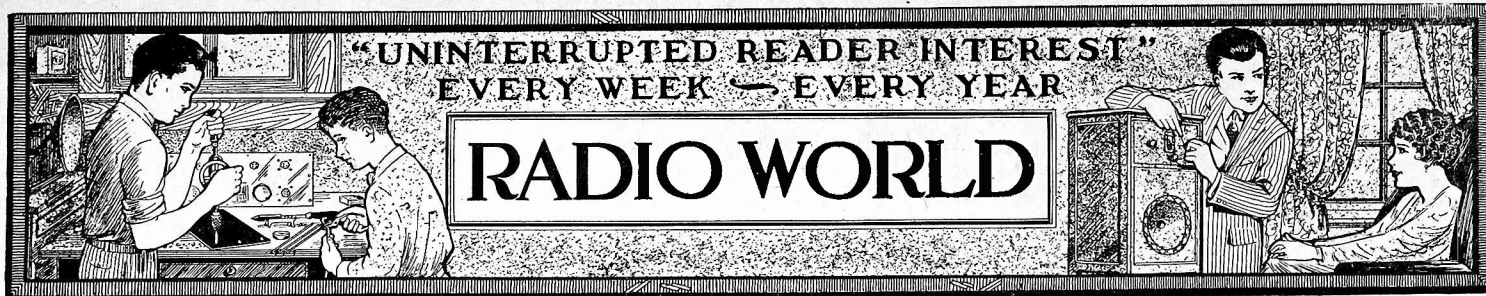

Vol. XIV, No. 21 Whole No. 359  
 FEBRUARY 9th, 1929  
 15c per Copy, \$6.00 per Year  
 [Entered as second-class matter, March  
 1922, at the Post Office at New York,  
 N. Y., under Act of March, 1879]

Latest News and Circuits  
 Technical Accuracy Second to None

A Weekly Paper published by Hennessy  
 Radio Publications Corporation, from  
 Publication Office, 145 West 45th Street,  
 New York, N. Y.  
 (Just East of Broadway)  
 Phone: BRyant 0558 and 0559

## MOTOR CHIEF EXPECTS RADIO TO RUN AUTOS

Automobiles of the future will be driven by electric motors which will receive their power by radio directly from centrally located transmitting stations, says G. M. Williams, president of the Marmon Motor Car Co. He adds:

"I can foresee with a reasonable degree of accuracy each automobile owner being assigned a specific power reception designation or wavelength and all that will be necessary for him to start his car will be to pull a switch on the instrument board, thereby automatically tuning into the power wave which has been assigned to him.

### Cars to Carry Watt-Meters

"If his is an 80-horse-power motor car, his maximum reception will be 80-horse-power and cars of this power will be controlled by a rheostat used similarly to the accelerator of today.

"As is the case today, these cars will be built in different horsepower and sizes and will be taxed accordingly. Motorists will not pay for more power than is used, as a metering arrangement will be installed in each car which, at periodical intervals, will be checked by the power company for the purpose of making a charge for the power actually used.

"It is an established fact that automotive engineers long have attempted to attain as great flexibility and economy in internal combustion engines as is possible to attain in electric motors, hence the increasing use of the eight-cylinder gasoline engine. The use of such electric motors, therefore, will attain flexibility and maneuverability to a superlative degree."

### Advantages Claimed

Among the advantages claimed by Mr. Williams for this new development are: speeding up of traffic, the elimination of noxious fumes on streets and highways, minimizing of maintenance cost of the car, complete elimination of heating and cooling of the engine, simplicity of operation and continued availability of power without replenishing fuel.

He further claims that the radio-operated automobile would effect great economies in the national wealth. Crude oil could be burned at the central generating stations in place of the costly refined gasoline. Consistent markets for the crude petroleum would be established and the cost of distribution of the fuel would be reduced. There would also be a considerable saving in the fuel considering the fact that the average automobile is not operated at maximum efficiency. It is estimated that 10 per cent of the gasoline used today is wasted by idling motors. Mr. Williams calls attention to the rapid

strides made during the last ten years by radio engineers, pointing especially to the success achieved in the transmission of sound waves. He has been advised, he says, by eminent radio engineers that within a relatively short time power transmission without the use of wires will be an accomplished fact. He predicts that within a short time there will be a greater co-operation between the radio and the automotive engineers along this line.

Is there an eminent radio engineer at this time who believes in the practical possibility of transmitting power by radio waves? The idea of transmitting large amounts of electrical energy by radio waves to be useful at specific points is an old dream. Possibly the only scientist of note who has entertained the idea seriously is Nikola Tesla, who first suggested the idea some thirty years ago.

### Idea Unpractical

It is quite possible to transmit large amounts of energy by radio waves. It is being done by every broadcasting station every day. A 50-kilowatt station transmits about the same power that is required by an average automobile, when that automobile is starting up or when it is pulling up a steep grade. It is possible to increase the power of stations almost without limit, if the power is available. It is conceivable that a broadcasting station could be built large enough to drive all the automobiles within 1,000 miles. But it would be so large that if all the available energy in the form of coal, oil, wind, tides, waterfalls and wood could be assembled to run the station it would not last more than five minutes. It would be a grand experiment, a magnificent explosion of all natural energy resources.

Automotive engineers are now worrying about the efficiency of internal combustion engines and the saving of fuel resources. As a means of solving their problems an automotive executive proposes that they turn to radio waves, and thus in effect to burn up all that is left in one grand explosion. There is not an automotive engineer in the world, he ever so lowly, that does not realize the impracticability of the proposal.

### Power by Radio Received

It is true that power is transmitted and received by radio waves. But the amount that is received by all the receivers tuned in on a given high-power station is not enough to light the lamp on the instrument board on an automobile. It is not the transmission of power by radio that has been developed to a high degree. It is simply the sensitivity of the receivers that has been developed. The power transmitted from a station in the form of radio waves represents only a small part of the power required to keep the station going. So at the very beginning the system is very inefficient.

Furthermore, of all the power that is radiated in the form of radio waves, more than 99.99 per cent travels on to the Milky Way, or to some other equally indefinite and inaccessible place. The remaining almost infinitesimal portion is intercepted by the millions of antennas in the world. And this intercepted power does not drive the receivers. —Technical Editor.

## INSIDE FACTS ON NBC GIVEN TO THE HOUSE

Washington.

The National Broadcasting Company, serving a total of 58 radio stations throughout the United States, has not been a sustaining enterprise, and now has a \$290,000 deficit, the House Committee on Merchant Marine and Fisheries was told by Merlin Hall Aylesworth, president of the N. B. C. Mr. Aylesworth appeared before the committee for the second day in connection with the White Bill to extend the administrative life of the Federal Radio Commission one year after March 15th.

The company, said Mr. Aylesworth, is approximately \$300,000 behind its receipts, exclusive of depreciation of equipment and other physical property.

When WEAJ, at New York, was purchased from the American Telephone and Telegraph Company, two years and two months ago, it had an income from sponsored programs of \$160,000 a year, he said. The annual income of the N. B. C. networks last year was \$11,000,000, he declared.

### Programs Optional

Mr. Aylesworth was cross-examined by Representative Davis (Dem.), Tullahoma, Tenn., as to the relationship between the National Broadcasting Company, its associated stations and its advertisers. Stations are not required to take an arbitrary number of hours per week, he said, replying to Davis.

If a particular station in a certain area does not want the N. B. C. program "we try to get a station that does," said Mr. Aylesworth. He said there is "misinformation" to the effect that stations of the N. B. C. are required to take programs offered by the company.

"The point I want to bring out is whether or not the stations are required to take programs and, if they don't, do you do anything about it?" Representative Davis asked.

"No, sir; we do nothing about it," replied Aylesworth.

### Encourage Local Programs

Under further questioning by Mr. Davis, Mr. Aylesworth declared that the NBC asks its stations not to take programs from the competing chain. This policy was adopted, he explained, because the NBC pays the American Telephone and Telegraph Company for the leasing of its wires over a period of 16 hours per day, whereas only a small portion of that time actually is used in the relaying of the chain programs.

The heavy expense involved in maintaining these wires, approximately \$2,000,000 a year, makes it mandatory that a

# NBC PROGRAMS DOUBLE SALE OF RADIO SETS

(Continued from preceding page)

station subscribe to only one chain, he said.

"It is an economic proposition," he declared.

"We encourage our stations to develop local programs and to take only such of our programs as to give them a national backbone," he continued. As a result of this, Mr. Aylesworth asserted, the associated stations have developed their local programs, and both of the large chains (the NBC and the Columbia Broadcasting System) are competing for the same business. If the stations used only a portion of the programs of both chains, cutting down the now small numbers of hours of broadcasting of the NBC program, the loss because of the wire tolls would be terrific, he said.

Representative Davis brought out that of the 40 cleared channels set aside by the Federal Radio Commission under the reallocation for high-powered stations, 32 of them are occupied by stations subscribing to the NBC program.

## High Power to Stay

"Blame these stations for getting us; do not blame us for getting these stations," said Mr. Aylesworth.

Representative Davis said he was "not hostile to chain broadcasting, but was friendly to it." He would like to hear chain programs part of the time, but not all of the time and would like to see a situation where one can get anything he wants within the range of his receiving set.

"That would be an ideal condition," he declared.

Mr. Aylesworth asserted that wherever the services of the National Broadcasting Company have been extended, the sales of radio sets have doubled within 30 days. "Why? Programs," he asserted.

He added that no matter who administered the radio law, the present condition respecting high-power grants would exist.

## Praises Commission

"I think radio broadcasting, in its engineering aspects, is in its infancy," he declared. "Its development since the creation of the Commission has been conspicuously marked. The Commission has had many difficult problems, and it has handled them as best it could."

Asserting that radio needs "real regulation," he said an adequate staff of engineers must be maintained by the governmental agency tackling the problem. He would not commit himself on the White bill, which proposed to vest in the Radio Commission its present administrative jurisdiction over radio for another year.

"We can get along with the Department of Commerce and have the Commission as a court of appeals," he said, "but before I can say as to the bill I would want to know from each member of the Commission his view as to whether it should continue as an administrative body."

Asked whether reception has improved since the reallocation, he said that in some cases improvements resulted, while in others conditions have been made worse, notably where stations taking chain programs were reduced in hours of operation.

He explained the functions and purposes of the company and its 58 affiliated

## "C. J."

We, of RADIO WORLD, are cast down this week by the fact that our good friend, Charles J. O'Brien, head of the printing firm that turns out RADIO WORLD and thirty other publications, has left us.

"C. J.," as he was known to his friends and associates in the printing trade for nearly two generations, was active in the business, civic and yachting activities of this section of the country.

"C. J." was graduated from the case. Perhaps that is why—as he never forgot those earlier days—he managed to get so close to the hearts as well as the heads of those with whom he did business. He was a good boss, a good printer, a fine husband and father and altogether a splendid type of American citizen.

It is good to have known such a man as "C. J." He proved all through his career that sturdy honesty, a keen eye for the other fellow's side as well as his own, and that Irish forthrightness and quick sympathy of his counted and always will count where men are men.

Farewell, "C. J." Your work is done. The last form is locked and the press starts ahead. May it run smoothly forever, good friend!—R. B. H.

broadcasting stations which serve the entire country. He declared it was the purpose of the company, owned jointly by the Radio Corporation of America, General Electric Company and Westinghouse Electric and Manufacturing Company, to serve the public interest in every way practicable.

## People Interested

He offered to the committee the facilities of the company to be used by Congress to inform listeners of the activities of Congress. Congress could appoint a committee to control the time of such broadcasts, he said, and put them on once a week, or perhaps twice or three times.

People will listen to talks of this character, said Mr. Aylesworth. The company has ascertained this through other programs and believes it would be in line with its editorial policy to provide for listeners unsponsored programs of such a character.

Outlining the history of the company, Mr. Aylesworth explained it owns only one station, WEAF, in New York City. It operates for the Radio Corporation, WJZ in New York, and WRG in Washington. There are 55 independently owned stations aside from these three which subscribe for the NBC programs, the witness explained.

"Today there are more than 150 applications of stations for our programs which we cannot serve," Mr. Aylesworth declared.

## 6,000 a Month

Advertising their products over the NBC chains are 90 separate organizations, who sponsor musical programs, he declared. In addition the NBC itself puts on "sustaining programs" or those not paid for by radio advertisers.

Discussing talent for its programs, Mr. Aylesworth said the NBC places more than 6,000 performers before the microphone every month.

The NBC does not want to see duplication of programs, said Mr. Aylesworth. But he explained to the committee that duplication exists for the most part only in rural areas where reception is not impeded by absorption of steel buildings, as it is in the city. He expressed the view that there is little or no duplication of programs in cities where reception is not as good as in rural areas.

High power likewise was declared to be obstructed by city conditions, but makes available better programs to rural areas. WEAF, for example, he explained, is 22

# REALLOCATION CALLED BLOW TO BIG CHAINS

miles outside of New York City, and broadcasts with 50,000 watts, but its signal strength in New York City comes in only at 5,000 watts. WOR, at Newark, in closer proximity to the city, and with only 5,000 watts, comes in as well or better in New York City because of its location.

## Free Speech

The desire of the NBC, said Mr. Aylesworth, is to serve with each of its stations an area of 100 miles around that station. High power, he declared, does not reach farther than low power, but gives the particular area "a more saturated service."

Saying he believed all five members of the Commission to be "honest," Mr. Aylesworth said, however, he was "not satisfied" with all they have done. The reallocation, he declared, hurt the chains of the NBC, but "it never complained."

New York was declared to be the center of talent for radio and for that reason almost all chain programs originate there. He declared there are no contracts with the stations subscribing to the chain and they take programs as they want them. The recent presidential campaign, he declared, demonstrated the demand for radio service of this character. Every station of the networks was offered this service and every one accepted, regardless of politics.

"There is free speech on the radio, and it is open to every party," he declared.

## Radio Installations

### Now Simple Matter

Radio has at last become so standardized and installation so simplified that the layman can now enter any radio or music shop and buy a socket-power receiver with every assurance that his investment is sound. No elaborate installation is needed; he can carry the set home and get it working in a few moments; no more does he have to climb the attic stairs to the roof and string an aerial with divers groans and expletives, nor does he have to search for a good ground, mayhap ruining the radiator or making a hole in the waterpipe in the effort.

A good electric socket antenna, such as the antenna plug clarostat, attached to the aerial post of the set and the ground binding post attached to one of the screws of the wall outlet, the extension cord of the set plugged in and the problem is solved. This useful little appliance, the antenna plug clarostat, is also meeting the needs of many fans who are so situated that they cannot use outside aerial or loop. —J. H. C.

## A THOUGHT FOR THE WEEK

**R**ADIO has reached out and entered the big business class. When you have a hundred million people or so wanting something and wanting it very much and when they are willing to pay handsomely for that something—well, that pretty nearly makes for big business. Radio has become so important and vital a part of the life of the whole civilized world that it has reached the enviable position of being considered as both a luxury and a necessity. Not a new thought, you say? Well, neither is the Sphinx or Niagara. But folks still wonder at them.



# R.C.A.-VICTOR MERGER UP TO HOLDERS NOW

In a letter to the holders of common stock of Victor Talking Machine Company, Edward E. Shumaker, president of the company, has requested the stockholders to deposit certificates for their holdings on or before March 4th with J. & W. Seligman & Co., or with Seligman Brothers, Ltd., London, as agent for the depository.

This is the first step in carrying out the plan for unifying the Victor Company with the Radio Corporation of America. The J. & W. Seligman Co. and Speyer & Co. will act as managers under the plan. They are urging the holders of Victor stock to deposit their holding in order to avail themselves of the offer by the Radio Corporation of America.

One of the conditions for the completion of the merger is that seven-eighths of the common stock of the Victor Company be deposited.

## What They'll Get

If the plan is consummated, the holders of Victor common stock will receive for each share deposited one share of "B" preferred stock of the Radio Corporation, without par value, but entitled to cumulative dividends of \$5.00 annually and redeemable at \$100 and accrued dividends; one share of the new common stock of the Radio Corporation, which is equal to one-fifth of the old stock, and \$5.00 in cash as well as the regular dividend at the rate of \$4.00 a share annually on the Victor common stock from February 1, 1929, until the date of the consummation of the plan.

Dividends on the Victor common stock will continue to accrue until the date on which dividends on the Radio Corporation "B" preferred stock will begin to accrue, which will be about April 1st. Victor 7 per cent prior preference shares and the convertible stock will be called for redemption when the plan is consummated.

## Activities Tie in Nicely

In his letter to the stockholders, Mr. Shumaker says:

"The activities of the Radio Corporation and the Victor company are complementary to an unusual degree. Broadcasting, the radio in the home, the phonograph, both mechanical and electrical, the new and popular art of talking motion pictures, the advent of television, are all part of the field of entertainment and closely related."

One of the reasons for the merger of the two companies, as suggested in Mr. Shumaker's letter, is to make available to the Radio Corporation and associated companies the great body of artists of the Victor company and the engineering and research talent of the Radio Corporation and associated companies to the Victor.

## IMPROVING THE "EVERYMAN 4"

E. Bunting Moore, identified with the "Everyman 4" since its inception, has developed an improvement on this circuit. Blueprints have been made and will be furnished to those who wish to improve their circuits at cost. Interested fans should address: E. Bunting Moore, care of Moore Radio Co., room 301, 72 Cortlandt Street, New York City. Mention RADIO WORLD.—J. H. C.

## New Drum Dial by Silver-Marshall

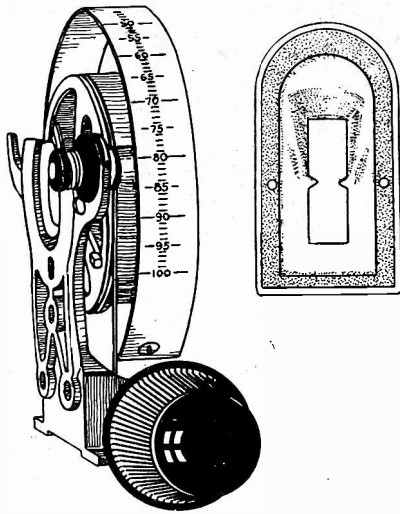

Silver-Marshall, Inc., 846 West Jackson Boulevard, Chicago, announces a new S-M type 810 drum dial. In construction it is of the strictly all-metal die-cast type, the only exceptions being the translucent celluloid scale, the rubber bumper stop, rubber insulating bushing for the miniature lamp socket used to illuminate the dial scale, and the bakelite control knob. The dial is of the positive, so-called "string drive" type, with no backlash. But no string is employed, the connecting link between shaft and drum being a bronze cable. This cable, being anchored both to drum and drive shaft, absolutely prevents backlash or slippage, no matter how stiff the dial "load" may be.

The drum itself has an outside diameter of  $3\frac{3}{8}$  in., which provides a useful scale length of about 6 in. for the 100-point scale. Each division is a full 1-16 in. in width, so that exact readings to  $\frac{1}{2}$  division or less can easily be made. The illuminating lamp placed directly behind the dial scale enables readings to be made even upon a set located in the dark.

The dial drum itself rotates in a die-cast bracket which carries the illuminating lamp socket and the  $\frac{1}{4}$ -in. drive shaft. This bracket is arranged so that when fastened to a chassis it is sufficiently rigid to provide all necessary mounting for one, two, or three gang condensers. Any standard condenser may be easily attached by virtue of five mounting holes provided in the bracket. On the other hand, if the dial is to be used in a receiver in which the condenser is firmly mounted upon a chassis, there is no need to anchor the dial itself permanently.

The dial is manufactured in two types—810L (bracket at left of drum), and 810R (bracket at right of drum). Both types are priced at \$3.75 each, list, complete with knob and lamp socket, but no lamp, and may be used with the S-M single window escutcheons (illustrated) at 50c list, or with the new 811 and 812 single window escutcheons shortly to be released.

## Three New Directors Are Chosen by R.M.A.

Three members have been added to the Radio Manufacturers Association board of directors, to fill vacancies. They are: Joseph L. Pay, of New York, general sales manager of the Radio Corporation of America; B. J. Grigsby, of Chicago, president of the Grigsby-Grunow Company, makers of Majestic sets; and Allan G. Messick, of Chicago, chairman of the board of the U. S. Radio and Television Corporation.

# \$650,000,000 YEAR FOR 1929, SAY ANALYSTS

Major R. A. Klock, of Chicago, chairman of the statistical committee of the National Electrical Manufacturers Association radio division, has just completed an analysis of the Department of Commerce figures for retail radio sales.

"The total average annual business for radio dealers carrying a stock of over \$500 for the year 1927 was \$11,195," Major Klock stated. "The July-August-September quarter of 1928, for which figures are now available, represented 19.25 per cent of the year's total, or \$3,030 per dealer for that quarter, indicating an average business for 1928 of \$15,470, or an increase of 32 per cent.

"Since the rate of increase indicated by the statistics recently released for this quarter has been more than maintained, it follows that a total sale of not less than \$650,000,000 for the 1928-1929 radio year is in prospect. This figure compares with the 1927-1928 total of \$500,000,000.

"In 1927, accessories amounted to 60 per cent of the year's total sales; this radio season accessories may fall to 20 per cent, the additional purchases required to complete the equipment of many receivers now being vacuum tubes only."

## 1929 Sales to Defy Comparison, He Says

Buffalo, N. Y. "1929, as a radio year, will be so far ahead of 1928 as to defy comparison."

This is the prediction made by H. G. Erstrom, executive secretary of the Federated Radio Trade Association, the national organization of the men engaged in the distribution of radio.

## Lynch Tubadapter Improves Set's Tone

Distortion due to the power tube overloading may be minimized, irrespective of what type power tube is used, by a small, inexpensive device called the Lynch Tubadapter, which reduces the impedance in the power stage by connecting two power tubes in parallel. The result is improved tone.

Although ordinarily the use of two power tubes in parallel would involve wiring changes, the Lynch Tubadapter dispenses with the inconvenience.

Remove power tube from last audio socket, then place two power tubes (the old one and a new one of the same type) in the Lynch Tubadapter. Put the Tubadapter, containing the two power tubes, in the audio socket of the receiver and the change is completed.

The current-capacity in the output of any receiver is now practically double.

Another advantage is increased life of the power tubes.

With due regard to space limitations and individual characteristics of different makes of receivers, the Tubadapter is made in several models and other models will be added as rapidly as possible, so it is important, at the present time, to mention the name of the set on which the Tubadapter is to be used in order to be certain that it will fit properly.

# Why Does Connection Different N

IF ALL the grid return leads of an AC set are connected to the same point in the circuit, namely the negative terminal of the B supply, how is it possible to get different grid bias values of the various tubes?

That question has been asked many times. While the answer is given nearly every time an AC receiver is described, the explanation usually assumes that the reader is conversant with Ohm's law and

By J. E.  
Technician

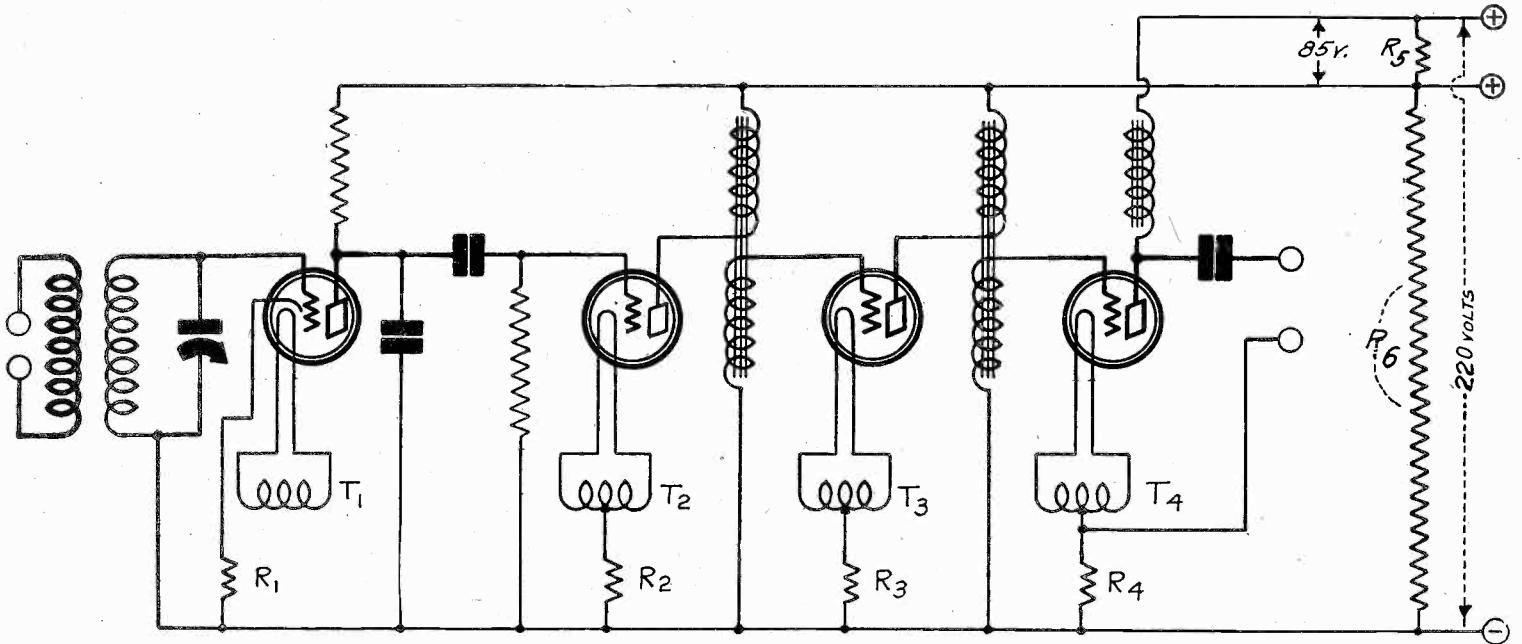

FIG. 1

A SIMPLIFIED DIAGRAM OF AN AC AMPLIFIER SHOWING HOW DIFFERENT GRID BIAS VALUES MAY BE OBTAINED FOR DIFFERENT TUBES WHEN THE GRID RETURNS ARE ALL CONNECTED TO THE SAME POINT.

that he can visualize the processes in an electric circuit.

As AC circuits are usually drawn they are not easy to reduce to simplest terms and to enable a novice to see what the potential of any point is with respect to some given point.

It will aid in the explanation if it is recalled that potential as used in electrical circuits may be compared with height, or the altitude of some point above an arbitrary datum level. When the altitude of points on the earth are given the datum level is usually the mean sea level at some point on the coast.

Nearly everybody understands what is meant when it is stated that the altitude of a mountain peak is 12,000 feet. He knows that it is the distance in feet between tip of the mountain to a point directly under it where the mean sea level would be if the water could get there.

Actually the altitude is the difference between the distance from the peak to the center of the earth and the distance between the mean sea level used as datum and the center of the earth.

### Difference of Potential

Instead of calling the difference distance "altitude" it could be called "difference of potential," by extending the meaning of potential just a little. And just as we can call the difference altitude a difference of potential, so can we call the difference of electrical potential a difference of electrical height. We shall use the term difference of potential, or simply potential, when one side is understood to be the zero potential level.

In an electrical circuit the negative terminal of the battery is taken as the zero level of potential, that is as the datum point.

There is one exception. The zero level for a given tube is always the cathode, or

some point on the cathode. In the case of the 27 heater tube the cathode is the zero level because the cathode as a whole is at the same potential. In the case of a three-element tube heated by AC the mid-point on the filament is the datum because that point is always at the same potential, whereas the ends of the filament are fluctuating in potential. This fluctuation has its counterpart in the sea level datum. The tides at any point cause a difference in the level at any instant, but the mean level remains the same.

In the case of DC heated tubes the zero level remains the same.

In the case of DC heated tubes the zero level is always the negative end of the filament.

The fact that the zero level for each tube is in general different from the zero level for the circuit should cause no difficulty. In altitude measurements local zero levels often are used. The height of a building, for example, is given as the distance from the top to the ground. The altitudes of various places in a city are often given as the height above some established point in the city.

### Simplified AC Circuit

In Fig. 1 is shown an audio frequency amplifier consisting of a 27 type detector tube and three three-element tubes. It is not drawn in the customary manner, but so as to bring out clearly the potentials of the various points in the circuit. Only the secondary windings of the heating transformers are shown because the primaries would only complicate the circuit. The primaries have nothing to do with the distribution of the potential.

At the right are two extreme terminals, one marked minus and the other plus. The B supply is supposed to be connected across these two points. The B supply may be considered as a pump lifting up

the current from the minus to the plus points, or it may be considered as an elevator lifting the current up to the corresponding height. Once the current is up it can fall down through any channel available. There are five such channels: four plate circuits, and the voltage divider, consisting in this case of two resistors R5 and R6 connected in series. The resistor R6 is not really necessary, but it helps to keep constant the potential at the lower plus terminal.

It should be kept in mind that we are dealing with DC only. Attention is called to this because the ends of the coupling impedances which for DC are at the highest potential are at the lowest for AC. The coupling impedance between the detector and the first audio is a resistance, the coupling impedances between the next two pairs of tubes are the primaries of the audio transformers and the coupling impedance between the power tube and the speaker is a choke coil.

### Grid Bias Resistors

The four secondary windings marked T have been raised a distance above the zero potential line and between the mid-point of each of the three secondaries T2, T3 and T4 is a resistor. There is also one between the cathode of the heater tube and the zero potential level. These are grid bias resistors. While these resistors are shown equal in length in the drawing, they do not have to be of the same value. Neither is it necessary that the potential difference between their ends be equal.

The potential at the upper end of each one depends directly on the value of the resistance and the current flowing in it. By Ohm's law, if the current flowing in any one is I ampere and the resistance is R ohms, the potential of the upper end is IR volts. Since all the grid returns are connected to the same level, the mid-

# to the Same Point Give Negative Biases?

Anderson

Editor

point, or cathode, is IR volts higher than the point to which the grid return is connected. Hence, the bias on the grid in question is IR volts negative with respect to the cathode or filament. This is because the zero point for the tube (that is, the local zero) has been raised above the general zero level.

Since each tube has a different resistance for bias, and an independent cathode or filament, its local zero may be raised to any desired potential above the general zero, and hence may be given any desired bias which is independent of the bias for any of the other tubes.

Suppose the value of R4 is 2,000 ohms and that the direct current that flows through R4 is 20 milliamperes. The voltage drop IR in that case will be  $2,000 \text{ ohms} \times .02 \text{ amperes}$ , or 40 volts. The grid of the fourth tube will be negative by this amount with respect to the mid-point of the filament, or, more accurately, with respect to the mid-point on the secondary T4.

Now, suppose that the value of R3 is 1,000 ohms and that .009 ampere flows through it. The IR drop in that case will be  $1,000 \times .009$ , or 9 volts. The mid-point of T3 is then 9 volts higher than the point to which the grid return is connected. Hence, the bias on that grid will be 9 volts. Again suppose that the value of R2 is 750 ohms and that the current through R2 is .006 ampere. Then the IR drop in R2 is  $750 \times .006$ , or 4.5 volts.

## Bias on Detector

Let the current in R1 be .002 ampere and the value of R1 10,000 ohms. The IR drop in R1 is then  $10,000 \times .002$ , or 20 ohms. The cathode has been raised 20 volts and the grid bias is 20 volts.

Thus each of the four tubes in the circuit has a different bias, although all the grid returns have been connected to the same point, the zero potential level for the circuit. The local zero levels have been raised by the amounts 20, 4.5, 9 and 40 volts, respectively.

The voltage drop that is used for any tube on the grid is subtracted from the plate voltage applied to that tube, for the tube is moved closer, electrically, to the highest point in the system by that amount. There is a point on R6, or in the "pump," which is at the same potential as the mid-tap of any transformer or as the high end of the resistor R1.

The high end of each of the resistors R could be connected to this point by a short circuit, and no current would flow through the short. This point for any tube could be found easily by connecting a meter in series with the short and moving the connection on R6 until no current was indicated by the meter. That is just what is done in Wheatstone bridges for measuring resistances. And the method could be used for measuring the DC plate resistance of any of the tubes in the circuit.

## Back Coupling

It will be observed that any of the grid bias resistors is both in the grid and the plate circuit of the corresponding tube, because the external grid circuit is from

the grid to the cathode and the external plate circuit is from the plate to the cathode. In the three-element tubes the mid-point of the filament is here termed the cathode. Since there is a common impedance or resistance between each plate and grid circuit, there is feedback. Indeed, the grid bias is due to DC feedback.

The signal feedback through the grid bias resistor as connected in Fig. 1 causes a reduction in the amplification. Hence, it is necessary to connect a large condenser across each of the grid bias resistors. In the last tube most of the AC or signal goes through the condenser and the speaker and returns directly to the cathode. That reduces the AC feedback, but not the DC feedback or the bias.

It is well known that the effective plate voltage on a tube is less than the voltage applied. This is clearly shown in Fig. 1. Each of the coupling impedances has a considerable resistance. Hence, there is a considerable IR drop in it. Each plate is at a lower potential than the high DC end of the coupling resistor or impedance, and it is lower by the amount of the IR drop. Thus in the case of the first tube, suppose that the coupling resistance is 50,000 ohms and that the current is .002 ampere. The drop in the resistor is then  $50,000 \times .002$ , or 100 volts. Hence, the plate is 100 volts lower in potential than the upper DC end of the resistor. Since the total voltage applied to this circuit is only 135 volts and there is a drop of 20 volts in R1, the net drop in the tube is only 15 volts. That is the effective voltage on the plate, and the plate is not much higher electrically than the cathode.

## Resistance in Transformers

In the other tubes there is a much smaller drop in the coupling impedances. Each of the two primaries of the transformers might have a resistance of 1,000 ohms. Since we have assumed a current of 6 milliamperes in the first, there would be a drop of 6 volts. The applied voltage is 135 volts and the grid bias is 4.5 volts, as previously determined. Hence, the effective voltage on that plate is 124.5 volts. That is the potential difference between the mid-point on T2 and the plate of that tube.

Similarly, the effective voltage on the plate of the third tube is 117 volts. Our assumptions and results would not be quite consistent were it not for the fact that we have not specified what tubes are used.

## More on Common Impedance

The resistance in the choke in the power stage might be assumed to be 500 ohms. We have assumed a current of 20 milliamperes. Hence, the drop in the choke will be 10 volts. The total applied voltage is 220 volts, but 40 of this has been used for grid bias. Therefore, the effective voltage on the plate is 170 volts. The plate is 170 volts higher than the mid-point of the secondary T4. It is important that the resistance any transformer primary or coupling choke be as low as possible, that is for any given inductance.

But the coupling resistor should be high.

It will be observed that the high DC ends of the coupling units of the first three tubes are connected to the junction of R5 and R6 on the voltage divider. This is done to get a lower applied voltage on the tubes. The drop in R5 is 85 volts. That is the current has been "pumped" up to a potential 220 volts, but the plate returns of three of the tubes have been connected to a point where the potential is only 135 volts. That is only done where the plate supply is a B battery eliminator.

The drop in R5 is due to the plate currents in the first three tubes and the current which flows through R6. We have assumed the current in the first three tubes to be .017 ampere. Let us assume that the current through R6 is .02 ampere, so that the total current through R5 is .037 ampere. Then in order to cause a drop in R5 of 85 volts the value of the resistor must be 2,300 ohms very nearly. But that holds only for the current distribution assumed in this case.

## Loss or Gain

All the signal currents from the first three tubes flow through R5. Hence, this constitutes a common coupling among the three circuits. This may cause either a reduction or an increase in the amplification, depending on frequency. If it is a reduction, no serious damage results. If it is an increase, and that increase is considerable, there will be serious distortion or even oscillation. To prevent back coupling through this resistance a condenser should be connected across it.

This condenser is seldom connected directly across R5, but it is connected from the low DC end of it to B minus. So connected the condenser does not so much good unless there is also a large condenser across the entire voltage divider and also a condenser across the grid bias resistors. To be most effective this condenser should be connected from the 135-volt potential point to the local zero point for each of the three tubes. But since these are all different in this circuit, three condensers will be necessary. These should be in addition to the condensers across the grid bias resistors.

## Unjustified Aversion

There is an aversion against the use of by-pass condensers among some fans. They regard them as extra frills designed for no other purpose than to sell parts. The only argument that can be made against the use of these condensers is that they increase the cost of the set. They always serve a good purpose and the larger they are the better they serve. If a circuit is good without condensers it will be better with them, and often the circuit is little good unless they are used.

In Fig. 1 the circuit is so connected that it is possible to give each tube a different bias. But suppose the two middle tubes be heated by the same secondary of the heating transformer. Then it is no longer possible to make the bias on one tube different from that on the other, because the local zero level for these tubes will be the same. Hence, the drop in the two resistors will be the same, for they are connected to the same points at both ends. In fact, it is only necessary to use one bias resistor. The current through this resistor would be the sum of the currents from the two tubes. So the resistance would have to be lower to give the same bias. The value to use can be determined by dividing the desired bias by the actual current.

# The Origin and Effect of Harmonics

By James

Contributor

IN the minds of radio listeners, harmonics mean distortion. In the minds of musicians they mean harmony, except for a few which mean dissonance. In the minds of the physicists they mean natural modes of vibration. In the minds of the mathematicians they mean the solutions of certain equations. In general they may mean all of these things.

It has been stated many times that harmonics are all exact multiples of some fundamental. That is only true for simple harmonics. There are many harmonics which bear very complex relationships to each other, and usually incommensurable relationships.

In a vibrating string, such as a piano or violin string, the harmonics are approximately simple so that the harmonics bear an integral relationship to some fundamental.

### Combination of Causes

This is particularly true of the violin string when it is bowed, not when it is plucked. It is true for reed instruments and organs. It is far from true for drums, cymbals, horns, bells and tuning forks.

The question has been raised what in general causes harmonics. In general no one thing causes harmonics. Such things as shape of the vibrating body, the manner in which it is excited, the amount of sound that it radiates, the amount of resistance there is to the vibration, and the intensity of the sound all contribute something to the answer.

The question relates particularly to the generation of harmonics in reproduced music in radio, but it also relates to the question of the generation of harmonics in generators and into the vibration of any system which is maintained in vibration by periodic force which is free from harmonics.

### Cause and Effect

It may be said in general that harmonics are introduced when the effect is not proportional to the cause. Engineers would say that harmonics are introduced when the strain is not proportional to the stress. Electrical engineers would say that harmonics are introduced when the current is not proportional to the voltage, or when the induced voltage is not proportional to the inducing current. In any case if the effect of a force, electrical or mechanical, plotted against the force, is a straight line, then the effect will be similar to the cause and no harmonics will be introduced. But if the curve is crooked the effect will not be similar to the cause and there will be harmonics.

Let us see how that works out in a few cases. Take the familiar example of the grid voltage plate current characteristic of a three-element vacuum tube. Such a curve is shown at B in Fig. 1, upper row left. The grid voltage is the force and the plate current is the effect of that force. The curve is crooked, showing that the current in the plate circuit is not proportional to the grid voltage.

### Grid Voltage Pivot

The shape of the output current wave when the voltage wave represents a pure tone will depend on the point on the curve about which the grid voltage swings, that is, on the grid bias. If the bias is very great, say such that the current is practically zero, the negative loops of the current wave will be missing entirely. The

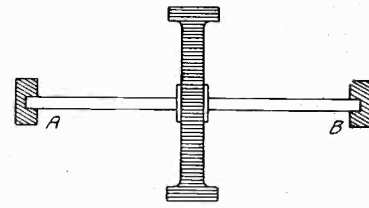
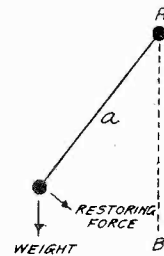
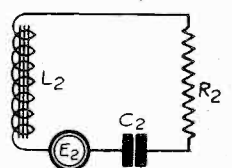
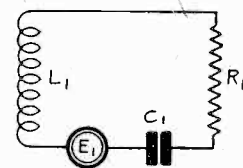
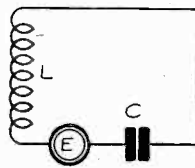
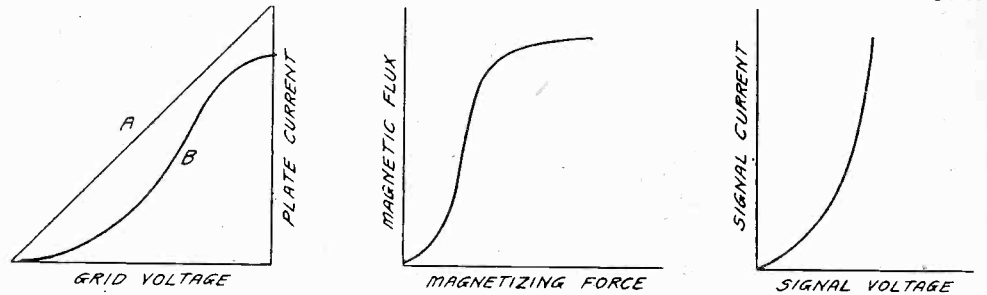

FIGS 1 TO 9

UPPER ROW—A FIG. 1 INTRODUCES NO HARMONICS, B DOES BECAUSE OF CURVATURE. FIG. 2 IS THE MAGNETIZING CURVE OF IRON. HARMONICS ARE INTRODUCED. FIG. 3 IS THE CURVE OF A CRYSTAL DETECTOR. HARMONICS ARE INTRODUCED BECAUSE OF THE CURVATURE, WHICH IS DESIRED IN THIS CASE.

CENTER ROW—FIGS. 4 TO 6 REPRESENT DRIVEN TUNED CIRCUITS IN WHICH THE LAST INTRODUCES DISTORTION.

BOTTOM ROW—FIGS. 7 TO 9 ARE MECHANICAL TUNED SYSTEMS. FIGS. 7 AND 9 INTRODUCE HARMONICS.

positive loops will appear. But the positive current wave will not be like the voltage wave because the current rises too rapidly. The positive current loop will be peaked as compared with the voltage wave.

If the grid voltage be lowered a little so that the operating point is on the lower bend, and the amplitude of the signal swing is not too great, the negative loops will appear but they will be relatively flat. The positive peaks still will be peaked relatively to the voltage wave. If the bias is lowered to the point where the direction of the curvature changes, the current loops will be very nearly like the voltage loops, provided that the swing is very small.

Now, if the bias is reduced to zero, the positive current loops will practically be missing while the negative loops will be very peaked. The positive loops will be missing because the curve is nearly flat on the positive side of the zero voltage line.

In all of these instances the current wave will be distorted relatively to the voltage wave. And that means harmonics. Why this means harmonics involves higher mathematics.

### Distortionless Amplification

Now suppose that the plate current grid voltage characteristic is A in the same figure. This is a straight line, showing that

the plate current is proportional to the grid voltage. Such a curve may be closely approximated in a resistance coupled amplifier if the coupling resistance is high. The A curve is higher than the B curve, and that assumes that a much higher plate voltage is used to get the A curve.

Since the A curve is a straight line, it makes little difference what the bias is, just as long as the grid voltage does not swing off the straight portion of the curve. The negative current loops will be exactly like the positive loops, and both will be proportional to the corresponding voltage loops. There will be no wave form distortion and hence no harmonics.

### Change of Flux

The S-shaped curve in Fig. 2, top row middle, shows the relationship between the magnetizing force and the magnetic flux in a piece of iron. The magnetizing force is the product of the current and the number of turns in the circuit around the iron. So in place of magnetizing force we could have written ampere-turns. It is clear that the flux, which is an effect, is not proportional to the force. Hence the flux wave in the iron will not have the same form as the magnetizing wave, that is, the current wave. The flux wave will have harmonics in it.

It is not the flux in the iron core whi

# Effect of Harmonics

Carroll

Editor

determines the performance of a transformer choke coil, but it is the change of the flux and this rate depends on the shape of the curve. The voltage developed across the choke, or across the secondary of a transformer, depends on the rate of change of the flux with respect to the magnetizing force. This rate of change, which is the permeability of the iron, varies throughout the curve. That is, the voltage across the primary or across the secondary of the transformer at any instant will depend on the value of the current through the coil. Since the curve is not straight this voltage will not be proportional to the current. There will be a distortion of the wave form and hence harmonics will be introduced in the induced voltage.

Another case of distortion due to curvature of the relation between the current and the applied voltage is that of a crystal detector. The curve of a typical crystal detector is shown in Fig. 3, top row right. In this case distortion of the wave form is the object sought, and the sharper the bend in the curve where the crystal is operated the more sensitive is the detector. Some crystals are operated at the zero point of the curve, without bias voltage. In that case the negative loops of the current wave are absent. The positive loops alone affect the speaker or headset. Other crystals, such as carborundum, require a bias voltage in order to bring the operating point to the most sensitive spot, that is, to the spot where the curve bends most rapidly. In that case the negative loops will appear and they will be very much weaker than the positive. The difference between the positive and the negative loops is greater in this crystal than the positive loops alone would be were the bias not used.

## Currents in Simple Circuits

Consider a circuit composed of a coil  $L$ , a condenser  $C$  connected in series with an alternating voltage  $E$  free of harmonics. If the coil has no iron in its field and if the condenser is a first class one, the cur-

rent in the circuit will be free of harmonics. If the circuit is as shown in Fig. 5, middle row center, there will be no harmonics in the circuit, provided that the resistance  $R_1$  does not depend on the current. It is quite possible that the resistance will change, but in ordinary metallic resistances the effect would be very small.

Fig. 6, middle row right, is a simple series circuit containing an iron core choke  $L_2$ , a condenser  $C_2$ , a resistance  $R_2$ , and an alternating voltage  $E_2$  free of harmonics. In this circuit there will be harmonics because of the iron core, and the greater the voltage  $E_2$  the more will the wave form of the current be distorted.

## Mechanical Vibrators

Fig. 7, lower row left, represents a pendulum. A weight is attached to a string and supported at a point  $A$ . If the weight is displaced from the position of rest, that is, from the line  $AB$ , there will be a force at right angles to the string tending to restore the string to its position of rest. It will not stop at the position of rest but will swing to the right almost as far as it was displaced to the left. It will continue to swing for a long while, continually decreasing in amplitude.

But the wave form will not be simple harmonics. It will be distorted. The reason for this is that the restoring force is not proportional to displacement as measured by the angle  $\alpha$ . For small values of  $\alpha$  the restoring force is very nearly proportional to the angle but for large values it is much greater.

A similar case is represented by Fig. 8, lower row center.  $AB$  is a steel rod clamped firmly at the ends. In the middle of this rod is a fly wheel attached firmly to the rod. If the wheel is twisted through a small angle and let go it will vibrate back and forth with a frequency depending on the stiffness of the rod and the moment of inertia of the wheel. The moment of inertia is the "rotational mass" of the wheel. The restoring force in this case is the resistance of the rod against twist-

ing. This force is very nearly proportional to the amount of twist even for large twists. And therefore the vibration is simple harmonic and does not contain any harmonics.

## Case of Tuning Fork

Fig. 9, lower row right, represents a tuning fork. This has many natural modes of vibration, and any one is a simple harmonic motion, provided that the swing is not very great. But the various harmonics are not integral multiples of the fundamental. The form may be excited so that it will vibrate at any one of its harmonics without the presence of the others, or it may be excited so that it will contain all. For example, if the fork is struck with a hammer it will vibrate in a composite manner, which is attested by the very rough and unpleasant sound given out.

Figs. 1 to 9 represent many different types of vibration, such as forced vibrations in an untuned circuit, Figs. 1 to 3, forced vibrations in a tuned circuit, Figs. 4 to 6, and free vibrations of tuned circuits, Figs. 7 to 9. Some are electrical and some mechanical circuits, or vibrating systems. Both electrical and mechanical systems may be forced or free.

In broadcasting we are not interested in free vibrations in tuned circuits. But we are interested in forced vibrations both in tuned and untuned systems. In the radio frequency end of the circuit we use forced vibrations in tuned circuits to obtain selectivity. In the audio end we are interested in forced vibrations in tuned systems, both electrical and mechanical, because such vibrations cause response peaks and frequency distortion. In this end of the circuit we are mainly interested in forced vibrations in untuned systems for they alone give straight line response between the force and the motion or current.

In the audio end, from the detector to the listener's ears, the driving force should not meet any impedance which changes with the current or the motion, for if they do, harmonics will be introduced due to the curvature of the relationship between the force and the effect.

## WEST IS WEST IN RADIOLAND

By Don E. Gilman

Manager of the Pacific Division of the National Broadcasting Company

More than a month's experience in regular broadcasting of Eastern programs on the Pacific Coasts has demonstrated conclusively that they are well received and looked forward to by the Western radio audience.

A recent trip to various sections of Pacific slope states and the contact with representative groups of men has convinced me that in the opinion of the radio audience the national broadcasting expresses a long-felt need and creates a wider audience for all radio programs.

The desire of the average listener for distant stations seems to have become important.

## Heated Crystal Steadies Wave

Rochester, N. Y.

Better distribution of its transmission is being enjoyed by WHAM, Rochester, because of its accurately maintained 1,150 k. c. carrier by thermostatic control of its crystal governor. Particularly after sunset is considerable improvement noted in the penetrating faculty of WHAM's wave, generated at the transmitter in Victor Township.

The station explained the situation as follows:

"In place of the frequency checking formerly necessary, we have new equipment that places an accurately ground and calibrated crystal in the transmitter circuit and gives it constant control of the carrier wave.

"This crystal is housed in an electrically heated compartment in which the heat is kept uniform by thermostatic control. The crystal keeps the carrier wave accurately on 1,150 kc. with a variation of only 1 per cent.

"The benefit accruing is a better penetration of the ether."

## HIGHER POWER IS HELD VITAL

Cincinnati.

That a great danger threatens the very existence of good radio is pointed out in a booklet now being distributed to the listeners of WLW and to others by the Crosley Radio Corporation. The booklet is entitled "The Country Needs Super-power Broadcasting Stations."

"There is a growing danger which threatens to eliminate WLW's service because of the lack of understanding on the part of our lawmakers in Washington of what high-powered broadcasting means to the people," the booklet sets forth.

"Few individual owners or institutions are willing to invest the amount necessary for a broadcasting station of the type of WLW. Some Senators and Congressmen may say it is not right to allow one broadcaster to use more power than another. This loses sight entirely of the fact that broadcasting is for the public."

# Radio University

FREE Question and Answer Department conducted by RADIO WORLD for its yearly subscribers only by its staff of Experts. Address Radio University, RADIO WORLD, 145 West 45th St., New York City.

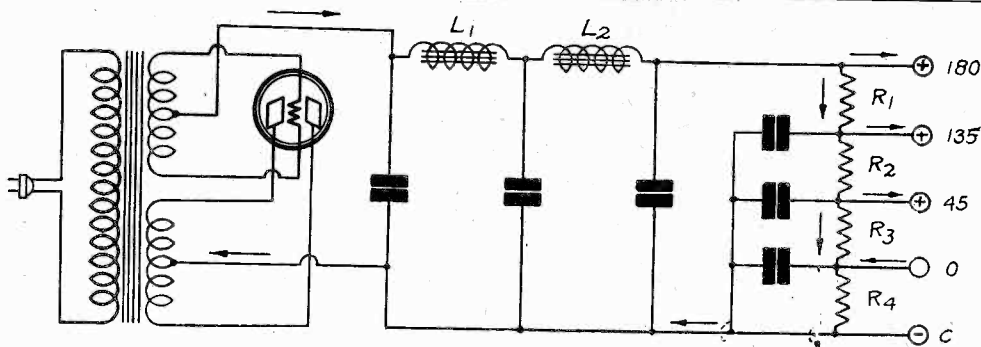

FIG. 728

THIS DIAGRAM MAY BE FOLLOWED IN BUILDING A SIMPLE CURRENT AND VOLTAGE SUPPLY FOR A RECEIVER AND THE FIELD WINDING OF A 90 VOLT DYNAMIC SPEAKER. REQUESTED BY FOLKE MODEEN.

PLEASE PUBLISH a diagram of a simple B battery eliminator which I can use not only for supplying the field winding of a dynamic speaker but also the radio set. I need voltages of 45, 135 and 180 besides the 90 volts for the field.

(2)—Please give the values of choke coils and condensers. I have adjustable resistors for the voltage divider.

(3)—How should the field winding be connected?

FOLKE MODEEN,  
St. Paul, Minn.

(1)—The circuit is shown in Fig. 728.

(2)—Make the condensers 2,2,4, 1,1,1 or larger. Make the chokes 30 henries and make sure that they can carry 80 milliamperes or more.

(3)—Connect the field winding between the 135 volt tap and C, and then connect a variable resistor in series with the field to adjust the current to the proper value. This will require reducing R1 to a comparatively small value.

\* \* \*

WHAT IS MEANT by beam transmission of radio signals?

(2)—What are the advantages of such transmission?

(3)—Is this system used on any broadcasting stations?

ARNOLD SAUER,  
Milwaukee, Wisc.

(1)—In beam transmission the radio waves are sent out in a beam just like the light beam from a searchlight.

(2)—The advantages are numerous. First all the power available is sent in the direction in which the signals are to be received so that for a given distance only a small amount of power is needed. Second, the concentration of the waves in the beam eliminates any possible interference with other stations.

(3)—No broadcasting stations are operated on this system for it is the opposite of broadcasting, which means sending signals equally in all directions. But there are stations sending out voice and music on beams. This is done when the signals are to be rebroadcast.

\* \* \*

IN MY RECEIVER I have .00035 mfd. condensers. I cannot tune down lower than 240 meters. What can I do to bring in the short wave stations?

(2)—I can tune in long wave stations all right, KSD coming in at 85 on the highest reading dial. Is it possible to remove turns to improve the set?

FRANK WILSON,  
St. Louis, Mo.

(1)—It is difficult to cover the band with .00035 tuning condensers, and the only thing that can be done is to remove turns from the tuning coils.

(2)—In view of the fact that KSD comes in at 85 on the dials you can remove several turns from all the tuning coils. Remove just enough off each coil

to bring KSD in at about 98 on the corresponding dial. If you can't tune in 200 meters stations then there is nothing that can be done about it.

\* \* \*

I HAVE A Magnaformer receiver with which I use an A battery substitute. This device cannot deliver enough current. Is there any simple way to increase the output or to decrease the requirements?

(2)—Will it help to omit the pilot lights? I have noticed that the set plays just as well without them.

CARL MILLER,  
Denver, Colo.

(1)—There is no simple device, but you might get two A battery substitutes and connect them in parallel so that each one takes half the load. Don't use the ninth tube any more than you have to.

(2)—Sure it will help. The only object of the pilot lights is to tell when the set is on or to illuminate the dials.

\* \* \*

I WISH to make a band pass filter of the transformer type which will pass frequencies between 45 and 55 kilocycles. What values of coils and condensers should I use?

(2)—Is it not possible to couple the two tuned circuits by a condenser instead of a choke or instead of mutual inductance? If so, give the value of the coupling condenser.

PAUL ACKERMAN,  
Miami, Fla.

(1)—Form the two tuned circuits out of two .005 mfd. condensers and two 2.5 millihenry coils. Couple the two by a .02025 mfd. condenser. One of these tuned coils is the secondary of the transformer that is connected to the plate circuit of the tube and the other is the primary of the transformer that is connected to the succeeding tube.

(2)—Connect the 2.5 windings and the .005 mfd. condensers in series so that the two coils are connected on one side and so that the two condensers are connected together at the other. Then connect the .02025 mfd. condenser from the junction of the coils to the junction of the condensers. The point where the three condensers are joined should be grounded.

\* \* \*

I PLAN to use screen grid tubes in my audio amplifier. Can you tell me how to estimate the amplification that I may expect per stage.

(2)—Is it practical to use more than two screen grid tubes in the audio amplifier?

(3)—What is the best type of coupling for the tubes?

(4)—Is it necessary to shield the audio stages?

AMBROSE KELLY,  
Dallas, Texas.

(1)—Multiply the mutual conductance of the screen grid tube by the load re-

sistance. The result is the amplification. For example, the mutual conductance of the screen grid tube is 350 micromhos so that if the load resistance is .1 megohm, the amplification is 35.

(2)—No. It is difficult to make the circuit stable.

(3)—Resistance coupling with .1 megohm or more for plate resistor and .01 mfd. for coupling condenser.

(4)—It is not necessary to shield. If there is any feed-back it will be through the plate voltage supply and the shield will not stop this.

\* \* \*

I HAVE a resistance coupled amplifier which I operate on a B battery eliminator. For certain adjustments of the detector circuits there is a high pitch squeal. What causes it?

(2)—Can you suggest any means of eliminating this squeal? The squeal is loudest when the detector is adjusted for greatest sensitivity.

JOHN SPRINGER,  
Dayton, Ohio.

(1)—It is undoubtedly an oscillation due to feed back through the B battery eliminator.

(2)—Treat the circuit generously with by-pass condensers. Connect them from A minus to the various B plus leads in the set. The larger these condensers are the more effective they will be. Units of 1 mfd. or larger should be in use.

\* \* \*

IF HEAT is radiated by waves just like radio waves would it not be possible to transmit and receive voice and music by such waves, using parabolic reflectors both at the receiver and the transmitter?

(2)—Is there any way of employing light waves for the same purpose, preferably by waves which are not visible, that is either infra-red or ultra-violet waves?

(3)—Can you suggest any means for receiving either the heat waves or the invisible light waves?

CHARLES EVANS,  
Toledo, Ohio.

(1)—It would be possible to use heat waves if there were any way of modulating and detecting them. Most of the devices known for receiving heat radiation are sluggish and are not suitable.

(2)—Any wavelength or group of wavelengths of light can be used for telephonic communication. Such waves can be modulated very easily. Ultra-violet and infra-red light waves as well as visible light have been used for telephonic communication over short distances.

(3)—Heat waves may be received with a radiometer. Light waves of any wavelength can be received with a photoelectric cell.

\* \* \*

WHEN A common balancing resistor is used for several -26 type tubes is there any coupling between the stages due to this resistor?

(2)—Is it better to use one balancing resistor for each tube than to use a common resistor? Is it not a fact that every balancing resistor takes considerable current from the transformer?

(3)—Does the amount of hum in the output depend on the grid bias and on the plate current?

(4)—How closely is it necessary to balance the filaments to obtain minimum hum?

WILBUR MATHESON,  
Harrisburg, Pa.

(1)—There is a considerable coupling, and it may cause oscillation in a circuit having high amplification.

(2)—Yes. The current drawn by the balancing resistors may be kept down by using higher resistors. Each may be 50 ohms.

(3)—It does. For a given bias there is always one plate current which gives least hum.

(4)—That depends on the tube. For the -27 tube there is little change in the hum when the circuit is unbalanced. For the -26 there is considerable change. The

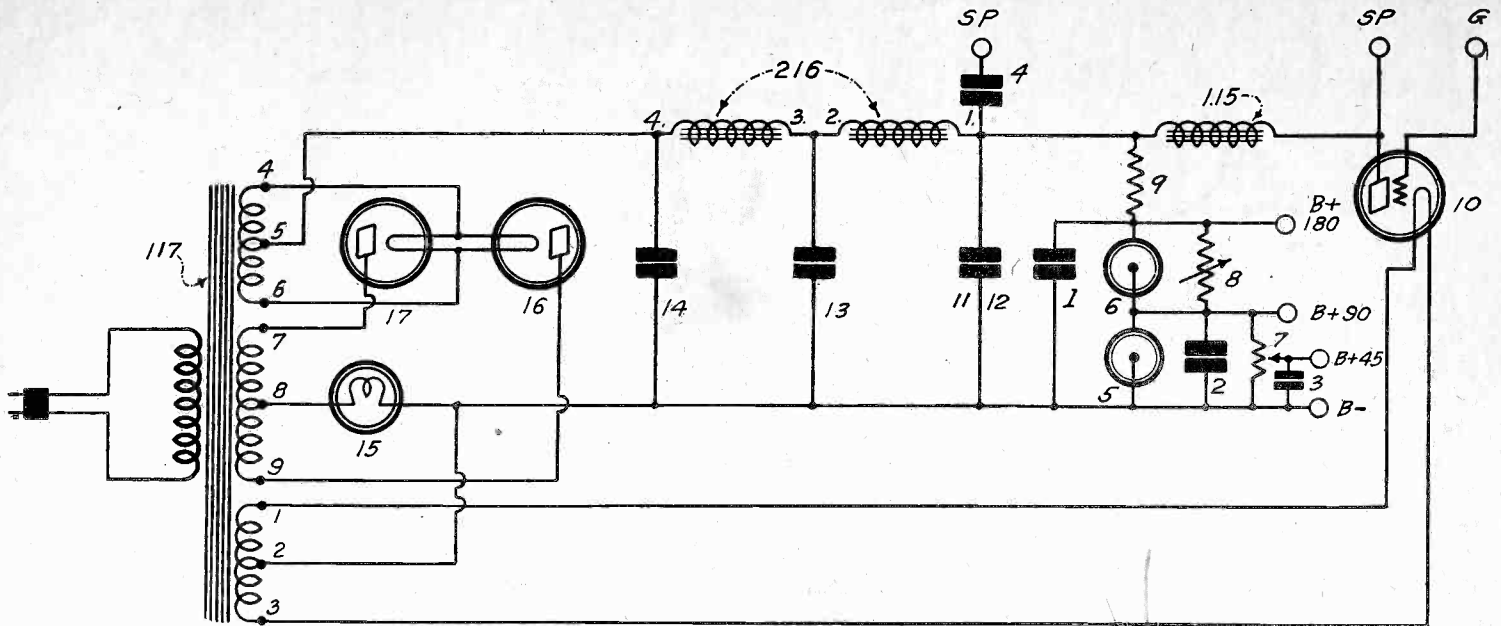

FIG. 729

THIS IS A DIAGRAM OF THE VICTOREEN POWER SUPPLY AND POWER AMPLIFIER, IN WHICH TWO VOLTAGE REGULATOR TUBES ARE USED TO KEEP THE VOLTAGE STEADY. THEY ARE CONNECTED IN SERIES SO THAT THE "STEADY VOLTAGE" IS 180 VOLTS. A DYNAMIC SPEAKER MAY BE CONNECTED ACROSS THE LOWER TUBE IF THE RESISTORS ARE ADJUSTED. CIRCUIT REQUESTED BY SAMUEL GREENBERG.

unbalanced should not be more than one per cent.

\*\*\*

I HAVE the parts for a Victoreen power supply and power amplifier but I don't know how to connect the voltage regulator tubes. Will you please publish a diagram showing the connection?

(2)—Can this power supply also be used for powering the field winding of a dynamic speaker? If so, where should the field be connected?

SAMUEL GREENBERG,  
Bronx, New York.

(1)—Fig. 729 shows the Victoreen power supply. The connections of the two voltage regulator tubes are shown at (5) and (6).

(2)—Connect the field winding across the lower voltage regulator tube. Readjust the resistors marked (8) and (9) so as to maintain the proper voltage distribution.

\*\*\*

ON CERTAIN notes there is a disagreeable buzz in my speaker. What causes it and how can it be remedied?

(2)—Do you think that the buzz originates in the speaker or in the circuit?

LE GRAND OTIS,  
Providence, R. I.

(1)—The buzz may be due to a resonance either in the radio receiver or in the speaker. If it is in the receiver it may be stopped by putting a resonant shunt across the loudspeaker line and tuning this to the frequency at which the buzz occurs. This in effect is a wave trap at that frequency. To prevent complete suppression of the frequency a suitable resistance may be put in series with the condenser and coil. If the buzz is due to a resonance in the speaker try to locate the vibrating member and dampen it by wrapping a rubber band around it.

(2)—We can have no opinion as to the location of the origin of the buzz in the absence of further data on the speaker and set.

\*\*\*

IS IT SAFE to use an -80 type rectifier on voltages as high as 400 volts and a total current drain of 100 milliamperes? I wish to apply 400 volts to a -50 type power tube, but do not wish to use an -81 single wave rectifier.

(2)—I wish to couple the power tube to the preceding tube with resistance. Can this be done without introducing distortion if I use a high mu tube?

ELMER WILCOX,  
Albany, N. Y.

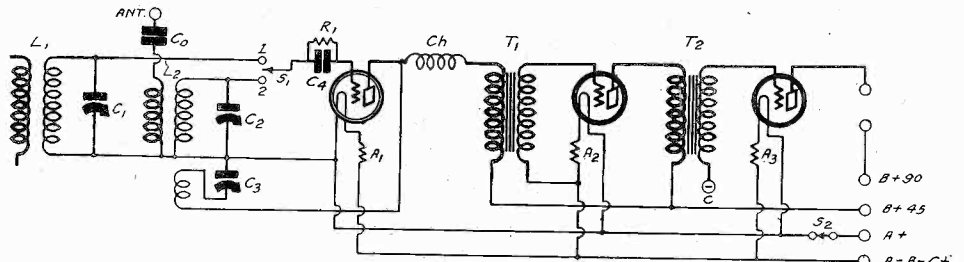

FIG. 730

CIRCUIT OF A SHORT-WAVE TUNER GRAFTED ON A BROADCAST.

(1)—While 400 volts is more than should be used on the -80 tube, it is usually safe. It is all right to draw 100 milliamperes from it.

(2)—This can be done provided that you use 180 volts on the plate of the high mu tube through a coupling resistor of .25 megohm.

\*\*\*

IN THE January 12th issue you published a short article on how to combine a broadcast and a short wave receiver so that the same knob could be used for tuning both the short wave set and the broadcast receiver. Please publish a diagram of this in schematic form.

(2)—Is this scheme applicable to a receiver of any number of tubes or only

to one in which the first tube is the detector?

(3)—If it can be used on receivers having several tuned circuits, where is the best place for placing the short wave adapter?

HARRY KENDALL,  
Muscatine, Iowa.

(1)—See Fig. 730 for the diagram. The designations in this schematic correspond with the picture diagram in the original article.

(2)—It is applicable to any receiver regardless of the number of tubes and tuners in the set.

(3)—The short wave adapter must be placed in the detector stage. It will not work in any other.

## Join RADIO WORLD' University Club

And Get Free Question and Answer Service for One or Two years.  
This Service Only for Those Who Subscribe by Filling out  
This Coupon and Sending Remittance.

Subscribe for RADIO WORLD for one year (52 numbers, one each week) at \$6, or two years at \$10 (104 numbers) by filling out this coupon and enclosing remittance. You will then become a member of RADIO WORLD'S University Club and receive a secret number.

Put this number on the outside of the forwarding envelope (not the enclosed return envelope) and also put at the head of your letter. If already a subscriber, send \$6 or \$10 for renewal from close of present subscription and your name will be entered in Radio University. No other premium given with this offer.

RADIO WORLD, 145 West 45th Street, New York City.  
Enclosed find \$6.00 for RADIO WORLD for one year (52 nos.); or \$10.00 two years (104 nos.) and also enter my name on the list of members of RADIO WORLD'S University Club, which gives me free information in your Radio University Department for the period of this subscription, and send me my secret number indicating membership.

Name .....

Street .....

City and State .....

# U. S. IS HEARD IN AUSTRALIA

Washington.

Great advancement in wireless telephony in Australia is reported in a statement made public by the Department of Commerce, based upon advices from the American Consul General at Sydney, E. M. Lawton. The statement follows:

Australia's isolation and large open spaces may be partly the reason for these great advances, but a major part of the credit belongs to the engineers who have been developing the industry for the past five years, Australians believe.

## Test Resulted

Successful tests during the past year of Australian broadcasting program sent to American and European stations, and also received and rebroadcast in Sydney, have lately culminated in a fortnight's test of wireless telephony to Java and Schenectady.

It is no longer a novelty for people in Australia to receive parts of London (2LO) programs or to hear "Big Ben" striking the hours in London.

Broadcasting programs have been relayed by Sydney stations from The Netherlands, Russia, Java, Japan, New Zealand, and the United States, not to mention the entire flight of the "Southern Cross" across the Pacific. Local stations, professional and amateur, have maintained contact with ships clear across the Pacific, and even to England.

## Government Ownership

The Commonwealth Government owns a controlling interest in the Amalgamated Wireless of Australasia (Ltd.), which first began development of wireless in Australia in 1918. An important service has been built up on a new scheme of centralizing the various activities of the company by having three groups—a transmitter center, a receiving center, and a control office.

# Sets Tried on Trains In German Experiment

Berlin.

The installation of broadcast receivers on trains, such as was successfully done in Canada, is now the subject of experiment in Germany. The ingenuity that was applied to installing radio telephone, so that train passengers could telephone to any part of Germany, is now being applied to the program end.

A fast train between Breslau and Berlin has been used for these tests, and reports are encouraging. Less interference has been encountered than would be expected. Reception on earphones alone is contemplated for the present. There will be no charge for using the headsets. The object is to make the journey a happier one.

# Davis Feels Own Law Has Not Been Obeyed

Washington.

"I do not feel that the Federal Radio Commission has administered the amendment either in letter or in spirit."

This statement was made by Representative Davis, of Tennessee, author of the provision in the radio law that required a reallocation.

# Literature Wanted

THE names and addresses of readers of RADIO WORLD who desire literature on parts and sets from radio manufacturers, jobbers, dealers and mail order houses are published in RADIO WORLD on request of the reader. Either this blank may be used, or a post card or letter will do instead.

RADIO WORLD,  
145 West 45th St., N. Y. City.

I desire to receive radio literature.

Name .....

Address .....

City or town .....

State .....

J. Elgie, 1008 Mainland St., Vancouver, B. C., Can.  
M. C. Alexandre, 11 West Park Ave., Charlotte, N. C.  
A. S. Beimrohr, 416 S. 13th St., Omaha, Neb.  
J. E. Koch, 317-18 Missouri Bldg., St. Louis, Mo.  
J. N. Schwartz, Box 56, Hilda, Alberta, Can.  
Wm. J. Schultz, 3137 Vine St., Cincinnati, Ohio.  
Chas. Sanford, Prairie Farm, Wis.  
H. O. Crawford, 809 S. 8th St., Evansville, Ind.  
W. C. Shelin, 508 Ferris St., Wilmington, Del.  
Otto Kaiser, 2014 Tytus Ave., Middletown, Ohio.  
James V. Farley, 38 Harlan St., Providence, R. I.  
Geo. G. Mitchell, Jr., P. O. Box 55, Hacketts-town, N. J.  
R. John Spooner, East Aurora, N. Y.  
John T. Julius, 726 So. Queen St., York, Pa.  
V. Kervel, 60 Charlotte Ave., Detroit, Mich.  
Albert G. Hirsche, 213 W. First St., Shakopie, Minn.  
A. F. Day, Sergeant, Ky.  
Ellison Godwin, P. O. Box 206, Turkey, Tex.  
H. C. Robinson, 210 Washington St., Geneva, N. Y.  
Tobias Zwerdling, 176 Stockton St., Brooklyn, N. Y.  
P. O. Grossman, 552 Ryerson Ave., Wood Ridge, N. J.  
J. O. Hart, 1608 W. 46th St., Oklahoma City, Okla.  
A. L. Wesemeyer, Jr., USS. Corwin, CG., Pascagoula, Miss.  
Chas. T. Estes, 946 Globe St., Fall River, Mass.  
Harry Heal, 208 N. Fillmore St., Gloucester City, N. J.  
O. E. Brown, 157 Farmington Ave., Bristol, Conn.  
C. B. Smith, Philippi, West Va.  
Suzarte & Whitney, 15 Moore St., New York City.  
Fidelity Radio Mfg. Co., 597 Washington St., Boston, Mass.  
H. G. Emmett, 11 Haddon Hill Rd., Edgewood Sta., Providence, R. I.  
M. E. Henzler, 305 Blair Blvd., Eugene, Ore.  
C. H. Weldy, 219 W. Broad St., Tamaqua, Pa.  
Francis Gutierrez, 46 E. 112th St., New York, N. Y.  
Leo. E. Ladue, N. E. Tele & Telegraph Co., Burlington, Vt.  
C. A. Owen, 701-4th Ave., East, Cedar Rapids, Iowa.  
E. C. Otton, 18 Wine St., East Greenwich, R. I.  
E. G. Lorenz, Colorado Bldg., Washington, D. C.  
R. A. Cowan, 1074 King St., East, Kitchener, Ont., Can.  
Chas. P. Johnson, 582 Arnett Ter., Cumberland, Md.  
Robert B. Riester, Stafford Springs, Conn.  
Chas. H. Jordan, 291 Bay St., Springfield, Mass.  
Kalamazoo Electric Co., M. K. Randall, Mgr., Kalamazoo, Mich.  
Chas. H. Jordan, 291 Bay St., Springfield, Mass.  
Aleck Gilson, 923 No. 5th St., Mankato, Minn.  
Geo. Knapp, 23 Seaview Ave., East Norwalk, Conn.  
J. Gilchrist, 59 Stranmillis Ave., St. Vital, Man., Can.  
Earle C. Wate, 1213 K St., West, Cedar Rapids, Iowa.  
Gustave Simmons, 228 Wyo. Ave., Billings, Mont.  
Wm. R. Cassell, 12909 St. Clair, Cleveland, Ohio.  
G. W. Kotts, Radio & Electric Shop, Hope, No. Dak.  
E. Eckerson, Box 412, Glens Falls, N. Y.  
John Rand, 1257 E. 168th St., Cleveland, Ohio.  
G. E. Luther, c. o. L. B. & O. R. R., Hinsdale, Ill.  
G. A. Spingler, 34 Hooker Ave., Poughkeepsie, N. Y.  
G. B. Lynch, 718 Oak St., Macon, Ga.  
R. T. Scott, 1700 Barclay St., Vancouver, B. C., Can.  
J. M. Mann, Box 60, Vancouver, Wash.  
Howard Johnson, 109-8th Ave., W., Duluth, Minn.  
P. A. Artis, 47 East Fayette St., Uniontown, Pa.  
E. C. Bryndal, 3527 E. 153rd St., Cleveland, Ohio.  
Hutcheson Hardware Co., Radio Dept., Sandersville, Ga.  
O. Siebern, 1722-46th St., Brooklyn, N. Y.  
J. Markham, 647 Lovett, S., Grand Rapids, Mich.  
L. C. Arnold, 1820 N. Wells St., Chicago, Ill.  
Capt. R. W. Argo, Fort Jay, Governor's Island, N. Y.  
J. E. Tracy, 41M Converse Hall, Burlington, Vt.  
John H. Dillingham, 362 Riverside Ave., Torrington, Can.  
Harry Ketcher, 626-56th St., Brooklyn, N. Y.

# BILL INCREASES CLEAR WAVES

Having become convinced after discussing the subject with leading engineers that fifty cleared channels would afford better radio reception, although at the expense of some small stations obtaining even less time on the air, Representative Frank Crowther, of Schenectady, N. Y., has introduced a bill in the House to compel the Federal Radio Commission to assign at least fifty cleared channels.

Such channels would provide an exclusive wavelength, without any simultaneous broadcasting on that wavelength, either.

## Total Is Now Forty

The reallocation, effective November 11th, established forty cleared channels, that is, eight for each of the five geographical zones into which the United States is divided for radio purposes.

Representative Crowther, who hails from the city in which WGY is situated, said:

"I believe that much greater service can be obtained from a cleared channel than from a regional or local. With fifty cleared channels it will be possible for each zone to have ten instead of eight. It would also enable the Commission to settle the WGY controversy and give that station full time on a cleared channel.

## He Prefers Sixty

In my opinion it would be better to provide sixty cleared channels, but I leave that to the discretion of the Commissioners and make it compulsory for them to provide only fifty.

"I have talked to many of the leading engineers and they all seem to favor at least fifty cleared channels."

## NEW CORPORATIONS

Bunnell Aircraft Radio Corp.—Atty. J. Marx, 342 Madison Ave.  
Radio Products Corp.—Atty. Joseph R. Richardson, Wilmington, Del.  
Geophysical Development Corp.—Atty. Franklin L. Mettler, Wilmington, Del.  
R. C. A. Communications, Inc., New York—Corp. Trust Co., Wilmington, Del.  
Tung Sol Radio Tubes, Inc., Newark—U. S. Corp. Co., New York, N. T.  
West Ark Radio Stores, Inc., Dover—Corp. Co., Dover, Del.  
A. C. Dadio Corp.—Atty. A. E. Klapper, 181 Lenox Road, Brooklyn, N. Y.  
Western Electric Co. of Brazil, Wilmington, Del.—Corp. Trust Co. of Am.  
Sharrar-Hohman, Rochester, N. Y., Radios—Atty. Chamberlain, Page & Chamberlain, Rochester.  
Steeveds Corp., Radio Equipment—Atty. M. E. King, 1564 Broadway, New York.  
Cosmos Broadcasting Co., Radio Apparatus—Atty. Cuthell, Hotchkiss & Mills, 20 Pine St., New York.  
Tobe Deutschmann Corp., Mountainside, Electrical and Radio—U. S. Corp. Co., Wilmington, Del.  
Monaco Service Co., Repair radios—Atty. N. W. Shapiro, 74 West 50th St., New York, N. Y.  
Radio Electric Co., Inc., Camden, Radio supplies—Atty. P. Wendkos, Camden, N. J.  
Radio Parlors, radios—Atty. Frank & Frank, 20 East 46th St.  
Robert C. Lyman, Main Street, Austin, Penna.  
F. L. Marvin, 15-6th Ave., Gloversville, N. Y.  
Clarence Locker, 70 Washington St., Lodi, N. J.  
W. H. Tresselt, 14 W. North St., Iion, N. Y.  
Ralph Luebbers, 114 Montgomery Ave., Irvington, N. J.  
Charles Mette, 2302 Lexington, Ashland, Ky.  
James J. Quinn, 632 E. 9th St., Chester, Pa.  
Clarence S. Perkins, Holderness, N. H.  
Victor Radio Service, 3215 Foothill Blvd., Oakland, Calif.  
E. F. Fitzgerald, 103-5th Ave., W., Cedar Rapids, Iowa.  
Illuminado M. Icasas, 332 F. B. Harrison St., Pasay, Rizal, P. I.  
William Rippel, 11425 Findlay Ave., Detroit, Mich.  
Marcus S. Potter, Johnson, Orange Co., N. Y.  
Rowan B. Tuley, Room 436, P. O. Dept., Washington, D. C.  
I. C. Barr, 4866 Maplewood, Detroit, Mich.  
Wyman H. Holden, 8419-90th St., Woodhaven, N. Y.



# Relief Seems Miracle

## to the Listeners Suffering from Hum and Other Line Noises

By C. B. Cabaniss

(Frank Kiernan Company)

SCARCELY a month after the Si-len-ser was perfected and introduced to the radio public! Yet, thousands of them have been placed from coast to coast with splendid results in almost every case. This speaks well for the performance of this new device which kills extraneous electrical noises which hamper reception on all-electric and electrically operated sets.

In practically every locality where line noises and electrical disturbances were the causes of noisy radio reception, the Si-len-ser has more than proven its value. And in some locations where any cure was deemed impossible, it has cleared up reception in a seemingly miraculous manner.

It has been tried and endorsed by practically every large metropolitan radio editor, national magazine radio laboratory and leading radio experts and seems to well answer the great demand for a practical noise and disturbance eliminator.

### Effectiveness Proved

Up to this time, the Si-len-ser is the only device that has really proven its worth, not only by laboratory tests, but in actual use in territories and spots where these troubles were strong and prevalent at all times. There have been many devices and many ways of curing these troubles, but all necessitated tracing down each individual noise to its source and then using a filter of various capacity to silence each.

This is a troublesome method, the search alone taking up perhaps many days of time, then the great cost of muting each trouble-making device besides getting each owner's consent to attachment.

The Si-len-ser, however, working on a different principle, attacks the trouble at the line, plugging directly into the line and the set in turn being plugged into the Si-len-ser, a matter of a few moments, the only expense being the original investment in the Si-len-ser.

The flood of praises received from those whose troubles have been cured by its means, indicates that this small expense paid big dividends.

### States Common Cause

According to Julien J. Proskauer, Associate Member of the Institute of Radio Engineers, who was responsible for the Si-len-ser, now being marketed universally by the Trutone Radio Sales Company, a common cause of hum in electric receivers equipped with powerful audio amplifiers is tremendous voltage on the uncontrolled power amplifier.

Unless there is a method for controlling volume in the audio stages, any slight hum produced in the detector or first audio stage is amplified to such a considerable extent that annoyance is bound to occur. In cases like this, the Si-len-ser is of no value because in such receivers it is necessary to reduce the strength of the signal fed to the detector tube to prevent undue volume because of the power of the amplifier.

The result is that the signal fed to the amplifier is weak in comparison to the strength of the hum generated in the amplifier, and is therefore pushed into the background by the hum.

If an 0-500,000-ohm high resistance potentiometer is connected across the secondary winding of the first stage audio transformer, with the grid of the first

amplifier tube connected to the movable arm of the potentiometer instead of to the "G" terminal of the first stage audio transformer, a means is provided of controlling the strength of both signal and hum fed to the first audio amplifier tube.

### Hum Cut Down

It will then be found that the volume control in the audio stages can be reduced to the point where a good signal from the detector will give all the volume that will ever be necessary, and at the same time cut down the hum to an extent which makes it a negligible factor. Then the volume control in the radio frequency stages can be used to cover the range of volume desired.

The Si-len-ser is absolutely invaluable where the interference is circulating high frequency circuits in the line because it will remove every trace of electric disturbance instantly.

If the trouble is traced to a specific device such as an electric refrigerator, oil burner, or other household apparatus, the Si-len-ser may be attached in the line that feeds such apparatus.

The Si-len-ser is by no means a "cure all," and has nothing to do with static noises that come through in the aerial, but is said by its makers to be the most efficient electric noise killer that has ever been devised, and a necessity in 99 out of 100 cases where line noise interferes with reception.

[Mr. Cabaniss, author of the above article, is one of the executives of Frank Kiernan Company, advertising agents, whose client, Trutone Radio Sales Company, manufactures Si-Len-Ser.]

## AN A AND B SUPPLY AND AUDIO AMPLIFIER

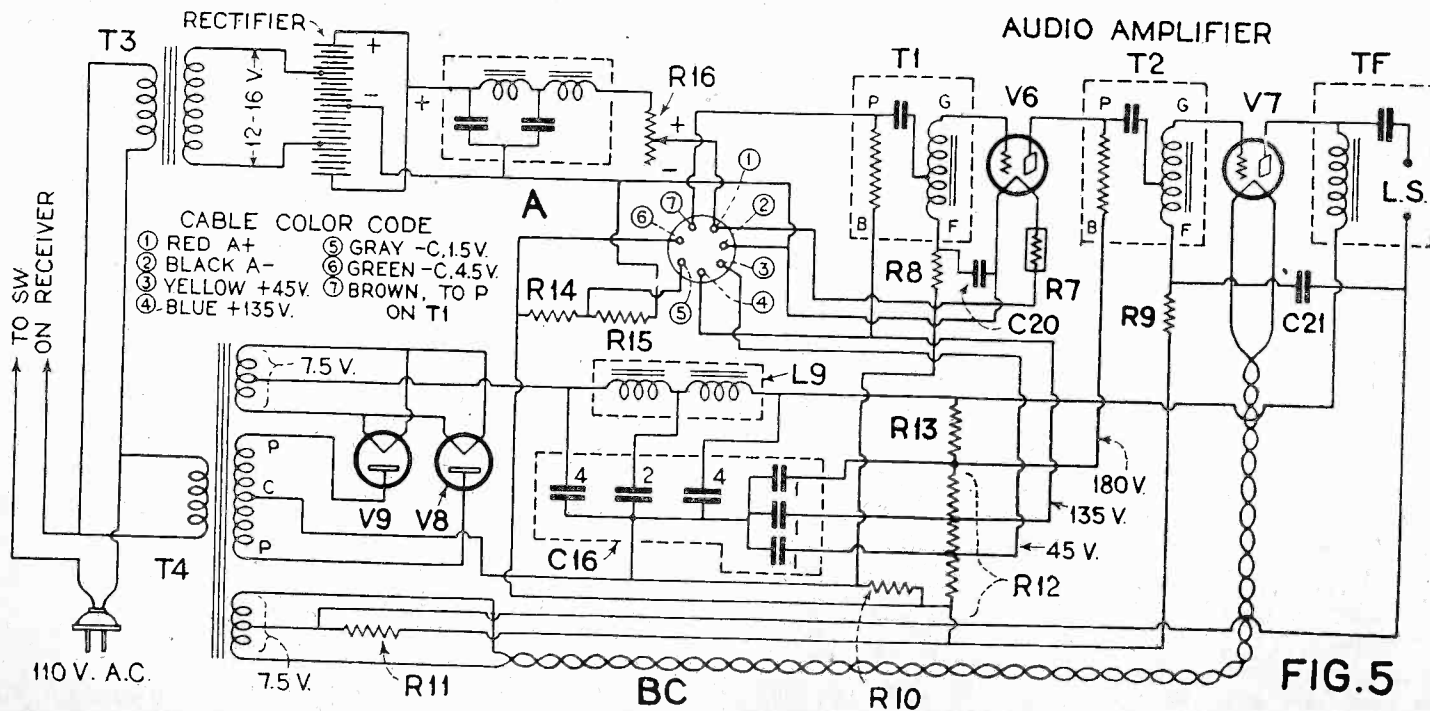

THE CIRCUIT DIAGRAM OF THE AUDIO AMPLIFIER AND POWER SUPPLY FOR THE RECEIVER DESCRIBED LAST WEEK BY JOHN B. BRENNAN, JR. THE FILAMENT CURRENT FOR THE FIRST AUDIO TUBE IS DIRECT AND IS DERIVED FROM DRY TYPE RECTIFIER THROUGH AN A FILTER. ALL POWER TERMINALS NOT NEEDED FOR THE AMPLIFIER TERMINATE IN A SEVEN-TERMINAL SOCKET WHERE THEY ARE AVAILABLE FOR THE RADIO FREQUENCY PORTION OF THE CIRCUIT.

# The New Screen

Designed to Give Every One

By Herma

Managin

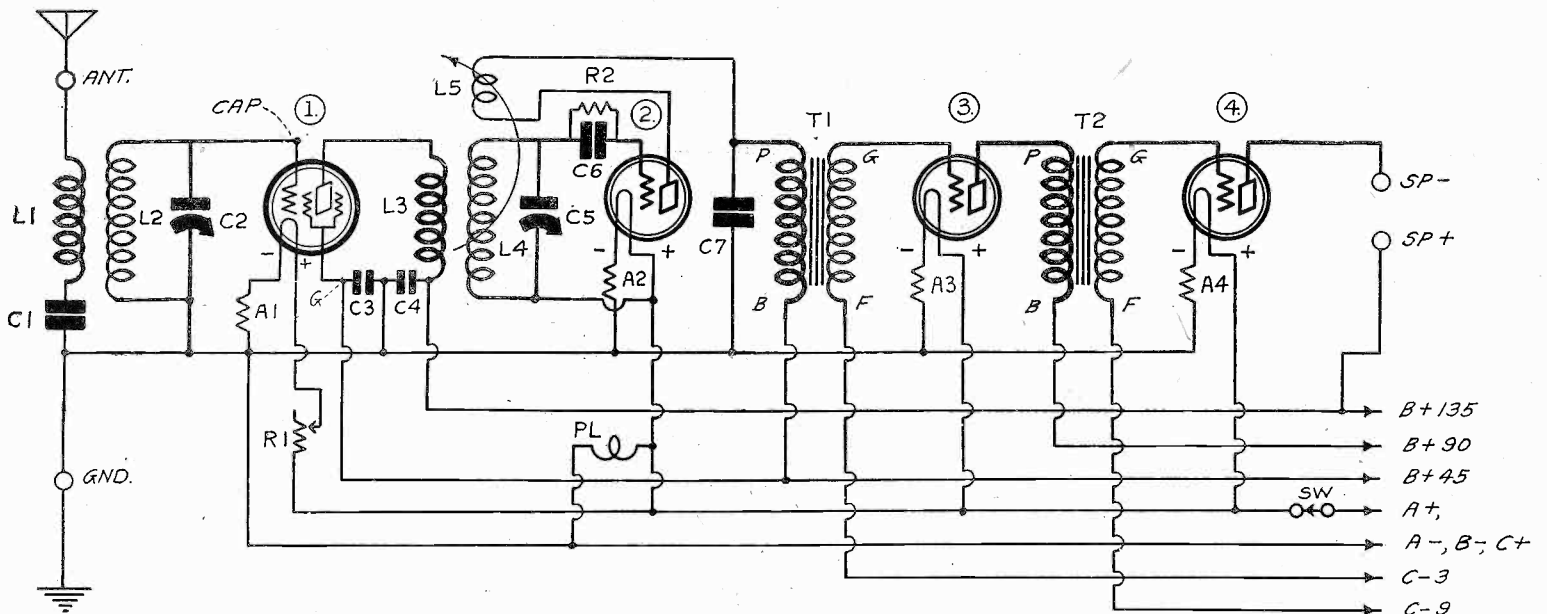

FIG. 1

GREATER SELECTIVITY IS OBTAINED FROM THE NEW MODEL SCREEN GRID DIAMOND OF THE AIR. THIS MODEL IS FOR BATTERY OPERATION OF THE FILAMENTS. EITHER A B ELIMINATOR OR A BLOCK OF B BATTERIES MAY BE USED FOR PLATE VOLTAGE. THE TUBES ARE (1) SCREEN GRID; (2) AND (3) 201A; (4) 112A. HOWEVER, A 200A OR 112A MAY BE USED AS DETECTOR WITH AN INCREASE IN SENSITIVITY.

IN line with other improvements, greater selectivity is being provided in the up-to-date kit circuits and factory-made receivers, because the reallocation enables many locations to receive a greater number of stations and thus requires the selectivity to separate them. Aside from this, the demand for increased selectivity has been growing, due to general circuit designs being worked in localities that are close to a broadcasting station, especially to some high-powered station that has been honored with a cleared channel.

The 4-Tube Screen Grid Diamond of the Air, therefore, has been redesigned, to meet this new selectivity demand. The antenna coil primary has been halved, but the high impedance fixed primary of the three-circuit coil, which coil connects the radio frequency stage to the detector, provides amplification gain that retains the usual high amplification of this receiver.

### New Coil Design

The Diamond of the Air was introduced to the public in 1925. It consisted of a stage of tuned radio frequency amplification, a regenerative detector, where a tickler coil was used to obtain regeneration inductively, and two stages of transformer coupled audio frequency amplification.

When the screen grid tube appeared, the circuit was changed only to afford inclusion of this great amplifier.

The present model increases the selectivity of its predecessor by proper coil design, and increases the range of volume control, since the amplification is too high to enable the volume to be cut down suitably by the usual 20-ohm rheostat.

### Tuner Is Gain-Provider

Even though a No. 622 Amperite is in series with the negative leg of the screen grid tube and a 50-ohm rheostat in the positive leg, making a possible total of 70 ohms in series with the 25-ohm filament of the screen grid tube, this is necessary to reduce the volume to the much-adver-

tised "whisper," or retain it at its maximum, by turning the rheostat knob to zero resistance position.

Looking at the circuit from antenna input, we find that, in series with the ground, a .0005 mfd. fixed condenser. This tends to keep the dial readings of the first tuned circuit the same, no matter how long

### LIST OF PARTS

- L1, L2—One antenna coil (AC5).
- L3, L4, L5—One screen grid three-circuit tuner (SGT5).
- C1—One Aerovox .0005 mfd. mica fixed condenser.
- C2—One Hammarlund .0005 mfd. Midline variable condenser.
- C3, C4—Two Aerovox .006 mfd. mica fixed condensers.
- C5—One Hammarlund .0005 mfd. Midline.
- C6—One Aerovox .0005 mfd. mica fixed condenser with clips.
- C7—One Aerovox .0005 mfd. mica fixed condenser.
- A1—One 622 Amperite with mount.
- A2, A3, A4—Three 1A Amperites with three mounts.
- R1—One 50-ohm Frost rheostat.
- R2—One 5-meg. Lynch metallized grid leak.
- T1, T2—Two National A 100 audio frequency transformers.
- Ant., gnd., speaker —, speaker +, four binding posts.
- PL—One pilot light bracket with jewel window and lamp.
- SW—One A battery switch.
- One 7x21-inch front panel.
- One 10x20-inch aluminum subpanel, self-bracketing, with four sockets (1, 2, 3, 4), affixed, and supplied with subpanel hardware and insulated bushings and washers.
- Two dials, with two pointers.
- Two knobs (one for tickler coil, the other for rheostat).
- One roll of stranded Braidite wire.

the aerial may be, while the small primary on the antenna coil is effective in the same direction.

### Higher Amplification

The antenna coil is of the standard type, except for the smaller primary, but, as with all things in radio, seemingly little differences may work great changes. The screen grid tube will not oscillate under the prescribed conditions, nor should it. Therefore, the diminished primary, which reduces the effective antenna resistance and hence operates in the direction of oscillation, actually enables higher amplification from the screen grid tube at lower input voltage, although still below the oscillation point.

But the circuit is keyed up mostly by the nature of the primary winding of the three-circuit primary. This primary consists of 24 turns. While the antenna coil primary was halved the three-circuit coil's primary was doubled.

### Secondaries Tuned

The secondaries are tuned in both instances, and the dials track nicely, due to absence of large distributed capacity. However, as the plate-to-filament capacity of the screen grid tube is larger than in other tubes, the antenna dial will give higher readings, if any difference develops, where the readings increase for higher wavelengths.

This is easily corrected by tuning in a low wavelength broadcasting station that does not come in very loud, and putting an adjustable capacity across the first tuning condenser, turning the antenna dial to match the reading of the other one exactly, and adjusting the extra capacity until the station comes in loudest. Once this adjustment is made it is left that way.

### Equalizer Serves Purpose Well

A convenient device for providing this extra capacity is the Hammarlund Equal-

# Grid Diamond

## All the Selectivity He Needs

Bernard

Editor

izer, total capacity 70 mmfd. The catalogue number of this device is EC-70 and the list price is 60 cents. It is physically attachable to one of the lugs of the Hammarlund tuning condenser.

It should be understood that this extra capacity is to be added only if found advisable by the constructor after he has given the circuit a fair trial without it; hence it is not included in the list of parts. With it in circuit the two dials may be made to track absolutely, but without it this result may be obtained or there may be a little difference, particularly at low number readings (low wavelengths), for here any small difference in capacity in the tubes is a much greater percentage of the included capacity of the condenser used for tuning. Some persons won't mind dials being a little "off," hence won't want the extra little condenser, but those who must have the two dials "on the dot" may prefer the additional Equalizer.

### DX Comes in Very Loud

It is not advisable, however, to use a double condenser in this circuit, but each tuned circuit should be separately tuned, for maximum sensitivity. And that type of sensitivity from such a receiver as this assures far-distant stations at great volume.

The circuit should be built as illustrated. It needs no shielding then. It will not bring about self-oscillation. You should not try adding another stage of tuned radio frequency amplification. That would require most careful shielding, would complicate the circuit and add very little to the sensitivity, because of the effect of the shields. Do not use a standard three-circuit tuner as the interstage coupler. If you do, then the screen grid tube will work no better than an -01a. A small primary on the interstage coil has the same effect as short-circuiting or bypassing a great part of the output of the tube. A high impedance load is required by this tube for a real "kick."

### Coil Data

The coils used in the laboratory model were the AC5 (antenna coil for .0005 mfd.) and the SGT5 (screen grid tuner for .0005 mfd.), manufactured by the Screen Grid Coil Company. The winding data on these coils are:

For L1, use 6 turns; leave 1/4-inch space and wind 48 turns for L2. The diameter is 2 1/2-inches, and the form 2 1/2-inches high, while the wire is No. 24 single or double silk covered.

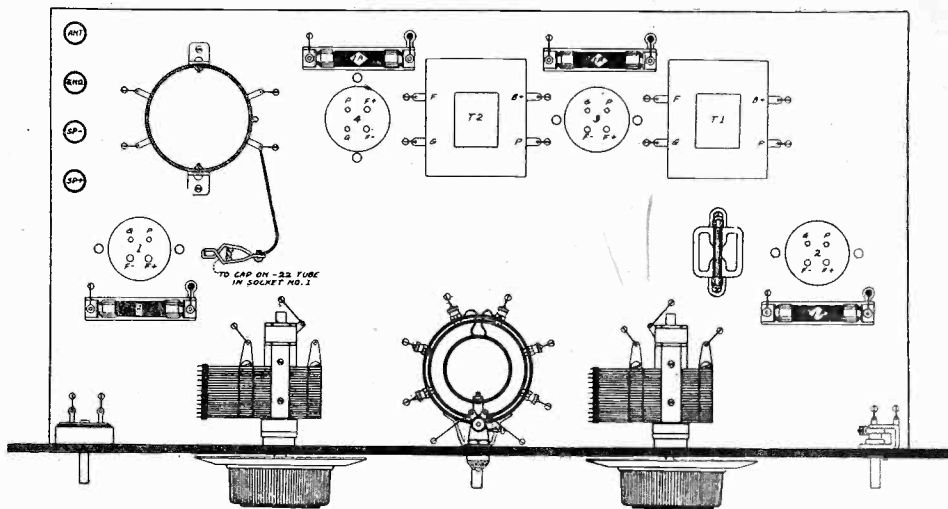

FIG. 3  
HOW THE PARTS ARE LAID OUT ON TOP OF THE ALUMINUM SUBPANEL.

The three-circuit coil is wound thus: L3 (primary), 24 turns; leave 1/4-inch space; wind 48 turns for the secondary, L4; the tickler, L5, consists of 24 turns on a 1 1/4-inch diameter 1 1/4 inches high. These data are for .0005 mfd. condensers. If .00035 mfd. is used, the only change is to increase the secondaries by 8 turns. The commercial coils for .00035 mfd. are AC3 and SGT3. All the wire may be of the same diameter and insulation, although the commercial coils used in the receiver have Litzendraht on the tickler, and larger than No. 24 wire on the primary of the antenna coil.

### A Glorious Color Scheme

These differences are mostly for appearance, since the commercial coils are wound on blood-orange bakelite. The primary of the antenna coil is green, the secondary blue. The primary of the tuner is strawberry, the secondary blue and the tickler gold. This makes a very fetching color scheme and shows off to great advantage against the aluminum subpanel, the black front panel and the black crackled finish of the National audio transformers, which, by the way, are the finest audio transformers made.

The tone quality depends on the type of audio transformers, the choice of tubes and the B and C voltages and speaker.

The tubes to use are one screen grid 222, two 201A and one 112A. Somewhat

greater sensitivity results if the detector is a 200A, instead of a 201A, while the rushing sound then becomes more pronounced. For the 200A change the detector grid return to F minus on socket (2). This does not mean A minus, which is the battery terminal, but the other side of A2. The 112A is superior to the 201A as a detector, but costs more, so that for economical reasons the 201A may be used.

The output is a 112A because 135 volts maximum are assumed. This voltage and tube are economical on batteries, and B batteries should last five or six months, if of the large-capacity type. Of course, a B eliminator may be used, and if included will usually provide 180 volts maximum. This makes possible the use of a 171A output tube, but requires also more biasing voltage—a total of about 45 volts—and an output filter. A good filter, which may be used externally, is the National Tone Filter. No wiring changes are necessary to incorporate this filter.

[This concludes the first part of the article on the highly selective model of the 4-Tube Screen Grid Diamond of the Air. Part II will be published next week, issue of February 16th. There will be two more articles after that, including trouble shooting and answers to questions.]

## WTAU Complains of Impairment

Washington. The service of WTAU, Columbus, Ohio, operated by the American Insurance Union, has been impaired by the reallocation, the committee was told by John J. Lentz. The station is on the same channel with KFI, Los Angeles, and now must cease broadcasting at sunset on the Pacific Coast, or at 7:30 o'clock local time. He asked the committee to rectify this condition in any new legislation. He said several million people within a radius of 100 miles of the station are served by the station, while the Pacific Coast station serves "a lot of fishes in the Pacific and cactus plants in the deserts."

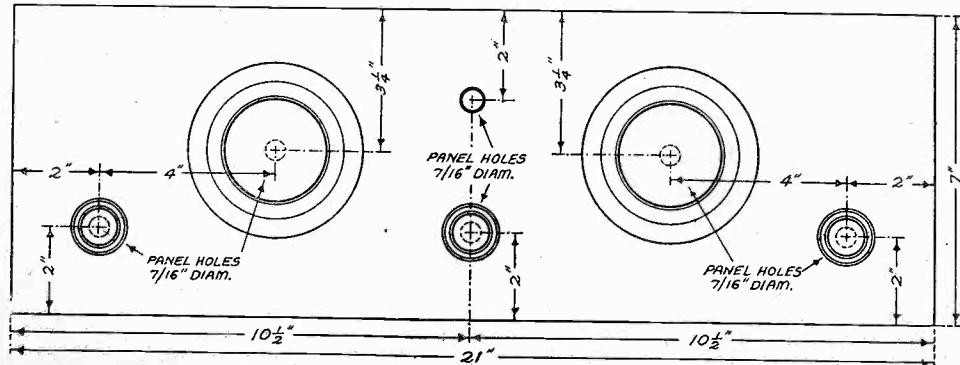

FIG. 2  
THE FRONT PANEL LAYOUT OF THE SCREEN GRID DIAMOND. EACH OF THE TWO CIRCUITS SHOULD BE INDEPENDENTLY TUNED.

# The New Screen

Designed to Give Every One

By Herma

Managin

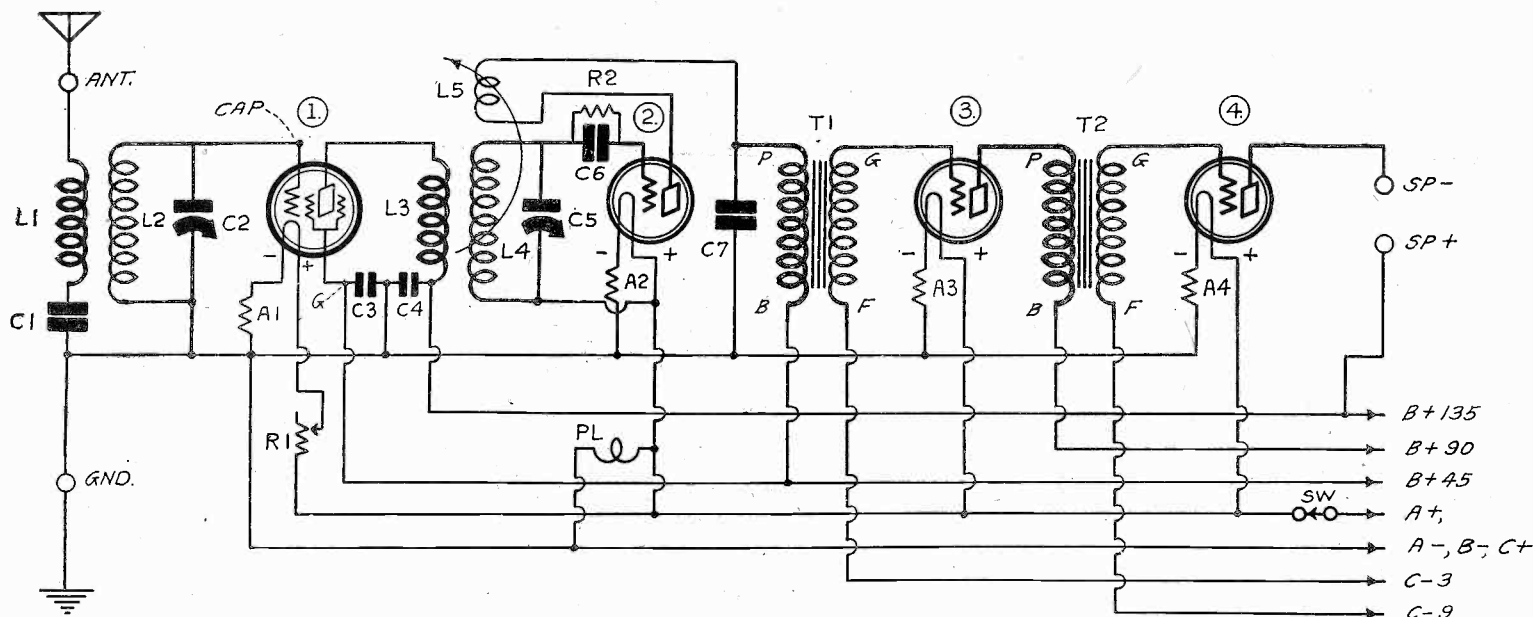

FIG. 1

**GREATER SELECTIVITY IS OBTAINED FROM THE NEW MODEL SCREEN GRID DIAMOND OF THE AIR. THIS MODEL IS FOR BATTERY OPERATION OF THE FILAMENTS. EITHER A B ELIMINATOR OR A BLOCK OF B BATTERIES MAY BE USED FOR PLATE VOLTAGE. THE TUBES ARE (1) SCREEN GRID; (2) AND (3) 201A; (4) 112A. HOWEVER, A 200A OR 112A MAY BE USED AS DETECTOR WITH AN INCREASE IN SENSITIVITY.**

In line with other improvements, greater selectivity is being provided in the up-to-date kit circuits and factory-made receivers, because the reallocation enables many locations to receive a greater number of stations and thus requires the selectivity to separate them. Aside from this, the demand for increased selectivity has been growing, due to general circuit designs being worked in localities that are close to a broadcasting station, especially to some high-powered station that has been honored with a cleared channel.

The 4-Tube Screen Grid Diamond of the Air, therefore, has been redesigned, to meet this new selectivity demand. The antenna coil primary has been halved, but the high impedance fixed primary of the three-circuit coil, which coil connects the radio frequency stage to the detector, provides amplification gain that retains the usual high amplification of this receiver.

### New Coil Design

The Diamond of the Air was introduced to the public in 1925. It consisted of a stage of tuned radio frequency amplification, a regenerative detector, where a tickler coil was used to obtain regeneration inductively, and two stages of transformer coupled audio frequency amplification.

When the screen grid tube appeared, the circuit was changed only to afford inclusion of this great amplifier.

The present model increases the selectivity of its predecessor by proper coil design, and increases the range of volume control, since the amplification is too high to enable the volume to be cut down suitably by the usual 20-ohm rheostat.

### Tuner Is Gain-Provider

Even though a No. 622 Amperite is in series with the negative leg of the screen grid tube and a 50-ohm rheostat in the positive leg, making a possible total of 70 ohms in series with the 25-ohm filament of the screen grid tube, this is necessary to reduce the volume to the much-adver-

tised "whisper," or retain it at its maximum, by turning the rheostat knob to zero resistance position.

Looking at the circuit from antenna input, we find that, in series with the ground, a .0005 mfd. fixed condenser. This tends to keep the dial readings of the first tuned circuit the same, no matter how long

### LIST OF PARTS

- L1, L2—One antenna coil (AC5).
- L3, L4, L5—One screen grid three-circuit tuner (SGT5).
- C1—One Aerovox .0005 mfd. mica fixed condenser.
- C2—One Hammarlund .0005 mfd. Midline variable condenser.
- C3, C4—Two Aerovox .006 mfd. mica fixed condensers.
- C5—One Hammarlund .0005 mfd. Midline.
- C6—One Aerovox .0005 mfd. mica fixed condenser with clips.
- C7—One Aerovox .0005 mfd. mica fixed condenser.
- A1—One 622 Amperite with mount.
- A2, A3, A4—Three 1A Amperites with three mounts.
- R1—One 50-ohm Frost rheostat.
- R2—One 5-meg. Lynch metallized grid leak.
- T1, T2—Two National A 100 audio frequency transformers.
- Ant., gnd., speaker —, speaker +, four binding posts.
- PL—One pilot light bracket with jewel window and lamp.
- SW—One A battery switch.
- One 7x21-inch front panel.
- One 10x20-inch aluminum subpanel, self-bracketing, with four sockets (1, 2, 3, 4), affixed, and supplied with subpanel hardware and insulated bushings and washers.
- Two dials, with two pointers.
- Two knobs (one for tickler coil, the other for rheostat).
- One roll of stranded Braidite wire.

the aerial may be, while the small primary on the antenna coil is effective in the same direction.

### Higher Amplification

The antenna coil is of the standard type, except for the smaller primary, but, as with all things in radio, seemingly little differences may work great changes. The screen grid tube will not oscillate under the prescribed conditions, nor should it. Therefore, the diminished primary, which reduces the effective antenna resistance and hence operates in the direction of oscillation, actually enables higher amplification from the screen grid tube at lower input voltage, although still below the oscillation point.

But the circuit is keyed up mostly by the nature of the primary winding of the three-circuit tuner. This primary consists of 24 turns. While the antenna coil primary was halved the three-circuit coil's primary was doubled.

### Secondaries Tuned

The secondaries are tuned in both instances, and the dials track nicely, due to absence of large distributed capacity. However, as the plate-to-filament capacity of the screen grid tube is larger than in other tubes, the antenna dial will give higher readings, if any difference develops, where the readings increase for higher wavelengths.

This is easily corrected by tuning in a low wavelength broadcasting station that does not come in very loud, and putting an adjustable capacity across the first tuning condenser, turning the antenna dial to match the reading of the other one exactly, and adjusting the extra capacity until the station comes in loudest. Once this adjustment is made it is left that way.

### Equalizer Serves Purpose Well

A convenient device for providing this extra capacity is the Hammarlund Equal-

# Grid Diamond

## All the Selectivity He Needs

Bernard

Editor

izer, total capacity 70 mmfd. The catalogue number of this device is EC-70 and the list price is 60 cents. It is physically attachable to one of the lugs of the Hammarlund tuning condenser.

It should be understood that this extra capacity is to be added only if found advisable by the constructor after he has given the circuit a fair trial without it; hence it is not included in the list of parts. With it in circuit the two dials may be made to track absolutely, but without it this result may be obtained or there may be a little difference, particularly at low number readings (low wavelengths), for here any small difference in capacity in the tubes is a much greater percentage of the included capacity of the condenser used for tuning. Some persons won't mind dials being a little "off," hence won't want the extra little condenser, but those who must have the two dials "on the dot" may prefer the additional Equalizer.

### DX Comes in Very Loud

It is not advisable, however, to use a double condenser in this circuit, but each tuned circuit should be separately tuned, for maximum sensitivity. And that type of sensitivity from such a receiver as this assures far-distant stations at great volume.

The circuit should be built as illustrated. It needs no shielding then. It will not bring about self-oscillation. You should not try adding another stage of tuned radio frequency amplification. That would require most careful shielding, would complicate the circuit and add very little to the sensitivity, because of the effect of the shields. Do not use a standard three-circuit tuner as the interstage coupler. If you do, then the screen grid tube will work no better than an -01a. A small primary on the interstage coil has the same effect as short-circuiting or bypassing a great part of the output of the tube. A high impedance load is required by this tube for a real "kick."

### Coil Data

The coils used in the laboratory model were the AC5 (antenna coil for .0005 mfd.) and the SGT5 (screen grid tuner for .0005 mfd.), manufactured by the Screen Grid Coil Company. The winding data on these coils are:

For L1, use 6 turns; leave 1/4-inch space and wind 48 turns for L2. The diameter is 2 1/2-inches, and the form 2 1/2-inches high, while the wire is No. 24 single or double silk covered.

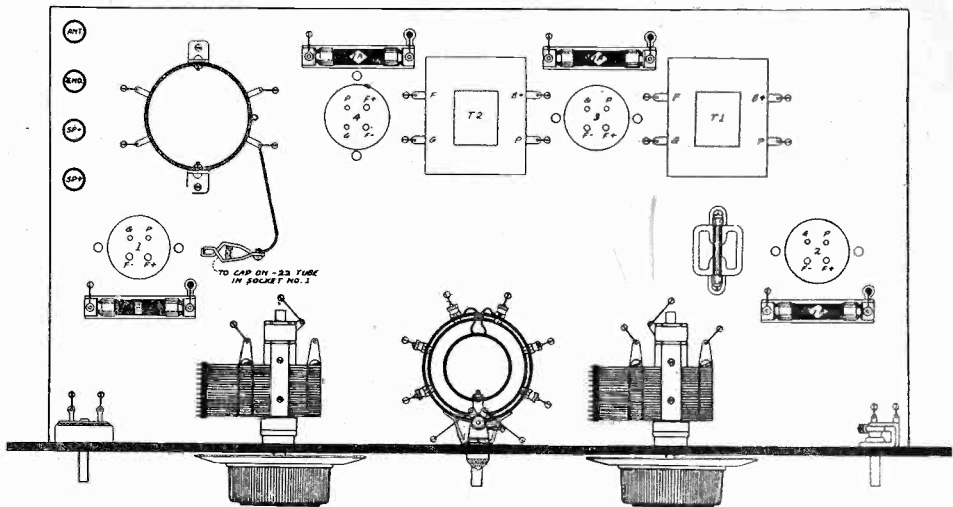

FIG. 3

HOW THE PARTS ARE LAID OUT ON TOP OF THE ALUMINUM SUBPANEL.

The three-circuit coil is wound thus: L3 (primary), 24 turns; leave 1/4-inch space; wind 48 turns for the secondary, L4; the tickler, L5, consists of 24 turns on a 1 1/4-inch diameter 1 1/4 inches high. These data are for .0005 mfd. condensers. If .00035 mfd. is used, the only change is to increase the secondaries by 8 turns. The commercial coils for .00035 mfd. are AC3 and SGT3. All the wire may be of the same diameter and insulation, although the commercial coils used in the receiver have Litzendraht on the tickler, and larger than No. 24 wire on the primary of the antenna coil.

### A Glorious Color Scheme

These differences are mostly for appearance, since the commercial coils are wound on blood-orange bakelite. The primary of the antenna coil is green, the secondary blue. The primary of the tuner is strawberry, the secondary blue and the tickler gold. This makes a very fetching color scheme and shows off to great advantage against the aluminum subpanel, the black front panel and the black crackled finish of the National audio transformers, which, by the way, are the finest audio transformers made.

The tone quality depends on the type of audio transformers, the choice of tubes and the B and C voltages and speaker.

The tubes to use are one screen grid 222, two 201A and one 112A. Somewhat

greater sensitivity results if the detector is a 200A, instead of a 201A, while the rushing sound then becomes more pronounced. For the 200A change the detector grid return to F minus on socket (2). This does not mean A minus, which is the battery terminal, but the other side of A2. The 112A is superior to the 201A as a detector, but costs more, so that for economical reasons the 201A may be used.

The output is a 112A because 135 volts maximum are assumed. This voltage and tube are economical on batteries, and B batteries should last five or six months, if of the large-capacity type. Of course, a B eliminator may be used, and if included will usually provide 180 volts maximum. This makes possible the use of a 171A output tube, but requires also more biasing voltage—a total of about 45 volts—and an output filter. A good filter, which may be used externally, is the National Tone Filter. No wiring changes are necessary to incorporate this filter.

[This concludes the first part of the article on the highly selective model of the 4-Tube Screen Grid Diamond of the Air. Part II will be published next week, issue of February 16th. There will be two more articles after that, including trouble shooting and answers to questions.]

## WTAU Complains of Impairment

Washington. The service of WTAU, Columbus, Ohio, operated by the American Insurance Union, has been impaired by the reallocation, the committee was told by John J. Lentz. The station is on the same channel with KFI, Los Angeles, and now must cease broadcasting at sunset on the Pacific Coast, or at 7:30 o'clock local time. He asked the committee to rectify this condition in any new legislation. He said several million people within a radius of 100 miles of the station are served by the station, while the Pacific Coast station serves "a lot of fishes in the Pacific and cactus plants in the deserts."

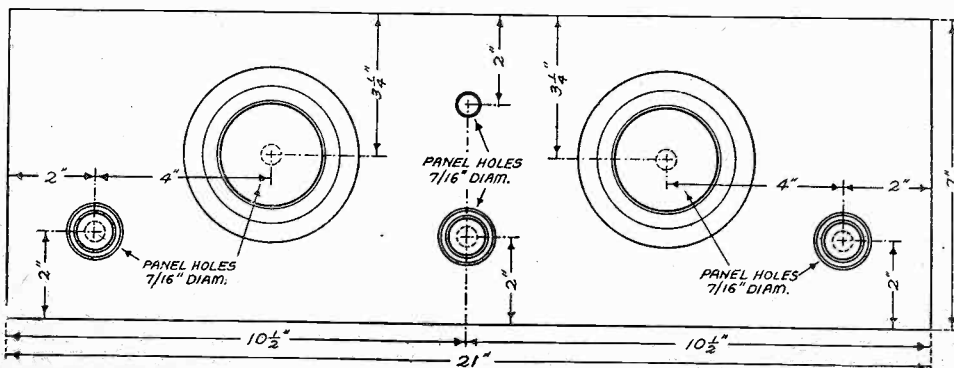

FIG. 2

THE FRONT PANEL LAYOUT OF THE SCREEN GRID DIAMOND. EACH OF THE TWO CIRCUITS SHOULD BE INDEPENDENTLY TUNED.

# Can Heavy Bodies Float

## Einstein's New Unit Theory Renew Investigation f

By J. E. Technical

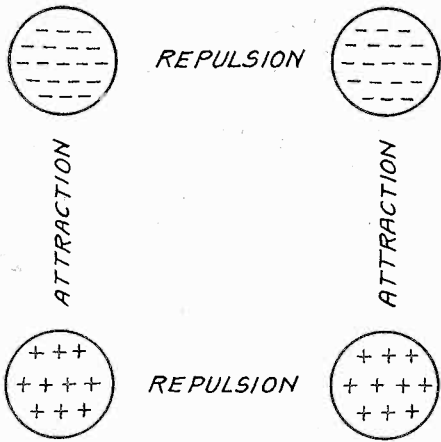

FIG. 1

ILLUSTRATING HOW TWO SIMILARLY ELECTRIFIED BODIES REPEL AND HOW THOSE CHARGED OPPOSITELY ATTRACT.

IN many tales, born of imagination run wild, we have read of the levitator, a device which nullifies the effect of gravitation. With the aid of this device a person can soar freely in air, an airplane will remain aloft without any engine and without any wind, a ship can leave the water and continue its journey in air, a rock raised above the ground will remain motionless in midair without any support, a person can step out of an airship or any other high place without falling.

Such tales are read with amusement largely because of their sheer absurdity. But are they as absurd as they seem? Is there not some scientific basis for them? Is there not some hope that ultimately science will develop a gravity shield which will nullify the gravitational attraction between two bodies, such as that between a rock and the earth, or that between the moon and the earth

### Analogous Cases

The law of gravitational attraction between two masses is that the force is directly proportional to the product of the

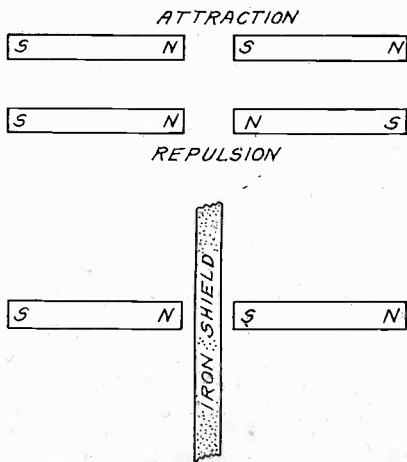

FIG. 3 (LEFT)

LIKE MAGNETIC POLES REPEL AND UNLIKE POLES ATTRACT. A SHEET OF IRON PLACED BETWEEN THE MAGNETS WILL KILL THE ATTRACTION AND REPULSION.

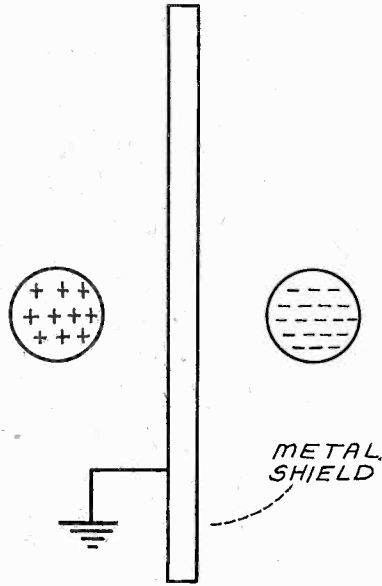

FIG. 2

A METAL SCREEN PLACED BETWEEN TWO CHARGED BODIES KILLS THE ATTRACTION OR REPULSION BETWEEN THEM.

masses and inversely proportional to the square of the distance between them.

There are similar laws in electricity and magnetism.

Two magnetic poles, one south and the other north, attract each other with a force which is proportional to the product of the strength of the two poles and inversely proportional to the square of the distance between them. Two electrified bodies, charged with opposite kinds of electricity, attract each other with a force proportional to the product of the charges and inversely proportional to the square of the distance between them.

Thus two masses attract each other just as if they were electrified or magnetized with opposite polarity. There is some justification in believing that mass is electromagnetic and that the similarity of behavior is due to this identity.

If two magnetic poles of the same polarity, or two bodies electrified with the same kind of electricity, be placed near each other, they repel each other with a force which follows the same law. There is no corresponding repulsion in gravita-

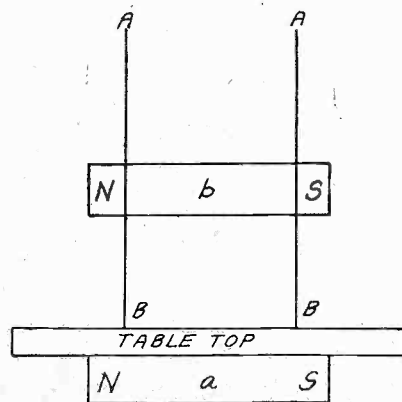

FIG. 4

A PERMANENT MAGNET MAY BE MADE TO FLOAT IN AIR BY PLACING IT OVER ANOTHER MAGNET. THE PERMANENT MAGNETS SHOULD BE OF COBALT STEEL.

tion. In this respect gravitation is different from magnetism and electricity. But this discrepancy can be removed by assuming that the gravitational "charges" are induced. If an electrified body be placed near an uncharged and insulated body there will be an induced charge on the uncharged body of the opposite kind of electricity. The inducing and the induced charges then attract.

The same holds in the case of magnetism. For example, if one end of a permanent bar magnet be held near a piece of soft iron, the iron becomes magnetized by induction. The side of the iron near the magnet becomes a pole of opposite polarity to the near pole on the bar magnet, and the iron is attracted to the magnet.

### Electric Shields

As is well known to every radio fan, one electrified body may be shielded from another by placing a grounded metal sheet between them. As soon as this shield is placed between the two bodies there is no longer a force of attraction or repulsion between them. One electrified body cannot induce a charge on the other body with the shield between them. The effect cannot travel through the metal. The electric effect can be screened off very easily.

It is also possible to shield one magnet from another, or to shield a piece of iron from a magnet. This is done by putting a sheet of iron between the two magnetized or magnetizable bodies. But it is more difficult to screen magnets than electrified bodies. The screen must be made of iron or other high magnetic material and it must be thicker to be effective than a corresponding electric shield.

### Penetrating Rays

The effectiveness of a screen depends on the frequency of the electromagnetic forces, as well as on the material of the shield. In the above instances we considered steady electric and magnetic fields. But there are also alternating and rapidly changing fields. There are magnetic and electric fields which change at a rate of a few cycles per year to many billion cycles per second. We have the earth's magnetic field, and the corresponding electric field, which changes at the rate of one cycle per year, and again at erratic rates.

Above these we have the commercial electric frequencies of 25, 40, and 60 cycles per second, as well as many other rates. Then come the electric currents of audio frequencies from 30 to 10,000 cycles, and carrier frequencies from 100 to 50,000 cycles. Then we have the radio frequencies from 30,000 to 60 million cycles, and higher. Then follow heat waves, light waves, X-rays and cosmic rays in an ascending scale of frequencies. Possibly we also have gravitational waves in the ether which are of the same electromagnetic nature.

### Opagues and Transparencies

Whether a sheet of a given material is a screen or not depends on the fre-

# in the Air Like Bubbles?

s Discussion of Possibility Under  
or a Century

Anderson

Editor

quency. A piece of ordinary glass is not a screen for ordinary light. The light passes through a window pane with very little diminution in intensity. But the window pane does not pass ultra-violet light. For that the glass is a screen or a shield. Quartz passes the ultra-violet light. Bodies which are perfectly opaque to visible light may pass ultra-violet or infra-red light. Some bodies may be opaque to heat waves and others transparent. X-rays pass through most solid bodies, even some metals. Lead stops them, provided the lead is thick enough for the frequency of the rays. The "harder" the X-rays are, that is the shorter their wavelength or higher their frequency, the more lead they will pass through.

The recently discovered cosmic rays are ether vibrations of much higher frequencies than the hardest X-rays, and they can pass through much more matter than light or X-rays.

### Gravitational Shields

Is it possible to shield one body from the effects of gravity? If gravitation is electromagnetic it should be possible. But so far nothing has been found which will stop the gravitational force. It passes through all matter just as if that matter were not there. The gravitational force, which is apparently caused by matter, is not stopped by other matter. In this respect, also, gravitation differs from electricity and magnetism.

But there is a connection between gravitation and electromagnetism. Energy, force and momentum exist in both, and wherever they occur they are the same. Scientists have been working for about a century trying to find out what the connection is, without a great deal of success.

The latest contribution to science by Professor Einstein is supposed to be the missing link. It is supposed to be a theory which connects gravitation and electromagnetism into a unified conception so that either gravitation or electromagnetism is a special case of the general theory.

If the theory is a success, the fantastic ideas suggested at the beginning of this article may have a scientific basis. It may be possible to cause a heavier-than-air body to float in air without support. But to make that possible a gravitational shield has to be invented. Or it may be possible to find gravitational "charges" of the same polarity so that the earth will repel instead of attract.

### Magnet Floats in Air

In Fig. 1 are shown four electrified bodies, two of which are positively and two negatively charged. The charge on any one is not supposed to be altered by the presence of the others. The repulsions and attractions are indicated. There are also attractive forces along the diagonals. In Fig. 2 are two bodies oppositely charged with a metal screen between them. This screen effectively stops the attraction that would exist between the bodies if the screen were not there.

In Fig. 3 are shown the corresponding cases for magnets. In this case the shield

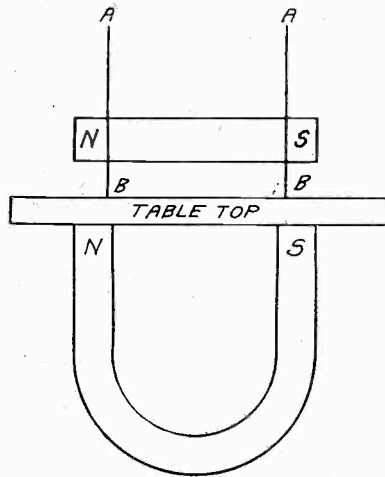

FIG. 5

**THE FLOATING MAGNET IS CONSTRAINED AGAINST ROTATION TO ENABLE "FLOATING" CONSTRAINTS MAY BE FOUR VERTICAL WIRES.**

is of iron. This shield has to be large in comparison with the dimensions of the magnets if it is to be effective.

It is an old laboratory trick to cause a magnet to float in air without any apparent cause. How this is done is shown in Figs. 4 and 5. A strong permanent magnet (a) Fig. 1 is mounted under the table top. Directly above this magnet is another permanent magnet (b) placed so that north and south poles are directly over the corresponding poles of the fixed magnet. There is a repulsion between the two. If the magnets are strong enough, and if the upper magnet is not too heavy, the repulsion will be greater than the weight of the upper magnet. It will rise a short distance above the table. If the upper magnet is free to turn it will swing around so that its north pole is over the south pole of the other magnet. When swung around it would be attracted down. To prevent the upper magnet from turning it is placed between two pairs of vertical guides AB, as fine threads or wires. Then the upper magnet will remain afloat over the table. The same arrangement is shown in Fig. 5, using a strong horse shoe permanent magnet to repel the other. This magnet may be one of those used in loudspeakers.

### Must Be Permanent

Both of the magnets must be permanent if the upper magnet is to remain afloat. If the magnets are not made of good magnet steel they will demagnetize each other, causing the upper magnet to fall down. The best steel for the purpose is cobalt steel.

Obviously the table top must not be too thick if the upper magnet is to leave the table. At most, the distance between the poles cannot be more than an inch or two. Similar arrangements could be made for electrified bodies. That is the force of repulsion between two bodies of the same charge could be made to neutralize the force of gravity of the upper body.

Thus we see how it is possible to neutralize gravity by means of electricity or magnetism. Both the gravitational and the electromagnetic forces act through the ether without any material between the bodies.

Fig. 6 represents a purely imaginative case. A body M is raised a distance above the earth. Gravity attracts it and it will fall unless some force is introduced to

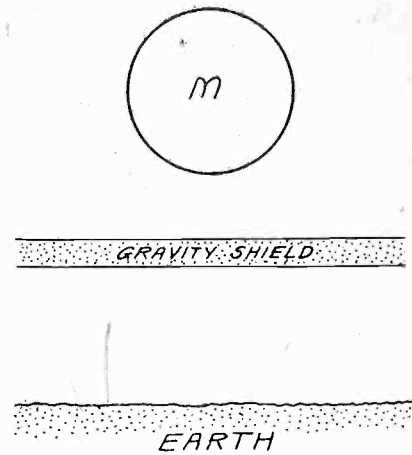

FIG. 6

**ANY TWO MASSES ATTRACT EACH OTHER. IT IS THEORETICALLY POSSIBLE TO CAUSE A HEAVY BODY TO FLOAT IN AIR.**

neutralize the pull of the earth on M, or unless a gravity screen can be placed between the body and the earth. Such a shield has been interposed, so the body M remains where it was put. What is that shield? Of what material is it made and how is it arranged? Perhaps Einstein's new theory will contain the answer. The shield cannot be made of matter, the stuff of which the earth and the Mass M are made, for that transmits the gravitational force.

While the gravity shield remains unknown, we shall have to use engines in airplanes, gas in balloons, elevators in buildings and parachutes for jumping from airplanes.

## Bureau Works Out Shielding Principles

General principles of shielding and grounding electrical apparatus, as worked out by the Bureau of Standards, will be presented at a forthcoming meeting of the American Institute of Electrical Engineers.

A number of extraneous disturbances can arise to interfere with the proper operation of electrical apparatus. The engineer is confronted with the necessity of eliminating these disturbances whenever he wishes to make careful electrical measurements.

To do this he often finds it necessary to place the apparatus in a metallic case or, sometimes, where there are magnetic troubles, in a case of iron. This case is generally called a shield.

The theory of many types of shields has been worked out so that it is possible to compute their effectiveness. This is particularly the case with magnetic shields.

However, there is much greater difficulty in developing a theory for radio waves. To shield against these waves one must use his best judgment and determine the result from experimental measurements.

### HAVERLIN TO WED

Wedding bells will soon ring for Carl Haverlin, commercial manager of KFI, Los Angeles, and Miss Virginia Flohri. Both Haverlin and Miss Flohri are well known to KFI's audience through their work before the microphone.

# New Ivory Finish POLO SPEAKER

The Most Beautiful Reproducer on the Market!

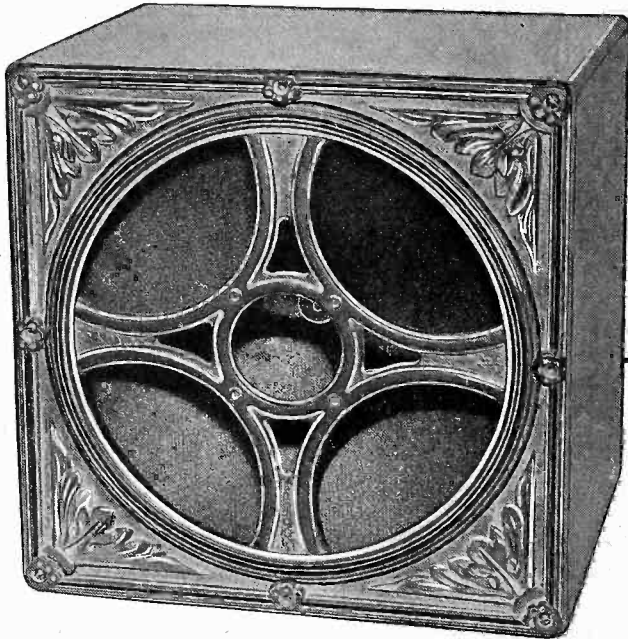

The polished tusk of an elephant is one of the choicest substances for the production of art objects, including precious carved trinkets. This ivory effect is now obtainable in the Polo Speaker (shown 1-3 scale). A new spraying process gives the real ivory effect—as entrancing as anything you've ever seen.

THE table Model Polo Speaker (illustrated) in a de luxe ivory finished housing, with moulded metal front piece, makes an outstanding table model speaker. It will stand the heaviest load—even two 250 tubes in push-pull without rattling—yet it is so sensitive it will work well from any output tube, even a 201A! The super-sensitive Twin Magnet Polo Unit is used, with a Burtex cone. Order one today at \$13.50, on 10-day trial. Pay \$9.00 C.O.D., rest in 90 days. You will receive the factory-built speaker, all ready to play.

The Polo Twin Magnet Unit is furnished with bracket, apex and 10-ft. cord, at \$10.00. Pay \$6.00 C.O.D., balance in 90 days.

A characteristic of the Polo Unit and the Polo Speaker is full, rich rendition of the low notes, due to even frequency response over the entire audible scale.

Acoustical Engineering Associates,  
143 West 45th Street, N. Y. City.  
(Just East of Broadway)

Please ship at once:

- One Ivory Finish Polo Speaker, at \$13.50; \$9 payable C. O. D., rest in 90 days.
- One Polo Unit with bracket, apex, chuck, nut and 10 ft. cord, at \$10.00; \$6.00 payable C. O. D., rest in 90 days.

[Put cross in proper square above.]

Name .....  
Address .....  
City..... State.....

TEN-DAY MONEY-BACK GUARANTEE

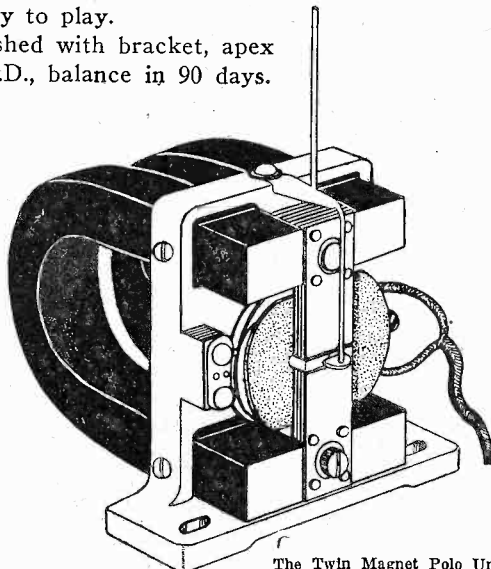

The Twin Magnet Polo Unit

## BLUEPRINT

FOR

### Bernard's Economy 3

Price \$1.00

PHILIP COHEN

(Suite 1214) 145 WEST 45th ST.  
NEW YORK CITY

## HIGH RESISTANCE VOLTMETERS

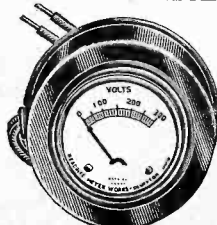

0-300 v., in portable type, full nickel finish, 3 1/2" tipped cord (illustrated at left). (Cat. No. 346) \$4.50

0-500 v., Tests ALL power packs, B eliminators, etc. Same casting as above. (Cat. No. 347) \$5.50

Just the thing for service men custom set builders, home experimenters.

GUARANTY RADIO GOODS CO.  
145 W. 45th St., N. Y. City

## Individual METERS For Portable or Panel Use

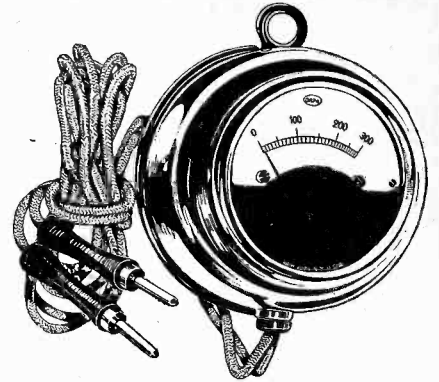

\$4.50

High resistance 0-300 Voltmeter, accurate to 1%. Measures any DC voltage to 300, including B eliminators. Provided with 30" cord, with luxurious jack tips and hanger. Meter full nickel de luxe finish. No. 346F.

No. 347F, same as above, but 0-500 volts, \$6.00

### POCKET AND PORTABLE VOLTMETERS

- No. 8—For testing A batteries, dry or storage, 0-8 volts DC scale.....\$1.00
- No. 10—For testing A batteries, dry or storage, 0-10 volts DC scale.....1.60
- No. 13—For testing A batteries, dry or storage, 0-15 volts DC scale.....1.00
- No. 50—For testing B batteries, dry or storage, but not for B eliminators, 0-50 volts DC scale.....1.60
- No. 39—For testing B batteries, dry or storage but not for B eliminators, 0-100 volts DC scale.....1.25
- No. 40—For testing A and B batteries, dry or storage, but not for B eliminators; double reading, 0-8 volts and 0-100 volts DC scale...1.75
- No. 42—For testing B batteries, dry or storage, but not for B eliminators; 0-150 volts DC scale.....1.50
- No. 348—For testing AC current supply line, portable, 0-150 volts.....4.00

### PANEL AC VOLTMETERS

(Panel meters take 2-5/64" hole)

- No. 351—For reading 0-15 volts AC.....\$2.25
  - No. 352—For reading 0-10 volts AC.....2.25
  - No. 353—For reading 0-5 volts AC.....2.25
- (See No. 348 under "Pocket and Portable Voltmeters.")

### PANEL VOLTMETERS

- No. 335—For reading DC voltages, 0-8 volts, \$1.00
- No. 310—For reading DC voltages, 0-16 volts, 1.00
- No. 316—For reading DC voltages, 0-16 volts, 1.00
- No. 326—For reading DC voltages, 0-6 volts, 1.00
- No. 337—For reading DC voltages, 0-50 volts, 1.00
- No. 339—For reading DC voltages, 0-100 volts, 2.25
- No. 342—For reading DC voltages, 0-150 volts, 2.25
- No. 340—For reading DC voltages, double reading, 1-8 volts, 0-100 volts.....1.50

### VOLTMETERS

- No. 18—For testing amperage of dry cell A batteries and voltage of dry or storage A batteries, double reading, 0-8 volts, and 0-40 amperes DC.....\$1.25
- No. 35—For testing amperage of dry cell A batteries and voltage of B batteries (not B eliminators); double reading, 0-50 volts, 0-40 amperes DC.....1.50

### PANEL MILLIAMMETERS

- No. 311—For reading 0-10 milliamperes DC..\$1.75
- No. 325—For reading 0-25 milliamperes DC..1.00
- No. 350—For reading 0-50 milliamperes DC..1.00
- No. 390—For reading 0-100 milliamperes DC..1.00
- No. 399—For reading 0-300 milliamperes DC..1.00
- No. 394—For reading 0-400 milliamperes DC..1.00

### VOLTAGE REGULATOR

- No. 218—For preventing excess voltage on the filament and cathode of AC tubes, by compensating for excess line voltage.....\$5.00

### POCKET AMMETER

- No. 1—For testing dry cells, 0-50 ampere DC scale pocket meter.....\$ .75

### 6-VOLT A BATTERY CHARGE TESTER

- No. 23—For showing when 6-volt A battery needs charging and when to stop charging; shows condition of battery at all times.....\$1.00

### PANEL AMMETER

- No. 338—For reading amperage, 0-10 amperes DC.....\$1.00

### Immediate Shipment

GUARANTY RADIO GOODS CO.,  
145 West 45th Street, New York City.  
Just East of Broadway

Send me the following individual meters (quantity in square):

- Cat. No.                       Cat. No.                       Cat. No.
- Cat. No.                       Cat. No.                       Cat. No.

NAME .....

ADDRESS .....

CITY..... STATE.....

TEN-DAY MONEY-BACK ABSOLUTE GUARANTY!



# De Luxe Carrying Case **FREE**

## With Each Jiffy Tester Combination!

### This Meter Outfit Makes Thirteen Vital Tests in Only 4½ Minutes!

INSTRUCTION SHEET GIVES FULL DETAILS OF THESE THIRTEEN TESTS

The Jiffy Tester in its Case is a Testing Laboratory All by Itself. Leave the meters in the case. Simply lift out the plug, attaching the four-prong adapter, if testing a four-prong tube. Put plug in socket of receiver to be tested; put tube in Tester socket. The B voltmeter automatically connects to the proper points when its tipped leads are inserted in the two binding posts at rear.

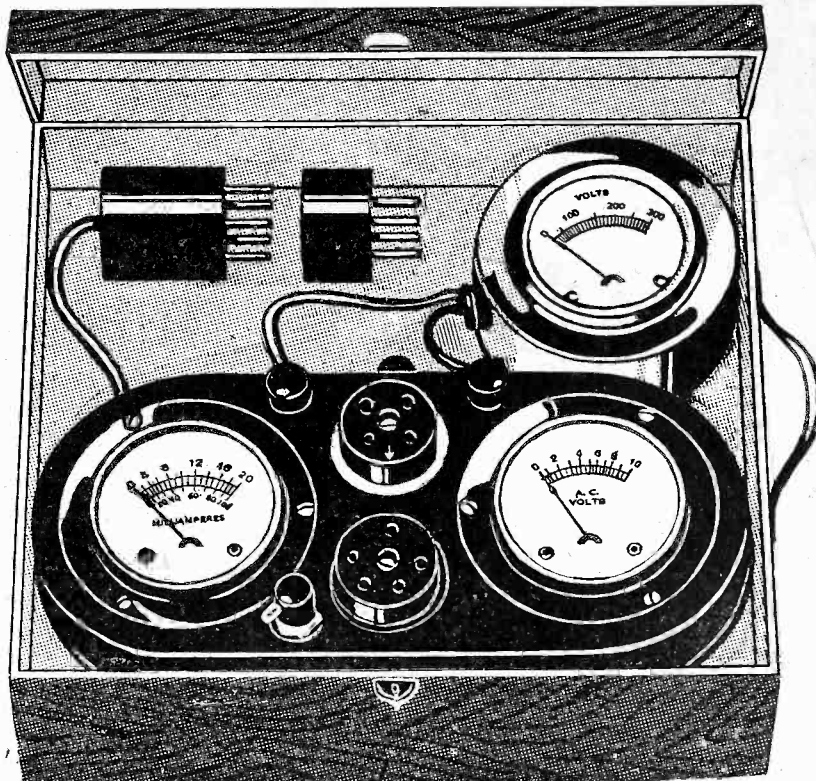

This housed Jiffy Tester, with high resistance voltmeter for measuring B voltages, including those of eliminators, is a service kit of the highest value. The case is furnished in a de luxe finish, with handle. A patented snaplock makes it impossible for the lid to open accidentally. The Tester and high resistance meter fit so snugly in place that they will not jar in transportation. A 5-day money-back guaranty attaches to each sale.

Jiffy Tester Combination, shown one-third size, includes 0-10 voltmeter reading AC or DC (same meter reads both); 0-20, 0-100 milliammeter, with change-over switch; cord and plug with 4-prong adapter; 0-300 high resistance voltmeter. Price \$13.50. Complete instruction booklet and de luxe carrying case FREE with each order.

## Jiffy Tester a Scientific Trouble Shooter

Every service man, custom set builder, home experimenter, student or teacher needs one of these Jiffy Tester Combinations. Ample accurate for this class of work. You will be well satisfied with assured 5% plus or minus accuracy. Jiffy Tube and Set Tester, consisting of 0-20, 0-100 combination milliammeter, 0-10 AC and DC voltmeter and 0-300 high resistance voltmeter. De luxe carrying case and instruction booklet FREE with each order. Jiffy Tester Combination A.

**\$13.50**

The 0-300 high resistance voltmeter in "Jiffy Tester Combination A" is accurate to 5% plus or minus, so that at maximum reading it is not more than 15 volts off. Those desiring a more accurate 0-300 high resistance meter, never more than 3 volts off, at maximum reading, should order "Jiffy Tester Combination B," which has a 0-300 meter accurate to 1%, at a cost of \$1 extra. Order "Jiffy Tester Combination B." De luxe carrying case and instruction booklet FREE.

**\$14.50**

## Here Are the Thirteen Vital Tests!

- (1) to measure the filament voltage, up to 10 volts, of AC and DC tubes;
- (2) to measure the plate current of any one tube, including any power tube, from less than 1 milliamperes up to 100 milliamperes;
- (3) to measure the total plate current of a receiver or amplifier, up to 100 milliamperes. (Hardly any set draws more);
- (4) to measure the B voltage applied to the plate of tube; the voltage across B batteries or B eliminators, up to 300 volts;
- (5) to determine the condition of a tube, by use of the grid bias switch;
- (6) to measure any tube's electronic emission;
- (7) to regulate AC line, with the aid of a power rheostat, using a 27 tube as guide;
- (8) to test continuity of resistors, windings of chokes, transformers and circuits generally;
- (9) to find shorts in bypass and other condensers, as well as in inductances, resistors and circuits generally;
- (10) to read grid bias voltages, including those obtained through drops in resistors;
- (11) to determine the presence of distortion and overloading;
- (12) to test for correct bias;
- (13) to determine starting and stopping of oscillation.

[Note—Instruction booklet fully informs you how to make each and every one of these tests in a jiffy.]

### Note All That You Get!

For \$13.50 you receive:

- (1) One Two-in-One 0 to 10 voltmeter for AC and DC. Same meter reads both. Scale especially legible at 1½ to 7½ volts. This meter reads the AC and DC filament voltages.
- (2) One DOUBLE reading DC milliammeter, 0 to 20 and 0 to 100 milliamperes, with changeover switch. This reads plate current, which is always DC in all sets.
- (3) One 0-300 volts high resistance voltmeter, No. 346, with tipped 30" cord to measure B voltages.
- (4) One 5-prong plug with 30" cord for AC detector tubes, etc., and one 4-prong adapter for other tubes.
- (5) One grid switch to change bias.
- (6) One 5-prong socket.
- (7) One 4-prong socket.
- (8) Two binding posts.
- (9) One handsome moire metal case.
- (10) One instruction sheet.
- (11) One de luxe carrying case.

If 0-500 volt 5% accuracy high resistance meter is preferred to 0-300 volts, add \$1.00, and order Combination C at \$14.50.  
If 0-500 volt 1% accuracy high resistance meter is preferred to 5% accuracy 0-500 voltmeter, add \$2.00, and order Combination D at \$15.50.  
[Note—A pair of adapters for UV199 tubes, Cat. No. 999, at \$1.00 extra. These are not sold except with Jiffy Tester Combination.]

GUARANTY RADIO GOODS CO.  
145 West 45th Street, New York City.  
(Just East of Broadway.)

Please ship at once your Jiffy Tester Combination for which I will pay post-man advertised prices, but no shipping charges. (Check off below.)

- One Jiffy Tester Combination A (0-10 v., 0-20, 0-100 m. a., 0-300 v., carrying case, instruction booklet FREE).....Price \$13.50
- One Jiffy Tester Combination B (same as above, but with 0-300 voltmeter accurate to 1%). Price.....\$14.50
- One Jiffy Tester Combination C (same as A, except 0-500 voltmeter re-places 0-300). Price.....\$14.50
- One Jiffy Tester Combination D (same as C, except 0-500 voltmeter in-accurate to 1%). Price.....\$15.50
- Set of 199 adapters. Price.....\$1.00

NAME.....  
ADDRESS.....  
CITY..... STATE.....

5-DAY MONEY-BACK GUARANTY

# HOW TO USE SCREEN GRID COILS

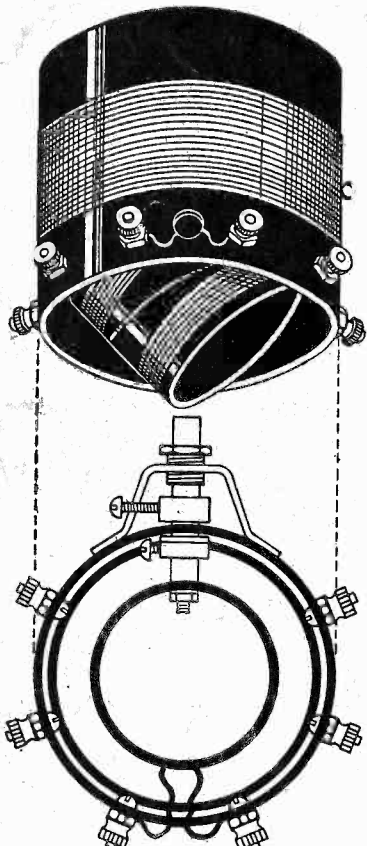

Model 5HT. High impedance 3-circuit tuner, to work out of a screen grid RF tube. For .0005 mfd. ....\$3.00  
Model 5TP. Same as above, but for .00035 .....\$3.25

WHEN a screen grid tube is used as a radio frequency amplifier, the maximum gain, the best amplification, the most volume and the most DX are obtained by tuning the plate circuit. Then this enormous amplification is itself doubled by providing a secondary with twice as many turns as the primary has. The secondary is not tuned. The high impedance 3-circuit tuner at left (Model 5HT) is an example, as is the two-winding coil (Model 5TP) at lower left. The primary in these two instances is the outside winding and the tuning condenser goes across it. The secondary is wound on a separate form that is riveted inside the primary form. Preferably mount coils with binding posts at bottom for short leads. Then the connections for Models 5HT, 3HT, 5TP and 3TP are, from right to left as you look at the back of the coil: B+135, near front panel; plate of screen grid tube; two rotary leads (for tuner only); grid and (next to panel) grid return.

The antenna coil to use in screen grid circuits is 5A or 3A (upper right), because it is so designed as to equalize tuning. The low, almost zero, capacity between grid and filament of the tube is compensated by extra turns of wire, so that if the tube following the screen grid is of another type, for instance a regular detector, the elemental capacity difference is nullified. The antenna coupler has a continuous winding in shaded colors. The end with the larger number of distinctive turns goes to grid, the opposite end to ground. Either of the two remaining binding posts goes to antenna.

For single control screen grid sets the inductive trimmer type of antenna coupler (Model 5AS or 3AS, at right) should be used. The inductive trimmer coil for interstage coupling is Model 5TPS or 3TPS (not illustrated), but its connections are shown in the diagram at lower right. An inductive trimmer adds to or subtracts from the reactance, which is very important for resonance in single control sets. Trimming condensers only increase reactance, hence fail where decrease is needed.

Model 5TPS Interstage coupler to screen grid tubes, with inductive trimmer. For .0005 mfd. ....\$2.25  
Model 3TPS, same as above, except it is for .00035.....\$2.50

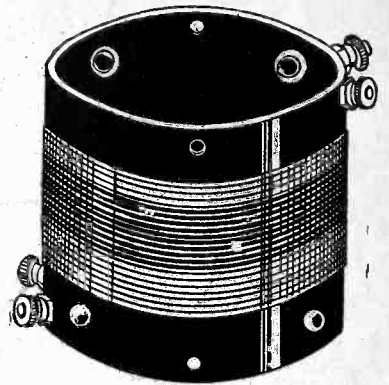

Model 5A. Conductively coupled antenna coil for input to screen grid radio frequency amplifier. For .0005 mfd. condenser. Price .....\$1.75  
Model 3A. Same as above, but for .00035 .....\$2.00

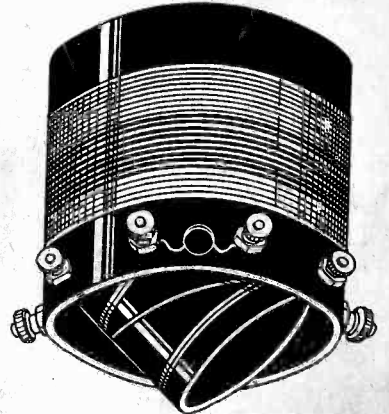

Model 5AS. Inductively coupled antenna coil for single tuning control screen grid sets. Rotor is an inductive trimmer. For .0005 mfd. ....\$2.75  
Model 3AS, same as above, but for .00035 .....\$3.00

## ALL ROTOR COILS HAVE SINGLE HOLE PANEL MOUNTING FIXTURE

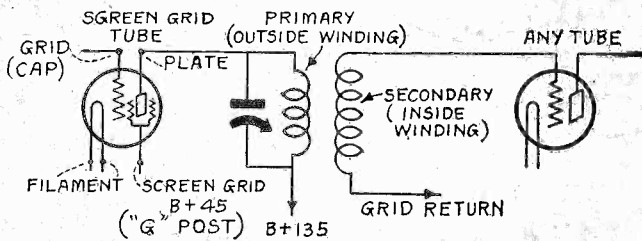

How tuned primary in plate circuit is wired for a screen grid tube. This illustrates the use of Model 5TP or 3TP, also Model 5HT and 3HT, except for the rotor coil connections.

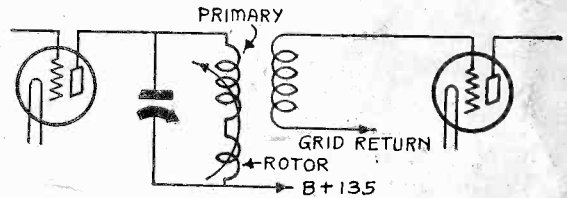

In single control circuits Model 5TPS is used as shown, for interstage coupling. The rotor is an inductive trimmer. The tube at left is a screen grid.

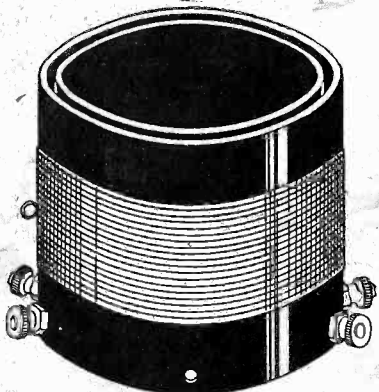

Model 5TP, the wiring of which is shown in the diagram directly above, is an interstage coupler for screen grid tubes. For .0005 mfd. ....\$2.00  
Model 3TP. Same as above, but for .00035 .....\$2.25

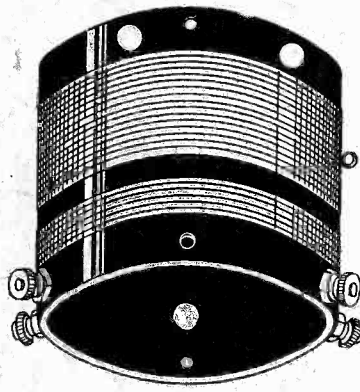

Model R5, interstage coupler for replacing present coil in existing receiver when screen grid tube is substituted. For .0005 .....\$1.50  
Model R3. Same as above, but for .00035 .....\$1.75

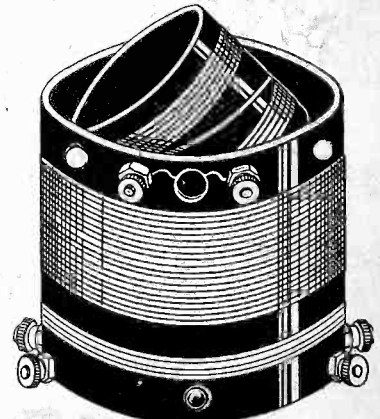

Model T5, standard 3-circuit tuner, not for screen grid tubes, but for all others. For .0005 .....\$2.50  
Model T3, same, but for .00035.....\$2.75

### Coils for Other Than Screen Grid Tubes

When any tubes other than screen grid tubes are used as radio frequency amplifiers, standard coils are used, for instance Models T5 and T3, the three-circuit tuner shown above at right.

For the antenna coil in such a circuit use one with two separate windings, the familiar radio frequency transformer, with about 14 turns on the primary. This RF transformer is therefore used as antenna coil and as an interstage coil.

The resultant loose coupling of antenna reduces the capacity effect of the antenna and thus the standard TRF coils, with 201A, 112A, 226, 227, 199 or 240 tubes, providing the same RF tubes are used throughout, may be used in single control sets without trimming devices. This is true if the coils are absolutely matched, as Models RF5 and RF3 are.

The small winding (primary) is connected in the antenna-ground circuit, or, for interstage coupling, in the plate circuit. The large winding (secondary) is tuned and is put in the grid circuit.

Model RF5. Antenna coil or interstage coupler for any and all tubes, excepting only screen grid tubes. For .0005 .....\$1.00  
Model RF3, same as above, but for .00035 .....\$1.25  
Model T5, standard 3-circuit tuner for .0005 .....\$2.25  
Model T3, standard 3-circuit tuner for .00035 .....\$2.50  
Model 5AC.....\$1.50 Model 3AC.....\$1.75

### USE THIS COUPON

Screen Grid Coil Co., 143 W. 45th St., N. Y. C. (Just East of Broadway)

(Specify Quantity in the Squares)

Please mail me at once your following coils, for which I will pay postman the advertised prices, plus a few cents extra for postage.

Model.....  Model.....  Model.....  Model.....  Model.....

Name .....

Address .....

City ..... State .....

SEND NO MONEY!