

# LIST OF STATIONS WITH 166 CHANGES FROM ORIGINAL REALLOCATION

(EFFECTIVE NOVEMBER 11TH)

NOV. 3d, 1928

15 CENTS

WGY GETS  
HEARING ON  
WAVE APPEAL

—○—  
*Regeneration  
Patent In  
Final Court*

—○—  
All Set To Put  
Election Returns  
On Air Quickly

—○—  
*Latest News  
of the Trade*

# RADIO

REG. U.S. PAT. OFF.

# WORLD

The First and Only National Radio Weekly

345th Consecutive Issue—Seventh Year

PICTURE DIAGRAM  
OF THE 4-TUBE SG  
DIAMOND-OF-AIR

—○—  
*New Victoreen  
Duplex Amplifier  
In Novel Push-Pull*

—○—  
New Disc Turns  
Two Ways At Once  
To Scan Objects

—○—  
*S-M Short-Wave  
Round-the-World 4*

## SKY-HIGH RF AMPLIFICATION IN NEW WAY!

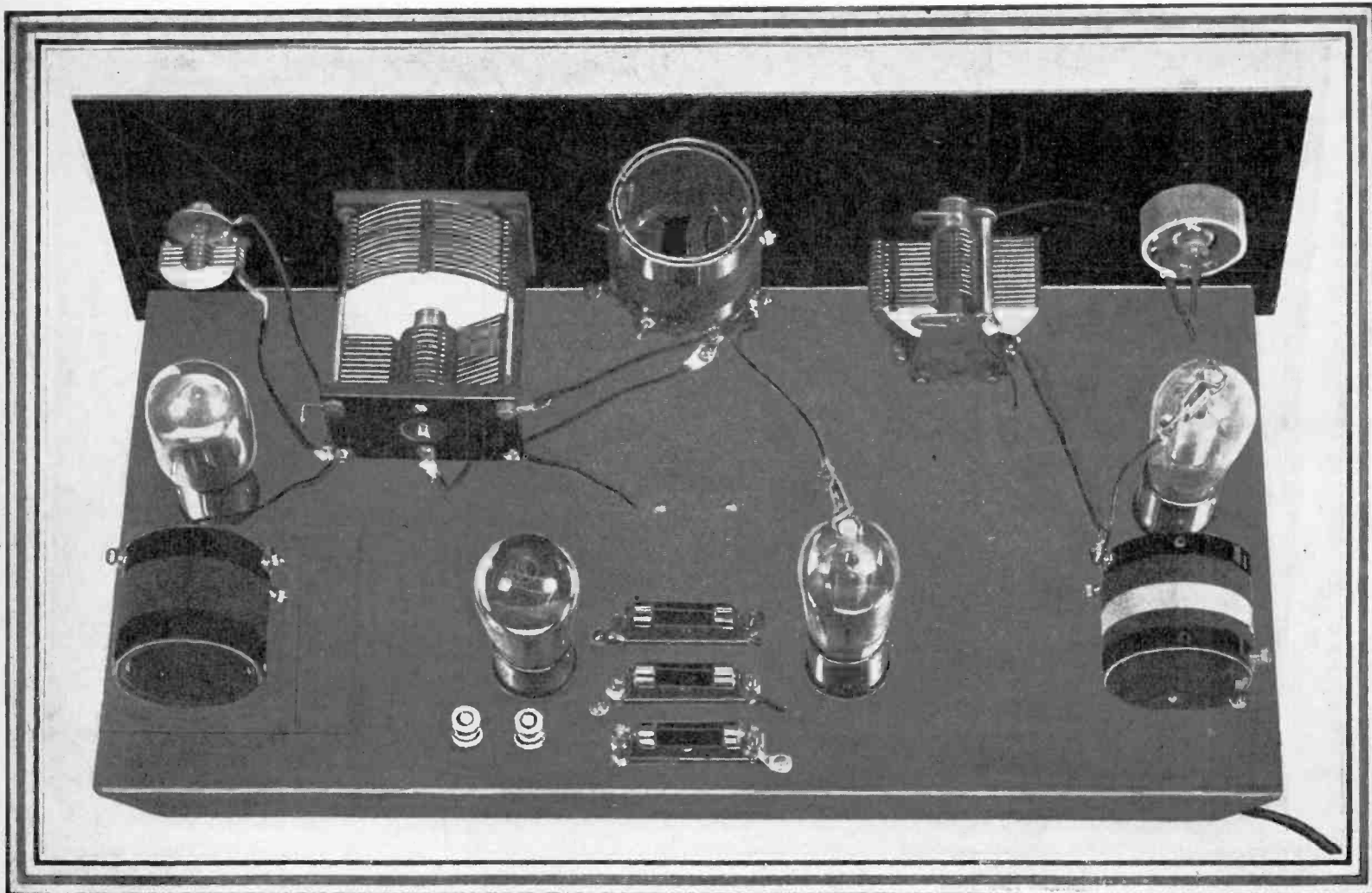

The Innovation Four uses two screen grid RF stages, detector and one audio—an original circuit of fascinating appeal. See pages 10 and 11.

# AIR COLUMN HORNS ARE SPLENDID!

Especially Those Made of Molded Wood

EVERYBODY who uses a horn loud speaker of the latest type, consisting of an air column design, with long tone travel, agrees that the tone is splendid. Our Model 595 has a travel distance of 8 feet from the unit to the large end of the "bell." If you must economize on space, use Model 570, with a 6-foot tone travel, with not quite as strong reproduction of low notes. But No. 595 is better and, if you've the room (21 1/4" high, 18" wide, 15" deep), choose that one. Every purchaser is a delighted customer. Order one of these specially moulded wood horns. Try it for 90 days. If not delighted, return it and get back your money, including any shipping charges you paid! (Note: Not a single one of these horns has ever been returned to us, though we've sold many hundreds!)



Model 595 (illustrated above) Baffle board (not shown) FREE with each order. List price \$18.00. Our price (40% and 2% off list price) —

**\$10.58**

Model 570, size 15" high by 12" wide by 12" deep, 6-foot tone travel. FREE baffle board. List price \$13.00. Our price (40% and 2% off list price) .. \$7.64

Model 112 horn motor stands 250 volts without filtering (illustrated at right). List price \$8.00. Our price (40% and 2% off list price).....\$3.53

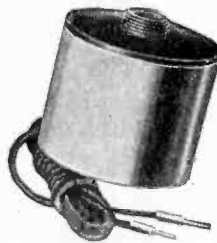

ACUSTICAL ENGINEERING ASSOCIATES, 143 West 45th St., New York City. (Just East of Broadway)

- Please ship me at once the following (check off):
- One No. 595 at \$10.58, plus a little extra to defray shipping costs; send it already mounted in FREE baffle board.
  - One No. 570 at \$7.64, plus a little extra to defray shipping costs; send it already mounted in FREE baffle board.
  - One No. 112 horn motor (universal nozzle) at \$3.53, plus a few cents extra for shipping.

NAME.....  
 ADDRESS.....  
 CITY..... STATE.....  
**90-DAY MONEY-BACK GUARANTEE!**

# HERE IT IS!

The Transformer You Have Been Looking for so Long

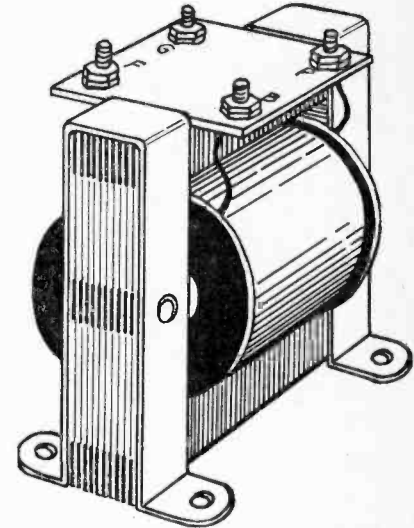

1-to-3 1/2 ratio audio frequency transformer; exactly same size as illustrated; two stages provide enormous volume for speaker operation. Tone pure, construction sturdy. Excellent for portables, home receivers, phonograph amplifiers, etc. Cat. 3521. Each....

**\$1.75**

## EXCELLENT FOR REPLACEMENT

When any audio transformer goes bad in a set you often wonder where to get another to replace it. This one is an ideal replacement transformer. Where any audio transformer is taken out, this one fits in. Money back if not satisfied in ten days.

### SEND NO MONEY

Guaranty Radio Goods Co., 145 West 45th Street, N. Y. City (Just East of Broadway)

Please send at once C.O.D.  Cat. No. 3521 Audio Transformers. (Write quantity in square.)

NAME.....  
 ADDRESS.....  
 CITY..... STATE.....

# Cash in on This Offer Now!

ONE full year's subscription for any TWO of the following magazines given to you—RADIO NEWS or SCIENCE AND INVENTION or RADIO (San Francisco) or BOYS' LIFE.

Select any TWO of these four publications, each of which will be sent to you (at only one address, however) each month for twelve months—in other words, 24 issues—if you will send in now your subscription for RADIO WORLD for two years (104 numbers) at \$10.00. RADIO WORLD'S subscription price for one year is \$6.00, so you gain the extra dollar by taking advantage of the liberal offer for two-year subscriptions; and, besides, you get a subscription for each of the TWO other magazines selected from the enumerated list, making a total of 128 numbers for \$10.00.

If you want to select only one from among the four other magazines, you may obtain this one for TWO years, so that you will be subscribing for RADIO WORLD for two years and for the other magazine for TWO years, all for only \$10.00 (both mailed to one address only).

These offers are rightly regarded as among the most liberal ever made, but as they are limited as to expiration date (see notice below) you must act now.

Please use the attached coupon.

## SPECIAL TWO-FOR-PRICE-OF-ONE COUPON

RADIO WORLD, 145 West 45th Street, New York City (Just East of Broadway): Enclosed please find \$10.00, for which send me RADIO WORLD each week for two years (104 numbers), and also send me, without extra cost, each month for one year each of the following TWO magazines—total, 24 issues—grand total, 128 numbers:

- RADIO NEWS  RADIO (San Francisco)
- SCIENCE AND INVENTION  BOYS' LIFE

If you want one of each, put a cross in a square next to the name of each of the two other magazines. If you want a two-year subscription for ONE of the above magazines, with the two-year subscription for RADIO WORLD (same grand total of 128 numbers), put two crosses before the name of one magazine.

If you prefer to pay \$6.00 for only one year's subscription for RADIO WORLD (52 numbers) and get one of the other magazines, without extra cost, put one cross in one square in front of the name of one magazine.

Present RADIO WORLD subscribers may renew under this offer. If renewing, put a cross here .

Name.....  
 Street Address.....  
 City..... State.....

**THIS OFFER EXPIRES AT NOON ON DECEMBER 15TH, 1928**

# BLUEPRINT FREE!

4-Tube Screen Grid Diamond of the Air Blueprint, full sized picture wiring diagram; also schematic diagram and panel layout.

At 15c per copy RADIO WORLD costs you 60c for four weeks. But if you send 50c NOW you get the first and only national radio weekly for four consecutive weeks and this handsome official blueprint FREE!

This blueprint is life-sized and shows in easy picture diagram form how to mount parts and wire this super-sensitive receiver. One screen grid tube is used as radio frequency amplifier. The rest of tubes are two—01A and one 112A.

This circuit gives you distance, tone quality, ease of performance. No shielding, no neutralizing required!

Radio World, 145 West 45th Street, New York City

Enclosed please find 50 cents (stamps, coin, check or money-order) for which send me RADIO WORLD for four weeks, and free Diamond S. G. blueprint.

Name.....  
 Address.....  
 City..... State.....  
 Renewal.

If you are already a mail subscriber for RADIO WORLD you may extend your subscription four weeks and get free blueprint, but put a cross in the square.

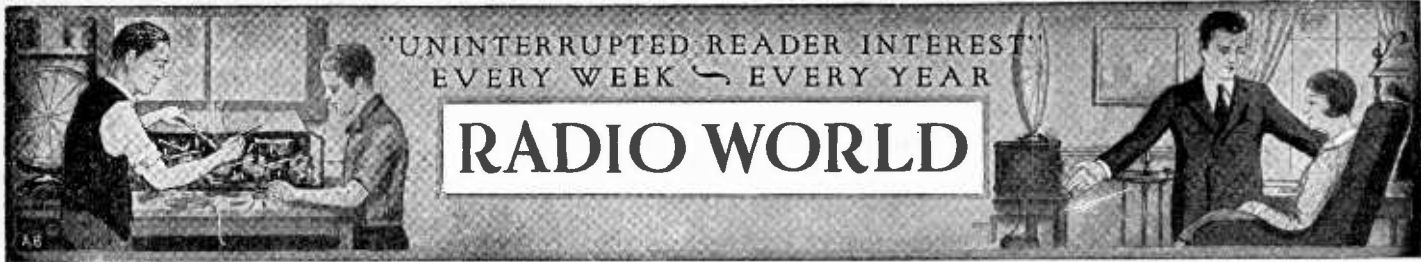

NOVEMBER 3, 1928  
 Vol. XIV, No. 7, Whole No. 345  
 15c Per Copy, \$6 Per Year.  
 [Entered as second-class matter, March,  
 1922, at the post office at New York,  
 N. Y., under Act of March, 1879.]

Latest News and Circuits  
 Technical Accuracy Second to None

A Weekly Paper published by Hennessy  
 Radio Publications Corporation, from  
 Publication Office, 145 West 45th Street,  
 New York, N. Y.  
 (Just East of Broadway)  
 Phone: BRyant 0558 and 0559

# Reallocation Revised

## Board Checks Up, Makes 166 Changes to Eliminate Interference and Injustice—Public and Stations Anxiously Await November 11th

Washington.

**L**ISTENERS and stations alike are anxiously awaiting the reallocation of frequencies and power, effective November 11th at 3 a.m., and in force until February 1st, 1929, when the station licenses under the reallocation will expire.

Confidence is expressed that reception conditions will improve, that listeners will obtain greater enjoyment because of easier tuning, absence of heterodyne growls or peanut whistles, and better promise of distant reception this Winter than has obtained in three years.

The members of the Federal Radio Commission and their expert assistants promise improvement, not only more distant reception but cleaner receptions as well.

Meanwhile the public and many of the stations are waiting anxiously and hopefully, confident of improvement, but preferring to discern the rosiness thereof with the eye of experience rather than accept it unreservedly from the mouth of prophecy. There was a reallocation last December, also introduced amid flourishes and ruffles, but it turned out to be of small help, and one of the Radio Commissioners recently said that attempt was a failure.

### 166 Changes Made

The impending reallocation itself will not be the identical one announced with such high praise, for 130 were changed a few weeks later, then 30 small stations in a few days, then six more stations, a total of 166 alterations. Many of these were made to get rid of interference and to prevent injustice. WGY, Schenectady, N. Y., was not one of those to benefit.

In this issue RADIO WORLD is publishing the reallocation list, as corrected and revised up to the moment of going to press, including the 166 changes.

The 130 changes, according to a statement by the Commission, were due in part to improvements in allocations made possible through an extensive check-up; to the desire to remedy certain injustices to particular stations, and to the necessity of correcting a few sources of interference.

Most of the changes were in the Middle-west and Pacific (Fourth and Fifth) Zones, where it was found possible to shift assignments and improve service to listeners.

There probably will be additional changes as a result

of applications of stations for modification of their licenses under the allocation, some 25 of which were heard recently by the Commission.

The Commission's statement announcing the 130 changes contained the following:

"All stations dissatisfied with their assignments under the revised allocation should follow the procedure set forth in the Commission's statement of September 11th, 1928. Applications must be on forms provided by the Commission; these may be obtained from the Radio Supervisors or from the secretary of the Commission.

"All such applications must specify what frequency, power, and/or hours of operation are desired by the applicant. No one application may specify more than one frequency. If one applicant files two or more applications for different frequencies, only one of the applications will be set aside for hearing, and consideration of the others will be postponed until the one heard is disposed of; if such an applicant fails to designate which application he desires to be heard first, the Commission will select such application."

### Hearings Are Begun

The succeeding thirty changes were simply announced as additional to the others, but affected local stations only.

The next six changes were only in the Second Zone.

Hearings on protests and requests were begun by the Commission. WJAR, Providence, R. I., requested a permit for 1,000 watts, so new equipment might be installed therefor, the station meanwhile using 500 watts.

KFSD, San Diego, Calif, asked to be restored to 1,000 watts. It had been given 500 watts.

WEPS, Gloucester, Mass., owner, Matheson Radio, Inc., requested a change in frequency from 1,010 to 1,040 kilocycles and an increase in power from 100 to 1,000 watts.

WGY is down for a hearing, finally. It seeks a cleared channel. Under the original reallocation it was put in secondary position to KGO, Oakland, on the same frequency, so that in effect WGY could not broadcast at night. Albert Ottinger, Attorney General of New York State, asked the Federal Radio Commission to permit the State to be represented at the hearing, in the interests of 3,000,000 WGY listeners, most of whom live in the State.

Much interest attaches to the case, not only because of the station's large service area, but because of the difficulty the station has experienced in obtaining a hearing, although it is one the six most important stations in the United States.

# HEARING FINALLY GRANTED TO WGY

Washington.  
An order for a hearing on the application of WGY, Schenectady, N. Y., owned and operated by the General Electric Company, on the application for a cleared channel, instead of sharing time, was granted by the Federal Radio Commission.

Harry Sadenwater, engineer, obtained the hearing on a formal application. The rules require that WGY state what cleared channel it desires. This the station is reluctant to do, explaining it has no quarrel with any other station, but it is expected to comply with the rules nevertheless.

Some confusion has arisen because Secretary Butman of the Commission has written, to persons sending in protests, that WGY can arrange with the other General Electric station,

KGO, Oakland, Calif., for division of time, so as to broadcast at night. The 790 kilocycle wave was given to KGO as a cleared channel "primarily," with WGY on that channel "supplementary," he wrote. Louis G. Caldwell, counsel to the Commission, pointed out in a letter to WGY that it had to select a proposed cleared channel allotted to the First Zone, in which WGY is located, while KGO is in the Fifth Zone, and must not be encroached upon under the proposed plan. Thus Butman virtually said that WGY could usurp the 790 kc channel, while counsel for the Commission said just the opposite. That left WGY under contradictory advice, except that the counsellor's letter to WGY was an official, direct communication to the station, while Butman's letter was to protesting listeners.

## Board's Counsel Puts Appeal up to WGY

Washington.

Louis G. Caldwell, general counsel of the Federal Radio Commission, wrote the following letter to the General Electric Company, operator of WGY, Schenectady, regarding the recent refusal of the appeal for a cleared channel and 150,000 watts power, which refusal was made without a hearing:

Apparently there has been a misapprehension on your part as to the action taken by the Federal Radio Commission on your recent application for modification of your license, effective November 11th, 1928. This misapprehension seems to have been conveyed to a large number of listeners of Station WGY.

In filing the application in question, you disregarded fundamental rules and regulations of the Commission, copies of which were mailed to you over a month ago. These rules and regulations have been brought to the attention of your representatives repeatedly during the past week and they have been told that there is no difficulty in the way of obtaining a hearing, provided you file a new application which is in compliance with the very reasonable requirements made by the Commission.

### Questions Propriety of Channel

The rules and regulations in question are General Orders Nos. 40 and 42. Under General Order No. 40, the 40 cleared channels have been divided equally among the five zones,—eight channels to each zone. The particular channels assigned to the first zone are 660, 710, 860, 990, 1,060, 1,100 and 1,150.

Instead of applying for one of these channels you applied for a channel assigned to the fifth zone, composed of the States of the far west. What you are really asking the Commission to do is to take away a channel from the fifth zone and give it to the first zone, in violation of the requirements of the Radio Act, as

amended, with the inevitable results of breaking down the structure which the Commission has built up after months of work, careful study and consultation with the leading radio engineers of the country.

### 50,000 Watts Total Limit

In addition, your application requests a power assignment of 150,000 watts, although you must have known that, under the terms of General Order No. 42, the maximum power that the Commission will license on any channel is 25,000 watts, together with an additional 25,000 watts, the continuation of which will depend upon whether interference results.

In this respect, your application is asking a favor from the Commission which has not been and will not be granted to any station in the country, so long as General Order No. 42 is in effect.

To obtain a hearing, all you have to do is to file a new application specifying a channel which is available to the first zone, and amount of power which is permitted under General Order No. 42.

### Glad to Give Hearing

With such an application on file, the Commission will be glad to accord you a hearing just as it would any other applicant. There is no necessity, however, for having a hearing as to the question of whether or not your present application complies with the rules and regulations of the Commission, since it is manifest from an inspection of the documents that it does not. You are, of course, free to attack the whole structure by questioning the validity of these regulations on appeal.

The Commission feels, however, that your listening public should be informed that if you do not obtain a hearing, it is due to your unwillingness to comply with rules that all other broadcasting stations are at present complying with.

has become obsolete, and installing better designs.

But what about engineering design in the equally-important "ether link" between receiver and transmitter?

It is to introduce corresponding high standards of engineering excellence into this great interconnecting medium between your receiver and your favorite station, that the present reallocation has been carefully worked out with the aid of the best engineering and radio minds in the country.

For what will it avail to have the best-engineered receivers and the best engineered transmitters, if the conductor between them is not carefully planned so as to utilize our precious few broadcasting wavelengths to best efficiency in the public interest.

Congress, by its Radio Act of 1928, ordered a reallocation of the nation's radio facilities. By this mandate of Congress, a general upsetting of the broadcasting wavelengths was inevitable.

With such reallocation coming anyhow, it has been the care of the Federal Radio Commission to see that the rearrangement of wavelengths and powers should also bring with it good radio reception to all listeners in all parts of the country. Conference after conference has been held with leading radio men and the best engineering advice and ingenuity have been applied, after incessant labors of the Commission's staff throughout the past four months.

In so far as the Commission has followed the engineers' advice, good radio is assured after November 11th, when the new plant takes effect.

In those respects where the Commissioners disregarded the engineers' recommendations, such as in adopting only 40 cleared channels, instead of the 50 recommended by the engineers, trouble already looms ahead for listeners, as well as for broadcasters.

### "A Grave Mistake"

Certainly, it would appear that the Commission has made a grave mistake in not providing enough clear channels to give full-time on the air for a great pioneer station like WGY of Schenectady.

In Chicago, a similar 50,000-watt transmitter, representing an investment of \$600,000, will have to stand idle five nights a week, because not enough clear channels were voted. In the South other 50,000-watt units will have to remain off the air half-time.

It is these great high-power units which serve huge audiences over great areas—audiences many times the total number of those of the two or three 500-watt stations which likewise consume a channel, but provide only limited service.

As the members of Congress learn the scientific facts concerning radio broadcasting, and the greater public interest to be served by more high-power channels, it can be predicted that action will be taken instructing the Commission to follow the engineers' advice and set aside 50 or 60 clear channels, to secure the greater public service.

## Commission's "Grave Mistake"

By Orestes H. Caldwell

Federal Radio Commissioner from the First Zone.

When you listen in on the radio tonight, three things are essential to your reception of the program: (1) A transmitting station; (2) a medium to carry the radio to you—the ether; and (3) your receiving set.

Now that radio receiving set in your home represents the best engineering design that its makers could command at the time it was built. Every part of that

set is carefully planned to work with best efficiency with every other part, so that the receiver, as a whole, is a marvelously effective unit.

Similarly, the great radio broadcasting stations which send out the programs are models of efficient engineering design. No effort or money is spared to get the best equipment. To this end, stations are continually replacing apparatus that



# GET YOUR ELECTION RESULTS BY RADIO!

The outstanding feature of the present political campaign for the presidency of the United States is that radio has been the chief agency for informing the electorate of the qualifications of the candidates and of the principles for which they stand. Never before have so many people heard the candidates themselves speak. Never before have so many people heard so many other prominent speakers, nor so often. Never before have so many people been so thoroughly interested in a campaign. Never before have so many people become acquainted with the candidates and the issues. Radio has brought all the people of the United States into one gigantic auditorium at the same time to listen with comfort to the candidates and to other prominent speakers.

It is true that radio was used to some

extent in the 1924 campaign, but not on the vast scale that it has been this year. At that time there were no national hook-ups as we know them today. At that time there were not so many listeners to any one station as there are today. Candidates and other prominent members of the various parties spoke before the microphone of one station at a time, and only a relatively small number of people listened. Even the speeches in those days were treated by the broadcasting stations as news, as were the proceedings of the conventions. About all that any listener in 1924 remembers of the conventions and the campaign is the "Twenty-four votes for Underwood."

Just as the 1928 campaign is primarily a radio campaign, so the election will be a radio election. The citizens will not

gather on the street corners this year to receive the returns as they are made available by the various election boards. They will not gather in huge numbers in front of newspaper offices to read the bulletins. They will not expose themselves to cold November rain and snow and wind. But they will remain comfortably in their homes and receive the latest returns without delay over their radio sets. And they will be entertained between reports by the finest music that radio has to offer, and that is the finest music the world has to offer as well.

This is truly a radio campaign, and it will be followed by a radio election.

Those who sponsor programs that evening on the national chains are fortunate because they are sure of having the entire population listening.

## Board's Power Upheld in Air Regulation

Chicago.

Federal Judge James H. Wilkerson has upheld the right of the Federal Radio Commission to regulate the wavelengths and powers of broadcasting stations under the Radio Act of 1927, in an order denying the petitions of two Chicago stations for an injunction to restrain the Commission from enforcing its order to reduce the power of the stations.

The stations were WCRW operated by Clinton R. White, and WEDC, operated by Emil Denmark. Their petition alleged that the Commission's order confiscated their property without due process of law and that the penalties for violation were excessive.

The Court rules as follows:

"Congress has the power to regulate radio wavelengths, time and power. The delegation of that power to the Radio Commission is proper.

"The standard of public interest, convenience and necessity is not vague, and if the plaintiffs maintain that the Commission acted arbitrarily in cutting their power they have the proper remedy, which is to appeal to the Circuit Court of the District of Columbia. The plaintiffs by starting their stations before the act was passed have no property rights in their use of the ether which cannot be regulated by the Commission."

Washington.

The members of the Federal Radio Commission were greatly pleased with the decision of Federal Judge James H. Wilkerson in the case of stations WCRW and WEDC against the Commission. Judge Eugene O. Sykes, Vice Chairman of the Commission, said that he had never doubted that the courts would uphold the radio law.

## Lamp is Lit by Current from Aerial

London

Power picked up by a steel crane from a broadcasting station's aerial 125 yards away, in the West End, was enough to light up a Neon tube that required 300 volts for brilliancy. Gasoline and matches were lighted during experiments by a radio engineer. He reported:

"Buildings in the vicinity of wireless transmitting stations carry unsuspected high oscillatory electric currents of some magnitude. If currents of anything like the magnitude of those encountered in the present tests exist on other sites there is a possible risk, due to the emanation of free gases and the electrolytic disruption of gas, water and electric mains forming part of a closed circuit.

"Careful study is advised."

## Davis Bill Provisions

The 1928 Radio Act, or Davis Amendment, approved March 28, 1928, requires that the radio supervising authority "shall as nearly as possible make and maintain an equal allocation of broadcasting licenses, of bonds of frequency or wavelengths, of bonds of frequency or wavelength and of station power, to each of (the five) Zones, and shall make a fair and equitable allocation of licenses, wavelengths, time for operation, and station power to each of the states . . . within each Zone, according to population."

The proportion of the total national radio facilities due each state is therefore fixed by law, and is shown by the percentages in Column B below,—based upon official estimates of 1928 populations (Column A) prepared by the U. S. Census Bureau.

The maximum of total broadcasting service can be simultaneously carried on without interference, under the present status of the law and the radio art, has been determined by the Radio Commission and its engineers, after exhaustive study and experiment, as comprising the simultaneous operation of forty stations of 5 kw and upwards, on cleared channels; 125 regional stations of 500 to 1000 watts, and 150 local stations of 10 to 100 watts. By time divisions, a larger number of actual transmitters can, of course, be operated at different times on these assignments."

## Chairman to Play Hookey from Hearings

Washington

Chairman Ira E. Robinson, of the Federal Radio Commission, formerly a Supreme Court Justice in Mississippi, said he would not sit at hearings on appeals by stations from their assignments under the reallocation plan that is effective November 11th. His brief statement follows:

"Having opposed and voted against the plan and the reallocation made there-

under, I deem it unethical and improper to take part in the hearing of complaints against the same or the hearings for the modification of the same."

Recently Commissioner Caldwell withdrew from a hearing at which a station was voicing complaint against its "draw." Virtually all of the Commissioners have found fault with some phase of the reallocation plan, although each one of them has praised the plan as a whole, excepting Chairman Robinson.

## A. T. & T. and W. E. Pay \$150,000 for Licenses

The Hazeltine Corporation has licensed the American Telephone and Telegraph Company and the Western Electric Company under the patents owned or controlled by the Hazeltine Corporation, for all radio communication, excepting broadcast receivers. But if the two licensed companies enter the receiver field, terms for extension of the license to include this are stated.

The existing contract calls for 5 per

cent. royalty. With the signing of the agreement \$75,000 was paid, as outright consideration, while \$50,000 was put up as advance royalties, \$25,000 to be paid when certain disputes now in the Patent Office are settled, which would make the total cash transaction \$150,000.

The neutralization patent is one of an important group of patents owned by the Hazeltine Corporation, which has offices in Jersey City, N. J.

## Edison Gets U.S. Medal in Chain Event

The United States Government and the British Government united recently to honor Thomas Alva Edison, the greatest inventor in the history of the world.

President Coolidge, in a broadcast speech from Washington, recounted Mr. Edison's career of amazing service to mankind. The Secretary of the Treasury, Andrew W. Mellon, a few minutes later, presented to Mr. Edison at the Edison laboratories in Menlo Park, N. J., the Congressional Medal of Honor, voted at the last session of Congress. Mr. Edison replied briefly. Ronald Ian Campbell, British Charge d'Affaires, voiced his Government's tribute and returned the original phonograph, loaned thirty-nine years ago to Kensington Museum. Mr. Edison responded with another short speech.

All these remarks were broadcast by a chain, with WEAf as the key station. The broadcast was acknowledged by the announcer from Washington as having been made possible through the courtesy of the General Electric Company.

### A Great Treat

The broadcast was one of the greatest treats in recent radio history, which has been replete with remarkable offerings, the one immediately preceding having been the broadcast of the inspiring flight of the Graf Zeppelin.

The President's speech took about ten minutes. At the conclusion he said:

"This is my message to Mr. Edison: 'Noble, kindly servant of the United States and benefactor of mankind, may you long be spared to continue your work and to inspire those who will carry forth your torch.'"

Mr. Edison is 80 years old. He is deaf, except that he can hear unusually loud shouting. Extra high amplification and ear phones possibly enabled him to catch some of the President's glowing words.

### Proud of His Medal

Mr. Mellon, who rarely appears before the microphone, revealed himself as a careful enunciator, an interesting, deliberate speaker. He, too, is an elderly man.

Mr. Edison, as usual, was brief and convincing in his remarks, uttering sincere appreciation each time. His two little speeches did not exceed a hundred words apiece. He said the medal would be preserved in his home amid his other choicest possessions.

Mr. Edison invented, among his many, many other devices, the electric incandescent lamp, the phonograph and moving pictures. He was first to contribute to the development of the modern radio tube by discovering the "Edison effect," which is that electric current will flow from the heated filament to a positive electrode, in an incandescent lamp.

## U. S. on Chain Reveals Facts to Aid Farms

Washington.

The United States Department of Agriculture has begun a five-day-a-week broadcast direct from Washington to the radio audiences of a network of fourteen stations associated with the National Broadcasting Company. The broadcast is scheduled at 12:15 to 12:30 p.m., Central Standard Time.

Secretary of Agriculture Jardine inaugurated the program with an address, "Putting Facts to Work on Our Farms."

Stations associated in the network are audible over an expanse of farming territory reaching from the Alleghenies to the Rockies and from the Canadian border to the Gulf Coast. It is estimated that 400,000 farm homes within good reception radius of the fourteen stations are equipped with radio receiving sets.

On Monday, Tuesday, Wednesday, Thursday and Friday of each week Federal workers in charge of investigations in farm production and farm economics will give the most timely farm facts of the day to this audience. The new broadcast is established, at the invitation of the National Broadcasting Company and associated stations, as a unit in the radio information service of the department. It is considered a valuable supplement to the already existing arrangements with more than 200 radio stations for transmission of weather, markets, and general agricultural knowledge.

Stations in the network for the noon-hour broadcast from Washington are: KDKA, Pittsburgh; KYW, Chicago; WCCO, Minneapolis; WOC, Davenport; WHO, Des Moines; WOW, Omaha; KDAF, Kansas City, Mo.; KWK, St. Louis; KVOO, Tulsa; WOAI, San Antonio; WHAS, Louisville; WSM, Nashville; WSB, Atlanta; and KOA, Denver.

The Radio Service of the department is in charge of the arrangement of programs.

## Canada to Consider State-Owned Stations

Ottawa

A commission will be appointed to determine whether the broadcasting stations of Canada shall continue to be privately operated, as in the United States, or whether the Government operation policy, as prevailing in England, should be followed.

In Manitoba, however, broadcasting is now conducted by the state.

### MARCONI ENDS CRUISE

London

Senator William Marconi has returned from a Mediterranean trip with his wife aboard his yacht "Electra."

## Debut Free to Winners In Audition

The National Broadcasting Company and the National Music League have worked out a plan to provide free professional concert debuts to young artists.

The League will hold auditions to select promising artists, who will then be presented, in small groups, in a program before an invited audience in the concert hall of the National Broadcasting Company at 711 Fifth Ave., New York. The programs will be broadcast, and it is hoped that the event will receive comment from the press in the entire country.

The object of the plan is to relieve young artists of the expense of their debuts. There will be absolutely no expense for the artists, either in connection with the audition or the debuts, the statement says.

### Talks on Expenses

George Engles, director of the National Broadcasting and Concert Bureau, will arrange both the auditions and the debuts. In connection with the expense of debuts to young artists he said:

"The average debut costs from \$600 to \$1,000. This is a tremendous drain on young artists, but it is considered indispensable to starting a musical career. Often the chief purpose of the debut is lost. The primary object, as every one knows, is to obtain New York press notices before attempting concerts in other parts of the country.

"Present over-crowded concert conditions make it impossible for the critics to give adequate attention to every musical event. At the height of the season there are four or five concerts on weekdays and from fifteen to twenty on Sundays.

### Musical Events

"Lesser known artists are fortunate if they secure perfunctory notice. With several artists grouped into a single concert under the new plan, some relief should be afforded to present conditions.

"These will be strictly musical events, maintaining the highest standards of the concert halls. Only the finest artists capable of winning the attention of any concert audience will receive this sponsorship."

Mrs. Otto H. Kahn represents the National Music League.

## Freshman in Merger with Freed-Eisemann

The Charles Freshman Company and the Freed-Eisemann Radio Corporation, both receiver and speaker manufacturers, have merged.

The Freshman Company stock of 500,000 shares, no par, is to be increased to 900,000 shares, no par.

### WAVES TO BE STUDIED

Ithaca, N. Y.

The Board of Trustees of Cornell University has appropriated \$70,294 for forty-two research projects. Radiation and wavelengths are to be studied, including X-rays, infra-red and shorter waves, and also the visible group.

### U. S. HEARS HOLLAND

PGJJ, Hilversum, Holland, is being picked up by American short wave receivers Thursday and Friday nights, 6 to 7:30 p. m., Eastern Standard Time, on 31.4 meters.

## Gentlemen Prefer No Blondes in Television

WRNY, the New York station operated by the Experimenter Publishing Company, publishers of "Radio News," had a television exhibit at the recent annual Electrical and Industrial Exposition, in New York City. Visitors were televised. Friends and others took turns at the

visor to see the results and enjoyed the demonstration.

The subjects for televising were confined to brunettes, it being explained that light-complexioned persons do not give so good results in the present state of development of the machine.

# The Official New Reallocation

A Call Book of Stations, Location, Power and Frequency, Arranged by States, Revised from the First List, and Including 166 Changes— Goes In Effect November 11th at 3 a.m., E.S.T.

The roster of stations, with call letters, location, frequency, and power, representing the new reallocation, constituting 166 changes from the original, goes into effect November 11th at 3 a.m. as follows:

| Station  | Owner   | Location | Power | Kc. | Station        | Owner   | Location | Power | Kc. |
|--|---|----------|-------|-----|----------------|---|----------|-------|-----|
| Washington.  |   |          |       |     | Colorado       |   |          |       |     |
| The roster of stations, with call letters, location, frequency, and power, representing the new reallocation, constituting 166 changes from the original, goes into effect November 11th at 3 a.m. as follows: |   |          |       |     | Colorado       |   |          |       |     |
| KFUM   | Colo. Springs, W. D. Corley..                                 | 1,000    | 1,270 |     | WEHS           | Evanston, Victor C. Carlson                             | 100      | 1,310 |     |
| KPOF   | Denver, Pillar of Fire, Inc.                                  | 500      | 880   |     | WKBS           | Galesburg, Permil N. Nelson                             | 100      | 1,310 |     |
| KOW  | Denver, Assoc. Industries, Inc.                               | 500      | 1,390 |     | WLBO           | Galesburg, Fred Trebbe, Jr.                             | 100      | 1,310 |     |
| KFUP   | Denver, Fitzsimmons Gen. Hospital                             | 100      | 1,500 |     | WBBM           | Glenview, Atlas Invest. Co.                             | 25,000   | 770   |     |
| KFEL   | Denver, E. P. O'Fallon, Inc.                                  | 250      | 940   |     | WJBT           | Harrisburg, Tate Radio Co.                              | 50       | 1,210 |     |
| KFNJ   | Edgewater, R. G. Howell..                                     | 50       | 1,500 |     | WCLS           | Joliet, WCLS, Inc.                                      | 100      | 1,310 |     |
| KGEW   | Ft. Morgan, City of Ft. Morgan                                | 100      | 1,200 |     | WKBB           | Joliet, Sanders Bros.                                   | 100      | 1,310 |     |
| KFKA   | Greeley, Colo, St. Tchrs. Col.                                | 500      | 880   |     | WJBC           | LaSalle, Hummer Furn. Co.                               | 100      | 1,200 |     |
| KFHA   | Gunnison, Western St. Col. of Colo.                           | 50       | 1,200 |     | WJJD           | Moosheart, Sup. Lod. of the World (Loy. Ord. of Moose)  | 20,000   | 830   |     |
| KFXF   | Denver, Pikes Peak Bdcastg. Co.                               | 250      | 940   |     | WJAZ           | Mt. Prospect, Zenith Radio                              | 5,000    | 1,480 |     |
| KOA  | Denver, Gen. Elec. Co.  | 12,500   | 830   |     | Peoria Heights |   |          |       |     |
| KLZ  | DuPont, Reynolds Radio Co.                                    | 1,000    | 560   |     | WMBD           | Peoria Hts., Radio Lab.                                 | 500      | 1,440 |     |
| KGDP   | Pueblo, Boy Scouts of America                                 | 10       | 1,210 |     | WTAD           | Quincy, Ill. Stock Med.                                 | 500      | 1,440 |     |
| KGHF   | Pueblo, Ritchie & Finch                                       | 250      | 1,320 |     | KFLV           | Rockford, Swed. Ev. Mis. Ch.                            | 500      | 1,410 |     |
| KGHA   | Pueblo, Sweeney & Walpole.                                    | 50       | 1,200 |     | WHBF           | Rock Is., Bearsley Spec. Co.                            | 100      | 1,210 |     |
| KGEK   | Yuma, Beehler Elec. Equip. Co.                                | 10       | 1,200 |     | WCBS           | Springfield, Dewing & Messer.                           | 100      | 1,210 |     |
| CONNECTICUT  |   |          |       |     | WTAX           | Streater, Wm. Hdw. Co.                                  | 50       | 1,210 |     |
| WICC   | Easton, Bridgeport Brdstg. Sta.                               | 500      | 1,430 |     | WHT            | Deerfield, Radiophone Brdstg. Corp.                     | 5,000    | 1,470 |     |
| WTIC   | Hartford, Travelers Ins. Co.                                  | 250      | 600   |     | WDZ            | Tuscola, Jas. L. Bush                                   | 100      | 1,070 |     |
| WDRC   | New Haven, Doolittle Radio Corp.                              | 500      | 1,330 |     | WRM            | Urbana, Univ. of Ill.                                   | 500      | 570   |     |
| WCAC   | Storrs, Conn. Agr. Col.                                       | 500      | 1,330 |     | WCBD           | Zion, Wilbur Voliva                                     | 5,000    | 1,160 |     |
| DELAWARE   |   |          |       |     | INDIANA        |   |          |       |     |
| WDEL   | Wilmington, WDEL, Inc.  | 250      | 1,410 |     | WHBU           | Anderson, Citizens Bank...                              | 100      | 1,210 |     |
| DISTRICT OF COLUMBIA   |   |          |       |     | WCMA           | Culver, Culver Military Acad.                           | 500      | 1,400 |     |
| WRHF   | Washington, American Brdstg. Co.                              | 150      | 1,270 |     | WGFB           | Evansville, Evansville on Air                           | 500      | 630   |     |
| WMAL   | Washington, M. A. Leese Co.                                   | 250      | 630   |     | WCWK           | Ft. Wayne, Chester W. Keen                              | 500      | 1,230 |     |
| WRC  | Washington, Radio Corp. of America                            | 500      | 950   |     | WOWO           | Ft. Wayne Main Auto Supply Co.                          | 5,000    | 1,160 |     |
| FLORIDA  |   |          |       |     | WKKS           | Gary, Johnson Kennedy Rad. Corp.                        | 500      | 1,360 |     |
| WFLA   | Clearwater, Clear. Cham. of Com. St. Petersburg Cham. of Co.  | 1,000    | 900   |     | WWAE           | Hammond, Dr. Geo. F. Courier                            | 100      | 1,200 |     |
| WSUN   | Clearwater, Clear. Cham. of Com. St. Petersburg Cham. of Co.  | 5,000    | 1,470 |     | WFBM           | Indianapolis, Ind., Pow. & Light                        | 500      | 1,230 |     |
| WRUF   | Gainesville, Univ. of Florida                                 | 5,000    | 1,470 |     | WKBF           | Ipls., Noble Butler Watson                              | 500      | 1,400 |     |
| WJAX   | Jacksonville, City of Jacksonville                            | 1,000    | 1,260 |     | WIAK           | Kokomo, J. A. Kautz                                     | 50       | 1,310 |     |
| WMBL   | Lakeland, Benford's Radio Studios                             | 100      | 1,310 |     | WBAA           | Lafayette, Purdue Univ.                                 | 500      | 1,400 |     |
| WOAM   | Miami, Elec. Equip. Co.                                       | 750      | 1,240 |     | WRAF           | LaPorte, Radio Club, Inc.                               | 100      | 1,200 |     |
| WMBF   | Miami Beach, Fleetwood Hotel Corp.                            | 500      | 560   |     | WLBC           | Muncie, Donald A. Burton                                | 50       | 1,310 |     |
| WIOD   | Miami Bch., Is. of Dreams Brdg. Co.                           | 1,000    | 1,240 |     | WSBT           | So. Bend, So. Bend Tribune                              | 500      | 1,230 |     |
| WDBO   | Orlando, Rollins College, Inc.                                | 1,000    | 620   |     | WBOW           | T. Haute, B. of Wab. Brdstg. Assn.                      | 100      | 1,310 |     |
| WCOA   | Pensacola, City of Pensacola                                  | 500      | 1,120 |     | WRBC           | Valparaiso, Immanuel Luth. Ch.                          | 250      | 1,240 |     |
| WJBW   | Sarasota, Financial Journal, Inc.                             | 250      | 1,010 |     | WKBV           | Brookville, Knox Bat. & El. Co.                         | 100      | 1,500 |     |
| WDAE   | Tampa, Tampa Pub. Co.   | 1,000    | 620   |     | IOWA           |   |          |       |     |
| WMBR   | Tampa, F. J. Reynolds   | 100      | 1,210 |     | WOI            | Ames, Iowa State College                                | 3,500    | 560   |     |
| GEORGIA  |   |          |       |     | KFGO           | Boone, Boone Biblical College                           | 10       | 1,310 |     |
| WGST   | Atlanta, Ga. School of Tech.                                  | 500      | 890   |     | KWCR           | Cedar Rapids, Harry F. Paar                             | 100      | 1,310 |     |
| WSB  | Atlanta, Atlanta Journal Co.                                  | 10,000   | 740   |     | KSO            | Clarinda, Berry Seed Co.                                | 1,000    | 1,380 |     |
| WTHS   | Atlanta, Atlanta Tech. H. S.                                  | 20       | 1,310 |     | KOIL           | Council Bluffs, Mona Motor Oil                          | 1,000    | 1,260 |     |
| WMAZ   | Macon, Mercer University                                      | 500      | 890   |     | WOC            | Davenport, Palmer School of Chiro.                      | 5,000    | 1,000 |     |
| WRB  | Columbus, Roy E. Martin                                       | 50       | 1,200 |     | KGCA           | Decorah, Chas. W. Greenley                              | 50       | 1,270 |     |
| WRBI   | Tifton, Kents Furn. & Music                                   | 100      | 1,310 |     | KWLC           | Decorah, Luther College                                 | 50       | 1,270 |     |
| WTFI   | Toccoa, Toccoa Falls Institute                                | 500      | 1,450 |     | WHO            | Des Moines, Bankers Life Co.                            | 5,000    | 1,000 |     |
| HAWAII   |   |          |       |     | KFIJ           | Ft. Dodge, C. S. Tunwill                                | 100      | 1,310 |     |
| KGU  | Honolulu, Marion A. Mulrony                                   | 500      | 940   |     | WSUI           | Iowa City, State Univ. of Iowa                          | 500      | 580   |     |
| KGHB   | Honolulu, Radio Sales Co.                                     | 250      | 1,320 |     | KFJB           | Marshalltown, Marshall Elec. Co.                        | 100      | 1,200 |     |
| IDAHO  |   |          |       |     | KTNT           | Muscataine, Norman Baker                                | 5,000    | 1,170 |     |
| KGIO   | Twin Falls, S. M. Soule                                       | 250      | 1,320 |     | WIAS           | Ottumwa, Poling Elec. Co.                               | 100      | 1,420 |     |
| KFAU   | Boise City, Indpt. Sch. Dist. of B. C.                        | 1,000    | 1,250 |     | KICK           | Red Oak, Atlantic Auto. Co.                             | 100      | 1,420 |     |
| KFND   | Jerome, Service Radio Co.                                     | 15       | 1,420 |     | KFNF           | Shenandoah, Henry Field Seed Co.                        | 500      | 890   |     |
| KFEY   | Kellogg, Union High School                                    | 10       | 1,210 |     | KMA            | Shenandoah, May Seed & Nurs. Co.                        | 500      | 930   |     |
| KSEI   | Pocatello, KSEI Brdstg. Assoc.                                | 250      | 900   |     | KSCJ           | Sioux City, Perkins Bros. Co.                           | 1,000    | 1,330 |     |
| ILLINOIS   |   |          |       |     | WJAM           | Waterloo, Waterloo Brdstg. Co.                          | 100      | 1,200 |     |
| WMAQ   | Chicago, Chicago Daily News                                   | 5,000    | 670   |     | KANSAS         |   |          |       |     |
| WMBI   | Addison, Moody Bible Inst.                                    | 5,000    | 1,080 |     | KGCN           | Concordia, Concordia Brdstg. Co.                        | 50       | 1,420 |     |
| WORD   | Batavia, Peoples Pulpit Assn.                                 | 5,000    | 1,480 |     | WLBF           | Kansas City, Everett L. Dilard                          | 50       | 1,420 |     |
| WCAZ   | Carthage, Carthage College                                    | 100      | 1,070 |     | KFKU           | Lawrence, Univ. of Kansas.                              | 1,000    | 1,220 |     |
| WEBB   | Chicago, Edgewater Beach Hotel Co.; Westinghouse El. & M. Co. | 5,000    | 1,020 |     | WREN           | Lawrence, Jenny Wren Co.                                | 1,000    | 1,220 |     |
| KFKX   | Chicago, Drovers Jour. Pub. Co.                               | 500      | 920   |     | KSAC           | Manhattan, Kan. State Agr. Col.                         | 500      | 580   |     |
| WAAF   | Chicago, Chicago F. of Labor                                  | 50,000   | 970   |     | KFKB           | Milford, John R. Brinkley, M.D.                         | 5,000    | 1,130 |     |
| WCFL   | Chicago, Clinton R. White                                     | 100      | 1,210 |     | WIBW           | Topeka, C. L. Carrell                                   | 1,000    | 1,300 |     |
| WCRW   | Chicago, Emil Denemark  | 100      | 1,210 |     | KFH            | Wichita, Hotel Lassen                                   | 1,000    | 1,300 |     |
| WEDC   | Chicago, Gt. L. Radio Brdstg. WBNB                            | 5,000    | 870   |     | KENTUCKY       |   |          |       |     |
| WENR   | Chicago, Oak Leaves Brdstg. Corp.                             | 500      | 1,360 |     | WFIW           | Hopkinsville, Acme Mills, Inc.                          | 1,000    | 940   |     |
| WGES   | Chicago, Goodson & Wilson                                     | 100      | 1,310 |     | WHAS           | Louisville, Courier-Journal Co.                         | 5,000    | 820   |     |
| WHFC   | Chicago, J. S. Boyd   | 50       | 1,310 |     | WLAP           | Louisville, Amer. Brdg. Corp. of Ky.                    | 1,200    |       |     |
| WIBT   | Chicago, Fred L. Schoenwolf                                   | 50       | 1,310 |     | LOUISIANA      |   |          |       |     |
| WKBI   | Chicago, No. Shore Cong. Ch.                                  | 500      | 570   |     | KGCH           | Cedar Grove, Bates Radio & El. Co.                      | 50       | 1,310 |     |
| WPCC   | Chicago, World Battery Co.                                    | 100      | 1,210 |     | KWKH           | Kennonwood, W. K. Henderson                             | 20,000   | 850   |     |
| WSBC   | Chicago, Sears, Roebuck & Co.                                 | 5,000    | 870   |     | WDSU           | New Orleans, Jos. H. Uhalt                              | 1,000    | 1,270 |     |
| WLS  | Crete, Westinghouse El. & M. Co.                              | 500      | 1,020 |     | WABZ           | New Orleans, Coliseum Pl. Bap. Church                   | 50       | 1,200 |     |
| WBAO   | Decatur, Jas. Millikin Univ. (same as WJBL)                   | 100      | 1,200 |     | WIBO           | New Orleans, Valdemar Jensen                            | 100      | 1,370 |     |
| WJBL   | Decatur, Gushard Dry Goods Co.                                | 100      | 1,200 |     | WJBW           | New Orleans, Chas. C. Carlson, Jr.                      | 30       | 1,200 |     |
| WIBO   | Desplaines, WIBO, Inc.  | 5,000    | 1,480 |     | WKBT           | New Orleans, First Baptist Ch.                          | 50       | 1,420 |     |
| WTAS   | Elgin, Tribune Co.  | 15,000   | 720   |     | WSMB           | New Orleans, Saenger Theatres, Inc., Maison Blanche Co. | 750      | 1,320 |     |
| WLIB   | Elgin, Tribune Co.  | 15,000   | 720   |     | WWL            | New Orleans, Loyola Univ.                               | 5,000    | 850   |     |
| WGN  |   |          |       |     | KFDX           | Shreveport, First Bap. Ch.                              | 102      | 1,210 |     |

(Continued on next page)

| Station               | Owner                          | Location                          | Power  | Kc.   |
|-----------------------|--------------------------------|-----------------------------------|--------|-------|
| LOUISIANA (Continued) |                                |                                   |        |       |
| KRMD,                 | Shreveport,                    | Robt. M. Dean..                   | 50     | 1,310 |
| KWEA,                 | Shreveport,                    | Wm. E. Antony..                   | 100    | 1,210 |
| KSBA,                 | Shreveport,                    | W. G. Patterson..                 | 1,000  | 1,450 |
| MAINE                 |                                |                                   |        |       |
| WABI,                 | Bangor,                        | First Univ. Church                | 100    | 1,200 |
| WLBC,                 | Dover,                         | Foxcroft, T. L. Guernsey          | 500    | 620   |
| WCSH,                 | Cumberland,                    | Con. Sq. Hotel                    | 500    | 940   |
| MARYLAND              |                                |                                   |        |       |
| WCAO,                 | Baltimore,                     | Monumental Radio,                 | 250    | 600   |
|                       |                                | Inc.                              | 100    | 1,370 |
| WCBM,                 | Baltimore,                     | Hotel Chateau..                   | 250    | 1,120 |
| WFBR,                 | Baltimore,                     | Balt. Radio Show..                | 250    | 1,120 |
| WLB,                  | Glen Morris,                   | Cons. Gas. E.                     | 5,000  | 1,060 |
|                       |                                | & P. Co.                          | 100    | 1,310 |
| WBES,                 | Salisbury,                     | Tom F. Little....                 | 100    | 1,310 |
| MASSACHUSETTS         |                                |                                   |        |       |
| WBZA,                 | Boston,                        | Westinghouse E. & M.              | 500    | 990   |
|                       |                                | Co.                               | 500    | 1,230 |
| WBIS,                 | Boston,                        | The Shepard Stores..              | 500    | 990   |
| WEEL,                 | Boston,                        | Edison El. Illum. Co.             | 500    | 590   |
|                       |                                | of Boston                         | 50     | 1,500 |
| WMES,                 | Mass. Educ. Soc.               |                                   | 100    | 1,420 |
| WSSH,                 | Boston,                        | Tremont Temple Bap.               | 100    | 1,420 |
|                       |                                | Church                            | 100    | 1,500 |
| WLOE,                 | Chelsea,                       | Wm. S. Pote.....                  | 100    | 1,500 |
| WMAF,                 | Dartmouth,                     | Round Hills Radio                 | 500    | 1,360 |
|                       |                                | Corp.                             | 250    | 1,450 |
| WSAR,                 | Fall Riv.,                     | Doughty & Welch                   | 250    | 1,450 |
|                       |                                | El. Co.                           | 100    | 1,200 |
| WEPS,                 | Gloucester,                    | Matheson Radio Co                 | 100    | 1,200 |
| WLEX,                 | Lexington,                     | Lexington Air Sta-                | 500    | 1,360 |
|                       |                                | tion                              | 250    | 1,450 |
| WBET,                 | Medford,                       | Boston Transcript Co.             | 250    | 1,450 |
|                       |                                | Bldg. Co.                         | 15,000 | 990   |
| WBZ,                  | E. Springfield,                | Westinghouse E.                   | 100    | 1,200 |
|                       |                                | & M. Co.                          | 100    | 1,200 |
| WKBE,                 | Webster,                       | K. & B. Elcc. Co..                | 100    | 780   |
| WBSO,                 | Wellesley,                     | H. Babson's Sta.                  | 100    | 780   |
|                       |                                | Organization                      | 250    | 580   |
| WTAG,                 | Worcester,                     | Worcester Tel. Pub.               | 250    | 580   |
|                       |                                | Co.                               |        |       |
| MICHIGAN              |                                |                                   |        |       |
| WKBP,                 | Battle Creek                   | Enquirer-News Co.                 | 50     | 1,420 |
| WSKC,                 | Bay City,                      | World's Star Knit.                | 500    | 1,410 |
|                       |                                | Co.                               | 1,000  | 680   |
| WEMC,                 | Berrien Spr.                   | Emmanuel Mis.                     | 1,000  | 920   |
|                       |                                | Col.                              | 100    | 1,420 |
| WWJ,                  | Detroit,                       | Detroit News                      | 100    | 1,310 |
| WMBH,                 | Detroit,                       | Mich. Brcdstg. Co.                | 100    | 1,500 |
| WBMH,                 | Detroit,                       | Braun's Music House               | 100    | 1,040 |
| WAFD,                 | Detroit,                       | Albert Parfet Co..                | 100    | 1,310 |
| WKAR,                 | E. Lansing,                    | Mich. State Col.                  | 100    | 1,240 |
| WFDE,                 | Flint,                         | Frank D. Fallain..                | 750    | 1,240 |
| WGHF,                 | Fraser,                        | Geo. Harrison Phelps              | 500    | 1,270 |
| WOOD,                 | Furnwood,                      | Walter B. Stiles                  | 250    | 1,270 |
| WASH,                 | G. Rapids,                     | Baxter Laundries                  | 100    | 1,370 |
| WIBM,                 | Jackson,                       | C. L. Carrel.....                 | 30     | 1,310 |
| WMPC,                 | Lapeer,                        | First Meth. Prot. Ch.             | 50     | 1,500 |
| WKBZ,                 | Ludington,                     | K. L. Ashbacher                   |        |       |
| WJR,                  | Pontiac,                       | WJR, Inc.                         | 5,000  | 750   |
| WAGM,                 | Royal Oak,                     | Robt. L. Miller..                 | 50     | 1,310 |
| WJBK,                 | Ypsilanti,                     | Ernest F. Goodwin                 | 50     | 1,370 |
| MINNESOTA             |                                |                                   |        |       |
| WCCO,                 | Anoka,                         | Washburn Crosby Co.               | 10,000 | 810   |
| KGDE,                 | Barrett,                       | Jaren Drug Co....                 | 50     | 1,200 |
| WFBJ,                 | Collegeville,                  | St. John, Univ.                   | 100    | 1,370 |
| WRHM,                 | Fridley,                       | Rosedale Hospital Co.             | 1,000  | 1,250 |
| KGFK,                 | Hallock,                       | Kittson County Enter-             | 50     | 1,200 |
|                       |                                | prise                             | 500    | 1,410 |
| WDGY,                 | Minneapolis,                   | Dr. Geo. W.                       | 500    | 1,410 |
|                       |                                | Young                             | 500    | 1,410 |
| WHDI,                 | Minneapolis,                   | W. Dunwoody Ind.                  | 500    | 1,410 |
|                       |                                | Inst.                             | 1,000  | 1,250 |
| WLB                   | Minneapolis,                   | Univ. of Minne-                   | 1,000  | 1,250 |
| WGMS,                 | Northfield,                    | Carleton College..                | 1,000  | 1,250 |
| KFMX,                 | Northfield,                    | St. Olaf College..                | 1,000  | 1,250 |
| WCAL,                 | Wescott,                       | Natl. Bat. Brcdstg.               | 10,000 | 1,460 |
| KSTP,                 |                                | Co.                               |        |       |
| MISSISSIPPI           |                                |                                   |        |       |
| WCOC,                 | Columbus,                      | Crystal Oil Co.                   | 500    | 880   |
| WRBO,                 | Greenville,                    | J. Pat. Scully....                | 100    | 1,210 |
| WGCM,                 | Gulport,                       | Gulf Coast Music                  | 100    | 1,210 |
|                       |                                | Co.                               | 10     | 1,500 |
| WRBJ,                 | Hattiesburg,                   | Woodruff Furn.                    | 300    | 1,360 |
|                       |                                | Co.                               |        |       |
| WQBC,                 | Utica,                         | Utica Cham. of Com..              |        |       |
| MISSOURI              |                                |                                   |        |       |
| KFVS,                 | Cape Girardeau,                | Hirsch B. &                       | 50     | 1,210 |
|                       |                                | R. Co.                            | 500    | 550   |
| KFUO,                 | Clayton,                       | Concordia Theo. Sem-              | 500    | 550   |
|                       |                                | inary                             | 500    | 630   |
| KFRU,                 | Columbus,                      | Stephens College                  |        |       |
| KMBC,                 | KLDLS,                         | Independence Midland Bldg. &      | 1,000  | 950   |
|                       |                                | Reorg. Ch. of J. C. of Latter Day |        |       |
| WOS,                  | Jefferson C. Mo. State Market, | Bureau                            | 500    | 630   |
| WMBH,                 | Joplin,                        | Edwin Aber....                    | 100    | 1,420 |
| KWKC,                 | Kans. City,                    | Wilson Duncan                     | 100    | 1,370 |
|                       |                                | Brdg. Co.                         | 1,000  | 610   |
| WDAF,                 | Kans. City,                    | Kansas City Star                  | 1,000  | 950   |
|                       |                                | Co.                               | 1,000  | 610   |
| WHB,                  | Kans. City,                    | Sweeney Auto Sch.                 | 1,000  | 610   |
|                       |                                | Co.                               | 1,000  | 610   |
| WOO,                  | Kans. City,                    | Unity School of                   | 1,000  | 610   |
|                       |                                | Chris.                            | 50     | 1,200 |
| KFKZ,                 | Kirksville,                    | N. E. Mo. St. Tchrs.              | 50     | 1,200 |
|                       |                                | College                           | 5,000  | 1,090 |
| KMOX,                 | Kirkwood,                      | Voice of St. Louis                | 2,500  | 560   |
| KFEQ,                 | St. Joseph,                    | Schroggia & Co.                   |        |       |
|                       |                                | Bank                              | 100    | 1,370 |
| KBX,                  | St. Joseph,                    | Foster-Hall Tire                  |        |       |
|                       |                                | Co.                               |        |       |

| Station              | Owner          | Location                     | Power  | Kc.   |
|----------------------|----------------|------------------------------|--------|-------|
| MISSOURI (Continued) |                |                              |        |       |
| KWK,                 | St. Louis,     | Grtr. St. L. Brcdstg.        | 1,000  | 1,350 |
| WLBF,                | Kansas City,   | (transfd. from               | 100    | 1,420 |
|                      |                | Kansas)                      |        |       |
| KFWF,                | St. Louis,     | St. Louis Truth Cen-         | 100    | 1,200 |
|                      |                | ter                          | 500    | 550   |
| KSD,                 | St. Louis,     | Pulitzer Pub. Co.            | 1,000  | 760   |
| WEW,                 | St. Louis,     | St. Louis Univ....           | 1,000  | 1,350 |
| WIL,                 | St. Louis,     | WIL Brcdstg. Co.             |        |       |
| WMAV,                | St. Louis,     | Kingshighway Pres.           | 100    | 1,200 |
|                      |                | Church                       |        |       |
| MONTANA              |                |                              |        |       |
| KGIR,                | Butte,         | Symons Brcdst. Co.           | 250    | 1,360 |
| KGHL,                | Billings,      | Northwestern Auto            | 250    | 950   |
|                      |                | Supply Co.                   | 500    | 1,360 |
| KFBB,                | Havre,         | F. A. Battery Co.            | 100    | 1,310 |
| KGZE,                | Kalispell,     | Flathead Brcdstg.            | 100    | 1,310 |
|                      |                | Assn.                        | 5      | 1,420 |
| KGHD,                | Missoula,      | Elmore-Nash Bdg.             |        |       |
|                      |                | Corp.                        | 500    | 570   |
| KUOM,                | Missoula,      | State Univ. of               | 10     | 1,420 |
|                      |                | Montana                      |        |       |
| KGKX,                | Vida,          | First State Bank of          |        |       |
|                      |                | Vida                         |        |       |
| NEBRASKA             |                |                              |        |       |
| KGES,                | Central City,  | Central Radio E.             | 1,000  | 740   |
|                      |                | Co. (consolidated with KGBZ) |        |       |
| KMMJ,                | Clay Center,   | M. M. Johnson                | 1,000  | 740   |
|                      |                | Corp.                        |        |       |
| KGBY,                | Columbus,      | Ervin Taddiken               |        |       |
|                      |                | (consolidated with KGBZ)     |        |       |
| KGEO,                | Grand Is.,     | Hotel Yancey                 |        |       |
|                      |                | (consolidated with KGBZ)     |        |       |
| KGDW,                | Humboldt,      | Frank J. Rist                |        |       |
|                      |                | (consolidated with KGBZ)     |        |       |
| GFOB,                | Lincoln,       | Howard Shuman                | 100    | 1,210 |
| KFAB,                | Lincoln,       | Neb. Buick Auto Co.          | 500    | 590   |
| WCAJ,                | Lincoln,       | Neb. Wesleyan Univ.          | 500    | 1,060 |
| WJAG,                | Norfolk,       | Norfolk Daily News           | 500    | 590   |
| WAAW,                | Omaha,         | Omaha Grain Exch.            | 500    | 600   |
| WOW,                 | Omaha,         | W. O. W. Life Ins.           | 1,000  | 590   |
|                      |                | Assn.                        | 50     | 1,420 |
| KGFW,                | Ravenna,       | Otto Sothman...              | 50     | 1,420 |
| KGCH,                | Wayne,         | Farmers & Merch. Coop.       |        |       |
|                      |                | (consolidated with KGBZ)     |        |       |
| KGBZ,                | York,          | Fed. Livestock Remedy        | 500    | 930   |
|                      |                | Co.                          |        |       |
| NEW HAMPSHIRE        |                |                              |        |       |
| WRBH,                | Manchester,    | N. H. Brcdstg.               | 50     | 1,310 |
|                      |                | Corp.                        | 500    | 1,430 |
| WKAU,                | Laconia,       | Laconia Radio Club           |        |       |
| WBRL,                | Tilton,        | Both Radio Lab.              |        |       |
| NEW JERSEY           |                |                              |        |       |
| WCAP,                | Asbury Pk.,    | Radio Indus. Bcstg.          | 500    | 1,280 |
|                      |                | Co.                          |        |       |
| WPG,                 | Atlantic City, | Municipality of              | 5,000  | 1,100 |
|                      |                | A. C.                        | 500    | 1,200 |
| WCAM,                | Camden,        | City of Camden               |        |       |
| WHAP,                | Carlstadt,     | Def. Truth Society           |        |       |
|                      |                | (see "New York")             |        |       |
| WCDA,                | Cliff. Pk.,    | Italian Edu. Brd.            |        |       |
|                      |                | Co. (see "New York")         |        |       |
| WPAP,                | Cliff. Pk.,    | Calv. Bap. Ch....            | 250    | 1,010 |
| WQAO                 |                | Inc.                         |        |       |
| WBS,                 | Elizabeth,     | N. J. Brcdstg. Corp.         | 250    | 1,450 |
| WMCA,                | Hoboken,       | Greeley Sq. Hotel            | 500    | 570   |
| WPHC,                | Hoboken,       | Conc. Radio Corp.            | 500    | 810   |
| WAAJ,                | J. City,       | Bremer Brcdstg. Corp.        | 300    | 1,070 |
| WKBO,                | J. City,       | Camith Corp....              | 250    | 1,450 |
| WLWL,                | Kearny,        | Miss. Soc. of St. Paul       | 5,000  | 1,100 |
| WOR,                 | Kearny,        | L. Bamberger & Co.           | 5,000  | 710   |
| WAAM,                | Newark,        | WAAM, Inc.                   | 500    | 1,250 |
| WGCP,                | Newark,        | May Radio Brcdstg.           | 500    | 1,250 |
|                      |                | Corp.                        | 250    | 1,450 |
| WNI,                 | Newark,        | Radio Inv. Co....            | 1,000  | 1,250 |
| WODA,                | Paterson,      | Richard O'Dea....            | 100    | 1,210 |
| WJBI,                | Red Bank,      | Robt. S. Johnson             | 1,000  | 1,130 |
| WVW,                 | Secaucus,      | Intl. Brcdg. Corp.           | 500    | 1,280 |
| WOAX,                | Trouton,       | Franklyn Wolff..             | 250    | 1,450 |
| WBMS,                | Union City,    | WBMS Brcdg. Corp.            |        |       |
| NEW MEXICO           |                |                              |        |       |
| KOB,                 | State Col.,    | N. M. Col. of Agri..         | 10,000 | 1,180 |
| KGFL,                | Raton,         | N. L. Cotter .....           | 50     | 1,370 |
| KGGM,                | Albuquerque,   | Jay Peters.....              | 100    | 1,370 |
| NEW YORK             |                |                              |        |       |
| WKBW,                | Amherst,       | Churchill Ev. Assn..         | 5,000  | 1,470 |
| WGBS,                | Astoria,       | Gimbel Bros.....             | 500    | 1,180 |
| WMBO,                | Auburn,        | Radio Serv. Lab.             | 100    | 1,370 |
| WINR,                | Bay Shore,     | Radiotel Mfg. Co.            | 100    | 1,210 |
| WEAF,                | Bellmore,      | N. Bdg. Co.....              | 50,000 | 660   |
| WBBC,                | Brooklyn,      | Brook. Brcdg. Corp.          | 500    | 1,400 |
| WLTH,                | Brooklyn,      | Voice of Brook, Inc.         | 250    | 1,400 |
| WMBQ,                | Brooklyn,      | Paul J. Gollhofer..          | 100    | 1,500 |
| WMSG,                | Brooklyn,      | Amateur Radio Spec. Co.      |        |       |
|                      |                | (See WLTH)                   |        |       |
| WSDA,                | Buffalo,       | H. H. Howell....             | 100    | 1,310 |
| WGR,                 | Buffalo,       | Fed. Radio Corp.             | 750    | 550   |
| WSVS,                | Buffalo,       | Seneca Voc. Sch.             | 50     | 1,370 |
| WCAD,                | Canton,        | St. Lawrence Univ..          | 300    | 1,220 |
| WMAC,                | Cazenovia,     | Clive Meredith...            | 500    | 440   |
| WCGU,                | Coney Is.,     | U. S. Brd. Corp.             | 500    | 1,400 |
| WNBF,                | Endicott,      | Hewitt-Wood Radio            | 50     | 1,500 |
|                      |                | Co.                          | 30     | 1,420 |
| WLBH,                | Farmingdale,   | Jos. J. Lombardi             | 100    | 1,210 |
| WGBB,                | Freeport,      | Harry H. Carman..            | 750    | 1,040 |
| WKEN,                | Grand Island,  | WKEN, Inc.                   |        |       |
| WCOH,                | Greenville,    | Westchester Bdg.             | 100    | 1,210 |
|                      |                | Corp.                        | 50     | 1,210 |
| WLCl,                | Ithaca,        | Lutheran Assn., Ithaca       | 10     | 1,420 |
| WMRJ,                | Jamaica,       | Peter J. Prinz....           | 25     | 1,210 |
| WOCL,                | Jamestown,     | A. E. Newton....             | 100    | 1,500 |
| WCLB,                | Long Beach,    | Arthur Faske...              | 100    | 1,500 |
| WLBX,                | Long Is. City, | John N. Brah                 | 750    | 900   |
| WMAK,                | Lockport,      | WMAK Brcdg. Sys.             |        |       |
|                      |                | Inc.                         | 500    | 1,440 |
| WOKO,                | Peekskill,     | Harold E. Smith..            |        |       |

| Station  | Owner                           | Location                 | Power  | Kc.   |
|--|---------------------------------|--------------------------|--------|-------|
| NEW YORK (Continued)                                     |                                 |                          |        |       |
| WBNY,  | New York,                       | Baruchrome Corp.         | 250    | 1,350 |
| WHN,   | New York,                       | George Schubel..         | 250    | 1,010 |
| WKBF,  | New York,                       | Stand. Cahill Co.,       | 250    | 1,350 |
| WNYC,  | New York,                       | Dept. of Plant &         | 500    | 570   |
|  |                                 | Struc.                   | 250    | 1,350 |
| WMSG,  | New York,                       | Mad Sq. Garden..         | 5,000  | 860   |
| WABC,  | New York,                       | Atlantic Brcdg. Corp.    |        |       |
| WABO   |                                 |                          |        |       |
| WHEC,  | Rochester,                      | Hickson Elec. Co.,       | 500    | 1,440 |
|  |                                 | Inc.                     | 15     | 1,500 |
| WBOQ   |                                 | (Consolidated with WABC) |        |       |
| WNBO,  | Rochester,                      | Gordon P. Brown          | 500    | 1,300 |
| WBBR,  | Rossville,                      | Peoples Pulpit Assn      | 1,000  | 740   |
| WEAL,  | Ithaca,                         | Cornell Univ. ....       | 10     | 1,290 |
| WNBZ,  | Saranac Lake,                   | Smith & Mace             | 50,000 | 790   |
| WGY,   | S. Schenectady,                 | Gen. Elec. Co.           | 750    | 900   |
| WFBL,  | Syracuse,                       | Onondaga Co., Inc.       | 500    | 570   |
| WVSR,  | Syracuse,                       | Oliver B. Meredith.      | 500    | 1,300 |
| WHAZ,  | Troy,                           | Rensselaer Poly. Inst.   | 100    | 1,200 |
| WTRX,  | Utica,                          | WIBX, Inc.               |        |       |
| WHAM,  | Rochester,                      | Stromberg Carlson.       | 5,000  | 1,160 |
| WEVD,  | Woodhaven,                      | Deb. Mem. Radio          | 500    | 1,300 |
|  |                                 | Fund                     | 100    | 1,500 |
| WWRL,  | Woodside,                       | Wm. H. Reuman..          |        |       |
| The following stations transferred from New Jersey area: |                                 |                          |        |       |
| WCDA,  | Italian Edu. Brcdg. Co.         |                          | 250    | 1,350 |
| WHAP,  | Def. of Truth Soc., Inc.        |                          | 500    | 1,300 |
| WPAP   | WQAD,                           | Calv. Bap. Church..      | 250    | 1,010 |
| WRNY,  | Experimenter Pub. Co.           |                          | 250    | 1,010 |
| WHPP,  | Bronx Brcdg. Co.                |                          | 10     | 1,420 |
| WPCB,  | Concourse Radio Corp.           | (day only)               | 500    | 810   |
| WLWL,  | Missionary Soc. of St. Paul.    |                          | 5,000  | 1,100 |
| WVOV   | (WGL) International Brcdg. Corp |                          | 1,000  | 1,130 |
| WJZ,   | Radio Corp. of America.         |                          | 30,000 | 760   |
| NORTH CAROLINA   |                                 |                          |        |       |
| WWNC,  | Asheville,                      | Chamber of Com.          | 1,000  | 570   |
| WBT,   | Charlotte,                      | C. C. Coddington..       | 10,000 | 1,080 |
| WRBU,  | Gastonia,                       | A. J. Kirby Music Co.    | 50     | 1,210 |
| WNRC,  | Greensboro,                     | Wayne M. Nelson          | 500    | 1,440 |
| WPTF,  | Raleigh,                        | Durham Life Ins. Co.     | 10,000 | 680   |
| WRBT,  | Wilmington                      | Wilmington Radio         | 50     | 1,370 |
|  | As.                             |                          |        |       |
| NORTH DAKOTA   |                                 |                          |        |       |
| KFYR,  | Bismarck,                       | Hoskins-Meyer            | 500    | 550   |
| KDLR,  | Devils Lake,                    | Radio-El. Co....         | 100    | 1,210 |
| WDAY,  | Fargo                           | WDAY, Inc.               | 1,000  | 1,280 |
| KFJM,  | Grand Forks,                    | Univ. of N. D.           | 500    | 550   |
| KGCU,  | Mandan,                         | Mandan Radio Assn.       | 100    | 1,200 |
| OHIO   |                                 |                          |        |       |
| WADC,  | Akron,                          | Allen T. Simmons..       | 1,000  | 1,320 |
| WFJC,  | Akron,                          | W. F. Jones Brcdg.,      | 500    | 1,450 |
|  |                                 | Inc.                     | 100    | 1,370 |
| WHBD,  | Bellefontaine,                  | First Pres. Ch.          | 10     | 1,210 |
| WEBE,  | Cambridge,                      | Roy W. Waller...         | 10     | 1,200 |
| WHBC,  | Canton,                         | St. John's, Cath. Ch.    | 25     | 1,420 |
| WAAJ,  | Cincinnati,                     | Ohio Mech. Inst.         | 500    | 550   |
| WKRC,  | Cincinnati,</                   |                          |        |       |



| Station   | Owner | Location | Power  | Kc.   | Station   | Owner | Location | Power  | Kc.   | Station  | Owner | Location | Power | Kc.   |
|---|-------|----------|--------|-------|---|-------|----------|--------|-------|--|-------|----------|-------|-------|
| <b>PENNSYLVANIA</b>   |       |          |        |       | <b>TEXAS (Continued)</b>  |       |          |        |       | <b>WASHINGTON</b>  |       |          |       |       |
| WCBA, Allentown, Musselman & B. Bryan                                 |       |          | 100    | 1,500 | WFAA, Dallas, Dallas Morning News (See Gen. Order No. 48)                 |       |          | 5,000  | 1,040 | KXRO, Aberdeen, KXRO, Inc.   |       |          | 50    | 1,420 |
| WSAN, Allentown, Allen, Call Pub. Co., Inc.                           |       |          | 100    | 1,500 | WRR, Dallas, City of Dallas   |       |          | 5,000  | 1,190 | KVOS, Bellingham, L. Kessler   |       |          | 250   | 570   |
| WFBG, Altoona, Wm. F. Gable Co.                                       |       |          | 100    | 1,310 | KFPL, Dublin, C. C. Baxter  |       |          | 15     | 1,370 | KFBL, Everett, Leese Bros.   |       |          | 50    | 1,500 |
| WNBW, Carbondale, Home Cut G. & C. Co.                                |       |          | 5      | 1,200 | WDAH, El Paso, Trinity Metho. Ch.   |       |          | 100    | 1,310 | KGY, Lacey, St. Martin's College   |       |          | 50    | 1,440 |
| WIBG, Elkins Pk., St. Paul's P. E. Church                             |       |          | 50     | 930   | KFJZ, Fort Worth, Henry C. Allison  |       |          | 100    | 1,370 | KUJ, Longview, Fed W. Lovejoy & R. W. Kerfoot                                      |       |          | 10    | 1,500 |
| WEDH, Erie, Erie Post Dispatch  |       |          | 30     | 1,420 | WBAP, Fort Worth, Carter Pub., Inc.                                       |       |          | 5,000  | 800   | KWSC, Pullman, State Col. of Wash.   |       |          | 500   | 1,320 |
| WRAC, Erie, C. R. Cummins   |       |          | 50     | 1,370 | KFOB, Fort Worth, W. B. Fishburn  |       |          | 1,000  | 1,240 | KFOA, Seattle, Rhodes Dept. Store  |       |          | 1,000 | 1,270 |
| WFKD, Frankford, Foulkrod Radio Eng. Co.                              |       |          | 50     | 1,310 | KFLX, Galveston, George Roy Clough  |       |          | 100    | 1,210 | KFOV, Seattle, KFOV, Inc.  |       |          | 100   | 1,420 |
| WSAJ, Grove City, Grove City Co.                                      |       |          | 100    | 1,310 | KFUL, Galveston, Will H. Ford   |       |          | 500    | 1,290 | KPO, Seattle, A. Taft & L. Wasmer  |       |          | 100   | 1,210 |
| WBAK, Harrisburg, Pa. State Police                                    |       |          | 500    | 1,120 | KGKL, Georgetown, M. L. Cates   |       |          | 100    | 1,370 | KVL, Seattle, Arthur C. Dailey   |       |          | 100   | 1,500 |
| WPRC, Harrisburg, Wilson Ptg. & Radio Co.                             |       |          | 100    | 1,200 | KGKB, Goldthwaite, Eagle Pub. Co.   |       |          | 100    | 1,500 | KJR, Seattle, N. W. Radio Service  |       |          | 5,000 | 970   |
| WHBP, Johnstown, Johnstown Auto. Co.                                  |       |          | 100    | 1,310 | KFPL, Dublin, C. C. Baxter  |       |          | 15     | 1,310 | KKP, Seattle, City of Seattle (Harbor Dept.)                                       |       |          | 15    | 1,420 |
| WABF, Kingston, Markle Bldg. Corp.                                    |       |          | 250    | 1,440 | KFPM, Greenville, New Furniture Co.                                       |       |          | 15     | 1,310 | KOMO, Seattle, Fisher's Blend Station  |       |          | 1,000 | 920   |
| WGAL, Lancaster, Lanc. E. S. & C. Co.                                 |       |          | 15     | 1,310 | KRGV, Harlingen, Harlingen Music Co.                                      |       |          | 500    | 1,260 | KPCB, Seattle, Pacific Coast Biscuit   |       |          | 100   | 1,210 |
| WKJC, Lancaster, Kirk-Johnson & Co.                                   |       |          | 50     | 1,200 | KRPC, Houston, Houston Ptg. Co.   |       |          | 1,000  | 920   | KRSC, Seattle, Radio Sales Corp.   |       |          | 50    | 1,120 |
| WMBS, Lemoyne, Mack's Battery Co.                                     |       |          | 500    | 1,430 | KTUE, Houston, Uhalt Electric   |       |          | 5      | 1,370 | KTW, Seattle, First Pres. Church   |       |          | 1,000 | 1,270 |
| WJBU, Lewisburg, Bucknell Univ.                                       |       |          | 100    | 1,210 | KGHX, Richmond, Ft. Bend City Sch. Bd.                                    |       |          | 50     | 1,500 | KXA, Seattle, Amer. Radio Tel. Co.   |       |          | 500   | 570   |
| WLBW, Oil City, Petrol. Tele. Co.                                     |       |          | 500    | 1,260 | KGFI, San Angelo, San Angelo Broadcasting Co.                             |       |          | 15     | 1,310 | KFIO, Spokane, N. Cen. High School   |       |          | 100   | 1,230 |
| WLAN, Phila. Keystone Bldg. Co.                                       |       |          | 500    | 610   | KCCI, San Antonio, Liberto Radio Sales                                    |       |          | 100    | 1,370 | KFPY, Spokane, Symons, Inv. Co.  |       |          | 500   | 1,390 |
| WABY, Phila., John Magaldi, Jr.                                       |       |          | 50     | 1,310 | KCDR, San Antonio, Joe B. McShane   |       |          | 100    | 1,500 | KGA, Spokane, N. W. Radio Serv. Co.  |       |          | 5,000 | 1,470 |
| WFI, Phila., Strawbridge & Clothier                                   |       |          | 500    | 560   | KGRC, San Antonio, Eugene J. Roth   |       |          | 100    | 1,310 | KHO, Spokane, Louis Wasmer, Inc.   |       |          | 1,000 | 590   |
| WCAU, Phila., Univ. Bldg. Co.   |       |          | 5,000  | 1,170 | KTSA, San Antonio, Alamo Brcdct. Co.                                      |       |          | 1,000  | 1,290 | KMO, Tacoma, KMO, Inc.   |       |          | 500   | 1,340 |
| WHBW, Phila., Dr. R. Kienle   |       |          | 100    | 1,500 | KTAP, San Antonio, Robert B. Bridge                                       |       |          | 100    | 1,210 | KVI, Tacoma, P. Sound Radio Bldg. Co.  |       |          | 1,000 | 1,340 |
| WIAD, Phila., Howard R. Miller  |       |          | 100    | 1,310 | WAOI, San Antonio, Southern Equip. Co.                                    |       |          | 5,000  | 1,190 | <b>WEST VIRGINIA</b>   |       |          |       |       |
| WIP, Phila., Gimbel Bros., Inc.                                       |       |          | 500    | 610   | WJAD, Waco, Frank P. Jackson  |       |          | 1,000  | 1,240 | WOBV, Charleston, Charleston R. Bldg. Co.  |       |          | 250   | 580   |
| WLIT, Phila., Lit Bros.   |       |          | 500    | 560   | KGKO, Wichita Falls, Highland Hgts., Christian Church                     |       |          | 250    | 570   | WQBJ, Clarksburg, John Raikes  |       |          | 65    | 1,200 |
| WNAT, Phila., Lennig Bros. Co.  |       |          | 100    | 1,310 | <b>UTAH</b>   |       |          |        |       | WSAZ, Huntington, McKellar Elec. Co.   |       |          | 250   | 580   |
| WOO, Phila., John Wanamaker   |       |          | 100    | 1,500 | KFUR, Ogden, Peery Bldg. Co.  |       |          | 50     | 1,370 | WWVA, Wheeling, W. Va. Bldg. Corp.   |       |          | 5,000 | 1,028 |
| WPSW, Phila., Phila. School Wire Tel.                                 |       |          | 50     | 1,500 | KDYL, Salt Lake City, Interm. Bridg. Corp.                                |       |          | 1,000  | 1,290 | WQZ, Weirton, J. H. Thompson   |       |          | 60    | 1,420 |
| WRAX, Phila., Berachah Church, Inc.                                   |       |          | 250    | 1,420 | KSL, Salt Lake City, Radio Serv. Corp. of U.                              |       |          | 5,000  | 1,130 | WMMN, Fairmont, Holt Rowe Co.  |       |          | 250   | 890   |
| KQV, Pittsburgh, Doubleday, Hill E. Co.                               |       |          | 500    | 1,380 | <b>VERMONT</b>  |       |          |        |       | <b>WISCONSIN</b>   |       |          |       |       |
| WCAE, Pittsburgh, Kaufmann & Baer Co.                                 |       |          | 500    | 1,220 | WCAX, Burlington, Univ. of Vermont  |       |          | 100    | 1,200 | WEBW, Beloit, Beloit College   |       |          | 250   | 600   |
| WJAS, Pittsburgh, Pitts. Rad. S. House                                |       |          | 1,000  | 1,260 | WNBX, Springfield, First Cong. Church                                     |       |          | 10     | 1,200 | WTMJ, Brookfield, Milwaukee Journal  |       |          | 1,000 | 570   |
| KDKA, Pittsburgh, West. E. & M. Co.                                   |       |          | 50,000 | 980   | WTAZ, Chesterfield Hills, W. Reynolds, Jr., & Thomas J. McGuire, Richmond |       |          | 15     | 1,210 | WTAQ, Eau Claire, Clyde, S. Van Gorden   |       |          | 1,000 | 1,330 |
| WRAW, Reading, Ave. Radio & El. Shop                                  |       |          | 100    | 1,310 | WNEW, Newport News, Bldg. Co., Inc.                                       |       |          | 100    | 1,310 | KFIZ, Fond Du Lac, Fond Du Lac Commonwealth Reprinter                              |       |          | 100   | 1,420 |
| WGB, Scranton, Scranton Brdrs., Inc.                                  |       |          | 250    | 880   | WTFE, Mt. Vernon Hills, Ind. Pub. Co.                                     |       |          | 10,000 | 1,460 | WCLO, Kenosha, C. Whitmore   |       |          | 100   | 1,200 |
| WQAN, Scranton, The Scranton Times                                    |       |          | 250    | 880   | WTAR, Norfolk, Reliance Elec. Co., Inc.                                   |       |          | 500    | 780   | WKBH, LaCrosse, Callaway Music Co.   |       |          | 1,000 | 1,380 |
| WPSG, State Col., Pa. State Col.                                      |       |          | 500    | 1,230 | WBBW, Norfolk, Ruffner Jr. High Sch.                                      |       |          | 100    | 1,200 | WIBA, Madison, Capital Times Strand Theater Station                                |       |          | 100   | 1,210 |
| WNBO, Washington, John Brownlee Spriggs                               |       |          | 15     | 1,200 | WLBG, Petersburg, Robt. Allen Gamble                                      |       |          | 100    | 1,200 | WHA, Madison, Uni. of Wisconsin  |       |          | 750   | 570   |
| WBAX, Wilkes-Barre, John H. Stenger, Jr.                              |       |          | 100    | 1,210 | WRVA, Richmond, Larus & Bro. Co., Inc.                                    |       |          | 5,000  | 1,110 | WOMT, Manitowoc, Mikadow Theater   |       |          | 100   | 1,210 |
| WALK, Willow Grove, Albert A. Walker                                  |       |          | 50     | 1,500 | WMBG, Richmond, Havens & Martin, Inc.                                     |       |          | 100    | 1,210 | WHAD, Milwaukee, Marquette Univ.   |       |          | 500   | 900   |
| WBRE, Wilkes-Barre, Louis G. Baltimore                                |       |          | 100    | 1,310 | WBBL, Richmond, Grace Covenant P. Church                                  |       |          | 100    | 1,370 | WISN, Milwaukee, Evening Wisconsin Co.   |       |          | 250   | 1,120 |
| <b>PORTO RICO</b>   |       |          |        |       | WDBJ, Roanoke, Richardson-Wayland E. Co.                                  |       |          | 500    | 930   | WIBU, Poynette, The Electric Farm  |       |          | 100   | 1,310 |
| WKAQ, San Juan, R. C. of Porto Rico                                   |       |          | 500    | 580   | WSEA, Portsmouth, Va. Beach Broadcasting Co.                              |       |          | 500    | 780   | WRJN, Racine, Racine Bldg. Corp.   |       |          | 100   | 1,200 |
| <b>RHODE ISLAND</b>   |       |          |        |       | <b>LITERATURE WANTED</b>  |       |          |        |       | WHL, Sheboygan, Press Pub. Co. & C. L. Carrell                                     |       |          | 500   | 1,410 |
| WDWF, Canston, D. W. Flint & Linc. Stud.                              |       |          | 100    | 1,210 | G. C. Diedrichs, 852 Delaware Ave., Detroit, Mich.                        |       |          |        |       | WEBC, Superior, Head of Lakes Bldg.  |       |          | 1,000 | 1,288 |
| WMBA, Newport, Leroy J. Beebe   |       |          | 100    | 1,500 | Frank Powell, 1612 Mona Ave., Muskegon Heights, Mich.                     |       |          |        |       | WLBL, Stevens Point, Wis. Dept. of Mark.   |       |          | 1,000 | 900   |
| WFBI, Pawtucket, Frank Crook, Inc.                                    |       |          | 100    | 1,210 | H. E. Marthas, 2711 Warren Ave., Station D., Chicago, Ill.                |       |          |        |       | WHBY, West Deper, St. Norbert's College  |       |          | 50    | 1,200 |
| WEAN, Providence, Shepard Co.   |       |          | 500    | 1,160 | H. Born, Sheboygan Press, Sheboygan, Wis.                                 |       |          |        |       | KFBU, Laramie, Bishop N. S. Thomas   |       |          | 500   | 600   |
| WJAR, Providence, The Outlet Co.                                      |       |          | 250    | 880   | W. E. Wright, R. F. D. 2-B 181 Y., Roanoke, Va.                           |       |          |        |       | <b>WYOMING</b>   |       |          |       |       |
| <b>SOUTH CAROLINA</b>   |       |          |        |       | J. A. Bailey, Box 696, Riverhead, N. Y.                                   |       |          |        |       | J. F. Barry, South Station, Fall River, Mass.                                      |       |          |       |       |
| WBBY, Charleston, Washington Light Inf.                               |       |          | 75     | 1,200 | Krauss Radio Stores, 217 W. 5th St., Cincinnati, Ohio                     |       |          |        |       | Mr. L. K. Doane, 106 S. Main St., Jersey Shore, Pa.                                |       |          |       |       |
| WRBW, Columbia, Paul S. Pearce  |       |          | 15     | 1,310 | Reliable Radio Service Co., 1335 E. Carey St., Philadelphia, Pa.          |       |          |        |       | Mr. H. J. Benner, 432 Sumner Ave., Springfield, Mass.                              |       |          |       |       |
| <b>SOUTH DAKOTA</b>   |       |          |        |       | H. McBride, Box 2, Houston, Miss.   |       |          |        |       | Alva M. Eckert, Box 12, St. Remy, N. Y.  |       |          |       |       |
| KFDY, Brookings, S. D. State College                                  |       |          | 500    | 550   | Chas. J. Wenker, 2616 Askew, Kansas City, Mo.                             |       |          |        |       | Carl L. Silbert, The Erie Pie Co., 1713 Canton St., Toledo, Ohio.                  |       |          |       |       |
| KGCR, Brookings, Cutler's Radio Bldg. Ser.                            |       |          | 100    | 1,210 | O. F. House, 419 Chase Ave., Walla Walla, Wash.                           |       |          |        |       | F. J. Walker, M.D., 709 Schweiter Bldg., Wichita, Kans.                            |       |          |       |       |
| KGDA, Dell Rapids, Home Auto Co.                                      |       |          | 15     | 1,370 | L. G. Fenton, 402 Holyoke Bldg., Seattle, Wash.                           |       |          |        |       | C. L. Dickey, Bloomington, Ind. (Monroe County Tire Store).                        |       |          |       |       |
| KGDY, Oldham, J. Albert Loesch  |       |          | 15     | 1,200 | A. B. Lang, Woodbridge, Conn.   |       |          |        |       | Harry G. Finley, 5752 Maple Ave., St. Louis, Mo.                                   |       |          |       |       |
| KGFX, Pierre, Danna McNeil  |       |          | 200    | 580   | Chas. W. Gierzak, 5493 Springwells Ave., Detroit, Mich.                   |       |          |        |       | Carl W. Kruse, 20 Courtland Ave., W., Kitchener, Ont., Can.                        |       |          |       |       |
| KSOO, Sioux Falls, Sioux Falls Bldg. Asso.                            |       |          | 1,000  | 1,110 | James Conway, R. R. No. 3, Marion, Ohio                                   |       |          |        |       | R. F. Hauf, 449 7th Ave., Brooklyn, N. Y.  |       |          |       |       |
| KUSD, Vermillion, University of S. D.                                 |       |          | 500    | 890   | Frank F. Donagh (9FOA), Compton, Ill.                                     |       |          |        |       | Arthur L. Schleter, Office of Master Mechanic, L. & N. R. R. Shops, Mobile, Ala.   |       |          |       |       |
| WCAT, Rapid City, S. D. Ste. Sch. of Mines                            |       |          | 100    | 1,200 | G. L. Berry, 150-12th Ave., N. E., Washington, D. C.                      |       |          |        |       | A. F. Fuller, Box 85, Sinton, Texas.   |       |          |       |       |
| WNAX, Yankton, Gurney Seed & Nursery Co. & Dakota Radio Apparatus Co. |       |          | 500    | 890   | B. G. Sweet, 221 E. Thomas, Rome, N. Y.                                   |       |          |        |       | Geo. L. Webster, 42 E. Seaview Ave., Bridgeport, Conn.                             |       |          |       |       |
| <b>TENNESSEE</b>  |       |          |        |       | Carlson & Johnson Radio Store, 933 K Street, N. W., Washington, D. C.     |       |          |        |       | Mr. Joseph Bailey, Box 696, Riverhead, L. I., N. Y.                                |       |          |       |       |
| WFBC, Knoxville, First Bap. Church                                    |       |          | 50     | 1,200 | Blackwoods Radio, 1801 N. 17th St., Phila., Pa.                           |       |          |        |       | J. H. Dimond, 117 E. Mason St., Jaxon, Mich.                                       |       |          |       |       |
| WNBI, Knoxville, Lonsdale Bap. Church                                 |       |          | 50     | 1,310 | The Dictaphone, 276 Washington St., Providence, R. I.                     |       |          |        |       | Frank J. Herring, 1131 Diamond Ave., Scranton, Pa.                                 |       |          |       |       |
| WNOX, Knoxville, Sterchi Bros.  |       |          | 1,000  | 560   | Union Commercial De Cuba, S. A., Habana, Cuba                             |       |          |        |       | E. T. Darrow, 2715 6th Ave., c/o Sun Drug Co., Tacoma, Wash.                       |       |          |       |       |
| WOAN, Lawrenceburg, Ch. of the Naz. & Vaughan Sch. of Music           |       |          | 500    | 600   | H. W. Hardie, care Public Works Dept., Bunnythorpe, New Zealand           |       |          |        |       | Geo. E. Melendy, 275 Main St., Nashua, N. H.                                       |       |          |       |       |
| WGBC, Memphis, First Bap. Church                                      |       |          | 500    | 1,430 | J. H. Henzmann, 617 Fifth St., St. Albans, W. Va.                         |       |          |        |       | J. F. Mullally, Laredo, Texas.   |       |          |       |       |
| WHBO, Memphis, Bldg. Sta. WHBO  |       |          | 100    | 1,370 | Robert Spencer, 302 E. Front, Grandlond, Neb.                             |       |          |        |       | Arthur Givoux, 166 Pine St., Lewiston, Me.   |       |          |       |       |
| WMBM, Memphis, 7th Day Adventist Ch.                                  |       |          | 10     | 1,500 | William Haine, LaPlume, Pa.   |       |          |        |       | Alfred T. L. Potts, P. O. Box 496, Vancouver, B. C., Can.                          |       |          |       |       |
| WMC, Memphis, Memphis Com. Appeal                                     |       |          | 500    | 780   | H. L. Tripp, 1406 Locust St., Kansas City, Mo.                            |       |          |        |       | Edward G. Wible, Briar Hill, Pa.   |       |          |       |       |
| WNBR, Memphis, John Ulrich  |       |          | 500    | 1,430 | Irwin R. Lynch, 2414 Indiana Ave., Columbus, Ohio                         |       |          |        |       | Wm. C. Biffar, Pearl River, N. Y.  |       |          |       |       |
| WBAW, Nashville, Waldrum Drug Co.                                     |       |          | 5,000  | 1,490 | Mr. Carlton Duncan, 114 Ozone St., S.W., Atlanta, Ga.                     |       |          |        |       | Gustave Zeidler, Jr., Medford, L. I., N. Y.  |       |          |       |       |
| WLAC, Nashville, Life & Cas. Ins. Inc.                                |       |          | 5,000  | 1,490 | Mr. Prestio Goldsberry, 12 St. 3 carso, Neb. City, Neb.                   |       |          |        |       | E. Danielson, Black Diamond, Wash.   |       |          |       |       |
| WSM, Nashville, Nat. Life & Acc. Ins.                                 |       |          | 5,000  | 650   | S. A. Vatter, c/o Main Post Office, Grand Rapids, Mich.                   |       |          |        |       | Carl W. Kruse, 20 Cortland Ave., W., Kitchener, Ont., Can.                         |       |          |       |       |
| WSIX, Springfield, 638 Tire & Vul. Co.                                |       |          | 100    | 1,210 | Jerome Sheridan, 239 W. 136th St., New York, N. Y.                        |       |          |        |       | A. F. Clement, Clement's Garage, Mansfield, La.                                    |       |          |       |       |
| WOBT, Union City, Tittsworth's R. A. M. Sp.                           |       |          | 15     | 1,310 | William A. Harding, 2013 No. 39th St., Philadelphia, Pa.                  |       |          |        |       | C. A. Morris, P. O. Box 1352, East Chicago, Ind.                                   |       |          |       |       |
| WREC, Memphis (transmitter at Whitehaven), WREC, Inc.                 |       |          | 500    | 600   | Wilson L. Fairbanks, Box 345, Passaic, N. J.                              |       |          |        |       | E. W. Brown, 29 Wade St., Brighton, Mass.  |       |          |       |       |
| WDOO, Chattanooga, Chattanooga R. Co.                                 |       |          | 1,000  | 1,280 | J. Wickers, P. O. Box 40, Sta. K, New York City.                          |       |          |        |       | Leon W. Wakeman, 31 Lafayette Ave., Middletown, N. Y.                              |       |          |       |       |
| <b>TEXAS</b>  |       |          |        |       | H. G. Landstrom, 284 Marshall Blvd., Pontiac, Mich.                       |       |          |        |       | Lewis Van Wagner, 25 Willow Ave., Schenectady, N. Y.                               |       |          |       |       |
| KGRS, Amarillo, Gish Radio Serv.                                      |       |          | 1,000  | 1,410 | A. L. Nelson, Clarksdale, Miss.   |       |          |        |       | Chas. K. Stetler, Cashier, The Farmers & Merchants National Bank, Hennessey, Okla. |       |          |       |       |
| WDAG, Amarillo, J. Laurence Martin                                    |       |          | 1,000  | 1,410 | F. E. Harmon, Kenilworth P. O., Union Co., N. J.                          |       |          |        |       | C. L. Carlson, 1859 Holly, Kansas City, Mo.  |       |          |       |       |
| KUT, Austin, Univ. of Texas   |       |          | 500    | 1,120 | F. Egan, 357 W. 45th St., New York City.                                  |       |          |        |       | John J. Hussey, 39 Welton St., Waterbury, Conn.                                    |       |          |       |       |
| KFDM, Beaumont, Magnolia Petrol Co.                                   |       |          | 500    | 560   |   |       |          |        |       |  |       |          |       |       |
| KFYO, Breckenridge, Kirksey B. B. &                                   |       |          |        |       |   |       |          |        |       |  |       |          |       |       |

## Enormous Gain Is Developed In a New Way

# The Innova

Screen Grid Tubes with Tuned

By Kimball

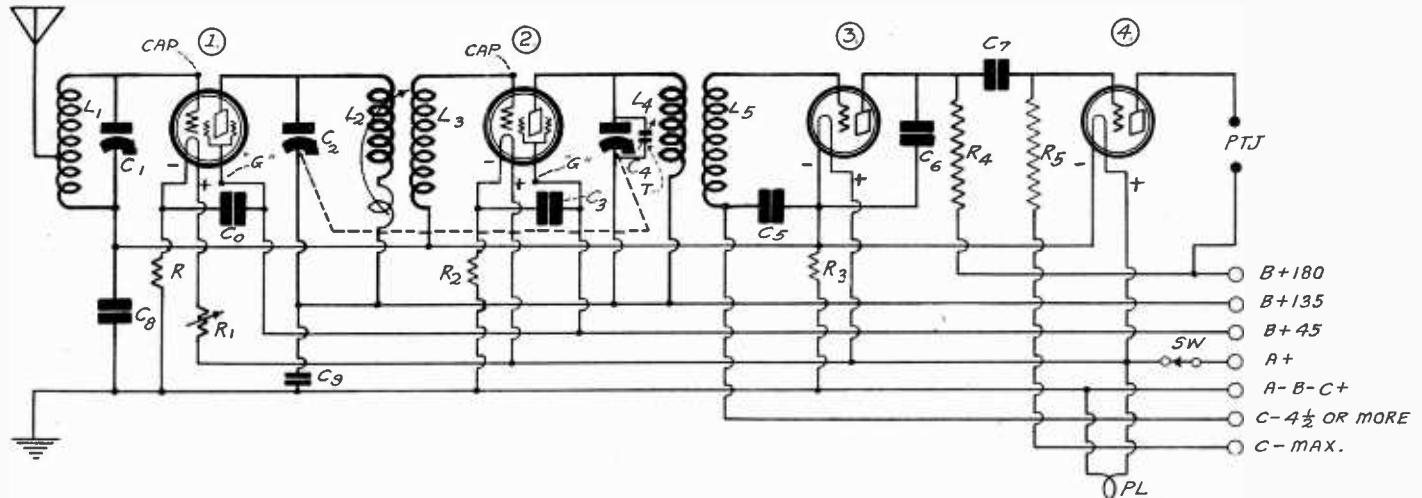

THE FIRST TRF SET EVER TO BE PRESENTED, WITH SCREEN GRID RADIO FREQUENCY AMPLIFICATION, UTILIZING TUNED PLATE WITH STEP-UP RATIO. ONE STAGE OF RESISTANCE COUPLED AUDIO AMPLIFICATION IS ABUNDANT FOR SPEAKER OPERATION. DO NOT OMIT ANY OF THE BY PASS CONDENSERS. THE FRONT PANEL HAS ENOUGH CONTROLS TO KEEP THE CIRCUIT WELL UP TO THE HIGHEST STANDARDS OF EFFICIENCY, INCLUDING PERFECT RESONANCE. BUT NOT ONE UNNECESSARY CONTROL. THE DIMENSIONAL FACTORS ARE GIVEN

A CONDUCTIVELY coupled antenna coil, followed by two tuned primary screen grid coils, their secondaries providing a step-up ratio but not being tuned, develops ample selectivity and volume, so that a speaker may be operated with only a single stage of resistance coupled audio.

It is well indeed to use shields any time more than one screen grid tube is used as a radio frequency amplifier, but if the B voltage on the screen grid (G post of socket) is made a little lower or higher than standard, the set may be operated with stability, despite the absence of shielding. On the other hand, a somewhat higher amplification becomes practical when shielding is included.

At any event, a metal can should be placed over each of the two screen grid tubes. These cans are commercial products, and as they, too, are called shields, some confusion has arisen, for at one time the word shield will refer to the can in which the tube is enclosed, and at another time it will mean the copper or aluminum surrounding the capacity and inductance of a tuned circuit.

### Resonance Assured

Maximum results are attained in the present circuit from the viewpoint of perfect resonance, since the antenna circuit is separately tuned, while each of the two succeeding circuits has a trimmer. The second stage trimming is done with the rotor of a three-circuit coil, connected in series with the primary, and the entirety being tuned. A midget condenser across the tuning condenser in the third stage completes the minor tuning adjustments.

The stages are referred to in their usual order, although one must "look into" a succeeding tube to understand the reference. Otherwise the antenna tuning and the plate circuit tuning, both associated with the same tube, might be considered as double tuning of the same stage.

The bypass condensers help to make

### LIST OF PARTS

L1—One Screen Grid Antenna Coil, model 5A.

L2L3—One Screen Grid three-circuit coil with high impedance primary, to which tickler is connected in series; Model 5HT.

L4L5—One Screen Grid high impedance two-winding interstage transformer, model 5TP.

C1—One .0005 mfd. tuning condenser.

C2C4—One two-gang tuning condenser, each section .0005 mfd.

R, R2—Two .622 Amperites with two mountings.

R3—One 112 Amperite with mounting.

R1—One Frost 30-ohm rheostat.

C5, C7, C8—Three .01 mfd. fixed mica condensers.

C0, C3, C9—Three .001 mfd. fixed mica condensers.

C6—One .00025 mfd. fixed mica condenser.

SW—One switch.

PL—One pilot light bracket with pilot light.

PTJ—Two Frost phone tip jacks.

C4—One trimmer condenser, a midget of about 5 or 7 plates (approximately 30 mfd.)

R4—One 0.5 meg. Lynch metallized resistor.

R5—One 2 to 5 meg. Lynch metallized resistor.

One Lynch bakelite double mounting.

One aluminum subpanel 10x20 inches, self-bracketing, with four sockets affixed, and supplied with insulating brushings and hardware.

One 7x21 inch drilled bakelite front panel.

Two dials.

Two Harmonique 222 screen grid tubes.

One Harmonique 240 high mu tube.

One Harmonique 112A or 171A tube,

the circuit easily operable, and also increase the sensitivity, by enabling the use of higher amplification levels without producing squeals. Therefore these condensers, C0 and C3 particularly, each .001 mfd., must be included.

It is well also to have C8 across the C filament resistor R3, and C5 across the C battery in the detector circuit. While it is true C5 and C8 may be omitted without the ear noticing the difference, it does not follow that they serve no useful purpose.

The one across the C battery virtually removes the C battery impedance to radio frequencies, an impedance which may run rather high in an almost depleted C battery. Both of these condensers are .01 mfd., because they affect audio frequencies, as well, hence must be reasonably large.

### How Audio Is Affected

The audio frequencies in the filament resistor are accounted for by the flow of some of the plate current through this resistor. The plate current flows from B plus 180., in this instance, through R4 to the plate of the tube, and then, due to the conductive path furnished by the filament electrons, flows through the grid to the filament, and divides, in this instance unequally, making its return through the negative and positive legs of the filament. The plate current here carries audio frequency variations.

Nobody need worry about the volume not being great enough. It is all-sufficient for all the usual purposes, indeed will be so great that one must tone it down to make it comfortable to listen to in a home, where overdoses of volume annoy not only some of the householders but, alas, all of the neighbors! But for the person with the taste for extra-loud music, here is a circuit!

The layout may be placed on a base-board, or an aluminum subpanel is available, of the self-bracketing type, with sockets affixed. The tubes, from left to right, are first radio, second radio, power

# tion Circuit

## Primary and Step-up Ratio

K. Wright

tube and detector. In other words, the chain turns to the left to get to the output tube.

### No Crowding Permissible

The front panel space is 7x21 inches, and the subpanel therefore is 20 inches wide, and may be 10 inches deep, to allow plenty of room. One must not crowd apparatus, particularly coils, in building a screen grid set that is not shielded.

There is room for shielding, for those who want to include this.

Regarding the tuning, conductive antenna coupling is rather uncertain as to its tuning characteristics, due to the antenna-ground capacity being different in different locations. Therefore a good plan is simply to take the conductively coupled antenna coil, seek out the two terminals (beginning and end) and connect one to grid of the first tube, which means a flexible lead with a clip to fit on the tube cap, and the other end of the winding to the lead running to minus filament of the 5-volt tubes.

The two other coils will match up, of course, since the circuits are equal, and, besides, any minor variations would be taken up, first, by the inductive trimmer and second by the capacitive trimmer.

The three-circuit coil has its primary on the outside, and this fixed primary is connected in series with the tickler, the tuning condenser going across the primary plus the tickler, not merely across the primary. In point of fact, the entire winding, consisting of the two in series, is the primary, but in ordinary speech only the outside winding is referred to by that term. Turning the rotary coil gives you the opportunity to increase or decrease the inductance from a parallel position of the movable coil.

### Antenna Tuning Kept in Step

The antenna is connected to the first coil, L1, by putting it to one of the remaining pair of binding posts on the coil. The tuning will not be the same, most likely, as in the double-condenser dial.

Likely the readings will be lower in the antenna circuit. Try putting the antenna instead at the remaining unused binding post of the antenna coil. Note the difference. Perhaps the readings will be still lower. If so, restore the connection to where it was, and tune in a station around 50 or 60 on the right-hand dial. Then turn the antenna condenser to exactly the same number, thus tuning out the station, and remove turns from the antenna coil until the station comes in loud again. You will note that the readings are exactly alike now—you made them so to start with—and they will track very nicely, except for possibly a few points at the lower-reading end of the dial. And in some instance the dials will keep in step even there.

The circuit is the first TRF receiver, using no regeneration, which has two stages of TRF, with tuned primary coils and step-up ratio used in the coupling. Hence it is an innovation.

### Effect of Step-Up

What that step up does in one stage—approximately doubling the voltage—is repeated in the next, so that a 1-to-4 step-up is achieved, which is as much as you would get from an audio transformer at the other end of the receiver. That is

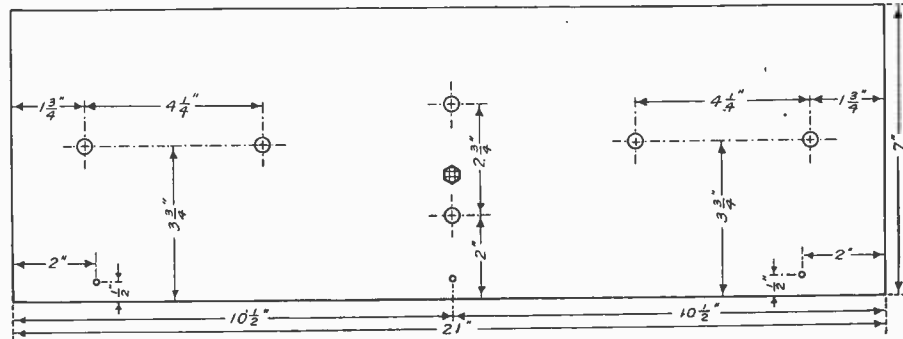

the main reason why only one audio stage is needed. It should be resistance coupled, working out of a high mu tube (240).

The circuit may be worked at a maximum of 180 volts, used on the detector plate and final output, or 135 volts will give satisfaction at both points, if this is all you have. The output tube for 135 high, and has 20 turns. The rotary coil is connected in series with the fixed part of the primary.

The other coil is the same as the interstage coupler, but with the tickler omitted.

The front panel is so arranged that the rheostat R1 is at left, the dial tuning the antenna input comes next, while up and down the center are, from top to bottom, the rotor of the first interstage coil, the pilot light window and the switch. To the right of these are the dial tuning the two-gang condenser, and the knob of the capacity trimmer, T.

### Coil Data

The circuit is bound to be very successful if you build it carefully, and, above all, reap the full gain of the step-up ratio of the coils. If you prefer to wind your own coils you may use No. 24 double silk wire throughout. L1, the conductively coupled antenna coil, used because it affords strongest pickup, consists of 45 turns, tapped at the 14th and 34th turns, these taps being brought out to binding posts on a 2 1/2 inch diameter 2 1/2 inches high. Either tap may be used for the antenna, depending on which works better, a point to be determined not on the basis of volume alone but on the basis of nearest approximation to the tuning of the other circuits.

You may have to remove turns to make the dials track, but this method has been explained.

The three-circuit coil L2L3 has 45 turns on a 2 1/2 inch diameter 3 inches high, constituting the stationary part of the primary. Inside is slipped a form 2 inches in diameter, and bolted in place after you have wound as much wire on the smaller form as it will stand, usually around 80 turns or so. The tickler is on a form 1 1/2 inches in diameter, 1 inch volts should be a 112A, with suitable bias, while for 180 volts it might be either a 112A or a 171A. The difference is that the 112A will not last quite so long with the higher voltage, but it will give more volume than the 171A on electro-magnetic type speakers. For dynamic speakers use the 171A, even at 135 volts, as a low mu output is a requisite for good results from the dynamic, because the tube plate resistance then is low, and

## Tone Superb as Detection Is Grid Bias

thus matches better the impedance of the output transformer built into all dynamic speakers.

### Dynamic Speaker Choice

As the present circuit draws only about 30 milliamperes, it is entirely practical to use the 110-to-150 volt DC type of dynamic speaker, connecting in series with one of the field coil leads a suitable resistance, usually around 1,500 ohms and rated at 50 watts, joining the free end of the resistor and the other cord of the field coil across the entire output of the B supply, if an eliminator is used.

For battery operated plates, this type of dynamic should not be used, but instead the 6-volt type, which connects directly to the storage battery for A eliminator, for it draws only half an ampere.

In any event the tipped leads for the speaker go directly to plate and B plus—to the phone tip jacks PTJ—just as they would if no dynamic speaker were used. The speaker cord connections always are the same, but the field coil connections differ, as explained.

These directions apply to tuning with .0005 mfd. condensers. If .00035 mfd. condensers are to be used, include five extra turns on the antenna coupler, simply by addition at either end, and tap at the 19th and 39th turns. The fixed primary of the first coupler would have 56 turns, instead of 48, the tickler remaining the same, and the secondary likewise. The third coil would have a 56-turn primary and a secondary as in the other instance.

As already suggested, grid bias detection is used. This is necessary, because the detector input must stand a wide swing. Leaky condenser detection would overload hopelessly.

Other illustration on front cover.

## Wind Instruments Taboo in WMCA Group

Frank A. Duggan, president and managing director of the Hotel McAlpin, New York City, announced elimination of the wind instruments from the orchestra of the McAlpiners.

This is the first large hotel in the country to emphasize the elimination of the old-fashioned jazz music from the hotel orchestra. Harold Veo and his McAlpiners will broadcast this new type of music from WMCA. Mr. Veo reports that a combination of Viennese and American music is becoming steadily more popular. This policy, Mr. Duggan says, will not apply to the orchestras which are brought in for private affairs held in the Hotel McAlpin.

Six Tubes in Amplifier that Makes Low-Voiced Talk or Music Audible to 15,000 Persons.

# The Victoreen

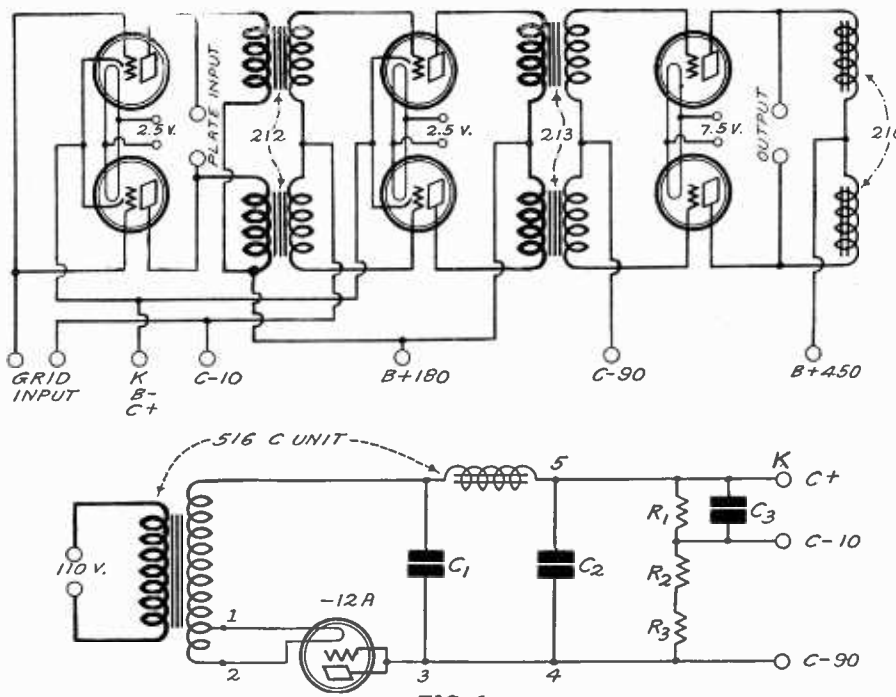

FIG. 1  
(A) THE CIRCUIT DIAGRAM OF THE VICTOREEN DUPLEX POWER AMPLIFIER, DETACHED FROM THE PLATE CURRENT AND THE GRID VOLTAGE SUPPLY CIRCUITS. (B) THE GRID VOLTAGE SUPPLY

[The Victoreen Duplex Power Amplifier, the latest achievement of John A. Victoreen, created a sensation at the recent radio shows in New York and Chicago. Mechanically the amplifier is the work of a master craftsman, electrically it is the work of an expert radio engineer. The design of this power amplifier is such that it clearly indicates that the designer is fully conversant with the demand of today and that he senses what the demand will be in the future. The amplifier has been designed for the tonal epicure of today and for those in the future who will appreciate fidelity of tone to the full.]

The Duplex amplifier is designed to handle very great volume without distortion. It is suitable for serving large audiences up to 15,000 or more, both indoors and outdoors. It is essentially a powerful public address system that can be used anywhere with exceptionally satisfactory results. It can be used even in a home, for the volume can be controlled to make it suitable for even the smallest apartment. And when that is done, only the cream of the volume remains. Distortion has been banished totally. The author offers a free blueprint. Address him care of RADIO WORLD.]

By E. A. Benson

THE Victoreen Duplex Power Amplifier, as its name implies, contains two equal audio amplifiers. Each one contains three tubes. The same signal enters both, but the first two transformers are arranged so that the signal in one is 180 degrees out of phase with the signal in the other. This change of phase is effected by simply reversing the leads on the primary of one of the first two transformers.

The plate circuits of the power tubes are in series, or they are connected in exactly the same manner as the output tubes in a push-pull amplifier. Thus the Duplex power amplifier is a push-pull circuit as a whole, although no push-pull transformers are used at any stage. The circuit has all the advantages of a complete push-pull circuit and the ability to handle much greater signals, in addition. Overloading of either of the tubes in a pair will not result in a distorted signal, for the other tube in the same stage is overloaded in the opposite direction so that the net result is faithful amplification.

One of the most desirable features of

a circuit of this type is that the requirements on the plate current supply is constant. When one tube in a pair requires more current, the other requires less in the same degree. Hence there are no sudden current draughts on the filter condensers. They remain charged to a certain constant voltage, which is the same as that when no signal is impressed on the amplifier.

#### Feedback Avoided

This constancy of the voltage is of utmost importance in a power amplifier as it prevents any feedback of signal from any stage to a preceding stage. Thus all the distortion which arises from this cause in ordinary unsymmetrical circuits is eliminated. And this feedback is one of the major sources of distortion and other amplifier troubles.

If there is any residual hum in the plate voltage supply, its effect also is eliminated in the symmetrical or duplex circuit.

The hum tends to increase and decrease the amplification periodically in both amplifiers, but as the two amplifiers

work in opposite phase, the increase in the amplification in one is accompanied by an equal decrease in the other, so that the change in the amplification due to hum is zero.

The circuit diagram of the Duplex Power Amplifier alone is given in Fig. 1A on this page. Four of the tubes are of the -27 type and two of the -50 type. The plate voltages on the -27 tubes, as will be noted, is 180 volts. This is so high that these tubes can handle any signal voltage required to load up the power tubes without appreciable overload on any one. And since they are in push-pull, as far as the effect is concerned, even the slightest distortion is balanced out.

#### Choice of Input

As will be noted, there are two places indicated as input. The grid input is used when the amplifier is to be used as a three-stage circuit, or when the first two tubes are used as detectors. The plate input is used when only two stages are required, or when a separate detector is used. The plate input may also be used when the output of a phonograph pick-up is used as the signal source.

The cathodes of the four -27 tubes are connected and terminated at a binding post K. To this should be connected the B- on the plate power supply and the C plus on the grid voltage supply unit. The B plus 180 and the B plus 450 should be connected to the corresponding terminals on the plate current supply unit, and the C-10 and C-90 to the corresponding terminals on the grid voltage supply unit.

There are two pairs of binding posts marked 2.5 volts. These go to the same 2.5 volt winding on the power supply transformer. The 7.5 volt terminals go to the 7.5 volt winding on the power transformer.

All the terminals, except the input and the output, are shown in this diagram for convenience. As the amplifier and the grid and plate voltage supply units should be built on the same baseboard, the leads may be run directly without any binding posts.

The Victoreen 212 Duplex audio transformer is put after the first pair of tubes. It is this which is so connected that the signal in one is reversed in phase with respect to that in the other.

The second Duplex transformer, No. 213, is connected in the usual manner. So is the Duplex choke unit No. 216. But the speaker terminals are connected directly across it with any stopping condensers.

The omission of the condensers has been done in the interest of bass note reproduction. Sometimes condensers are inserted for protection against shocks from the high voltage. They serve only to protect the careless at the expense of the low notes. A shock is not dangerous, but it is a very forceful reminder that there is a switch in the supply line which should be used whenever any changes are to be made in the circuit.

#### The C Supply Unit

The grid voltage supply unit as used in the Victoreen Duplex Power Amplifier is shown in Fig. 1B. The rectifier tube used in this circuit is a -112A type, the filament of which is heated by a 5 volt winding on the transformer portion of the Victoreen 516 C Unit. A second winding on this transformer supplies the

The First Circuit of its Kind Ever to Be Published



# Duplex Amplifier

May be Used in Auditorium, Theatre or Home for Radio, Phonograph or Public Addresses.

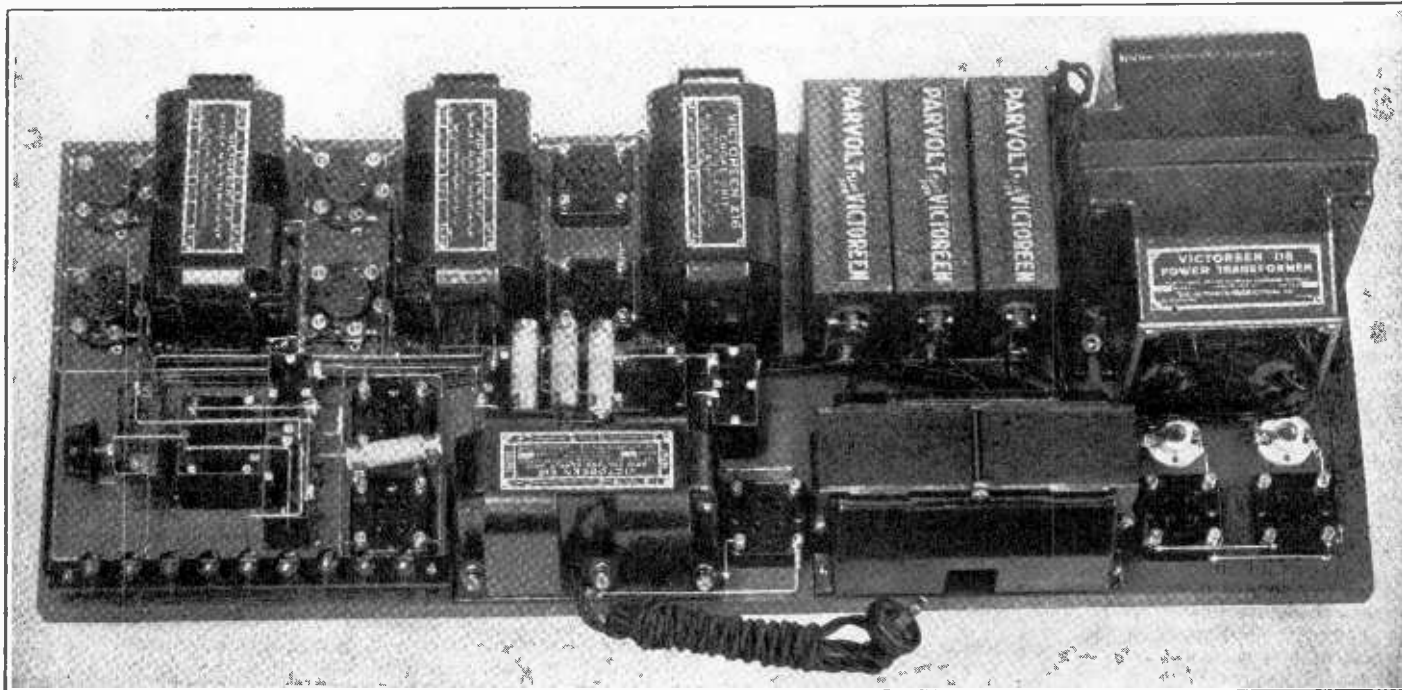

FIG. 2

THE COMPLETED UNIT, WHICH GIVES ENOUGH AMPLIFICATION TO ENABLE A WHISPER TO BE HEARD ALL OVER MADISON SQUARE GARDEN

current to be rectified. It is so proportioned that the output voltage is 90 volts.

The filter part of the unit consist of choke winding in the 516 unit one 1 mfd. condenser C, and one 2 mfd. condenser C. The filtering is sufficient although such small condensers are used because

the choke coil has a high inductance and the current drawn from the device is very small. In fact the current is only about one milliampere. This small current practically insures an indefinite life to the rectifier tube. If the life of the tube is 2,000 hours when it delivers 12 milliamperes it will be 24,000 hours in the C supply unit. That means a good many years of normal operation.

power transformer supplies the necessary filament and plate voltages. It has four center-tapped windings. One supplies the 7.5 volts for the filaments of the two -81 type rectifier tubes. Another supplies the 7.5 volts for the filaments of the two -50 type power tubes in the amplifier. A third supplies the 2.5 volts for the heaters of the four -27 type tubes in the amplifier. And a fourth winding supplies the high voltage which is rectified to yield the 450 volts for the power stage, as well as the lower voltages on the voltage divider.

The filter in the plate current supply consists of three 4 mfd. high voltage condensers C1, C2, and C3 and the Victoreen 217 choke unit. Each of the choke coil sections has an inductance of 40 henrys at normal load.

The voltage divider is designed to maintain constant voltages of 180 and 90 volts. The constancy is assured by the used of two 874 voltage regulator tubes, connected in series. The voltage across each of these is automatically held at 90 volts. These tubes also minimize any fluctuations in the voltages applied to the power tube and to the radio frequency stages.

(Continued next week)

## LIST OF PARTS

(For the Duplex Amplifier)

One Victoreen 212 Duplex audio transformer.

One Victoreen 213 Duplex audio transformer.

One Victoreen 216 Duplex choke unit.

Four Benjamin UY spring sockets.

Two Frost UX sockets.

Six Eby binding posts.

(For the plate current supply)

One Victoreen 118 power transformer unit.

One Victoreen 217 hocke unit.

C1, C2, C3—Three Parvolt 4 mfd. condensers, 600 volt test.

C4—One Parvolt 2 mfd. condenser, 200 volt test.

C5, C6—Two Parvolt 1 mfd. condensers, 200 volt test.

R1—One 5,000 ohm 20 watt fixed resistor.

R2—One 25,000 ohm truvolt variable resistor.

Four Frost UX sockets (Two for -81 tubes and two for -74 tubes).

(For the C Supply)

One Victoreen 516 C unit.

One Benjamin UX socket.

C1, C3—Two Parvolt 1 mfd. condensers, 200 volt test.

C2—One Parvolt 2 mfd. condenser, 200 volt test.

R1—One 10,000 ohm resistor.

R2—One 25,000 ohm resistor.

R3—One 50,000 ohm resistor.

## Voltage Divider

The voltage divider on the C supply unit consists of three resistors, R1, 10,000 ohms, R2, 25,000 ohms and R3, 50,000 ohms. The drop in the 10,000 ohm unit is about 10 volts. A tap is therefore made between R1 and R2 to supply the grid bias for the four -27 type tubes in the Duplex power amplifier. The entire output voltage of 90 volts is used for the two -50 type tubes in the amplifier.

An additional 1 mfd. condenser C, is connected across the 10,000 ohm resistor to prevent any possible feedback through this voltage divider.

The grid battery eliminator supplies a constant grid bias for the tubes in the set as long as the voltage of the supply line is constant. If this voltage fluctuates the grid bias will fluctuate in the same proportion. But so will the plate voltage from the plate current supply because it is connected to the same line. Thus the grid and plate voltages are automatically adjusted. This is not true when a grid battery is used.

## Generous Plate Supply

A plate current supply device intended to drive a higher power amplifier like the Victoreen Duplex, and the radio frequency amplifier in addition, must be built on generous lines.

The Victoreen plate current supply system is so built. Fig. 3 shows the circuit detached from the amplifier and the grid voltage supply units. The Victoreen 118

## LIST OF PARTS

(For the C Supply)

One Victoreen 516 C supply unit.

One 1 mfd. Acme by-pass condenser, 200 volt test.

One 2 mfd. Acme by-pass condenser, 200 volt test.

Two Electrad 50,000 ohm variable Truvolt resistors.

One UX type socket.

One type 112A tube.

Five Eby binding posts.

One binding post strip.

One Baseboard 5½x7½ inches.

## Two Equal but Opposite Channels of AF

# No Dots In Television Use At Any Time

WHEN writers on television discuss the high frequency requirements of the system they invariably mention the number of dots per square inch. What has "dots-per-square-inch" to do with the clarity of a reproduced television image, anyway? In what system of television are dots of various sizes used to reproduce the picture?

We might stop here and ask how many dots per square inch are required in a photograph to make it sharp and clear. Obviously no dots at all, but a continuous gradation from white to black. The "dots per square inch" devotee might say that that is equivalent to an infinite number of dots per square inch. He is undoubtedly correct, but he would also be correct if he admitted that there are no dots per square inch.

The "dots-per-square-inch" idea, of course, is taken from half-tone reproduction of photographs. Such a reproduction is made of a certain number of dots, of various sizes, per square inch. The smaller the "screen," the more nearly is the "cut" like the original photograph, providing the paper is of a high grade suitable for printing the cut well.

### No Dots in Television

If a half-tone picture were reproduced by television there would be dots, if the television process were true. But in the transmission of pictures of natural objects there are no dots. It is difficult, then, to see what light the talk about "dots-per-square-inch" sheds on the principles of television.

Television images contain a certain number of lines per linear inch. The larger the number of these lines per linear inch, the clearer the image. But each line is not a row of dots, but a line of continuously varying light intensity. The intensity might change abruptly at some places. However abrupt, the gradation is continuous. It is not broken up into dots of light specking a dark field. Each line is similar to a true photograph and not a half-tone of a photograph.

It would not be impossible to devise a television system which made a half-tone reproduction of a true picture. But such a system would be incomparably more complex than any of the systems now used, and the resulting clarity of the image would not be so good.

So why talk about "dots-per-square-inch?"

### Lines Per Linear Inch

It would be much more instructive to discuss the number of lines per linear inch that should be used to obtain a given clarity or definition of the image, and to discuss the frequency requirements for properly varying the light intensity of the lines. The discussion would then be confined to actualities, and not to something taken from a remotely allied art that has no bearing on the case.

Suppose the television system is such that there are 48 lines per picture and 20 pictures per second. What are the frequency requirements of the system if this picture is to be reasonably faithful? Since there are 20 pictures per second there will be a component in the signal which has a frequency of 20 cycles per second. The entire system must therefore be able to handle this low frequency. It must also handle all its harmonics.

Since there are 48 lines per picture, there will be another component in the signal having a frequency  $20 \times 48$ , or 960 cycles per second. The transmission sys-

# A New Sca

## DISC ROTATES ABOUT

By J. E.

Technical

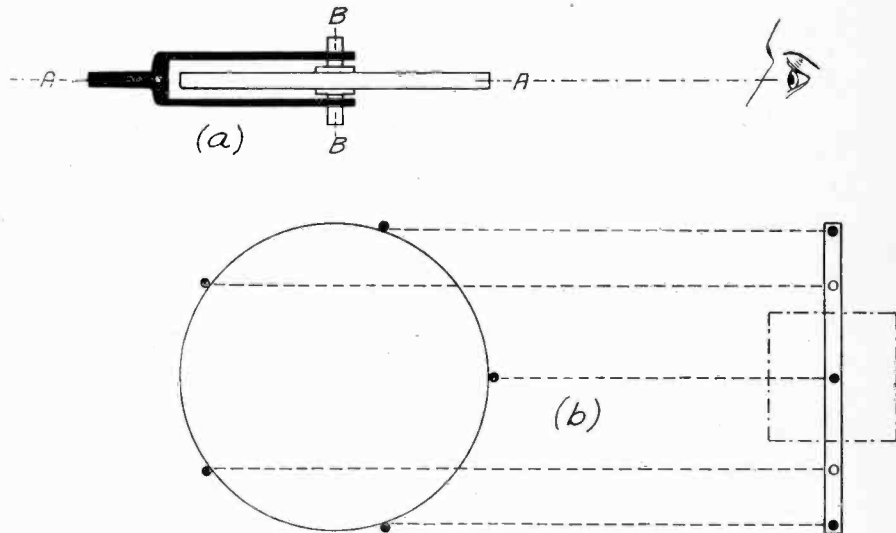

FIG. 1

THIS ILLUSTRATES THE PRINCIPLE OF THE KODOL SCANNING SPHERE, A NEW DEVELOPMENT IN TELEVISION SCANNING. (A) SHOWS THE TWO AXES OF ROTATION OF THE DISC WITH ONE POSSIBLE POINT OF VIEW. (B) SHOWS THE DISC BROADSIDE, LEFT, AND EDGEWISE, RIGHT, AS IT APPEARS ONCE FOR EACH REVOLUTION ABOUT AXIS AA

A NEW type of scanning device for television transmission and reception has been announced by Clarence E. Ogden, president of The Kodol Electric & Manufacturing Company, Cincinnati, Ohio. It is claimed this device is capable of transmitting or receiving much larger and much finer images than any other scanning device previously known. It is said to be greatly superior to the scanning disc and that it seems to point the way to a more rapid development of television as a practical form of home entertainment.

### A Spinning Globe

The device is based on the use of a circular disc which is so mounted that it can be rotated simultaneously both about center and about one of its diameters. The disc is mounted in a forked support in which it can be rotated at a high speed and then the base of the fork is mounted in bearings so that the fork and disc as a whole can be rotated at some other speed. When the disc is rotated about a diameter at a high speed the appearance is that of a spinning globe. This is true, of course, whether or not the disc spins about its own axis, but the rotation about this axis is necessary to produce the proper distribution of the scanning effect.

### How Scanning Is Effected

On the periphery of the disc, photo-

tem must handle this frequency with all its harmonics.

### One System

These two conditions are really one, for if the system can handle the 20 cycle frequency with all its harmonics, it can also handle the 960 cycle component and all its harmonics because 960 is a har-

monic of the 20 cycle fundamental. electric cells or neon glow tubes are mounted, depending on whether the device is to be used for transmission or reception. An odd number of these tubes is used, five being suitable, and the tubes are spaced at equal intervals.

When the disc spins about its axis these tubes trace a straight line if viewed in the plane of the disc, a circle if viewed at right angles to the plane along the axis of rotation, or an ellipse if viewed from an intermediate direction. If the disc spins both about its axis and about the axis of the fork supporting the disc, the tubes describe the sphere.

If the tubes are luminous the sphere is also luminous. The sphere will be traced by a multiplicity of spiral lines, one for each tube for each revolution. The closeness of these lines will depend on the relative speeds of the two independent rotations.

### Cylinder Could Be Used

In Fig. 1 a is shown a simplified construction of the device. The axis of the disc is BB, around which the rotation is very rapid. The axis of the fork carrying the disc is AA, around which the assembly spins at a slower speed. In Fig. 1b the disc is shown without the fork but with the positions of the tubes indicated by black dots.

It is not necessary that the tubes be placed outside as shown. A drum could

monoc of the 20 cycle fundamental.

But there will be components in the signal which are not necessarily harmonics of the 20 cycle frequency. These components will depend on the rate at which the intensity of a picture strip varies. If the intensity of a strip is everywhere the same there will be no additional requirements, for there will be only the

# Scanning Device

## OWN AXIS AND DIAMETER

Anderson

Editor

be used with the tubes mounted inside, with only a small hole in the surface in front of each tube so that the light can enter or escape.

### The Point of View

The question arises as to what point of view should be used. If the point of view is as in (a) a circle will be seen. But the luminosity will not be uniform over the entire circular area. All the lights will pass through the apparent center and hence that will be brighter than the peripheral areas.

If the assembly is viewed from side the distribution will be better but part of the field will be obstructed by the fork. There would be a permanent shadow in the field. Also the center of the field, in so far as it is not obstructed by the fork, will have less illumination than the peripheral areas because the angular velocity of the lights is greatest at the center.

The size of the luminous field available is determined by the size of the disc and the angular separation between the tubes or lights. Only one of the tubes must be in the field at a time, and only one must be active at a time. The square at the right in (b) shows the size permissible if the point of view is as in (a). The diagonal of this square must not be greater than the distance between two adjacent tubes on the near side of the disc. The narrow rectangle at the right shows the edge of the disc with the black dots representing tubes on the near side and the white circles on the far side.

If the point of view is in the other direction as shown in (b) at the left the same limitation of field holds.

### Commutator Used

As only one photo-electric cell or neon tube must be active at the same time, unless a separate transmission channel is used for each, it is necessary to use a system of commutators which automatically switches the line to the tube in the field of view. This commutation does not invalidate the limitation of size of the field of view explained above, for if the frame did not limit the field, the commutator would do so automatically. A commutating system is used in the system developed by the Kodal Electric & Manufacturing Co.

It will be recalled that in other systems of scanning commutators have been banned because of the sparking. The sparks affect the received image. It is obvious that in the Kodal system the sparking will have the same effect. This is not a serious disadvantage because sparking always can be reduced by filters and the effect of it can be minimized by shielding to any degree required.

### Details in Image

It is claimed for the Kodal system that

20 and 960 cycle components together with their harmonics.

If all the strips also have the same intensity there will be no signal for the field of view will be blank. But if the intensity of the object varies gradually from one side to the other the intensity of the strips, or lines, will vary in steps, and the 20 and the 960 cycle components

any degree of definition of the received image may be attained with ease. In fact it has been said that an image as large as that on a moving picture can be reproduced with the same clearness. Other systems are not yet capable of such fine definition.

It is obvious that in the new system the number of lines per frame and the number of repetitions per second can be made whatever is desired by merely changing the speeds of the two rotations. The greater the speeds the more lines and more repetitions.

But it is not obvious that the greater the speeds the finer the definition will be. The fineness of the images will depend as much on the area covered by the photo-electric cells and the neon lamps as by the number of lines. It will do little good if the number of lines are increased indefinitely if the lines are so wide that they overlap.

A fine screen half tone cut will produce a very fine, detailed picture, but if the same cut is used to print on the same paper several times, displacing the cut each time a minute distance, the composite picture will be nothing but a blur. The same holds true in the television scanning device as well, and much more effectively.

### Frequency Limitations

Granting that it is possible to arrange the scanning device so that the lines at both the transmitter and receiver are of sufficiently fine texture to equal moving picture projection, there is still the question of frequency limitation to contend with. The older systems of scanning are coarse because of this limitation. The new system is limited by the same conditions. The transmission channel does not change its characteristics to suit the scanning device.

### Synchronization

The new system lends itself readily to synchronization. The fork may be driven by a synchronous motor, or any other constant speed motor. The disc rotating in the fork then can be geared to the main shaft in such a manner that the speed ratio has the desired value. If the same ratio is used for both the transmitter and the receiver there is only one speed ratio has the desired value. If automatically if both are driven by synchronous motors connected to the same electrical distributing system.

Even if the Kodal system is not free from the limitations of the older systems, there is no doubt that it advances the art of television. It is a new conception in scanning and it offers many interesting possibilities. It has one advantage of being flexible.

will occur in the signal as well as all their harmonics.

### Complex Picture Strips

Suppose the light intensity of the object varies abruptly in the direction of the scanning lines. For example, there might be black streaks across a light background. The scanning line will have to pass these streaks at a high rate of

## Lines Used Must Allow for Details

speed. The light intensity will be broken up and the signal will contain frequency components depending on the rapidity of change from light to dark.

There will be no regular change in the intensity in any natural picture. Hence the signal will contain frequency components of all kinds of values. And the system must handle them all, together with their harmonics. In other words, the system must be able to handle all frequencies from 20 cycles up.

The question is where the limit should be put in a practical case. Will the picture be tolerably clear if all frequencies up to 20,000 cycles are transmitted and reproduced faithfully? The only place where there will be any blurring or indistinctness is at points where there is sharp contrast in the object, where the scanning beam crosses abruptly from a dark to a light area, or from a light to a dark. If the system cannot handle the extremely high frequencies the signal intensity cannot change suddenly, but will go from one value to another gradually. The reproduced image then will appear as if viewed on a photographic ground glass when the camera is out of focus. A little blurring of this type is not objectionable, for we accept such pictures continually. Every motion picture, every photograph and almost every direct view is blurred to some extent. Yet it is not noticed unless it is very bad or unless two similar pictures, one distinct and the other blurred, are observed at the same time.

### Inadequate Scanning

If there are too few scanning lines per picture there is also blurring, even if the lines are accurately adjusted so that there is no overlapping or open spaces. The scanning beam covers a definite width, and the intensity of the object may not be the same throughout the width. The signal does not contain this variation, but only the mean value of the intensity in the width of the beam. The mean value is reproduced also. Thus the image must vary in intensity if steps. The more and narrower the scanning beams the more nearly will the mean intensity be equal to the actual intensity at the center of the beam, and the less blurring.

The tendency in television development is to adopt 48 lines per picture frame with a speed of 20 per second. It would seem that this speed is great enough to prevent flicker even at low illumination. But it would be desirable to increase the number of scanning lines per frame, but 48, with two exceptions, is the highest number used. There will not be much progress in television until there is some agreement as to the number of lines and scanning speed used, and it will not come from talking about the number of "dots per square inch."

## \$250 for a Name for Molded Products!

The manufacturers of molded products want a new name—a coined word to become identified with all molded products, as "rayon" is now used to mean artificial silk.

The National Electric Manufacturers' Association, 280 Lexington avenue, New York City, is willing to pay \$250 for the selected name. Address the association for particulars. Mention RADIO WORLD.

# SG Diamond Hookup

By H. B. Herman

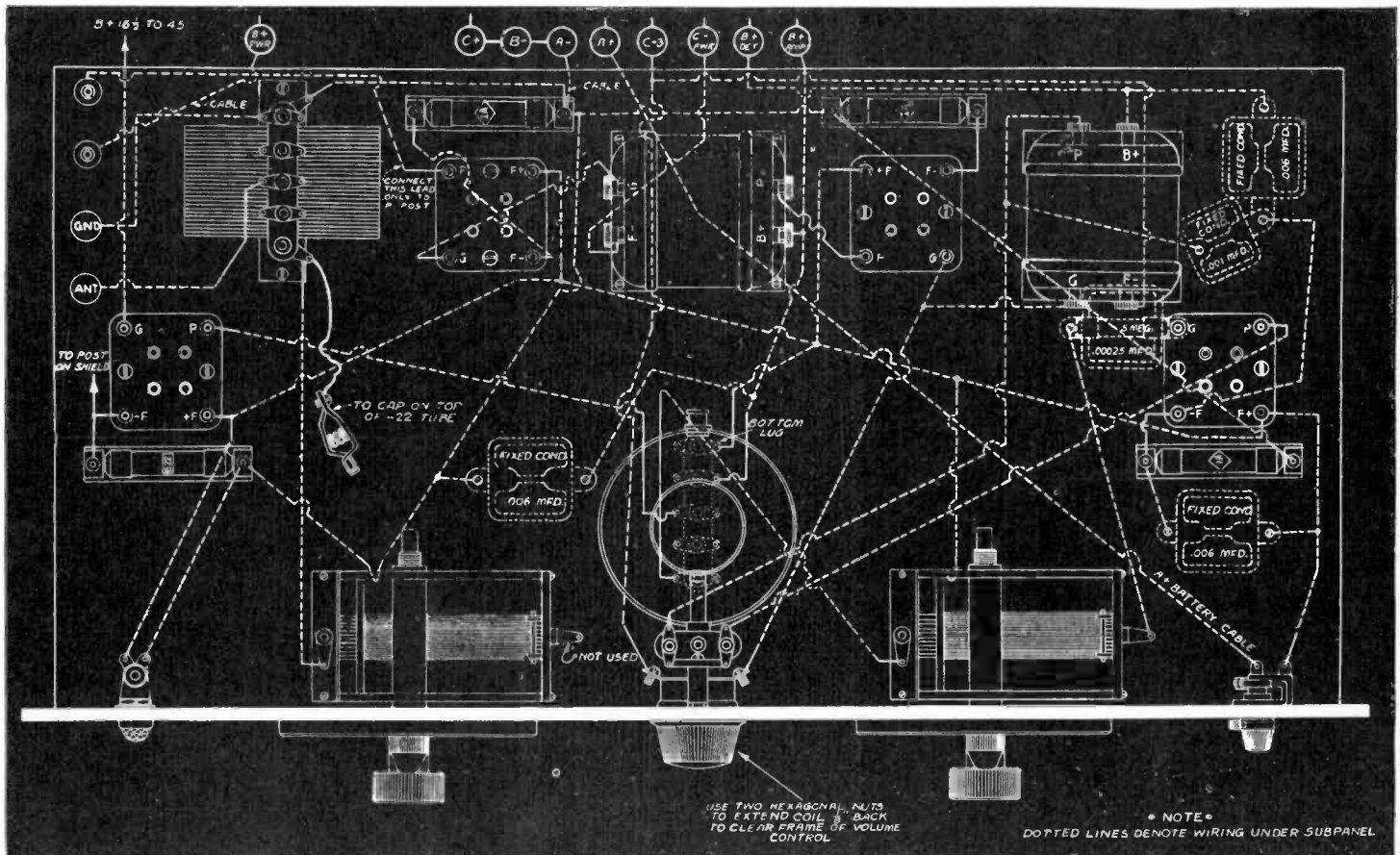

BY following the picture diagram of the four-tube Screen Grid Diamond of the Air, published herewith for the first time, the building of this receiver is made easy. The same wiring, life sized, however, is contained in the blueprint.

The receiver is built on an aluminum subpanel. Since the subpanel is usually grounded by the constructor, and is likewise the minus A circuit, insulating washers, secured to holes in the subpanel, prevent any shorts. These insulators are furnished with the subpanel.

Any one may prepare the 7x21 inch front panel from the blueprint dimensional directions, or may purchase one already drilled for this layout.

#### Coils to Use

The coils used are the Hammarlund HR23. They comprise the antenna coil and the three-circuit tuner. The wiring, as shown, uses only part of the primary of the three-circuit coil, for greater selectivity in air-congested areas. But for greater volume the plate lead from the RF tube may be put instead one lug farther up. The lugs are in central foreground of the picture diagram.

When the full primary is used the voltage amplification is greater, and many will prefer this connection, but all should try both, separately, and adhere to the one that suits the purpose better.

The antenna coil also permits connection to more or fewer primary turns, the greater number of turns affording more volume and less selectivity, and the fewer number of turns, more selectivity and less volume.

#### Volume on DX

Two transformer coupled stages of audio are used, and the volume is more than enough for fine speaker operation

#### LIST OF PARTS Vital Kit

Hammarlund HR 23, consisting of one antenna coupler and one three-circuit coil, both for .0005 mfd. tuning.  
Two .0005 mfd. tuning condensers, type 23.

Two audio frequency transformer.  
One No. 622 Amperite with mounting.  
Three No. 1A Amperites with three mountings.

One Lynch 5 meg. grid leak.  
One Volume Control Clarostat.  
Three Aerovox .006 mfd. fixed mica condensers.

One Aerovox .00025 mfd. mica grid condenser, with clips.  
One .001 mfd. Aerovox mica fixed condenser.

One Yaxley No. 10 battery switch.  
One Yaxley No. 310 pilot light bracket (with lamp extra).

Two Frost phone tip jacks, No. 253.  
Two binding posts (Ant., Gnd.).  
One 7 x 21 inch front panel.

One 10 x 20 inch self-bracketing aluminum subpanel, with sockets affixed.  
Two dials.

One Pee-Wee clip (No. 45 Universal clip).

#### ACCESSORIES

One shielded grid tube (Harmonique 222).  
One Vac-Shield for shielded grid tube.  
Two 201A tubes (Harmonique 201A).  
One power tube (Harmonique 112A).  
Corwico Braidite for wiring.  
One 7-lead battery cable.  
One set of cable markers.  
A, B and C supplies.

on locals, so that the volume control should be used in such instances.

When receiving distant stations you will use the maximum volume, for this will make distance come in on a volume par with the toned-down locals—just the right volume for you.

#### Point-to-Point Wiring

It will be noted that the leads run directly from point to point without making any unnecessary bends and angles. This is the best method of wiring. The only reason it has not been used much in the past is that its appearance is not so attractive when the wiring is on top of the sub-panel. Appearance takes a secondary importance to proper wiring when the leads are under the sub-panel, as they are in this receiver.

When this type of wiring is employed it is best to use flexible and insulated wire, for this can be handled more easily than stiff bus bar wire. It makes little difference what kind of flexible insulated wire is used, but if it is tinned copper soldered connections can be made with ease. And every connection should be soldered carefully unless a terminal can be put under a nut.

In that case the wire should be twisted hard before it is wrapped around the screw. This will make a better and more positive joint.

If there should be any divergence between the dials settings it must not be assumed that something is wrong. A difference is the normal thing and should be expected in this circuit as well as in all others. If the divergence is small it may be removed by connecting a small equalizing condenser across that tuning condenser which indicates the highest reading on the dial.



# Round-the-World Four

By F. Edwin Schmitt

[Part I of this article on a fine receiver that gets both short waves and long was published last week, issue of October 27th. The following is the final instalment.]

THERE is another radio frequency choke, Ch2, in the circuit. Its object is to force regeneration when it is wanted. It is a stop-loss coil which prevents the radio frequency currents from escaping through the audio coupler following the detector. For short waves this coil is as necessary as the tube itself.

There is a .25 mfd. by-pass condenser C0 from ground to the G post on the screen grid tube socket. It serves to keep the voltage on the screen grid constant in so far as radio frequency fluctuations are concerned. Temptations to omit this condenser should be resisted for it is a really necessary adjunct to the set. Without this condenser the tube will not function as it should on the higher frequencies.

The grid condenser C4 is considerably smaller than grid condensers usually are, being only .00015 mfd. It should be for short waves. Similarly the suggested values for the grid leak are much higher than values ordinarily recommended, being from 5 to 10 megohms. Much higher detecting efficiency is obtained on short waves with a small condenser and high resistance than with the ordinary combinations.

### How Volume Is Controlled

Volume may be controlled in either of two ways. First there is the tickler condenser C5. This is used to increase the volume or regeneration. Second there is the 20 ohm rheostat Rh in the filament of the detector tube. This is used to cut down excessive volume. The two controls together provide ample control for a very wide range of signal intensities.

Note the two resistors R1 and R2 in the filament circuit of the screen grid tube. Each one has a value of 10 ohms. One half of the total 20-ohm ballast is put in each filament leg in order to give the proper bias to the tube and still permit the grounding of the low potential end of the input choke coil.

### A Parting of the Ways

Up to this point the description of the circuit applies to both the "Round the World Four Receiver" and the "Round the World Adapter." But at this point there must be a divergence.

Consider first the complete receiver. In Fig. 1 a two stage audio amplifier is connected to the detector by five dotted lines. These are to be considered as connections when the complete receiver is to be built. There are two audio transformers, 255 and 256, in the amplifier. These are of special construction and intended for high voltage amplification and faithfulness to the signal. They must be connected in the order shown in the drawing.

In the event the amplifier should howl due to feedback in the plate voltage supply the 60,000 ohm resistance R4 should be connected across the output terminals of the first transformer. If the circuit does not howl without it, it should not be used.

A .002 mfd. condenser is connected across the speaker. It serves to remove much of the high frequency noise sometimes heard in receivers.

A common 2-ohm ballast resistor R5 is used for the two audio tubes.

Two binding posts are provided for grid bias on the audio tubes. On the first this should be 4½ volts and on the second 9 volts.

### Adapter Arrangement

Now if an adapter is to be built, and not a complete receiver, everything to the right of the dotted lines is to be disregarded. An adapter plug should be provided. It either may be purchased or constructed from an old tube base and a few feet of insulated wire. The terminal marked Y in the drawing is connected by a wire of suitable length to the plate prong on the old tube base. When this old tube base is inserted in the socket of the receiver and the detector tube is put in the detector socket of the adapter the output of the adapter is impressed on the audio amplifier in the broadcast receiver.

While it is customary in short-wave adapters to put the filament leads also in the plug, this is not recommended in this case because the detector rheostat or ballast in the broadcast receiver would have to handle the filament current of both tubes in the adapter. It is preferable to provide binding posts on the adapter for both the filament and plate voltages, just as if a complete receiver were to be constructed.

The filament voltage should be 6 volts since the screen grid tube requires this in order to provide the bias and the detector because it is of the -01A type.

The screen grid voltage should be 45 volts and the plate voltage on the screen

grid tube should be from 90 to 135 volts, which ever works the better.

A separate binding post should be provided for the plate of the detector because it may be necessary to try different voltages. If the detector does not oscillate on 45 volts the voltage should be increased until it does.

### Construction of Circuit

Either the adapter or the complete receiver may be built on any baseboard of suitable size. But if the official layout is not followed, care should be taken that the sockets are placed at least one inch from the panel. This condition is particularly applicable to the coil socket.

If only the adapter is to be built the parts above appearing to the right of the dotted lines in the circuit diagram should be omitted. The parts necessary for the tuner called the essential kit, may be obtained separately. Also the complete parts for either the adapter or the receiver may be obtained in kit form. There is also a hardware kit which contains all the necessary incidental small parts.

Considerable money may be saved by buying the complete kits for either the adapter or the complete receiver. And when complete kits are obtained the purchaser is assured that every thing will fit, as the jobs have been carefully designed and coordinated.

The writer will supply full information on any of these kits if requests are made of him in care of RADIO WORLD, 145 W. 45th St., New York, N. Y.

## MOST REMARKABLE OFFER!

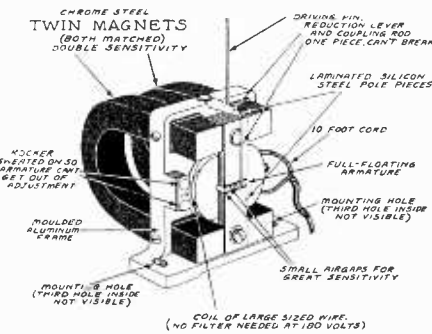

THE POLO Duo-Magnetic Unit has been acclaimed the outstanding unit.

Satisfy yourself it is louder, clearer, stronger, purer, better. Compare it with anything else in the world. Take NINETY DAYS for your trial: At the end of that time, if you want to keep the unit—and you will—then send the extra \$4. Otherwise return the unit in 90 days and get your \$6 back.

**Polo Unit** (With Bracket, Cord, Apex, Chuck and Hardware)

List Price, \$10.00

Just think of it! NINETY-day trial!

### Compare!

Make your comparisons all-inclusive, even against dynamic speakers. If you have a 171, 171A, 210, or 250 output tube, or any of these in push-pull, there won't be so much difference between the \$10 Polo Unit and the considerably more expensive dynamic speakers. But if you use 112, 112A, 120 or other similar power tube, or no power tube, the Polo Unit, with any cone or cloth speaker, will far outclass even the dynamic.

Take immediate advantage of our liberal offer. You must use attached coupon. Send \$6 and try out this marvelous Polo Unit at OUR risk.

We guarantee immediate shipment.

### YOU MUST USE THIS COUPON

POLO ENGINEERING LABORATORIES  
(Tel. Cortlandt 5112)  
57 Day Street, New York City

Enclosed please find \$6.00 on account, for which please send me at once one Polo Twin Magnet Unit, mounting bracket, 10-ft. cord, apex, chuck and hardware. I will send you the extra \$4 (making total of \$10) within 90 days after your date of shipment, to complete the purchase; or within 90 days will return the unit for complete, quick refund of purchase money.

Name.....

Address.....

City..... State.....

NINETY-DAY Money-Back Guarantee

# Write for this Book



## 80-page Manual Tells How to Build 4 NEW Hi-Q RECEIVERS and Save Money!

This new 80-page Hi-Q Construction Manual is the most important radio book of the year—shows you how to save at least \$100.00 or how to make a big, steady income through the New CUSTOM-BUILT Hi-Q Receivers—Junior Hi-Q 29 at \$54.35; Junior A.C. Hi-Q 29 at \$103.95; Master Hi-Q 29 at \$99.50; Master A.C. Hi-Q 29 at \$151.80—4 wonderful completely shielded “coast-to-coast” instruments—acknowledged to be the last word in sensitivity and knife-like selectivity—unequaled in tone quality by any ready-made set selling for \$50.00 to \$100.00 or more.

This greatest of all Hi-Q manuals is complete with text, photos and diagrams. Covers every detail of Hi-Q building. Gives full information on power amplifiers, short wave adapters, installation, antennae, house wiring and a wealth of other data. Shows you how to save money on your own set and how to make money building for others. Price 25 cents postpaid.

Write for your copy today before first edition is exhausted.

Hammarlund-Roberts, Inc.

1182-V Broadway, New York City



Bakelite Drilled Front panel and aluminum self-bracketing, socketed SubPanel of the REVELATION 4

Immediate shipment ..... \$5.00  
 (Subpanel alone, self-bracketing, socketed) .. \$3.50  
 (Drilled Front panel alone) ..... 2.00

Front and subpanel for 4-tube Screen Grid Diamond of the Air, same prices.

GUARANTY RADIO GOODS CO.  
 145 West 45th St., New York City

# Feedback Patent Argued in Last Court

Washington. Cases involving priority of radio patent rights in regard to what is known as the feedback circuit, and the ‘oscillating audion,’ used extensively in apparatus for the transmission and reception of programs, messages, still lectures and television, were considered in the Supreme Court of the United States. Arguments were heard in the cases of Westinghouse Electric & Manufacturing Company v. De Forest Radio Telephone & Telegraph Company, No. 35, and Westinghouse Electric & Manufacturing Company et al, v. United States et al, No. 36.

The subject matter in controversy is in an electrical circuit employed with a vacuum tube or “audion” known as the “regenerative” or “feedback” circuit. The identical circuit, when properly adjusted, becomes an “oscillator” circuit.

### Armstrong Got Patent

In October, 1913, Edwin H. Armstrong, assignor of petitioner, filed application for a patent on the invention of the feedback circuit. This patent was granted in October, 1914. In December, 1913, Armstrong also filed for patent an invention by which he used his feedback circuit in such a way as to produce an “oscillating audion.”

This patent was pending when Dr. Lee DeForest filed an application for an “oscillating audion” and after numerous controversies in the Patent Office, a patent was granted Dr. DeForest on this invention February 8, 1916.

### Then De Forest Got Priority

After decisions of different State courts and Patent Office proceedings, some of which were not in harmony, the court was told, the priority of this patent was granted to Dr. De Forest, says “The United States Daily.” The case is before this Court on certiorari.

It was contended by counsel for the petitioner that the evidence does not support the respondent’s contentions that Dr. De Forest had conceived or reduced to practice the invention in question.

Counsel for the petitioner admitted that possibly Dr. De Forest had accidentally stumbled on the new invention, but

that he at no time prior to Armstrong’s patent understood the workings of the invention, nor could he control it so as to reproduce certain sounds, but on the contrary it was uncontrollable and emitted certain unharmonious sounds and then ceased to emit sounds at all.

Even if it be erroneously assumed that Dr. De Forest had a conception of the invention in 1912, he is not entitled to the patent, counsel declared, since he failed to reduce it to practice with due diligence, and Mr. Armstrong in the meantime both conceived and reduced to practice. Dr. De Forest’s conduct and notebook entries for a period of three years after his claimed date of invention completely contradict his contention that he made it in August, 1912, counsel added.

The alleged disclosure of the radio invention to a person in October, 1912, was not a disclosure of the invention, but, at most, was a vague prediction of possible utility for a device which is not the invention at issue, counsel declared.

### De Forest’s Disclosure

Counsel for the respondents contended that Dr. De Forest made a full and complete disclosure of the invention to Dr. Stone, radio engineer, on October 29, 1912, tending to prove that he had at that time the correct idea as to the workings of this invention and that he fully understood all of its qualities.

It was also contended by counsel for the respondent that Dr. De Forest did not abandon his invention in 1912, but put it to practice and as soon as he had secured money enough, set up a laboratory and attempted to make further investigations in that line.

Counsel pointed out that the invention was complete under the law and that it is nothing against the invention that it was made accidentally, or in the course of investigating something else, provided only that the presence and nature of the thing was recognized when it came.

Frederick H. Wood (Drury W. Cooper and Thomas Ewing with him on the brief) argued for the petitioners. Charles Evans Hughes, Thomas G. Haight and Samuel E. Darby, Jr., with him on the brief) was heard for the respondents.



|                         |       |        |
|-------------------------|-------|--------|
| 201A                    | ..... | \$1.00 |
| 200A                    | ..... | 2.00   |
| 112A                    | ..... | 2.00   |
| 171A                    | ..... | 2.00   |
| 112                     | ..... | 1.85   |
| 171                     | ..... | 1.85   |
| UX199                   | ..... | 1.25   |
| UV199                   | ..... | 1.25   |
| UV199 (standard socket) | ..... | 1.25   |
| 226AC                   | ..... | 2.00   |
| 227AC                   | ..... | 3.50   |
| 240                     | ..... | 1.50   |
| 222                     | ..... | 3.50   |
| 280                     | ..... | 3.50   |
| 281                     | ..... | 5.00   |
| 210                     | ..... | 6.50   |
| 250                     | ..... | 8.50   |

KELLY TUBE COMPANY  
 8718 Ridge Boulevard, Brooklyn, N. Y.

# SUBSCRIBERS!

## Look at the Expiration Date on Your Wrapper

Please look at the subscription date stamped on your last wrapper, and if that date indicates that your subscription is about to expire, please send remittance to cover your renewal.

In this way you will get your copies without interruption and keep your file complete.

SUBSCRIPTION DEPARTMENT

RADIO WORLD

145 WEST 45TH ST., N. Y. CITY

A few doors east of Broadway



## HEAR LONDON ON SHORT WAVES CHANGE BANDS AS QUICKLY AS CHANGING A TUBE

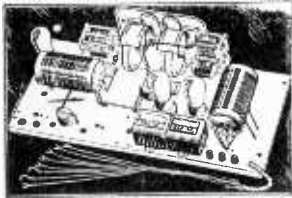

Your television experiments and short wave reception—do you depend on a receiver which is itself of "experimental" construction and requires excessive attention to insure reliability and time to change wave lengths? If you own an S-M "Round-the-World" Receiver, in its neat aluminum shielding cabinet, with its screen grid r.f. stage and quick-action plug-in coils, you can rest assured your reception—whether code, voice, or pictures—interstate or international—will be top-notch all the time.

### COMPLETE KIT

Everything necessary to build the complete four tube r.f. regenerative (non-radiating) short-wave set, including aluminum cabinet and two S-M Clough audio transformers. 730 Complete Kit.....\$51.00

### ADAPTER KIT

Complete with aluminum cabinet, less the two audio stages. Used with an adapter plug, it converts any broadcast receiver for short-wave use. Ideal for Television. 731 Adapter Kit.....\$36.00

### ESSENTIAL KIT

Contains the two tuning and tickler condensers, four wound plug-in coils, coil socket, and three r.f. chokes, with full instructions for building a 1, 2, 3, or 4 tube set. 732 Essential Kit.....\$16.50

Are you receiving the "The Radiobuilder" regularly? Every month it gives you all the earliest S-M news, operating hints and kinks. To S-M Authorized Service Stations, it comes free of charge, with all new constructional Data Sheets. If you build professionally, write us about the Service Station franchises.

SILVER-MARSHALL, Inc.,  
878 W. JACKSON BLVD., CHICAGO, U.S.A.

You can use your Round-the-World Four on broadcast bands with the new extra coils—131X for 190-350 meters, \$1.25; 131Y for 360-650 meters, \$1.50.

Silver-Marshall, Inc.  
878 W. Jackson Blvd., Chicago, U. S. A.

....Send your complete catalog, with sample copy of the Radiobuilder.

....For enclosed 10c, send five sample S-M Data Sheets.

Name .....

Address .....

## SPEAKERELAY

Cat. No. 121

\$2



For connecting two speakers by turn of knob so that at No. 1, left, you operate one speaker alone; at No. 2 you operate both speakers together; at No. 1, right, you operate the other speaker alone. Excellent for store demonstrations or home use. Earphones may be substituted for one speaker.

GUARANTY RADIO GOODS CO.  
145 WEST 45TH STREET  
NEW YORK CITY Just East of Broadway

## On Every Parts List

AMPERITE automatic filament control is officially specified for all of the popular new circuits. Engineers have used and praised it for seven years. Put AMPERITE on your parts list. Entirely unlike fixed resistors. A type for every tube—battery or A. C. At all dealers.

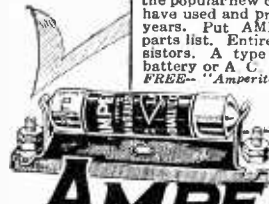

Write Dept. R.W. 21  
RADIALL CO.  
50 Franklin St.,  
New York

**AMPERITE**  
The "SELF-ADJUSTING" Rheostat

New PAUSIN Speaker—Octagon Model or \$10.00

Circular Model .....

Ideal for multi-tube high-power sets, and is the perfect Speaker for Electric Receivers in every price class. Sent prepaid if cash with order or plus postage if C.O.D.

Understand! You cannot get a better speaker at double the price!

Sold direct only by the manufacturers:

PAUSIN ENGINEERING COMPANY  
727-739 Frelinghuysen Avenue Newark, N. J.

# Classified Ads

## Radio World's Speedy Medium for Enterprise and Sales

10 cents a word — 10 words minimum — Cash with Order

**RAMSEY CREEK KENNELS**—Hundred hunting hounds, trial. Write for prices. Ramsey, Ill.

**TAKE Your Choice of 4 Other Publications for New Radio World Subscribers Ordering Now.** Radio World has made arrangements to offer, with one year's subscription for Radio World, a year's subscription for any one of the following publications FREE: Radio News or Science and Invention or Boys' Life or Radio (San Francisco).

Send \$6.00—now. State which other listed publication you desire. Radio World, 145 W. 45th St., N. Y. City.

**RECENT** issues of Radio World, 15 cents each Any number published in 1928 available for a short while. Six issues 75 cents, 10 issues \$1.00. Send stamps, coin or money order NOW, before the issues are sold. RADIO WORLD, 145 West 45th Street, New York City.

**QUICK SERVICE.** Order radio goods now, shipments made day following receipt. All merchandise pre-tested. Set of Screen Grid Coils for Bernard's Economy Three, consisting of antenna coil Model 2A and High Impedance Tuner, Model 5 HT, \$4.75. One screen grid tube, one high mu tube, one —12A tube, total for three tubes, \$7.00. Blueprint for Bernard's Economy Three, \$1.00. Front panel and subpanel for 4-tube Screen Grid Diamond of the Air, \$5.00. All merchandise guaranteed on five-day moneyback basis. Send remittance and I pay carrying and shipping charges. Philip Cohen, 236 Varet Street, Brooklyn, N. Y.

**NEW B BATTERY ELIMINATORS** 135 Vts. C. O. D. \$7.90. Money back if dissatisfied. National Mfg. Co., 2309 Lawrence, Toledo, Ohio.

## NEW VICTOREEN

"A.C." - or - "D.C."

you cannot realize the Marvelous Development in Radio Reception

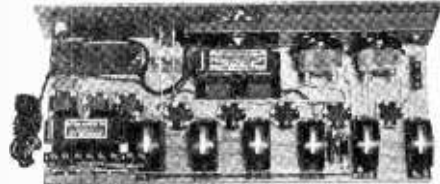

The new Victoreen is simply wonderful—that is the only way to describe it. It has wonderful tone—wonderful selectivity—wonderful sensitivity. It is wonderfully simple to assemble, wonderfully easy to operate. Anyone who has the slightest "knack" can assemble in a few pleasant hours a set which, from every standpoint, simply cannot be surpassed.

This is a season of wonderful radio programs. With a Victoreen you can enjoy them from coast to coast. If a Victoreen can't get a station it can't be had.

Victoreen R. F. Transformers have been greatly improved; the circuit has been still further developed; many other radical improvements have been made which make Victoreen more than ever, the world's standard "Super."

Write for the complete Victoreen story and the FREE Blueprint giving constructional data and full directions. You'll have a set that you can boast about when you have a Victoreen.

The Blueprint is FREE  
Victoreen  
Power Amplifier  
and "B" Supply  
Makes Any Good Set Better

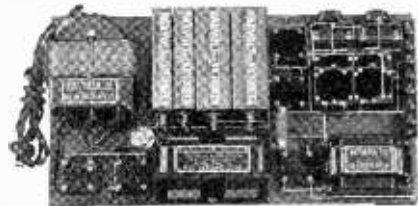

Supplies 45, 90, 180 and 450 volts, using a UX210 or 250 in the last stage. Contains two voltage regulator tubes so that the 90 and 180 volt taps are supplied with a constant volt potential. It is the last word in "B" supply. For the most satisfactory results you MUST have it.

FREE BLUEPRINT with list of parts and complete assembly instructions will be sent upon request. Victoreen Duplex Power Amplifier blueprint free, too.

# Victoreen

The GEORGE W. WALKER Co.  
MECHANICAL DIVISION OF VICTOREEN RADIO PRODUCTS  
2826 CHESTER AVENUE CLEVELAND OHIO

# Supreme Dynamic Speaker at Merely the Price of a Fair Cone!

Great on any set that has 171, 171A, 210 or 250 power tube, or any two of these as push-pull output. Not suitable for 112, 112A and 120 power tubes, or sets that have no power tube.

## 110-125 Volt AC, 50-60 Cycle Dynamic Chassis R-13

This is a dynamic speaker (illustrated at right) operating direct from the alternating current (AC). It has a built-in dry rectifier and filter to supply the field coil with the necessary current and voltage. Uses only 3.5 watts from line. Also built-in is an output transformer (in the housing). No additional output transformer need be used. Supplied with 10-foot cord. Dimensions 9" wide, 9" high, 6 1/2" deep. Weight 13 1/2 lbs. Cat. R-13, list price \$40.00. Our price to you (40% and 2% off list) ....

**\$23.52**

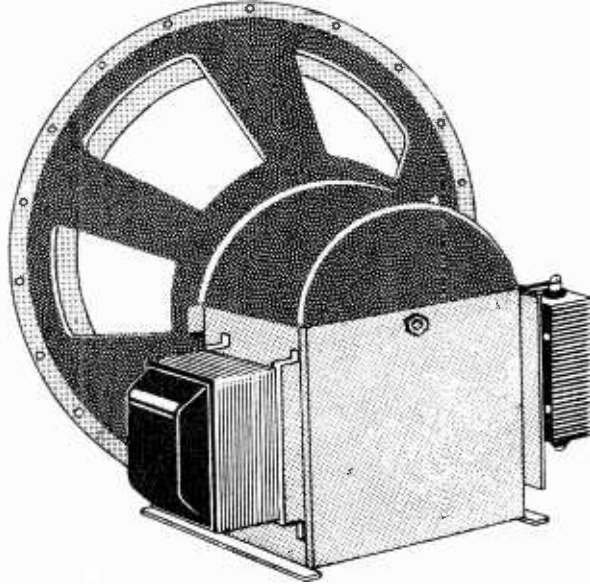

## 6 Volt DC Dynamic Chassis R-14

This is our lowest priced dynamic chassis. All of our four models produce exactly the same results, in fact all are simply different powered models of the same speaker. The R-14 may be powered from a 6-volt storage battery or A eliminator. Field coil draws only 1/2 ampere at 6 volts. Output transformer is built into the housing. Supplied with 10 ft. cord. Dimensions 9" wide, 9" high, 6 1/2" deep. Weight 10 lbs. Cat. R-14, list price \$30.00. Our price to you (40% and 2% off list) .....

**\$17.64**

Rear view of R-13, the model described at left. (Note: These dynamic chassis are licensed under both the Magnavox and the Lektophone patents.)

## All Other Commercial Types of Speakers far Outclassed in Tone by the Dynamic!

FOR sheer range and fidelity of tone nothing in the commercial field today even compares with the dynamic speaker. Also, the dynamic speaker handles more volume than any other type of speaker. Supreme in tone and volume, the only things that count! Then these amazing dynamic speakers must be frightfully expensive, you might imagine! Except for the high price you'd get one right away! But the interesting reverse is true now. You can get a dynamic chassis at \$17.64, which is less than you'd pay for an indifferent cone or cloth speaker.

Four chassis models of the supreme dynamic speaker are available. It is the same speaker—tone exactly as pure, volume exactly as great—and it comes ready to play.

The chassis is built-up. It consists of the cone, supported by a ring at the edge; the diaphragm; the field coil, which magnetizes the voice coil, the two constituting the motor; the supporting frame; the built-in output transformer (not visible) and the 10-foot cord. You may place the speaker in a console or anywhere else, or enclose it in any sort of box or baffle you prefer.

It is called a chassis because it does not come in a finished wooden case. You encase it yourself, if you like and where you like. It is a built-up speaker, not a kit—and is all built up ready to play.

The Supreme Dynamic Chassis never wears out!

THE dynamic speaker plays no favorites. The soprano—oh, you've heard the jokes about the radio soprano. No more joking now. The realism is so startling you are sometimes suspicious some one has intruded into your home. Your friends will listen with you and admire your expert speaker choice. You'll have to tell them to go home. Nobody wants to stop listening to music like that, singing like that!

And it's louder than your new or old cone or cloth speaker!

Purer, louder, better, less expensive!

How can you ever resist a combination like that?

Hundreds of thousands haven't been able to, because they know.

Put a dynamic speaker on your set by connecting the usual tipped cords to the speaker output posts of your set. In the direct current (DC) models two other wires emerge. (These go to the field coil voltage source. See the information in the corners herewith.) In the alternating current (AC) models these two extra leads also emerge, but end in a wall socket plug.

With the supreme dynamic speaker connected up, marvel at the difference between dynamic reproduction and any other you have ever heard. The low notes are strong and real. Strange you never heard them as crisp, clear and distinctive as that before or perhaps not ever at all, on that set. It wasn't the set, after all, but the speaker!

## Dynamic Speakers All the Rage—Order Yours Today!

On everybody's lips, in every radio store, on the street, in homes, in automobiles and airplanes, everywhere the dynamic speaker is under discussion. Not under debate, for there's nothing to debate. Hundreds of thousands have been sold recently—the figure this year may exceed a million. The dynamic has taken the country by storm! And now is your opportunity to get a fine one at a low price!

Be a dynamic fan yourself. Order one of our dynamic chassis. If it does not give the most wonderful reproduction you ever got from your set, return the chassis in ten days, without getting our permission, ask for your money back, and your purchase money will be refunded at once in full! No questions asked. You'll be more than overjoyed, we know; but you will decide that at our risk.

## 110-150 Volt DC Dynamic Chassis R-15

This model may be operated from any DC source of 110-150 volts, for instance, from the house lighting socket in districts that have 110 volts direct current. Power required, about 5 watts. It may be powered from a B eliminator of sufficient current capacity. Note especially the versatile voltage range within which it works splendidly, also the low power consumption. The current is 44 milliamperes at 110 volts, 60 milliamperes at 150 volts. The resistance of the field coil is 2,500 ohms, and its inductance is 40 henrys at 40 milliamperes. Model has output transformer built into housing. Supplied with 10-ft. cord. Dimensions 9" wide, 9" high, 6 1/2" deep. Weight 10 lbs. Cat. R-15. List price \$35.00. Our price to you (40% and 2% off list) ..

**\$20.58**

Acoustical Engineering Associates, 143 West 45th St., N. Y. City (Just E. of B'way).

Please ship at once, 10-day money back absolute guarantee. dynamic speaker chassis as follows:

(Put cross in square below.)

Cat. No. R-13, 110 to 125 volts AC, 50 to 60 cycles; price \$23.52

Cat. No. R-16, 110 to 125 volts AC, 25 to 40 cycles; price \$26.46

Cat. No. R-14, 6-volt DC (storage battery or A eliminator operation); price \$17.64

Cat. No. R-15, 110 to 150 volts DC (for DC house current connection or energy from a B eliminator); price \$20.58

All models are the same speaker in performance, all have built-in output transformer, also 10-ft. cord, and all are exactly as described in your advertisement in RADIO WORLD.

(Also put cross in one square below)

I am enclosing remittance of \$..... and you are to pay packing and cartage.

Please send C.O.D. and I will pay a little extra for packing and cartage.

Name .....

Address .....

City .....

State .....

## 100 to 125 Volt AC, 25 to 40 Cycles Dynamic Chassis R-16

In many districts residents desire the advantages of dynamic speaker reproduction direct from the AC house lighting socket, but instead of the usual 50-to-60 cycles they have 25-to-40 cycles. Therefore the standard AC model cannot be used. The winding about the power transformer core must be specially large—high inductance—and there must be more iron core. Therefore this 25-to-40 cycle model is the highest priced chassis. It is otherwise exactly the same as the R-13 (described at upper left), and has precisely the same appearance. Provided with 10-ft. cord and built-in output transformer. Dimensions 9" wide, 9" high, 6 1/2" deep, overall. Weight 12 1/2 lbs. Cat. R-16. List price \$45.00. Our price to you (40% and 2% off list) .....

**\$26.46**



# SOCKET WRENCH

**F  
R  
E  
E**

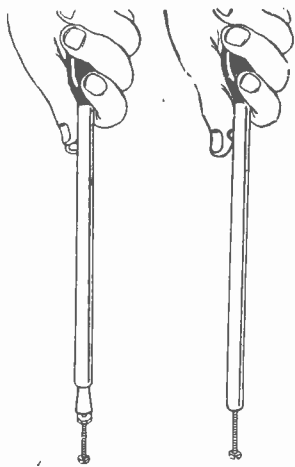

Push out control lever with knob (as at left) and put wrench on nut. Push down on handle only (at right), then turn nut left or right.

ONE of the handiest tools for a custom set builder, service man or home constructor is a BERNARD socket wrench.

It consists of a 6 1/2" long metal tubing in which is a plunger, controlled by a knob. The plunger has a gripping terminal (called a socket, hence the name "socket wrench") that may be expanded or contracted to fit 6/32, 8/32 and 10/32 nuts, the most popular sized nuts in radio.

Use the knob to push out the plunger, press down on the handle to grip the nut, then turn the nut to left for removal or to right for fastening down. Total length, distended, including stained wooden handle, 10". Gets nicely into tight places. Send \$1 for 8 weeks' mail subscription for RADIO WORLD and get this wrench FREE.

No other premium with this offer. Present subscriber may extend subscription by stating he is one, and entitle himself to this FREE premium, making \$1 remittance.

**RADIO WORLD**  
145 WEST 45TH ST., N. Y. CITY  
A few doors east of Broadway

**SET Builders** **FREE**  
LATEST RADIO GUIDE

Elections have brought back Custom Set building. Business is booming. Thousands of old-timers are cleaning up. Let Barawik show you the way to bigger profits, more sales. Send today for Barawik's Big Bargain Book — the radio man's bible.

**BARAWIK CO.** 111 Canal St., CHICAGO, U. S. A.

**BLUEPRINT**  
FOR  
**Bernard's Economy 3**  
Price \$1.00  
**PHILIP COHEN**  
236 VARET STREET  
BROOKLYN, N. Y.

**That DX Thrill**

On November 11th, the new wave allocations will provide many cleared broadcast channels. And we shall be ready for the good old DX sport once more. Get ready by installing a GRID LEAK CLAROSTAT in place of the present fixed grid leak. It will adjust your detector for maximum sensitivity. It will sharpen your selectivity on powerful local signals.

Order your Grid Leak Clareostat from your local dealer. Ask him for the Clareostat literature, or write us.

**CLAROSTAT MFG. CO., Inc.**  
Specialists in Variable Resistors  
291 North 6th Street Brooklyn, N. Y.

**CLAROSTAT**  
Reg. U. S. Pat. Off.

RADIO WORLD, published every Wednesday, dated Saturday of same week, from publication office, Hennessy Radio Publications Corporation, 145 West 45th Street, New York, N. Y., just east of Broadway. Roland Burke Hennessy, President; M. B. Hennessy, Vice-President; Herman Bernard, Secretary. Roland Burke Hennessy, Editor; Herman Bernard, Managing Editor; J. E. Anderson, Technical Editor; Anthony Sodaro, Art Editor.

## PLUG AND CABLE for any SHORT WAVE ADAPTER

Handiest thing for ANY short-wave adapter. Put detector tube of your present set in socket of any short-wave adapter you build, put plug in detector socket of your broadcast receiver. Cable, 34". Leads identified both by color scheme and tags.

5-prong plug and 5-lead cable for AC short wave adapter. May be used as 5-lead battery cable plug with UY socket. (Cat. No. 21AC) \$1.50. 4-prong extra plug only, necessary addition to other for DC short-wave adapter (Cat. No. 21DC) \$0.50.

Cat. No. 21AC and 21DC ordered together \$1.75.  
Cat. No. 21AC and 21DC with 99 adapter \$2.25.

145 WEST 45TH STREET  
New York City Just East of Broadway  
**GUARANTY RADIO GOODS CO.**

# New Powertone Unit Brilliant to Eye and Ear!

## 1929 Model Far Excels Anything Else in Its Price Class!

Having won highest repute last season, the Powertone Unit, which gave maximum volume and quality reproduction at lowest price, again wins leadership because, without any increase in price, it assures still better performance.

The coil is wound a new way, with double the former impedance, giving remarkably faithful low-note reproduction, a region in which many units are deficient. The middle and high notes are faithfully reproduced, too.

**GOLD AND VAN DYKE**

The magnet is gold-dipped, giving it a rich and handsome appearance. The dipping is done before the "horseshoe" is magnetized, so there is no detrimental effect on flux. The back frame is sprayed with a Van Dyke finish—deepest brown, a splendid color combination. Imagine gold against Van Dyke! Use this unit for its superior performance and fetching appearance!

**WHAT YOU GET:**

At \$3.75 each, this unit represents the utmost you can obtain at anywhere near this price. Not only do you get the unit, but also a mounting bracket, apex, chuck, thumbscrew nut and 5-foot cord.



**\$3.75**

This unit will drive any type of cone, airplane cloth, linen or similar speaker, but will not work a horn. The Powertone Unit will stand 150 volts without filtering and is fully guaranteed against ALL defects for one year. The armature is adjustable to power tube impedance. Order a unit NOW!

**SEND NO MONEY!**

Just order one new Powertone Unit with equipment. It will be mailed at once C. O. D. You will pay postman \$3.75 plus a few cents extra for postage.

Try it for five days. If you don't think it superb, simply return the unit with a letter asking for refund, and your purchase money will be returned immediately! You run no risks! All you can do is win!

**36" OR 24" KIT**

You can use this unit on any type cone or other diaphragm speaker you prefer. If you want to build a 36" or 24" cone yourself, specify which, and unit, paper, bracket, apex, nut, thumbscrew, cement, pedestal, cord and instructions will go forward at \$6.00 C. O. D. plus small cost of cartage. You will be overjoyed with the new 1929 model improved Powertone Unit. Order one TO-DAY!

**GUARANTY RADIO GOODS CO., 145 W. 45th St., New York City. Just East of Broadway**

# "JIFFY TESTER" Pays You Profits!

"Something wrong with my set!"  
 How often is this complaint made? The problem is to find the trouble in a jiffy; save time, worry, earn money.  
 "Jiffy Tester" turns the trick quickly!

Jiffy Tube and Set Tester, consisting of 0-20, 0-100 combination milliammeter, 0-10 AC and DC voltmeter and 0-300 high resistance voltmeter (Cat. No. 215-346 Comb.).

## \$13.50

If 0-500 high resistance voltmeter is desired. Instead of 0-300, order Cat. No. 215-347 at \$14.50.

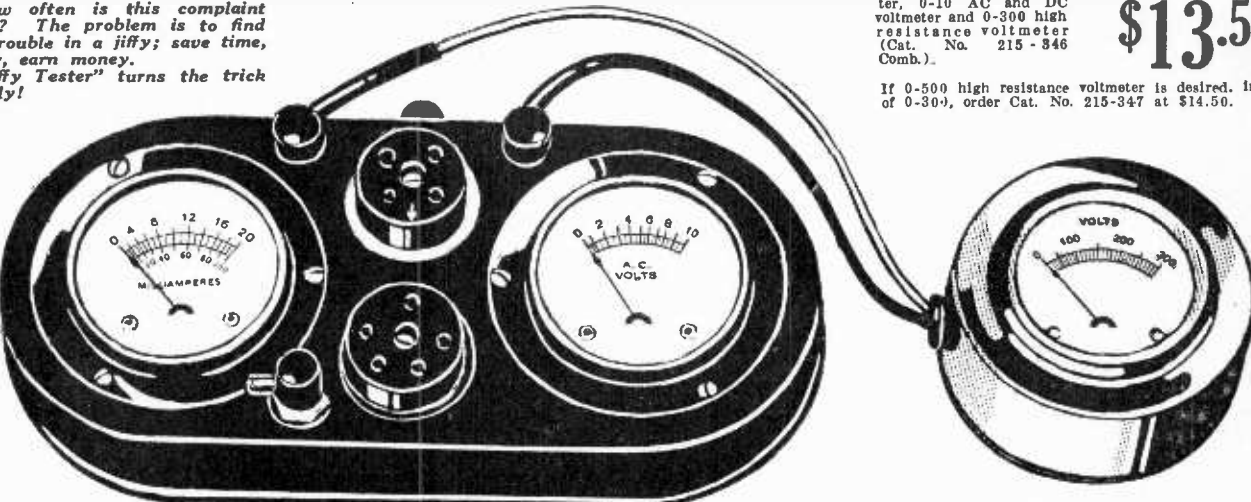

The 5-prong plug fits 5-prong AC tube socket of receiver. The 4-prong adapter converts the plug for tests of 4-prong tubes.

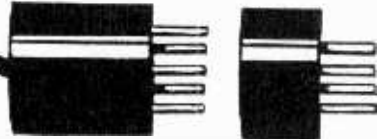

The 215 Jiffy Tester makes twelve vital tests in 4½ minutes, locates trouble, ends fuss, saves you time and nerves, and makes money for you, because you get the same pay for doing the same job quickly and scientifically as you can get for doing it slowly and unscientifically. The Tester is built to withstand hard knocks and rough usage.

## Even More Accurate than Your Work Requires

The meters are accurate to 5% plus or minus, which is more than ample for service work, home experimenting, and all other needs, except commercial laboratory testing.

Twice as great accuracy costs four times as much. Note how extremely low the price is. You cannot buy any other such Tester at anywhere near that price. Great production makes possible our low price.

- Cat. No. 215-346 Comb. Consists of:
- (1) One newly-designed Two-in-One 0 to 10 voltmeter for AC and DC. Same meter reads both. Scale especially legible at 1½ to 7½ volts. This meter reads the AC and DC filament voltages.
  - (2) One DOUBLE reading DC milliammeter, 0 to 20 and 0 to 100 milliamperes, with changeover switch. This reads plate current, which is always DC in all sets.
  - (3) One 0-300 volts high resistance voltmeter, No. 346, with tipped 30" cord to measure B voltages.
  - (4) One 5-prong plug with 30" cord for AC detector tubes, etc., and one 4-prong adapter for other tubes.
  - (5) One grid switch to change bias.
  - (6) One 5-prong socket.
  - (7) One 4-prong socket.
  - (8) Two binding posts.
  - (9) One handsome nickel metal case.
  - (10) One instruction sheet.

[Note: A pair of adapters for UV199 tubes, Cat. No. 999, at \$1 extra. These are not sold except with 215-346 Comb. or 215-347 Comb.]

## Individual Meters for Portable or Panel Use



0-300 high resistance voltmeter, for testing all B voltages up to 300. 30" tipped cord. Nickel finished case. Cat. No. 346 ..... \$4.50



Cat. No. 326 The panel voltmeter Cat. No. 326 reads DC voltages, 0-8. Put one on any set you build, using DC tubes.....\$1.65



The panel milliammeter, Cat. No. 390, reads 0-100. This is much more current than any set is likely to draw, so you can read the total B current drain of any set.....\$1.65

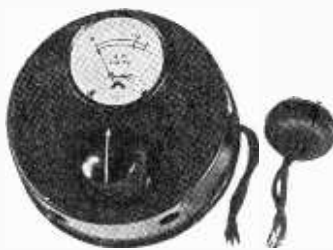

Cat. No. 218 Voltage Regulator, to save life of AC tubes.....\$5.00

### POCKET AND PORTABLE VOLTMETERS

- No. 8—For testing A batteries, dry or storage, 0-8 volts DC scale.....\$1.65
- No. 10—For testing A batteries, dry or storage, 0-10 volts DC scale.....1.65
- No. 13—For testing A and B batteries, dry or storage, 0-16 volts DC scale.....1.65
- No. 50—For testing B batteries, dry or storage, but not for B eliminators, 0-50 volts DC scale.....1.65
- No. 39—For testing B batteries, dry or storage, but not for B eliminators, 0-100 volts DC scale.....1.85
- No. 40—For testing A and B batteries, dry or storage, but not for B eliminators; double reading, 0-8 volts and 0-100 volts DC scale... 2.25
- No. 42—For testing B batteries, dry or storage, but not for B eliminators; 0-150 volts DC scale.....2.00
- No. 346—For testing B voltage, including eliminators. High resistance water 0-300 volts DC scale.....4.50
- No. 347—Same as No. 346, except that scale is 0-500 volts.....5.50
- No. 348—For testing AC current supply line, portable, 0-150 volts.....4.50

### PANEL AC VOLTMETERS

- (Panel meters take 2-5/64" hole)
- No. 351—For reading 0-15 volts AC.....\$2.25
  - No. 352—For reading 0-10 volts AC.....2.25
  - No. 353—For reading 0-6 volts AC.....2.25
- (See No. 348 under "Pocket and Portable Voltmeters.")

### PANEL VOLTMETERS

- No. 335—For reading DC voltages, 0-8 volts, \$1.65
- No. 310—For reading DC voltages, 0-10 volts, 1.65
- No. 316—For reading DC voltages, 0-16 volts, 1.65
- No. 326—For reading DC voltages, 0-8 volts, 1.65
- No. 337—For reading DC voltages, 0-50 volts, 1.65
- No. 339—For reading DC voltages, 0-100 volts, 1.75
- No. 342—For reading DC voltages, 0-150 volts, 1.75
- No. 340—For reading DC voltages, double reading, 0-8 volts, 0-100 volts..... 2.25

### VOLTAMMETERS

- No. 18—For testing amperage of dry cell A batteries and voltage of dry or storage A batteries, double reading, 0-8 volts, and 0-40 amperes DC.....\$1.85
- No. 35—For testing amperage of dry cell A batteries and voltage of B batteries (not B eliminators); double reading, 0-50 volts, 0-40 amperes DC..... 2.00

### PANEL MILLIAMMETERS

- No. 311—For reading 0-10 milliamperes DC..\$1.95
- No. 325—For reading 0-25 milliamperes DC.. 1.85
- No. 350—For reading 0-50 milliamperes DC.. 1.65
- No. 390—For reading 0-100 milliamperes DC.. 1.65
- No. 399—For reading 0-300 milliamperes DC.. 1.65
- No. 394—For reading 0-400 milliamperes DC.. 1.65

### VOLTAGE REGULATOR

No. 218—For preventing excess voltage on the filament and cathode of AC tubes, by compensating for excess line voltage.....\$5.00

### POCKET AMMETER

No. 1—For testing dry cells, 0-40 ampere DC scale pocket meter.....\$1.50

### DC PIN JACK VOLTMETERS

- No. 306—For Radiolas No. 25 and 28, 0-6 volts DC.....\$2.50
- No. 308—For No. 20 Radiola, 0-8 volts DC.. 2.50
- No. 307—Desk type voltmeter with cord, 0-6 volts DC..... 2.50

### 6-VOLT A BATTERY CHARGE TESTER

No. 23—For showing when 6-volt A battery needs charging and when to stop charging; shows condition of battery at all times.....\$1.85

### PANEL AMMETER

No. 338—For reading amperage, 0-10 amperes DC.....\$1.65

GUARANTY RADIO GOODS CO.,  
 145 West 45th Street, New York City.  
 Just East of Broadway

- Please send me at once, by parcel post, on a 10-day money-back guaranty, one Jiffy Test outfit, consisting of one No. 215 and one No. 346 combination, for which I will pay the postman \$13.50, plus a few cents extra for postage.
- If 0-500 volts, high resistance voltmeter No. 347 is preferred, put cross in square and pay \$14.50 plus postage, instead of \$13.50, plus postage.
- One No. 215 and one No. 346, with two adapters, for UV199 tubes, \$14.50.
- One No. 215 and one No. 347, with two adapters for UV199 tubes \$15.50.
- One No. 215 alone, \$10.00.
- One No. 346 alone, \$4.50.
- One No. 347 alone, \$5.50.

Send me the following individual meters (quantity in square):

|                                   |                                   |                                   |
|-----------------------------------|-----------------------------------|-----------------------------------|
| <input type="checkbox"/> Cat. No. | <input type="checkbox"/> Cat. No. | <input type="checkbox"/> Cat. No. |
| <input type="checkbox"/> Cat. No. | <input type="checkbox"/> Cat. No. | <input type="checkbox"/> Cat. No. |

NAME .....

ADDRESS .....

CITY ..... STATE.....

TEN-DAY MONEY-BACK ABSOLUTE GUARANTY!

# New Coils Produce Revolutionary Results!

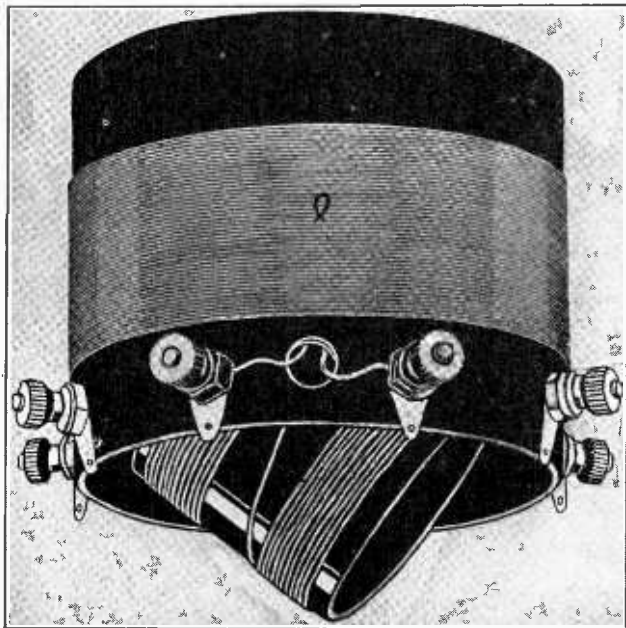

High Impedance Screen Grid Tuner, three windings. Primary center-tapped for short waves. Single hole panel mount. (Model 5HT) ..... **\$3.00**

**ENORMOUS VOLTAGE GAIN!  
MORE VOLUME! MORE DX!  
THE SHORT AND LONG WAVES  
WITHOUT CHANGING COILS!**

**WORKING** out of a screen grid tube, the High Impedance Tuner develops incredible voltage.

The primary, the outside winding, is tuned by a variable condenser the user puts across it. At resonance this gives *infinite impedance!* What the screen grid tube needs is a high impedance plate load, otherwise the tube's full, amazing quantity of amplification is missed. Could there be any impedance higher than *infinite?*

The secondary has a step-up ratio of about 2-to-1, the first time a voltage increase by radio frequency coupling ever has been made available with a tuned primary. The secondary is wound on a separate form and riveted inside the primary form.

The third winding is rotatable inside the secondary form, from a front panel knob, and has a variety of uses. Bakelite forms are used exclusively.

It is inconceivable the revolutionary effect this coil has—volume so great you would never imagine it possible—greatly increased sensitivity, often 100 times greater than an ordinary TRF coil—more distant reception, much more, in fact—and—short waves may be tuned in by shorting out half of the primary, without change of coil or condenser.

Mount coil upside down for short leads. All terminals are then on bottom.

High Impedance Screen Grid Tuner Primary Center-tapped for short waves. Single hole panel mount (for .0005 mfd.). Model 5HT ..... **\$3.00**  
For .00035 mfd. Model 3HT..... **\$3.25**

## Wonders of Screen Grid Tubes Fully Capitalized for First Time

### ANTENNA COIL

Like the High Impedance Tuner, the Screen Grid Antenna Coil is specially designed for input to a screen grid tube. Its inductance is so arranged that the dial readings of the antenna circuit will be like those of the tuned circuit in which the High Impedance Tuner is used.

The antenna coupling is conductive, giving the maximum signal strength consistent with selectivity—a degree of volume that is so enormous as to astound you! Using these two coils, the volume is so great that only one stage of audio works a loud speaker superbly—thrillingly!

For short wave reception all except 14 turns of this single, continuously-wound coil are shorted out, and short-wave tuning confined to the succeeding stage or stages.

The Screen Grid Antenna Coil is matched to the High Impedance Tuner, by having dissimilar turns that equalize the tuning. Dial readings track nicely because the Screen Grid Antenna Coil's individual inductance is made to atone for the effect mutual inductance has on the High Impedance Tuner's primary.

Screen Grid Antenna Coil. One tap for short waves. For .0005 mfd. (Model 5A) **\$1.75**  
For .00035 mfd. use (Model 3A)..... **\$2.00**

### REPLACEMENT COIL

A great many persons now possess good radio receivers and do not desire to part with them, but would like to gain the benefit of the wonderful new screen grid tubes that, with proper coils, increase volume and sensitivity enormously, and without reducing selectivity.

Moreover, they do not want to tear down existing receivers and virtually rebuild them. No need to do so. The Screen Grid Replacement Coil, for either .0005 mfd. or .00035 mfd. tuning, occupies a space only 2 1/2 x 2 1/2 inches, so can be put in almost any receiver from which the old coil has been removed.

The replacement coil has an untuned primary of high impedance—generous number of turns—while the secondary is tuned. Thus it conforms to requirements of the usual tuned radio frequency receivers. Custom Set Builders, Service Men and Home Experimenters will welcome this opportunity to redeem "the old set," make it pep up and step out—cure that loss of the old kick—capitalize the great advantages of radio's outstanding tube! In replacement work one of these coils should be used as the antenna coil.

Screen Grid Replacement Coil for .0005 mfd. Secondary center-tapped for short waves. (Model 2R5) ..... **\$1.50**

Screen Grid Replacement Coil for .00035 mfd. Secondary center-tapped for short waves. (Model 2R3) ..... **\$1.75**

### OTHER SCREEN GRID COILS

For circuits using screen grid tubes, with single tuning control, four models of coils are manufactured with rotors that serve as trimmers, so that no midget trimming condenser is needed.

These single control coils are:

Model 2SC5. Conductively coupled antenna coil, for input to a screen grid tube, with two turns taken from the stator and wound on the rotor. Thus the variations in tuning, due to the antenna's capacity effect on the tuned circuit, are compensated for by turning the panel knob. For .0005 mfd. tuning. Usual tap for short waves. (Model 2SC5) ..... **\$2.75**

Model 2SC3, same as above, except that inductance is for .00035 mfd. tuning. Usual tap for short waves. (Model 2SC3)..... **\$3.00**

Model 2RSC5 is a replacement coil for single control sets, corresponding to 2R5, but having the trimmer coil on a rotatable form, so that any interstage coupling out of a screen grid tube may be accomplished efficiently. Usual tap for short waves.

(Model 2RSC5) ..... **\$2.75**

Model 2RS3, same as above, except this is for .00035 mfd. tuning. Usual tap for short waves. (Model 2RSC3)..... **\$3.00**

Model 5TP (.0005) ..... **\$2.00**  
Model 3TP (.00035) ..... **\$2.25**

### Coils for Other Than Screen Grid Tubes

For all circuits other than screen grid circuits the STANDARD group of coils is manufactured, as distinguished from SCREEN GRID Coils. The STANDARD coils are for 201A, 240, 199, 226AC, 227AC and all other non-screen grid tubes.

All the coils, both STANDARD and SCREEN GRID, have 2 1/2 inch diameter, the smallest diameter consistent with high efficiency! All are sturdily made and are carefully designed and constructed with the idea of having them last TEN YEARS. That includes coils with rotatable forms, for they are no less rugged than the others—another exceptional virtue.

All coils have a short-wave tap, but this need not be used, if not desired.

### STANDARD COILS

3-circuit tuner, for .0005 mfd. Secondary center-tapped for short waves. (Model T5) ..... **\$2.25**

3-circuit tuner for .00035 mfd. Secondary center-tapped for short waves. (Model T3) ..... **\$2.50**

TRF coil. Interstage coupler and also used as antenna coil. For .0005 mfd. Secondary center-tapped for short waves. (Model RF5) ..... **\$1.00**

TRF coil. Same as above, except it is for .00035. Secondary center-tapped for short waves. (Model RF3) ..... **\$1.25**

[Note: This advertisement contains our complete line of coils. Inquiries invited from the trade, custom set builders, etc.]

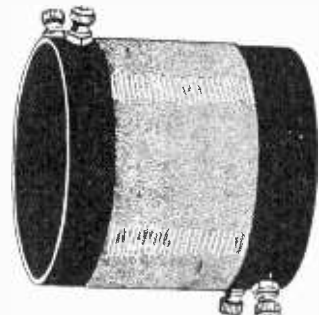

Screen Grid Antenna Coil, for Input to any Screen Grid RF Amplifier. Tapped once for short waves. (Model 5A) ..... **\$1.75**

### SCREEN GRID COIL COMPANY

143 WEST 45th STREET  
NEW YORK CITY

Just East of Broadway

Screen Grid Coil Co., 143 W. 45th St., N. Y. City, Squares

Please mail me at once your following coils, for which I will pay post. man the advertised prices, plus a few cents extra for postage.

Model.....  Model.....  Model.....  Model.....  Model.....

Name .....  
Address .....  
City .....  
State .....

SEND NO MONEY! (RW)

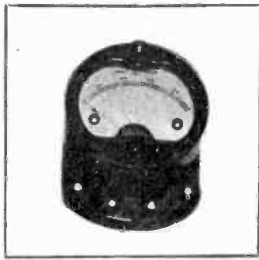

**AUDIO FREQUENCY TRANSFORMERS  
and RADIO PRODUCTS**

*receive preference by engineers who KNOW*

Real audio transformers with flat curves. Special output transformers for all speakers and tubes. High grade iron core chokes for "B" Eliminators. Three range portable meters. 1,000 ohms per volt. 10/50/250 scale. Three range portable meters. 200 ohms per volt. 150/7½ volt and 15 Mill. scale with switch. By-pass Condensers—2MF—400 volt and 200 volt. Circulars sent on request.

Detailed instructions for building the Ferranti Straight Line Push-Pull Universal Power Amplifier and Power Unit for all power tubes up to and including 250 type sent prepaid for \$1.00 net.

Instructions for building the SKY-SCRAPER, \$1.00 net.

*Send 15c in coin for copy of 1929 Ferranti Year Book*

**FERRANTI, LTD.**  
Hollinwood  
England

**FERRANTI, INC.**  
130 West 42nd St.  
New York, N. Y.

**FERRANTI ELECTRIC  
LIMITED**  
Toronto, Canada

**Raytheon  
Kino-Lamp**

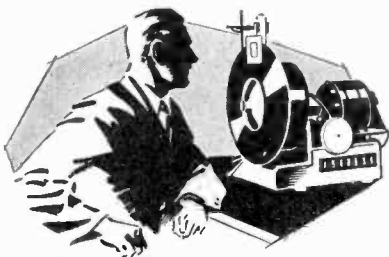

**TWO PIONEER  
TELEVISION  
ACCESSORIES**

The Raytheon Laboratories invite correspondence from both engineers and amateurs in regard to Kino-Lamp and Foto-Cell, two accessories now in successful operation.

Price \$7.50

Raytheon Kino-Lamp is the first television-reception tube developed to work on all systems.

**Raytheon  
Foto-Cell**

—an extra sensitive broadcasting tube, is supplied in either HARD VACUUM or GAS-FILLED types.

**Raytheon Mfg. Company**  
Cambridge, Mass.

*For Best Results*

With the

Newest  
Screen-Grid  
Diamond of the Air  
Use the

**HAMMARLUND  
HR23 COILS**

Follow instructions carefully and use only the parts specified by the designer. You will be amply repaid in satisfaction.

For Better Radio  
**Hammarlund**  
PRECISION  
PRODUCTS

**FREE**

UP-TO-DATE LIST OF  
U. S. AND FOREIGN  
**SHORT-WAVE  
STATIONS**

(Do not even  
send stamps)

Call Letters, Waves, Location

**RADIO SUPPLY CO.**  
217 Havemeyer Street Brooklyn, N. Y.

**REMEMBER**

that poor condensers are soon broken down by voltage overloads. Blown condensers mean burned-out transformers and tubes. It's economy to buy the best.



Specified for the Victoreen Duplex Audio and B Supply

**Play Safe With  
PARVOLTS**

All MFD Capacities—All Working Voltages  
**THE ACME WIRE COMPANY**  
NEW HAVEN, CONN.

**LYNCH**

equalizers for filament control make rheostats unnecessary. Complete with mount ..... **\$1.00**

**ARTHUR H. LYNCH, INC.**  
1775 Broadway New York City  
Send for free Lynch radio manual

EXCELLENT unit for phonograph attachment, to play records. Connects to speaker terminals, nozzle to phonograph, \$4.20. P. Cohen, 236 Varet St., Bklyn., N. Y.