

Feb. 4

1928
#306

15c.

RADIO

REG. U.S. PAT. OFF.

WORLD

DC ELECTRIFICATION

Vol-12 ————— No-20

TELEVISION'S STRIDE

4-TUBE S-G DIAMOND

LYNCH-AERO FIVE



TYRMAN

70

with

Shielded

Grid Tubes



The Tyrman "70," Using Three Shielded Grid Tubes in the Intermediate, Is a Super-Sensitive Super-Heterodyne. See Page 3.

A5

KARAS PARTS

Specified for the Shielded Grid

DIAMOND OF THE AIR

IN the Diamond of the Air described in this issue of Radio World, Karas Harmonic Audio Frequency Amplifying Transformers and the NEW Karas S. F. L. Removable Shaft Variable Condensers are specified. Be sure to order these parts for your Diamond



of the Air when you build this receiver. The Karas Harmonic Transformer, price \$5, gives the maximum of distortionless audio frequency amplification, producing tremendous volume and superb tone.

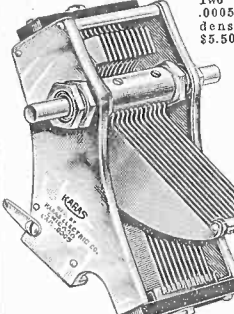

Two Karas S. F. L. .0005 Variable Condensers, price, each \$5.50, are used in the Diamond of the Air. These new Karas Condensers have been found superior to scores of even higher priced condensers because of their absolute lossless, but only straight frequency line tuning, and the fact that they may be used with either 100-0 or 0-100 type Dials. Secure these Karas parts for your Diamond of the Air from your dealer today.

KARAS ELECTRIC CO.
4039-L North Rockwell St., Chicago

VOLUME CONTROL CLAROSTAT



Specified for the Shielded Grid Diamond of The Air by H. B. HERMAN

Clarostats are indispensable to Set Builders, Set Owners, and Manufacturers who demand Radio Perfection.

GET ACQUAINTED WITH THE CLAROSTAT FAMILY

Ask your dealer how. Or, better still, send for our booklet, "Metric Resistance," which tells how to get the best radio results. And when you buy Clarostats, be sure you get the genuine article in its distinctive green box and name stamped on nickel-plated shell.

AMERICAN MECHANICAL LABORATORIES, INC.
Specialists in Variable Resistors
285 N. Sixth Street Brooklyn, N. Y.

For Best Results

With the

DAVEN A. C. 5

Diamond

Shielded Grid

and

TYRMAN 70

Receivers

Use only the

HAMMARLUND

PARTS

Specified by the Designers

For Better Radio

Hammarlund

PRECISION PRODUCTS



Why Postpone Building It?
Send for your copy of the Concertrola Manual IT'S FREE!

Leo Fenway for DX! Inc.
831 8th AVENUE
NEW YORK, N. Y.

CARTER

Condenser Block Fixed Condensers
A. C. Switch
Specified—as usual—in
Daven A.C. Converter



Halldorson Overtone Transformer

Chosen for the **DAVEN A.C. FIVE**
Described in This Issue

SET BUILDERS!

Halldorson Overtone Audio and Output transformers are proving a revolution to set builders all over the country. They will give you quality that you never dreamed possible. Try them in your receiver; if they don't astonish you with their lifelike reproduction your money will be gladly refunded. At your dealer or sent direct. Price, each, \$6.00.

THE HALLDORSON COMPANY
Factory: 4745 N. Western Ave. CHICAGO, ILL.
Office: 223 W. Jackson Blvd.

MASTER THE AIR

Master the air, where fortunes are being made in radio. Big opportunities. Our money-making plan gets the business for you. Be first to get the facts. Send for complete booklet and guide, FREE, and learn of rich rewards awaiting you. **BARAWIK CO.**, Dept. 882, Chicago, U. S. A.

YAXLEY

Specified for **Tyrman "70"**

- No. 915K—15 ohm Switching Rheostat.....\$1.75
- No. 125K—25 ohm Rheostat..... 1.35
- No. 669—Cable Connector..... 3.25
- No. 416—Pup Jack..... .15
- No. 815—15 ohm Resistance..... .15
- No. 41—Resistance..... .15

At Your Radio Dealers.
YAXLEY MFG. CO.
9 South Clinton Street CHICAGO

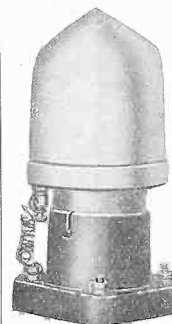

Stabilize Your Set "Vac-Shields"

Bring in DX

THE invention of these non-magnetic shields for Type 201-A or the new Type 222 Tubes prevents interstage coupling and electro-static effects, overcoming stray capacities that make tuning of distant stations so difficult. Guard tubes against breakage. Attached in a minute.

U. S. Patent No. 1,564,694

Order today at your dealer's, or by mail, postpaid, \$1.00.

ORANGE RESEARCH LABORATORIES
247-249 McKinley Avenue
East Orange, N. J.

BECOME ACQUAINTED WITH alternating current tubes and their circuits by getting a copy of the December 24 issue, and reading about the "AC 300," a remarkable 4-tube AC operated receiver. Other interesting features of this issue which you should not fail to get are: "An AC Circuit Dissected" by Martin Fortescue; "Why 5 Windsor Chairs Were in Double Danger," a B. Herman; "Position Is Everything in a Microphone's Life," by Spencer Woolrath; "The Conclimator and power amplifier story," by H. B. fession of a Reformed Service Gyp"; and "The Parts Buyers." Also in the issue are an abundance of illustrations and technical kinks. Send 15c for this issue to

RADIO WORLD, 145 West 45th Street, New York City

Professional Set Builders!

SEND NOW for full size X-Ray, two-color, Wiring Diagram for Magnaformer 9-8—fully described by J. E. Anderson, in December 10 issue of Radio World. The only set ever constructed that fully lives up to its advertising claims. Every set installed, by its superior performance, automatically sells many others. Address Radiart Laboratories Co., Dept. 69, No. 19 South La Salle Street, Chicago, Ill.

Name

Address

How Shielded Grid Tubes Greatly Increase Amplification in The Tyrman 70 Super

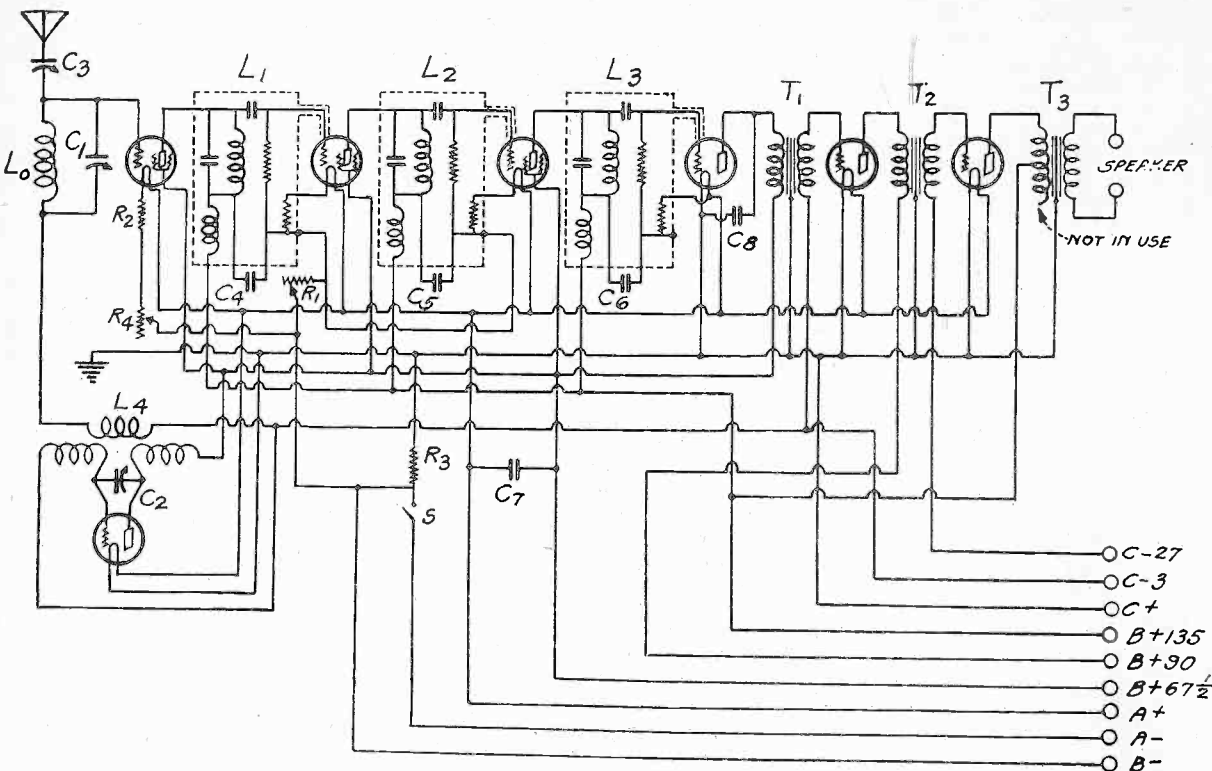

THE CIRCUIT DIAGRAM OF THE TYRMAN 70 SHIELDED GRID TUBE SEVEN SUPER-HETERODYNE RECEIVER.

By Brunsten Brunn

ANY device which enables seven to do the work of ten in any given art, and do it fully as well, is a development; but a device which in addition will enable the seven to do the work better is a remarkable advance in that art.

The shielded grid tube is such a device. It enables seven tubes in a receiver to achieve a sensitivity which ten tubes of the old variety do not surpass. And it does not require the use of seven of the new tubes either, but only three of them. The four remaining are of the old variety.

If it be assumed that the four old type tubes are as efficient in the new combination as they were in the old, it is obvious that the three new shielded grid tubes do the work of six of the old variety, and they do it better.

The amplification capability of a typical tube of the old type when operated at radio frequency is sevenfold. The amplification of the shielded grid tube under similar conditions is thirty-fold. In a stage of intermediate frequency the performance of the old tube is about ten-fold, whereas,

the performance of the shielded grid tube is fifty-fold. Thus for intermediate frequencies the ratio of gain is 5 to 1. Therefore two stages with the shielded grid tube will give a much greater amplification than three stages of the old type of tube. In fact the ratio in favor of the two shielded grid tube stages is 2½ to 1.

Other Advantages

But mere amplification is not the only advantage gained by the use of the shielded grid tubes. Stability of the circuit is another, and it is far from the least of the advantages. There is smaller tendency to oscillate in the intermediate or radio frequency amplifier when it is designed for and used with the improved tubes. Thus all the noise, distortion and squealing arising from oscillation in the amplifier may be circumvented. And the fact that fewer tubes will do the work required eliminates many of the tube and battery noises which limit the practical sensitivity in a multi-tube receiver.

The shielded grid tube is one of the

most promising additions to the radio art since the invention of the three electrode tube.

The shielded grid tube has properties all its own and it requires special handling if it is to perform according to promises. The tube cannot be put into a socket intended for an ordinary tube with much chance of success. The tube will not function there. It will not live up to its reputation of squeal-free behavior even if it is used in a multi-stage amplifier with the proper voltages on its elements unless scrupulous shielding precautions are taken.

The effect of the shield grid between the plate and the control grid does not extend outside the glass envelope containing the elements. But the shielding must be extended if the tube is to amplify without squealing. The shielding of one stage from the rest must be thorough if a high amplification is desired.

In conjunction with the thorough shielding a generous use of by-pass condensers of a size suitable to the frequency em-

TYRMAN "70" WITH

ployed should be used in the circuit so that the coupling between the various leads will not defeat the shielding which has been put both inside and outside the tubes.

An Engineering Feat

As soon as the shielded grid tube became available to the engineers in the various radio research laboratories the idea of using the tube in Super-Heterodynes occurred. A period of intensive work on the problem followed, particularly in the laboratory of the Tyrman Electric Company. As a result of this work a Super-Heterodyne of outstanding merit and incredible sensitivity emerged.

Of course, the primary reason for sensitivity on the Tyrman 70 is the use of three of the shielded grid tubes in the receiver. One is used as a first detector and two as intermediate frequency amplifiers. But a reason of comparable importance is the fact that the designers of the receiver have coordinated all the factors affecting sensitivity to achieve correct proportioning of the grid, shield grid, plate and filament voltages, the load impedances on the several tubes, the oscillation pickup, the type of oscillator, the signal collector system, and the layout of the circuit.

On a par with the sensitivity or distance getting ability of a receiver is the tone quality. How does this seven tube Super-Heterodyne measure up on this point?

Tone Quality Retained

In designing any receiver, and a Super-Heterodyne in particular, a constant watch must be maintained against distortion. Contortions of the signal will creep in at every turn if not prevented by careful design. Some of the sources of distortion are: incorrect voltages on the various tubes, the use of tubes not able to handle the signal, inadequate audio frequency transformers and too sharp tuning.

All of these sources of distortion are controllable. The engineer can design his receiver for certain voltages and then recommend to the ultimate user of the set to use these voltages. That disposes of the

- LIST OF PARTS**
(For Antenna Model)
- Lo—One Tyrman Type 9-80 antenna inductance.
L1, L2, L3—Three Tyrman Type 9-90 RF impedance coupler units.
L4—One Camfield Type 622 oscillator coupler.
T1, T2—Two Tyrman Type 3-30 audio transformers.
T3—One Tyrman Type 3-51 power output transformer.
C1—One Camfield .0005 mfd. single condenser.
C2—One Camfield .00025 mfd. single condenser.
C3—One Hammarlund 50 mmfd. midget condenser.
C4, C5, C6, C7—our Carter 1 mfd. by-pass condensers.
C8—One Carter moulded type .0005 mfd. condenser.
R1—One Yaxley 15 ohm rheostat, with switch, Type 915K.
R2—One Yaxley 15 ohm resistor.
R3—One Yaxley 4L resistor.
R4—One Yaxley 25 ohm rheostat.
Seven Tyrman shielded sockets.
One Tyrman double vernier drum dial.
One Yaxley No. 669 cable.
One Yaxley pup jack.
Five XL binding posts.
One 7 x 24 Lignole panel.
One 8 x 23 sub-panel.
One pair Benjamin brackets.

one source of distortion. The engineer can also design his set to work with definite tubes and so choose them that no tube in the receiver will be overloaded for normal volumes. The problem of audio transformer design no longer offers any difficulty.

Nevertheless, many receivers still fail to approach natural reproduction for no other reason than that inferior transformers are used. This indictment cannot be entertained against the seven tube receiver described herein.

One of the greatest sources of distortion in a Super-Heterodyne, as well as in many

other sets, is too high selectivity, or too sharp tuning. While selectivity is generally considered a virtue, it becomes a vice when the signal is so encroached upon that only a narrow band of frequencies in the middle of the signal is able to get through the tuner. When such is the case, the higher signal frequencies are almost completely suppressed and nothing but the booming lower notes are passed.

Double Advantage

Three things are effective in the Tyrman 70 receiver to limit the selectivity to a practical value. The first is the high intermediate frequency employed in the circuit, a frequency of 340 kc. (882 meters). The second is the type of tuned intermediate frequency circuit used. The third is the fact that shielded grid tubes are used in the intermediate amplifier.

The effectiveness of a tuned circuit of given selectivity to cut side bands depends on the frequency. The lower the frequency the more the side bands are cut. A frequency of 340 kc. is so high that cutting is not much in excess of what it is in a similar tuner at the lower end of the broadcast band. Thus quality is retained. But tone quality is not the only advantage gained by the use of a high intermediate frequency, as will be brought out later.

The intermediate frequency couplers have been especially designed to retain both adequate selectivity and unimpaired tone quality, as well as to effect the large voltage step-up per stage. The mean step-up in the transmission band is about 50 per stage, and this is practically constant throughout the band of essential frequencies. This uniformity can only be accomplished with the aid of filter circuits such as are used in the couplers labeled L1, L2 and L3 on Fig. 1.

The matching of these filter units is not a simple task, as the work must be done with high accuracy and with the aid of expensive and intricate apparatus. For that reason it is best that the builder obtain factory made coupling units so that he may be sure that the adjustment of the filters is correct.

A good deal of the research work done by the staff of the Tyrman Laboratories was devoted to perfecting the coupling unit and in bringing it to a high point of effectiveness; and now the performances of the Tyrman 70 receiver fairly shout from far and near the praises of the accomplishment.

One of these couplers, such as L1, consists of a small condenser and a tuning coil in parallel, a choke coil in series with this circuit, a coupling resistor, a coupling condenser, and a filament ballast. These parts are all enclosed in one case and carefully adjusted.

But this assemblage of parts must be considered in conjunction with the plate to filament capacity and resistance of the tube preceding, the grid to filament capacity of the tube succeeding, and the by-pass condenser C4. All these elements have been coordinated by laboratory methods.

The Collector Preferred

Some persons prefer a loop for picking up the signals from space; others prefer a small open circuit antenna. The Tyrman 70 can be adapted to either type of pick-up very easily, so that the wishes of all can be filled.

Fig. 1 shows the antenna type of pick-up. The antenna may consist of a small wire concealed behind the picture moulding and may be as short as 10 feet. A small variable condenser C3 is put in series with the antenna lead for controlling

Good Looks New Asset As Radio Vision Looms

Los Angeles.

The successful demonstration of television by the Radio Corporation of America and the General Electric Company at Schenectady, brings the realization of this much-talked-of feature nearer reality, and only a matter of time intervenes in its adaptation as a necessity to every home radio.

When it does become part of radio reception, broadcasting will have changed considerably, in the opinion of Earle C. Anthony, owner of KFI, the Los Angeles station that entertains the whole country.

The method of putting on a radio program today, will never satisfy the audience of tomorrow, which will be enabled through television, to sit before the fireplace and enjoy an entire vaudeville bill, perhaps a drama, certainly the great operas.

Some fear television may develop so greatly as to worry theatrical magnates, who will have nothing more to offer on their stages than can be had in one's own home. Perhaps not as much, because of

the great sums which can be expended in talent for a single broadcast because of the vast audience which it reaches. This, however, is improbable, because of the love of the American public for mass gathering—because of its general restlessness and its penchant for activity. There will always be people who will not stay at home but must seek amusement hither and yon.

Television will cause many changes in talent available for broadcasting. Where only the art is broadcast now, television will bring the personage into being and appearance will be as great a factor in radio as it is on the stage. Many artists who are unable to appear on the stage because of physical drawbacks or because they lack physical personality are successful on radio where only their talents register.

Television will make possible the broadcasting of humor in the form of monologues and the like which require physical personality to be effective and are not acceptable radio entertainment today.

The possibilities are great.

SHIELDED GRID TUBES

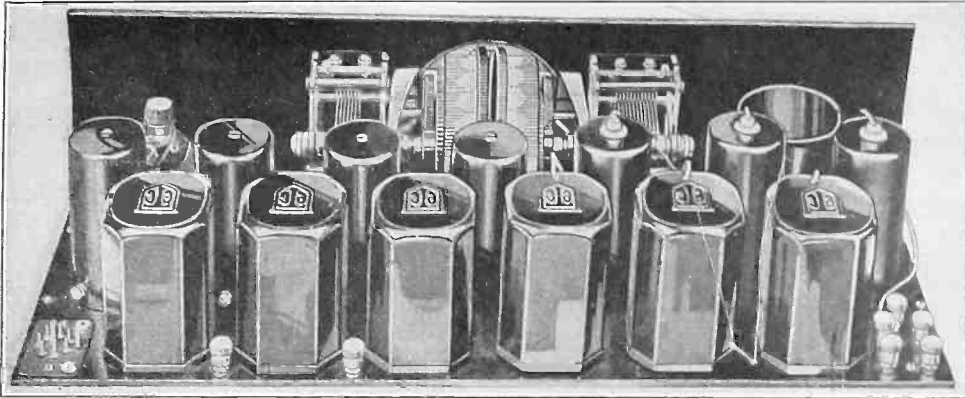

INTERIOR VIEW OF THE TYRMAN SHIELDED SEVEN RECEIVER.

the volume. Its value is not critical and may be .00005 mfd.

Condenser C3 also aids in the radio frequency selectivity in that it reduces the effect of the antenna resistance on the tuned circuit, and it also prevents the antenna capacity from adding to the tuning capacity C1. Thus the first tuned circuit acts almost as if the antenna were not connected to it, yet the signals are transferred to the first grid.

The relative values of inductance and capacity in the first tuned circuit are not important, but considering the fact that the minimum setting capacity of the circuit is somewhat increased by the antenna connection it is well not to use a too small condenser. A value of .0005 mfd. for C1 is recommended. The coil across the condenser should be designed to work with this size of condenser.

The oscillation pick-up coil which is connected in series with the grid circuit of the first tube is an integral part of the oscillation coupler L4 and is mounted so that the degree of coupling between it and the oscillator coils can be varied. The oscillator coil in this unit is of such value that it tunes suitably with a .00025 mfd. condenser.

The use of an intermediate frequency as high as 340 kc., as is adapted in this circuit enables the elimination of the repeat spots on the oscillator dial and makes the circuit so-called "one-spot." The higher the frequency the more stations can be brought in under "one-spot" conditions, and the fewer are the chances of squealing and image interference.

The signals therefore slide in and out of hearing without the accompaniment of whistles, growls or hisses. This is a distinct advantage of using a high intermediate frequency.

Rheostat Control of Volume

In the negative leg of the filament circuit of the first shield grid tube is a resistance of R2 of 15 ohms. In series with this is a 25 ohm rheostat R4 by means of which the volume can be controlled by varying the detecting efficiency of the first tube.

Another rheostat R1 of 15 ohms is placed in the common negative lead to the filaments of the two shielded grid tube amplifiers. This rheostat also carries the filament circuit switch and it is placed on the panel. It constitutes an effective volume control in that it governs the amplification of the two tubes. Note that R1 is used in addition to the ballasts built into the intermediate coupling units. When R1 is set at zero the ballasts admit

the normal filament current and makes the tubes of the highest efficiency consistent with tube safety.

How Grids Are Biased

A master ballast, R3, is used for all the three element tubes in the receiver, and since there are four of them, each drawing a quarter ampere, the resistance should be one ohm.

The first tube is the modulator, or detector, and it works on the principle of negative bias. The effective bias on the control grid of this tube is obtained from the voltage drop in R2 and R4 and from a 3 volt battery to which the grid return lead is connected. When the voltage of the A battery is 6 volts the bias is therefore 5.7 volts with R4 set at minimum. As the voltage of the battery may vary between 5.7 and 6.4 volts, the bias also may vary over an appreciable range. This variation is not consistent with maximum

sensitivity and therefore the variable resistor R4 is necessary for maintaining the correct adjustment regardless of the state of charge of the battery.

The bias on the grids of the two shielded grid tubes is obtained from the drop in the ballasts. This drop varies only with the amount of current flowing in the ballasts, and this is controlled by the voltage of the battery and the rheostat R1. The current can always be adjusted to normal value and thus the bias will remain constant and correct. But small variations in the bias will not change the sensitivity much since the tube is not critical.

A super-sensitive circuit cannot be built successfully without bias condensers. Hence several such are used at strategic points in the circuit. C4, C5 and C6, points in the circuit. C4, C5 and C6 are 1 mfd. Carter non-inductive condensers.

(Part II next week)

Television Quits Dream Road for Real Bumps

Fifteen years ago radio telephony was hardly more than a fantastic dream. Radio broadcasting had not yet been conceived. Even ten years ago broadcasting had not become an accomplishment, and very few had even dreamed of it. Today broadcasting is universal; radio telephony is world-wide and world-encircling. The benefits of radio broadcasting are denied to none. The waves enter every dwelling, whether of high or low degree. The development has been rapid and the benefits stupendous.

Every other advance in human civilization has had a similar period of growth. First the dream, then conception of the working principle, then the precipitate development and improvement of the technique and the acceptance of it by the public as a source of pleasure and profit, and finally its emergence as a necessity of life. This is the story of the steamship, the railroad, the automobile, the telephone, the electric power system, the airplane, the motion picture.

Will it also be the story of television? Or is this entrancing subject destined to be an exception? Why should it be an exception? It is almost impossible to find any exception to the rule of growth of an idea, and as far as the story of television has been written it has obeyed the rule in

every detail.

Ten years ago television was a dream which had disturbed the minds of very few men. Two years ago it had reached the conception stage. The physical requirements of television had been worked out, but the means for fulfilling these requirements were not yet. As far as practical results go, television was still a dream. One year ago a few lines of success had been written into the story. Today chapters have been written and complete success is close at hand.

Television is now where broadcasting was ten years ago; its possibility has been demonstrated. It has even gone a bit further in that the erection of television broadcast stations have been proposed and wave channels set aside for this purpose. If the development of television follows the same law as all other major developments in human progress, it will only be a few years until there will be a television receiver in every home, when any one may tune in an operatic performance and not only hear all the music and incidental sounds but also see the performance in every detail, when a fight fan may tune in the broadcast of an important fight and both see the action and hear the sounds, when every broadcast will be both visual and auditory.

The New Twist That

EPOCH-MAKING inventions are often the result of looking at an old thing in a different way, from a new viewpoint. An inspiration suggesting a slightly different "twist" in attacking the problem at hand comes to a perplexed worker, and it turns out to be the long sought solution. And in most cases of the kind the new "twist" is much simpler than anything previously tried. As soon as the solution has been pointed out it seems so obvious that everybody wonders why it was sought so long in vain.

A great deal of research work has been done in television during the last two years, particularly during 1927. But even that year would not have been credited with anything but indifferent success and groping in the dark in the realm of television had it not been for a new "twist." This new "twist" transformed television from a pleasant but uncertain dream to an accomplished fact.

Let There Be Light

At the beginning of the year 1927 all who worked with television, and all who spoke of it with understanding, cried for more light. Insufficient illumination on the object to be "televized" was the chief obstacle in the way of practical television. "Give us more light and we shall see across the ocean." So pleaded and promised the workers on the television problem. And they did neither plead in vain or break their promise.

It was not the lack of a source of light of sufficient intensity that limited the illumination on the object to be sent by television, but rather the limit of toleration of brightness by the living object. The brightness had to be greater than that caused by the noonday sun, and even that is too much for physical comfort. The human eyes will rebel against such brilliancy.

This condition was not ameliorated in the least by the resort to ultra-violet light for illumination. The photo-electric cells used in the instruments for transferring light fluctuations into electric current fluctuations are more sensitive to the short ultra-violet rays of light than to the vis-

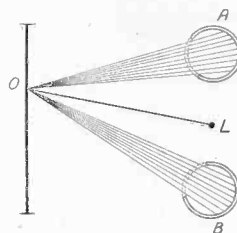

FIG. 1

This illustrates the principle of the Gray system of scanning. L is a point source of intense illumination which is focused on the object O to be transmitted. The direction of the line LO is systematically changed so that every point on the object is covered from 18 to 24 times a second. A and B are two large photo-sensitive cells which intercept some of the diffusely reflected light from the object.

ible, and the effective illumination could thus be increased by using short light waves. But the human eyes, and perhaps the cells of the skin also, are also photo-electric cells which work in the same manner. While the effective illumination would be increased by shortening the light waves the physiological limit of toleration of the living object would be lowered in the same proportion, so that there would be no net gain.

Seven-Eyed Monster

In the earlier attempts to achieve television the object to be transmitted was thoroughly and systematically scanned with a single photo-electric cell, in much the same manner that a one-eyed person would give the object a thorough "once over." But the photo-electric cell had to search the object point by point, while the one-eyed person could take it all in at a glance. And the cell had to "cover" the object at least 16 times every second to create the illusion of continuous vision at the receiving end.

Thus the photo-electric cell could not

Alexanderson's Earlier Model Illumination of the Original Laboratories Develops Illumination

By Neal Fitzalan

finger very long on any one point. It had to see and record each point almost instantaneously and pass to the next point. Therefore every point had to be illuminated very brightly before the cell would get an impression of detectible intensity.

A one-eyed man cannot see as well as a man with two good eyes. If the law that applies to television machines applies to man also, the one-eyed man can only see one-fourth as well. Two photo-electric cells, suitably guided, see four times as well as one; four cells 16 times as well; seven cells see 49 times as well as one cell. That is, if seven photo-electric cells are used in place of one it is possible to reduce the speed of the scanning device so that each cell lingers on a given point 49 times longer, or if the speed is kept constant it is possible to reduce the illumination 49 times.

It was E. F. W. Alexanderson of the General Electric Co. who introduced the idea of using seven photo-electric cells instead of one to reduce the speed of the scanning machine to practical values and still to "cover" the object thoroughly. Dr. Alexanderson built a model television machine on this idea and demonstrated the results which he had got with it. Television had been approached.

The New Twist

Had a better method not been found soon after this contribution was made public it is possible that the developments in television would have been made in the direction pointed out by this seven-eyed machine. Perhaps scanning machines having as many photo-electric cells as an insect has facets on its compound eyes would have been built. But the new "twist" made that unnecessary.

Before the new and epoch-making invention, the object to be transmitted was floodlighted with as great brilliancy as the object would tolerate, and while it was thus illuminated the photo-electric cell, or cells, were made to look it over systematically.

There are many obvious limitations to this process. The illumination could not be increased indefinitely without endangering the eyes of the person being televised; the sensitivity of the photo-electric cells could not be greatly increased; the resulting electric current could not be amplified indefinitely without introducing ruinous distortion; the number of photo-electric cells could not be increased because of the rapidly mounting complexity.

Yet along this road the workers plodded patiently with really practical television still only a dream. And perhaps they would have continued to dream and plod along the same road had not the genius of Dr. Frank Gray of the Bell Laboratories supplied the new "twist."

What It Is

Dr. Gray and his co-workers in the Bell Laboratories had met all the obstacles that other television workers had met. They felt keenly the limitation that insufficient illumination imposed, and they knew that something different had to be done if any real progress was to be made.

Television Across Ocean Claimed by Baird Co.

London. Television between London and New York has been definitely established as a result of secret experiments, according to L. G. Hutchinson, managing director of the Baird Television Development Company, before he sailed recently for New York on the Aquitania.

For six weeks the Baird Company has been conducting secret research work in London and succeeded in establishing contact with New York on several occasions, he said. Mr. Hutchinson added that it has been possible to see faces and hands of human beings, and while the features were somewhat blurred the results indicated that refinements in the technique will bring about distinct television across the ocean at no distant future.

On the Threshold

"We are at the beginning of the era," said Mr. Hutchinson, "when the electrical eye will enable people to see distant friends in any part of the world.

"Even now it is possible to see a man's tongue from a great distance, but at the

moment it is impossible to determine the color. Color possibly will enter the field in the future, and one could visualize a physician ordering a tonic for a patient perhaps hundreds of miles away.

"Now that the question of transatlantic television is entering the field there should be in future immense possibilities."

Mr. Hutchinson stated that he was going to America to conduct official experiments in transatlantic vision and explore the possibility of applying the results commercially.

Know Nothing About It

Officials of the American Telegraph and Telephone Co. said that their company had not conducted any experiments with Mr. Baird.

David Sarnoff, vice-president of the Radio Corporation of America, said, when questioned about Mr. Hutchinson's statement, that to his knowledge neither the General Electric Co. nor the Westinghouse Electric had cooperated with Mr. Baird in the television tests.

Made Television Spurt

Cramped by Lack of Practical Subject, Dr. Gray of Bell Superior Method of Scanning

TELEVISION EDITOR.

And they did something different, and as a result at this time we have practical television and a promise of broadcast television service for use in conjunction with radio broadcasting.

And what is this new contribution? Just looking at an old thing from a new point of view.

The old method of scanning consisted of systematically rolling the eye ball, so to speak, keeping the illumination constant. The new "twist" consists of keeping the eye ball fixed in position and then playing the light on the object. In the system suggested by Dr. Gray the photo-electric cells which convert the light fluctuations are fixed in position, picking up every light change that takes place. The object may sit in normal illumination or in complete darkness. If both the object and the cells are in darkness the cells are not active. If both are in normal illumination the cells are active but they are not in focus, so to speak. Though the object contains contrast, the effect in the cells is a gray monotone, or rather a steady electric current which does not affect the transmission.

The light to which the cells respond is the diffuse reflection of a fine concentrated ray from an arc lamp, rich in violet and ultra-violet wavelengths. This fine ray of light is made to scan the object in somewhat the same manner that a person would read a printed page with the aid of a narrow beam searchlight, point for point, line for line, except that extreme rapidity is achieved for television. The whole object must be covered point for point and line for line in about 1/18 of a second, and the process must be repeated 18 times a second as long as the transmission takes place.

The Light Beam Flits About

Suppose all stray light is excluded from the object and the photo-electric cells while an observer looks on. Before the light beam is started the observer cannot see the object at all. But when the light beam is playing on the object the observer sees it, assuming some light in the beam is of visible wavelengths. But the light beam is never at more than one point at a time.

The apparent floodlighting effect is due to the persistence of vision in the observer, and it is this also which makes reception possible.

If the observer could not see the object at the transmitting end when the light beam is playing on it, granting that visible light is used, the reproduced image would not be visible either. The beam of light must cover the object so rapidly that the effect on the observer's eye, caused by the reflection of light from a given point, does not die out before the light again is reflected from that point. In motion pictures the repetition must be at the rate of 16 per second to give the illusion of continuous motion. The same rate could be used in television, but from 18 to 24 repetitions per second are used at present, as the higher rate improves definition and results in less flicker.

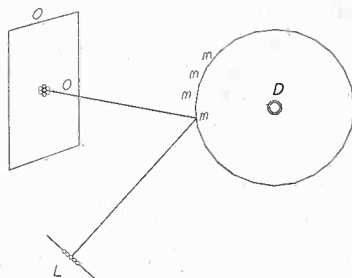

FIG. 2

This illustrates the Alexanderson seven spot system. If L is a source of seven bright light spots and M is a mirror the seven spots are reflected to the screen as shown. If D is a drum which can be rotated about a horizontal axis the group of light spots will sweep across the screen in a vertical line. If the drum carries many mirrors set at different angles the vertical lines can also be made to move across the screen horizontally. This is the reproducer, but if seven photo-electric cells are put at L and the object illuminated it becomes a transmitter.

Wherein is the Gray system of scanning superior to the systems previously used? In several respects. In the first place the intensity of the scanning beam used can be increased greatly before the object will suffer from it, as the intense beam does not remain at any one spot more than an instant.

In the second place, the system makes it possible to use larger and more sensitive photo-electric cells. The cells may be made so large that a considerable portion of the light reflected from the object is caught, or the number of cells used can be increased to achieve the same objective. The more of the light beam that is reflected and caught by the cells the greater the speed of scanning may be made, the better will be the definition, and the less will the photo-electric current have to be amplified by vacuum tubes.

It should be noticed that this system de-

pends on its operation on the diffuse reflection of the light beam from the object. If it were possible to surround completely the object with photo-sensitive cells all the light of the incident beam that is reflected from the object would be effective in changing photo-electric current. Of course that is not possible; but the photo-sensitive surface exposed to the diffusely reflected light can be made as large as desired within certain limits. Gray's system enables the use of more light in a concentrated beam, where it is needed and nowhere else, and it also makes possible the collection of more of the reflected light than previous systems.

There are other advantages of the new system which pertain to the mechanical and optical systems of the scanning device.

New System Adopted

Workers in television quickly saw the advantages of the new system of scanning. Dr. Alexanderson himself, who invented the seven spot method of scanning, in speaking of the Gray system called it an epoch-making contribution to the art of television. He also adopted it for the transmitter in his new radio television broadcast system which was recently given a public demonstration in Schenectady.

The Gray system of scanning has thrown more light on television, and it is now possible to see across the ocean. Indeed, a report from London states that Baird has succeeded in looking across the Atlantic from London to New York. Whether he employed Gray's system or one like it is not known at this time. But by means of Gray's system successful television was carried out over telephone lines between Washington and New York and over a radio circuit between Whippany, N. J., and New York during the latter half of 1927. This was some time before the same method was applied to radio television broadcasts by Dr. Alexanderson.

The scanning process here credited to Dr. Frank Gray was first made public in a paper and demonstration in May, 1927, by Dr. Herbert Ives, who is in charge of telephoto and television developments in the Bell Telephone Laboratories.

Colored Television Due; Three Cells Suggested

At several of the demonstrations of television questions have been raised as to the possibility of television in natural color. The usual answer is that black and white is difficult enough at present. But what is the possibility of color television?

It is coming as certainly as black and white television has come. When the technique of white and black television has been perfected it will be no great complication to add colors.

Comparison with the progress of other arts is instructive in this respect. At the beginning of half tone printing, only black and white could be reproduced. Now the art has been developed so that it is simple to print in three or four colors and to approach natural color very closely. The problem is one of color filtering and registration. In color television the problem would be the same.

Color photography followed black and white photography. Color motion pictures followed black and white. It appears that

once television in black and white has been worked out, it will be easier to extend it to television in three or more colors than it was to extend photography, motion pictures, and half tone reproduction from black and white to colors.

No doubt the colors used will be blue, yellow and red. Intense lights of the colors will have to be developed. There seems to be no difficulty in that as they are available now in quality but not in quantity. Suitable color filters are also available, having been developed for other arts and sciences.

The Gray system at first thought does not lend itself to colored television. If colored beams are played on the object the diffusely reflected light would be mixed in the photo-electric cells and result in gray.

But there is nothing against using three sets of cells with a color filter in front of each. Perhaps it would not be necessary to use three colored beams at all but only a white beam and the three sets of photo-electric cells.

Easy Electrification

By J. T.

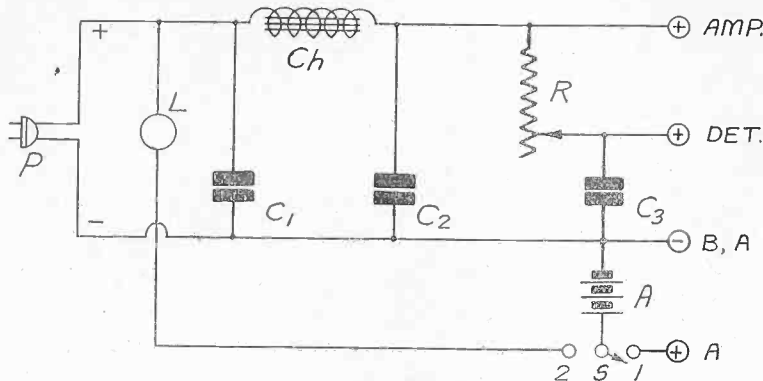

FIG. 1
SCHEMATIC DIAGRAM OF THE DC ELIMINATOR DESCRIBED
BY J. T. BERNSELY

THE adaptation of a radio receiver to operation from a direct current line is both simple and inexpensive. And when it has been done the owner will be well satisfied. The storage battery will always be in a good condition of charge, provided that a few simple precautions are observed, and the plate voltage will never drop as long as the power house is running.

What is needed for electrifying a receiver in a DC district? A filter and a few small extra parts. Anybody who can read a schematic diagram and wield a pair of pliers can do the job in an hour, once he has collected all the necessary components.

Why is it so easy and inexpensive to electrify a receiver in a DC district? Because the supply is direct current.

Expensive Parts Not Used

In an ordinary B battery eliminator designed to convert alternating current into a steady unidirectional current the most expensive parts are the filter condensers and power transformer.

The only part in common with an AC and a DC eliminator is the filter. But the filter necessary to remove the residual ripple in DC need not be as complex as the filter required in an AC eliminator. The current from the rectifiers used in AC eliminators, even with full wave rectification, drops to zero twice every cycle; and this wide fluctuation must be smoothed out so that there is no variation in the current at all.

Ripples Easily Removed

In a DC supply the current does not vary in the same manner. Sometimes it does not drop to zero at all, but merely takes a little dip from the maximum value. Whereas, the rectified AC in an eliminator consists of unidirectional pulses of current, the output from a DC supply source is steady except for the tiny ripples on top. These are easy to remove.

It is customary to employ choke coils in series with the rectifier output in AC eliminators together with necessary condensers between and on both sides of the chokes. In a DC eliminator only one choke is necessary, since the supply current is already partly filtered.

It is also unnecessary to use as many condensers.

Hence the DC is less expensive than the AC eliminator not only because the power

transformer and the rectifier are unnecessary but also because the filter required is simpler.

Charges Battery, Too

Since the supply current is direct it can be used for charging the storage battery used with the set. It is only necessary to insert a suitable resistor in series with the line and the battery to limit the current to the desired value. The necessary resistance can well be a 110 volt lamp of a wattage depending on the charging rate.

For an approximate estimation of the charging current the following table is useful, which gives the values of the currents admitted by lamps of various wattages.

| Lamp wattage | Charging rate |
|--------------|----------------------|
| 25 | $\frac{1}{4}$ ampere |
| 50 | $\frac{1}{2}$ ampere |
| 75 | $\frac{3}{4}$ ampere |
| 100 | 1 ampere |
| 200 | 2 amperes |

That is, the current in amperes is obtained approximately by dividing the wattage of the lamp by 100.

Emergency Charging

If it is desired to charge a battery quickly, a high charging rate should be employed, the highest rate recommended by the makers of the battery. This may be 6 amperes. There is no common lamp which can be used in this case, but there are many household appliances which are rated as high as 600 watts and over. For example, a heater resistance of 550 to 660 watts could be used for an emergency charge.

Likewise toasters, flat irons and motors can be connected in series with the storage battery when it needs a quick charge.

But in order that the battery may be in good condition all the time it should be put on trickle charge whenever it is not used for heating the filaments of the tubes.

The rate of the trickle charge would depend on the current drain during operation and on the number of hours daily that the receiver is operated.

Suppose that the receiver has five $\frac{1}{4}$ ampere tubes and one $\frac{1}{2}$ ampere tube and that there is no other current drawing de-

vices such as shunt resistors, potentiometers and pilot lights. The total current taken by the set is then $1\frac{3}{4}$ amperes.

Battery 80% Efficient

Now suppose that the receiver is operated on an average of 3 hours a day. The total drain from the battery for each average day is $3 \times 1\frac{3}{4}$, or $5\frac{1}{4}$ ampere-hours. As this amount is taken out of the battery every average day it must be restored during the 21 hours the receiver is not in operation.

But the battery is not 100% efficient. The efficiency is about 80%, so that it is necessary to put 20 more into the battery than is taken out. Hence the charge put in during the 21 hours should be 6.3 ampere-hours, or the rate should be $6.3/21$, or .3 ampere.

That is little bit more than is given by a 25 watt lamp according to the table above.

Even if a 25 watt lamp is used under the assumed conditions the battery will run down in time, necessitating an emergency charge. To circumvent this a 40 watt lamp could be used. This would keep the battery in a fully charged condition all the time, even if the receiver were used half an hour longer every day. And the excess rate is not so great as to cause any considerable loss of power. It would only make it necessary to replenish the distilled water in the battery more often.

The circuit diagram of connections for the DC B battery eliminator and charger is shown in Fig. 1. P is an ordinary plug terminal for insertion into any DC outlet.

Mark the Plug

It should be marked so that it may be inserted in the same way every time without the necessity of testing the polarity. L is a porcelain lamp socket for holding the electric lamp or resistor which is to control the charging rate of the circuit. S is a single pole double throw switch. When this switch is thrown to position No. 1 the six volt storage battery A discharges into the filaments of the receiver, providing there is no other open switch in the circuit. When S is thrown to position No. 2 the filament circuit is opened and the battery is put on charge. This switching arrangement always leaves the high voltage on the plates of the tubes, but will do no harm since no plate current can flow when the filaments are not on.

The filter circuit consists of the two 4 mfd. condensers C1 and C2 and the 30 henry choke coil Ch. There is an additional condenser C3 of 1 mfd. connected across the detector plate circuit. R is a 0-50,000 ohm variable resistor used to control the voltage applied to the plate of the detector tube.

Affords About 100 Volts

The effective plate voltage obtainable for the set with this eliminator is about 100 volts when the line voltage is 110 volts. The difference is due to loss in the resistance of the choke coil. In many cases 100 volts is enough to operate the set satisfactorily, but if more power is desired the voltage obtained from the line may be boosted with dry batteries.

For example, if it is desired to use a -71 type tube the high voltage required

for DC Locations

Bernsley

LIST OF PARTS

- P—One plug and six foot cord.
- C1, C2—Two Flechtheim 4 mfd. by-pass condensers, Type F 400.
- C3—One Flechtheim 1 mfd. by-pass condenser, Type B 100.
- Ch—One FMC 30 henry choke coil.
- R—One Carter 0-50,000 ohm resistor.
- S—One single pole double throw switch.
- One porcelain lamp socket.
- Two battery clips.
- One small bracket for supporting the resistance.
- Four binding posts.

can be obtained by connecting two 45 volt dry cell batteries in series with the B plus amp. binding post and the corresponding terminal on the set. This boosts the voltage up to 190 volts. This can be used on a -71 type tube if the bias be raised to about 45 volts.

A photograph of this simple eliminator is shown in Fig. 2. The Carter variable resistor R is shown at the extreme left. The 30 henry choke coil is in the middle, and directly back of the choke are the three condensers. The two 4 mfd. units are in plain view, but the 1 mfd. is just barely audible at the left of the larger Flechtheim condensers. The lamp socket and the control switch are at the right. The switch shown in the photo is a double pole double throw. This, of course, can be used as a single pole double throw by using one-half of it. Follow the diagram in wiring rather than the photo, as the diagram shows the connections more clearly.

One Side Grounded

When a unit like this is connected to the radio set it should be remembered that one side of the line is grounded. Usually one side of the receiver is also grounded. Now the set is grounded at the negative side while the line is grounded on the positive side in most cases. Care must be taken to prevent blowing out the house fuses or the tubes in the set. The simplest way to insure safety is to remove the ground from the receiver. No ground at all will be needed. So if the set is connected to the cold water pipes or the radiator remove the connection before hooking the receiver to the DC eliminator.

Oriental Designs Marks New Vitalitone Speaker

The Vitalitone Radio Corporation has developed a new artistic loudspeaker.

This model consists of a circular casting, approximately 18 inches in diameter, with an attractive Oriental motif and figure in the center. The general effect is Oriental gold polychrome and the figure is tinted in faint neutral shades. The cone or diaphragm forming the background consists of a special Oriental-design copper-colored cone.

In this model, the Vitalitone unit is employed.

The unit is especially designed for the high voltage output for the electric sets now on the market, and is guaranteed to carry an output up to 450 volts. In tests twice this amount of voltage has been used.



FIG. 2

A PHOTOGRAPH OF THE DC ELIMINATOR SHOWING THE ARRANGEMENT OF THE VARIOUS PARTS.

Monopoly Complaint Amendment Argued

Washington.

The Federal Trade Commission took under advisement the motion of counsel for the Commission to amend the complaint against the General Electric Company and others respecting an alleged monopoly in the radio equipment trade.

The amendment, as presented by William T. Chantland, proposed including unpatented consoles and cabinets and other unpatented devices in the products in which a monopoly is alleged to exist.

The attorney for the respondents, Thurlow M. Gordon, claimed that there was no monopoly or unfair competition in the radio industry and with respect to the proposed amendment contended that the articles concerned were only pieces of furniture which were not manufactured by the respondents.

Transmitting Condenser Is Flechtheim's Latest



The New Flechtheim Transmitting Condenser

KENT SUGGESTS EDUCATION

Washington.

Definite organization for the general use of radio in schools and colleges may be effected in the near future, as the result of a suggestion made to the Federal Radio Commission by A. Atwater Kent, Philadelphia manufacturer and broadcaster. In a letter dealing with extension of the use of radio in education, Mr. Kent urges the Commission to bring together leaders in the radio and educational fields, working out a practical program.

The A. M. Flechtheim Co., Inc., of New York City, has just placed upon the market a new type of transmitting condenser for high voltage operation. Designed especially to meet the demand and requirements of the amateurs and experimenters in the field of short-wave, high-powered transmission, the new condensers are made in two types: 2000 volt DC test, for 1500 volts DC operation, and 4000 volts DC tests for 2500 volts DC operation. These condensers are available in 1, 2 and 4 mfd. and are equipped with porcelain terminal insulators.

The condenser itself is encased in a metal silver-finished container and in the short period in which it has been on the market, it has found rapid favor among the amateurs. Frank Lester, 2AMJ in the Bronx, New York City, has been using them with excellent satisfaction and with his transmitter operating on the short waves, is in constant touch with Brazilian and South American stations.

BLUEPRINT and Instruction Sheet

for the

Shielded Grid Six

The New Receiver Utilizing the New Shielded Grid Tubes with Their Powerful Kick.

25 Cents

Guaranty Radio Goods Co.
145 WEST 45TH STREET
NEW YORK CITY

HERMAN BERNARD, managing editor of *Radio World*, discusses radio topics of popular interest every Friday at 5:40 P. M. from WGBS, 348.6 meters, the Gimbel Bros. station in New York City. Listen in.

NOTABLES CONFER ON WAVELENGTHS

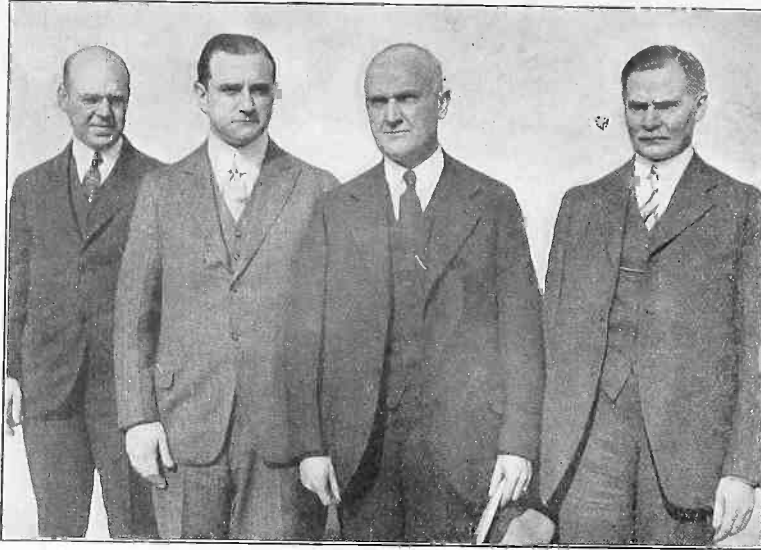

(Henry Miller)

WAVELENGTHS AND OTHER PROBLEMS WERE DISCUSSED AT A RECENT CONFERENCE CONDUCTED UNDER THE AUSPICES OF THE SMITHSONIAN INSTITUTION, WASHINGTON, D. C. THE RADIO CORPORATION OF AMERICA WAS REPRESENTED BY AN IMPOSING DELEGATION, INCLUDING (LEFT TO RIGHT) W. A. WINTERBOTTOM, ALFRED N. GOLDSMITH, CHIEF BROADCAST ENGINEER; GEN. JAMES A. HARBORD, PRESIDENT, AND C. H. TAYLOR, CHIEF COMMUNICATION ENGINEER.

How to Kill Off Hum
In an AC Receiver

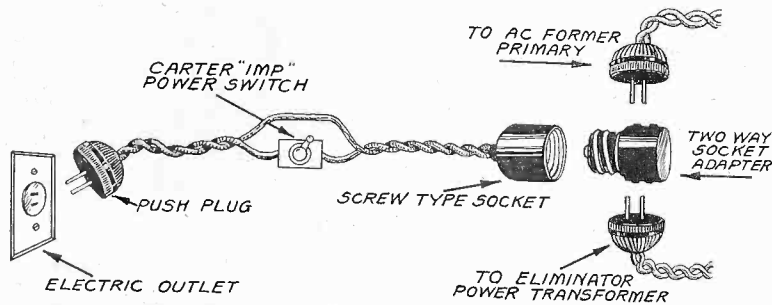

THIS SHOWS HOW THE DAVEN AC 5 CAN BE CONNECTED SO THAT A SINGLE SWITCH CONTROLS BOTH THE ELIMINATOR AND THE HEATING TRANSFORMER. THE CARTER POWER SWITCH CAN BE PUT ON THE RECEIVER PANEL PROVIDED THAT ALL EXPOSED DURING WIRING IS INSULATED.

[Part I of this article on the Daven AC Five was published last week. The final instalment follows.]

A difficulty sometimes experienced with AC sets is hum. It enters the signal by several routes, and all of these must be stopped up before the signal will emerge from the loudspeaker as free of hum as if the set were operated purely with DC.

Some of these channels through which hum may enter are unbalanced filament circuits, residual hum in the plate voltage, electromagnetic coupling between the leads carrying AC and those carrying the signal, electrostatic coupling between the same leads, regeneration or oscillation at any frequency in the circuit and overloading of tubes and of transformers, including the power transformer.

The filament circuits can be balanced very simply by using center tapped re-

sistors especially made for this purpose, but if an electrically center-tapped transformer like the Karas is used this is unnecessary. Where resistors are used they are connected across the filament terminals. The center point is connected to the grid and plate returns.

Residual hum in the plate voltage may be a severe source of annoyance, as it not only affects the audio amplifier but it enters the radio frequency amplifier and modulates the carrier frequency.

Electromagnetic coupling between AC and signal leads is one of the major sources of hum, but it is not difficult to reduce this coupling to negligible proportions. Twist together the AC leads of the Daven AC Five wherever possible and keep them away from signal leads, particularly those of the grid circuits.

Twisting the leads not only helps to remove the electromagnetic coupling but

New Speaker
Over Rad

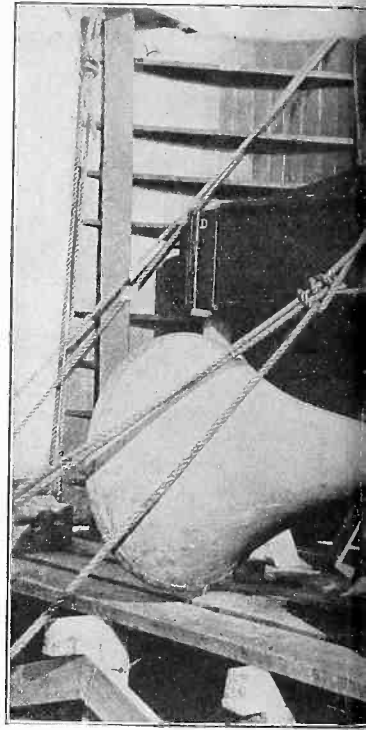

(Wide World)

THE NEW LOUDSPEAKER PERFECT LABORATORIES, WHICH CAN THROW TH OUT DISTORTION. THE NEW DEV PERSONS IN AN AREA UP TO A DRESSES OR OTHER REPRODUCTI HOPKINS, OF THE BELL LABORAT WITH ITS NINE RECEIVERS, THAT ITS BIG BROTHER, PICTURED IN ACROSS THE

Castle Stevens Bluff, Hoboken, overlooks the Hudson River and lies opposite the Bell Telephone Laboratories. On that bluff gathered a few of the Bell engineers on a cold morning. They took turns speaking into a field telephone which they had brought along. Dr. R. W. King was the first to speak.

"Hey, there, tug captain," he said in a normal speaking voice. A few moments later a gigantic voice came from the New York side, as if the original voice had been thrown back and intensified by the immense buildings.

"Hey, there, tug captain," rolled that gigantic voice over the Hudson and back to the bluffs and beyond. The great voice came from a huge loudspeaker a mile from Hoboken and located on top of the building housing the Bell Telephone Laboratories, 463 West Street, Manhattan. Pure and clear was that great voice, and a true magnified copy of Dr. King's voice, although it was strong enough to cover an enormous area.

The new speaker is the latest development of the Bell Telephone Laboratories

also the electrostatic. But there are other places where the electrostatic coupling may introduce hum. Shielding and grounding will help in these cases. For example, the cores and the cases of the Halldorson audio frequency transformers

er Is Clear us of a Mile

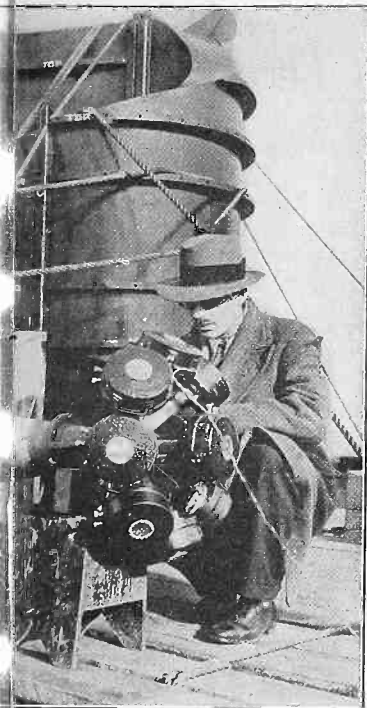

BY THE BELL TELEPHONE LABO-
UMAN VOICE FOR A MILE WITH-
IS DESIGNED TO ENABLE 1,000,000
E AWAY TO HEAR PUBLIC AD-
OF SOUND. PHOTO SHOWS H. F.
ES, SETTING UP A SMALL HORN
OVED NO LESS EFFECTIVE THAN
E REAR, IN SHOOTING VOICES
SON RIVER.

sound reproduction. The loudspeaker
mploys a small aluminum alloy dia-
ragm, not much larger in circumference
an a watch and thinner than gold leaf,
hich renders the transducing mechanism
uch more efficient than previous speak-
ers. "This loudspeaker," said Dr. King,
ointing across the river to an object on
op of the laboratories, "marks a notable
dvance in the development of such de-
ces. It is very efficient, converting
out 50 per cent of the electrical energy
ppplied to it into sound."

The new speaker, which is the develop-
ent of E. C. Wente and A. L. Thuras of
e Bell Laboratories, is remarkable in its
ithfulness in reproduction. It gives
qual response to all frequencies between
and 6,000 cycles and down to 40 cycles
er second and up to 8,000 cycles it dis-
rts so little that it is doubtful if anyone
ould detect it. It responds without dis-
rtion over a wide range of intensities.
will reproduce faithfully pianissimo and
rtissimo and change from one to the
ther with utmost quickness, as the
emonstration proved.

ould be connected to ground or to a
w potential point in the circuit. It is
good policy to ground the core and case
the filament power supply transformer.
Where AC leads, even when twisted, run
lose to any part of a tuned circuit, hum

MUSICAL TALENT IN THEIR BLOOD



MME. LOUISE HOMER AND HER TWO DAUGHTERS, KATHERINE HOMER AND LOUISE HOMER STIRES, WHO ASSISTED HER IN A RECENT ATWATER KENT HOUR. MISS HOMER IS A PIANIST AND MRS. STIRES IS A SOPRANO, WHILE THE MOTHER IS ONE OF AMERICA'S FOREMOST CONTRALTOS. IF MME. HOMER'S HAIR WERE A LITTLE DARKER YOU MIGHT SUPPOSE THESE WERE THREE SISTERS. YOU'RE WELCOME, MADAME.

may be introduced by electrostatic coupling. In that case a grounded metal shield around the AC carrying leads will suppress it. A prolific source of hum in a receiver of this kind is regeneration, or what is the same thing, oscillation. It makes little difference whether the oscillatory or regenerative condition occurs at radio or audio frequency. Whatever the frequency is oscillatory condition helps to upset the balance, increases the couplings which cause hum, and overloads the tubes and transformers.

If there is the slightest residual hum in the B supply the oscillation takes hold of the ripple and makes it a major disturbance in the circuit. If hum is severe and no other howl is heard in the set then it is well to test the circuit for some super-audible oscillation or excessive regeneration.

Overloading of tubes is also a source of hum but before this is severe the signal will be so distorted that it will not make much difference. The remedy is obviously to keep the volume of the output down to a reasonable value. But overloading of the chokes in the eliminator filter may give rise to considerable hum due to lack of filtering. When the current drawn from the eliminator is more than the chokes have been designed for the inductance of the chokes drops and the ripple admitted to the receiver increases. The remedy lies in getting filter chokes coils which will carry all the current required and have a wide margin of safety.

By-Passing is Essential

There is no greater aid to quiet operation than by-passing. Many and large condensers placed at appropriate points make the AC heated, B battery eliminator serviced receiver behave like one having individual batteries for every stage. That is, condensers strive for perfection. The Carter condensers used in this receiver have been chosen with the idea of economy of space and cost in mind as well as getting large values of capacity.

An important detail in the circuit is the low pass filter composed of the 85 millihenry Hammarlund RF choke L7 and the

HERE'S GLADYS



GLADYS RICE, RICHLY ENDOWED VOCALLY, AS ALL WHO LISTEN TO ROXY'S PROGRAMS KNOW, IS THE DAUGHTER OF THE FAMOUS VAUDEVILLE SKETCH TEAM OF 15 YEARS AGO, RICE AND COHEN.

Carter .0005 mfd. by-pass condenser C12. They prevent the radio frequency currents from interfering with the audio frequency amplifier. They not only stop radio frequencies but also reduce the high frequency noises which often accompany a signal.

It should not be assumed that the AC receiver gives much trouble from hum. It does not. Even when there is a hum it is just barely audible when no signal is coming in on the carrier wave and when the ear is put close to the speaker.

The Lynch

By Perry S.

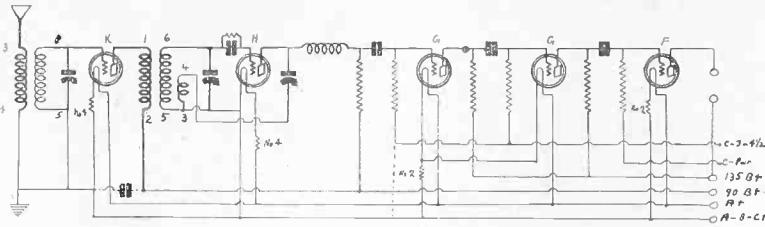

THE NUMBERS ON THE COILS IN THE DIAGRAM CORRESPOND TO THOSE ON THE AERO COILS, THE LETTERS ON THE TUBES TO THE CECO TUBES SPECIFIED, THE NUMBERS ON THE RESISTORS TO THE TYPE EQUALIZORS TO USE. IF REGENERATION FAILS REVERSE CONNECTIONS 3 AND 4. ALSO TRY DIFFERENT DETECTOR PLATE VOLTAGES. THE FIRST AF GRID MAY GO TO —A FOR 1-VOLT NEGATIVE BIAS, BUT THE SECOND AUDIO TUBE MUST HAVE EXTRA BIAS. THE FINAL AUDIO TUBE, FOR 135 PLATE VOLTS, USES 9 VOLTS NEGATIVE BIAS, MORE OR LESS.

MANY circuit combinations and arrangements have been featured during the past four years. Several of these are highly efficient. Efficiency may be placed at one end of a scale and simplicity at the other. They should meet if each is to express the maximum of its meaning. In radio today we have a fundamental circuit which realizes maximum simplicity and at the same time maximum efficiency. This is the one stage RF followed by a regenerative detector.

We all want high amplification. A stage of RF will give it, when properly damped to prevent oscillation. A regenerative detector will give excellent RF amplification, as well as performing its function of wiping out the carrier wave and leaving the pure audio component, that is, the music and voice just as transmitted from the broadcasting station.

One of the intriguing points of this arrangement is that when one regenerates to a marked degree on the detector circuit it affects the first circuit, causing some regeneration in it, and thus compensating for the usual losses due to balancing, neutralization, damping, or any other arrangement for preventing oscillation.

High Gain

Further consideration of this arrangement will show that only two tuned circuits are used, but since these are both regenerative they tune very sharply and therefore give as much selectivity as the usual three-tuned-circuit five and six tube tuned RF receivers. Thus we get efficient amplification and efficient tuning.

Two tuned circuits mean only two tuning controls and no ganging of condensers with possible resultant loss, due to the difficulty of accurately operating all three circuits together from a single control. Two tuned circuits also mean only two condensers and two coils.

Carrying this a step further we find that for an inexpensive audio amplifier there is little that can compare with a good three stage resistance coupled job. Now if we could have our audio amplifier all mounted on a panel with its filament control resistance and sockets as an accompaniment this could be quickly combined with a front panel carrying the two condensers and coils and there would be our complete receiver.

This is exactly what is achieved in the Lynch Aero Five. This set gives maximum efficiency, simplicity and tone quality and is extremely inexpensive to build.

Everyone is familiar with resistance coupled amplification. When used with tubes of high mu characteristics and a power tube in the last stage it is probably unsurpassed for quality and undistorted reproduction.

Arthur Lynch Designed Deck

In the construction of the Lynch Aero Five everything has been simplified in regards to the actual wiring and locating the parts. All the apparatus is mounted on two panels, the tuning units on the front panel and the audio amplifier together with the RF and detector sockets on a sub-panel. The sub-panel is not an ordinary piece of hard rubber panel necessitating much drilling for the various mountings, but is a complete unit in itself.

This unit is known as a "deck" and was designed by Arthur H. Lynch, former editor of "Radio Broadcast." The deck itself is a compact sub-panel of Westinghouse micarta with everything necessary for making a five tube receiver, except the tuning units and a few small items depending upon circuit used and mounted thereon.

The audio amplifier is entirely complete and partly wired. Many new ideas in arrangement and type of equipment used are made underneath the sub-panel. The resistances and coupling condensers are snapped into spring clips provided for holding them securely. At the back of the deck drillings are provided for mounting the necessary Eby binding posts. Binding posts are not part of the deck equipment itself, as some prefer to use a battery cable, or, if desired, a cable plug.

The Lynch Suppressor, RF choke and Equalizers are also not part of the deck equipment as received and it is necessary that they be mounted on the deck after assembling the necessary material for the receiver. Sufficient space is available and their use in the circuit will be described.

In choosing the locations for the various parts, thought was given to simplicity of design. The two Aero coils are mounted at either end of the front panel.

The reactance system of regeneration control is employed in the circuit, replacing the variable inductance method. The reactance circuit consists of a fixed inductance placed in an inductive relation to the grid circuit, and a capacity. The inductance and capacity are connected in series between the plate circuit of the detector tube and the negative filament circuit or grid return. A variation of the

LIST OF PARTS

One Lynch five tube De Luxe deck, including—
Five Eby De Luxe sockets.
Three .1 emg. Lynch resistors.
Three .05 meg. Lynch resistors.
One 2.5 meg. Lynch resistor.
Three special cartridge type coupling condensers.
One special cartridge type grid condenser.
Four sets of special mountings for resistors and condensers, all assembled and ready to wire.

Two Lynch No. 4 Equalizers, with mounts.
Two Lynch No. 2 Equalizers, with mounts.
One Lynch 750 ohm Suppressor, with mount.
Two National Type C dials.
One Aero Coil kit, U-95 (2 coils).
One Aero RF choke, No. 60.
Two Amsco S.L. Frequency condensers, No. 1223 .0005 mfd.
One Precise midget condenser, .00001 mfd.
Eight Eby binding posts.
Two S. M. mounting brackets.
One 7 x 18 inches Celoron panel.
Twenty-five feet Acme Celatsite flexible wire.
Four lengths Acme Celatsite solid wire.
One Yaxley 6 ohm rheostat.
One No. 1 Yaxley midget switch.
Miscellaneous assortment of machine screws and solder.
Total list price of above, \$47.00.

ACCESSORIES

One kit Aristocrat CeCo tubes consisting of—
One Type K.
One Type H.
Two Type G.
One Type F.
One cone speaker.
One storage battery.
Three 45 volt B batteries.
One 9 volt C battery.

capacity in the circuit controls the amount of feedback, thereby controlling the oscillation.

Aero Choke Serves Good Purpose

The purpose of the choke coil in the plate circuit of the detector stage is to choke out the radio frequency currents and direct them to the filament circuit through the .0005 mfd. condenser and the tickler coil, thereby keeping them out of the audio circuit and reducing the intensity of interfering noises. A fixed by-pass condenser at this point must not be used for this circuit, as each condenser would be detrimental to the effect of the regeneration condenser.

It is not always possible to use the regeneration condenser for the volume control, as it is sometimes necessary to boost regeneration considerably to obtain sufficient selectivity and the volume is thus made greater than desired. To provide for this condition a 6 ohm filament rheostat, connected in series with a No. 4 Equalizer and the filament of the R tube, provides a suitable control of volume without materially affecting the tuning elements.

A No. 4 Equalizer is used to regulate the filament of the detector tube, a No. 2 Equalizer to regulate the first two amplifier tubes and another No. 2 Equalizer for the third or last tube, which is a

Aero Five

Graffam

power tube. This should be changed to a No. 4 if $\frac{1}{4}$ ampere power tube is used.

After all of the parts have been obtained unwrapped it is well to start the building of this set in some systematic manner. The first thing to be done is the preliminary work on the "deck." The sub-panel brackets, the choke coil and the binding posts must be attached.

The sub-panel brackets are to be attached to the deck, one on each end, reasonably close to the edges, about one-half or three-quarters of an inch in. They should be attached so that the deck will be as far away from the front panel as possible and at the same time utilizing both screw holes in the brackets. The brackets must also be mounted so that they do not touch any of the leads to mounting lugs of any of the instruments on the deck.

Just how this will work out will be made entirely clear with the parts before you. Lay out the position of these sub-panel brackets on the bottom of the deck, drill the holes and attach. The choke coil should be mounted in the lower left-hand corner, behind the detector socket. The mounting hole for this will also have to be drilled.

Mount the four Equalizers and Suppressor mountings. These are located at either side of the RF tube socket. Next mount the binding posts. The first post—the one directly behind the detector socket—is the A plus post, then the A minus, B minus, plug 135, two speaker posts, antenna and ground. The antenna and ground posts are mounted on the side—at the right-hand edge of the deck, when the back of the deck is next to us.

Two Methods of Procedure

Now take the 7 x 18 inch front panel and mark the holes that are to be drilled for the sub-panel brackets. The sub-base should, of course, be centered on the front panel and the bottom of the brackets should be even with the bottom of the front panel. The deck may now be placed to one side while the front panel is drilled and the apparatus mounted. Note the handsome appearance when the two National dials are in position.

For those who are experienced in wiring, the deck should be wired before attaching to the brackets. For those less familiar with circuits it perhaps would be best to wire the receiver with all parts attached. The wiring is simple.

The battery leads for filaments are in cable form. Acme flexible Celatsite is used for this purpose and when all leads are in place they are sewed with a lock stitch, using No. 3 waxed cord. The connections other than battery leads are made with Acme solid Celatsite. It is recommended that different colors of Celatsite be used so that in checking the wiring the leads can be more easily traced.

Soldering is very important and a neat job should be done. Have the iron very hot, not half heated, and use a good soldering flux or resin core solder.

After completing the wiring of the receiver, check over each connection carefully for loose connections and remove any excess solder. Next test the circuit.

Tubes to Use

For this receiver the Aristocrat set of CeCo tubes is recommended. This set of tubes contains a CeCo type K tube especially designed for use in the RF stage of a receiver. This tube has a higher am-

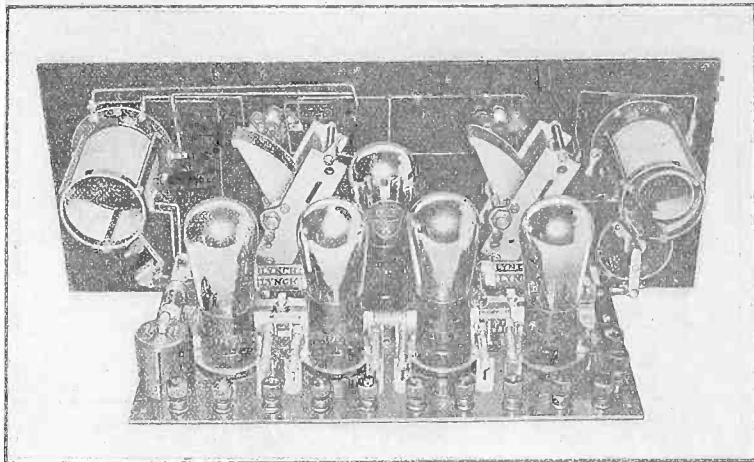
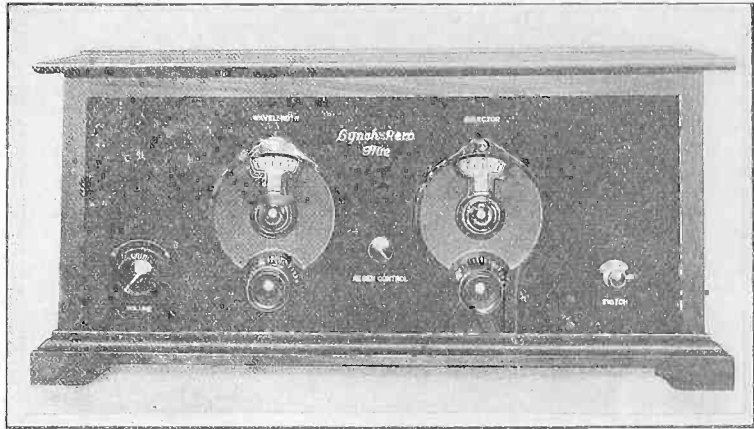

AN ATTRACTIVE FRONT PANEL CHARACTERIZES THIS COMPACT SET, WITH NATIONAL DIALS. BELOW IS THE REAR VIEW. NOTE THE NOVEL AND SERVICEABLE MANNER OF MOUNTING THE AERO COILS.

plification constant than the usual A type and thus increases the distance over which the receiver will pick up stations. The detector tube is the CeCo H special detector. This tube is similar to the type K and is a more sensitive detector than the A type. The amplifier tubes furnished in the tube kit include two CeCo type G tubes for the first two stages. These tubes are moderately high mu, designed for use in resistance coupled amplified circuits.

The CeCo type F tube is supplied for the last or power stage, and the receiver is designed and arranged for this type tube. Very satisfactory results will be obtained when using the F tube with 135 volt B battery. If desired, a CeCo type J-71 can be used instead of this F tube, by changing the C bias to 40.5 volts and supplying additional B voltage (total 180). When using such a high voltage, it is not safe to apply the output of the receiver direct to the loudspeaker. A tone filter should be used, such as a National Tone Filter. This unit can be placed on the table adjacent to the reproducer.

Having placed the proper tube in each socket, connect the A battery. Turning on the battery switch, all tubes should

light. Now connect the B batteries or eliminator to the set. Connect the various voltages. Connect a small C battery for bias for the power tubes, to its respective binding posts. Connect antenna and ground wires and attach loudspeaker to the two speaker posts. The set is ready for tuning.

If the radio frequency tube tends to oscillate, as can readily be told if the set squeals when a local station is tuned in, with the volume control rheostat turned about $\frac{1}{3}$ of the way "on," then either too much B voltage is being used on the RF stage or else a larger size (higher resistance) grid suppressor is needed.

Keep the regeneration condenser just below the oscillating point.

The tone quality will be found more natural and real than is found in the majority of receivers. Perfect tone reproduction has its limitations and when an amplifier is used with a poor loudspeaker of the cheaper cone type or old style horn reproduction will be ruined. For this reason alone choose a good speaker for the best reproduction. The Western Electric Cone speaker is excellent for its type and the Newcombe-Hawley a good example of the exponential horn type.

Short Wave Allocations Debated Before Board

Television Proponents, Railways, Department Stores, Labor and Amateurs Request Channels to Which a New and Great Importance Attaches

Washington.

The Federal Radio Commission closed its two-day hearing on short waves after considering proposals respecting the use of high frequency channels submitted by representatives of railways, department store chains, "wired wireless" interests, motion picture producers, broadcasters, amateurs and technical laboratories.

The high importance of short wavelengths for a wide variety of purposes was almost invariably emphasized by the speakers.

Specialists offered varying theoretical scales of wavelength allocations and many technical suggestions. Caution was urged by scientists as to the limitation in the number of channels available.

The hearings, attended by more than 150 persons, were conducted by the Federal Radio Commission as a prelude to defining its policy with respect to assigning the channels below 200 meters to different kinds of services.

Use by Railroads

G. T. Stanton, chairman of the Committee on Radio and Wire Carrier Systems, presented on behalf of the telegraph and telephone section of the American Railway Association the short wave radio uses desired for operation by the railroads represented by the Association.

"The principal radio short wave service desired by the railroads at the present time," he said, "is a means of signaling and communicating between the head and rear end of freight trains.

"Point-to-point communication for emergency use is desired, in common with other utilities having need for such service, though this latter service may not be of such general application as the foregoing mobile services."

R. H. Aishton, president of the American Railway Association, supplemented the statement of Mr. Stanton by stressing the importance of the uses of radio desired by the railroads.

Publishers Ask Assignments

Joseph Pierson, of Chicago, representing the American Publishers' Committee, said his organization does not oppose the claims of any other group, but insisted that the elucidation of those claims before the Commission had established that the newspapers occupy a position of public convenience, interest and necessity second to none of the others except the Army and Navy.

Swager Sherley appeared on behalf of the Radio Corporation of America. He discussed the problem of the Commission from an international standpoint.

"England dominates the cable systems between the United States and Europe and largely of the world," he said. "America's position is entirely secondary, and were it conceivable that war troubles could arise between the two countries it would be in Europe's power to prevent the uses of 14 of the 18 cables to England.

National Defense Plea

"We cannot hope for wire independence in world communication under the present cable system."

Mr. Sherley said that no single factor had contributed to the national defense

more than the development of an independent communication system of radio with the rest of the world, and added that its maintenance and expansion was of first importance. He said that a point-to-point service which contemplates full time use should have preference over partial time use.

He recommended that the Commission grant the use of no frequency for communication between fixed points to any organization unless that organization has adequate facilities and has the obligation under the law to accept messages from the public and to serve any and everyone of the public equally and fairly and without discrimination.

Labor Wants Four Channels

Edward H. Nockels, of Chicago, appeared on behalf of the American Federation of Labor and affiliated organizations, representing 5,000,000 persons. He asked that the Commission give due consideration to the requirements of labor channels so that labor can be adequately served not only for entertainment but for information, education and leadership, affecting its social and economic welfare.

Four channels were necessary, he said, two for point-to-point telegraphic services interconnecting the various organizations in time of need, one to be for national daylight transmission, and the other for night time service, the other two for rebroadcasting and synchronization.

Morrison Capron appeared on behalf of R. H. Macy & Co., Inc., of New York City.

"Many very marked advantages," he said, "will result to us when our chief executives in New York City can be in frequent and personal touch with our stores in Toledo and Atlanta and with our offices in London, Berlin and Paris and other far-flung locations.

The Goal of Stores

"Direct operating economies must accrue to us and in turn be passed to our patrons. We shall be able to consolidate our administrative organization so that our great experience and leadership may be made available to widely separated points.

"It is probable that radio can be developed to a point where widely separated stores can be operated on a basis comparable with the single larger store, and with the attendant advantages that have marked the growth of the modern department store. It is that goal that urges us now."

"Wired radio" was explained to the meeting by H. D. Counick, representing Wired Radio, Inc., who announced that the North American Company, after six years of experimenting and patent uncertainties, has completely developed for "wired radio." He said that "wired radio" proposes to make its service available to all homes in the country via electric power lines.

How Plan Is Arranged

The scheme involves a simple tuning device which may be attached to a home electrical socket and from which a listener may be able to choose three broadcast programs. Wired Radio, Inc., he said,

wants to broadcast its programs by short waves to cities where local power substitutions will pick them up and transmit them to local listeners.

George Cochrane, representing Universal Films, said the motion picture industry seeks to use short waves for communicating between the East and West coasts and from studios to filming parties "on location."

The chief broadcast engineer of the Radio Corporation of America, Dr. Alfred N. Goldsmith, pointed out the limitations in the use of the channels in the short-wave spectrum. Capt. S. C. Hooper of the Navy, he indicated, showed there were only about 170 available minimum width channels which was about the same estimate made by Col. Manton Davis of the R. C. A. the day before.

Need of Wide Bands

He predicted that several times as many channels may be made available in the next few years, but that "too fast pace" cannot be made by American engineers as short waves travel over great distances and frequency settings may not always be accurate in foreign countries.

Extremely wide bands will be needed for the transmission of motion pictures, or television, he declared in emphasizing the limited number of channels that are practically available. Undeveloped possibilities which give hope for adding to the number of channels were suggested in directional transmission, the developing of highly precise frequency transmitters, the development of frequency meters, the improvement of short wave receivers for more accurate tuning and the perfection of multiplex transmission.

Not for Own Relay

A "theoretical ideal" would present 500,000 channels, said Dr. Goldsmith, but the radio art is not developed to that point yet.

The R. C. A. does not seek wavelengths for short wave relay broadcasting within the United States, said Dr. Goldsmith, but is planning to inaugurate international exchanges of programs received via short wave relays.

A letter was read from Dr. C. Francis Jenkins, Washington radio inventor, regarding "visual radio." Two bands are needed, one below and one above 3,000 kilocycles (100 meters) for proper work in television both as to facsimile and motion picture transmission, Dr. Jenkins wrote.

Amateurs Want Protection

The Secretary of the American Radio Relay League, T. B. Warner, raised objection to the occupancy of the amateur wave band by nonamateur services and asked the Commission to relieve the situation for the benefit of the 18,000 amateur operators in this country.

He also asked that the present amateur bands be retained and that interference from other services be reduced.

At the previous session, Charles Evans Hughes, Jr., counsel for the Mackay Radio and Telegraph Company, analyzed the short wave situation in the United States and the radio service the Mackay company is developing in this country and the probable expansion of that service.

CONTAINING INFORMATION on aspects of radio which every fan should know, the March 19 issue is one to procure immediately, read from cover to cover and keep as an invaluable reference and guide. Some of the features in this issue are: "Filter Condensers Spared from Breakdown Due to Voltage Surges," by I. E. Anderson; "Grid Bias for Selectivity," "Psycho-Analyzing Circuits," by Thomas H. MacKay, "Wiring the New Universal," an excellent four-tube circuit, by Herman Bernard; "How to Use a Wave Trap," by James H. Carroll, and three full pages of Circuit Data for the Novice. There are also many technical items and photographs of interest to all constructors. Send 15c for the March 19 issue to
RADIO WORLD, 145 West 45th Street,
New York City

The Radio Trade

Short Waves Offer Big Markets, Says Caldwell

The Radio Manufacturers' Association, comprising more than 300 of the leading radio manufacturers of the United States, met at the Hotel Pennsylvania, New York City, for a four-day session. Orestes H. Caldwell, Federal Radio Commissioner, spoke on the subject, "Some Growing Markets for Radio."

He emphasized the importance of short waves as the field of the future and suggested that the manufacturers put on the market suitable equipment for these waves.

He also spoke of the work of the Commission during its year of existence and pointed out that, although there was still some interference, the chaos existing a year ago had been almost completely cleared. The Commission had done all in its power to clear up the situation, according to Mr. Caldwell, but had been

greatly handicapped by lack of police power, and the constant threat of injunction proceedings.

Had the Commission attempted to rule out some 300 stations a year ago it would have been tied up with injunction suits which would have required the whole year for clearing up. By their policy the Commissioners avoided injunctions and at this time they are ready to take them up.

One of the important subjects considered by the R. M. A. is that of pooling of radio patents. A. J. Carter, Chairman of the Committee of Patent Interchange, reported the findings of the committee to the association at a meeting held at 10 A. M., which only members attended. The pooling plan is being worked out in the radio industry in cooperation with C. C. Hanch, originator of a similar plan in the automotive industry.

Service Meters Listed for Dealers in Sets

Splitdorf Radio Corporation has issued a service manual advising each dealer handling all-electric sets to equip himself with the following for testing:

One voltmeter 0-3 AC; one voltmeter 0-10 AC; one voltmeter 0-150 AC; one ammeter 0-1 AC; one milliammeter 0-25 DC; one milliammeter 0-5 DC; one voltmeter 0-250 DC, 800 to 1,000 ohms per volt.

Tools—One 10" Yankee screw driver, 1/4" bit; one 4" Yankee screw driver, 1/8" bit; one pair side cutting flat nose pliers; one pair diagonal cutters; one 1/4" tip soldering iron; one Bakelite tuning rod and wrench; screws, nuts, friction tape, amberoid, etc.

Gold Seal Tubes in Demand

In addition to their popular GSX201a and GS199 type tubes, the new Gold Seal AC tubes, the GSX227 and GSX226, are finding great favor with fans and the trade. Several important improvements are embodied in the AC tubes, covered by patents. An unconditional replacement guarantee goes with every tube sold. Gold Seal engineers believe these tubes practically troubleproof. The Gold Seal super power tubes also stand high in popular favor. Among these are the GSX112, GSX171, GSX210, GSX240 and the GSX120. They also make a super-sensitive detector tube, the GSX200a and a full line of rectifier tubes, GSX216b, GSX281, GSX213 and GSX280. Gold Seal tubes have been manufactured for a number of years and this line represents the acme of their development and research. D. C. Ogilvie, the New York man, notwithstanding the fact that he has the hardest territory for results, maintains a high volume of sales. This concern has gotten out a handy illustrated little booklet that is invaluable to every radio fan, clerk and dealer. It tells all about radio tubes, their use and installation and may be had for the asking from Gold Seal Electrical Co., Inc., 250 Park Avenue, New York City.—J. H. C.

Novel Antenna Wins Favor of Experimenters

The new All-Direction Antenna put on the market by the American Radio Hardware Company, 135 Grand Street, New York City, has immediately jumped into favor with fans and the trade in general. This is a ring of pure solid copper 14 inches in diameter, occupies very little space and is quickly and easily installed. It can be mounted in many different ways, and while receiving signals from all direc-

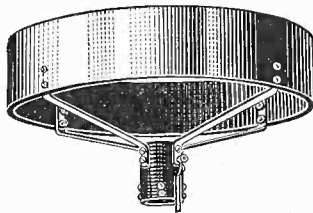

tions, eliminates and overcomes interference from other aerials. The lead-in may be fastened into the spring clip provided so that no soldering is necessary. Full information will be sent to those interested by the above concern.—J. H. C.

CHOCK-FULL OF INSTRUCTIVE DATA on all phases in radio, the December 31 issue is one which you should not deny yourself the pleasure of procuring immediately. Here are some of the articles which appear in this issue: "DC Sets Converted to AC Operation," by W. G. Masson-Burbridge; "Canny Cures for Unceasing Noises," by J. E. Anderson; "Phases that Shift Like the Sands and the Tides," an immensely interesting discussion on phase and its application to radio; "A Complete Driver for an AC Set," by Robert Frank Goodwin; "The AC 300 Receiver." Absorbing illustrations, as well as many technical kinks are also to be found in this remarkable issue. Send 15c for one copy of the December 31 issue to

RADIO WORLD, 145 West 45th St., New York City

HERMAN BERNARD, managing editor of *Radio World*, discusses radio topics of popular interest every Friday at 6:40 P. M. from WGBS, 348.6 meters, the Gimbel Bros. station in New York City.

Literature Wanted

THE names and addresses of readers of RADIO WORLD who desire literature on parts and sets from radio manufacturers, jobbers, dealers and mail order houses are published in RADIO WORLD on request of the reader. The blank below may be used, or a post card or letter will do instead.

RADIO WORLD,
145 West 45th St., N. Y. City.

I desire to receive radio literature.

Name

Address

City or town

State

- Chester Gelbar, 684 Penn Ave., Milwaukee, Wis.
 Forrest B. Arnold, 303 Vanderbilt Ave., Brooklyn, N. Y.
 C. F. Shaw, 45 White St., West Haven, Conn.
 I. C. Lacy, Box 35, Geneva, Ala.
 Russell H. Slimm, 570 Auburn St., Camden, N. J.
 Earl F. Hatch, 4056 45th Ave., South, Minneapolis, Minn.
 Harold E. Temple, 13227 Canfield, Detroit, Mich.
 John Kaufman, 238 9th Ave., N. Y. City.
 Richard Owen, 307 Hampden Ave., Mt. Oliver Station, Pittsburgh, Pa.
 Edward Baungartel, 4-6th St., Attleboro, Mass.
 R. H. Slimm, 570 Auburn St., Camden, N. J.
 R. B. Miles, 525 Garfield, Moberly, Mo.
 P. S. Bell, 3286 Ardmore Road, Shaker Heights, Cleveland, O.
 A. Roos, 7861 80th St., Glendale, L. I., N. Y.
 Wilbur S. Kille, 9 West Wayne Terrace, Collingswood, N. J.
 Edward G. Wible, Brier Hill, Pa.
 A. J. Harvey, 1116 Sheridan, Lawton, Okla.
 S. E. Lesser, 2111 N. 33d St., Philadelphia, Pa.
 Rennie Steen, 47 Third St., Brooklyn, N. Y.
 L. S. Devore, c-o Osage Ice Co., Pawhuska, Okla.
 R. D. Palmer, 535 8th St., Oakmont, Pa.
 C. L. Holland, 717 Osage Ave., Charlton, Ia.
 George Rice, 90 Market St., Attica, N. Y.
 Harvey Young, 1533 Fulton St., San Francisco, Calif.
 M. A. Reynolds, 23 Burriss St., Hamilton, Canada.
 L. R. Schafer, 199 Harvey Ave., Doylestown, Pa.
 Gordon Campbell, USS Patoka, c-o PM, New York, N. Y.
 McRae Walker, 13 1/2 Brenner St., Newark, N. J.
 L. Berg, 814 East 181st St., Bx., N. Y.
 A. A. Salmon, 1468 Seabury Place, Bx., N. Y. City.
 Chas. N. Wyman, 109 Bay St., Sidney, O.
 A. More, 170 Calot St., Holyoke, Mass.
 J. R. Fernandez, 1189 Harrison St., Santa Clara, Calif.
 Earl F. Campbell, 25 W. 45th St., N. Y. City, N. Y.
 George Strochlein, 575 Crescent St., Brooklyn, N. Y.
 Clark W. Wright, 48 Chestnut St., Painesville, O.
 E. R. Haan, 7407 N. Ashland, Chicago, Ill.
 D. P. Bryan, c-o Ritz Carlton Hotel, Atlantic City, N. J.
 H. V. Landers, 6 Kress St., Binghamton, N. Y.
 L. Svarovsky, Prague-Smichov, Trida Svornosti 26, Czechoslovakia.
 Henry B. Irey, 105 S. 59th St., Philadelphia, Pa.
 E. Nelson, 142 N. 18th St., Philadelphia, Pa.
 Fred Carbert, Mohall, N. D.
 W. A. Hanson, 813 Peck Ave., San Antonio, Tex.
 Frank S. Dobbins, 24 Wakullah St., Roxbury, Mass.
 O. J. Larsen, 2609-30 Ave. S., Minneapolis, Minn.
 Amos L. Martens, 1208 36th St., Rock Island, Ill.
 Albert Williams, 317 East 49th St., N. Y. City.
 Harold Doyle, Spencer, Mass.
 M. Cockran, 4721 37th Ave., S. W., Seattle, Wash.
 A. S. Cooke, 1304 Pacific St., Brooklyn, N. Y.
 J. Dyczkowski, 1629 E. Falls St., Niagara Falls, N. Y.
 John A. Coy, 2957 Taylor Ave., Detroit, Mich.
 Kenneth Allen, 3706 Bellefontaine, Kansas City, Mo.
 Carl Deutsch, 728 Wabash Ave., Kansas City, Mo.
 O. C. Franklin, 215 N. Center St., Royal Oak, Mich.
 R. G. Artz, 422 5th Ave., Altoona, Pa.
 P. J. Conway, 2741 40th Ave., S., Minneapolis, Minn.
 George Downing, 1718 Josephine St., New Orleans, La.
 O. W. Vollette, 415 Dallas Ave., Houston, Tex.
 Ernest Miller, R. No. 2, Burlington, N. D.
 James P. Beattie, 9432 Hayes Blvd., Detroit, Mich.
 R. M. Russell, 4617 S. 3rd St., Louisville, Ky.
 F. J. Collienne, 2626 Broadway, N. Y. City.
 Harvey Arthur, 59 Bridge, Beverly, Mass.
 I. P. Clifford, 631 Brookline Ave., Brookline, Mass.

A THOUGHT FOR THE WEEK

MANY a noted musician or singer or other celebrity who announced quite solemnly a couple of years ago that he or she — disclaiming knows no sex — would never, never appear before the microphone, is now very glad, indeed, to be among those present at the studios on these midwinter listening-in nights. But let us not be too satirical, for there is no humiliation connected with a brave acknowledgement of an error.

SIXTH YEAR

RADIO WORLD

The First and Only National Radio Weekly

Radio World's Slogan: "A radio set for every home."

TELEPHONES: BRYANT 0558, 0559

PUBLISHED EVERY WEDNESDAY

(Dated Saturday of same week)

FROM PUBLICATION OFFICE

HENNESSY RADIO PUBLICATIONS CORPORATION

145 WEST 45TH STREET, NEW YORK, N. Y.

(Just east of Broadway)

ROLAND BURKE HENNESSY, President

M. B. HENNESSY, Vice-President

HERMAN BERNARD, Secretary

Chicago: 55 West Jackson Blvd.

Kansas City, Mo.: E. A. Samuelson, 300 Coca Cola Bldg.

Los Angeles: Lloyd Chappel, 611 S. Coronado St.

European Representatives: The International News Co.

Breams Bldgs., Chancery Lane, London, Eng.

Paris, France: Brenlano's, 8 Avenue de l'Opera

EDITOR, Roland Burke Hennessy

MANAGING EDITOR, Herman Bernard

TECHNICAL EDITOR, J. E. Anderson

TELEVISION EDITOR, Neal Fitzalan

ART EDITOR, Anthony Sodaro

CONTRIBUTING EDITORS:

James H. Carroll, John Murray Barron and

Capt. Peter V. O'Rourke

SUBSCRIPTION RATES

Fifteen cents a copy, \$6.00 a year, \$3.00 for six months, \$1.50 for three months. Add \$1.00 a year extra for foreign postage. Canada, 50 cents.

Receipt by new subscribers of the first copy of RADIO WORLD mailed to them after sending in their order is automatic acknowledgment of their subscription order. Changes of address should be received at this office two weeks before date of publication. Always give old address; also state whether subscription is new or a renewal.

ADVERTISING RATES

General Advertising

Table with 3 columns: Ad size, Lines, Price. Includes 1 Page, 7 1/4" x 11", 462 lines, \$300.00; 1/2 Page, 7 1/4" x 5 1/2", 231 lines, 150.00; 1/4 Page, 8 1/2" D. C., 231 lines, 150.00; 1/8 Page, 4 1/2" D. C., 115 lines, 75.00; 1/8 Page, 4 1/2" S. C., 57 lines, 37.50; 1 Column, 2 1/4" x 11", 154 lines, 100.00; 1 Inch, 10.00; For Rate Line, .75

Time Discount

Table with 2 columns: Issue frequency, Discount. Includes 52 consecutive issues (20%), 26 times consecutively or E. O. W. one year (15%), 13 times consecutively or E. O. W. (12 1/2%), 4 consecutive issues (7 1/2%).

WEEKLY, dated each Saturday, published Wednesday. Advertising forms close Tuesday, eleven days in advance of date of issue.

CLASSIFIED ADVERTISEMENTS

Ten cents per word. Minimum 10 words. Cash with order. Business Opportunities, ten cents per word, \$1.00 minimum.

Entered as second-class matter March 23, 1922, at the Post Office at New York, N. Y., under the Act of March 3, 1879.

Custom Set Builders Indorse Plan for Club

In the January 14 issue of RADIO WORLD I wrote up my experiences as a professional set builder and put forward the suggestion that an organization be formed, so that all members could gain advantage of the experience of other custom set builders. The response has been very encouraging, and I feel I have made much progress, but I would like to hear from several hundred, and be assured by them that they favor the idea of such an organization before I actually undertake the work of forming it.

Remember that the custom set builder is an important cog in the wheel of radio trade, that he is, next to the radio magazines, the principal agency for sale of parts, and that besides he renders a distinct service to the public by making available to them the very latest improvements in radio technique.

Such an important group, it seems to me, needs organization for the benefits the members will bestow on themselves financially, on the public and on the trade.

Any desiring to indorse the plan should fill out the coupon and mail it to me. I am attaching the names and addresses of some of those who have sent me kind notices of approval. They are custom set builders.

- Arthur Du Haine, 551 West 204th St., N. Y. City.
Walter A. Glenney, 39 Linden Ave., Belleville, N. J.
C. G. Culin, c-o Arthur Lynch, Inc., 1775 Broadway, N. Y. City.
William Fulmer, 607 E. Lippincott, St., Philadelphia, Pa.
M. Scozzari, 428 East 11 St., N. Y. City.
Sam Narefsky, 2 West 120th St., N. Y. City.
Arthur P. Wagner, 1123 E. 211th St., Bronx, N. Y. City.
Joseph Ross, 23 Cooper St., Brooklyn, N. Y. City.
Henry J. Geibel, 1243 N. 30th St., Philadelphia, Pa.
Jos. A. Seykora, 217 East 66th St., N. Y. City.
Louis T. Thoma, 3125 Vine St., Cincinnati, Ohio.
R. G. Fehrenz, 1086 President St., Bklyn., N. Y. City.
William C. Massett, Shakespeare Drive, R. F. D. No. 2, Berea, Ohio.
W. A. Barth, 6114 Commonwealth Ave., Detroit, Mich.
Walter C. Gregory, 149th St. & Whitlock Ave., N. Y. City.
E. E. Nelson, 259 N. Broad St., Mobile, Ala.
M. M. Hoff, 1715 Mt. Vernon St., Phila., Pa.
Jos. J. Schiller, 1003 East Adams Ave., Temple, Texas.
John A. C. Callan, Alabama Polytechnic Institute, Auburn, Alabama.
Anthony Hitzzenhammer, 1450 Argyle St., Chicago, Ill.
C. C. Peugh, 54 Linden St., Schenectady, N. Y.
Harry A. Buckingham, 2153 Barbara Ave., Detroit, Mich.
G. W. Counter, Box 1088, Buckburnett, Texas.
Sam'l W. Faber, 3058 E. Thompson St., Philadelphia.
M. N. Koch, 224 N. Blank St., Allentown, Pa.
Max De Tait, Friendship, N. Y.
W. I. Chambers, 1834 Eye St., N. W., Washington, D. C.
Francis G. Glead, Fifth Ave., West Hamilton, Ontario, Canada.
A. C. Jeffrey, 518 East 10th St., Rushville, Ind.
R. J. Roberts, 4428 15th Ave., So., Minneapolis, Minn.
R. E. Carter, 108 Seward Ave., Grand Forks, N. D.
J. Doll, 128 Bergan St., Newark, N. J.
A. Taylor, 208 W. Ga. Ave., College Park, Ga.

Robert H. W. McCord, c/o RADIO WORLD, 145 West 45th Street, N. Y. City.

I am a custom set builder and would like to join you in the formation of a national organization of custom set builders. Please list my name and address. I am one of the indorsers. This does not obligate me in any way.

NAME
ADDRESS
CITY STATE

Colonial Is Licensed Under Hogan's Patent

A license has been granted to the Colonial Radio Corporation under the Hogan single-control tuning patent. The inventor, John V. L. Hogan, has licensed more than forty other radio manufacturing organizations. The licensees include the Radio Corporation of America, General Electric, Westinghouse and Atwater Kent. Hogan has brought suits for alleged infringement of his patent by several radio set builders, among which was the Colonial Radio Corporation. By the new agreement, this suit is withdrawn and Colonial pays royalties for its past activities and future production and sales for single dial sets.

FILL OUT AND MAIL NOW SUBSCRIPTION BLANK RADIO WORLD

145 West 45th Street, New York City (Just East of Broadway)

Please send me RADIO WORLD for ... months, for which please find enclosed

SUBSCRIPTION RATES: Single Copy \$.15, Three Months \$ 1.50, Six Months \$ 3.00, One Year, 52 Issues \$ 6.00. Add \$1.00 a Year for Foreign Postage; 50c for Canadian Postage.

The Pre-Power Unit

[Part I of this article was published last week. The final instalment follows.]

It is an excellent plan to have an amplification control at radio frequencies, such as the tickler, and besides a volume control in the audio side. That gives double opportunity to correct overloading, in that the detector escapes it and the audio outputs are kept undistorted.

Less Noise, More Legibility

Another point is that a tickler alone is not a sufficient volume control, since for a practical maximum of regeneration, to obtain reception of far-distant signals, the volume may be too large for real enjoyment, since the noise level may be high. It is a phenomenon that reduction of audio amplification will reduce noise level without reducing the intelligibility of the distant signal.

One important incentive to the construction of a receiver by your own hands is adjustment to the required operating conditions. You take the measure of your location, so to speak, and make the circuit pattern accordingly. In that way you obtain a surpassing receiver, something you can demonstrate proudly to your friends. No change need be made in the diagram as shown, and yet this advantage of measuring up to your location's requirements is complete. All that is necessary is to choose the constants properly. What this choice should be, and the factors determining it, will be discussed presently in detail.

You may not be able to use an outdoor aerial, because the landlord objects, or for other reasons. Instead you may use an indoor aerial with this receiver. Indeed, if neither of these two is desired, then a loop may be used in place of the antenna coupler L1L2. Omitting the coupler, the loop would be connected to the two points of the first tuning condenser, C1. These points, in respect to the coupler secondary (which would not be used were loop reception preferred) are shown as C and D. And the reception on a loop is excellent, including distant stations.

You may want to use neither indoor nor

outdoor aerial, nor loop, but instead a lamp socket antenna. This, too, works well with this set, if it works on any TRF set. In some locations a lamp socket antenna has next to no pickup, due possibly to the fact that buried lighting mains are often effectually grounded, and the pickup is almost nil. But if there is only a fair amount of pickup—and in most instances there will be—the receiver as shown will perform.

Outdoor Aerial Preferred

With all these antenna choices at your command you can rest assured that whatever you select will provide reception.

The outdoor antenna is to be preferred. This is standard advice for all receivers, excepting possibly Super-Heterodynes. But the alternatives are satisfactory although all give somewhat less volume than the outdoor favorite.

As for the length of an outdoor antenna, that depends on your location. If signals as a rule come in poorly and weakly on virtually all sets you've tried, then use 100 feet. But if your location is merely good, then a 50-foot antenna will be all-sufficient.

Have as much of the antenna vertical as you your location permits. If you have an outdoor aerial 100 feet long, or more, you may introduce a fixed condenser in series with the aerial. This will cut down the fundamental wavelength of the aerial, also reduce the pickup and increase the selectivity. The series condenser should be no more than .00025 mfd., although less capacity than that normally is preferable. Many use around .0001 mfd.



Don't Waste Your Money

Buy radio tubes as you do other commodities—on a basis of value.

You want clear reception, full volume, natural tone. These CeCo tubes will give and IN ADDITION an extraordinary long life of steady, unflinching performance.

CeCo is the scientifically engineered tube—the laboratory-tested tube, the tube endorsed by great radio authorities.

CeCo

makes any good receiver BETTER.

Ask your dealer to help you choose the types of CeCo best suited to your set.

C. E. MFG. CO., INC.
Providence, R. I. U. S. A.



SEND FOR FREE CATALOG

From Chicago's
Oldest Radio Jobbers
The Most Valuable Radio
Catalog.

Write for your copy today—IT'S FREE

TELEPHONE MAINTENANCE CO.
123-5 S. Wells St. Dept. 62 Chicago, Ill.

Guaranteed "A" Power Unit—\$13.75

No better "A" Socket Power Unit can be obtained even at twice this amazingly low price. No hum or noise. Operates on 50 or 60 cycles at 110 volts A. C. Approved by rigid laboratory tests of Radio News and Popular Radio. Fully guaranteed. Shipped complete, subject to inspection, on receipt of price—or C.O.D. if you wish. 5% discount if cash in full is sent with order. Send order NOW! RADIO BATTERY CO., 1219 South Wabash Ave., Dept. 64, Chicago, Ill.

Blueprints

for the

4-Tube Shielded Grid Diamond of the Air

As Designed by H. B. HERMAN

All Prescribed Parts Shown, Actual Size, with clear wiring connections. All dimensions given, besides. Front panel, subpanel and wiring. Immediate delivery.
\$ 1 . 0 0

RADIO WORLD

145 West 45th Street New York City

Subscribers: Look at the Expiration Date on Your Wrapper

We do not like to take your name from our subscription list without specific instruction to do so, because many of our readers wish to keep a complete file of the paper.

Please therefore, look at the subscription date stamped on your last wrapper, and if that date is earlier than the issue contained in the wrapper, please send check to cover your renewal.

In this way you will get your copies without interruption.

Subscription Dept, RADIO WORLD, 145 W. 45th Street, New York City.

FULL OF USEFUL INFORMATION on 101 aspects of radio, the December 10 issue is one to keep and study. It is a reference book all by itself. Some of the features are "My Three Months with the Magnatormer 9-8," by J. E. Anderson, Technical Editor (seven full pages, including illustrations in colors—the presentation that evoked 700 laudatory letters); "The Object of a Power Amplifier, With Special Emphasis on Push-Pull Stage," by C. T. Burke, engineer, General Radio Co.; "The Floating Armature Coil Reproducer," by H. B. Herman, acoustical expert, featuring the new Magnavox electrodynamic reproducer; "A Battery Powered Two-Tube Phonograph Amplifier," embodying the Phonovox, by James H. Carroll; "Giving the Crackles the Gate," by Tim Turkey; "The Everyman 4," by E. Bunting Moore; "The Analysis of the Concertina," by Leo Fenway, its noted designer; "Scientists Freeze Resistance Out of Metals"; other features, abundant illustrations. Send 15 cents for copy of December 10th issue to—
RADIO WORLD, 145 W. 45th St., New York City

NEXT WEEK! THE ADAMS 1-2-3

Radio World's CLASSIFIED ADS for Quick Action

10 Cents a Word—10 Words Minimum—Cash With Order

FOR SALE—Grebe five-tube Synchronphase Radio. Single control. R. Schlegel, 1118 No. Negley, Pittsburgh, Pa.

SETBUILDERS AND REPAIRMEN—Transformers 650 and 7½, \$5.50; 550 and 5 volts, \$4.00; knockdown 50 and 100 watt with primary only \$2.50 and \$3.00. Write for lists. Radio Parts Sales Co., Orange, N. J.

ARE YOU MAKING MONEY in radio? If not send for booklet. Co-Operative Radio Doctors, Dept. W, 131 Essex St., Salem, Mass.

DIRECT FACTORY SALE—Wholesale prices. Tremendous Savings. Selling direct to you. Here are some of our many items: 30 Henry Choke, 100 M.A., \$2.19; 10 Henry Choke, 400 M.A., \$5.48. Power Transformers for all kinds of Eliminators and for all types of A.C. Tubes, at Special Low Prices. EVERY ITEM FULLY GUARANTEED. Promptly shipped, upon receipt of order. Send for free illustrated catalog today. Todd Electric Co., Inc., (Manufacturers) 36 West 20th Street, Dept. D, New York City.

COMPLETE DETAILS on the Laboratory-Super appeared in the Nov. 19, 26 and Dec. 3 issues of RADIO WORLD. Send 45c for these issues.

DON'T BUY A RADIO until you have tried my beautiful two-dial, five-tube, long-distance receiver. Thirty days free. Price, completely assembled, \$16.00. New shielded grid super seven, complete kit, \$65.00. New shielded grid six; complete kit, \$40.00. Write General Radio Sales Co., Box 545, Oklahoma City, Okla.

RADIO FURNITURE, direct from factory to you. Receiving set cabinets, any size. Consoles and tables. Free catalogue on request. Fulbright Cabinet Co., Hickory, North Carolina. W-2-18

The Big Thrill of DX, and at very Small Cost to You

Everybody who owns a radio set likes to tune in far-distant stations now and then because not only is there a thrill in hearing a voice or instrument thousands of miles away but one verifies the fact that he has a powerful receiver and that it is in good condition, if it is able to pick up these weak signals. Now that the broadcasting stations are more suitably distributed as to wavelength or frequency, fans are in a better position to tune in distance. Besides, the weather is in their favor these days. But what kind of a set shall he use? You know very well that if the set can tune in distance once in a while, you can develop sufficient skill to make it tune in far-distant stations very often, virtually every night. Then when you have visitors you need not boast about the DX qualities of your set but simply tune the receiver and let them listen to stations thousands of miles away. You must be sure to have a receiver capable of responding to your distance-getting desires. You also want this set to have delightful tone quality, so that your own critical ears cannot detect even a single flaw in the reproduction. Indeed, even music lovers who may be guests at your home will comment admiringly upon the bewitching tone of your receiver. Then you know you have something real. The ability to get distance and to reproduce the original music without distortion depends largely on the circuit design, and you will find that the Diamond of the Air, either the 4-tube or the 5-tube model, will live up to your highest expectations. How are you going to know which to build? Carefully inspect the textual data as well as the blueprints that fully expound the theory, operation, characteristics and amplification of these two outstanding receivers that differ principally in the type of audio amplification.

The 5-Tube Diamond

Can be constructed in a couple of hours. The authorized blueprints that make this speed and efficiency possible are just off the press and will be shipped at once, together with the new booklet of full textual exposition of construction, including the winding of coils, how to connect terminals, what values of condensers and resistors to use, etc. The receiver consists of a stage of tuned radio frequency amplification, a specially sensitized detector, first stage of transformer audio and next two stages of resistance audio. It is easily adapted to playing phonograph records through the set and on your speaker. Get acquainted with this new delight.

The 4-Tube Diamond

represents the most that is obtainable from four tubes. A stage of tuned radio frequency amplification, a specially sensitized detector and two stages of transformer coupled audio. Follow the blueprint to amazing success. Build the set from parts you have. Full instructions cover utilization of such apparatus. Thousands are eager to build an economical set of surpassing performance and amazing achievement and this one is the most economical, the most scientific, and the least expensive in cost of parts and upkeep. Works splendidly from batteries, either type 99 or type 1A tubes, and can be used with A and B eliminators, power packs, etc., with great success.

Look over both of these

blueprints and read the text in both cases before choosing the receiver you are to build.

Guaranty Radio Goods Co.

145 West 45th Street, New York City

Please send me one newly-printed official blueprint of the 5-tube Diamond of the Air, one newly printed official blueprint of the 4-tube Diamond, and the textual data giving full directions for constructing these sets. Enclosed please find 50 cents to defray all expense.

Name

Address

City..... State.....

Exclusive Waves Favored For the Fine, Big Stations

Radio reception in the Middle West is far from ideal, according to Frank W. Elliott, manager of station WOC, Davenport, Iowa, who was in New York recently seeking information on installing and operating a 50 kilowatt transmitter.

"We feel that the work of the Federal Radio Commission has helped some," stated Mr. Elliott, "but conditions will not be what they should be until the better grade stations have exclusive wavelengths, with high power and properly lo-

cated geographically to avert interference.

"Today Santa Monica, Cal., interferes with WOC, because both are on the same wavelength. WEAF, New York, when it reaches the Mid-West, intermingles with KGW, Portland, Ore. There is a low beat note growl on WJZ's wave when it reaches Iowa. WOR, Newark, is generally clear. WGY, Schenectady, is clear. We never hear WNYC, the New York municipal station."

End Radio Bothers

DO YOU KNOW what's wrong when your radio set isn't working right? Ten to one, you don't. Twenty to one, you would if you had a copy of

Hoff's Radio Trouble Finder



Ever hear of M. M. Hoff, radiotrician, of Philadelphia? He was one of the very first "radio bugs" and has been building and studying sets ever since. And now, out of his broad experience, this man has written a book to tell radio owners how to keep their sets working right.

He tells in plain words and illustrations how a set is made, what the parts are called, what are the few usual troubles and how to fix them. Then he lists 103 troubles that sometimes happen and tells how to detect and fix each one.

The book is a regular encyclopedia of radio information—only it's in a language anyone can understand. Read it five minutes and you'll know more about radio than you ever dreamed of.

It will save you many a repair man. It will save you hours of guessing and fussing and fuming. It will help you to keep the tone of your set always sweet and strong. It will keep you from losing many programs. And, best of all—

IT WILL MAKE YOU STOP SWEARING—MUCH TO THE SURPRISE OF YOUR FAMILY—because radio repairs are expensive. Why hire them done when you can easily learn how to keep your set from needing them?

All It Costs Is \$1

Send cash with your order and you get also a Dictionary of Radio Terms and the latest list of Radio Broadcasting Stations with call letters and the new Federal Radio Commission wave lengths. Send your dollar today while the copies last. Six copies for \$4.00.

CHICAGO BARGAIN HOUSE

424 QUINCY BUILDING

CHICAGO, ILLINOIS

Take Your Choice of 7 Other Publications For NEW RADIO WORLD Subscribers Ordering NOW

Radio World has made arrangements

—To offer a year's subscription for any one of the following publications with one year's subscription for RADIO WORLD—

RADIO NEWS or POULAR RADIO or SCIENCE AND INVENTION or BOYS' LIFE or RADIO DEALER or RADIO (San Francisco) or RADIO AGE.

This is the way to get two publications

- for the price of one:
- Send \$6.00 today for RADIO WORLD
- for one year (regular price
- for 52 numbers)
- and select any one of the other
- nine publications for twelve months.
- Add \$1.00 a year extra for
- Canadian or Foreign Postage
- Present RADIO WORLD subscribers
- can take advantage of this offer by
- extending subscriptions one year
- if they send renewals NOW!

Radio World's Special Two-for-Price-of-One Subscription Blank

RADIO WORLD, 145 West 45th Street, New York City.

Enclosed find \$6.00 for which send me RADIO WORLD for twelve months (52 numbers), beginning and also without additional cost, Popular Radio, or Radio News, or Science and Invention, or Radio Dealer, or Radio (San Francisco), or Radio Age, or Boys' Life (or \$10.00 for a two-year subscription to one address). No other premium with this offer.

Indicate if renewal. Name

Offer Good Until March 15, 1928 Street Address

City and State

Business Man as Talker Equals Best Announcers

In the recent Victory Hour Fred and Dorothy Stone shone "Wonderful Dad," a duet from "Stepping Stones," was sung by father and daughter. In the song these lines appear:

"I'd rather be a father Than be the King of Spain."

At the conclusion of their turns Stone said: "Well, so long everybody. Dorothy and I are glad to be with you if even for these few minutes. God bless you all."

Then Will Rogers spoke: "Gee, that was fine! It certainly was good to hear you all again! The California climate must have got to them."

Thus did Rogers remind himself to discuss the celebrated climate. He referred to Graham McNamee's description of the Pittsburgh-Leland Stanford, Jr., University football game, broadcast on the celebration of New Year's Day (January 2).

"Every time anybody made a touchdown he announced the color of the violets or how many flowers were on some float, but we never did learn who made the touchdown."

Mr. Wilmer's turn came next. His was an unexpected appearance. He was conscious of being sandwiched in a notable program that his public was unwilling to have interrupted, but he promised "just a few words," and all hands probably sighed relievedly, but as he got well into those "few words"—and they were few—he became more and more interesting. He spoke with superb diction, putting himself at once on the same class as Milton J. Cross, Alois Havrilla, Louis A. Witten and Floyd Neal. He told in general about the new car and referred listeners to the following day's newspapers and to showrooms for details. Besides, he spoke about the enormity of the listening audience.

"Made Over a Million"

Rogers next introduced as follows: "The only man who can sing a song better than a singer and tell a joke better than a joke-teller. He's what Elinor Glynn calls 'It.' He has made over a

million dollars singing about his old mammy in the South, whom he left in Moscow more than 45 years ago—Mr. Al Jolson of New Orleans."

"Let's sing and joke to the largest audience I ever faced in my life, though I can't see them," said Jolson, as if addressing his piano accompanist, Dave Dreyer, the composer.

Jolson started with a medley of songs that he has made famous and that have helped to make him famous. Then he sang "Mammy."

"I haven't sung in five weeks, so I'll do a brand new song," he promised. It was "Golden Gate," two lines of which were: "Golden Gate, I'm comin' to yuh; Golden Gate, Sing Hallelujah."

Next came "The Song Is Ended, But the Memory Lingers On," words and music by Irving Berlin. Following this came "Four Walls," composed by Dreyer, as a companion piece to Dryer's own "Me and My Shadow." These songs melodyize and dramatize the spirit of loneliness.

Familiar, indeed, was "Four Walls," another almost nightly visitor in the radio-blessed home, but not familiar the outstanding way Jolson did it, especially the recitative portraying of a person being driven insane by loneliness "looking at just four walls!"

Jolson signed off saying: "I hope my mother listened in at Hartsdale to her little priddy singing." "Pridgy" was probably her pet name for her son.

Whiteman's Orchestra, without announcement, played "Among My Souvenirs."

Everybody's Talking About It

There's a wealth of reliable, hotted-down, and interesting information in "Resistance, The Control Valve of Radio." Simply written—clearly illustrated. This valuable handbook on resistance in radio is worth dollars—send only 25 cents for your copy.

ARTHUR H. LYNCH, Inc.
1775 Broadway New York City

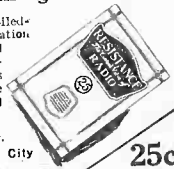

25c

Guaranty Radio Goods Co.

Attractive Parts

[Send No Money!]

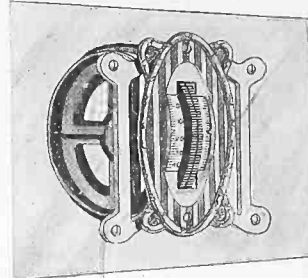

DRUM CONTROL

Gives that Ritzy appearance to your set.

Consists of two drums, one aluminum mounting frame, one bronze panel plate (escutcheon) and two bronze mounting screws. Catalogue No. 1001.

\$2.50



Low Loss R.F. Transformer, wound for .0005 mfd. condenser; 80% air dielectric; useful for antenna or interstage coupling. Catalogue No. 1002.

Tuning Coil, with variable third winding. Catalogue No. 1003.

\$3.30

\$1.80

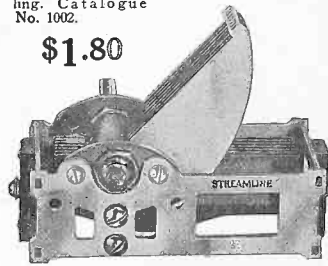

A rugged, reliable .0005 mfd. Variable Condenser—straight line frequency. Catalogue No. 1150.

\$2

36-Inch Cone Kit For superb tone quality build this speaker.

\$10.00



FREE! With each 36" cone kit order we will give a Corbett Tri-Foot Pedestal (Illustrated). Kit consists of licensed Giant Cone Unit; designed front sheet; Fonotex, plain back sheet; Fonotex; two metal rings; one bracket; one apex; one tube of cement; screws, nuts, COMPLETE INSTRUCTION SHEET. Cat. No. 1160.

Send No Money - All Goods on Five-Day Money-Back Guaranty

Order by Catalogue Number
GUARANTY RADIO GOODS CO., 145 West 45th St. New York City. Ship me at once the following on a five-day money-back guaranty: Catalogue Nos.

I am to pay the postman the advertised price, plus a few cents for postage.

Name.....
Address.....
City..... State.....

RW28

The TRICKLE CHARGER

You Need—

Converts your A Battery Into a Self-Charging Power Unit

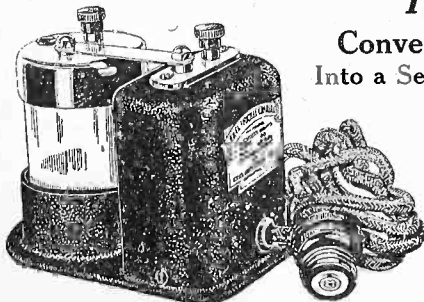

\$4.00 Absolutely Guaranteed

Cost of Operation Negligible

Very Compact Shipping Weight 9 Lbs.

No acid or other harmful or destructive liquid used. Solution is non-poisonous, stainless, and gives off no noxious fumes. Self-regulating in accordance with daily set consumption. No hum or other noises interfering with reception. Not necessary to disconnect from battery when set is in operation. You need have no fears of discovering any defects arising from natural use. Charger is encased in a beautifully finished casting, insuring durability and permanent neatness of appearance.

GUARANTY RADIO GOODS CO., 145 West 45th Street, New York City.

Please send me one of your Trickle Chargers on a five-day, money-back guaranty, for which I will pay the postman \$4.00, plus a few cents extra for postage.

These Chargers Are Sold on Five-Day, Money-Back Guarantees.

NAME.....
ADDRESS.....
CITY..... STATE.....

Good Back Numbers of RADIO WORLD

The following illustrated articles have appeared in back issues of RADIO WORLD in 1927.

MAY 21.—Part I of a three-part article on the Victoreen Portable receiver, by Capt. P. V. O'Rourke. Data on the new Raytheon cartridge.

MAY 28.—A three-tube reflex, using a special low pass filter system, by Edgar B. Francis. Part II on the Victoreen portable receiver with layout data, by Capt. P. V. O'Rourke.

JUNE 4.—Part III of a three-part article on how to construct an efficient portable Victoreen Super-Heterodyne, by Capt. P. V. O'Rourke. A complete discussion on the RCA AC tubes.

JUNE 18.—The six-tube Equamatic, a neutralized two-stage tuned RF, three-stage AF resistance coupled set, by Herbert E. Hayden. How to get the low notes with transformer or impedance AF, by Dennis J. O'Flaherty.

JUNE 25.—The Lindbergh Plane Speaker, an excellent cone type reproducer, by Herbert E. Hayden. A tube and set tester, by Herman Bernard.

JULY 2.—The Planofier 7, single control super-sensitive set using resistance AF by R. F. Goodwin and S. S. Bruno. Discussion on the new Freshman Equaphase, by Robert Sagala. Data on the six types of units used for loud speaker operation, by J. E. Anderson.

JULY 9.—How to build a DC A supply where the line voltage is 220 or 240, by Frank Logan. Important data on RF choke coils, by Horatio W. Lamson.

JULY 16.—How to use a voltmeter as a milliammeter, by D. Barretti. How to build a 4-tube, 2-control regenerative portable set.

JULY 23.—Building a 7-tube Super for your auto, using Victoreen IFT, by John F. Rider (Part I). How to build a 6-tube neutralized set, using three tuned RF, two transformer AF, by John F. Rider. Inside dope on motorboating, by J. E. Anderson.

JULY 30.—A 5-tube standard TRF set adapted to AC operation by the use of the QRS 400 mill rectifier tube, with the aid of series filament connections, by RF Goodwin and S. S. Bruno. Shielding the 11-tube Melo-Heald Super-Heterodyne receiver, by Clifford Denton. Part II of the two part article on the Super in the auto by John F. Rider. How to control volume in AC sets by D. Ferrup.

AUG. 6.—A three-tube regenerative portable with portion of the cabinet as the speaker, by M. J. O'Reilly. The Cashbox Unitone, an ingenious converted four-tube quality receiver by Wendell Buck. How to use AC tubes by C. T. Burke.

AUG. 13.—Hints on constructing a portable set, by Herbert E. Hayden. A seven-tube, two-control AC operated receiver by Capt. P. V. O'Rourke. Obtaining the C bias in an ABC unit, using the BA Raytheon 85 mill tube.

AUG. 20.—The Four AC, a four-tube regenerative set employing AC tubes. Tim Turkey's argument on why rheostats should not be used as volume controls. The Drum Power-tone, a five-tube single control set, using resistance coupled audio.

AUG. 27.—Part I of a four part article on building the 1-Dial Witz, a single control, voluminous selective 5-tube set, by A. Irving Witz. A detailed explanation of the exponential type of horn by H. B. Herman. Details on the revolutionary Reisz condenser type of speaker. Constructional data on a special 5-tube, 2-dial regenerative set, with three stages of AF, by Tim Turkey.

SEPT. 3.—Part I of a four-part discussion on the new 1928 Victoreen Universal, a super-sensitive 8-tube Super-Heterodyne, by Capt. P. V. O'Rourke. Complete data on the three types of phonograph pickups, by J. E. Anderson. Part II of the 1-dial Witz, wiring hints emphasized.

SEPT. 10.—The Puratone AC set, a 6-tube duo-control receiver, using AC tubes, by R. F. Goodwin and S. S. Bruno. Part II of the 1928 Victoreen Universal, discussing the placement of parts. Part III of the 1-Dial Witz on the special placement of the coils.

Any Copy 15c. Any 7 copies, \$1.00. All these 16 copies for \$2.00, or start subscription with any issue. Any 8 of these numbers sent as premium with NEW yearly subscription. No other premiums allowed. RADIO WORLD, 145 West 45th St., New York City.

Turkey Makes Fight Resolve

Next time there is a championship fight on the air I aim to know about it before any of my old friends come around. I shall look forward to the fights as I now do to outstanding musical programs. I shall invite my friends who have no radio receivers to come to listen in with me. We shall take sides and organize cheering sections and help the affair out with a little local color. We shall provide against an SOS or any other emergency. I shall even take care to see that the fighting is confined to the radio.

An old friend is a rabid fight fan, not because he is a low brow, for he is a learned physician of high attainments, but because he is a virile, healthy man. And he is not the only normal individual of high attainment who loves to see a good fight. Ask any physician, dentist, lawyer, business man, educator whose physical condition is in good order what his attitude is toward the game, and you will find a fight fan.

—TIM TURKEY.

TWO NATIONAL TYPE C DIALS

SPECIFIED FOR THE LYNCH-AERO FIVE
Described on pages 14 and 15 of this issue
by Perry Grafham

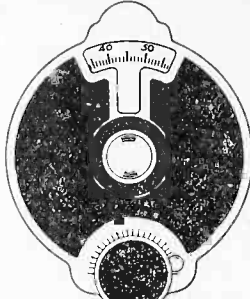

National Velvet Vernier Dial, Type C,
Illuminated \$3.00 each
NATIONAL COMPANY, Inc.
W. A. READY, President Malden, Mass.



VICTOREEN Super Coils

Send for Folder
Geo. W. Walker Co.
225 Chester Avenue
Dept. B Cleveland, O.

The New Morecroft Opens Wide Field To You

The great Morecroft has a new message for you. The second edition of his masterpiece, "Principles of Radio Communication," just off the press, is offered to you by Professor John H. Morecroft of the Electrical Engineering Department of Columbia University and past president of the Institute of Electrical Engineers.

The outstanding book on radio principles and practice is something that you must not be without. Every set builder, every designer, every engineer, every service man, simply must have this book. Ready reference to all intricate problems makes this volume invaluable. Distributors and dealers, salesmen and teachers, students and operators, all find Morecroft their standby, and now the new second edition awaits you. 1,001 pages and 831 illustrations in this cloth-bound volume.

SEND NO MONEY

Fill out and mail in the attached coupon:

GUARANTY RADIO GOODS CO.,
145 West 45th St., New York City.

Gentlemen: Please send me at once and without cost to me full analytical exposition of brand-new edition of Professor Morecroft's famous "Principles of Radio Communication," consisting of 1,001 pages and 831 illustrations, constituting the second edition, which is brought right up to date, and constituting the most complete and authoritative book.

NAME.....

ADDRESS.....

CITY..... STATE.....

Individual Receiver

Is A Supreme Joy

There is a supreme joy in having an outstanding and individual receiver. Just as a man or woman—particularly a woman—wants clothes distinctive in appearance and abnormally well-wearing, so he or she, if inclining toward the finer things, wants a radio set "made to measure." And that measure is out-performance and personal eye appeal. To both of these considerations, particularly that of appearance, the woman of the house pays close attention, and it is generally observable, as you might expect, that what the woman wants is likely to be the thing that the man gets.

I find that these women help me in my business, because they appreciate my catering to their personal tastes and the reliability of my service, including the fact that I am just as eager to repair a set as I was to take the money for the original.

—ROBT. J. W. MCCORD.

25 Cents

Brings ALL THIS!

One Official Blueprint of the Five-Tube Diamond of the Air

One Official Booklet describing in detail How to Build this Famous Set, Wind Coils, etc.

Act Now! Send that Quarter to

RADIO WORLD

145 West 45th Street, New York City

The Magnaformer 9-8 By J. E. Anderson

The pinnacle of achievement in the presentation of a circuit marked the seven full-page article by J. E. Anderson, Technical Editor, in the Dec. 10 issue of Radio World.

Read this fascinating, expert, complete exposition, illustrated in colors. This article evoked 700 laudatory letters. Send 15c for Dec. 10 issue.

RADIO WORLD, 145 West 45th St., N. Y. City

Trouble Shooting Test Set

The best inexpensive combination for trouble shooting is a Double R Tube Checker, comprising a 0-10 milliammeter, a 0-6 voltmeter, a switch, a rheostat and a socket. Add a high resistance voltmeter (0-300 or 0-500 v.). With these it is advisable to use a plug, so that all you need do is remove a tube from a receiver that you're testing, put the plug in the empty socket and the removed tube in the socket of the tester. You can immediately find open any short circuits, broken or flimsy connections, reversed connections, etc.

The Double R Cord and Plug, and the Double R Tube checker are shown herewith.



No. 21 Cord and Plug.....\$1.85

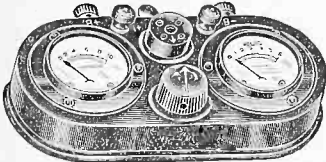

No. 210 Tube Checker consists of 0-6 volts D.C. Voltmeter, 0-10 D.C. Milliammeter, Grid Bias Switch, Rheostat, Socket, Binding Posts (with instruction sheet)....\$6.50

The cord terminals of the plug leads correspond with the binding posts of the tube checker.

Now connect the 0-300 or 0-500 volts high resistance voltmeter from A+ to B+ posts and you get all necessary readings. You can test plate voltage from B eliminators, or any other B supply, D.C. plate current and D.C. filament voltage, as well as the efficacy of the tube, by throwing the grid bias switch, for the plate current should change within given limits, depending on the type of tube.

No. 346 D.C. Voltmeter (1,000 ohms per volt).....\$4.50

No. 347 D.C. Voltmeter (1,000 ohms per volt).....\$5.50

Service Men!
Custom Set Builders!
Experimenters! Students!

Equip your testing outfit with the indispensable combination that constitutes the Trouble Shooting Test Set and Time-Saver. You quickly locate trouble while others flounder about.

Complete Combination (with 0-300 Voltmeter, No. 346).....\$12.00

Complete Combination with 0-500 Voltmeter, No. 347).....\$13.00

GUARANTY RADIO GOODS CO.,
145 West 45th Street, New York City.

Please send me on five-day, money-back guaranty, one complete Trouble-Shooting Test Set, consisting of your Cat. Nos. 346, 210 and 21, for which I will pay postman \$12, plus a few cents extra for postage.

If 0-500 volts No. 347 meter is preferred, put cross here and pay \$13 instead of \$12.

NAME

ADDRESS

CITY STATE R.W. 28

"Double-R" Meters With Resistance of 1,000 Ohms Per Volt

to Measure Voltages of B Eliminators, Bias Resistors, Batteries

0-300 volts, handsome full nickel finish, convenient portable type meter, accurate to within 2 1/2% plus or minus, with a resistance per volt of a little more than 1,000 ohms, hence more than 300,000 ohms total resistance. Fully guaranteed. To manufacture this meter requires 35 different dyes. No voltmeter but a high resistance one will enable you to tell the voltages of B eliminators and across C biasing resistors. This meter is excellent for general D.C. use. It is furnished with long connecting cords. Catalogue No. 346 (illustrated).

\$4.50

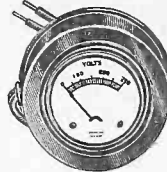

0-500 volts, this meter; of same external appearance and general construction as the 0-300 voltmeter; particularly appeals to the custom set builder, service man, experimenter, etc., who deal with power packs, B supplies, etc., that feed 210 or 310 tubes and otherwise require measurements up to 500 volts. A meter with resistance of more than 1,000 ohms per volt; excellent for all D.C. measurements. Nickel finish; long connecting cords. Catalogue No. 347. \$5.50

It is absolutely necessary to use a high resistance voltmeter in measuring the voltage of B eliminators, either across the total output or at any intermediate voltage. A low resistance meter at least partly short-circuits the eliminator and causes the voltage reading to be away off. Sometimes the reading is a little as 25 per cent of the total actual voltage. The Double R meters 346 and 347 are accurate to 2 1/2 per cent plus or minus and have the highest resistance per volt of all popular priced meters for this work—more than 1,000 ohms per volt!

COMPLETE CATALOGUE

| Cat. No. | Type | Price | Cat. No. | Type | Price |
|---------------------------------------|---|--------|---|---|--------|
| POCKET AMMETER | | | PANEL VOLTMETERS | | |
| No. 1 | For testing dry cells, 0-40 ampere DC scale pocket meter..... | \$1.50 | No. 326 | For reading DC voltages, 0-6 volts.... | 1.65 |
| POCKET AND PORTABLE VOLTMETERS | | | No. 335 | For reading DC voltages, 0-8 volts.... | 1.65 |
| No. 8 | For testing A batteries, dry or storage, 0-8 volts DC scale..... | 1.65 | No. 310 | For reading DC voltages, 0-16 volts.... | 1.65 |
| No. 10 | For testing A batteries, dry or storage, 0-10 volts DC scale..... | 1.65 | No. 316 | For reading DC voltages, 0-16 volts.... | 1.65 |
| No. 13 | For testing A batteries, dry or storage, 0-16 volts DC scale..... | 1.65 | No. 337 | For reading DC voltages, 0-50 volts.... | 1.65 |
| No. 50 | For testing B batteries, dry or storage, but not for B eliminators, 0-50 volts DC scale..... | 1.65 | No. 339 | For reading DC voltages, 0-100 volts.... | 1.75 |
| No. 39 | For testing B batteries, dry or storage, but not for B eliminators, 0-100 volts DC scale..... | 1.85 | No. 342 | For reading DC voltages, 0-150 volts.... | 1.75 |
| No. 40 | For testing A and B batteries, dry or storage, but not for B eliminators; double reading, 0-8 volts and 0-100 volts DC scale..... | 2.25 | No. 340 | For reading DC voltages, double reading, 0-8 volts, 0-100 volts..... | 2.25 |
| No. 42 | For testing B batteries, dry or storage, but not for B eliminators; 0-150 volts DC scale..... | 2.00 | PANEL AC VOLTMETERS | | |
| No. 346 | For testing B battery eliminators, grid bias voltage across resistors, batteries, etc.; 0-300 DC scale..... | 4.50 | No. 351 | For reading 0-15 volts AC..... | \$2.25 |
| No. 347 | For same as No. 346, except scale is 0-500..... | 5.50 | No. 352 | For reading 0-10 volts AC..... | 2.25 |
| No. 348 | For testing AC current supply line, portable, 0-150 volts..... | 4.50 | No. 353 | For reading 0-6 volts AC..... | 2.25 |
| VOLTMETERS | | | (See No. 348 under "Pocket and Portable Voltmeters.") | | |
| No. 18 | For testing amperage of dry cell A batteries and voltage of dry or storage A batteries, double reading, 0-8 volts, and 0-40 amperes DC..... | 1.85 | PANEL MILLIAMMETERS | | |
| No. 35 | For testing amperage of dry cell A batteries and voltage of B batteries (not B eliminators); double reading, 0-50 volts, 0-40 amperes DC..... | 2.00 | No. 311 | For reading 0-10 milliamperes DC.... | \$1.95 |
| 6-VOLT A BATTERY CHARGE TESTER | | | No. 325 | For reading 0-25 milliamperes DC.... | 1.85 |
| No. 23 | For showing when 6-volt A battery needs charging and when to stop charging; shows condition of battery at all times..... | 1.85 | No. 350 | For reading 0-50 milliamperes DC.... | 1.65 |
| PANEL AMMETER | | | No. 390 | For reading 0-100 milliamperes DC.... | 1.65 |
| No. 338 | For reading amperage, 0-10 amperes DC..... | \$1.65 | No. 399 | For reading 0-300 milliamperes DC.... | 1.65 |
| | | | No. 394 | For reading 0-400 milliamperes DC.... | 1.65 |
| | | | DC PIN JACK VOLTMETERS | | |
| | | | No. 306 | For No. 25 and No. 28 Radiolas, 0-6 volts DC..... | \$2.50 |
| | | | No. 308 | For No. 20 Radiola, 0-6 volts DC..... | 2.50 |
| | | | No. 307 | Desk type voltmeter with cord, 0-6 volts DC..... | 2.50 |
| | | | TUBE CHECKER | | |
| | | | No. 210 | For experimenter, professional set builder, dealer and service man. Consists of 0-6 DC voltmeter, 0-10 DC milliammeter, grid bias switch, rheostat, socket and binding post, instruction sheet..... | \$6.50 |
| | | | CORD AND PLUG | | |
| | | | No. 21 | For connecting meters in A and B leads of a receiver without any disconnections. Terminals correspond with posts on No. 210 tube checker..... | \$1.85 |

A pocket type meter will fit easily in a man's vest pocket. A portable type meter will fit in his sack-coat outside pocket. The other meters—panel type—are intended for panel mounting, 2 5/64-inch hole.

GUARANTY RADIO GOODS CO.,
145 West 45th Street, New York City.

Please send at once your meters, catalogue numbers:

.....
.....
.....
for which I will pay the postman the price as advertised in Radio World, plus a few cents extra for postage.

Name.....

Address.....

City..... State.....

ALL METERS SOLD ON FIVE-DAY MONEY-BACK GUARANTY.

Tyrman "70"

Shielded Grid Amplimax

Using Shieldplate Shielded Grid Tubes

A-C or Battery Operation

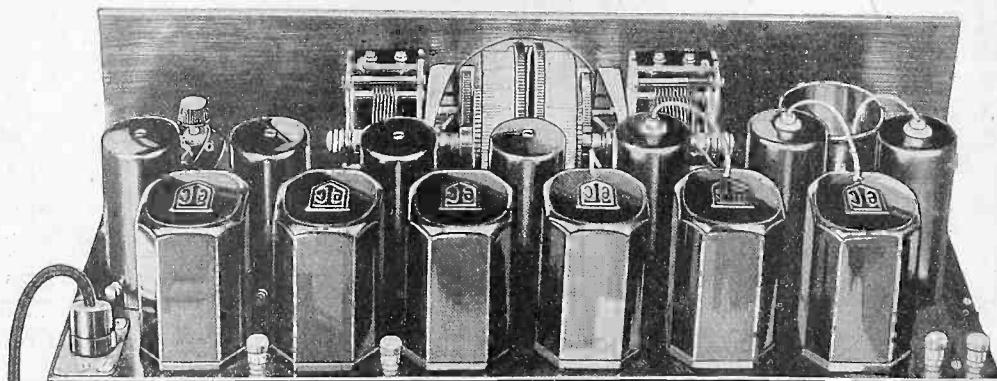

WEBSTER "70"

A Real Companion for the Tyrman "70"

Webster "10" (a Power Unit). Operates any set from 4 to 10 tubes.

6000 MILES on a SIX FOOT Antenna without Distortion or Oscillation

The Tyrman "70" is guaranteed to outperform any other present-day receiver when built according to specifications.

Fans in New York, Chicago, Los Angeles and many other congested cities report reception from stations 5000 and 6000 miles distant with local volume. These verified records were MADE IN AMERICA this year and SHATTERS ALL PREVIOUS CLAIMS for DX reception.

Ease of construction and simplicity of tuning are remarkable features of the Tyrman "70".

Build the Tyrman "70" and benefit by the revolutionary development incorporated in this new design.

Sold at all Reliable Jobbers and Dealers

Tyrman Electric Corp.
141 West Austin Avenue, Chicago, Ill.

Mail Coupon Today!

TYRMAN ELECTRIC CORP.
Dept. RW, 141 W. Austin Ave.
Chicago, Illinois

Gentlemen:

Kindly send me, gratis, special literature describing the Tyrman "70" Shielded Grid Amplimax in detail.

Name.....

Address.....

City..... State.....