

1927

RADIO WORLD

REG. U.S. PAT. OFF.



America's First and Only National Radio Weekly

THE EVERYMAN 4

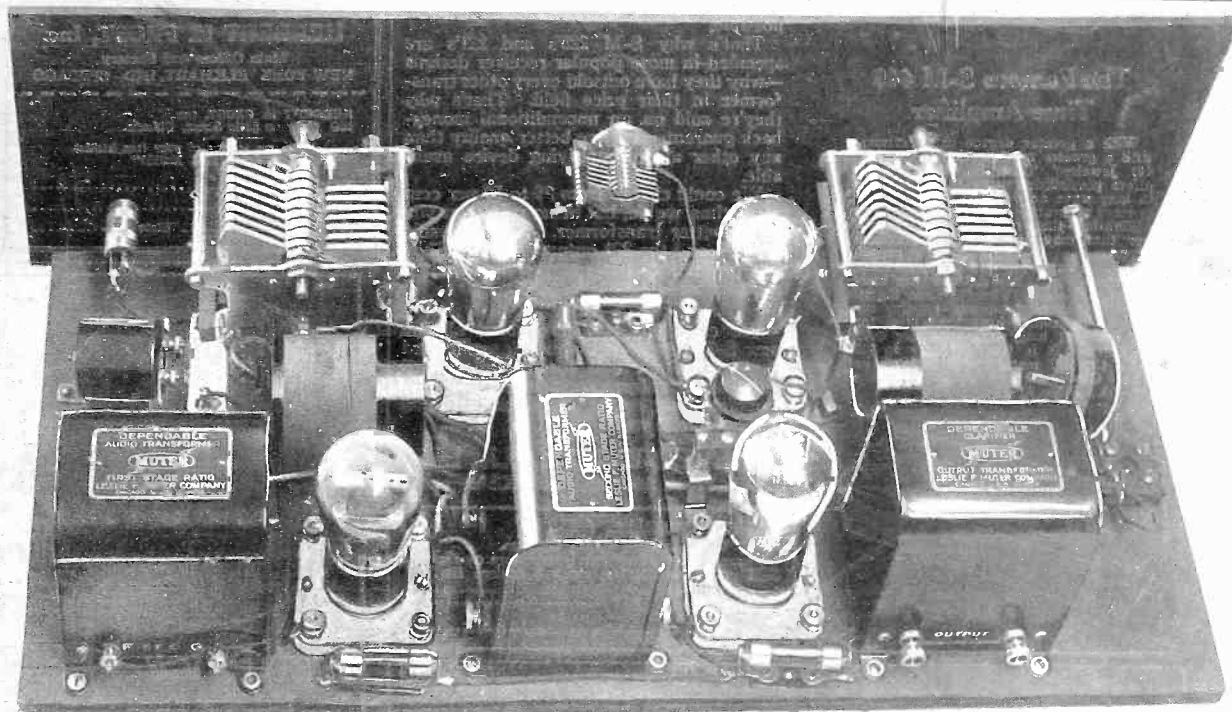

It is this neat and accurate layout of parts which contributes largely to the remarkable results obtainable with the Everyman 4.—See pages 8 and 9.

Getting Tube Characteristics at a Glance

See Pages 12 and 13

Efficiency Data on the 4 and 5-Tube Model Diamond

See Pages 10 and 11

SM

**We Could Charge
More—But
A Better Transformer
Can't Be Made**



**The Famous S-M 440
Time Amplifier**

With a greater degree of selectivity, with a greater amplification factor—the 440 Jewelers' Time Signal Amplifier offers possibilities never before realized in long wave amplifier construction. It is more accurate—with a finer degree of calibration—than any long wave amplifier that may be built from standard parts today. It is housed in a copper and brass catacomb and its three radio frequency stages and detector are individually shielded. The 440 Time Signal Amplifier is tremendously popular already. Thousands have been sold, for it's the best long wave amplifier ever developed. It is tuned exactly to 112 K.C., the 2677 meter wavelength of the Naval Observatory station at Arlington (NAA). Price \$35.00.

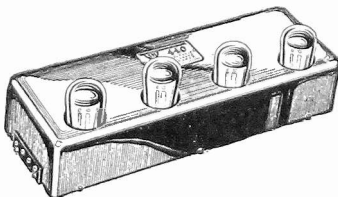

Imitated everywhere—never equalled—the S-M 220 audio transformer stands out today as the finest for audio amplification that money can buy just as it did when introduced a year and a half ago. The 220 has been copied in one or more of its characteristics by every high-grade transformer put on the market since then—in its rising low note characteristic or in its 5000 cycle cut-off. That's proof that the principles of the 220 first introduced are right—that the market is still trying to catch up.

Don't be misled by exaggerated claims—for it takes real core and wire to make a good transformer. The 220 has from 25 to 50 per cent more steel and copper in its construction than any other transformer on the market. That means a high primary impedance only through which real bass note amplification is made possible.

That's why S-M 220's and 221's are specified in more popular receiver designs—why they have outsold every other transformer in their price field. That's why they're sold on an unconditional money-back guarantee to give better quality than any other audio amplifying device available.

We could charge from 25 to 50 per cent more than we do, but at no price can you get a better transformer. The 220 audio is \$8.00, and the 221 output is \$7.50. They are priced low, but not merely made to sell at a low price.

* * *

We can't tell you here about all the new S-M developments, but if you'll send the coupon we will forward more full data on transformers, power amplifiers, complete light socket operation than you can read in a week.

SILVER-MARSHALL, Inc.
878-B West Jackson Blvd., Chicago, Ill.

SILVER-MARSHALL, Inc.
878-B West Jackson Blvd., Chicago.
Please send me complete information on the new S-M developments, for which I enclose 10c

Name

Address

Talk About Gifts! And About the Gifted, Too!

The Holiday Gifts Number of Radio World will be the December 10 issue—alive with the Christmas spirit, full of ideas on what to buy for Christmas in the radio parts, accessories and set fields—Fit for Superlatives That Rightly Ride on Santa's Sleigh.

Dated December 10, to press on Wednesday noon, November 30, on the news-stands Wednesday, December 7, all over the United States, and in our subscribers' hands before December 7, the Holiday Gifts Number will be a resplendent, inspiring, stimulating, pulling number.

EDITORIAL FEATURES INCLUDE

- "Three Months With the Great Recreator," by J. E. Anderson, Technical Editor.
- "High Mu Tubes as Detectors," by Robert W. Sandell.
- "Giving the Crackles the Gate," by Tim Turkey.
- "What Every Novice Should Know," by James H. Carroll, Contributing Editor.
- "Welcome Radio Christmas Gifts," by Herbert E. Hayden.
- "The Everyman Four," as designed by Fred H. Ehlert.
- Front cover in colors, I. Ticktin, "The Caroler."

FROST-RADIO

**Specified for the new
SILVER-MARSHALL
Laboratory Model
Shielded Super**

THE list of parts specified for the Silver-Marshall Shielded Super described in this issue includes the following items of Frost-Radio:
1 No. 1903 3 ohm Frost Gem Rheostat.
1 No. 1922 200 ohm Frost Gem Potentiometer.
4 No. 253 Frost Cord Tip Jacks



FROST-RADIO



These Frost items, specified for their superior quality, insure a good little rheostat of ample current carrying capacity, the Frost Gem, and a potentiometer capable of fine, smooth regulation, our No. 1922 Gem, plus permanently trouble-free Frost Cord Tip Jacks.

**Mail Coupon for
Valuable Booklet**

Our new booklet, "What Set Shall I Build?" will be mailed you free on request. Just fill out coupon below and mail to us. This booklet tells you all about the popular circuits, gives much interesting and instructive data regarding them, and will prove of tremendous value to the set builder. Sign and mail coupon NOW.

HERBERT H. FROST, Inc.
Main Offices and Factory
NEW YORK ELKHART, IND. CHICAGO

HERBERT H. FROST, Inc.
180 North La Salle Street, Chicago.

Mail me a copy of your free booklet
"What Set Shall I Build?"

Name

Address

City, State



LIST PRICE \$18.00

Including Panel
F.O.B. Factory. Packed in STRONG CARTON.
Dimensions: 23½x12x7 or 8 in.
Special Chassis, Size: 20x11x1½ in., \$2.18

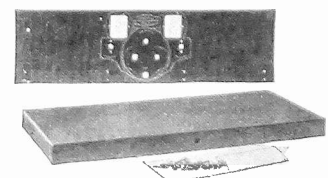

**Metal Panel and Chassis for
SILVER-MARSHALL
1927 Improved Laboratory Model**

Complete assembly, fully drilled, beautiful wood finish with special two color decoration, all fibre bushings and washers included, also screws, bolts and hardware accessories.

THE VAN DOORN COMPANY
160 North La Salle Street Chicago, Ill.
Factories, Quincy, Ill.

RADIO WORLD

A Weekly Paper Published by Hennessey
Radio Publications Corporation from
Publication Office, 145 West 45th Street,
New York, N. Y.
Phone: BRyant 0558 and 0630

[Entered as second-class matter, March, 1922, at the post office at New York, N. Y., under Act of March, 1879]

New Rule: Stop Whistling!

Master Minds Developing Means to End Heterodyne Interference Between Stations Assigned to Same Frequency — What Happens When Two Things, Equal to the Same Thing, Are Not Equal to Each Other

Considerable work is being done both by the Federal Radio Commission and private interests with a view of eliminating the heterodyne whistles which are causing interference with radio reception.

The problem now is not so much interference between stations operating on adjacent channels as the interference between stations assigned to the same channel but separated by hundreds of miles. The problem now is to make these stations operate on exactly the same frequency.

As yet the Commission does not require a closer adherence to the assigned frequency than 500 cycles above or below, although this deviation is far too great to insure listeners against interference. The 500 cycle limit is adequate to prevent interference between two adjacent channels, but not to eliminate interference between two stations nominally operating on the same frequency, for then a deviation of no more than 5 cycles above or below is permissible by the law of hearing.

When practical methods have been worked out whereby any two stations can be synchronized as closely as this, it is safe to predict that the Federal Radio Commission will issue a ruling requiring them so to synchronize.

There are three methods now used for synchronization.

A report on an experiment in eliminating interference by heterodyne between two Washington broadcasting stations operating on the same wavelength has been submitted to the Federal Radio Commission by the president of the Doolittle Radio Corporation of New Haven, Conn., Franklin M. Doolittle.

The "beat note" method was used with a receiving set and telephone circuit, whereby WDRG, New Haven, operating with 500 watts on the same wavelength as WAU, Columbus, Ohio, using 5,000 watts, are prevented from interfering with each other. The frequency is 1,060 kilocycles (282.8 meters).

Following is Mr. Doolittle's report in full:

Before we adopted the present arrangement the heterodyne was so bad that it ruined our program for several nights.

I have rented a circuit from the Telephone Company between my home and the transmitting plant at Beacon Hill, the two points being about five miles apart.

The output of the receiving set is connected through a step-down transformer to the line. The station end of the line is connected to the input of a two-stage amplifier which compensates

for the line loss. As the circuit is entirely by cable, the quality is decidedly bass. The line could, of course, be equalized, but this is not necessary for the purpose, in fact, it is rather desirable to emphasize the bass.

Adjusts for Zero Beat

This arrangement allows the operator at the station to hear the program as it is being received five miles distant, and if a heterodyne howl is present from Columbus, he then adjusts until zero beat is obtained. This arrangement does not necessitate passing radio frequencies over the circuit, but employs the audio output of the receiver.

Our transmitter is of the master oscillator type and we employ a crystal for checking frequency, so that it is comparatively easy to make the adjustment with certainty and still not get away from our frequency. In this connection, our crystal checks with Columbus within about 100 cycles.

I have particularly wanted to watch the results obtained with the system for a period of nights before giving you a report.

As to the results obtained, while the method does not completely eliminate in-

A method of synchronization has been suggested by Clive B. Meredith, of Syracuse. This involves the use of a central oscillator kept at a constant frequency of 10,000 cycles, from which all the transmitting stations in the country would derive their operating frequencies by selecting the harmonics assigned to them by the government. The Commission is greatly interested in this scheme, as it seems to be a general solution to most heterodyning interference.

If this scheme is adopted the standard frequency could be distributed in at least two ways. It could be broadcast as a modulation on a suitable short wave with power enough to reach all interested stations; and it could also be transmitted by land lines and distributed the same way that chain programs are now distributed.

The standard oscillator under this scheme could be kept by a Government agency at a centrally located place, and its frequency could be held constant by well known means to an accuracy of one part in a million over long periods of time. This would mean that the greatest variation in a frequency of 1,000,000 cycles would be one cycle per second. But as all stations operating on the same carrier would change by the same amount in the same direction simultaneously there would not even be a trace of a heterodyne.

interference, it greatly reduces it when Columbus is very loud and for all practical purposes eliminates it when they are coming in with moderate volume.

Only a Hiss Left

In either case it eliminates the howl and leaves only an unintelligible hissing sound in the background between breaks and soft passages in our program. This interference sounds much like the hissing quality obtained when spark signals are received by the heterodyne method.

So far WAU is the only one of the two stations sharing time on 1060 kilocycles in Columbus which has caused us any trouble. We have made the same adjustment with WEAO and their intensity is so much less than that of WAU that it completely solves the situation as far as they are concerned. The arrangement is reciprocal in that it would, of course, reduce interference in the vicinity of Columbus in the same manner.

We have had such satisfactory results with this method of reducing interference that I am going to try an automatic control which will start to function as soon as the heterodyne appears.

Has Faith in It

So far this is merely an idea, but I be-

lieve it can be made to work and will send you details as soon as I have had a chance to try it out.

The general plan of the scheme is to control our transmitter with our crystal and to vary the frequency of the crystal by variation in temperature which is controlled from the receiving set at my home.

I may have difficulty with the control as I have not worked out details but I believe that it can be done by the combination of a tube arrangement and a tuned relay. The relay would have to be tuned to some subaudible frequency, say 10 cycles, so that it would respond before the heterodyne became audible and would not be influenced by program frequencies.

Incidentally, it would seem to me if such a system is practical it might aid in chain broadcasting on the same frequency.

Orestes H. Caldwell, Federal Radio Commissioner, discussed heterodyne interference and remedies as follows:

Even under best conditions we have far too many stations to accommodate on 89 wavelengths. As long as 700 stations are to be assigned places in the broadcasting band, there are bound to be heterodynes under present methods, for the Commission, against its better judgment has been forced to locate stations too close together to avoid interference under conditions of maximum-reception.

That some heterodynes now exist, cannot be denied, but the transient character of most of these—here tonight and gone tomorrow—or gone even in the next hour—indicates that they result from distant stations wandering off their assigned channels and straying into the adjoining rights-of-way of the stations thus imposed upon.

With the help of the Radio Division of the Department of Commerce, frequent measurements observations are now being made on all broadcasting stations to see that they adhere to their wavelengths within the one-half kilocycle limit prescribed by the Commission.

Stations Must Behave

For even the most perfect allocation structure can be rendered useless if stations do not walk the "ether chalk lines," and keep on their assignments.

With the broadcasting channels filled to overflowing on the basis of station separation at distances necessary to eliminate heterodyning between carrier-waves, another avenue for relief is presented by the engineering method of accurately synchronizing the frequencies of stations on the same channel, so that the only interference will be cross-talk and not heterodyning.

For, as is well known, although the audible signal of a 500-watt station may under good average conditions be heard 100 to 200 miles, its carrier under the same conditions will cause heterodynes or "whistles" up to 1,000 miles. Heterodyning results from the slight difference in frequencies of two stations on the same channel.

The Beat Note

For example, on the 900 kilocycle channel, if one station is operating accurately at 900,000 cycles, and a second station within carrier-wave range is operating at 900,250 cycles, the listeners between and at a distance from both stations will hear a squeal which is the audible difference between the two frequencies—that is, a musical note of 250 cycles or about middle C on the piano.

If, however, the frequencies of these two stations can be brought into such close synchronism that the difference between their radio frequencies is less than an audible frequency, the former heterodyne will disappear. The stations can then safely be located closer together geographically up to a minimum distance

1060 KC. WEST—

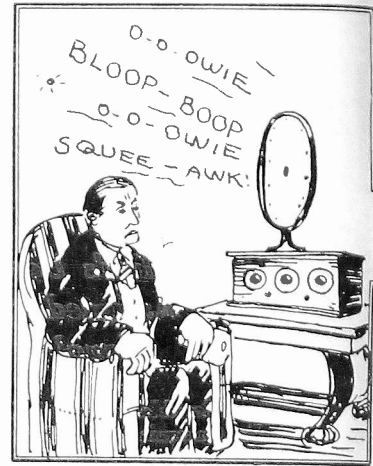
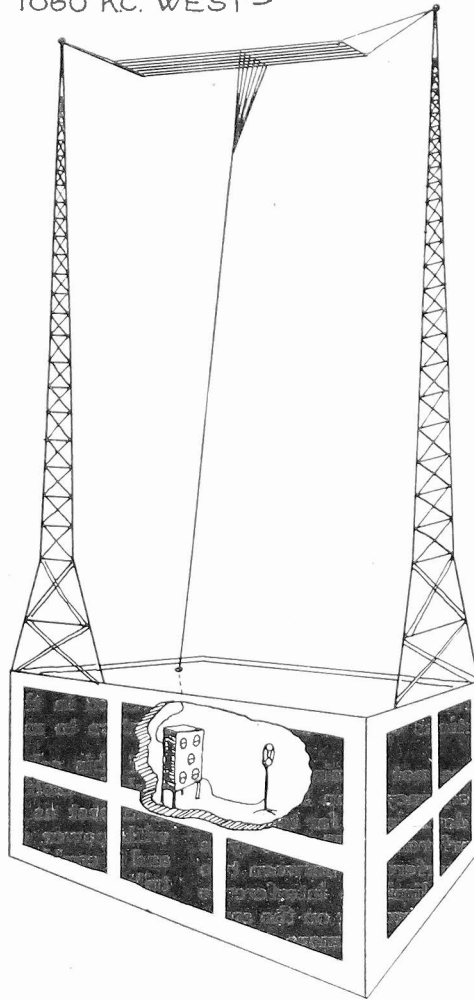

TWO TRANSMITTING STATIONS, ONE IN THE EAST AND THE OTHER AT THE SAME TIME. NO TROUBLE IS EXPERIENCED IN RECEIVERS IF ONE STATION STRAYS OFF ITS PROPER FREQUENCY BY A SMALL A 250 CYCLE WHISTLE IN HIS LOUDSPEAKER, WHICH WILL SPOIL HETERODYNE BELOW AUDIBLE

where the program of one comes in loud enough to appear as "cross-talk" on the other.

This separation-distance where noticeable cross-talk occurs between stations, is from one-quarter to one-tenth of the separation-distance at which heterodyning or "carrier-wave interaction" becomes objectionable.

Hence if stations on the same frequency can be accurately synchronized, it will be possible to utilize our present channels many fold more effectively, and to eliminate heterodynes that now persist because of the close duplication of stations necessary on the same frequency channel.

Three methods for such station synchronization appear to promise excellent possibilities:

Wire Control

1. Wire control of two or more stations from a common source of radio frequency. This plan is being operated with success nightly between station WBZ, Springfield, Massachusetts, and its auxiliary WBZA, in Boston, a distance of 100 miles.

These two stations operate on the 900 kilocycle channel at precisely the same frequency, without heterodyning. While they deliver the same program, their suc-

cessful operation indicates the possibility of synchronizing stations further apart, at "non-cross-talk" distances, and transmitting different programs.

Similar wire synchronizing of stations is now contemplated in several other locations. When further developed, this plan offers an economic solution of the very serious problem of chain-program operation, where 20 to 40 channels are now sometimes tied up with an identical program. If such chain programs could be limited to one of two channels, obviously many channels now tied up would be freed for other services.

Radio Synchronization

2. Radio synchronizing of stations. A receiving set is installed 6 to 10 miles away from the station to be synchronized. On this set, the incoming carrier-wave from the distance station on the same channel is picked up, and transmitted by telephone to the station control room. By the zero-beat method, the local station is synchronized with the distant station.

Cites WDRC-WAIU

Operation then continues without heterodyning, and this is accomplished

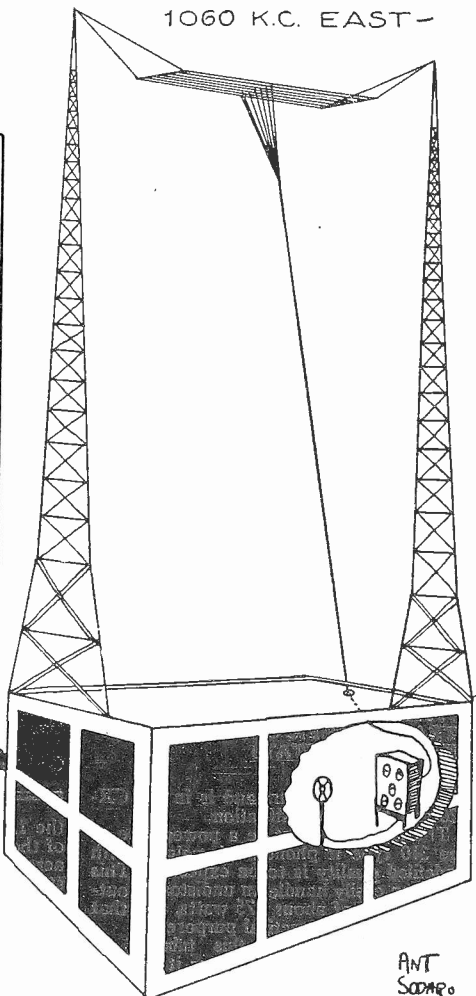

ANT
SOME

WEST, ARE BOTH RADIATING THE SAME FREQUENCY, SAY 1060 KC. THE FIELDS OF THE TWO STATIONS, AND LISTENERS ARE HAPPY. BUT MOUNT, SAY 250 CYCLES, EVERY RECEIVER IN THE FIELDS WILL HEAR TION. SYNCHRONIZATION OF THE TWO STATIONS THRUSTS THE OR AWAY DOWN TO ZERO.

under separations between stations which would produce terrific beats or howls if the ordinary method of approximate frequencies were employed. This plan is successfully employed by station WDRC at New Haven, Conn., to avoid a bad heterodyne that would otherwise occur from the 5,000-watt Station WAIU on the same channel at Columbus, Ohio, only 500 miles distance.

Matched Crystals

3. It is only possible to synchronize two stations by controlling frequencies with identical crystals.

Herewith is some interesting data on using the crystals and beat method for synchronization, as stated by a member of Radio World's Engineering Staff:

The difficulty with the matched crystal method is that the crystals may be identical when they are at the same place and working under exactly the same conditions, but they may vary by an audible beat frequency when they are in different places and working under different conditions. The greatest variable here is temperature. Even quartz crystals vary in frequency slightly as the temperature changes, and it is not easy to keep the temperature of two crystals exactly the same when one of these crystals may be operating in Florida and another in Maine.

Weather Not Only Factor

It is, of course, possible to use thermostat control of the temperature of the crystals, these thermostats being calibrated and adjusted against the same standard. This minimizes one variable factor which might give rise to a difference in frequency.

But it is not the weather alone which determines the temperature of a crystal. It is also affected by its rate and amplitude of vibration. A crystal may vibrate so violently that it gets red hot. If one vibrates more than the other, the temperature of one will be different from that of the other. But the intensity of the vibration also can be maintained automatically close to a standard.

While it is very difficult to change the frequency of a crystal controlled oscillator, small changes may be effected by introducing damping of various degrees. Thus if the frequency of one of the crystals pulls away from that or the other, it is possible to bring it back, increasing or decreasing the damping. But this is of little avail unless the operator of one station is able to tell when here is a beat between his own station and the other. Thus the matched crystal method of synchronization works well in conjunction with one of the other methods, for ex-

ample, that developed by Prof. Doolittle. When one operator hears a heterodyne whistle between his own and the other station he can change the damping on his crystal so as to effect synchronization, and when he has changed the frequency he can depend on the crystal to hold the adjustment for some time. Or he can change the temperature of the crystal if he wants to introduce a somewhat greater change in the frequency.

Beat Method Explained

The beat or heterodyne is really a regular variation in the intensity of the received signal. If this variation in the intensity occurs at a rapid rate, between 16 and 10,000 waxings and wanings per second, it is heard as a whistle or squeal. The heterodyne may exist at a frequency above audibility but it will give no trouble since the ear will not detect it. In fact any two transmitting stations will generate a beat frequency above the audible limit. For example, stations WEAF and WJZ, operating on 610 and 660 kc respectively do generate a heterodyne of 50,000 cycles in every receiver, and the intensity of this beat is quite strong when the receiver is tuned to one of the waves. This beat can be picked out with suitable equipment.

Anybody interested in this can make the two stations play a duet. It won't be a pleasant or a concordant one but the two stations will perform at the same time. Here is the way it can be done. Tune in each station with a separate tuner, but using the same detector tube. Put the output into an intermediate frequency amplifier tuned to 50,000 cycles. Detect and impress the result on a loudspeaker. An interesting point is to note what happens when one of the waves is unmodulated, that is, in between numbers and announcements.

Special Broadcasts For Arctic Begin

Radio broadcasting again has linked together the far corners of the earth, when KDKA, the powerful transmitter of the Westinghouse Electric and Manufacturing Company at Pittsburgh, transmitted the first program of the 1927-28 Far North Broadcast, on November 19.

In addition to KDKA, stations WBZ at Boston, WBZA the synchronized operated station at Springfield and KYW of Chicago, all members of the Westinghouse chain of stations, will in the future transmit the far north programs. KDKA will transmit on 65 meters and their regular wave of 316 meters, the others using the regular waves only. Following is the schedule:

WBZ-WBZA, 333 meters; December 17, 1927 (Saturday), 11 o'clock, E. S. T.; January 7, 1928, (Saturday), 11 o'clock, E. S. T., and February 4, 1928 (Saturday), 11:00 o'clock, E. S. T.

KDKA, 316 meters and 65 meters; December 25, 1927 (Sunday), 11:00 o'clock, E. S. T.; January 14, 1928 (Saturday), 11:00 o'clock, E. S. T., and February 18, 1928 (Saturday), 11:00 o'clock, E. S. T.

KYW, 525 meters, December 3, 1927 (Saturday), 10 o'clock, C. S. T.; January 1, 1928 (Sunday), 10 o'clock, C. S. T.; January 28, 1927 (Saturday), 10 o'clock, C. S. T., and February 11, 1928 (Saturday), 10 o'clock, C. S. T.

This is the fourth year of these broadcasts. To the trapper, traders, missionaries and the mounted police, who maintain world's outposts, the programs represent the only link with civilization during the long winter months.

The programs consist of messages from friends and relatives, current news and bits of music. These have been translated in English, Icelandic, Danish and for the first time this year in Esquimo.

Modernizing the Phonograph

By H. B. Herman

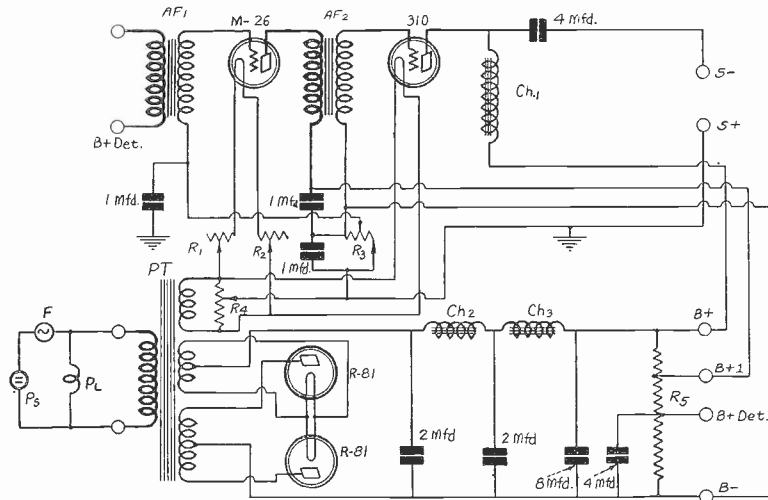

ALL-ELECTRIC AUDIO AMPLIFIER FOR PHONOGRAPH REPRODUCTION AND AF CHANNEL OF RADIO, WITH B POWER SUPPLY FOR 210 OUTPUT, USING VICTOREEN POWER TRANSFORMER, CHOKES, AUDIO UNIT, RESISTANCE BANK AND RHEOSTATS

THERE are many thousands of old-style cabinet phonographs throughout this country which have been in little or no use since broadcasting became artistic. Mechanically these phonographs are good: acoustically they are hopeless. They will rotate any record as well as the most up-to-date electrical phonograph, but they will turn the best record into a burlesque.

Every owner of one of these phonographs wants to know one thing—how can he modernize it, thus salvaging his previous investment, and obtaining the quality of the Panatrop and the Orthophonic?

The first thing needed is to electrify the phonograph. A first-class audio frequency amplifier with a suitable power supply source will do that nicely. The solution can be worked out for direct or for alternating current, or, indeed, with batteries, for those whose homes are not wired for electricity. The present discussion concerns the AC solution.

Two stages of audio amplification will be needed. Hence, there are two audio frequency transformers, AF1 and AF2, and two amplifier tubes in the circuit. The first of these transformers is used to couple the amplifier to the phonograph pick-up. Both transformers must be of high quality if natural sounding output is desired.

What the Circuit Is

The circuit for A C operation is to be wholly "electric," that is, no batteries whatsoever are to be used, the tube filaments of both the amplifier tubes being heated with alternating current, the grid bias voltages being taken from drops in resistors and a high-power B eliminator being used for a power source. This is so arranged as to give 310 or 210 amplification—the kind the electric phonographs have.

One of the best AC tubes for a preliminary stage is the 1.5 volt. 1.05 ampere filament type which is large enough to handle the load in the stage, and from which hum can be easily removed by simple balancing. This tube is CeCo M-26

on the circuit diagram and is in the CX-326 and UX226 classification.

The last tube must be a power tube of the 310 type if phonograph volume with undefiled quality is to be expected. This tube can easily handle an undistorted output wattage of about 1.75 watts, and that is ample for all practical purposes.

The plate DC for this tube is so heavy that it is unsafe to pass it through the winding of an ordinary loud speaker. It is necessary to separate the DC from the AC and let the AC alone through the speaker. This separation is accomplished with a high inductance choke coil Ch1 and a condenser of from 2 to 4 mfd. The smaller condenser gives good reproduction but the larger costs twice as much and gives about 10 per cent greater response below 30 cycles. Some persons prefer the larger value for technical reasons only, not because they can tell the difference in the quality by ear.

By Pass Condensers Needed

It is always good practice to insert by-pass condensers at strategic points in a circuit, particularly when they improve the results without in the least affecting the higher frequencies. Three such condensers are to be found in this amplifier, and each of them is a 1 mfd. unit.

One of these by-passes that portion of the resistance R3 which is used for a bias in the first audio amplifier. It is connected between the low potential side of the first transformer secondary and ground.

The second by-passes that portion of the plate voltage potentiometer which pertains to the first tube. It is connected between the low potential side of the primary of the second audio transformer and the negative side of the plate voltage supply line. The third is simply put across the total resistance R3 where it serves the useful purpose of improving the quality and increasing the amplification. These by-pass condensers must not be omitted.

There is another interesting point about the filament circuit of the amplifier. Note that there is only one heating winding which supplies both the 7.5 volt tube and

LIST OF PARTS

- AF1, AF2—One Victoreen 112 audio unit (comprises two transformers)
- PT—One Victoreen 116 power transformer
- Ch1—One Victoreen 115 output unit
- Ch2, Ch3—One Victoreen 216 choke unit
- R5—One Victoreen 316 resistance unit
- R1, R2—Two Victoreen manganin 6-ohm rheostats
- R3—One Centralab fourth terminal 2,000 ohm potentiometer, PF2,000
- R4—One Carter 100 ohm potentiometer
- Three Tobe 1-mfd. condensers No. 301
- Two Tobe 2 mfd. 1,000 volts condensers, No. 602
- Three Tobe 4 mfd. 1,000 volts condensers, No. 604
- One Tube 4 or 2 mfd. condenser (No. 602 or No. 604.)
- Four Frost UX sockets
- One Pacent Phonovox
- One CeCo M-26 AC tube.
- One 310 power tube
- Two CeCo R-81 rectifier tubes
- Eight Eby binding posts
- Twelve feet flexible Celatsite wire
- One 110 volt pilot light with Candelabra socket
- One 6 ampere fuse

the 1.5 volt tube. Of course the filament of the M-26 tube is not connected directly across the 7.5 volt winding. Two rheostats are put in the leads to that tube to take up the excess voltage. Six volts must be dropped, and the voltage must be dropped symmetrically. That is, 3 volts must be dropped in each leg of the filament. Hence the two 6-ohm rheostats R1 and R2 are in the circuit, as diagrammed, and are put at half-setting.

The filament of the last tube takes all the voltage that the heating winding has to give.

Question of Balance

The Victoreen power transformer has the necessary winding that carries the current of the 26 and the 310 without core saturation.

Hum must be eliminated from the output. The way to do it is to balance the filament circuits. It is customary to tap the winding in the center and return the plate circuit to that point to effect balancing. But this balancing is not always accurate enough to remove sufficient of the hum. A much more effective way is to put a low resistance potentiometer across the 7.5 volt winding and return the plate circuit to the slider. This can then be set experimentally at a point where the hum disappears entirely. The correct point may be found considerably off center. R4 is that potentiometer. It can have any value from 20 to 100 ohms, but the lower values are preferable. It may be improvised from a 20 ohm rheostat by isolation of the arm.

Now, let us return to R1 and R2. They have another object besides dropping the voltage to the proper value. They are also used to balance out the hum from the first amplifier tube. For an absolute minimum of hum the two tubes must be adjusted independently for no hum. But R4 affects both of the tubes, since the plate currents of both of them flow through its branches. When R4 is balanced for the last tube it may be away

You Now Have

off for the first. Well, if it is, the balance for the first tube can always be effected with R1 and R2. To effect the balance it may be necessary to insert all of R1 and none of R2 or vice versa. The ideal adjustment, of course, is when 3 ohms of each are used.

That puts the hum out of the set as far as the filament heating is concerned. But if a transformer is used that unit carries the 26 filament current besides the 210 filament current, hum will result.

Bias Considerations

How about the grid bias? There is the double slider rheostat R3 to take care of that. The fixed end of that rheostat is connected to the negative side of the power supply line. One slider is grounded and is connected to the slider of R4. The voltage drop in this is used as the bias for the power tube. The second slider is left somewhere between the first slider and the end. The drop in this portion is used as bias for the first tube. If the total value of R3 is 2,000 ohms it will be large enough to give a suitable bias for the power tube, and that is more than the first tube requires, so both are taken care of.

And that concludes the discussion of the amplifier. We take up the power supply.

We start at Ps, which is a plug that fits into any standard outlet. A fuse F is inserted in one side of the line as a precaution against short circuits. A six ampere fuse is used. P1 is a small 115 volt pilot light to show when the power is turned on. It is merely a convenience.

PT is the Victoreen power transformer especially designed for circuits like the one under discussion. It has three secondary windings, or perhaps it has one secondary, one tertiary and one quaternary. Anyhow, it has one extra 8 volt winding and this is used to heat the filaments of two CeCo rectifier tubes, R-81.

Filtering Well Done

The transformer has also a high voltage winding which supplies the plates of the rectifier tubes. The voltage is such that the DC voltage on the output side of the filter is 475 volts.

The output of the rectifier is well filtered, and therefore no hum get into the amplifier from this source. The filtering is made easy by the fact that a full wave rectifier is used, but this fact has not induced the designer to skimp on the filter. Two chokes Ch2 and Ch3 of high inductance and low DC resistance are used. The by-pass condensers 2, 2, 8 and 4 mfd. are distributed so as to be most effective in removing the hum.

The B plus terminal for the detector is left unconnected. It should, of course, be connected to the corresponding terminal on the primary of the first audio transformer unless the circuit is to be used solely for phonograph purposes.

Use for Radio Purposes

If the phonograph is to monopolize this circuit the leads from the pick-up unit are connected across the primary of the first transformer. The Patent Phonovox works well with or without B current across it. If the phonograph is to share the circuit with the radio set, the primary of the first transformer is connected to the detector in the usual way and the phonograph pick-up unit is plugged into the detector socket, just as the makers of

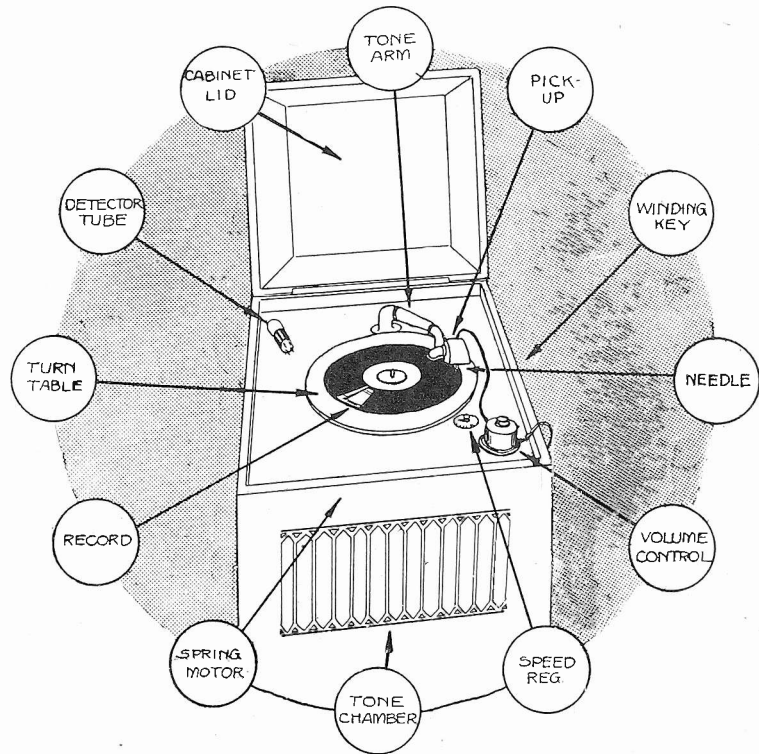

DEFINITION BY ILLUSTRATION—THE PHONOGRAPH PHYSICALLY ADAPTED TO MODERN QUALITY REPRODUCTION. THE ACCOMPANYING ARTICLE DESCRIBES THE INSTALLATION OF B SUPPLY AND POWER AMPLIFIER. THE DETECTOR TUBE IS REMOVED. IN THE DETECTOR SOCKET THE PICK-UP PLUG IS PLACED INSTEAD

the pick-up units usually arrange matters.

The B supply and audio amplifier of course, may be used, as it most likely will be used, also to furnish power and amplification to a radio receiver. If the radio receiver is already equipped with audio amplification, that is not used, but instead the audio amplifier in the phonograph installation. The connection is made very simply from the radio set by carrying a lead from a P post of the detector socket to the P post to the first audio transformer on the phonograph cabinet. The B plus detector voltage is supplied within the phonograph cabinet itself, but the B leads for the radio amplifier tube are fed from B plus No. 1 of the power supply.

The B supply, power amplifier and phonograph pick-up as described are suitable for installation in Victor, Brunswick, Aeolian, Sonora, Columbia and other upright models of phonographs of the style of a year ago or more, that is which do not possess the special horn and sound box with which the modern phonograph are equipped. And what you are to get now is 310 amplification, which you find in the 104 speaker, and never in any mere phonograph. You will use your radio speaker for reproduction.

Personal Experiences

My own installation was made in an Aeolian Vocalion. This instrument originally cost me \$125 and the furniture is just as good today as it was that day four years ago when I bought it. As probably 85 per cent of the cost of producing a

phonograph in those days went into the furniture, it was only natural that I should desire to retrieve this investment. I feel myself very well repaid for the installation I have made, because the quality of reproduction is truly marvelous, due to the wise coordination of parts and choice of tubes. The plate voltage on the 310 is 475, and some such high voltage being necessary for adequate response on low notes in modern speakers.

The Aeolian phonograph has a large tin horn in the tone chamber which is rather difficult to remove. First in any case, no matter what phonograph you have, you must remove the winding key by turning it counter clockwise. Then you will be able to lift the turntable off its seat. The next move will be to take it out of the set so that you can work on the horn. It will be necessary to disconnect the graduola. The entire tubing may be removed as well as the front knob. Then the set screws inside the cabinet are removed to permit lifting the horn out through the top. It is impossible to get the horn through the front opening where the music formerly used to come out, in other words through the tone chamber door.

When working on the Victor models the slab is taken out of the rear cabinet wall and the horn is brought out in that fashion.

In the case of the Victor, I had to supply 3/4 inch long and 1/4 inch wide stove bolts so that the tone arm pedestal could be fastened. The horn itself had contained an aperture for securing similar bolts but when the horn was removed it was necessary to use nuts and as nuts of the correct thread were not readily obtainable it was

(Concluded on page 29)

The Everyman 4

By E. Bunting Moore

The Radio Kit Co.

"WHAT set is the best? Have you ever heard that question?" Personally I do not believe any one set is the best, so let's change the question to: "What set meets most of my requirements the best?"

Having read the articles, description, claims, etc., made by F. C. Ehler of the New York "Sun" about his "borrowed-for-the-purpose" circuit, the "Everyman 4," with the usual fans' pessimism, having constructed sets, from Super-Heterodynes to the three circuit tuners, my hopes still conquered my doubts enough for me to traverse the ten intervening blocks. One Monday, late on a September afternoon, I went to ascertain how much truth there might be in so vast an amount of optimism!

The Author Is "Sold"

I went! I saw! I was conquered! After 6 P. M., when WNYC and WEAF were both broadcasting, WNYC on 526 meters using 500 watts, only 150 yards away, and WEAF on 492 meters using 5,000 watts, located about a mile from the "Sun's" aerial, either could be tuned in, without any cross talk!

"Turn down the volume of WEAF and see if WNYC is in the background," was suggested. Not a whisper! Also, WHN, WGL, and WOKO, local stations, were tuned in. They are not distance, no, but are rarely heard in that location, regardless of the set.

I immediately procured the necessary parts and assembled the set. There were two or three friends around, waiting to give me the usual "I told you so." But when the first signal was properly tuned in I heard:

"That's what I call real quality."

"Oh! What a kick—what a wallop!" "Look how selective it can be made, and how easy it is to reduce that volume!" Quality—selectivity—volume!

DX Brought In

Further trials in New York City's downtown and worst radio reception location, brought in WFI and WLIT of Philadelphia during the day.

In Newark, N. J., WJAX, Jacksonville, Fla., and WSM, Nashville, Tenn., are heard with loudspeaker volume any time they are on the air. Reports from Flushing, L. I., only a couple of miles from WABC, are that the Pittsburgh station, KDKA, can be tuned in without trouble.

I have tuned in WBBM, Chicago, 390 meters, when WMCA, a local using 500 watts on the 370 meter wave, was on the air, before 10 P. M.

Another report was from Glen Cove, L. I. Under ideal conditions, high and perfectly installed aerial situated on a hill, on Saturday, October 29, at 10:30 P. M., with WJZ and WEAF both broadcasting, KFI and WFAA were heard on the loudspeaker with plenty of volume! This is exceptional, of course.

So many New Yorkers have now told me that WOC, WSB, WLS, Chicago, Canadian and New England stations are received during the early evening, when the local stations are going full blast, that no doubt can possibly remain.

Analysis of Circuit

Now let's have a few more facts. The Everyman 4 consists of one very efficient stage of stabilized tuned radio frequency, a detector with or without regeneration—this latter not required for locals—and

two stages of excellent transformer coupled audio frequency amplification with protective output filter device. Three type -A tubes and one -71 type—four tubes!

The exceptional volume generated in this circuit is attributed to the method of conductive coupling used in the RF stage. Selectivity is derived from the vari-coupled antenna circuit, and the wonderful quality is assured by the use of well designed, large audio transformers.

The antenna coil is wound on 2 inch Bakelite tubing with No. 24 silk covered cotton covered wire, that is a silk layer over a cotton layer. The primary has fourteen turns, the secondary sixty-six. The RF coil is of greatest importance. It consists of sixty-six turns, tapped at the twentieth turn and also at the forty-third turn. One tap supplies the proper value of inductance for the stabilizing condenser and the other for the B voltage supply of the RF tube. The beginning of the coil goes to the regeneration condenser. The tuning condenser, it will be noted, floats across this coil and the plate of the RF tube—not in the usual location across the grid and filament. These connections are vitally important.

Advice on Mounting

Assembly is not at all difficult. I have found that for correct spacing it is best first to mount the two tuning condensers, regeneration condenser and filament switch on the panel. Then by holding the panel against the front edge of the baseboard the spacing is much easier to estimate. By keeping the audio transformers as near the rear edge of the 10x20 inch baseboard as possible, it will be found that approximately one inch can be had between them and the coil, and another inch between the coil and tuning condensers.

Mount the transformers, using lugs to ground all the cases, then sockets and tubestat holders, neutralizing condenser, RF choke coil and by-pass condensers; finally the two remaining sockets.

Here is another important detail. Mount the detector socket with the grid and plate terminals toward the panel, but the RF socket with those terminals toward the rear of the set. Then mount the tubestat holders close to each socket. The lugs of each holder can be bent up and toward the filament terminal, so that only another small lug placed on the socket terminal need be soldered to the holder lug, making an easy connection.

The by-pass condensers may be mounted flat on the baseboard and slightly under the tuning condensers, if necessary. Do not mount the coils yet.

Wiring Directions

Now wire the audio end first and carry all the B and filament leads bunched together to a cable and plug connector. The two filament terminals on the first and second audio transformers go to minus C, and I use short independent wires, enabling the C batteries to be placed in, or immediately attached to the back of the cabinet.

Now for the detector tube. Be sure the socket is mounted with G and P terminals toward the panel, the RF socket these point toward the rear of the set. From P of plate of the detector tube a wire goes to the RF choke coil, one side of which has been attached already

to the post marked P on the first audio transformer. From the same socket P terminal attach a wire of about five inches in length for connection later on to the regeneration condenser.

The ordinary shunt type of grid leak and condenser must not be used. It will bring disaster. Connect one end of the leak to the grid terminal of the detector tube, and the other end to A plus.

Coil Connections

Now prepare the antenna and ground strip and attach the flexible lead of the primary coil. The end of the winding nearest the fixed secondary coil goes to the ground, the other to the antenna.

Mount a lug on the ground post also, for the filament negative.

Now by mounting the panel and the primary control rod to the panel the secondary coil may be mounted on the baseboard, remembering the spacing—one inch between the coil and condenser. Slightly bend the rod if necessary so that the primary can be raised. By twisting this coil toward the rear of the set it can be locked on the rod to equal the inch away secondary coil.

A couple of trials will show how easy it really is. The end of the secondary next to the primary goes to the .5 mfd. by-pass condenser and on to the P terminal, or C minus, on the first audio transformer, for the minus 4½ volts. Two separate voltages of C are not absolutely necessary. The RF and first audio can be connected together and same voltage used. However, the diagrams show these voltages as separate.

The opposite end of the coil runs to the stator plates of the tuning condenser and grid of the RF tube, and from this socket terminal continues to the neutralizing condenser.

The other neutralizing terminal connects with the forty-third turn tap of the RF coil. The twentieth turn tap goes to a .5 by-pass condenser and on to the 67 volts of B. The P terminal of the RF socket connects to the regeneration condenser by as short a lead as possible, and from this same tube socket a wire goes to the rotor plates of the right-hand tuning condenser and start of the RF coil.

The sixty-third turn, or end of this coil, goes to the stator plates of the right-hand condenser and one side of the .00025 grid condenser, whose other terminal is connected to the grid of the detector socket.

This set will work from either good batteries, or a B eliminator if of good workmanship and with 60 mil current output at 180 volts. Using a 171 type tube, 40½ volts of minus C will give fine quality. Of course the same tube can be used with either 135 or 157 volts of B, and then 27 or 33 volts of negative C, respectively, would be needed. This will give better quality reproduction without tube overloading than the 112 type of tube, though not as much volume.

After wiring is complete, check carefully against the diagram. Be positive proper tubestats are inserted in their respective places. Connect the A battery cable wire to the A battery, plug in the cable plug, and turn on the switch. If the tubes glow, the filament is O. K. If not, check up carefully.

[List of parts and construction data next week.]

Picture Diagram of Ehlert's "Everyman 4"

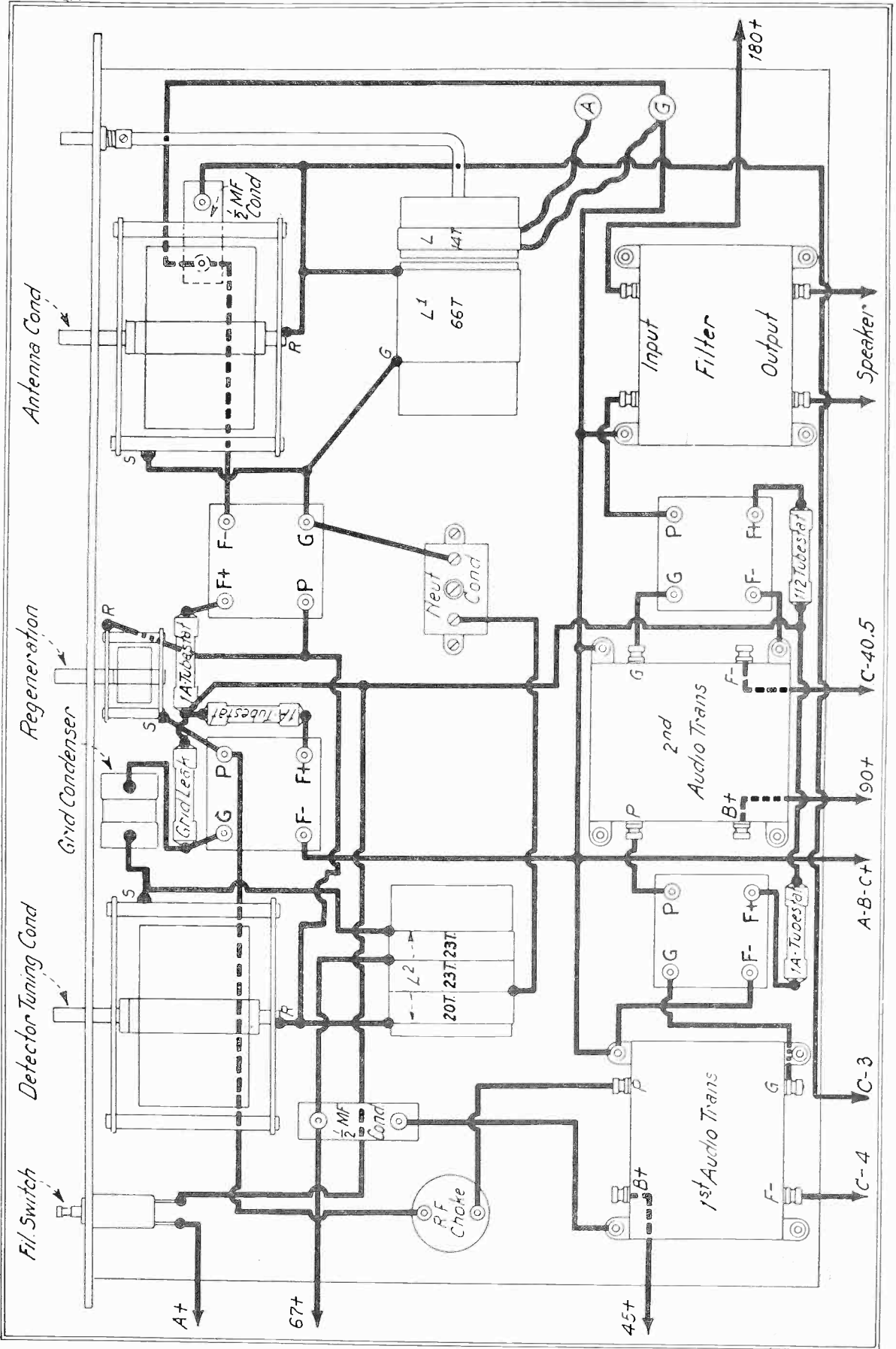

The Diamond in Four

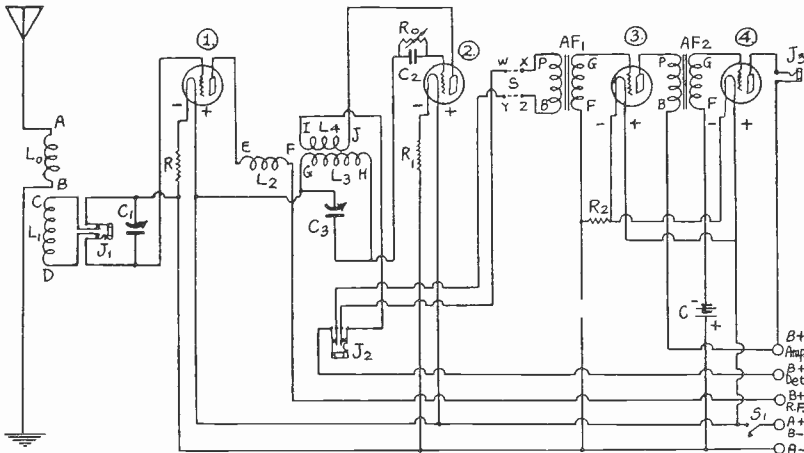

CIRCUIT DIAGRAM OF THE FOUR TUBE DIAMOND. BREAK IN MINUS A LEAD INDICATES S2.

By Campbell Hearn

THE interest in the Diamond of the Air has continued unabated ever since its introduction about three years ago. The demands for blueprints, for additional information about the circuit, and for any possible improvements have been continuous.

While no circuit is so good that it cannot be improved there has been no need of making any vital changes in the Diamond of the Air. A good circuit never grows out of date. That does not hold of the parts of which the receiver is assembled. Parts have been greatly improved and when such parts are substituted for the old a general improvement results in the receiver. Such changes have been made in the Diamond with gratifying results.

Many fans want to know which is the better, the four tube Diamond or the five tube circuit. There is very little difference between them as to selectivity and volume. The four tube Diamond contains two audio frequency transformers; the five tube Diamond contains one transformer and two resistance couplers. The radio ends of the circuits are identical. It is considered by some that the quality of resistance coupled amplifiers is better than the quality of transformer coupled

circuits. That was obviously true when transformers were poor.

Building either the five tube circuit or the four tube circuit is very simple. For the four tubes the socket next to the last is removed from the socket strip and the second audio frequency transformer is put in its place, covering up the aperture. The circuit is then wired in accordance with the four tube diagram. The resistance couplers which are now superfluous may be removed entirely or they may be merely disconnected from the circuit. It may be well to leave them in since it may be decided some time to restore the five tube circuit.

It is advisable that any one who builds the set should afford himself the benefit of the blueprints, which show the exact location and identification of each part, life size, and which therefore may be followed much as if it were templates, which in some respects indeed they are.

The solenoid having been used in the original model, it is advisable to adhere to that form of coil, which consists of a single layer on a cylindrical form. The cylinder happened to be one formed by quartzite rods, supported by Bakelite rings at either end. A small diameter is

LIST OF PARTS

- L0L1—One Bruno 99 antenna coupler.
- L2L3L4—One Bruno 99 three circuit tuner
- C1C3—Two Karas SFL .0005 mfd. condensers
- R, R1—Two No. 1A Amperites
- R2, R7—Two No. 112 Amperites
- One Karas Harmonik audio frequency transformer
- R3, R5—Two Polymet .25 megohm resistors with mountings
- R4, R6—Two Polymet 1 megohm resistors with mountings
- R0—One Bretwood variable grid leak
- C2—One Polymet .00025 grid condenser
- C4, C5—Two Polymet .1 mfd. condensers
- J1, J2—Two double circuit jacks
- J3—One single circuit jack
- Five Patent X type sockets
- S1, S2—Two Yaxley battery switches
- WXYZ—Four Eby binding posts
- One 7x24 inch panel
- Antenna and ground binding posts
- One pair of Bruno brackets
- Two Marco 4 inch dials
- One Marco 2 inch dial.

N. B.—For the four tube Diamond use two AF transformers and omit R3, R4, R5, R6, R7, C4, C5 and one socket.

preferable, as it sets up a smaller field and there is less danger of magnetic interplay or stray coupling, which would result in difficulty in controlling oscillations. For the radio-frequency coil (LL) this diameter may well be 2½ inches to duplicate the commercial coils employed, which were the Bruno 99 RF. In the case of the interstage coupler, or 3-circuit tuning coil, the same diameter is preferable again (L2L3L4).

For the 2½ inch diameter form the primary consists of 10 turns, ⅜ inch space being left, then the secondary being wound adjacent to the primary and consisting of 58 turns. The wire is No. 24, silk-over cotton or No. 24 double cotton covered.

The 3-circuit tuner is wound in the same fashion, as to the stator form, but inside this there revolves the rotary form, which is 1 inch diameter and 1 inch high, and on which are wound turns of No. 26 single silk covered wire until the wire al-

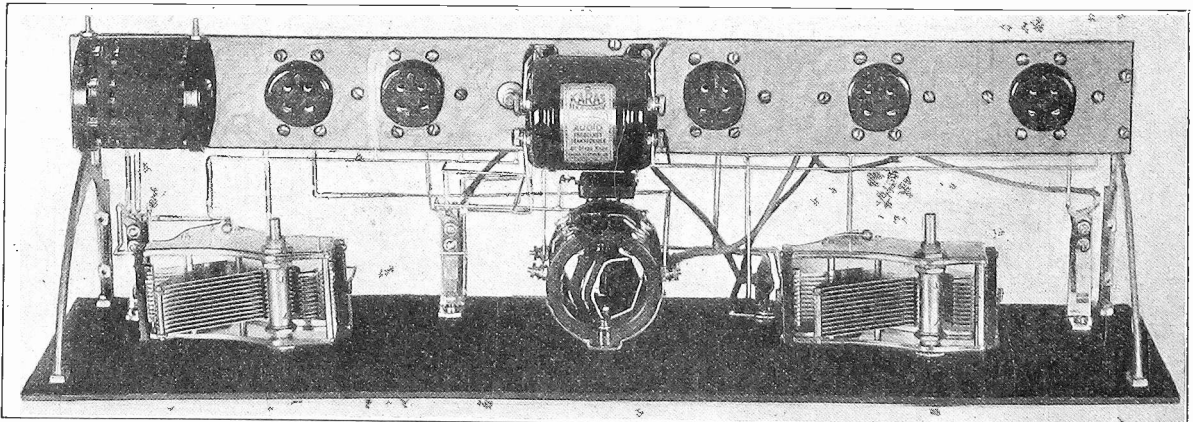

THE TOP VIEW DISCLOSES THE RIGHT-ANGLE RELATIVITY OF THE TWO COILS AND POINTEDLY PRESENTS THE FRONT PANEL AND TOP-OF-SUBPANEL MOUNTING DETAILS.

and Five Tube Models

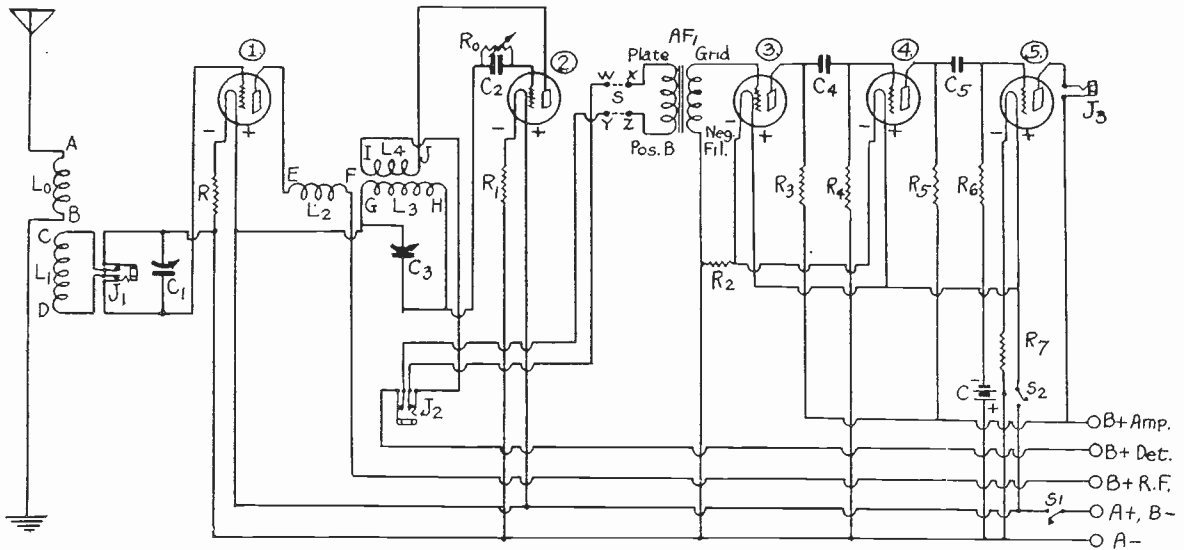

CIRCUIT DIAGRAM OF THE FIVE TUBE DIAMOND

most completely covers the form, which will be about 38 turns.

If a 3 inch diameter form is used for RF coil the primary would consist of 8 turns and the secondary of 47 turns, the same kind and insulation of wire being used. The tickler, 2 inches diameter, would have 30 turns of No. 26 SSC.

Terminals of Coils

The coil terminals in the diagram are designated by letters. These should be followed without alteration, except that I and J may be interchanged. The coil terminals are as follows:

A is the beginning of the aperiodic primary L, in the antenna circuit, and is connected to the aerial. In the Bruno coil trace this lead to its origin on outside of primary, though this post is at opposite end of the coil.

B is the end of that winding and goes to ground.

C and D should be watched carefully, as their source may be lost in the confusion of jack wiring. C is the beginning of the secondary L1, and is the terminal of the secondary which adjoins the end of the primary L (i.e., point B). In the laboratory receiver the Bruno coils were used, and these have binding posts on them, to which the coil terminals are secured. The wire terminals are not brought to the nearest binding posts, but the wire is turned back, so that the winding is thus given added support, hence this is something to watch in determining the beginning and the end of a winding. It is easily done at a glance, but might be overlooked unless attention were called to it.

C is the beginning of the secondary winding and goes to that inside spring of the jack J1, which ultimately connects to minus A when the jack is closed.

D is the end of the winding and makes connection to the other inside spring of J1, which ultimately goes to grid. Trace this. Confirm the fact that the aerial goes to outside of primary, grid to outside of secondary.

E is the beginning of the RF plate coil L2 and connects to the plate of tube 1.

(Concluded on page 28)

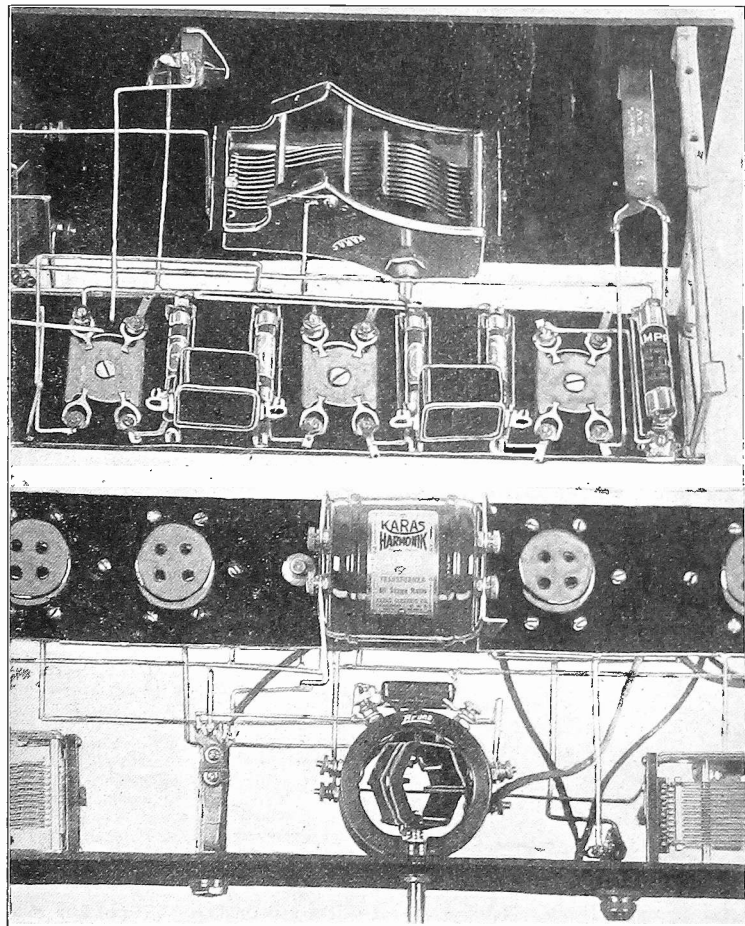

THE AUDIO END, UPSIDE DOWN VIEW, IS SHOWN AT TOP, WITH MOUNTING DETAILS CLEARLY REVEALED. THE OTHER VIEW SHOWS THE POSITION OF THE AUDIO TRANSFORMER AND THREE CIRCUIT TUNER. THESE ARE VIEWS OF THE 5-TUBE MODEL

Cherchez La Voltage; Never Mind the Woman

From E. T. Cunningham, Inc.

It is unfortunate in a way that vacuum tubes are very much like faithful horses in performing the duties imposed upon them. Tubes like horses will work and strain at tasks that should never have been imposed upon them, until they crack under the strain.

According to Roger M. Wise, chief engineer of E. T. Cunningham, Inc., the failure to realize that adjustment "by ear" of the voltages furnished by "B" power devices almost invariably results in the use of excessive plate voltage, is frequently responsible for dissatisfaction on the part of the listener at the service obtained from the tube.

This is particularly true of power tubes, with which reception, as judged by the ear improves as the tube is overloaded as regards plate voltage.

Follow Instruction Sheet

Complete specifications and operating characteristics of tubes are given in the sheet of instructions regarding their proper use which tube manufacturers supply in the cartons in which their tubes are packed. These specifications, regarding the proper filament voltage, plate voltage and grid bias to use with such tubes and the uses to which the tubes can be put should be studied carefully before the set is designed and wired so that full advantage can be taken of the knowledge gained by the manufacturers in the experimental and development work which has been done with the tubes.

As a concrete instance it might be mentioned that with a grid bias of 40½ volts, the normal plate current drawn by a CX-371 power tube at 180 volts is 20 milliamperes whereas with no grid bias the plate current may run as high as 100 milliamperes, dissipating so much heat in the tube that the plate of the tube will be heated to redness.

Measure Correctly

With the growing popularity of battery eliminators, the tendency has grown to adjust the voltages supplied to the receiver by such units entirely by ear. Since these eliminators and the conditions under which they are used vary greatly, it is almost impossible to determine the correct settings merely by listening to the receiver and adjusting the unit until reception sounds all right.

The variable adjustments of these units should be set accurately to the receiver with which they are used, a high resistance voltmeter being employed for the purpose.

When once adjusted they should be left severely alone unless a change in tube or tube types is made. The adjustment should preferably be made by a radio service man who is properly equipped with instruments to make the necessary tests. The man who installs the eliminator is the logical man to adjust it to the set. Nothing less than a reading of the voltage delivered at each tap should be accepted as a satisfactory test on his part.

TUBE CHART QUICKLY GIVES NEEDED FACTS

A CHART containing in concentrated form all the principal characteristics of all the Radiotrons on the market is an extremely useful adjunct to the equipment of any one who is continually working with vacuum tubes and circuits. Such a chart will give at a glance the answer to almost any question of design, electrical and mechanical, which may arise.

Such a chart has been issued by the Radio Corporation of America and is reproduced herewith. While this chart gives the average characteristics of the Radiotrons only it also applies accurately to the Cunningham line of tubes, and to other brands of tubes having similar characteristics.

Valuable Information

This chart gives the general purpose of every type of Radiotron, the circuit requirements of each tube, the type of socket to use with each, and the physical dimensions of every tube.

Then it gives the filament, grid and plate voltage and current requirements for both detection and amplification, as well as many other useful data.

Of particular interest in this chart are the characteristics of the new UX-222 screen grid tube. It has characteristics radically different from those of any other tube. It has a static amplification factor in one case of 300 and in another of 60, depending on the value of the positive voltage on the inner grid.

112A and 171A

The corresponding plate AC resistances are 850,000 and 150,000 ohms. Such a tube then is eminently suited for resistance coupling both for radio frequency and audio frequency amplification.

Another feature of interest is the change in the filament requirements of the 112 and the 171 group. Tubes, now requiring only .25 ampere instead of .5, for the filament, are changed in designation to 112-A and 171-A.

[See Chart on Next Page]

Condenser Easily Cures Noises Due to Sparks

When the public first became conscious that roars, rumbles and crackles were not necessarily an adjunct of radio broadcast there was a wide-spread belief that whatever the nature of noise it must be looked upon as a permanent institution. So general was this belief that many communities passed legislation against vibratory battery chargers and in some towns mercury arc rectifiers were looked upon with considerable disfavor.

One of the many important results of a survey made by the Radio Manufacturers Association has been the establishment of proof that while noise is threatening the future of radio in every large community it is nevertheless one of our most easily eradicable nuisances.

Just why this should be is easily understood if one comprehends the nature of radio noises.

Sparking Causes Trouble

Most of these disturbances are due to spark emanation and a consequent broadcasting of trains of high frequency currents which are cast off by the power lines and picked up by receiving set collectors. The range of the spark broadcast would not be more than a few feet were it not for the antenna effect of the lines leading from the source of trouble.

Once this was realized it became evident that a cure, complete and instant, would be possible the instant one devised a means of keeping the high frequency currents from stepping back into the lines. Of course the solution was a by pass condenser.

High frequency discharges go just as far as they have to go and no farther. So a fairly large condenser connected across a spark gap provides for them a path that they much prefer to the miles of straight wire that otherwise they might have to travel.

The Easiest Way

A working circuit is provided for them without harm to the normal functions of the device which produced them, they remain close to their point of origin and the neighborhood is thus enabled to listen to radio broadcast without that static effect so noticeable in cities.

Nearly all disturbances can be silenced by these simple means. Where small currents are consumed a condenser of a quarter microfarad will be found sufficiently large. Where large currents are required—as in elevator control systems—the application of the cure is more expensive but the principles are the same. In some elevator systems—particularly where they are old and worn and prone to sparking—condensers of some thirty microfarads have been required. But even so the expense of installation is a low enough price to pay for peace in the neighborhood.

Clicks and thuds often heard in a radio receiver and caused by the sparking when circuits are broken, such as the turning off a light, travel some distances over the wiring. They can be eliminated with by-pass condensers.

Two Black Crows Sign Up for Columbia Broadcasts

Moran and Mack, known to vaudeville audiences, radio listeners and phonograph record owners throughout the country as the "The Two Black Crows," will have a full hour's session in one of the Columbia hours to be presented over the Columbia Broadcasting system chain soon.

The last appearance of this inimitable pair was during the Radio Industries Banquet, last September, in N. Y. City.

WTIC Seeks New Site So Power May Go Up

HARTFORD.

Believing that if the station is moved out of the city the Federal Radio Commission will allow the use of higher power, engineers of WTIC are seeking a site, ten miles outside of the city limits.

Their present plans call for the location of only the transmitter out of the city, the studios to remain in the central portion of Hartford.

The Laboratory Super

By Edward Farrell

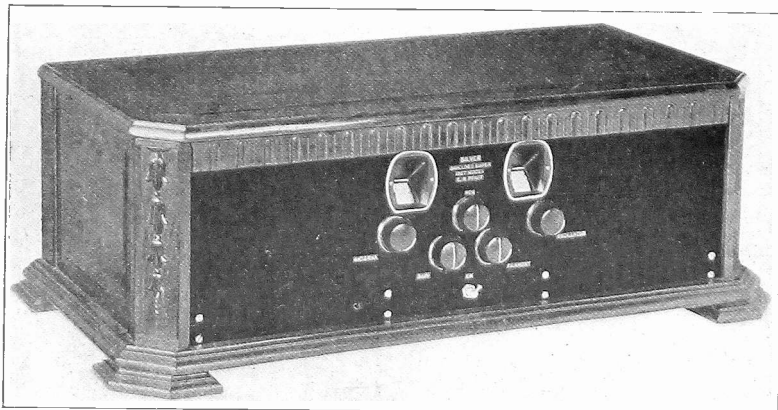

PANEL VIEW OF THE LABORATORY SUPER-HETERODYNE

ONE reason for the erratic performance of some Super-Heterodynes is the stray coupling between the modulator and the oscillator. Sometimes this coupling bucks and sometimes it aids the intentional coupling. It may aid at one frequency band and buck at another. Uncertain action results.

But it is not necessary to tolerate this uncertainty. The Super-Heterodyne can be made to function as certainly and accurately as the theory of the circuit would lead one to expect. The secret is simply to limit the coupling between the oscillator and modulator to the intentional coupling, eliminating others by suitably designing the receiver.

The intentional coupling is usually inductive. If there is stray inductive coupling as well, it is only necessary to reduce the intentional coupling between the pick-up coil and the oscillator. It is not well to have very close coupling between the oscillator and the modulator.

Two Ways to Do It

When the intentional coupling is inductive all capacitive coupling must be removed carefully. There are two methods of doing it. First, the oscillator and the modulator can be placed far apart; second, they can be shielded. Both of these methods have been used in the new Laboratory Super-Heterodyne, using the Jewelers Time Signal Amplifier. The oscillator is in the right-hand corner and the modulator in the left corner, each completely inclosed in an aluminum shield. The distance between the parts belonging to the two units is so large that capacity coupling between the two is extremely small. The mutual inductance between the coils of the two units is so small that it has no measurable effect on the total coupling. The complete grounded shields around each unit further reduce the stray coupling to the vanishing point.

Hence the shielding is advisable for the above reasons.

There remains one form of stray coupling which may give rise to trouble, and that is resistance coupling. Liberal use of by-pass condensers across the battery or power supply leads solves that problem.

In the new Laboratory Super-Heterodyne the coupling between the oscillator and the modulator is as close to the intentional inductive coupling as it is practical to make it.

There is another unique feature in this

circuit and that is the intermediate frequency amplifier. That, too, is shielded thoroughly as a whole and each stage in it is shielded from the rest. That is, each stage in the intermediate frequency amplifier is set in a metal-inclosed compartment, which is grounded. Hence there can be no capacity or inductive coupling between the stages and oscillation in the amplifier as a result is thus eliminated. There may be a regenerative effect through the inter-electrode capacity which is not eliminated by the shielding, but as the circuit operates on one frequency only, this need never give any trouble. In fact, the effect may be used to make the circuit more sensitive.

As in the case of the radio frequency level, there will be some interstage resistance coupling in the intermediate amplifier, but by-passing the leads to the batteries solves the difficulty here also.

The Time Signal Feature

Another unique feature of the intermediate frequency amplifier is that it has been tuned to the frequency of the Standard time signals from station NAA at Arlington. The standard time signals thus can be received directly on the receiver without the use of the modulator and the oscillator. This is an especially valuable feature to jewelers, seafaring men, and all others who are dependent on exact time.

But this is not the only valuable feature of the frequency used. Arlington sends out the time signals on a frequency of 112 kc. This is a much higher frequency than is ordinarily used for intermediate amplifiers. Two advantages accrue from the use of a high intermediate frequency. First, the quality of the reproduced music will be better by virtue of the minimum suppression of the higher side frequencies. Second, the number of squeals in the output will be minimized by the elimination of "repeats." A Super-Heterodyne in which the intermediate frequency is low, say 30 kc., will squeal at four times as many places as a Super working on a frequency of 120 kc. It is clear, then, that a Super working on a frequency of 112 kc. is greatly superior in this respect to a super working on a frequency of 30 kilocycles.

The audio amplifier in the Silver Shielded Super consists of two stages of transformer coupling with one general purpose tube and one power tube. The transformers used are SM 220.

The oscillator used in this receiver is

of the tuned grid type. This connection makes it possible to ground the oscillator condenser and thus greatly stabilize the tuning and operation of the set. For reasons that are somewhat obscure this excellent form of oscillator is not used in many circuits though it has many obvious advantages.

The modulator is of the regenerative type and the feedback is controlled with a midget condenser connected in series with the reaction coil. The steady plate current flows through a radio frequency choke coil which is connected in parallel with the feedback condenser and coil. The grid leak in the modulator has a resistance of two megohms and the grid condenser a capacity of .00015 mfd. This capacity is more suitable for the modulator than the larger capacity ordinarily used in that it makes the circuit more sensitive.

A Few of the Many

That the Laboratory Super-Heterodyne is an all-satisfying circuit is proven by letters from delighted users. For example:

A Cambridge, O., fan wrote: "This Improved Laboratory Super is the finest I have yet built or heard of Supers or anything else."

From Fredericton, N. B., came this: "Have neglected writing you since I received the Improved Laboratory Super. Away down here in Canada is a great place to test Supers. There is less electrical disturbances and local stations, which enables one to test for distance. My friend (a professor at college) and myself have done considerable testing in radio lately, and we cannot find a set even in the Supers that will give the results your Improved Laboratory receiver gives. We have had KYW, Chicago, here in A. M., (8:30 A. S. T.) on loudspeaker using short aerial."

An enthusiast from Iowa City, Ia., wrote:

"Thank you much for your past assistance. I should say that the Improved Laboratory Receiver is by far the most powerful I have ever operated or demonstrated, and it has attracted widespread attention and interest here."

What DX He Gets!

A Chicago user said: "After having had many different types of radios, trying to find one that would satisfy me as to tone quality and selectivity without success, I heard about your Improved Laboratory Super and decided to try this model.

"Having such good results I feel I must tell about it. I have never been much of a DX hunter but since I have built this set distance comes in like locals and I am getting to be a DX fan.

"Most of the distant stations come in through locals. One night we had PWX and listened to them for one hour and forty-five minutes without any fading and as loud as my loudest local which is station WENR only two and a half miles from where I am located. I am using a 50 foot outdoor aerial including lead-in.

"I cannot say enough for this set because it does more than I expected. Anyone wishing to hear this receiver is welcome to do so at any time."

[In the November 19 issue, the first part on the Laboratory Super-Heterodyne was published. Last week, November 26 issue, constructional data was given.]

Now Audio Has the Floor

(From Acme Apparatus Co.)

"Please turn down the radio!"

Generally this request is made because of the sounds, coming from the loudspeaker, have gotten on somebody's nerves. Yet were this same somebody seated in the studio of the broadcasting station listening to the same orchestra playing the same selection, the chances are he would not only find the music unobjectionable, but contrariwise a decided aid to relaxation.

The average set owner probably never pauses to analyze why, in one case, the result may be nerve wracking, and, in the other, restful. He may think he has the best radio in the world; he may proudly call the attention of his friends to the "mellowness" of his loudspeaker, and to the extreme depths and power of the lower tones; but, if he cannot find relaxation and a complete sense of realism in the music it produces—if the set must forever be turned down—then, in all probability, there is something seriously wrong with it.

Piano Test a Good One

Let us suppose, for example, we are listening to a piano selection and that the volume of sound coming from the loudspeaker is approximately that of a piano played in the same room. A piano selection, incidentally, is one of the best means of testing the quality of a receiving set and speaker. If there is an undue and recurring emphasis on certain notes, in either the upper or lower registers, the amplifying system has not a flat frequency response.

Assuming the fault is not in the speaker, this peak, or undue amplification of a certain frequency, is generally found in the upper registers in the case of transformer-coupled amplifiers and may be attributed to poor amplifying units. When, however, an impedance or resistance-coupled amplifier is used, this over-emphasis, when present, occurs generally in the base notes, particularly those having a very low frequency, and is usually caused by unwanted regeneration in the audio end of the circuit.

Evidence of Distortion

If the tones in the upper register of the piano are pleasing and natural, but the bass notes, even if they do not exaggerate one particular frequency, sound drum-like, or resemble the roll of an organ, serious distortion is present.

In the long run, a speaker or amplifying system that favors or over-emphasizes the low tones, is far more nerve wracking, because of an indefinable lack of definition and absence of brilliancy, than is an amplifying system that affords good reproduction over a comparatively limited range in the upper register.

For truthful reproduction, not only must the fundamental tones be present, and they are present in all but the most deficient speakers and amplifiers, but the overtones and harmonics must also be accurately recreated. Harmonics, it may be pointed out, are always in an integral relation to the fundamental tone responsible for them. They may be two, three, four, etc., times the frequency, and are richest in the case of stringed instruments. Overtones, on the other hand, are never exact multiples of the fundamental, and occur mostly in the case of percussive instruments, drums, reeds, the human vocal organs, etc.

Sometimes It's the Speaker

Now, this over-emphasis of the lower

registers, which is one of the most prevalent faults of the present-day receiver, may be due to deficiencies in the speaker itself, or again in the amplifier; and the set owner would do well to borrow a speaker that he knows gives excellent results so that he may localize the trouble. It would also be well to investigate the B power supply. Engineers of the Acme Apparatus Company have found, for example, that the existence of an alternating current hum, due to poor filtering effects of the chokes used in the poorer types of B power devices, will actually modulate the applied signal—a condition that frequently accounts for very peculiar effects as the frequency of the applied signal approaches that of the residual AC.

On the other hand, the B power supply may also account for the absence of bass notes. When music is played or a person talks or sings, frequencies come into play, varying, let us say, from 27 to 10,000 cycles per second. When notes in the lower registers are to be reproduced, the amount of current necessary is considerably increased over that required by the higher frequencies.

Use Large Condenser

Unless sufficient storage of energy is provided in the B supply, these notes will not be produced in exact proportion to the high ones, and may not even be heard. To obviate this possibility, a large capacity condenser must be placed across the B supply. This condenser must store energy so that any sudden demand for more current for the low notes can be met. If, through a desire to reduce the cost of the manufactured eliminator, condensers of insufficient capacity are used, not only will the bass notes be inadequately reproduced, but the tendency toward motorboating, which is a form of low-frequency oscillation, will be increased.

With the development of the cone speaker the inherent resonance of the horn of former days is eliminated, but, of course, the speaker cannot offset faults of the amplifier or B supply, or vice versa.

To obtain the very low and very high frequencies engineers of the Acme Apparatus Company have developed an audio amplifier that utilizes resistance coupling for the first stage, transformer for the second resistance again for the third.

The Impedance Leak

A feature of the third stage is the utilization of an impedance, rather than a resistance, as the leak, which helps offset any tendency to motorboating at the lower frequencies.

The reasons for the employment of an impedance leak are interesting. In an amplifier circuit utilizing a grid leak, a regular detector circuit results, and rectification occurs. To prevent this rectification, which is a prolific source of distortion, Acme engineers have designed a special unit, incorporating the necessary resistance and impedance, which drains the grid of its accumulated charge without affecting signal intensity. Where transformers are employed in the first and second stages of an amplifier, even when the ratios are different, distortion of a blurring nature may occur. This is a transient effect due to the continuous variation in frequencies and can only be entirely eliminated by the use of an impedance or resistance stage after or before the transformer stage.

For the highest quality in reproduction, a power amplifier should of course be utilized. A good speaker used with an ordinary amplifier—that is, one in which a tube of the 201-A type is used in the last stage—will generally give sufficient volume to satisfy its user, but it will be found that the reproduction is not, in most cases, faithful. This is due to the fact, assuming of course that the amplifier itself is not deficient, that the last tube in amplifier is being overloaded.

By overloading is meant that the tube is being used over a greater portion of its characteristic than is permissible for undistorted output.

This distortion manifests itself particularly when strong signals are applied, and may be entirely absent when the receiver is operating at half volume. Undistorted amplification means that the voltage to be amplified is delivered by the amplifier tube to the speaker exactly as the amplifier tube received it from the preceding stage. The only change which the tube is permitted to make is to increase the amplitude of the applied voltage.

Using ordinary tubes in the last stage, it will be found that as the volume increases the quality of the reproduced signals become noticeably harsh and unpleasant, because of the inability of the ordinary tube to handle large volumes.

Constitution of Power Amplifier

It is quite possible that, even at the low volumes, distortion is still taking place, possibly due to the improper operation of the tube; but at low intensities it is not sufficiently great to be noticed by the average set owner. When using a properly designed power amplifier supplied with the proper high voltage, results are, of course, tremendously improved.

A power amplifier consists essentially of a power tube, especially designed for the purpose, and its accessories. The power tube may be either a 210 or 310. These tubes are designed to operate with a plate potential of 450 volts, and cannot, for this reason, operate properly from the ordinary B supply.

Transformers capable of delivering this high voltage, have recently been developed. Two rectifier tubes of the 216 B type are frequently used with their filaments in parallel.

The filter system used with this type of power supply cannot be made up with the ordinary available condenser blocks, since most of these are designed for operation on 400 volts DC, while the 210 amplifier is designed for 450 volts. It is therefore necessary that the condensers be rated for continuous use at not less than 800 volts to take care of the increase in voltage if the filament of the 210 tube is turned off.

In the power amplifier, one of the main reasons for distortion is incorrect C, or grid bias. Where a B power supply is used, it is often difficult to tell whether the correct voltages are being applied. In the case of a milliammeter reading to fifty mills, it can well be utilized as a means of determining whether distortion is occurring from this cause. The meter should be placed in the plate circuit of the power stage and the needle noted. If it fluctuates more than ten per cent. of the total reading, distortion is serious.

When the kick is downward, it generally indicates that too much C battery is being applied. When the kick is upwards, or towards the high readings on the scale, the C voltage is not sufficient and more should be added.

COUNT DEMONSTRATES FINDER

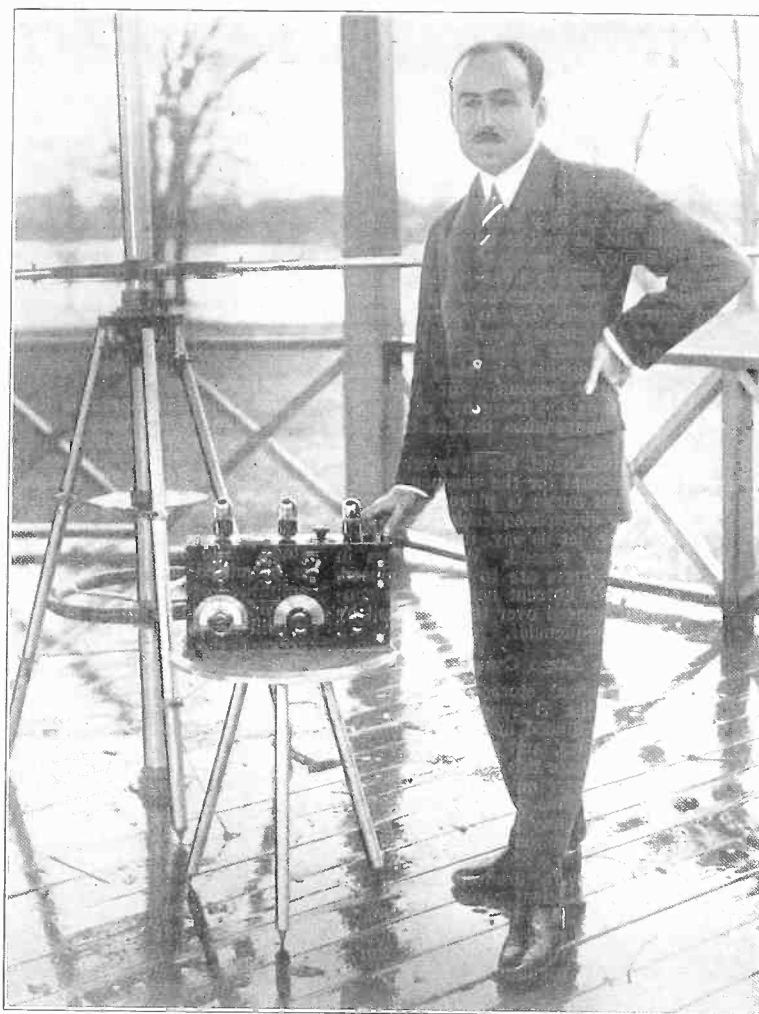

(Henry Miller)

COUNT GUY DU BOURG DE BOZAS, WELL KNOWN FRENCH TECHNICAL DIRECTOR WITH HIS WIRELESS DIRECTION FINDER WHICH HE DEMONSTRATED TO U. S. OFFICIALS IN WASHINGTON. THE APPARATUS IN CONNECTION WITH THE RECEIVING SET SHOWN ON TABLE, IS USED TO FIND SHORT AND LONG WAVE WIRELESS STATIONS, NO MATTER HOW FAR AWAY. THE DIRECTION FINDER OF THE SET CAN BE SEEN STANDING BESIDE THE RECEIVING SET. THE INSTRUMENT IS NOW BEING USED BY FOREIGN GOVERNMENTS WITH SUCCESS

News Agencies Seek Short Wave Licenses

On behalf of three publishing concerns who applied for licenses to operate short wave stations for the dissemination of news to different points within the United States, the Federal Radio Commission will hold a hearing on January 10. The New York Times and the International News Service Company, both of New York, and the Examiner Printing Company of San Francisco were the applicants.

The commission decided in a formal way, a couple of weeks ago, when an application was submitted by the San Francisco Examiner to send out news between San Francisco and Los Angeles, that such a license would not be granted, as long as it was possible to utilize other sources for this type of business, such as

the telegraph lines.

As far as the transmission of news to foreign countries is concerned, licenses would be granted. The Hearst organization which operates the Examiner and the International News have already been promised such a license, New York and Halifax to be the points between which news will be transmitted.

The commission states that although 89 per cent of its time has been devoted to the broadcasting service and clearing of the eighty-nine channels in the band, it has always been aware of the fact that there are other bands used in the national and international communication that are to be given real consideration under the Radio Act of 1927. The news hearing is one of the first of these considerations.

69 Stations Sh Air Clear

So as to eliminate heterodyning and make distant reception an easier task than heretofore, the Federal Radio Commission has changed the status of 69 stations whose frequencies lay in the 600 to 1,000 kilocycles band. Some have been completely lifted out of this choice region.

The Commission states that it realizes there will be some stations adversely affected, but that they must be martyrs to better radio. The Commission also says that if it has erred it would be happy to allow a public hearing, so that facts which warrant a station's shift to a better position could be heard.

In the N. Y. City district stations WJZ, WEA, WOR and WABC have been given a clear channel, so that their high powered transmitters may be heard across the continent.

Some Protest, Others Praise Ruling

Some stations have already protested against the Commission's ruling. Officials of WAAM, Newark, N. J., which was transferred from 860 to 1,120 kilocycles and had its power cut from 500 to 250 watts, stated that they would fight to a finish.

Officials of most of the other stations, however, have praised the ruling, stating that they now are beginning to appreciate the true value of the Commission. One prominent radio personality who was overjoyed with the ruling was A. H. Grebe, president of the Atlantic Broadcasting Company.

"This is really a wonderful thing for the whole radio industry," gloated Mr. Grebe. "The ideal conditions now made possible will stimulate the sale of radio sets and equipment to a new high level, since listeners will be assured maximum service in reception of both local and distant stations."

"Previous to the recent chaotic conditions, it was not an unusual thing for Eastern stations to be heard regularly on the Pacific Coast and in some instances even farther. An example of what might be expected with a clear channel, such as WABC will possess is found in the fact that WAHG, a 500 watt station which preceded WABC, was often reported heard in Alaska and in Australia. That was when all the channels were clear."

Ruling Explained By Commission

The commission, in its statement, explains exactly how the new system works out:

"The newly designated band includes important stations scattered throughout the United States. Over these cleared channels it will thus be possible for rural and remote listeners to pick up stations in all sections of the country. Listeners with a particular taste for DX will also

SWEDISH USE NOVEL ANTENNA

Gothenberg, Sweden.

It is not necessary that the rooftop's appearance be ugly, simply because antennas have to be installed. At least that is what the township of Gothenberg say, for they have arrived at a scheme whereby the rooftop becomes a thing of beauty with the installation of antenna wires. Quite unlike that of those in New York City.

A spider web antenna arrangement is employed by the Swedish. The wires are all brought to a central ring. From here they radiate to the roofs of many houses around. The leadins are taken off the center of the wire.

aken Up; ed for Big Ones

find the tracks cleared for them and all the way across the continent in the case of several of the Pacific Coast stations which have adequate power to deliver a signal in the East under good receptive conditions.

"San Francisco can be heard for three hours after Newark shuts down on 710 kilocycles. And Portland will come in on WEAF's wave length after the big Long Island transmitter has closed for the night.

"KOA, Denver, as a mile-post for cross-continental radio tourists, will be heard when two 500-watt stations in New York City are off. And Porto Rico, which shares Louisville's channel, will prove a long distance southern test when the Kentucky broadcaster has closed down.

Preference to Chicago Station

"Chicago has been assigned some five cleared waves, and while this is the largest number given to any single community, it must be remembered that Chicago, by its original location, is in a position to furnish programs for the entire United States, both East and West, and for this reason considered from the standpoint of the tremendous audience of remote listeners surrounding Chicago, it was deemed desirable that this number of cleared channels be freed for the Chicago broadcasters.

"Other centrally located cities in the Middle West, such as Cincinnati, St. Louis, Cleveland and Detroit, are also given the opportunity to share with Chicago in providing radio programs for the great Mississippi Valley and central Western audience.

"The South is particularly well represented in this picture of cleared channels." The Commission thinks that not until January 15 will the 600-1,000 kc band be completely cleared up, due to the many hearings which it will, no doubt, have to hold. Immediately after this date, the Commission will make an attempt to clear up the higher frequencies from 1,000 to 1,200 kilocycles.

PLAYS RARE AIRS



PAULINE WATSON HEARD RECENTLY FROM WPCH, NEW YORK CITY

A concert artist who is heard occasionally on the radio is Pauline Watson, violinist, who features rare music, including particularly French pieces. She played her violin to advantage from WPCH recently. Her own arrangement of "La Chante," a old French air, was the chief rendition.

A. K. ARTIST



EDITHA FLEISHER, SOPRANO WHO WAS RECENTLY HEARD IN THE ATWATER KENT HOUR FROM WEAF AND ITS ASSOCIATED STATIONS. MANY LETTERS OF COMMENT WERE RECEIVED.

Western Senators Plan to Broadcast

Washington.

A national educational campaign through the use of radio broadcasting is to be initiated in support of the legislative program of the recently formed group of Western Senators who plan to work together for legislation of interest to the West.

The plan as outlined by Senator Brookhart who represents the group calls for the establishment in Washington of a low powered station broadcasting below the regular broadcast band. This station, the Senator said, is to be built and paid for by the persons interested in the Western legislation plans. Programs broadcast over this low powered station are to be picked up by Station KTNT at Muscatine, Iowa, which station, the Senator says, is able to reach most of the Western States.

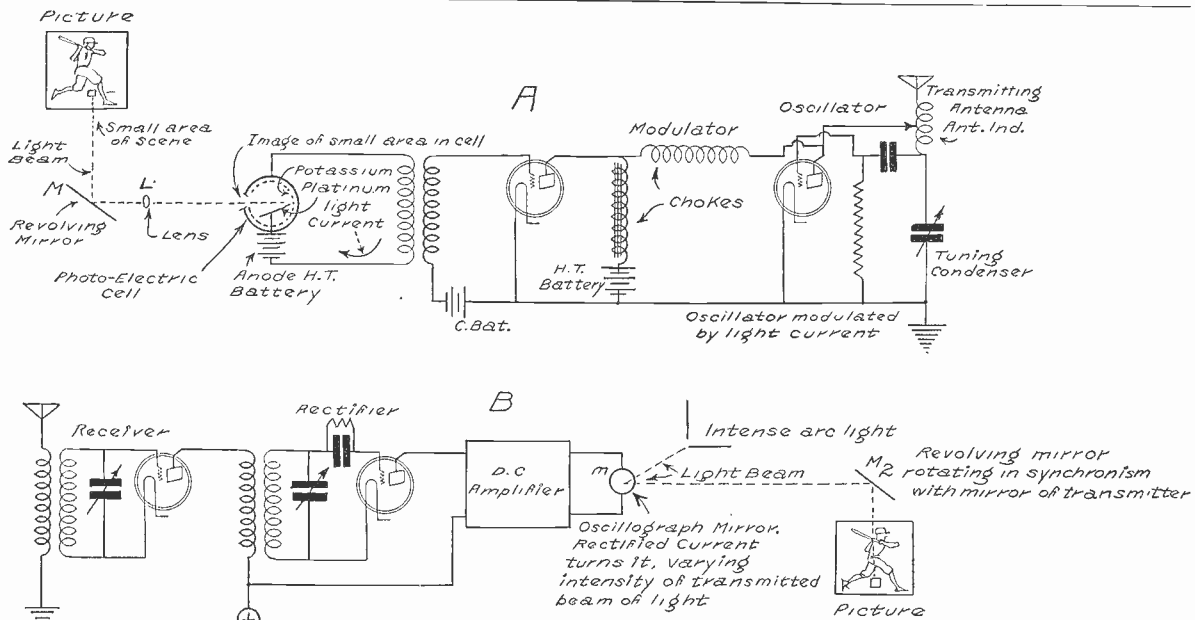

SCHMATIC DIAGRAMS ILLUSTRATING HOW TELEVISION WORKS.

COUNT DEMONSTRATES FINDER

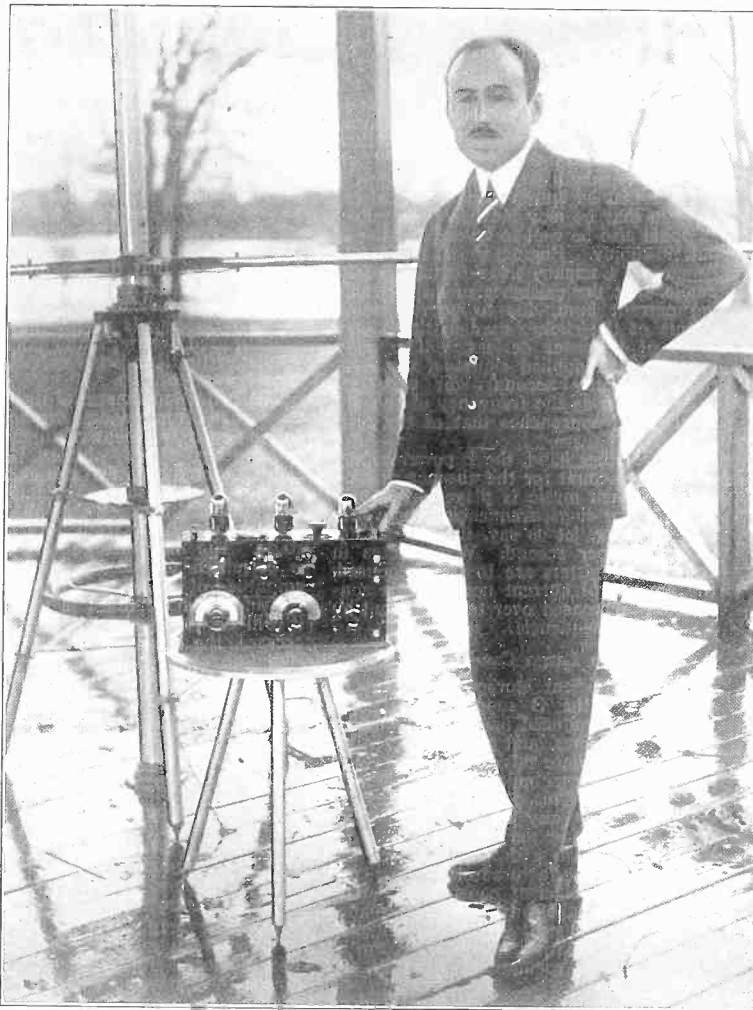

(Henry Miller)

COUNT GUY DU BOURG DE BOZAS, WELL KNOWN FRENCH TECHNICAL DIRECTOR WITH HIS WIRELESS DIRECTION FINDER WHICH HE DEMONSTRATED TO U. S. OFFICIALS IN WASHINGTON. THE APPARATUS IN CONNECTION WITH THE RECEIVING SET SHOWN ON TABLE, IS USED TO FIND SHORT AND LONG WAVE WIRELESS STATIONS, NO MATTER HOW FAR AWAY. THE DIRECTION FINDER OF THE SET CAN BE SEEN STANDING BESIDE THE RECEIVING SET. THE INSTRUMENT IS NOW BEING USED BY FOREIGN GOVERNMENTS WITH SUCCESS

News Agencies Seek Short Wave Licenses

On behalf of three publishing concerns who applied for licenses to operate short wave stations for the dissemination of news to different points within the United States, the Federal Radio Commission will hold a hearing on January 10. The New York Times and the International News Service Company, both of New York, and the Examiner Printing Company of San Francisco were the applicants.

The commission decided in a formal way, a couple of weeks ago, when an application was submitted by the San Francisco Examiner to send out news between San Francisco and Los Angeles, that such a license would not be granted, as long as it was possible to utilize other sources for this type of business, such as

the telegraph lines.

As far as the transmission of news to foreign countries is concerned, licenses would be granted. The Hearst organization which operates the Examiner and the International News have already been promised such a license, New York and Halifax to be the points between which news will be transmitted.

The commission states that although 89 per cent of its time has been devoted to the broadcasting service and clearing of the eighty-nine channels in the band, it has always been aware of the fact that there are other bands used in the national and international communication that are to be given real consideration under the Radio Act of 1927. The news hearing is one of the first of these considerations.

69 Stations Sh Air Clear

So as to eliminate heterodyning and make distant reception an easier task than heretofore, the Federal Radio Commission has changed the status of 69 stations whose frequencies lay in the 600 to 1,000 kilocycles band. Some have been completely lifted out of this choice region.

The Commission states that it realizes there will be some stations adversely affected, but that they must be martyrs to better radio. The Commission also says that if it has erred it would be happy to allow a public hearing, so that facts which warrant a station's shift to a better position could be heard.

In the N. Y. City district stations WJZ, WVEAF, WOR and WABC have been given a clear channel, so that their high powered transmitters may be heard across the continent.

Some Protest, Others Praise Ruling

Some stations have already protested against the Commission's ruling. Officials of WAAM, Newark, N. J., which was transferred from 860 to 1,120 kilocycles and had its power cut from 500 to 250 watts, stated that they would fight to a finish.

Officials of most of the other stations, however, have praised the ruling, stating that they now are beginning to appreciate the true value of the Commission. One prominent radio personality who was overjoyed with the ruling was A. H. Grebe, president of the Atlantic Broadcasting Company.

"This is really a wonderful thing for the whole radio industry," gloated Mr. Grebe. "The ideal conditions now made possible will stimulate the sale of radio sets and equipment to a new high level, since listeners will be assured maximum service in reception of both local and distant stations."

"Previous to the recent chaotic conditions, it was not an unusual thing for Eastern stations to be heard regularly on the Pacific Coast and in some instances even farther. An example of what might be expected with a clear channel, such as WABC will possess is found in the fact that WAHG, a 500 watt station which preceded WABC, was often reported heard in Alaska and in Australia. That was when all the channels were clear."

Ruling Explained by Commission

The commission, in its statement, explains exactly how the new system works out:

"The newly designated band includes important stations scattered throughout the United States. Over these cleared channels it will thus be possible for rural and remote listeners to pick up stations in all sections of the country. Listeners with a particular taste for DX will also

SWEDISH USE NOVEL ANTENNA

Gothenberg, Sweden.

It is not necessary that the rooftop's appearance be ugly, simply because antennas have to be installed. At least that is what the township of Gothenberg say, for they have arrived at a scheme whereby the rooftop becomes a thing of beauty with the installation of antenna wires. Quite unlike that of those in New York City.

A spider web antenna arrangement is employed by the Swedish. The wires are all brought to a central ring. From here they radiate to the roofs of many houses around. The leadins are taken off the center of the wire.

taken Up; ed for Big Ones

find the tracks cleared for them and all the way across the continent in the case of several of the Pacific Coast stations which have adequate power to deliver a signal in the East under good receptive conditions.

"San Francisco can be heard for three hours after Newark shuts down on 710 kilocycles. And Portland will come in on WEAF's wave length after the big Long Island transmitter has closed for the night.

"KOA, Denver, as a mile-post for cross-continental radio tourists, will be heard when two 500-watt stations in New York City are off. And Porto Rico, which shares Louisville's channel, will prove a long distance southern test when the Kentucky broadcaster has closed down.

Preference to Chicago Station

"Chicago has been assigned some five cleared waves, and while this is the largest number given to any single community, it must be remembered that Chicago, by its original location, is in a position to furnish programs for the entire United States, both East and West, and for this reason considered from the standpoint of the tremendous audience of remote listeners surrounding Chicago, it was deemed desirable that this number of cleared channels be freed for the Chicago broadcasters.

"Other centrally located cities in the Middle West, such as Cincinnati, St. Louis, Cleveland and Detroit, are also given the opportunity to share with Chicago in providing radio programs for the great Mississippi Valley and central Western audience.

"The South is particularly well represented in this picture of cleared channels."

The Commission thinks that not until January 15 will the 600-1,000 kc band be completely cleared up, due to the many hearings which it will, no doubt, have to hold. Immediately after this date, the Commission will make an attempt to clear up the higher frequencies from 1,000 to 1,200 kilocycles.

PLAYS RARE AIRS



PAULINE WATSON HEARD RECENTLY FROM WPCH, NEW YORK CITY

A concert artist who is heard occasionally on the radio is Pauline Watson, violinist, who features rare music, including particularly French pieces. She played her violin to advantage from WPCH recently. Her own arrangement of "La Chante," a old French air, was the chief rendition.

A. K. ARTIST

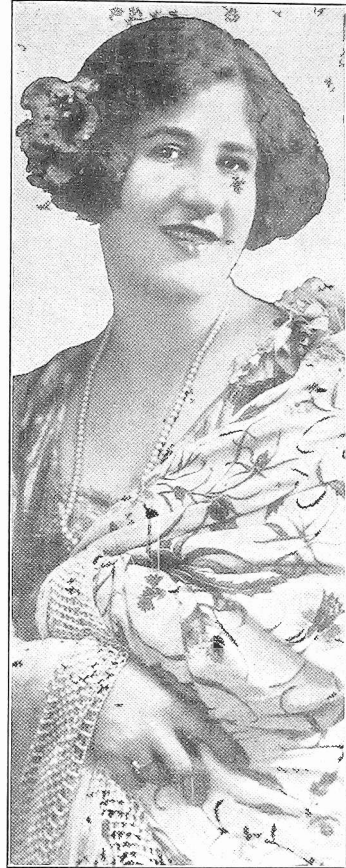

EDITHA FLEISHER, SOPRANO WHO WAS RECENTLY HEARD IN THE ATWATER KENT HOUR FROM WEAF AND ITS ASSOCIATED STATIONS. MANY LETTERS OF COMMENT WERE RECEIVED.

Western Senators Plan to Broadcast

Washington. A national educational campaign through the use of radio broadcasting is to be initiated in support of the legislative program of the recently formed group of Western Senators who plan to work together for legislation of interest to the West.

The plan as outlined by Senator Brookhart who represents the group calls for the establishment in Washington of a low powered station broadcasting below the regular broadcast band. This station, the Senator said, is to be built and paid for by the persons interested in the Western legislation plans. Programs broadcast over this low powered station are to be picked up by Station KTNT at Muscatine, Iowa, which station, the Senator says, is able to reach most of the Western States.

Picture

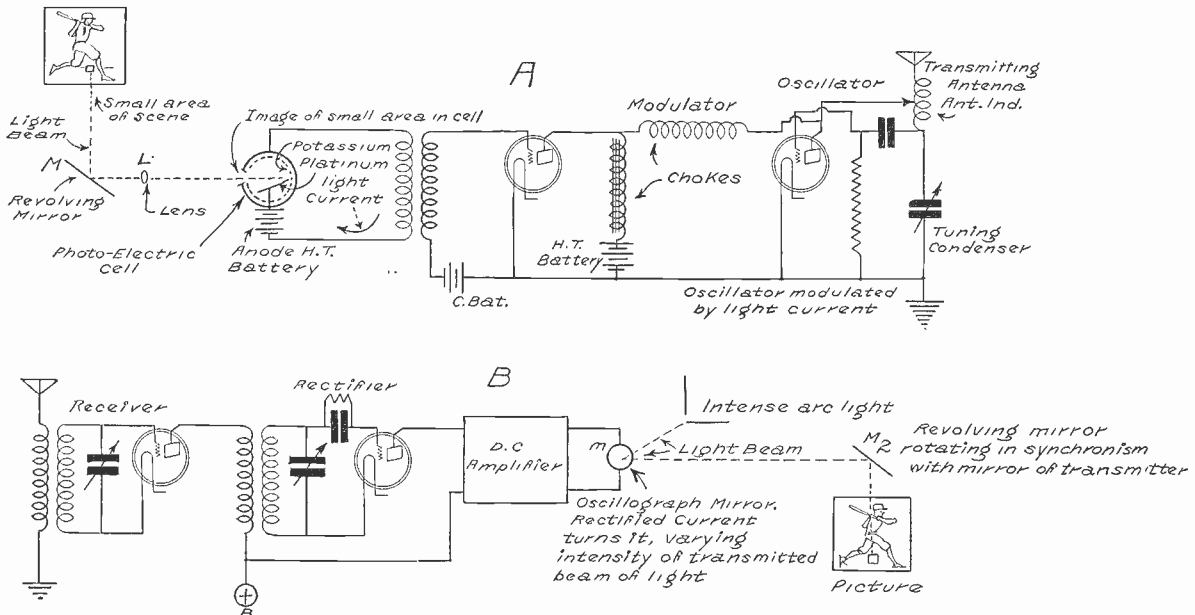

SCHEMATIC DIAGRAMS ILLUSTRATING HOW TELEVISION WORKS.

Resistor Used Wrongly Has Surprising Ohmage

By Pierre Raoul St. Ives

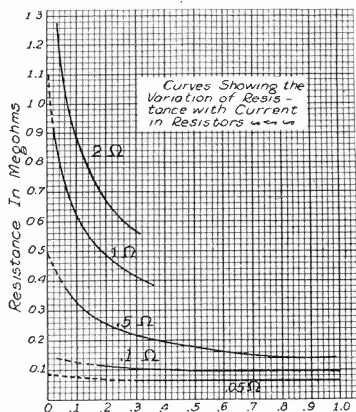

FIG. 1

THESE CURVES SHOW THE VARIATION IN THE RESISTANCE OF RESISTORS MADE OF AN ARTIFICIAL SUBSTANCE. THE VARIATION FOR THE HIGHER RATED RESISTORS IS VERY GREAT, AND THIS MAKES THEM UNSUITABLE FOR PLATE COUPLING RESISTORS.

Resistors are not always what they are expected to be—fixed in value and of the value specified. This fact was strikingly brought out in a test on a number of commercial resistors of an artificial compound. The tests included five different samples of as many different ratings of the same material. The results of these tests are shown in the accompanying graphs. Resistance values in megohms are plotted as ordinates and the current load in milliampères as abscissas.

The top curve in Fig. 1 is that of a grid leak resistor rated at 2 megohms. The first observation was made when the current flowing through it was 36 microamperes. The resistance was 1.28 megohms. As the current increased the resistance dropped very rapidly, and at 310 microamperes it had dropped to .56 megohm. This resistor was intended for grid lead use where the current through it will not be more than a few microamperes.

More Than 2 Meg. in Detector

In view of the rapid change in resistance for low values of current it is probable that when used as a leak its resistance will not only be the rated 2 megohms but much more.

The second curve from the top is that for a grid leak resistor rated at 1 megohm. This also shows a very rapid change of resistance as the current through varies, but not nearly so great as for the previous resistor. The first observation was taken at 20 microamperes where the resistance was found to be .92 megohm.

Then the resistance dropped so rapidly as the current increased that at 360 microamperes it was only .38 megohm. By extending the curve upward beyond the first observed point it appears that at a current of 5 microamperes the resistance is 1.1 megohms. Thus when this is used for the purpose intended the resistance is close to the rated value.

The middle curve shows the resistance variation of a .5 megohm resistor. The first observation was taken at 60 micro-

amperes, where the resistance was .38 megohm. As the current increased the resistance dropped, first rapidly then more slowly, so that at 1 milliampere it was only .14 megohm.

A Little Extrapolating

By extrapolating below the first observed point the curve may be extended to the rated value of .5 megohm when the current is zero. Since the resistor never will be used at zero current, this particular resistor has been overrated.

The next curve shows the variation of a high duty resistor rated at .1 megohm. The first observation at 165 microamperes shows a resistance of .12 megohm. The variation throughout the observed range of current is small and does not deviate much from the rated value. For very low values of current, however, the resistance seems to rise to much higher values than the rated value.

The lowest curve shows the variation of resistance in a .05 resistor. Its resistance is substantially constant over the current range observed, but it is slightly over 60,000 ohms instead of 50,000 ohms. This slight underrating is of no importance for most purposes. This resistor also was of the heavy duty type.

All these resistors were measured under conditions which would be met in the plate circuit of resistance coupled amplifiers, and the object of the tests was to see whether grid leaks of this type could be safely used as coupling resistors. It is apparent that the three of the higher ratings are not at all suitable.

Seeks Greater Amplification

One reason for using high values of resistance in the plate circuits is to secure a greater amplification. This object is defeated by the rapid decrease in the actual resistance of these resistors. Another reason for using high value resistors in the plate circuits is to flatten out the dynamic characteristic as possible and thereby minimize harmonic distortion which results from the curvature of the characteristic. This object is not only defeated by the rapid decrease in the coupling resistance but the dynamic characteristic of the tube and coupler is actually curved by it. Where the effective conductance of the tube increases the conductance of the coupling resistor also in-

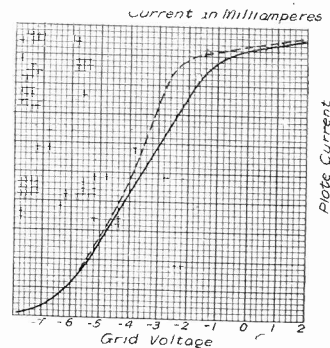

FIG. 2

CURVES SHOWING THE EFFECT OF VARIATION IN COUPLING RESISTOR ON THE DYNAMIC CHARACTERISTIC. THE CURVATURE IS INCREASED BY THE VARIATION AS INDICATED BY THE DOTTED CURVE.

creases so that the dynamic characteristic of the amplifier becomes greatly curved and the harmonic distortion will be considerable. The effect is shown qualitatively in Fig. 2, in which the full line shows the dynamic characteristic of a tube and a fixed coupling resistor and the dotted line shows the characteristic of the same tube with a resistor the resistance of which decreases as the current increases.

Several Preferred to One

It would seem that if a high plate resistance is desired to take full advantage of the amplification factor of the tube and at the same time straighten out the dynamic characteristic of the circuit that it is better to obtain the high resistance by adding many high duty resistors in series than to use one of a high rating.

Most resistors available for coupling purposes have a negative coefficient of change of resistance with current, just as those represented in the accompanying curves. Some do not vary as much as the present, and when the variation is small it is possible to use a single resistor of high value for a coupling resistance.

Nearly all metals have a positive coefficient of resistance change with current, or rather with temperature, and therefore resistors made of such metals are preferable for coupling resistors, particularly since the change in resistance is quite small. But metallic resistors of the wire wound type are not practical in values of the order of 1 megohm, and metallic film resistors such as are commonly used do not have the same characteristics as wire wound resistors.

200,000 Sets in Russia; 47 Broadcast Stations

Washington.

Radio fans are multiplying so rapidly in the Soviet Union that the Government is steadily expending its efforts to keep up with the demand for receiving sets, according to a report from the Central Statistical Administration to the Soviet Union Information Bureau here. The number of receiving sets in use has now reached 200,000, as compared with 116,000 on February 1 last and 30,000 at the beginning of 1926.

Forty-seven radio stations now broadcast daily programs in the Soviet Union, where there was only one in 1924 and

nine in 1925. A dozen new stations are being built. There is now a broadcasting station in every large city. Moscow has four stations, Leningrad two, and Khar'kov, the capital of the Ukraine, has two.

On the occasion of the recent celebration of the tenth anniversary of the Soviet State, a broad hook-up carried the proceedings in Moscow, the capital, to remote parts of the country. Peasants in Siberia and in Central Asia, gathered in their village club rooms, listened in on the music and the speeches attendant on the celebration in the distant capital. All were enthusiastic.

The Fenway Electric Concertrola

By *Leo Fenway*

Associate, Institute Radio Engineers

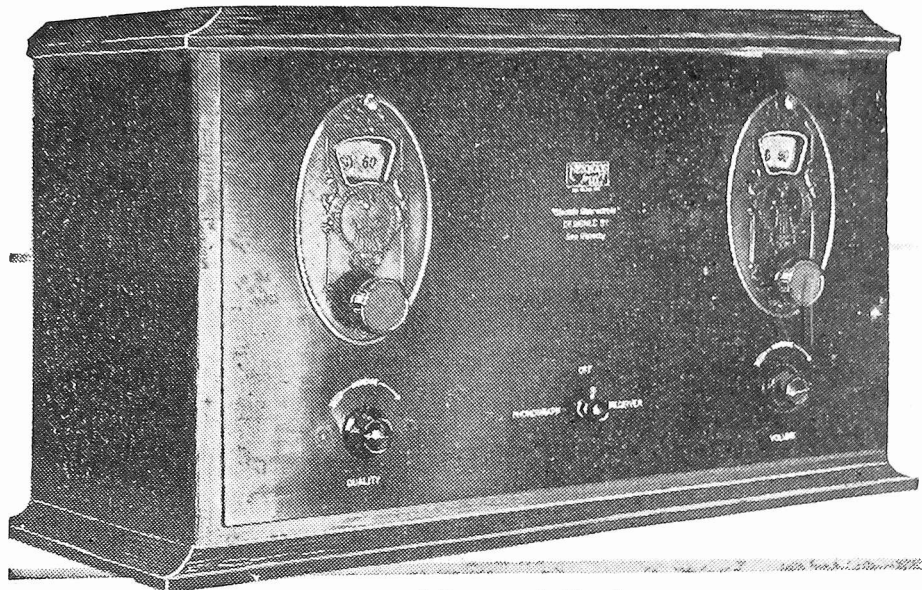

Cabinet Type of Concertrola Receiver.

PART V

THE sweetest melody grows stale through over-repetition; the cleverest witticism loses its flavor through reiteration. So the story of the Fenway Concertrola can verge on the monotonous. And yet when Heterodyne Smith and Eder Franklin returned to Fred Wundsam's apartment-laboratory for another session, all three did little else but talk about the Concertrola.

As we peek in upon the unholy trinity we hear Franklin saying: Heterodyne, I thought that you were going to get your set working with RCA tubes in one night. I'll wager that you threw a couple of wires together and then went fooling around your super. Hi, hi?

Heterodyne said: "I ran out of solder, to be exact, and you know an electric set ought to have all connections firmly joined. Besides," he continued, "I was too tired to give it the consideration it deserves. If I can't do a job right, well, I lay off it; see what I mean?"

'Twill Be a Gift

In appearance Heterodyne was a rotund fellow given to Palm Beach suits with a curving cut that served to emphasize his rotundity. His voice was low, his speech long drawn out. Lazily he selected a cigar from his pocket, and then proceeded with the rest of the process with slow haste. He exhaled from his lungs a cloud of pungent smoke, and without waiting for anyone to speak, remarked:

"Oh, I suppose I'll finish the set sometime between now and Christmas. I'm going to make it as a gift to a friend, anyway."

Franklin stood facing his friend.

"I'm afraid," he said, "that some of your ideas about multi-tube sets have been shocked. You know, old dear, pride is a bubble

and I think yours has been pricked. For as long as I have known you, I've heard nothing from your lips but ravings about seven, eight and nine tube superheterodynes. You've often declared that a Super was the last word. So you fondly dreamed. Your dreams—like your prayers—perhaps, ascended into the empyrean.

Gives Demonstration

"They clattered up the wings of Saturn and curdled the nightly sweetness of the Milky Way. Finally the answer is coming. Like a feather it is floating, darting, zig-zagging down and down—coming to rest in Fred's battery model and mine made with McCullough tubes.

"And, believe me, Heterodyne, we are showing you that a real four tube set, like the Concertrola, is capable of bringing in great DX stuff, with good volume and almost perfect quality. Realism, Fred calls it."

"You said it!" Fred exclaimed. "Here's a sample of what I call realism."

He snapped on the switch of his battery model Concertrola and the little apartment-laboratory was suddenly electrified with the atmosphere of a night club.

Blare of the Trumpet

Heterodyne started to speak, but just then his attention was drawn to the center of the room where, it seemed, a gay and hilarious crowd were walking right out of the loudspeaker. It seemed to Heterodyne as if the decorations of blue and gold of the night club approved of his company. He felt as if he has passed through rows of congested revellers to a far table, glowing white and crystal—a table far enough removed to permit unmolested indulgence in the arms of Morpheus.

The trumpet blared; the saxophone

crooned and Heterodyne watched a couple as they gave an exhibition of Spanish and Apache dances. He saw the dancer seize his partner by the waist as he swung her and whirled her and tossed her around the room, and the lights turned red and blue and green, and when they turned white, he grabbed her by the fragile waist and dragged her back into—the loudspeaker. Fred had turned the set off.

"There's something about the music of those upholstered sewers," said Heterodyne, "that always gets me. However, let's get back to the Concertrola. What can you fellows tell me about it that I don't already know?"

Hope Is the Foundation

Almost every circuit which has made its mark has had back of it some underlying hope of a worth-while accomplishment. Franklin had this thought in mind when he said to Heterodyne, "The thing I like about the Concertrola is the fact that the same set, apparently, can be used for batteries, McCullough tubes, R C A tubes and can be operated on either alternating or direct current. The simplicity of the thing must strike a popular cord.

"And the fact that it can be operated for less than one cent per hour, proves that it is very economical.

"You know, fellows," he went on, "even the dry cell C batteries can be dispensed with.

"It is a very simple matter to insert a fixed resistance of about 3,000 ohms in the grid return circuits of the first two tubes. This, of course, ought to be a variable resistance, such as the Royalty Truvolt or the Carter. A similar resistance of about 2,000 ohms can be used in the first audio stage, thereby doing away with the nine volt C

(Concluded on page 26)

A THOUGHT FOR THE WEEK

AN SOS call at sea—a plea for help from a stricken countryside—a startling message from a man bird in the polar regions—a staccato cry of haunting vividness from a South American morass or a Himalayan fastness—a hundred different causes in a hundred different places for the use of radio—all making for deep-throated drama of the kind that holds the world tense and makes the human heart respond in fullest measure—all this is radio in 1927.

SIXTH YEAR

RADIO WORLD

The First and Only National Radio Weekly

Radio World's Slogan: "A radio set for every home."

TELEPHONES: BRYANT 0558, 0559

PUBLISHED EVERY WEDNESDAY

(Dated Saturday of same week)

FROM PUBLICATION OFFICE

HENNESSY RADIO PUBLICATIONS CORPORATION
145 WEST 45th STREET, NEW YORK, N. Y.
(Just East of Broadway)

ROLAND BURKE HENNESSY, President
M. B. HENNESSY, Vice-President
HERMAN BERNARD, Secretary

Chicago: 55 West Jackson Bldg.
Kansas City, Mo.: E. A. Samuelson, 300 Coca Cola Bldg.
Los Angeles: Loyd Chappel, 611 S. Coronado St.
European Representatives: The International News Co.
Brema's Bldgs., Chancery Lane, London, Eng.
Paris, France: Brentano's, 8 Avenue de l'Opera

EDITOR, Roland Burke Hennessy

MANAGING EDITOR, Herman Bernard

ASSISTANT EDITOR, Lewis Winner

TECHNICAL EDITOR, J. E. Anderson

ART EDITOR, Anthony Sodaro

CONTRIBUTING EDITORS:

James H. Carroll, John Murray Barron and
Capt. Peter V. O'Rourke

SUBSCRIPTION RATES

Fifteen cents a copy, \$6.00 a year, \$3.00 for six months, \$1.50 for three months. Add \$1.00 a year extra for foreign postage. Canada, 50 cents.

Receipt by new subscribers of the first copy of RADIO WORLD mailed to them after sending in their order is automatic acknowledgment of their subscription order. Changes of address should be received at this office two weeks before date of publication. Always give old address; also state whether subscription is new or a renewal.

ADVERTISING RATES

General Advertising

1 Page, 7 1/2"x11"	462 lines.....	\$300.00
1/2 Page, 7 1/2"x5 1/2"	231 lines.....	150.00
1/4 Page, 8 1/2" D. C.	231 lines.....	150.00
1/4 Page, 4 1/2" D. C.	115 lines.....	75.00
1/8 Page, 4 1/2" S. C.	57 lines.....	37.50
1 Column, 2 1/4"x11"	154 lines.....	100.00
1 Inch	10.00
Per Apage Line.....	75

Time Discount

52 consecutive issues.....	20%
26 times consecutively or E. O. W. one year.....	15%
13 times consecutively or E. O. W. one year.....	12 1/2%
4 consecutive issues.....	10%

WEEKLY, dated each Saturday, published Wednesday. Advertising forms close Tuesday, eleven days in advance of date of issue.

CLASSIFIED ADVERTISEMENTS

Ten cents per word. Minimum 10 words. Cash with order. Business Opportunities ten cents per word. \$1.00 minimum.

Entered as second-class matter March 23, 1922, at the Post Office at New York, N. Y., under the Act of March 3, 1879.

TUBE CHARGES ISOLATED

Washington.

The Federal Trade Commission refused to mix up the anti-trust case against the R. C. A. and six others with the charges by independent manufacturers that the tube clause in R. C. A. license contracts is monopolistic. The set makers are compelled to sell R. C. A. tubes with the sets.

The Customer's "Electric" Shock

THERE is so much misleading advertising appearing in the public press on alternating current tubes that radio sales have fallen off to an alarming extent. Several reliable, but misguided, manufacturers have over-done their job in selling the public on the idea of the "No Batteries, No Eliminators—Your Light Socket Supplies all Power."

What is the result? People walk into a radio store and demand a radio set or a kit of parts that will work directly from the house wiring current. They simply want to "plug-in" and forget it—just as the adv. says. The customer appears hurt and grieved when the dealer tells him that no electric radio set has ever been built, or ever can be built which does not require a so-called "B battery eliminator" or "power unit." The customer is amazed and dumfounded when the dealer tells him that the current as it comes from the light socket is totally unsuited to operate any radio set without the use of power units.

My Word! Anything But That!

"You mean by that," says Mr. Prospective Radio Buyer, "that I've got to use one of those old-fashioned sets or kits of parts that requires an eliminator? Nothing doing!" And to prove that Mr. Prospective Radio Buyer means business, he removes his hand from the pocket that contained the necessary wherewithal and leaves the store, muttering incoherently to himself, "Plug into the Light Socket—Bologna!"

After Mr. Prospective Radio Buyer has visited several stores, and heard the same story in each, he decides that, perhaps it will pay him to wait until radio has outgrown the experimental laboratory stage and entered the phase of commercial utility.

In the meanwhile, the dealer has lost a sale. The manufacturer has lost a customer. And the customer has lost his mess of radio pottage.

The blame for all this rests on somebody's shoulders. Somebody has been making false statements which had reacted to the disadvantage of the entire radio industry. October sales prove it.

The Standing and Walking

All along the line dealers have been "standing by" while customers were walking by—customers who had the means, and oftentimes the desire, to own a complete radio outfit, either electrified or all-electric.

Yet the customer and the dealer cannot do business simply because several reliable, although misguided, manufacturers have been applying wild superlatives in order to put across their "all-electric" sets.

Back in 1926 the popularity of battery eliminators, trickle chargers and the like was very great, simply because to get what one wanted with a certain amount of truthfulness on the part of the man who had it to sell was a matter of simplicity itself. Today all that is changed.

The radio manufacturer of yesteryear, who used to state that his receiver could be obtained with or without batteries, or with certain types of eliminators, is in the discard. In his stead has come the radio manufacturer, with psycho-analysis at his command. "See my new set," he explodes, "it works *entirely without batteries, without eliminators—your light socket supplies all power!*" See these new tubes?" he raves on, "there are AC tubes. They work right off the bat, from your 110-125 volt AC line. Great Stuff! Yes, sir. Right from your AC line!"

Facts Will Out

Yet, despite the glowing statements of

the manufacturer, the unwary purchaser soon discovers—sometimes too soon!—that his set, like that of his neighbor, has tumbled away in each corner, a B battery eliminator and either a small storage battery with a trickle charger, or in place of the latter, a step-down or so-called heater transformer as a means for supplying the A current.

Of course the set is an electric set. And in nine cases out of ten, it is a good electric set. Moreover, there is nothing wrong with the current supplying methods used by this particular manufacturer—absolutely nothing. But, there is **SOMETHING DECIDEDLY WRONG WITH HIS METHODS OF ADVERTISING!**

In telling the prospective buyer that his set works without batteries or eliminators, he is not only guilty of downright lying but he is also injuring his trade and the trade of his fellowmen.

As often as not, the customer would be satisfied with his product if the manufacturer simply said that the set was an electrified outfit, made so by virtue of B eliminators and AC tubes, supplied by transformers. The customer could even understand that it was necessary to have some sort of current supplying devices, just as he is obliged to have a battery, a generator and a gas supply in his car.

Like Self-Starter

Now, B eliminators, AC tubes and certain A devices, which work from the light socket, are to the radio set what the self-starter is to the automobile. In the old days, to get the old buss started one had to get out and crank the thing—just as he has had to use batteries. Then came the self-starter. It was handy, convenient, and represented progress in the automotive world. Still, the old wagon ran just as smoothly when it was cranked by hand! And the radio set will continue to run just as smoothly when it is supplied by direct current devices, such as batteries, eliminators and the like.

There is no reason to suppose that the new AC tubes will work better or worse than ordinary DC tubes. There is no especially good excuse why the owner of a radio set, now being supplied with current from batteries or eliminators, should junk his outfit. Nor is there any sense in trying to dissuade the unversed technical buyer from becoming interested in "self-starting" radio receivers. But let's tell him the truth about the matter.

Good But Will Be Better

While AC tubes are good at present, they will become much better as days pass into weeks. Because present-day methods of manufacturing AC tubes are not perfect does not necessarily mean that they will never improve. The difficulties now being experienced, which of course curtail production, will eventually be swept aside. In the meanwhile the radio industry must carry on. Christmas is coming. Little stockings must be filled to overflowing with the good things of life. Even the stockings belonging to children of radio dealers must come in for their share. So the manufacturers who in the past have been publishing misleading advertisements about their "all-electric-direct-from the light-socket-sets" must abandon their tactics and get down to business.

No electric set has ever been built or marketed which does not require a so-called "B-battery eliminator" and a transformer for the A current supply. The sooner everybody understands and realizes this, the sooner the radio dealer, manufacturer, jobber and salesman will have turkey on the table.

The Circuit One Flaw Alone Positively Kills

(Continued from last week)

It is a simple matter to build a super-selective receiver. It is equally simple to build a super-sensitive receiver. Both of these can be attained with particular ease when the intermediate frequency amplification method of reception is employed in the receiver.

It is not difficult at all to build a receiver of startlingly realistic tone quality. It is not particularly difficult to build a receiver which is easy to tune and to control. Both are easy of attainment when the double detection method of reception is not employed.

The difficulty enters when an attempt is made to combine these four desirable qualities into a receiver and to make that receiver approach perfection in all. Hundreds of radio engineers have met rebuff and failure when they have tackled this seemingly insuperable problem. They may have succeeded in mastering any one, or any two, or even any three of the qualities, but not all four in the same receiver.

One Flaw Kills Circuit

There has been usually at least one flaw in their product, a sufficient cause to consign it to oblivion.

But the failures of hundreds do not preclude the possibility of success of one. When the problem to be solved is clearly delimited and understood by some one, that one will have gone a long way toward the solution. And if he has learned by the errors of others and profited by their successes, he is very likely to arrive at the optimum solution.

One may truly say that a designer has attained the goal which many others have sought in vain—a receiver which is within a fraction of a percent of perfection. And he attained the goal not only by avoiding the errors of others and by taking advantage of their successes, but by introducing original ideas of his own.

In what respect did the designer take advantage of the successes of others? By selecting the best possible parts for the receiver, by selecting parts which fitted perfectly in with the desired overall characteristic, by co-ordinating the characteristics in a scientific and logical manner, and by choosing the proper circuit.

The Intermediate Coils

In this way he took advantage of the results obtained in scores of research laboratories equipped with the best trained minds and the best instruments.

For example, let us consider the intermediate frequency amplifier. This is the backbone of any double detection receiver. Selectivity resides in it, sensitivity is its major contribution, quality is related to it, and ease of control depends on it. The receiver either stands or falls on the performance of the intermediate amplifier. When the public renders its verdict of a receiver of this type after a trial period, no direct reference is made to the intermediate amplifier; but in every case that is what has been tested.

In view of the great importance of the intermediate frequency amplifier it is logical to assume that special attention is given to it in the design of a great recreator. Whether this is the case or not will be brought out when we examine the construction of the intermediate frequency transformer.

There is one more feature peculiar to the double detection receiver that always deserves special attention. That is the oscillator. There are many types of oscillator

circuits. There is probably only one circuit which gives uniformly good results over the entire broadcast band. That is the one to use.

The oscillating circuit consists of the principle tuning condenser and a large by-pass condenser both in series with a split oscillator winding.

One of the problems in designing a double detection receiver is to retain a high degree of selectivity and the higher audio notes at the same time. That is, high selectivity without side band cutting. Correct intermediate coil design contributes to this.

Wave Form Distortion Avoided

There is a form of distortion which occurs in every set, and that is wave form distortion. This form of distortion is more serious than any other because it is the one that the ear notices first.

The amount of this distortion in the out-

put of a receiver depends on the design and on the tubes used, as well as on the voltages used.

If adequate filament current, plate voltage, and suitable grid bias are used, then the amount of wave form distortion depends on the power handling capacity of the tubes. Particularly the detector, the first audio and the second audio amplifiers.

If the detector is standard and if a 112 tube is used in the first audio stage and a 171 in the second, then the wave form distortion will be very small for all volumes practical in an ordinary home. Such tubes are used in the circuit and the amount of wave form distortion in the output is wholly negligible and imperceptible.

The expression "ease of control" covers several things. It refers to the ease with which stations can be tuned in and separated from stations not wanted. In this respect it is a delight. The condensers must turn very easily and without any jerks or lost motion. This greatly aids in bringing in distant stations. Then ease of control also refers to the modulation of the volume or the adjustment of sensitivity. In this respect a circuit is simple when it has only one major volume control, perhaps a potentiometer controlling the grid bias on the intermediate tubes. In addition, and secondarily, a rheostat may be used for control of the filament current in the intermediate tubes.

(Continued next week)

Baffin Party Received 310 Stations in Arctic

What is believed to be a record for long distance reception in the Arctic Circle was made public by Edward Manley, radio operator of the Morrissey, who has just returned from a five months' trip with the Putnam-Baffin Land Expedition.

From the Northern extremity of the expedition's itinerary, in wild Fox Basin, a total of 310 stations were "copied" by Manley, using a three tube dry battery powered short wave receiver of the regenerative type.

Relying solely on this three tube set, and its dry batteries for power, the Morrissey operator pulled in 204 stations from the United States on the 40 meter wavelength and 85 on 20 meters. A total of 18 foreign countries were also in communication in this manner with the party in Fox Basin. They included 8 Canadian stations, one in Greenland, two in South America, one each in South Africa and New Zealand, three Belgian, two French, one in Porto Rico and 2 in Labrador.

Got Time Signals Daily

In addition, Manley "copied" each day the time signals from Washington, D. C., which enabled Capt. Bartlett, the skipper of the Morrissey, to check his chronometers.

The Morrissey was the first ship to enter Fox Basin, carrying white men, in a hundred years. In the year 1822-3, two ships entered the Basin, but since that time, until the Putnam party penetrated its icy fastnesses, no white man ever entered its practically unexplored waters. The fact that no white man had preceded them for a full century did not, however, obscure the fact that the white man's signals had already penetrated the forbidding area. Station after station was pulled in at the operators' command during their stay in the Basin.

In addition to copying the signals from these stations, the radio apparatus of the Putnam Expedition proved invaluable in the party's exploration in surrounding waters.

Operated by Monroe Barnard, son of

George Grey Barnard, the sculptor, a long wave receiver using both B and A dry batteries, was taken by a number of the party on their 400-mile trip in the Morrissey's whale-boat.

Proceeding eastward 100 miles and northward 100 miles, and thence returning to the ship, the whale-boat succeeded in actually cutting a huge area off the map of Baffin Island. The receiver was used for checking the chronometers, the exact time signals as received by the radio set being used to compute the differences in time between the Greenwich Meridian and their own location.

To this fact was largely due the ability of the party to compute distances so accurately that their final measurements showed Baffin Island to be 5,000 square miles less in area than the preceding expedition's map, until now universally accepted, showed it to be. Inability of previous explorers to check their chronometers was given as the reason of their failure to measure accurately the Arctic Island.

Included in the whale-boat party were George Palmer Putnam, his son David, young Barnard, George Weymouth, John A. Pope, Lawrence A. Gould and the Eskimo Avalita.

Magnetic Pole Static-less

Mr. Manley pointed out that these radio operations were carried on at a point nearer to the Magnetic Pole than had ever before been done. For this reason, he said, it is of interest to note that the further away that the stations which were received were located, the more clearly they came through. Very little static was encountered, far less than at any other place known.

His radio power equipment on which he achieved his record "copy" of 310 stations, consisted of three Eveready Layerbilt 45 volt dry B batteries on the short wave receiver and Eveready dry cells and 22.5 volt vertical B batteries on the long wave receiver.

Literature Wanted

THE names and addresses of readers of RADIO WORLD who desire literature on parts and sets from radio manufacturers, jobbers, dealers and mail order houses are published in RADIO WORLD on request of the reader. The blank below may be used, or a post card or letter will do instead.

RADIO WORLD,
145 West 45th St., N. Y. City.

I desire to receive radio literature.

Name

Address

City or town

State

Roy C. Briggs, 708 North Spring St., Independence, Mo.
Fred Swart, 93 Cedar St., Brockville, Ontario, Canada.
L. Leonards, 3016 Lyncaste, Detroit, Mich.
John D. Johnson, 2601 66th Ave., Oakland, Calif.
R. C. Cosgrove, 17 Oakwood Road, Quincy, Mass.
J. L. Crouck, 1401 9th St., Moundsville, W. Va.
Joseph Linker, 81 Covert St., Brooklyn, N. Y.
Thomas V. Wright, P. O. Box 14, Mattoon, Ill.
Fred H. Scheel, 440 20th St., Bettendorf, Ia.
Arthur Bornd, Box 104, Macon, Ga.
Radio Service Bureau, 1524 Macombs Road, Bx., N. Y. City.
C. F. Laurel, RFD 1, Wyandotte, Mich.
G. L. Darby, 6509 Avenal Ave., Oakland, Calif.
Warren Smith, Box 601, Wakefield, Mich.
F. C. Krause, Jr., 212 Narp St., San Antonio, Tex.
L. E. Harper, W. U. T. Co., Brownsville, Pa.
Chas. Schwaver, 1899 19th, Galveston, Tex.
Edwin Dunn, 4631 Park Ave., N. Y. City, N. Y.
John Clark, 15 Holiday Street, Dorchester, Mass.
A. L. McWhirter, 537 N. Union Street, Shawnee, Okla.
J. Robert Chandler, Arcade Bx. 1004, Los Angeles, Calif.
A. J. Sadick, 1090 Simpson St., Bx., N. Y. City, N. Y.
Carlisle Strausbach, 1920 Post St., San Francisco, Calif.
E. Tanley, 204 Progress Ave., Hamilton, O.
Hans Muller, Carrioba, Villa Americana, Estado De S. Paulo, Brazil
S. Balcerowicz, 611 S. Milton Ave., Baltimore, Md.
J. Hampshire, 174 Warburton Ave., Yonkers, N. Y.
L. C. Quiros, 276 Fair Paks St., San Francisco, Calif.
E. G. Freese, 205 South Hl. Arcanum, O.
R. S. Hooker, Jr., 2147 N. Howard St., Philadelphia, Pa.
Arthur W. Mooers, 109 High Holborn, Gardiner, Me.
George E. Leavitt, Pineflat, Sonoma County, Calif.
Thornton Bogert, 1153 Halpin Ave., Cincinnati, O.
Frank Cox, Foley, Mo.
Wallace J. Swires, Box A-10488, North Side Station, Pittsburgh, Pa.
Harvey H. Phillips, 1316 East 13th St., Des Moines, Ia.
Lloyd Fitzgerald, Diablock, Ky.
George F. Neubert, c/o Broadway Central Hotel, N. Y. City, N. Y.
Lexington Radio Shop, 134 East 110th St., N. Y. City, N. Y.
W. B. Kulberg, 2871 Humboldt South, Minneapolis, Minn.
Ben C. Dunlap, 1915 Georgia Ave., Toledo, O.
S. A. Kolz, c/o Y. M. C. A., Sand St., Brooklyn, N. Y.
D. C. Bedwell, 1025 Redfern Ave., Dayfan, O.
S. B. Folkman, 1903 East 9th St., Cleveland, O.
W. J. McMahon, 511 Broughton St., E. Savannah, Ga.
W. S. Sweeney, 23 Blecker St., Brooklyn, N. Y.
John Orel, 338 East Houston St., N. Y. City, N. Y.
Parvin R. Thomas, Boonville, Ind.
Nelta R. Simpson, Chandler, Ind.
Edward Guinan, 55 Van Pelt St., Long Island, N. Y.
A. Munor, 3017 N. Bonsoll, Philadelphia, Pa.
Frank A. Martin, 457 Seldom St., Detroit, Mich.
James W. Massison, 724 East 3d Street, Sedalia, Mo.
Power Corporation of New York, Trust Company Building, Watertown, N. Y.
Charles Sasse, Jr., 189-25 116 Road, St. Albans, Long Island, N. Y.
F. C. Olander, 1485 Vallijo Street, No. 2, San Francisco, Calif.
Frank E. Blatz, 1136 1/2 West 42nd Street, New Bedford, Mass.
L. J. Hauser, 405 Glenwood, Buffalo, N. Y.
J. A. Dowie, Washington Ave., North Braddock, Alexandria, Va.
Howard L. Allen, 6 Locust Street, Nashua, N. H.

The Radio Trade

Best Programs Spoilt By Poor Obsolete Sets

By Eric H. Palmer

Two thousand dollars a night tenors do not sound much better than the two bucks variety on twenty dollar receiving sets, and of course it takes the finest instruments to record faithfully the thrills of Metropolitan sopranos.

This holds true in the reproduction of leading orchestras, now playing nightly for invisible millions.

Obsolete sets, makeshift contraptions, or hauls from the job lot sales, all too common in the big cities, are inadequate to meet present broadcast conditions.

Their presence warrants a strike by the foremost talent.

Certainly, it is not fair to judge the artistic merits of a program by such sets. Even much more important from the viewpoint of the listener is the constant tinny and blurring effects trying both ears and patience that follows the installation of bargain counter apparatus.

Modern Sets Do The Trick

Modern receivers, with their perfect amplification, bring in the deluxe entertainments with fidelity, making radio a source of keenest enjoyment, as it is meant to be and should be, and is, among the discerning.

There has been a lot of criticism, openly expressed, and presumably much more privately circulated, regarding the relative merits of the stars who have appeared on the chain programs. In the cases which have come under special notice, investigation reveals that ancient equipment, with rattling speakers ("squeakers" would be more like it) giving a blaring and distorting effect, was being relied upon, constituting an insult, virtually, to the performers.

Because reproduction of song and music was not all that it ought to be, in the experimental days, many brilliant artists refused to appear before a microphone. That is no longer the case. They are aware of the vastly improved methods of transmission; they realize that there are receivers which bring them to the family fireside in a manner adding to their fame and glorifying their art.

Replacement Not Fast Enough

Yet a survey reveals that replacement of unsatisfactory receivers has not been as speedy as most artists imagined. That is why they have reasonable cause for

complaint over ensuing damage to their reputations.

It is true that many thousands are tuning in on the Chicago Civic Opera presentations, for example, on receivers that are unable to meet the proper standards. Faulty amplification is the worst evil. Overloading the last stage is ruinous, but that has been obviated by the new receivers, with their finer transformers and utilization of power tubes.

Modern receivers are essential for full-est enjoyment. Their superiority over the old type of sets is more remarkable than has generally been emphasized. Advance in radio designs has been noteworthy. And the same holds true of speakers.

There is another consideration. Old-time sets did not possess the selectivity required by present conditions, with so many stations clamoring for recognition, on higher power than in the past. Unless tuning is sharp, chaotic conditions arise. Those who believe that broad tuning outfits are sufficient for local reception, with which they profess to be satisfied, find themselves hopelessly coping with heterodyning, cross talk, and whistles, all nerve-shattering, due to the many broadcasters actually humming in, particularly at this season.

What A Difference!

That there should be necessity for calling attention to these aspects of broadcast reception seems rather strange, in view of the knowledge acquired by hundreds of thousands of people to whom radio was only a dream a decade ago; but from information gleaned from centres now supplied with chain programs for the first time there appears to be considerable ground for justifying conclusions of this character.

Feature events relayed through local stations are becoming more and more popular in broadcasting.

This has brought about a feeling, among certain individuals, that "the old sets will do just as well."

Were these same persons to hear these programs on 1928 sets and speakers, they would feel as if they were leaving barnyard noises to hear echoes from a cathedral.

It's about the same as comparing a flute with a tin whistle.

R. C. A. \$4,141,355 AHEAD

The statement of operations of the Radio Corporation of America showed that for nine months ending September 30 the surplus amounted to \$4,141,355.32. The gross income from sales, communications, etc., amounted to \$16,775,091.27.

STATION FOR EAST AFRICA

Washington.

A license has been granted to the British East African Broadcasting Company to operate a broadcasting station in Nairobi, Kenya, Africa. Relayed programs from the European stations will constitute most of the transmitted material.

Many Uses for 'Homekaster'

The Alpine Radio Laboratories, 30 Church Street, New York City, who are putting out the "Homekaster," a novel device for broadcasting through one's receiver, report that many enthusiastic commendations are being received on this useful device.

Users also tell of many new ways of using it for instruction, entertainment and amusement which will be compiled in an article soon to be released. Another fan writes suggesting that it makes the ideal and most appreciated radio Christmas gift, fitting as it does all pocketbooks and creating a new use and interest in radio entertainment.

Some Interesting Circuit Designs

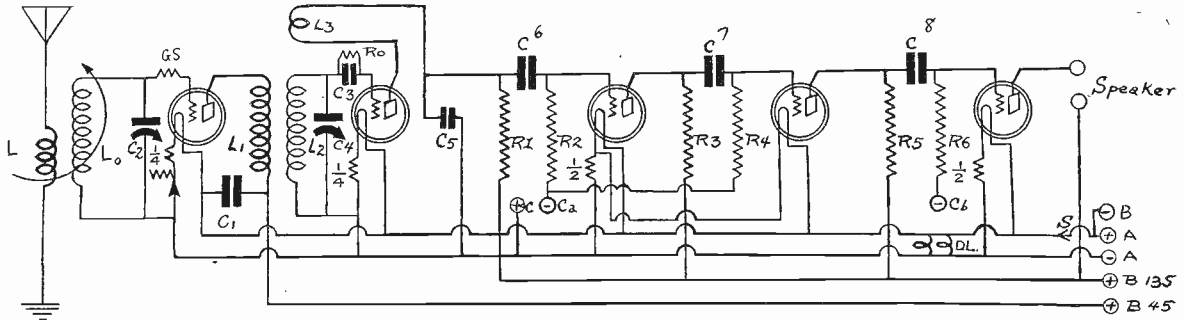

SCHMATIC DIAGRAM OF AN EFFICIENT 5-TUBE REGENERATIVE SET.

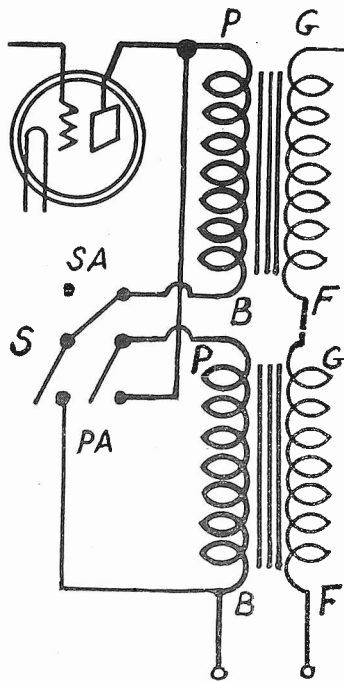

FOR HIGH AND LOW NOTE REPRODUCTION TRY THIS.

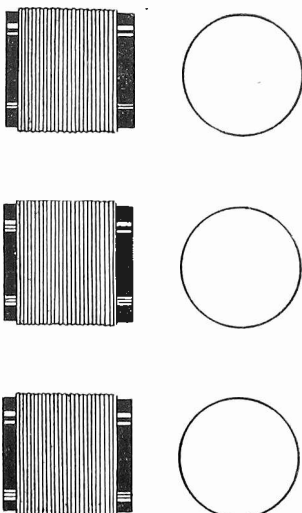

PLACING COILS THIS WAY WILL CAUSE SQUEALS

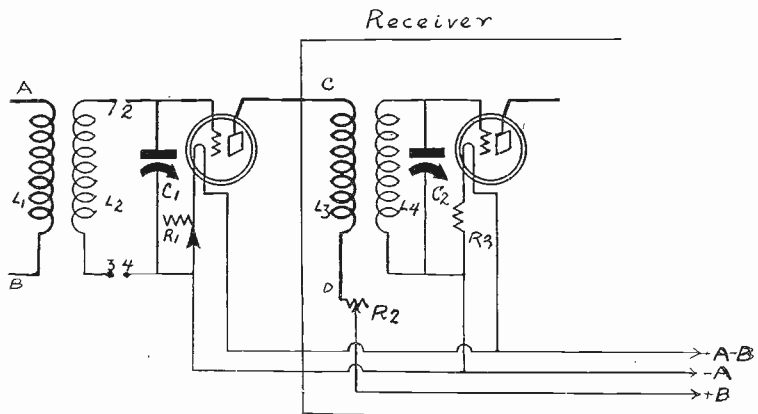

HOW TO CONNECT UP AN EXTRA STAGE OF TUNED RF.

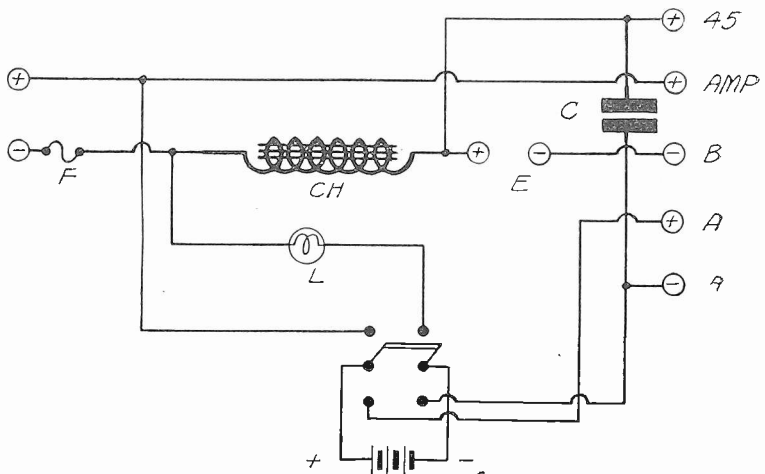

A DC B ELIMINATOR WITH PROVISION FOR CHARGER.

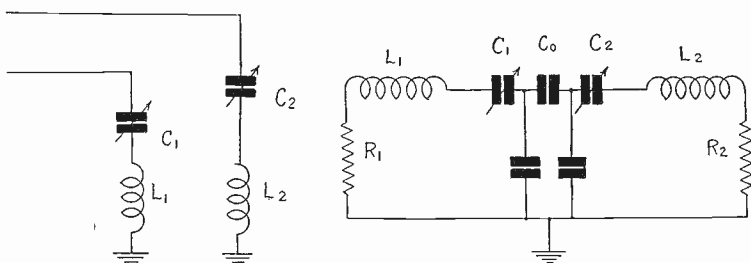

HOW TWO ANTENNAS IN PARALLEL AFFECT TUNING.

Radio University

A FREE Question and Answer Department conducted by RADIO WORLD for its yearly subscribers only, by its staff of Experts. Address: Radio University, RADIO WORLD, 145 West 45th St., New York City.

When writing for information give your Radio University subscription number.

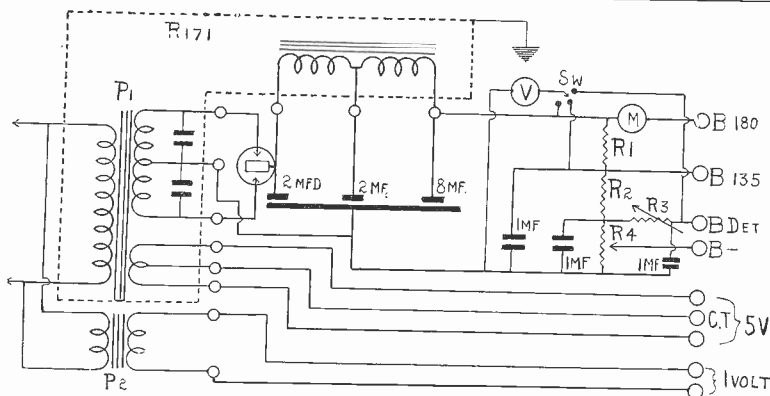

FIG. 580

THE ELIMINATOR DESIGN REQUESTED BY ORRIN FLINTLY.

PLEASE SHOW how to hook up a 180 volt B eliminator using a Raytheon BH tube with a Thordarson R171 power compact unit. I have a Clarostat, a condenser block containing two 2 mfd. and one 8 mfd. high voltage fixed condensers, three 1 mfd. fixed condensers, a high resistance voltmeter (0 to 200), a milliammeter (0 to 50), and a transformer with a one volt winding, all of which I wish to use in this eliminator. I am going to use the 1 volt transformer for lighting the filaments of Armor AC 100 tubes.—ORRIN FLINTLY, Passaic, N. J.

The circuit diagram of this eliminator is shown in Fig. 580. Each of the units is identified on the diagram. R1 and R2 are 1500 ohm fixed resistors. R4 is a variable resistance, 50,000 ohms maximum. R4 is the Clarostat. You will note that the voltmeter is so connected that it is possible to read the individual voltages for the detector, amplifiers, etc. The milliammeter is inserted in series with the maximum voltage post.

I HAVE a Yaxley No. 60 double throw, double pole jack switch. I wish to connect it so that I can use either the antenna and ground or loop. My set is of the seven-tube model, having three stages of tuned RF amplification, a detector and three stages of double impedance audio coupling.

Fig. 581 shows the method of hooking this jack switch up.

SEVERAL MONTHS ago I saw a diagram in the Radio University columns of RADIO WORLD of a trap circuit which used a 3-circuit tuner, a 201A tube and a filament rheostat. The primary of the coil was connected to the antenna and to the ground, while the antenna and ground connections of the receiver were made to the tickler and B plus terminals of the unit, respectively. Does not this trap circuit also act as an extra stage of radio frequency amplification? That is, will I get more distance when this is installed? Will the tuning become more difficult?

(2)—I have a four-tube set using a regenerative detector and three stages of transformer coupled audio, using low ratio transformers. A tuned plate is used in the detector circuit. Would you advise adding this unit to my set?

(3)—Should the extra unit be built in a separate cabinet, or can it be built within the set? There is plenty of room in my set for it.—GEORGE HAROLDS, Brooklyn, N. Y.

(1 and 2)—The unit is another stage of radio amplification. With the set you now have, however, this addition should

not be made, unless with some other changes. Take the regeneration out of the detector tube circuit, so that you have regeneration only in the radio frequency or trap unit. Otherwise the tuning will be very difficult. The addition of the unit will bring you more distance as well as volume. The selectivity will also be bettered.

(3)—You can build this unit in with your present receiver. Be sure that you keep the tuner coil away from the coil used in the detector circuit. See that all the leads to the grid and plate are short.

* * *

I INTEND building the 5-tube receiver described by Tim Turkey in the August 27 issue of RADIO WORLD. You will recall that this receiver utilizes a tuned stage of radio frequency amplification hooked up for loop operation, a regenerative detector and three stages of resistance coupled audio amplification. Please answer the following regarding this set.

(1)—I would like to use .01A tubes throughout. Could this be done?

(2)—Will this necessitate the use of lower B voltage, e.g., 135, as well as a common C for the audio tubes?

(3)—Can I use an antenna coupler in the loop input circuit, so as to be able to employ an antenna and ground?

(4)—I have a coil with a 6 turn primary and a 62 turn secondary, both of which are wound on a 2½ inch diameter winding with No. 22 single cotton covered wire. Could this be used?

(5)—What capacity variable condenser would you suggest shunting across the secondary of this coil?

(6)—Are there any changes to make when installing the coil? I do not wish to use the loop at all.—SANFORD DEVORE, Los Angeles, Calif.

(1)—Yes.

(2)—Apply 135 volts to the detector and the three audio tubes. Use a separate 4½ volt C bias for the first two audio tubes and a separate 4½ volt C bias for the last audio tube.

(3)—Yes, with great success.

(4)—Yes.

(5)—Use a .0005 mfd. variable condenser. Be sure that the rotor plates are brought to the beginning of the secondary winding, which is next to the end of the primary winding, which should be connected to the ground. The stationary plates of the condenser are brought to the end of the secondary winding.

(6)—No.

* * *

I DESIRE to build the Laboratory Electric which was described in the No-

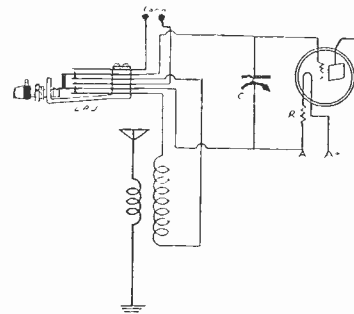

FIG. 581

THE LOOP-ANTENNA JACK SWITCH ARRANGEMENT.

ember 12 issue of RADIO WORLD, on pages 12 and 13.

(1)—What hookup wire do you recommend?

(2)—Which leads should I cable and which should I avoid cabling?

(3)—What is the value of the radio frequency choke coil?

(4)—Is it necessary to incorporate a coupling transformer when using the 171 tube?

(5)—What other tube may be employed in the last stage of audio frequency amplification?

(6)—In the circuit diagram, only two .5 mfd. fixed condensers are indicated, while six are specified in the list of parts. Are the four other condensers, which are between the arm of the potentiometer and one side of the line, one on each side of the .5 mfd. value?—LEONARD WALFORD, Kansas City, Mo.

(1)—Use regular flexible wire for the grid and the plate connections. This applies to the grid return, and the B plus, also. For the filaments, use heavy No. 14 rubber covered wire. In case you are going to use a power tube in the last stage, such as the 210, then use the No. 14 also, for the B lead.

(2)—Cable all the filaments and the B plus leads.

(3)—Use a 85 millihenry Hammarlund choke.

(4)—Although it is not necessary, it is desirable.

(5)—The 210 will work great here. This will necessitate the construction of an eliminator which will deliver 460 volts at 50 milliamperes. The Victoreen power supply, described in the Oct. 15, 22 and 29 issues of RADIO WORLD can be used here.

(6)—Yes, this is the right idea.

* * *

IN OCTOBER I built a 6-tube set in which three stages of tuned radio frequency, a detector (non-regenerative) and two transformer audio stages were incorporated. The set worked great. I did not, however, at that time, place the set in a cabinet. Recently I acquired one and put the set in. I, as well as all the other members of the family was really startled at the tremendous increase in volume and improvement in quality when the set was inserted into this new cabinet. What could have happened? I never was under the impression that a set had to be installed in a cabinet, before you could get the best out of it, but this test seems to have proved this to me. Is this so? The coils and the condensers in the set are enclosed in shields. So as to make a neat job, I shaved out grooves underneath the baseboard, so that I could run the leads here. I used insulated staples to hold the wires in place. Would this have any effect on the results?—JAMES TRUMP, Camden, N. J.

Due credit can not be given to the cabinet proper. What probably happened, was that a couple of leads which heretofore were only making slight con-

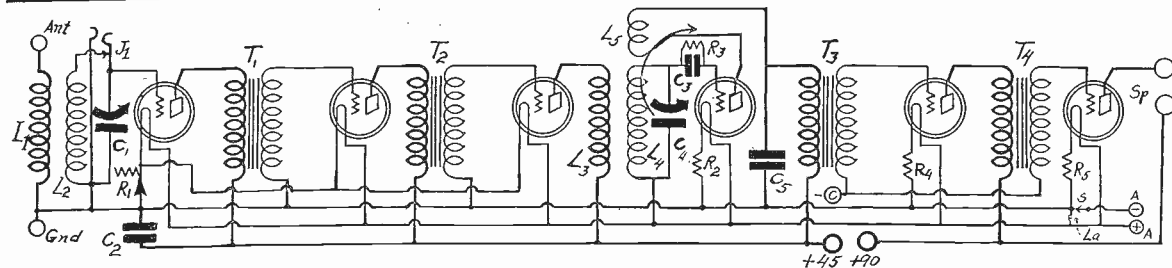

FIG. 582
THE CIRCUIT DIAGRAM OF THE 6-TUBE RECEIVER REQUESTED BY PAUL FROWN.

tact were forced up against the terminals with which they were supposed to make contact, so as to strengthen the contact. In other words, if you took the set out of the cabinet and tightened up the connections on these loose leads, the effect would have been the same. Try it now and see. Test all the connections with a battery and phones.

I HAVE decided to build a 5-tube tuned radio frequency receiver and would like to have the following questions answered.

(1)—Using the angle method of mounting solenoid coils, is it necessary to use shields? I have made up out of brass, some angles which you can adjust to any angle you desire. This is accomplished with the aid of hinges which have been soldered to the angles. The hinges have springs which are very taut. That is, they will stay put, without the angle folding up, when pressure is applied. After the proper angle is obtained, I intend using a small spring to hold it in place.

(2)—I have coils which contain 20 turn primaries, and 50 turn secondaries. These are wound on a tubing 3 inches in diameter, using No. 22 double cotton covered wire. The spacing between the primary and the secondary winding is only 1/4 inch. Can these coils be used? The secondaries are tapped at the 12th turn from the beginning.

(3)—Is it all right to place the 5 tubes in a row, right next to each other?

(4)—Could I use a radio-frequency choke coil and a bypass condenser in the detector output circuit? How would a 65 mil choke and .0005 mfd. fixed condenser do?

(5)—Is the correct angle of mounting, 55 degrees? — WARREN KELMAN, Berkeley, Calif.

(1)—You don't have to use shields between the coils. It wouldn't be a bad idea, however, to place the entire set in a metal housing, this to be grounded. This will prevent the coils from acting as miniature antennas, thus causing them to pick up energy and which cause broad tuning.

(2)—Yes, these coils can be used.

(3)—Yes. It will be necessary to watch the grid and plate leads to see that they are not placed parallel to each other.

(4)—Yes, use the values you specify.

(5)—Yes.

I HAVE a 5-tube receiver. It consists of two tuned radio frequency stages, a crystal detector in an untuned radio frequency stage, and three stages of resistance coupled audio frequency amplification. The set worked splendidly until a month ago, when the signals became so low that I could hardly hear them. It has been acting this way ever since. I have tried new tubes, batteries, crystal and checked up the antenna and ground. All are O. K. I am beginning to think that the trouble is in one of the resistors. Could they have burnt out?—THOMAS MILLER, Troy, N. Y.

It is very possible that either the plate or the grid resistors are burnt out. It is also possible that the fixed condensers have gone 'west.' Be sure that the contact between the tube prongs and the

socket terminals is all right. Dust usually collects here and acts as an excellent insulator. Test the leads going to the batteries, to see if there is a break along the line.

SOME MONTHS ago I saw a hookup of a 4-tube set using a single tuned radio frequency stage, a regenerative detector (3-circuit tuner) and two transformer coupled audio stages. The radio stage and the detector were tuned by a variable condenser having a common rotor. Would you suggest building a set of this type?

(2)—The set does not show any by pass condensers. I have noticed that in many of the later models of receivers, such condensers of the 1 mfd. type are connected between the B plus posts connected to all the plates and the minus A post, even if there are four B plus posts. Could this be done with this set? There are three posts, one going to the detector plate, one to the radio frequency and the first audio plate and the other going to the last audio plate.—G. HENRY PHILLIPS, Pittsburgh, Pa.

(1)—It would be better to build this set with two separate condensers. They may be hooked up to a drum dial which will make the operation similar to that of a single dial. That is, although these condensers are individual, they may be turned at the same time, because of the proximity of the controls.

(2)—The bypass condensers would greatly improve the set. They may be connected as you suggest. If the radio frequency tube filament has no rheostat, insert one that has a resistance of 20 ohms. The detector and audio tubes can each be controlled by Amperites, the type depending upon tubes used.

I WANT to build a six-tube set with provision for a loop or an aerial, using the following parts:

Two .0005 mfd. variable condensers, a radio frequency coil and a 3-circuit tuner, both of which have secondaries matched for these condensers, two untuned radio

frequency transformers (200 to 500 meters), a pilot light, a filament switch, a single circuit closed jack, and two audio frequency transformers, both of which have a ratio of 2 to 1. Please give me the circuit diagram of a set with which I can use these parts.—PAUL FROWN, Jersey City, N. J.

The circuit diagram of a receiver using the parts you possess is shown in Fig. 582. The radio frequency transformer is used in the first stage, the untuned transformer in the next two stages, and the 3-circuit tuner in the detector stage. The audio transformers are, of course, used in the audio end. The filaments of the radio amplifier tubes are each controlled by a 10 ohm rheostat. The detector filament, and the audio tube filaments are each controlled by a 1A Amperite. The variable condensers are shunted across the secondaries of the tuned and the 3-circuit coils. C4 is a 1 mfd. fixed condenser. The grid leak R3 has a resistance of 4 megohms. C5 is a .001 mfd. fixed condenser. C3 is a .00025 mfd. fixed condenser. La is the pilot light. S is the filament switch. The single circuit jack is used for switching the antenna out and the loop in, or vice versa, by simply putting in or out the plug connected to the loop. Use a 4 1/2 volt C battery.

WOULD YOU advise building a receiver using two tuned radio stages, a detector and three stages of resistance audio coupling with the first tube reflexed? I intend using two double condensers. Would they work all right?—F. MANUEL CORSETT, Cleveland, O.

No, such a set would be difficult to operate. It is suggested that you build the set, leaving the reflexed stage out. The double condensers can be used, but it will be necessary to use small midgeet condensers across each one. These midgeets have two stators and a common rotor just like their big brothers. Their capacity is, however, about .00005 mfd. maximum, for each half.

Join RADIO WORLD'S University Club

And Get Free Question and Answer Service for the Coming 52 Weeks
This Service for Yearly Subscribers Only

Have your name entered on our subscription and University lists by special number. Put this number on the outside of the forwarding envelope (not the enclosed return envelope) and also put at the head of your queries. If already a subscriber, send \$6 for renewal from close of present subscription and your name will be entered in Radio University. No other premium given with this offer.

[In sending in your queries to the University Department please paragraph them so that the reply can be written under or alongside of each query. Write on one side of the sheet only. Always give your university number.]

RADIO WORLD, 145 West 45th Street, New York City.
Enclosed find \$6.00 for RADIO WORLD for one year (52 nos.) and also enter my name on the list of members of RADIO WORLD'S University Club, which gives me free information in your Radio University Department for 52 ensuing weeks, and send my number indicating membership.

Name

Street

City and State

**THE LATEST IMPROVED
"DIAMOND OF THE AIR"
HERMAN BERNARD'S
GREAT SET STILL THE
BEST CIRCUIT**

Complete Authorized Kit of Parts for 5-tube set, as specified in this issue, **\$39.00** ready to build

4 TUBE KIT, \$35.00

Get our money-saving prices on following kits!

Karas Equamatic, Karas Knickerbocker 4, Silver-Marshall Shielded Six, New Hammarlund-Roberts HI-Q, Everyman 4, Aero-7, Powertone, 4-Tube Diamond of the Air, Lynch Five and all New Kits.

IF IT'S A KIT, WE HAVE IT
Send for New Free Catalog, Just Out

B.C.L. RADIO SERVICE CO., Inc.
220 FULTON ST., NEW YORK CITY

RADIO MAILING LISTS AND SALES COPY

We furnish all classification of lists—and Write copy for Sales Letters, Folders, Catalogs, Ads for the Radio and Auto Industries. Give us your proposition for FREE suggestions. FAULTLESS ADVERTISING SERVICE.

430 Quincy Bldg., Chicago, Ill.

"Double R"

**PANEL METERS
RUGGED AND RELIABLE
ASSETS FOR YOUR SETS**

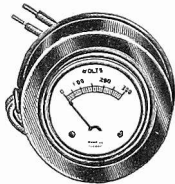

Tubes last longer when the voltages are right. The panel meter is just the thing you want for that. If you are discriminating you want the finest tone quality. A 0-50 millimeter in the plate circuit of the last tube serves that object admirably. Mount the meter on the panel.

You will be delighted at the enjoyment that will be afforded by the use of a panel meter. accurate, yet priced very modestly.

The DOUBLE R meters are sturdily built and accurate, yet priced very modestly. You send us nothing yet we send the meters. All you have to do is let us know what meters you want. Order by catalog number, which appears on the left in the list printed herewith. When the postman delivers the meter you pay him the price listed below, plus a few cents postage. Then you will put your meter into action and enjoy the fruits of your wise buy. Note AC meters for new AC tubes.

DC PANEL MILLIAMMETERS

No.	Price	No.	Price
No. 311—0-10 mil-ampères	\$1.95	No. 390—0-100 mil-ampères	\$1.65
No. 325—0-25 mil-ampères	1.85	No. 399—0-300 mil-ampères	1.65
No. 350—0-50 mil-ampères	1.65	No. 399—0-400 mil-ampères	1.65

DC PANEL VOLTMETERS

No.	Price	No.	Price
No. 326—0-6 volts	\$1.65	No. 342—0-150 volts	\$1.75
No. 335—0-9 volts	1.65	No. 340—0-8, 0-100 volts (double reading)	2.25
No. 310—0-10 volts	1.65		
No. 337—0-50 volts	1.65		
No. 339—0-100 volts	1.75		

DC PIN JACK VOLTMETERS

No.	Price	No.	Price
No. 306—0-6 volts for No. 25, 28 Radialas	\$2.50		
No. 308—0-6 volts for No. 20 Radialas	2.50		
No. 307—0-6 volts, desk type with cord	2.50		

AC PANEL VOLTMETERS

No.	Price	No.	Price
No. 351—0-15 volts	\$1.75	No. 353—0-6 volts	1.75
No. 352—0-10 volts	1.75		

GUARANTY RADIO GOODS CO.

145 West 45th St., New York City.
Please send me Double R meters catalogue numbers

....., for which I will pay the postman on receipt of meters, plus a few cents extra for postage. These meters are to be received by me on a 5-day money-back guaranty.

Name
Address
City State.....

**Interesting Sidelights
on the Concertrola**

(Continued from page 19)

battery. Naturally, you fellows saw all this on the blueprints. Why don't you, Heterodyne, use that method on your set?

Tracing the Blueprints

"I had it in mind," Heterodyne retorted. "I suppose you'd call it the B battery drop method. It shows on the blueprint that the grid return of the tube to be biased is connected to negative B circuit, and the proper resistance is then connected from this point to the ground. I guess it's because the cathode or heater type of tube allows you to do this is the reason these tube have been specified. Now let's trace it again on the blueprint. Let's see, now. The grid return of the first two tubes, which is now connected to minus of the three volt C battery, should be connected to the ground, also to one side of a 1 mfd. condenser, also to one side of the 3,000 ohm variable resistance. So far, so good. Now, the other side of the 1 mfd. condenser and the other side (meaning, of course, the side not used the first time), of the variable resistance should be connected to the cathode of the tube—at the point where the C plus is now connected. Of course, it shows that the cathode must not be grounded when using this method. The variable resistance should be adjusted until the loudest signal is heard in the speaker. Simple, hi!"

"I had an idea," Fred cut in, "that you didn't understand that much about radio, Heterodyne. But don't forget, you fellows, that no matter what changes you make in electrifying your set, fundamentally the circuit is the same as my battery outfit, that is, from a radio frequency standpoint."
"Just one more question," Heterodyne ad-

ressed his remark to Franklin, "What about the rectifying tube. Have you had any trouble with them burning out?"

"Yes and no. A good gaseous rectifier tube ought to last for at least 1,500 hours. Especially in the Concertrola, because the drain on the tube is very light. Perhaps you know that all gas rectifier tubes go west because of 'gas fatigue.' This is the breaking down point of the gas used as an ionizing agent through impurities.

"A genuine gas rectifier, I'm using a C. R. A. with fine results in my set, is filled with 99-78/100 per cent. pure helium gas. They tell me that a C. R. A. tube has all parts purified in hydrogen atmosphere before assembly, so that no impurities can combine with the helium. This can only mean that such tubes have long life, sustained output, with no gas fatigue. When my C. R. A. goes bad, Heterodyne, I'll send you a postal card!"

"Well," Heterodyne assumed a reclining posture, and lit another cigar, "well, before I build my set I am going to find out all about tubes, transformers and speakers. I've made out an examining paper, and when I can answer all the questions which I have listed, then I'll show you my speed."

Questions

He brought forth several sheets of foolscap, upon which were the following questions:

- 1—How many tubes are used in the Concertrola?
- 2—Which tubes will produce the best results, McCullough, Sovereign, R. C. A. or standard tubes?
- 3—How is the current furnished for the heater type of tubes?
- 4—What is the DXer used for?
- 5—Is the Concertrola entirely shielded?
- 6—Where is the power stage located, and what tube is used?
- 7—Does the set work from an aerial, loop, ground or counterpoise?
- 8—Is there even the slightest hum or buzz, and if so, how can it be eliminated?
- 9—What is the 75 or 100 ohm potentiometer used for?
- 10—How are the Concertrola Coils made?
- 11—Why have Ferranti transformers been chosen?
- 12—Is the Concertrola a new type of electric set?
- 13—How many connections, of what color wire?

(Concluded on page 27)

CARTER PARTS
Represent the latest developments in the Radio Art
Carter Radio Co.
300 S. Racine Ave. CHICAGO

SPECIFIED PARTS IN STOCK

The Everyman 4

Official Sales and Service Station
SET ON DEMONSTRATION
Mail Orders on Kits, or Custom-Built to Your Order Sets, Filled Anywhere
RADIO KIT COMPANY
Room 401 Tel. Cortlandt 1849
72 Cortlandt Street, New York City

BOOKS ON AVIATION

ABC of Aviation \$1.25
Aviation Engines 1.25
Glossary of Aviation Terms... 1.00
Aviation Trouble Chart..... .38
Modern Aircraft 5.00

All Five Books Sent on Receipt of \$8.00

THE COLUMBIA PRINT
145 West 45th St., New York City

RADIO WHOLESALE

Write for my Big 1928 Radio Catalog—just off the press. Thousands of marvelous bargains in nationally advertised goods. All the LATEST IN RADIOS and equipment. Lowest wholesale sale prices.

FREE

It's a regular encyclopedia on Radio. All about trouble finding. **FREE Log and Call Book and Catalog.** Get your copy today. Send postcard now!

American Auto & Radio Mfg. Co.
DEPT. SECUR-ARTZ-2080, PHOEN. Dept. 193, American Radio Bldg., Kansas City, Mo.

DEALERS NEW 1928 CATALOG
Agents Wanted.

Why is the Karas Equamatic the Most Efficient Receiver Ever Designed?

Write us for Full Information

KARAS ELECTRIC CO.
4039-LA, No. Rockwell St., Chicago, Ill.

(Concluded from page 26)

- 14—Can I use the Concertrola as a phonograph amplifier?
- 15—What metallic phonograph pick-up unit is specified?
- 16—What is the actual cost, in dollars and cents, for operating the set? What is the cost of constructing it?
- 17—Is it possible to purchase a complete kit of parts?
- 18—Who sponsored the Concertrola Circuit?

* * *

(The first of this series of articles on the Fenway Electric Concertrola appeared in the November 5 issue. Constructional data appeared in the November 12 issue. In the November 19 issue, it was described for use with batteries, while last week data on how to electrify it with the RCA tubes were given. Some interesting pointers on wiring are given this week, while next week in the concluding article, a complete summarization of the receiver discussing all the important high spots of the circuit will appear. Questions will also be answered.)

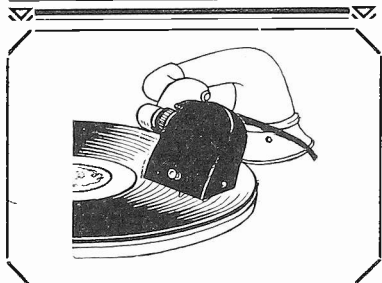

The Patent PHONOVOX
(The Electric Pick-Up)

—with your radio set, converts any phonograph into producing the equivalent of Electric Phonograph reproduction—the wonderful tone quality and the wider range covered which brings a new interpretation of fine music, at a cost of only \$12.50.

Easily and quickly attached by anyone in two minutes' time without tools or changes in wiring.

All dealers handle the Phonovox. Ask for a demonstration.

Patent Radio Corporation
156 West 16th Street, New York City

Flechtheim Appoints Adelman as Executive

Arthur M. Flechtheim, president of the A. M. Flechtheim and Company, Inc., announces the appointment of Leon L. Adelman as head of the sales department and consulting engineer.

Mr. Adelman's radio career began behind the counter of one of the pioneer radio stores. He was successively service engineer for the F. A. D. A. Co., radio editor of "Science & Invention," associate editor of "Radio News," assistant advertising manager and publicity director for the Chas. Freshman Co., Inc., and assistant sales manager for the Hammarlund Manufacturing Co.

Interesting Issues of Radio World

MAY 7.—Part I of the Six-Tube Adams-Griffin Shielded Set, by Dana Adams-Griffin.

APRIL 30.—The Equamatic mixer which can be used with almost any "super" coils, by Herman Bernard.

APRIL 23.—How to measure the cut-off in the resistance AF, by J. E. Anderson. Constructional data on the Melo-Heald, an eleven-tube Super-Heterodyne, by Herbert E. Hayden, (Part II). Part IV of the four-part article on how to obtain best results with the Nine-in-Line Super-Heterodyne, by Lewis Rand.

APRIL 16.—Part I of the description of the Melo-Heald Super-Heterodyne, by Herbert E. Hayden. Part II of discussion on the Nine-in-Line Super-Heterodyne, by Lewis Rand.

APRIL 9.—A five-tube shielded set employing transformer AF, by Herbert E. Hayden. Part II of constructional data on Power Compact, by Lewis Winner. Part II of the four-part article on the Nine-in-Line Super-Heterodyne, by Lewis Rand.

APRIL 2.—(Fifth Anniversary Number) Part I of the four-part article on the super-sensitive Nine-in-Line Super-Heterodyne, by Lewis Rand. The three-tube compact, a simple one-dial, three-tube regenerative set by Jasper Henry, Part I of the two-part article on a Power Compact, the B eliminator with a stage of power audio frequency amplification by Lewis Winner.

15 cents a copy—all 6 issues for 70 cents
Radio World, 145 W. 45th St., N. Y. City

Guaranteed "A" Power Unit—\$13.75

No better "A" Socket Power Unit can be obtained even at twice this amazingly low price. No hum or noise. Operates on 50 or 60 cycles at 110 volts A. C. Approved by rigid laboratory tests of Radio News and Popular Radio. Fully guaranteed. Shipped complete, subject to inspection, on receipt of price—or C.O.D. if you wish. 5% discount if cash in full is sent with order. Send order NOW! WORLD BATTERY CO., 1219 South Wabash Ave., Dept. 64, Chicago, Ill.

CeCo Tubes
Types R81 and M26
Specified

By H. B. HERMAN for
Phonograph Amplifier and B Supply

Read Article in This Issue



Unseen Precision

Quality in a Radio Tube cannot be measured by a micrometer. But the "Yard Stick" of experience, technical skill and exclusive methods of manufacture show unmistakably the superiority of performance, clarity, volume and longer life.

Radio authorities, including Brouning, Lynch, Cockaday, Hurd, Best, Bernard, Henney and many others endorse CeCo—the Tube of Longer Life.

Ask Your Radio Dealer



A Type for Every Radio Need

Radio World's CLASSIFIED ADS for Quick Action

10 Cents a Word—10 Words Minimum—Cash With Order

DIRECT FACTORY SALE—Wholesale prices. Tremendous Savings. Selling direct to you. Here are some of our many items: 30 Henry Choke, 100 M.A., \$2.19; 10 Henry Choke, 400 M.A., \$5.48. Power Transformers for all kinds of Eliminators and for all types of A.C. Tubes, at Special Low Prices. EVERY ITEM FULLY GUARANTEED. Promptly shipped, upon receipt of order. Send for free illustrated catalog today. **Roid Electric Co., Inc. (Manufacturers)** 36 West 20th Street, Dept. D, New York City.

RADIO CABINETS AND CONSOLES—Before buying your radio cabinet or console see our catalog. A postal card will bring it to you. Odd sizes built to your specifications. Standard sizes shipped promptly. **FULBRIGHT CABINET CO., HICKORY, NORTH CAROLINA.**

MEN—SOUTH AMERICAN WORK—Oil, fruit, rubber companies. Expenses paid. South American Service Bureau, 14,600 Alma, Detroit, Mich.

VALET AUTOSTROP RAZOR—The only razor that sharpens its own blades. Highly polished nickel-plated, self-sharpening Valet AUTOSTROP Razor, with one blade, in elvet lined metal case. Leather strap especially prepared, and complete outfit in neat, lithographed carton. Mailed post paid on receipt of 50c. **SPECIAL:** Send \$2 for one-third of a year subscription for Radio World (yearly price \$6), mention this particular ad, and complete "Pal" set will be sent as a premium. If already a subscriber, your subscription will be extended three months. **THE COLUMBIA PRINT,** 145 West 45th Street, New York City.

SEND \$1 for 8 weeks' subscription to RADIO WORLD, 145 W. 45th St., N. Y. C.

EDISON "A" BATTERIES—Three-cell, 20-ampere-hour; in neat metal cases. Price, \$2.50 each; two or more, \$3.00 each. Cash with order. Department "B," 25 East South Street, Indianapolis, Indiana.

CHOKES WITH ADJUSTABLE CORE for correcting filter operation, range 30.H to 100.H 150 M.A., \$5.75. Transformers—650 volts, \$7.25; 550, \$3.50; 280, \$2.00. Low voltage transformers to specifications, \$4.50. Write for lists. **Radio Parts Sales Co., Orange, N. J.**

HERMAN BERNARD, managing editor of Radio World, discusses radio topics of popular interest every Friday at 6:40 P. M. from WGBS, 348.6 meters, the Gimbel Bros. station in New York City. Listen in.

COMPLETE AND LATEST LIST OF STATIONS appeared in Radio World, dated Oct. 29. Sent on receipt of 15c, or start your subscription with that number. **RADIO WORLD, 145 West 45th St., New York City.**

HOW TO BUILD RADIO WORLD'S Four-Tube Universal Receiver fully described by Herman Bernard in the March 12, 19 and 26 issues of RADIO WORLD. Send 45c and get these three numbers or start your subscription with the first of these numbers. **RADIO WORLD, 145 West 45th Street, New York City.**

Before You Decide Hear A **BALDWIN "99"** Loud Speaker

The Big Thrill of DX, and at very Small Cost to You

Everybody who owns a radio set likes to tune in far-distant stations now and then because not only is there a thrill in hearing a voice or instrument thousands of miles away but one verifies the fact that he has a powerful receiver and that it is in good condition, if it is able to pick up these weak signals. Now that the broadcasting stations are more suitably distributed as to wavelength or frequency, fans are in a better position to tune in distance. Besides, the weather is in their favor these days. But what kind of a set shall be used? You know very well that if the set can tune in distance once in a while, you can develop sufficient skill to make it tune in far-distant stations very often, virtually every night. Then when you have visitors you need not boast about the DX qualities of your set but simply tune the receiver and let them listen to stations thousands of miles away. You must be sure to have a receiver capable of responding to your distance-getting desires. You also want this set to have delicate tone quality, so that your own critical ears cannot detect even a single flaw in the reproduction. Indeed, even music lovers who may be guests at your home will comment admiringly upon the bewitching tone of your receiver. Then you know you have something real. The ability to get distance and to reproduce the original music without distortion depends largely on the circuit design, and you will find that the Diamond of the Air, either the 4-tube or the 5-tube model, will live up to your highest expectations. How are you going to know which to build? Carefully inspect the textual data as well as the blueprints that fully expound the theory, operation, characteristics and amplification of these two outstanding receivers that differ principally in the type of audio amplification.

The 5-Tube Diamond

Can be constructed in a couple of hours. The authorized blueprints that make this speed and efficiency possible are just off the press and will be shipped at once, together with the new booklet of full textual exposition of construction, including the winding of coils, how to connect terminals, what values of condensers and resistors to use, etc. The receiver consists of a stage of tuned radio frequency amplification, a specially sensitized detector, first stage of transformer audio and next two stages of resistance audio. It is easily adapted to playing phonograph records through the set and on your speaker. Get acquainted with this new delight.

The 4-Tube Diamond

represents the most that is obtainable from four tubes. A stage of tuned radio frequency amplification, a specially sensitized detector and two stages of transformer coupled audio. Follow the blueprint to amazing success. Build the set from parts you have. Full instructions cover utilization of such apparatus. Thousands are eager to build an economical set of surpassing performance and amazing achievement and this one is the most economical, the most scientific, and the least expensive in cost of parts and upkeep. Works splendidly from batteries, either type 99 or type 1A tubes, and can be used with A and B eliminators, power packs, etc., with great success.

Look over both of these blueprints and read the text in both cases before choosing the receiver you are to build.

SEND NO MONEY

Just fill out the coupon below and note what you get FREE.

Guaranty Radio Goods Co.

145 West 45th Street, New York City
Please send me one newly-printed official blueprint of the 5-tube Diamond of the Air, one newly printed official blueprint of the 4-tube Diamond, and the textual data giving full directions for constructing these sets. I agree to pay the postman 75 cents on delivery. Also, you are to send me, without extra cost, one Auto Strop Safety Razor, one blade and one automatic razor strop.

Name
Address
City..... State.....

How to Connect Up Any Pickup in the Diamond

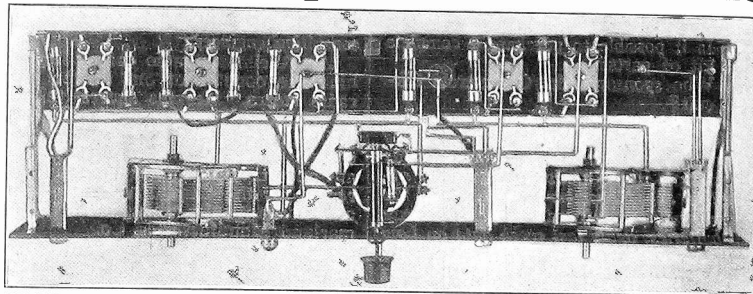

THE NEAT SUBPANEL WIRING, MOST OF WHICH IS DONE UNDERNEATH. NOTE POSITION OF THE BRETWOOD VARIABLE GRID LEAK.

(Concluded from page 11)
F is the end of L2 and connects to B plus 67½ or 90, i.e., B plus RF.

BENJAMIN

Cle-Ra-Tone Sockets

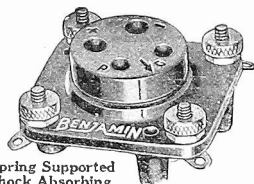

Spring Supported Shock Absorbing

The choice for practically every prominent circuit for several years. Among the most recent hook-ups for which it has been specified are:

- Fenway Electric Concertrola, New Laboratory AC Receiver, Thompson Super 7, H. F. L. Nine-in-Line, Camfield Super Selective 9, Thompson A. C. Super, Magnaformer 9-8, L. C. 28, Lynch Suppressor Circuit, World's Record Super 10, Strobodine 8, Melo Heald Fourteen, St. James Super, Two-Dial Equamatic, Qualitone 6, Knickerbocker 4, Hilograd Receiver, International One-Spot, Hot Spot Fourteen.

Push Type, on Mounting Base:

- Benjamin Cle-Ra-Tone Sockets.....75c each
- Without Mounting Base.....50c each

New Y Type Socket

- Specially designed, for use with 5-pronged A. C. Radio Detector Tubes:
- For direct attachment to panel... 90c each
- For mounting on top of panel...\$1.20 each

At all Radio Jobbers and Dealers

Made by

Benjamin Electric Mfg. Co.

120-128 S. Sangamon St., Chicago
New York San Francisco
247 W. 17th St. 448 Bryant St.
Manufactured in Canada by the Benjamin Electric Mfg. Co. of Canada, Ltd., Toronto, Ontario

G is the beginning of the detector input secondary L3 and connects to positive A.

With the Bruno 3-circuit coil mounted with tickler on top, G is the lower binding post for secondary. G does not connote "grid" here, but A plus.

For Phonograph Pickup

In the diagram of the Diamond are shown two switches S1 and S2. S1 is the master switch which controls the filament current in all the tubes. S2 controls that in the audio amplifier alone. This arrangement of the switches was made when it was desired to use the audio end of the circuit independently of the radio frequency end. The binding post arrangement WXYZ was included for the purpose of using either the radio or the audio ends of the circuit independently. Since the development of phonograph pick-ups the audio amplifier is usually wanted for phonograph music independently of the radio amplifier and the detector. For this reason it is desirable to be able to turn off the radio frequency tubes and leave the audio tubes burning. A slight rearrangement of the filament switches is necessary. The short lead between S1 and S2 is simply shifted to the opposite side of S1, or next to the A battery. Then neither switch controls all the filaments. It is necessary to turn on and off each independently.

VALET AUTOSTROP RAZOR—The only razor that sharpens its own blades. Highly polished nickel-plated, self-stropping Valet AUTOSTROP Razor, with one blade, in velvet lined metal case. Leather strop especially prepared, and complete outfit in neat, lithographed carton. Mailed post paid on receipt of 50c. SPECIAL: Send \$2 for one-third of a year subscription for Radio World (yearly price \$6), mention this particular ad, and complete "Pal" set will be sent as a premium. If already a subscriber, your subscription will be extended three months. THE COLUMBIA PRINT, 145 West 45th Street, New York City.

HERMAN BERNARD, managing editor of Radio World, discusses radio topics of popular interest every Friday at 6:40 P. M. from WGBS, 348.6 meters, the Gimbel Bros. station in New York City.

FILL OUT AND MAIL NOW SUBSCRIPTION BLANK

RADIO WORLD

RADIO WORLD

145 West 45th Street, New York City
(Just East of Broadway)

Please send me RADIO WORLD for months, for which

please find enclosed

SUBSCRIPTION RATES:
Single Copy\$.15
Three Months 1.50
Six Months 3.00
One Year, 52 Issues 6.00
Add \$1.00 a Year for Foreign Postage; 50c for Canadian Postage.

Modernizing the Phonograph You Have

(Concluded from page 7)

necessary to buy three stove bolts and three nuts.

The details of actual construction inside the phonograph can be worked out to one's own satisfaction. There is ample room for suiting one's convenience and taste.

In the case of the Victor phonograph the record rack may be removed from the bottom, and the amplifier and B supply placed therein. There is room to spare.

In fact, if one wants to include installation of a radio receiver there is plenty of room in a Victor by using a 7x14 inch front panel for location behind the tone arm doors. This front panel has to be notched at the two top corners 1 1/4 inches in and 1/4 inch deep.

The tuning condensers should be at left and right, so as not to strike the spring motor or governor. The coils would have to extend at left and right along the inside walls at the top.

The main consideration is the choice of a correct amplifier and B Supply and the physical details are so easy to work out that one will prefer the work of doing it himself.

However, if any one has a Victor, Aeolian or similar phonograph and feels that he needs assistance on the physical or electrical end, I would be very glad to have him write me care of RADIO WORLD.

(This is the first of a series of articles by H. B. Herman on modernization of phonographs that, though bought only a few years ago, are now seldom, if ever used, and are truly inferior, unless adapted for audio amplification and B voltage. Treatment of many kinds of installation will be discussed.)

A Simple Way To Control Volume

One of the best volume controls as well as a good oscillation control is a rheostat in the filament circuit of the first radio frequency tube. The rheostat should have a resistance of at least 20 ohms with a -01A tube and a six volt battery. It is well to have an Amperite in series with the rheostat to prevent excessive heating of the filament.

When the tube is of the 60 milliamper type the resistance of the rheostat must be much higher—from 75 to 100 ohms.



FERRANTI

AUDIO FREQUENCY TRANSFORMERS

Type AF3...\$12.00 Type AF 4...\$25.50

No Better Transformers Available

If you haven't yet filled out and sent in this coupon do so now—

Leo FENWAY for DX! INC.,
249 W. 53rd St., New York, N. Y.

Gentlemen: Tell me more about how I can purchase a complete kit of Conterrola parts and pay for it on the deferred payment plan. No obligation, of course.

Quote your lowest cash price for the same kit.

NAME

ADDRESS

(R.W.)



Trade Mark Registered U. S. Patent Office

CONDENSERS

are exclusively specified by Leo Fenway for the Fenway Electric Conterrola.

It is the constant report from leading laboratories as well as radio editors and authors that Tobe condensers are superior to all others tested.

For the Fenway be sure of matchless performance by using Tobe condensers. Your dealer has them in stock.

"It's got to be Tobe"

Send for Price Catalogue

TOBE DEUTSCHMANN CO.
Engineers and Manufacturers of Technical Apparatus
CAMBRIDGE, MASS.



5 TUBE RADIO ONLY \$19.98

It's a wonder for power and selectivity. Famous ARL circuit. Coast to coast reception. Finely built of selected, tested parts. Thousands now in use.

FREE Log and Call Book and New 120 cc. Catalog with thousands of nationally advertised bargains. Latest in radio at big savings. Write for Free copy.

AMERICAN AUTO & RADIO MFG. CO.
HARRY SCHWARTZBERG, PRES.
Dept. 401 American Radio Bldg., Kansas City, Mo.

The
LOGICAL
Filament Control

AMPERITE is the only self-variable filament control. Automatically does the work of hand rheostats and delicate meters. Proved for years. Specified in every circuit. Entirely different from fixed filament resistors. Accept nothing but AMPERITE.

AMPERITE

"The SELF-ADJUSTING" Rheostat

Unified
DIAMOND

Your heart will beat pitter-patter with joy when you turn on the switch after completing the Unified Diamond of the Air. This design consists of a balanced two-stage RF amplifier and detector, constituting the Radio Frequency Fountain, and a three stage resistance coupled channel constituting the Audio Frequency Basin. Any other form of audio may be used. Send 50c for complete description of construction (issues of Sept. 17, 24, Oct. 1, 8, 15).

Radio World, 145 W. 45th St., N. Y. C.

Unified
DIAMOND

BETTER THAN ANY FIXED LEAK is the Bretwood Variable Grid Leak. It allows adjustment of grid voltage to maximum sensitivity for reception of far-distant signals, with distortion. The Improved 1928 Model De Luxe Bretwood Grid Leak, \$1.75; or \$2.25 for Grid Leak with Bretwood Bullet Condenser attached. The North American Bretwood Co., 145 West 45th Street, New York City.

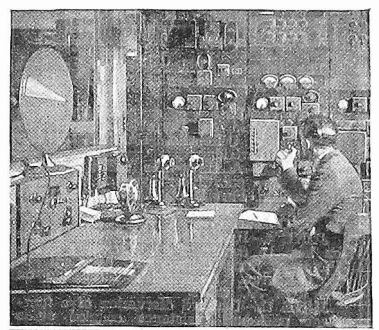

Would You Like To Earn More Money-in Work That's Almost Romance?

Then be a RADIO EXPERT!



If you're earning a penny less than \$50 a week, clip coupon below. Get my big Free Book telling about opportunities for big money in Radio. Television, trans-Atlantic Radio, telephony, many other wonderful inventions and developments constantly creating big new Radio opportunities. Here's work that's almost romance, a NEW, speedy, growing, live-wire profession.

And Radio needs trained men! Salaries from \$50 all the way up to \$250 a week are not unusual. You can easily learn Radio for bigger pay by my tested, practical methods. Hundreds of men have already done it. You learn quickly in your spare hours AT HOME—it's all so interesting to you that it's easy!

Extra Dollars For You Almost At Once

Think of making \$15, \$20, \$30 extra every week "on the side," without interfering with your regular job! I'll teach you to do it almost at once after you start your Radio training with me, by using spare time that you're wasting now, and all the while you'll be getting ready for the bigger Radio jobs ahead!

Six Big Outfits of Practice Material Given Free of Extra Cost

With your training you get free of extra cost 6 great outfits of real Radio practice material. With these 6 outfits you can build 100 real Radio circuits. This is the practical kind of home training. You learn to hold a job—not on paper—ON THE PAY-ROLL. Send coupon below for details of this offer.

You can easily pay for your course and put money in the bank while learning, when you learn by my practical methods. And you don't need to leave home, or interfere with the job you have now, while you're doing it! Fill out and mail the coupon below for the big book of Facts and Proof.

64-Page Book Sent Free

When I receive your coupon I'll mail you my big 64-page Book immediately. It's filled with photos and facts about the opportunities in Radio, and tells how you can prepare, quickly and easily in your spare time at home, to be an expert in this field. No previous Radio experience needed to take advantage of this offer. No special schooling required. Mail coupon now—address J. E. Smith, President.



J. E. SMITH, President
National Radio Institute,
Dept. PC-7, Washington, D. C.

Dear Mr. Smith: Kindly send me your 64-page Free Book which tells about learning Radio for bigger pay. Also send information on your offer of 6 outfits of material free of extra cost. I understand this places me under no obligation.

Name

Address

Town State

Good Back Numbers of RADIO WORLD

The following illustrated articles have appeared in back issues of RADIO WORLD in 1927.

MAY 21.—Part I of a three-part article on the Victoreen Portable receiver, by Capt. P. V. O'Rourke. Data on the new Raytheon cartridge.

MAY 28.—A three-tube reflex, using a special low pass filter system, by Edgar B. Francis. Part II on the Victoreen portable receiver with layout data, by Capt. P. V. O'Rourke.

JUNE 4.—Part III of a three-part article on how to construct an efficient portable Victoreen Super-Heterodyne, by Capt. P. V. O'Rourke. A complete discussion on the RCA AC tube.

JUNE 11.—Detailed discussion of a four-stage push-pull resistance coupled audio amplifier, by J. E. Anderson. The Suitcase 6, using a tuned RF stage, two untuned RF stages, regenerative detector and two transformer AF stages, by James H. Carroll. Balsa Wood for speakers, an excellent discussion on how this wood may be employed for speakers, by H. B. Herman.

JUNE 18.—The six-tube Equamatic, a neutralized two-stage tuned RF, three-stage AF resistance coupled set, by Herbert E. Hayden. How to get the low notes with transformer or impedance AF, by Dennis O'Flaherty.

JUNE 25.—The Lindbergh Plane Speaker, an excellent cone type reproducer, by Herbert E. Hayden. A tube and set tester, by Herman Bernard.

JULY 2.—The Planofier 7, single control super-sensitive set using resistance AF by R. F. Goodwin and S. S. Bruno. Discussion on the new Freshman Equaphase, by Robert Sagala. Data on the six types of units used on loud speaker operation, by J. E. Anderson.

JULY 9.—How to build a DC A supply where the line voltage is 220 or 240, by Frank Logan. Important data on RF choke coils, by Horatio W. Lamson. **JULY 16.**—How to use a voltmeter as a milliammeter, by D. Barretti. How to build a 4-tube, 2-control regenerative portable set.

JULY 23.—Building a 7-tube Super for your auto, using Victoreen IFT, by John F. Rider (Part I). How to build a 6-tube neutralized set, using three tuned RF, two transformer AF, by John F. Rider. Inside dope on motorboating, by J. E. Anderson.

JULY 30.—A 5-tube standard TRF set adapted to AC operation by the use of the QRS 400 mill rectifier tube, with the aid of series filament connections, by R. F. Goodwin and S. S. Bruno. Shielding the 1-tube Mel-Head Super-Heterodyne receiver, by Clifford Denton. Part II of the two part article on the Super in the auto by John F. Rider. How to control volume in AC sets by D. Ferrup.

AUG. 6.—A three-tube regenerative portable with portion of the cabinet as the speaker, by M. J. O'Reilly. The Cashbox Unitone, an ingeniously contrived four-tube quality receiver by Wendell Buck. How to use AC tubes by C. T. Burke.

AUG. 13.—Hints on constructing a portable set, by Herbert E. Hayden. A seven-tube, two-control AC operated receiver by Capt. P. V. O'Rourke. Obtaining the C bias in an ABC unit, using the BA Raytheon 85 mill tube.

AUG. 20.—The Four AC, a four-tube regenerative set employing AC tubes. Tim Turkey's argument on why rheostats should not be used as volume controls. The Drum Powertone, a five-tube single control set, using resistance coupled audio.

AUG. 27.—Part I of a four part article on building the 1-Dial Witz, a single control, voluminous selective 5-tube set, by A. Irving Witz. A detailed explanation of the exponential type of horn by H. B. Herman. Details on the revolutionary Reisz condenser type of speaker. Constructional data on a special 5-tube, 2-dial regenerative set, with three stages of AF, by Tim Turkey.

SEPT. 3.—Part I of a four-part discussion on the new 1928 Victoreen Universal, a super-sensitive 8-tube Super-Heterodyne, by Capt. P. V. O'Rourke. Complete data on the three types of phonograph pickups, by J. E. Anderson. Part II of the 1-dial Witz, wiring hints emphasized.

SEPT. 10.—The Puratone AC set, a 6-tube duo-control receiver, using AC tubes, by R. F. Goodwin and S. S. Bruno. Part II of the 1928 Victoreen Universal, discussing the placement of parts. Part III of the 1-Dial Witz on the special placement of the coils.

Any Copy 15c. Any 7 copies, \$1.00 All these 17 copies for \$2.00, or start subscription with any issue. Any 3 of these numbers sent as premium with NEW ally subscription. No other premiums allowed. RADIO WORLD, 145 West 45th St., New York City.

HOMEKAST!!!

The wonderful new HOMEKASTER enables you to furnish your own radio entertainments. It plugs into the radio set, just like a tube. With the HOMEKASTER, anyone can announce, sing, etc., before the transmitter in another room, and the sounds will be greatly amplified, coming out of the loud speaker, just as if the performer were at the broadcasting studio. Mystify visitors and friends. Entertain the children.

Reverse the process and the HOMEKASTER becomes an extremely sensitive detective device. The slightest sound in the room where the innocent-looking loud-speaker stands, will be loudly reproduced in the earpiece, which may be located in any other part of the home.

HOMEKASTER comes complete and ready to use. Fully guaranteed. Orders filled in rotation. Send check, money order, or pay postman \$5.00 upon delivery.

Approved by RADIO WORLD Laboratories
APLIN RADIO LABORATORIES
Suite 429, 30 Church St., New York, N. Y.

New! The Braxton-King

SHIELDED PLUG-IN
Intermediate
Transformers

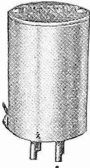

Fits any socket

The last word for intermediate stages. Fully shielded, therefore very stable. Plug into any UX socket. Ideal for compact construction. Only 2 1/2" high, 1 1/2" wide. Air-core, sharply peaked and laboratory-matched in sets. No filter necessary.

SET OF 4, \$18.00

Order direct if dealers can't supply. Jobbers and dealers, write for catalogue sheets, samples, and discounts.
Mississippi Valley Radio Company
914 Pine Street St. Louis, Mo.

Powerful British Short-wave Station on Air

Any one desiring to test the DX capability of their short wave receiver can try to tune in the powerful English short-wave broadcasting station 5SW, at Chelmsford, England, which sends out test programs consisting of phonograph music and talks, every day from 1 to 3 P. M. eastern standard time.

Many have already reported hearing the station, Armistice day being one during which most reports were received. On this day the Prince of Wales spoke in London. The reception was not very good due to the heavy static which prevailed.

This Armistice program was also intercepted at Schenectady, and rebroadcast by WGY on the regular 380 meter wave. Persons who listened to this station reported that the reception was quite good.

BIG NEW CATALOG FOR RADIO BUILDERS

FREE My big 1928 Radio Catalog, Call Book and Trouble Finder. 132 pages about Radio. Check full of newest circuits—kits, transmitter parts, short wave outfits, eliminators and speakers. Thousands of bargains at lowest wholesale prices. A Regular Radio Encyclopedia—Free. Write today.
American Auto & Radio Mfg. Co.
HARRY SCHWARTZBERG, PRES.
Dept. 195, American Radio Bldg., Kansas City, Mo.

LATEST RADIO CIRCUITS

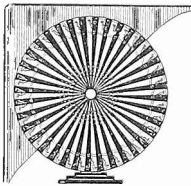

\$15

Brand new 20" disc speaker. 4 beautiful designs on each speaker. Beautiful—Efficient—A gift that will be long remembered.

THE IDEAL CHRISTMAS GIFT

Endorsed by laboratories of Radio World, Radio News and leading radio engineers. A beautiful, lasting and useful Christmas gift for your friends

FANSPEAKER
RADIO CO., 199 Fulton St., New York

Fanspeaker Radio Co., Dept. RW.
199 Fulton St., New York City

Please send me one Fanspeaker, postpaid, price \$15 C.O.D. or one Fanspeaker—Wall Type without base—\$12.50. (Cross off one.)

I will pay postman the money and understand I can return in 10 days and get my money back if not entirely satisfied.

Name

Address

"Everyman 4"

Its Possibilities Will Never Be Exhausted

FOR BEST RESULTS USE ONLY MUTER AND OTHER SPECIFIED PARTS

Muter Supreme Audio Transformer, First Stage.....	\$7.00
Muter Supreme Audio Transformer, Second Stage.....	7.00
Muter Clarifier and Tone Filter.....	5.00
Muter Radio Frequency Choke.....	1.50
Muter Variable Condenser.....	.75
Muter Push-Pull Panel Switch.....	.35
Muter Moulded Fixed Condenser.....	.40
Muter Heavy Duty Grid Leak.....	.50
Muter Grid Leak Holder.....	.15
Muter Bypass Condenser.....	.75
Muter Tubestat.....	.50

The number of owners of the Everyman 4 circuit is running into thousands. Selectivity, volume, distance, tone quality, ease of tuning, simplicity of construction, extreme low cost.

LESLIE F. MUTER CO.

76TH AND GREENWOOD AVENUE

CHICAGO, ILL.

New York Representative: EDWARD J. BECKLEY, 154 Nassau St., N. Y. C.

Three-Gang Condenser Uses Drum Tuning

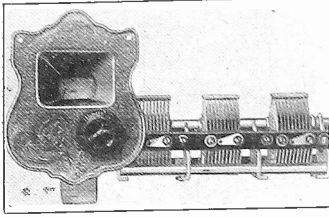

NEW U. S. L. PRODUCT

The United Scientific Laboratories, Inc., of 80 Fourth Avenue, New York City, recently placed on the market a drum control to be known as the Scientific Drum Control Tuning Unit. This unit has been designed to meet the need for a dependable, fine appearing drum control to be used in circuits requiring three ganged condensers.

The escutcheon shield is made of bronze. The drum dial is made of pressed steel and is calibrated 0 to 100 with clear, bold figures and markings. The drum action is powerful and smooth and develops no backlash. A friction drive rum is employed at type .00035 mfd. three ganged condenser is used. The condenser and drive are completely assembled at factory so that this unit comes complete ready to be installed on sub-panel of receiver.

Pittsburgh Explosion Victims Comforted By Radio

Pittsburgh.

News of the disastrous explosion which rocked Pittsburgh two weeks ago was broadcast to the public by Westinghouse station KDKA less than an hour after it occurred. Authentic reports from the Equitable Gas Company were transmitted over the air at regular intervals. In addition to broadcasting the reports of the explosion, a special program was given that evening for the American Red Cross to aid them in a campaign to relieve the unfortunate people whose homes had been destroyed by the disaster.

HELLO JAPAN!



The thrill of receiving Tokio, Japan and Sidney and Melbourne, Australia on a Magnaformer 9-B was experienced by K. G. Orndorff and party on the night of September 11, 1927. 45,000 to 50,000 miles on the loud speaker with a world of volume. The thrill of great distance added to the enormous, true-to-life tone quality for which the Magnaformer 9-B is famous, gives you a truly supreme entertainment combination. The Magnaformer 9-B, the Creator of True Tone Quality, "Commonly in 'Chief of the Air'", is the finest and most powerful receiving set ever designed. The secret lies in the perfect Magnaformer Intermediate Long Wave R. F. Transformers with which it is equipped. Prominent Radio Editors are giving these coils highest praise in editorial articles in Radio, Popular Radio, Radio Home, Citizens Call Book, Radio World and other magazines and numerous newspapers. Each coil is unalterably peaked at 29.75 Kilocycles (400 meters). They are so securely and acoustically put together mechanically that nothing can change their electrical characteristics. It is the greatest set in the world. Build it from the fully illustrated official construction sheet 28x34 inches, both sides printed solid. Send at once, right now while you have it in mind, for FREE illustrated Magnaformer story, wonderful testimonials and full account of K. G. Orndorff's unique experience—W. L. Scott's challenge and defeat. Don't build a set! You hear from us in a day or two. RADIANT LABORATORIES COMPANY Dept. G9, Chicago, Ill. 19 S. La Salle Street

Everybody's Talking About It

There's a wealth of reliable, boiled-down, and interesting information in "Resistance the 'Control Valve' of Radio." Simply written — clearly illustrated. This valuable hand-book on resistance in radio is worth dollars—send only 25 cents for your copy.

ARTHUR H. LYNCH, Inc. 1775 Broadway, New York City



25c

FLECHTHEIM Superior Condenser



Specified for 4 and 5 Tube Diamonds
BY-PASS FILTER BUFFER HIGH TENSION And TRANSMITTING Condensers

for every use in all types of radio circuits

Accurate—capacity rating. Dependable—for continuous duty.

Write for Catalogue

Special proposition for dealers and jobbers.

A. M. FLECHTHEIM & CO., INC.

136 Liberty St., New York

C·R·A·

The REAL RECTIFIER TUBE

Guaranteed for a full year.



If your Eliminator has failed you at a most critical moment—if its voltage drops suddenly after a few weeks' use—then, you have never used a C. R. A. pure Helium gas filled tube. Because a C. R. A. tube in your present Eliminator provides an unfailing, constant current supply, dependable at all times. Approved by Thordarson, Muter, Cornell, Mayolian, Bosch, Pathe—the list is endless. Specified by Leo Fenway for the Concertrola. At all good dealers. If yours cannot supply you, send us his name, with your check or money order. Immediate shipment, prepaid.

PRICE, \$4.50

Charles R. Ablett Co.

Lamp Specialists for Twenty Years
22-24-26 READE STREET :: NEW YORK

Victoreen

POWER SUPPLY

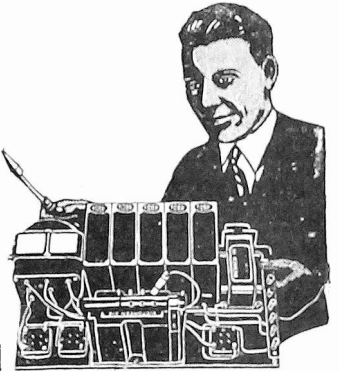

A new plate supply with maximum of 175 volts, with provisions for a 210 output, constitute the Victoreen Power Supply. The power transformer was specially designed to carry the load with ample safety margin. The choke unit was made to exacting specifications to assure most efficient filtering. The output unit was made to conform to requirements of low direct current resistance, with suitably high impedance at the working frequencies, and the resistance unit was specially designed for an absolutely dependable steadiness of voltage output. Made with proper filter condensers and using two UX-281 or 210-B tubes for full wave rectification, this new supply affords amazing depth of tone, richness of volume and flawless reproduction even at enormous signal loads.

The construction of the Power Supply was described by J. E. Anderson in the Oct. 15 and 22 issues of RADIO WORLD. How to build the Victoreen Power Supply with an audio amplifier is described in October 29 issue by the same distinguished engineer. In the present issue H. B. Herman, acoustical expert, tells how to make a phonograph installation.

The Victoreen 112 audio transformer unit is used in conjunction with the previously mentioned apparatus to constitute one of the finest power supplies and audio amplifiers ever designed.

Everybody who has heard one has gone into ecstasies and has wanted one immediately for himself. Enjoy the fullest and finest that radio has to offer and let the guests you entertain in your home see what a wise choice you make when it comes to selecting a suitable power supply and audio channel. Critical persons who have heard this de luxe outfit simply marvel at the difference between this and the ordinary B eliminator and ordinary audio amplifier. The Victoreen apparatus is most extraordinary in its performance because no pains are spared in the search for perfection, and every piece of apparatus is tested three times and then once more for good measure to make sure that it measures up to the Victoreen standards of flawlessness.

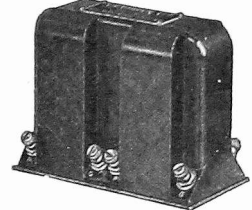

The 112 audio transformer unit

Two transformers in a single casing constitute the 112 unit, which amplifies with perfect naturalness. Use a 112 tube in the first stage and a 210 in the last stage in connection with the Victoreen Power Supply.

The 112 unit may be used as the audio channel in any receiver. Send for booklet and learn how your Victoreen parts are obtainable at your dealer.

- Victoreen 116 power transformer..... \$16.00
- Victoreen 216 choke unit..... 15.00
- Victoreen 115 output unit..... 10.00
- Victoreen 316 resistance unit..... 3.00
- Victoreen 112 audio transformer unit..... 22.00
- Victoreen manganin rheostats, each..... 1.20

Write today for 1928 blueprints and circulars



THE R IS MADE STRAIGHT LINE!

IN electricity in all its forms, including radio, "R" stands for resistance. Any resistor that is variable should vary directly in proportion to the adjustment. In variable grid leaks this asset of "straight line R" has been missing. But now it is supplied—efficiently, perfectly—in

The New De Luxe Model BRETWOOD

Variable Grid Leak

The improvements made in the new model—imported from England and released for the first time—are:

(1) Constant readings, (2) even distribution of the resistance element, (3) support provided for optional base-board mountings.

By using the Bretwood Variable Grid Leak you improve tone quality, by avoiding detector tube overloading, achieved by correct leak setting. Thereafter the leak may be varied for extremely distant stations, or may be left at the original setting.

North American Bretwood Co., 145 West 45th St., N. Y. City.

Gentlemen: Enclosed find \$1.75. Send me at once one De Luxe Model Bretwood Variable Grid Leak on 5-day money-back guarantee. (Or \$2.25 for leak with grid condenser attached.)

NAME

ADDRESS

CITY..... STATE.....

Inquiries Solicited from the Trade

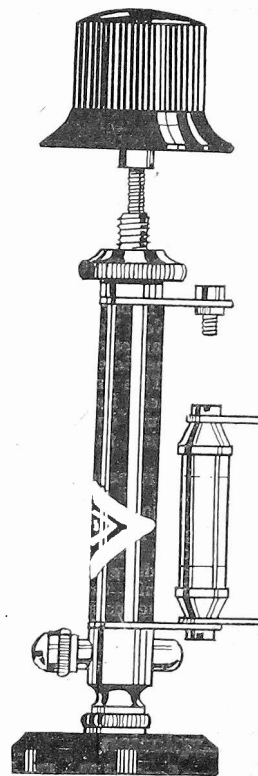

The DE LUXE MODEL
with Condenser Attached

The De Luxe Model Bretwood Variable Grid Leak specified by Herman Bernard for Radio World's Four-Tube Universal Receiver.

1. The knob is hard rubber.
2. The shaft is durable brass, and can not jam or stick.
3. The brass lock nut, with milled edge, enables single hole panel mount.
4. The barrel is of hard rubber and houses the the resistnace element and plunger.
5. The lugs are adjustable to any position within the sweep of a circle.
6. The grid condenser is securely fastened to the lower lug and requires no extra room, as it is within the projection of the lugs.
7. The syphon container distributes a constant supply of resistance element, making the reading straight line resistance, and preventing uneven distribution of the resistance element.
8. The hard rubber pedestal affords the option of perpendicular mounting, as on a base-board.

Each Bretwood Variable Grid Leak and Bretwood Bullet Condenser is guaranteed against mechanical or electrical imperfections and is sold on an absolute five-day money-back guarantee.

If you're not delighted with results, then we're not even satisfied!