

1927.

# RADIO

Vol-12  
No-5  
291

REG. U.S. PAT. OFF.

# WORLD

America's First and Only National Radio Weekly

## BLINDFOLDED NOVICE TUNES IN DX ON TYRMAN TEN

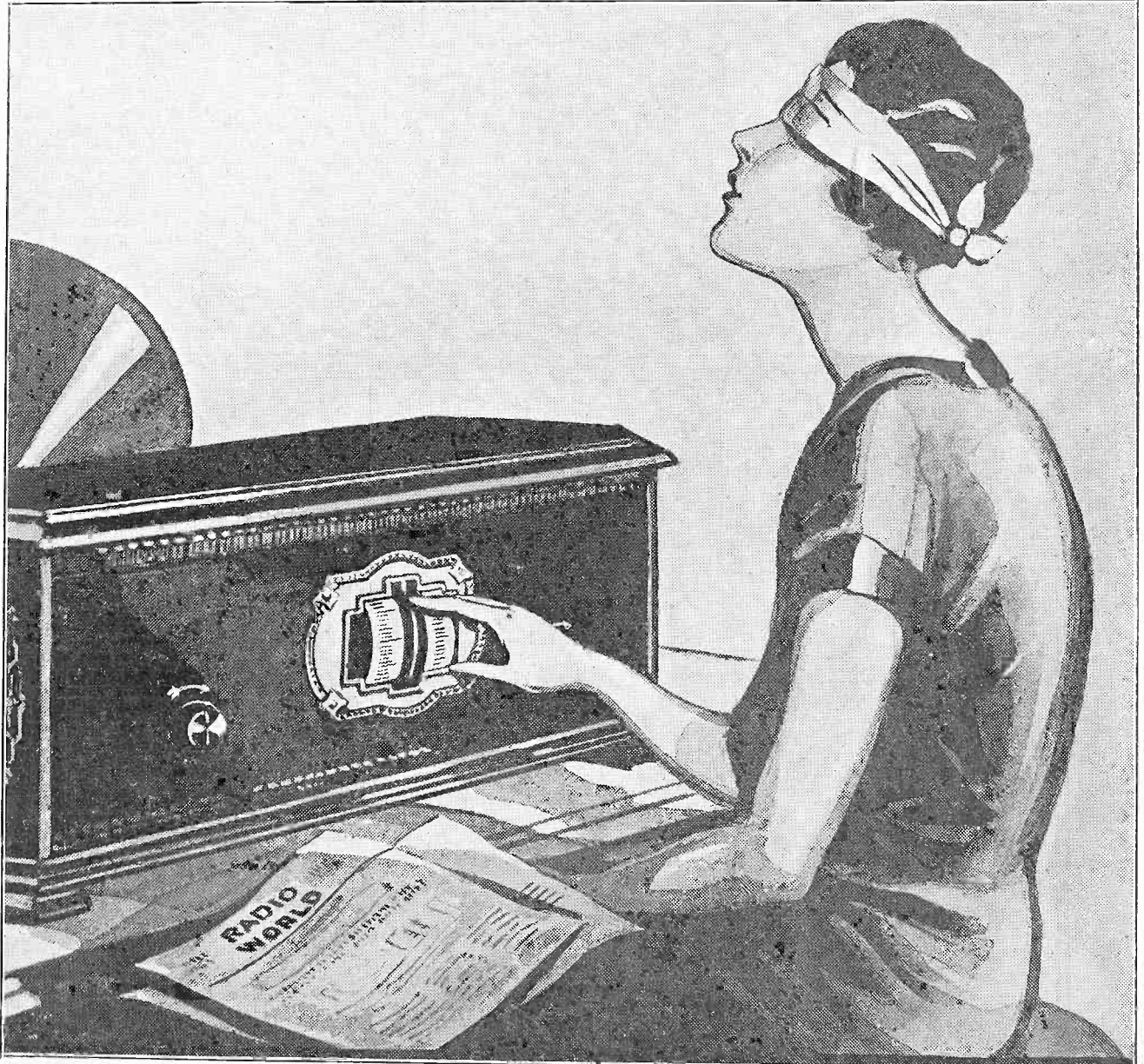

### OUT OF THE AIR

The true significance of the expression "picking the stations out of the air" is appreciated when one is blindfolded, tunes a set and brings in distance. Read the absorbing description of how this is done. See page 3.

# "YOU WILL When You Know Why"

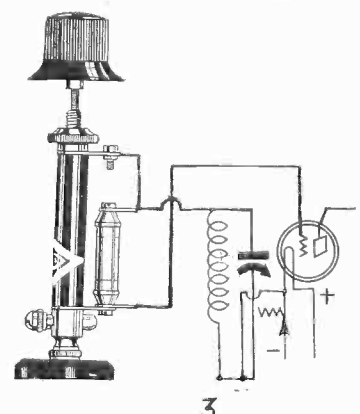
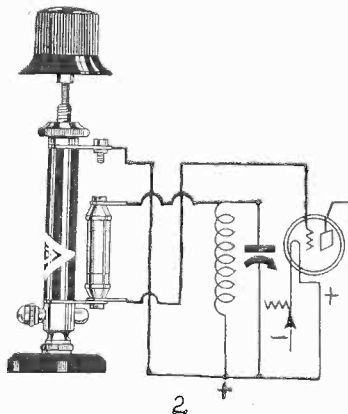
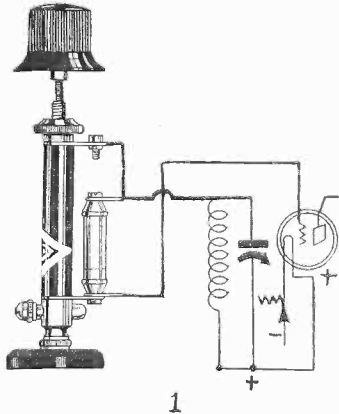

North American Bretwood Co.,  
145 West 45th Street, New York City.

Gentlemen: Enclosed find \$1.75. Send me at once one De Luxe Model Bretwood Variable Grid Leak on 5-day money-back guarantee. (Or \$2.25 for leak with grid condenser attached.)

NAME .....  
ADDRESS .....  
CITY ..... STATE .....

Dealers: If your jobber can't supply you, write us.

In the diagrams the bullet condenser is shown attached to the leak. No. 1 shows the commonest way of connecting a grid leak, that is, in parallel with the grid condenser, the grid return being made through the secondary coil to positive A. No. 2 shows the method of connection where the grid is to be returned to positive A, although the coil may be connected either to plus or minus. In the diagram it is shown going to plus, but it could be moved over to minus without short circuit. This hook-up is used for gang tuning condensers.

No. 3 is the same as No. 1, except that the return is to negative filament instead of to negative A. The No. 3 method is for the special detector tube, e. g., 200A, 300A, etc.

**North American Bretwood Co.**  
145 West 45th Street, New York, N. Y.

Specified for the

TYRMAN

TEN

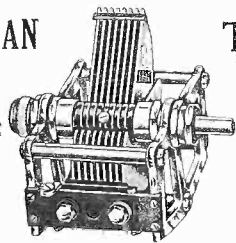

**Camfield**

EQUALTUNE CONDENSERS

Camfield condensers are again specified! Equalizing adjustment device makes them unequalled for accuracy, mechanical design, electrical efficiency, workmanship and general utility. They look the part, too—as handsome a job as you ever saw.

A TRIBUTE TO A LEADER

That's the reason why Camfield condensers are so popular. They are the selection of leading circuit designers and are officially specified for the Camfield Super-Selective-9 and 10, Tyrman Ten, Madison Moore, Citizens Super-8, Duoformer-7, Duoformer-5, Thompson Super-7 and many other circuits.

Leading jobbers and dealers supply Camfield's. No other condenser will give such remarkable service.

Mail coupon for free booklet, "Wherever You Require Quality"

CAMFIELD RADIO MFG. COMPANY  
35 E. Walker Drive Dept. R.W. Chicago

Mail me your free booklet as advertised.

Name .....  
Address .....

**CARTER**

Another Circuit  
—as usual—  
specifies  
Carter Parts  
**Tyrman Ten  
Receiver**  
Any Dealer Can Supply  
Carter Radio Co.  
Chicago

**ACME WIRE CO.**

**CELATSITE**

for RADIO WIRING

Flexible stranded Celatsite is composed of fine, tinned copper wires with non-inflammable Celatsite covering in 9 bright colors. Strips clean, solders readily. Sold only in 25' coils, in cartons colored to match contents. Solid Celatsite has same colored covering, but over bus bar wire. Write for folder to The Acme Wire Co., Dept. Y, New Haven, Conn.

We have in stock parts for  
**THE TYRMAN TEN**  
Just as described in this issue. It is truly radio's newest and greatest receiver for distance—one—sensitivity—selectivity. Send your order immediately. Generous discounts to set builders and dealers.  
**THE EARLMOR CO.**  
308 N. Michigan Ave. Chicago, Ill.

You Can Build This Wonderful  
Three-Foot Cone Speaker  
For Only \$12

Exactly the right size to reproduce the complete range of a symphonic orchestra in all its fullness of beauty. Kit contains everything needed—every part the best—including genuine Pono-tex Alhambra Resonator and the famous Fenco Master Unit. Takes up to 500 volts without rasping.

Just 30 minutes of pleasant work with scissors and screw-driver and you have, for only \$12, a handsome radio speaker of great volume and delightful tone quality—the equal of any \$60 ready-made speaker on the market.

Money refunded if not delighted. Send check or money-order to  
**FENCO CONE CO., 57 Murray Street, New York**

The  
Three-Foot  
**FENCO**  
DOUBLE CONE

Complete Kit \$12



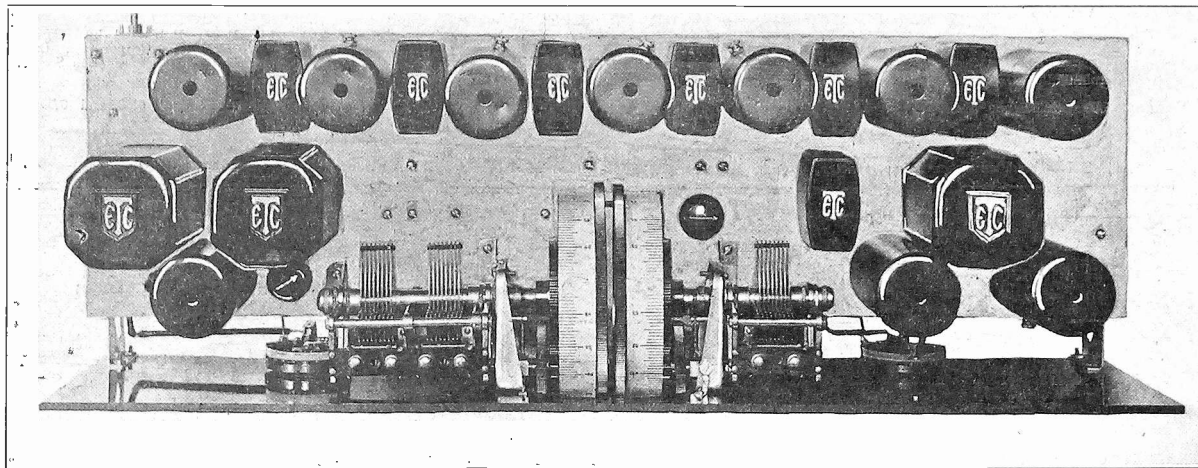

TOP VIEW OF THE TYRMAN TEN. THE BACK ROW, IN PERFECT ALIGNMENT, SHOWS THE COILS PLACED BETWEEN EACH TYRMAN SHIELDED TUBE SOCKET. LEFT FOREGROUND, THE TYRMAN AUDIO TRANSFORMERS WITH ONE OF THE SHIELDED AUDIO TUBES. AT RIGHT, THE TYRMAN OUTPUT, RF CHOKE, WITH THE TYRMAN DRUM AND THE CAMFIELD CONDENSERS IN THE CENTRE. THE PICTURE GIVES ONLY A SLIGHT IDEA OF THE BEAUTIFUL EFFECT GIVEN BY THE SHINING BLACK PARTS ON THE SOFTLY GLEAMING SUB-PANEL.

distorted volume enough to make the welkin ring.

But all of this would be merely potential volume were it not for the almost incomprehensible amplification in the intermediate amplifier. It is here where the weak signals from the remote stations are pulled from infinitesimal levels and placed on the plane of the signals from the local stations. It is here where the greater part of the amplification and nearly all the selectivity reside.

Both the amplification and the selectivity could be expressed in numbers but they would be so large as to be meaningless to the human intelligence. But anyone can appreciate the fact that the Tyrman Ten brings in the distant stations of high and low degree without any interference from other stations.

#### Results Prove It

The proof of superiority lies in the results. How does the Tyrman Ten score on the claim of top-notch quality of tone reproduction? It scores heavily in the family of the blindfolded girl. Ma and pa are both musicians of no mean ability and they say that the reproduction is as good as the original. They would not say so if they were not highly pleased with the set. The younger members of the family like the set, too, but that is not indicative of fine quality but of jazz hot volume. Perhaps one of the greatest compliments ever paid to the set was given by the neighbors. They admitted that the quality of the Tyrman Ten was better than that of their own set!

Now let us take one more fling at the technical aspects of the Tyrman Ten. Note on the circuit diagram that there is a radio frequency tube ahead of the first detector. This tube has two outstanding effects on the signals received. It increases their volume several times; it insures that they be received uniquely. By that is meant that the first tube and the extra tuner cut out interference to the extent that image interference is impossible. This type of interference must be cut out in the radio frequency level or it will not be cut out at all. Well, a tube and a sharp tuner do the trick very effectively.

The receiver uses an open circuit antenna which is coupled directly to the high potential through a small .00005 mfd. variable condenser. This connection insures increased sensitivity of the circuit without a decrease in the selectivity, and it also adds greatly to the simplicity of the receiver.

Another feature about the circuit which deserves special attention is the coupling between the oscillator and the first detector. It is by means of a .00005 mfd. variable condenser connected between the grid of the oscillator and the grid of the first detector.

The object of this capacity coupling is to reduce the mutual effect of the two tuned circuits and make the tuning of the two independent as far as that is possible with the necessary coupling between the two.

By means of this variable condenser the amount of coupling between the oscillator and the mixer tube can be changed at will. Thus this forms an excellent volume control.

#### An Exceptional Case

There is an additional volume control in the 25 ohm rheostat placed in the filament circuit of the mixer tube. All volume control should be confined to these two methods as far as possible. It may be that these will not prove adequate on very strong local stations. Then recourse can be had to the 200 ohm potentiometer across the filament battery.

The grid returns of the intermediate

amplifiers have been connected to the sliding arm of this potentiometer and consequently it can be used to control the grid bias on the tubes. With the grid bias the volume is also controlled.

#### The Camfield Condensers

One reason why the Tyrman Ten is so easy to tune that the manipulation is a real pleasure lies in the combination of the exquisite Tyrman drums and the mechanical construction or the tuning condensers. The condensers turn easily without any hop-skip-and-jumps and they can be stopped exactly where the operator desires to stop them. It seems as if they turn without any frictional resistance whatever, yet they are absolutely firm in their bearings. Notwithstanding the lack of resistance to turning, there is no play in the bearings. This condenser is a mechanical masterpiece.

The condensers are mounted so that they can be turned simultaneously with the Tyrman drum controls. The drums can be turned independently. One drum controls a single section Camfield condenser, the other controls a double section Camfield. Each of the three sections has a capacity of .00035 mfd.

[Next week, "Efficiency Data on the Tyrman Ten."]

#### LIST OF PARTS

- Two Tyrman Type 8-70 R.F. transformers.
- One Tyrman Type 8-71 R.F. transformer.
- Four Tyrman Type 8-80 R.F. transformers.
- One Tyrman Type 3-30 audio transformer.
- One Tyrman Type 3-50 power input transformer.
- One Tyrman Type 3-51 power output transformer.
- One Tyrman Double vernier Drum.
- Ten Tyrman shielded sockets.
- One Kurz-Kasch capacity connector.
- One 7x26 inch front panel.
- One 7x26 inch sub-panel.
- Two Benjamin brackets.
- Two Carter 1 mfd. condensers.
- One Carter ½ mfd. condenser.
- One Carter .00025 mfd. mica condenser.
- One Carter .002 mfd. mica condenser.
- One Yaxley No. 669 cable connector.
- One 3 megohm resistance, with mounting.
- One Yaxley 6L filament resistance, 1½ amp. 5 volts.
- One Yaxley 5L filament resistance, 1½ amp. 5 volts.
- One Yaxley 200 ohm potentiometer.
- Two 50 mmfd. midget condensers.
- One Yaxley 25 ohm rheostat with switch.
- Two binding posts.
- One Type 351 Camfield .00035 mfd. condenser.
- One Type 352 Camfield .00035 mfd. two-gang condenser.
- One Yaxley 200 ohm grid resistance.

## Radio's Broad Scope Is Covered by Book

Heister & Roberts, 116 West 39th Street, New York City, have an up-to-date book which is a practical education on radio in all its branches. It is the combined work of twelve distinguished authors, among them Steinmetz, Langmuir, Fressenden, Felix and Sir Joseph Thompson. It begins with the first principles of radio, covering the electron, proton, etheric and electromagnetic waves, treating on chemical atoms in their relation to radio and dissecting the similarity of radio, electrical and chemical phenomena. It progresses by easy and readily understandable stages through the electricity of radio in all its branches into the radio diagram, the shorthand of the art. It carries the reader on into a thorough understanding of the mechanics of radio.

Originally four volumes, now bound into one beautiful de-luxe binding, this book is a useful and necessary addition to every library. Further information may be had from the concern itself.—J. H. C.

# The Effect of an Iron Core

By H. G. M. Ballant

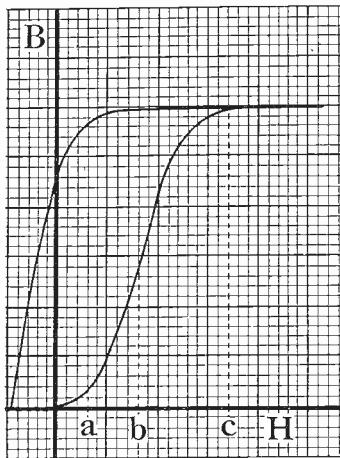

FIG. 1

A typical B-H curve of a sample of magnetic material. The B is the magnetic flux density, or flux per square centimeter, which results when a magnetizing force H is impressed on it. H is proportional to the current flowing in the winding of the coil. These are standard designations.

THE inductance of transformers and chokes having iron cores changes with the direct current that flows in them. The reason for this change becomes evident after a consideration of the behavior of magnetic materials toward magnetizing forces. In Fig. 1 is shown a typical curve giving the relationship between the magnetizing force H and the magnetic flux density B. The magnetizing force is proportional to the current producing it and for a certain coil the current may be taken as the magnetizing force. The flux density is the flux per unit section of the core, that is, per square centimeter.

From the curve it is seen that as the current through the coil increases the magnetic density increases at first slowly, then more rapidly, and finally it flattens out and remains constant for all magnetizing forces. For magnetizing forces greater than that represented by point (c) the core is said to be saturated.

The permeability of a sample of magnetic material is the measure of its magnetizability of the material. The greater the permeability the easier is the material magnetized.

### Shown in Diagram

The permeability of the material is the slope of the curve in Fig. 1. Since the curve is not a straight line it is evident that the permeability varies with the current flowing. At (a), where the current through the winding is small, the slope is gentle and therefore the permeability at that point is low. At (b) the slope is steep and hence the permeability is high at that point. At (c) the slope is again gentle and the permeability low. The permeability is a maximum about the point (b). The maximum permeability of silicon steel as used in good transformers is about 6000.

The effective permeability of a core of a transformer or coil differs from the permeability of the steel of which it is partly made. It is customary to introduce an airgap into the magnetic circuit to prevent core saturation. When this is done the effective permeability depends very largely on the

FIG. 2 Graphical representation of the performance of audio frequency choke coils, showing the effect of the direct current flowing and the airgap in the magnetic circuit. Curve A has a practically zero airgap, Curve C two gaps of .005 inch and Curve E two gaps of .010 inch. The longer the airgap the greater the current may be.

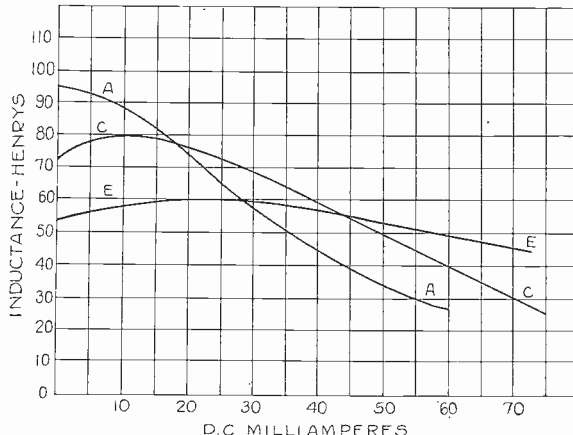

length of the gap. The general trend of the B-H curve, however, remains the same. The longer the air-gap the farther out is the maximum in the permeability curve.

The inductance of a coil is directly proportional to the permeability of the core. Hence the inductance of a coil varies with the direct current flowing in its winding. If the coil is measured with a low value AC and with a low value direct current in the winding, the inductance is low.

### It's Not Indefinite

If the direct current is increased the inductance is also increased. But not indefinitely. As the current is increased beyond the point which makes the permeability maximum, the inductance decreases. When the core is saturated the inductance is very low.

When the airgap is zero the maximum inductance occurs when there is no direct current in the winding. As the length of the airgap, or airgaps, is increased the value of the current at which the maximum occurs is also increased.

One of the reasons for the failure of audio transformers of small section to give undistorted reproduction is the saturation of the core and the reduction in the induction transfer of voltage from the amplifier tube of the primary. One condition for high transfer of voltage from the amplifier tube to the transformer and the next tube is that the impedance of the primary be high. When the plate current is so large as to saturate the core the inductance decreases and the voltage transfer falls. So does the amplification. This effect is particularly great when no grid bias is used so that a high current flows in the plate circuit.

### Low Notes Suffer First

The fall in the amplification appears first at the low notes, where the impedance is low as a result of the low frequency. To hold up the amplification of the low notes the inductance of the primary must be high. This does not boost the amplification on the high notes in proportion to the frequency just because the reactance of the primary does. There is a definite upper limit of voltage gain per stage, and that limit is the product of the  $\mu$  of the tube and the turns ratio of the transformer. For example, if the  $\mu$  of the tube is eight and the ratio of the transformer is 4, the limit is 32.

The transformer should be so designed that the limit is approached closely at the lowest note it is desired to reproduce with full volume. The choice of primary current, that is, plate current so that the transformer is operating at the steepest part of

the B-H curve will help to bring up the curve at the lower end, and to hold it up.

The fact that the inductance of a coil varies with the current in the primary introduces harmonics into the signal passing through the transformer, since the amplification depends on the plate current and the signal is a variation in the plate current. But if the transformer is operated at the optimum point not only is the amplification greatest but the harmonic distortion is least. This shows the importance of designing an audio transformer or choke to work with a definite tube with a definite grid and plate voltage adjustment.

### Relative Curves

In Fig. 2 are shown a set of four curves giving the relationship between the inductance of a choke coil and the direct current in its winding. Curve A starts with a maximum value of inductance when the direct current is zero. This represents the case when the airgap in the magnetic circuit is very short, or when the ends of the laminae actually touch each other at the joint. Such a coil is suitable as a choke when there is no direct current involved. Curve C is that of a choke coil in which the airgap in the magnetic circuit is a little greater than coil A. The inductance now does not attain the maximum value until a current of about 12 milliamperes flows in the winding. As the current in the winding increases the inductance of the coil decreases, but it does not decrease so rapidly as when the airgap is practically zero. A coil like that represented by Curve C is suitable for use in a plate circuit in which the plate current is approximately 12 milliamperes. No serious reduction in the inductance takes place if the direct current is less than 12 milliamperes.

### When to Increase Gap

If the coil is to operate in a circuit in which a heavy direct current flows the airgap should be increased. Curve E shows the case when the airgap is just twice as long as it was in coil C. The maximum inductance now comes when the direct current is 25 milliamperes, and the curve is fairly flat so that the inductance variation as the current varies is small. The coil should be suitable for use as a choke coil in the plate circuit of a 71 or a 10 type tube in which average plate currents of from 15 to 35 milliamperes will be encountered.

While these curves were obtained for choke coils they apply equally well to transformers. A transformer primary and a choke coil placed in the plate circuit of a tube both look alike to the tube provided they have the same windings and the same cores.

# Wiring The Victoreen

By J. E.  
Contributor

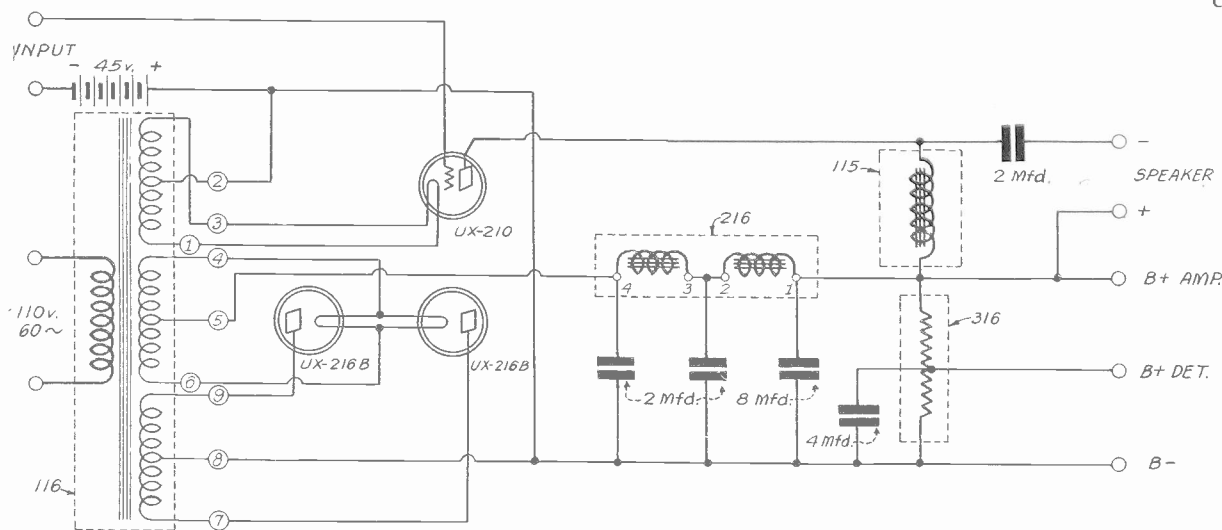

THE COMPLETE SCHEMATIC WIRING DIAGRAM of the Victoreen Power Supply unit, employing two half wave rectifier tubes in a full wave rectifier arrangement and a UX-210 power tube. An adequate filter is also included in the hook-up.

[A power supply of excellent design, using only first-class parts, and working into a 210 power tube, is the Victoreen Power Supply, first presented to the reading public in last week's issue (October 15). Wiring is stressed in the present issue. This Supply was designed by John A. Victoreen. At the New York and Chicago radio shows it attracted admiring attention from knowing home constructors, and engendered abnormal activity in the trade.—Editor.]

THE builder of the Victoreen Power Supply unit got the correct layout of the component parts from the photographic reproduction of the unit, on the front cover, and the schematic drawing of the layout, both of which were published last week. It is possible to use either of these illustrations in wiring the parts together, since all the leads and terminals

are clear and distinct. Some builders will prefer to follow these illustrations in completing the hook-up. But most of the fans who have decided to build this remarkable and powerful power source and amplifier will want a symbolic representation, too. For their benefit the schematic diagram of the circuit is given herewith. The numbers of the terminals in the schematic are the same as the numbers to be found on the component parts and no difficulty should be experienced in wiring the unit.

It should be pointed out that as high voltages are involved it is best to avoid all bare connections. All leads running from terminal to terminal should be well insulated so as to minimize the chance of getting an accidental shocks after the unit is completed and the power is turned on. It must not be taken from this warn-

ing that the shock one might get is dangerous. It is not, but it is unpleasant to take when one does not expect it. There is not as much danger on the secondary side of the input transformer as there is on the primary 110 volt line, and nobody worries about that.

## Connection of Windings

Looking at the diagram it will be seen that the Victoreen 116 power transformer has four windings. One is labelled 110 volts and 60 cycles. This is connected to the house supply line with a convenient cord and plug, just as if it were a flat iron or other household appliance. The secondary winding having terminals (1), (2) and (3), is connected to the filament circuit of the power tube. Strictly only (1) and (3) are connected to the filament terminals and (2), the mid-tap on the winding, goes to the positive of the C battery and to the negative side of the rectifier.

The winding comprising the terminals (4) and (6) is connected to the filaments of the two 216-B or 281 rectifier tubes. The mid-tap (5) of this winding is the positive terminal of the high voltage output and it is connected to terminal (4) on the Victoreen 210 choke unit as well as to one side of the first 2 mfd. Tobe by-pass condenser. The second Tobe 2 mfd. by-pass condenser is connected to the mid-point of the choke unit, that is, to terminals (2,3). The main by-pass condenser is a Tobe 8 mfd., and this is connected across the final output of the rectifier. While all the condensers across the line are effective in removing ripple from the voltage, the 8 mfd. condenser alone is effective in preventing feedback in the amplifier.

## Prevents Feedback

The Victoreen 316 resistance unit is connected across the line in parallel with the 8 mfd. Tobe condenser. This resistor has a number of taps for various voltages. But only one is shown in the schematic circuit diagram. This goes to the B plus detector binding post on the radio receiver. If other voltages are re-

## Drums Crisp and Clear with No. 10 Output Tube

No one who has never heard a properly designed amplifier using a 10 in the last stage with a high plate voltage can appreciate the delightful quality and pep that can be obtained from such a circuit. The signals, whether vocal or instrumental, are crisp and snappy in all regions of the scale, and they truly give the illusion of reality. The base drum is plainly heard on almost any set or speaker, with such an output tube. Tone for tone, they are a true reproduction of the original. The loudspeaker fed by such a tube not only radiates sound power but it radiates confidence as well. It puts the listener at ease. It frees him from the unpleasant feeling that at any moment the signal will break into rasping and irritating sounds. Repeated reproduction of intense passages all over the scale, and particularly at the lower end of the scale, without a single instance of a break in the purity has

fostered the listeners confidence in the amplifier.

## Wise Choice

John A. Victoreen, designer of the Victoreen Power Supply and Audio Amplifier, fully realized the importance of adequate power in the last tube in the circuit. He chose a plate voltage of 475, with a 45 volt negative bias on the grid. This combination allows an even greater maximum undistorted output than the 425 volt plate and 35 volt bias, which is rated at 1.54 watts output with a second harmonic distortion less than 5%. With the voltages recommended by Mr. Victoreen one can expect a maximum undistorted output of 1.75 watts. This is enough to show remarkable improvement at the lower notes.

It is difficult to be convinced of the startling realism without actually hearing it.

# Power Supply

Anderson

## LIST OF PARTS

### For the Power Supply

- One Victoreen 116 power transformer.
- One Victoreen 216 choke unit.
- One Victoreen 316 resistance unit.
- Two Tobe 2 mfd. 1000 volt DC condensers, No. 602.
- Three Tobe 4 mfd. 1000 volt DC condensers, No. 694.
- Two Frost sockets.
- One baseboard 9x16 inches.
- One binding post strip with six Eby posts (speaker +, speaker -, B + Amp., B-, B + Det., one blank).

### For the Power Amplifier

- One UX 210 power tube.
- One Frost socket.
- One Victoreen 115 output unit.
- One Tobe 2 mfd. condenser, No. 302.
- Twelve feet of Acme Celatsite wire.
- Two No. 763 Eveready batteries.

quired the other taps on the 316 resistance strip are also used.

A Tobe 4 mfd. condenser is connected across that portion of the resistor strip which supplies the plate voltage to the detector tube. This large condenser so placed is very effective in preventing undesirable feedback in the receiver and aids greatly in preserving the quality of the signal.

The winding comprising terminals (7), (8) and (9) is the high voltage winding which supplies the current to be rectified. The midtap on this winding is the negative terminal of the line and is connected to minus B on the set, as well as to the common electrode of all the by-pass condensers and the positive terminal of the grid battery. The voltage across each half of the (7,8,9) winding is such that the effective rectified voltage across the Victoreen 316 resistor strip is 475 volts when the supply unit is delivering plate current to an average set and one 210 power tube. The current drawn by the power tube and the resistor strip is large in comparison with the total plate current drawn by the average set so that variations from the average do not introduce any appreciable changes in the output voltage. This makes it possible to employ the Victoreen Power Supply unit in connection with sets of a few tubes as well as sets comprising eight or more tubes.

A 45 volt dry cell battery is connected in connected between (2) and the low potential side of the input terminals to the power tube. This battery gives the proper grid bias to the tube recommended when the set is operating with normal output voltage.

### "Input" Connections

The two terminals indicated "input" may be connected across the secondary terminals of the last audio transformer in the receiver, just ahead of the final tube, in case transformer coupling is used in that set. If resistance coupling is used the input terminals should be connected across the final grid leak. The same applies if the coupling used is impedance-resistance. This merely substitutes the 210 power tube with its high plate voltage for the tube in the last socket, which therefore may be removed.

If there is a provision for a grid bias on the last tube in the old set, and there probably is, it is best to remove the feature, as it may be short-circuited when making the connection to the Victoreen Power Supply as recommended. The 45 volt battery supplies the necessary bias.

If any one should be doubtful as to the proper connection he will find it in next week's issue, in which a complete hook-up of a radio receiver with the Victoreen Power Supply unit will be given. This will feature the Victoreen 112 audio unit.

### Filtered Output

The loudspeaker is coupled to the power amplifier tube by means of a high inductance choke coil, known as the Victoreen 115 choke, and by means of a Tobe 2 mfd. condenser. Thus only the alternating current in the plate circuit passes through the speaker. This allows a much greater signal amplitude to be impressed on the speaker and the quality will also be better.

The 115 choke has been designed to give a maximum inductance when the normal plate current from the 210 flows with the voltage recommended. Thus the inductance of the choke remains constant with signal variations of the current, and no harmonic distortion is introduced by the choke.

The inductance is high enough to prevent appreciable by-passing of the lower audible notes in the signal, and the coupling unit thus preserves the quality that reaches the last tube.

While two 216-B rectifiers are recommended in the full-wave rectifier two of the newer and more powerful UX-281 can be substituted without making any other changes in the circuit.

What is the object of using two rectifier tubes in a power supply unit when

one will do? If one tube did as well as two there would not be any object at all. Two rectifier tubes do the work twice as well as one of the same type. When two are used so that both halves of the input wave can be utilized, a lower supply voltage can deliver the same output voltage. The lower voltage will be much easier on the elements of the tubes and on the insulation. The first condenser in the output of the rectifier will not be subjected to nearly so severe jolts as it will when a single wave rectifier tube is used alone.

But there is a still greater advantage in using a double rectifier. Its output is much easier to filter and smooth out. The choke coils in series with the line need not be so large nor so heavily insulated. The same applies to the condensers in shunt with the line. Condensers of a given capacity will do a better job of filtering and they will not be subjected to as great electric stresses.

The output of the double rectifier is easier to filter than the output of the single rectifier because it is partly filtered as it comes out. There are no blanks to fill in with electricity stored up in the condensers, no blanks to be filled in with energy from the choke coils. There will only be depressions in the rectified output, touching zero twice every cycle but of no appreciable duration. In the half wave rectifier the pulses of current occur once a period and half of the time there is no current at all.

Elementary considerations will show why it is easier to remove irregularities from a continuously pulsating current than to remove them from an intermittently pulsating current.

It is not a waste of energy to use a double wave rectifier even if that rectifier is larger than required. If the power is not needed it is not drawn from the source no matter how large the device is. Of course this assumes that the rectifier is 100% efficient. Some energy is required to keep the filaments hot and the larger tubes require more current for that. But this power is well spent.

There is no single tube available now that provides full wave rectification at the high voltages at moderate drain, compared with tubes intended for series filament heating.

## Tapped Choke Better Than 2 Separate Chokes

In impedance coupled push-pull amplifiers there are two methods of obtaining the plate chokes. In one a single high inductance coil with a tap in the exact electrical center is used and the plate supply is connected to the tap. In the other, two entirely separate choke coils of high inductance are used. The question has been raised as to which of these two methods is the better.

Suppose that the inductance of each half of the tapped inductance is the same, when measured with pure AC, as the inductance of either of the two separate chokes. Under these conditions which is the better?

As is well known a direct current flowing in an iron core coil will lower the effective inductance of the coil. If the direct current is heavy the reduction in inductance is great, particularly when the core is magnetically saturated. This reduction in inductance decreases the load on the tube, which in turn results in decreased amplification and the introduction of harmonics. The saturation of the core itself introduces harmonics in addition to the harmonics introduced by the tube.

### DC Flows Here

When a single choke with a tap in the center is used direct current flows in the windings just as in the case of the double

choke. But the current has no magnetizing effect on the core because the current from one tube neutralizes the effect of that of the other. Hence when the tapped coil is used the inductance remains unchanged by the direct current. The core will not be saturated and none of the detrimental results will follow. In all effects only alternating current flows through the windings of the tapped inductance.

When two separate chokes are used this is not so. Both of the chokes may become saturated as a result of the direct current. Hence it would seem that it is preferable to use a single choke with a tap in the center than to use two separate chokes.

### The Summary

The elimination of the direct current component as a magnetizing force from the tapped choke allows the use of a smaller core and this results in the saving of both space and expense. But the inductance of the single choke coil must be made more than twice the inductance of either of the two separate chokes in order to have the same inductance in each of the plate circuits. This calls for more turns and larger core.

But this effect is more than offset by the increase in the inductance due to the absence of direct current magnetizing forces.

# The Electrified Aero 7

By Zeh Bouck

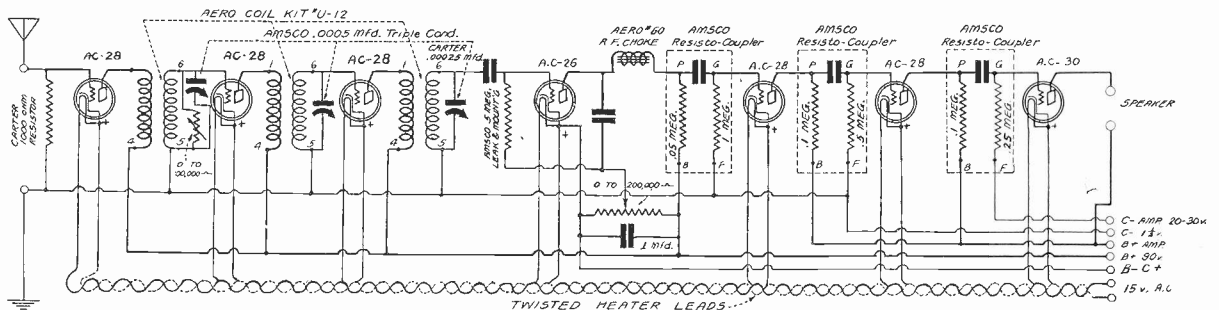

THE CIRCUIT diagram of the Aero 7 in its electrified form.

IN THE October 15 issue of RADIO WORLD the writer completed a description of the Aero-Seven receiver one of the season's predominant achievements. It is hardly our custom to become unduly enthusiastic over any receiver, and we qualify our description of the Aero-Seven as a "predominant receiver" by an expression of its consistently good design. The Aero-Seven may be briefly described as combining the excellent points of many receivers while avoiding the majority of unfavorable points.

Since describing the original model, the author has received numerous requests for an AC design, in recognition of the general availability of alternating current tubes. This article, and the receiver it describes, is the response to a logical demand.

### Construction

The actual construction of the receiver itself is practically identical with that of the original battery model. The same panel, sub-panel and foundation unit are used and the reader is referred to the preceding issues (October 8 and 15) for details of layout and wiring, other than the general photographic and schematic diagram accompanying this article.

The receiver is designed for use with Arcturus AC tubes.

The following changes are made in the

wiring of the Aero-Seven for Arcturus AC tubes:

All rheostats and resistors are eliminated from the filament lighting circuit. The filament circuit now becomes a heater circuit. The heater circuit should be wired with flexible twisted cord.

The potentiometer employed as a volume control in the DC model (the left-hand knob) is eliminated and a variable 0 to 100,000 ohms resistor is mounted in its place. This is connected across the second RF secondary and functions as a volume control.

A zero to 200,000 ohms potentiometer is mounted in place of the rheostat (the right hand knob), where, connected between minus B and plus 90 volts, with the arm to the detector gridleak, it provides a variable "D" bias for the detector tube. A plus bias of about six or seven volts is the optimum value here and is readily determined by varying the potentiometer control.

### Uses No Filament Switch

The filament switch is eliminated from the circuit.

All secondaries of the radio frequency transformers, and the grid returns from the first two resistance coupled stages, are grounded.

Minus 1.5 volts is connected to ground and the plus side of the battery to the

detector cathode (but not to any AC wire leading to the cathode). The cathode is the filament plus post.

These various connections are clearly indicated in the wiring diagram.

Five Arcturus type 28 tubes are plugged into the first, second, third, fifth and sixth sockets, a type 26 in the fourth or detector socket and a type 30 in the last or output socket.

### Operation

The operation of the AC model is identical with that of the battery type, with the exception that a fifteen volt transformer is substituted for the storage battery. An Ives toy transformer is recommended for this purpose. The correct connections should be made and the variable tap set for fifteen volts.

If necessary, the AC model of the Aero-Seven can be operated. Without loss of efficiency as a DC set. Battery tubes and a storage battery are merely substituted for the AC tubes and transformer. No additional changes are necessary or recommended.

The Aero-Seven receiver can be completely electrified by the use of AC tubes,

(Concluded on page 14)

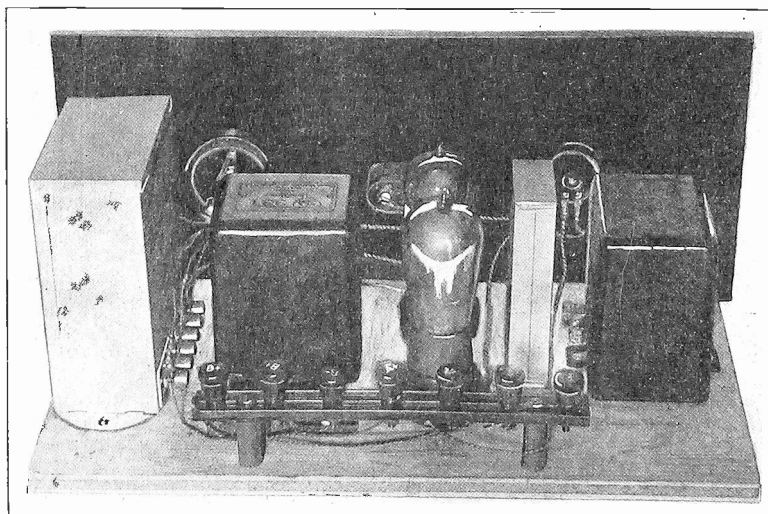

A REAR view of the B and C eliminator, which can be used with the Aero 7.

### LIST OF PARTS FOR AC SET

One Aero-Seven Foundation Unit	\$12.00
One Aero Choke Coil No. 60	1.50
One Aero Kit of Coils No. U-12	12.00
One Silver-Marshall Drum Dial	3.00
One Carter H-1000 Resistor	.30
One Carter .00025 mfd. Condenser	.40
One Carter .001 mfd. Condenser	.50
One Carter Bypass 1/2 mfd.	
Condenser	.90
Ten X-L Binding-posts	1.50
One Amsco Floating Socket	1.00
Six Amsco Universal Sockets	3.00
One Amsco Triplet Condenser .0005 mfd.	11.25
One Amsco Grid Gate Mounting	.30
One Amsco 5 meg. Grid Gates	.50
Three Amsco Resistor Couplers	
No. RC 2	3.75
One .25 Meg. Resistor	1.00
Two .1 Meg. Resistors	1.50
One .05 Meg. Resistor	.50
One .5 Meg. Resistor	.50
One 1. Meg. Resistor	.50
One Zero to 100,000 ohms Variable Resistor	1.50
One Zero to 250,000 ohms Variable Resistor	1.50

TOTAL \$58.90



# Big Primary Best for AF

By Hemstreet Fletcher

THE performance capability of a transformer can most clearly be shown with a curve giving the relationship between the voltage gain and the frequency. Such a curve should be plotted on an octave basis rather than on a frequency basis, so the curve may most nearly represent the manner in which pitch is appreciated by listeners. Such a curve stretches out the lower end of the scale and contracts the higher end in such a manner that the frequency interval between 30 and 40 cycles, for example, occupies the same space as the interval between 300 and 400, or between 3,000 and 4,000.

To the trained musician and acoustical engineer, a curve plotted in this manner tells a lucid and forceful story, while a curve of the same data plotted on the frequency basis tells a top-heavy and baseless story. Even when the story it tells is true the manner of telling is likely to induce erroneous inferences.

The data on any given transformer should have been taken while working under normal operating conditions. For example, if the transformer is intended to work from an 01A tube into the grid circuit of another tube, the amplification data of the transformer should be taken under those conditions. Otherwise the data would be meaningless. If the contribution of the transformer alone is desired this can easily be segregated from the total gain of the amplifier stage. But even when separated, the data would not be applicable to every tube but only to tubes having the same plate impedance as the tube with which the data were obtained.

## Two Strong Reasons

There are two strong reasons for studying the transformer in conjunction with the tube it is to work with, rather than to study it separately. The first is the effect of the plate current in the tube on the impedance of the transformer windings and the second is the effect of the relative impedance of the tube and transformer primary.

Suppose a series of observations of the voltage step-up of the transformer alone is taken with pure AC in the primary and with a constant primary voltage. A certain curve will be obtained. Most likely it will rise uniformly as the frequency increases, until the frequency becomes so high that the various capacities associated with the windings will become effective. Then the step-up ratio will drop. There is also likely to be evidences of peaks on the curve just before the drop begins.

But the results obtained under these conditions do not mean anything in reference to the faithfulness of the instrument when it is used in an amplifier, because in the practical case the primary voltage does not remain constant as the frequency varies and the current in the primary winding is not pure AC.

## Inductance Changes

The plate current in the primary of the transformer alters the inductance, and this alteration partly depends on the amplitude of the signals, since the tube nearly always rectifies a little. Low frequency amplitudes are normally greater for equal power than high frequency amplitudes and therefore the current in the primary depends on the frequency.

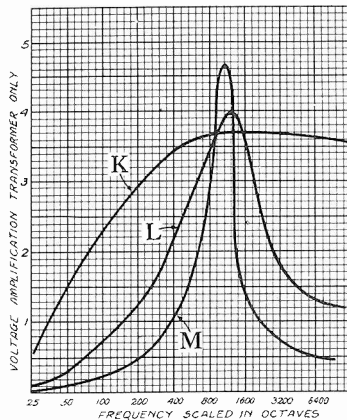

Since the primary current changes the impedance of the transformer it also changes the voltage step-up of the tube and transformer. As the impedance of the transformer is lowered a greater portion of the available voltage is spent in the plate resistance of the tube and a smaller is impressed across the transformer primary. The amplification drops as a result. In a good transformer this effect is small, because the core is large and a suitable airgap has been introduced into the magnetic circuit. But no matter how good a transformer may be, the effect is there and if the performance of the transformer is not taken under actual working conditions the data are misleading.

It is interesting and instructive to compare the performance curves of various typical transformers working under similar and normal conditions. In a graph herewith are shown three such curves of as many different transformers.

## On an Octave Basis

All the curves are of the transformers alone, the contribution of the tube having been divided out. The curves are plotted on an octave basis, that is, step-up against musical interval.

The curve K is that of a first class transformer which is capable of a high degree of fidelity. The minute falling of the curve at the upper end is completely negligible. The gradual falling of the curve at the lower end is offset by the selectivity of the tuner, and does not cause a perceptible diminution in the intensity of the lower tones.

Curve L shows the performance of a medium priced transformer. It does not show up very well though the quality obtainable with a pair of the transformers is tolerable. The rapid fall of the lower end of the curve prevents the amplification of the lower tones, as the selectivity of the tuner cannot make up for it. The sharp peak near 1250 cycles will cause blasting at that frequency and this fact will force down the volume obtainable from the receiver to such a degree that the circuit will seem lacking in power. The rapid drop above the peak will effectively eliminate all the higher frequencies that have not already been eliminated by the tuner. Thus the receiver built with a couple of the transformers will be weak on the low tones, extremely strong on the middle notes, and it will be nearly dead at the high notes.

## How Price Shows Up

Curve M shows the performance of a cheap transformer. The curve is similar to curve L but all the defects have been greatly exaggerated. The music reproduced with a receiver in which two of these transformers are used will be extremely tinny, lacking the fullness and richness contributed by the bass notes and the crispness added by the high. The circuit will blast much more easily than a circuit built with a couple of transformers represented by curve L and it will be impossible to get the same volume out of it, even when the same tubes and voltages are used. Imagine the response when two such transformers are used and the curves are superposed! The peak which now is 4.65 volts high will be nearly 22 volts. At 400 cycles where the step-up is one, the voltage with two transformers will still be one. Thus the step-up ratio between 1000 cycles and 400 cycles is 22. The volume at 1,000 will be 22 times greater than at 400 when the same voltage input is used at both frequencies.

It will be observed that the maxima of all the curves fall in the octave between 800 and 1,600 cycles. Their positions are not greatly shifted by the effect of the tuned circuit, but in some cases the peaks are brought down, thus making the quality somewhat better than would appear from measurements of the audio amplifier alone. When a transformer without appreciable peaks is used in conjunction with a tuned circuit of average selectivity an amplification peak is sometimes introduced, and it usually lies in the same region of the scale. When the transformer is of the best type and the selectivity of the circuit is high, this peak is quite low down the scale.

## Arborphone Combines with Wells-Gardner

Wells-Gardner and Company, Chicago, and the Precision Products Company, Ann Arbor, Mich., have merged their radio manufacturing businesses and organized a new Delaware corporation, known as The Consolidated Radio Corporation, with C. A. Verschoor, as President.

The merging companies will continue their present manufacturing plants in Chicago and Ann Arbor, but in the future the combined business will be conducted by the new Corporation operating the two plants, as separate units, one as the Wells-Gardner Division and the other as the Arborphone Division.

One of the first steps of the Consolidated Radio Corporation was the taking out of a license under the radio patents of the Radio Corporation of America, Westinghouse Electric and Manufacturing Company, General Electric Company and American Telephone and Telegraph Company. This license combined with their own patents places the new company in a very favorable position in the radio field.

## AURORA PRODUCES MUSIC

Siberia. While watching the aurora borealis, operators of the station at Berezov, Tobolsk Province, recently reported that they heard musical sounds. As the aurora rose or fell, the signals varied both in intensity and in frequency.

# Metal Band on Coil Boosts Amplification

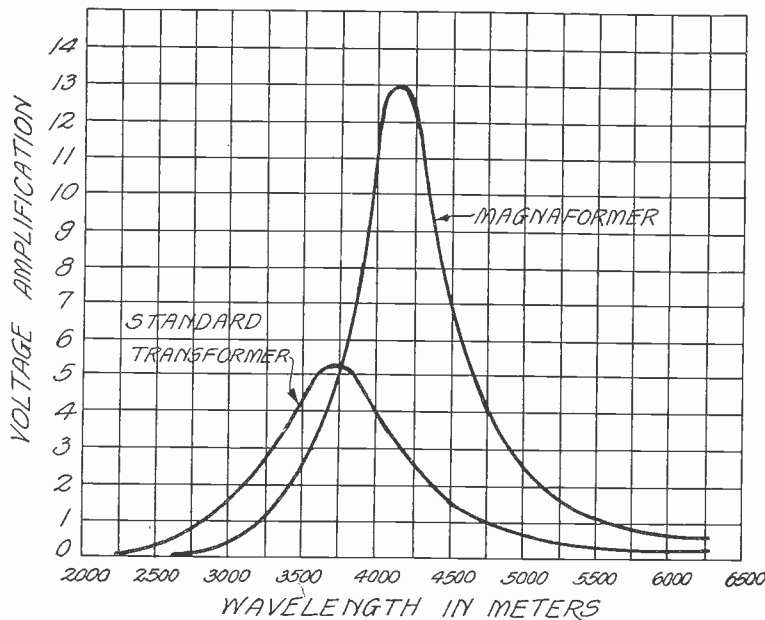

THESE CURVES show the advantage of matching impedances between the plate circuit of a tube and the primary of the intermediate transformer. The high curve shows the voltage amplification of the Magnaformer with proper matching and the low curve is a corresponding curve of another make of intermediate transformer.

What makes one Super-Heterodyne superior to others of the type? Is it mere accident that one picks up distant stations with clock-like regularity and certainty while others fail except under the most favorable conditions?

Is it mere chance that the quality of the one should be superb while that of the other is atrocious? Did the fates decide that the selectivity of one should be as incisive as that of the others is obtuse? Is it merely a remarkable coincidence that the sensitivity, the selectivity and the quality are all combined in one in the optimum degree?

Chance, fate and accident have little to do with it. One is superior in all phases because every component part has been designed as dictated by laboratory results. One is superior because all the parts have been chosen for their individual superiority as well as for their harmonious coordination in the circuit.

## Co-Ordinated Efficiency

An example of scientific design and coordination is the Magnaformer Super-Heterodyne.

The radio frequency circuit has been designed to give the utmost selectivity in that level so as to minimize image interference. The oscillator has been designed to give constant amplitude of oscillation over the entire broadcast band and yet not give any harmonic frequencies. The intermediate frequency amplifier has been designed to give great amplification and high selectivity without cutting the higher side frequencies. The audio amplifier has been designed to give an even response over the entire audio band.

## Audio Consideration

To effect this the audio transformers were chosen so as to offset the reduction in amplification of the higher audio frequencies due to the necessary selectivity of the circuit.

The effect of the coordination of the

intermediate and the audio amplifier is to give the circuit a bandpass response characteristic. That is, all the frequencies in the audible scale are passed with equal intensity, and near the upper limit of audibility the cut-off is sharp and complete. Thus radio and intermediate frequency currents are eliminated from the audio amplifier.

One might say that the Magnaformer intermediate frequency transformers are

the heart of the entire receiver. They are responsible for the surpassing amplification of the circuit, for its great selectivity, for the steadiness of the intermediate frequency, and for the freedom from noise, which is an outstanding characteristic of the receiver.

The intermediate frequency transformers have been designed to work with tubes of standard characteristics and give the maximum voltage step-up of which such tubes and transformers are capable. The matching has been effected by properly choosing the primary and secondary turns, the mutual inductance between the two windings, and the resistance of the secondary circuit. This resistance feature particularly has been brought to the highest peak of efficiency and it accounts more than any other thing for the remarkable results reported for the Magnaformer circuit. There is a metal band around the coil form which has the effect of a short-circuited turn. This stabilizes the circuit and at the same time introduces resistance into the tuned secondary circuit, which resistance is necessary to effect proper matching of the plate impedance of the coil for maximum voltage transfer at the tuned frequency. Hence the band, theoretically a loser, actually is a gainer, as the curve shows. The adjustment of the intermediate transformers to the same frequency has been very carefully done and the adjustment has been made so it stays put after the coil leaves the laboratory.—J. E. Anderson.

## Woolf Making Hit

### With Speaker Line

Since adding the new Baldwin 99 speaker in both table and pedestal models to the line, a large sales increase in the national and export business has been experienced by J. W. & W. L. Woolf, of New York City, distributors and exporters for the Nathaniel Baldwin Co., of Salt Lake City. The Woolf organization has greatly increased its selling staff and now occupies triple the office space it did less than a year ago.

Mr. Woolf is convinced that business this season will be good for manufacturers who have a quality product.

# New Arcturus AC Tubes Fit Standard Sockets

A new alternating current tube fitting the standard four prong socket has been developed by the Arcturus Radio Company of Newark, N. J. The tube is of the heater type, i.e., a tube in which the filament heats the electron emitter but does not give off electrons itself. By thus eliminating alternating current from the emitter the possibility of hum is considerably reduced.

The retention of the standard four prong base without additional side or overhead wiring, has been made possible by the connection within the tube of one side of the heater to the cathode. The heater is of the low current high potential type, contrary to the general procedure. This departure from conventional design, according to the claim of the manufacturer, results in the further reduction of hum (to a point of practical elimination) as it is easier to shield voltage fields than current fields, the cathode around the filament acting as the shield.

Aside from this electrical advantage of the low current high voltage carbon filament, the convenience to the set builder and rewirer is considerable. The heater filaments can be connected in parallel, just

as the filaments are in the majority of DC operated receivers, and lighted from a readily available toy transformer selling for a few dollars.

The tubes are made in three types, (all of which are of the heater design), amplifier, detector and power tubes. The characteristics of the detector and amplifying tubes are as follows:

Filament potential, 15 volts.  
Filament current, .35 ampere.  
Mutual conductance, 1,100.  
Amplification constant 10.5.

Plate impedance, 9,500 ohms.

The characteristics of the power tube are similar to the above, with the exceptions that the mutual conductance is 1,665, the amplification constant 4.5 and the plate impedance 2,700 ohms.

The mechanical and electrical design of the Arcturus tubes is such that any receiver can be made over for AC operation with comparatively few changes. No potentiometers or additional equipment, other than the step-down transformer, are required. A receiver once wired for AC can be operated with DC tubes, in an emergency, without making any changes in the circuit.

# Use of High Mu Tubes In Knickerbocker Four

By Herbert E. Hayden

It is generally supposed that high mu tubes cannot be used to good effect in transformer coupled circuits. And the supposition is true in regard to audio frequency amplifiers, but not to detectors nor to radio frequency amplifiers.

The reason high mu tubes do not show up well in transformer coupled amplifiers, audio or radio, is that they are not loaded sufficiently. That is, the impedance of the primary of the transformer connected in the plate circuit of the tube is not high enough. When the impedance of the load in the tube is high compared with the impedance of the plate of the tube, advantage can be taken of the high amplification constant of the tube and a great gain per stage is possible. If the transformer used in the circuit is capable of bringing out the low notes with full volume when it is working with a —01A tube then it will give good results with a high mu tube.

### High Mu As Detector

One place where a high mu tube is especially efficacious is in the detector socket. A direct comparison between a mu 30 and a mu 8 tube strikingly demonstrates the superiority of the high mu tube. Turn the signal down to a volume barely audible when a mu 8 tube is used as detector and then insert a mu 30 tube. The effect is often as if another audio amplifier tube had been cut into the circuit. It must be repeated that the impedance of the primary of the audio transformer following the high mu tube must be high, so that the tube is well loaded. It is high indeed in the case of the Karas Harmonik audio transformers, used in the Knickerbocker Four.

Even as a radio frequency amplifier the mu 30 tube can be used to good advantage. The condition here also is that the impedance of the primary of the radio frequency transformer connected in the plate circuit of the tube be high at the frequency it is desired to amplify. This does not mean that the inductance of the primary should be enormously high. It is not the reactance of the primary which constitutes the load when the secondary of the transformer is tuned. The load impedance is dependent on the mutual inductance between the two windings, on the frequency of the carrier amplified and on the effective resistance in the secondary circuit.

### When Selectivity is Halved

When the tubes and the transformers have been properly matched and the amplification is a maximum the selectivity of the tuned circuit is just half as great as it is when the coupling between the primary and the secondary is negligibly small. But this does not mean that the effective selectivity of the circuit is not great enough.

When the selectivity of the tuned circuit by itself is measured it is so great that, if it were possible to use this selectivity in the receiver the sidebands would be greatly suppressed. That is, the selectivity of the circuit would be so great that the quality of the signal would be intolerably impaired. Thus the matching of the transformers to the tubes not only increases the volume obtainable but it also improves the quality. There remains enough selectivity for all practical requirements, and more.

The condition for maximum amplification is that the mutual inductance times the frequency times 6.28 be equal to the product of the plate impedance of the tube times

the effective resistance of the secondary circuit at the frequency of resonance.

Hence when a high mu tube is used its high plate resistance can be matched by increasing the mutual inductance between the two windings, that is, increasing the coupling, and by decreasing the effective resistance of the secondary winding.

The mutual inductance can be varied both by increasing the primary inductance and by increasing the coupling coefficient. In the Knickerbocker Four the coupling between the first tube and the detector can be set at any desired value by merely turning the primary coil on its hinge. The inductance cannot be increased quite so easily, but a considerable gain in the amplification can be obtained by adjusting the setting of the primary coil without adding any more turns.

### Neutralization Retained

The Karas RF coils used in the circuit have been constructed on a truly low loss basis, and there is regeneration besides which lowers the effective resistance. The amount of regeneration is completely within the experimenter's control because the tickler can be set at any desired angle on the shaft of the second tuning condenser.

The neutralizing feature of the Knickerbocker Four need not be sacrificed when a high mu tube is tried in the first socket. This tube also will oscillate if conditions are favorable to oscillation. They will not be when the special neutralizing feature is incorporated and adjusted, and consequently the circuit will be stable and quiet in operation.

In making a substitution of a high mu tube for a mu 8 tube it is advisable to make a readjustment of the neutralizing condenser since the distributed capacity of the high mu tube is not the same as that of the mu 8 tube.

### BEETHOVEN AIR FAVORITE

The results of a questionnaire sent out by the Edison Company, in connection with their hour of music broadcast weekly from WRNY, show that Beethoven is the most popular of composers.

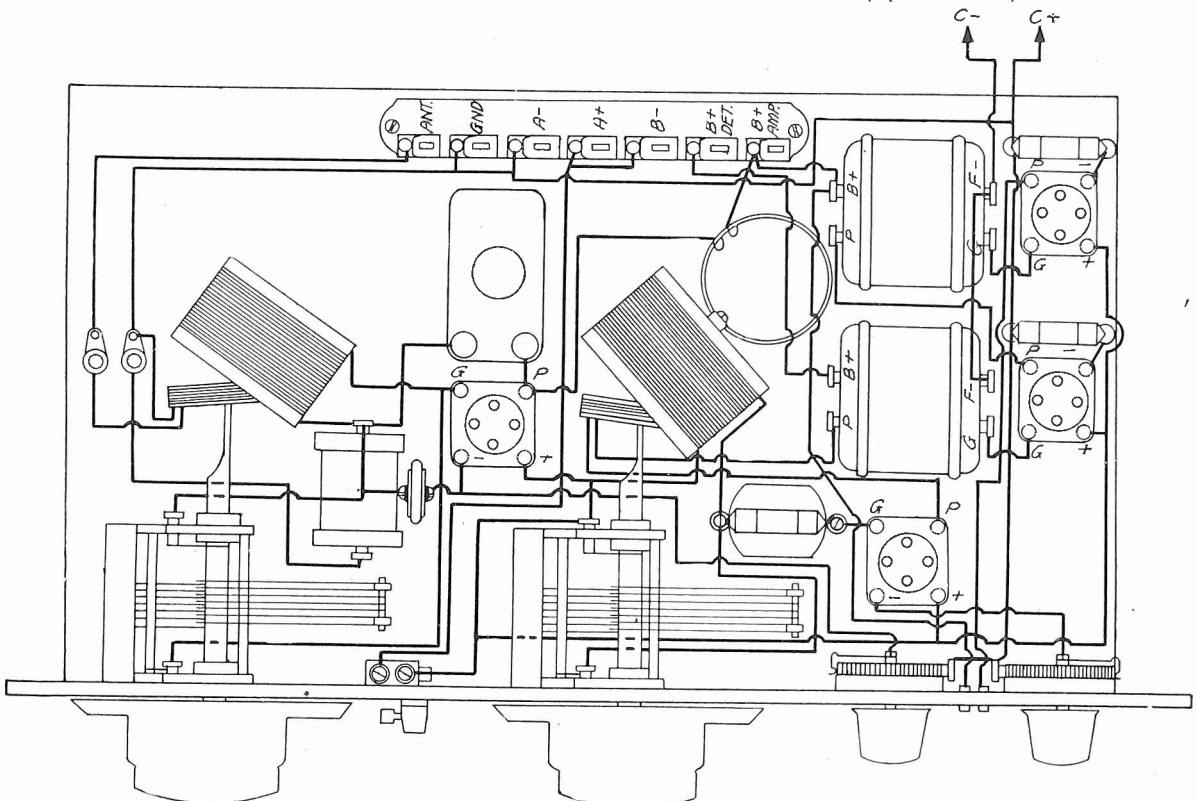

IN THE KNICKERBOCKER FOUR the volume can be increased by putting a high mu tube in the detector socket, which appears at the right just back of the rheostats. The volume can also be increased by putting a similar tube in the first socket,

MARCONI ON VISIT



(Acme)

WILLIAM MARCONI, the noted radio scientist, with his bride of six months, the former Countess Christina Bezzi Scala, on their recent arrival in this country. Marconi attended the International Radio Conference in Washington and addressed the Institute of Radio Engineers in New York City. The couple were guests of the Radio Corporation of America at the Ritz Carlton Hotel.

# Wanted: More

By Dailey Paskman

Director, WGBS



MINSTREL SHOW, put on by Dailey Paskman, being

## Huber Is Strong For Great Outdoors

One of the outstanding features of entertainment at the recent B. & O. Centenary Exposition were the outdoor radio concerts arranged by Frederick R. Huber, director of WBAL, Baltimore. These concerts were given nightly at Mt. Vernon Place Square. The amplifying system which carried the strains to those present on the grounds was installed on the base of the Washington Monument. Among the many musical stars which were heard during this series of concerts was Mabel Garrison, celebrated operatic and concert star.



(Bain News Service) FREDERICK R. HUBER

### RADIO MAN HONORED

Sidney Vorzimir, president of the Yorkville Radio Company, has been elected to the honorary post of Mayor of Yorkville by a two-to-one majority. The election was held in connection with the celebration of "Old Home Week" which ran for a full week. Yorkville is a section of New York City, on the East Side of central Manhattan.

Tambo: What you-all do fo' a livin'?  
 Bones: Ah raises pigs. Ah buys little pigs in de spring, feeds 'em for a yeah, an' den, when dey's big an' fat, ah sells 'em.  
 Tambo: How much those little pigs cost you-all in de Spring?  
 Bones: One dollah per each.  
 Tambo: An' how much does you-all git fo' 'em when you-all sells 'em?  
 Bones: Ah gets a dollar each fo' 'em.  
 Tambo: Why, boy, you-all caint make any money that-a-way.  
 Bones: Yeah. Ah knows. Ah found dat out!!!

Of such is minstrelsy composed. It is light, airy, requiring no deep thought from its audience, yet arousing much mirth, mingled at times with not a little pathos. For, while the foundation of minstrelsy rests upon the gay, carefree, almost child-like, nature of the old-fashioned plantation ducky, there is, in every worthwhile minstrel show, a real "tear-jerker" ballad. Not only does this serve to accentuate the high spots of humor, but it also reflects the deeply buried melancholy which is manifest in the folk-songs and spirituals of the negro race.

### 95 Per Cent. Humorous

Nevertheless, 95% of every real minstrel show is humorous: dialogue and jokes, in the negro dialect; popular songs; intricate, and often ludicrous, tap dances; funny riddles, monologues. And all of these may be broadcast.

Love of laughter is the one characteristic that distinguishes man from the beasts. Everyone appreciates laughter in all its forms, from a school girl's giggle to a teamster's guffaw. And laughter had too small a part on the radio programs being broadcast; they lacked humor.

Now, I believe that there is no finer, cleaner humor than that contained in the old-time minstrel shows. True, they date back to the first laugh, but a good joke, like a beautiful statue, never grows old. It can be enjoyed by generation after generation.

### Too Much Music Now

Radio, ever since its inception, has had too much of one good thing—music. Music is very essential, I will grant, but one can get fed up on candy, no matter how great his liking for it, or how excellent its quality. Educational talks, information, fights, how to boil eggs, build houses, be beautiful and choose the right fork or husband are all very interesting to radio listeners, but one must be cheered as well as counseled. A good, hearty laugh, from a wholesome joke, is always well relished. It is truly a part of our daily diet, and without it we would wither and die, like flowers without sunshine. And minstrelsy is the one constructive form of humorous entertainment that can be served to a radio audience.

That the radio public really wanted such programs was instantly proven by the stacks of mail that poured into my office on the eighth floor of Gimbel

# Laughs

## MACHINE AUTOMATICALLY ANNOUNCES SOS

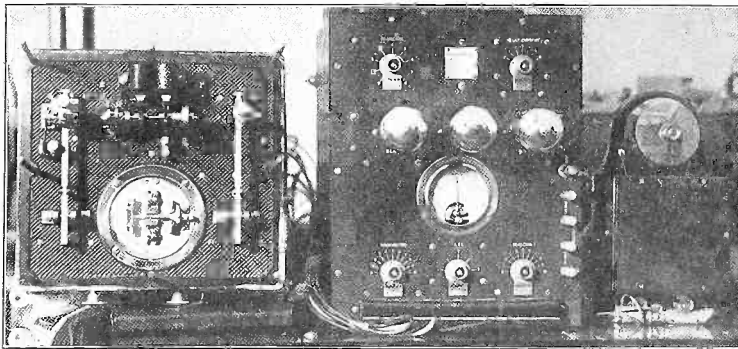

(Wide World)

**THE THREE UNITS**, which comprise the Marconi Auto Alarm, (selector, receiver and bell, left to right), which notifies the radio operator when off duty, as well as other members of the crew, when a ship within the receiver's range is in distress. A special signal is used besides the common SOS call. This consists of a series of 12 dashes sent in one minute, the duration of each dash being four seconds with a one second interval between each. The alarm operates on the termination of the third consecutive dash received, bells located in different parts of the vessels ringing. After the receiver picks up the signal it is fed to the selector, and thence to the bell.



roadcast.

others. The concensus was: "Now that we have heard the Dailey Paskman—WGBS Radio Minstrels, we wonder how we ever got along without them. Only when television was working, so we could see them, too."

### Radio Artists Go on Stage

The first few hundreds of these letters passed us greatly, but when several thousand people asked to see our minstrels, something had to be done about it. Consequently, the minstrels have been away from WGBS for several months, making a trans-continental vaudeville tour, to sat-

isfy their million radio friends. Whenever their itinerary brings them near New York, they make a flying trip to the Gimbel station, and put on a gala program for the radio audience.

### Popularity Great

Isn't it strange that such an old form of entertainment should continue to be overwhelmingly popular? The first minstrel troupe was organized back in 1843—over eighty years ago—the first and only purely "100%" American entertainment. It is to the theatrical world as baseball is to the sport world—identified as a national characteristic. And, although a good joke lives forever, and a tuneful song is never forgotten, I feel that I am doing my part in perpetuating the best traditions of minstrelsy, together with such of its famous characters as "Mr. Bones," "Tambo," and "Sambo," by putting them not only on the stage, but on the air, as well. But, regardless of what one man may do to preserve the art, minstrelsy is enshrined in the hearts of the American people, and, I feel sure, is destined to live throughout the ages.



DAILEY PASKMAN

## WGN's Schedule of Football Games

Once again WGN, popular Chicago station, is ready to write radio football history with its 1927 schedule. This is the fourth year that this station has indulged in this type of broadcasts. The cream of the year's mid-west collegiate games will be sent out. All the games of the Chicago Bears, the local professional football team, will also be sent out. The noted Red Grange, Benny Friedman, George Willson and Ernie Nevers are all members of this strong professional eleven, which is sure to furnish a barrel of thrills. Quin Ryan will describe all the battles.

Following is the schedule of collegiate football games to be broadcast:

- Oct. 29—Michigan at Illinois.
- Nov. 5—Minnesota at Notre Dame. (South Bend).
- Nov. 12—Notre Dame at Army (New York City).
- Nov. 19—Minnesota at Michigan.
- Nov. 26—Southern California at Notre Dame (Chicago).

Here is the professional football schedule:

- Oct. 30—Chicago Cardinals vs. New York Yankees (tentative).
- Nov. 6—Chicago Bears vs. Providence.
- Nov. 13—Chicago Bears vs. Pottsville Independents

## THESE MEN REPRESENTED U. S. AT WORLD CONFERENCE

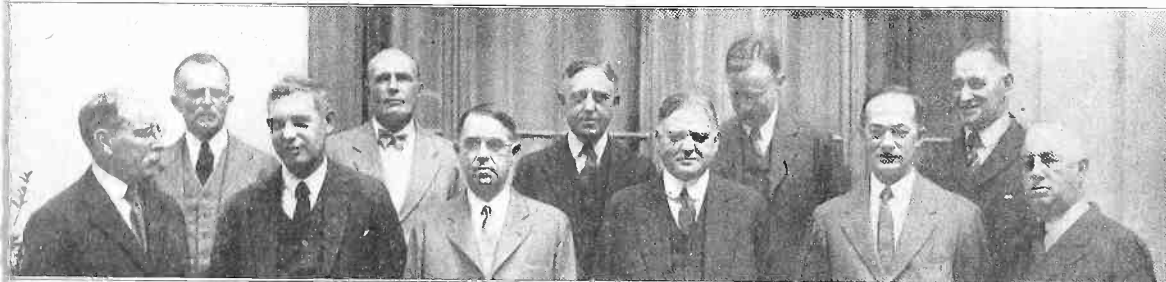

International Newsreel)

**THE AMERICAN DELEGATION** to the International Radio-Telegraph Conference held at the Chamber of Commerce Hall in Washington, D. C. Front row, left to right; Prof. A. B. Kennelly, W. R. Vallance, Stephen Davis, Herbert Hoover (chairman), and B. White and Rear Admiral W. G. Bullard. Rear row, left to right; W. D. Terrell, Captain T. Craven, W. H. White, W. R. Castle, Jr. and Colonel Samuel Reber.

# Selectivity Gain Easy In Unified Diamond

By the Laboratory Staff

There may be cases when a greater selectivity will be required than has been provided for in the Unified Diamond. In such cases the sharpness of the circuit may be increased by putting a small condenser in series with the antenna. The size required would depend on the individual antenna and on the required increase in the selectivity. A .00025 mfd. may serve in some cases, but in most others .0001 mfd. would be as large as would be practical.

Since the possible requirements differ so widely it would be well to make a few tests.

It is not particularly recommended that this condenser be made an integral part of the circuit, because in the majority of instances the selectivity as provided will suffice.

An increase in selectivity is always accompanied by a loss in sensitivity unless the increased selectivity is obtained in conjunction with additional amplifier tubes. Therefore no owner of the Unified Diamond should expect that both the selectivity and the sensitivity can be increased at the same time by any means which does not combine amplification and tuning.

### Study of Couplers

There is an important feature in the couplers of the Unified Diamond which merits special notice. It will be observed that the primaries of the two Aero couplers following the antenna coupler are tapped. Each contains four terminals instead of two. The extra terminals are to accommodate the couplers to different types of tubes.

As is well known, the voltage transfer from one tube depends on the impedance of the coupler as it looks to the plate of a tube. This impedance depends on the number of primary turns as well as on the constants in the secondary circuit. Since the different tubes such as the CeCo types G, A and C have different plate impedances and thus require different plate loads for maximum voltage transfer to the next tube, it is necessary to use a different number of turns for each tube. For the tube of highest plate impedance, that is, the G or high mu, the largest number of turns should be employed and for the tube of lowest plate impedance the fewest turns should be used.

It is not to be supposed that when the tubes have been matched with the impedance of the transformer, that is loading them, they all give the same amplification. The amplification in each case is the greatest possible with that tube but the tube with the highest mu will give the greatest voltage amplification.

The filament circuits are controlled with Amperities. They keep the current constant

when the voltage varies within certain limits. Some may be inclined to scoff at this claim until they have seen the simple explanation of the action. The operation is based on an electro-thermal principle. As is well known, the resistance of all metals increases with temperature. In some metals the increase is much more rapid than in others. Again the increase of the resistance with temperature is much more rapid at some temperatures than at others.

Hence to construct an automatic filament control it is necessary to choose a metal

which has a very high temperature coefficient of resistance increase and then so to proportion the resistance element that its temperature normally will coincide with a point where the change in resistance for that element is great.

Suppose then that the resistance element has been so chosen and so constructed as to take greatest advantage of the resistance change. When the voltage increases the current tries to increase, and does just a little bit. But the increase in the current increases the temperature of the element and that in turn increases the resistance. Thus the current cannot increase in proportion to the voltage increase. The voltage may increase 10% and the current will not increase more than 1%. Such a small change is wholly negligible and therefore it can be truthfully stated that the current remains constant as the voltage changes.

(Construction of the Unified Diamond was described in the September 17, 24 and October 1 issues.)

## Set Utilizes "D" Bias; Runs Without Batteries

(Concluded from page 8)

as described, in conjunction with a satisfactory C and B battery eliminator. The Pausin Electric Company makes an eliminator especially designed for use with Arcturus tubes having A, B and C windings.

A highly satisfactory B and C battery eliminator for use with the Aero-Seven is shown diagrammatically below and in the accompanying photographs. This eliminator will supply plate potentials of ninety volts for the RF tubes and 180 volts for the audio end, minus 1.5 volts for the amplifier grid returns and a variable high C potential for the power tube. The D bias voltage to the detector tube is taken care of in the receiver itself.

The initialing on the diagram refers to manner in which the choke coils, transformer and filter systems are connected.

The eliminator is of course wired to the receiver in place of the usual B and C batteries. The minus B is connected in the conventional manner to the post provided for it on the set. This automatically takes care of the C plus connection.

The amplifier C potential is varied by adjusting the arm on the monostat until the receiver functions most satisfactorily—until the tone sounds most natural.

If a 0 to 25 milliampere meter is available it should be included in the plate circuit of the power tube, while the C potential to this tube is being adjusted. The C voltage is varied until there is the least fluctuation of the needle on a loud signal.

All battery troubles are forever elimin-

### LIST OF PARTS FOR ELIMINATOR

One Silver-Marshall 330 Transformer	\$ 6.00
One Silver-Marshall 331 Choke Coil	6.00
Two AmSCO Universal Sockets at .50 cents each	1.00
One Raytheon BH tube	4.50
One Raytheon type R Regulator Tube	4.00
One AmSCO 1000 ohm Monostat	2.00
One AmSCO 50 TT Rheostat	.75
One Tobe type 311, Buffer Block	1.50
One Tobe type 760, Filter Block	9.50
One AmSCO type 125, 3000 ohm Resistor	1.50
<b>TOTAL</b>	<b>\$36.75</b>

ated by the use of AC tubes and the eliminator described. Your receiver becomes as reliable as your power house, a consistency only comparable with its all around efficiency.

### NEW HOME FOR WJZ AND WEAF

Listeners in to WJZ no longer hear, "located at 33 West 42nd St." Instead they now hear, "located at 711 5th Ave." which is WJZ's new home, as well as the home of the National Broadcasting Company. WEAF will also move into the new building very shortly, followed by the entire office staffs of both stations. The studios of both prominent stations will, then, for the first time be housed under the same roof.

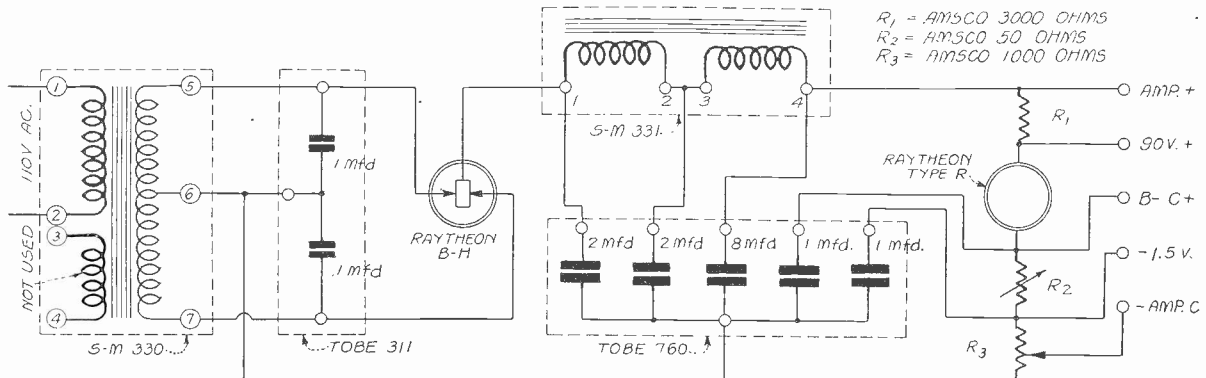

THE B AND C ELIMINATOR DESCRIBED BY ZEH BOUCK.

# Radio University

A FREE Question and Answer Department conducted by RADIO WORLD for its yearly subscribers only, by its staff of Experts. Address Radio University, RADIO WORLD, 145 West 45th St., New York City.

When writing for information give your Radio University subscription number.

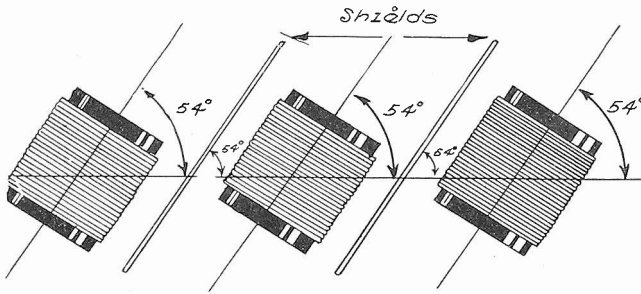

FIG. 569

**WHAT IS** the so-called Neutrodyne angle?

(2)—Is the neutrodyne angle the same for all sizes and shapes of coils and for all distances apart?

(3)—Can two or more coils always be placed so that there is no magnetic coupling between them?

(4)—Will you please publish a diagram showing the proper placement of neutrodyne coils.—George Fine, Cheboygan, Mich.

(1)—The neutrodyne angle is about 54 degrees and 45 minutes, or more exactly the antitangent of the square root of 2.

(2)—No, it applies strictly only to single layer solenoids of given size and shape and distance apart.

(3)—Yes, but not for more than three coils.

(4)—See Fig. 569.

\* \* \*

**IS THERE** any advantage in using an output filter consisting of a choke and a condenser over an output transformer?

(2)—What should be the inductance of the choke coil and the capacity of the condenser in an output filter?

(3)—What should the ratio of the transformer be if this method of output is employed?

Karl Bishop, Superior, Wisc.

Each method has advantages over the other but perhaps the choke and condenser method has the more. There is less danger of saturating the core, the inductance used can be larger, and it is possible to shunt the AC component of the output around the B voltage source.

(2)—The inductance of the choke used across the speaker should be about 100 henrys when working with normal plate current in its winding. Good results will be obtained if the inductance is as low as 35 under the same conditions. The condenser should have a capacity of at least 4 microfarads.

(3)—It depends on the type of tube and on the type of speaker. The primary impedance should be somewhat larger than the impedance of the tube and the secondary impedance should be the same as the impedance of the speaker. Often that means a ratio of one to one.

\* \* \*

**IS IT POSSIBLE** to use the new AC tubes in a resistance coupled amplifier?

(2)—What values of inductance and capacity are required to tune in a frequency of 100,000 cycles?

(3)—Can an intermediate frequency transformer be used as a long wave oscillator? If so, how should it be connected? Clinton Morchouse, Oakland, California.

(1)—Yes, it is possible, but the filament circuits have to be wired for the new tubes.

The amplification will not be as great as when high mu tubes are used.

(2)—Inductance 2.5 millihenrys and capacity .001 mfd.

(3)—Yes. Connect the high winding in the grid circuit and the low winding in the plate circuit of the oscillator tube. Connect as if the various terminals on the socket belonged to two different tubes. If circuit does not oscillate reverse one pair of leads. Connect condenser across high winding for longer waves and across the low winding for shorter waves.

\* \* \*

**WHY DO** certain transformer manufacturers recommend the use of a low ratio transformer next to the detector and a somewhat higher ratio in the amplifier stage when the rule has long been just the opposite?

(2)—Is there any advantage in the newer method and is it worth while to switch the transformers around in my old set?

Jefferson Lane, Kansas City, Mo.

(1)—The detector has a higher impedance than the amplifier tube hence the transformer coupled to the detector should have a higher impedance. The lower ratio transformer has a higher impedance.

(2)—The newer method gives a little better amplification on the low notes. If your old transformers are reversed in position the same effect will be present, but hardly noticeable. There is little object in making the change, unless up-to-date transformers be installed.

\* \* \*

**WHY DOES** the resistance of a coil increase with frequency? I understand that the resistance of a wire is directly propor-

tional to its length and inversely and proportional to its cross section. Don't these remain the same as the frequency varies?

Leo Lensky, Detroit, Mich.

There are two reasons why the resistance of a coil goes up with the frequency. The first is that the effective area of the cross section of the wire does not remain the same as the frequency is increased, but decreases rapidly. The second is that at the higher frequencies there are greater losses due to eddy currents in surrounding metal bodies, as well as greater dielectric losses. The decrease in the effective area is known as the skin effect. The current travels in a thin layer on the surface of the wire and the higher the frequency the thinner the layer in which current flows. The increase in radio frequency resistance with frequency, that is the skin effect, depends on the conductivity of the wire, on the diameter and on the permeability of the material of which the wire is made. For magnetic metals of high permeability such as iron the skin effect is very large. Even for comparatively low frequencies the current travels on the surface to such an extent that the resistance of the wire is several times the direct current resistance. For fine wires the skin effect is not nearly so pronounced as for heavy wires. It is for this reason that radio frequency conductors are frequently stranded, that is made of a large number of very fine wires.

\* \* \*

**I HAVE HEARD** that there is a UX-112-A tube out which has improved characteristics over the 112. I have been unable to obtain any trustworthy information about this tube. Is there such a tube, and if there is, what are its advantages?

(2)—Can the tube be used as a power tube in the ordinary sets without rewiring?

(3)—Will it give as much volume as the 171 tube?

(4)—Can it be used to advantage in place of a 201-A?

Irving L. Cohen, Aurora, Ill.

(1)—Yes, there is such a tube, though we have not seen it announced or advertised. The tube is identical in all respects to the 112 tube except that its filament requires only .25 ampere instead of .5 ampere. The emission efficiency is as great.

(2)—The tube can be used as a power tube in place of the 112 without rewiring except that the filament ballast must be adapted to .25 ampere. For example, where a 112 Amperite is used with the 112 tube a 1-A Amperite is used with the 112-A tube. The filament voltage of the tube should be five volts, as for the old tube.

(3)—It is not capable of giving as much undistorted output as the 71 tube but it will give a much greater output for a given input voltage. That is, it amplifies more.

(4)—Yes, it can be substituted everywhere for a 201-A tube to good advantage—RF, detector or AF.

## Join RADIO WORLD'S University Club

And Get Free Question and Answer Service for the Coming 52 Weeks This Service for Yearly Subscribers Only

Have your name entered on our subscription and University lists by special number. Put this number on the outside of the forwarding envelope (not the enclosed return envelope) and also put at the head of your queries. If already a subscriber, send \$6 for renewal from close of present subscription and your name will be entered in Radio University. No other premium given with this offer.

[In sending in your queries to the University Department please paragraph them so that the reply can be written under or alongside of each query. Write on one side of the sheet only. Always give your university number.]

RADIO WORLD, 145 West 45th Street, New York City. Enclosed find \$6.00 for RADIO WORLD for one year (52 nos.) and also enter my name on the list of members of RADIO WORLD'S University Club, which gives me free information in your Radio University Department for 52 ensuing weeks, and send me my number indicating membership.

Name .....  
Street .....  
City and State.....

# Wiring Instructions for Winner's Shielded Set

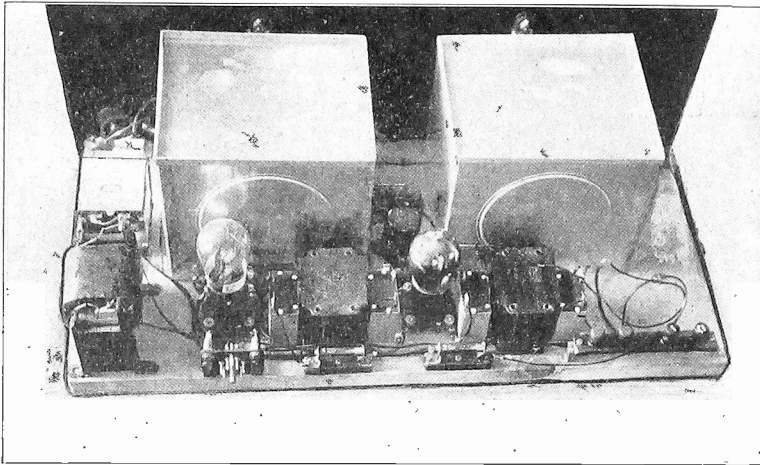

FIG. 5

A rear view of the completed receiver.

By Lewis Winner

Technical Editor; Associate, Institute of Radio Engineers

[Part I of this article appeared in the Oct. 1 issue. Part II was published in the Oct. 8 issue. Part III appeared last week, Oct. 15 issue. Part IV follows.]

The first stage audio transformer is  $\frac{1}{8}$  inch away from the condenser and  $\frac{3}{4}$  inch from the rear of the baseboard. Another 1 mfd. fixed condenser is placed  $\frac{1}{8}$  inch from the other side of this transformer and in line with the other. Next comes the socket for the first studio stage. This is  $2\frac{1}{2}$  inches from the rear of the baseboard. It is also  $\frac{1}{4}$  inch from the last condenser mounted. The next 1 mfd. condenser is  $\frac{1}{4}$  inch from the socket and in the same line with the other fixed condensers. The second audio transformer is placed  $\frac{1}{8}$  inch away from this condenser, in the same line as the other transformer. The next 1 mfd. fixed condenser is placed  $\frac{1}{8}$  inch away from this transformer on the other side and in the same line as the other condensers. The last audio socket is then screwed down, this being  $\frac{1}{4}$  inch from the last mounted condenser and in the same line as the other socket. Directly behind this socket, but flush up against the edge of the board, the Yaxley cable connector plug-mounting is mounted.

Flush up against the rear of the board 8 inches from the right-hand portion of the board, a grid leak mounting is screwed down. It will be noted that this is parallel to the short edge of the second transformer. In the same line with this leak, but 2 inches away, another grid leak mounting is placed. The fibre strip containing the four binding posts is next mounted, this being 3 inches from the last grid leak mounting. Z shaped brackets hold this strip in place. These are  $\frac{3}{4}$  inch high, while the flat bended portions are  $\frac{1}{2}$  inch long. The output choke is next mounted. This is  $\frac{1}{8}$  inch from the rear and close up against the right-hand edge of the baseboard. The 4 mfd. fixed condenser is placed  $1\frac{1}{2}$  inches from the choke and  $\frac{1}{2}$  inch from the right side. Midway between this condenser and the panel a .5 mfd. fixed condenser is mounted. We next turn our attention to the radio frequency choke, which is 12 inches from the left and

right-hand sides and  $5\frac{1}{2}$  inches from the rear of the board. Directly in front of this choke  $\frac{1}{2}$  inch away, the two .0005 mfd. fixed condensers are placed. A screw is placed through one metal band of each condenser for holding. In this way a metallic connection is also effected. The only parts that remain to be mounted are the ballast mountings of the first and second audio tubes. Both are placed directly in front of the filament posts of the sockets,  $1/16$  inch space separating them.

### The Filament Wiring

The filament circuit should first be wired. Through one of the small holes in the front portion of RF can bring a lead from the F minus post of the socket in this shield, which is the RF tube, to a post on rheostat, R1. The other terminal of the rheostat is connected to a terminal of the pilot light on one control. From a terminal commonly connected to this terminal, another lead is brought to the terminal on the other control. It is also connected via a terminal connected to this one, to a post on the ballast resistor mounting in the detector can, which is farthest away from the F post. The other terminal of the ballast is connected to the F minus post on the detector tube socket. Now put up the right-hand side of the detector can. Before putting the rear one in place, drill a  $\frac{1}{8}$  inch hole, 1 inch from the right,  $1\frac{1}{2}$  inches from the bottom and another in the same

line, but  $2\frac{1}{4}$  inches away. Now a lead is brought from the low side of the ballast resistor in the detector can to the low side of both the ballast mountings of the first and second audio tubes. The other sides of the ballast resistors are connected to the F minus posts of the first and second audio tubes, respectively. From the low side of the ballast resistor in the second audio circuit, a lead is brought to the minus A rod on the plug. Through hole on right side of front of RF can, bring a lead from the plus F post to a terminal on the pilot light. This is not the same lead as the minus F post was connected. Instead it is about  $\frac{1}{2}$  inch distant and upon close investigation will be seen to be the other terminal of the filament in this lamp. This lead is continued to the terminal of the other pilot lamp on the other control and thence through a hole on the right of the detector can to the plus F post of the detector socket. The plus F post of this socket is now connected to the plus F post of the first audio tube, via a lead which passes through a hole drilled in the left-hand portion of the rear shield in the detector can. It is then continued to the plus F post of the last audio socket. Scrape some insulation off the plus lead connecting the pilot lamps the point to be directly in line with the switch. Solder a lead from this point to a terminal on the switch. A lead is brought from the other terminal of the switch to the plus A rod on the plug. The remaining missing portions of the shields can now be put into place.

A lead is brought through a hole in the left side of the RF can from the F minus post of the RF tube to a terminal of the .1 mfd. fixed condenser in the detector can. The other side of this condenser is connected to the third terminal from the right on the connecting strip of the coil in the detector can. This is the end of the plate winding L3.

Through one of the holes in the lower portion of the front of the detector can, bring a lead from the other terminal of the .1 mfd. fixed condenser to a terminal on the variable resistance R2. The other terminal of R2 is then brought to a rod on the plug, (B plus 1).

### Plug Hints

A cut-out piece of paper when placed over the rods on this plug will enable you to identify the leads later on, due to the coloring and marking on the paper. There will be several rods where there are no markings, which you should mark yourself. There will be just enough rods to take care of all the A and B leads and one C lead, the two other C leads being made with flexible wire. In order to identify the exact B voltages necessary to employ, it is wise to paste on small pieces of paper which have been marked, "B plus RF," etc.

The second terminal from the front on the strip of the detector coil is connected to the plate of the RF tube socket, via a lead run through a hole in the left hand side of the detector can and the right hand side of the RF can.

[Concluded next week]

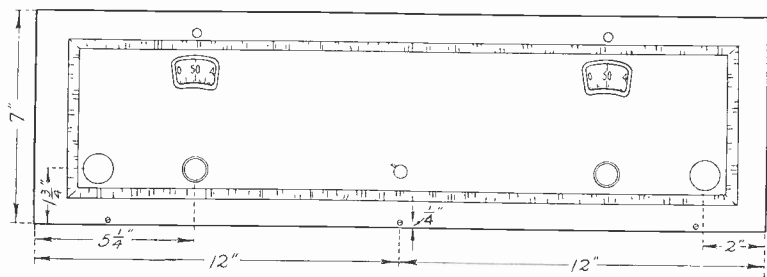
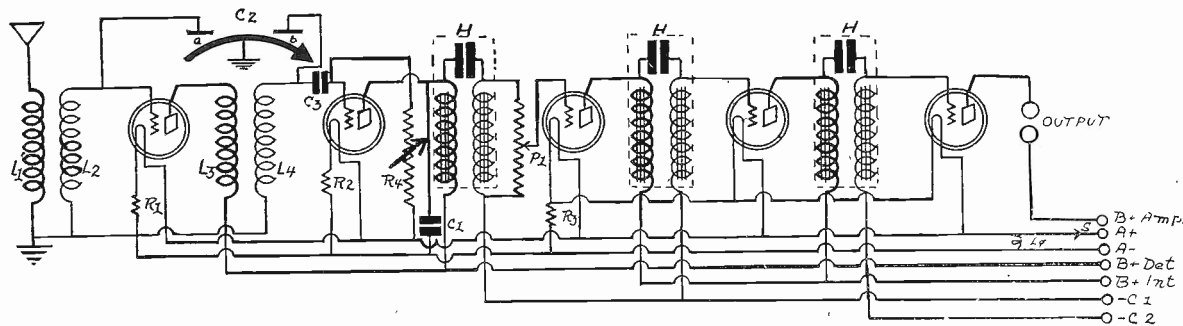

FIG. 6

The panel layout, with drilling data.



# Interesting Hookups for Experimenters



CIRCUIT DIAGRAM of the 1-Dial Witz, described in the Aug. 27, Sept. 3, 10 and 17 issues of Radio World.

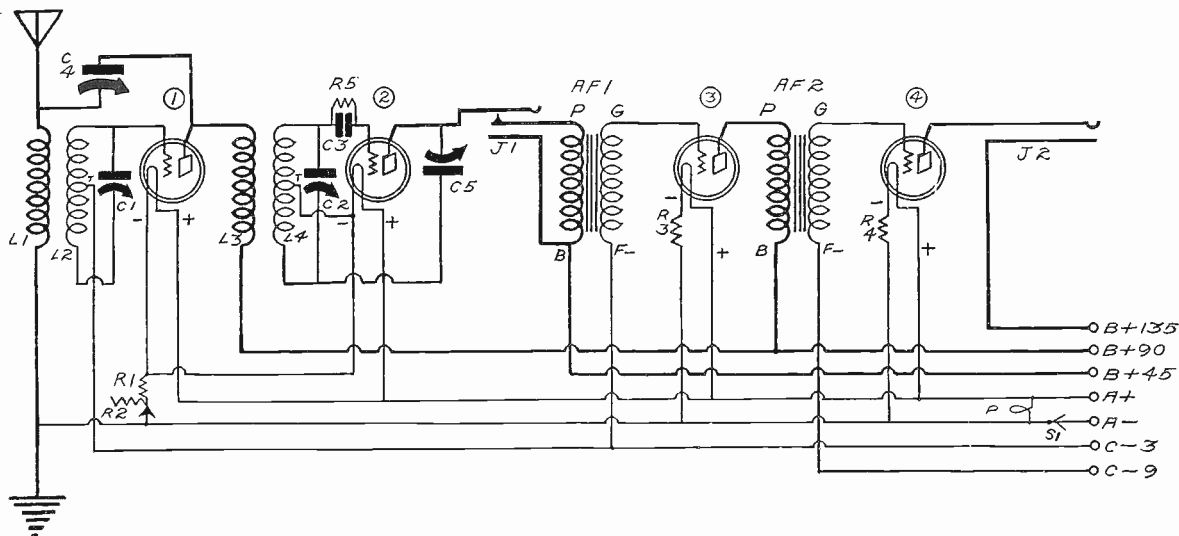

RADIO WORLD'S 4-tube Universal, described in the March 12, 19, 26 and April 2 issues.

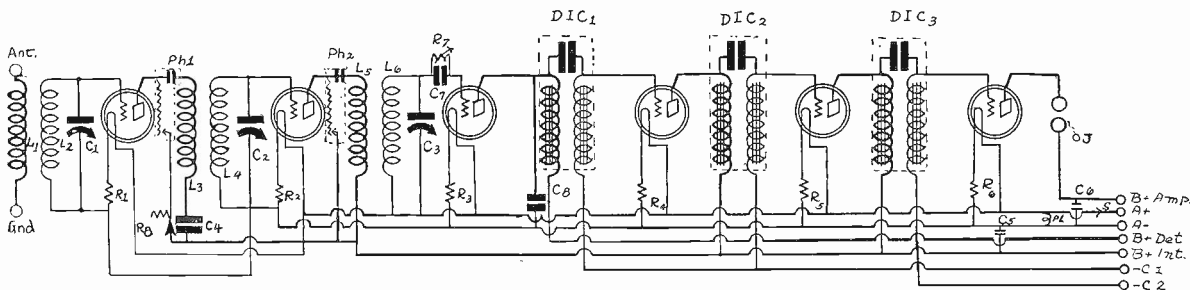

SCHEMATIC DIAGRAM of the Ford Six, the balanced receiver, described in the Oct. 1 issue.

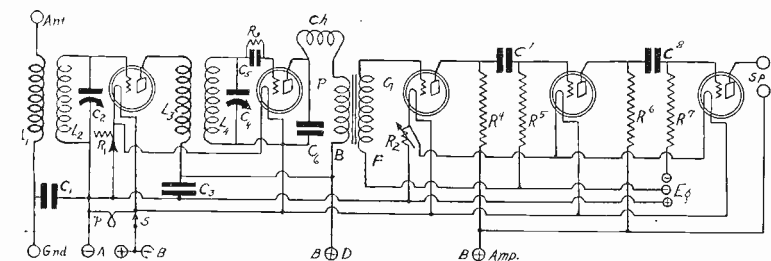

ELECTRICAL DIAGRAM of a 5-tube non-regenerative receiver, in which a stage of transformer coupled and two resistance coupled audio stages are employed. Eg indicates the grid batteries. Any standard type of tuned radio frequency transformers can be employed.

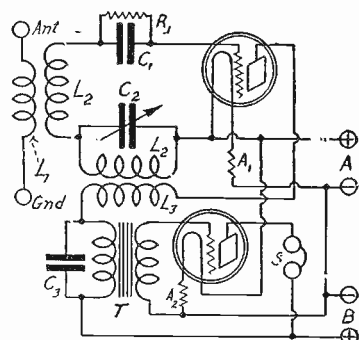

A SIMPLE two-tube regenerative receiver using the popular 3-circuit tuner.

## A THOUGHT FOR THE WEEK

THERE'S one thing to be said for the weather that folks kick about; you know—smacking rain that drives into your clothes and literally soaks you to the skin, and the blizzard weather that encrusts your eyelashes and gets the better of father's goggles. Well, the worse it is overhead and underfoot, the better it is for radio—for then folks stay indoors and burn out tubes and wear sets to a frazzle, and the result is found in the profit sheets of the radio trade. Therefore, fine weather is fine, and so is the other kind.

SIXTH YEAR

# RADIO WORLD

The First and Only National Radio Weekly

Member, Radio Publishers Association

Radio World's Slogan: "A radio set for every home."

TELEPHONES: BRYANT 0558, 0559

PUBLISHED EVERY WEDNESDAY

(Dated Saturday of same week)

FROM PUBLICATION OFFICE

HENNESSY RADIO PUBLICATIONS CORPORATION

145 WEST 45th STREET, NEW YORK, N. Y.

(Just East of Broadway)

ROLAND BURKE HENNESSY, President

M. B. HENNESSY, Vice-President

HERMAN BERNARD, Secretary

European Representatives: The International News Co.

Breems Bldgs., Chancery Lane, London, Eng.

Paris, France: Brentano's, 8 Avenue de l'Opera

EDITOR, Roland Burke Hennessy

MANAGING EDITOR, Herman Bernard

TECHNICAL EDITOR, Lewis Wlener

CONTRIBUTING EDITORS:

J. E. Anderson, Capt. Peter V. O'Rourke, and

James H. Carroll

## SUBSCRIPTION RATES

Fifteen cents a copy, \$6.00 a year, \$3.00 for six months, \$1.50 for three months. Add \$1.00 a year extra for foreign postage. Canada, 50 cents.

Receipt by new subscribers of the first copy of RADIO WORLD mailed to them after sending in their order is automatic acknowledgment of their subscription order. Changes of address should be received at this office two weeks before date of publication. Always give old address; also state whether subscription is new or a renewal.

## ADVERTISING RATES

## General Advertising

1 Page, 7 1/2" x 11"	482 lines.....	\$300.00
1/2 Page, 7 1/2" x 5 1/2"	231 lines.....	150.00
1/2 Page, 8 1/2" x 5 1/2"	231 lines.....	150.00
1/4 Page, 4 1/2" x 5 1/2"	115 lines.....	75.00
1/4 Column, 2 1/2" x 11"	154 lines.....	100.00
1 Inch	.....	10.00
For Agate Line.....	.....	.75

## Time Discount

62 consecutive issues.....	20%
28 times consecutively or E. O. W. one year.....	15%
4 consecutive issues.....	10%

WEEKLY, dated each Saturday, published Wednesday. Advertising forms close Tuesday, eleven days in advance of date of issue.

## CLASSIFIED ADVERTISEMENTS

Ten cents per word. Minimum 10 words. Cash with order. Business Opportunities ten cents per word, \$1.00 minimum.

Entered as second-class matter March 28, 1922, at the Post Office at New York, N. Y., under the Act of March 3, 1879.

## THEY SAY

**HERBERT HOOVER, Secretary of Commerce:** "We enjoy the marvelous child of science that we call broadcasting, by which for the first time in human history the voice of a single speaker is heard by millions of distant individuals at the moment of utterance. Great programs of news, of information, education, and entertainment not only spread over our countries but are rapidly spreading across our borders. Radio helps the aviator to keep in touch with the earth and

# All Radio Branches Wide Open to Women

By Bertha Brainard

Manager of WJZ

The present organization of the broadcasting field utilizes a greater variety of ability than any other one business with which I am acquainted.

There is, first of all, the technical phase of broadcasting. I am not aware that any women are working in this branch of radio, although I see no reason why they should not be successful as radio engineers and technicians. It is a generally accepted axiom that mechanics and the sciences do not appeal to women. I maintain, however, that for a woman sufficiently interested in this line of work, broadcasting offers the same chances for success which it extends to men.

Musical knowledge and ability are required in many phases of our work—not only on the part of artists who appear in our radio features, but in planning and executing programs. Still, I see no reason why women are better suited or not so well suited to this work, aside from the fact that for some features, we need female voices, while for others we require male.

Of course, in the work of our program departments, we find it advisable to use both men and women, since it is necessary that our features appeal to both sexes in the radio audience, but I have never been able to see that women as a class were better suited to the work than men, or vice versa. Some broadcasts are predominantly feminine, as in the case of WJZ's Women's Hour, but the bulk of our program must appeal to men and women alike, old and young, and all types and classes.

## Must Be Willing

My own work with the National Broadcasting Company as I have stated, has convinced me that a woman can fill practically any sort of a position, provided she is willing to concentrate her energies upon it and do the job exactly as a man would.

Day by day, specialists in employment work and high executives in many businesses are coming to the conclusion that it is no longer a question as to whether a particular job is best suited to a man or to a woman. The problem is for the most part a strictly individual affair—it simmers down to the question of what particular man or woman is best qualified to carry on in the position.

I believe that gradually, it will come about that sex is no longer a factor in

business. Moreover, I am convinced that it is an extremely unimportant factor at present. Today, many women are filling high positions and filling them well, whereas ten years ago, it would have been out of the question for any woman to have been considered for a position of responsibility in the average large commercial concern. But experience is wiping out this barrier.

Today, there are still some few old-fashioned business men who raise their eyebrows in surprise when they meet a woman on an equal footing in business. I have come in contact with some of them, and I confess that I have been secretly but highly amused by the manner in which their mental reactions to the fact that I—a woman—was manager of WJZ have been manifested in their countenance. But it is rarely that I meet one of these men nowadays.

## Call Her "Mr." Brainard

For the most part, I believe that the majority of men with whom I am in business contact during the course of a year think nothing of the fact that I am a woman. Business men are business men, and in the present age of enlightenment, they see nothing peculiar in a woman's holding a position of responsibility. So long as they can transact the business in which they are interested and accomplish their objectives quickly, personally or sex fail to be any considerable factor in their daily business lives.

I am positive of this fact, because many business men with whom I have had correspondence, although I sign my full name when writing letters, continue to address me as "Mr. Brainard." Apparently, the fact that I am a woman completely fails to register upon their consciousness. To them, I am merely a representative of the National Broadcasting Company, occupying a certain position.

There has been—and I suppose there will continue to be—a great deal of talking and writing on the advantages of having the "woman's point of view" in big business organizations. We hear considerable about the "feminine touch" and "woman's intuition." Through experience, I have come to believe that there is little to this propaganda. I have worked with men possessing twice the amount of intuition of the average woman, and I have known plenty of heavy-headed women workers.

guides him to his destination. Thousands of amateur operators are engaged in international communication with one another, and in research and experimentation. Their messages flash between countries half-way round the globe. We are experiencing the radio reproduction of photographs at points far distant, across lands or waters, and some of us have seen the visualization of moving objects, which we call television, by which distance is destroyed for sight as well as for sound."

\* \* \*

**ROBERT W. PORTER, vice-president, Splitdorf Radio Corporation:** "The all-electric radio receiver will find an immediate market in strictly farming territory of close to a quarter of a million

farm homes. But the important aspect is not the immediate market but the future. I am considering farms alone. By 1938, it is estimated 3,000,000 farms will be electrified. Not counting the city and town markets at all, but just taking the farming element by itself, we have a tremendous ten-year 'group' market to which to appeal on a single phase of radio development—the all-electric set."

## PORTO RICO - U. S. SERVICE

With the transmission of a congratulatory message from General J. G. Harbord, president of the Radio Corporation of America in New York City to Governor Horace M. Towner of Porto Rico, a direct communication service between the United States and Porto was inaugurated.

# Station Fading Worst 60 to 125 Miles Off

Washington. Fading is at its worst at distances of 60 to 125 miles from a broadcasting station, according to Scientific Paper No. 561 of the Bureau of Standards on "Cooperative Measurements of Radio Fading in 1925," which has just been issued.

This paper describes the third extensive program of cooperative radio observations conducted by the Bureau of Standards. The first two of these were investigations carried on with the cooperation of several hundred amateurs in 1920-21 and 1922-24, being respectively on radio signal fading and on the conditions affecting distance range of broadcasting.

### Cooperative Study of Fading

At the beginning of 1925 the Bureau invited a number of qualified laboratories to participate in a cooperative program of measurements of fading, i.e., radio waves fluctuations. Twenty-three laboratories, most of them in universities in the northeastern part of the United States and Canada, engaged in the work.

The series of measurements on fading was devoted to studies of fading during the sunset period, effects during the solar eclipse of January 24, the fading variations throughout a 24-hour day, and the

effects of high transmitting power on fading. For these tests special transmissions were made by broadcasting stations WGY and KDKA.

The results of 150 graphic fading records made by the cooperating observers established definitely a number of facts about fading that had been only surmised or guessed previously. In addition, a number of new facts about fading and other vagaries of radio waves were

# Nine Miles of Wire Used By WOR as New Ground

Many new and interesting features have been incorporated in the new transmitter and studios of WOR, which recently started operating on 5,000 watts from Kearney, N. J.

Nine miles of wire are used as the ground system for the transmitter. The building housing the transmitter is completely shielded on all sides by sheet copper. The huge antenna towers are equip-

brought to light. It was found that fading is at its worst about 60 to 125 miles from a broadcasting station, for greater distances it diminishes but then increases again with distance, and has repeated maxima and minima for greater distances. There are two readily distinguishable kinds of fading, a fairly slow and a relatively rapid fluctuation.

This work led to the discovery of a highly regular kind of fading which sometimes occurs during the 45 minutes just following sunset. This is especially interesting because of the light it throws on the mechanism of radio wave transmission through upper air.

Copies of this paper can be obtained from the Superintendent of Documents, Government Printing Office, Washington, D. C., at 15 cents each.

ped with large ruby lights, which serve as a beacon for aviators.

The transformer supplying 17,300 volts to the plates of the tubes weighs a ton and a half.

The studios and offices take up the entire 25th floor of the building at 1140 Broadway in New York City. The main studio, one of the largest of its kind, is 44 by 33 by 18 feet, having an air content of 22,760 cubic feet. The control room is 33 by 19 by 18 feet.

Then there is an outdoor studio which will be used during the summer months for broadcasting band contests. So that the proper atmosphere may be had, a special lighting system is maintained.

The music library contains 6000 sheets of all types and classes of music.

The transmitting station, which is located on the Lincoln Highway in Kearny is open to visitors.

# Commissioner Dillon Dies of Cancer at 61

San Francisco.

After an illness of five months, Lieutenant Colonel John F. Dillon, Federal Radio Commissioner, died of cancer at the Letterman General Hospital.

He was born in Bellevue, Ohio, March 6, 1866. After receiving his high school education and engaging in various occupations, at the age of 28, he enlisted in the Signal Corps of the United States Army. He served continuously from 1895 to 1912, becoming a master electrician during this period.

Colonel Dillon was identified with the radio regime since the Spanish American War. In 1912, he was appointed radio inspector in the Department of Commerce. Shortly after he was put in charge of the 8th district. During the World War, he returned to the army signal corps, where he was commissioned captain. He served in France from 1917 to 1919 and was promoted to major in 1919. In the latter portion of 1919, he returned to the Department of Commerce as inspector. In 1923, he was chosen for the post of radio supervisor of the sixth district, which position he held until appointed radio commissioner in March, 1927.

### BEACON TESTS SUCCESSFUL

Washington.

Directional radio experiments, using the radio beacon, established at Hadley Field by the Airways Division have proved highly successful. Lieutenant Settle, Communication Officer at the Lakehurst, N. J., Naval Air Station, reports that the beacon as heard in his sector is operating perfectly.

# Antenna Tower Lights Warn Night Aviators

The location of KFUO, St. Louis, with regard to aviation is such that airplanes frequently fly over the plant.

This fact induced the station to install lights on the top of the transmission towers. Says the Rev. Herman H. Hohnstein, director of the station:

"We realize that the landowner has the right to improve his property to any extent he sees fit and that the airman must recognize such improvements and steer clear of them.

"In fact, the controverted question has been and perhaps still is, whether the aviator has any legal right at all to fly over the land of another. Nevertheless it would be a good stroke of policy on the part of radio stations in the United

States to install lights on the towers, to burn at night.

"A collision of a fast-moving airplane might put the station's service out of commission for an indefinite time. The machine, in falling, might do substantial damage to the station's property, and the idea of having been a contributing cause to such a disaster involving one or more lives is not pleasant, even though no legal consequences attach thereto. Of course, once the lights are installed, they will become beacons by which air navigation will be done at night.

"Perhaps some day the Federal Radio Commission will require all radio stations situated as KFUO is in relation to aviation to install lights on their towers."

## SYMMETRY TAXES INGENUITY

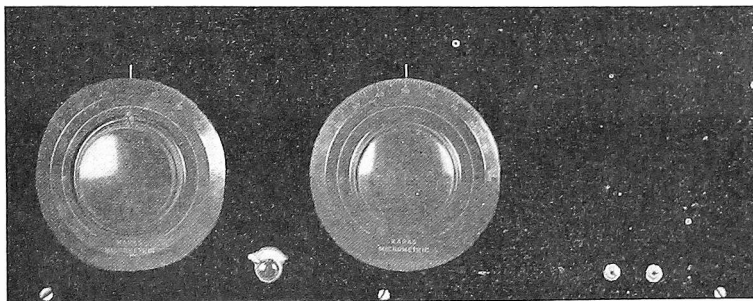

ONE OF THE PROBLEMS THAT CONFRONT an engineer in the design of a receiver is the front panel, especially its arrangement so as to afford attractive appearance while sustaining efficiency of design. Some persons would object to dials being placed as illustrated above, although shorter leads might be facilitated, for they consider the balanced disposition of the dials much more inviting to the eye. Therefore two schools of front panel thought have sprung up and both of them have their hosts of followers. All hands are enjoying fine reception pending decision by the celestial court of last resort.

**NEW CORPORATIONS**  
 Radio Design Publishing Company, Brooklyn, N. Y., \$5,000. (Atty., H. Shapiro, 261 Broadway, N. Y. City).  
 Eastern Broadcasters, N. Y., radio stations, \$50,000. (Atty., T. Koegh, 233 Broadway, N. Y. City).

**For Best Results**

*with the*  
**"WINNER"**  
**RECEIVER**

*Featured in*  
**RADIO WORLD**

*Use Only the*

**HAMMARLUND**  
**CONDENSERS, COILS**  
**and SHIELDS**

Specified by the Designer  
**HAMMARLUND MFG. CO.**  
 424-438 West 33d Street, New York

*For Better Radio*  
**Hammarlund**  
 PRECISION  
**PRODUCTS**

**Set Builders!**

Be first to build the new Magnaformer 9-8 Circuit—Commander-in-Chief of the Air—featured by Radio Authority G. M. Best in Sept. and Oct. Radio. Read his articles. See also Sept. and Oct. Popular Radio and C. R. Call Book. Two years ahead of the field. Outstanding feature is its marvelous Tone-Quality. Women, musicians and experts especially are enthusiastic in their praise of its amazing fidelity of tone. The NEW scientifically designed and precisely matched Magnaformer Intermediate Long Wave K. F. Transformers are the cause. Everyone who hears or tunes a Magnaformer 9-8 decides to own one immediately. Rebuilds instantly. Great distance getter—super-selective—a world of volume—quiet operating—easy to tune—easy to build. Any one can do it. All standard parts. NO AFTER-SERVICE. INC. The Ideal set to build for others. Send NOW for free descriptive literature.

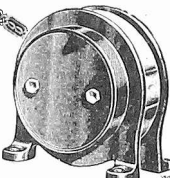

**RADIARY LABORATORIES COMPANY**  
 19 S. La Salle Street Dept. 67 Chicago

**Reproduction Easily Improves the Original**

*By Ray Solvert*

The statement that the quality of the reproduced music may be better than the original may be challenged. But the defense is quite simple. Suppose that a music critic listens to an orchestra selection at a certain

distance from the leader and in a certain direction. He will hear the various instruments with different intensity. The effect of the whole may not be nearly so pleasing as if he heard every instrument with an intensity proportional to the intensity with which that instrument is played.

When the orchestra plays for radio every instrument is placed in such relation to the microphone or microphones, as to give the most pleasing effect. An individual auditor could not possibly hear the same proportion of intensity if he were in the presence of the orchestra, unless he could occupy all the positions of the microphones at the same time.

Another case in which the reproduced music may be better than the original relates to the individual instrument. All instruments of a certain type may be lacking in certain essential harmonics. The radio amplifier can in many cases compensate for this defect. This compensation may for example change the tone of a \$10 fiddle to that of a price-less Stradivarius. That is an extreme example, of course, but it illustrates the meaning.

We all know that the voices of certain speakers are made unpleasant because certain changes have been introduced by uneven amplification. All speaking voices are far from perfect in the original. It is entirely possible that the same changes that make the reproduction of one voice unpleasant will make another much more pleasing than the original.

**ARCTURUS A-C TUBES**

- A-C 26, Detector .....\$5.00
- A-C 28, Amplifier ..... 5.00
- A-C 30, Power ..... 5.00

A four prong base heater tube for the powerizing of all circuits and receivers.

ARCTURUS tubes fit standard sockets without additional side or overhead wiring. Fewer changes are necessary in adapting receivers to ARCTURUS tubes than to any other A-C bulb.

From your dealer or direct from the factory.

**THE ARCTURUS RADIO COMPANY**

255 Sherman Avenue  
 Newark, N. J. Dept. A

**AMSD** **PARTS**  
 are specified in the  
**AERO-SEVEN** and in many  
 other fine receivers.

**LAUNCH**  
**METALLIZED**  
**FIXED RESISTOR**

**Better by Far**  
 Than any fixed leak in the detector  
 circuit is the  
**BRETWOOD**  
**VARIABLE**  
**GRID LEAK**



Because it allows adjustment of grid voltage to maximum sensitivity for reception of far-distant signals, while permitting faster discharge of electrons when receiving strong local stations, thus preventing distortion from this cause. Therefore a Bretwood Variable Grid Leak means more miles plus best possible tone quality, without any extra tubes. A patented plastic and foolproof plunger insure permanence in holding any desired resistance setting from .25 to 10 megohms, as well as very long life of the leak itself. As no grid leak can function any better than its grid condenser, be sure that you use a leak-proof Bretwood Bullet Condenser, of mica dielectric, and of .00025 mfd. capacity (another precision product, accurate to plus or minus one per cent.). Get these two parts and also get our

**FREE**

The New Bretwood with Condenser Attached. (Less than half actual size.) hookups, supplied with each purchase. Just fill out and mail the actual size.)

**Don't Send a Solitary Cent!**

The Bretwood Leak may be baseboard or panel mounted. Works the same in any position. No fluid used.

North American Bretwood Co.,  
 145 West 45th Street, N. Y. City.

Please mail me at once one New and Improved 1928 Model De Luxe Bretwood Variable Grid Leak (price, \$1.75) and attach one Bretwood Bullet Condenser (50 cents extra), for which I will pay the postman \$2.25 on receipt. Both must be the genuine Bretwood articles, imported from England.

NAME .....

STREET ADDRESS .....

CITY ..... STATE .....

RW-917

**Take Your Choice of 7 Other Publications**  
**For NEW RADIO WORLD Subscribers Ordering NOW**

Radio World has made arrangements

—To offer a year's subscription for any one of the following publications with one year's subscription for RADIO WORLD—

**RADIO NEWS or POPULAR RADIO or SCIENCE AND INVENTION or BOYS' LIFE or RADIO DEALER or RADIO (San Francisco) or RADIO AGE.**

This is the way to get two publications

- for the price of one;
- Send \$6.00 today for RADIO WORLD
- for one year (regular price
- for 52 numbers)
- and select any one of the other
- nine publications for twelve months.
- Add \$1.00 a year extra for
- Canadian or Foreign Postage
- Present RADIO WORLD subscribers
- can take advantage of this offer by
- extending subscriptions one year
- if they send renewals NOW!

**Radio World's Special Two-for-Price-of-One Subscription Blank**

**RADIO WORLD**, 145 West 45th Street, New York City.

Enclosed find \$6.00 for which send me **RADIO WORLD** for twelve months (52 numbers), beginning ..... and also without additional cost, **Popular Radio**, or **Radio News**, or **Science and Invention**, or **Radio Dealer**, or **Radio (San Francisco)**, or **Radio Age**, or **Boys' Life** (or \$10.00 for a two-year subscription to one address). No other premium with this offer.

Indicate if renewal. Name .....

Offer Good Until Street Address .....

Nov. 30, 1927. City and State .....

## Polymet in Front Row, Due to Greene's Ideas

Nat Greene and his associates of the Polymet Manufacturing Corp., have placed this corporation in the front rank of radio parts manufacturers and made them one of the largest in the industry, now occupying two large floors at 599-601 Broadway, New York City.

The laboratory staff, in addition to testing work and the maintaining of Polymet standard of quality, is busily engaged in extensive research.

Many of the leading set manufacturers now specify Polymet products for all their models, among them Fada, Freshman, Freed-Eisemann, King Radio and Stewart Warner. Some of the Polymet products are: mica condensers, filter condensers, condenser blocks, wire-wound resistors, potentiometers, extension connectors, grid leaks, phone plugs, clare plugs, polytols, metal resistors, rheostats and resistance coupled kits.

## Kansas City Offers Another "Marion Talley"

Kansas City musical enthusiasts believe they have produced another Marion Talley in Gladys Morrison, coloratura soprano, the first Missouri winner in the National Radio Audition of The Atwater Kent Foundation. Miss Morrison is only 21. She is a pupil of Ottley Cranston, whose early instruction started her predecessor on the road to fame, and she has gained enthusiastic local acclaim as a member of the Kansas City Civic Grand Opera Company in the role of "Gilda," in Rigoletto—the same role in which

## World "A" Power Unit--\$12.75

Automatically provides even, unvarying "A" current from four light sockets. Absolutely noiseless. Assures full tone quality from your set and wider D. X. range. Famous WORLD quality—at less than half the cost of any similar equipment. Shipped complete, subject to inspection on receipt of price, or C. O. D., if you wish. 25 amp. unit for sets of 4 tubes or less, \$12.75. 60 amp. unit for sets of 5 tubes or more, \$15.75. 5% discount if cash in full is sent with order. Send order today. World Battery Co., 1219 So. Wabash Ave., Dept. 82, Chicago, Ill.

## Subscribers: Look at the Expiration Date on Your Wrapper

We do not like to take your name from our subscription list without specific instruction to do so, because many of our readers wish to keep a complete file of the paper.

Please therefore, look at the subscription date stamped on your last wrapper, and if that date is earlier than the issue contained in the wrapper, please send check to cover your renewal.

In this way you will get your copies without interruption.

Subscription Dept, RADIO WORLD, 145 W. 45th Street, New York City.

Marion Talley made her debut on the Metropolitan Opera stage.

Miss Morrison and Delmer R. King, baritone, now enter the State Audition, with young men and women from other cities of Missouri, to compete for a chance at the national prizes to be awarded by The Atwater Kent Foundation in the finals in New York in December.

## Qualitone DeLuxe Loop

In addition to the regular model of the Qualitone Loop, the Duro Metal Products Co., Chicago, Ill., announces that their new deluxe model of this loop is now ready for shipment. This loop is made to fit in limited space, revolving in a radius of only 5½ inches, still giving excellent pickup. It is beautifully finished and an ornament in any surroundings, is electrically perfect and insulated, is wound with the best quality loop wire and is assembled and dismantled almost instantly. The Qualitone, the sister loop, is slightly larger and has the same excellent characteristics. Both models are provided with a centre tap and have a patented feature that always keeps the wires from sagging. All models are designed for use with .005 condensers.

For lovers of fine phonograph reproduction this concern is also putting out a new Qualitone matched combination tone arm and reproducer.—J. H. C.

## United DIAMOND

The Ever-Popular IMPROVED DIAMOND of the AIR KIT \$37.50

GET OUR PRICES! SAVE ON THESE! Karas Equamatic, Karas Knickerbocker 4, Silver-Marshall Shielded Six, New Hammarlund-Roberts H-1-C, Everyman 4, Aero-7, Powerfone, 4-Tube Diamond of the Air and other New Kits.

Send for New Free Catalog, Just Out  
B.C.L. RADIO SERVICE CO., Inc.  
220 FULTON ST. NEW YORK CITY

**the LOGICAL**  
 *filament Control*

AMPERITE is the only self-variable filament control. Automatically does the work of hand rheostats and delicate meters. Proved for 6 years. Specified in every circuit. Entirely different from fixed filament resistors. Accept nothing but AMPERITE.

FREE—"Amperite Boo!" of the season's best circuits and latest construction data. Write Dept. RW22 RADIALL COMPANY 50 Franklin St., New York

**AMPERITE**  
REG. U.S. PAT. OFF.

The "SELF-ADJUSTING" Rheostat



## Tireless Performance

These gulls fly and fly until we wonder how such stamina can be contained in so frail an object.

Just so with CeCo Tubes. A strong combination of frail materials. Glass for a covering; hair-like wires for filament; fine spun metal for grid.

But so carefully engineered, so cleverly assembled, so skillfully exhausted, so thoroughly tested that their durability and performance are astounding to the radio operator and fan.

You expect MORE of CeCo Tubes—and get more.

### A Type for Every Radio Need

- General Purpose Tubes
- Special Purpose Tubes
- Power Tubes
- Filament Type Rectifiers
- Gas Filled Rectifiers and A. C. Tubes

Ask your radio dealer for a complete data sheet.

C. E. MFG. CO., Inc., Providence, R. I.

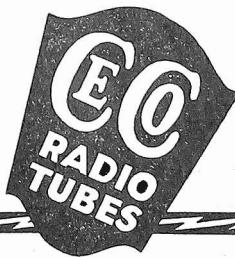
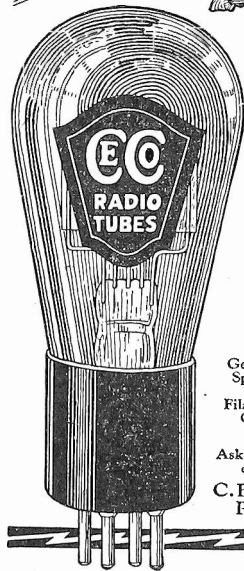

## Radio World's CLASSIFIED ADS for Quick Action

10 Cents a Word—10 Words Minimum—Cash With Order

**DIRECT FACTORY SALE**—Wholesale prices. Tremendous Savings. Selling direct to you. Here are some of our many items: 30 Henry Choke, 100 M.A., \$2.19; 10 Henry Choke, 400 M.A., \$5.48. Power Transformers for all kinds of Eliminators and for all types of A.C. Tubes, at Special Low Prices. EVERY ITEM FULLY GUARANTEED. Promptly shipped, upon receipt of order. Send for free illustrated catalog today. Todd Electric Co., Inc. (Manufacturers) 36 West 20th Street, Dept. D, New York City.

SEND \$1 for 8 weeks' subscription to RADIO WORLD, 145 W. 45th St., N. Y. C.

**VALET AUTOSTROP RAZOR**—The only razor that sharpens its own blades. Highly polished nickel-plated, self-stropping Valet AUTOSTROP Razor, with one blade, in velvet lined metal case. Leather strop especially prepared, and complete outfit in neat, lithographed carton. Mailed post paid on receipt of 50c. SPECIAL: Send \$2 for one-third of a year subscription for Radio World (yearly price \$6), mention this particular ad, and complete "Pal" set will be sent as a premium. If already a subscriber, your subscription will be extended three months. The COLUMBIA PRINT, 145 West 45th Street, New York City.

**BUILD THE WORLD'S RECORD** one-tube set. By employing an amplifying crystal detector it operates a speaker and receives great distances. Instructions 50c. Literature free. Tre Strong, Box 771, Oklahoma City, Okla.

**AMPLIFYING CRYSTAL DETECTOR**—Operates speaker—No tubes; no transformers. Money back Guarantee. Plans 50 cents. Frank Pritchard, Box 107, Oklahoma City, Okla.

**RADIO SET ASSEMBLING, Wiring, Repairing.** Guaranteed workmanship. Reasonable charges. Write Wm. H. Vordenfeld, Shumway, Illinois.

# BLUEPRINTS OF INEXPENSIVE DX RECEIVERS

**THE FIVE-TUBE DIAMOND OF THE AIR**, a very selective circuit of thrilling tone quality, that brings in distant stations to the great delight of the fans, is easily built, in fact can be constructed in a couple of hours. The authorized blueprints that make this speed and efficiency possible are just off the press and will be shipped at once, together with a booklet of full textual exposition of construction, including winding of coils, how to connect coil terminals, what values of condensers and resistors to use, etc. If you want a tone quality set that will give you great enjoyment, be sure to build this five-tube Diamond of the Air. The receiver consists of a stage of tuned radio frequency amplification, a specially sensitized detector, first stage of transformer audio and next two stages of resistance audio. It is easily adapted to playing phonograph records on your speaker. Get acquainted with this NEW delight.

## THE FOUR-TUBE DIAMOND

represents the most that is obtainable from four tubes. A stage of tuned radio frequency amplification, a specially sensitized detector, and two stages of transformer coupled audio. Follow the diagrams as shown in the blueprint and you can't go wrong. You will be amazed at the results. Build the set from parts that you have. Full instructions cover utilization of such apparatus. Thousands are eager to build an economical set and this one is the most economical in cost of construction and upkeep, where one considers the surpassing results. Works splendidly from batteries, with either type 99 or type 01A tubes, and can be used with A and B eliminators, power packs, etc., with great success.

## Look Over Both of These

Blueprints and read the text in both cases before choosing the receiver you are to build.

## SEND NO MONEY!

Just fill out the coupon below, and note what you get FREE!

Guaranty Radio Goods Co.  
145 West 45th Street, New York City

Please send me one newly-printed official blueprint of the 5-tube Diamond of the Air, one newly printed official blueprint of the 4-tube Diamond, and the textual data giving full directions for constructing these sets. I agree to pay the postman 75 cents on delivery. Also, you are to send me, without extra cost, one Auto Strop Safety Razor, one blade and one automatic razor strop.

Name .....  
Address .....  
City ..... State.....

# Shielding Is Stressed For New 2-Grid Tube

[From Radio Corporation of America.]  
Amateurs and experimenters will be interested in the recent announcement of the Radio Corporation of America concerning a new Radiotron of the screen grid type—a new development in the field of vacuum tubes. It is intended primarily for radio-

frequency amplification (without neutralization or stabilizing resistance) in circuits especially designed for it. The tube has a voltage amplification factor of over 250. This makes possible an actual voltage amplification of about 20 to 30 per stage (depending on circuit losses), as compared with about 4 to 6 per stage when using tubes of the general purpose type.

The new Radiotron will be known as UX-222. It has a filament, a plate and two grids, in place of the usual three elements employed in other receiving Radiotrons. This second grid is responsible for its high voltage amplification and also for freedom from oscillation in the circuit in which it is used.

Radiotron UX-222 may also be used as a "space charge grid" tube in audio frequency circuits. It is also useful in other experimental circuits, where a double-grid, four-element tube can be used.

The Radio Corporation is glad to be able to offer this tube for those who are interested.  
(Concluded on page 23)



**KITS** Radio Freq. Fountain...\$46.55  
Audio Freq. Basin...\$12.45

We are headquarters for these, also the Winner, Everyman 4, Strobodone, Victoreen, Knickerbocker Four and all the New Circuits

Send 80% of Price with Order.  
Balance in Two Weeks—Free Service  
Endorsed by RADIO WORLD

**RADIO KIT CO.**, 72 Cortlandt Street  
New York City

## ALMOST UNCANNY IN ITS PRECISION AND PERFORMANCE

was the unanimous verdict of the engineers in RADIO WORLD'S laboratory on Amperite, the self-adjusting rheostat which they specify for the Unified Diamond.

Amperite is self-adjusting because it is constructed of a special alloy, chemically coated, which maintains exactly the right current despite voltage changes at the supply source. For instance: If a 6-volt storage battery were supplying a 201-A tube filament, in series with which there was a 1-A Amperite, the filament voltage would be 5 volts and the current 1/4 ampere, and if the battery voltage should drop to 5 1/2 volts, for instance, the current and voltage of the tube filament nevertheless would remain as before. This is due to the action of the secret alloy, which changes in resistance according to the changes that take place in the battery. Therefore, Amperite is not a fixed resistor that reduces a supply voltage to a lesser voltage, nor is it a mere ballast which lacks automatic means of decreasing in resistance as the battery voltage runs down and increasing as it goes up, but Amperite works on the thermo-electric principle—the greater the supply voltage the greater the heat generated in the special alloy, and the greater the resistance.

The laboratory staff of RADIO WORLD specifies three 1-A Amperites and one 4-A Amperite for the Unified Diamond.

Amperites are specified for the leading circuits by America's foremost experts in receiver and amplifier design. Types for every tube and battery sold everywhere.

## IMPROVED TURN-IT



Variable Grid Leak (Non-Evaporating) \$1.00  
5 to 12.6 megohms. Specified for the Unified Diamond

GARDNER & HEPBURN, Inc., 611 Widener Bldg., Philadelphia, Pa.



1-A Amperite—Price complete, with mounting, \$1.10  
4-A Amperite—Price complete, with mounting, \$1.10

EBY Binding Posts are exclusively specified for the Unified Diamond. Permanent, strongly constructed, with knob of moulded bakelite. EBY Binding Posts are built to last.

ACME Celastite, with its non-inflammable insulation and its high conductivity, is the approved wire to use in building the Unified Diamond.

CECO tubes specified for the Unified Diamond are: two type K; one type H; two type G; one type F.

THE ELECTRAD PHASATROL is the neutralizing agent used in the circuit.

LYNCH METALLIZED FIXED RESISTORS are used in the audio circuit.

## THE UNIFIED DIAMOND GROUP

145 West 45th St., New York City

## FILL OUT AND MAIL NOW SUBSCRIPTION BLANK

# RADIO WORLD

RADIO WORLD

145 West 45th Street, New York City  
(Just East of Broadway)

Please send me RADIO WORLD for ..... months, for which  
please find enclosed .....

**SUBSCRIPTION RATES:**  
Single Copy ..... \$ .15  
Three Months ..... 1.50  
Six Months ..... 3.00  
One Year, 52 Issues ..... 6.00  
Add \$1.00 a Year for Foreign  
Postage; 50c for Canadian Postage.

(Concluded from page 22)

ed in experimenting with the newest that the art has to offer," said Mr. Bucher, assistant vice-president of the Radio Corporation of America.

"It should be realized, however, that this tube will not bring about any revolutionary developments in the radio industry, nor will it render obsolete the types of sets now in use or being sold. It must be remembered that although these tubes give greater radio-frequency amplification per tube than former types, nevertheless, a certain number of tuned circuits must be used under present-day broadcasting conditions to obtain adequate selectivity; therefore, all things considered, the new Radiotron will not necessarily reduce the number of tubes required in a given broadcast receiver."

"Radiotron UX-222 cannot be utilized in the present-day receiver. Special circuits and specially shielded apparatus are necessary to realize its maximum capabilities."

The new Radiotron has a standard four prong UX base and differs in external appearance from the ordinary tube by the addition of a small metal cap at the top of the glass envelope for a fifth connection to the control grid. The filament terminal

voltage for this tube is 3.3 volts and the filament current consumption is .132 amperes. A filament resistor makes it usable with a 6 volt Storage Battery. The recommended plate voltage is 135 volts.

According to Mr. Bucher the new tube will be placed on the market before the end of the present year.

DEPENDABLE "B" BATTERY POWER

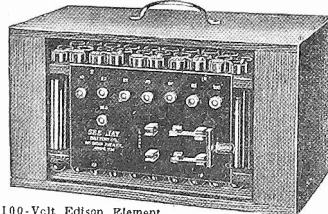

100-Volt Edison Element. Non-Destructive. Rechargeable "B" Battery with charger. Shipped dry with solution. 12, 140 Volt with charger. \$17. Sample cell, 20c. See how it operates.

SEND NO MONEY—PAY EXPRESSMAN Write for our Free Illustrated 24-page Booklet SEE JAY BATTERY COMPANY 913 BROOK AVE. NEW YORK CITY

# KARAS Parts Enable the NEW WONDER SET, The "KNICKERBOCKER 4" To Deliver Truly Amazing Results

THE KNICKERBOCKER 4 was built around Karas Parts and no others will give you the same results, so be sure to use the following Karas Parts when you build this set:

- 2 Karas Orthometric S.F.L. Extended Shaft .00037 mfd. Variable Condensers
- 2 Karas Harmonik Audio Transformers
- 1 Karas Equamatic Inductance Coil
- 1 Karas 3-Circuit Inductance
- 2 Karas Micrometric Vernier Dials

Your dealer can supply you with these Karas parts and the

other standard parts you will need to build this receiver. Begin to build it today. You know the quality and strength

frequency line Karas Orthometric Condensers—the splendid volume and purity of tone provided by Karas Harmonik Transformers—the reliability of Karas Inductance Coils and 3-Circuit Inductances—and the 1-1000th of an inch control furnished by Karas Micrometric Vernier Dials. So be sure to order these Karas parts, so as to make sure of 100 per cent performance of your KNICKERBOCKER 4.

Write for complete, detailed information about the KNICKERBOCKER 4—wiring instructions—everything you need in the way of information. Mailed free on request. Address

## KARAS ELECTRIC CO.

4039-J NO. ROCKWELL STREET CHICAGO Complete Stocks of Parts for the KNICKERBOCKER 4 Now Are Available at All Dealers



2 Karas Harmonik Audio Transformers are used in the Knickerbocker 4. Price, each \$5.00.

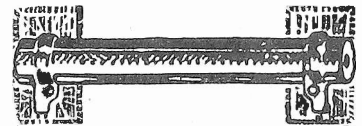
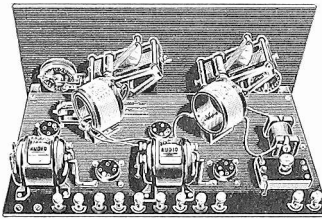

## There is a Vitrohm Radio Resistor for EVERY circuit

MORE than 90 standard Vitrohm Resistors and Rheostats cover the entire resistance need of every socket power circuit now on the market.

As new circuits and new resistance needs arise, Ward Leonard will develop new resistor units scientifically correct for the work to be done.

Vitrohm Resistors and Rheostats are guaranteed unconditionally for continuous duty in any circuit where they operate within their watts dissipation rating—and Vitrohms have the highest continuous-duty watts dissipation rating without resistance change of any resistor.

Bulletin 507 covers Vitrohms for radio. Send for it. There is no charge.

## Ward Leonard ELECTRIC COMPANY Mount Vernon N. Y.



## FREE RADIO GUIDE

BIG NEW 1928 CATALOG—4000 ITEMS Shows the latest circuits, the newest developments in radio at startlingly low prices. Get the parts you want here and save money. The best in parts, kits, complete factory-built sets and supplies. Orders filled same day received. Write for free copy NOW Standard discounts to dealers, set builders, agents. Barawk Co., 129 N. Jefferson St., Dept. 491, Chicago U. S. A.



## 25 Cents Brings ALL THIS!

One Official Blueprint of the Five-Tube Diamond of the Air

One official booklet describing in detail how to build this famous set, wind coils, etc.

Act Now! Send That Quarter to

## RADIO WORLD

145 West 45th Street, New York City

## The Best Radio Book on the Market for \$2.00

First Principles of Radio: The Electricity of Radio; Diagrams—The Shortband of Radio; The Mechanics of Radio; The Vacuum Tube. Audio-frequency Amplification; Radio-frequency Amplification; Fixed and Variable Condensers; Coils; Improvement of Broadcast Reception. How to Make Radio Measurements; Learning the Language of Dots and Dashes; Batteries, Battery Chargers and B-Eliminators; Different Types of Receivers.

Radio Accessories: The Wonders of Radio Transmission; Wiring-Gramps for Receivers & Transmitters. 4 volumes in one de luxe binding, 800 illustrations and diagrams, 12 contributing authors. Limited Quantity in Publisher's Hands. **Remit With Order**

Inquiries solicited from the trade HEISTEN & ROBERTS 116 West 39th Street N. Y. City

### RADIO ACCESSORIES at WHOLESALE

Radio Sets, "B" Eliminators, Chargers, Tubes, Ribs, Parts—everything new in Radio at lowest wholesale prices. Thousands of factory direct bargains. All listed and illustrated in my Big New Catalog and Free Call Book.

132 Pages of valuable Radio information—trouble finding, set building—Radio knowledge of all kinds. Write today. HENRY SCHWARZBAUM PRES. AMERICAN AUTO & RADIO MFG. CO. Dept. 19 4. American Radio Bldg. Kansas City, Missouri



**FREE BIG BARGAIN CATALOG**

BETTER THAN ANY FIXED LEAK is the Bretwood Variable Grid Leak. It allows adjustment of grid voltage to maximum sensitivity for reception of far-distant signals, with distortion. The Improved 1928 Model De Luxe Bretwood Grid Leak, \$1.75; or \$2.25 with Bretwood Bullet Condenser attached. The North American Bretwood Co., 145 West 45th Street, New York City.

HOW TO BUILD RADIO WORLD'S Four-Tube Universal Receiver fully described by Herman Bernard in the March 12, 19 and 26 issues of RADIO WORLD. Send 45c and get these three numbers or start your subscription with the first of these numbers. RADIO WORLD, 145 West 45th Street, New York City.

COMPLETE AND LATEST LIST OF STATIONS appeared in Radio World, dated Oct. 8. Sent on receipt of 15c, or start your subscription with that number. RADIO WORLD, 145 West 45th St., New York City.

# Victoreen

## Power Supply

New and Most Remarkable!

The Victoreen Power Supply, featured in the October 15 and October 22 issues of Radio World by J. E. Anderson, contributing editor, represents a distinct advance in design and coordination of apparatus for a plate supply. Full-wave rectification, using two 216-B tubes, scientific filtration with Victoreen chokes, "A" and "B" supply [475 volts] for a 210 output tube, and "B" supply for all other tubes in the set, are provided. Build this new, surpassing power supply, for it affords superb tone quality at incredible volumes!

The required Victoreen parts are obtainable at your dealer.

Victoreen 116 Power Transformer.....	Price	\$16.00
Victoreen 216 Choke Unit.....		15.00
Victoreen 115 Output Unit.....		10.00
Victoreen 316 Resistance Unit.....		3.00

Send for Power Supply Circular



# TOBE

Trade Mark Reg'd U. S. Pat. Office  
**CONDENSERS**

are exclusively specified by the Victoreen laboratories and by J. E. Anderson for the Victoreen Power Supply.

It is the constant report from leading laboratories as well as radio editors and authors that Tobe condensers are superior to all others tested.

For the Victoreen Power Supply be sure of matchless performance by using Tobe condensers. Your dealer has them in stock.

The following Tobe condensers are specified for the Victoreen Power Supply:

Two Tobe 2 mfd. 1000 volt DC Condensers, No. 602.....	Price	\$3.50 each
Three Tobe 4 mfd. 1000 volt DC Condensers, No. 604.....		6.00 each
One Tobe 2 mfd. Condenser, No. 302.....		1.75

"It's got to be Tobe"

Send for Price Catalogue

**Tobe Deutschmann  
Company**

Engineers and Manufacturers  
of Technical Apparatus  
CAMBRIDGE, MASS.

