

U51-12
No-4
290

RADIO WORLD

REG. U.S. PAT. OFF.

America's First and Only National Radio Weekly

The Victoreen Power Supply

By J. E. Anderson

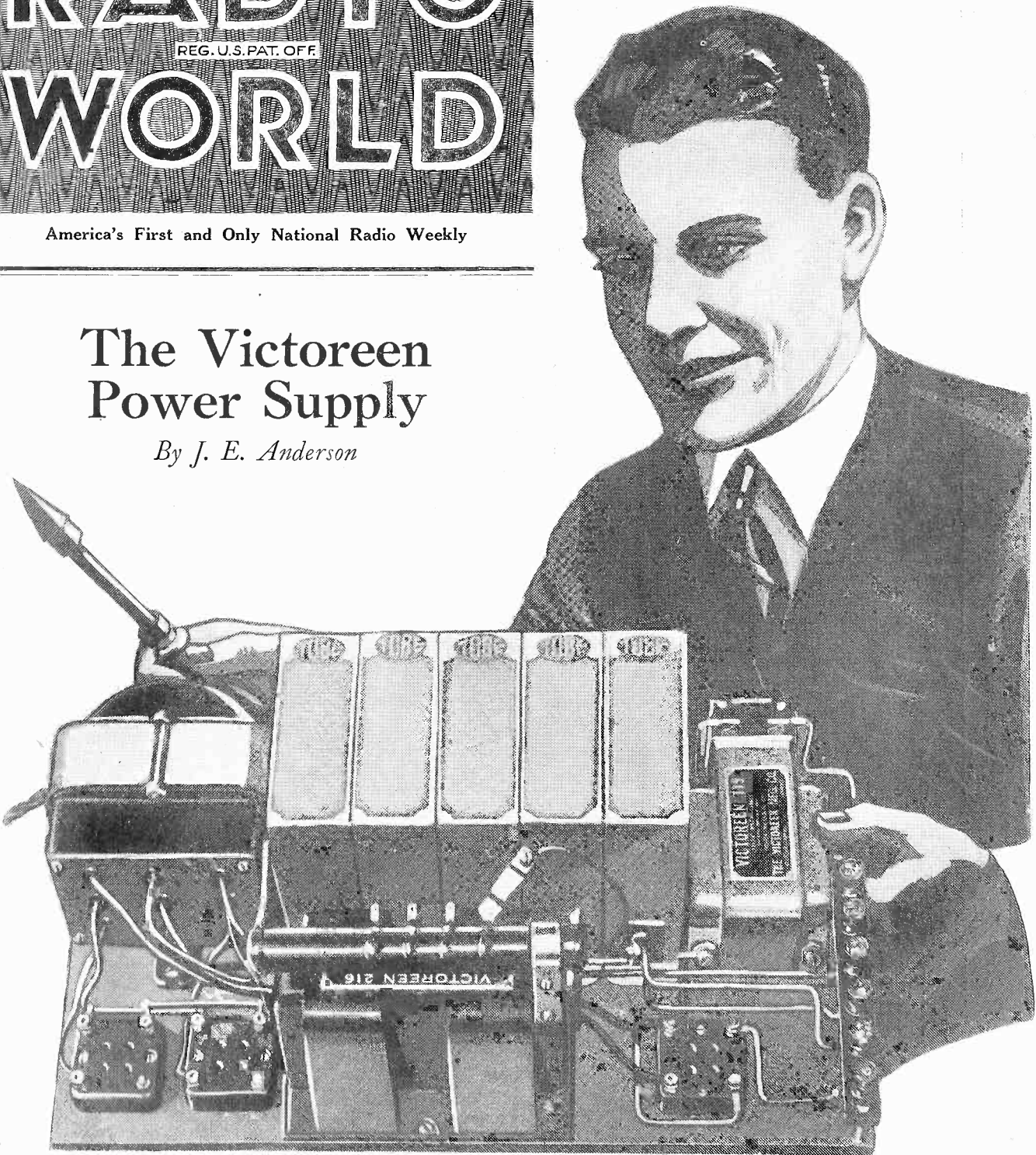

A WISE DESIGN indeed for a power supply is that made by
John A. Victoreen. See page 4.

Victoreen

IT'S RADIO TIME NOW!

Artists of note are tuning their various instruments for wonderful winter programs! Are you ready to receive their offerings? Will you get all the quality they will put into their music, regardless of where they are? If you want to be sure of quality, selectivity, distance and stability—you will build a Victoreen Super—the real sure way to reception satisfaction.

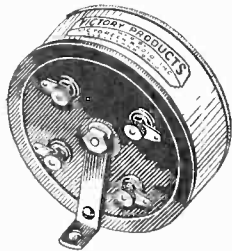

Victoreen Radio Frequency Transformers

No. 170—For Storage Battery Tubes
No. 171—For Dry Battery Tubes

Actually timed to one-third of one per cent., these high precision instruments offer the builders of "Super" Sets the assurance of freedom from oscillation, howls or squeals and a minimum of B Battery consumption. Due to their exclusive construction features, stray fields are eliminated, enabling the transformers to be placed in close relation to each other. Victoreen Transformers have well been called the Heart of the Super Circuit.

PRICE: \$7.00 EACH

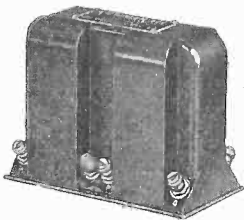

Victoreen 112 Audio Transformer Unit

This unit is worthy of its place in the Victoreen Circuit and renders a marvelous offering in tonal quality—presenting all the intimate naturalness of the original program.

Designed to handle up to 400 volts of B Battery supply, this unit is especially adapted to the Western Electric cone speaker or similar types. The transformer consists of two stages of Audio amplification in one case and is designed for use with two 112 power tubes.

PRICE: \$22.00

Write Today for 1928 Blue Print of the Victoreen Circuit



Testing CeCo Tubes

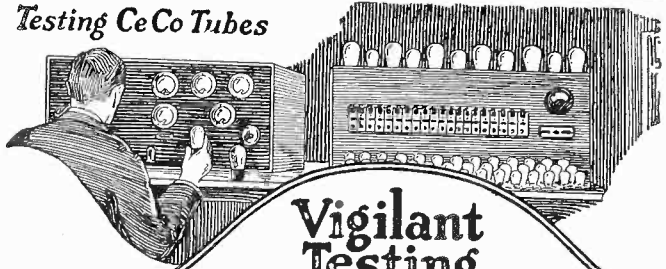

Vigilant Testing

All materials and parts entering into CeCo Tubes are tested critically to highest standards of quality. These tests involve exhaustive study of chemical, electrical and mechanical characteristics.

Assembled stems are inspected, mounts are inspected, sealed tubes are tested before and after exhaustion. Each completed tube is electrically measured for vacuum, and any tube falling below the CeCo high standard is rejected. You expect more of CeCo Tubes—and GET more.

A Type for Every Radio Need.

Ask your Radio Dealer for Complete CeCo Data Sheet

C. E. MFG. CO., Inc., PROVIDENCE, R. I., U. S. A.

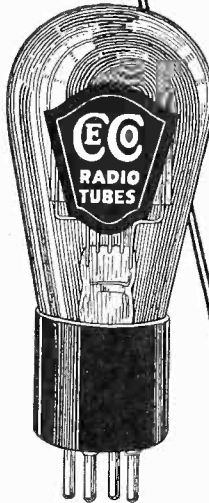

CECO

RADIO TUBES

Warp-PROOF Heat-PROOF for Power Circuits CENTRALAB POWER RHEOSTAT

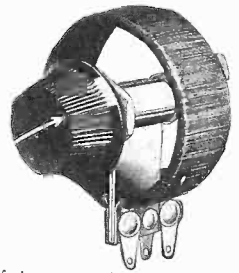

THIS sturdy unit is a "knock-out" for warp-proof, heat-proof performance in socket power circuits. The heat-proof characteristic permits continuous operation at temperatures of 482° F. and beyond. Special design and construction assure this. The resistance wire is wound on metal core, asbestos insulated. The wire is firmly held in position at all times because the metal core will expand under heat in the same degree as the wire. This provides a smooth acting control under all conditions.

Smooth regulation is further insured by narrow resistance strips. The narrow width gives small resistance jumps per turn.

Compact 2" diameter; 1" behind panel. Single hole mounting. Bakelite knob. Ohms—500, 250, 150, 50, 15, 6, 3, .2, .5—price, \$1.25. Can also be furnished as a potentiometer.

At dealer's, or C.O.D. Send postal for new circuit literature. You need this ideal POWER RHEOSTAT.

CENTRAL RADIO LABORATORIES
13 Keefe Avenue, Milwaukee, Wis.

Centralab

RADIO WHOLESALE

Write for my Big 1928 Radio Catalog—just off the press. Thousands of marvelous bargains in nationally advertised goods. All the LATEST IN RADIOS and equipment. Lowest wholesale prices. Agents Wanted.

It's a regular encyclopedia on Radio. All about trouble finding. **FREE Log and Call Book and Catalog.** Get your copy today. Send postcard now!

American Auto & Radio Mfg. Co.
HARRY SCHWARTZBERG, PRES.
Dept. 193, American Radio Bldg., Kansas City, Mo.

DEALERS NEW 1928 CATALOG

World "A" Power Unit--\$12.75

Automatically provides even, unvarying "A" current from your light socket. Absolutely noiseless. Assures full tone quality from your set and wider D. X. range. Famous WORLD quality—at less than half of the cost of any similar equipment. Shipped complete, subject to inspection on receipt of price, or C. O. D., if you wish. 25 amp. unit for sets of 4 tubes or less, \$12.75. 60 amp. unit for sets of 5 tubes or more, \$15.75. 5 per cent discount if cash in full is sent with order. Send order today. World Battery Co., 1219 So. Wabash Ave., Dept. 82, Chicago, Ill.

RADIO WORLD

REG. U.S. PAT. OFF.

Vol. XII
No. 4Whole No. 290
October 15, 1927

15c per Copy. \$6.00 per Year.

A Weekly Paper Published by Hennessey
Radio Publications Corporation from
Publication Office, 145 West 45th Street,
New York, N. Y.

Phones: BRyant 0558 and 0559

[Entered as second-class matter, March, 1922, at the post office at New York, N. Y., under Act of March, 1879]

New Tube Has Double Grid

Amplification Factor of From 150 to 200 in RF Stages Characterizes UX-222—Uses 135 Plate Volts, 3.3 Filament Volts at .13 Amp.

By Hutchinson Speed

HE thermionic vacuum tube is growing by adding one element after another. About 1904 Dr. J. A. Fleming, of England, introduced his two-element oscillation valve as a detector of radio signals. It proved to be a considerable improvement over the older types of detectors.

Shortly after the introduction of the two element valve, or in 1907, Dr. Lee DeForest added another element, or the grid, to the oscillation valve. The little evacuated bottle now became an amplifier and an oscillation generator, as well as a detector of radio signals.

The grid put in the old Fleming valve was the key that opened up the vast possibilities in radio. It gave us broadcasting and radio telephony, short wave communication over enormous distances, with small powers, and it gave us long distance telephony over land lines.

For twenty years the three-element vacuum tube, as conceived by DeForest, has held the field. But it has certain inherent defects which give rise to uncontrollable oscillation in radio frequency amplifiers, and which prevent the successful extension of radio into the ultra-high frequencies.

The Capacity Effect

The principal defect is the capacity between the plate and the grid in the tube. Since both of these elements are of metal and since they are placed in proximity, they constitute a condenser, the capacity of which depends on the extent of the conductors and on the distance between them.

In ordinary receiving tubes this capacity is of the order of 10 mmfd. Tubes in which the grid and plate leads are brought out at opposite sides of the envelope instead of through the base have a much lower inter-electrode capacity, but the effect is still there. The difficulty has led to the construction of other types of tubes.

Several investigators have explored the possibilities of tubes having two grids, one a control electrode performing the functions of the ordinary grid, and the other an auxiliary electrode for altering plate current-grid voltage characteristic to suit various requirements. The auxiliary electrode is usually employed to rob the plate of some of the electrons and hence to limit the normal plate current.

Very satisfactory bends for detection can be obtained in this manner. But double grid tubes were never placed on the market, due mainly to the critical adjustments necessary to take advantage of the peculiarities of the special tube.

But now we are promised an early public appearance of a four-element tube under the code name UX-222. In this tube the fourth electrode is not used particularly to increase the detecting efficiency of the tube but to eliminate the effects of the inter-electrode capacity. The fourth element thus

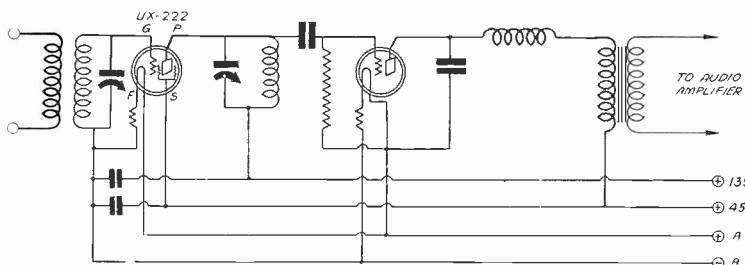

FIG. 1.

The circuit diagram of a stage of radio frequency amplification and a detector in which the first tube is a four element tube. High radio frequency amplification without oscillation at the low frequencies is possible with the circuit.

will be used to stabilize the circuit when the tube is used as a radio frequency amplifier and to render various other stabilizing and neutralizing schemes unnecessary.

The added electrode is in the form of a grid surrounding the plate, thus shielding the control grid from the plate. The new electrode takes the position of the old control grid on the socket and the plate and filament terminals remain as in the old type tubes. But the control grid is brought out separately through a seal in the glass envelope and is placed so that it has the minimum possible capacity to the other electrodes.

Circuit Diagram

One circuit in which the UX 222 tube is used as radio frequency amplifier is shown in Fig. 1. F is the cathode and is represented on the socket by two terminals as usual. P is the shielded plate which occupies the same position on the socket as the plate of ordinary tubes. S is the shield electrode which occupies the position of the control grid in the ordinary tubes. G is the control grid which is not represented on the socket at all.

G can be given the usual grid bias when the tube is operated as an amplifier, and it can be biased with or without a battery or with a voltage drop in a resistor. The plate P can be operated at various voltage, but 135 volts is recommended. In the circuit in question the shield electrode should be operated at a voltage of plus 45 volts.

The load on the tube is a parallel tuned circuit and consequently the first tube is coupled to the detector tube with a pure resistance at resonance. At frequencies off resonance the load is either condensive or inductive. With an ordinary tube in the first socket this circuit will not oscillate when the load is condensive or when it is a pure resistance, but it will oscillate when the load is inductive, that is, it will oscillate on the lower sideband. Thus with the ordinary tube the circuit is not practical without adding some form of neutralization.

When the four-element tube is used in the first stage the extra electrode effects

the neutralization. The shield prevents any of the plate signal voltage from getting to the control grid.

The amplification obtainable with the new tube is not a definite quantity but depends on the voltage adjustments on the shield and plate electrodes. It is possible to get an amplification with it several times that obtainable with an ordinary tube. This augmented amplification holds for the shorter waves as well as for the longer since the capacity between the plate and the control grid is not a limiting factor.

Note that by-pass condensers have been put across both the 45 volt and the 135 volt sections of the plate and shield supply. This is done to minimize the effects of the plate battery impedance on the action of the tube.

It must be pointed out that the shield around the plate is not complete. If it were, not a single electron could find its way from the filament to it. The shield is in the form of a grid or a gauze. Electrons not attracted to the shield will slip through the interstices of the shield and reach the plate.

If it were not for this action the tube would be useless.

The proportion of the total number of electrons leaving the filament that strike the shield and those that reach the plate depends on the voltages of the shield and the plate, the various distances between the four elements, and on the size of the shield conductors as compared with the holes in it.

As soon as the new tube is available to the experimenter he will have a device of attractive possibilities in his hands. Many new and effective circuits can be built around it. Many odd effects can be taken advantage of. There is no doubt that this tube will add greatly to the development of radio in the future.

Tube Characteristics

The characteristics of the UX 222 tube, according to information given out by Elmer E. Bucher of the Radio Corporation of America, are as follows: maximum plate voltage 135 volts, filament voltage 3.3 volts, filament current .13 ampere, and the amplification factor from 150 to 200.

[To radio set builders, particularly readers of *Radio World*, the name of John A. Victoreen is well-known for his design of the Victoreen radio frequency coils and more recently the No. 112 Victoreen audio unit. Now he comes forward with a substantial B power supply.—EDITOR.]

An Eng

By J. E. Anderson

RADIO users are gradually coming to the realization that quality cannot be obtained without adequate power. Persons used to be satisfied with the output of a 99 tube, and they waxed enthusiastic about the quality. Now these same persons are not satisfied without a 71 or a 10 tube with high voltages. Where a few years ago outputs were measured in milliwatts they are now measured in watts; where plate voltages were from 45 to 90 they are now 180 to 750 volts.

The object of increasing the power of the radio receivers is not to provide enormous volumes but to supply moderate volumes with a wide margin of safety. The volume a person will tolerate in a home is fairly well determined by the normal speaking voice of the announcer. But the intensity of signals in certain musical compositions varies normally a thousandfold above and below the intensity of the normal speaking voice. The audio amplifier with its power supply must be so designed as to respond to all

and the 210 requires a power supply which will deliver the necessary voltage and current continuously without breaking down, and without being subject to voltage fluctuations in the signal.

One device which does this efficiently is the Victoreen Power Supply Unit. This consists of a power transformer, two rectifier tubes, a substantial filter, and a power amplifier.

Output Voltage 475 Volts Net

The power transformer, which is known as the Victoreen 116, contains a primary for 110 volts and three center-tapped secondaries. Two of these secondaries are of 7.5 volts and are intended for heating the filaments of the two rectifier tubes and the 210 power tube. The third secondary is the high voltage which is impressed on the plates of the two rectifier tubes. The voltage across each half of the high voltage secondary is sufficient to give an output voltage of 475 volts after accounting for the unavoidable voltage drops in the filter and rectifier tubes.

The two rectifier tubes used are the UX-

210 and the 210 requires a power supply which will deliver the necessary voltage and current continuously without breaking down, and without being subject to voltage fluctuations in the signal.

The condensers used across the line in various places must be large and they must be able to withstand electric stresses at least twice as great as the voltage which will normally be impressed across them. The larger the condensers are in capacity, the less will the series impedance of the filter and rectifier be, looking from the amplifier. And the smaller this impedance, the less will be the regenerative effect in the amplifier through this impedance. Since regeneration usually causes distortion, large condensers are desirable to minimize this effect.

The first condenser used across the line is 2 mfd. If a larger condenser is used here the voltage output will be slightly greater, but not enough greater to warrant the extra space required by a larger condenser. The second condenser is also 2 mfd. in size. This condenser is large enough when a large condenser is used across the line next to the amplifier.

Another Good Point, 8 Mfd

The condenser across the output of the

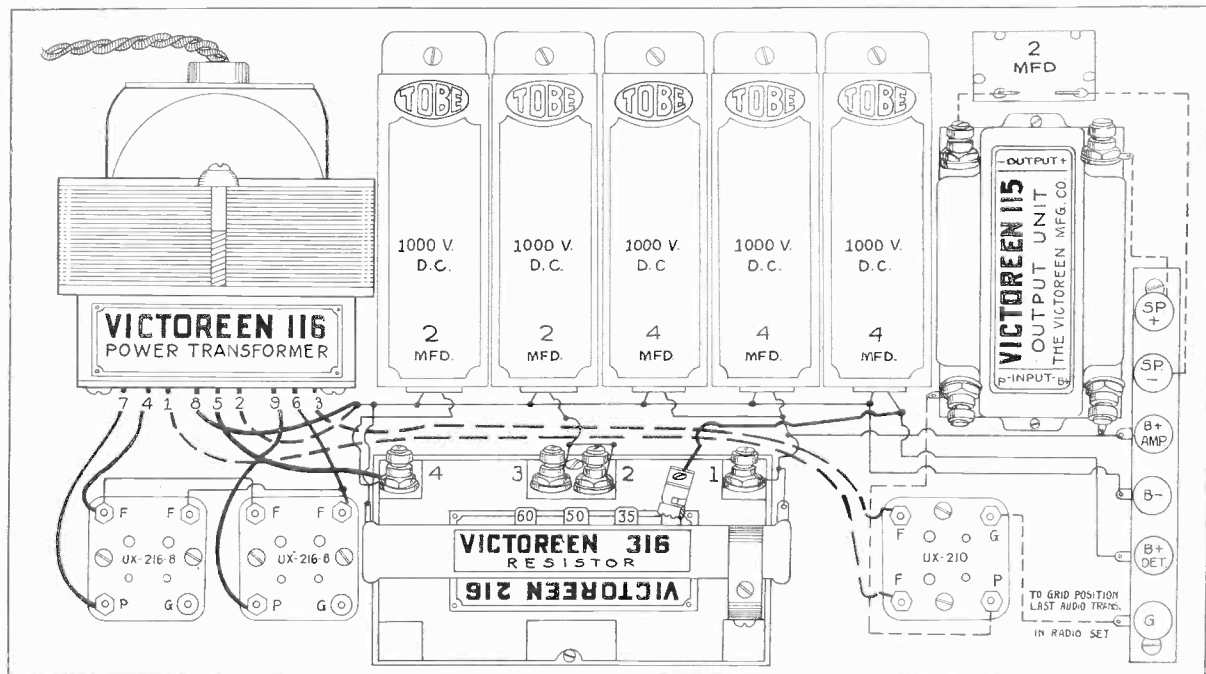

THE WIRING OF THE VICTOREEN POWER SUPPLY SHOWN IN PICTURE DIAGRAM FORM.

these variations. Particularly, it must be powerful enough to handle the loudest passages without a trace of distortion.

Low Notes Exacting

The low notes of full volume are especially exacting of the amplifier. Distortion usually shows up first on these tones in the correctly designed amplifier.

Since power is the product of voltage and current when in the electrical form, the power radiated by the loudspeaker can be increased by raising the voltage applied to the plates of the last tube in the circuit and by increasing the plate current. When the 71 type tube is used to deliver the power to the speaker both the voltage and the current are increased over the corresponding quantities in the A tube. When the 10 type of tube is used the power is mainly increased by increasing the plate voltage.

The use of power tubes like the 112, 171

216-B. The newer and more powerful UX281 may be used, if so desired. Either of these tubes will stand the voltage impressed and the current drawn from the eliminator without detriment to the elements. Indeed, the factor of safety is so large that rarely will the tubes be called on to work at maximum rated output. This factor of safety insures the optimum in regulation, or steadiness of output voltage as the current drawn varies.

There is no waste of power in using the larger tubes. If the maximum power is not needed it is not drawn from the line; but if it is needed the rectifier tubes are able to handle all that is needed.

The Filter Is Very Important

While every part in the eliminator is vital, there is no more important part than the filter. It must be adequate to meet all requirements. If it is not, poor results will

filter is 8 mfd. This large size is not usual, but it greatly improves the operation of the eliminator. One of the chief reasons for failure of certain eliminators to operate certain circuits is that this condenser is too small. Values as low as 2 mfd. have been used. The use of 8 mfd. is an almost revolutionary advance in eliminator design.

The condenser used to by-pass the detector plate supply is also much larger than usual. It is quite common to use 1 mfd. In this power supply unit 4 mfd. are used. The virtues of large by-pass condensers are just beginning to be fully appreciated by the public. The amplification of the low notes in the modern amplifiers has speeded up the change in favor of the larger by-pass condensers.

All the condensers are of Tobe manufacture. The requirements of the choke coils are that they have a high inductance and a low resistance to both direct and alternating

Inventor Uses His Head

John A. Victoreen Designs a Power Supply That Represents an Advance in the Science—Double Wave Rectification, Efficient Chokes, Condensers of Adequate Capacity and No. 10 Output Tube, with a Battery for C Bias, Constitute This Captivating Device

LIST OF PARTS

For the Power Supply

One Victoreen 116 power transformer.
One Victoreen 216 choke unit.
One Victoreen 316 resistance unit.
Two Tobe 2 mfd. 1000 volt DC condensers, No. 602.
Three Tobe 4 mfd. 1000 volt DC condensers, No. 634.
Two Frost sockets.
One baseboard 9x16 inches.
One binding post strip with six Eby posts (speaker +, speaker -, B + Amp., B-, B + Det., one blank).

For the Power Amplifier

One UX 210 power tube.
One Frost socket.
One Victoreen 115 output unit.
One Tobe 2 mfd. condenser, No. 302.
Twelve feet of Acme Celatsite wire.
Two No. 763 Eveready batteries.

current. If the inductance is not high the filtering will not be satisfactory. If the resistance is too high the voltage drop in the chokes will be excessive and the regenerative effect in the amplifier fed by the eliminator will be so high as to cause noticeable distortion of the signal.

In the Victoreen 216 choke unit the core is of large section and the wire is heavy. This insures high inductance without high resistance. There are two sections to the choke unit with one of the 2 mfd. condensers connected across the line at the junction of the two.

Another essential section of the eliminator is the output potentiometer. This is known as the Victoreen 316 resistor. It has a total value of 100,000 ohms and is tapped at 25M, 35M and 60 M ohms, where M signifies 1,000. The safe power dissipation is 20 watts. The resistor unit is so designed as to fit on the 216 choke unit.

The various taps on this unit are to supply various voltages as needed for radio frequency amplifiers, the detector and the first stage audio amplifier. The total voltage should be used on the plate of the power tube. A clip is used so that the tap to the detector post can be moved to various points on the 316 resistor, and the 4 mfd. condenser is so connected that the detector plate post is by-passed no matter where the clip is.

The loudspeaker is coupled to the 210 power tube by means of a Victoreen 115 output unit and a 2 mfd. condenser, which separates the AC from the DC in the output of the power tube. High inductance with low DC resistance is the requirement of a good output choke coil, and the one used in this eliminator and amplifier satisfies this condition.

No provision has been made for a grid bias in this power supply unit, although a power tube is used in connection with it. This was left out after careful consideration of the subject. If anyone should desire to take some of the output voltage of the rectifier and use it as a grid bias he can do it without trouble. All that is necessary is a suitable resistor in the lead to the midtap on the heating transformer which supplies the power amplifier. But this method of obtain-

ing a bias is not recommended in a high quality receiver on account of its effect on the amplification. The use of a biasing resistor is almost universal. The reason is the desirable elimination of a grid battery, but very few have thought of the possibly detrimental effects of the grid bias resistor.

John A. Victoreen, designer of the Victoreen power supply unit, had the courage to omit the resistor and he is to be commended for his independence. He recommends a 45-

volt dry battery to give the necessary grid bias for the power tubes. This has no detrimental effects on the amplification, because the AC plate current does not flow through it. The same 45-volt battery can be used as grid bias for the other tubes in the receiver if suitable taps are provided.

* * *
Next week operating features of the Victoreen Power Supply will be published, as well as some analytical data.

No. 10 Tube as Output Is Far Ahead of Field

By Capt. Peter V. O'Rourke

Quality in reproduction has been achieved by gradually climbing up the scale of power and descending the musical scale. The course followed was a bit jagged and all improvements came by strengthening the weakest points, one at a time, as the need arose.

At first, loud-speakers were improved to the point where they actually seemed to be the source of distortion. Their fidelity was so great that they brought out every defect in the receiver which fed them. Then followed improvements in the audio amplifier to make these devices as faithful to the cause of quality as the best loudspeakers.

Transformers capable of uniform response from the lowest to the highest audio notes were designed. Impedance coupling was improved until amplifiers of this type were impartial to the essential notes in the audio scale. Resistance coupling was divested of trouble-making errors of design and made to perform as faithfully in fact as in theory.

Other Distortion Sources

But as the coupling devices and the loudspeakers were perfected other sources of distortion became evident. The peanut tubes formerly used to feed loudspeaker were found inadequate to handle the power required. As a result the tubes grew until we had the 71 type of output tube. Surely it seemed that that tube would handle all the power required!

It would undoubtedly have sufficed had not the capabilities of the loudspeakers and the coupling devices been extended into the nether octaves, or if the nature of sound energy had been different from what it is. But the output tube had to take sound as it is, and it could not remain the weakest link in the quality chain.

The tube had to be large enough to handle the wide voltage swings necessary on the lower notes to maintain equality of energy output over the whole tonal range. Where a swing of one volt was enough for a given energy output at 1,000 cycles, 10 volts are necessary at 100 cycles. Where one volt is enough at 10,000 cycles, 400 volts will be necessary at 25 cycles. Hence as the frequency response of a receiver was leveled out, greater and greater demands were made of the tubes in the amplifier, and particularly of the last tube. They had to be able to stand greater voltage swings on the grids.

The most attractive output tube at the present time is the 210 or 310 when used with high plate voltages. This is the tube used in the electric Orthophonic and Panatropes. It will easily stand 500 volts on the plate and a grid voltage amplitude of 40 volts. While this grid voltage is not as great as the highest permissible input to the 71 tube, the 10 tube is capable of a much greater undistorted output than the 71 because of its higher mutual conductance and the higher applied plate voltage. The maximum undistorted output of a 71 tube with 40½ volts on the grid and 180 volts on the plate is .65 watt, whereas the maximum undistorted output of the 10 tube with 425 volts on the plate and 35 volts on the grid is 1.54 watt, or 2.37 times as great.

There is another reason why the 10 is particularly attractive as compared with the 71, and that is its greater amplification factor. The μ of the 71 is only 3 while that of the 10 is 7.5. Hence for the same power output of the two tubes the input of the 10 does not need to be so great, the ratio being almost 2½ to 1 in favor of the 10 tube. This means that for a given output to the loudspeaker, the tube preceding the power tube need not be operated with as wide voltage swings when feeding into a 10 as when feeding into a 71. Hence overloading distortion will also be minimized in the tube preceding the power tube.

An Advantageous Gain

This advantage is not limited to the tube before the power tube but extends all the way to the antenna, and even to the power of the broadcasting station received. The added gain in the last tube is particularly advantageous in preventing overloading of the detector tube. This is often an annoying source of distortion and one that is not easily located. The 10 tube helps to keep distortion out of the circuit all around.

The filament requirements of the 10 tube are 1.25 amperes and 7.5 volts, that is, nearly 9.4 watts. The tube can be operated on a 6 volt storage battery by directly applying the full 6 volts, with 160 on the plate.

It is preferable always to operate the tube with alternating current on the filament. This can be supplied with a step-down transformer with a 7.5 volt secondary, or with a similar winding on the power transformer supplying the B battery eliminator. The winding should be tapped in the middle for the return of the plate and grid circuits.

Safe Curve Ahead on Knickerbocker Road

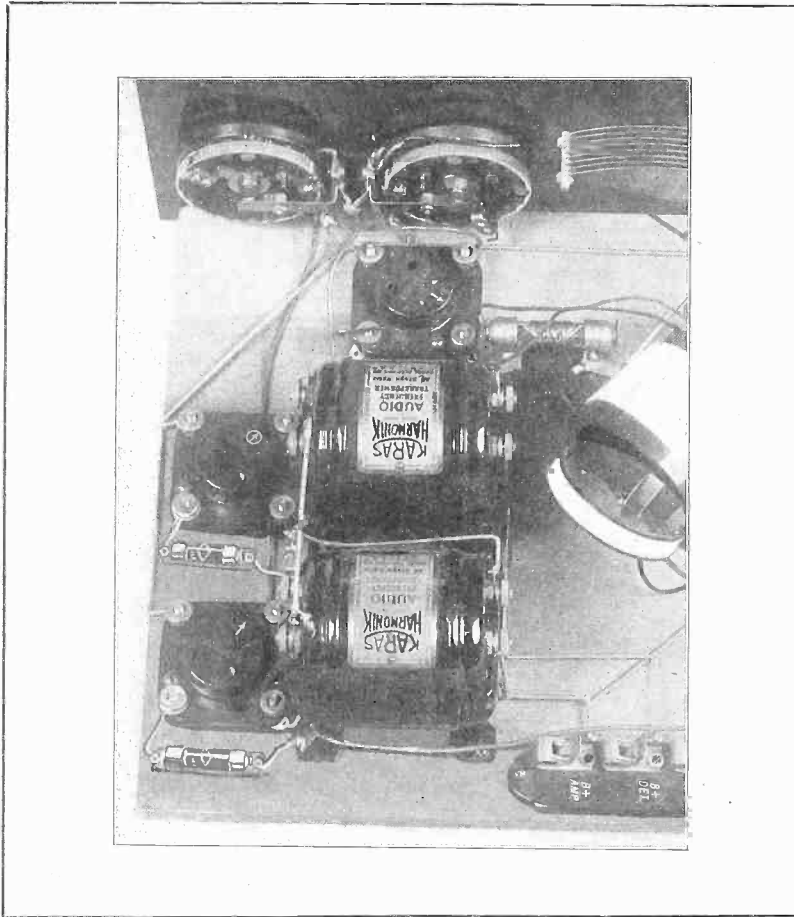

VIEW of the audio channel of the Knickerbocker Four, with associated apparatus.

By Herbert E. Hayden

The quality of the reproduced radio signal is almost completely determined by the audio frequency amplifier and the loudspeaker. The effect of the whole can be no better than either of its parts, except in a few instances where equalization is effected by the selection of parts of complementary characteristics. But such equalization is usually not possible outside of fully equipped laboratories. Hence the fan will get better overall results if he chooses each part that goes into his receiver because of the desirable characteristics of that part.

The fan now has access to reproducers of good quality. He also has access to first-rate transformers with which to assemble his amplifier. His choice of transformers will very largely depend on the amplification curves of the transformers as they have been determined under average working conditions, not as they have been embellished by artists.

Good Response Curve

One of the conditions for equal amplification of all notes is that the frequency response curve of the transformer chosen be a straight line over the entire essential range of audio frequencies. We might take the curve of the Karas Harmonik as an example. The transformer has a straight line response between about 400

cycles and the upper sideband limit as practiced in broadcasting. This means all the notes above 400 cycles are amplified with equal intensity. There are no amplification peaks of perceptible magnitude to affect the quality adversely.

What happens to the amplification below 400 cycles in this transformer? It falls very gradually, in fact so slowly that at 100 cycles the gain is about two-thirds of the maximum. Below 100 cycles the fall is just as slow, so that at the lower audible limit there is no great diminution in the amplification. The thing that holds up the amplification in this case is the ample cross section of the silicon steel core and the very high inductance in the primary of the transformer.

Great Volume

A small decrease in the amplification at the lower end of the scale is advantageous in the interest of uniform output. The reason for this is that the tuner in the radio frequency end of the amplifier discriminates slightly in favor of the low tones. The fault of the tuner and the fault of the transformer, both of which are unavoidable, work harmoniously together to effect an even response.

Two of these straight line response transformers are used in the Knickerbocker Four, and this fact is one reason

LIST OF PARTS

- Two Karas Orthometric .00037 mfd. condensers.
- One Karas antenna coupler.
- One Karas three circuit coil.
- Two Karas Harmonik audio transformers.
- One Yaxley No. 10 midget battery switch.
- Two Yaxley No. 416 pup jacks.
- One Samson 85 millihenry R. F. choke coil.
- One Samson neutralizing condenser (.00003 to .0003 mfd.).
- One Sangamo .00025 mfd. by-pass condenser with clips.
- One Sangamo .0001 mfd. by-pass condenser.
- One Amisco 2 megohm grid leak.
- Two Yaxley No. 120K 20-ohm rheostats.
- Two 1A Amperites.
- Two Karas Micrometric dials.
- One 7x18x3-16 inch Micarta panel.
- One wooden baseboard, 9 $\frac{3}{4}$ x17 $\frac{1}{4}$ x $\frac{1}{4}$ inch.
- One Mucher binding post strip containing 7 Fahnestock clips.
- Four Benjamin sockets.
- One No. 669 Yaxley connector plug with two extra contacts (optional).

why the radio building fraternity have become enthusiastic about the quality of the circuit. The volume is enormous.

Another delightful feature about the Knickerbocker Four is the distribution of the stations on the tuning dials. There are 100 divisions on the dial and every division represents a broadcasting station. The stations are distributed on the dial in the same proportion as they are in the frequency spectrum, without crowding anywhere. With the Orthometric condenser used in the Knickerbocker Four straight line frequency is a fact, not a mere claim.

Smooth Rotation

Still another feature about the condensers which is far from objectionable to the person who tunes the Knickerbocker Four is the velvety touch of the controls. The condensers turn just as if the rotors were running in well-oiled ball bearings. This illusion is due to the special cone type of bearings used on the condensers, which make the rotors turn smoothly yet firmly.

The layout of the audio amplifier of the Knickerbocker Four is clearly depicted in the accompanying photograph. On the panel are the volume controls, both of which are Yaxley rheostats. Back of these is the detector socket and then the two Karas Harmonik audio frequency transformers. At the right of the transformers are the sockets for the audio tubes together with the Amperites associated with them.

[The construction of the Knickerbocker Four was described September 17, 24 and October 8. New features will be dwelt on next week.]

Understudy Fiddler Becomes Concert Master

When Gregory Besrodny appeared before the Columbia Broadcasting System chain's microphone in the studio of WOR, the key station, to play an emergency solo in place of Ivor Karman, Hungarian violinist, who was kept away by his wife's illness, he performed so admirably that he was appointed concertmaster of the Columbia Symphony Orchestra by Maurice Van Pragg, the director.

This is another reason why WOR is steadily acquiring more listeners.

Final Unification of the New Diamond

By the Laboratory Staff

Every circuit has certain points that require special attention. It is therefore advisable that every series of articles on how to build a circuit be followed by one on trouble-shooting, or efficiency data, as it is sometimes called with greater euphony. Also there are bound to be discoveries, based on experience, that should be passed along to the one's fellow set-builders.

It is no reflection upon a circuit that it well deserves attention along the lines of trouble-shooting. Every human being in the course of his life is bound to be sick sometimes, and as radio sets are but the product of human brains and hands, they are no greater than their makers, and have ills, too. So long as those ills can be cured, which is nearly always possible, if the circuit is well designed, there is no reason for real concern.

The only unhappy aspect is that some novice will encounter a difficulty and not know the solution. Therefore quite likely he will condemn the circuit. But hosts of such denouncers turn out to be the greatest boosters for a circuit, once their individual trouble has been cured. Like as not they are given to extremities, be they of denunciation or exaltation.

Three Interesting Points

In the Unified Diamond of the Air, the name given to the six tube receiver design described in RADIO WORLD for September 17 and 24 and October 1 and 8, there are a few points to which special attention should be called. One of them is the adjustment of the three tuned circuits to frequency resonance along the broadcast spectrum, another is accessibility to the Phasatrol and the setting of this stabilizing device, and yet another the permanent installation of a phonograph pickup without motorboating.

As for the three tuned circuits being actuated as one, there is every reason why synchronization should be successful. It is true that the antenna has capacity, average about .00025 mfd., the antenna coil (primary) is capacitatively coupled to the secondary, and the wires leading to grids and plates in particular add capacity, as does the internal or elemental structure of the tubes. Also, a fact not often mentioned, the antenna resistance and the grid leak resistance, as well as the grid condenser capacity have

their own tuning effects. The theory is that in the face of so many possible alteration factors no experimental assurance exists that one will "just hit it right." The subject is well worth attention, because an engineer of some standing casually raised it the other day in connection with this circuit.

One Knob Tunes in DX

The points raised are true, but the conclusion is not, because it is true that capacities differ, and not that they can not be adjusted so as to achieve an excellent compromise. The theory is that the thing is too complicated. The fact is that it is simple. The theory is that it can't be done. The fact is that it has been done, is being done and will continue to be done. When one knob tunes in distance you know that practice has triumphed. The reasons are not far away.

One of the requirements for obtaining successful tandem tuning without an extra tube to be used as a dummy and first RF amplifier, is that the antenna circuit be tuned more broadly than the rest. Thus the condenser setting may be 5 mmfd. or even more off the point otherwise required for energetic response, yet there will be no appreciable diminution of signal strength, at least the signal does come in well, and all that is needed is sufficient audio amplification to cause it to actuate a reproducer.

For matching use only a weak signal, one of the weakest that you can obtain. Do not simply reduce the audio amplification to make a strong signal sound weak, but bring in a station on a wavelength below 400, preferably around 300 meters, that has a low field intensity about your antenna.

Greatest Response

Then adjust the trimming condenser on the second tuning condenser from the left. As the Remler three-in-line straight frequency line condenser is used, the trimmers and the condenser tuners are from left to right in the order of the RF stages. See that this model condenser is used.

It will be found that the third condenser's trimmer, affecting the detector input, does not cause total loss of signal when turned, but merely reduces, or increases, signal strength. Hence turn this until the sound is loudest.

If you have not pushed the adjustable antenna coil winding, or primary, down as far as you can, do so, and see if the signal strength increases perceptibly. More than likely it will. If so, you should test the response gently and finely adjust the trimmers to see whether still greater signal strength is possible. If it is get the strength to maximum.

Some Good Hints

Now, the signals may be inexplicably weak at best. If so increase the B voltage applied to the radio frequency tubes. If oscillation results, turn the Phasatrol to get rid of this disturbance.

By the way, it is a good plan to drill a hole in the bottom of the cabinet, right under the Phasatrol, so that if you desire to get at this valuable device you need not remove the receiver from the cabinet. Usually the adjusting is done before the receiver is placed in the cabinet.

And another by the way: When testing for synchrony, put a cigar box or other support an inch or more higher, under each of the two brackets to elevate the receiver, otherwise the wiring may get too near a tablecloth and introduce losses that show up in the tuning by requiring variable capacity, due to the absorption by the cloth. When the set is put in a cabinet it would then tune differently.

Other pointers: Try higher detector plate voltage. Try reversing connections to 3 and 4 on the antenna coil.

The Pickup

The permanent installation of a phonograph pick up, like the Facent Phonovox, may be made by omitting the usual plug-in at an emptied detector socket, and instead connecting the pickup permanently in the grid circuit. This may be done in series with the "low" end of the detector input coil (just to the left of S2 in the diagram), or between the Frost potentiometer and the .002 meg. Lynch resistor, about an inch to the right of the dotted line in the diagram.

Muter Has Clarifier for the Speaker Output

Characteristic of all their high-grade products, the Leslie H. Muter Company, 76th St. and Greenwood Ave., Chicago, Ill., have added the Muter Clarifier. It consists of a specially constructed dual choke which assists the output energy of your set to build up and operate your speaker to its fullest efficiency. And a large filter condenser, which prevents the high B voltage from entering and otherwise injuring the speaker windings. The tone quality and the volume are greatly improved.

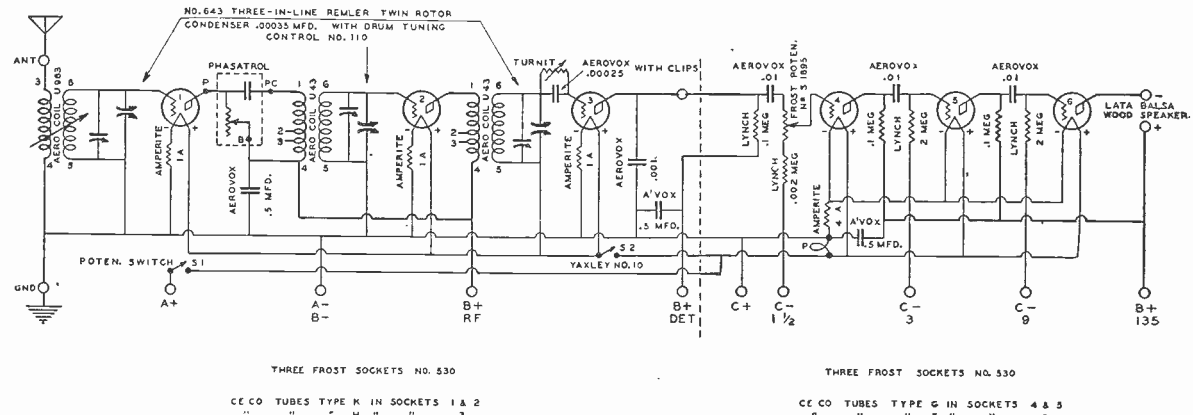

IN BRINGING the Unified Diamond up to full efficiency it is necessary to have the various settings of the tuned circuits resonate, and how this is done is explained in the trouble-shooting text herewith. Also, connections for a phonograph pickup, so as to avoid motorboating, otherwise almost certain, are given.

The Winner

By Lewis Winner

Technical Editor; Associate, Institute of Radio Engineers

[Part I of this article appeared in the Oct. 1 issue. Part II was published last week, Oct. 8 issue. Part III follows.]

INSTEAD of drilling the front portion of the shield, to which the control will be attached, a slot $1\frac{7}{8}$ inches wide, 1 inch from top and $2\frac{3}{4}$ inches from the left hand side, can be cut out with the aid of a pair of heavy shears. Then with the triangular shaped binders the shield can be slipped into place. This method and the method outlined last week is satisfactory.

It is to be remembered that the side as well as the rear shields have not and should not as yet be put into place. The panel should now be attached to the baseboard by means of screws 2 inches long, $\frac{1}{4}$ inch diameter. These screws as will be seen from the diagram, Fig. 6, are directly underneath the two rheostat knobs and switch, $\frac{1}{4}$ inch from the bottom. It is well to have these holes drilled at the same time as the others, e.g., control, rheostat, etc.

The front shields in place, attach the variable condensers. The coils need not as yet be placed on the frame of the condensers. The condensers should be so placed that the frame runs parallel to the surface of the bottom shield. If you will study the condenser you will note that there is a stopping rod, and a pointed piece of metal which falls against this stop when all the plates are in mesh. The piece of metal should lay perfectly straight or horizontal, while the rod should be in full view. The rod should appear on the left-hand side. In this position the frame will also appear on the left-hand side.

Now attach the coils. This should be done carefully and slowly. Hold one coil so that it is perfectly vertical with the primary winding at top. The long thin screws which are in the center hole of the three holes in the small block of metal at the top should be taken out. Push the movable rod which falls against a spring,

on the long shaft in the hole to the extreme left on the metal block, up. Now take the fibre cam and attach it to the rotary shaft of the variable condenser, so that the rod on the movable shaft just falls at the beginning of the rounded out portion of the cam.

Don't put it against the flat edge. Now tighten the cam and turn the condenser shaft. You will note that as you turn the plates out of mesh, the primary is actually pulled away from the secondary. A U shaped rim with a small bended piece of metal in the center, this having a hole and small V shaped piece of metal cut out, will fall up against the frame of the condenser, coil being placed right. The same operations are followed when mounting the other coil. After both condensers and coils have been securely mounted, dismount the panel. Now there is a small screw in a slotted piece of metal which runs out at an angle to the left on the control. By adjusting this, it will be found that it will be possible to have the hole in the frame to the left meet the screw at the lower end of this slot. This should be tightened up. It is this screw which holds condenser in place. Therefore be sure and tighten the screw as much as possible.

Drill two $\frac{1}{8}$ inch holes, $\frac{1}{4}$ inch away from each other and $\frac{1}{8}$ inch from the bottom, at the extreme lower left-hand portion of the left-hand front side of the shield. There are no holes to be drilled in the right-hand front portion of the shield. The panel can now be placed back. A socket is placed on the left-hand compartment. This is $4\frac{1}{2}$ inches from the right, taking the edge of the shield laying on the baseboard as the standard. It is $\frac{1}{4}$ inch from the rear. The same measurements should be followed for the placement of the socket in the other shield compartment. Parallel to the rear of this socket or $\frac{1}{2}$ inch from the rear snug up against the side, a ballast mounting is placed. Parallel to the right side of the shield, $\frac{1}{4}$ inch away, a

LIST OF PARTS

L1, L2, C1; L3, L4, C2—Two-Hammarlund Auto-couple units, using Hammarlund Midline condensers.

L5—One General Radio 60 millihenry RF choke coils, type 379.

C3—One Tobe .1 mfd. bypass condenser, type 210.

C4, C5—Two Dubilier .00025 mfd. fixed mica condensers.

C6—One Dubilier .0001 mfd. fixed mica condenser.

C7, C8, C9, C10—Four Tobe 1 mfd. bypass condensers, type 201.

C11—One Tobe 4 mfd. output condenser, type 304.

C12—One Tobe .5 mfd. bypass condenser, type 250.

R1—One Electrad 10 ohm rheostat.

R2—One Electrad 0 to 10,000 ohm variable resistance, type G.

R3, R4—Two Daven No. 1 filament ballasts, with mounting base.

R5—One Daven No. 2 filament ballast, with mounting base.

R6, R7—Two Daven .1 megohm resistors, with mounting base.

R8—One Daven 3 megohm grid leak.

AFT1—One Amertran DeLuxe first stage audio transformer.

AFT2—One Amertran DeLuxe second stage audio transformer.

OC—One Amertran output choke, type 854.

One Yaxley No. 10 midget battery switch.

One Yaxley cable connector plug with phone tip jacks.

Four Benjamin sockets for baseboard mounting.

Four Eby binding posts (two plain, one Ant., and one Gnd.)

Two Hammarlund shields.

One strip of hard rubber, $5 \times \frac{3}{4}$ inches.

Two Z shaped brackets.

Two Mar-Co Illuminated Controls.

One Lignole mahogany panel, inlaid, 7×24 inches.

Twelve lengths of Acme Celatsite.

One wooden baseboard, $11 \times 23 \times \frac{3}{4}$ inches.

.1 mfd. condenser is mounted. This concludes the placement of the parts within the shields.

One 1 mfd. Tobe condenser is placed $5\frac{1}{2}$ inches from the left and $1\frac{1}{8}$ inches from the rear of the baseboard.

(Part IV next week)

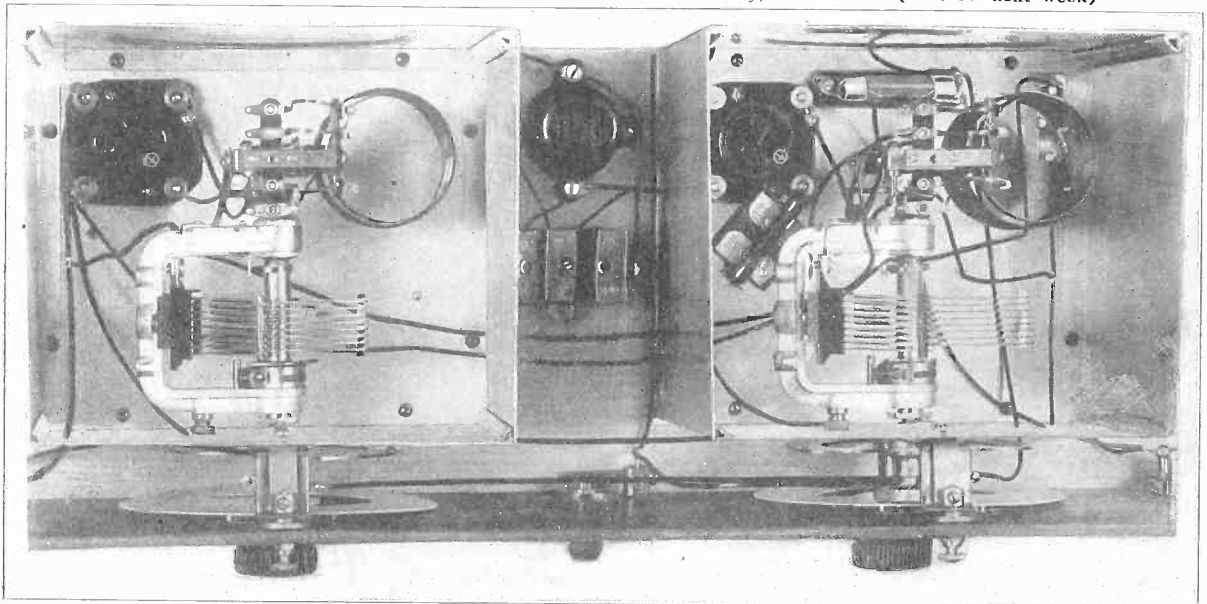

FIG. 5

A closeup of the radio frequency and detector portion of the set.

Wiring the Aero-Seven

By Zeh Bouck

[In last week's issue Part I of this article was published.]

OLD sayings are remembered because they apply to new ideas and problems. The theory of doing well anything worth doing at all is vitally applicable to radio construction, where a careless deviation from approved practice may greatly affect the efficiency of the apparatus.

As was intimated in the preceding instalment, the construction of a single control receiver incorporating several tuned steps requires painstaking design not essential to the satisfactory operation of simpler layouts. However, the problems of correct design as far as the Aero-Seven is concerned have been solved by the engineers designing the receiver. It is only necessary that the constructor follow closely the procedure outlined and recommended below. A copy of the October 8 issue of Radio World should be at hand, because of the illustrations in that issue.

Start With Subpanel

The actual building of the Aero-Seven is best described in the detail photographs and in the instrument layout drawings.

In the assembly of the receiver the subpanel is the best starting point, as most of the work may be done on it without putting on the front panel, thus allowing the work to progress unhampered. Looking at the front cover of last week's issue you see the back of the assembly.

The first radio frequency tube socket is partially hidden behind the first radio frequency coil, but is mounted with one screw so that the grid and plate terminals are nearest the first Aero coil.

Across the back of the panel are mounted the second two radio frequency tube sockets in the same direction as the one previous. This places the grid and plate connections closest to the points to which they are to connect.

Next, closer to the front panel side and in succession, are mounted the Amsco cushion detector socket and the three audio sockets. If these latter are mounted with the grid and plate terminals towards the binding post holes and the Amsco resistor couplers directly behind, a practically direct connection is secured to the plate and grid terminals.

Where to Mount Sockets

In the blank space in front of the radio frequency coils and sockets is mounted the Amsco triplet condenser. Four brackets are supplied with this condenser, which may be secured by carefully removing the nuts at the corner bracing rods, one at a time and placing the long side of the bracket over the stud and replacing the nut firmly.

The brackets should be mounted on the side opposite the small adjustment condensers, so that in mounting these adjustments will be perfectly accessible. The condenser is then bolted down to the subpanel with the shaft extending near the center of the receiver.

The panel brackets should now be put on so as to support the subpanel while working. All the minor accessories such as binding posts, condensers, etc., may now be put on before the receiver is wired. These accessories are better shown in the bottom view. Holes are provided for all these fittings and in some cases holes which were used to hold ob-

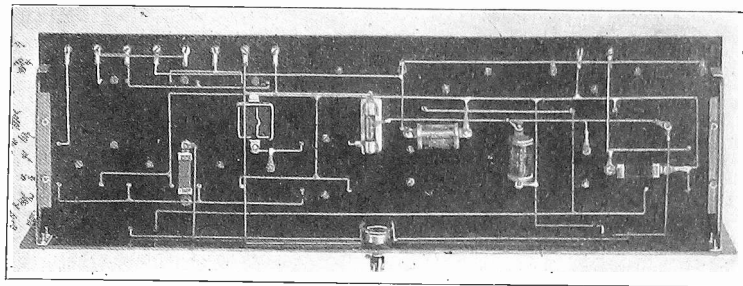

THE SUBPANEL as seen from underneath.

jects to the top of the panel are used for one or both ends of another object on the bottom.

Looking at the bottom view we have, from right to left, the 1,000-ohm Carter resistor used in the antenna input circuit, the Carter 1/2-mf. bypass used across the potentiometer, another across the 90 volt B supply, the Amsco resistor mounting with grid leak the .001 bypass across the plate and filament of the detector tube, and the Carter 1-ohm resistor for the A circuit.

After all these have been mounted the subpanel is ready to wire in accordance with the circuit diagram. The wiring is so simple that most of it can be followed out from the photographs. It should be noted that in most cases where a circuit is to pass through the subpanel that a hole has been provided in the drilling of the foundation unit, and where no hole is provided the lead is intended to pass through the panel by use of the nearest mounting screw of that piece of apparatus.

The bracket from the Silver-Marshall drum dial should now be mounted under the single hole mount nut of the condenser and the front panel prepared.

The dial plate should be mounted on the panel with the Carter 200-ohm potentiometer at the left, the rheostat at the right, and the battery switch below, the connection screws of both pointing downward. This done, the panel may be screwed to the assembly by means of the panel bracket holes and the holes in the drum dial bracket. Care should be taken that the shaft and collar assembly of the drum dial are in place before putting on the panel. Now, by putting on the drum and with a screw driver inserted in the lips of the shaft mechanism the drum may be slid along the condenser shaft and into the aperture of the drive shaft and released.

At the same time the dial should read 100 degrees with the condenser plates full in and the set screw is then locked on the condenser shaft.

The remainder of the wiring to the potentiometer and rheostat may now be completed and the receiver is ready to set up. The antenna and ground are connected to the two posts at the left of the set and the battery connections in the manner marked at the right. It will be noted from the circuit diagram that the -A BAT post is used as well for the -B and +C. The +AMP B BAT post should be supplied from a 180-volt battery for the amplifier and power stages, while the C battery on the power stage will be 35 to 40 volts.

The Amsco resistors should be unpack-

ed and inserted in the clips of the Resisto-couplers in the order shown in the circuit diagram form, left to right while facing the front panel.

The tubes necessary for the operation of the receiver are as follows: Five CX-340 or UX-240, which are placed in the radio frequency sockets, the detector and the first stage of audio frequency; One CX-301A or UX-201A for use in the second audio stage; and a CX-371 or UX-171, for use in the last or power stage. Where extra good quality is desired, the second stage should employ a 112 tube rather than the 201A, particularly when receiving loud signals from a station nearby.

In lining up the radio frequency stages, a screwdriver should be made from a sliver of wood or bakelite to use on the condenser adjustment. These midget capacities should be screwed all the way out as a preliminary and a station tuned in, preferably on the lower waves.

After tuning to maximum volume the dial reading should be decreased ever so slightly.

If the signal is a weak one it will disappear by this procedure, while if a strong one it will only be diminished in volume. After this has been done the small condensers are adjusted with the wooden screwdriver until the volume is at maximum.

Blueprints Available

In the course of doing this it may be noted that as a perfect adjustment is approached the receiver may oscillate. In this case the potentiometer should be retarded as much as necessary to prevent this and then proceed with the adjustment for maximum volume.

With this adjustment made the receiver is in perfect operating condition over the entire wave band.

Actual size blueprints of this circuit have been prepared, and are obtainable free with the Aero Foundation unit. The circuit presented herewith, however, affords opportunity to view the prospect of the completed set.

The Aero-Seven Foundation unit, in addition to the actual size blueprint, consists of a drilled and engraved front panel 7x24x3/8; drilled subpanel 7x23x3-16, and two Aero subpanel brackets.

The receiver as described is designed for operation from the usual six-volts storage A battery, and with B and C batteries or an efficient eliminator.

[The concluding article of this series will appear in the next issue of Radio World, and will describe a completely electrified Aero-Seven employing AC tubes and an especially designed eliminator.]

Methods of Governing Voltages of the Output

By *H. G. Richter*
Chief Engineer, Electrad, Inc.

There are a number of specific methods of controlling the output voltages of a "B" eliminator or power unit which have been employed for some time. There is no justification in a statement that any one of the existing methods is preferable to all others any more than there is justification in a declaration that the opinion of one man should hold forth in contradiction to the opinions of others.

There are two fundamental systems for controlling the output voltages of a "B" power unit and both systems have their advantages and disadvantages.

The first general method employed consisted of one or more variable resistances, each connected in series with the high voltage line and by-passed, with fixed condensers, to the low voltage side of the line. Obviously, with this arrangement there are two or more separate paths for current flow.

Tapped Resistance

The second method, and the one most commonly employed today, consists of a single, tapped resistance shunted across the output of the filter circuit. This potentiometer arrangement, with taps at predetermined places on the resistance, provides two or more fixed voltages. With this arrangement there is a direct load across the output of the eliminator and the output of the filter circuit flows through all of the resistance at periods of no load.

Now, as to the advantages and disadvantages of the two systems. A number of variable resistances offer the advantage of individual voltage adjustment for the tube or tubes they are in series with.

This may or may not be considered as a desirable feature since a change in the voltage for one series of tubes may likewise alter the actual voltage on the plates of the other tubes, due to an increase or decrease in the load, as the case may be.

Of Small Effect

Still, if a rectifier tube, which is capable of supplying sufficient current to the receiver for all purposes, is employed in the eliminator, a change in load on one series of tubes will not materially affect the actual voltage impressed on the plates of the other tubes.

In other words, if the rectifier tube is capable of maintaining a fairly constant output voltage with varying loads and the line voltage at the input of the eliminator remains fairly constant, the change in voltage at all of the taps on the output of the eliminator, due to a readjustment of one or more of the variable resistances, will not be appreciable.

With the potentiometer method, or tapped fixed resistance shunted across the output of the filter circuit there is less actual chance of a change of voltage at the various taps with a varying load.

Changes the Drop

Of course, a momentary heavy current drain, due, say to the functioning of the power tube in amplifying a low frequency note, will change the voltage drop throughout the entire tapped resistance, but again, this drop will not be very great if the rectifier tube is capable of maintaining a fairly constant voltage under heavy load.

With this arrangement there is the disadvantage that it is impossible to adjust individually the voltage at each tap and this disadvantage is increased by the fact

that a miscalculation in the current drain of the receiver or a miscalculation in the formula for determining the resistance required to drop the voltage a given degree with a certain current flow may result in too high or too low a voltage impressed on the various tubes in the receiver. As a matter of fact, even though the necessary calculations are made, it is next to impossible to determine what the voltage is at each tap without the use of a high resistance voltmeter.

The Alternative

The only alternative in this case is to employ a variable power resistor connected in series with one side of the primary winding of the power transformer.

This variable resistance will accomplish two things.

First, its adjustment will make up for any change in the line voltage and thus allow for a constant voltage at the output of the filter circuit. Secondly, assuming a constant line voltage, it makes provision for adjusting the total output voltage of the filter circuit most desirable for the operation of the receiver. However, the use of such a resistance is advisable only in the case that the rectifier tube is of the gaseous conduction type.

There is another point that should be mentioned regarding the two systems just outlined. It is obvious that when employing the variable resistance arrangement that there is no constant load at all times on the output of the eliminator.

Maintains a Limit

When employing the potentiometer method, however, there is a constant load and this helps to maintain a limit above which the voltage cannot rise and to some extent acts as a voltage regulator when the load on the eliminator varies.

It is seen that both systems have their advantages and disadvantages and that it is very difficult to decide which method to employ. If economy were the main factor the potentiometer system would be the best, since only one tapped resistance is required and the number of by-pass condensers is cut to a minimum.

The author wishes to present a new method of controlling the voltages at the output of a "B" power unit which has all of the advantages, but practically none of the disadvantages, of the two systems outlined. This system is not based on a new principle but rather on a new type of resistor which heretofore was not at all practical from the manufacturing standpoint.

The Feelers

We have pointed out the obvious advantages of the variable resistance method which allows for individual voltage adjustment and of the fixed potentiometer method which does not allow for individual adjustment.

The new system is of the potentiometer type, but instead of having a number of fixed taps it employs one or more "voltage feelers."

What we have is really a high resistance shunted across the output of the filter circuit and movable contact arms ranged along limited portions of the resistance.

Thus, it is possible to individually adjust the voltage at each tap and do so without changing the voltage at any of the other taps, by moving one of the contact arms to a different section of the re-

A SCRATCH FILTER

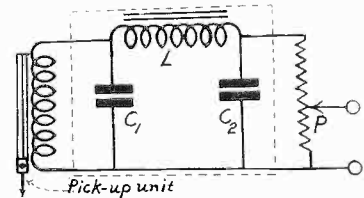

WHEN USING a phonograph pickup, needle scratches may be heard. To prevent this, a scratch filter can be built along the lines diagrammed above. L is a 65 millihenry choke coil. C1 and C2 are .002 mfd. fixed condensers. P is a 500,000 ohm potentiometer, used to control the volume. The entire unit may be housed in a container, 8 inches long, 6 inches deep and 5 inches high.

sistance where the voltage drop is either greater or less. The output of the filter still flows through the entire resistance, at no load, and provides the advantages heretofore outlined in connection with the fixed potentiometer arrangement. The number of by-pass condensers required is cut to a minimum.

Details of New Unit

The system, of course, is very simple but it has been impossible to carry it out in practice heretofore because no high resistance, power potentiometers were available. That they are available now is due to a new manufacturing process and in order to indicate the practicability of these high resistance potentiometers and their particular adaptation to "B" power units it might be well to describe their construction.

It is basically a wire-wound resistance but it is obvious that the usual high resistance of this type requires exceptionally fine wire to get the total resistance within a small space and that this wire would snap if a contact arm were run over it. It was for this reason that a new design had to be developed. Instead of the usual method, nichrome wire is closely wound on an asbestos cord having an enamel-covered copper core.

Wound on Tube

This resistance element in turn is wound on a threaded isolantite tube. Since the fine resistance wire is wound twice before the unit is complete it is seen that each turn of the wire, as it is on the asbestos cord, is parallel to the axis of the tube and consequently a contact arm scribing an arc from one end of the tube to the other will not strike the fine wire at right angles but nearly parallel to the turns as they are on the asbestos cord. Thus, the contact arm slides evenly over the fine turns and cannot snap them.

As the resistance wire is wound openly around the tube, the full length of the bare wire is exposed for the dissipation of heat directly into the air. Since there is no iron or zinc in the wire itself, it cannot rust or oxidize. The contact arm moving across the turns of wire gives fine regulation with as many points of control as there are turns.

Ranges

These variable potentiometers are made in ranges from 0 to 2,000 ohms up to 0 to 50,000 ohms.

If it is found by calculation that a maximum of say 50,000 ohms is required at the output to obtain the necessary voltage drop and it is desired to have two variable voltage controls, then two of the 25,000 ohm units can be connected in series. These units are rated at 25 watts, which is sufficient for practically all purposes.

Paper Condensers Ruled By Tremendous Trifles

Few things are more deceptive than the paper condenser. Literally, it is nothing more than two strips of tinfoil separated by several thicknesses of paper, rolled tightly together, soaked with wax, and pressed flat and hard. Yet there is no phase of electrical manufacture that presents more and greater problems—as well as grief—than the production of these seemingly simple paper condensers.

A paper condenser, like the proverbial chain, can be no stronger than its weakest link or material. A tiny speck of metal imbedded in the paper during the paper-making process, a trace of moisture due to dampness of the air at the time of winding, the slight perspiration from the fingers of the girl operator on a warm day, a wrinkle in the tinfoil, a tear in the long paper strip—these and many other seemingly slight flaws may spell a poor condenser which, while it may get by the flash test, will soon break down in actual use.

Microscopic Flaws

Hence the first and most important step in the making of paper condensers is the examination and testing of the materials entering into the production, followed by careful use of such materials in making the condensers.

There are three basic materials in the paper condenser—paper, tinfoil, and impregnating compound.

The paper, contrary to lay opinion, is not waxed at the time it is made into a condenser. It is a thin, tough, smooth and clean bond paper of special manufacture, made of pure linen rags. The paper measures half a thousandth of an inch in thickness.

Since in dealing with paper condensers we are dealing with minute details, this clean paper has microscopic flaws which would never be noticed in any other application. These flaws comprise tiny metal particles, worn off the steel rollers of the paper machine, quite insignificant in the mechanical sense but most important when dealing with the high voltages to be insulated by the paper dielectric.

Ingenious Test

Dubilier specifications for condenser paper are most rigid, so that a certain number of flaws per square foot must not be exceeded. Each lot of paper is accordingly tested by an ingenious chemical process, which causes the tiny, invisible flaws to show up as colored circles or spots, in order that the laboratory staff may count the number of flaws and note their size, in every given lot of paper. Of course just a sample is used to represent each lot of paper.

Aside from the flaws, which are the most important consideration, the paper is also tested for tensile strength, ageing, porosity, acidity, alkalinity, moisture absorption, and electrical strength. The paper, therefore, is of a certain quality or it does not find its way into a Dubilier condenser.

The tinfoil is likewise specified in no uncertain terms. It must be smooth, free from wrinkles, capable of "staying put" when rolled tightly, and devoid of holes. It measures $\frac{1}{4}$ to $\frac{1}{2}$ thousandth of an inch in thickness, and is also carefully examined before it can enter a condenser job.

Wound, Not Assembled

The impregnating compound, which in the case of Dubilier condensers is a certain petroleum preparation found to possess the desirable properties of impregnation, electrical strength, mechanical

strength and freedom from moisture absorption, is of utmost importance. In the Dubilier Research Laboratories you will see impregnating compounds under test not only for these various properties, but also in miniature impregnating tanks so as to have trial tests with small lots, before entrusting regular production to a given lot of compound.

With the materials examined and tested, so as to bar the proverbial weak link, the first step is the winding operation. Paper condensers are wound, rather than assembled layer upon layer, as in the case of the mica condensers or micadons. Skilled girl operators, sitting at the business end of long winding machines, with the many rolls of paper and tinfoil bring the ends of the rolls of paper and tinfoil on to a mandrel and start the machine turning.

Rapidly, while the turn counter is being watched, the continuous paper strips with interleaved tinfoil strips are formed into a sort of jelly roll, if we may be permitted some poetical license in a highly technical subject. The proper number of turns attained, the deft fingers of the girl operator cut the various strips with scissors, leaving the outside paper strip longer so that it may be wrapped around to protect the assembly. A rubber stamp now christens the newly-born paper condenser to the extent of giving it the identification of the operator and the date.

Atmosphere a Factor

Although the major part of the winding operation is done by machinery, a skilled operator is absolutely essential. More than that, a conscientious operator is a prerequisite. The slightest neglect, such as a wrinkle, a tear, perspiration, moisture or other factor, will mean a poor condenser and jeopardize the good name of Dubilier. For this reason the condensers are identified at the time of winding, so that faulty units may be traced to the winding machine and the operator in order to rectify such trouble.

In warm weather, the girl operators wear rubber finger tips to prevent perspiration getting into the condenser. The atmosphere plays an important part, and it is this factor, in fact, that caused the selection of the unusual site for the Dubilier plant on the heights overlooking the Woodlawn section of New York City, where the air is exceptionally dry.

Following the winding, the sections, as these rolls are called, are tested for short-circuits, so as not to waste further effort on defective units.

Now comes the critical part of the process, namely, the impregnation of the loose sections which must first be squeezed flat and tightly. The loose roll of paper and tinfoil is placed in an iron frame with a steel slab on top and bottom. Other rolls are placed in the same frame, also with steel slab at top and bottom, so that each roll is between steel slabs. When the sections are entirely stacked in the frame, the frame is placed in a press and a predetermined pressure applied so as to compress the stack to a given degree. In the compressed state, the top of the frame is bolted in place, holding the sections tightly.

Filled With Wax

The frames, with their flattened condenser sections, are now brought to the vacuum impregnating tanks. These tanks are huge iron pots, consisting of two sections or vats, so that the impregnating liquid may be driven from one to the other to facilitate loading and unloading. The pots or vats are steam-jacketed, in

BIASING METHOD

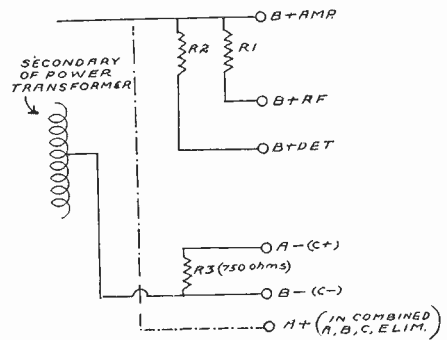

C BIAS from a standard eliminator may be obtained by inserting a resistance as diagrammed above (R3). When you don't know the exact value to be obtained, of course, a variable resistance is inserted here.

order to provide the necessary degree of heat for keeping the impregnating compound in the liquid state. A heavy lid, hermetically sealing the treatment vat, is closed and bolted after the frames have been placed in the otherwise empty vat. The air is now pumped out, so as to produce a vacuum. During this operation the condensers are compelled to give up the last trace of imprisoned air and also whatever moisture may have got into them during winding operations. The vacuum treatment completed, the impregnating compound is permitted to run into the sealed vat from the adjoining vat.

The hot liquid penetrates throughout each condenser section, so that the compressed mass is thoroughly filled with compound. This impregnation not only extends to every crevice and fold but even soaks into every last fibre of the heretofore plain paper. The condensers are now cooled off and removed from the adjoining vat.

Certain treating and annealing processes follow, after which the condensers are removed from the iron racks or frames. The condenser sections are now solid, rock-hard blocks of paper, tinfoil and impregnating compound, having much the appearance of taffy cut into neat slices.

Sectional Manufacture

It will be noted that paper condensers are made in sections, rather than in single large units, except in capacities of 2 mfd. or less. The larger capacities are made up of a number of smaller sections.

The sections are given a flash test which, in the case of Dubilier condensers, is many times higher than the working voltage of the final condenser. These flash tests serve to detect any faulty condensers at this time. The sections that pass the flash test are now assembled in groups electrically coupled by means of stout, flexible conductors, placed in a metal can and sealed, with the terminals protruding through the seal, or in the case of the latest Dubilier blocks, with the leads coming through the can. The assembled condensers are now given another flash test, the cans cleaned up bright and lacquered with an air brush, and the label applied. Packaging is the final operation.

So it will be noted that good materials, proper production methods, adequate tests, and pride of name enter into the production of a good paper condenser. In fact, a paper condenser calls for laboratory technique, and while it is obviously impossible to supply the demand with the limited facilities of the largest research laboratory, it is well within the range of possibility to have the production end but an extension of the research laboratory technique.

OPTION FOR PICK-UP WIRING



THE PHONOGRAPH PICK-UP may be connected through a variable resistor volume control to a plug that goes into the detector socket of your set. The detector tube (left rear) must be removed. For resistance or impedance coupled audio it is sometimes better to omit the plug arrangement and connect the two pickup leads permanently in the first A F grid circuit. The Walford pickup is shown.

Schedule of Broadcasts of Big Football Games

The National Broadcasting Company announced its schedule for the broadcasting of the season's football games through the associated stations of the Red and Blue Networks.

The first football broadcast takes place Saturday afternoon, October 15, when Notre Dame meets the Navy eleven at Baltimore. Each Saturday thereafter until the close of the season the N. B. C. will put one or two games on the air through its two networks. Arrangements have been effected this season whereby, in most instances, the N. B. C. Blue Network will broadcast one game while the Red Network will transmit another at the same time.

Graham McNamee and Phillips Carlin will handle the descriptive work, the so-called "radio twins" alternating on Red and Blue Network assignments.

The complete schedule of games is as follows:

Oct. 15—Notre Dame vs. Navy at Baltimore, Red, Carlin.

Oct. 22—Yale vs. Army at New Haven, Blue, McNamee; Harvard vs. Dartmouth at Cambridge, Red, Carlin.

Oct. 29—Penn. vs. Navy at Philadelphia, Red, Carlin; Yale vs. Dartmouth at New Haven, Blue, McNamee.

Nov. 5—Penn. vs. Harvard at Philadelphia, Red, McNamee; Ohio State vs. Princeton at Princeton, Blue, Carlin.

Nov. 12—Michigan vs. Navy at Ann Arbor, Red, McNamee; Yale vs. Princeton at New Haven, Blue, Carlin.

Nov. 19—Harvard vs. Yale at Cambridge, Red and Blue, McNamee and Carlin.

Thurs. Nov. 24—Penn. vs. Cornell at Philadelphia, Red and Blue, McNamee and Carlin.

Nov. 26—Army vs. Navy at Polo Grounds, Red and Blue, McNamee and Carlin.

Tanks in Action Keep on Talking

London. Employing a specially designed 30-watt transmitter and 7-tube Super-Heterodyne, Captain K. E. Hartley, a British Territorial officer, has succeeded in maintaining constant communication between armored tanks while in action. Using padded headphones, the terrific noises, caused by the rolling tank itself and the

roaring guns, is eliminated. An interest and ingenious addition is the flexible antenna, which consists of a hollow rod, ten feet high, attached to the roof of the tank with some door springs. As the tank passes under any obstruction such as a bridge or branch of a tree, the rod lies down and then rises as soon as it passes.

Socialist Station Has University

WEVD at Woodhaven, L. I., operated by the Debs Memorial Radio Fund, will conduct a radio extension university, English, citizenship, government, history and politics, etc., being included in the curriculum.

"Mr. Debs devoted his life to the work of better understanding and a fuller life," said G. August Gerber, secretary of the fund. "So, too, WEVD will be devoted to building up that sympathetic understanding which is so necessary to international peace, and that knowledge and appreciation of our social and economic organization which is basic to the creation of domestic tranquility.

"WEVD contemplates that an intelligent and alert citizenry, with a live interest in political and social questions, will be created and nurtured by its work. Light entertainment will be introduced into the programs of WEVD as time allowance permits. The station will be operated not only for the entertainment of its listeners, but also for their improvement and benefit."

His Other Interests Lure De Mott from Publishing

R. W. De Mott, formerly secretary and business manager of Experimenter Publishing Company, Inc., and The Conrard Company, Inc., both of 230 Fifth Avenue, New York City, has disposed of his entire holdings and interests in those two companies to his former associates, in order to devote his entire time to his other interests, which include the importation of foreign steel and the management of his real estate properties. The Experimenter Publishing Company publishes "Radio News," "Science & Invention," "French Humor" and other magazines.

Description Sensitive

[Part I appeared in the Oct. 1 issue; Part II in Oct. 8. Part III, the conclusion, follows:]

Now, for zero adjustment of the instrument the screens and the mirror are so adjusted that the light bands from the source are reflected through the openings in the screen S'S'. The photo-electric current in the cell, and the reading on the galvanometer, will be maximum. Now if the mirror is tilted ever so little some of the light of a given band, as that of LPO, will be intercepted by the opaque part of the second screen. That is, part of the light will now strike h2 instead of going through h1.

If the mirror is tilted a little more, all of the light in a given band will strike the opaque band on the second screen, and no light will be sent into the photo-electric cell, and there will be no reading on the galvanometer. If the mirror is tilted still more the light transmitted into the cell will increase again.

It is possible to compute from the reading on the galvanometer, the sensitivity of the photo-electric cell, the strength of the light source and the width of the bands on the screen just how far

Radio Power Used for Fertilization

Rochester.

By transmitting 103,000 volts at a frequency of 500,000 cycles into the soil, via a specially constructed plow, Hamilton L. Roe of Pittsburgh, has found that crops can be made to grow much faster, than when using the standard farm fertilizing method. The device known as the Roe Electric plow was demonstrated to experts from agricultural schools and plain farmers who marvelled at its efficiency.

As an experiment, one field was planted with corn, beans and potatoes, half of it being tilled with the standard methods, e. g., treated with 1000 pounds of fertilizer and planted with regular seed. The electric system was used on the other half. Within five days, the crops in the electrically fertilized field were up. Sixteen days were necessary for the crops in the regular fertilized field to rise. Cow peets which do not thrive in Rochester were planted in an electrically fertilized field and within six days after planting, the beets were up. Mr. Roe said:

"When the electric current first penetrates the soil, the latter must be moist, and the first treatment is to kill the insects and small animal life. The second treatment kills the weeds and fixes the nitrogen of the air in the soil so that the nitrogen, oxygen and carbon combine with the moisture of the soil and produce viable carbonate of ammonia, which we have termed 'Electric-CHON' which is a synthetic compound resulting from the current generated by the plow.

The current of the plow is produced by a generator which excites a vibrator transformer, coils, etc., whereby the static is aroused and transformed into high frequency currents.

"Mounted in the plow are two aeri- als with other radio equipment. These have partly the function of receiving and partly that of a sending station. Instead of broadcasting static energy, the apparatus sends it into the soil."

of the Micrometer

The mirror has tilted for a given reading of the meter. With the angle known it is also possible to tell how much the wire has shortened or stretched by a given magnetizing force. It is necessary to keep track of how many openings in the second screen a given light band has traversed, for the coil does not measure how many bands the light beam has passed over as a result of the tilting of the mirror, but only the fractional bands.

The current in the galvanometer will vary whenever the wire lengthens or shortens; no matter what the cause of the change in length may be. Thus it will change whenever the temperature changes, as well as when the magnetization changes. And the temperature changes are overwhelmingly greater.

A change in the temperature of .00001 degree Centigrade will cause the luminous spots to move from one ruled line to the next. Hence the temperature of the sample under test must be kept constant to a much higher degree than this. To protect the wire from all changes in temperature the apparatus is placed in a kind of thermos bottle and then mounted in springs to eliminate all jarring of the instrument.—Lewis Rand.

ODD BUT GOOD

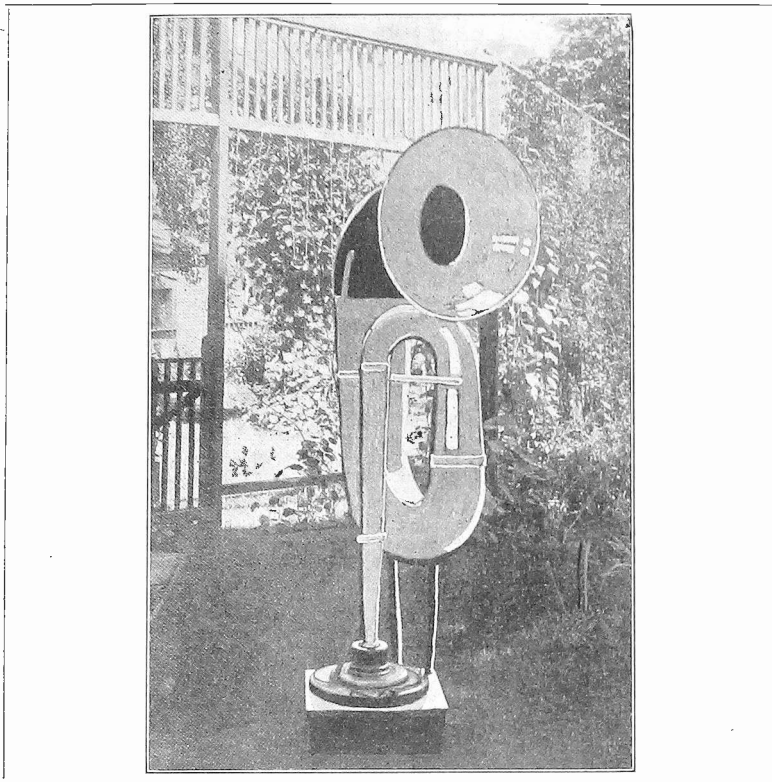

A TUBA-LIKE loudspeaker built by William E. Emrick, of Aspenwall, Pa. The speaker is 11 feet and 6 inches long, confined to 5 feet 8 inches by contortion. The bell is 22 inches across. It has been built of 1-8 inch wood.

At this moment we are at the renaissance of the horn in loudspeakers. It has returned with more graceful curves and more slender and elongated outlines. It brought quality with which never before had been heard outside the laboratory. Now enjoyable reproduction can even be heard in certain radio stores which previously had driven pedestrians off the block with raucous howls. The revival of the horn was mainly due to the popularization of the exponential curve idea—an idea that is old to the scientist but is right off the griddle as far as the popular mind is concerned.

What can be done with the long and slender horn is exemplified in a unique loudspeaker designed and built by William E. Emrick of Aspenwall, Pa. He

has built a horn 11 feet 6 inches long out of wood 1-8 inch thick in the form of a giant tuba. Since the air column is folded the horn stands only 5 feet 8 inches although the length is actually about twice as great.

It is said that this speaker is capable of unusually clear and mellow reproduction. It is more realistic than most speakers. It is not difficult to believe the claim in view of the long air column and the narrow neck terminating the horn in the driving unit. The load on the ample diaphragm is suitable to the length of the horn and such as to radiate sound effectively and uniformly over a wide part of the audible scale. The bell of this horn has a diameter of 22 inches. Sound radiation is uniform.

DC Charging Expensive, But Convenient

The charging of a storage battery from a 110 volt line is rather expensive. Each 100 ampere-hour charge costs just about as much as a service man charges for charging the battery, including transportation charges to and from the service station. But it is more convenient to charge the battery without moving it from its place. Also, the battery is subjected to less wear when it is charged in suit. Hence it is preferable to charge the battery at home.

It is possible to charge the battery at home without extra cost. Suppose a light is inserted in the lamp socket while charging the battery. This will supply all or a part of the light required in the house.

While the light is burning the battery charges at a slow rate and there is no appreciable diminution in the brightness of the light.

Of course, the charger could not be placed under a bushel and still make use of the light.

There are many other appliances that can be inserted in the socket. Some of them are a curling iron, a soldering iron, a flat iron, a sewing machine, a washing machine, a fan, a heater, a toaster, and many other appliances. Some of these will charge the battery at a high rate and it may be necessary to insert a 10-ampere fuse in the receptacle.

Kent Adds New Blood to Sunday Night Hour

Nahan Franco, former conductor of the Metropolitan Opera Company's orchestra, with which he was connected for twenty-five years, will this season conduct a twenty-piece orchestra supporting the artists in the Atwater Kent series.

Another newcomer from the Metropolitan will be Nina Morgana, soprano, who has sung for Metropolitan patrons for the past six years. Miss Morgana is widely known throughout the country, having toured the United States in concert with Caruso.

Giuseppe de Luca, baritone, who made his debut at the Metropolitan Opera, in 1915, is another star artist scheduled for his first broadcasting in this famous series of concerts. De Luca is a native of Rome and sang in the leading opera houses of Europe before coming to America.

Beniamino Gigli, leading tenor with the Metropolitan, is also scheduled to sing in the Atwater Kent concert sometime prior to Christmas. Gigli is another prominent Italian singer who joined the Metropolitan organization in 1920, after a most successful career in Europe. He is popularly known as Caruso's successor.

Other artists who will be presented in the Atwater Kent concerts for the first time include Mary Chainey, concert violinist; Mildred Seeba, who has just returned from two years study in Rome, being the first recipient of the award of the Caruso Foundation. Miss Seeba has sung in opera in both this country and abroad. Other artists with whom negotiations are now pending will not be announced until later.

Among the old popular favorites of Atwater Kent artists—that is, old in radio—who will again be heard this winter are Reinald Werrenrath, America's most popular baritone; Maria Kurenko, well known Russian soprano; Albert Spalding, the American violinist; Alexander Brailowsky, Russian pianist; Margaret Matzenauer, contralto; John Powell, American concert pianist; Kathryn Meisle, contralto; Edith Fleischer, soprano; and Andre' Benoist, pianist.

Station WBT, of Charlotte, N. C., is a

new station that has been added to the network of stations broadcasting this premier series of radio concerts, which as last year will go on the air each Sunday night at 9:15 eastern standard time. The complete hook-up will include WEAf, New York; WJAR, Providence; WEEL, Boston; WSAI, Cincinnati; WRC, Washington; WCCO, Minneapolis-St. Paul; WGN, Chicago; WFI, Philadelphia; WCAE, Pittsburgh; WGR, Buffalo; WOC, Davenport; WTAG, Worcester; KSD, St. Louis; WWJ, Detroit; WGY, Schenectady; WSB, Atlanta; WSM, Nashville, and WHAS, Louisville.

Havrilla New Star Among Announcers

By R. W. McAdam

"This is Alois Havrilla announcing."—Night after night this phrase is heard by listeners of the National Broadcasting Company's Red Network, emanating from its key station, WEAf, in New York City. As a fair-haired youth in the foothills of a Czecho-Slovakian mountain range he little knew he was destined to score conspicuous success in a distant land, leading to occupation in a newly established field which would make his name almost a household word.

Graham McNamee, veteran announcer, first directed Havrilla's thoughts to broadcasting as a career. McNamee served as announcer for a concert program from Carnegie Hall and was impressed by the voice of Havrilla, soloist of the evening, to such an extent that he invited him to come to WEAf, New York, for an audition. The audition led to recitals over the air and these in turn to his engagement as announcer.

Havrilla came to this country at an early age settling in Bridgeport, Conn.,

WEAF Transmits 30 to 10,000 Cycles

Satisfaction as to the result of testing of 2XZ, new National Broadcasting Company 50 kw transmitter at Bellmore, Long Island, which replaces WEAf's New York transmitter, was expressed by O. B. Hanson, Manager of Operations and Engineering for the National Broadcasting Company. He said:

"The test indicated that frequencies from 30 to 10,000 cycles were satisfactorily transmitted."

GREBE NOW LICENSED

Under a recently made agreement, A. H. Grebe and Co. became a licensee of the Radio Corporation of America.

and there began the study of music. His first definite advance in music came at the age of eight when he became contralto soloist in a boys choir. Upon coming to New York City a few years later and after general studies at New York University, Havrilla turned to concert work as his life career. His appearances as vocal soloist with the New York Philharmonic and other leading orchestras were frequent. He has appeared with such noted artists as Percy Grainger, pianist, Jeanette Vreeland, soprano, and Paul Althouse, tenor. The concert platform was not alone in claims upon his time before the era of broadcasting for he appeared in roles on the stage in such productions as "Hassan," "Madame Pompadour" and "Princess Flavia."

Following his initial recital at WEAf, Havrilla gave much time and attention to radio appearances. His excellent baritone voice, adequate musical training and microphone experience presented undoubted qualifications when the National Broadcasting Company sought another announcer for its staff. A unique feature of his repertoire is a collection of Czecho-Slovakian folk songs from which he frequently draws for singing before the microphone. Many of these have been arranged and published in collaboration with Deems Taylor.

Havrilla resides in Briarcliff Manor, N. Y., where he is taking great interest in the musical organization of the community. He is Director of the Senior and Junior choirs of the Briarcliff Congregational Church and the conductor of the Briarcliff Unit of the Westchester Choral Union.

R.C.A. Is Working On Timed Music for Movies

In an address before the company's distributors, Major-General James G. Harbord, president of the Radio Corporation of America, stated that the R.C.A. was perfecting a device which would synchronize sight and sound.

"A new system of synchronizing the fleeting lights and shadows of the moving picture screen with musical accompaniment or the sound of the human voice will be radio's first contribution to link sight and sound," he said.

"Remarkable progress has been made. The Radio Corporation is now making plans to develop this system upon a commercial basis.

"Through the application of radio technique, a point has been reached in the synchronization of music and screen pantomime where the entire score of a seven-reel picture can be played by a symphony of 100 pieces and a splendid reproduction in tone, to any desired

volume, exactly synchronized with the film, can be given in any theatre in the country.

"In furnishing good music to the scattered motion picture theatres of the country, many of which still depend on a solitary pianist, it would seem as if radio is destined to repeat there the service it now renders to millions of homes.

"The new system, employing the technique of radio reproduction, brings nearer the day also of the 'talking movie' news picture, when current personalities will not only be shown on the screen, but heard by the audience as they are being interviewed by a 'movie' reporter.

"The picture of an important event will be accompanied by all the stirring sounds that emanate from a great mass of people; the parade thrown on the canvas will bring the music of the bands and the cheering of the spectators. The system would likewise have great educational value."

Hints for Charging

A Battery from DC Line

If a storage battery is of the 100 ampere hour size, the charging current should not exceed 6 amperes. Hence the highest wattage device that should be inserted in series with a DC line is 660 watts. This may rule out heaters, washing machines, if these were to have been employed. By multiplying the voltage and amperage, the wattage is obtained, if this is already not stated on the device and you are in doubt. Hence 6 amperes and 660 watts on a 110 volt line are the limits of a 100 ampere hour battery.

Demonstration Proves Remote Tuner Clever

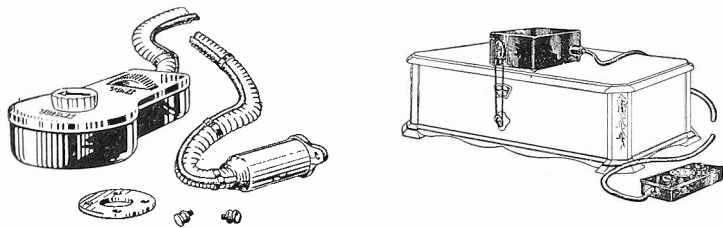

THE mechanical model is at left and the electrical model of the remote tuning device is at right

The device which enables a fan to tune and control his radio set from a distance was recently demonstrated by the Algonquin Electric Company, 245 Fifth Avenue, New York City. The device is made in two models, one mechanical and one electrical.

The mechanical device is intended for distances of several feet, while the electrical is intended for any distance desired.

The electrical device is composed of two main parts, a small control box at the operator's end and a reversible electric motor at the receiver end. The motor is coupled to the master tuning dial of the receiver by means of a worm reduction gear and a sprocket chain. The reduction is such that when the motor runs at normal high speed the dial on the set turns at a suitable tuning rate. The motor is reversible so that the dial can be turned backwards and forwards. The motor and the worm gear are mounted in a metal case which can be placed either on top of the receiver or at one side.

The control box at the operator's end is so small that it can be held in one hand while manipulating the controls. It visibly contains two small push buttons, a volume control knob and a meter calibrated in wave lengths. In connection with the volume knob is a switch which controls a relay at the receiver end. This

relay turns on the filament current in the set. Hence to turn on the filament current in the set the volume control knob is given a slight turn. The two push buttons control the motor and hence the tuning.

When one button is pressed the motor turns in one direction, and when the other button is pressed the motor turns in the opposite direction.

The needle on the meter moves over the scale in conformity with the tuning condenser, always indicating to what wave length the circuit is tuned. This is merely a convenience to indicate which button to press. Accurate tuning is determined by ear as in any other case.

When the volume control knob is turned on farther than that required for tuning on the set the volume is cut down.

Since there is no slip possible in the worm gearing and the sprocket coupling, and the condensers are so made that they stop on zero and full scale, it is necessary to provide some means to protect the mechanism in case either of the control buttons is pressed down too long. This is introduced in the condenser dial sprocket wheel in the form of an automatic release clutch.

The mechanical model works on the principle of a flexible coupling similar to that used in dentists' drilling machines and similar devices.

from the pick-up on the phonograph run to two binding posts located on the top of the adapter.

A 50,000-ohm variable resistance controls volume smoothly, so that you may have a soothing background for the reading of the evening newspaper, or the full volume you wish for dancing in the living room or on the porch in summer.

If you already have a volume control in the audio side of your set, this resistance is unnecessary.

The maximum volume obtainable will depend, of course, on the energy output available from the audio frequency amplifier in the radio set.

The first step in converting the old phonograph is to remove the reproducing unit from the tone arm and replace it with a pick-up. This pick-up unit is equipped with a suitable arm which holds it tightly to the tone arm of the phonograph. The reproducing unit taken from the phonograph is not needed, and should be put away for safe keeping.

Simple to Operate.

Place the adapter in the detector socket of the radio receiver, with the phone cord connecting the adapter and the pick-up unit on the phonograph. Any radio set with a well-designed audio amplifier gives very satisfactory results.

The variable volume control, across the pick-up, may be physically placed wherever you find it convenient. This resistance is the only adjustment in the entire phonograph-radio combination. A turn of the knob gives a wide range of volume control.

The operation of the combination is essentially the same as playing the phonograph alone. A good cone speaker will be found best for bringing out all the possibilities of the converted phonograph.

Plug the speaker in the set in the regular way, and turn on the tubes. Now start the record and place the needle on the unit just as if you were playing the record on the regular phonograph. When the record is started let down the cover on the phonograph. Now simply adjust volume with the variable resistance.

Too Good to Recognize.

If the amplifier in the radio receiver has good parts, proper tubes and correct battery voltage, the reproduction will undoubtedly be no small surprise. One thing is certain: you will never recognize the music as coming from an old type phonograph that you were just about ready to give away. Particularly noticeable is an entirely new base, fuller and richer than you could ever get from the phonograph of two or three years ago.

It should be borne in mind that the make or model of the phonograph makes little difference in the final tone quality. The phonograph is employed simply as a means of revolving the record and supplying energy to the amplifying system of the radio set. The actual sound reproduction is accomplished not by the sound box of the phonograph, but by the speaker in the output of the audio amplifier.

If you own a power amplifier, or combination eliminator power amplifier, it may be used very effectively with the converted phonograph-radio combination. Adding this type of device, a dance orchestra might just as well be right in the room, so far as realistic music is concerned. The combination comes very close to equaling any of the higher-priced phonographs with power speakers, working from either record or radio.

WOR ON HIGH POWER

The reason for the tremendous increase in volume as well as improved quality from WOR is a new 5,000 watt transmitter, which has been installed at Kearney, N. J. Persons near and distant noted the improvement with delight.

New Thrill In Home Is Given By Pick-Up

(From Pacent Electric Co.)

Scattered throughout the country are thousands of phonographs which are out of date in the matter of the quality and range of reproduction. Two or three years ago they represented the best that the phonograph art could offer. But important developments in design since then have made them obsolete.

Recently engineers perfected a way of converting the old machine, as thousands had hoped it could be done.

If you have a phonograph that fails to deliver the tone and range of reproduction you want, and a radio set that pleases your ear, use a good phonograph pick-up.

The pickup replaces the ordinary reproducing unit on the phonograph. The Pacent Phonovox, to cite an example, is a pick-up of the magnetic type, and con-

sists essentially of a permanent magnet in the field of which is a specially designed small coil. Attached to the needle running in the record groove is an iron reed, placed within the coil. The energy developed in the coil by the movement of the needle on the record is transferred through the adapter which fits in the detector socket of the radio set. It is fed from here into the audio frequency amplifier. The small initial energy is built up and amplified many times, just as a radio signal is stepped up to volume ample for the loud speaker.

Need Change No Wiring.

The adapter requires no wiring changes of any kind in the detector socket, where it fits, or in any other part of the radio receiver. It is simply inserted, just as you might insert a tube. Connections

Household Utilities As Power Resistors

By J. C. M. Curran

Sometimes a resistor of a high current carrying capacity is wanted in connection with some electrical or radio work. Resistors of high resistance are plentiful, but resistors of high current carrying capacity are not so common. That is, they are not common as resistors. But they are available in every home in the form of electric lamps, toasters, heaters, flat irons, etc. They range in wattage consumption from about 5 watts to one kilowatt. Nearly all of these household appliances are designed for 110 volts.

Every one of these devices has a certain resistance which depends on the wattage at which the device is rated. The wattage is the product of the voltage and the current. For example, if the rating on the device is 110 volts and 2 amperes, the wattage is 220 watts. These two values are often given on the devices. Sometimes the wattage is given directly and the current is omitted. The voltage is usually given on the device to inform the user on what line to connect the device. For example, if the device is rated at 110 volts it would not be safe to hook that on a 220 volt line.

Determination of Current.

When the wattage and the voltage are given the current which will flow through the device is obtained by dividing the wattage by the voltage. Thus if the wattage is 660 watts and the line voltage is 110 volts, the current will be 6 amperes.

When a resistor of a given value is desired it is nearly always possible to get it by combining in a suitable manner lamps and appliances already in the house. Suppose we want a resistance of 100 ohms. What is the wattage of the electric lamp which comes nearest to that? The wattage is the product of the current and the voltage. The current in turn is the ratio of the voltage to the resistance. That is, if W is the wattage, V the voltage, I the current and R is the resistance $W=VI$ and $V/R=I$. Therefore the wattage is equal to the square

of the voltage divided by the resistance, or $W=V \times V/R$.

In our problem the resistance is 100 ohms and the voltage is 110. Hence the wattage of the required lamp is $110 \times 110 / 100$, or 121 watts. Now there is no 121 watt lamp available but there is a hundred watt lamp and a 20 watt lamp. If these two be put in parallel the total wattage is 120 and the resistance of the combination is very nearly equal to 100 ohms.

What is the resistance of a 20 watt lamp designed for 110 volts? We have 20 watts equals $110 \times 110 / R$. Or R is equal to 605 ohms.

The following table gives the resistance of various wattage lamps or other devices designed for 110 volts lines:

5	2420	75	161
10	1210	100	121
15	807	200	60.5
20	605	300	40
25	484	400	30
30	403	500	24.2
40	302	600	20
50	242	1000	12.1

The resistance of devices having different wattages from any of those given above can be obtained by dividing 12,100 by the wattage, provided that the lamp or appliance is intended for 110 volts. If the appliance is intended for 220 volts, the resistance is obtained by dividing 48,400 by the wattage.

AC Meters Necessary for Testing New Tubes

The use of alternating current for heating the filaments of amplifier tubes requires a new set of meters if one is to know at all times just how much filament current flows or how much voltage is applied to the terminals. Meters designed for measuring direct current and steady voltage are not at all suitable. If a direct current voltmeter is put across an AC line the needle will not deflect but it will simply vibrate about zero.

Alternating voltmeters are more expensive than direct current voltmeters, and for that reason many will refrain from buying them. But alternating current meters are usually not so expensive. A point in favor of the AC meters is that they will also measure direct current, at least some of them will, and do it with sufficient accuracy for all practical purposes.

It is possible to tell with the aid of suitable direct current meters what the alternating current flowing in the filaments is. For example, the filament current can be measured by measuring the

direct current plate under known conditions. With a given grid and plate voltage on a tube a certain plate current will flow when the filament current has a definite value irrespective of whether the current in the filament is AC or DC. In fact, by the definition of equivalence of AC and DC the two are equal when they release the same number of electrons from the same filament under the same conditions.

Now suppose we have a 0-10 milliammeter and we wish to determine intensity of the alternating current flowing in the filament of a tube. The meter is connected in the plate circuit of the tube and the power is turned on. The grid return should be to the midpoint of the filament, or to the midpoint of a resistor across the filament. A certain current will flow in the plate circuit. Substitute an A battery for the AC source and with a rheostat placed below the mid-tapped resistance, adjust the filament current until the reading in the plate milliammeter is the same as it was when AC was flowing in the filament. Measure the direct filament current with a DC ammeter. This direct current is equal to the alternating current, which flowed previously. If a direct current ammeter is not handy and a direct current is, then measure the voltage across the terminals, when the correct direct current flows. This voltage is then equal to the effective alternating current voltage which existed across the same terminals when alternating current was flowing, and when the reading on the plate milliammeter was the same.

The reason that it is necessary to return the grid to the mid point of a resistance is that that is the only way in which identical grid bias values can be obtained for the tube condition, that is, when AC and DC are employed. In either case, the grid is effectively returned to the middle point of the filament, which is at the mean potential of the filament, irrespective of the type of current which is used in heating it.

RUMOR SQUELCHED

A report from London that the Columbia Graphophone Company of London is taking over the control of sixteen American broadcasting stations, with plans for international broadcasting was denied by the Columbia Broadcasting System. The 1927 radio law specifically prevents foreign control of American transmitting stations.

SUCH A NOISE DOES WHITEMAN HEAR!

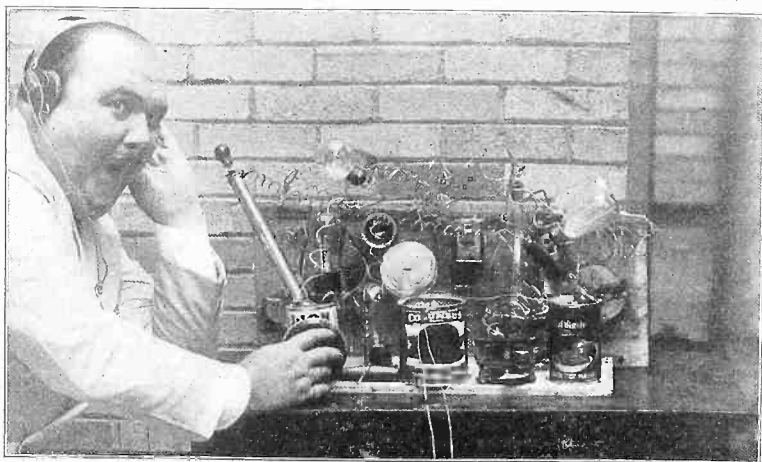

(Wide World)

PAUL WHITEMAN, potentate of jazz, with his what-not receiver, using the best brand of haywire and the cheapest form of shielding.

Scout Planes Report Sea Distress by Radio

A new chapter in the history of Government rescue work at sea may be written as the result of airplane radio telephony tests that have been progressing satisfactorily over the water adjacent to the Massachusetts coast.

Information received by the Coast Guard concerning the experiments that have been in progress indicated successful results in two-way telephone conversation between the Coast Guard planes as far as 25 miles off the shore and covering as much as 200 miles of distance between the airplanes and Coast Guard vessels and stations.

Can Locate Vessels

The value of this work, it was explained at the Coast Guard, is that the airplanes may be used in locating vessels in distress and in relaying the information to the nearest ship at sea or land point from which aid might be sent. Not only were the results said to have proven satisfactory in telephonic conversation, in both directions from the airplanes, but from the planes that have made experimental forced landings on the sea. The airplanes from the sea and from the air are reported to have talked back and

forth with the Coast Guard personnel at Boston, Block Island, Nahant and Woods Hole.

The planes of the Coast Guard, is added, also have been, and are being used in making determinations of the best locations for laying cable connections.

Airplane Observations

The observations of the sea bottoms in the vicinity of the proposed locations of cables are made from the airplanes and the formation so obtained used in determining the best location for the cable laying operations in connection with the Lighthouse Service. Life Saving Stations, Naval Radio Compass Stations, and other agencies. These operations have been conducted along the New England coasts.

The Chamber of Commerce of Gloucester, Mass., has asked the Coast Guard to issue instructions to its observers in these airplanes to telephone the Gloucester authorities whenever a school of fish is observed from the planes, so that the fisher fleet at Gloucester may be advised. The division commander of the service has been ordered by the Washington headquarters to use his discretion in the supplying of such information.

Sales Distribution Studied by Board

Washington.

The Electrical Equipment Division of the Department of Commerce has undertaken a survey to determine the aggregate disposals of radio merchandise in different portions of the country. Questionnaires will be sent to dealers throughout the country every three months in an effort to obtain the above information.

Emphasis is stressed by the Electrical Equipment Division that all returns will be held strictly confidential and under

no circumstances will the reports be made public. It is hoped that all the dealers will answer these questionnaires, since it is believed that the results will be of a marked importance to the radio trade at large. It will be the first time that it will be possible to plot an accurate chart of the consumption of radio apparatus.

The sending of the questionnaires began October 1 and already many have responded.

De Forest Balks At Cross-Ocean Phone

London.

Dr. Lee DeForest, through whose invention of the audion trans-Atlantic telephone conversations were made possible, picked up a receiver and asked for the fee for telephoning to America via radio.

"That's a lot of money," he said when informed of the cost. Hanging up the receiver he added: "I think I shall cable."

DUTCH TO PHONE U. S.

Washington.

The Dutch government has been granted a license by the British postal authorities to use the English receiving and transmitting stations for radio telephone conversations with the United States. Land and sea lines will carry the messages from Holland.

EDISON DAY TO BE Aired

Oakland, Cal.

Broadcasting stations covering the entire nation will unite in commemorating the forty-eighth birthday of Thomas Edison's invention of the incandescent lamp, Friday, October 21.

Literature Wanted

THE names and addresses of readers of RADIO WORLD who desire literature on parts and sets from radio manufacturers, jobbers, dealers and mail order houses are published in RADIO WORLD on request of the reader. The blank below may be used, or a post card or letter will do instead.

RADIO WORLD,
145 West 45th St., N. Y. City.

I desire to receive radio literature.

Name
Address
City or town.....
State

Theodore Wojciechowski, 2880 Fulton St., Brooklyn, N. Y.

A. J. Kamme, 131 North 12th, Allentown, Pa.
Robert Kenny, 85 Magnolia St., Dorchester 25, Mass.

Earle Russell, 812 32nd Ave., San Francisco, Calif.

C. C. Nichols, 1353 Marne Ave., Los Angeles, Calif.

W. L. Poole, 905 Carter Road, Roanoke, Va.
Edward Phillips, 2230 N. 17th St., Philadelphia, Pa.

James R. McElfresh, Ridgeley, W. Va.
Claude A. Eaton, 103 Kinne St., East Syracuse, N. Y.

P. F. Hills, American Radio Exchange, Princeton, Ill.

John Denery, 2550 River Drive, Denver, Colo.
H. P. Skelton, 5109 Prospect, Little Rock, Ark.

J. R. Pethel, Box 636, Norfolk, Neb.
Philip T. Handiges, 833 Kingston Ave., Toledo, O.

R. A. Miller, 1128 16th St., Oakland, Calif.
G. E. Bolman, 116-59 147th St., Jamaica, N. Y.

J. C. Davies, 178 Leprohon St., Montreal, Canada.
William P. Bivins, 607 W. Lexington Ave., High Point, N. C.

Leon Pollard, 326 South A St., Arkansas City, Kans.

Eugene W. Buckley, 1213 Belle St., Alton, Ill.
Harry Dodes, 106 West 46th St., New York City, N. Y.

J. B. Dempster, 109 Coburn Ave., Worcester, Mass.

C. A. Kollof, 715 10th St., Rock Island, Ill.
Arthur Argenbight, 130 South St., Chambersburg, Pa.

Joseph DeBay, 370 East Main St., New Britain, Conn.
Edwin Lindberg, 16 Nutton St., Worcester, Mass.

J. A. Thren, Battery F, 52nd C. A., Fort Eustis, Va.

D. W. Hurley, 2701 James St., Syracuse, N. Y.
W. B. Parker, Box 213, Lake Odessa, Mich.

Ralph Hassinger, 98 Highland Place, Ridgefield Park, N. J.

A. C. Roegner, 364 9 Hunt St., Detroit, Mich.
Harold E. Rice, 227 Holland St., Somerville, Mass.

Paul A. Mohr, 18 Nobles Lane, Mt. Oliver P. O., Pittsburgh, Pa.
Leon P. Dickey, 702 West Green St., Marshall, Mich.

Eimer Westerberg, 11 Franklin St., Red Wing, Minn.
Robert C. Saunders, Colonial Hotel, Florida, Ala.

ATWATER KENT ARTISTS



MILDRED SEIBA, lyric soprano



NAHAN FRANKO, Atwater Kent orchestra leader.

A THOUGHT FOR THE WEEK

BY George, there really seems to be no end to the uses to which radio can be put. We know a maid in New Rochelle, N. J., who hung out the family wash on the family aerial. It didn't seem to hurt the clothes, although it didn't improve reception to any noticeable degree.

SIXTH YEAR

RADIO WORLD

The First and Only National Radio Weekly

Member, Radio Publishers Association

Radio World's Slogan: "A radio set for every home."

TELEPHONES: BRYANT 0558, 0559

PUBLISHED EVERY WEDNESDAY

(Dated Saturday of same week)

FROM PUBLICATION OFFICE

HENNESSY RADIO PUBLICATIONS CORPORATION

145 WEST 45th STREET, NEW YORK, N. Y.

(Just East of Broadway)

ROLAND BURKE HENNESSY, President

M B HENNESSY, Vice-President

HERMAN BEINHARD, Secretary

European Representatives: The International News Co.

Breema Bldgs., Chancery Lane, London, Eng.

Paris, France: Brentano's, 8 Avenue de l'Opera

EDITOR, Roland Burke Hennessy

MANAGING EDITOR, Herman Bernard

TECHNICAL EDITOR, Lewis Winner

CONTRIBUTING EDITORS:

J. E. Anderson, Capt. Peter V. O'Rourke, and

James H. Carroll

SUBSCRIPTION RATES

Fifteen cents a copy. \$6.00 a year. \$3.00 for six months. \$1.50 for three months. Add \$1.00 a year extra for foreign postage. Canada, 50 cents.

Receipt by new subscribers of the first copy of RADIO WORLD mailed to them after sending in their order is automatic acknowledgment of their subscription order. Changes of address should be received at this office two weeks before date of publication. Always give old address; also state whether subscription is new or a renewal.

ADVERTISING RATES

General Advertising

1 Page, 7 1/2" x 11"	462 lines	\$300.00
1/2 Page, 7 1/2" x 5 1/2"	231 lines	150.00
1/4 Page, 8 1/2" D. C.	231 lines	150.00
1/4 Page, 4 1/2" D. C.	115 lines	75.00
1 Column, 2 1/2" x 11"	154 lines	100.00
1 Inch		10.00
Per Agate Line		.75

Time Discount

52 consecutive issues	20%
28 times consecutively or E. O. W. one year	15%
4 consecutive issues	10%

WEEKLY, dated each Saturday, published Wednesday. Advertising forms close Tuesday, eleven days in advance of date of issue.

CLASSIFIED ADVERTISEMENTS

Ten cents per word. Minimum 10 words. Cash with order. Business Opportunities ten cents per word. \$1.00 minimum.

Entered as second-class matter March 23, 1922, at the Post Office at New York, N. Y., under the Act of March 3, 1879.

THEY SAY

WILLIAM H. G. BULLARD, chairman, Federal Radio Commission: "Education by radio could be developed to such an extent as to arouse general public interest, and I have received many inquiries as to how best to proceed to develop a practical course in education. Some radio broadcast stations now cooperate with their local educational institutions, and in some localities loud speakers are installed in classrooms and students are required to take notes of the lectures delivered by qualified instructors from a central studio. It is perfectly apparent that by this means a larger class may be served than the audience of an ordinary class room. Students at a distance from their educational institutions may take such courses and particularly

Why R.C.A. Licensing Is Industrial Asset

By David Sarnoff

Vice-President and General Manager,
Radio Corporation of America

Baseless rumors and speculation which have followed the agreements negotiated in recent months by the Radio Corporation of America, whereby twenty-three manufacturers in the radio industry have been licensed under certain of its set patents, require some statement, perhaps, as to what this policy does mean, and does not mean, in relation to the R. C. A. and its distributors and dealers.

The licensing policy adopted by the Radio Corporation, we believe, is a contribution towards greater and sounder radio industry, in which those who serve best will profit most.

Regardless of the royalties received from licensees, the Radio Corporation of America, in addition to its communication interests, will remain a development and sales organization, vitally concerned also with research and manufacture, and engaged in the development and sale of broadcast receivers and other radio devices.

Will Enlarge Activities

Its present plans call for greatly increased programs of research and production to retain and maintain R. C. A. leadership in the radio art and in the radio industry.

The recent introduction of a complete line of Radiola receivers, including the four new perfected radio receivers, Radiolas 32, 30-A, 16 and 17, and new Radiola Loudspeaker 100-A, is the first step in this direction. The latter set, employing our new AC tubes, is an important landmark in the development of low priced receivers for socket power operation.

So much for the general position of the R. C. A. in the radio industry.

With regard to some of the detailed provisions in our licensing agreements, it should be made clear

First, that the Super-Heterodyne circuit, a basic feature of our line, is exclusively reserved to the Radio Corporation.

Second, that the agreements executed with our licensees grant manufacturing rights only under our patents for tuned radio frequency receivers, and power supply devices.

Third, that contrary to rumors, these agreements do not debar the Radio Corporation from manufacturing and sell-

ing receivers of the tuned radio frequency type.

Fourth, that the position of Radiotron jobbers remains unaffected by the provision that licensees shall equip their sets with a sufficient number—and only with that number—of our standard vacuum tubes to make the sets initially operative.

Licensees Not Jobbers

With reference to the latter point, it should be evident that licensees are in no sense jobbers of our tubes; it is our recommendation that these tubes be sold for no other purposes than for the equipment of their licensed sets. Suitable arrangements have been effected with our tube distributors whereby the matter of obtaining replacements of defective tubes supplied as initial equipment will be adequately taken care of, and in a manner that will be convenient to the dealer.

We believe that the day is near when radio manufacturers will equip their sets with the principal accessories at the manufacturing source; and one step in this direction is our present policy of supplying vacuum tubes as initial equipment to our licensees. If this policy is sound in the automotive industry, it is many times more necessary in the radio industry, where a vacuum tube may make all the difference between an operative and an inoperative set.

Cites Popularity

Nor is the plan without definite and growing advantages to our distributors and dealers. Radiotrons, the perfected products of the leading electrical laboratories of the country, have already attained impressive and nationwide consumer acceptance. The wider use of our standard tubes in initially equipped radio sets, the better quality of reception that will thus be made evident and the consumer satisfaction that will naturally result must inevitably broaden the market for our vacuum tubes.

In brief, the policy adopted by the Radio Corporation of America towards the stabilization of patent rights in the radio industry in no way affects its position as a research, development and sales organization, nor detracts from the opportunities of its distributors and dealers to build up a solid, permanent and increasingly successful business.

would this be desirable on the farms in the long Winter evenings. Proper educational lectures, interspersed with good music, should prove very attractive and very useful to such a class of students or others who may be excluded from the lecture halls of the cities."

* * *

H. B. RICHMOND, treasurer, General Radio Co., director, engineering division, Radio Manufacturers Association: "Radio has been phenomenal in its growth. It is, therefore, only natural that organizations within the trade should show a similar growth. Within a period of a few years the Radio Manufacturers' Association, the leading trade association of the industry, has grown from a dozen to three hundred members. It now has ten times the membership of any other manufacturers' trade association within the industry. As the Association now is so nearly 100% representative, it feels that any standardization work it may do

will be truly representative of the industry."

* * *

FRANK A. RYDER, general sales manager, Radiart Laboratories, Chicago: "Radio tubes should be operated at their rated filament voltages and be properly biased for the recommended plate voltage and the nature of the work the tube does. From that point should proceed all design. While this is an ideal, and suffers practical limitations in some ultra-sensitive receivers, many engineers are engaged on experimental work with this fundamental as a foundation."

NO DYNAMITE HERE

Muscataine, Ia.
KTNT, owned by the Tangle Company, of this city, has the distinction of having had more than 132,000 visitors in 16 Sundays and two holidays, July 4 and Labor Day. This excludes the week-day visitors.

Sets Cheaper Than Seats, Tex Rickard Laments

Although the broadcasting of the \$3,000,000 battle of the century between Jack Dempsey and Gene Tunney, heavyweight champion of the world, from Soldiers' Field, Chicago, injured the gate receipts, according to Tex Rickard, promoter of the fight, he added that broadcasting of big fights must continue, not only because of popular demand, but because of its huge value as a publicity agent for creating a better understanding of the sport.

"Radio is one of the most wonderful things in the world," Mr. Rickard continued.

"I would not be at all surprised if radio television would be developed, within a comparatively short time, to the point where it could be applied to fights along with the broadcasting of the announcer's voice from the ringside. Of course, if that comes to pass, many fight followers

might stay at home, listen in and also see the bouts.

"Just how such a situation might be handled from the standpoint of the fight box office I am not prepared to say at present. I want to give fights to the people over the air, but it will be necessary to evolve a workable scheme so that all the fans will not stay home and listen in, especially if radio television is introduced on a wholesale basis.

"The sale of seats in Chicago seems to indicate that the man of moderate means preferred to buy a radio set, or make a payment on one, rather than spend the money to attend the fight. We deduce this from the fact that all of the \$40 seats were sold while 3,805 of the \$5 seats remained vacant. In addition, 22,000 of the \$10 seats were not occupied. Patrons who had plenty of money purchased ringside seats."

WINNER TAKES ALL

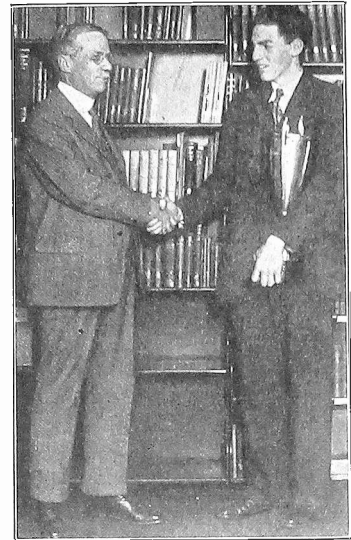

(Underwood & Underwood)

JOHN H. HARTLEY, winner of the first prize in the radio set building contest held at the recent Radio World's Fair in New York City, being congratulated by A. L. Closton, principal of the Brooklyn Technical High School, of which Hartley is a pupil. This is the third successive year that Hartley has won the coveted prize.

Announcer's Ruse Tames a Soprano

Los Angeles.

A well known radio soprano wished to sing a song which long ago was banned by KFI because of its age. When Leslie Adams, announcer, told her she could not sing it, the lady said she did not choose to sing anything.

Very calmly the announcer told her that she was booked on the program, and rather than disappoint her public he would have to announce her name and sing a song himself in falsetto. When the soprano saw her reputation destined for sure ruin, she quickly changed her mind.

WOC's Wave Grant Displeases Many

More than seventy-five per cent, of the daily correspondence reaching WOC contain heated protests from listeners-in scattered throughout the midwest on WOC's present wavelength, assignment which was changed last June by the Federal Radio Commission. Listeners-in located even as close as 40 miles from WOC report that many of the features in recent months have been spoiled by a heterodyne whistle on WOC's wave.

Francis St. Austell of Des Moines, president of the Iowa Listeners' League, is attempting to obtain at least two affidavits from each town in the State urging the Federal Radio Commission to bring immediate relief to this condition.

Roxy to Go On Sunday Mornings

A new Roxy feature will be offered over WJZ and the Blue network by Roxy from the Roxy Theatre, beginning Sunday Morning, October 16. The 110-piece orchestra, directed by Erno Rapee, will give from the stage of the theatre a public symphonic concert every Sunday, beginning at 11 A. M. and lasting an hour and a half. This concert will replace the regular Sunday afternoon broadcast strolls with Roxy and his Gang.

The Monday night broadcasting by Roxy will continue as usual.

SALESMAN INSPECTS



(Underwood & Underwood)

SIDNEY E. FINKELSTEIN, until recently road salesman for Chas. Freshman, Inc., manufacturers of Equaphase receivers, who was called in from the road to inspect sets, due to the rush of orders received for these popular receivers.

N. Y. High School Teaches by Radio

Under the auspices of the Board of Education of the City of New York, education lectures broadcast from WNYC are to be received in the auditorium of the Washington Irving High School, New York City, via a specially installed receiver. These lectures will be sent out on the evenings of October 17, 24, 31; November 7, 14, 21, 28; December 5, 12, 19 and 26, at 8:30 P. M.

R. C. A. Tube Monopoly Charged by De Forest Co.

Charging that Radio Corporation of America will gain a monopoly on the sale of tubes due to the "tube clause" contained in the licenses issued to set manufacturers, Arthur D. Lord, receiver of the De Forest Radio Company, has filed a complaint with the Federal Trade Commission in Washington.

The clause prevents independent tube producers, such as the DeForest Company, to sell tubes to Manufacturers licensed by the R. C. A., as was permitted before the licenses were granted, says Lord. To make the license operative it is compulsory, the clause states, to use R. C. A. tubes.

New Chain Founded By Movie Interests

Utilizing WHN, New York City, as the key station, a large broadcasting chain, which will take in cities from coast to coast, is being organized under the sponsorship of Loew's, Inc., and the Metro-Goldwyn-Mayer Pictures Corporation.

This will be the National chain. The others are the Columbia and the National Broadcasting systems.

CREDIT TO "RADIO NEWS"

The first part of a three-part article on the Strobodine, by Brunner Brunn, RADIO WORLD writer, was published in the September 17 issue of RADIO WORLD, and published acknowledgement made to "Radio News" as having been the first to present this circuit in the United States, and to have pioneered the circuit in this country. Omission of similar credit to "Radio News" from the Strobodine articles in the September 24 and October 1 issues was unintentional.

Good Back Numbers of RADIO WORLD

The following illustrated articles have appeared in back issues of RADIO WORLD in 1927.

MAY 21.—Part I of a three-part article on the Victoreen Portable receiver, by Capt. P. V. O'Rourke. Data on the new Raytheon cartridge.

MAY 28.—A three-tube reflex, using a special low pass filter system, by Edgar B. Francis. Part II on the Victoreen portable receiver with layout data, by Capt. P. V. O'Rourke.

JUNE 4.—Part III of a three-part article on how to construct an efficient portable Victoreen Super-Heterodyne, by Capt. P. V. O'Rourke. A complete discussion on the RCA AC tubes.

JUNE 11.—Detailed discussion of a four-stage push-pull resistance coupled audio amplifier, by J. E. Anderson. The Sutcase 6, using a tuned RF stage, two un-tuned RF stages, regenerative detector and two transformer AF stages, by James H. Carroll. Balsa Wood for speakers, an excellent discussion on how this wood may be employed for speakers, by H. B. Herman.

JUNE 18.—The six-tube Equamatic, a neutralized two-tube tuned RF, three-stage AF resistance coupled set, by Herbert E. Hayden. How to get the low notes with transformer or impedance AF, by Dennis J. O'Flaherty.

JUNE 25.—The Lindbergh Plane Speaker, an excellent cone type reproducer, by Herbert E. Hayden. A tube and set tester, by Herman Bernard.

JULY 2.—The Planofier 7, single control super-sensitive set using resistance AF by R. F. Goodwin and S. S. Bruno. Discussion on the new Freshman Equaphase, by Robert Sakala. Data on the six types of units used for loud speaker operation, by J. E. Anderson.

JULY 9.—How to build a DC A supply where the line voltage is 220 or 240, by Frank Logan. Important data on RF choke coils, by Horatio W. Lamson.

JULY 16.—How to use a voltmeter as a milliammeter, by D. Barretti. How to build a 4-tube, 2-control regenerative portable set.

JULY 23.—Building a 7-tube Super for your auto, using Victoreen IFT, by John F. Rider (Part I). How to build a 6-tube neutralized set, using three tuned RF, two transformer AF, by John F. Rider. Inside dope on motorboating, by J. E. Anderson.

JULY 30.—A 5-tube standard TRF set adapted to AC operation by the use of the QRS 400 mill rectifier tube, with the aid of series filament connections, by RF Goodwin and S. S. Bruno. Shielding the 11-tube Melo-Heald Super-Heterodyne receiver, by Clifford Denton. Part II of the two part article on the Super in the auto by John F. Rider. How to control volume in AC sets by D. Ferrup.

AUG. 6.—A three-tube regenerative portable with portion of the cabinet as the speaker, by M. J. O'Reilly. The Cashbox Unitone, an ingeniously contrived four-tube quality receiver by Wendell Buck. How to use AC tubes by C. T. Burke.

AUG. 13.—Hints on constructing a portable set, by Herbert E. Hayden. A seven-tube, two-control AC operated receiver by Capt. P. V. O'Rourke. Obtaining the C bias in an ARC unit, using the BA Raytheon 85 mill tube.

AUG. 20.—The Four AC, a four-tube regenerative set employing AC tubes. Tim Turkey's argument on why rheostats should not be used as volume controls. The Drum Powertone, a five-tube single control set, using resistance coupled audio.

AUG. 27.—Part I of a four part article on building the I-Dial Witz, a single control, voluminous selective, 5-tube set, by A. Irving Witz. A detailed explanation of the exponential type of horn by H. B. Herman. Details on the revolutionary Reisz condenser type of speaker. Constructional data on a special 5-tube, 2-dial regenerative set, with three stages of AF, by Tim Turkey.

SEPT. 3.—Part I of a four-part discussion on the new 1928 Victoreen Universal, a super-sensitive 8-tube Super-Heterodyne, by Capt. P. V. O'Rourke. Complete data on the three types of phonograph pickups, by J. E. Anderson. Part II of the I-dial Witz, wiring hints emphasized.

SEPT. 10.—The Puratone AC set, a 6-tube duo-control receiver, using AC tubes, by R. F. Goodwin and S. S. Bruno. Part II of the 1928 Victoreen Universal, discussing the placement of parts. Part III of the I-Dial Witz on the special placement of the coils.

Any Copy 15c. Any 7 copies, \$1.00 All these 17 copies for \$2.00, or start subscription with any issue. Any 8 of these numbers sent as premium with NEW yearly subscription. No other premiums allowed. RADIO WORLD, 145 West 45th St., New York City.

Bucher Wins Promotion; Ray Heads R. C. A. Sales

Following the promotion of Elmer E. Bucher to assistant vice-president, the Radio Corporation of America, in a statement by David Sarnoff, vice-president and general manager of that corporation, announced the appointment of Joseph L. Ray as general sales manager.

"The growth in the business of the Radio Corporation of America is responsible for the promotion of Mr. Bucher and the addition of Mr. Ray as general sales manager," said Mr. Sarnoff. "We are fortunate in obtaining the services of Mr. Ray, who until

recently was the general supply sales manager of the Graybar Company, which position included supervision of all sales excepting telephone apparatus, line construction, materials and appliances. Mr. Ray has been with the Western Electric Company for twenty-three years. He was born at Carnegie, Allegheny County, Pennsylvania, in 1884. He will assume his new duties as general sales manager of the Radio Corporation October 15.

"Mr. Bucher successively has been commercial engineer, sales manager and general sales manager and his promotion is a recognition of unusual services rendered to the R. C. A. since its inception in 1919. Prior to that he occupied important positions for seven years with the Marconi Company. Mr. Bucher has been continuously identified with and employed in the radio industry since 1903.

"Probably the most important assignment of the assistant vice-president, who now becomes an officer of the corporation, will be contact with the various licensees under R. C. A. patents."

CeCo Shadow Boxing Is Counter Knockout

The C. E. Mfg. Co., of Providence, R. I., makers of the well-known CeCo tubes, have just brought out an attractive display which will be available for dealer use in the radio industry.

The display measures 13 inches high by 9 inches wide by 3 inches deep. It is attractively printed in a red and black color combination that carries out the color scheme of the CeCo boxes.

The center panel is a recessed shadow box with a platform on which is mounted a CeCo tube. The size of the display is planned so that any type of CeCo tube can be displayed attractively.

Wholesalers and retailers of CeCo tubes may secure one of these displays by writing to H. H. Steinle, sales manager, C. E. Mfg. Co., Inc.

For Best Results

with the

"WINNER" RECEIVER

Featured in

RADIO WORLD

Use Only the

HAMMARLUND CONDENSERS, COILS and SHIELDS

Specified by the Designer

HAMMARLUND MFG. CO.

424-438 West 33d Street, New York

For Better Radio
Hammarlund
PRECISION
PRODUCTS

Take Your Choice of 7 Other Publications For NEW RADIO WORLD Subscribers Ordering NOW

Radio World has made arrangements

—To offer a year's subscription for any one of the following publications with one year's subscription for RADIO WORLD—

RADIO NEWS or POPULAR RADIO or SCIENCE AND INVENTION or BOYS' LIFE or RADIO DEALER or RADIO (San Francisco) or RADIO AGE.

This is the way to get two publications

- for the price of one:
- Send \$6.00 today for RADIO WORLD
- for one year (regular price for 52 numbers)
- and select any one of the other
- nine publications for twelve months.
- Add \$1.00 a year extra for
- Canadian or Foreign Postage
- Present RADIO WORLD subscribers
- can take advantage of this offer by
- extending subscriptions one year
- if they send renewals NOW!

Radio World's Special Two-for-Price-of-One Subscription Blank

RADIO WORLD, 145 West 45th Street, New York City.

Enclosed find \$6.00 for which send me RADIO WORLD for twelve months (52 numbers), beginning and also without additional cost, Popular Radio, or Radio News, or Science and Invention, or Radio Dealer, or Radio (San Francisco), or Radio Age, or Boys' Life (or \$10.00 for a two-year subscription to one address). No other premium with this offer.

Indicate if renewal. Name
Offer Good Until. Street Address
Nov. 30, 1927. City and State

Samson Coil Book Gives Valuable Data

Samson Electric Company, Canton, Mass., has published a booklet on the Samson inductance units. While this booklet gives the essential facts in detail on these inductance units, it is not confined to that. It contains much other useful and interesting information. It shows how to calculate the frequency of resonance when the coil inductance and the condenser capacity are known, including the general formula and numerical applications.

It also discusses inductance calculation of solenoidal coils, using the formula of Nagaoka. Numerical applications simplify the discussion. The booklet also contains a chart giving winding data for the Samson coil form. The curves give the inductance for various turns and sizes of wire.

Appended to the booklet are a set of nine tables giving useful radio information for the calculation of inductance, resonance frequencies and wavelengths, resistances of coils, and wire constants. These tables are invaluable to the radio engineer and experimenter.

The Samson coil form is of moulded Bakelite and of suitable size for all radio receiver purposes. All metal inserts have been left out and all necessary metal appendages have been kept down to an absolute minimum in order to keep losses down. The scrupulous compliance with scientific requirements in the design, and the painstaking care observed in the execution of these coils and coil forms, result in superior efficiency.

Lynch Demonstrates Lata Balsa Speakers

Quality reproduction seekers should be happy to learn that Lata Balsa Wood reproducers, aptly titled "Nature's Sounding Board," manufactured by the Balsa Wood Reproducer Corporation, 331 Madison Avenue, New York City, are being demonstrated in the studios of Arthur H. Lynch, Inc., 1775 Broadway, New York City. James Kennedy is in charge of the demonstration. The Lynch corporation is exclusive distributor.

HEAVY ARMY-NAVY TRAFFIC

Washington. The Army Signal Corps handled more than 10,033,153 words in radio messages, during the last fiscal year, while the naval communication service handled more than 15,034,801 words of communication, according to J. P. Jackson, Assistant Chief Coordinator.

This is a tremendous increase of traffic.

UP THEY GO

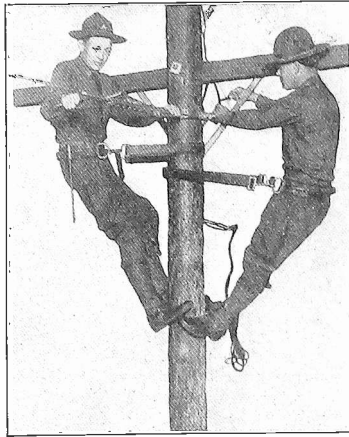

(Acme) TWO N. Y. STATE Guardsmen, perched high on a pole, repair an antenna as a part of their many duties in their maneuvers about the State. Their main object is efficiency.

ACME WIRE CO. CELATSITE

for RADIO WIRING

Flexible stranded Celatsite is composed of fine, tinned copper wires with non-inflammable Celatsite covering in 9 bright colors. Strips clean, solders readily. Sold only in 25' coils, in cartons colored to match contents. Solid Celatsite has same colored covering, but over bus bar wire. Write for folder to The Acme Wire Co., Dept. X, New Haven, Conn.

Only Clarostat

Covers the entire resistance range — from practically zero to 5,000,000 ohms with a current carrying capacity of 20 watts.

"THE GATEWAY TO BETTER RADIO." 32 pages covering the latest angles in radio. Send 25c to Dept. R. W. American Mechanical Labs., Inc., 285 N. 6th St., B'klyn.

LYNCH METALLIZED FIXED RESISTOR

Enesco THE ORIGINAL AND WORLD'S FINEST 3 FOOT SPEAKER KIT

STANDARD KIT \$10.00 WITH HARDWOOD WALL FRAME \$11.00

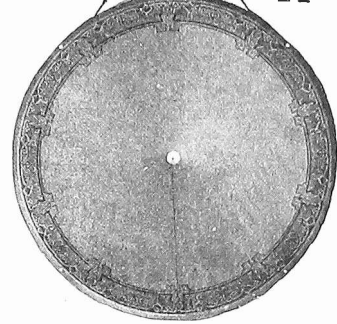

Why buy a manufactured speaker at a high price when you can buy the "Enesco" Kit at \$10.00, assemble it in less than an hour and have the equal of the finest speaker money can buy. We guarantee the "Enesco" to be the equal of any manufactured speaker, regardless of cost. The Kit is complete—every necessary part is included. Your choice of six styles and three sizes, all described in the illustrated instruction book. Anyone can assemble the kit. No soldering or complicated work. At your dealer's or direct from any of the offices listed below. Send check, money order or C. O. D. (Shipping charges paid) in Canada \$11.50 and \$12.50. Absolute money back guarantee.

ENGINEERS' SERVICE COMPANY
28 Church Street, New York 73 Cornhill, Boston
25 E. Jackson Blvd., Chicago 331 Bay St., Toronto, Can.

United DIAMOND

KITS SPECIAL PRICE
The Ever-Popular IMPROVED \$37.50
DIAMOND of the AIR KIT

Karas Equamatic, Karas Knickerbocker 4, Silver-Marshall Shielded Six, New Hammarlund-Roberts H1-Q, Everyman 4, Agre-7, Powerton, 4-Tube Diamond of the Air and other New Kits. **GET OUR PRICES! SAVE!**

Diamond 36-Inch Giant Cone Kit \$10.50
Complete
Including Tri-Foot Stand FREE

Send for Free Catalog
B.C.L. RADIO SERVICE CO., Inc.
220 FULTON ST., NEW YORK CITY

BETTER THAN ANY FIXED LEAK is the Bretwood Variable Grid Leak. It allows adjustment of grid voltage to maximum sensitivity for reception of far-distant signals, with distortion. The Improved 1928 Model De Luxe Bretwood Grid Leak, \$1.75; or \$2.25 for Grid Leak with Bretwood Bullet Condenser attached. The North American Bretwood Co., 145 West 45th Street, New York City.

Radio World's CLASSIFIED ADS for Quick Action

10 Cents a Word—10 Words Minimum—Cash With Order

AMPLIFYING CRYSTAL DETECTOR—Operates speaker—No tubes; no transformers. Money back Guarantee. Plans 50 cents. Frank Pritchard, Box 107, Oklahoma City, Okla.

DIRECT FACTORY SALE—Wholesale prices. Tremendous Savings. Selling direct to you. Here are some of our many items: 30 Henry Chokey, 100 M.A., \$2.19; 10 Henry Chokey, 400 M.A., \$5.48. Fewer Transformers for all kinds of Eliminators and for all types of A.C. Tubes, at Special Low Prices. **EVERY ITEM FULLY GUARANTEED.** Promptly shipped, upon receipt of order. Send for free illustrated catalog today. Todd Electric Co., Inc. (Manufacturers) 36 West 20th Street, Dept. D, New York City.

RADIO SET ASSEMBLING, Wiring, Repairing. Guaranteed workmanship. Reasonable charges. Write Wm. H. Vordenfeld, Shumway, Illinois.

VALET AUTOSTROP RAZOR—The only razor that sharpens its own blades. Highly polished nickel-plated, self-stropping Valet AUTOSTROP Razor, with one blade, in velvet lined metal case. Leather strop, specially prepared, and complete outfit in neat, lithographed carton. Mailed post paid on receipt of 50c. **SPECIAL:** Send \$2 for one-third of a year subscription for Radio World (yearly price 36c), mention this particular ad, and complete "Pal" set will be sent as a premium. If already a subscriber, your subscription will be extended three months. **THE COLUMBIA PRINT,** 145 West 45th Street, New York City.

HOW TO BUILD RADIO WORLD'S Four-Tube Universal Receiver fully described by Herman Bernard in the March 12, 19 and 26 issues of RADIO WORLD. Send 45c and get these three numbers or start your subscription with the first of these numbers. **RADIO WORLD,** 145 West 45th Street, New York City.

COMPLETE AND LATEST LIST OF STATIONS appeared in Radio World, dated Oct. 8. Sent on receipt of 15c, or start your subscription with that number. **RADIO WORLD,** 145 West 45th St., New York City.

BLUEPRINTS OF INEXPENSIVE DX RECEIVERS

THE FIVE-TUBE DIAMOND OF THE AIR, a very selective circuit of thrilling tone quality, that brings in distant stations to the great delight of the fans, is easily built, in fact can be constructed in a couple of hours. The authorized blueprints that make this speed and efficiency possible are just off the press and will be shipped at once, together with a booklet of full textual exposition of construction, including winding of coils, how to connect coil terminals, what values of condensers and resistors to use, etc. If you want a tone quality set that will give you great enjoyment, be sure to build this five-tube Diamond of the Air. The receiver consists of a stage of tuned radio frequency amplification, a specially sensitized detector, first stage of transformer audio and next two stages of resistance audio. It is easily adapted to playing phonograph records on your speaker. Get acquainted with this NEW delight.

THE FOUR-TUBE DIAMOND represents the most that is obtainable from four tubes. A stage of tuned radio frequency amplification, a specially sensitized detector, and two stages of transformer coupled audio. Follow the diagrams as shown in the blueprint and you can't go wrong. You will be amazed at the results. Build the set from parts that you have. Full instructions cover utilization of such apparatus. Thousands are eager to build an economical set and this one is the most economical in cost of construction and upkeep, where one considers the surpassing results. Works splendidly from batteries, with either type 99 or type 01A tubes, and can be used with A and B eliminators, power packs, etc., with great success.

Look Over Both of These blueprints and read the text in both cases before choosing the receiver you are to build.

SEND NO MONEY!

Just fill out the coupon below, and note what you get FREE!

Guaranty Radio Goods Co.
145 West 45th Street, New York City

Please send me one newly-printed official blueprint of the 5-tube Diamond of the Air, one newly printed official blueprint of the 4-tube Diamond, and the textual data giving full directions for constructing these sets. I agree to pay the postman 75 cents on delivery. Also, you are to send me, without extra cost, one Auto Strop Safety Razor, one blade and one automatic razor strop.

Name
Address
CityState.....

Lata Balsa Wood In Custom Speakers

E. Howard Figg, president of the Balsa Wood Reproducer Corp., 331 Madison Avenue, New York City, announces that "Nature's Sounding Board," the Lata Balsa Wood Producer, was one of the outstanding hits of the recent Radio Show in this city, and the Chicago show. He also stated that the volume of business written, dealers signed up and interest displayed far exceed his expectations. This is in the trade only, and from the fan angle, hundreds of thousands of people, a great percentage of these of the fair sex, viewed the line and waxed enthusiastic over the new custom-made speakers.

Technical fans were greatly interested in the kits and Balsa units, made expressly for the Lata Balsa diaphragm. Hundreds of complete speakers and kits were sold the week after the New York show. In addition to the two widely sought sizes of kits and the Lata Balsa units for home-builders, the line now covers several models of wall, pedestal and floor type completely finished speakers, all ready to operate, at a wide range of prices. These are all finished off in exquisite taste in harmonious coloring and richness of design. This speaker, under the able direction of Mr. Figg, has

leaped into popular favor in a remarkably short space of time, and now, with Arthur Lynch and organization in charge of sales, it seems as if the demand will soon exceed the supply.

"WIRELESS" EGERT ENLARGES

William Egert, better known as "Wireless" Egert, has enlarged and improved his commodious store at 179 Greenwich street, New York City. Here he opens for the new season all prepared with the best of the standard lines of radio in parts, accessories, speakers, eliminators and power parts for electrification. Egert has long been noted for having the hard-to-get parts and carries a complete stock for hams as well as for B. C. Ls. This store is the downtown headquarters for the well-known Ward-Leonard line, practically everything that Ward-Leonard makes being on hand at all times.—J. H. C.

BEAM TESTS SUCCEED

Washington.
Radio beam tests between Great Britain and India have been very successful. In spite of monsoon atmospheric conditions, it was possible to transmit and receive more than 130 words per minute for seven successive days, 18 continuous hours a day. This far exceeded the government contract agreements. The system is operated by the Marconi Company.

KARAS Parts Enable the NEW "KNICKERBOCKER 4" To Deliver Truly Amazing Results

The circuit used in the KNICKERBOCKER 4 is new—different—better than any other 4-tube circuit ever designed. And simpler. Instead of having to make adjustments in the detector circuit with an extra control, this is automatically accomplished with the dial of the tuning condenser in this circuit. The turning of this dial gives absolutely hair line adjustment of the Karas 3-Circuit Inductance and Karas Condenser both at one time. There never was such a circuit for simplicity of operation—ease of tuning—satisfactory results.

KARAS PARTS ARE VITAL TO ITS SUCCESS

The KNICKERBOCKER 4 was built around Karas Parts and no others will give you the same results, so be sure to use the following Karas Parts when you build this set:



- 2 Karas Orthometric S.F.L. Extended Shaft .00037 mfd. Variable Condensers
- 2 Karas Harmonik Audio Transformers
- 1 Karas Equamatic Inductance Coil
- 1 Karas 3-Circuit Inductance
- 2 Karas Micrometric Vernier Dials

Your dealer can supply you with these Karas parts and the other standard parts you will need to build this receiver. Begin to build it today. You know the quality and straight frequency line characteristics of Karas Orthometric Condensers—the splendid volume and purity of tone provided by Karas Harmonik Transformers—the reliability of Karas Inductance Coils and 3-Circuit Inductances—and Dials. So be sure to order these Karas parts, so as to make sure of 100 per cent performance of your KNICKERBOCKER 4. Write for complete, detailed information about the KNICKERBOCKER 4—wiring instructions—everything you need in the way of information. Mailed free on request. Address

KARAS ELECTRIC CO.

4039-J NO. ROCKWELL STREET CHICAGO
Complete Stocks of Parts for the KNICKERBOCKER 4
Now Are Available at All Dealers

FILL OUT AND MAIL NOW SUBSCRIPTION BLANK

RADIO WORLD

RADIO WORLD

145 West 45th Street, New York City
(Just East of Broadway)

Please send me RADIO WORLD for months, for which please find enclosed

SUBSCRIPTION RATES:
Single Copy\$.15
Three Months 1.50
Six Months 3.00
One Year, 52 Issues 6.00
Add \$1.00 a Year for Foreign Postage; 50c for Canadian Postage.

Radio University

When writing for information give your Radio University subscription number.

I HAVE a resistance coupled amplifier made of excellent parts and a first-rate cone to go with it. I procured one of the best phonograph pick-up units I could find with the expectation of getting as good phonograph music as radio reproduction. The amplifier motor-boats with the pick-up unit, while it is perfectly stable with the detector tube in place. Why does the circuit behave like that? 2.—Can you suggest anything that will enable me to use the phonograph pick-up without the motorboating?

CHARLES EVERETT, Saginaw, Mich.

1.—The change is due to the difference in the internal impedances of the phonograph pick-up unit and the detector tube. The impedance of the pick-up at low frequencies is very low in comparison with the plate resistance of the detector tube. The lower impedance admits a greater feedback through the impedance of the eliminator. 2.—One of the simplest ways to remedy the trouble is to connect the pick-up to the grid filament circuit of the detector instead of the plate-filament. If this gives too much volume, or if it does not cure the oscillation, insert the pick-up plug in the grid filament circuit of the first audio amplifier.

* * *

WITH MY five-tube set I use a small B battery eliminator. I got fair results out of it at first but now it does not give satisfactory results. I have changed to a 112 tube in the first AF socket and a 71 in the last. Would the change in tubes have anything to do with the performance?

P. J. CALLAHAN, Knoxville, Tenn.

The heavy current drain with the power tubes has probably reduced the effective plate voltage to a point where operation is unsatisfactory. Or it may be that your eliminator rectifier tube has ceased to function properly. A new and larger rectifier, higher voltage and larger wire in the chokes will help matters. That practically means a new and larger eliminator.

* * *

I WANT to make a wave meter which covers the range 250 to 750 kilocycles. What condenser should I use and what side of inductance coil?

ROBERT FILMORE, St. Louis, Mo.

Use a condenser having a maximum

capacity of 1,000 mfmfd (i. e., .001 mfd.) and a coil having an inductance of 400 microhenrys.

* * *

I AM PLANNING to build a Stroboddyne, as described in RADIO WORLD. I need a great deal of volume, but I want it without the distortion which usually goes with it. Will the Stroboddyne as described meet the condition? If not, what can be done to increase the volume of it?

CECIL BENNETT, Butte, Mont.

The power tube in the Stroboddyne was

wired for direct current and six volts, which limited the tube to the -71 type. The use of a 310 tube is rapidly gaining in favor because of the increased volume and improved quality that is obtainable with it. This tube is best heated with alternating current. If an eliminator is used to supply the plate voltages there is undoubtedly a provision made for a power tube of this type. If not, a step-down transformer is needed, one which steps the voltage down from 110 to 7.5. To adapt the set to AC operation of the last tube, the filament leads to that tube are cut and connected to the terminals of the 7.5 volt transformer. The grid is returned to the mid-point of the 7.5 winding, either directly to the middle turn or to the middle of a potentiometer connected across that winding. The grid voltage is adjusted according to the plate voltage applied to the 310 tube.



PARTS ARE THE HEART OF THE AERO-SEVEN



AERO-7 PARTS

- Resistance coupled kit. \$7.00
- Six UX sockets. 3.00
- One floating socket. 1.00
- Triplet condenser 11.25
- Grid Gate and mounting80

\$23.05

From your dealer or direct by mail from—

And of many of the world's most efficient receivers.

There can be no compromise with results.

Amsco prices are the lowest compatible with quality.

Write for our free catalog of fine radio equipment.

AMSCO PRODUCTS, Inc.
BROOME and LAFAYETTE STREETS NEW YORK CITY



CC

LYNCH RESISTORS

Tubes were chosen by the Laboratory Staff of Radio World and specified for the Unified Diamond of the Air because CeCo tubes proved best by test. Type K for the two RF amplifiers, type H for the detector, type G (high mu) for the first two AF stages, and type F for the power tube were the unanimous choice of these experts.

are exclusively specified for the Unified Diamond. Precisely made, the Lynch resistors are steady and unflinching in service. The values specified for the 3-stage resistance coupled Audio amplifier of the Unified Diamond are two 0.1 meg., two 2 meg. and one .002 meg. (2,000 ohms) Experts constantly choose and specify Lynch fixed resistors exclusively.

The Unified Diamond is balanced at radio frequencies by means of the Phasatrol invented by John F. Rider and manufactured by Electrad, Inc.



See the Sept. 17 and 24 and Oct. 1 and 8 issues of Radio World for the constructional articles on this 6-tube receiver.

THE UNIFIED DIAMOND GROUP

145 West 45th Street, New York



Radio Freq. Fountain
Audio Freq. Basin

We are headquarters for these, also the Winner, Everyman 4, Stroboddyne, Victoreen, Knickerbocker Four and all the New Circuits

SEND NO MONEY—PAY POSTMAN 80% OF PRICE—BALANCE IN TWO WEEKS

Endorsed by RADIO WORLD

RADIO KIT CO., 72 Cortlandt Street, New York City



810 NEW 1928 CATALOG—4000 ITEMS Shows the latest circuit, the newest developments in radio at startlingly low prices. Get the parts you want here and save money. The best in parts, kits, complete factory-built sets and supplies. Orders filled same day received. Write for free copy NOW. Standard discounts to dealers, set builders, agents. Garawk Co., 120 N. Jefferson St., Dept. 400, Chicago, U. S. A.



“YOU WILL When You Know Why”

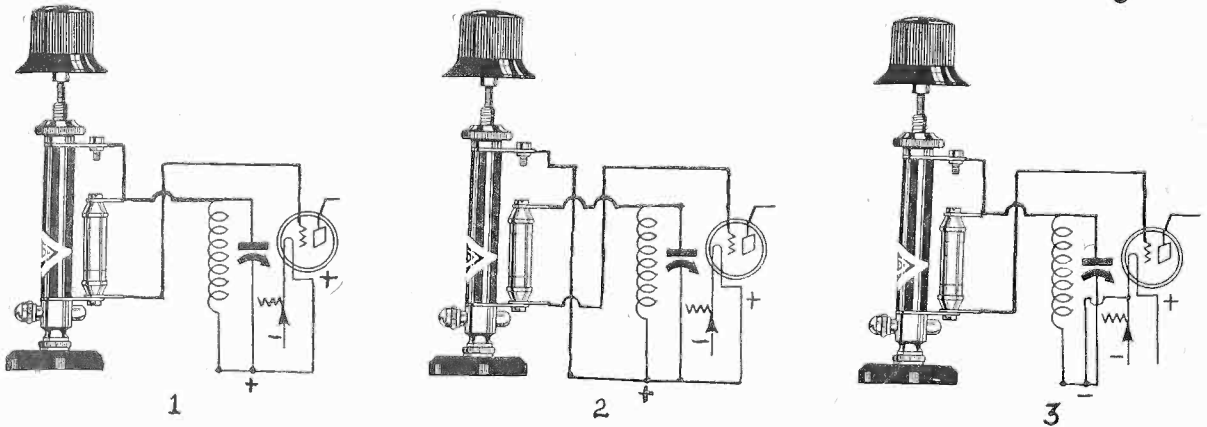

THERE are a great many things a person will NOT do, because he does not know of a good reason for doing them. And that is a good reason for NOT doing them.

If you do not know why you should have a variable grid leak in your receiver, then you are satisfied to be without one. But if you know why you should have a variable grid leak, then you will be dissatisfied without a Bretwood!

ONE The main reason for using a variable grid leak is to obtain maximum efficiency from your detector tube. By turning to the correct leak setting you establish greatest sensitivity, fullest volume. Exactly what that resistance value should be can not be told in advance. You simply turn the knob of the Bretwood Variable Grid Leak until your ear tells you that best results are being achieved. Then you may leave the leak setting in that position forever afterward.

TWO

A variable grid leak atones for any discrepancy in the capacity of a fixed grid condenser you may be using, and dispenses with the necessity of a variable grid condenser. Leak and condenser together must equal a certain product. Use a fixed condenser and a variable leak to obtain the result.

“My Good Luck”

I read about the Bretwood Variable Grid Leak and decided to buy one. I tore off and filled out the coupon. I enclosed my check with the coupon and you promptly sent me the leak. While I did not immediately become a millionaire after tearing off that coupon, nor had my salary raised \$5,000 a year, I nevertheless consider it was my good luck and not yours that the leak was sold to me. Why? Because I can bring in stations with that Bretwood Leak in the set that I can not bring in with any fixed leak of any resistance. My advice to others is: Fill out that coupon!—B. A. Reiners, 127-A Clarkson Ave., Brooklyn, N. Y.

THREE

When you get a new detector tube you adjust the leak to the new tube's needs, instead of buying a new leak to match the tube.

How To Connect the Leak

In the diagrams the bullet condenser is shown attached to the leak. No. 1 shows the commonest way of connecting a grid leak, that is, in parallel with the grid condenser, the grid return being made through the secondary coil to positive A. No. 2 shows the method of connection where the grid is to be returned to positive A, although the coil may be connected either to plus or minus. In the diagram it is shown going to plus, but it could be moved over to minus without short circuit. This hook-up is used for gang tuning condensers.

No. 3 is the same as No. 1, except that the return is to negative filament instead of to positive A. The No. 3 method is for the special detector tube, e. g., 200A, 300A, etc.

North American Bretwood Co.,
145 West 45th Street, New York City.

Gentlemen: Enclosed find \$1.75. Send me at once one De Luxe Model Bretwood Variable Grid Leak on 5-day money-back guarantee. (Or \$2.25 for leak with grid condenser attached.)

NAME
ADDRESS
CITY STATE

Dealers: If your jobber can't supply you, write us.

North American Bretwood Co.

145 West 45th Street,
New York, N. Y.