

APRIL
24
1936

RADIO WORLD

**15
CENTS**

Vcl. 9. No. 5

Reg. U. S. Patent Office

Every Week

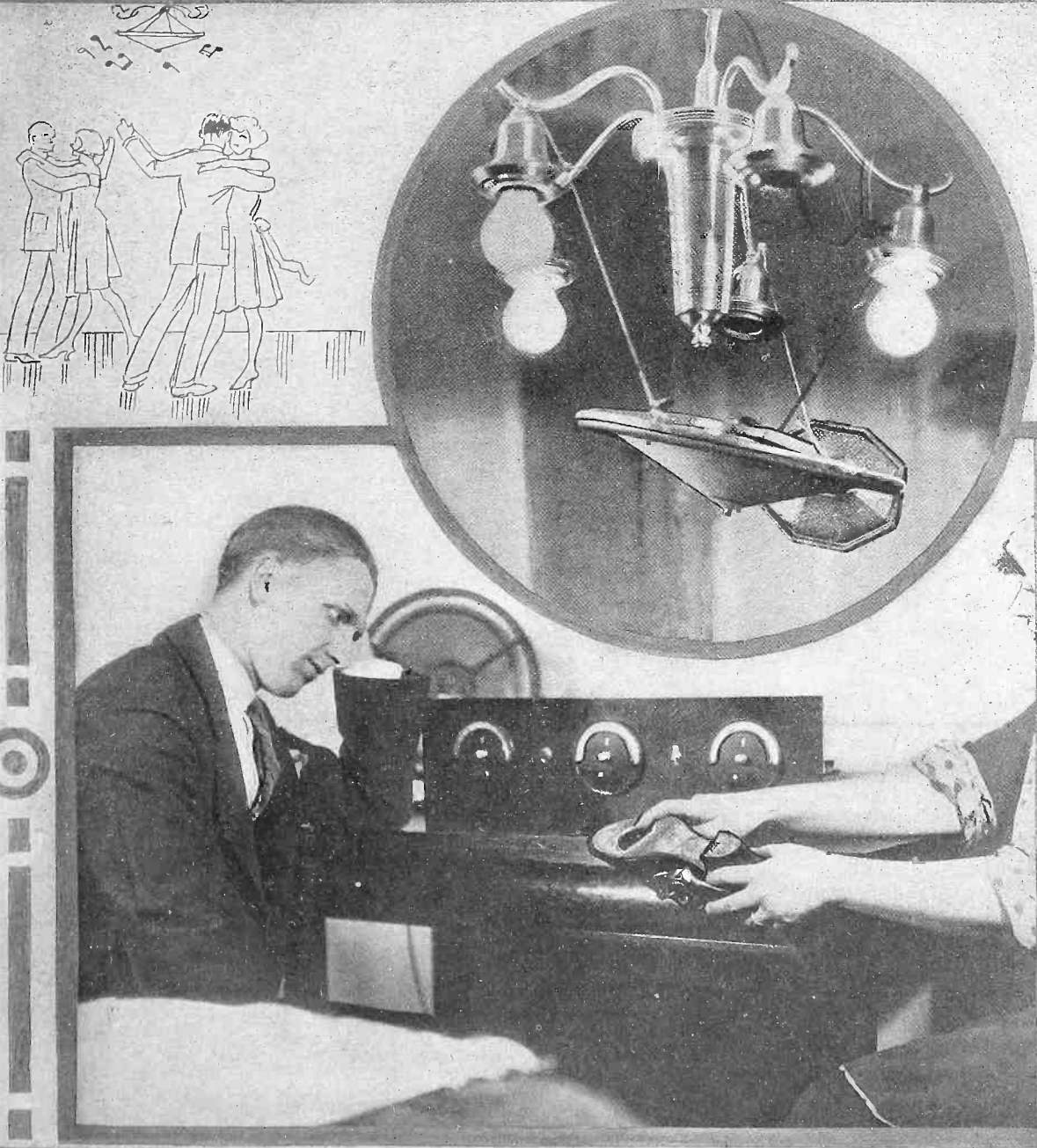

THE LOUDSPEAKER, hung from a chandelier, as shown in inset, is highly suitable for a radio dance. So tempting is the music that the women are likely to dance a hole in the sole of their ballroom slippers. (Hayden)

Get the Utmost From Your Set!

Use a Bretwood Variable Grid Leak!

WHEN you realize that the voltage output of a set may be increased 25 per cent. by correct grid leak setting—when you realize that regeneration and oscillation control is finely achieved by the variable grid leak—when you realize that nobody knows in advance just what is the correct leakage for an individual detector tube—then you know that you must use the Bretwood Variable Grid Leak, else be content with less than maximum efficiency from your set. More volume, greater distant reception, clearer signals should be your goal. Bretwood is the solution. Adopt it to-day!

Price, \$1.50

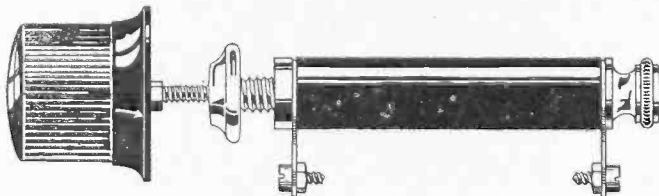

The Bretwood Variable Grid Leak
(Bretwood, Ltd., Sole Patentees and Owners)

Guaranteed Precision Range $\frac{1}{4}$ to 10 Megohms

The Bretwood Variable Grid Leak is Officially Prescribed for the 1926 Model Diamond of the Air

The North American Bretwood Co.

Telephone, BRyant 0559

145 W. 45th St., N. Y. City

Sole Distributors for United States

North American Bretwood Co., 145 West 45th St., N. Y. City.

Gentlemen: Enclosed find \$1.50. Send me at once one Bretwood Variable Grid Leak with 5-day money-back guarantee.

NAME.....
ADDRESS.....
CITY..... STATE.....

Inquiries Solicited from the Trade

Purchasers Are Delighted With Results

I received the Bretwood Grid Leak. Thanks for your promptness. The Bretwood is the best grid leak that I have ever had. Since I placed it in my 1926 Model Diamond of the Air I have received stations from nearly every part of the country. WMBF, WSB, KOA, 6KW, WBAP, WJAX, WOC, KFKX, PWX, KGO and KFI were all brought in on the speaker as soon as this instrument was put into the receiver. As for clearing up distortion, I have never seen anything to equal the Bretwood Grid Leak. I have placed one also across the primary of the first audio-frequency transformer and the results are marvelous.

E. HIGGINS,
130 Washington Ave.,
Elizabeth, N. J.

* * *

An obligation of gratefulness impels me to write you that any one who has not used the Bretwood does not know what a grid leak is.

BRUNO GONZALEZ,
General Staff Sergeant,
Cuban Army.

P. O. Box 910,
Havana, Cuba.

* * *

I think the Bretwood is the best grid leak I have ever used. Have made quite a few sets and this beats them all. Get DX very plainly and clearly.

WM. HEBERSON,
2510 N. Franklin St.,
Philadelphia, Pa.

* * *

Bretwood Grid Leak received and tested out. I find it is the only variable leak I ever used that is really variable.

Enclosed find \$1.50, for which please send me another one.

F. E. STAYTON,
Box 240, Ardmore, Okla.

* * *

With your grid leak I was able to bring in with good volume 15 W stations in one week with a Diamond of the Air set from a city hard to get out of.

Thanking you.

F. W. COLLINGWOOD,
3442 Sacramento St.,
San Francisco, Cal.

* * *

I received the Bretwood Variable Grid Leak last night and it sure did bring in stations. Denver was as far as I could get until last night, when, with the Bretwood in my set, I brought in KFI, Los Angeles, and KPO, San Francisco, Cal., clear and fine.

JOS. L. MARIE,
4026 Grezella St.,
Pittsburgh, Pa.

* * *

Do YOU Want to Get Results Like These? If so, the Bretwood Variable Grid Leak is the Answer! Indorsed by Leading Radio Engineers and Laboratories. It Is the World's Best Grid Leak!

RADIO WORLD

[Entered as second-class matter, March, 1922, at the post office at New York, N. Y., under Act of March 3, 1879]

A Weekly Paper Published by Hennessy Radio Publications Corporation from Publication Office, 145 West 45th St., New York, N. Y. Just East of Broadway Phones: BRYant 0558 and 0559

Vol. IX. No. 5. Whole No. 213.

April 24, 1926

15c per copy, \$6.00 a year

All Waves on One Set

Broadcast Programs Heard on All Wavelengths on Which They Are Sent, From 545 Meters, Down to the Experimental Call Stations on the Shortest Waves—Set Also Useful for Amateurs—Efficient Receiver Has 15 to 75 Meter Range.

By Capt. P. V. O'Rourke

THE short waves have a fascination beyond the power of words to express. The mere fact that you are listening to broadcasting 'way down below the regular belt, indeed almost near the zero wavelength line, lends a thrill to the reception. And, besides, you may bring in stations on these short waves that are hundreds or even thousands of miles away, when your regular broadcast wavelength tuning would not enable you to cut through locals, or indeed to extend the reception that far with no locals on. As an example: If you are living in New York City you tune your regular broadcast receiver to bring in WGY, Schenectady, N. Y. You have no luck. You try several times. Still no success. Then you try to catch the WGY program on one of the short wavelengths used by the General Electric Company at Schenectady. The same program is transmitted, only at the higher frequency (lower wavelength). You succeed in picking it up. Indeed, not only that, but you try for the same program from another of WGY's experimental stations at Schenectady, and, to your delight, you pick up the program again. At frequent intervals the operator of the experimental station will cut in on the short wavelength alone and announce the call letters, which will be X—something, as X is the call of experimental stations. He tells you the wavelength on which he is rebroadcasting the regular WGY program. Therefore you know what station you are hearing and you know the wavelength. You may chart the dial setting of the tuning condenser, C1 in Fig. 1, and bring in the same station at the same setting of that dial at some subsequent occasion.

The Special Jack Feature

You switch from one wavelength range to another by using interchangeable coils. The circuit, Fig. 1, is that of the Aero-dyne, with three stages of audio-frequency amplification added. The audio channel is an excellent one, and is so wired, by a special jack switching device designed by Herman Bernard, to enable one to utilize the audio circuit with any external tuner. This comes in handy when you are experimenting with some other tuner circuit

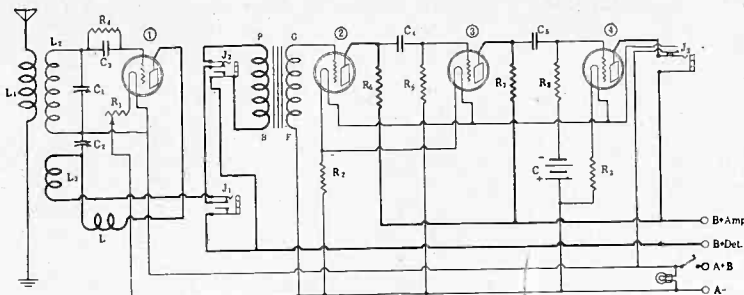

FIG. 1
The wiring of the interchangeable coil set that covers from 15 to 575 meters.

and desire to hear how it sounds on the speaker. You simply connect a phone cord from the plate and B plus of the experimental tuner, insert the opposite ends of the cords in an ordinary phone plug, and plug into the proper jack, J2 in Fig. 1. Meanwhile you always have the excellent Aero-dyne receiver as your standby.

For the past several weeks I have been getting a great deal of enjoyment out of this set. I use the Aero Interchangeable Coil System, which entails five coils, three for short waves, two for regular broadcasts.

With the Hammarlund .00014 mfd. condenser for C1, the tuning range in the broadcast band is as shown in Figs. 6 and 7. Fig. 6 is a graph of the tuning accomplished with the Aero coil that has the fine yellow winding. With the tuning condenser cited, the range proved to be from 263 to 575 meters. This coil is rated from 235 to 550 meters, and will cover that range if a lower capacity tuning condenser is used.

Wavelength and Frequency

Although the tuning condenser is of the straight line frequency type, the graph in Fig. 6, as well as that in Fig. 7, was made on the basis of wavelength, since most broadcast fans are more familiar with the wavelength than with the frequency method of calculation. Besides, all the newspapers carrying broadcast programs publish the wavelength of the stations, but not all publish also the frequency. Roughly speaking, the frequency is 300,000 (the speed of a radio wave in kilometers) divided by the wavelength in meters, and this gives the answer in kilocycles, or thousands of cycles. Fig. 9 is a table which enables one to convert wavelength into frequency and frequency into wavelength. It is a scientifically accurate table and is based on the precise factor 299,820, instead of 300,000, which represents only roughly the speed of the radio wave, which is the same as the speed of light. The convertible feature will be understood after one studies the table a little. The figures between heavy black upright lines represent those that are convertible. For instance, 50 kilocycles (fifth row from top in first column at left in table) is 5,996 kilocycles, and 50 kilo-

cycles is 5,996 meters. The order of the heading—kc or m, and m or kc—is your key.

Anybody interested in shortwave work should have this table handy at all times, especially if it is desired to calibrate a receiver in terms of frequency. While seldom is the wavelength to be determined from frequency, often it is desired to obtain the frequency when one knows only the wavelength. As the frequency change is very rapid on the short waves, accuracy is necessary. And the table affords that.

How To Read Curves

As the charts represent the result of actual operation of the set, we will consider the coils used in the order of the amount of inductance or number of turns they have, hence the larger largest coil will be No. 1, the next largest No. 2, then No. 3, No. 4 and No. 5.

With coil No. 1 the tuning was as shown in Fig. 6. You read this chart by finding the proper horizontal wavelength line at the left and following it to the right until it intersects a vertical line, and when you carry your eye down this vertical line you get the dial reading. Hence, by working either way, you may ascertain the dial setting from the wavelength or the wavelength from the dial setting. Of course the chart does not hold true if some condenser of different capacity is used. The condenser is counterclockwise, and a Bruno Slo-Moshen Dial was used that also was counterclockwise, so that the higher the dial reading, the higher the wavelength. Even with frequency method of tuning so popular, fans seem to prefer the wavelength method of dialing, where the higher readings represent the higher capacity settings of a condenser, although the frequency method is that of low numbers for the high wavelengths (since the lower the frequency, the higher the wavelength). However, fans may suit themselves about this, and get a clockwise Bruno dial if they want the method other than the one I am suggesting. That will make the dial numbers at bottom of the charts read from 100 to 0, left to right, instead of from 0 to 100, as now.

Fig. 7 shows the tuning when coil No. 2 is used. The range is from 124 to 270 meters, or a greater range by 21 meters than even the Aero Products Co. claims for this coil, thus showing gratifying

Plug-in Coils Are Used

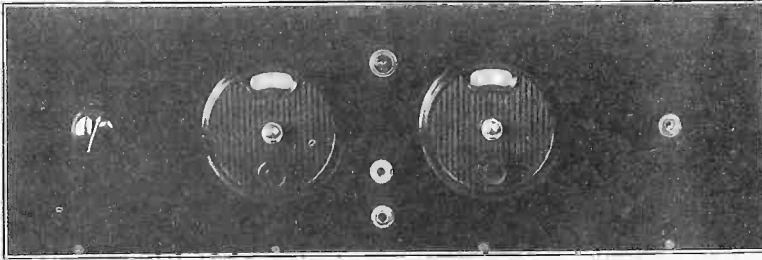

The panel view shows R1 at left, J3 at right. J1 is the lower center jack and J2 is directly above it. At top center is the light switch with ruby bull's eye.

conservatism. The lowest point of coil No. 1 overlaps the highest of coil No. 2, which is absolutely necessary for safety, this overlap being 7 meters, which is a good-sized margin at this part of the band, where 7 meters equals about 30 kilocycles (30,000 cycles).

Just for the sake of interest another chart was drawn of the tuning of coil No. 1 (a conversion of Fig. 6), except that the dial settings are plotted against frequency, instead of against wavelength (Fig. 8). This shows how close the tuning condenser comes to the theoretical straight edge.

Wiring Information

Making this set is no difficulty at all, especially when one has the photographic views to give valuable help. The aerial coil, L1, is adjustable, but is not removable, being used for all waves, only varied as occasion may demand. For the short waves looser coupling will be found more practical than the closer coupling that provides the best volume for the long waves.

The secondary is L2, and this is not wired to the set at all, the leads from the tuning condenser C1 being brought to the two exterior lugs of the mounting strip which is part of the coil equipment. One of these lugs goes to the grid condenser, and preferably should be the lug connecting to the side of the coil farthest from the aerial coil, e.g., the one nearer the back of the baseboard in Fig. 3. Note in that figure that the aerial coil is nearer the panel. The two inside lugs connect to coil terminals which are in the plate circuit when a coil is plugged in. With the different sized secondary coils the plate inductances differ, too, but this is a matter of factory construction, and all you need do is plug in, and the rest automatically takes care of itself. The plate coil differs because the same capacity feedback condenser, C2, .00025 mfd., is in use all the time. Note with particular care that the feedback condenser C2 is about twice the capacity of the tuning condenser. This is correct, although at variance with the practice necessary in other types of circuits.

The Choke Coil L

Between the tuning coil and C1 in Fig. 3 is a solenoid. This is the choke coil, L in Fig. 1. It consists of 150 turns of No. 34 or finer wire on a 1½" diameter, or 200 turns on a 1" diameter.

The wiring of the feedback condenser, C2, is somewhat odd for those who have had little experience with this type of regenerative control, so I will go into it rather extensively. Assuming the aerial coil put in place, with binding posts toward the panel, and the secondary coil lugs connected to stator of C1 and grid condenser, as one lead, and rotor plates and A plus as the other, then connect the

rotor plates of the feedback condenser, C2, to A plus also. In other words, the rotors of both tuning condensers are connected together. Now, the plate of the detector tube (1), goes to one side of the choke coil and the other side of the choke coil goes to the rotor plates of the feedback condenser, C2. Now, as outlined, L1, the aerial coil, is not interchangeable, and obviously neither is the choke coil, hence we have only two interchangeable inductances, the secondary L2 and the plate coil, L3. These constitute one coil with two windings, in each of the Aero products. Therefore, as we did not connect the secondary itself, but only the

lugs where the secondary would make contact when the coil was inserted, so we do not now connect the plate coil itself, but only its companion lugs on the coil socket strip, and these lugs are the inside ones, side by side. Connect that one of these two lugs nearer the back of the baseboard to the choke coil and rotor of C2, a lead already established, and connect the other lug to the outside hooked spring of the double circuit jack J1. This is the detector listening post. The fact that one spring is unconnected is immaterial, as the jack is used as a 3-point affair to save the necessity of soldering that third point. A study of the diagram will confirm the efficacy of this.

But when we come to the other jack, J2, we have a different story to tell—a confession that this is something novel. Instead of the output being connected to outside spring and right angle or frame, respectively, the usual order of jack connection is reversed. The inside spring that contacts with the outside hooked one—the lead to P on the audio transformer—takes one output lead. The right angle or frame of the jack goes to B plus detector, normally 45 volts, and the B post of the audio transformer is permanently connected to the same point.

[Concluded next week.]

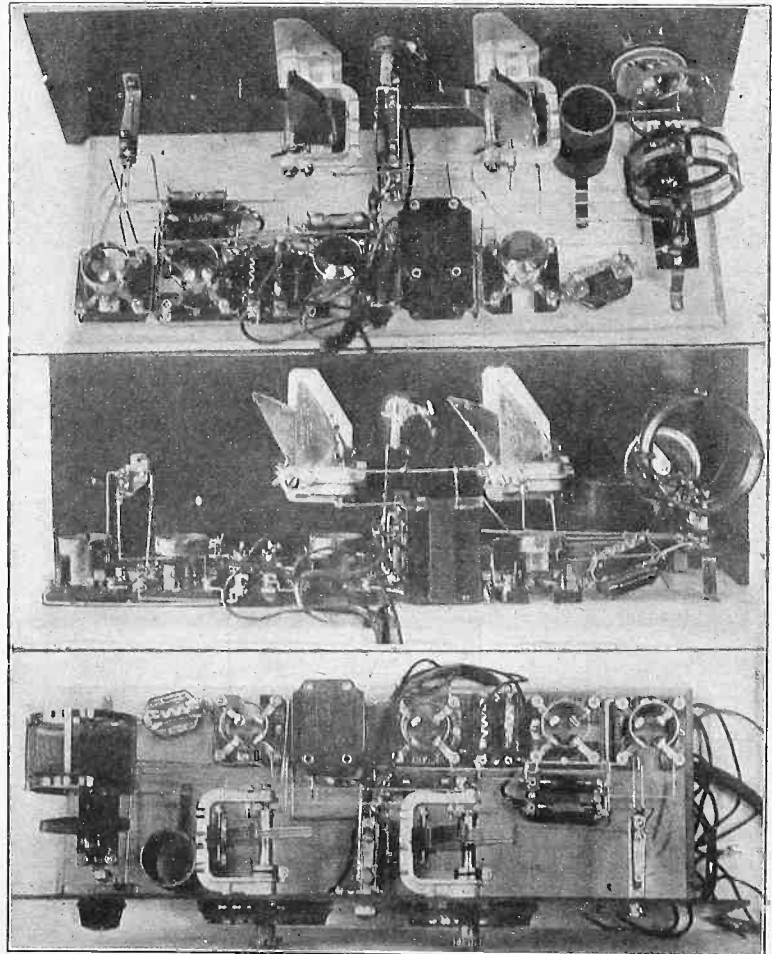







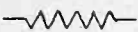

FIGS. 3, 4 and 5 (TOP TO BOTTOM)

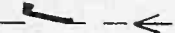
The layout of the parts is well disclosed by Figs. 3 and 5, while Fig. 4 shows the rear view, with battery cable jutting out. The shortest-wave coil is shown inserted in Fig. 3.

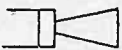
THE NOVICE'S NOOK

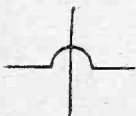
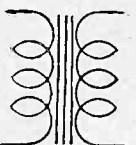
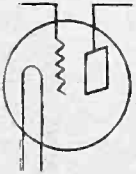
By the Beginner's Friend

-  Resistor
-  Variable Resistor (2 connections)
-  Variable Resistor (potentiometer type, 3 connections).
-  Switch
-  Telephone receivers.
-  Loud Speaker
-  Voltmeter
-  Joined Wires
-  Crossed Wires (not joined)
-  Transformer (iron or steel core)
-  Vacuum Tube
-  Lamp (pilot light)

Symbols Explained So That the Novice May Read Schematic Diagrams — System Often Includes Two Ways of Showing the Same Thing

AN electrical schematic diagram is much simpler to follow than a pictorial diagram, if you can read all of the symbols. It takes just a little practice to learn how to read them. One should not memorize the symbols. He should draw them, until he actually knows each and every symbol. Memorizing or just studying how the symbol looks will do little good. This will cause confusion when a great many are to be drawn, or to be read from the diagram.

Differences Cleared Up

It will be noted that in several cases there are more than one symbol for a given part. There are two ways of showing a variable resistor. With only the arrow through the zig-zag lines it is an indication of a rheostat or a variable resistance with two terminals. However, when the point of the arrow is brought to a certain portion, it is an indication that a variable resistance is such as represented by a potentiometer having three terminals. There are also two ways of showing a switch.















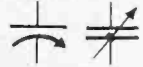

In a great many diagrams, when there is no connection made, the lines just pass over one another. The jump or looped line should be used though, as a great many errors are thus easily avoided.

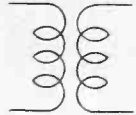
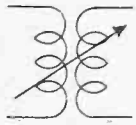
Any transformer having a core is indicated in the same fashion, regardless of its purpose, with the lines in the center.

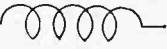
A symbol which causes a great deal of confusion is that representing the battery. The plus and minus points here are the erring factors. The long line always represents the positive pole, while the short line represents the minus pole.

A popular way of showing a variable condenser is by the specific indication of the curved line for rotor plates underneath a straight line for stator plates.

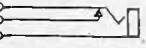
That a coil may be variable and still not be adjustable is well illustrated. The coil that is variable is not tapped. It can be rotated through a certain arc. The tapped or adjustable coil can be tapped in at various points. Whether the coil be a solenoid, basketweave, toroid or spiderweave, the same symbol is used. An inductor is a coil that serves a radio purpose by virtue of its inductance.

-  Ammeter
-  Battery (two or more cells)
-  Cell
-  Coil Antenna (Loop)
-  Fixed Condenser
-  Shielded Condenser.
-  Variable Condenser.
-  Variable Condenser (rotor plates indicated)
-  Counterpoise
-  Inductive Coupler (Fixed)
-  Inductive Coupler (Variable)
-  Ground
-  Inductor (Coil)
-  Inductor With Core
-  Inductor (Variable)
-  Inductor (Tapped)
-  Jack
-  Lightning Arrestor

HERMAN BERNARD, managing editor of RADIO WORLD, broadcasts every Friday at 7 p. m., from WGBS, Gimbel Bros., N. Y. City-315.6 meters. He discusses "What's Your Radio Problem?" Listen in!

PART 2 OF RADIO WORLD'S BATTERY ELIMINATORS appeared in RADIO WORLD dated Dec. 19. Other great articles in that issue. 15c per copy or start your sub. with that number. RADIO WORLD, 145 W. 45th St., N. Y. C.

The Control of Feedback

Rotary Ticker Efficient, But Resistance Control of a Fixed Plate Coil Makes Finer Adjustment Easier—Capacity Feedback Popular, Especially on Short Waves

By Barney Feete

FUNDAMENTALLY the three circuit tuner is as pictured in Fig. 2. It is called a three-circuit tuner because there are three distinct circuits, the primary, secondary, and tertiary, or tickler circuits. The primary circuit may be tuned or untuned, the latter being the method generally used today. The secondary is tuned by a variable condenser. The tickler coil is made variable with respect to the secondary, and it is in this way that the regeneration, or feedback action which controls the sensitivity of the circuit, is regulated.

A change in the tickler coil adjustment may mean a change in the secondary tuning circuit. In other words, the readjustment of the tickler coil sometimes detunes the rest of the circuit. This can be counteracted to a certain extent by using a small tickler winding.

The Fixed Ticker

Many fans use a fixed tickler arrangement. The design of a fixed tickler is not difficult.

When the set is built with the tickler coil in fixed relation with the secondary, the set will continually oscillate. At least, the tickler should be so placed that the circuit will continue to oscillate moderately. To throttle or control this regeneration, so that we can use the circuit for reception, some device will have to be introduced in the plate circuit to adjust things to best advantage.

One of the things which will stop regeneration is resistance. It acts as a brake on the power furnished by the feedback action of the receiver. A variable resistance unit, of the non-inductive type and of at least several hundred ohms full resistance is connected at the terminals of the tickler winding. (Fig. 1).

The knob of this resistance unit is what will now control the regeneration of the receiver. The plate coil's position will not affect to any appreciable extent the tuning of the secondary circuit.

Resistance Unit Adjustment

When adjusting the resistance unit proceed as follows: Adjust the tickler coil permanently in a position from $\frac{1}{2}$ " to 1" away from the secondary winding. If it has already been fixed, the problem is simplified. If of the flat, revolving type, allow about 20 to 40 degrees of coupling, and then fix the winding in that position.

The best method to use for the permanent location of the movable coil is to listen to the set, and leave the coil there where it will oscillate gently without any resistance unit connected across the tickler, but with the secondary condenser all the way in. Then permanently fasten the tickler coil and disconnect it from the shaft fastened to the dial on the front panel.

For the resistance unit, a compression type may be used. It will be noticed that as the lower waves are tuned in, more resistance will have to be included in the

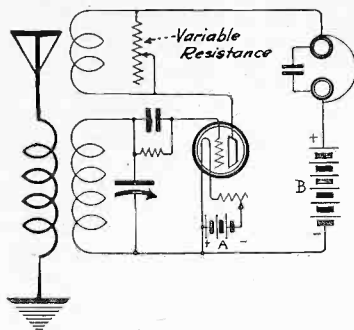

FIG. 1

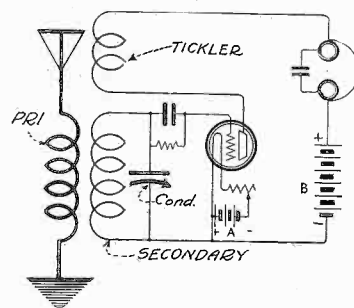

FIG. 2

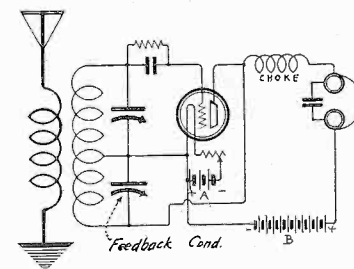

FIG. 3

circuit. The resistance unit provides gradual control of regeneration.

The Series Connection

Another way to accomplish the same thing is to place the resistance unit in series with the tickler coil winding, instead of in parallel. (Fig. 4). In this

case, it will be necessary to use a unit with a larger resistance, at least 3,000 ohms maximum.

The series connection is perhaps not as desirable as the parallel one, because it makes possible, through poor, imperfect, or open contact, inefficient functioning of the tickler or plate circuit. Any "open" in this part of the set renders it practically inoperative.

Capacity Control

Amateurs have been using for some time another method of regenerative control, which has proved very successful for the reception of short wave amateur and broadcast stations. It is as simple of control as any of the two methods already described. The tickler coil is fixed in position as usual. (Fig. 5).

By varying the capacity of the condenser, the feedback action is increased or decreased as desired. Ordinarily, a bypass condenser is included in this part of the circuit to shunt off the radio frequencies from the phones. In ordinary circuits the resistance of the phones and batteries is sufficient to stop feedback action. Some feedback is needed for sensitivity, and the variable by-pass condenser furnishes a method of controlling it easily and accurately.

Instead of passing through the rest of the circuit, the radio frequencies will use the bypass condenser path. As the plates are tuned in to full capacity, more and more energy is passed and the stronger the regenerative effect. A point is rapidly reached where oscillations are possible.

It is a little more difficult to adjust a receiver to use this method of control. It is efficient enough so that experimenters will want to try it. When altering the receiver, it will be necessary to adjust the number of turns on the tickler coil, as well as the distance between the secondary and tickler coils, rather carefully. This should be done while both the secondary and bypass condensers are at maximum while the tube is oscillating.

The feedback condenser affects but slightly, if at all, the setting of the secondary condenser. At the same time, it will be found possible for the operator to obtain regeneration even with the secondary condenser near the lower end of its scale.

This may be called a conductively form of capacity controlled feedback.

A further interesting method of controlling regeneration which has been ex-

How to Locate Primary To Obtain Most Volume

Fans who construct their own tuned radio frequency transformers will find it worth while to experiment with the location of the primary winding with respect to the secondary. This detail, while ignored by most fans, is of great importance if the maximum is to be obtained, for by proper location of the primary and secondary the maximum energy transfer is obtained, and consequently maximum volume.

As a suggestion it is recommended that the primary winding should be located at some point midway between the filament end of the secondary winding and the midpoint of that winding. Somewhere in that zone will be found the point of critical coupling, resulting in maximum volume with minimum reaction between the two wind-

ings, and minimum effect of the primary upon the secondary insofar as broad tuning of the secondary is concerned.

Another suggestion which can be very profitably employed is to wind the primary so that the capacity coupling between the primary and the secondary windings is minimum. This condition can be very easily attained and consists simply of staggering the primary turns, that is, instead of winding the primary turns in the conventional manner, to wind them any old way, one turn on top of another, in a haphazard fashion. When so doing, the total inductance of the winding will only be slightly effected whereas the capacity coupling between the two windings of the transformer will be reduced to a minimum.

How the Circuits Work

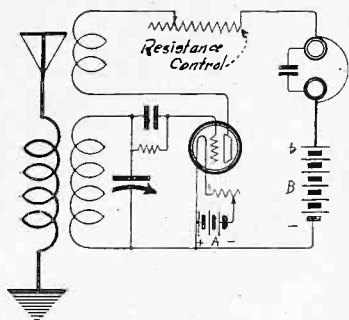

FIG. 4

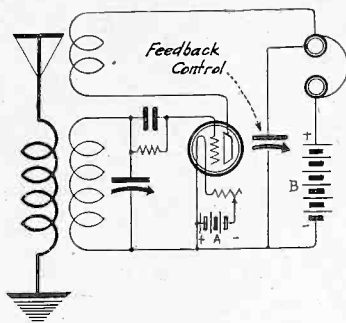

FIG. 5

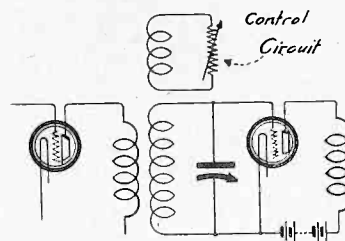

FIG. 6

Placement of Tickler is Important — How to Solve the Problem so That Smoothest Control Will be Obtained

tensively used in amateur receivers is variously termed "capacitive feedback,"

"modified Reinartz" or "Weagant-Reinartz." In this case, the construction of the secondary and tickler coils is slightly different than in previous cases. The two coils are merely a continuation of each other (Fig. 3), maintaining very close coupling. The regenerative control is provided by a variable condenser, connecting to the tickler coil.

By making this secondary-tickler arrangement a single coil equipped with suitable plug-in terminals, quick change over from low to high waves, and vice versa, can be effected. As a matter of

fact, this is necessary for short wave reception.

Use in an RF Circuit

Practical applications of the methods of regeneration control suggested above can be applied to the radio frequency circuits of any receiver. In Fig. 6 is shown a way of controlling the regeneration in the secondary circuit of an RF stage. The coil is coupled closely to the secondary, and a resistance across it provides the control. It is a variation of the 4-circuit tuner arrangement, but uses a resistance instead of a condenser for control.

Construction and Action of a Loudspeaker Unit

By J. E. Anderson

ALTHOUGH everybody is familiar with the performance of speaker units and knows their external appearance, there are not so many who know their construction or the principle upon which they work, such as the principle of the Baldwin unit. An explanation of the principle and a description of the unit are therefore not out of place.

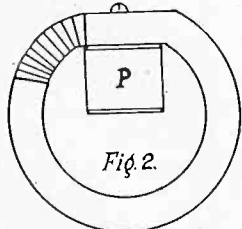
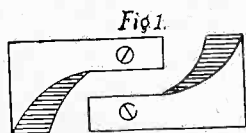

The principle of operation may be explained briefly by reference to Fig. 3, which depicts a section of the unit. A single bar of magnet steel NOS is bent into a circular shape. To the poles, N and S, of this magnet are secured two U-shaped pole pieces PP. In the space inside the two pole pieces is placed a spool containing a single winding. The walls of this spool have been indicated on Fig. 3, but the winding has been omitted. In the center of the spool is suspended a small iron armature, aa', pivoted at p. As a signal current is sent through the winding surrounding the armature the latter becomes magnetized in a direction depending on the direction in which the current is sent through. Suppose this is such that the left end, or a, of the armature becomes a north pole. Since the pole

piece directly above that end of the armature is north also there is a repulsion there, and that end of the armature tends to move down. The pole piece directly under the left end of the armature is south, or it is of opposite polarity to that of the armature. Hence there is attraction between the two, and again there is a tendency to move down. The armature is therefore both pushed and pulled down at that end. At the right end, or at a', the armature is of south polarity, but the polarity of the two pole pieces is the same as on the other end. Therefore the action here is opposite to that at the left end, that is, the right end of the armature is both pushed and pulled up instead of down. The action of the magnet on the armature is therefore quadruple. Since the armature is pivoted at the center the motion is one of counterclockwise rotation. Now when the current through the armature winding is reversed, the polarity of the armature is also reversed, and the motion becomes clockwise. Hence when an alternating current is sent through the winding the armature executes a rocking

(Concluded on page 26)

Small Compact Coils Favored for Oscillators

The supremacy of the low loss coil is beyond discussion, but there are times and positions in certain receivers where low loss coils are unnecessary. An example of this is the oscillator coupler in Super-Heterodyne receivers.

The difference between an average inductance and one of low loss design is not great enough to stop reception. And if the coil is used in a circuit which is continually oscillating, and from which the magnitude of the output is not of great importance, the concern being its continual oscillation over the waveband covered, the necessity of a low loss coil for the oscillator coupler fails to be

sustained. The oscillator in a Super-Heterodyne is utilized simply to produce a beat note with the incoming carrier. The item of importance is the use of a coil with a small external field and one which requires the minimum amount of space. Therefore the oscillator coupler in the best of Super-Heterodynes can be a diamond weave, spider-web Lorenz or single layer coil, not necessarily of low loss design, although the coils specified as manufactured, usually are low-loss. It is quite all right to have them low-loss, for this position, but not vital. In other parts of the circuit the low-loss feature is important.

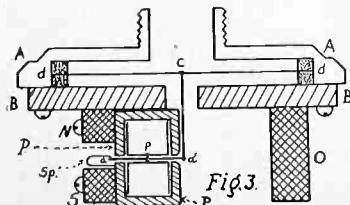

PARTS used in a speaker unit.

How to Cure Volume Drop

WHEN a radio receiver fails to give its customary volume the B batteries are often blamed. It is true that they are sometimes the cause of the trouble, but it is advisable to measure their voltage before arriving at conclusions. The B batteries should be tested with a voltmeter, after the set has been in operation for several hours. Batteries recuperate while idle, and if tested after an idle period the voltmeter will show a higher reading than it would if the measurement were made after the batteries were in use.

Battery experts estimate that a good make of B battery of adequate size should last, even with a receiver consuming heavy B battery current, for at least six months, and if it is a moderately economical receiver, from nine to twelve months, provided it is given the average use of about two hours per day. Failure to give such life is an indication either that it is a battery of inferior make or of inadequate capacity for the set used or that there is a defect in the receiver.

C Battery Important

Factors most frequently causing short B battery life are: Audio-frequency amplifier not equipped with C battery; C battery exhausted; excessive plate voltage; tubes draw excessive current because of accidental displacement of grid and plate; B battery of insufficient capacity for the drain placed upon it.

This last cause is frequently overlooked because the first cost of large batteries is somewhat more than that of small ones. But it is indeed a wasteful practice to use a battery of inadequate capacity. This is apparent if the cost is figured in cents per hour of use, rather than in first cost. On the face of it, it seems more expensive to pay about 25 per cent. more for a heavy duty B battery, but the economy is apparent when the heavy duty lasts twice as long in service as the "large" size battery. The savings are even greater when heavy duty B batteries are substituted for the small portable size batteries which are sometimes erroneously used for home receivers.

Great Reduction In Expense

There have been cases when B battery maintenance cost has been reduced from

12 cents an hour to 2 cents an hour, by using a heavy duty or extra large size B battery when volume fails. The slightly increased volume which new B batteries give may lead to the conclusion that an exhausted B battery was the cause of the reduced volume. A B battery voltmeter, however, might show only a normal fall in voltage, which would not account for the reduction in volume.

In such cases it is advisable to inspect the antenna connections for a broken or corroded lead-in, loose ground connection, worn-out C battery or lost magnetization of loudspeaker unit. Still another cause of reduced volume is the loss of active material on the tube filaments.

End Comes Before Burnout

Quoting from The Technical News Bulletin, issued by the National Bureau of Standards:

"Electron tubes in radio receiving sets eventually lose their sensitivity. This sometimes progresses to the point where the receiving set operates very poorly or not at all, even though the tube filament is not burned out. The user of the set frequently confuses this condition with that due to an exhausted B battery. If the tubes are of the thoriated tungsten (X-L) filament type, they can usually be rejuvenated by a simple process, and made to serve as well as new tubes in the receiving set."

The Rejuvenation Method

A simple process of rejuvenation, which can be performed at home, consists in disconnecting the B battery from the set and burning the filaments at full brilliance for a half hour. Usually this restores the filaments to full activity.

The two major causes of reduced volume are exhausted B batteries and worn-out tube filaments. It is easy to determine which is responsible for the loss of volume. A good, reliable voltmeter will indicate the condition of the B batteries. If each 45-volt B battery registers 34 volts or more, the cause of reduced volume lies elsewhere, probably with the tubes. Lacking a reliable voltmeter to test B batteries, a good plan is to have on hand one or two spare tubes which are

known to be in good condition. Substitute the new tubes for those in the set, and if this makes a marked improvement in volume it is an indication that the old tubes require re-activation or removal.

"Eveready Hour" Oldest Program Feature on Air

The "Eveready Hour" is the oldest regular feature broadcasting today.

A recent survey of the whole field of radio entertainment features revealed the fact that the "Eveready Hour" is the "veteran" of them all in point of regular and continuous service.

This weekly broadcast program first went on the air on December 4, 1923. From that time on, without exception, each week has had its "Eveready Hour" through station WEAf, and since early in 1924 a gradually extending network of stations scattered throughout the East and Middle West. There are contemporary broadcast features which began just about the same time as the "Eveready Hour," but none of these others has had an unbroken run.

The "Eveready Hour," in its earliest days, however, was not the same type of broadcast program that it is today. It began, like most other features, as a program of more or less miscellaneous numbers. Slightly less than a year after its debut it launched its present type of program, which has come to be known as the "continuity" radio program—a sort of radio scenario which tells a story with a combination of music and the spoken word. The first of these "continuity" programs was broadcast on the evening of November 10, 1924, on the eve of Armistice Day, and the story was that of America's part in the World War.

Americans Building Fine Station in Brazil

American engineers are building a new station in Sao Paulo, Brazil, which when completed, will be the best broadcasting station, from the point of equipment, in South America. The transmitter is being manufactured in the United States.

The station will be complete in every detail to permit broadcasting from the local studio or from remote points with the aid of telephone service. Two towers 165 feet in height are being erected on the site for the new station, at one of the highest points in the city.

Marion Talley Assured \$1,500 for Each Concert

It is reported that Marion Talley, the 19-year-old Kansas City soprano, recently heard on the air, has proved such a promising box office attraction that each of her concert engagements carries with it a \$1,500 guarantee.

This in addition to the 5-year contract she has with the Metropolitan Opera Company and an agreement to make records exclusively for the Victor Talking Machine Company.

WDAF Linked to WEAf For Tri-Weekly Program

Station WDAF of Kansas City, Kan., has been added to WEAf's chain. This station has contracted to take programs originating in New York on Monday, Wednesday and Friday evenings from 9 to 11 o'clock Eastern Standard Time.

Leak Excels Condenser As Volume Diminisher

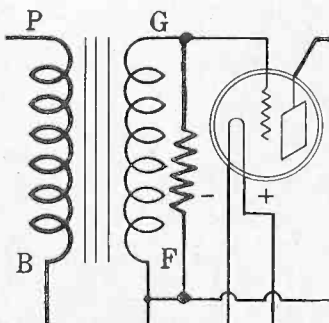

AN EXAMPLE of a 500,000-ohm resistor across the secondary.

A resistance is always better than a fixed

condenser across the secondary of an audio frequency transformer when it is desired to reduce the volume output of the amplifying unit. While the output volume is reduced in both cases, the action of the shunt condenser is such as to change the operating characteristic of the transformer and cause a loss of amplification on the high notes and also on some low notes. In fact, if the condenser is too large there will be noted a marked loss of high notes, and whatever high notes would come through would sound flat. On the other hand, the use of a shunt resistance with a minimum resistance of 100,000 ohms and a maximum resistance of 500,000 would act as a volume control without the detrimental effects of the shunt capacity. However, it is not necessary that this resistance be variable; if the total signal is to be reduced just slightly, a shunt fixed resistance of 500,000 ohms would do the trick.

Curing Portable Trouble

The following, Part IV, completes the article on the Bernard Portable.

THE other jack, connected to oscillator primary and thence to A plus, is connected to the rotor plates of C1. Then C2 is wired, with the stator plates going to grid of the oscillator tube and the rotor plates to A minus, the lead starting from the green lug of the plug. These leads are made respectively to G on the socket and to the minus A minus battery lead side of the rheostat at the most convenient point of that line.

The plate coil L3 requires attention now. This is connected with inside terminal to plate and the outside to the B plus detector lead, established at the B post of the filter.

Connect the cable of the multi-plug so that the free ends go to the batteries as follows: red to A plus, pink to B plus amplifier, 67½ volts; blue to B plus detector, 45 volts. Skip green. Now put one tube in any socket. Turn on the rheostat and see whether the tubes light. If so, disconnect the A minus cable lead from the battery and connect the yellow cord to B minus at the B battery. See if the rheostat lights the tube. It should not. The B minus is automatically connected in the set through the plug itself.

Now restore the green cable lead to A minus, plug in the loop tips at the phone tip jacks therefor provided, and plug in the speaker tips at the output jack posts. Try to tune in a station.

Don't be at all surprised if trouble develops. Even skilled radio engineers have their troubles getting a Super-Heterodyne to work properly. Few make a set that works right off the reel just as they want it to work. Some attention must be given to correction factors.

Insert all tubes. Turn on the set. If no signals are heard and there is no sign of life in the tubes, see that the prongs contact properly, and finally see whether B minus really is connected automatically through the plug, by putting a separate wire at A plus and just for a bare fraction of a second touching it to B minus. If there is a spark, connect the B minus to A minus (instead of to A plus), with this separate wire. Then there will be no spark. Put the wire on and off B minus and note if there is any difference. If tube noises—the familiar rushing sound—disappear during this removal, then B minus need be connected by the separate method and you need look no farther for trouble.

If tube rushing is heard, but signals not, reverse the oscillator plate coil leads.

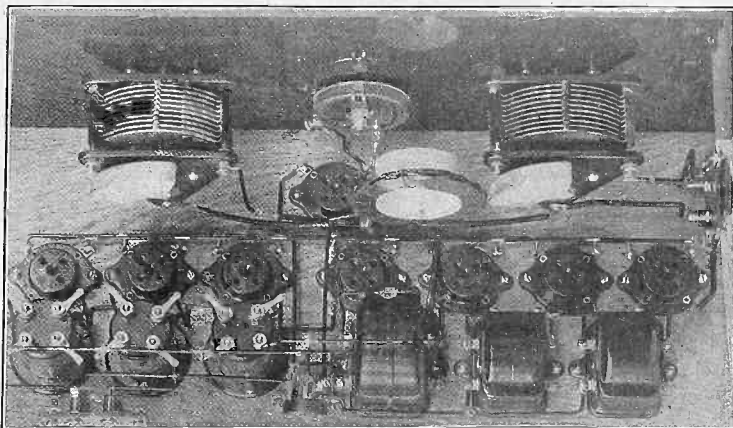

REAR VIEW of the Bernard Portable, taken at a slant. The neatness and simplicity of the wiring and layout are clearly shown.

About the most important difficulty is oscillation control. This is always a ratable factor. If squealing develops try the following cures:

(1) Reverse the connections to the primary of the filter, so that the two leads change places.

(2) If no improvement is noted, or little improvement, leave this as it is now, and consider the ends of the secondaries of the two first two medium frequency transformers, joined commonly to A minus. Instead make this connection to F minus, which is any F minus socket post. This is easily done by cutting the joint of this lead at the left-hand rear point of the second medium frequency transformer, and carrying the common lead directly backward to F minus of the third socket from right. This action changes the bias from slightly negative to zero.

(3) If there is some oscillation control, but it is not satisfactory enough, put a few turns of resistance wire, say six or seven turns on a pencil size, or equivalent resistance strip in series with the F minus post of the oscillator socket and the filament side (not battery side) of the rheostat. Room for this is easily provided by pushing back the lead that was connected from rheostat to F minus of the oscillator socket. The reason for this move is that sometimes the oscillator tube is too keen to enable satisfactory operation of all tubes at the same filament potential, hence the extra resistance wire, taken from an old rheostat, if need be, makes the oscillatory tendency keep pace on the filament

operating basis. Another system of aiding this effect is to move the oscillator plate coil farther from the secondary.

(4) If oscillation trouble still persists, then remove the extra resistance wire just mentioned, restore the oscillator filament lead as it was, and put this resistance wire in series with the two sockets, second and third from right, to make tubes (2) and (3) lag. By these methods the proper balance may be established.

(5) Restore filter primary to original connection for additional test.

(6) Of course the oscillatory tendency may be controlled by a potentiometer of about 400 ohms, connected with its side terminals to F minus and A plus—not to A minus and A plus, for then the potentiometer always would be drawing current, while the other way the rheostat, when turned off, disconnects the potentiometer. The midpoint or movable arm of the potentiometer would be connected to the common lead of the two medium frequency transformers established at left front (to posts opposite the one marked G, and on the same side, marked "Sec"). The potentiometer would be mounted on the panel above the rheostat, and that is why so much care was advised in the placement of the rheostat.

South African Veldt Hears WGY, 8,000 Miles

A New York Liederkrantz chorus and a Syracuse dance orchestra entertained radio listeners on the African rand and veldt recently when the program of WGY was rebroadcast after what is believed to be a record relay. In Johannesburg, South Africa, 8,000 miles from Schenectady, L. E. Green, picked up 2XAF, which was carrying the music of WGY on 32.79 meters, and put it back into the air with new strength and energy for South Africans to hear. 2XAF uses about ten kilowatts.

Sometime prior to the successful rebroadcast Mr. Green had asked the permission of the General Electric Company engineers to rebroadcast the short wave signals which were then coming into Johannesburg with fair volume on 35 meters. This permission was granted and then the transmitter of 2XAF was changed and signals were broadcast on 32.79 meters. The first night the new wavelength was on the air, Mr. Green, who is known to the radio fraternity as A4V, picked up the signals and rebroadcast.

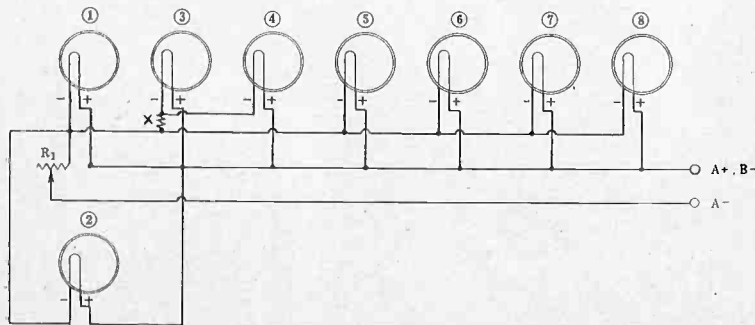

THE INTRODUCTION of an extra filament resistor, X, used for retarding the filament emission of the two intermediate frequency stages, if they give oscillation trouble.

Radio University

A FREE Question and Answer Department conducted by RADIO WORLD for its yearly subscribers only, by its staff of Experts. Address Radio University, RADIO WORLD, 145 West 45th St., N. Y. City.

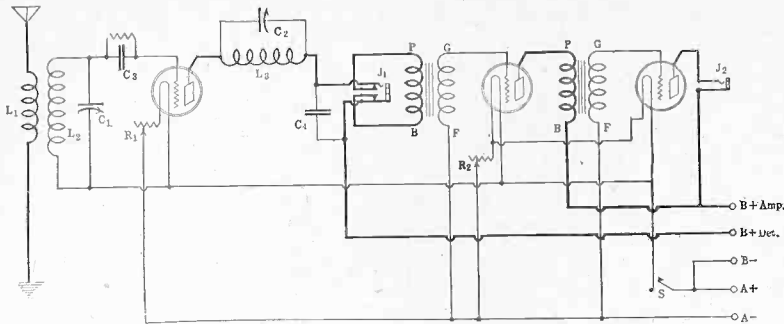

FIG. 299

The circuit diagram of the 3-tube regenerative set requested by Mr. Trauser.

I WOULD like to have a circuit diagram of a 3-tube receiver employing a regenerative detector and two stages of transformer coupled audio frequency amplification. It is desired that the plate of the detector tube be tuned by a variable condenser in shunt to a coil. A separate rheostat should control the filament of the detector tube while another should control the filaments of the two amplifier tubes. A jack should be inserted in the detector output circuit, for listening in on the phones.—Jacob Trauser, Waterville Valley, N. H.

Fig. 299 shows the electrical diagram of a receiver which will suit your needs. The primary of the RFT, L1, consists of 10 turns. The secondary, L2, consists of 45 turns. These are wound on a tubing $3\frac{3}{4}$ " in diameter. No. 22 double cotton covered wire is used to wind the coil. There is a $\frac{1}{8}$ " separation between the primary and secondary windings. The plate coil, L3, is wound on a separate tubing, 3" in diameter and consists of 20 turns of No. 24 single silk covered wire. C1 and C2 are both .0005 mfd. variable condensers. C4 is a fixed condenser having a value of .001 mfd. R1 is a 6 ohm rheostat, having a carrying capacity of $\frac{1}{4}$ amperes, while R2 is also a 6 ohm rheostat, having, however, a carrying capacity of $\frac{1}{2}$ amperes. The grid condenser, C3 is of the common .00025 mfd. fixed type. The grid leak, which shunts the fixed grid condenser has a value of 2 megohms. Both the audio transformer are of a low ratio type. S is a filament switch. Only 90 volts need be applied to the plates of the amplifier tubes. The plate of the detector tube should receive about 45 volts. If upon completion, you find that it is difficult to make the detector tube oscillate, add on 4 more turns to L3. If it oscillates too much, take off 4 turns. The jack on the detector output is of the double circuit variety, while the one on the amplifier output is of the single circuit type.

WILL I get as good results with straight line wavelength variable condensers as with straightline frequency, when used in a standard 5-tube tuned radio frequency receiver? (2)—I would like to build the 1926 Model Diamond of the Air, but am desirous of knowing if it will cut through local stations and get distance. (3)—Will it be all right to use a 6-to-1 ratio audio transformer and a 2-to-1 ratio in the first and second stages of an audio amplifier?—James J. Seollan, 110 Waverly St., Providence, R. I.

(1)—Yes. (2)—This it is doing repeatedly. (3)—Yes, but the 6-to-1 in the first stage.

I HAVE the following parts with which I wish to construct a 5-tube receiver: One 7x18" panel; one 7x17" baseboard; three 4" Slo-Moshen dials; two single circuit jacks; one filament control switch; one 6-ohm, $\frac{1}{2}$ ampere, rheostat; one 20-ohm, $\frac{1}{4}$ ampere, rheostat; one 2x18" binding post strip; nine binding posts; three .00035 mfd. variable condensers; three low loss radio frequency transformers with secondaries wound to be shunted by the .00035 mfd. variable condensers (65 turns on a $3\frac{3}{4}$ " tubing); two audio frequency transformers, one having a 5-to-1 ratio and one having a $3\frac{1}{2}$ -to-1 ratio; five standard base sockets; one .00025 mfd. grid condenser; one variable grid leak, with a range of from $\frac{1}{2}$ to 10 megohms; one .006 mfd. fixed condenser and one .002 mfd. fixed condenser. Now I would like to have a description of the wiring of a receiver using all these parts.—A. Fabris Arce, 4116 Ave. R, Galveston, Tex.

Consider the primary of the first RFT as L1, of the second RFT as L3 and of the last RFT as L5. Consider the secondary of the first RFT as L2, of the second RFT as L4 and of the last RFT as L6. Consider the variable condenser shunting the secondary of the first RFT as C1, of the second RFT as C2, of the third and last RFT as C3. Consider the 6-ohm rheostat controlling the filaments of the RF tubes, as R1. Consider the 20 rheostat controlling the filament of the detector tube as R2. Consider the grid condenser as C4 and the grid leak as R4. One extra unit that you haven't on your list will have to be used. This is a $\frac{1}{2}$ ampere ballast resistor, R3, which controls the filaments of the last two audio tubes. The beginning of the primary winding, L1, goes to the antenna post. The end of this winding goes to the ground post. The beginning of the secondary winding, L2, goes to the rotary plates of the variable condenser, C1, and to the arm of the rheostat, R1. The resistance wire of this rheostat, goes to the F minus post on the first socket, first RF tube the end of the secondary winding, L2, goes to the stationary plates of the condenser, C1 and to the G post on this first socket. The beginning of the primary winding, L3, goes to the P post on this same socket. The end of this winding goes to the B plus post, at which an intermediate voltage, 67 $\frac{1}{2}$ volts, should be applied. The beginning of the secondary winding, L4, goes to the rotary plates of the condenser, C2 and to the F minus post on the second socket, holding the second RF tube. This same terminal goes to the resistance terminal of R1, which went to the F minus post on the first socket. The end of this

winding, L4, goes to the G post and to the stationary plates of the condensers, C2. The beginning of the primary winding, L5, goes to the P post on this same socket. The end of this winding, goes to a B plus post, same post as for other RF tube. The beginning of the secondary winding, L6, goes to the variable plates of C3 and to the F plus post on the third socket. This socket carries the detector tube. The end of this winding, goes to the stationary plates of the condenser, C3 and to one terminal of the grid leak, R4, grid condenser, C4, combination. The other terminals of this combination goes to the G post on the detector socket. The resistance terminal of the second rheostat, R2 (20 ohm type), goes to the F minus post on this socket. The arm goes to the A minus post. The arm of R1 also goes here. The F plus posts on all the sockets are connected together and to one terminal of the filament switch. The other terminal of the switch goes to the A plus B minus post. The ballast resistor, R3, is connected in series with the negative legs of the filaments of the two audio tubes, e. g., one terminal of resistor goes to the F minus posts of both sockets, other terminal going to A minus. The P post on the detector socket goes to the P post on the high ratio AFT and to one terminal of the .006 mfd. fixed condenser. The other terminal of this condenser goes to the F minus post on detector socket. The B plus post on this AFT goes to the B plus Detector, 45 volt, post. The G post on this AFT goes to the G post on the fourth socket first amplifier. The F minus post on this AFT goes to the C minus post. The P post on the low ratio AFT goes to the P post on this fourth socket. The G post on this AFT goes to the G post on the last socket. The B plus post of the low ratio AFT goes to the B plus Amplifier post. The P post on this socket goes to the top terminal of a single circuit jack. The bottom terminal goes to the B plus amplifier post (90 volts). The C plus goes to the A minus. The .002 mfd. fixed condenser shunts the G and P posts of the last AFT (high ratio).

* * *

I AM building the 4-tube DX Symphony set, as published in the Jan. 9 issue of RADIO WORLD and described by Irving Witz. I wound the coils myself and would like to know if I wound the regeneration coil O. K.? First I wound 8 turns. This constituted the primary, or L3. I then left a $\frac{1}{8}$ " space and started to wind the secondary, L4. I then wound 8 turns and made a tap. This point went to the F plus post on the detector. The beginning of this winding went to the variable plates of the condenser, which go to the plate of the same tube. I concluded the winding of 42 turns, the last turn of which went to the grid leak and condenser combination.—John Mathers, 16 Washington Place, East Orange, N. J.

Your method winding and connecting are O. K.

* * *

COULD THE same choke coils, step-up transformer condenser and chemical jars, as described by Lewis Winner in the Jan. 2 issue of RADIO WORLD, be employed in the Practical B Supply, described by Capt. P. V. O'Rourke in the March 26 issue?—James McDonnell, Clifton, N. J.

Yes.

* * *

I HAVE been reading a great deal lately about the wonderful results that are obtainable when the antenna of a receiver is tuned. However I have not seen any circuit using this scheme. I would like to build a set consisting of about 4 tubes, e. g., a stage of tuned radio frequency amplification, a non-regenerative detector and two stages of trans-

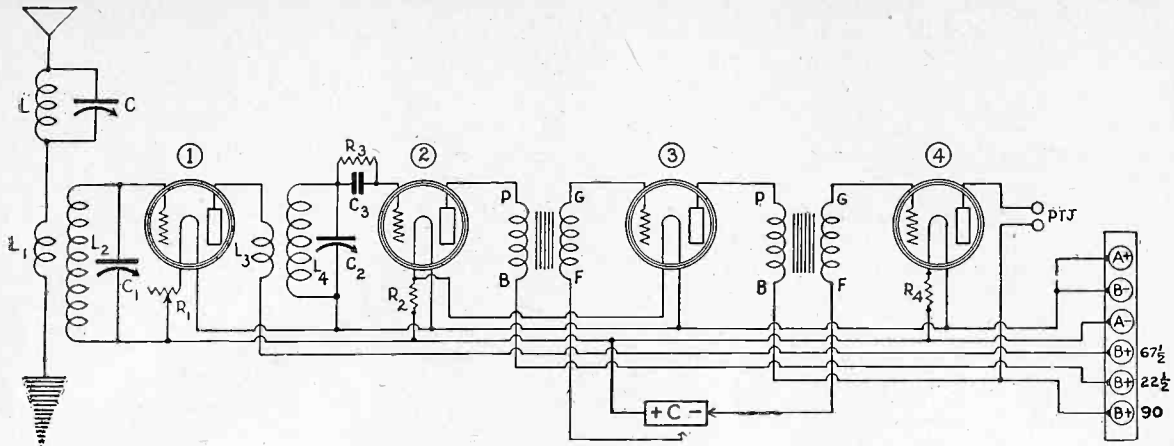

FIG. 300—The schematic diagram of the antenna tuned, 4-tube receiver.

former coupled audio frequency amplification, using this tuned antenna system. A diagram of such a receiver would be very much appreciated. The number of turns that should be placed on the coils, values of condensers, tubes, and etc., is also desired.—Norbit Jameson, Blaker Mills, W. Va.

Fig. 300 shows the schematic diagram of a receiver, which you desire. The primaries in these RFT consists of less turns than in the usual RFT, e. g., 6, instead of 10. The secondaries consists of 45 turns. The special antenna coil L, consists of 35 turns, shunted by a .0005 mfd. variable condenser. This coil is wound on a tubing 3/4" in diameter and 3" high. The windings of the RFT are placed on tubings also, 3/4" in diameter and 3" high. No. 22 double cotton covered wire is used in all cases. The other two variable condensers, C1 and C2 are also of the .0005 mfd. variable type. C3 is a .00025 mfd. grid condenser, while R3 is a 2 megohm grid leak. Only one rheostat is used. This is R1, which controls the filament of the RF tube. The filaments of the detector and the first amplifier tubes are controlled by one ballast resistor of the 1/2 ampere type. The filament of the last tube is controlled also by a ballast resistor. If the -01A type tube is used here, then a 1/4 ampere type is used. However, if a power tube of the 112 type is used, then a 1/2 ampere ballast resistor should be used. In the RF, detector and the first amplifier stages, the -01A type tube is used. Separate C voltages are obtainable for both the amplifier tubes.

I WISH to build a simple 2-tube receiver from which I will be able to receive signals from local stations as well as from stations about 100 miles distant. I do not like the regenerative set, as I

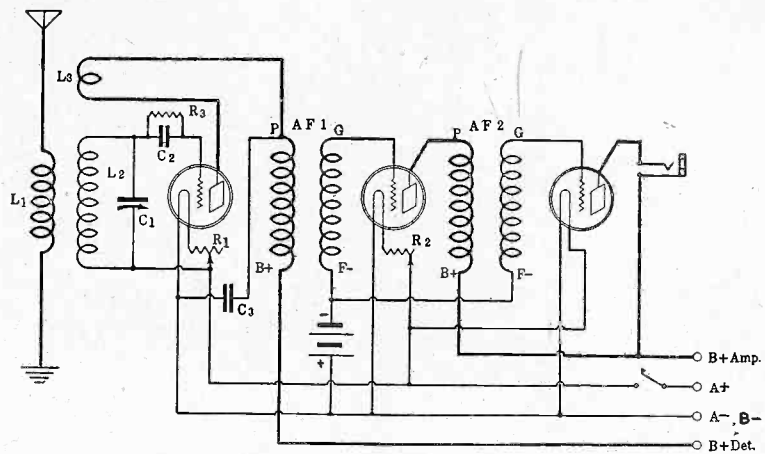

FIG. 302—The circuit diagram of the 3-tube, 3-circuit tuner, receiver.

have had no luck with it, unstability of operation being the main difficulty. Could I have a circuit diagram of a receiver of this type, with all the information regarding the coils, condensers, etc?—Al Muter, Pendaries, N. M.

Yes. In Fig. 301, you have the diagram of such a set. The primaries, L1 and L3, consists of 8 turns. The secondaries, L2 and L4, consist of 53 turns. The primary and secondary of each RFT is wound on a basket weave form, 3" in diameter. The form consists of 15 spokes, each having a diameter of 1/4". These spokes are equally spaced. First 22 turns of the secondary winding are put on. The under two and the over two method of winding is employed. Then 8 turns of the second-

ary winding are wound with 8 turns of the primary winding. Finally the 23 turns of the secondary are put on. The secondaries, L2 and L4, are shunted by .0005 mfd. variable condenser of the SLF type. R1 and R2 are 6 ohm rheostats, having a carrying capacity of 1/4 amperes, each. C3 is a .00025 mfd. grid condenser. R3 is a 3 megohm grid leak, of the fixed type. The detector plate receives 45 volts. The amplifier plate receives 90 volts. The grid return of the RF tube is connected to the negative point of the A battery, while the grid return of the detector tube goes to the positive point of the A battery. The -01A type tubes are employed.

I HAVE a 3-circuit tuner, viz.: 10 turn primary, 45 turn secondary wound on a 3/8" diameter tubing; 36 turn tickler wound on a 2 3/4 tubing; which I would like to put into a receiver employing two stages of transformer coupled audio frequency amplification. The diagram of such a receiver is requested. I would like to insert a C battery in series with the grid returns of the two transformers, AF1 and AF2. I also have two rheostats of the 6 ohm type, one passing a 1/4 ampere, the other passing 1/2 ampere.—J. William French, Joise, Neb.

Fig. 302, shows the diagram of this popular receiver. A .0005 mfd. variable condenser shunts the secondary of the tuner. The .00025 mfd. grid condenser and the 2 megohm grid leak combination is employed. This of course is placed in series with the grid of the detector tube. C2 is a .001 mfd. fixed condenser. The usual filament switch is placed in series

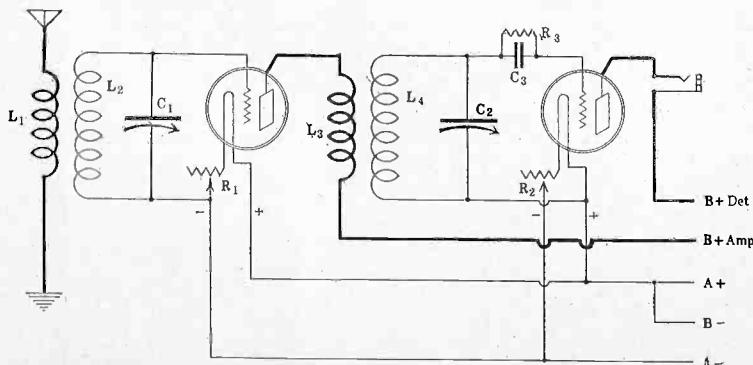

FIG. 301—The circuit diagram of the 2-tube receiver, requested by Mr. Muter.

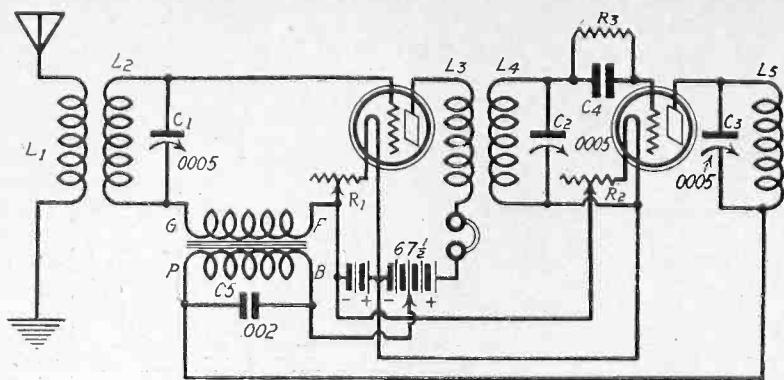

FIG. 303—The electrical diagram of the 2-tube reflex.

with the negative lead of the A battery. If it is found that the detector tube oscillates too great, take the fixed condenser, C2, out.

I WOULD like to have the circuit diagram of a 2-tube reflex receiver, employing a regenerative detector. State the specific constants of the coils, condensers, etc.—Forrest Bunhill, Stoner, Colo.

In Fig. 303, you have the schematic diagram of a receiver based upon your description. The primaries, L1 and L3, consist of 11 turns. The secondaries, L2 and L4, consists of 52 turns. Spidervieb forms are used. These have an inside hub of 1". There are 15 spokes with a 1/4" diameter used. No. 24 single silk covered wire is used. The under two and over two method can be pursued. The plate coil, L5, consists of 30 turns, wound upon the same type of form as the RFT, still using No. 24 single silk covered wire. R1 and R2 are 6 ohm, 1/4 ampere rheostats. The —01A type tubes are employed. The high ratio AFT is employed in the reflexed stage of amplification. The standard 2 megohm grid leak and .00025 mfd. grid condenser combination is used.

I HAVE built the Compact B battery eliminator, as described by Lewis Winner in the April 3 issue of RADIO WORLD and have had very good results with it. I did not however build the metal cabinet, which I wish to do now. Upon looking over the data in the text, I find that the dimensions of the sides and the perimeter are missing. Could I have this dope?—Arthur Draper, Wade, Miss.

Figs. 304 and 305, respectively show the dimensions of those portions which you desire.

I AM enclosing a diagram of a 5-tube receiver, which I obtained from some local radio store, and from which I built the set. I find that I am troubled by body capacity. Toroid coils are used as RFT. The secondaries of these RFT are shunted by .00035 mfd. variable condensers. A 10 ohm rheostat is used to control the filament temperature of the detector tube. A .001 mfd. fixed condenser is brought

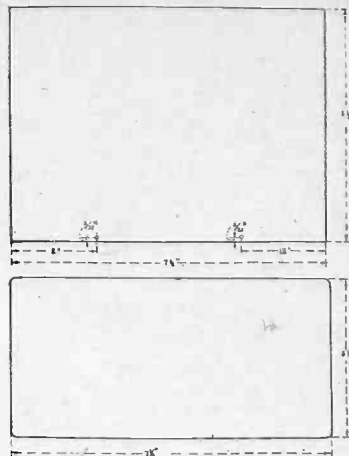

FIGS. 304 and 305 (top to bottom)

The top diagram shows the dimensions of a side of the cabinet. The bottom represents the perimeter of the top of the cabinet. This is not a plate, but the sides, upon looking down into the four sides of the cabinet.

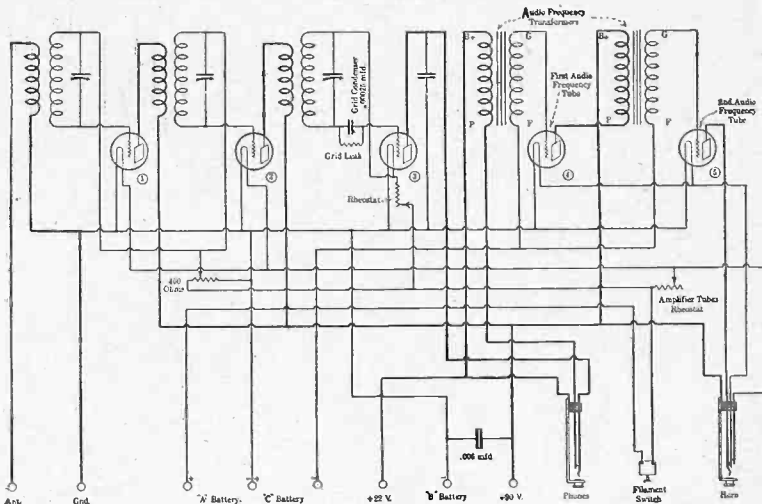

FIG. 306—This shows the diagram of the 5-tube set, built by Mr. Weras, which developed body capacity effects, the cure for which is set forth in the text.

from the plate post of the detector tube to the F minus post on the same socket. Low ratio AFT are used. How can this body capacity be reduced?—Charles Weras, Emington, Ill.

The rotary plates of the variable condenser, in the case of the first two tubes,

should go to the arm of the potentiometer, and in the third case to A plus. The grid terminals of the coils should go to the stator plates.

I RECENTLY built the T-A 4-Tube receiver described by Raymond C. Wells in the March 10 issue of RADIO WORLD. The results upon completion were great. However, I found it necessary to move the set from its original place. When it was again connected I could hear nothing but a loud hum, similar to the familiar 60-cycle AC hum. The antenna and the ground leads were only made about a foot longer. Therefore I do not think that the trouble could lie there. The batteries are all connected up O. K. The tubes are also all right. As a matter of fact nothing was touched, the whole outfit, with the batteries, etc., being carried to the other corner of the house. Now what could be the trouble?—James Gerahly, Des Moines, Ia.

When moving the receiver you must have either broken or loosened some of the leads. Look at all the binding post connections. The nuts easily loosen up. This applies to the nuts on the posts of the RFT, variometer or AFT, etc.

Join RADIO WORLD'S University Club

And Get Free Question and Answer Service for the Coming 52 Weeks.

This Service for Yearly Subscribers ONLY

Have your name entered on our subscription and University lists by special number. Put this number on the outside of the forwarding envelope (not the enclosed return envelope) and also put at the head of your queries. If already a subscriber, send \$6 for renewal from close of present subscription and your name will be entered in Radio University.

[In sending in your queries to the University Department please paragraph them so that the reply can be written under or alongside of each query. Write on one side of sheet only.]

RADIO WORLD, 145 West 45th Street, New York City.

Enclosed find \$6.00 for RADIO WORLD for one year (52 Nos.) and also enter my name on the list of members of RADIO WORLD'S University Club, which gives me free information in your Radio University Department for 52 ensuing weeks, and send me my number indicating membership.

Name

Street

City and State

Station Music Fees Soar

Charges Levied By Composers' Society Cited as WLS, \$2,500; WQJ, \$1,600; WJJD, \$2,000—Broadcasters Fear Exorbitancy Will Force Them Off the Air—KTCL and KJR Among Them—Net Profits of Composers \$113,000 a Year.

The fight over the Copyright Law, and its intended amendment as affecting broadcasting, has brought out the fact that stations complain they are now at the mercy of the American Society of Authors, Composers and Publishers. Several stations are declared in danger of discontinuance, due to the demand for too high a payment for the privilege of broadcasting songs of which the Society is an assignee of the copyright. The larger broadcasters want all stations to pay the same amount, Congress to fix the price.

WASHINGTON

That many newspapers favor the copyright bills introduced by Senator Dill, of Washington, and Representative Vestal, of Indiana, was brought out in the recent hearings in Washington. These measures were introduced to determine how much a radio station should pay the owner of a musical composition for broadcasting it and the remedy they suggested was that Congress fix the price, as was done in the case of phonograph records.

Elisha Hanson, of Washington, D. C., representing the American Newspaper Publishers Association, declared his organization was squarely behind the measures. Incidentally, he remarked that between ninety and a hundred newspapers either have broadcasting stations or sponsor programs.

The situation, in so far as publishers are concerned, is rapidly growing worse, according to William S. Hedges, of Chicago, who appeared as spokesman for Walter Strong, chairman of the radio committee of the American Newspaper Publishers Association.

50c Each for Sears-Roebuck

"Station WLS, in Chicago, was levied a fee of \$2,500 for the current year," Mr. Hedges told the committee, "for the privilege of using the Composers Society music under rather drastic conditions. I am told WQJ, Chicago, is to be assessed a similar sum and WEBB, Chicago, because of newspaper connections was let out at \$1,600. WJJD, Mooseheart, Ill., is fighting the assessment which is said to be \$2,000. That station claims to be an educational institution broadcaster, because of its fraternal ownership, but the Composers Association demands a review of advertising contracts. The fees charged this year may be boosted next year. At WEBB's rate, they are paying about 35 cents a number. WMAQ, which broadcasts very little popular music, is paying at the rate of 20 cents a number. WLS will be paying about 50 cents a number."

W. E. Harkness, assistant Vice President of the American Telephone and Telegraph Company, said that the pending measures would give stability to the radio business. Declaring that new contracts offered broadcasters are much higher in



OFFICIALS OF THE NATIONAL ASSOCIATION OF BROADCASTERS, photographed in the lobby of the Senate office building attending the hearings on the Dill-Vestal Copyright Bill. In the front row, left to right, Paul B. Klugh, executive chairman of the Association; John Shepard, 3d, of Boston, treasurer; William H. Heinz, of WHO, vice-president, and Major N. Levinson, of KPO, San Francisco, Cal. Back row, left to right, S. E. Baldwin, of WTAM; W. E. Harkness of the A. T. and T. Co.; L. S. Baker, and W. S. Hedges of the Chicago Daily News. (Underwood & Underwood)

most cases this year than last, Mr. Harkness wondered where it would end, and added:

"We are interested not only in what we are to pay this year but next year and so on if we are to stay in broadcasting."

A. T. & T. Hopes for Profit

Mr. Harkness said it was not correct that stations were making large amounts of money. It was true that some of them were taking in considerable revenue but because of the expense of broadcasting, it all went out again.

"The broadcasting department of our company," Mr. Harkness asserted, "has not made any money yet but we hope to do so this year."

The witness told of a test made by broadcasting one act of a certain play in New York, after which the box office sale was declared to have been increased by 3,000 tickets. He added that John McCormack, singing over the radio, had brought in 60,000 orders for a single record. A client had received 500,000 letters from listeners in connection with a certain popular radio feature.

500% Increase

Senator Dill read two telegrams from Seattle. The first from Station KTCL said the Composers were assessing a new rate on the station of 500 per cent increase or approximately one third of their broadcasting cost and that the increase would practically force the station to close.

Another from KJR, at Seattle, urged that all pressure be brought to bear to pass the Dill bill as the American Composers Association "today refused to renew our license except on such prohibitive terms as to make operation impossible."

The Composers yielded in presenting their side of the case to give Arthur Tuttle, counsel for the Broadcasters, an opportunity to finish. He remarked that broadcasting had proved the greatest song plucker in the world.

"Radio," he said, "is the surest barometer of success that has yet been discovered. And, however much they make the pretense to the contrary," Judge Tuttle continued, "the Composers are extremely anxious to have their songs broadcast."

By way of bringing to the attention of the Committee what he said was an enor-

McCormack's Radio Singing Sold 60,000 Records of a Single Song, Says W. E. Harkness—One Client of A. T. & T. Station Got 500,000 Letters from Listeners—Microphone Called Valuable Publicity Agency for Music—Congressional Hearings on Dill-Vestal Bill Held.

mous increase in copyright broadcasting fees, the broadcasters' counsel read an extract from a letter addressed to George C. Furness, of the National Carbon Company, of New York, from the Radiophone Broadcasting Corporation, of Chicago, as follows:

"I am very much interested in knowing your present viewpoint on the Authors and Composers situation. Our license is up for renewal now and they have a gun on each side of us. Where we paid \$600 for our license last year, they are attempting to exact a price of \$5,000 with an additional \$25 per hour for advertising programs."

Composers Have Their Inning

Up to this time only the broadcasters had been heard, so when the opportunity came for the other side to present its case Gene Buck, president of the Composers Society, lost no time getting into action. He said the organization had been started by the late Victor Herbert to protect itself against "piracy". Its members included such well known composers as John Philip Sousa, who himself was present at the hearings, Fritz Kreisler, Carrie Jacobs Bond, Rachmaninoff, and 530 other members.

"An effort is being made to have you legalize piracy," Mr. Buck said earnestly. "They say the broadcasting stations are not making any money. Let me say that

(Continued on page 14)

Separate Commission Asked by Couzens

WASHINGTON.

The creation of a Commission on Communications, which would take over the regulation of radio, telephones and telegraph is sought in a bill which will be introduced in the near future by Senator James Couzens, of Michigan.

Senator Couzens does not believe that the Secretary of Commerce or any other one man should have control of the regulation of broadcasting. He thinks that ultimately a Communications Commission will be necessary, and he is in favor of its immediate creation.

"I think Hoover has done a mighty

(Concluded from page 13)

great deal of profit is not tangible. It is rather in the thing known as good will. Ninety per cent of the composers are poor men.

"The Radio Corporation of America and its allied stations—one of the biggest broadcasters in the country—has not taken out a license with us. That proves we do not have a monopoly.

"Our society last year distributed among 530 members radio profits amounting to \$113,000. This is a price fixing bill—have no illusions about that.

"All the broadcasters want is our hits. Sousa has written a thousand marches but all they want are his best—the high lights. You were told about a light opera that was popularized by radio and 3,000 tickets sold. The same producer, Mr. Hammerstein, produced another opera following that, which was put on the radio, but it was not a success. Later he produced a third opera which proved one of the greatest successes of the season and Mr. Hammerstein told me he didn't want it broadcast because it hurt his business."

Mr. Buck said the radio had caused the sale of sheet music to drop off 50%.

"Charles K. Harris, who wrote 'After the Ball' back in 1892," he continued, "before piano players, phonographs, or other mechanical reproducers were in vogue, made more money out of that song than Irving Berlin made out of 'Remember,' recently composed and put on the air with the aid of radio and all the mechanical reproduction agencies."

"I am here fighting for the creator—the writer of songs. Never again will any composer die in poverty in this country."

good job of regulating broadcasting with the limited authority he has had," said the Michigan Senator. "But at the same time radio is growing so fast that nobody can tell where it will end up.

"I am not in favor of the Commission proposed in the White bill. I think it is a makeshift proposition. Nor do I favor placing radio with the Interstate Commerce Commission. That body already has its hands full with the railroads.

"If we are going to pass a bill at all, we should make a good job of it. Too much is at stake for us to gamble with the public interest by enacting a haphazard, makeshift bill."

New Bill Avoids Having Congress Fix Music Price

WASHINGTON.

The attempt to have a bill passed whereby Congress would fix the fee that composers are to charge broadcasting stations is believed doubtful of success, so Representative Vestal, of Indiana, has introduced a third bill. Said Mr. Vestal:

"The new bill I have introduced provides that radio broadcasters, hotel orchestras, cabarets, in fact anybody playing copyrighted music, shall have the right to deal directly with the owner of the music.

"Also it provides that if the owner of the copyright wants to reserve the right for broadcasting he must so state and fix the price so that the broadcaster, hotel, or whoever wants to use it may know exactly what he must pay for it.

"And further, the bill provides that the owner of the copyright shall affix on some accessible place on such music and upon phonograph, disc, cylinder or other contrivance for the mechanical reproduction, a notice of the amount of royalty prescribed for any use of such music for public performance for profit.

"Thus the copyright owner fixes his own price instead of the matter of price being put up to Congress. Likewise, when the music is released for the purpose of broadcasting to one, it is released to all."

Static Ground With Sausages In Meat Mart

TUCSON, ARIZ.

A small split phase motor operating a sausage grinding machine in a meat market was found to be the cause of a considerable amount of the radio interference reported by fans. A radio inspector who covers that region reported that the proprietor of the market complied with suggestions made by the inspector and as a result all of the interference in that locality was eliminated.

Trolley Truck Motors Interfere

WASHINGTON.

Investigating many complaints from listeners-in in a western city, the Radio Inspectors of the Commerce Department ascertained that a new type trolley car used by the local traction company was causing practically all of the trouble.

After testing the rail bonding, trolley poles, and other suspected causes of the interference, the inspectors discovered that the truck motors on the cars were responsible.

The inspectors reported that the traction company readily agreed to cooperate in helping to improve the situation by issuing orders to equip all such type cars with a special filter for the truck motors. It is believed that the filters will eliminate practically all of the present interference in that locality.

Five Sources Predominate

WASHINGTON.

Radio inspectors in a Western city found that practically all reported interference was caused by leaky telephone ringing machines, power and telegraph lines, pole transformers and small motors, etc.

Complying with the trouble eliminating suggestions of the department's inspectors one of the leading power companies volunteered to rebuild one of its 60,000 volts transmission lines. In addition, the company authorized the purchase of a Super-Heterodyne to patrol its lines in an effort to reduce to a minimum any interference which might be caused by its equipment.

Million in Cold Cash Was One Plan Discussed

E. C. Mills, chairman of the executive committee of the American Society of Authors, Composers and Publishers, said that negotiations had taken place between the Society and the Broadcasters' Association in connection with a proposed agreement, under which the broadcasters would pay \$1,000,000 for three years for the use of all copyrighted music controlled by the society.

"We agreed to accept those terms if the broadcasters could get 80 per cent. of the broadcasting stations to sign up," said Mr. Mills. "We found, however, that the committee with which we made the agreement did not attempt to sign up the 80 per cent., but merely endeavored to keep us negotiating, while they sent out calls to all broadcasters asking for contributions to help their fight to push the proposed legislation through Congress."

SPEAKER SETS POPULAR

About four-fifths of the sets in the United States are equipped for loud speaker operation.

Committee Hearing on Copyright Bill



A GENERAL view of joint committees of the Senate and the House holding hearings on the Dill-Vestal Copyright Bill, with an interested audience of publishers of popular music and broadcasters in the background. (Underwood & Underwood).

High School Education for All, Is Radio's Aim

TO give every one in the United States a high school education is the part radio is destined to play in twentieth century schooling, according to Ira Cammack, superintendent of schools of Kansas City, Mo., and a pioneer in teaching by radio.

"Radio will make United States citizens the best educated people of all time," Superintendent Cammack predicted, "in two ways—first, by conveying instruction to adults who were compelled to leave school prematurely, and, second, by making methods of teaching children more practical.

"Boys in Kansas City whistle grand opera music more than jazz tunes.

"Why? Because radio has made their musical education much more than a weekly hour of singing 'do-re-me-fa' and so on up the scale.

A Living Representation

"To teach the civics lesson on 'How the President of the United States is Inaugurated,' we last year assembled the children in their school auditoriums, where, from radio loud speakers installed there, they actually heard Chief Justice Taft administer the oath of office to President Coolidge and the President's inaugural address. Thus radio improves the old method of simply making children memorize the oath of office from a book."

Radio broadcasting of agricultural and home economics information makes educators realize that this would not be necessary had these facts been learned at school, and prods them to teach this practical knowledge thoroughly in classrooms, Superintendent Cammack added.

An Extension School

Appreciating that some Americans always will have to go from classroom to workshop before completing high school courses, educators plan to convey to them by radio the education from which they otherwise might be averted.

Mexico's government is giving its citizens a grammar school education by radio. Educators of the United States, through broadcasting stations at universities, already have started to carry this movement at least one step higher, Supt. Cammack pointed out.

That radio is destined to have a much larger place in education both in school and out than now is realized is the opinion advanced by Joy Elmer Morgan of the National Education Association. Mr. Morgan cites as an example that among our 25,000,000 school children in the United States there are probably a million who are studying approximately the same thing at the same time.

Readings by Authors

"It would be possible to take some selection in literature that every child should know and have it read by some such beautiful master voice as Julia Marlow," Mr. Morgan went on. "It would be possible on holidays, such as Washington's birthday, to have noted authors read from their own selections. No child could listen to Edwin Markham read his noble poem, 'Lincoln, the Man of the People,' without getting a fuller appreciation of Abraham Lincoln and a fine feeling for poetry.

"It would be possible to have musical selections, both vocal and instrumental, played to a national audience of school students. Geography could be made a rich adventure by introducing frequent talks by men and women who had recently

Coolidge Before "Mike"

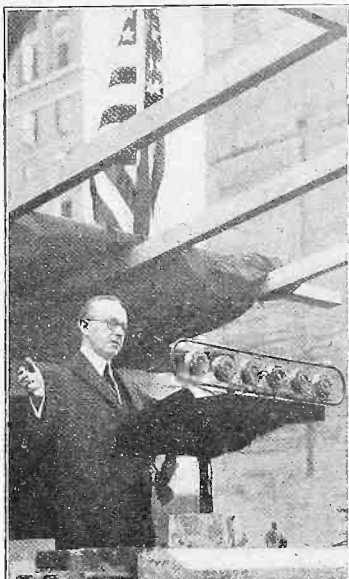

PRESIDENT COOLIDGE speaks at laying of the cornerstone of the new \$100,000,000 home for the National Press Club, in Washington, D. C. The speech was broadcast by stations throughout the country. (International Newsreel)

visited areas which the children were studying. There are also large possibilities for radio in the improvement of instruction.

Radio in the Classroom

"Were there a radio in every school it would be possible to broadcast master lessons and recitations in various subjects which would be rich in suggestions to younger and inexperienced teachers. There is another angle that is more important. Teaching is an arduous occupation. There are long hours of uninterrupted strain. To break this strain a few times during the day by genuinely helpful inspirational material over the radio would enable the teacher to come back into the day's work with fresh vigor. These are just a few of the possibilities.

"Every state school system, every city school system of any size, the United States bureau of education or department of education, and every manufacturer of radio should have an expert at work studying the possibilities of using this new tool, probably the greatest contribution to the advancement of popular intelligence since the invention of movable type at the middle of the fifteenth century."

WBPI Uses Crystal As Wave Confiner

The WBPI transmission apparatus will be "crystal controlled" to hold the transmitter on its exact frequency assignment thereby eliminating any possible interference with other stations on wavelengths near 263 meters. This controlling device will be of the type which is coming into wide use among many of the larger stations of the country. WBPI, owned by the I. R. Nelson Co., will be the first station in Newark, N. J., to put in a device of this nature.

Fading Linked With the Swing Of the Signals

ITHACA, N. Y.

The directional change in transmission, an old phenomenon, is allied with that other great mystery of fading, Dr. C. C. Bidwell, professor of physics at Cornell University, announced following careful experiments. Prof. Ernest Merritt told of the results as follows:

"Fading is familiar to most radio fans. It often interferes seriously with reception, especially of distant signals. If indicating devices more sensitive than the ear are used it is found that the intensity of radio signals often fluctuates back and forth through a wide range in just a few seconds and that these fluctuations are extremely erratic.

Fading Worse at Night

"Fading is worse at night and depends in some manner not well understood upon weather conditions, especially in the upper atmosphere.

"It probably is not generally known that there are fluctuations in the direction from which signals seem to come that are just as violent and erratic as the changes in intensity. If a direction finder or radio compass is used to determine the direction of signals from some broadcasting station, the direction may be found to be widely different from the exact geographic location, and the apparent direction changes back and forth in a most puzzling way.

"During the eclipse of the sun a year ago observers at Ithaca found that Station WEAJ in New York City had apparently moved over into New Jersey so that for ten or fifteen minutes after totality it was located in the neighborhood of Trenton. Then it got over its nervousness and moved back again to Manhattan Island as the sun became unobscured.

Less Marked on Sea

"Fortunately, direction changes are much less marked on sea than on land; otherwise the radio compass would be of little value.

"Direction changes also are greater at night and undoubtedly depend upon atmospheric conditions. Recently, Professor Bidwell has detected a relation not previously known to exist between these apparent direction fluctuations and fading.

"Simultaneous observations made of changes and intensity over a number of hours would show, besides the sudden and erratic changes, a gradual drift up and down in intensity, and to one direction and another. Professor Bidwell finds that these go together.

"For example, great intensity comes at the same time that the direction is deflected to the north, small intensity when the direction is toward the south. This relation is found in so many instances that it seems hardly possible it can be accidental.

"Apparently, therefore, direction changes and fading are due to the same ultimate cause. There is every reason to believe that it is connected with conditions in the upper atmosphere at an altitude of 100 miles or more and it seems likely that the continued systematic study of the phenomena will help to find out what the condition is."

EXTENT OF LISTENING

It is estimated the average listening period is more than two and less than three hours at night.

Improvised Alarm Switch Insures Getting Up for the Dawn Exercises

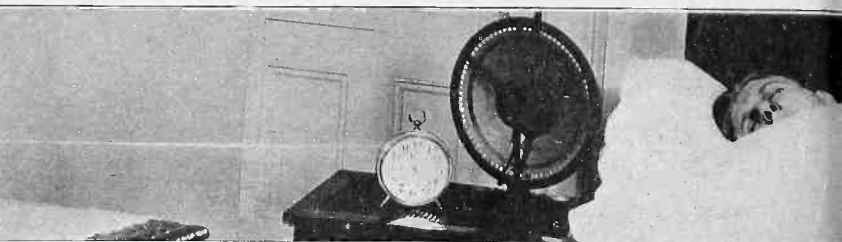
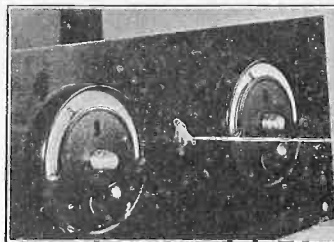

THE conventional object of an alarm clock is to wake you up, but it may be made to do this and likewise turn on the set to bring in the setting-up exercises. The alarm winder is connected to the A battery switch of the set. When the bell rings the winder reverses and pulls the switch. The clock is secured to the table, to prevent the timepiece from decorating the floor.

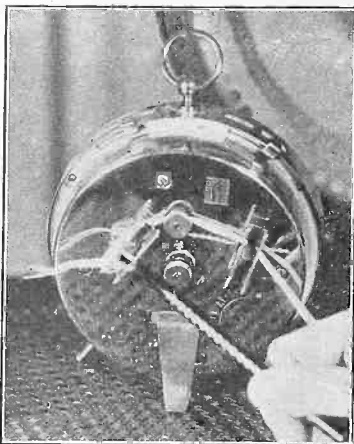

HERE is the rear view of the clock. The alarm winder is at left. Note the brace at bottom, securing the clock to the cane work. A 6/32 screw and nut are used. Wind up the clock, set it for the appropriate hour and minute of arising, then attach the cord so that when the winder unwinds it winds the cord on itself. This pulls the switch. (Hayden).

A Station from Aloft

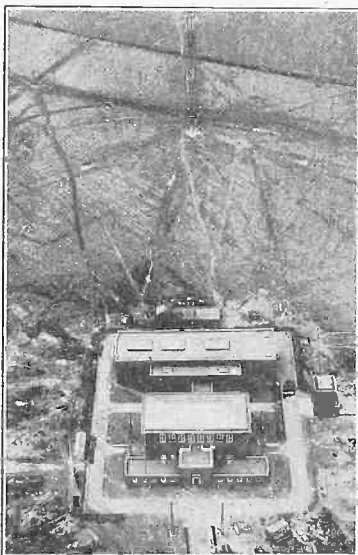

FROM the top of one of the twelve steel antenna masts, each 820 feet high, the new Hillmorton (Eng.) radio station looks like this. (International Newsreel).

A Courageous Woman



WHILE a student is listening to a broadcast lesson on how to shampoo a woman's hair, the fearless human testboard lets him put into practice the tips that come over the air.

Simple Short Wave Set

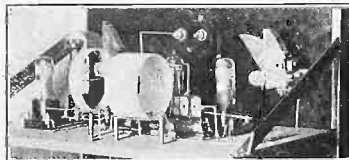

HERE WE have a neat layout of a short wave receiver. It will be noted that straight line frequency variable condensers are employed. The capacity method of feedback avoids the use of a rotary tickler coil.

Frequency Tuning



IF you employ SLF condensers and you wish to obtain accurate adjustment, a vernier dial (center) should be employed. If, however, you have a semi-circular plate condenser, by using SLF the dial, at right, the same effect may be had. (Hayden).

A Speaker in Each Room



MANY folk have formed the habit of putting a speaker plug-in switch in each room. In new houses the electric wiring would include speaker leads to all rooms. Hence, even while shaving one may have the speaker at hand. The audio output should be through a 1-to-1 transformer or a choke coil-condenser combination to prevent severe volume drop in the long leads to speaker. (Hayden)

A Song Restorer

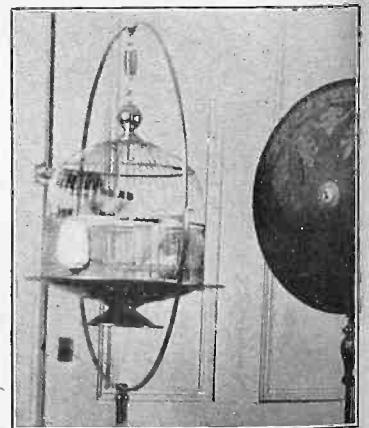

OFTEN better than medicine, if a canary has stopped its song, is a radio set. The music and voice put the bird in fine spirits. (Hayden).

Boon to Family Life



SO INTERESTED is this fan in his set, that he can't wait to get home and upon entering, with coat on, tunes in dinner music. Everyone eats together in this home. (Hayden).

A Simple Antenna Coupler

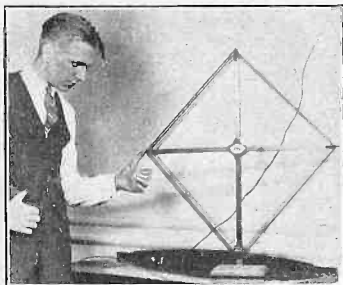

AN EASY WAY to get the benefit of outside aerial current, when it is desired, is to bring the aerial leadin to the loop as shown. Use flexible wire. Wind six turns in and out, between spokes of the loop, in coil fashion, and connect the end of the leadin to ground. (Hayden).

Rethberg Sings and Hears Her Voice Twice



A UNIQUE experiment in broadcasting was recently made by Mme. Elisabeth Rethberg, soprano of the Metropolitan Opera Co., and R. E. Lacault, former managing editor of "Radio News," and now Chief Engineer of the Phenix Radio Corporation. Mme. Rethberg was enabled to hear her own voice sent out over the air and received in the transmission room on an Ultradyne receiver. (International Newsreel).

Britain Starts Air Interviews of Notables



FOR THE first time in the history of British broadcasting a newspaper conducted a complete interview over the air. Laura LaPlant, motion picture actress, was interviewed by L. Malcolm Kraft for British stations G2KS, G2DK and G2OD. Newspaper men in Great Britain, Paris, Sidney and Cape Town heard her voice quite clearly, according to reports. (Acme).

Voice in Phones Comes From Speaker

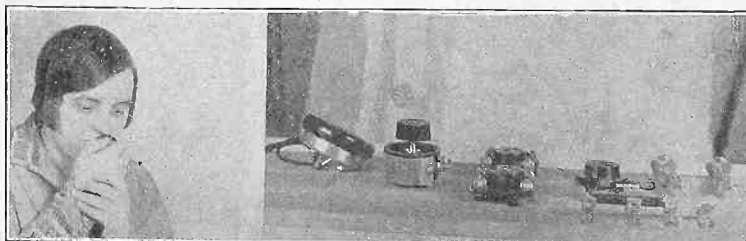

BY speaking into the phones, inserted in the audio input as a microphone, your voice may be heard in the speaker. (Hayden).

A THOUGHT FOR THE WEEK

WE highly approve of the public interest in radio, but in so doing we cannot refrain from entering a protest against the over enthusiasm of the so-called "radio bandit" of New York. This zealot wanted to collect so many sets that he smashed front doors, used fire escapes, and even sandbagged unwilling contributors while in pursuit of his favorite indoor sport.

RADIO WORLD



Radio World's Slogan: "A radio set for every home."

TELEPHONE BRYANT 0558, 0559
PUBLISHED EVERY WEDNESDAY
(Dated Saturday of same week)
FROM PUBLICATION OFFICE
HENNESSY RADIO PUBLICATION CORPORATION
145 WEST 49th STREET, NEW YORK, N. Y.
(Just East of Broadway)
ROLAND BURKE HENNESSY, President
M. B. HENNESSY, Vice-President
FRED S. CLARK, Secretary and Manager
European Representatives: The International News Co.
Breems Bldgs., Chancery Lane, London, Eng.
Paris, France: Brentano's, 8 Avenue de l'Opera
San Francisco: Lloyd B. Chappell, 636 O'Farrell St.

EDITOR, Roland Burke Hennessy
MANAGING EDITOR, Herman Bernard
TECHNICAL EDITOR, Louis Winner
CONTRIBUTING EDITORS, John F. Rider, J. E. Anderson

SUBSCRIPTION RATES

Fifteen cents a copy. \$6.00 a year. \$3.00 for six months. \$1.50 for three months. Add \$1.00 a year extra for foreign postage. Canada, 50 cents.
Receipt by new subscribers of the first copy of RADIO WORLD mailed to them after sending in their order is automatic acknowledgment of their subscription order. Change of address should be received at this office two weeks before date of publication. Always give old address; also state whether subscription is new or a renewal.

ADVERTISING RATES

General Advertising	
1 Page, 7 1/2" x 11"	602 lines, \$300.00
1/2 Page, 7 1/2" x 5 1/2"	251 lines, 150.00
1/4 Page, 8 1/2" D. C.	231 lines, 130.00
1/4 Page, 4 1/2" D. C.	115 lines, 75.00
1 Column, 2 1/2" x 11"	154 lines, 100.00
1 Inch	100.00
Per Agate Line	.75

Time Discount

52 consecutive issues	20%
26 times consecutively or E. O. W. one year	15%
4 consecutive issues	10%

WEEKLY, dated each Saturday, published Wednesday.
Advertising forms close Tuesday, eleven days in advance of date of issue.

CLASSIFIED ADVERTISEMENTS

Ten cents per word. Minimum 10 words. Cash with order. Business Opportunities ten cents per word, \$1.00 minimum.

Entered as second-class matter March 23, 1923, at the Post Office at New York, N. Y., under the Act of March 3, 1879.

APRIL 24, 1926

This Won't Help Any

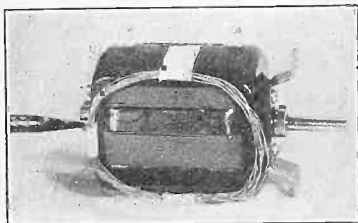

IF TURNS are added to a variometer as shown above the effect of the addition will be nil. The turns must be put either right on the rotor or stator form.

Popular Harmonizers of KYW



HERE WE have the members, namely A. W. Carpenter, F. W. Willard, L. Rowles and O. Covert, of the famous Apollo Male Quartette, who are frequently heard from Station KYW, Chicago, Ill. Thousands of letters are always received when these songsters appear. They can never fill all the requests that are received during their recital.

Medalist Heard Weekly



MARTHA KOVACKS, called the Medal Violinist, will be heard on all Sunday afternoons at WBNY, New York City. Miss Kovacks is only seventeen but her concert work has taken her all over the country. She was first brought to light when she easily won in a contest, competing against hundreds.

Ardent Radio Fan

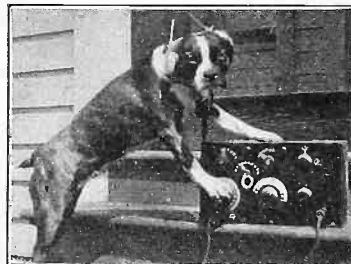

EVEN OUR four-legged friends are interested listeners in. Here we see Buddy tuning in for DX. A vote in the contest for best programs, recently held by RADIO WORLD, was cast by Buddy's owner. The point that Buddy liked classical music was stressed, "He barks like mad when he hears jazz," says his possessor.

The Placing of Coils

Troublesome interaction between the single layer coils in a receiver can be eliminated or at least diminished by the radio fan, if he really gives careful attention to the location of the various coils. Energy will not be transferred by induction into another coil, if the plane of the wires constituting the winding is at right angles to the wires of the other coil.

MacDonald Attacks Hoover in War Over Use of Outlaw Wave

WJAZ's appropriation of a wavelength not awarded to it by the Department of Commerce was legal and justified, because the station is "engaged in the transaction of bona fide commercial business by radio communication or in experimentation in connection with the development and manufacture of radio apparatus for commercial purposes." Such is the contention of Commander E. F. MacDonald, Jr., president of the Zenith Radio Corporation, the station owner. The government sued to shut down the station at Mt. Prospect, Ill. His statement follows:

My attention has been directed to an Associated Press dispatch from Washington quoting Secretary Hoover, in which he says "the future of radio broadcasting on the American continent depends upon the outcome of the Government test suit against the Zenith Radio Corporation, and that a decision against the Government will make \$600,000,000 worth of radio receiving set useless."

I have heretofore refused to answer similar statements from Mr. Hoover while the case was pending, but this last statement demands an answer.

The Secretary of Commerce had his opportunity to present the facts and argue this case before Judge Wilkerson when the case was on trial, and I believe that this attempt to retry the case in the newspapers before the decision is rendered is eminently unfair to the public. In addition, Mr. Hoover's apparent attempt as a representative of the Executive Department of the Government to influence public opinion in a pending Federal Court case is reprehensible and establishes an extremely dangerous precedent.

This statement attributed to Mr. Hoover is absolutely incorrect, and Mr. Hoover, or at least his attorneys, know that it is not correct. The only effect of the decision in this case will be the determining of the right of the Secretary of Commerce to place restrictions as to wavelengths on a certain limited class of broadcasting stations.

Regulation No. 15 of the Radio Communication Laws, as enacted by Congress in 1912, reads as follows:

"Fifteenth. No private or commercial station not engaged in the transaction of bona fide commercial business by radio communication or in experimentation in connection with the development and manufacture of radio apparatus for commercial purposes shall use a transmitting wavelength exceeding 200 meters, or a transformer input exceeding one kilowatt, except by special authority of the Secretary of Commerce contained in the license of the station."

The only question raised in the test case in Chicago is whether or not the Secretary of Commerce has the right arbitrarily to assign wavelengths and hours of operation to stations engaged in one of the two above described classes. The Zenith Radio Corporation comes within the latter class. The great majority of radio stations are not in either class, and no broadcasting stations other than those engaged in the two special classes described by Congress can operate on a wavelength in excess of 200 meters, without special authority from the Department of Commerce. No one has ever claimed otherwise, and the Secretary's power in

that respect is not being questioned in the Zenith case.

I am surprised to read Mr. Hoover's statement to the effect that the present division of wavelengths is a voluntary one. This is directly opposite to the position taken by him, through his attorneys, at the hearing of the Government case in Chicago. He then distinctly contended that he had absolute power to allocate wavelengths as to all broadcasting stations. The Zenith Radio Corporation did not dispute his authority to do so, except in the case of broadcasting stations coming within the two limited classes above described by Congress. The language of

the radio act of 1912 establishes these two classes definitely and is clear and unambiguous, and they cannot be confused with the general run of broadcasting stations.

Frowns on Chaos Talk

Regardless of the decision in this case in Chicago, there will be no chaos as a result. If conditions do become more chaotic than they are at the present time, it will be because of Mr. Hoover's inequitable administration of the law.

While the present radio law gives to the Secretary of Commerce considerable power in regulating radio generally, Zenith Radio Corporation is heartily in favor of legislation which will more effectively regulate broadcasting. It is opposed, however, to vesting in any individual, whether it be the Secretary of Commerce or any other Government officer, the sole and arbitrary power to administer the rights of broadcasting stations. This authority should be vested in an impartial Commission and I sincerely hope that legislation will be passed to accomplish this.

Details of Wiring Up a DC Eliminator Unit

The following supplements Lewis Winner's article on DC eliminators, published April 10.

The other terminal of the fuse goes to one terminal of the choke coil, L1, and to a terminal of the fixed condenser, C1. The other terminal of the cord goes to one terminal of the switch. The other terminal of the switch goes to one terminal of the fuse. The other terminal of the fuse goes to the other terminal of the fixed condenser, C1, to one terminal of C2, to one terminal of C3, to one terminal of C4, to the B minus post and to one terminal of C5. The other terminal of L1, goes to the other terminal of C2 and to one terminal of L2. The other terminal of L2, goes to the other terminal of C3, to the B plus Amp. post and to the resistance post of the variable resistor, R2. The B plus detector post goes to the arm of the variable resistor, R2. This post also goes to the other terminals of C4 and the fixed resistor, R1. The left off terminal of C3 goes to the ground post.

All wiring may be done with flexible wire, such as Celatsite. Some type of insulating material would cover the wire, to prevent shorts, etc., as the wiring is very close. The voltage obtained from this eliminator will not be very high, e.g., about 90 maximum. This is due to the low input voltage, e.g., 110, and the drop across the chokes.

Be sure that when you connect the plus

and minus of the DC line to the plus and minus of the eliminator, you have the correct terminals. This is best determined by placing both leads from the line in a glass of salt water. About the negative leg bubbles will form, while nothing will happen around the other terminal. The variable resistor varies the voltage usually placed on the plate of the detector tube.

The fixed condensers, C4 of Eliminator 1, and C5 of Eliminator 2, are protective devices. Therefore when installing these be sure that they do not contain a closed circuit. Let us suppose that C4 is shorted. Let us also suppose that instead of the minus post of the eliminator being connected to the minus of the line, it is connected to the positive side. The A minus or A plus, which goes to the B minus, in most sets is grounded. The negative side of the DC line also is grounded. The result would then be a perfect short circuit in the line and the blowing out of the tubes. However, by connecting the set ground post to the by-passed ground (same set ground used before, but connected to the condenser post in the eliminator) and reversing the leads, neither side of the line will be conductively grounded again by that of the set, as there is no direct contact. Of course, you want to be sure of the positive and the negative side of the line, using the method mentioned heretofore

How the "Cans" Are Placed in the Fenway

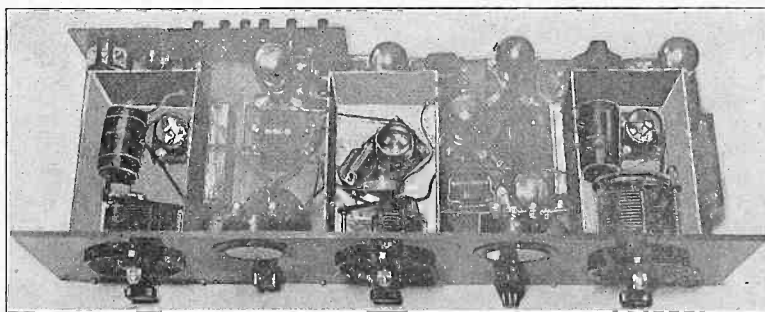

THE arrangement for placing the copper or tin shields in the Fenway is shown clearly, the cans and their contents being accentuated. The center can shows a grid leak and condenser, the Micamold products being standard in this receiver.

THE RADIO TRADE

Fada and Kent Tied In Distribution in N. Y.

A survey of more than 200 radio dealers in New York City, made by the New York University Bureau of Business Research, shows the following:

Fada and Atwater Kent are tied for first place among sporting goods stores, each having 53 per cent. distribution. The Radio Corporation of America comes next with 47 per cent., Eagle next with 33 per cent. and Stromberg-Carlson has 20 per cent.

In electrical stores Atwater Kent is first with 49 per cent. and Fada second with 37 per cent.; then come Stromberg-Carlson with 29, Freshman with 26 and Freed-Eisemann with 23.

In auto supply stores Fada and Atwater Kent tie for first place with 42 per cent. each in distribution in this type of outlet. Radio Corporation of America runs third.

New Fada Set Reaches Daventry Wave Also

F. A. D. Andrea, Inc., has announced a specially built long wave neutrodyne receiver designed to receive both the normal 200 to 600 meter band and the 1,050 to 2,500 meter band.

The circuit is designed to tune in such stations as Daventry, England, 5XX, transmitting on 1,600 meters. The set was specifically designed for use in England and on the Continent. But the fact that many fans in this country would be also interested in such a model caused the manufacturer to build the unit so as to be available in limited quantities at this time for use in any of the Fada cabinets or art furniture model combinations.

The additional wavelength band is secured by means of special wound inductances mounted over the standard neutroformers and with three small lever switches operated from the face of the panel, which permits instantaneous throw-over from the 200 to 600 meter band to the 1,050 to 2,500 meter band.

Southern California Show, Sept. 5 to 12

The committees of the Radio Trades Association of Southern California is busily engaged in plans for the 1926 Radio Show, to be held in the Ambassador Auditorium, Los Angeles, from Sept. 5 to 11, inclusive. This association is composed of the representative radio dealers, jobbers, distributors and manufacturing agents of Southern California.

Among the prominent radio men of the Southwest, who have been named on the committee are: J. A. Hartley, Carl A. Stone, C. H. Mansfield, W. D. Scott, J. W. Boothe, Lombard J. Smith and Al Meyer. J. A. Hartley is chairman of the committee, laying out the preliminary plans. Waldo T. Tupper, exposition expert, who so successfully handled the event last year, has been named as manager.

OPENSHAW IN EUROPE

M. Openshaw, of the Radiall Company, left for an extended trip to Europe, where he will visit all the important radio centers in the interests of his company.

In hardware stores Atwater Kent is the only manufacturer with heavy distribution. In radio stores Atwater Kent runs 47 per cent. and Fada 37, with Freshman at 28 per cent. In music stores Atwater runs 66 per cent. and Fada 30 per cent., the investigation covering in this type only 49 stores.

According to the survey, the six manufacturers with leading distribution in the five boroughs of New York City are: Atwater Kent, 56 per cent.; Fada, 36; Radio Corporation of America, 29; Freed-Eisemann, 21; Stromberg-Carlson, 17.

The investigation disclosed these six and two others with 11 per cent. distribution and 129 other brands. An interesting point was that some very well known sets had only between five and ten per cent. distribution in the New York market.

Third Radio World's Fair To Be Held Sept. 13 to 18

New and larger headquarters have been opened by the Radio World's Fair management. The offices have been moved from the sixth to the eighteenth floor in the Times Building, New York City.

The first national convention of radio artists and celebrities, at which will be present men and women whose voices are known to millions of Americans, will be held in New York City September 13 to 18. Announcers will be included in the array of guests at the convention, which will be a feature of the radio exposition at the New Madison Square Garden.

In addition to completing plans for the Third Radio World's Fair in New Madison Square Garden, September 13 to 18, G. Clayton Irwin, Jr., is actively at work in making preparations for the Fifth Annual Chicago Radio Show in the Coliseum, October 11 to 17.

Parts Exceed Sets In Month's Exports

WASHINGTON.

Exports of radio apparatus from the United States totaled \$543,972 in February as against \$477,591 for the corresponding month of 1925. Of the total February shipments of radio apparatus, receiving sets accounted for \$172,910 and receiving set accessories and components for \$272,000.

New A Battery Tester

A new means of stesting storage A batteries that is absolutely accurate and approaches the Cadmium Test, which is the laboratory standard, has been perfected. It eliminates hydrometer reading, which is a means of telling the specific gravity in the battery. This new device, which is as efficient as an ammeter, a voltmeter and a hydrometer combined, tells the exact condition of the battery, whether fully charged and in good condition, partly charged but all right to use or if in need of charging. One merely has to press a button. This insures uninterrupted battery service and greatly lengthened battery life. A neat folder containing full information regarding this Cell-o-meter will be sent free by Stoner & Heath, Inc., 122 Greenwich Street, New York City. Mention RADIO WORLD.

Literature Wanted

THE names of readers of RADIO WORLD who desire literature from radio jobbers and dealers are published in RADIO WORLD on request of the reader. The blank below may be used, or a post card or letter will do instead.

Trade Service Editor.

RADIO WORLD,
145 West 45th St., N. Y. City.

I desire to receive radio literature.

Name

City or town

State

Are you a dealer?.....

If not, who is your dealer?

His Name

His Address

Dr. H. P. Lindsey, Clarydon, Ia.
C. A. Hartman, 366 Cleveland Ave., Trenton, N. J.
Percy Hough, Box 151, Stone, Ky. (Dealer).
Joe Hamata, Raymond, Neb. (Dealer).
William Kardie, West Hazleton, Pa. (Dealer).
Willie E. Hunter, Prosperity, S. C.
James H. Simmons, Gaffney, S. C.
S. S. Shatford, Jr., 39 South Park St., Halifax, Nova Scotia. (Dealer).
E. T. Hall, 13 Hunt Ave., Buffalo, N. Y.
Louis M. Wagner, Box 31, Elkader, Ia. (Dealer).
Roy Loux, Room 409, Y. M. C. A., 1013 West Lehigh Ave., Philadelphia, Pa.
William Staunton, 4345 Bryant St., Denver, Colo. (Dealer).
G. E. Robertson, 717 East 11th St., Oklahoma City, Okla.
E. T. Wesley, 1329 East 9th St., Kansas City, Mo. (Dealer).
E. J. Murray, 340 East 139th St., N. Y. C. (Dealer).
L. Lacey, 2031 Georgia Ave., N. W., Washington, D. C. (Dealer).
S. T. Bond, 775 Bush St., San Francisco, Cal.
Merrill Elliott, c/o Wiley High School, Terra Haute, Ind.
Crescent Garage, Central Park, N. Y. C. (Dealer).
Morris Kress, 245 West 10th St., Jacksonville, Fla.
Ernest L. Wolf, 919 West Madison St., Chicago Ill. (Dealer).
D. T. Ternican, 508 New York Ave., Ogdensburg, N. Y.
Garry Radio & Electric Co., 3401 Kildare Rd., Cleveland Hts., O. (Dealers).

Business Opportunities Radio and Electrical

Rates: 10c per word; Minimum, \$1.00; Cash with order.

WANTED—ALL KINDS OF METAL STAMPING in any kind of metal; we handle 50,000 pieces daily; can manufacture anything in metal; can make your dies for manufacturing any article; at low prices; we own our own water power, our overhead is small; we can save you from 20 to 40 per cent. in manufacturing metal stamping. Address the Hart Manufacturing Company, Unionville, Conn.

COMPLETELY EQUIPPED RADIO PLANT, machine shop, precision lathes, screw machines, presses, fifteen automatic triple winding machines, tools and dies, raw materials used in manufacturing nationally known phone and loud speaker, for sale at \$5,000, about 25 per cent. of original investment. Box 00, Radio World.

RADIO MAN—ATTENTION—WILL SUBLET space in piano, phonograph establishment, doing big business; excellent transient section, Bronx. Further information, Room 4, 354 East 149th, N. Y. City.

SPORTING GOODS, LUGGAGE, RADIO, suburbs of New York; 5 years established; \$42,000 yearly business; will sell stock, fixtures and good will for \$5,000; rare opportunity. Box G. G., Radio World.

RADIO STORE BUSIEST UPTOWN CORNER established 3½ years; also handling sporting goods in Summer; \$7,000 cash necessary; excellent proposition; must sell account sickness. Box XI, Radio World.

METAL ARTICLES, STAMPING ASSEMBLING, finishing, dies and tools for economical quantity manufacturing. Metal Craft Co., 306 East 40th, N. Y. C.

ELECTRICAL AND MECHANICAL MANUFACTURING work wanted, complete facilities, also light drilling, assembling. Robertson, 540 West 22d, N. Y. C. Phone Watkins 6471.

BATTERY CHARGING DEPARTMENT, established location, no competition. General Service, 307 West 42d, N. Y. C.

THE TRIAL OF A MAN'S SOUL

By Dan Napoli



Radio's Greatest Advance Was In Last Four Years

By John F. Rider

Member, Institute of Radio Engineers

SINCE the advent of the first commercial broadcast receiver there has been a general advancement in the electrical design of the various units which comprise a set. An era of painstaking research and development proved beneficial to the entire radio industry and was an important factor in elevating the radio industry to the imposing position it now enjoys.

Were one to compare the best products of yesteryear with those of today, he would at one glance note the superiority of the present-day product. Of course this is not limited entirely to the radio industry, but in the radio industry particularly, due to the insistent demands of an interested public, there has been rapid and marked development in a short time. In fact, if a comparison were made along the lines of development between the years of 1913, the year of birth of the regenerative circuit, till 1922, the year of birth of regular commercial broadcasting, and the ensuing years between 1922 and today, the developments in radio transmission and reception of voice and music during the past four years completely overshadow those of the previous nine years. And in line with this gradual development of the important parts of receivers, such as inductances, condensers and transformers, manufacturers of the small, and to all intents, unimportant parts of receivers have studied these new developments and made every effort to adopt them to their products. This was quite a difficult task, for many of these smaller units were so far removed in their function as an integral part of the receiver that the radical improvements effected upon the major items had no bearing upon them. But to keep pace with the development trend it was necessary to effect improvements, with the result that the present crop of fixed condensers, fixed resistances, grid leaks and sockets is far in advance of that utilized in receivers which brought in the voices of the pioneer radio broadcasters.

Sockets Play Big Part

Of the above mentioned items, the socket assumes the smallest role, as the least important item, yet if one delves deeply into the true function of a socket he finds that the socket, too, bears heavily upon the overall operation and efficiency obtainable with a radio receiver. That vacuum tube sockets did not keep pace

with the development of other radio units is due solely to the neglect of what had been frequently termed a by-product. That manufacturers of sockets made efforts to improve their products is beyond question. The radio industry as a unit has evolved into one of the most competitive industries that ever existed in this country, perhaps never equaled, and finally it will develop into the survival of the fittest.

Now, it may seem strange that so much stress is being placed upon what the majority of fans consider an inconsequential item. The reason for it is that there existed a necessity for greater development in socket design. It is not at all necessary to adhere to the designs of old.

Take for example the Airgap socket, a pioneer among improved sockets, even as the Rauland Lyric and the General Radio audio transformers were pioneers in the development of quality in that line.

Yet if we analyze this new type of socket we find nothing radical in design, nothing which requires a highly trained technical mind to develop, or a highly trained technical mind to comprehend—only the application of common sense in compliance to the demands of the present time.

Effect of Dirt

Many articles have been written describing the detrimental effects of lint, moisture and dust settling upon sockets, especially between the grid and plate terminals, causing a fair amount of surface leakage, consequent leakage of the positive potential from the plate to the grid, resulting in unsatisfactory reception. The recommendation was made to clean the sockets periodically, so as to free them of this source of disturbance. Yet no one thought of isolating the grid terminal from the plate terminal, until this socket made its appearance. Now fans are requesting information relative to the best method of cutting a slot between the grid and plate terminals. The gap does the trick. While it may not show marked superior result in this respect when first installed, the gap makes the advantage apparent after several months. By exercising foresight this manufacturer obviated the necessity of this periodical housecleaning of the socket.

In line with the elimination of grid to plate capacity, so important in tuned radio frequency receivers, the socket practically eliminates all capacity between the grid and plate contact on the socket. That this is so was determined by a very simple experiment. A regenerative re-

ceiver and two-stage audio amplifier were hooked up.

Socket Under Test

An Airgap socket was connected in shunt with the tuning condenser of the receiver. A flexible lead of constant length and position was provided so that either the grid plate contacts were in shunt with the tuning condenser or the plate filament contact. With the former arrangement there was no direct connection between the grid and plate terminals, unless traced through the two filament terminals. In other words, the gap was interposed between the grid and plate and connected across the tuning condenser. In the latter method, the solid dielectric between the plate and filament was connected across the tuning condenser. The receiver was tuned to zero beat with the radio frequency oscillator with the flexible connection to the socket open. The lead was connected to the grid terminal of the Airgap socket. There was no change in the zero beat tuning. The lead was then shifted to the filament terminal and an 600 cycle beat note became audible, showing that the capacity across the solid dielectric in the socket was sufficient to change the tuning of the receiver. This experiment may be carried out by any of the readers, using a broadcasting station in place of the local radio frequency oscillator.

Now this airgap in the solid dielectric between the grid and plate is not an inspiration, but plain common sense, and in operation is of sufficient importance in some unneutralized tuned radio frequency receivers which are critical on internal balancing against oscillation to even remove this unstable condition. Of course, the socket is not a panacea for all radio ills, but it is a great improvement. The pyrex socket, insofar as efficiency is concerned, was an advancement over the majority, and with a gap between the grid and plate would perhaps again reign supreme.

Effect on Short Waves

In line with ultra short wave work, where grid to plate capacity is of paramount importance, the airgap is important since its design practically eliminates all capacity between the grid and plate, and as for surface leakage between the grid and plate, along the dielectric, the path is about as long as one can make it, being around the socket, via the filament terminals.

In measurements conducted upon a batch of standard tubes and sockets it was found that the grid to plate capacity of the tube, including the base, was of the order of from 10 to 12 micro-microfarads.

TEN MILLION POUNDS OF COPPER!

The radio industry has more than doubled its consumption of copper during the last two years and is now approximating 10,000,000 pounds a year.

A 6-Tube Neutrodyne Receiver

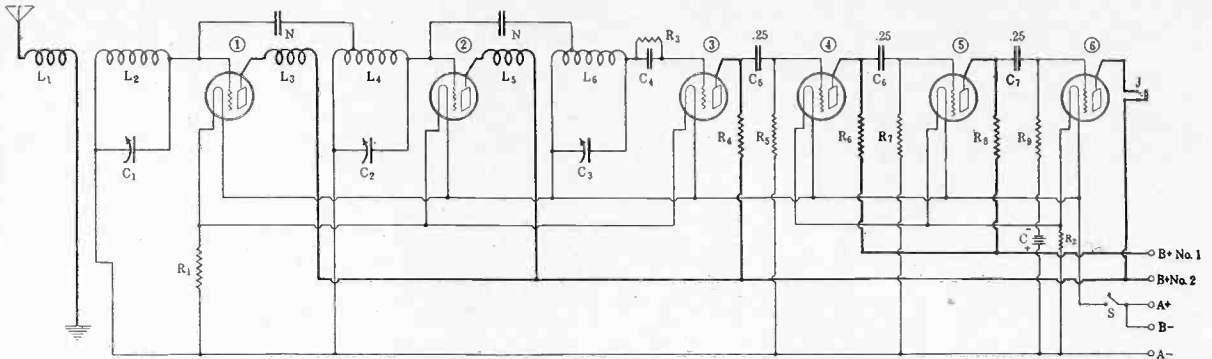

THE SCHEMATIC diagram of the popular Neutrodyne, but with 3 stages of resistance AF coupling. One ballast resistor controls the filaments of the RF and detector tubes, while another ballast resistor controls the filaments of the three audio amplifier tubes. N represents the neutralizing condensers.

How to Get Quality on Three Tubes

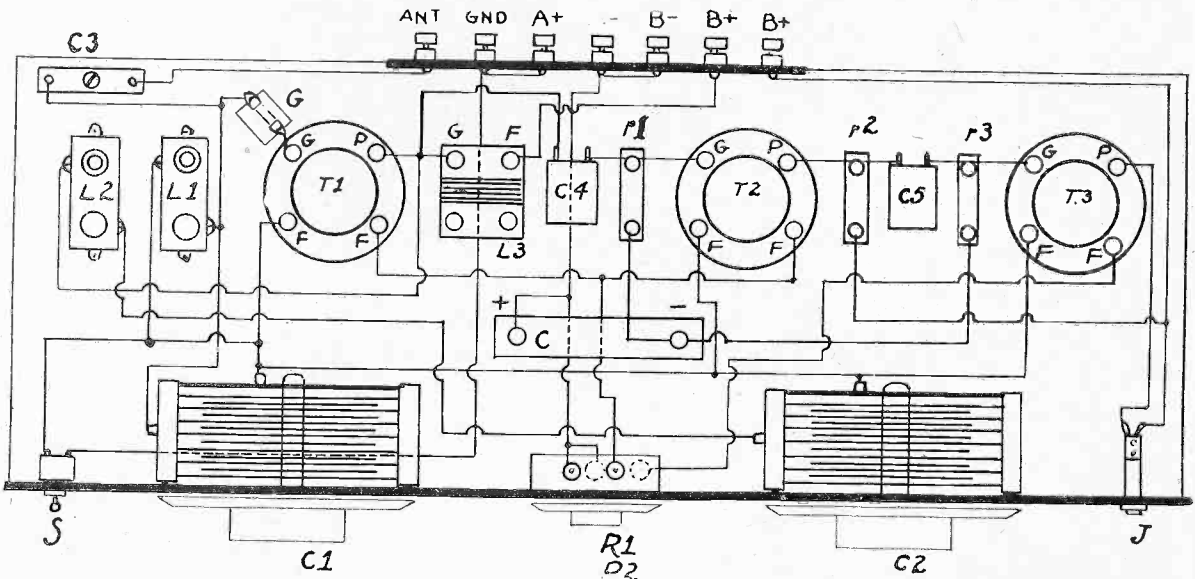

THE PICTURE diagram of the 3-tube quality receiver, described by Brainard Foote in the Feb. 20 issue of RADIO WORLD. It will be noted that besides obtaining a clear idea of the complete wiring, the panel and the layout of the parts on the baseboard are easily seen. Moderate volume with wonderful quality of signals from distant and local stations are obtainable.

The Standard 5-Tube TRF Radio Set

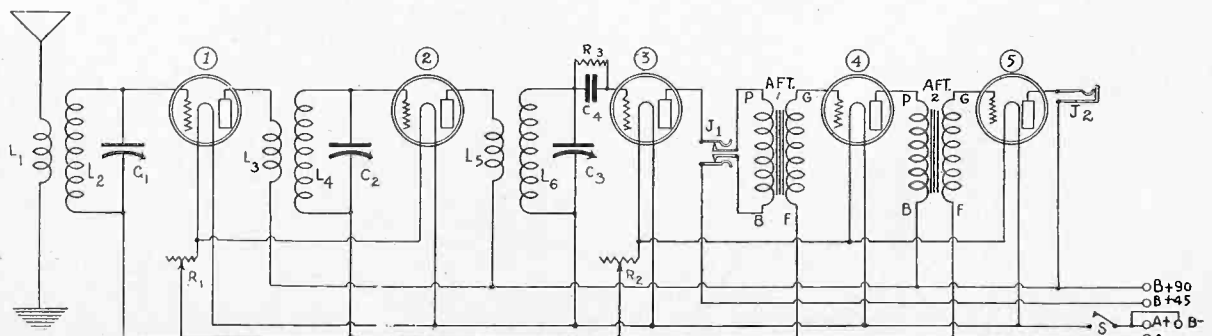

THE CIRCUIT diagram of the 5-tube tuned radio frequency receiver described by Capt. P. V. O'Rourke in the Dec. 26 issue of RADIO WORLD. R2 is a 20-ohm rheostat.

4-Tube Set Affords Excellent Quality

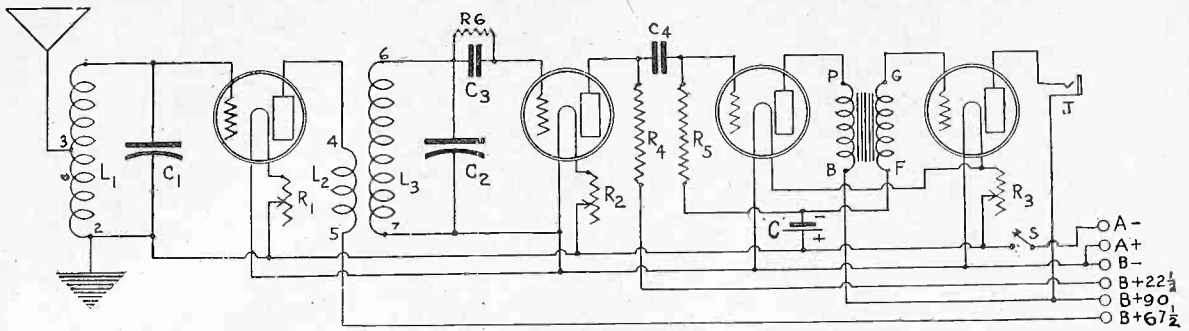

THE SCHEMATIC diagram of the RX1, described in the Oct. 17 issue of RADIO WORLD. With this receiver true reproduction of signals from local and fairly distant stations is obtainable. A separate rheostat controls the filament temperature of the RF and the detector tubes, while one rheostat controls the filament of the two audio tubes.

Low Waves Made Easy Interference

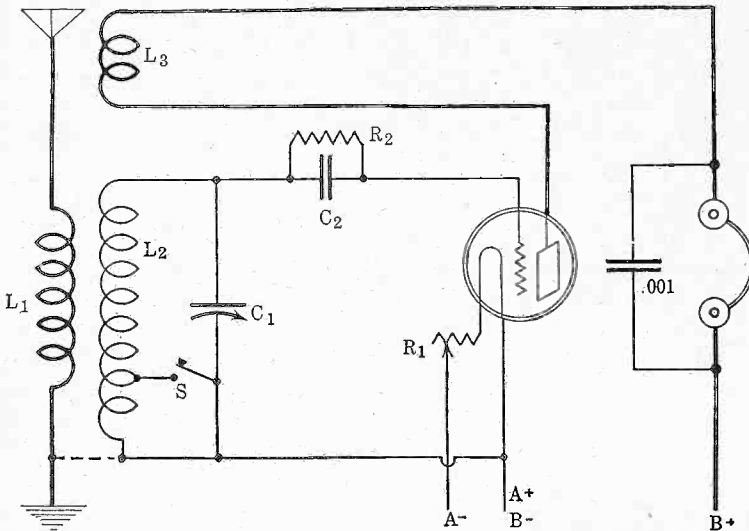

THE ELECTRICAL diagram of the popular "1-tube set, called "A Set A Baby Can Build," described by Herbert E. Hayden in the Aug. 29 issue of Radio World. The switch, S, is used when stations below 200 meters are to be heard, or when the fundamental wavelength of the antenna is too great and the lower wave lengths cannot be heard. If the signals are not voluminous, then the end of the primary winding, L1, should be joined to the beginning of the secondary winding, L2. This is indicated by the dotted line. The switch is cut in about 1-3 the way up on the secondary, from the A battery end, to make the low waves easier to tune in.

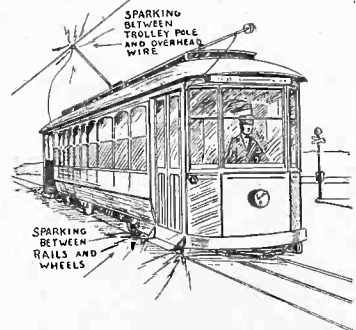
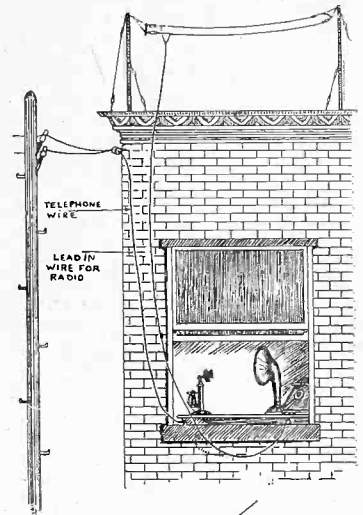

1-Tube Loud Boy Receiver

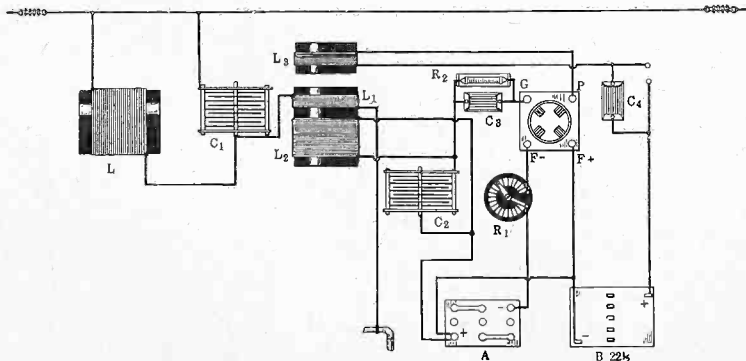

THE PICTURE diagram of the Loud Boy, described by Herman Bernard in the Feb. 6 and 20 issues of Radio World. A standard 3-Circuit tuner is used, while a special coil, shunted by a .001 variable condenser, is placed in series with the antenna. The tuned aerial accounts for the great volume obtainable with this set.

ABOVE WE have two of the most common of electrical disturbances. Placing the antenna lead-in in proximity to the telephone wire is a common cause of static trouble. The peculiar intermittent rumbling is caused by the ringing of the bells, connected by the telephones in the main line. Overhead trolley lines, parallel or in close relation to the antenna or lead-in, are a cause of crackling, also. Often a hum present in a set is due to grounding of the negative filament, and if this grounding is disestablished, the hum disappears.

How to Measure Correctly An Eliminator's Output

One sometimes hears adverse criticism of B battery eliminators on the ground that the voltage supply is insufficient. It is perfectly natural for a fan to try to measure the voltage output of the eliminator unit by the same methods applied to the regular dry or storage battery units. In substance this consists of shunting the output terminals with a sufficiently high-scale voltmeter, the voltage as indicated by the voltmeter being taken as the voltage output of the eliminator.

The solution to the problem is the use of a voltmeter with a high "ohms per volt" value, a voltmeter with a high internal resistance.

The Reciprocal Law

The limiting factor in the design of B battery eliminators has been the definite current output at certain output potentials. The current output decreases with the increase in voltage and conversely the voltage output decreases with any increase in current drain. A B battery eliminator without any load may have an output of

180 volts, but with a load of 25 milliamperes, the output voltage drops to about 145 and with a load of 40 milliamps the output voltage decreases to approximately 80.

If the true voltage output of the eliminator is to be read, it is essential that the potential measuring device draw very little, if any, current. If the resistance of the voltmeter windings is low, the

instrument will draw sufficient current to cause a fluctuation in the source of potential. Fluctuation would be a definite drop in output voltage. Consequently the reading on the voltmeter would not be a true indication of the voltage output of the eliminator.

Meter Drain

Most voltmeters are satisfactory for the determination of the battery voltage, under load, of dry or storage type batteries, but not for the determination of

Distributors of Kits and Parts on:

Victoreen Super Heterodyne, Samson Transcript, Silver-Cockaday, Ultradyne, All Silver-Marshall Products, Roberts Knockout, Drilled & Engraved Panels for all circuits.

Dealers Write for Discounts!

MAURICE SCHWARTZ & SON

710-712 Broadway Schenectady, N. Y.

SANGAMO CONDENSERS WESTON INSTRUMENTS MAGNATRON TUBES

All types and sizes carried regularly in stock for immediate delivery.

ROSSITER & CO., Inc.
Wholesale Distributors
136 Liberty Street, New York

A&B Battery Charger ONLY \$2

SATISFACTION GUARANTEED

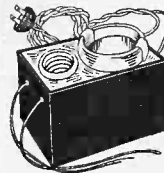

Charges any type of storage A or B Battery, using a few cents worth of ordinary house current, either alternating or direct. Cannot injure battery. May be used as a trickle charger. Tested and approved by Radio News Laboratories. Complete directions enclosed. Anyone can operate. No expensive "extras" to buy.

Why pay \$10.00 to \$15.00 for a charger when you can get this splendid GUARANTEED R. B. Charger by mailing us two dollars (bills, money-order, check or stamps), plus ten cents in stamps or coin to pay mailing costs. Charger will be sent postpaid. If you are not satisfied, return within five days and we will refund your money. Order at once—TODAY!

R. B. SPECIALTY COMPANY
Dept. 701, 308 East Third St., Cincinnati, Ohio

THE VICTOREEN

How to build this 8-tube Super-Heterodyne described in February 20, 27, March 6 and 13 issues of RADIO WORLD. Send 60c for all four copies, including FREE blueprint. Send \$6 for year's subscription and get these four copies and blueprint FREE!

RADIO WORLD
145 W. 45th St. New York City

FREE!
12-Cell—24-Volt Storage'B'Battery

Positively given free with each purchase of a WORLD "A" Storage Battery. You must send this ad with your order. WORLD Batteries are famous for their guaranteed quality and service. Backed by years of successful manufacture and thousands of satisfied users. Equipped with Solid Rubber Case, an insurance against acid leakage. You have 60 per cent and get a 2-Year Guarantee

Bond in Writing WORLD Batteries "sell their friends." That's our best proof of performance. Send your order in today. Solid Rubber Case Radio Batteries:
6-Volt, 100-Amperes \$11.25
6-Volt, 125-Amperes 13.25
6-Volt, 140-Amperes 14.00

Solid Rubber Case Auto Batteries:
6-Volt, 11-Plate \$13.25
6-Volt, 13-Plate 15.00
12-Volt, 6-Plate 16.00

Send No Money Just attach battery wanted and press C. O. D. subject to your examination on arrival. FREE "B" Battery included. Extra Offer: 5 per cent discount for cash in full with order. Buy now and get a guaranteed battery at 60 per cent saving to you.

WORLD BATTERY COMPANY
1219 So. Wabash Ave., Dept. 17 CHICAGO, ILL.

Set your Radio Dial at 210 meters for the new 1000 watt World Storage Battery Station. WSB, Chicago. Watch for announcements.

CHANGES OF ADDRESS

should be sent to Subscription Department at least two weeks in advance of publication in order to insure early and proper attention. RADIO WORLD'S subscription list is so large that it is necessary that changes be sent in as requested. Address, Subscription Department, RADIO WORLD, 145 W. 45th St., New York.

Approved and Listed as Standard by Leading Authorities including Radio News Laboratories, Popular Science Institute of Standards, Popular Radio Laboratories, Radio Broadcast Laboratories, Radio in the Home, and Leaf, Inc.

WORLD BATTERY COMPANY
1219 So. Wabash Ave., Dept. 17 CHICAGO, ILL.

World STORAGE BATTERIES

TWO-FOR-ONE SUBSCRIPTION OFFER

Radio World has made arrangements —To offer a year's subscription FREE for any one of the following publications with one year's subscription for RADIO WORLD:

- POPULAR RADIO or
- RADIO BROADCAST or
- SCIENCE AND INVENTION or
- RADIO NEWS or
- RADIO DEALER or
- RADIO (San Francisco) or
- RADIO AGE or
- COLLIER'S or
- BOYS' LIFE or

This is the way to get two publications —for the price of one:
—Send \$8.00 today for RADIO WORLD
—for one year (regular price for 52 numbers)
—and select any one of the other nine publications for twelve months.

—Add \$1.00 a year extra for Canadian or Foreign Postage.
—Present RADIO WORLD subscribers can take advantage of this offer by extending subscriptions one year —if they send renewals NOW.

FENWAY

—for DX

Winter or Summer the Fenway is a consistent DX-getter. Naturally, you want to own one of these super-sensitive receivers. Fenway Blueprints show you how to build a laboratory set.

PRICE OF COMPLETE SET OF BLUEPRINTS—\$3.00 Postpaid
Others Give Their Radio Prints Away FREE!—Fenway Prints Cost You \$3.00—WHY?

Radio Division, The Columbia Print
147 West 45th Street New York City

RADIO WORLD'S Special Two-For-Price-of-One SUBSCRIPTION BLANK
RADIO WORLD, 145 West 45th St., N. Y. City:
Enclosed find \$6.00, for which send me RADIO WORLD for twelve months (52 numbers), beginning.....and also, without additional cost, Popular Radio, or Radio Broadcast, Radio News, or Science and Invention, or Radio Dealer, or Radio (San Francisco), Boys' Life, or Radio Journal, Collier's or Radio Age (or \$10.00 for two yearly subscriptions).

Name

Indicate if renewal. Offer Good Until May 20, 1926.

Street Address

City and State

the eliminator voltage. Tests made upon voltmeters that indicate potentials from 40 to 250 volts show ohms per volt values ranging from 5 to 800, the majority ranging between 80 and 120 ohms per volt. Expressed in current drain values, it required from 1.25 milliamps to approximately 180 milliamps to push the pointer across the scale, to show maximum deflection; the lower the ohms per volt value, the greater the current drain. From these values one can easily imagine the action taking place when a voltmeter drawing from 15 to 18 milliamps is shunted across the output terminals of the eliminator to ascertain the voltage, when the eliminator is supplying energy to a receiver

drawing from 15 to 20 mls. The additional drain of the voltmeter causes the eliminator output voltage to drop.

How to Measure Output

Instruments drawing from 100 to 150 milliamps for full scale deflection should never be used to determine eliminator output voltage.

To determine the output voltage of B battery eliminators under load, it is advisable that an instrument of at least several hundred ohms per volt be used. An instrument of this type registering 250 volts full scale would draw approximately 1.25 milliamps, a negligible drain, and the reading obtained would be a true indication of the voltage output of the unit. Such an instrument could be used with perfect impunity when the eliminator was in operation without fear of

obtaining an erroneous reading by overloading the potential source. Also, greater justice is done to B batteries if a high resistance voltmeter is used in measuring them.

RESULTS

RESULTS EDITOR:

I have constructed the 5-Tube, 1-Control Powertone as described by Herman Bernard in the Aug. 29, Sept. 5, 12 and Dec. 12 issues of RADIO WORLD and have found it a wonderful receiver. All the distance that one could be desirous of obtaining is at hand. The tuning is very simple. In one night I tuned in more than 21 stations, the locations being in every section of the country. Some of these stations came in louder than our locals. It is no difficult task to separate stations which are no more than one meter apart as to wavelength. The tonal quality also is wonderful. The simplicity of the tuning of the set makes it ideal for the woman of the house. I certainly do appreciate this receiver and would not part with it.

W. E. GOODRICH,
222 East 13th St.,
Covington, Ky.

FREE RADIO CATALOG



Just off the press! Our second catalog for 1926. 100 pages of parts, accessories, kits and sets—all the best and the latest. A copy is yours for the asking. Just drop us a line—do it today!

DEPT. PM

CHICAGO SALVAGE STOCK STORE

509 S. State Street CHICAGO, U. S. A.



No guessing, less wiring and—no grief—with AMPERITE. Eliminates hand rheostats. AMPERITE is the only perfect filament control. Specified in all popular construction sets. Price \$1.10.

Radiall Company

Dept. R.W.-4, 50 Franklin St., New York City



Write for FREE Hook-ups

AMPERITE

The "SELF-ADJUSTING" Rheostat

AIR SERVICE

Tuned Radio Frequency Kit

consisting of

3 Mounted Matched Coils and Condensers \$395

For postage prepaid add 15c

Blueprint of constructional plans for assembling and wiring the Air Service 5-tube tuned radio frequency receiver sent free with each kit.

GREENWICH RADIO COMPANY
185 Greenwich St. New York City

THE DIAMOND A BADGE OF MERIT

Join the Happy Thousands Who Triumphantly Built This 5-Tube Set!

Real Know Quality!



Easy to Tune, Easy to Build!

Herman Bernard, designer of this wonder circuit, has written an illustrated booklet on "How to Build RADIO WORLD'S 1926 Model Diamond of the Air." Send 50c and get this booklet, including a full-sized wiring blueprint and free nameplate.

Outstanding Features of Set: (1) Fans, charmed by tone quality, sensitivity and selectivity, report speaker reception of far-distant stations with great volume. (2) A 2-tube earphone set, a 5-tube speaker set, and a separate 3-stage audio-amplifier for immediate use with any tuner, are combined in one. (3) No rheostats are used. (4) The set is inexpensive to construct and maintain.

Send \$6 for year's subscription and get booklet, blueprint and nameplate FREE.

[Newsdealers or radio dealers, order the booklets with blueprints included, in quantity, direct from American News Co. or Branches.]

Radio World, 145 West 45th St., New York City
Nameplates Free to All

BERNARD PORTABLE USES

MELOFORMER

DESIGNERS of the Bernard Portable described in this issue have chosen MELOFORMER for amplification. Pure tone, quality and unusual compactness make MELOFORMER desirable. Send for free Booklet A of Hookups.



Robertson-Davis Co.
420 Orleans Street
Chicago, Ill.

ACCUSTI-CONE SPEAKER

FROM FACTORY TO YOU

19-inch Full Size full floating cone \$7.50

Would cost \$30 in a retail store. You save by buying direct. It is superior to any speaker made. Try it in your home; if not satisfied, return and get money back.

Accusti-Cone Laboratories
96 Church St. New York

Action of Speaker Unit Described In Detail By Anderson

(Concluded from page 7)

motion in conformity with the frequency of the impressed current. This rocking movement is communicated to the diaphragm ded by means of the coupling rod a'c, and the diaphragm in turn communicates the motion to the air. The presence of a direct current component in the impressed current does not affect the motion as long as this component is not large enough to upset the balance of the moving system. The direct current present in the output of a vacuum tube is usually not sufficient to upset the balance when the tube is of ordinary power and is operated properly.

The moving parts of the unit are extremely light. The combined weight of the counterspring, the armature, the coupling rod, and the diaphragm is less than that of the ordinary iron diaphragm of the common bi-polar type of movement. The diaphragm is therefore able to follow faithfully the very highest audio frequencies without any choking effect. The effective elastic reaction of this moving system is no greater than is necessary to balance the magnetic forces acting on the armature, that is, it is just sufficient to pull the armature away from either pair of poles and to hold it in the center when no current is flowing through the winding, with a small margin of safety to allow for any unbalance that may be caused by a direct current component in the signal current. For this reason the moving system is able to follow faithfully the lowest audio frequencies in the signal without any elastic choking. The absence of all unnecessary mass and elasticity from the moving system reduces to a minimum any tendency at resonance for certain frequencies, a defect which is inevitably present in most units. The winding is such as to match the output impedance of an ordinary UV-201-

A tube, but it will operate somewhat better when connected to a tube of lower impedance, like the 216A, Daven Mu6, or the RCA UX-120 or UX-112. The matching with these tubes will occur at a much lower frequency and hence the quality will be better throughout the audio range. This unit will give the best account of itself when working into a long horn of the proper shape, or into a tone chamber of ample size and correct shape.

FREE BOOKLET FOR INVENTORS

IF YOUR INVENTION is new and useful it is patentable. Send me your sketch.
Z. H. POLACHEK, 70 Wall St., New York
Reg. Patent Attorney-Engineer

VEBY HIGH-MU TUBES

Made especially for Resistance Coupled Amplifiers. Now you can get more volume with greater clarity.

A. F. 20 for the 1st and 2nd Stage \$3.00
A. F. 6 Power Tube for 3rd Stage 4.50

VEBY RADIO CO.
47-51 Morris Avenue Newark, N. J.

THE BANK FIAT WOUND LOOP

RADIO APPLIANCE CORPORATION
4886 North Clark St. Chicago, Ill.

SHORE

**TRANSFORMERS
CHOKE COILS
CONDENSERS**

Will
Enable You to
Build Your Own
**RAYTHEON
TECTRON "B" BATTERY
ELIMINATOR
AND THE 2 D. C.
ELIMINATORS**

As Described by Lewis Winner

PRICES:

Fectron Transformer\$5.50
Raytheon Transformer 5.50
30 Henry Choke Coils (two required) 3.75
40 Henry Choke Coils (2 required) 3.75
Condenser Bank, 13 mfd. 7.00
Two .1 mfd. Condensers. 1.25

All Goods Sent on Receipt of Amount

SHORE ELECTRIC CO., Inc.
64 University Place
New York City
"Shore for Transformers"

Pleased with 1-Tuber

RESULTS EDITOR:

I have built the Bernard 1-Tube DX set described by Herman Bernard in the Oct. 24 issue of RADIO WORLD and am more than pleased with it. It took me only one hour and a half to construct it. The first night the set was in operation WJZ, WIOD, WDAE, WMBF, WJAX, KDKA, WTAM, WADC and KFKX came in with wonderful volume. During the first week I logged 34 stations.

I am a very consistent reader of RADIO WORLD never missing a copy.

WILLIAM H. PITTS, JR.,
211 East South Street,
Raleigh, N. C.

Join the Happy Diamond Family!

Build This Famous 5-Tube Set
and Know Real Quality
Reception!

Easy to Build, Easy to Tune!

Herman Bernard, designer of this wonder circuit, has written an illustrated booklet on "How to Build RADIO WORLD'S 1926 Model Diamond of the Air." Send 50c and get this booklet, including a full-sized wiring blueprint. Also name plate, FREE.

Outstanding Features of Set:

- (1) Fans, charmed by tone quality, sensitivity and selectivity, report speaker reception of far-distant stations with great volume.
- (2) A 2-tube earphone set, a 5-tube speaker set, and a separate 3-stage audio-amplifier for immediate use with any tuner, are combined in one.
- (3) No rheostats are used.
- (4) The set is inexpensive to construct and maintain.

What the Circuit Is

The 1926 Diamond consists of one stage of tuned radio-frequency amplification, regenerative detector, one transformer-coupled audio stage, and two resistance audio stages—the utmost from five tubes!

Follow Bernard

You can't go wrong if you follow the directions as written by the designer himself, as contained in the booklet. The diagrams, including blueprint, are guaranteed 100% accurate. Play safe!

Send \$6 for year's subscription and get booklet blueprint and nameplate FREE.

[Newsdealers or radio dealers, order the booklets with blueprints included, in quantity, direct from American News Co. or branches.]

RADIO WORLD
145 West 45th St., New York City

Equip Your Receiver With a Set
of the New

Musicktron Tubes
and wonder at
the difference



**VOLUME
AND QUALITY
IS YOURS
FOR SUMMER
RECEPTION!**

KH-20 for Resistance Coupling.....\$3.00
KH-6 1/2 Amp. Power Tube..... 3.50

Mfg. and Guaranteed by

K. & H. ELECTRIC CO.
41 Commercial St., Newark, N. J.

Exclusive Distributors

B-C-L RADIO SERVICE CO.
220 Fulton St. New York
Mail orders promptly attended to

KESTER Radio SOLDER

(Rosin-Core)

If your dealer cannot supply you
send us 25c in postage

CHICAGO SOLDER COMPANY
CHICAGO, U. S. A.

1925 BACK NUMBERS OF RADIO WORLD WANTED

Mail us copies of any of the following 1925 issues of RADIO WORLD, and we will send you a copy of a current issue for every copy sent us: February 21, April 4, 11; May 16, 23; June 6, 13, 20; July 4, 11, 18, 25; Sept. 5, 26, 1925.

How to Determine Amperes That a Coil Will Pass

To find the number of amperes that a specific coil or a piece of wire in an alternating current circuit will pass, the impedance and the applied voltage must be known. This system is made use of in transformers and choke coils or reactors, e.g., to find the number of amperes that the filament winding of a step-down transformer will pass.

The reactance of the coil has to be ascertained. This is done with the aid of this formula: 6.28 times the frequency

in cycles per second of the alternator connected in the circuit of the concentrated inductance, times the inductance of the coil in henries. Let us suppose that a coil we are using has an inductance of .11 henries and is connected to a common 60-cycle line. The inductive reactance of this coil will equal 6.28 times .11 times 60, which equals 41 ohms. As the frequency is increased, the reactance increases with direct ratio. That is, if the generator has a frequency of 100,000

cycles, then the reactance of the coil first considered, is 79,800 ohms. Now, the flow of current through this coil is controlled by the reactance and the resistance of this circuit, which equals the impedance of the circuit. This is found with the aid of this formula: the square root of the resistance of the coil squared, plus the reactance of the coil squared. Then if this same coil, as expressed before, had an inductance of .11 henries, a supposed resistance of 10 ohms and the found reactance of 41 ohms, the impedance of this coil will equal 42.1 ohms approximately. Now to find the number of amperes flowing through this circuit, we use this formula: I (amperage) equals E (voltage) over Z (impedance) or 110 over 42.1. The coil will pass 2.6 amperes.

Now! more than ever will you appreciate the fine qualities of the 1926 **DIAMOND OF THE AIR KIT—\$35.00**

Each kit bears the seal and signature of Herman Bernard, which is your guarantee of parts perfectly matched for the best possible reception.

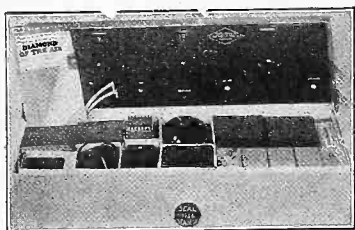

For the convenience of the builder, Sidney E. Finkelstein's 16-page booklet, with full size blueprint, is included with every kit. Extra Copies ... 50c ea.

The Assembly of Our Diamond Kit

SOMETHING NEW! SOMETHING NOVEL!!!
YOUR SET DESERVES ONE

The Bruno Ruby Light Switch is a combination A battery switch and pilot light. When you turn the switch on the flashlight bulb which goes in the switch socket lights up. A ruby crystal, with scintillating facets, is on the front of the switch, serving both as the knob and the window.

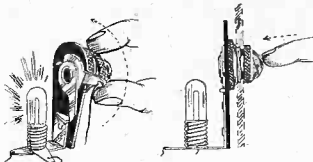

The Bruno Light Switch

Thus through the ruby window you see a red light that makes the panel look so fascinating when the set is in operation. Also the red light is a warning that your set is turned on, and you will not go to bed, forgetting to turn off the set, when this reminder stares you in the face. 75c

The Basic Diamond Kit—\$20.



is recommended for those who have already some of the necessary parts.

The contents of this Kit can be used for any four or five tube circuit as well as the Diamond. It contains: One Bruno "99" tuning coil; one Bruno "99" R.F. coil; three Bruno vernier dials; two "23" Streamline frequency condensers and one light switch. To be genuine each Kit must bear the seal and signature of Herman Bernard. Neatly packed ready to assemble. Shipped anywhere the day the order is received.

Bernard Loud Boy Kit, \$9.65

The New **RADIO RESEARCHES** is ready. Order your copy now... **10c!**

B.C.L. RADIO SERVICE COMPANY 221 FULTON ST. NEW YORK, N. Y.

Sockets

The average capacity between the grid and plate contacts in sockets is about 2 microfarads. Thus where the total capacity would be 14 micro-microfarads, the elimination of the socket capacity means a reduction of approximately 14 per cent., quite a saving when the maximum is only 14 mmfd. in all.

As to the effects of surface leakage from plate to grid, whether it be in the radio frequency or the audio frequency part of the complete receiver installation, the consequence is a reduction in amplification in the radio frequency portion and distortion in the audio frequency amplifying unit. This phenomenon has been frequently observed with receivers operating near the seashore, and while the total reduction was due to the cumulative effect of the heavily salt-laden atmosphere attacking and settling upon the various parts of the receiver, a great percentage was due to the path between the grid and plate. Removing this path greatly improved reception.

Superior to Any Other TECTRON "B" ELIMINATOR

Smaller than one B Battery. Delivers as high as 150 Volts and up to 60 Milliampere of Humless Rectified Power.

TECTRON RADIO CO., 1270 Broadway, N. Y.



DX OWL



EUREKA

Right to the Point! Eureka Dial Pointers Polished Nickel or Gilt 10c Each
DX Owl Nickel.....10c
DX Owl Goldplated...15c
At your dealers or sent direct for stamps:
C. W. BLITS, INC.
42 Hedden Place
East Orange, N. J.



TINS YOUR IRON

DO YOU KNOW HOW TO SOLDER? **FREE!! A BOOKLET** FOR AMATEUR BY PROFESSIONALS WITH EVERY UNITE-IT KIT (RADIO CONSTRUCTION) **MADE EASY** SENT DIRECT BY MAIL (STANDARD SIZE) PRICE 25¢ UNITE-IT SPECIALTIES CO. DEPT M BALDWIN, N.Y.



ALDEN MANUFACTURING CO. Dept. S-2 Springfield, Mass.

J. E. Anderson Explains How to Bring in Distance

[The following is Part II, the conclusion of J. E. Anderson's article on "How to Get DX." Part I was published in the April 10 issue. Capt. P. V. O'Rourke discussed the same subject in the April 3 issue from other angles.]

FOR any given current flowing in the primary coil, with both circuits tuned to exactly the same frequency, the current in the secondary will be greatest for a particular coupling between the two coils. This coupling should be obtained by varying the mutual inductance between the two coils. The number of turns required on the primary and its position with respect to the secondary can only be found by experiment. While this adjustment gives the greatest transfer of energy from primary to secondary, and hence gives the greatest response, it does not by any means give the greatest selectivity. The coupling is such that mutual inductance is the square root of the product of the resistances in the primary and secondary circuits divided by 6.2832 times the frequency. For instance, suppose that the primary resistance is 25 ohms, the secondary 9 ohms, and the frequency of the signal wave is 1,000,000 cycles, then the mutual inductance required is $5 \times 3 = 15$ divided by $6.283 \times 1,000,000$, or 2.4 microhenries. The required mutual inductance in the broad-

cast range would vary from 1.6 microhenries for the shortest wave to 4.3 microhenries for the longest wave in the range, for these resistance values.

Favors Low-Loss Parts

In line with the policy of energy conservation in the receiver, the resistance in the secondary circuit with all its associated apparatus must be as low as it is possible to get it. That is, the tuning coil must be a truly low-loss coil both by

It's Easy to Build a Powerful Set Using the New and Improved FRESHMAN "TRF" Low Loss Kit



Straight Line Wave Length Condensers With Low Loss Self Balanced Coils

These are the identical units which have made the FRESHMAN MASTERPIECE factory built Receivers the World's Greatest Radio Sets.

\$9.50

Complete instructions for building this powerful five tube receiver, written in plain everyday English, together with actual size schematic wiring diagram, are furnished with every FRESHMAN "TRF" Kit.

Sold by Authorized Freshman Dealers Only!

CHAS. FRESHMAN CO., Inc
Freshman Building, New York
2626 W. Washington Blvd., Chicago

How to Build THE FENWAY

The famous DX set that, by the turn of a switch, is a 4-tube tuned RF set, with regeneration, or a 9-tube Super-Heterodyne! Remarkably sensitive!

Described by Leo Fenway himself in the February 6, 13, 20 and 27 issues, including trouble shooting. Send 60c for all four issues, or send \$6 for year's subscription and get these four copies FREE!

RADIO WORLD, 145 W. 45th St., N. Y. C.

Good Back Numbers of RADIO WORLD

The following illustrated articles have appeared in recent issues of RADIO WORLD:

- Aug. 29—A Set a Baby Can Build, by Herbert E. Hayden. A Fine Meter Switch-board, by Lewis Winner.
- Sept. 12—The 1926 Model Diamond of the Air (Part 1), by Herman Bernard. A 25-to-110 Meter Receiver, by Sidney E. Finkelstein.
- Sept. 18—Diamond of the Air (Part 2), by Herman Bernard. A Tube B Battery Eliminator, by Louis Winner.
- Oct. 3—The Thorderson-Wade Set (Part 1), by Herman Bernard.
- Oct. 10—The 3-Tube, 3-Circuit Tuner, by Capt. P. V. O'Rourke. The Thorderson-Wade Set (Part 2), by Herman Bernard.
- Oct. 17—The Thoroughbred (1-Tube DX Set), by Herbert Hayden. The Thorderson-Wade Set (Part 3), by Herman Bernard. Trouble Shooting Article.
- Oct. 24—A Phonograph Cabinet Set, by Lewis Winner. The Thoroughbred, by Herbert Hayden (Part 2).
- Oct. 31—The 4-Tube Pathfinder, by S. E. Finkelstein. How to Make a Simple Loop, by Herbert E. Hayden.
- Nov. 7—A 3-Tube Dry-Cell Circuit, by Capt. P. V. O'Rourke. One of the Best Crystal Sets, by Herbert E. Hayden. 1-Tube DX Set, Herman Bernard.
- Dec. 5—A Toroid RF Set, Using Crystal, by Lewis Winner. The Diamond of the Air (In Text and Diagram), by Herman Bernard.
- Dec. 12—A Self-Contained Receiver, by H. E. Hayden (Part 1). B Battery Eliminator, by Lewis Winner (Holiday Gifts No. 1).
- Dec. 19—The Lomax Entertainer, by Ed Spiegler. Feldman 5-Tube Set, by Lewis W. Feldman.
- Dec. 26—The Regenerative Wave Trap, by John F. Elder. The 5-Tube Tuned RF Set, by Capt. P. V. O'Rourke.

1926:

- Jan. 2—The 2-C Set for Simplicity, by Capt. P. V. O'Rourke.
- Jan. 9—The 4-Tube DX Symphony Set, by A. Irving Witz. A Skillfully Made 1-Dial Set, by Herman Bernard.
- Jan. 16—Anderson's 5-Tube Quality Receiver, The Raytheon B. Eliminator, by Lewis Winner.
- Jan. 23—The 4-Tube Diamond of the Air, by Herman Bernard. The Antennator, by Herbert E. Hayden (Part 1). B Batteries Last Six Months, by S. E. Finkelstein.
- Jan. 30—An Individual AF Amplifier, by H. E. Hayden. The Antennator, by Herbert Hayden (Part 2). Trapping Out Super-Power in New Jersey, by Capt. P. V. O'Rourke.
- Feb. 6—The Fenway (4 or 9 tubes), by Leo Fenway (Part 1). The Great 1-Tube DX Set, by Herman Bernard.
- Feb. 13—Anderson's 5-Tube Economical Receiver, Trouble Shooting for Novices, by M. B. Strook. The Fenway, by Leo Fenway (Part 2).
- Feb. 20—The 8-Tube Victoreen, by Herbert E. Hayden. The Fenway, by Leo Fenway (Part 3). Quality Stressed in 8-Tube Set, by Brainard Foote.
- Feb. 27—The 4-tube DX Dandy, by Herbert E. Hayden. Umbrella Aerial for DX, by Hugo Gernsback. Part 2 of The Victoreen.
- Mar. 6—The 1 tube Set, by Capt. O'Rourke. The Chemistry of Batteries, by A. R. Rold. The Victoreen Set (Part 3), by Herbert E. Hayden.
- Mar. 13—The Non-Regenerative Browning-Drake Set, by M. B. Sleeper. The Teetron Eliminator (Part 1), by Lewis Winner. Curving Victoreen Trouble, by Herbert E. Hayden.
- Mar. 20—The Super-Heterodyne, by J. E. Anderson. A 2-Tube Speaker Set, by Percy War. The Browning-Drake Set (Part 2), by M. B. Sleeper. A 2-tube Eliminator, by Lewis Winner.
- Mar. 27—An Economical 4-Tube Set, by Edgar T. Collins. A Practical B Battery, by Capt. P. V. O'Rourke. Teetron Trouble Shooting, by Lewis Winner.
- April 3—The Bernard Portable, by Herman Bernard (Part 1). How to Get DX, by Capt. P. O'Rourke. A Compact B Supply, by Lewis Winner.
- April 10—The Bernard Portable, by Herman Bernard (Part 2). Two Eliminators for DC, by Lewis Winner. A Super From An Old Set, by C. King.
- April 17—The New 1-Dial Powerline, by Capt. P. V. O'Rourke. The Bern rd Portable (Part 3), by Herman Bernard. The Action of Transformers, by Lewis Winner.

Any copy, 15c. Any 7 copies, \$1.00. All these 29 copies for \$4.00, or start subscription with any issue. RADIO WORLD, 145 W. 45th St., N. Y. C.

WHY USE "B" BATTERIES?

A remarkable "B" battery substitute simplified. Now you can build your own "B" eliminator easily and cheaply at home. No troublesome coils to wind, no bulbs to burn out, no acids to spill. Uses all standard parts, obtainable anywhere, and costs no more to construct than price of ordinary set of "B" batteries.

Operates from house current socket, delivers powerful and absolutely noiseless "B" supply. Fully guaranteed. Complete drawings and instructions, \$1.00.

RADIO EQUIPMENT COMPANY
408 W. 11th Ave. Mitchell, S. D.

The AIRGAP SOCKET

"It gets that last mile"

Electrically and Mechanically It's Perfect. Sent direct if your dealer cannot supply you. 75c each.

AIRGAP PRODUCTS CO., Mfr.
188-192 N.J.R. Rd. Ave., Newark, N.J.
Dealers write for trade prices.

WHITEHALL LOW-LOSS INSULATORS

Tested and Approved by the Radio World

Do you realize how much you lose of VOLUME and DISTANCE by poor insulation? Use the WHITEHALL. Always dry in wet or damp weather. Moulded from No. 1 PORCELAIN, each surface highly glazed, and prove to yourself how much the BEST insulation means to your set.

NOTE THE DIFFERENCE in RECEPTION, this is the test.

Send 98c and we will mail you a set of WHITEHALL INSULATORS (Two). If, after connecting them to your aerial you are not satisfied with the result, mail them back and we will refund your money.

WHITEHALL INSULATORS

Shipping Dept., 4 Blount St., Whitehall, N.Y.

itself and as placed in the receiver. It should not be so placed as to cause eddy current losses in metal bodies placed in its field. Likewise the condenser should be really low loss, separately as well as in conjunction with the other parts. All insulators used in the set should be of the highest quality, and this applies to sockets, coil supports and condenser di-electrics. Should additional tubes for amplification and additional tuners for se-

lection be used in the receiver, the same idea of energy conservation should, of course, be used throughout. The coupling between one tube and the next should also be adjusted in somewhat the same manner as that between the antenna and the first tube, but this is not quite so simple, since only one of the two circuits can be successfully tuned. However, for the greatest transfer of energy from the plate circuit of one tube to the grid circuit of the next a rather large primary is required, about one-fourth as many turns as are on the secondary, and these turns may be placed concentrically with the secondary and near its middle. They should be made of fine wire and spaced from the secondary turns so as to minimize the capacity coupling between the two windings.

The Detection Factor

Since the grid condenser and leak method of detection is more sensitive on

weak signals this should, of course, be used in the DX receiver. To make the set as sensitive as possible, the grid condenser should be very much smaller than is customary, say about .0001 mfd., and the grid leak resistance should be adjusted to the value which gives greatest response, which is very large for most tubes. A good detector tube, preferably of the soft variety, is essential, and its grid bias should be regulated carefully. For extreme sensitivity it is not enough simply to connect the grid return lead to the positive end of the filament.

Stray coupling should be carefully eliminated as between the various radio frequency stages. This may be done by experimentally placing the coils so as to make the magnetic fields at right angles to each other and then neutralizing the electric coupling. This may be done as in the Neutrodyne. In doing so it is only necessary to stop oscillations for all settings of the tuning condensers. A small portion of the electric coupling may usually be retained to take advantage of the regenerative action. This will greatly increase the sensitivity of the set and raise its DX-getting capabilities.

Advices Regeneration

Regeneration should of course be employed, and this is best placed in the detector tube. The movable tickler type of circuit is the simplest and is as effective as any. The number of turns on the tickler should be no longer than required to effect oscillation on all wavelengths to which the receiver responds, and the wire used should be fine gauge. By pass condensers of generous size should not be stinted.

FREE RADIO BOOK

Science has invented a new kind of coil. Now have it on your present set. Gives 4 great advantages otherwise impossible. Write for new book just published, showing many new ideas. Also 8 new circlod circuits. Address Electrical Research Laboratories, R.W., 2548 Cottage Grove Avenue, Chicago.

Vacuum Tubes Rebuilt \$1.00 each



POSITIVELY GUARANTEED equal to new tubes in every respect. Money will be refunded if tubes prove unsatisfactory for any reason other than burn-outs. Send us your broken and burned out tubes by parcel post. (Not necessary to insure or guard against breakage.) We make return shipments by parcel post C.O.D. and try to maintain 24-hour service.

HARVARD RADIO LABORATORIES
200 Old Colony Avenue
South Boston, Mass.

CLAROSTAT



prescribed by LEWIS WINNER for the TECTRON "B" ELIMINATOR, and the 2 D.C. "B" Eliminators.

The success of these and many other RADIO WORLD Circuits depends on CLAROSTAT.

Also O.K.'d by RAYTHEON and a host of other nationally known eliminator manufacturers. \$2.25.

AMERICAN MECHANICAL LABORATORIES, INC.

285 N. 6th St., Dept. R.W., Brooklyn, N. Y.
A book of valuable radio diagrams and information covering the above subjects will be mailed to you upon receipt of four cents in stamps.

QUICK ACTION CLASSIFIED ADS

10 CENTS A WORD. 10 WORDS MINIMUM. CASH WITH ORDER

600 MILE RADIO, \$2.95. NO-BATTERY nor tubes needed. Always ready. Fully guaranteed. 200,000 sold. No screeching nor grinding. Real radio, no toy. Sent postpaid. Order one today. Crystal Radio Company, Wichita, Kansas.

PURE HONEY, GUARANTEED, HEALTHFUL, \$2.00 gallon. H. D. Gaines Seed Co., Waterman, Illinois.

MERSHON ELECTROLYTIC CONDENSERS absolutely filter out sixty cycle hums in eliminators. Cannot burn out; last a lifetime; stand 450 volts. Special price three dollars each on twenty mfd. size in metal cans. C. J. Brown, 52 Vanderbilt Ave., New York City.

CONSTRUCTION OF RADIO PHONE AND TELEGRAPH RECEIVERS by M. B. Sleeper, sent on receipt of 75c. The Columbia Print, 145 W. 45th St., N. Y. C.

DESIGN DATA FOR RADIO TRANSMITTERS AND RECEIVERS by M. B. Sleeper, sent on receipt of 75c. The Columbia Print, 145 W. 45th St., N. Y. C.

WIRELESS IN THE HOME by Lee deForest, sent on receipt of 15c. The Columbia Print 145 W. 45th St., N. Y. C.

HERMAN BERNARD, managing editor of RADIO WORLD broadcasts every Friday at 7 p. m., from WGBS, Gimbel Bros., N. Y. City, 315.6 meters. He discusses "What's Your Radio Problem?" Listen in!

SILVER-GILT, THE NEW SILVER PLATED bus wire. Price 4c foot, postpaid. Also silver-plated antenna wire. Send for circular. J. A. Armstrong, 124 Pleasant St., Attleboro, Mass.

BULLDOGS BEAUTIFUL REGISTERED BULL PUPS, \$15. Bulldogs, 501 Rockwood, Dallas, Texas.

PATENTS—Write for free Guide Books and "Record of Invention Blank" before disclosing inventions. Send model or sketch of your invention for our inspection and Instructions Free. Terms reasonable. Radio, Chemical, Mechanical, Electrical and Trademark experts. Victor J. Evans Co., 924 Ninth, Washington, D. C.

"ME WANTS MORE DX"—worth framing. This is the front page of RADIO WORLD dated March 6. If you haven't a copy, get this number and you will find that this youngster with the earphones is one of the cutest little kids you ever saw, except your own, of course. 15c per copy, or start sub. with that number. RADIO WORLD, 145 W. 45th St., N. Y. C.

CONSTRUCTION OF THE 4-TUBE A-A RECEIVER by Herbert E. Hayden, appeared in RADIO WORLD dated Nov. 21. 15c per copy, or start your subscription with that number.

1926 DIAMOND OF THE AIR BOOKLET with full instructions to make the Diamond, with blue print, 50c. Newsdealers and radio dealers can get supply from American News Co. and its branches. RADIO WORLD, 145 W. 45th St.

FENWAY
—for DX

VOLUME, QUALITY and SELECTIVITY also wonderful on this remarkable 4- and 9-tube set. The whole world of radio recommends the Fenway—why postpone building it?

FENWAY BLUEPRINTS and FENWAY RADIO SERVICE render it simple—easy—for you to build one of these receivers. And they cost so little, \$3.00 postpaid, for full sized drawings—25x40 in.—showing the complete layout, wiring diagrams, drilling dimensions, data for making your own coils and copper cans, list of parts, etc.

FENWAY FREE SERVICE with each order for blueprints. This service SAVES YOU from \$5.00 to \$50.00 on trouble-shooting. For example: From the time you start building your laboratory set, and until it is finished and working properly, you have the advice and help of the designer himself. You simply can't go wrong!

So, send today for your DX blueprints—Fenway means DX, Winter or Summer!

LEO FENWAY

Consulting Radio Engineer

29 West 64th Street New York, N. Y.

DISTANCE AND VOLUME

At Your Command

Build a 5-Tube Tuned Radio-Frequency Set, Using the Streamline Kit **\$7.50**



Boxed kit consists of 3 Streamline straight line frequency .00035 mfd. condensers, 3 basketweave coils, 3 mountings.

STREAMLINE STRAIGHT FREQUENCY CONDENSERS
.00025 mfd. \$2.00; .00035 mfd. \$2.25;
.00005 mfd. \$2.50.

STREAMLINE RADIO CO.

213 FULTON STREET
New York City

FILL OUT AND MAIL NOW
SUBSCRIPTION BLANK
RADIO WORLD

RADIO WORLD

145 West 45th Street, New York City,
(Just East of Broadway)

Please send me RADIO WORLD for months, for which please find enclosed \$.....

SUBSCRIPTION RATES:

Single copy \$.15
Three Months 1.50
Six Months 3.00
One Year, 52 Issues 6.00
Add \$1.00 a Year for Foreign Postage; 50c for Canadian Postage.

Twist Joint Useful Where Soldering is Hard



Although soldering of the antenna wire to the lead-in wire and also minor joints is preferred, the difficulty of keeping the iron hot for a length of time, always presents itself. There are several good methods of twisting the wire to obtain

We Specialize in Complete Kits
The M. & H. Engineering Service Will Supply Parts
or Complete Sets of Any Hook-Up

DESCRIBED IN THIS OR ANY
OTHER RADIO MAGAZINE

M & H SPORTING GOODS CO.
512 Market St. Philadelphia, Pa.

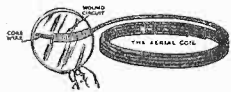

Make
Your Set
Deliver its
Best with

The WOUND WIRE AERIAL
Improved Reception and Greater DX Guaranteed!
Approved by Popular Radio and Radio World.

For indoor or outside aerials
Send postal for descriptive booklet
"Something New in Radio"

THE WOUND WIRE AERIAL CO.,
Reedville, Virginia

LOOK UP DOWN

For specified parts for the

FENWAY

FOUR NINE

Special copper cans, special coupler, Panels,
Baseboards, Royalty Resistance, Yaxley
General Radio, Silver-Marshall, National
Dials (New Type) etc., etc.

CHAS. W. DOWN

Super-Heterodyne Specialist
711 Eighth Ave. N. Y. City
Building—Repairs—Wiring, Etc.

AEROVOX

Is Specified by
Lewis Winner
for the

**Tectron
& 2 D. C.
Eliminators**

and all other
Radio World's
"B" Eliminators
Why?

Because they are
"BUILT
BETTER."

Also FIXED MICA CONDENSERS, RESISTORS and RESISTANCE-COUPLED UNITS.

AEROVOX WIRELESS CORP.
489-491-493 Broome Street N. Y. City



A Coil Winding Tip

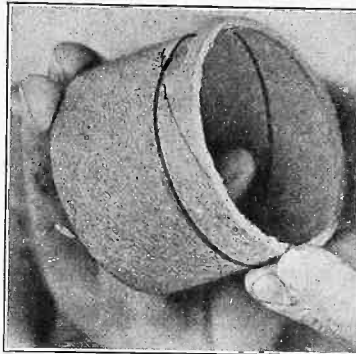

A COIL may be wound carefully by holding the wire and form, as shown, and turning the form, rather than the wire. (Hayden).

as nearly perfect contact as possible. One of these methods is shown herewith. This is known as the American Twist Joint. It is used by the telephone and telegraph companies. The straight end of the end of one wire is brought over the end of the other wire and twisted around for several turns. The ends of these turns are knotted. The wire is then pulled. Tin foil is then put over the joint, followed by a rubber tape covering.

JACK AND PLUG FOR LOOP CUT WAVE RANGE OF CIRCUIT

Plugs and jacks find their most effective use in audio frequency circuits and should be employed there, rather than in radio frequency circuits, especially in conjunction with loops. The effective capacity of the plug and jack combination is at least equal to the minimum capacity of the average tuning condenser, consequently the wavelength band which may be covered is appreciably reduced. Second, the insulation used in the majority of plugs, while very satisfactory for audio frequency circuits, is unsatisfactory for high frequencies. Hence in most plugs used with a loop we have a miniature capacitance unit of a very low order of efficiency shunted around the expensive and well designed major condenser.

YOUR SPEAKER HAS TONE QUALITY—GET IT



\$10 postpaid.
"A Jaynxon Product"

by forms of amplification. \$100 to \$500 net performance for \$10 or money back.

JAYNXON LABORATORIES
57 Dey Street New York City
Approved by RADIO WORLD Laboratories

With a Jaynxon
TONE BRIDGE
Matches tube impedance to modern
Speakers.
Keeps Direct Current out of Speaker
prolonging Speaker life indefinitely.
Perfects tone quality at all audio-frequencies.
Eliminates expensive
Installation of Power Tubes and other cost-

COMING EVENTS

JUNE 1 to DEC. 1—Sesqui-Centennial, Industrial Arts Bldg., Philadelphia, Pa., with concurrent radio exposition. J. C. Johnson, manager, 1560 B'way, N. Y. City.

SEPT. 13 to 18—Third Radio World's Fair, Madison Square Garden, New York City. G. Clayton Irwin, manager, Times Bldg., N. Y. City.

OCT. 11 to 17—Fifth Annual Chicago Radio Show, Coliseum, Chicago, Ill. G. Clayton Irwin, manager, Times Bldg., N. Y. City.

OCT. 30 to NOV. 6—Cleveland Radio Industries Exposition, Public Auditorium, Cleveland, O. G. B. Bodenhoff, manager, 511 Guarantee Title Bldg., Cleveland, O.

Bring in Europe on a

Victoreen "Super"

Write for Layout and Parts List
THE GEORGE W. WALKER CO.
6515 Carnegie Avenue Cleveland, Ohio

NEW FREE RADIO GUIDE 1926

Newest Edition Ready

Shows the latest circuits, the newest developments in radio at startlingly low prices. Get the parts you want here and save money. The best in parts, kits, sets and supplies. Orders filled same day received. Write for free copy NOW; also please send names of one or more radio fans.

BARAWIK COMPANY, 102-140 So. Canal St., Chicago.

FANS! All Parts for The NEW S-C 4 TUBE

SINGLE CONTROL RECEIVER
as designed by McMurdo Silver and L. M. Cockaday; Described in March Issue of Popular Radio. Wave Lengths Range from 50 to 1800 Meters.

RADIO MAIL ORDER HOUSE
P. O. Box 129, Times Square Station, N. Y. C.

HARD RUBBER

SHEET—ROD—TUBING
Special Hard Rubber Parts Made to Order
RADION HARD RUBBER
PANELS ANY SIZE

Send for price list
WHOLESALE RETAIL
NEW YORK HARD RUBBER TURNING CO.
212 Centre Street New York

FIXED RESISTORS Micamold FIXED CONDENSERS

Specified for the Fenway. Superb in all circuits. Accurate, Constant in Value, Indestructible. "Made of Mica and Moulded in Bakelite."

At Good Radio Stores.
MICAMOLD RADIO CORP.
Flushing and Porter Aves.,
Brooklyn, N. Y.



ACCURACY GUARANTEED
—VALUES REMAIN CONSTANT



TEAR OFF AND MAIL TODAY

8 Week's Trial Subscription, \$1.00

KEEP ABREAST OF THE LATEST
RADIO DEVELOPMENTS

RADIO WORLD
145 WEST 45th ST. NEW YORK CITY

BST-6 HIGHBOY

A better Highboy or radio could not be bought for even double the money

A Radio Highboy of unequaled value

The HIGHBOY is of genuine walnut-plywood designed by master craftsmen, beautifully finished in a rich two-tone. Dimensions $45\frac{1}{4} \times 25\frac{1}{4} \times 14\frac{1}{4}$. A piece of furniture that will last a lifetime, gladden the eye and bring joy and refinement to the home.

Equipped with the famous BST-6, a six-tube tuned radio frequency receiver of astonishing volume; of clear, rich, beautiful tone. The circuit consists of two stages of tuned radio frequency, tube detector and three steps of balanced audio.

The concealed built-in loud speaker occupies the entire top of the HIGHBOY, overcoming entirely that tinny metallic sound of many of the old horn loud speakers and in its stead giving forth that rich sympathetic tone of the old violin of long seasoned wood.

Beneath the radio itself is the two-door compartment with ample room to fully conceal the A, B and C batteries.

Direct from factory to you

\$85.00

Includes the BST-6 Receiver Installed in Highboy Period Cabinet, as illustrated and loud speaker. F.O.B. New York.

Guarantee

Each HIGHBOY is carefully examined so we know that the wood, carving, finish and trimmings are flawless and in perfect condition. It is packed by experts in a separate, specially-built, padded, wooden packing case, so that it must reach you in perfect condition.

The radio and loud speaker are tested and inspected for workmanship, volume, tone and distance reception, so you will receive as nearly as is humanly possible a perfect radio in this BST-6 Highboy.

IMMEDIATE DELIVERY

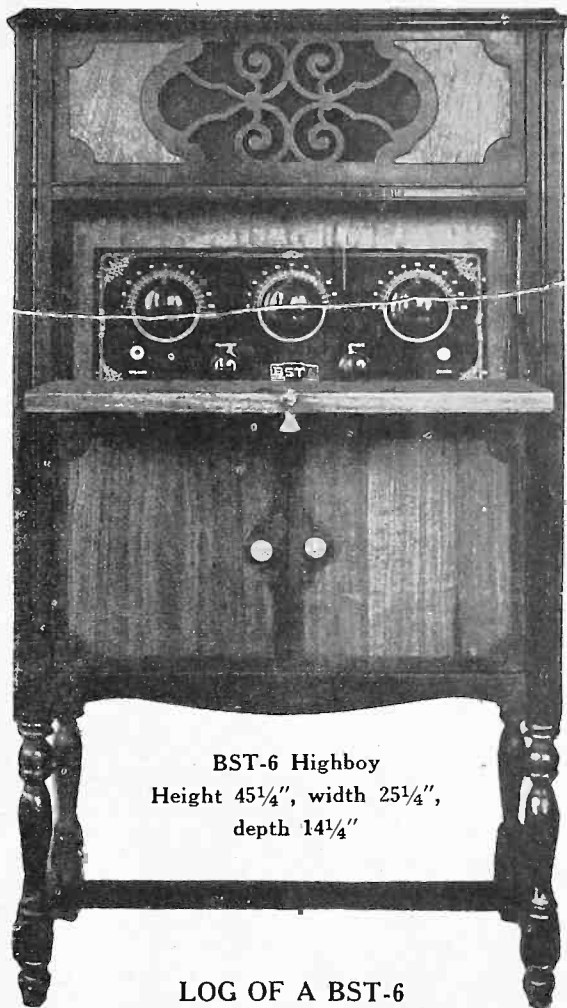

BST-6 Highboy
Height $45\frac{1}{4}$ ", width $25\frac{1}{4}$ ",
depth $14\frac{1}{4}$ "

LOG OF A BST-6

Taken on a Fifteen Foot Aerial in One-half Hour by Al. Kraus, 996 Aldus Street, New York City.

WSBC	10	WGY	50
WBBR	16	WMAK	51
WEBH	49	WMSG	11
WHT	55	WOC	85
WCCO	61	WFAA	78
WSB	66		

Send Check or P. O. Money Order to

COLUMBIA PRINT, Radio Division

143 WEST 45th ST.

NEW YORK CITY

RADIO WORLD Guarantees the Responsibility of This Advertiser

BST-6

B-for Beauty of Cabinet
 S-for Selectivity
 T-for Tone purity
 6-its 6 tubes for distance

Volume Control

Range 180-550

Perfect Calibration



The BST-6. 2 Feet 4 Inches Long. 9 Inches Inside Depth. 8 3/4 Inches High.

THIS marvelous six-tube tuned radio frequency receiver is Self-Equalized and built of low-loss materials throughout. Its clear, rich tone of astonishing volume is a revelation. The circuit consists of two stages of tuned radio frequency, tube detector and three stages of balanced audio amplification. Air cooled rheostats and universal sockets are used.

Modified straight line frequency variable condensers are employed, insuring separation of the low wave length stations. **PERFECT CALIBRATION—STATIONS ONCE TUNED IN CAN ALWAYS BE LOGGED AT THE SAME DIAL POINT.**

The balanced amplifier gives absolutely natural reproduction of all overtones. The universal sockets permit the use of all the popular tubes, either dry cell or storage. The set does not oscillate, thereby preventing the reradiation of signals and reducing interference to a minimum.

LOG OF BST-6

Taken on a Fifteen Foot Aerial in One-half Hour by Al. Kraus, 996 Aldus Street, New York City.

WSBC	10	WGY	50
WBBR	16	WMAK	51
WEBH	49	WMSG	11
WHT	55	WOC	85
WCCO	61	WFAA	78
WSB	66		

SELECTIVITY

I Live Within Four Blocks of WLWL, and since the opening of this station have had great difficulty in choking them off my old set. Even after employing a wave trap I could still hear WLWL around the entire dial and was told by several friends that living so near this powerful station it would be impossible to entirely cut them out with anything less than a super-het. It was a very agreeable surprise, therefore, when I installed my new BST-6, to find that while WLWL came in on 25 I could tune in WRNY on 21 and entirely cut out WLWL. *This is certainly real selectivity.*—F. S. Clark, 350 West 55th Street, New York City.

Specifications

Bakelite Panel, Walnut Finish—
 With Etch-O-Gravure and Gold Decorations—
 Bakelite Sub-Base—
 Kurz-Kasch Bakelite-Walnut Pointers; Gold-filled, to Match—
 Kurz-Kasch Bakelite Gold-filled Rheostat Knobs—
 Lubree Straight Line Frequency Condensers—
 Special Coils; Double Silk Solenoids—
 Shore Audio Transformers—
 Caswell-Runyan Two-tone Walnut-Finished Cabinet.

Guarantee

Satisfaction or Money Back

Each receiver is tested and retested, boxed and inspected before leaving factory, and guaranteed to reach you direct in perfect condition. Workmanship throughout guaranteed the best. Assembled by experts.

Immediate Delivery

Direct from factory to you
 No dealers' or middlemen's profits

\$40.00

Send Check or P. O. Money Order to

COLUMBIA PRINT, Radio Division

143 WEST 45th ST.

NEW YORK CITY

RADIO WORLD Guarantees the Responsibility of This Advertiser