

# RADIO WORLD

Title Reg. U.S. Pat. Off.

1926

Vol. 9. No. 3. ILLUSTRATED Every Week



THE RADIO FRANKS, famous entertainers, when singing Scotch songs, not only dress themselves in costume, but similarly adorn the microphone. Frank Bessinger and Frank White and their silent partner have a good time over it at WMCA, New York. (Wide World).

**IN THIS ISSUE:** A Super-Heterodyne from an Old Set—How to Build the Powertone 3-Dial RF Receiver—Direct Current B Eliminators—A 4-Tube Tuned Aerial Set—Coaxing in DX—The Bernard Portable—Latest News—Page of Interesting Hookups—Three Full Pages of Questions and Answers.

Kits may come and kits may go—but the 1926 Model  
**“Diamond of the Air,” Kit \$35**

is growing more popular every day. There's a reason!

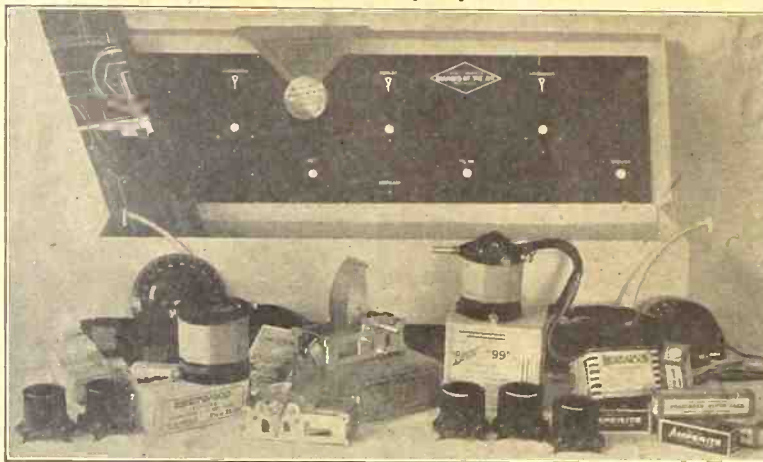

The parts used in this boxed and sealed kit are of the best obtainable. They are matched and perfectly balanced to give the best possible results in this circuit.

Each kit bears the seal and signature of Herman Bernard and the approval of Sidney E. Finkelstein, two of Radio's foremost engineers. This is your guarantee of a perfect receiver.

We are pleased to announce that each kit will contain Sidney E. Finkelstein's special 16-page booklet, with a new, full-size blueprint, which gives all data necessary for the construction, care and operation of the Diamond of the Air. We are able to supply the consumers with a copy at 50 cents each.

**Some of Our Money Saving Specials**

<b>KITS</b>			<b>TUBES</b>		
Bruno 3-Tube.....	\$18.00	Thorndarson 3 to 1.....	\$2.95	R. C. A. 201-A.....	\$1.80
Bruno 4-Tube.....	22.00	Thorndarson 6 to 1.....	3.10	Cunningham.....	1.80
Ambassador 3-Tube.....	16.00	Thorndarson Push Pull, Pr.....	8.50	New Venus Blue, 201-A.....	1.00
Ambassador 4-Tube.....	20.00	Thorndarson Autoformer.....	3.75	Veby Mu 20.....	2.95
Browning Drake.....	19.00	Eria 3 to 1, 6 to 1.....	2.95	Veby Mu 6 Power Tube.....	3.25
<b>CONDENSERS</b>		Federal No. 05 or 65A.....	2.95		
Bruno No. 18-22 Plate.....	\$3.95	Rauland Lyric.....	6.25	<b>MISCELLANEOUS</b>	
Hammarlund 23 P.S.L.F.....	4.10	Modern Symphony.....	4.50	Cutler-Hammer 6-ohm Ver.....	\$0.59
Hammarlund 11-43 Plate Ver.....	2.25	Jefferson Star 6 to 1.....	2.10	Turn-It Grid Leak.....	.85
General Instrument, Any Size.....	2.40	Crescent 3 to 1, 3 to 1.....	2.10	U. X. Adapter.....	.30
U. S. Tool 11-18-23-43 Plate Ver.....	1.75			Patent Plug.....	.25
Heath 11-23-43 Plate Ver.....	1.75	<b>VERNIER DIALS</b>		Botts & Botts Loop.....	2.50
Murdock Enclosed 23-43 Plate.....	.95	Mareo.....	\$1.00	Bruno WD-11 Socket.....	2.50
U. S. L. 23-43 Plate Ver.....	1.50	Eria.....	1.95	Daytan Potentiometer 400 ohm.....	35
Preferred 11-23 Plate.....	1.35	Ameco.....	1.50	3" Dial.....	20
Amso 17 Plate S. L. F.....	1.85	Unvernier.....	.75		
Amso 23 Plate S. L. F.....	3.25	Geo-Haw.....	1.95		
King Cardwell 11 Plate.....	2.10	B. M. S.....	1.10		
Freshman Mercury.....	.95	Accutune.....	2.75		
Manhattan 15-23 Plate Ver.....	2.95	Patent—Gold or Silver.....	1.95		
Patent 11-43 Plate.....	.75	National 3%.....	1.85		
Streamline S. L. F. 0005.....	2.50				
Streamline S. L. F. 00035.....	2.25	<b>LOUD SPEAKER UNITS</b>			
Streamline S. L. F. 00025.....	2.00	Baldwin.....	\$3.85		
Garco 23 Plate Ver.....	1.25	Baldwin (Type H).....	4.95		
Comco, All Sizes, Ver.....	1.25	Morrison.....	3.25		
		Western Electric.....	6.75		
		Baldwin Phones.....	7.25		
		<b>LOUD SPEAKERS</b>			
		Farrand Jr.....	\$16.50		
		Manhattan, Large.....	11.50		
		Acme.....	22.50		
		Bosch Jr.....	14.50		
		Thorola Jr.....	13.95		
		Supreme Concert.....	13.95		
		Crosley Cone.....	13.25		
		<b>DIALS</b>			
		Naald Bakelite 4".....	\$0.50		
		Fada Bakelite 4".....	.45		
		Freed Eisemann Baker.....	.45		
		Lite 4".....	.45		
		Garod Bakelite 4".....	.45		
		Patho 2", 3", 4".....	.25		

**Powertone TRF Kit \$22.50**  
**With Bruno Vernier Dials 1 Tube Loudboy Kit \$9.65**

**SOCKETS—BAKELITE**  
 Federal..... \$0.65  
 Naald De Luxe..... .45  
 Hoosick Falls..... .50  
 Hoosick Falls 199..... .35  
 Hoosick Falls Triple 199..... .95  
 Eby UX..... .80  
 Patent UX Universal..... .55

Just off the press! "RADIO RESEARCHES," a monthly booklet and blueprint issued from the laboratories of the Bruno Radio Corp., containing data that every set builder should know. Free with every \$5 purchase, single copies 10c each.



Bruno "77" or "99" Winding Form.....\$2.00



Bruno "99" Tuning Coil.....\$5.50

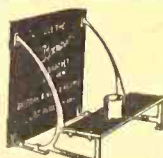

Bruno Brackets, per pair.....\$1.00



B-C-L Dials.....59c

**B.C.L. RADIO SERVICE Co. 221 FULTON ST. NEW YORK N.Y.**

# RADIO WORLD

[Entered as second-class matter, March, 1922, at the post office at New York, N. Y., under Act of March 3, 1879]

A Weekly Paper Published by Hennessy Radio Publications Corporation from Publication Office, 145 West 45th St., New York, N. Y. Just East of Broadway Phones: BRYant 0558 and 0559

Vol. IX. No. 3. Whole No. 211

April 10, 1926

15c per copy, \$6.00 a year

## A Super From An Old Set

By Caesar King

BESIDES the army of fans who build Super-Heterodynes from regular kits there are others who would like to convert their existing receiver into a Super, using the parts from the existing set. About the lowest one dares go, so far as tubes are concerned, is six, hence a receiver of this sort is shown in Fig. 1. The regulation tuned radio-frequency set may be converted into this Super-Heterodyne by adding one tube, an oscillator coil and one intermediate frequency transformer. It is advisable entirely to rewire the set, although an existing panel may be used "as is," since there are three controls, as in the run of 5-tube sets.

Considering the diagram constructionally, first there are a stage of tuned radio frequency amplification and a detector. L1L2 and L3L4 are wound alike and may be any tuned RFT, basket-weave, solenoid, diamond weave, spider web, etc., with proper inductance on the secondary to tune with the value of condenser used for C1 and C2. The oscillator coil may be a 3-circuit tuner, where the tickler remains stationary after one places it in a position that generates oscillations over the wave band. In other words, if you hear no signals, turn the tickler until you do, then let it stay put.

### The Oscillator Secondary

The 3-circuit tuner is connected with its primary interrupting the grid return of L4. It is in both circuits—modulator (tube 3) and oscillator (tube 2). The secondary L6 of the oscillator coil is bridged by a variable condenser. If this secondary is wound for a .0005 mfd. condenser, then .00035 mfd. may be used for C3, the oscillator tuning instrument, or, for .0005 mfd. a few turns may be taken off this secondary. This may be done experimentally until C3, for any given stations, has approximately the same dial readings, as have C1 and C2.

As a 5-tube tuned RF set usually has three RFT, the extra one may be used as L5L6, and a coil wound to stick inside the secondary and serve as the plate coil, L7. On a 2-in. diameter L7 may consist of 30 turns, any popular size wire, e.g., No. 24 single silk, or it may be a 35-turn honeycomb. Reverse leads to L7 to be sure of inducing oscillation. The set works only if L7 is connected the one right way.

The set will work well on the 99 or 01A type of tubes. The rheostat R1 for 01A may be 20 ohms, while for the 99 tubes it may be 30 ohms. R3 is half of R1 in resistance. The audio channel has Amperites suited to the tubes used—type 1-A for the 01A and type 4v-99 for the 99 tubes operated from a 4½-volt source. The same applies to R2.

The C battery is 4½ volts for the run of tubes, used in the audio channel, but somewhat less may be necessary on the radio frequency side, so experiment with the grid return of L2 at intermediate C

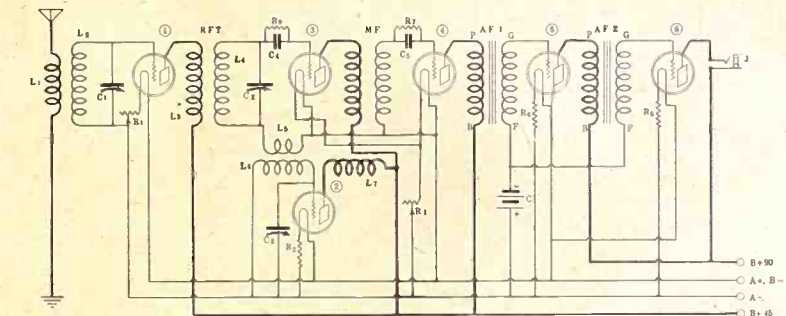

THE WIRING DIAGRAM (Fig. 1) of the 6-tube Super-Heterodyne, converted from an existing 5-tube TRF or other similar set, using most of the parts of the existing set.

voltages. The receiver is very selective. Its amplification is a little more than of two stages of tuned RF preceding a regenerative detector, and that is quite considerable. It will work a loop, and this may be substituted for L1L2, or with a double circuit jack affording an interchangeable feature.

The medium frequency transformer, MF, is used merely as the coupling medium from the first detector to the second detector, these two tubes adjoining. There is really no stage of intermediate frequency amplification, the only kind of amplification at that wave being the adventitious gain in the second detector. What the set really does is to use the Super-Heterodyne method of tuning, following a regulation radio frequency amplifier that is sensitive, but none too selective.

### Tuning Information

The tuning is much the same as with other 3-control sets, with the exception that two different settings of the oscillator tuning condenser, C3, may bring in the same station. However, only one of these settings is used, as the set is logged on this basis, and stations are brought in accordingly. C1 should tune without causing any uncontrollable oscillation, since there are only 45 volts on the radio frequency amplifying tube (1). This tube is there mostly to make the set ultra-selective. Hence, if one encounters oscillation trouble on the lower waves, it is safe to remove turns from the primary L3 of the first interstage coupler. This will depend much on the layout of parts, too, but whatever the cause, the remedy can be applied successfully.

A good layout is to have the oscillator tube at about the middle, near the back of the panel, while the other tubes may be placed in a three-quarters of the way back on the panel, and in the order shown in the diagram. In fact, this layout is suggested by the diagram itself.

L1L2, if a single layer solenoid, to be used with a .0005 mfd. value for C1, may consist of 8 turns, while L2 consists of 47 turns, 3/8" separation being preserved

### LIST OF PARTS

- Two radio frequency transformers, L1L2, L3L4.
- One oscillator coil, L5L6L7.
- One medium frequency transformer (any popular make), MF.
- Two audio frequency transformers, AF1, AF2.
- Six sockets.
- One 20-ohm rheostat, R1.
- One 10-ohm rheostat, R3.
- Three 1-A Amperites, R2, R4, R5.
- Two grid leaks and two grid condensers, 2 meg. and .00025 mfd. (R6C4, R7C5).
- Three vernier dials.
- One 7x21" panel.
- One single circuit jack, J.
- One 7x20 baseboard.

between primary and secondary. The wire is No. 24 double cotton covered and the tubing is 3½" in outside diameter, and about 3½" high. If the diameter is smaller, put on more wire, if it is larger, put on less wire. For a basketweave coil, using the same wire, and a 3½" diameter, put on 50 turns for the secondary and wind the primary along with the secondary, near one end, say ½" away from the beginning. Then pick up the wire that is to be the primary, which is 10 feet long, and wind this simultaneously with the secondary, until the 10-foot stretch gives out. The same directions apply to L2L3. Put ten extra turns on the secondaries if .00035 mfd. condensers are to be used for C1 and C2.

As for the other coil, L5L6L7, this may be wound the same as the previous coils, except that there are 10 fewer turns on the secondary. The primary is the same as the previous primaries. The plate coil L7 should be wound on a form or tubing of sufficiently smaller diameter to be inserted inside the secondary, and No. 24 DCC or finer wire, such as No. 26 single silk covered, may be used. This winding should be of sufficient inductance to induce oscillations over the entire band.

# A Stabilized TRF Receiver

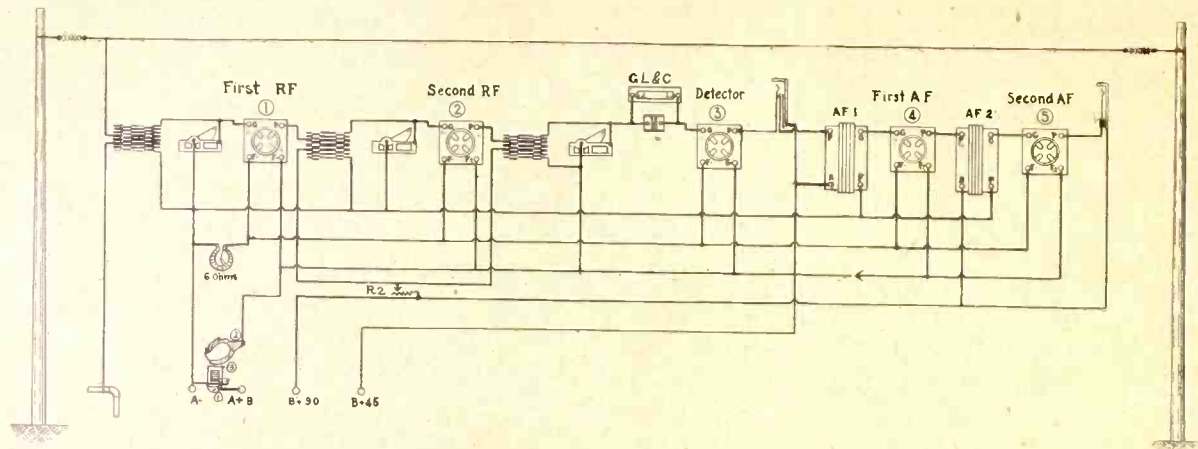

FIG. 1, the wiring diagram of the receiver.

By Roger Ferris

THE 5-tube tuned radio frequency receiver is a great favorite with the fans. It may be constructed without any external balancing device if certain methods are pursued, and these are acceptable, but require care of a kind not always within the scope of the home constructor. Hence some form of stabilizing agency may be introduced. In the 5-tube Powertone tuned radio frequency set, using three tuning dials, this is a variable resistor with a maximum value of 200,000 ohms. It is connected in rheostat fashion in series with the B plus lead of the two radio frequency amplifying tubes. It is R2 in the schematic diagram. Thus the effective plate voltage, hence the impedance, and of course the current are varied, and this may be done in all instances until there is no squeal due to over-oscillation.

#### When Resistance Lags

In an effort to obtain clear reception and prevent oscillation in the radio frequency amplifier, designers of some sets have balanced the receiver with small capacities, using one condenser for each tube in the radio frequency circuit, but frequently with home built receivers, even these sets are by no means as efficient as they could be made. The trouble can usually be traced to excessive oscillation at the shorter wavelengths, and when correcting this it is advisable to consider the cause and effect of oscillation in the set.

Any circuit including a coil and a condenser is capable of electrically oscillating, provided its resistance is low enough. One of the chief purposes of the vacuum tube is to compensate for resistance losses in oscillating circuits. It supplies energy from the B battery at the proper frequency and phase to make the circuit sensitive. If the energy supplied by the tube more than compensates for the resistance loss, however, the circuit will generate sustained oscillation and will not clearly reproduce radio broadcasting when in that condition.

#### Too Much Energy

It is evident from this that the circuits of a radio receiver must be adjusted up to oscillation to insure efficient reception, but some controlling factor must be provided or the tubes supply too much energy and set up continuous oscillation, or the regenerative whistles familiar to

all radio fans. The Neutrodyne controls this factor with a counter electromotive force introduced by means of the neutralizing condensers. Unfortunately, the adjustment for a wavelength of say 500 meters is not suitable for a wavelength of 300 meters, and vice versa, since radio receivers tend to oscillate more at the shorter wavelengths, and if oscillation at the short wavelengths is balanced out there may be such a lack of sensitivity at the longer wavelengths that many stations cannot be heard at all.

Distance fans will welcome a scheme whereby in exchange for an occasional squeal or two, volume on distant stations will be increased and the range extended several hundred miles. This is made possible by using a non-critical oscillation control that can be adjusted from the panel, and with this adjustment the radio frequency circuits can be maintained in their most sensitive condition at all wavelengths.

#### May Use a Bypass

To control oscillation the non-inductive variable high resistance R2 is introduced in series with the positive B battery leads running to the primaries of the radio frequency transformers. It is important to use a resistance of proper value and taper and the 200,000 ohm non-inductive type made by the Central Radio Laboratories, Milwaukee, is suggested.

A feature that appeals to many is a bypass condenser of approximately 1 mfd. bridged from the end of the primaries of the two coils at right, to A minus, not shown in Fig. 1. This provides a direct path for the radio frequency currents, which otherwise would encounter resistance in the control and B batteries. It is obvious, therefore, that the radio frequency circuits will be free to oscillate without added resistance, insuring greatest selectivity and sensitivity. Oscillation can be exactly controlled, however, by varying the resistance knob, which in turn varies the pressure of the B battery current passing to the radio frequency amplifier tubes.

The receiver will use less B battery current than before, particularly at the shorter wavelengths, and B batteries, therefore, will last much longer. By far the greatest advantage, however, is the fact that the receiver is rendered more sensitive and selective on the short waves where congestion exists, as tuning will be sharper in the associated circuits. Un-

desired signals are more readily excluded. The variable resistance, furthermore, provides an excellent volume control, and since oscillation can be adjusted so smoothly and accurately, there will be a noticeable improvement in the tone quality.

#### Easy to Wire

The wiring of the set is easy, and it is clearly set forth in Fig. 1. The coils are mounted on the backs of the condensers, and tuned radio frequency kits include these mountings. A socket shelf is used, this being supported by brackets, and a neat layout is thus created.

The entire wavelength band is tuned in, with proper values of condensers and coils, and these are readily obtainable. As basketweave coils are used, and as they are turned out much more expertly from factories than the home constructor can produce, it is suggested that such be obtained.

#### Panel Data

The panel is 7x18", and the layout is shown in the panel photograph. The volume control, at lower left, is the 200,000 ohm variable resistor, while the clarity knob is for the rheostat, which is 6 ohms and controls all five tubes. It will easily pass the 1¼ amperes of five-01A tubes. Besides the speaker output through the jack at left, there is a detector jack, inserted mainly to enable tuning in distant stations with greatest accuracy, the music then to be put on the speaker. Simple detector listening is growing un-



fashionable. But any who desire protracted periods of earphone reception should insert an A battery switch of the push-pull type on the socket shelf, to cut off the two audio tubes when earphones alone are used. This switch is only for those who desire this additional service, and it is shown by the arrow in the A plus lead at right in Fig. 1. It is not in the regular list of parts.

A feature not to be overlooked is the A battery switch which controls the set as a whole. You turn the switch and the set

(Continued on page 26)

# The T-A 4-Tube Receiver

By Raymond C. Wells

**EXCELLENT** control of a receiver may be enjoyed by the use of a variometer in the aerial circuit. It should be a wide-range variometer, not one that has insufficient inductance to enable one to cover the wavelength band, as is the case with some cheap products. By the system shown in Fig. 1 you have a tuned aerial circuit, and this makes the receiver extremely sensitive to the respective frequencies desired to be tuned in, without, however, contributing to the selectivity of the set. An added attraction is that the self-oscillation tendency is kept within easy bounds by the variometer adjustment. This tendency usually is noticeable from 300 meters down, even on sets that employ only a single stage of tuned radio frequency amplification ahead of non-regenerative detector.

## The Antenna Series Condenser

The tuned aerial set—called T-A for short—is shown with a fixed condenser in series with the antenna, as this is advisable with many types of variometers. But first one should try the variometer without the fixed condenser, as it may not be necessary. Its object is to cut down the total capacity, or rather reactance, of the antenna-ground system. The variometer may be so constructed that it covers the wavelength band under laboratory test, with some indicating advice, such as a current squared galvanometer, used in conjunction with an oscillator, but when the variometer is placed in a regular receiver, especially in the antenna circuit, the added capacity prevents the tuning in of the lower wavelength stations with full volume. The fixed condenser will cure this. It should be about .001 or .00015, although with some high capacity antenna systems .00025 mfd. will do very nicely.

The small primary is retained in the radio frequency transformer, L1L2, but an altered situation presents itself. The small winding is used rather as the agency for the transfer of the energy, and can not be classed as untuned, when the variometer is varied for wavelength, since it is indeed a part of the tuned antenna system, a sort of combined loading and coupling coil, the loading function being unintentional. While L1 may have the conventional small number of turns, it is somewhat better to use about 12 to 15 turns, instead of 8 or 10.

## Tuning Characteristics

Some peculiarities of tuning develop. One is that the variometer alone, while a volume control and wavelength tuner combined, may be used on the lower wavelengths to tune in one station after another, without disturbing the settings of C1 and C2. This is not the recommended practice. I am simply remarking that it can be done. The reason is that the selectivity of the set results from the tuning of the three circuits, resonance in all being the easy goal. So, when even two of them are slightly out of resonance, the variometer will be able to take care of tuning stations in or out, until one gets to the higher wavelengths.

The schematic diagram shows a situation that is attractive to many—the ability to tune each circuit independently. This enables one to log the dials. But as antennas are subject to capacity changes, due to atmospheric, weather and other conditions, the variometer setting may vary very slightly from the registered setting of a previous occasion.

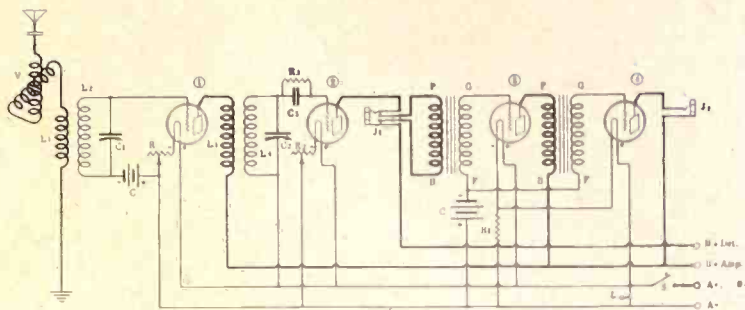

FIG. 1, the wiring diagram of the tuned aerial set. The variometer controls excess oscillations besides rendering the receiver more sensitive.

## A 2-Control Option

While the set affords maximum response for each individual wavelength, if the variometer setting is left intact, the whole wave band, as many have surmised, still may be tuned in, by using C1 and C2, for then the familiar condition of an antenna with fixed natural period with an untuned primary exists, as in the more conventional types of sets. Hence for local reception the receiver may be employed as a 2-control affair, but greater volume and better sensitivity result—hence improved chances of getting distance—if the variometer is used for its intended purpose.

The number of turns on the primary L3 of the interstage radio frequency transformer is important. As few as 8 turns may be used, on a  $3\frac{1}{2}$ " diameter or thereabouts, and the check upon free oscillations will be very good, without dependence on the variometer for help. The volume will be less than if more turns are on L3.

## Suit the Set to Location

Here it is well to remark that greater separation between L3 and L4, without disturbing the number of turns, has about the same effect as reducing the number of turns without affecting this separation. The less coupling, either by increased separation or by reduced number of turns, the greater the selectivity, hence one may accommodate this receiver, as is true with many others, to the demands of one's location. Above all, one must have a set that tunes in stations without the program of one station overlapping that of another, and this may be rated as the first requisite no matter what the accompanying disadvantage. As was remarked previously, a drop in volume is one of these untoward features, but this is subject to a two-fold consideration: (1), the human ear may not be able to notice the difference, since if the volume is even only one-fiftieth of what it was before, many ears will be unable to detect any change, and (2) if more volume is needed, more B battery voltage may be applied in the audio channel. As the hookup stands, 90 volts are used for B plus amplifier. That is why the C battery is included in the grid return side of L2.

## Values of Grid Bias

The bias would be about  $3\frac{1}{2}$  volts negative, yet this should be varied until best volume is obtained. The bias in the audio channel may be set down as  $4\frac{1}{2}$  negative for the tubes popularly used. Either dry-cell or storage battery tubes may be employed, the -01A and -99 being preferred in their respective classes. This applies to all four sockets.

## Coil Data

Commercial coils may be employed throughout, with suitable capacity tuning condensers (C1 and C2) bridging the secondaries of the radio frequency transformers.

Those desiring to wind their own coils may use tubing  $3\frac{1}{2}$ " in diameter,  $3\frac{1}{2}$ " or 3" high. L1L2 are wound on one tubing and L3L4 on another. L1 has 12 turns while L2 has 47 turns, with  $\frac{1}{4}$ " separation between the respective windings. L3 may have 10 turns and L4, 47 turns, with the separation between them  $\frac{1}{4}$ ", to be increased if circumstances require, by pushing the entire primary winding away from the secondary another  $\frac{1}{4}$ " and drilling new anchorage holes on the form to take care of the terminals of the winding. The secondaries, as stated, are for tuning with .0005 mfd. variable condensers, straight-line frequency or otherwise. If .00035 mfd. condensers are used, put on 57 turns, instead of 47, and use forms 4" high. The wire throughout is No. 24 double cotton covered.

An important item is the coil mounting. Put L1L2 at right angles to L3L4 and as far from it as convenient.

In conjunction with the receiver it is attractive to use a light switch. This acts as an A battery switch and turns on a flashlight bulb that shines through a red window on the panel. When the red light is aglow it is a sign that the radio tubes are on. This corresponds to the red light in a broadcasting studio signifying that the microphone is on the air. The popularity of the light switch is becoming greater day by day, because of its usefulness and the fascination it lends to the operation of the set. The bulb, at 6 volts, will draw less than a radio tube. Even  $4\frac{1}{2}$  volts will light a 6-volt flashlight bulb.

## LIST OF PARTS

- One variometer, V.
- Two radio frequency transformers, L1L2, L3L4.
- Two variable condensers, C1, C2.
- One grid leak and condenser, C3, R3.
- Two 20-ohm rheostats, R and R2.
- One No. 112 Amperite, R1.
- Four sockets.
- One Bruno light switch, LS.
- One double and one single circuit jack, J1, J2.
- Two audio frequency transformers, PBGF.
- One 7x21" panel.
- One 7x20" baseboard.
- Three 4" dials.
- One fixed condenser for series connection in aerial (experimentally .0001, .00015 or .00025 mfd.

# B Battery Eliminators

By **Ralph Root**

President, Pep Mfg. Co., Inc.

THE present interest in battery eliminators is well justified by the notable progress made in perfecting them.

The engineering problem of adapting line current for use on the plates of vacuum tubes has not been an easy one. Pioneer eliminators put out for this purpose were satisfactory on perhaps twenty per cent. of the sets to which they were connected. Progress by manufacturers has been rapid and the best instruments on the market today will give ideal results under the conditions found in the homes of from eighty to ninety per cent. of listeners-in.

## Uses Electrolytic Cells

Let those who have been disheartened by the failure of early eliminators be cheered by my experience. My set is a 9-tube Super-Heterodyne using six 201A tubes and three 216A power tubes. Before installing my present eliminator I used a 140-volt storage B battery. I still keep that battery and can readily switch the set from the eliminator to the battery. I

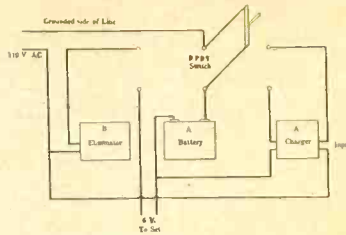

SWITCHING arrangement for B eliminator, A battery and charger.

have yet to find a guest who has not preferred the signals obtained from the eliminator.

The instrument is a stock model and uses the electrolytic cell method of transforming alternating line current into the required direct current. It is equipped with eight of these electrolytic cells and it is to this feature that I attribute the remarkable results it is giving. The use of any smaller number of cells has always left something to be desired. Progress has

been quite encouragingly speedy in both the tube-rectifying and the cell-rectifying types of eliminators. The 201A tube has too short a life as a rectifier to make it really satisfactory, but new tubes developed for the purpose by many makers show marked improvement both in this particular and in the volume of current they will pass.

Early electrolytic types used pure lead and aluminum electrodes with a borax electrolyte. These materials were unsatisfactory, for the electrodes coated in a comparatively short time and their resistance increased, causing a serious drop in the voltage output under a fixed current requirement. This has been completely remedied by using alloy electrodes, with a compound electrolyte, and by increasing the number of cells to eight, thus giving sufficient electrode surface so that the very slight coating that forms after long use has no material effect on the output of the eliminator. There is also a distinct effect in smoothing the output current and eliminating AC hum, obtained by the use of a large number of electrolytic cells. This effect has not been fully explained, but is probably due to the high capacity of the cells which act as electrolytic condensers.

## How Telephone in Home Differs from Radio Action

The operation of the telephone, using a direct line, and the telephone employing the medium of a radio wave, is very interesting.

Let us first consider the line telephone. Suppose a microphone or transmitter is at one end, with one terminal connected through a line to a terminal of the receiver. The other terminal of the microphone is connected to a source of energy, viz., battery or generator, while the other terminal of the source is connected to the ground. The other terminal of the receiver is also connected to the ground. When a word is spoken into the microphone a diaphragm, consisting of a piece of circular metal, about .006" thick, is set into motion. It vibrates at the same speed as the sound impressed. Carbon granules are packed between the microphone and a holding box. These granules act as a resistance to the passing of the current. This resistance depends upon the amount of compression to which the granules are subjected. In this way the current is varied in harmony with the motion of the diaphragm. As this action takes place the current is modulated. When the modulated current flows through the magnetic windings of the telephone, the diaphragm of the receiver reproduces the same vibration as was sent from the microphone.

When working with radio telephony the same system as that employed with the line telephone possibly could be used. However, the telephone current frequencies range from about 90 to about 5,500 cycles. The wavelength at a frequency of 500 cycles, would be 600,000 meters, which would require an antenna of extreme length for proper radiation of signals. We therefore have to use a system whereby radio frequency current is used. In this manner, the transmission is greatly improved and a comparatively short antenna can be used. When using these high frequency currents it is necessary, though, that the current be modulated in harmony with the speech at the transmitting point, while at the receiving end the wave must be put back again into the audio-frequency current. In other words, instead of only having to deal with audio-frequency currents, as with the line telephone, we have to deal with an audio-frequency current impressed upon a radio-frequency current, or a modulated carrier, and then reinstate the sound wave. Thus the original carrier wave is changed to another and varying radio-frequency by the modulation and it is the purpose of the receiver to catch the radio wave and finally get rid of it, so that only the audio-frequency current is left.

## Arcing In a Circuit Caused By Heated Air

The arcing effect in electricity is baffling too many. When there is no visible conductor to complete a circuit it sometimes happens that the air between the open points of the circuit is heated up. Visibility is then restored, for the hot air glows. Also, as the heating reduces the resistance of the air, thus making it a good conductor, the circuit is completed. The rule with metals is that heat

increases the resistance. That is where the point of confusion often arises.

The nature of the arc, the medium through which the arc is made and the constituents of the material causing the arc are a very important factor. If hydrogen or illuminating gas in its pure state is present, the resistance is higher than air. At RF the resistance of the air between the two points does not vary.

## The Hum Trouble

Subduing the AC hum has been the most difficult achievement in eliminator construction. It has been reduced below the point of audibility, though theoretically, of course, it must be there. How far progress has gone in this direction is shown by my present equipment. With a powerful Super-Heterodyne set for maximum sensitivity and in resonance with a wavelength on which no signals are coming in, no trace of hum can be had from headphones in the detector plate circuit, and no hum can be heard from the speaker with the ear at a distance of twelve inches from it—this with the high audio amplification obtained from three power tubes. To get such results the minus terminal of the A battery must be grounded.

An objection to eliminators by some users is that they must be turned off and on every time the set is used. A simple arrangement as diagrammed herewith takes care of both this difficulty and of turning the A battery charger on and off. It makes an A battery (trouble) eliminator out of the present equipment of the majority of radio fans. Necessary is only a double pole double throw switch, preferably attached with its base vertical to a block screwed to the under side of the radio table at the front, so as to be most convenient to the operator's hand.

## How Switch Works

When this switch is thrown to the left it turns on the set and the B battery eliminator; with the switch handle straight out, all wiring is dead so that the set can be tinkered with safely; and with the handle to the right the A battery is being charged. When a trickle charger is used, the switch will be kept to the right most of the time while the set is not in use; with a high rate charger, only occasionally as required.

Doubtless among others I have used this arrangement for several months and have found in the perfected eliminator handled by this switching arrangement a radio satisfaction unmarred by the necessity of even giving a thought to the formerly troublesome question of current supply.

# Two Eliminators for DC

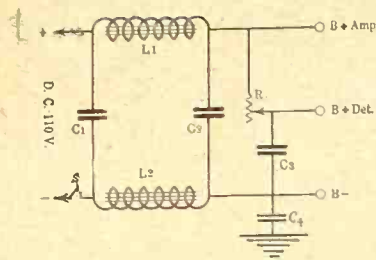

FIG. 1, showing the electrical diagram of Eliminator 1.

By Lewis Winner

Associate, Institute of Radio Engineers

ALTHOUGH in most of the homes alternating current is the type of source of electrical energy, many homes have direct current. The B battery eliminators previously described were for use with alternating current only. Therefore those who have DC have no use for such eliminators. The DC eliminator employs a certain portion of the AC eliminator, known as the filter circuit. With the AC eliminator, you will recall, a step-up-down transformer, one or two tubes and the filter circuit was employed. The step-up-down transformer supplied the necessary plate and filament voltage for the tubes which rectified the current. Therefore after it left the tubes, it was DC, although not very pure. It resembled DC obtained from the main. A ripple was present. The ripple from the main is due to commutator contact used on the generators. The material in these segments wears down quickly, causing minute interrupted breaks between the revolving commutator and the brushes. This hinders the output of pure DC. The various losses in the iron employed, bearing friction, brush friction, armature, excitation and brush contact, etc., cause the DC emitted to be ripply. It is not inconstant enough to have any effect upon the lights, or whatever may be the house appliance used. However, if a pair of phones is placed directly at the output of the line, a distinct characteristic hum will be heard. Now the same hum will be noted if the phones are placed across the output of the tubes in the eliminator. In other words, there is a great resemblance between the DC obtained from the house line and that obtained from the rectifier tubes.

Direct current shall be dealt with only in this paper.

## Two Types of DC Units

In Figs. 1 and 2 we have the circuit diagrams of two types of B battery eliminators, both of which are slight modifications of the filter systems employed in the Rex and the Tectron B battery eliminators. Note that in the first filter system there are chokes on each side of the line. The choke on the minus side of the line is more of a safety device than anything else. It has little function as a portion of the filter system, but, as the safety device is worth while. Both these chokes have an inductance of approximately 40 henries, with a resistance of approximately 600 ohms. Therefore, if accidentally either side of the line is shorted for a brief period, the current will just heat up the windings. If noted at the moment it should be rectified, although the windings will not burn out, as they will pass the current drawn by the plates of the tubes in the receiver. Therefore,

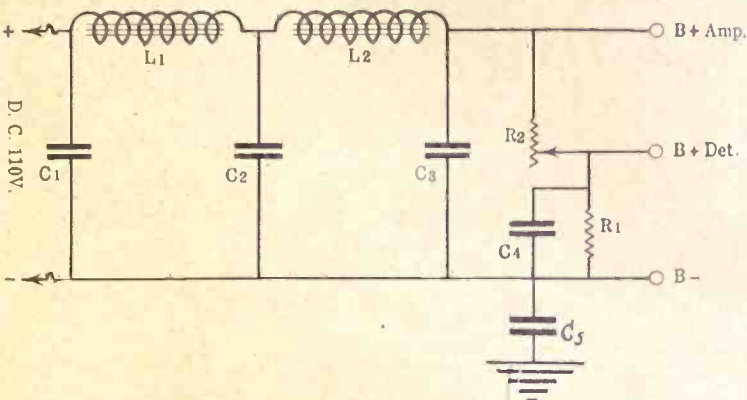

FIG. 2, showing the electrical diagram of Eliminator 2.

## LIST OF PARTS FOR ELIMINATOR 1

Two 40 henry choke coils, L1L2 (Shore).  
Two 4 mfd. fixed condensers, C1C2 (Aerovox).  
One 1 mfd. fixed condenser, C3 (Aerovox).  
One .5 mfd. fixed condenser, C4 (Aerovox).  
One variable resistor, Clarostat, R (American Mechanical Laboratories).  
One switch.  
One panel, 6x4 $\frac{3}{4}$ ".  
One baseboard, 7x4 $\frac{3}{4}$ ".  
Two strips of aluminum or brass, 10x $\frac{3}{8}$ ".  
Accessories: Four binding posts, electric cord, plug, wood screws, nuts and bolts, and flexible connecting wire.

## LIST OF PARTS FOR ELIMINATOR 2

Two 30 henry choke coils, L1L2 (Shore).  
Three 4 mfd. fixed condensers, C1C2C3 (Aerovox).  
One 1 mfd. fixed condenser, C4 (Aerovox).  
One .5 mfd. fixed condenser, C5 (Aerovox).  
One variable resistor, Clarostat, R2 (American Mechanical Laboratories).  
One 10,000 fixed resistor, R1 (Aerovox).  
Two 3 ampere fuses (DC type).  
One switch.  
Rest of the parts are the same as those for Eliminator 1.

fuses are unnecessary in this type. This eliminator therefore is also safer from that point of view. The filtering action of the filter system is not as efficient as that shown in Fig. 2. Here two chokes, having only an inductance of 30 henries and a resistance of 470 ohms are employed, but in the positive side of the line only. Fuses are also employed in both sides of the line. Here one of the fuses will blow if there is short in either the external or internal portion of the line. The fixed condensers in the first eliminator discussed must be able to stand an overload voltage of 300. Those employed in the second one are smaller and need stand an overload voltage of 150. The chokes have a tendency to build up the current in the same manner as a condenser.

## Need Few Parts

As was stated previously, since only the filter system is employed, few parts are necessary to make up the complete eliminators. The eliminator (Fig. 1) will be known as Eliminator 1, while the other

will be known as Eliminator 2. The choke coils in Eliminator 1 consist of 6,200 turns of No. 32 enameled wire. There are 80 laminations necessary to make up the core for the choke coils, used in both Eliminators 1 and 2. However, the choke coils used in Eliminator 2 consists of only 5,800 turns of No. 32 enameled wire. In both cores there is a normal gap of .005" in the laminations. Shell type laminations of the same type described in the March 20 and April 3 issues of RADIO WORLD are employed. Be sure when making these cores that the gap is present. Otherwise the filtering action will be very poor. Now condensers C1, C2, C3 and C4 of Eliminator 1 may be purchased in one unit or separately. The same applies to the condensers C1, C2, C3 and C4 in Eliminator 2. C5 here is an extra. The complete unit will be used in describing the placing of the parts. In both eliminators the size of the unit is the same. This bank or unit is 4 $\frac{1}{2}$ " long, 4" wide and 2 $\frac{1}{2}$ " high.

In each case, the manner of placing the parts is the same. In Eliminator 2, a pair of fuses and the fixed resistor, R1, are the only extra parts. The condenser bank and the two choke coils are mounted on either a metal or wooden baseboard, metal preferably. This board should be 7" long and 4 $\frac{3}{4}$ " wide. The bank is placed at one end of the base, with a  $\frac{1}{4}$ " space between the terminals, and the end of the board, while there will be a space of 3" between the bank and the other end, where the panel will be placed. Now in order to mount the bank and the choke coils, it is necessary to make angle brackets. These may be of aluminum or brass. Two strips to make the brackets are necessary, each of these being 10" in length. Now, on each side of one strip make a  $\frac{1}{2}$ " bend. This is for the placing of the holes, so as to hold the bracket in the baseboard. Then 2 $\frac{1}{2}$ " from the  $\frac{1}{2}$ " bends on both sides, make complete bends. This long piece of stripping goes over the top of the bank and is 4" long. Drill holes in the centers  $\frac{1}{2}$ " bends of the 3/16" diameter.

## Drilling Data

Drill 3/16" holes at the extreme ends of the 4" portion (going over the top of the bank). These are for the choke coils. Now place the two brackets so that the holes drilled in both are only 2" apart. This is measured from the centers of the holes. After this is done, the panel is tacked. Either Bakelite, hard rubber or even sheet metal may be employed. This should be 6" high and 4 $\frac{3}{4}$ " wide. First  
(Continued on page 30)

# How Super Power Saves Money for the Radioist

By Dr. A. N. Goldsmith

Chief Broadcast Engineer, Radio Corporation of America

FROM the beginning there has been a more or less instinctive increase in the power of broadcasting stations. Five years ago a humble ½-kilowatt broadcasting station was regarded as quite a satisfactory means of reaching the public by radio telephony. Its limitations soon became painfully evident, and it was found that the reliable service range of such ½-kilowatt stations, winter and summer and day and night, was about 10 miles (although on occasions in the winter evenings they could be heard over considerably greater distances in more or less erratic fashion).

Suburban communities nowadays extend considerably more than 10 miles outward from the center of large cities and to cover the metropolitan and suburban areas it was necessary to increase the power of broadcasting stations. So the next step was taken and the 5-kilowatt station came into existence. It was heralded by frenzied shrieks of wild alarm from those who pictured the powerful signals produced by the 5-kilowatt station as burning up receiving sets, swamping the air, tearing apart loud speakers and otherwise producing wholesale radio destruction. Of course the predictions of these prophets of evil never came true, for the 5-kilowatt station is immensely popular and has conclusively demonstrated its worth. Broadcast listeners of today are very appreciative of the improved service rendered by the 5-kilowatt station.

## Needed Still More

But the great rural districts and smaller towns which are not provided with high grade broadcasting stations remained without adequate service even after the 5-kilowatt station was established. What was needed was clearly a station having a service range at practically all times of more than 100 miles. And thus, born of a desire to serve the country at large with reliable and clear broadcasting service, there came into existence the 50-kilowatt broadcasting station, the two conspicuous examples of which are WJZ's experimental station at Bound Brook, New Jersey (call letters 2XAR) and WGY's experimental station at South Schenectady, New York (call letters 2XAG). These stations of the Radio Corporation of America and the General Electric Company, as well as KDKA of the Westinghouse Electric and Manufacturing Company at Pittsburgh (which is also a powerful experimental station) have literally brought about a new epoch in radio reception. High power broadcasting saves the listener money. It can safely be taken for granted that the listener will be in favor of any institution which does that for him.

Let us first estimate the amount of power radiated into the air at night from the 530 or 540 broadcasting stations of the United States. Two of these have a power of 50-kilowatts, about 15 of them a power of 5-kilowatts each, and the remaining 525 average perhaps 1.5 of a kilowatt apiece. Adding up the total power of all these stations we find 280 kilowatts of power radiated from them. In round numbers, the broadcasters of the United States pour into the air each evening about 300 kilowatts of program-carrying power. This figure should be kept in mind.

## Power Used by Sets

The individual receiving set in the

United States does not use much power, but since there are many receiving sets, the total power used is very considerable. We can take it for granted for the purpose of this approximate discussion that there are 5,000,000 receiving sets in the United States and that they average three tubes apiece. Of course many sets have more than three tubes, but there are also a large number of people who are still using one-tube and two-tube sets. An average of three tubes in the set is close enough for the purposes of these calculations. Assuming these tubes to be electrically similar to the UV201A, they will use 0.25 ampere at 6 volts for each filament. This is 1.5 watts power per filament, or 4.5 watts to light the filament of the three tubes. The plate battery will probably have 90 volts and deliver 10 milliamperes, or a power of 0.9 watts for the two plate circuits of the three tubes. We may neglect the grid circuit power in most cases.

It appears then that the average receiver uses 5.4 watts, and that all the receivers in the country use 5,000,000 times as much, or 27,000 kilowatts.

In round numbers, the receiving sets of the United States use therefore 30,000 kilowatts, or no less than 100 times as much as the total antenna power of all the broadcasting stations in the country! This is certainly not in accordance with most people's preconceived notions, for it certainly is not generally believed that the receiving sets of the United States require 100 times the power which is supplied to the antennas of the broadcast transmitting sets. And, with the increase in the use of 6-tube and 8-tube sets, the ratio will become still higher unless broadcast transmitting stations increase their power.

## Need For Economy

It should be pointed out that the cost of the power used in receiving sets is high. It is expensive to produce filament and plate power at the peculiar voltages which are required, and the cost per kilowatt of such power is far greater than the cost of power delivered from power plants. So that the listeners of the United States would greatly appreciate any transmitting method which would enable them to cut down their consumption of power in the receiving set.

Let us imagine for a moment that the broadcasters of the United States, or at least the low powered stations, increased their power 100-fold. They would then use the same amount of power for broadcast transmission as is now used for broadcast reception, but it would be power purchased at the lower rates which apply to that generated at a large power plant. The listeners of the United States on the other hand would get signals 100

## Volume Control at Table



WHILE at dinner one may care to modulate the speaker input, hence control tone and volume without leaving the table. This may be done by having a variable resistor on or under the table. The resistor should be in the order of 200,000 ohms. It may be placed in a box. It is connected, one side to each of the speaker cords, by two wires running to the control. (Hayden).

times as loud as before, and therefore they could either use less tubes or cut down their filament circuit consumption of power to a considerable extent. An important point in this connection is the increase in tube life which would at once result from cutting down filament consumption.

## Saves Batteries

Another important consideration is the increase in convenience which would result from not having to replace dry batteries or recharge storage batteries as often as at present. On the score of economy and convenience the listeners of the United States would be much benefited if the burden of using large amounts of power were transferred from the receiving stations of the United States in the homes of the listeners to the transmitting stations, where it properly belongs.

High power broadcasting is simply an intelligent attempt, and one which will be successful, to reduce the maintenance costs of receivers and to improve the reliability and quality of reception over great areas in this country. This is the reason why such stations as WJZ, at Bound Brook, mean a great deal to the future of the radio art, since they act as sign posts pointing to a future where radio broadcasting is conducted on a sound economic basis with a minimum burden on the listeners and with power consumption in the transmitting station, where power can be purchased and radiated at much less cost than it can be produced for use in the listener's receiving set. Super power broadcasting is the beginning of an era of efficient and economical broadcast reception.

## AUDIO AF COMPARED

Resistance coupled audio amplification is regarded as the purest, with choke coil next. Transformer coupling gives the most for the money, requiring only two tubes, and is fine if the transformers are of the best.

# Phones As Choke Coil Aid Oscillation Control

If you are the owner of a 3-tube set, employing a 3-circuit tuner, with two stages of transformer coupled audio-frequency amplification, which oscillates very freely when using the detector tube only, but very poorly when the entire three-tubes are used, the tips of a pair of phones, having a resistance of about 3,000 ohms should be inserted in series with the plate circuit of the detector tube.

This acts as a radio-frequency choke coil. At the same time you may also

listen in on the detector stage, while the loud speaker is going. You can regulate the volume to greater degree of efficiency. Distant signals can also be brought in with greater volume. The tips of the phones may either be inserted in a pair of clips, placed on the panel, or in a plug and inserted in a jack of the double or single circuit type. Any receiver employing a regenerative detector and transformer AF coupling can employ this suggestion.



# Bait That Coaxes In DX

**Strong Pick-up Is First Consideration, Hence Tuned Antenna Is Advised — Practical Tips Include Smaller Grid Condenser, Variable Grid Leak and the Use of Regeneration.**

[In last week's issue, April 3, Capt. P. V. O'Rourke discussed "How to Get DX." He treated the subject almost exclusively from a constructional viewpoint. The author of the following article stresses both theoretical and practical points. Both authors agree that the antenna should be tuned for utmost DX.]

**By J. E. Anderson**  
Consulting Engineer

THERE are certain general principles in radio reception which must be recognized and complied with if one desires to get the greatest volume from stations located at remote points from the receiver. The first of these is that one must pick up the greatest amount of radiant energy from space; the second is that one must conserve the energy picked up to the greatest possible extent and to so apply it as to make it perform the greatest amount of useful work; and the third is that one must amplify the received energy as much as possible with the equipment at hand. Let us consider these principles in detail.

In order to get the loudest signals from a given wave, this wave should induce the greatest voltage in the antenna circuit. Now, the voltage induced by an incident wave is directly proportional to the effective height of the antenna. It is evident, therefore, that, other conditions being equal, the higher the antenna the greater will be the distances from which the receiver will receive. But great effective height of the antenna is not the only consideration for picking up loud signals from distant stations. Account must also be taken of the location of the antenna with respect to its immediate surroundings and the direction from which the desired wave comes. That is, the antenna must not be placed in a dead spot or in an electric shadow. To do so is analogous to going into a dense shadow or a dark room when threading a fine needle. When that operation is to be performed one usually holds the needle up against a bright light.

## The Parallel of the Ship

To get an objective analogy of dead spots and shadows as regards radio reception, the receiver may be compared with a ship. When the ship is out on the open sea, far away from all land obstacles, or when it is on the windward side of an obstacle, it is tossed about violently on the high waves; but when the ship is inside a safe harbor, or when it is on the leeward side of a land obstacle, it is not appreciably affected by the waves, no matter how high they may be out on the open sea. Obstacles to radio waves are high buildings, particularly steel structures, hills and mountains. These form dead areas, or harbors and shadows, or leeward calms, to radio receivers under analogous conditions. Of course, a radio receiver should

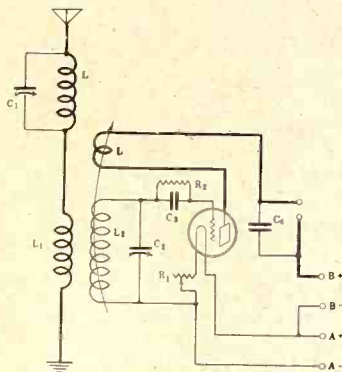

A TUNED antenna circuit is prescribed by both J. E. Anderson and Capt. P. V. O'Rourke for maximum DX. An example of a condenser-tuned aerial is shown above. This is the schematic diagram of the 1-tube Loud Boy, described by Herman Bernard in the February 6 issue, with photographs in the February 20 issue.

not be placed in any of these calm areas, but in the most exposed places where the ether is most turbulent.

Having erected an antenna as high as possible and in a place as exposed as practicable and thus brought about the right conditions for picking up the greatest amount of radio energy, it remains to conserve this and make the best use of it. To conserve it, the radio frequency resistance of the antenna must be as low as can be practically attained, so that losses will be low. This also requires that it be kept away from all objects as much as this can be done. Particularly nothing should be placed between it and the ground which might absorb part of the energy, such as trees, shrubbery and small structures. The insulators, which connect it with its supports, must be of the highest quality, and particular attention should be paid to preventing leakage across them in wet weather. The antenna wire itself should be heavy copper, preferably enameled. A very good low-resistance ground is essential. Where a good system of cold water pipes

is available this may be used, as it forms an excellent ground.

## Counterpoise Suggested

If this is not available, and if plenty of space is, then a system of wires may be buried directly under the antenna, and this system should be more extensive than the overhead wire. A counterpoise, consisting of a system of wires similar to the antenna but more extensive, placed directly under it, about ten feet above the ground, is of great help in reducing the antenna-ground resistance. The antenna inductance, which is coupled to the secondary, should be placed as near the ground connection as possible, or if a counterpoise is used the coil should be placed next to this on the antenna side, because at this point the antenna current is greatest. Both a counterpoise and a ground may be used if desired to cut down the resistance.

Reducing the resistance to a minimum and obtaining the highest possible voltage in the antenna circuit are not the only conditions for obtaining a high current. The reactance in the antenna circuit must also be reduced to zero so that the current obtained is the maximum. By reducing the reactance, of course, is simply meant that the antenna circuit must be tuned. Now if the antenna is very high its capacity to earth will be very small, unless the flat or horizontal portion is very long. Since the capacity is very small, a very large inductance is required to tune the circuit to the broadcast band, except for the shortest waves in that band. This inductance is usually very much larger than can be used for a primary to couple to the secondary tuning coil. Therefore a loading coil is required. This loading coil should preferably be a wide range variometer, such as the General Radio. If the antenna is long and low and of heavy wire, the capacity will be large and it may be necessary to use a series condenser for the shorter waves if the circuit is to be tuned for these also. The variometer should be placed in series with a small coil placed in inductive relation to the secondary tuning coil. This coil may be of slightly smaller diameter than the secondary and it should contain from 5 to 15 turns.

[The conclusion of this article on getting DX will be published in the next issue, dated April 17.]

## Listeners Are Requested To Test the Short Waves

All radio listeners who have short-wave receivers and who are interested in the progress of broadcasting are asked to co-operate with the engineers of the General Electric Company, who are conducting a series of tests in wave propagation on 32.79 and 65.5 meters. Special telegraph tests also are made on 15, 26.4 and 50.2 meters.

Every evening except Wednesday and Sunday, 2XK, using 65.5 meters, and 2XAF, operating on 32.79 meters, broadcast the programs of WGY. The ways of the longer waves, particularly those in the present broadcast band, are familiar to the engineers, but much remains to be learned of the characteristics of shorter wavelengths, and it is for the purpose of accumulating a vast fund of information that the engineers are transmitting and seeking reports on these particular wavelengths.

Until April 29, a former series of wave propagation tests will be run, the regular programs being replaced by two 24-hour schedules each week, one from Wednesday noon to Thursday noon and the other from Saturday noon to Sunday noon. During these transmissions on short waves the WGY programs will be broadcast through 2XAF and 2XK during the times when they are regularly on the air. Through the rest of the 24 hours telegraph transmissions will be made. In addition to 2XAF on 32.79 meters and 2XK on 65.5 meters, there will also be the following telegraph transmitters:

2XAW at 15 meters or 20,000 kilocycles.

2XAD at 26.4 meters or 11,370 kilocycles.

2XAC at 50.2 meters or 5,970 kilocycles.

# How Super Power Saves Money for the Radioist

By Dr. A. N. Goldsmith

Chief Broadcast Engineer, Radio Corporation of America

FROM the beginning there has been a more or less instinctive increase in the power of broadcasting stations. Five years ago a humble ½-kilowatt broadcasting station was regarded as quite a satisfactory means of reaching the public by radio telephony. Its limitations soon became painfully evident, and it was found that the reliable service range of such ½-kilowatt stations, winter and summer and day and night, was about 10 miles (although on occasions in the winter evenings they could be heard over considerably greater distances in more or less erratic fashion).

Suburban communities nowadays extend considerably more than 10 miles outward from the center of large cities and to cover the metropolitan and suburban areas it was necessary to increase the power of broadcasting stations. So the next step was taken and the 5-kilowatt station came into existence. It was heralded by frenzied shrieks of wild alarm from those who pictured the powerful signals produced by the 5-kilowatt station as burning up receiving sets, swamping the air, tearing apart loud speakers and otherwise producing wholesale radio destruction. Of course the predictions of these prophets of evil never came true, for the 5-kilowatt station is immensely popular and has conclusively demonstrated its worth. Broadcast listeners of today are very appreciative of the improved service rendered by the 5-kilowatt station.

## Needed Still More

But the great rural districts and smaller towns which are not provided with high grade broadcasting stations remained without adequate service even after the 5-kilowatt station was established. What was needed was clearly a station having a service range at practically all times of more than 100 miles. And thus, born of a desire to serve the country at large with reliable and clear broadcasting service, there came into existence the 50-kilowatt broadcasting station, the two conspicuous examples of which are WJZ's experimental station at Bound Brook, New Jersey (call letters 2XAR) and WGY's experimental station at South Schenectady, New York (call letters 2XAG). These stations of the Radio Corporation of America and the General Electric Company, as well as KDKA of the Westinghouse Electric and Manufacturing Company at Pittsburgh (which is also a powerful experimental station) have literally brought about a new epoch in radio reception. High power broadcasting saves the listener money. It can safely be taken for granted that the listener will be in favor of any institution which does that for him.

Let us first estimate the amount of power radiated into the air at night from the 530 or 540 broadcasting stations of the United States. Two of these have a power of 50-kilowatts, about 15 of them a power of 5-kilowatts each, and the remaining 525 average perhaps 1.5 of a kilowatt apiece. Adding up the total power of all these stations we find 280 kilowatts of power radiated from them. In round numbers, the broadcasters of the United States pour into the air each evening about 300 kilowatts of program-carrying power. This figure should be kept in mind.

## Power Used by Sets

The individual receiving set in the

United States does not use much power, but since there are many receiving sets, the total power used is very considerable. We can take it for granted for the purpose of this approximate discussion that there are 5,000,000 receiving sets in the United States and that they average three tubes apiece. Of course many sets have more than three tubes, but there are also a large number of people who are still using one-tube and two-tube sets. An average of three tubes in the set is close enough for the purposes of these calculations. Assuming these tubes to be electrically similar to the UV201A, they will use 0.25 ampere at 6 volts for each filament, or 4.5 watts to light the filament of the three tubes. The plate battery will probably have 90 volts and deliver 10 milliamperes, or a power of 0.9 watts for the two plate circuits of the three tubes. We may neglect the grid circuit power in most cases.

It appears then that the average receiver uses 5.4 watts, and that all the receivers in the country use 5,000,000 times as much, or 27,000 kilowatts.

In round numbers, the receiving sets of the United States use therefore 30,000 kilowatts, or no less than 100 times as much as the total antenna power of all the broadcasting stations in the country! This is certainly not in accordance with most people's preconceived notions, for it certainly is not generally believed that the receiving sets of the United States require 100 times the power which is supplied to the antennas of the broadcast transmitting sets. And, with the increase in the use of 6-tube and 8-tube sets, the ratio will become still higher unless broadcast transmitting stations increase their power.

## Need For Economy

It should be pointed out that the cost of the power used in receiving sets is high. It is expensive to produce filament and plate power at the peculiar voltages which are required, and the cost per kilowatt of such power is far greater than the cost of power delivered from power plants. So that the listeners of the United States would greatly appreciate any transmitting method which would enable them to cut down their consumption of power in the receiving set.

Let us imagine for a moment that the broadcasters of the United States, or at least the low powered stations, increased their power 100-fold. They would then use the same amount of power for broadcast transmission as is now used for broadcast reception, but it would be power purchased at the lower rates which apply to that generated at a large power plant. The listeners of the United States on the other hand would get signals 100

## Volume Control at Table



WHILE at dinner one may care to modulate the speaker input, hence control tone and volume without leaving the table. This may be done by having a variable resistor on or under the table. The resistor should be in the order of 200,000 ohms. It may be placed in a box. It is connected, one side to each of the speaker cords, by two wires running to the control. (Hayden).

times as loud as before, and therefore they could either use less tubes or cut down their filament circuit consumption of power to a considerable extent. An important point in this connection is the increase in tube life which would at once result from cutting down filament consumption.

## Saves Batteries

Another important consideration is the increase in convenience which would result from not having to replace dry batteries or recharge storage batteries as often as at present. On the score of economy and convenience the listeners of the United States would be much benefited if the burden of using large amounts of power were transferred from the receiving stations of the United States in the homes of the listeners to the transmitting stations, where it properly belongs.

High power broadcasting is simply an intelligent attempt, and one which will be successful, to reduce the maintenance costs of receivers and to improve the reliability and quality of reception over great areas in this country. This is the reason why such stations as WJZ, at Bound Brook, mean a great deal to the future of the radio art, since they act as sign posts pointing to a future where radio broadcasting is conducted on a sound economic basis with a minimum burden on the listeners and with power consumption in the transmitting station, where power can be purchased and radiated at much less cost than it can be produced for use in the listener's receiving set. Super power broadcasting is the beginning of an era of efficient and economical broadcast reception.

## AUDIO AF COMPARED

Resistance coupled audio amplification is regarded as the purest, with choke coil next. Transformer coupling gives the most for the money, requiring only two tubes, and is fine if the transformers are of the best.

# Phones As Choke Coil Aid Oscillation Control

If you are the owner of a 3-tube set, employing a 3-circuit tuner, with two stages of transformer coupled audio-frequency amplification, which oscillates very freely when using the detector tube only, but very poorly when the entire three-tubes are used, the tips of a pair of phones, having a resistance of about 3,000 ohms should be inserted in series with the plate circuit of the detector tube.

This acts as a radio-frequency choke coil. At the same time you may also

listen in on the detector stage, while the loud speaker is going. You can regulate the volume to greater degree of efficiency. Distant signals can also be brought in with greater volume. The tips of the phones may either be inserted in a pair of clips, placed on the panel, or in a plug and inserted in a jack of the double or single circuit type. Any receiver employing a regenerative detector and transformer AF coupling can employ this suggestion.

# Bait That Coaxes In DX

**Strong Pick-up Is First Consideration, Hence Tuned Antenna Is Advised — Practical Tips Include Smaller Grid Condenser, Variable Grid Leak and the Use of Regeneration.**

[In last week's issue, April 3, Capt. P. V. O'Rourke discussed "How to Get DX." He treated the subject almost exclusively from a constructional viewpoint. The author of the following article stresses both theoretical and practical points. Both authors agree that the antenna should be tuned for utmost DX.]

**By J. E. Anderson**  
Consulting Engineer

HERE are certain general principles in radio reception which must be recognized and complied with if one desires to get the greatest volume from stations located at remote points from the receiver. The first of these is that one must pick up the greatest amount of radiant energy from space; the second is that one must conserve the energy picked up to the greatest possible extent and to so apply it as to make it perform the greatest amount of useful work; and the third is that one must amplify the received energy as much as possible with the equipment at hand. Let us consider these principles in detail.

In order to get the loudest signals from a given wave, this wave should induce the greatest voltage in the antenna circuit. Now, the voltage induced by an incident wave is directly proportional to the effective height of the antenna. It is evident, therefore, that, other conditions being equal, the higher the antenna the greater will be the distances from which the receiver will receive. But great effective height of the antenna is not the only consideration for picking up loud signals from distant stations. Account must also be taken of the location of the antenna with respect to its immediate surroundings and the direction from which the desired wave comes. That is, the antenna must not be placed in a dead spot or in an electric shadow. To do so is analogous to going into a dense shadow or a dark room when threading a fine needle. When that operation is to be performed one usually holds the needle up against a bright light.

### The Parallel of the Ship

To get an objective analogy of dead spots and shadows as regards radio reception, the receiver may be compared with a ship. When the ship is out on the open sea, far away from all land obstacles, or when it is on the windward side of an obstacle, it is tossed about violently on the high waves; but when the ship is inside a safe harbor, or when it is on the leeward side of a land obstacle, it is not appreciably affected by the waves, no matter how high they may be out on the open sea. Obstacles to radio waves are high buildings, particularly steel structures, hills and mountains. These form dead areas, or harbors and shadows, or leeward calms, to radio receivers under analogous conditions. Of course, a radio receiver should

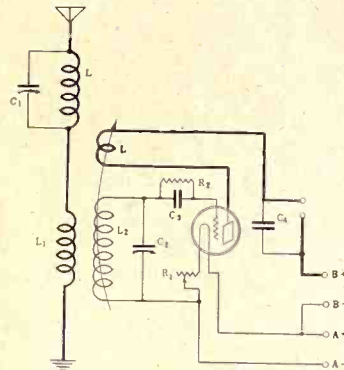

A TUNED antenna circuit is prescribed by both J. E. Anderson and Capt. P. V. O'Rourke for maximum DX. An example of a condensertuned aerial is shown above. This is the schematic diagram of the 1-tube Loud Boy, described by Herman Bernard in the February 6 issue, with photographs in the February 20 issue.

not be placed in any of these calm areas, but in the most exposed places where the ether is most turbulent.

Having erected an antenna as high as possible and in a place as exposed as practicable and thus brought about the right conditions for picking up the greatest amount of radio energy, it remains to conserve this and make the best use of it. To conserve it, the radio frequency resistance of the antenna must be as low as can be practically attained, so that losses will be low. This also requires that it be kept away from all objects as much as this can be done. Particularly nothing should be placed between it and the ground which might absorb part of the energy, such as trees, shrubbery and small structures. The insulators, which connect it with its supports, must be of the highest quality, and particular attention should be paid to preventing leakage across them in wet weather. The antenna wire itself should be heavy copper, preferably enameled. A very good low-resistance ground is essential. Where a good system of cold water pipes

is available this may be used, as it forms an excellent ground.

### Counterpoise Suggested

If this is not available, and if plenty of space is, then a system of wires may be buried directly under the antenna, and this system should be more extensive than the overhead wire. A counterpoise, consisting of a system of wires similar to the antenna but more extensive, placed directly under it, about ten feet above the ground, is of great help in reducing the antenna-ground resistance. The antenna inductance, which is coupled to the secondary, should be placed as near the ground connection as possible, or if a counterpoise is used the coil should be placed next to this on the antenna side, because at this point the antenna current is greatest. Both a counterpoise and a ground may be used if desired to cut down the resistance.

Reducing the resistance to a minimum and obtaining the highest possible voltage in the antenna circuit are not the only conditions for obtaining a high current. The reactance in the antenna circuit must also be reduced to zero so that the current obtained is the maximum. By reducing the reactance, of course, is simply meant that the antenna circuit must be tuned. Now if the antenna is very high its capacity to earth will be very small, unless the flat or horizontal portion is very long. Since the capacity is very small, a very large inductance is required to tune the circuit to the broadcast band, except for the shortest waves in that band. This inductance is usually very much larger than can be used for a primary to couple to the secondary tuning coil. Therefore a loading coil is required. This loading coil should preferably be a wide range variometer, such as the General Radio. If the antenna is long and low and of heavy wire, the capacity will be large and it may be necessary to use a series condenser for the shorter waves if the circuit is to be tuned for these also. The variometer should be placed in series with a small coil placed in inductive relation to the secondary tuning coil. This coil may be of slightly smaller diameter than the secondary and it should contain from 5 to 15 turns.

[The conclusion of this article on getting DX will be published in the next issue, dated April 17.]

## Listeners Are Requested To Test the Short Waves

All radio listeners who have short-wave receivers and who are interested in the progress of broadcasting are asked to co-operate with the engineers of the General Electric Company, who are conducting a series of tests in wave propagation on 32.79 and 65.5 meters. Special telegraph tests also are made on 15, 26.4 and 50.2 meters.

Every evening except Wednesday and Sunday, 2XK, using 65.5 meters, and 2XAF, operating on 32.79 meters, broadcast the programs of WGY. The ways of the longer waves, particularly those in the present broadcast band, are familiar to the engineers, but much remains to be learned of the characteristics of shorter wavelengths, and it is for the purpose of accumulating a vast fund of information that the engineers are transmitting and seeking reports on these particular wavelengths.

Until April 29, a former series of wave propagation tests will be run, the regular programs being replaced by two 24-hour schedules each week, one from Wednesday noon to Thursday noon and the other from Saturday noon to Sunday noon. During these transmissions on short waves the WGY programs will be broadcast through 2XAF and 2XK during the times when they are regularly on the air. Through the rest of the 24 hours telegraph transmissions will be made. In addition to 2XAF on 32.79 meters and 2XK on 65.5 meters, there will also be the following telegraph transmitters:

- 2XAW at 15 meters or 20,000 kilocycles.
- 2XAD at 26.4 meters or 11,370 kilocycles.
- 2XAC at 50.2 meters or 5,970 kilocycles.

# Proper Filament Control Affects Life of Tubes

By M. Openshaw

MANY still remember the early days in the automotive field, the days of "cranking her up," when it needed at least one doubled-up man power and a sprained wrist to start the thing. How far off those days seem now, when no one would dream of buying an automobile that wasn't equipped with a self-starter!

But a problem far more serious than that confronting the automobile industry faced the radio industry when it became a question of how to build a radio set which would be simple enough for the layman who has no mechanical knowledge, even as most people are able to handle an automobile or a phonograph.

Be it remembered that radio burst upon an unsuspecting public with a rush such as had never been seen before or since. Radio, which constitutes the greatest achievement of the present century, found millions of people ready to enjoy it—but a comparatively small number sufficiently trained to operate a radio set. Not before the handling of a radio set could be made so simple that even a child could operate one, could the industry hope to attain that degree of popularity which it is beginning to reap.

Hence simplicity of operation became the guiding star of everybody connected with the radio industry and tremendous strides have been made in this direction.

## A Safeguarding Factor

One of the most vexed questions was "how to safeguard the tubes," the correct operation of the tubes being, of course, the very essence of proper reception.

Consequently a great deal of effort has been directed toward the elimination of hand-rheostats.

It would be underrating American ingenuity to assume that this difficulty could not be solved, and concurrent with an insistent demand for simplified operation, it was solved by Amperite, the self-adjusting rheostat. This has been to radio what the self-starter has been to the automobile. It not only makes the set equipped with it easier to operate, but actually makes it foolproof.

The tubes are the most important factor in the set, and to operate them at their highest efficiency it is essential that the tube filament gets neither too much current, which would damage it, nor too little, which would impair its efficiency. To achieve perfect tube performance it is necessary to introduce a variable resistance in the filament circuit, i. e., either a hand-rheostat, by means of which the operator can increase or decrease the current at will, or a variable resistance such as Amperite, which is self-adjusting and exercises this function automatically.

## The Thermo-Electric Principle

By way of demonstration let us first take an ordinary kind of wire and see how it acts under the influence of electric current. As everybody knows, the electric current heats up the wire. We have here in fact the principle on which electric heaters and incandescent lamps work. But a wire or filament, subjected to electric current, increases its resistance to the current as it heats up. This is called the thermo-electric characteristic of the wire, and the change of resistance when heated differs considerably in all kinds of metals or alloys.

## A Rack as Insulator



A GLASS RACK, such as is used in the bathroom to hang towels on, may be pressed into service as an aerial insulator. It will stand considerable pressure. (Hayden)

Look at the tungsten vacuum lamps burning in your home. Irrespective of their wattage or voltage all burn at the same temperature. This is not merely a coincidence. Every tungsten vacuum lamp is carefully designed to operate at that definite temperature. Why?

The life of any vacuum tube depends upon the life of the filament. The best scientists and metallurgists in the world spent many years in trying to develop a method to make tungsten into fine filaments. The difficulty lay in the fact that tungsten is very hard and brittle; it was like trying to draw an eggshell into wire.

## The Solution is Found

Nevertheless a process was finally developed which changed the eggshell-like structure of tungsten into tungsten that could be drawn into wire of less than one-thousandth of an inch in thickness. This kind of tungsten is used in modern radio tubes, and to keep this tungsten-filament in the proper ductile form for giving best results it must be operated at a definite temperature.

Contrary to popular conception some tubes will not last longer if burned at a lower temperature. Doing this in fact changes the filament to the eggshell structure and any slight vibration breaks it. On the other hand, if the tube is operated above the proper temperature, the filament is rapidly vaporized and the tube may be burned out. It is evident, therefore, that the temperature and current must be kept within a very narrow range.

There are certain kinds of wire, consisting of metallic alloys, which possess the quality of increasing their resistance under heat to such an extent as to exactly counterbalance a voltage across the filament. If then a voltage applied to such a filament is increased, the wire simply heats up a little more and increases its resistance, so that, even with a higher voltage, only the required amount of current can flow and no more.

## The Filament

It is a filament of this kind of metallic alloy of which Amperite consists and which adjusts the current automatically. It is contained in a hermetically sealed glass tube, filled with an inert gas, which operating under the aforementioned thermo-electric principle. It has, as already indicated, the unique property of automatically changing in resistance as the A battery voltage changes, thereby maintaining an even flow of current in the tube filament.

This is most clearly demonstrated when we observe the current passing through a set which is operated on a freshly

## Noted Men Send Congratulations On Anniversary

Mr. Roland B. Hennessy,  
RADIO WORLD,  
145 W. 45th St.,  
New York City.

Dear Mr. Hennessy:

Congratulations on RADIO WORLD'S fourth birthday.

May this fifth year of service bring to you increased prosperity and a continuance of the high esteem in which you are regarded by the entire radio fraternity.

Sincerely yours,  
RADIO NEWS,  
H. Gernsback.

\* \* \*

Editor RADIO WORLD,  
145 W. 45th St.,  
New York, N. Y.

Dear Sir:

I wish to congratulate you on attaining your fourth anniversary. The work you are doing in popularizing and disseminating reliable information on the complicated facts of radio is one of great importance.

Very truly yours,  
J. H. DELLINGER,  
Chief, Radio Laboratory,  
Bureau of Standards.

\* \* \*

Roland Burke Hennessy, Esq.,  
RADIO WORLD,  
145 West 45th St.,  
New York City.

Dear Mr. Hennessy:

I cannot allow the fourth anniversary of RADIO WORLD to go down into history without offering comment on the record the publication has made since its inception.

The growth of the magazine has been coincident with the remarkable advance of radio and in its first five years RADIO WORLD has done its job well. It has built a foundation whose permanence gives promise of offering radio a substantial ally for many years to come. I want to take this opportunity of offering you every good wish for continued success in the future.

Sincerely,  
L. A. NIXON.

charged battery. The current tends to rise above the point for which the tube is designed, a condition which calls for adjustment. It is effected automatically by the self-adjusting rheostat, whose filament at once heats up. It thus increases its resistance and decreases the current that can flow through its filament to the tube with which it is connected. It is obvious, therefore, that a tube, which is connected to the right kind of filament resistance, never becomes overheated or gets out of commission.

On the other hand when, in course of operation, the battery potential becomes weaker, as the charge of the battery decreases, the self-adjusting rheostat again takes care of this by decreasing its resistance through cooling off. It thus once more allows the proper amount of current to flow through the tube filament, until the battery becomes exhausted, when the tube naturally won't function. Then it is time for the battery to be recharged.

## THE LIFE OF A TUBE

The best radio tubes are figured to give good electron emission for 1,000 hours, but the filament must not be overheated, as this sharply shortens the tube's life.

# The Bernard Portable

[Part 1 of this article on how to construct the Bernard Portable, an 8-tube Super-Heterodyne, was published last week, together with wiring diagrams. Part II is published herewith, while Part III, completing the constructional features, will be published next week, issue of April 17. Thereafter an article on tuning, trouble shooting, etc., will be printed].

## By Herman Bernard

Associate, Institute of Radio Engineers

THE coils for the Bernard Portable consist of two units, first the loop, second the oscillator coil. The loop used with the original was the Fiat, which will tune with a .0005 mfd. condenser across it, and which nevertheless covers the band in conjunction with the .00035 mfd. General Radio condenser, cited in the list of parts (C1). The oscillator coil has three windings, a primary, L1, a secondary, L2, and a plate coil, L3. The primary is the conventional untuned type, while the secondary has fewer turns than would be necessary to tune in signal frequencies with the specified value of condenser. The plate coil has enough turns to afford the oscillatory action at any dial setting of C2. The reference to the constants will be clarified by a glance at the wiring diagrams published last week.

If a diamond weave coil is to be used, it may be wound on a 2" inside diameter, such as a block of wood in which 15 dowel sticks, about 1/8" thick, are inserted radially, and at equal distance around the circumference. The wire is wound over and under each successive dowel. The combined secondary and primary, from beginning of the winding, at the rim of the form, to the outer edge, will be no more than 1", so very short dowels should be inserted. Using No. 24 single silk covered wire, put on 8 turns. Then pick up 12 feet of the wire, cut as a separate piece, and wind this alongside of the continuation of the secondary, winding both at the same time, until you come within a foot of the end of the primary winding. It is advisable to leave that much excess in the beginning, too, as the surplusage is for connection purposes. This affords 10 feet actually wound. Now continue winding the secondary until a total of 55 turns has been put on. This is more than you will need, but not much more. The better practice is to put on that much wire, to be sure you have enough inductance, and then adjust the coil later, so that you will have both dials reading alike, or very nearly alike. Sparingly apply collodion to the coil, and after this has dried, remove the coil from the form. The plate coil, L3, is wound in the same fashion, and consists of 42 turns. The coil is treated with collodion, as was the other, and is then removed from the form. It is more accurate to say, no doubt, that the form is removed from the coil, as the dowel sticks have to be pulled out from the coil and hub, to leave the coil without any supporting form. The rigidity will be all-sufficient, due to the collodion, and this binder also protects the coil against moisture effects.

### The Celluloid Ring

A strip of celluloid, 1" wide, is then bent into a 2" circle, or, preferably, bent so that it fits snugly against the inside diameters of the two coils. These coils are placed right up against each other, by slipping both of them onto the celluloid ring. Through the celluloid a small hole is made, to enable one to pass a screw through the hole, from the inside of the

celluloid ring, through one of the apertures of the coil, to the baseboard, on which the coil is mounted. The plate coil is held sufficiently rigid in its place by the snugness of its fit on the celluloid ring, aided by the wiring to the plate of the oscillator tube and the B plus lead. The set may be wired with the coils made as prescribed, and turns taken off the secondary after the set is in operation, to insure consonant dial readings.

### Other Coils

While the coil described was the one used, others may be employed, and small solenoids, spider-web and basketweave coils may be used. For a solenoid, the 8-turn primary and the 55-turn secondary are suitable on a 2" diameter tubing, 3" long, while the spider-web has 44 turns for the secondary and 8 for the primary. These secondaries all are experimental, particularly as the inductance of the loop one uses is a consideration in the achievement of synchronized tuning.

### Loop Data

The loop, by the way, might consist of 17 turns of No. 18 double cotton covered wire, or loop wire, on an 18" square frame, should one desire to make a loop.

Of course the loop should be of the folding type, if it is to be housed in the portable or in the power plant adjunct of the receiver. The Fiat is such.

As for the panel layout panel arrangement, it is the first thing to consider in the constructional work. The panel is 7x18", preferably Bakelite. The center shafts for the two tuning condensers are respectively 4 1/2" from left and right, on a central line, which is, of course 3 1/2" either from top or bottom edge of the panel. The rheostat R1 is the only other panel mounted instrument, not even dial pointers being required, since the enclosed type of dial is used, with a hairline in the window that is the pointer. The rheostat is at center from left and right—9" either way—and has its shaft 2 1/2" up from the bottom. As a baseboard is to be used, holes will have to be drilled to fasten the baseboard to the panel. This will be taken up later.

### Choice of Rheostat

On the subject of the rheostat, this may be a General Radio Type 214A, which is for panel mounting, and which has a resistance of 2 ohms, for by using that rheostat you have a set accommodated to either 3 1/2 and 5 volt tubes (the —99 and

### LIST OF PARTS

- Two Type 247-N General Radio variable condensers, C1, C2.
- One Sickle's coil, 3-circuit type, L1, L2, L3.
- One 7x18" Bakelite panel.
- Eight Klossner Model X sockets.
- Two Micamold .00025 mfd. grid condensers, with 2 meg. grid leaks built in, C3R2, C4R3.
- Two Type 271 General Radio Medium Frequency Transformers, MF1, MF2.
- One Type 331 General Radio tuned transformer, MF3.
- One 6-ohm Centralab or 2-ohm General Radio Type 214A rheostat, R1.
- Four phone tip jacks, PTJ1, PTJ2.
- Two Marco 4" counterclockwise dials.
- Three audio-frequency transformers (Meloformers), AF1, AF2, AF3.
- Accessories: Four B 2 1/2-volt batteries, three 1 1/2-volt dry cells, flexible connecting wire, screws, nuts, solder.

—01A groups). The determining factor is the amount of current the rheostat will handle without heating, and the General Radio type 214-A will handle 2.5 amperes. If eight —01A tubes are used, the amperage would be 2, i.e., 8x.25 amp. The resistance required to drop the one volt (to give 3 1/2 at the filament from a 4 1/2-volt source) would be about 2 ohms. (Resistance equals the voltage, 1, divided by the amperage, .48). For eight —01A tubes the resistance would be 1/2 ohm (1 volt divided by 2 amperes). Ordinarily, however, any 7 or 6 ohm rheostat may be used that will pass the desired current without heating, yet few will do this. For the 99 tubes any 6-ohm rheostat may be depended on. The original model, intended for 99 tubes, uses the Centralab 6-ohm rheostat.

### Hints on Placement

The location of the variable condensers on the panel determines, to some extent, the placement of a few of the parts. The oscillator coil is between the two condensers, near the panel, with the socket for the oscillator tube a little to the right of the coil. The General Radio medium frequency transformers are behind sockets (1), (3) and (4), with the tuned transformer at right.

As the layout of the parts is very important for best results, this will be discussed in detail in a subsequent article.

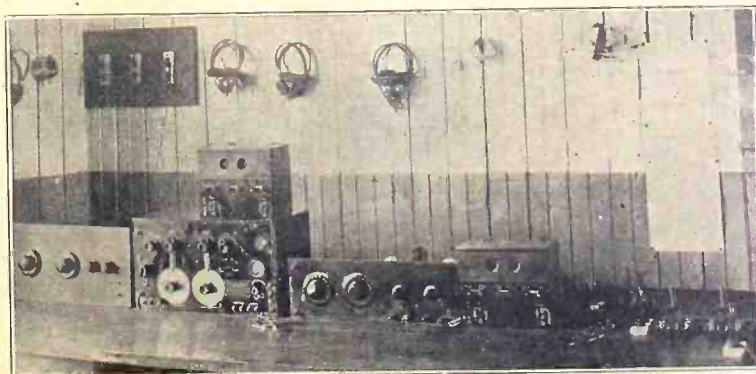

THE RECEIVING SET, switches and keys on the operating table of station 2CXL. (Kadel & Herbert).

# Five Fully Proven Circuits

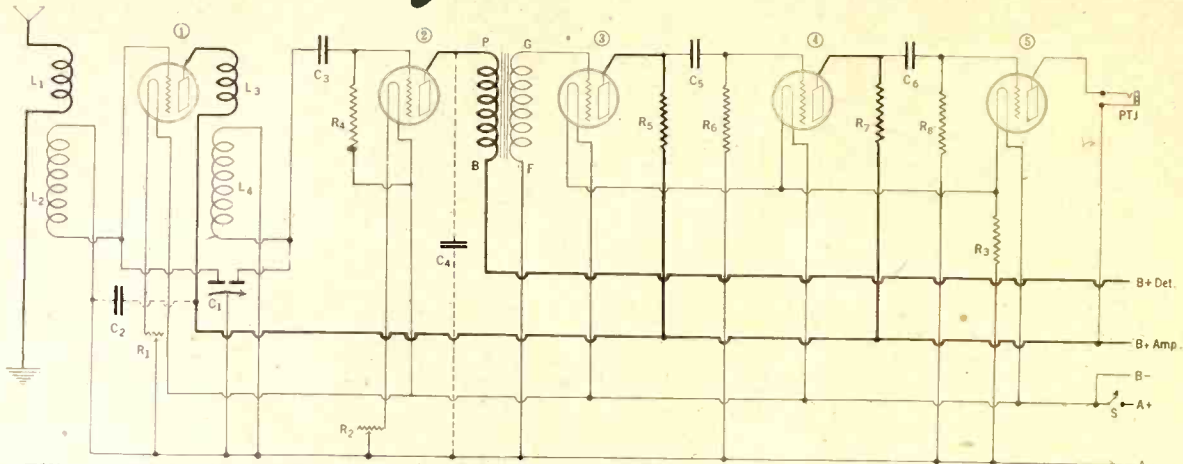

THE WIRING diagram of the Powertone, 5-tube 1-dial receiver, described by Herman Bernard in the Aug. 29, Sept. 5, 12, and Dec. 12 issues. Note the optional fixed condensers, C2 and C4, both of which increase the oscillatory value of the RF and detector tubes respectively.

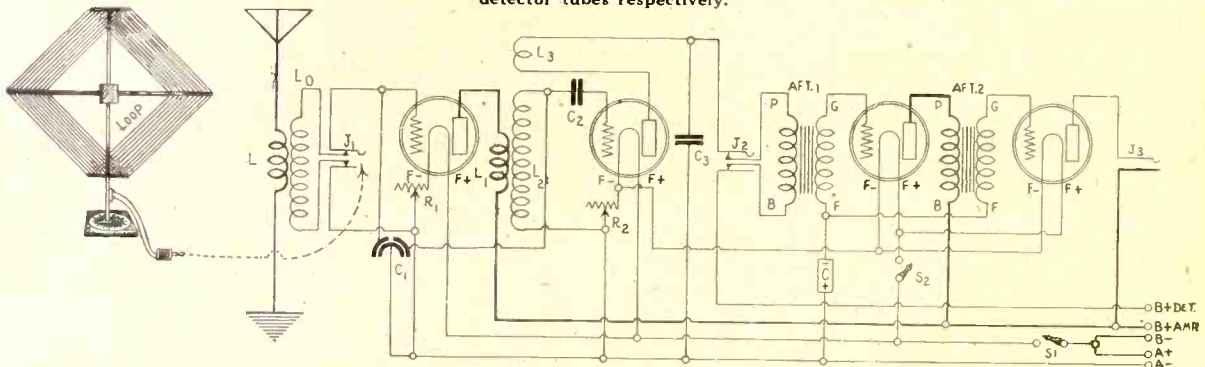

THE ELECTRICAL diagram of the 2-control 4-tube Diamond of the Air, which was described by Herman Bernard in the May 23 issue of RADIO WORLD. Note the special loop jack connections.

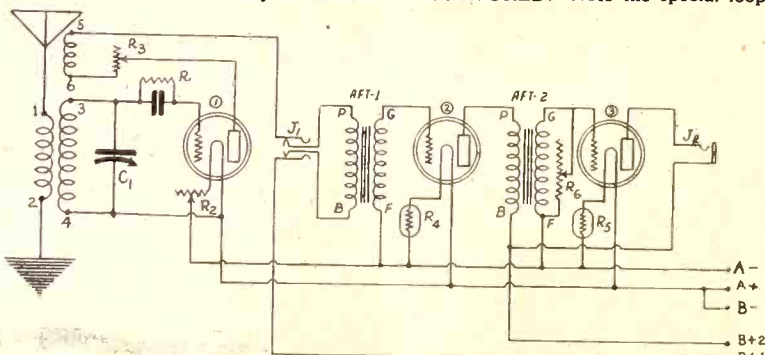

A 3-TUBE receiver, employing a 3-circuit tuner, with a variable resistance as a regeneration control.

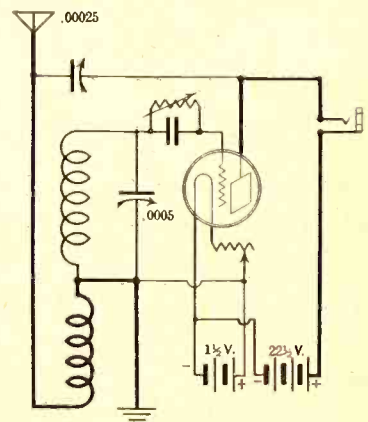

THE CIRCUIT diagram of the "1-Tube Set That Affords 1,000-Mile Reception," described by Wm. Mercer of 887 Dundas St., East Toronto, Canada, which many fans have already built and are reporting consistent reception from stations, 1,500 miles distant. The coil is wound with No. 20 DCC wire on a tubing 3 1/2" in diameter and 4 1/2" high. Fifteen turns are wound. A small loop is made and the winding is continued on for 42 more turns, making a total of 57, tapped at the 15th turn. Regeneration is obtained by returning the plate lead to the antenna-grid circuits through the variable condenser at top.

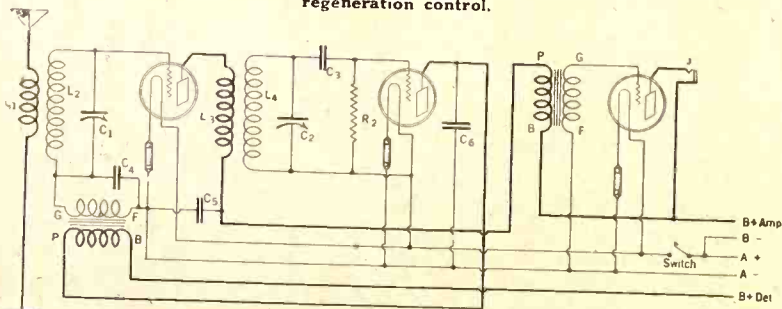

THE CIRCUIT diagram of the Freedom-Reflex, described by Capt. P. V. O'Rourke in the July 4 issue.

# Radio University

A FREE Question and Answer Department conducted by RADIO WORLD for its yearly subscribers only, by its staff of Experts. Address Radio University, RADIO WORLD, 145 West 45th St., N. Y. City.

I HAVE for some time intended to express my appreciation of your very interesting and valuable magazine, of which I have not missed a number since first taking it. Neither do I intend to miss any numbers.

I am a beginner, having built four sets in all (excluding a simple crystal set), in the following order: A 1-tube regenerative set, a 1-tube Harkness Reflex with Crystal detector, a 3-tube Harkness Counterflex, and last, the excellent 1-tube Bernard DX set with a stage of AF added, the account of which first interested me in RADIO WORLD October 24 last. I enclose a photograph of this little set as I made it. It is a dandy. It worked immediately, and within five minutes Dallas, Texas, was heard (WRR) with good headset volume. In this first test, one Saturday midnight, I brought in ten or twelve stations, including Dallas and Denver, three of which (Chicago stations) were quite audible on the loudspeaker; a little faint it is true, but loud enough that two or three persons sitting round the speaker did not miss a word. This, I think, is good for two tubes when one considers that no one here has enjoyed good volume on distant reception since January 1 and very often it has been impossible to bring in anything at all, so poor has radio been all the winter. The best feature of the little set, however, is its almost unbelievable selectivity. I can separate WOK and WBBM with one point's movement of the dial, and have a dead spot between them! This is fact! I would be interested to find out how well it would cut through local stations in a large city, but we have no nearer station than CKY (Winnipeg, 125 miles away). There are a few points on which I should like your advice as follows: (1) I used in the Bernard set a coil form  $3\frac{1}{2}$  in. diameter as per instructions, with 10 turns, primary; 60 turns, secondary, wound upon it, shunted with a 17-plate condenser (.00038 mfd.). However, the stations, instead of being spaced from 0-100 on the dial, are all included from 0-70, as if there were too many turns on the secondary. 217 meters comes in at 5; 300 at 17; 400 at  $33\frac{1}{2}$ , and WOAW, Omaha, Neb., 526 meters, at about 65 on the dial. Can you account for this, in view of the coil and condenser being all as specified? (2) Although it is of little importance and does not cause inconvenience when operating, still I would like to know why the set will not oscillate below 5 on the dial; the dial is set correctly with regard to the condenser plates and the set oscillates freely above this point. (3) Would you recommend enlarging this set, which is so satisfactory as a one or two tube set, into a four tube receiver, by adding ahead a stage of RF; and two stages of audio amplification; or would it be more advisable for me to pick out a set as described in RADIO WORLD from time to time, of the size and number of tubes that suits my purpose? (4) What are the correct instruments to use to test voltage and amperage of A and B dry batteries? (5) What amperages should they show when in good condition, and when nearly exhausted? I recently had trouble with a new 45 v. battery whose voltage was apparently O. K., for it would light a 110 v. house lamp dully, and was therefore unsuspected. After looking for the cause of "frying" noises for a long time, we finally located the trouble in the battery, it was so dead in amperage that it would not spark when shorted, but still would light the 40-watt lamp.

In conclusion, I want to say how well RADIO WORLD has pleased me, and pleases me week by week. I find in every issue

three features not all present in any other one magazine. The first is the University. I read every question and answer every week and gain considerable information thereby. Second, your diagrams; a beginner needs diagrams so clear that it is next to impossible to make mistakes. RADIO WORLD diagrams are thus, with their primaries and ground connections indicated by heavier lines. The third feature is your illustrations, which make everything clear and add to the interest generally.—Cyril G. Palmer, Box 56, Kenora, Ontario, Can.

(1) Your condenser capacity is a little larger than specified. Hence, remove five turns from the secondary at the end opposite the one where the tap is located.

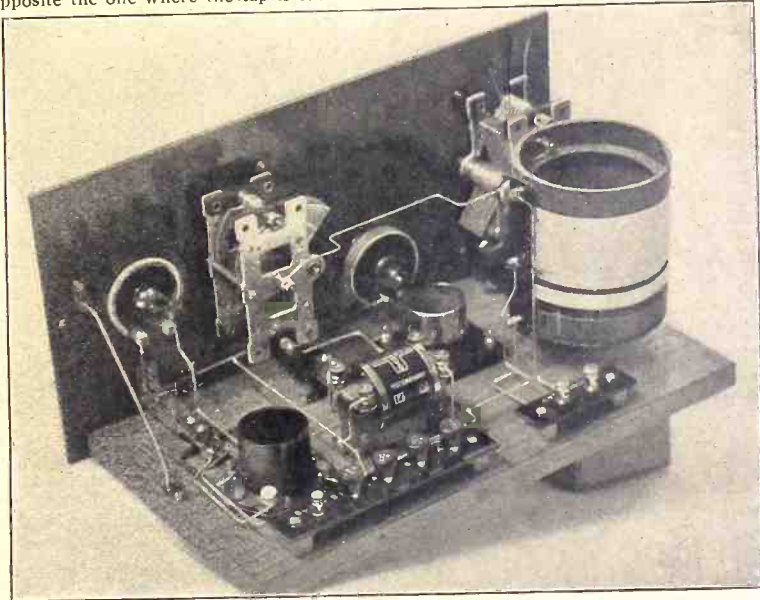

THE BERNARD DX Set, built by Cyril G. Palmer.

Then you will not have to establish a new tap or relocate the primary. (2) Slightly increase the B battery voltage or make a new tap for feedback, three or four turns further up. This method also would dispense with the necessity of taking turns off the secondary, as suggested in the answer to your first question. (3) You are doing so well with the set that merely an extra stage of AF. is suggested. (4) A 0-7 and 0-140 double range voltmeter and a 0-35 ammeter. (5) The B batteries need be tested only for voltage, for all ordinary purposes. Not until a  $22\frac{1}{2}$ -volt battery is below 17 or a 45-volt battery below 34 need one consider replacement. Shorting the battery is not to be countenanced. It ruins any battery.

I HAVE a 4-tube Acme Reflex set, which uses a loop. I would like to convert the set, so that an outdoor antenna can be employed. Please give the information required to do this and the methods of wiring the RFT in this portion of the circuit.—F. Franzieb, 587 Bay St., Stapleton, S. I., N. Y.

You may use either a fixed or tuned RFT. To make a TRFT, wind an antenna coil on a tubing  $3\frac{1}{4}$  in. in diameter. The primary consists of 10 turns. The secondary consists of 45 turns. There is a  $\frac{3}{8}$  in. separation between the two windings. Use No. 22 double cotton covered wire. The .0005 mfd. variable condenser shunts the secondary of the RFT instead of the loop. The results, when using a

fixed RFT, of any manufacture, with a range of from 200 to 600 meters will not be equal to those obtained when using the tuned RFT. If a fixed RFT is employed the variable condenser which shunts the loop is omitted. The P post goes to the antenna. The B plus post goes to the ground of the RFT. The F post goes to the F minus post on the first RF socket, while the G post goes to the G post on the same socket. The tuned RFT is wired thus: the beginning of the primary goes to the antenna post. The end of the same winding goes to the ground post. The beginning of the secondary winding goes to the F minus post of the first RF socket. The end of this winding goes to the G post. The condenser is connected across the secondary.

\* \* \*

I WOULD like to build the 4-tube Diamond of the Air, but before doing so the following information is requested.

(1)—Will this set bring in local stations

with good volume, when employing the loop? (2)—Would the Fiat loop work successfully in conjunction with this receiver? (3)—Is it necessary to use the RF stage, when using the loop? (4)—Can the Ambassador coils and condensers be used in this receiver? (5)—Will the 200 or 300 type tube work as satisfactory as the 01A type tube, as a detector in this set? (6)—If the .00 type is used as the detector, is it necessary to use a vernier rheostat as a filament control? (7)—Can the .01A type tubes be used throughout the set? (8)—Would it be advisable to use a Clarostat across the secondary of the last audio-frequency transformer as a volume control?—Fred Gegenheimer, 1231 Sheridan Ave., N. Y. C.

(1)—Yes. (2)—Yes. Remove turns from loop, if necessary to get dials to read alike. (3)—Yes. This stage is a great help in getting DX stations. (4)—Yes. (5)—Yes. When using this tube, you will have to change the grid return to negative, instead of positive as for the .01A type. (6)—Advisable. (7)—Yes. (8)—Yes. Connect the resistance to the G post of the first AFT and the arm to the G post on the next to last socket.

I HAVE a Hetroplex 3-circuit tuner. (1)—Can this coil be used in conjunction with the 1926 Model Diamond of the Air? The secondary is wound to be shunted by a .0005 mfd. variable condenser. I have a RFT wound on the same size tubing, with the same number of turns

# Five Fully Proven Circuits

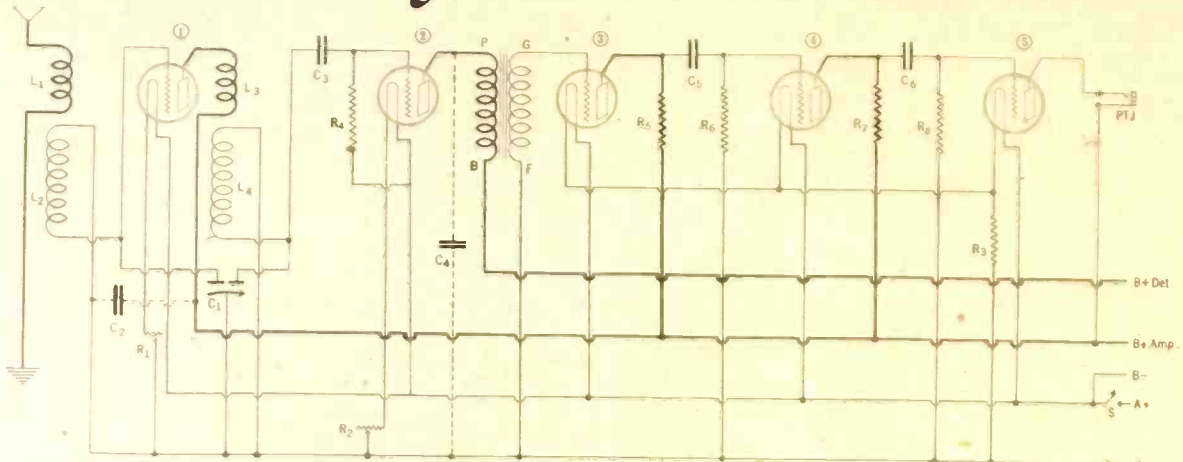

THE WIRING diagram of the Powertone, 5-tube 1-dial receiver, described by Herman Bernard in the Aug. 29, Sept. 5, 12, and Dec. 12 issues. Note the optional fixed condensers, C2 and C4, both of which increase the oscillatory value of the RF and detector tubes respectively.

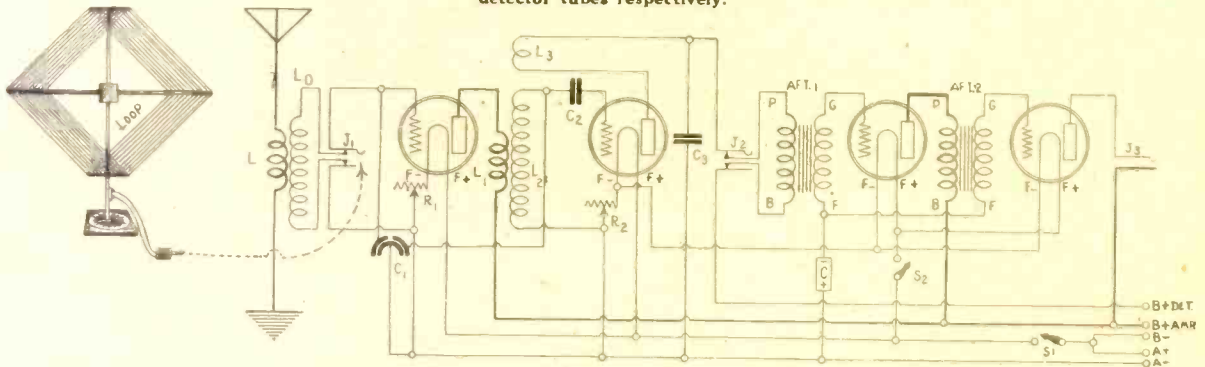

THE ELECTRICAL diagram of the 2-control 4-tube Diamond of the Air, which was described by Herman Bernard in the May 23 issue of RADIO WORLD. Note the special loop jack connections.

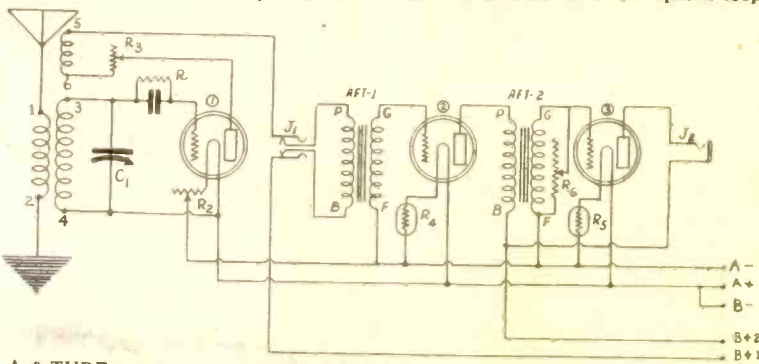

A 3-TUBE receiver, employing a 3-circuit tuner, with a variable resistance as a regeneration control.

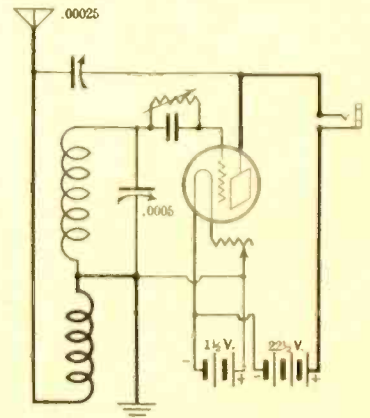

THE CIRCUIT diagram of the "1-Tube Set That Affords 1,000-Mile Reception," described by Wm. Mercer of 887 Dundas St., East Toronto, Canada, which many fans have already built and are reporting consistent reception from stations, 1,500 miles distant. The coil is wound with No. 20 DCC wire on a tubing 3 1/2" in diameter and 4 1/2" high. Fifteen turns are wound. A small loop is made and the winding is continued on for 42 more turns, making a total of 57, tapped at the 15th turn. Regeneration is obtained by returning the plate lead to the antenna-grid circuits through the variable condenser at top.

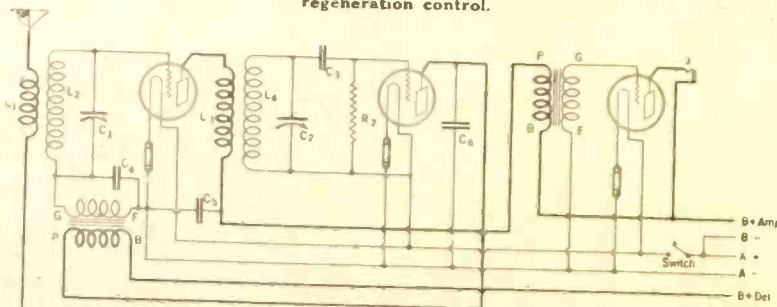

THE CIRCUIT diagram of the Freedom-Reflex, described by Capt. P. V. O'Rourke in the July 4 issue.



# Radio University

A FREE Question and Answer Department conducted by RADIO WORLD for its yearly subscribers only, by its staff of Experts. Address Radio University, RADIO WORLD, 145 West 45th St., N. Y. City.

I HAVE for some time intended to express my appreciation of your very interesting and valuable magazine, of which I have not missed a number since first taking it. Neither do I intend to miss any numbers.

I am a beginner, having built four sets in all (excluding a simple crystal set), in the following order: A 1-tube regenerative set, a 1-tube Harkness Reflex with Crystal detector, a 3-tube Harkness Counterflex, and last, the excellent 1-tube Bernard DX set with a stage of AF added, the account of which first interested me in RADIO WORLD October 24 last. I enclose a photograph of this little set as I made it. It is a dandy. It worked immediately, and within five minutes Dallas, Texas, was heard (WRR) with good headset volume. In this first test, one Saturday midnight, I brought in ten or twelve stations, including Dallas and Denver, three of which (Chicago stations) were quite audible on the loudspeaker; a little faint it is true, but loud enough that two or three persons sitting round the speaker did not miss a word. This, I think, is good for two tubes when one considers that no one here has enjoyed good volume on distant reception since January 1 and very often it has been impossible to bring in anything at all, so poor has radio been all the winter. The best feature of the little set, however, is its almost unbelievable selectivity. I can separate WOK and WBBM with one point's movement of the dial, and have a dead spot between them! This is fact! I would be interested to find out how well it would cut through local stations in a large city, but we have no nearer station than CKY (Winnipeg, 125 miles away). There are a few points on which I should like your advice as follows: (1) I used in the Bernard set a coil form 3 1/2 in. diameter as per instructions, with 10 turns, primary; 60 turns, secondary, wound upon it, shunted with a 17-plate condenser (.00038 mfd.). However, the stations, instead of being spaced from 0-100 on the dial, are all included from 0-70, as if there were too many turns on the secondary. 217 meters comes in at 5; 300 at 17; 400 at 33 1/2, and WOAW, Omaha, Neb., 526 meters, at about 65 on the dial. Can you account for this, in view of the coil and condenser being all as specified? (2) Although it is of little importance and does not cause inconvenience when operating, still I would like to know why the set will not oscillate below 5 on the dial; the dial is set correctly with regard to the condenser plates and the set oscillates freely above this point. (3) Would you recommend enlarging this set, which is so satisfactory as a one or two tube set, into a four tube receiver, by adding ahead a stage of RF.; and two stages of audio amplification; or would it be more advisable for me to pick out a set as described in RADIO WORLD from time to time, of the size and number of tubes that suits my purpose? (4) What are the correct instruments to use to test voltage and amperage of A and B dry batteries? (5) What amperages should they show when in good condition, and when nearly exhausted? I recently had trouble with a new 45 v. battery whose voltage was apparently O. K., for it would light a 110 v. house lamp dully, and was therefore unsuspected. After looking for the cause of "frying" noises for a long time, we finally located the trouble in the battery, it was so dead in amperage that it would not spark when shorted, but still would light the 40-watt lamp.

In conclusion, I want to say how well RADIO WORLD has pleased me, and pleases me week by week. I find in every issue

three features not all present in any other one magazine. The first is the University. I read every question and answer every week and gain considerable information thereby. Second, your diagrams; a beginner needs diagrams so clear that it is next to impossible to make mistakes. RADIO WORLD diagrams are thus, with their primaries and ground connections indicated by heavier lines. The third feature is your illustrations, which make everything clear and add to the interest generally.—Cyril G. Palmer, Box 56, Kenora, Ontario, Can.

(1) Your condenser capacity is a little larger than specified. Hence, remove five turns from the secondary at the end opposite the one where the tap is located.

fixed RFT, of any manufacture, with a range of from 200 to 600 meters will not be equal to those obtained when using the tuned RFT. If a fixed RFT is employed the variable condenser which shunts the loop is omitted. The P post goes to the antenna. The B plus post goes to the ground of the RFT. The F post goes to the F minus post on the first RF socket, while the G post goes to the G post on the same socket. The tuned RFT is wired thus: the beginning of the primary goes to the antenna post. The end of the same winding goes to the ground post. The beginning of the secondary winding goes to the F minus post of the first RF socket. The end of this winding goes to the G post. The condenser is connected across the secondary.

I WOULD like to build the 4-tube Diamond of the Air, but before doing so the following information is requested. (1)—Will this set bring in local stations

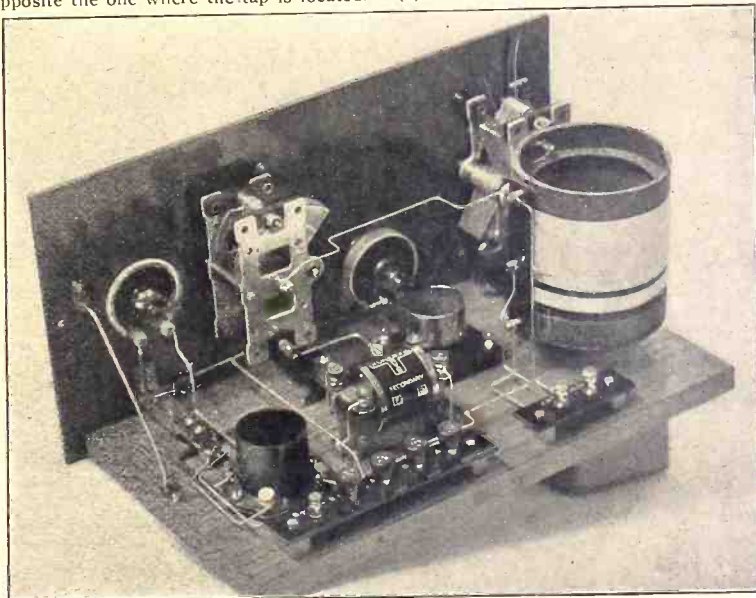

THE BERNARD DX Set, built by Cyril G. Palmer.

Then you will not have to establish a new tap or relocate the primary. (2) Slightly increase the B battery voltage or make a new tap for feedback, three or four turns further up. This method also would dispense with the necessity of taking turns off the secondary, as suggested in the answer to your first question. (3) You are doing so well with the set that merely an extra stage of AF. is suggested. (4) A 0-7 and 0-140 double range voltmeter and a 0-35 ammeter. (5) The B batteries need be tested only for voltage, for all ordinary purposes. Not until a 22 1/2-volt battery is below 17 or a 45-volt battery below 34 need one consider replacement. Shorting the battery is not to be countenanced. It ruins any battery.

I HAVE a 4-tube Acme Reflex set, which uses a loop. I would like to convert the set, so that an outdoor antenna can be employed. Please give the information required to do this and the methods of wiring the RFT in this portion of the circuit.—F. Franzieb, 587 Bay St., Stapleton, S. I., N. Y.

You may use either a fixed or tuned RFT. To make a TRFT, wind an antenna coil on a tubing 3/4 in. in diameter. The primary consists of 10 turns. The secondary consists of 45 turns. There is a 3/8 in. separation between the two windings. Use No. 22 double cotton covered wire. The .0005 mfd. variable condenser shunts the secondary of the RFT instead of the loop. The results, when using a

with good volume, when employing the loop? (2)—Would the Fiat loop work successfully in conjunction with this receiver? (3)—Is it necessary to use the RF stage, when using the loop? (4)—Can the Ambassador coils and condensers be used in this receiver? (5)—Will the 200 or 300 type tube work as satisfactory as the 01A type tube, as a detector in this set? (6)—If the -00 type is used as the detector, is it necessary to use a vernier rheostat as a filament control? (7)—Can the -01A type tubes be used throughout the set? (8)—Would it be advisable to use a Clarostat across the secondary of the last audio-frequency transformed as a volume control?—Fred Gegenheimer, 1231 Sheridan Ave., N. Y. C.

(1)—Yes. (2)—Yes. Remove turns from loop, if necessary to get dials to read alike. (3)—Yes. This stage is a great help in getting DX stations. (4)—Yes. (5)—Yes. When using this tube, you will have to change the grid return to negative, instead of positive as for the -01A type. (6)—Advisable. (7)—Yes. (8)—Yes. Connect the resistance to the G post of the first AFT and the arm to the G post on the next to last socket.

I HAVE a Hetroplex 3-circuit tuner. (1)—Can this coil be used in conjunction with the 1926 Model Diamond of the Air? The secondary is wound to be shunted by a .0005 mfd. variable condenser. I have a RFT wound on the same size tubing, with the same number of turns

# Five Fully Proven Circuits

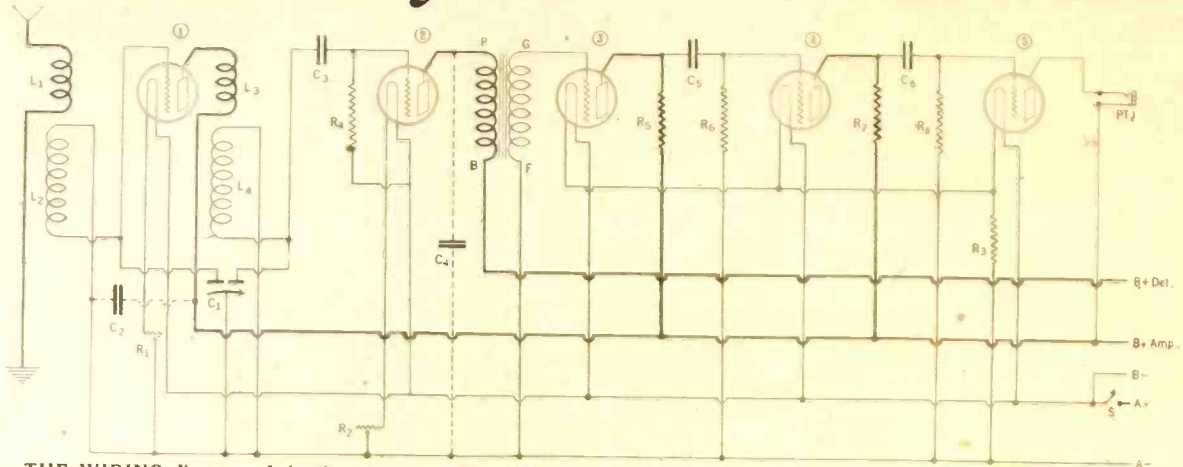

THE WIRING diagram of the Powertone, 5-tube 1-dial receiver, described by Herman Bernard in the Aug. 29, Sept. 5, 12, and Dec. 12 issues. Note the optional fixed condensers, C2 and C4, both of which increase the oscillatory value of the RF and detector tubes respectively.

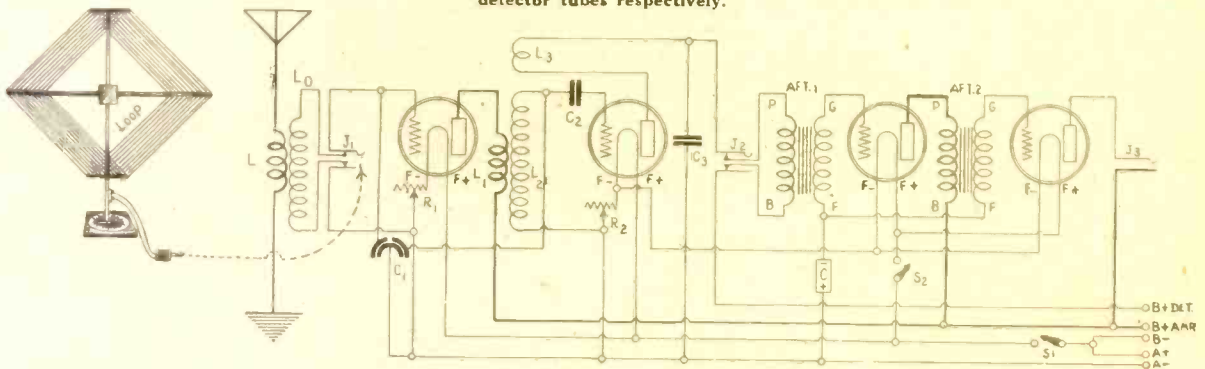

THE ELECTRICAL diagram of the 2-control 4-tube Diamond of the Air, which was described by Herman Bernard in the May 23 issue of RADIO WORLD. Note the special loop jack connections.

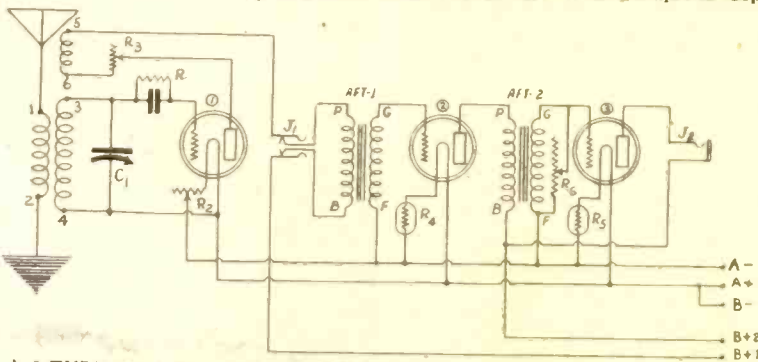

A 3-TUBE receiver, employing a 3-circuit tuner, with a variable resistance as a regeneration control.

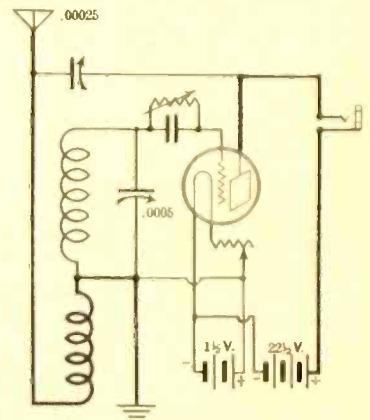

THE CIRCUIT diagram of the "1-Tube, Set That Affords 1,000-Mile Reception," described by Wm. Mercer of 887 Dundas St., East Toronto, Canada, which many fans have already built and are reporting consistent reception from stations, 1,500 miles distant. The coil is wound with No. 20 DCC wire on a tubing 3 1/2" in diameter and 4 1/2" high. Fifteen turns are wound. A small loop is made and the winding is continued on for 42 more turns, making a total of 57, tapped at the 15th turn. Regeneration is obtained by returning the plate lead to the antenna-grid circuits through the variable condenser at top.

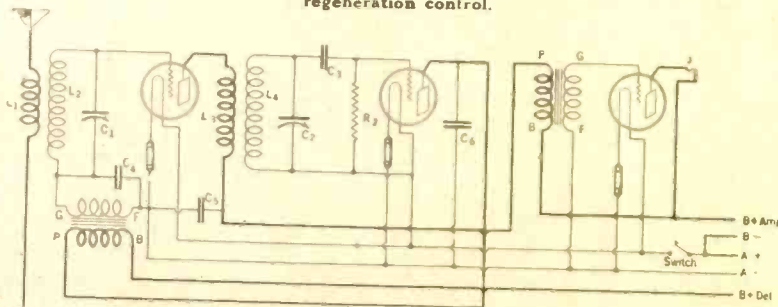

THE CIRCUIT diagram of the Freedom-Reflex, described by Capt. P. V. O'Rourke in the July 4 issue.

# Radio University

A FREE Question and Answer Department conducted by RADIO WORLD for its yearly subscribers only, by its staff of Experts. Address Radio University, RADIO WORLD, 145 West 45th St., N. Y. City.

I HAVE for some time intended to express my appreciation of your very interesting and valuable magazine, of which I have not missed a number since first taking it. Neither do I intend to miss any numbers.

I am a beginner, having built four sets in all (excluding a simple crystal set), in the following order: A 1-tube regenerative set, a 1-tube Harkness Reflex with Crystal detector, a 3-tube Harkness Counterflex, and last, the excellent 1-tube Bernard DX set with a stage of AF added, the account of which first interested me in RADIO WORLD October 24 last. I enclose a photograph of this little set as I made it. It is a dandy. It worked immediately, and within five minutes Dallas, Texas, was heard (WRR) with good headset volume. In this first test, one Saturday midnight, I brought in ten or twelve stations, including Dallas and Denver, three of which (Chicago stations) were quite audible on the loudspeaker; a little faint it is true, but loud enough that two or three persons sitting round the speaker did not miss a word. This, I think, is good for two tubes when one considers that no one here has enjoyed good volume on distant reception since January 1 and very often it has been impossible to bring in anything at all, so poor has radio been all the winter. The best feature of the little set, however, is its almost unbelievable selectivity. I can separate WOK and WBBM with one point's movement of the dial, and have a dead spot between them! This is fact! I would be interested to find out how well it would cut through local stations in a large city, but we have no nearer station than CKY (Winnipeg, 125 miles away). There are a few points on which I should like your advice as follows: (1) I used in the Bernard set a coil form  $3\frac{1}{2}$  in. diameter as per instructions, with 10 turns, primary; 60 turns, secondary, wound upon it, shunted with a 17-plate condenser (.00038 mfd.). However, the stations, instead of being spaced from 0-100 on the dial, are all included from 0-70, as if there were too many turns on the secondary. 217 meters comes in at 5; 300 at 17; 400 at  $33\frac{1}{2}$ , and WOAW, Omaha, Neb., 526 meters, at about 65 on the dial. Can you account for this, in view of the coil and condenser being all as specified? (2) Although it is of little importance and does not cause inconvenience when operating, still I would like to know why the set will not oscillate below 5 on the dial; the dial is set correctly with regard to the condenser plates and the set oscillates freely above this point. (3) Would you recommend enlarging this set, which is so satisfactory as a one or two tube set, into a four tube receiver, by adding ahead a stage of RF.; and two stages of audio amplification; or would it be more advisable for me to pick out a set as described in RADIO WORLD from time to time, of the size and number of tubes that suits my purpose? (4) What are the correct instruments to use to test voltage and amperage of A and B dry batteries? (5) What amperages should they show when in good condition, and when nearly exhausted? I recently had trouble with a new 45 v. battery whose voltage was apparently O. K., for it would light a 110 v. house lamp dully, and was therefore unsuspected. After looking for the cause of "frying" noises for a long time, we finally located the trouble in the battery, it was so dead in amperage that it would not spark when shorted, but still would light the 40-watt lamp.

In conclusion, I want to say how well RADIO WORLD has pleased me, and please me week by week. I find in every issue

three features not all present in any other one magazine. The first is the University. I read every question and answer every week and gain considerable information thereby. Second, your diagrams; a beginner needs diagrams so clear that it is next to impossible to make mistakes. RADIO WORLD diagrams are thus, with their primaries and ground connections indicated by heavier lines. The third feature is your illustrations, which make everything clear and add to the interest generally—Cyril G. Palmer, Box 56, Kenora, Ontario, Can.

(1) Your condenser capacity is a little larger than specified. Hence, remove five turns from the secondary at the end opposite the one where the tap is located.

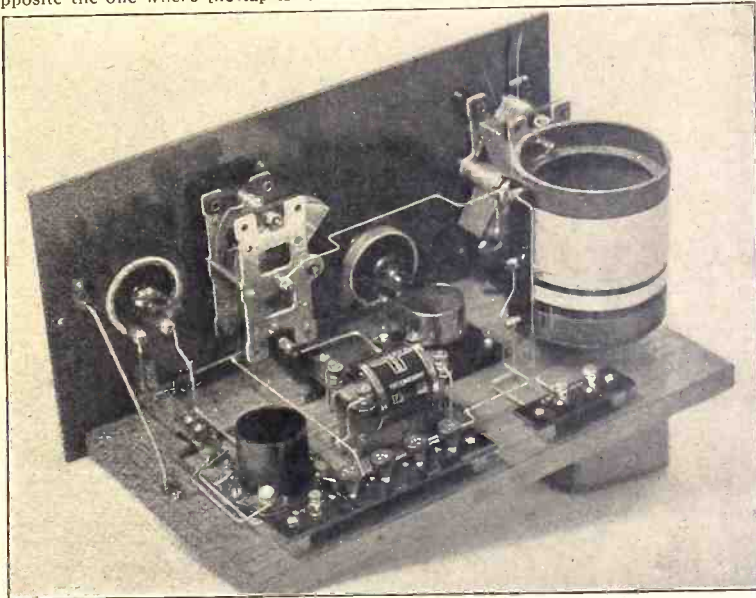

THE BERNARD DX Set, built by Cyril G. Palmer.

Then you will not have to establish a new tap or relocate the primary. (2) Slightly increase the B battery voltage or make a new tap for feedback, three or four turns further up. This method also would dispense with the necessity of taking turns off the secondary, as suggested in the answer to your first question. (3) You are doing so well with the set that merely an extra stage of AF. is suggested. (4) A 0-7 and 0-140 double range voltmeter and a 0-35 ammeter. (5) The B batteries need be tested only for voltage, for all ordinary purposes. Not until a  $22\frac{1}{2}$ -volt battery is below 17 or a 45-volt battery below 34 need one consider replacement. Shorting the battery is not to be countenanced. It ruins any battery.

I HAVE a 4-tube Acme Reflex set, which uses a loop. I would like to convert the set, so that an outdoor antenna can be employed. Please give the information required to do this and the methods of wiring the RFT in this portion of the circuit.—F. Franzlieb, 587 Bay St., Stapleton, S. I., N. Y.

You may use either a fixed or tuned RFT. To make a TRFT, wind an antenna coil on a tubing  $3\frac{1}{4}$  in. in diameter. The primary consists of 10 turns. The secondary consists of 45 turns. There is a  $\frac{3}{8}$  in. separation between the two windings. Use No. 22 double cotton covered wire. The .0005 mfd. variable condenser shunts the secondary of the RFT instead of the loop. The results, when using a

fixed RFT, of any manufacture, with a range of from 200 to 600 meters will not be equal to those obtained when using the tuned RFT. If a fixed RFT is employed the variable condenser which shunts the loop is omitted. The P post goes to the antenna. The B plus post goes to the ground of the RFT. The F post goes to the F minus post on the first RF socket, while the G post goes to the G post on the same socket. The tuned RFT is wired thus: the beginning of the primary goes to the antenna post. The end of the same winding goes to the ground post. The beginning of the secondary winding goes to the F minus post of the first RF socket. The end of this winding goes to the G post. The condenser is connected across the secondary.

I WOULD like to build the 4-tube Diamond of the Air, but before doing so the following information is requested. (1)—Will this set bring in local stations

with good volume, when employing the loop? (2)—Would the Fiat loop work successfully in conjunction with this receiver? (3)—Is it necessary to use the RF stage, when using the loop? (4)—Can the Ambassador coils and condensers be used in this receiver? (5)—Will the 200 or 300 type tube work as satisfactory as the 01A type tube, as a detector in this set? (6)—If the -00 type is used as the detector, is it necessary to use a vernier rheostat as a filament control? (7)—Can the -01A type tubes be used throughout the set? (8)—Would it be advisable to use a Clarostat across the secondary of the last audio-frequency transformer as a volume control?—Fred Gegenheimer, 1231 Sheridan Ave., N. Y. C.

(1)—Yes. (2)—Yes. Remove turns from loop, if necessary to get dials to read alike. (3)—Yes. This stage is a great help in getting DX stations. (4)—Yes. (5)—Yes. When using this tube, you will have to change the grid return to negative, instead of positive as for the -01A type. (6)—Advisable. (7)—Yes. (8)—Yes. Connect the resistance to the G post of the first AFT and the arm to the G post on the next to last socket.

I HAVE a Hetroplex 3-circuit tuner. (1)—Can this coil be used in conjunction with the 1926 Model Diamond of the Air? The secondary is wound to be shunted by a .0005 mfd. variable condenser. I have a RFT wound on the same size tubing, with the same number of turns

on the primary and the secondary, using the same kind of wire as on this 3-circuit tuner. Can this be used also? (2)—Can -12 type tubes be employed successfully in this set? (3)—If so, what size Amperites should I use? (4)—I have a 5 to 1 radio Hedgehog AFT and a 3 to 1 All American AFT. Which of these should I use in the set?—Samuel DeStein, 120 Second Ave., Pittsburgh, Pa.

(1)—Yes, both the tuner and the RFT may be used. (2)—Yes, but the volume will not be great. (3)—Use a Amperite No. D-11 for each tube. (4)—Either one may be used.

\*\*\*  
**WHEN A .00015 mfd. fixed condenser** is placed in series with the antenna, will I be able to receive lower wavelength stations than if it were left out? That is, if I couldn't receive stations below 400 meters, using a standard 3-circuit tuner with a 45-turn secondary, it being shunted by a .0005 mfd. variable condenser, would the above method help? (2)—How would I increase the wavelength of the set, so that I could receive stations as high as 600 meters, the 500 meter band being the highest that I could reach? (3)—When I use the second stage of AF amplification, there is a terrible howl. If a .0005 mfd. fixed condenser is placed across the P and the G posts of the second AFT in this 3-tube receiver, will the howl be killed? (4)—What spacing should there be between the primary and the secondary windings in a 3-circuit tuner? (5)—What spacing should there be between the primary and the secondary windings on a tuned radio-frequency transformer?—C. Lessner, 26 Humboldt St., Brooklyn, N. Y.

(1)—Yes. (2)—Add 8 turns to the secondary. (3)—That is one method. A leak, about 1.0 or 0.5 meg., is usually better, connected the same way. (4 and 5)—The spacing between the primary and the secondary windings in both the RFT and a tuner is the same. e.g.  $\frac{3}{8}$  or a  $\frac{1}{4}$  in.

\*\*\*  
**IN REGARD** to the Victoreen, described in the Feb. 20, 27, March 6 and 13 issues of RADIO WORLD: (1)—What is the proper amount of B battery voltage to be used on the first six tubes and the audio-frequency amplifiers? (2)—Is it possible to leave either C5 or C8 out of the circuit and still obtain good results? (3)—Are storage batteries superior to dry batteries, as to long life and all around efficiency? (4)—Would the World storage A and B batteries be all right to use in conjunction with this set?—Roy E. Morgan, 25 Division St., Wilkes-Barre, Pa.

(1)—The plates of the oscillator, first detector, three RF and the second detector tubes receive 45 volts. This is known as the detector voltage. The plates of the amplifier tubes receive 90 volts. This is known as the amplifier

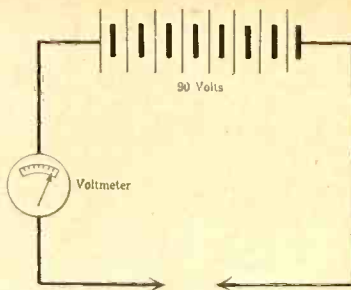

FIG. 288, illustrating the method of connecting a voltmeter.

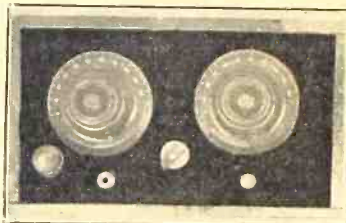

FIG. 289, showing the panel view requested by Mr. Sraughtin.

voltage. (2)—C8 may be left out. (3)—Storage batteries last longer, but they are no more efficient than dry batteries. A storage A battery should be used. The B battery may be of the dry cell type. (4)—Yes.

\*\*\*  
**IS A voltmeter** connected in series or in shunt to a battery? (2)—Please show the correct and the wrong ways of connecting a voltmeter in a B battery circuit.—Harvel Strewens, Perth Amboy, N. J.

(1)—A voltmeter is always connected in shunt to a battery circuit. An ammeter is always connected in series to a battery or generator source. (2)—Fig. 288 illustrates the methods of connecting up a voltmeter. The correct way is to connect the two arrows together. The wrong way is to connect one arrow to, say, the plate of a tube and the other arrow to the A minus, etc.

\*\*\*  
**I WOULD** like to have a panel view of a 1-tube regenerative receiver, using a 3-circuit tuner and a variable condenser to shunt the secondary of the tuner. A rheostat is also used, to control the filament of the detector tube. A switch is inserted in series with the A plus side. A single circuit jack is used in the plate output. A Bretwood variable grid leak is shunted across the grid condenser. The panel should be no more than 7x14". Please state the measurements.—Frank Sraughtin, Lexington, Ore.

Fig. 289, shows the panel view. The hole for the shaft of the variable condenser is 4" from the left and 3 $\frac{1}{2}$ " from the top and the bottom of the panel. The hole for the shaft of the tickler coil, is 4" from the right, 3 $\frac{1}{2}$ " from the top and the bottom of the panel. The hole for the rheostat is 7" from left and the right hand edges and 2" from the bottom. The hole for the switch is 3 $\frac{1}{2}$ " from the right and 1" from the bottom. The hole for the jack is 3 $\frac{1}{2}$ " from the left and 1 $\frac{1}{2}$ " from the bottom. The hole for the Bretwood leak, is 1" from the left and 2" from the bottom.

\*\*\*  
**WILL YOU** please give me a diagram of a 5-tube receiver employing a step of tuned non-regenerative radio-frequency amplification, an untuned non-regenerative detector stage, a stage of transformer coupled AF followed by two stages of resistance coupled AF amplification? Provisions should be made in the RF stage, so either a loop or an antenna and ground may be employed. The plate of the RF tube should be coupled to the F minus through a .001 mfd. fixed condenser. The plate of the detector tube should be coupled through an other .001 mfd. fixed condenser to the B plus post. The filaments of the RF and the detector tubes should be controlled by rheostats, while those of the three AF tubes should be controlled by a single ballast resistor. Please state the constants of the coils, condensers, resistors, rheostats, etc.—H. Gradur, Stanwood, Ia.

Fig. 290 shows the diagram that you request. The RFT is wound on a tubing 3 $\frac{1}{4}$ " in diameter and 4" high. The primary, L1, consists of 10 turns. The secondary consists of 45 turns. There is a  $\frac{3}{8}$ " separation between the two windings. L3 and L4 are the primary and the secondary respectively of the fixed radio-frequency transformer. A .0005 mfd. variable condenser shunts the secondary of the tuned RFT. The second RFT may be of the tuned variety if desired. In that case, a tubing 3 $\frac{1}{4}$ " in diameter and 4" high is used. The primary, L3 consists of 10 turns, while the secondary, L4, consists of 45 turns, with a  $\frac{3}{8}$ " separation between the two windings. No. 22 double cotton covered wire is used to wind the tuned RFT. C2, the grid condenser, has a capacity of .00025 mfd. The grid leak, R3, has a resistance of 2 megohms. R1 and R2 are both 6 or 10-ohm rheostats, with a carrying capacity of  $\frac{1}{4}$  amperes. R8 is a  $\frac{3}{4}$  ampere ballast resistor. C5 and C6 are .25 mfd. fixed condensers. R4, R6 and R7 are .1 mfd. resistors, while R5 is a .5 mfd. fixed resistor. S is a filament switch. A single circuit jack or a pair of phone tips may be connected in the output. All the tubes employed are of the -01A type. The plates of the detector and the RF tubes receive the same B battery voltage,

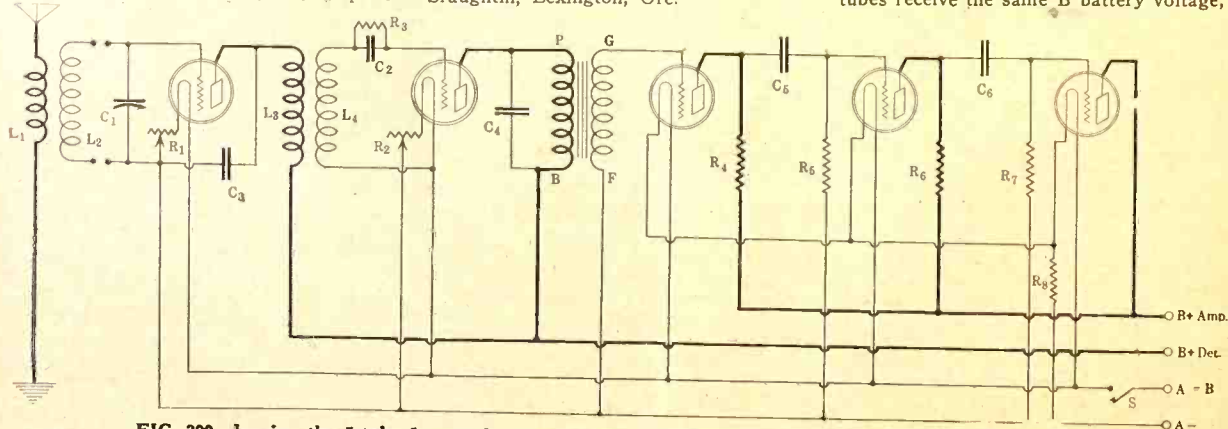

FIG. 290, showing the 5-tube 1-control receiver with one transformer and two resistance AF couplings.

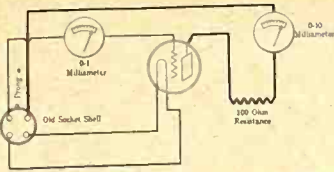

FIG. 291, showing the special meter arrangement.

which is 45. The plates of AF amplifying tubes receive at least 135 volts.

**PLEASE SHOW** how to insert a milliammeter with a reading of from 0 to 1 in the grid circuit, and a milliammeter in the plate circuit, with a reading of from 0 to 10. In series with the milliammeter place a 100 ohm resistance. I wish to use the 100 ohm resistance so as to prevent the meter from blowing in case there is a surge in the current, as I have no higher reading instrument. Connect up the meters in such a fashion, so that I can make the battery connections to a tube socket, instead of to a strip. A C battery should be included. The idea of this hookup is to obtain simultaneous readings of the grid and plate current, at a specifically applied voltage.—Burns Johnson, Brook Vale, Va.

FIG. 291, shows the diagram for the insertion of the meters as you suggest. The A, B and C battery leads are attached to their respective places, e.g., B battery to the P post on the socket, G post to the minus post of the C battery, the A plus to the F plus and the A minus to the F minus posts.

**CAN ANY** other tube than the Raytheon be employed in the B battery eliminator described by Lewis Winner in the Jan. 16 issue of RADIO WORLD?—John Weider, Long Island City, N. Y.

No. The complete step-up transformer and first portion of the filtering system are built around the specific action of this tube, which is a gaseous rectifier and is unlike the common rectifier tubes of the two element type.

**I DESIRE** to make the Tectron B battery eliminator, described by Lewis Winner in the March 13, 20 and 27 issues of RADIO WORLD.

(1)—What are the dimensions of the laminations employed to make up the core for the choke coil, using the closed core system? (2)—What are the dimensions of the laminations employed to make up the cone for the transformer? (3)—Is it possible to wind a separate secondary on the transformer to deliver 2 amperes, so that an A battery may be charged? (4)—I have a stack of transformer punchings, 3" high and 5 3/8" long. They are .005" thick. When two of these laminations are placed so as to make a square, the inside dimensions are 1 3/8" high and 4 1/8" long. Can these be employed to make up the core for the choke coils and the transformer?—Charles H. Patterson, 221 West Park Avenue, Anaconda, Mont.

(1 and 2)—The laminations for the choke coils and the transformers are the same. They are 2 1/2" high, 3 3/4" long, 3/4" wide, with a thickness of .005".

(3)—No. You will have to use a special autotransformer in conjunction with the Tungar tube, employed to pass 2 amperes, which seems to be the only one of its type on the commercial market, that can do so. (3)—Instead of 120 laminations to make up the core for the choke coils, only 100 should be used. Instead of 128 laminations in the core for the transformer, there are only 104 laminations.

**IN REFERENCE** to the 5-Tube TRF Set, described by Capt. P. V. O'Rourke in the December 26 issue of RADIO WORLD. (1)—If the A minus is grounded, will the

reception of the signals be improved? (2)—Is it necessary to place a filament switch in series with the positive leg of the detector tube to get best results? (3)—Would a .001 mfd. fixed condenser across the secondary of the RFT help any? (4)—How would a C battery be placed in the set? (5)—Would it be all right, if I used two low ratio type AFT, or should I use a high ratio AFT in the first AF and a low ratio AFT in the second AF stage?—H. H. Hessler, Jr., 38 The Arcade, Cleveland, O.

(1, 2 and 3)—No. (4)—Break the lead running from the F minus posts to the A minus post. Connect the C minus post to the F minus posts of the AFT. Connect the plus of the C battery to the minus of the A battery. (5)—Two low ratio type AFT are all right to use in the set.

**I HAVE** a .00035 mfd. variable condenser, which is enclosed in a metal box which I think is made by the Connecticut Tel. and Tel. Co., of Meriden, Conn.; a toroid coil, whose secondary is wound to be shunted by the .00035 mfd. variable condenser; a 99 type socket; a No. 4V-199 Amperite; a 2 megohm grid leak; a .00025 mfd. fixed condenser; a .0005 and a .0001 mfd. fixed condenser; a pair of phones, batteries, antenna and ground, etc. Now I would like to use these parts to make up a 1-tube regenerative receiver, which is to be placed in a box 7" high and 10" long. Could I have the circuit diagram of such a receiver and also photographs of the completed set? Please state data on cabinet, placing of parts, etc.—Hardy Goodheart, Oceanville, N. J.

Fig. 292 shows the circuit diagram, while Figs. 293, 294 and 295 show three different views of the completed receiver. L1 is the primary. L2 is the secondary. C3 is the .0005 mfd. fixed condenser. C4 is the .0001 mfd. fixed condenser. C1 is the variable condenser. C2 is the grid condenser. R2 is the grid leak. R1 is the Amperite. The placing of the parts is shown clearly in Fig. 293. The condenser is the only instrument that is mounted on the wooden panel. This is in the front.

**I HAVE** added three stages of autotransformer audio frequency amplification to my 3-tube 3-circuit tuner receiver. However, I am troubled with a consistent howl. I connected the transformers in this fashion, e.g., P posts to the P posts of the detector and two AF tubes; B posts to their respective B voltage terminals; G posts to one terminal of three .25 mfd. fixed condensers. Fixed resistances of the .5 megohm type were used to shunt the grid-filament circuits of the three amplifier tubes.—Grant Lawrence, Port Jervis, N. Y.

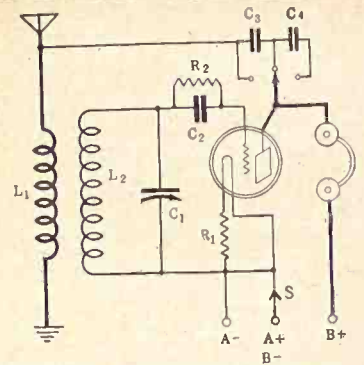

FIG. 292, circuit diagram of the 1-tube receiver designed for Mr. Goodheart.

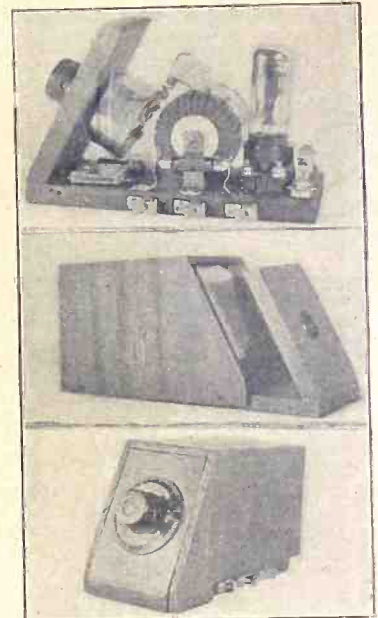

FIG. 293 (top), side view of the complete receiver. Fig. 294 (center), showing the cabinet. Note the sloping effect of panel and cabinet. The panel is mounted at angle of 65 degrees. Fig. 295 (bottom), showing how the complete set appears. Note the small compact size.

You should have used a 500,000 ohm variable resistor in the first or second stage. The resistance is in shunt to the grid filament circuit. The resistor arm goes to the G post of the same tube.

## Join RADIO WORLD'S University Club

And Get Free Question and Answer Service for the Coming 52 Weeks. This Service for Yearly Subscribers ONLY

Have your name entered on our subscription and University lists by special number. Put this number on the outside of the forwarding envelope (not the enclosed return envelope) and also put at the head of your queries. If already a subscriber, send \$6 for renewal from close of present subscription and your name will be entered in Radio University.

[In sending in your queries to the University Department please paragraph them so that the reply can be written under or alongside of each query. Write on one side of sheet only.]

RADIO WORLD, 145 West 45th Street, New York City.

Enclosed find \$6.00 for RADIO WORLD for one year (52 Nos.) and also enter my name on the list of members of RADIO WORLD'S University Club, which gives me free information in your Radio University Department for 52 ensuing weeks, and send me my number indicating membership.

Name .....

Street .....

City and State .....

# Pliers with Elastic Bands Serve as a Handy Vise



SOLDER being applied to a clip, held by the plier vise.

Although vises for holding small objects are not expensive, they require space and usually the use of the kitchen table.

Where heavy objects are to be sawed, etc., a vise is a necessity, but when soldering a terminal to another terminal, a pair of pliers and a pair of heavy rubber bands are all that are necessary to make up the special vise. Insert the article to be soldered in the teeth of the pliers. Wrap the heavy rubber bands around the ends of the pliers, so that the teeth close with a tight tension upon the object. Lay the pliers on the table and solder with the iron. A heavy object may be placed alongside of the handle of the pliers to act as a brace.

# Comparison of Receivers Requires Careful Tests

By Carter McKay

ONE of the worst jobs performed by the run of radio experimenters is receiver comparison. Naturally it is a subject that interests them deeply, as they are undecided on which type of set to construct or buy, and solicit the opinion of other fans. The questioners are themselves gone through the experience of comparison.

The best test that can be made is a laboratory one, where precision instruments are used to determine the selectivity, sensitivity, volume and the amplification of the receiver at audio and radio-frequencies. These tests develop certain factors that enable accurate comparison of all types of receivers. The functioning of the sets under actual operating conditions in the home, granting due regard for tubes, batteries and antenna system, will confirm the advantages or disadvantages as ascertained in the laboratory. But resonance peaks, amplification factors, audibility charts, etc., are beyond the run of fans, hence they turn to the operation comparison, including volume, selectivity and the ability to get distant stations. This is a fair test, even granting the wide margin of variation caused by differing conditions.

### The Long Ago

The chief vice that enters here is that comparisons are made with results obtained from sets used several months ago, or even a few years ago, whereas conditions have changed vastly since then, especially in cities. All over the country the stations are using higher power than formerly. In urban localities there are several times as many stations as there were a few years ago, and the blanketing effect of their power is to make distant reception possible, in many cases, only when these stations are off the air. Hence to compare results obtained with a set bought today, and results a couple of years ago with a set that had fewer tubes, even though it had more controls, is not a test at all, but an utter absence of comparison, for the attempt is being made to concoct a comparison out of unlikes.

Ever so many more persons, live close to broadcasting stations now that the problem of tuning out that neighboring transmitter, even to obtain merely other local stations, is sometimes a difficult one. A regenerative wavetrap is a fine solution, and any one interested in achieving the trapping out of such an interferer

should read the article by John F. Rider in the December 26 issue of RADIO WORLD. Looking at this problem from another phase, a Super-Heterodyne, particularly with a stage of tuned radio-frequency amplification ahead of the frequency converting system, will enable one to tune out the neighboring station. Persons who live near a station should not compare the operation of any receiver which is put to the test of excluding that station, with the results obtained from the same or any other receiver before that station was there.

In the purchase of a manufactured set, the so-called commercial models the names of which are familiar to all, it is not asking too much to be assured that the set will operate satisfactorily in the place where it is to be installed. Hence you may patronize a reputable dealer, and he will give you such a guarantee and live up to it, for if the set does not tune out interference, or otherwise proves unsuitable, he will see you satisfied before he finally disposes of your case. But it is imperative not to string out the test until the set has been used so long it is unreasonable to ask any one to think of accepting its return. Nor is it a just complaint that a receiver does not get distance, or, that it once did so but now fails to do so, as these things may be due to local conditions, and your location may require a set of a type much more expensive than the one you have. Do not expect everything for next to nothing. Virtually all sets made today are capable of distant reception—Super-Heterodynes, Neutrodyne, tuned radio-frequency sets and reflexes certainly—and the most important fact in favor of distant reception is knowing how to tune in a DX station. This requires very careful manipulation of the dials and other controls, necessitating catching a wave by so exact a setting that the barest fraction of a division on a dial will cause the station to be tuned in or out. For this reason control reduction is growing more and more popular, and single control sets are winning favor. The public has come to regard two controls with great favor. Such members of the public who have tuning skill do not mind three controls. There are many housewives and even children throughout the land who get DX stations on 3-control sets, and this type of receiver has lost no popularity.

If tests are to be made under actual receiving conditions, different sets may be tested the same night, one right after the

## Speaker Location H



TUNING a set with the speaker along; not judge how the reception sounds to about the same distance from set, operation be made by the operator (whose chair system requires an extra piece of furniture reveals the usual poor location.

## The Crosleys E



MR. AND MRS. POWEL CROSLY, Dubilier aboard their motor yacht, M waters. Both men are well-known

other, and the tests repeated on subsequent occasions, for then can one feel certain that he is doing some justice to the endeavor. Hence persons who do not know the relative efficacy of receivers may well look to impartial experts for advice, because they have made such tests, or, better still, have put various receivers

Correct Judgment



it has disadvantages. The operator can- ners in the room. If the speaker is plac- and other listeners a just appraisal may d shoulder are visible in photo). This re, such as the table. The lower photo of the speakers. (Hayden).

Entertain Dubliers



MR. entertained Mr. and Mrs. William ma, during a recent cruise in Florida manufacturers of radio apparatus.

through laboratory tests and developed data that, under receiving conditions, are translatable into volume, selectivity and DX. Both types of tests constantly are being made in RADIO WORLD's laboratories, and that is why receivers, the construction of which are described in this maga- zine, give fans so much satisfaction.

# Battery Plates Deteriorate If Not Given Proper Care

The plate of a small storage B battery, if the battery is either charged in the wrong direction or is allowed to stand and sulphate, deteriorates. In either case, the lead peroxide or spongy lead falls out. The plate also bends, causes the separators to be cracked, due to the heat generated and touches the next plate, thereby short circuiting the complete battery. The same effect is obtained with the plates of a large A battery.

The frame or grid, as you see in the photograph, is made up of an alloy of lead and antimony. The positive plates are made by giving them an extra heavy charge from a direct current source. This oxidizes the material in the squares of the plates, which are composed of lead and oxide paste until it is transformed into lead peroxide, or a brown material. The negative plates are reduced from the oxide state until the solution becomes



PENCIL points to broken plate of battery.

spongy and appears to be dull gray in color. If you ever happen to take a battery apart you will note that there is an extra negative plate. This is because a negative plate is the starting plate as well as the concluding plate.

# Suiting the Set to Location Requires Real Expertness

The making of a radio receiver to order, and its installation, is work requiring expertness and care. Not only must the set work well in the place where it is made, to satisfy the maker, but, still more important, it must perform well in the home where it is to be installed. The client is likely to be particular, and he has a right to be so, but he should be prepared to pay an expert quite well for his services, for they require a mixture of knowledge and patience that is not found readily.

A case in point is that of a New York radio engineer of high repute who was engaged to construct a Fenway Super-Heterodyne for a client in the automotive field. The set has a stage of tuned radio frequency amplification ahead of the modulator. In the expert's laboratory, under antenna conditions there, this stage did not flop into uncontrollable oscillation. The constructor took the set in his automobile to the client's home in New Jersey. There the aerial was only 30 feet long, and the lesser resistance naturally made oscillation easier, in fact too easy, so that the potentiometer adjust-

ment scarcely could kill it. So the expert made the long trip back to his laboratory in his car, to take turns off the primary of the interstage coupler, and also to remedy roughness that developed in the audio circuit due to the transformer secondary leaking across the laminations to the primary. Correction of these and some minor ills took a few hours more. Finally the set was adjusted to best operating conditions for the locality where it was to rest the weary legs of its cabinet, and gave excellent results.

The experience merely confirms the necessity of knowing the effect of special local conditions upon the operation of receivers, the value of sufficient knowledge to know how to remedy these, and the fact that real work lies behind a proper construction and installation job. These are benefits that service branches of set manufacturing firms, or selling agents, render with expertness, and which specially retained engineers perform for sets they make for others. Why best results are not always obtained from sets bought in department store sales thus may be readily understood.

# Chicago Manufacturers War on Credit Crooks

CHICAGO.

The Radio Manufacturers' Association, under the leadership of B. W. Ruark, executive secretary, is rapidly stamping out corrupt firms and individuals who are preying on legitimate members of the radio industry. Every case brought to the attention of the association is investigated and future operations are prevented by extensive publicity among its members and the trade in general.

This is proving very effective. "A favorite method employed," according to Mr. Ruark, "is to assume the name of a reputable firm in a large city, use a different street address and purchase goods from out-of-town manufacturers and jobbers. The credit manager of the

manufacturer looks up the rating finds it satisfactory and the goods are shipped.

"Future correspondence is ignored, or in some cases forwarded to the real firm, who immediately checks up the matter and gives the facts to the manufacturer and the association, who take steps to warn other members of the industry, and to request information other firms may have on the same company.

"As an example, in one city there were three firms operating under the same name, and in a number of instances goods were shipped to irresponsible parties. In another case even the name of the purchasing agent of a certain company was carefully reproduced with a rubber stamp," Mr. Ruark added.

## Equal Tax on Music Favored By Broadcasters

THE National Association of Broadcasters favors the Vestal bill, now before the House, which would compel stations to pay a statutory fee to music copyright owners. The measure is a companion one to the Dill copyright bill. The association cited the closing of stations at the Biltmore and the Ambassador, in Los Angeles, as the effect of the present state of affairs, where differing charges are taxed by the Society of Authors, Composers and Publishers. It professed belief that all stations might shut down if the present system continues, and said that some stations now are forced to pay per year "as high as \$25,000 and over."

### Likes Definiteness

On the subject of the remedial bill the Broadcasters said:

"While this plan imposes a burden upon broadcasters in the United States which is not found in Canada or any European country, it will, nevertheless, be supported by the National Association of Broadcasters. This support is based on the theory that whatever tax the new law provides, the amount will be a definite and known quantity, and will prevent individual broadcasting stations from being taxed amounts running, in some cases, as high as \$25,000, and over.

### Music 90% Favorite

"A survey of the records of public approval and disapproval of the country's broadcasting programs indicates that the listening public demands that 90 per cent. be music. No station could continue without the use of music, and exorbitant tax demands from music interests would undoubtedly cause practically every principal broadcasting station to close down, thereby dealing a death-blow to this new, truly great factor in national life."

## DX in Canada Slumps; Reason Is Mysterious

MONTREAL. "It is my belief that the Dominion of Canada has suffered to a greater extent from disturbed atmospherics, in so far as they relate to radio reception and broadcasting, than has been the experience of the United States during the winter season." This observation was offered by A. R. McEwan, Director of Radio, Canadian National Railways, following a request for a statement regarding radio conditions in Canada.

Because of the magnitude and organization of the Radio Department of the Canadian National Railways, the Director is in a position to obtain a great deal of data not available to others outside the Governmental services. The CNR operates ten broadcasting stations so situated as to be able to record conditions in the great stretch of country from the Atlantic to the Pacific. In addition, there are 42 coaches containing radio receiving equipment, and as these cars are in daily movement over the same vast territory from Halifax to Vancouver, a train route distance of 3,780 miles, the operators have unusual facilities for obtaining observations under varying conditions. These operators must furnish a log of each run, and such logs, combined with those of the ten broadcasting stations, offer a fertile source of interesting data.

## Mary, Doug and Ann!



MARY PICKFORD and her husband Douglas Fairbanks, broadcasting from station WBOQ, of Richmond Hill, N. Y. With them is Miss Ann Morgan, sister of J. P. Morgan. (Underwood & Underwood)

## Pennsylvania Farms Have the Most Sets

Pennsylvania, with 14,953, leads in the census being taken of the number of radio sets on farms in ten states reporting. Among others are California, 13,254; Oregon, 3,251; Tennessee, 1,970, and Washington, 2,691.

**COOLIDGE MAY 30 SPEECH TO BE BROADCAST BY CHAIN**  
The Memorial Day address to be delivered at Arlington Cemetery by President Coolidge on May 30 will be broadcast by several stations.

## Pithy Program Pointers From Particular Fans

I don't dislike jazz; I'm sick of it just about the same way as children get sick of too much candy around Christmas.

T. J. STRATTON,  
Taylor City, Tex.

\* \* \*

The penalty for reading out telegrams of requests and applause should be revocation of license and ten years at hard labor.

H. S. HAINES,  
1012 Westover Ave.,  
Norfolk, Va.

\* \* \*

The run of programs is good. They can't suit all, but one can always switch to something else.

L. C. BENNETT,  
Bensonville, N. Y.

\* \* \*

Stop all jazz hounds and Charleston mules.

W. T. LAMBERT,  
310 Lakeview Ave.,  
West Palm Beach, Fla.

\* \* \*

I am more than a fan, I am a nut on radio. I think radio the greatest thing on earth.

HARRY DUNNING,  
6 Exchange St.,  
Danesville, N. Y.

\* \* \*

Please not so many speeches. Let us have more music and less hot air.

J. C. STURM,  
Concorn, N. H.

\* \* \*

Popular music played on a pipe organ is to my notion the best entertainment and the most neglected on the air.

HOWARD BROWNING, D. C.,  
Detroit, Mich.

\* \* \*

It's not so much the classification, but the quality that counts.

E. A. FORSTER,  
Cedar Rapids, Iowa.

\* \* \*

A kick for the announcer who is so ashamed of his station or program that he will not give call letters.

G. C. DUNCAN,  
Dallas, Tex.

\* \* \*

No soap box politics. No cheap wit from announcer.

I. W. MILLARD,  
17 State St.,  
New York City.

\* \* \*

The more programs on the air, the merrier.

FREDERICK WM. FOERTSCH,  
Hawthorne, N. J.

\* \* \*

Listeners will be gradually educated to good programs.

W. W. ELDSINGER,  
16 Franklin St.,  
Washington, D. C.

## Lodge Invents Way To Prevent Radiation

LONDON.

Sir Oliver Lodge, noted radio authority and spiritualist, has invented a method of preventing radiation by regenerative and other receivers. The system hinges about the aerial circuit, where tuning is omitted. New sets will not cost more, if the system is installed, but existing sets would have to be changed slightly. Sir Oliver did not give details.

In resuming his remarks on the experiences of the current season, Mr. McEwan said: "These adverse conditions do not appear to be confined to any one section of the country, although they have been more marked on the Atlantic Coast and the middle section of Canada, bordering on the St. Lawrence and the Great Lakes. than in the extreme West.

"Long range reception, which was enjoyed during the winter of 1923-24 and even during the summer of 1924, has gradually waned, with periods of favorable conditions interspersed. These favorable receiving and broadcasting conditions have of late been very much more infrequent than heretofore, and I hear of many sections of Canada where it is practically impossible to obtain anything but local reception for several nights in succession. These conditions are prevailing in and about Montreal and Ottawa, and, in fact, throughout the greater part of Eastern Canada.

"The theory of sun spots, which has been advanced, is certainly a plausible one, but until sufficient data have been accumulated it will be impossible to determine whether the relation between sun spot cycles and radio reception conditions can be definitely accepted as basic."

The sun spot theory may save dispute.



# Office Eyelet Machine Makes Good Coil Posts

EYELETS may be used as binding posts on coils. When attaching lugs to the tubing, which is of either of cardboard, hard rubber or bakelite composition, you will find that by simply flattening them down with a pair of pliers, they will not stay put. An office hand eyelet machine does the trick. Insert eyelets, purchasable in any hardware store, are put through the holes in the coil form. Press with the eyelet machine and you then have a perfect grip.



PUNCHING the eyelets with the machine.

## Call Letters In a Telegram Only One Word

WASHINGTON.

Many listeners have encountered differences of opinion at telegraph offices as to whether or not call letters should be charged for as one word for each letter. A case of this kind recently arose here, whereupon the question was put up to the local officials.

Thomas P. Dowd, Superintendent for the Postal Telegraph Company, said that call letters of four letters would go as one word but that precaution should be taken to write the letters together as one word.

H. F. Taff, of the Western Union, replied to the same effect, saying that the call letters of a radio station written as a group would be counted at the rate of one word for any five letters or a fraction of five letters in such a group.

## Joke Not Funny Enough, Fan Writes Supervisor

SAN FRANCISCO.

Smacking of Tambo and Bones of the old-time minstrel show, nevertheless new on the air, a communication forwarded to Washington by J. F. Dillon, supervisor of radio here, criticizes the following joke as not funny enough for radio:

"What is the difference between Uncle Sam, a rooster, and an old maid?"

"Uncle Sam says Yankee doodle do; the rooster says cockadoodle do; and the old maid says any doodle do."

## Nerve Messages Recorded With Aid of Amplifier

LONDON.

A 3-stage amplifier has enabled Dr. E. D. Adrian, fellow of the Royal Society, to record the effects of impulses passing through a single human nerve fibre. It had been known that nerve sensations called messages, are electrical disturbances, but few could be recorded photographically. Dr. Adrian succeeded by amplifying these disturbances 2,000 times, using a radio hookup and tubes.

## GREETING DISPLEASES HIM

A critical listener remarked that a soloist on the air should not attempt to address an audience following a rendition.

# Tax on Sets In Berlin Stirs Fans to Fury

BERLIN.

The deficit developed by the municipal opera has led the City Council to propose a tax on radio receiving sets, and a heavy tax, at that. This has infuriated many set owners, particularly those who are also dog owners, because a tax of \$18 a year on dogs was levied for the same operative reasons. This resulted in many being forced to give up their dogs, since \$18 a year is a fearsome tax for nearly all. Their dogs killed in the lethal chamber, their radio sets perhaps being next in line for annihilation, the citizens in this class are wondering what kind of confused financing and taxation is necessary to support a civic opera that lags behind their radio in preference. An added source of ranking is the fact that the amusement taxes have been increased enormously, so that persons prevented from attending vaudeville and other shows, because the tax was nearly as large as the admission fee, relied on their radio sets for entertainment.

Mass Meetings are being planned. Radio clubs will protest strongly against the proposed tax.

## INTERESTING FACTS

Poland will have its first radio exposition this month.

\* \* \*

Thirteen wireless stations throughout Bolivia are now open for public service.

\* \* \*

A discriminating burglar in New York is reported as stealing nothing but radio sets.

\* \* \*

Radio bed time stories for American children told at 7 o'clock, are three hours too early!

\* \* \*

What many can't understand about the radio is how the static knows you have company that night.

# Slander Over the Air New Problem In Law

WASHINGTON.

WHAT is generally supposed to be the first suit brought against a station for slander broadcast over the radio has not been sustained. It was filed against station KFJF at Oklahoma City by C. W. Friss, undersheriff of Oklahoma County, for \$20,000 as the outgrowth of a sermon by Rev. Lincoln McConnell, pastor of the First Baptist Church, in which reference was made to alleged illegal acts by county officials.

The case was dismissed on a demurrer filed by Dudley Shaw of KFJF. He likened himself to a telephone company which furnishes the lines over which the program is transmitted from the remote control to Station KFJF. It was Mr. Shaw's argument that as a telephone company could not be held liable for a slanderous conversation passing over its wires between two individuals, neither could a broadcasting station be held.

## Follows Amendment Defeat

Oddly enough, this Oklahoma case came within a few days after just such a thing had been predicted by Representative Blanton, of Texas, who advocated in the House of Representatives, Washington, an amendment subsequently defeated, making slander over the air a criminal offense.

"The night before election in any district in the United States serious damage could be done to any candidate for Congress," Representative Blanton argued. "That alone should appeal to members of Congress. Damage may be done to any citizen. Serious damage could be done to any candidate for President of the United States or to the Governor of any State just before election. From the National Capital I hear once in a while a program from Dallas, Texas., in my home

State, nearly 2,000 miles away, and this I do enjoy. Some one in St. Louis or Kansas City might absolutely cover my State with a radio message that could damage seriously individuals or candidates for office or business enterprises. How are the people of New Jersey going to hold responsible the people of New York, who may damage them in their personal standing and character and in their business in the transmission of radio messages, unless you have some kind of a controlling statute on this matter?"

## Believe State Should Punish

Although some saw merit in Representative Blanton's argument, Government officials appeared to believe, and apparently this is borne out by the action in the Oklahoma case, that after all slander is a matter between the parties directly concerned, whether it takes place over the telephone, a broadcasting station, or otherwise, and that punishment for such an offense should not be lodged in a Federal court statute.

It appears to be their opinion that this could be adequately taken care of by an amendment to the State laws, such as apply to libelous matter in newspapers. In other words, they believe that State laws rather than national laws could be made to adequately cover the situation.

## Crowe's Case

State Attorney Crowe recently heard an announcer at a cabaret broadcast the statement Crowe was sitting there enjoying the show. Crowe, listening on his set at home felt offended. He organized a squad and raided the place. No law was found covering slander or libel by radio, so a disorderly conduct charge was lodged.

## A THOUGHT FOR THE WEEK

Esperanto is interesting enough, but it doesn't seem to have progressed very far. Radio music comes pretty near to being "the universal language."

# RADIO WORLD



Radio World's Slogan: "A radio set for every home."

TELEPHONE BRYANT 0558, 0559  
PUBLISHED EVERY WEDNESDAY

(Dated Saturday of same week)

FROM PUBLICATION OFFICE

HENNESSY RADIO PUBLICATION CORPORATION  
145 WEST 45th STREET, NEW YORK, N. Y.

(Just East of Broadway)

ROLAND BURKE HENNESSY, President

M. B. HENNESSY, Vice-President

FRED S. CLARK, Secretary and Manager

European Representatives: The International News Co.  
Breems Bldg., Chancery Lane, London, Eng.  
Paris, France: Brenano's, 38 Avenue de l'Opera  
San Francisco: Lloyd B. Chappell, 656 O'Farrell St.

EDITOR, Roland Burke Hennessy

MANAGING EDITOR, Herman Bernard

TECHNICAL EDITOR, Lewis Winner

CONTRIBUTING EDITORS, John F. Rider, J. E. Anderson

## SUBSCRIPTION RATES

Fifteen cents a copy. \$6.00 a year. \$3.00 for six months. \$1.50 for three months. Add \$1.00 a year extra for foreign postage. Canada, 50 cents.

Receipt by new subscribers of the first copy of RADIO WORLD mailed to them after sending in their order is automatic acknowledgment of their subscription order. Changes of address should be received at this office two weeks before date of publication. Always give old address; also state whether subscription is new or a renewal.

## ADVERTISING RATES

General Advertising

1 Page, 1 1/4" x 11"	462 lines	\$300.00
1/2 Page, 1 1/4" x 5 1/2"	231 lines	150.00
1/4 Page, 3/4" x 11"	231 lines	150.00
1/4 Page, 4 1/4" x 11"	115 lines	75.00
1 Column, 3 1/4" x 11"	154 lines	100.00
1 Inch		75.00
Per Apage Line		75.00

Time Discount

52 consecutive issues	20%
26 issues consecutively or E. O. W. one year	15%
4 consecutive issues	10%

WEEKLY, dated each Saturday, published Wednesday. Advertising forms close Tuesday, eleven days in advance of date of issue.

## CLASSIFIED ADVERTISEMENTS

Ten cents per word. Minimum 10 words. Cash with order. Business Opportunities ten cents per word, \$1.00 minimum.

Entered as second-class matter March 25, 1922, at the Post Office at New York, N. Y., under the Act of March 3, 1879.

APRIL 10, 1926

## Service Medal Founded by "Popular Radio"

A medal for conspicuous service has been instituted by "Popular Radio," under the guidance of Kendall Banning, editor. The announcement sets forth:

It shall be awarded without discrimination to all amateurs—men, women or children, of any race, nationality, color or creed—through whose prompt and efficient action radio is utilized to perform an essential part in rescue work. The awards shall be restricted to non-professionals only.

The medal will be awarded to as many individuals as qualify for it and at such times as the Committee of Awards may authorize.

All communications may be addressed to the Secretary of the Committee of Awards, Popular Radio Medal for Conspicuous Service, 627 West 43rd Street, New York City.

# Marvels of the Future

MUCH experimenting is being done in fields that promise marvels in radio for the future. First of these in interest is television. This is a system of transmitting light waves so that they may be received in one's home, as a program is now. Perhaps both may be modulated on the same carrier wave, so that you hear the voice and see the singer through the same agency. Much progress is necessary before a practical solution can be offered to the public, but the advance made to date is encouraging. The system has been popularly called "radio movies," although this is not technically correct, since movies are a reproduction of permanently recorded scenes, and exhibited at will, while television is simultaneous with the event. It amounts rather to seeing the actual event, not a photograph of it, somewhat the same difference as exists between radio and phonograph.

This is a marked difference.

On the receiver side, experiments are being conducted on schemes for omitting tubes and batteries entirely from radio receivers, although here progress is unencouraging. While the secrets of this work are well guarded, it has been hinted that chemical amplification is being attempted.

We are familiar only with chemical rectification.

Inventive minds operate much along lines dictated by public preference. This year has been seen the development of the B battery eliminator to an advanced degree, and receivers that include a B eliminator as part of the installation are familiar to all. Some sets even have both A and B eliminators, which means that much hard thinking and hard work had to be done, because the A battery eliminator is a problem. It is true, however, that dry-cell B batteries are by far the favorite, even now, and the public has learnt how to buy and how to use them. Nowadays even owners of 5-tube sets, who use them quite considerably, enjoy four to six months' use of their B batteries, and the average is about five months. There is naturally commercial competition between the B battery eliminator and the B battery. The strength of the argument, made by the battery maker, that a user need buy a block of batteries only twice a year, has been effective. Against this may be rated the convenience and sightliness of the eliminator, two points that the manufacturers of these stress strongly.

# The Human Antenna Puzzle

BODY capacity is a mysterious thing.

It is defined as the ability of the human body to be a condenser plate. But it is more than that, since the human body also is a collector of radiant energy, and much of the body capacity effects is due to the pickup function. Hence the capacity is like that between aerial and ground. It is also true that different persons have different degrees of body capacity, and some have hardly any at all. Nervous persons seem to have more of it than the calm and cool type. It had been assumed for a long while that the bulkier persons had more body capacity than the frail ones, but experience does not justify this. Maybe the nerves running through the body act as an antenna, and those persons with jumpy nerves have more sensitive antennas within them. The field is interestingly speculative.

Persons who have much body capacity

sometimes remark that those who have the most vitality have the most capacity.

Anyway, one member of a family, in tuning a set, will complain that it howls when he places his hand near the dial, while another will deny this, and each will prove his case. Sometimes this condition has less to do with body capacity than with incorrect tuning. For instance, a regenerative set, or any other set, when operated at critical feedback, which often means too much of it, invites trouble from body capacity, and that trouble may be avoided by turning back the tickler a trifle, or lowering the filament temperature, if the set is non-regenerative. No set should be a body capacity barometer. The design of present-day condensers, with grounded rotors, and coils with confined fields, makes for the elimination of body capacity. If the nuisance persists, shielding should be employed.

# "How Dear to This Heart"

Radio is so dear to the heart of the public that if it is denied reception for even so much as a night it feels as if some one dear to it were missing. In thousands of American homes the radio set is in operation every night of the week. Therefore to be without radio would be a hardship for this class.

As warmer weather approaches, with its lure of the outdoors, persons should consider the advisability of having a portable

set, or a set installed in the motor car or boat. Then the discomforting void will not be experienced. Radio sets have reached such a state of efficiency that, even in portable form, they may be depended on to bring in stations when one is deep in the woods, far from any station. And that is when reception is most welcome, for there is an added charm lent by the surroundings.

Try it and see.

## Navy Tests Refute Interference Charge

WASHINGTON.

The Navy has ordered all of its stations possessing powerful receiving sets to listen to broadcasts, to determine to what extent, if any, Navy transmission of code interferes with programs.

During the recent international broadcasting week, a special board appointed by the Commandant of the Submarine Base at New London, Conn., devoted nine nights to eavesdropping on the broadcast wave bands and succeeded in tracing all but two of the many alleged Navy sets interferences to other causes.

## New York Doubtful On Keeping WNYC

The municipal administration in New York City is making a canvass of radioists to determine whether the city's station, WNYC, should be continued. The annual payroll alone is \$37,000. Maintenance and floor space are additional items of cost.

The abolition of the station was one of the first things suggested to Mayor Walker when he came into office and was looking about for means of economy. An investigation was started by the engineers of the Department of Plant and Structures to determine its usefulness.

# THE RADIO TRADE

## Set-Making Is Hard; Needs Skill for Success

By Fred W. Barr

SEVERAL set manufacturers have fallen into the pit of financial troubles during the past several months. Not all were in the small-fry class, either. It is obvious that set manufacturing is risky business, unless the product is one that stays sold and the financial resources are strong enough to purchase deserved popularity. Otherwise money spent for publicity buys only unpopularity.

After a business has hit the rocks a crop or army of hindsight experts rushes forward with the "authentic" analysis of the reasons for the smash. Merchandising policies and engineering counsel come in for a full share of blame. Usually the cause is complex, a combination of many factors, but a great deal of the trouble would be avoided if the following were observed:

(1) The product should be tested under adverse conditions to insure its meeting the needs of the day as to selectivity, volume and distance.

(2) Factory supervision should be an important item and packing and shipping should be carefully watched. Some firms fail because they cannot stand the loss entailed in returns due to breakage, as insurance does not always cover this leak.

(3) Quantity production should not be undertaken until the demand shows strong signs of justifying it. This precludes possibility of profit for even an entire season, in many cases. Overproduction leads to department store sales which may kill the market for the set.

(4) Money spent for publicity should be spent where it will do the most good. Whoever spends that money may be inclined to do so in a manner entailing least effort, rather than in a way that produces most sales. Appeals to general circulation, at an enormous cost, like \$2,500-a-week electric signs on Broadway and \$7,500 pages in popular weeklies, do not fit in with the restricted returns on most radio set sales.

(5) The markets in the large cities—e.g., New York and Chicago—should not be overestimated. The rural districts have "made" most receivers; the cities have killed most of the sets that have passed into the misery of custodianship by a creditors' committee.

Besides these matters, a set manufacturer need not expect to pale the efforts of Freshman, Atwater Kent, Crosley, R. C. A., etc., on a shoestring. It seems certain enough that, at present, success cannot be won in one season, and moreover, that it cannot be won in any season unless much wise spending is done, without batting an eye, and with expectancy of return relegated to the ensuing season.

Also, it should be remembered, a set that the public does not take to is as valuable to-day as a newspaper published last week.

### GRIMES QUILTS GRIMES, INC.

David Grimes, inventor of the inverse duplex system, has resigned from David Grimes, Inc. His letter of resignation was addressed to the Creditors' Committee. He said his confidence was shaken by the management.

### A Radio Mecca



HERE it is—Cortlandt Street, New York City—famous radio lane.  
(Hayden)

### Rossiter & Co.

#### Add Weston

Rossiter & Co., wholesale distributors, have laid in a complete stock of Weston reliable instruments, covering the entire range of voltmeters, ammeters and milliameters as follows:

Type 506, voltmeters, single range (2 binding posts) 3-5-7-8-10-15-50 or 150 volts. Double range (3 binding posts with push button) 125/5-140/7 or 150/7.5 volts. Double range (4 binding posts without push button) 125/5-140/7 or 150/7.5 volts. Double range (with 9 point bi-polar switch) 140/7 volts.

Milliameters, 1.5, 5, 10, 15, 25, 50, 100, 300 and 500 M. A. Ammeters, 1, 1.5, 3, 5, 10 and 15 Amps.

Type 425, antennae ammeters, 1, 1.5, 2, 3, 5, 10, 15, 20 Amps. Thermo-Galvanometer, 4.5-ohms (115 M. A.). Thermo-Milliameters, 125, 250 and 500 M. A. Type 489, 0-7.5 volts-0-150, double range portable voltmeter. Type 301, filament voltmeters, 1.5, 2, 3, 5, 7, 8, 10, 15, 20, 25, 30 and 50 volts. Plate voltmeters, 50, 100, 150, 300, 500, 1000, 1500, 2000, 2500 and 3000 volts. Filament ammeters, 1, 1.5, 2, 3, 5, 8, 10, 15, 20, 30 and 50 Amps. Plate milliameters, 1.5, 2, 5, 10, 15, 25, 30, 50, 100, 150, 200, 300, 500 and 800 M. A. Zero center voltmeter, 3-0-3 and 10-0-10 volts. Type 506, pin jack voltmeter. Type 301, 150-7.5 volts. Double range voltmeter.

They also carry Sangamo, the heat, fume and moisture proof reliable fixed condenser, which is guaranteed to be accurate within 10% under all temperature and humidity conditions. All capacities are regularly carried in stock. Any information as to these lines may be obtained from Rossiter & Co., Inc., 136 Liberty Street, New York City.

### New Corwico Price List

The time for erecting new aerials is here, and dealers and others who are interested in wire for every radio purpose will do well to send for the new price list on Cornish Wire. It covers boxed aerial kits, loose aerial wire in every style; loop wire in all capacities and coverings, and every kind of wire used in radio. This concern is noted for the quality of its products. Address the Cornish Wire Co., 30 Church Street, New York City. Mention RADIO WORLD.

### Literature Wanted

THE names of readers of RADIO WORLD who desire literature from radio jobbers and dealers are published in RADIO WORLD on request of the reader. The blank below may be used, or a post card or letter will do instead.

Trade Service Editor.

RADIO WORLD,  
145 West 45th St., N. Y. City.

I desire to receive radio literature.

Name .....

City or town .....

State .....

Are you a dealer? .....

If not, who is your dealer? .....

His Name .....

His Address .....

- C. D. Wilkins, 1307 Republic St., Cincinnati, O.
- S. B. Folkman, 1903 East 9th St., Cleveland, O.
- James C. Lamphere, 616 East 10th Ave., Spokane, Vincent T. Haier, 527 North Sawyer Ave., Chicago, Vincent T. Hoier, 527 North Sawyer Ave., Chicago, Ill.
- James Whitfield, Hialeah, Fla.
- W. F. Bacchus, 10 Stark St., Ashtabula, O.
- E. P. Capstack, R. F. D. 6, Ashtabula, O.
- Victor Wallace, 14 Hope St., Ashtabula, O.
- Myco Radio Service, 137 West Delavan Ave., Buffalo, N. Y. (Dealers).
- E. Anderson, 5524 24th St., Omaha, Neb.
- E. Schevegwan, 1917 Kinney Ave., Cincinnati, O.
- Clayton T. Pierce, Dalton, Mass.
- C. C. Hampson, Pateros, Wash.
- Thomas Ciranni, 16 Main St., Homer City, Pa. (Dealer).

### Welty Unit Improved; Tuner Added to Line

Wm. A. Welty & Co., 36 South State Street, Chicago, have improved their detector-amplifier unit, which consists of a socket to which a tuner is to be wired, followed by a compact and efficiently wired two-stage transformer coupled audio amplifier. Posts are provided for C battery connections, or the posts may be bridged to omit the C battery. There is only one rheostat, instead of two, and this rheostat controls the detector tube. A ballast governs the two audio tubes. The appearance has been made ever more attractive than before.

The company is adding a 3-circuit tuner Welty unit to its line, in two forms, one with spaced winding of gold wire on a skeleton Bakelite form, the other a basket weave coil, with spider-web primary. In both models the primary is variable. The fixed tickler is bridged by a variable resistor, Clarostat, for regeneration control.

### Business Opportunities Radio and Electrical

Rates 10c per word; Minimum, \$1.00; Cash with order

**RADIO AND MUSIC STORE, HAVING THE** Stromberg-Carlson, also Freshman Agency, besides handling other prominent make of Radio, with five-year lease in very good Brooklyn business and theatre location; business steadily increasing; to party who can appreciate this opportunity are prepared to make attractive proposition; principals only. Box 10, 294 9th St., Brooklyn, N. Y.

**RADIO CONE SPEAKER MANUFACTURING** business for sale; established connection with distributors; near Newark; excellent facilities; principals only. For details address Box 100, Radio World.

**METAL ARTICLES, STAMPING, ASSEMBLING,** finishing, dies and tools for economical quantity manufacturing. Metal Craft Co., 306 East 40th, New York City.

**STORE, RADIO, BUSY LOCATION, WONDERFUL** opportunity for live wire. 136 West 23d., New York City.

**1926 DIAMOND OF THE AIR BOOKLET** with full instructions to make the Diamond, with blue print, 50c. Newsdealers and radio dealers can get supply from American News Co. and its branches. RADIO WORLD, 145 W. 45th St., N. Y. C.

### Bruno Corp. Moves into New Large Quarters

The Bruno Radio Corporation, well-known parts manufacturers, with offices for the past several years at 221 Fulton Street, New York City, and factory at New Haven, Conn., announces its removal to a large plant at 40 Paynter Avenue, Long Island City. The entire organization is now housed in the new building, the total floor space for the general offices and factory assembly units amounting to more than 6,500 square feet.

The Bruno headquarters are a few blocks from Queensboro Plaza, fifteen minutes out of Grand Central. The building is a brand new one of the latest type concrete construction, with sides formed almost entirely of glass windows.

The new factory is being devoted to the manufacture of the Bruno low-loss inductances, the recently designed Bruno bakelite-shaft straight line frequency variable condenser, micrometer and straight line frequency dials, pilot light battery switch and aluminum shelf brackets. An experimental laboratory has been fitted out with the most advanced measuring instruments for precision research work.

The acquisition of the Long Island City plant marks the culmination of the most successful year in the history of the Bruno Radio Corporation, which has developed from an insignificant cellar shop into one of the leading independent parts organizations in the country. Its products, particularly its coils and condensers are being used by radio fans in every part of the world, and have been adapted to receiving sets of many different types.

### Paul S. Weil Moves Into Larger Quarters

Due to the necessity for larger and more modern quarters, Frank Kiernan & Co., advertising agency, has moved its offices to the ninth floor of the new building at 41 Maiden Lane, New York City.

This agency, through Paul S. Weil, who is in charge of radio advertising, was one of the first to realize the vast possibilities in this field. Mr. Weil and his associates have been actively engaged in the radio field for more than four years and number several of the most representative manufacturers among their clients, including the Chas. Freshman Co., Inc., Ambassador Sales Co., De Jur Products, Inc., Cleartron Vacuum Tube Co., United Scientific Labs.

### New Resistor Manual Published by Daven

The new edition of the Resistor Manual, published by the Daven Radio Corporation, which is perhaps the most authentic publication on the subject of resistance coupled amplification, is now available to the public. It clearly explains resistance coupling, what and why it is, and gives many photographs and wiring diagrams showing how resistance coupling can be added to present sets. It also gives complete construction data for building many standard circuits, including the new Daven Bass Note Circuit. Copies may be obtained at any radio dealers or from the Daven Radio Corporation, Newark, New Jersey. Mention RADIO WORLD.

#### SETS FAIL IN EUROPE

##### WASHINGTON.

Many American radio sets offered for sale in Europe are not capable of receiving at wavelengths above 600 meters, according to a consular report to the Department of Commerce.

### STATION NEWS

KHQ, at Spokane, Washington, 394.5 meters, has been allowed to increase its power from 500 to 1,000 watts. This followed tests which indicated that the station was so located that no interference was caused by the use of higher power on that wavelength.

The call letters of WJBG at Charlotte, N. C., have been changed to WNRC.

#### BEAUTY-QUALITY-LOW PRICE

TYPE 5SS 5-Tube Tuned Radio Frequency. \$45  
TYPE 6RR 6-Tube Resistance Coupled Audio Tuned Radio Frequency. \$50

If your dealer cannot make immediate delivery we will ship direct from factory  
**American Interstate Radio Service**  
183 Greenwich Street New York City  
Distributors. Jobbers, Dealers, write for special trade terms

#### FREE RADIO BOOK

Science has invented a new kind of coil. Now have it on your present set. Gives 4 great advantages otherwise impossible. Write for new book just published, showing many new ideas. Also 8 new circlod circuits. Address Electrical Research Laboratories, R.W., 2548 Cottage Grove Avenue, Chicago.



Make Your Set Deliver its Best with

#### The WOUND WIRE AERIAL

Improved Reception and Greater DX Guaranteed! Approved by Popular Radio and Radio World.

For indoor or outside aerials Send postal for descriptive booklet "Something New in Radio"

THE WOUND WIRE AERIAL CO.,  
Reedville, Virginia

#### JOHN F. RIDER

announces that his laboratory is now available as a service institution catering to the radio fan constructor and the broadcast listener.

Also his personal services are available to radio fans as consultant in matters pertaining to radio receivers in all their phases.

Mr. Rider is the author of the Laboratory Scrap Book appearing each Saturday in the New York Sun Radio Magazine, Contributing Editor of Radio World, and contributor to many other leading radio periodicals of the country.

LABORATORY OF JOHN. F. RIDER  
145 West 45th Street New York City  
Telephone Bryant 2383

### HEADQUARTERS FOR LATEST CIRCUITS

#### A FEW OF OUR BARGAINS:

Cockaday's L. C. 26 Complete Parts.....\$54.20  
The New Silver-Cockaday Complete Parts.....49.95  
Bremor-Tully Counterphase Six Complete Parts \$1.80  
General Radio Universal Complete Parts..... 86.75  
Hammarlund Roberts Complete Parts..... 48.50  
Silver-Thordarson E Eliminator Kits..... 28.90

#### IMMEDIATE DELIVERY

Only Genuine Specified Parts, No Substitutions  
Send for our FREE FOLDER.

#### ECONOMY RADIO SALES CO.

"Everything in Radio at a Saving"  
288 Sixth Ave. Dept. E New York, N. Y.

We Specialize in Complete Kits  
The M. & H. Engineering Service Will Supply Parts or Complete Sets of Any Hook-Up

#### DESCRIBED IN THIS OR ANY OTHER RADIO MAGAZINE

M & H SPORTING GOODS CO.  
512 Market St. Philadelphia, Pa.

#### DON'T USE "B" BATTERIES

A remarkable device just perfected. Easily built by any radio fan. Plugs into common light socket, uses no acids or tubes. Delivers powerful, absolutely noiseless "B" supply. Fully guaranteed.

Complete drawings and instructions \$1.00  
**RADIO EQUIPMENT CO.**  
408 W. 11th Avenue Mitchell, S. D.

### New and Improved FRESHMAN MASTERPIECE

AT AUTHORIZED FRESHMAN DEALERS ONLY

### WORLD'S FINEST LOUD-SPEAKER

A three-foot cone speaker—unit developed by the inventor of the Tropadyne. Can be assembled in fifteen minutes, saving 80% of the cost. Complete Kone Kit with blue prints sold on rigid money-back guarantee—shipped prepaid—\$10.

Engineers' Service Company  
Suite 203 15 Park Row, New York

### ULTRA-LOWLOSS CONDENSER

SPECIAL CUTLASS PLATES DISTRIBUTE THE STATIONS EVENLY OVER THE DIAL SIMPLIFIES TUNING CAPACITY—0005 MFD

\$5.00  
PHENIX RADIO CORP., 116-F East 25 St., N.Y.C.



### Vacuum Tubes Rebuilt \$1.00 each

POSITIVELY GUARANTEED equal to new tubes in every respect. Money will be refunded if tubes prove unsatisfactory for any reason other than burn-outs.

Send us your broken and burned out tubes by parcel post. (Not necessary to insure or guard against breakage.) We make return shipments by parcel post C.O.D. and try to maintain 24-hour service.

**HARVARD RADIO LABORATORIES**  
200 Old Colony Avenue South Boston, Mass.

### FILL OUT AND MAIL NOW SUBSCRIPTION BLANK

## RADIO WORLD

RADIO WORLD

145 West 45th Street, New York City (Just East of Broadway)

Please send me RADIO WORLD for ..... months, for which

please find enclosed \$.....

SUBSCRIPTION RATES:  
Single Copy..... 15  
Three Months..... 1.50  
Six Months..... 3.00  
One Year, 52 Issues..... 6.00  
Add \$1.00 a Year for Foreign Postage; 50c for Canadian Post etc.

1, 2 or 3  
201A-199  
**"BUKTRONS"**  
Get What U Pay For  
"RADIOTUBES"  
744 N. Clark St. Chicago, Ill.

Bring in Europe on a  
**Victoreen "Super"**

Write for Layout and Parts List.  
**THE GEORGE W. WALKER CO.**  
6515 Carnegie Avenue Cleveland, Ohio

**AT LAST** UX-112 Power Tube attached without rewiring by Na-Ald No. 112 Connectorald.

The UX-112 Power Tube produces increased volume without distortion. Na-Ald No. 112 Connectorald

No re-wiring—has attachments for B and C Batteries—does not raise \$1.25 tube in socket. Price

Write—Alden Manufacturing Company Dept. S1 Springfield, Mass.



**WHITEHALL**

**LOW-LOSS INSULATOR**

Tested and Approved by the Radio World

Do you realize how much you lose of VOLUME and DISTANCE by poor insulation? Use the WHITEHALL. Always dry in wet or damp weather. Moulded from No. 1 PORCELAIN, each surface highly glazed, and prove to yourself how much the BEST insulation means to your set.

NOTE THE DIFFERENCE IN RECEPTION; this is the test. Send 98c and we will mail you a set of WHITEHALL INSULATORS (Two). If, after connecting them to your aerial you are not satisfied with the result, mail them back and we will refund your money.

**WHITEHALL INSULATORS**  
Shipping Dept., 4 Blount St., Whitehall, N.Y.



**KESTER Radio SOLDER**  
(Rosin-Core)

If your dealer cannot supply you send us 25c in postage

**CHICAGO SOLDER COMPANY**  
CHICAGO, U. S. A.

# Radio Bill Expected To Pass This Session

WASHINGTON. Public hearings on the White radio bill will be initiated soon in the Senate Interstate Commerce Committee, according to the chairman, Senator James Watson,

of Indiana. Senator Watson says he has given considerable thought and study to the White bill and he is favorably impressed by many of its features. He believes it is possible that the White bill will be substituted for the Dill bill, which has been under consideration. Radio legislation should be enacted this session of Congress, Senator Watson believes.

**VEBY HIGH-MU TUBES**

Made especially for Resistance Coupled Amplifiers. Now you can get more volume with greater clarity.  
A. F. 20 for the 1st and 2nd Stage.....\$3.00  
A. F. 6 Power Tube for 3rd Stage.....4.50

**VEBY RADIO CO.**

47-51 Morris Avenue Newark, N. J.

There are only two Super-Heterodynes in the whole world worth building—and the Fenway is both of them.

**Fenway Blueprints Still Going Strong.**  
Price, \$3 Postpaid.

**LEO FENWAY**

29 West 64th Street New York, N. Y.

**FIXED RESISTORS**  
**Micamold**  
**FIXED CONDENSERS**

In Herman Bernard's Portable Receiver the Micamold Condenser Resistor Unit is used. It is accurate, constant in value and indestructible. Made of mica and molded in bakelite. At all good radio stores.

**MICAMOLD RADIO CORP.**  
Flushing and Porter Aves., Brooklyn, N. Y.



ACCURACY GUARANTEED  
VALUES REMAIN CONSTANT

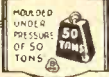

**LOUD SPEAKER RECEPTION**  
from either coast on three tubes

Blueprint and instructions .....\$1.00  
Necessary low loss coil ..... 2.50  
Beautiful finished instrument .....35.00

**S. A. TWITCHELL CO.**

1930 Western Avenue Minneapolis, Minn.

## BOOKS

Many readers inquire about a good text book on radio. One of the standard text books is "Principles of Radio Communication," by J. H. Morecroft, Professor of Electrical Engineering at Columbia University. A Pinto, Test Engineer at the Otis Elevator Co., of Yonkers, N. Y., and W. A. Curry, Instructor in Electrical Engineering at Columbia University and Assistant to the Chief Electrical Engineer of the New York Edison Co., aided Prof. Morecroft in writing certain chapters of the book, which is published by John Wiley & Sons, Inc., of New York City.

There are 919 pages of diagrams and text regarding radio communication of a tremendous value to anyone desiring to have a good knowledge of the fundamentals and also advanced theories and practice of radio engineering.

The first chapter treats with the study of electrons, electric fields, continuous and alternating current, self-induction, resonance, decrement, types of coupling, etc. The second chapter deals with resistance, inductance and capacity. The third chapter will prove of great interest to the radio fan with little or no technical knowledge, for a general view of radio communication is treated very carefully. Wave motion in water, different types of waves, selectivity, interference, transmitting and receiving, atmospheric interference and freak transmission are some of the popular subjects treated. Chapter four deals with the laws of oscillating circuits. Chapter five deals with spark transmitters.

Chapter six deals with a comprehensive study of vacuum tubes and their operation in typical circuits. Possibility of electric emission, uses of the three electrode tube and characteristic curves are among the numerous subjects treated.

Chapter seven deals with continuous-wave transmitters and receivers.

## Delights From WGBS

Members of the Kittredge Glee Club were heard over WGBS in a program of Easter Carols, and appropriate music—



MRS. IDA HUTCHINSON

aided by the ukelele section of the club. The Kittredge Singers recently gave a recital at their clubhouse, New York City, and the merit of the recital caused Daily Paskman to book them for an hour from the Gimbel station. The Kittredge Club was founded 35 years ago by the Rev. Abbott E. Kittredge and is for the professional and business girl. It is a non-commercial non-sectarian organization and today is presided over by Mrs. Ida Hutchinson, resident director, who has handled their activities for ten years.

# AEROVOX

Is Specified  
By LEWIS WINNER

for the TECTRON &  
2 D. C. ELIMINATORS

and all other Radio World's "B" Eliminators

Why? Because they are "BUILT BETTER."  
Also FIXED MICA CONDENSERS, RESISTORS and RESISTANCE-COUPLED UNITS.

**AEROVOX WIRELESS CORP.**

489-491-493 Broome Street

New York City



# 1,500,000 Sets in Britain; 4 Times U. S. Popularity

In Great Britain there are 1,500,000 licensed radio receivers, the Postmaster's Special Committee reported. A great many bootleg sets are in use—these being owned by license fee dodgers—but excise officers are tracking them down fast. The 1,500,000 sets mean that one family out of every five has a set, as compared to only one family out of twenty in the United States.

The license fee must be paid by all set owners. It is \$3 a year for home-made sets and \$2.50 for all others, except that foreign-made sets are prohibited a license.

There are twelve broadcasting stations in Great Britain, the report continues, and 90 per cent. of the population is either crystal range of at least one station.

As was published recently, the committee advocated the abrogation of the private monopoly of radio enjoyed by the British Broadcasting Company, and instead advocated the control of radio by a directorate elected by Parliament.

## Selectivity Independent Of the Readings on Dial

Frequency tuning is no more selective and no less selective than the other method. Selectivity is a function of the receiver, not of the shape of the plates of

a condenser or of the mechanical design of a dial. Selectivity is the ability of a set

### CLAROSTAT



prescribed by LEWIS WINNER for the TECTRON "B" ELIMINATOR and the 2 D.C. "B" Eliminator. Also O.K.'d by RAYTHEON and a host of other nationally known eliminator manufacturers. \$2.25. American Mechanical Laboratories, Inc. 285 N. 6th St. Brooklyn, N. Y. Dept. R. W.

A book of valuable radio diagrams and information covering the above subjects will be mailed to you upon receipt of four cents in stamps.

Sent Prepaid Anywhere in the U. S. SPACES PERFECTLY \$7.50

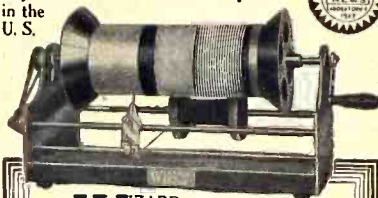

### WIZARD WIRE WINDER

eliminates the most trying and difficult job in building sets. Saves hours in time and waste! Winds automatically and uniformly any thickness of silk, cotton and enamelled wire into practically any style coil from 1/2 in. to 3 1/2 in. diam. and up to 10 1/2" long. Full instructions with each machine. Ready for instant use. Nickel plated throughout, strongly built.

SEND NO MONEY we'll send your WIZARD C.O.D., or enclose \$7.50 with your order—either way we pay the postage.

Wizard Wire Winder Co. 3812K Central Ave. Los Angeles, Calif. Dealers! Investigate!

Sold on an Absolute Money Back Guarantee



to receive a given frequency, or small band of frequencies, to the exclusion of all other frequencies or small bands of frequencies. Interpreted into practice it means the ability to tune in one station to the exclusion of all other stations. A reasonable distance from the station always is supposed. Frequency tuning, without affecting the selectivity, gives you much more room on the dial between stations of low wavelength when accomplishing this tuning.

## WELTY'S

DETECTOR AMPLIFIER UNIT

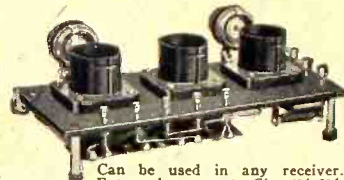

Can be used in any receiver. Extremely compact. Size 4 1/4 x 9 1/4. All strictly high class parts. Universal sockets. Distortionless transformers. Will handle the volume of any set. Only 4 connections necessary to hook up to any tuning apparatus. Price only \$19.50.

WILLIAM A. WELTY & CO. 36 South State Street, Chicago

# IN THE WEST it's "RADIO"

For Seven Years the Best Practical Radio Magazine.

A Free Sample Copy for the asking

PACIFIC RADIO PUB. CO. Pacific Bldg. San Francisco

# FREE RADIO CATALOG

WRITE for a copy of our NEW 100-Page Radio Catalog—Parts, Accessories—Kits—Sets—Everything for the Fan.

DEPT. R. W.

## CHICAGO SALVAGE STOCK STORES

509 S. State Street, CHICAGO, U. S. A.

## You Can Build a Laboratory Receiver! FENWAY BLUEPRINTS SHOW YOU HOW

Life-Size Drawings—Coil Data—Everything You Should Know About This Ultra-Modern Radio Receiver.

PRICE OF COMPLETE SET OF BLUEPRINTS—\$3.00 Postpaid

Others Give Their Radio Prints Away FREE!—Fenway Prints Cost

You \$3.00—WHY?

Radio Division, The Columbia Print 147 West 45th Street New York City

## TWO-FOR-ONE SUBSCRIPTION OFFER

Radio World has made arrangements

—To offer a year's subscription FREE for any one of the following publications with one year's subscription for RADIO WORLD:

- POPULAR RADIO or
- RADIO BROADCAST or
- SCIENCE AND INVENTION or
- RADIO NEWS or
- RADIO DEALER or

- RADIO (San Francisco) or
- RADIO AGE or
- COLLIER'S or
- BOYS' LIFE or

This is the way to get two publications

- for the price of one:
- Send \$6.00 today for RADIO WORLD
- for one year (regular price
- for 52 numbers)
- and select any one of the other
- nine publications for twelve months.

- Add \$1.00 a year extra for
- Canadian or Foreign Postage.
- Present RADIO WORLD subscribers
- can take advantage of this offer by
- extending subscriptions one year
- if they send renewals NOW.

### RADIO WORLD'S Special Two-For-Price-of-One SUBSCRIPTION BLANK

RADIO WORLD, 145 West 45th St., N. Y. City:

Enclosed find \$6.00, for which send me RADIO WORLD for twelve months (52 numbers), beginning.....and also, without additional cost, Popular Radio, or Radio Broadcast, Radio News, or Science and Invention, or Radio Dealer, or Radio (San Francisco), Boys' Life, or Radio Journal, Collier's or Radio Age (or \$10.00 for two yearly subscriptions).

Indicate if renewal.

Offer Good Until

April 28, 1926

Name .....

Street Address .....

City and State .....

# Voltmeter Is Deceitful In Test of an A Battery

The condition of a lead cell storage battery should never be determined by means of a volt meter. The battery may be in a condition absolutely necessary for charging and yet a reading of 6.05 volts,

may be obtained. The hydrometers or the "battery guide" is the only instrument that should be employed. It is the only safe method of obtaining the exact state of the battery. When a reading of 1,200 is ob-

tained, although good reception may still be obtained, it is best to charge it, at this point. When the specific gravity runs too low, the plates start to buckle. This weakens them and every time causes more difficulty in charging. Therefore, if you let the battery run down, you will note that the charge does not last as long and also that it takes a very long time to take the charge.

## KSD Added to Chain For Capitol Programs

Station KSD, St. Louis, has been added to the chain of stations broadcasting the Sunday evening programs from the Capitol Theatre, New York City, under the direction of Major Edward Bowes. The list of stations now relaying this popular entertainment includes WEAF, New York; WCAP, Washington; WJAR, Providence; WWJ, Detroit; WCAE, Pittsburgh; WEEL, Boston, and WTAG, Worcester. Since the construction of the new broadcasting studio at the Capitol, the transmission and control of the programs have been considerably improved from a technical viewpoint. The American Telephone and Telegraph Company cooperated with the theatre in installing the most improved and highly perfected devices obtainable.

### ALTOONA DIRECTOR DIES

News has been received of the death of Walter S. Greevy, Director of Station WFBG, Altoona, Pa. This follows closely the death of George Kuhns, of WHO, Des Moines, Ia. Both were directors of the National Association of Broadcasters.

### HARD RUBBER

SHEET—ROD—TUBING

Special Hard Rubber Parts Made to Order

**RADION HARD RUBBER**

PANELS ANY SIZE

Send for price list

WHOLESALE RETAIL  
NEW YORK HARD RUBBER TURNING CO.  
212 Centre Street New York



D-X OWL



EUREKA

Right to the Point!  
Eureka Dial Pointers  
Polished Nickel or Gilt  
10c Each  
DX Owl Nickel.....10c  
DX Owl Goldplated...15c  
At your dealers or sent  
direct for stamps.  
C. W. BUTTS, INC.  
42 Hedden Place  
East Orange, N. J.



# "Bruno"

## Basic Diamond Kit \$20.00

Once in a lifetime a Man reaches the position of being an authority on a certain subject; when that Man specifies a particular something that something goes. Herman Bernard is that type of Man. He made a suggestion, and when Herman Bernard makes a suggestion it's good. Thereby hangs the reason for the NEW "Bruno" Basic Diamond Kit.

The contents of this Kit can be used for any four or five tube circuit. It contains: One Bruno "99" tuning coil; one Bruno "99" R.F. coil; three Bruno vernier dials; two "23" Streamline frequency condensers and one light switch. To be genuine each Kit must bear the seal and signature of Herman Bernard. Neatly packed ready to assemble. Shipped anywhere the day the order is received.

### Bruno Auxiliary Kit

When you buy the Bruno Basic Kit, you should get this one too. You will need such parts, and quality goes with quality. Its contents are: One socket strip, with five sockets; one 7x24" panel, engraved and drilled; one set of Bruno brackets. ....\$10.50



### "BRUNO" Light Switch

Lighten your radio expense. Save your batteries and your temper. The miniature Mazda Lamp throws a brilliant red light as an indication that your set is being used. Mounts on panel front by a simple operation. Consumes very little current.

Price (without bulb).....75 cents

RADIO RESEARCHES, a monthly bulletin in booklet form containing the reports of the previous month of the laboratory staff of the Bruno Radio Corporation, can be had with laboratory blueprints of a tested circuit.

10 cents per copy. \$1.00 per year.

## BRUNO RADIO CORPORATION

218 FULTON STREET

NEW YORK CITY

Philadelphia Office: 611 Widener Bldg. Detroit Office: 159 E. Elizabeth St. Chicago Office: 337 W. Madison St. San Francisco Office: 274 Brannon St.

# SHORE

TRANSFORMERS  
CHOKE COILS  
CONDENSERS

Will

Enable You to  
Build Your Own

## TECTRON "B" BATTERY ELIMINATOR

As described by Lewis Winner  
in this issue

Full Instructions Accompany Each  
Article Employed in the Eliminator.

Prices.	
Tectron Transformer	\$5.50
Raytheon Transformer	5.50
30 Henry Choke Coils (two required)	3.50
Condenser Bank, 13 mfd.	7.00
Two .1 mfd. Condensers.	1.25
Baseboard	.50

All Goods Sent on Receipt of  
the Amount

Prices on request

SHORE ELECTRIC CO., Inc.  
64 University Place  
New York City

All types of special  
transformers built  
to specifications

# The 3-Dial Powertone, A 5-Tube TRF Receiver

## LIST OF PARTS

- Three basketweave radio frequency transformers.
- Three Pilot .00035 mfd. variable condensers.
- One 6-ohm Bruno rheostat.
- One Centralab 200,000 ohm variable resistor, R2.
- One 5-gang Bruno socket shelf, 2½x17", with brackets.
- One bypass condenser.
- Three Bruno Slo-Moshen Bakelite dials.
- One Bruno light switch.
- One single circuit jack.
- One double circuit jack.
- Two audio frequency transformers.
- One 7x18" panel.
- One battery cable, with tagged leads.
- Two binding posts, for antenna and ground.
- One 2 megohm grid leak and one .00025 mfd. grid condenser (GL & C).
- Ten lengths of busbar.

(Continued from page 4)

is on, whereupon a red light glows on the front panel. You press the switch and the

## PERFECT CONTACT

For "UV" OR "UX" TYPE TUBES is assured in the Bernard Portable Superheterodyn by using

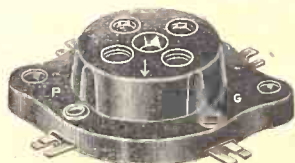

THE NEW KLOSNER UNIVERSAL SOCKET

Insures perfect electrical contact with either the "old" or "new" style tube. In addition to this essential outstanding feature

### KLOSNER SOCKETS

- incorporate other features such as:
  1. Hexagonal shaped holes for the large prongs.
  2. Spring grip terminal lugs.
  3. Can be mounted either single-hole or under sub-base panel.

It is the socket leader of 1926.

"Write for interesting booklet"

At all progressive dealers or order direct, postpaid from

The Manufacturers

**KLOSNER RADIO CORPORATION**  
1020 E. 178th St., New York

## How to Build THE FENWAY

The famous DX set that, by the turn of a switch, is a 4-tube tuned RF set, with regeneration, or a 9-tube Super-Heterodyne! Remarkably sensitive!

Described by Leo Fenway himself in the February 6, 13, 20 and 27 issues, including trouble shooting. Send \$6.00 for all four issues, or send \$8 for year's subscription and get these four copies FREE!  
RADIO WORLD, 145 W. 45th St., N. Y. C.

set is turned off. Of course then the light behind the red window goes out, too. This light is supplied by a flashlight bulb. The Bruno light switch was used, and it is drawn perspective in Fig. 1. The lug extending at upper right and a revolving arm, spring controlled, that makes contact with it, constitutes the switching device. When this arm is turned to the right on the panel (to the left in Fig. 1) it engages a clasp at the middle, at right, and this is the same metallic lead that extends forward in lug fashion at the lower base. Between this lowest level and the next one, immediately under the socket, is an insulator, so that the lug extending to the right at the bottom is for A minus and

# SANGAMO CONDENSERS and WESTON INSTRUMENTS

all types and sizes carried regularly in stock for immediate delivery.

**ROSSITER & CO., Inc.**  
Wholesale Distributors  
136 Liberty Street, New York

## The MOLLIFORMER "B" UNIT REPLACES "B" BATTERIES

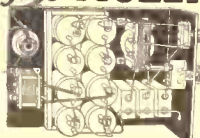

Build the High Grade B Eliminator described by Captain O'Rourke in March 27 issue. Also tested and highly praised by Radio Broadcast, Radio Digest, Radio News, Popular Radio and a large number of newspaper laboratories.

Parts and designs can also be had for B Units delivering up to 175 volts.

- List of Genuine Molliformer Parts:
- 1 Power Transformer 60 cycle 110-125 V..... \$6.00
  - 1 Molliformer (125 henries)..... 6.00
  - 4 Improved electrolytic rectifiers (with chemicals)..... 2.00
  - 2 Filter condensers, 2MF..... 3.30
  - 1 Filter condenser, 1MF..... 1.30
  - 1 Lavite resistor, 100,000 ohms..... .75
  - 1 Lampsocket..... .15
  - Complete Kit of parts for 60-cycle current..... \$17.00
- Add \$2.00 for 25- or 40-cycle Transformer.

This B Power Unit will deliver 30 milliamperes at 90 volts or 15 mils. at 120 volts without even a trace of AC hum. Excellent for distant or local signals.

Sold on a money-back basis.

If unable to get at your dealer's, send order direct to factory. Immediate delivery. Accept no substitutes! The Molliformer is the only choke coil of 125 henries available on the market. Dealers and set manufacturers, write for discount.

**C. E. JACOBS, Sole Manufacturer**  
2803 N. Kedzie Ave. Chicago

## 1925 BACK NUMBERS OF RADIO WORLD WANTED

Mail us copies of any of the following 1925 issues of RADIO WORLD, and we will send you a copy of a current issue for every copy sent us: January 10, February 21, March 21, 28, April 4, 11, 25; May 16, 23, 30; June 6, 13, 20; July 4, 11, 18, 25; August 8, 15, 29; September 5, 26.

connects to the flashlight cell. When the switch is closed the A plus lead is established from battery to all the lamps in the set, the five radio bulbs and the flashlight lamp. This bulb operates at 6 volts.

In the diagram the rotor plates of the

(Concluded on page 27)

**FREE!** To Each Purchaser of a WORLD 6-Volt Auto or Radio BATTERY

**12-Cell—24-Volt Storage 'B' Battery**

Positively given free with each purchase of a WORLD "A" Storage Battery. You must send this ad with your order. WORLD Batteries are famous for their guaranteed quality and service. Backed by years of successful manufacture and thousands of satisfied users. Equipped with Solid Rubber Cases, an insurance against acid and leakage. You save 50 per cent and get a

**2-Year Guarantee**

**Bond in Writing** "All their friends." That's our best proof of performance. Send your order in today.

**Solid Rubber Case Radio Batteries**  
6-Volt, 100-Amperes . . . \$11.25  
6-Volt, 120-Amperes . . . 13.25  
6-Volt, 140-Amperes . . . 14.00

**Solid Rubber Case Auto Batteries**  
6-Volt, 11-Plate . . . \$11.25  
6-Volt, 13-Plate . . . 13.25  
12-Volt, 7-Plate . . . 16.00

**Send No Money** Just state battery wanted and we will ship day order is received, by Express O. D., subject to your examination on arrival. **FREE "B" Battery** included in full with order. Buy now and get a guaranteed battery at 60 per cent saving to you.

**WORLD BATTERY COMPANY**  
1219 So. Wabash Ave., Dept. 17 CHICAGO, ILL.

Approved and Listed as Standard by Leading Authorities including Radio News Laboratories, Popular Science Institute of Standards, Popular Radio Laboratories, Broadcast Laboratories, Radio in the Home, and Lefax, Inc.

**World STORAGE BATTERIES**

Set your Radio Dial at 210 meters for the new 1000 watt World Storage Battery Station, WSBG Chicago. Watch for announcements.

WDAE WPAE WGN WJW KRJ KGO KFAE WVA KOP

## GET THE OFFICIAL BOOKLET ON HOW TO BUILD Radio World's 1926 Model DIAMOND OF THE AIR

The text of the official Diamond booklet was written by HERMAN BERNARD, designer of the 5-tube circuit which offers the most in selectivity, volume, tone, quality and DX. Price, per copy **50c** **CERTIFIED BLUEPRINT**

**FREE** with every copy of the OFFICIAL booklet. Bernard's signature is on every booklet and every blueprint. Both sent FREE to new yearly subscribers. Also name plate FREE. News and Radio Dealers: Send to publication office for Wholesale Prices. Or order direct from American News Co., Inc., 131 Varick St., N. Y. C., or American News Co. Branches in other cities.

**RADIO WORLD, 145 W. 45th St., N. Y. C.**  
Enclosed find 50c. Send me copy official Diamond Booklet, with FREE blueprint. Or both free with \$6.00 for yearly subscription.

NAME .....

ADDRESS .....

CITY..... STATE.....



## Meloformer



Set builders are turning to MELOFORMER for perfection in audio amplification. Pure tones—no distortion—no interstage coupling—perfectly stabilized impedance. For sale at all dealers for \$4.00 each.

Send for Free Booklet of MELOFORMER Hookups.

**ROBERTSON DAVIS CO.**  
420 ORLEANS ST. CHICAGO, ILL.

## ACCUSTI-CONE SPEAKER



FROM FACTORY TO YOU

19-inch Full Size full floating cone **\$7.50**

Would cost \$30. in a retail store. You save by buying direct. It is superior to any speaker made. Try it in your home; if not satisfied, return and get money back.

Accusti-Cone Laboratories  
98 Church St. New York

(From page 26) variable condensers are represented by the shaft, shown at center of the apparatus, while the stator plates, which go to grid in two instances, and to one side of the grid condenser in the other, are at upper right in the diagram. The grid leak and condenser are connected to the detector G socket. Note that the grid return lead of each coil, including the audio transformer secondaries, goes to A minus in every instance, except in the case of the detector, where the grid return is to A plus.

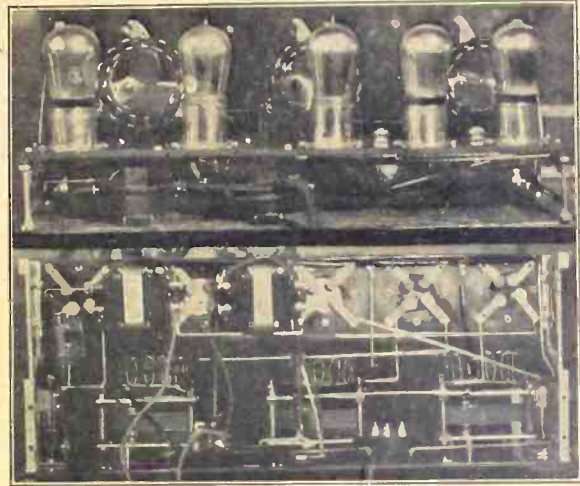

FIGS. 2 and 3, top and back view.

The double circuit jack in the detector circuit is wired with one spring unconnected. The electrical result is the same whether this connection is established or

not, so, as it is not necessary, it is omitted. The plate of the detector tube goes to the hooked outside spring of the jack, while the inside spring that makes contact with the hooked one goes to the P post of the first audio transformer. The frame or right angle of the jack is connected to B plus, and this same lead is connected to the B post of the first audio transformer. Hence there is no need for the idle spring being brought into service, as the B plus connection is always at the B post of AFI.

**FREE BOOKLET FOR INVENTORS**

IF YOUR INVENTION is new and useful it is patentable. Send me your sketch.  
Z. H. POLACHEK, 70 Wall St., New York  
Reg. Patent Attorney-Engineer

# Chosen for Performance



Type 271—M. F. Transformer  
Price, \$5.00

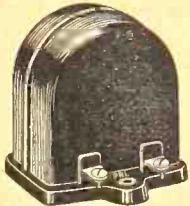

Type 331—Tuned Transformer  
Price, \$5.00



Type 349—UX Tube Socket  
Price, 50c

The performance of a radio receiving set depends primarily upon two things, an efficient circuit and the use of good parts.

Wherever you find a popular circuit you will invariably find General Radio parts.

General Radio parts are built to exacting laboratory standards by a company which has contributed more in scientific apparatus for radio research than any other one company in the history of radio.

To insure maximum performance from your set select a reliable circuit—then build it carefully with General Radio parts.

**GENERAL RADIO Co**  
CAMBRIDGE 39 MASS.

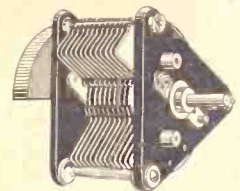

Type 247-N—Variable Condensers  
Price, \$3.75



Type 214-A—20-Ohm Rheostat  
Price, \$2.25

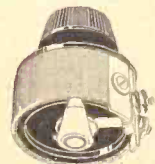

Type 301—6-Ohm Rheostat  
Price, \$1.25

# GENERAL RADIO INSTRUMENTS

“Behind the Panels of Better Built Sets”

# The 3-Dial Powertone, A 5-Tube TRF Receiver

### LIST OF PARTS

- Three basketweave radio frequency transformers.
- Three Pilot .00035 mfd. variable condensers.
- One 6-ohm Bruno rheostat.
- One Centralab 200,000 ohm variable resistor, R2.
- One 5-gang Bruno socket shelf, 2½x17", with brackets.
- One bypass condenser.
- Three Bruno Slo-Moshen Bakelite dials.
- One Bruno light switch.
- One single circuit jack.
- One double circuit jack.
- Two audio frequency transformers.
- One 7x18" panel.
- One battery cable, with tagged leads.
- Two binding posts, for antenna and ground.
- One 2 megohm grid leak and one .00025 mfd. grid condenser (GL & C).
- Ten lengths of busbar.

(Continued from page 4)

is on, whereupon a red light glows on the front panel. You press the switch and the

## PERFECT CONTACT

For "UV" OR "UX" TYPE TUBES is assured in the Bernard Portable Superhetrodyn by using



THE NEW KLOSNER UNIVERSAL SOCKET

Insures perfect electrical contact with either the "old" or "new" style tube. In addition to this essential outstanding feature

### KLOSNER SOCKETS

- incorporate other features such as:
1. Hexagonal shaped holes for the large prongs.
  2. Spring grip terminal lugs.
  3. Can be mounted either single-hole or under sub-base panel.

It is the socket leader of 1926.

"Write for interesting booklet"

At all progressive dealers or order direct, postpaid from

The Manufacturers  
**KLOSNER RADIO CORPORATION**  
1020 E. 178th St., New York

## How to Build THE FENWAY

The famous DX set that, by the turn of a switch, is a 4-tube tuned RF set, with regeneration, or a 9-tube Super-Heterodyne! Remarkably sensitive!

Described by Leo Fenway himself in the February 6, 13, 20 and 27 issues, including trouble shooting. Send 50c for all four issues, or send \$5 for year's subscription and get these four copies FREE!  
RADIO WORLD, 145 W. 45th St., N. Y. C.

set is turned off. Of course then the light behind the red window goes out, too. This light is supplied by a flashlight bulb. The Bruno light switch was used, and it is drawn perspective in Fig. 1. The lug extending at upper right and a revolving arm, spring controlled, that makes contact with it, constitutes the switching device. When this arm is turned to the right on the panel (to the left in Fig. 1) it engages a clasp at the middle, at right, and this is the same metallic lead that extends forward in lug fashion at the lower base. Between this lowest level and the next one, immediately under the socket, is an insulator, so that the lug extending to the right at the bottom is for A minus and

# SANGAMO CONDENSERS and WESTON INSTRUMENTS

all types and sizes carried regularly in stock for immediate delivery.

ROSSITER & CO., Inc.  
Wholesale Distributors  
136 Liberty Street, New York

## The MOLLIFORMER "B" UNIT REPLACES "B" BATTERIES



Build the High Grade B Eliminator described by Captain O'Rourke in March 27 issue. Also tested and highly praised by Radio Broadcast, Radio Digest, Radio News, Popular Radio and a large number of newspaper laboratories. Parts and designs can also be had for B Units delivering up to 175 volts.

- List of Genuine Molliformer Parts:
- 1 Power Transformer 60 cycle 110-125 V..... \$6.00
  - 1 Molliformer (125 henries)..... 6.00
  - 4 Improved electrolytic rectifiers (with chemicals)..... 2.00
  - 2 Filter condensers, 2MF..... 3.30
  - 1 Filter condenser, 1MF..... 1.30
  - 1 Lavite resistor, 100,000 ohms..... .75
  - 1 Lampsocket..... .15
  - Complete Kit of parts for 60-cycle current..... \$17.00
- Add \$2.00 for 25- or 40-cycle Transformer.

This B Power Unit will deliver 30 milliamperes at 90 volts or 15 mills. at 120 volts without even a trace of AC hum. Excellent for distant or local signals.

Sold on a money-back basis.

If unable to get at your dealer's, send order direct to factory. Immediate delivery. Accept no substitutes! The Molliformer is the only choke coil of 125 henries available on the market. Dealers and set manufacturers, write for discount.

C. E. JACOBS, Sole Manufacturer  
2803 N. Kedzie Ave. Chicago

### 1925 BACK NUMBERS OF RADIO WORLD WANTED

Mail us copies of any of the following 1925 issues of RADIO WORLD, and we will send you a copy of a current issue for every copy sent us: January 10, February 21, March 21, 28, April 4, 11, 25; May 16, 23, 30; June 6, 13, 20; July 4, 11, 18, 25; August 8, 15, 29; September 5, 26.

connects to the flashlight cell. When the switch is closed the A plus lead is established from battery to all the lamps in the set, the five radio bulbs and the flashlight lamp. This bulb operates at 6 volts.

In the diagram the rotor plates of the

(Concluded on page 27)

**FREE!** To Each Purchaser of a WORLD 6-Volt Auto or Radio BATTERY

**12-Cell — 24-Volt Storage 'B' Battery**

Positively given free with each purchase of a WORLD "A" Storage Battery. You must send this ad with your order. WORLD Batteries are famous for their guaranteed quality and service. Backed by years of successful manufacture and thousands of satisfied users. Equipped with Solid Rubber Cases, an insurance against acid and leakage. You save 50 per cent and get a

**2-Year Guarantee**

**Bond in Writing** WORLD Battery "sell their friends." That's our best proof of performance. Send your order in today.

**Solid Rubber Case Radio Batteries**  
6-Volt, 100-Amperes..... \$11.25  
6-Volt, 120-Amperes..... 13.25  
6-Volt, 140-Amperes..... 14.00

**Solid Rubber Case Auto Batteries**  
6-Volt, 11-Plate..... \$11.25  
6-Volt, 13-Plate..... 13.25  
12-Volt, 7-Plate..... 16.00

**Send No Money** Just state battery wanted and we will ship day order is received, by Express C. O. D., subject to your examination on arrival. FREE "B" Battery included.

**Extra Offer:** 5 per cent discount for cash in full with order. Buy now and get a guaranteed battery at 60 per cent saving to you.

**WORLD BATTERY COMPANY**  
1219 So. Wabash Ave., Dept. 17 CHICAGO, ILL.

**World STORAGE BATTERIES**

Set your Radio Dial at 216 meters for the new 1000 watt World Storage Battery Stations, W5BC Chicago, W5CA Chicago. Watch for announcements.

Approved and Listed as Standard by Leading Authorities including Radio News Laboratories, Popular Science Institute of Standards, Radio Laboratories, Broadcast Laboratories, Radio In the Home, and Lefax, Inc.

## GET THE OFFICIAL BOOKLET ON HOW TO BUILD Radio World's 1926 Model DIAMOND OF THE AIR

The text of the official Diamond booklet was written by HERMAN BERNARD, designer of the 5-tube circuit which offers the most in selectivity, volume, tone, quality and DX. Price, per copy **50c**

**CERTIFIED BLUEPRINT**

**FREE** with every copy of the OFFICIAL Booklet, Bernard's signature is on every booklet and every blueprint. Both sent FREE to new yearly subscribers. Also name plate FREE.

News and Radio Dealers: Send to publication office for Wholesale Prices. Or order direct from American News Co., Inc., 131 Varick St., N. Y. C., or American News Co. Branches in other cities.

RADIO WORLD, 145 W. 45th St., N. Y. C.  
Enclosed find 50c. Send me copy official Diamond Booklet, with FREE blueprint. Or both free with \$6.00 for yearly subscription.

NAME.....  
ADDRESS.....  
CITY..... STATE.....

## Meloformer



Set builders are turning to MELOFORMER for perfection in audio amplification. Pure tones—no distortion—no interstage coupling—perfectly stabilized impedance. For sale at all dealers for \$4.00 each.

Send for Free Booklet of MELOFORMER Hookups.

**ROBERTSON DAVIS CO.**  
420 ORLEANS ST. CHICAGO, ILL.

## ACCUSTI-CONE SPEAKER



FROM FACTORY TO YOU

19-inch Full Size **\$7.50**  
full floating cone

Would cost \$30. in a retail store. You save by buying direct. It is superior to any speaker made. Try it in your home; if not satisfied, return and get money back.

Accusti-Cone Laboratories  
96 Church St. New York

(From page 26) variable condensers are represented by the shaft, shown at center of the apparatus, while the stator plates, which go to grid in two instances, and to one side of the grid condenser in the other, are at upper right in the diagram. The grid leak and condenser are connected to the detector G socket. Note that the grid return lead of each coil, including the audio transformer secondaries, goes to A minus in every instance, except in the case of the detector, where the grid return is to A plus.

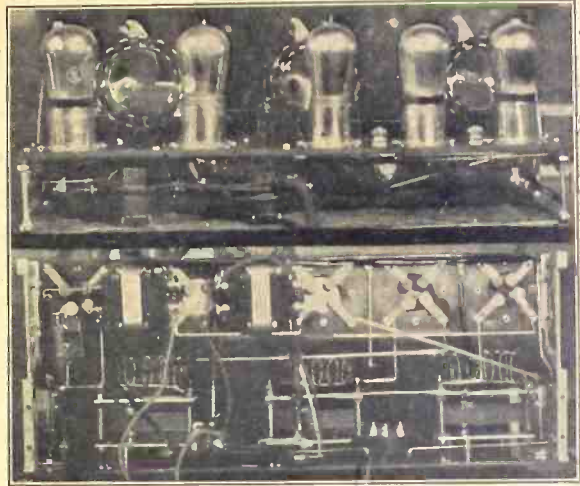

FIGS. 2 and 3, top and back view.

The double circuit jack in the detector circuit is wired with one spring unconnected. The electrical result is the same whether this connection is established or

not, so, as it is not necessary, it is omitted. The plate of the detector tube goes to the hooked outside spring of the jack, while the inside spring that makes contact with the hooked one goes to the P post of the first audio transformer. The frame or right angle of the jack is connected to B plus, and this same lead is connected to the B post of the first audio transformer. Hence there is no need for the idle spring being brought into service, as the B plus connection is always at the B post of AFI.

**FREE** BOOKLET FOR INVENTORS

IF YOUR INVENTION is new and useful it is patentable. Send me your sketch. Z. H. POLACHEK, 70 Wall St., New York  
Reg. Patent Attorney-Engineer

# Chosen for Performance



Type 271—M. F. Transformer  
Price, \$5.00



Type 331—Tuned Transformer  
Price, \$5.00



Type 349—UX Tube Socket  
Price, 50c

The performance of a radio receiving set depends primarily upon two things, an efficient circuit and the use of good parts.

Wherever you find a popular circuit you will invariably find General Radio parts.

General Radio parts are built to exacting laboratory standards by a company which has contributed more in scientific apparatus for radio research than any other one company in the history of radio.

To insure maximum performance from your set select a reliable circuit—then build it carefully with General Radio parts.

**GENERAL RADIO Co**

CAMBRIDGE 39

MASS.

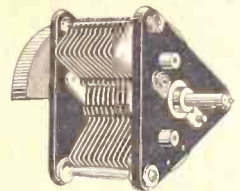

Type 247-N—Variable Condenses  
Price, \$3.75



Type 214-A—20-Ohm Rheostat  
Price, \$2.25



Type 301—6-Ohm Rheostat  
Price, \$1.25

# GENERAL RADIO

INSTRUMENTS

“Behind the Panels of Better Built Sets”

# BST-6

B - for Beauty of Cabinet  
S - for Selectivity  
T - for Tone purity  
6 - its 6 tubes for distance

*"A thing of beauty is a joy forever"*



The BST-6. 2 Feet 4 Inches Long. 9 Inches Inside Depth. 8 $\frac{3}{4}$  Inches High.

This marvelous six-tube tuned radio frequency receiver is Self-Equalized and built of low-loss materials thruout. Its clear, rich tone of astonishing volume is a revelation. The circuit consists of two stages of tuned radio frequency, tube detector and three stages of resistance coupled audio. Air-cooled rheostats and universal sockets are used thruout.

Straight line frequency variable condensers are employed, insuring separation of the low wave length stations. Stations once tuned in can always be logged at the same dial points. The resistance AF coupling gives absolute natural reproduction of all overtones. The universal sockets permit the use of all UX and CX tubes and all the old tubes except only C11, WD11, UV199 and C299. The set does not oscillate, thereby preventing the reradiation of signals and reducing interference of that type to a minimum.

**Direct from factory to you** **\$40.00**  
**No dealers or middleman's profits**

### SPECIFICATIONS

Bakelite Panel, Walnut Finish—  
With Etch-O-Gravure and Gold Decorations—  
Bakelite Sub-Base—  
Kurz-Kasch Bakelite-Walnut Pointers; Gold-filled, to Match—  
Kurz-Kasch Bakelite Gold-filled Rheostat Knobs—  
Lubree Straight Line Frequency Condensers—  
Special Coils; Double Silk Enameled, Primary and Secondary—  
Shore Audio Transformers—  
Caswell-Runyan Two-tone Walnut-Finished Cabinet.

### GUARANTEE

Each receiver is tested and retested, boxed and inspected before leaving factory, and guaranteed to reach you direct in perfect condition. Workmanship thruout guaranteed the best. Assembled by experts.

**IMMEDIATE DELIVERY**

Send Check or P. O. Money Order to

**Columbia Print, Radio Division 143 West 45th St.,  
NEW YORK CITY**

*RADIO WORLD Guarantees the Responsibility of This Advertiser*

# HIGHBOY **BST-6**

“The joy of the hand that hews for beauty  
Has the sweetest solace beneath the sun”

## A Radio Highboy of unequaled value

The HIGHBOY is of genuine walnut-plywood designed by master craftsmen, beautifully finished in a rich two-tone. Dimensions 45 $\frac{1}{4}$  x 25 $\frac{1}{4}$  x 14 $\frac{1}{4}$ . A piece of furniture that will last a lifetime, gladden the eye and bring joy and refinement to the home.

Equipped with the famous BST-6, a six-tube tuned radio frequency receiver of astonishing volume; of clear, rich, beautiful tone. The circuit consists of two stages of tuned radio frequency, tube detector and three stages of resistance coupled audio.

The concealed built-in loud speaker occupies the entire top of the HIGHBOY, overcoming entirely that tinny metallic sound of many of the old horn loud speakers and in its stead giving forth that rich sympathetic tone of the old violin of long seasoned wood.

Beneath the radio itself is the two-door compartment with ample room to fully conceal the A, B and C batteries.

Direct from factory to you

**\$85.00**

Includes the BST-6 Receiver Installed in Highboy Period Cabinet, as illustrated and loud speaker. F.O.B. New York

### GUARANTEE

Each HIGHBOY is carefully examined so we know that the wood, carving, finish and trimmings are flawless and in perfect condition. It is packed by experts in a separate, specially-built, padded, wooden packing case, so that it must reach you in perfect condition.

The radio and loud-speaker are tested and inspected for workmanship, volume, tone and distance reception, so you will receive as nearly as is humanly possible a perfect radio in this BST-6 Highboy.

**IMMEDIATE DELIVERY**

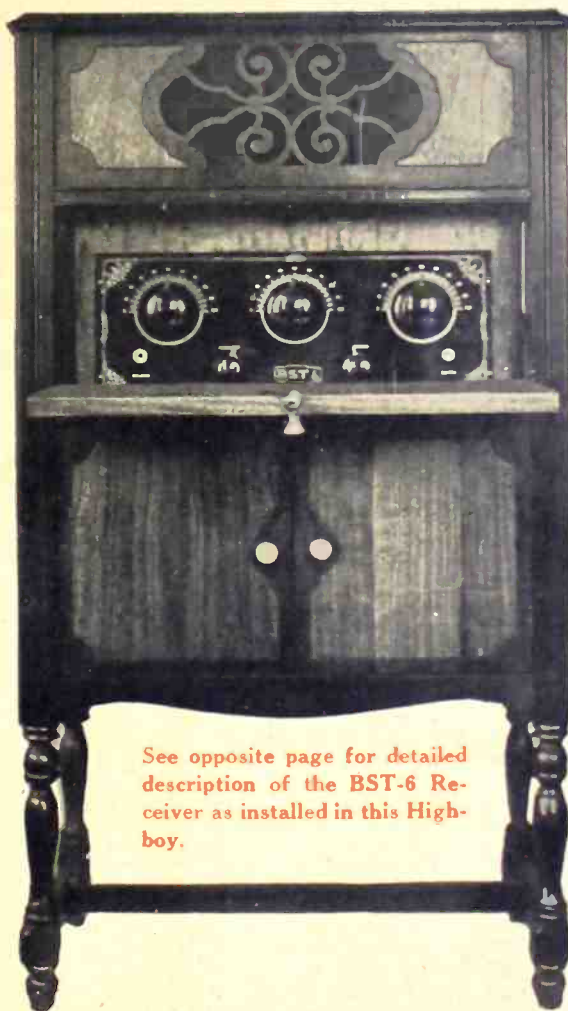

See opposite page for detailed description of the BST-6 Receiver as installed in this Highboy.

BST-6 Highboy  
Height 45 $\frac{1}{4}$ " , width 25 $\frac{1}{4}$ " , depth 14 $\frac{1}{4}$ "

Send Check or P. O. Money Order to

**Columbia Print,** Radio Division **143 West 45th St.**  
**NEW YORK CITY**

*RADIO WORLD Guarantees the Responsibility of This Advertiser*

## Two DC Eliminators; Both Easy to Build

(Continued from page 7)

the hole for the shaft of the variable resistor is drilled. This is 3" from the top and the bottom and 2 3/8" from the sides. A 1/2" hole should be drilled. The hole for the switch is 1" from top or bottom and 2 3/8" from the sides. This is a 1/4" hole. The holes for the binding posts are next attended to. These are all 1" from the end opposite to that of the location of the switch. There are four holes drilled, each one of which is 1 3/16" apart from other and the sides. They are 3/16" holes. The fuses for Eliminator 2 can be placed on the panel on both sides of the variable resistor. These fuses are mounted like grid leaks. The dimensions will not be given, as they vary for the many different types which may be purchased. They are placed on the panel, as they have to be easily accessible.

The holes for the screws to hold the panel to the baseboard should be about 1/8" from the bottom (where the switch is located) and 1/8" from the sides. They should be 3/16" holes. A cabinet made of sheet metal should surround the base-

board and the panel. It should be 4 3/4" wide, 7" long and 7" high.

### Wiring the Eliminators

The wiring for Eliminator 1 will be first discussed. One lead of the cord, holding the plug which will go to the mains, is brought to a terminal of the choke coil, L1, and to a terminal of the fixed condenser, C1. The other terminal of the cord is brought to a terminal of the switch. This cord can be brought through the back of the cabinet. A knot will hold it in place. The other terminal of the

switch goes to the other terminal of the fixed condenser, C1, and to L2. The other terminal of L1 goes to a terminal of C2, to the B plus Amp. post and to the resistance portion of the variable resistor, R. The other terminal of the fixed condenser, C2, goes to the other terminal of L2, to the B minus post, to one terminal of C4 and to one terminal of the fixed condenser, C3. The other terminal of the fixed condenser, C3, goes to the B plus detector post and to the arm of the variable resistance unit, R. The other terminal of C4 goes to the ground binding post. This condenser is inserted, so as to prevent accidental grounding in the set.

The wiring of Eliminator 2 will be described next week. Getting maximum results from the eliminators will also be discussed.

NEW  
1926

## FREE RADIO GUIDE

Newest Edition Ready

Shows the latest circuits, the newest developments in radio at startlingly low prices. Get the parts you want here and save money. The best in parts, kits, sets and supplies. Orders filled same day received. Write for free copy NOW; also please send names of one or more radio fans.

BARAWIK COMPANY

102-140 So. Canal St. Chicago, U. S. A.

## DISTANCE AND VOLUME

At Your Command

Build a 5-Tube Tuned Radio-Frequency Set, Using the Streamline Kit

**\$7.50**



Boxed Kit consists of 3 Streamline straight line frequency .00035 mfd. condensers, 3 basketweave coils, 3 mountings.

### STREAMLINE STRAIGHT FREQUENCY CONDENSERS

.00025 mfd \$2.00; .00035 mfd. \$2.25; .00005 mfd. \$2.50.

### STREAMLINE RADIO CO.

223 FULTON STREET  
New York City

### STATEMENT OF THE OWNERSHIP, MANAGEMENT, CIRCULATION, ETC., REQUIRED BY THE ACT OF CONGRESS OF AUGUST 24, 1912.

Of Radio World, published weekly at New York, N. Y., for April 1, 1926.  
State of New York }  
County of New York } ss.:

Before me, a Notary Public, in and for the State and County aforesaid, personally appeared Roland Burke Hennessy, who, having been duly sworn according to law, deposes and says that he is the Editor of the Radio World, and that the following is, to the best of his knowledge and belief, a true statement of the ownership, management (and if a daily paper, the circulation), etc., of the aforesaid publication for the date shown in the above caption, required by the Act of August 24, 1912, embodied in section 411, Postal Laws and Regulations, printed on the reverse of this form, to wit:

1. That the names and addresses of the publisher, editor, managing editor, and business managers are: Publisher, Hennessy Radio Publications Corp., 145 W. 45th St., N. Y. C.; editor, Roland Burke Hennessy, 145 W. 45th St., N. Y. C.; managing editor, Herman Bernard, 145 W. 45th St., N. Y. C.; business manager, Fred S. Clark, 145 W. 45th St., N. Y. C.

2. That the owner is (if owned by a corporation its name and address must be stated, and also immediately thereunder the names and addresses of stockholders owning or holding one per cent. or more of total amount of stock. If not owned by a corporation the names and addresses of the individual owners must be given. If owned by a firm, company or other unincorporated concern, its name and address, as well as those of each individual member must be given). Hennessy Radio Publications Corp., 145 W. 45th St., N. Y. C.; Roland Burke Hennessy, 145 W. 45th St., N. Y. C.; Mrs. Mary MacArthur, 1886 East 82nd Street, Cleveland, Ohio.

3. That the known bondholders, mortgagees, and other security holders owning or holding 1 per cent. or more of total amount of bonds, mortgages, or other securities are: (If there are none, so state.) None.

4. That the two paragraphs next above, giving the names of the owners, stockholders, and security holders, if any, contain not only the list of stockholders and security holders as they appear upon the books of the company but also, in cases where the stockholder or security holder appears upon the books of the company as trustee or in any other fiduciary relation, the name of the person or corporation for whom such trustee is acting, is given; also that the said two paragraphs contain statements embracing affiant's full knowledge and belief

as to the circumstances and conditions under which stockholders and security holders who do not appear upon the books of the company as trustees, hold stock and securities in a capacity other than that of a bona fide owner; and this affiant has no reason to believe that any other person, association, or corporation has any interest direct or indirect in the said stock, bonds or other securities than as so stated by him.

5. That the average number of copies of each issue of this publication sold or distributed through the mails or otherwise, to paid subscribers during the six months preceding the date shown above is ..... weekly. (This information is required from daily publications only.)

ROLAND BURKE HENNESSY, Editor.

(Sworn to and subscribed before me this 31st day of March, 1926.)

ESTHER M. GURIN.

Notary Public, Bronx County, N. Y. (My commission expires March 31, 1928.)

Note.—This statement must be made in duplicate and both copies delivered by the publisher to the postmaster, who shall send one copy to the Third Assistant Postmaster General (Division of Classifications), Washington, D. C., and retain the other in the files of the post office. The publisher must publish a copy of this statement in the second issue printed next after its filing.

## "LOOK UP DOWN"

SUPER-HETERODYNE SPECIALIST

## COMPLETE PARTS

FOR THE FAMOUS

# FENWAY

FOUR OR NINE PARTS AS SPECIFIED

Special **\$110.00** Special  
—COMPLETE—

ALL ORDERS SHIPPED WITHIN 24 HOURS

SATISFACTION GUARANTEED OR MONEY REFUNDED

BUILD THE FENWAY AND DX ALL SUMMER

ALL QUESTIONS ON SUPERS ANSWERED CHEERFULLY

CHAS W. DOWN

711 EIGHTH AVE PENN 7779 NEW YORK CITY

A Complete Radio Testing Laboratory for the Correction of Radio Troubles

## QUICK ACTION CLASSIFIED ADS

10 CENTS A WORD. 10 WORDS MINIMUM. CASH WITH ORDER

VICTOREEN KITS, \$30.00, 15% to 25% discount on parts and sets. W. Landan, 113 Scoville Way, N. S. Pittsburgh, Penna.

SELL MARVELOUS NEW RADIO INVENTION that improves summer reception 100%. Effarsee marvel inside antennae gives better tone, greater selectivity, less static. Sells to every radio owner for only \$4.00. Write today. Fishwick Radio Co., 137 Central Parkway West, Cincinnati, Ohio.

PATENTS—Write for free Guide Books and "Record of Invention Blank" before disclosing inventions. Send model or sketch of your invention for our inspection and instructions free. Terms reasonable. Radio, Chemical, Mechanical, Electrical and Trademark experts. Victor J. Evans Co., 924 Ninth, Washington, D. C.

BULLDOGS

BEAUTIFUL REGISTERED BULL PUPS, \$15. Bulldogs, 501 Rockwood, Dallas, Texas.

# With "Bernard's Portable" Use a Fiat Bank Wound Loop:— Experience the Superior Performance of This Wonderful Combination

The "FIAT" has proved its merits with VICTOREEN, MADISON MOORE, FENWAY, DIAMOND OF THE AIR, BROWNING DRAKE, ETC., ETC.

The "FIAT" is especially adapted for Portable sets because of its very small size when folded—only 17½" x 5" x 3" over all, and erected the "FIAT" is 18" on a side,—affording wonderful pick up.

Sold by the leading Radio Jobber and Dealer everywhere.

Order Now Through Your Local Dealer

FREE INFORMATION:—Send for a FIAT circular giving full description, loop circuits, etc.

PRICE \$12.50

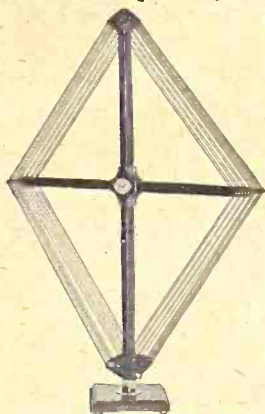

Patented October 25, 1925



FOLDED

**RADIO APPLIANCE CORPORATION**  
4886 NORTH CLARK STREET CHICAGO, ILLINOIS

ALL RADIO RECEIVERS WILL USE A LOOP EVENTUALLY

# "Send Me Another BRETWOOD Variable Grid Leak"

Thank you for introducing me to the Bretwood Variable Grid Leak! I have installed one in my Three Circuit Tuner according to your instruction and find that it does all you said it would and more.  
S. R. HUBBS,  
180 Quincy St.,  
Brooklyn, N. Y.

The grid leak I sent for arrived and has been installed in a 4-tube regenerative set. I have tried them all, but have never had the pleasure of a real grid leak before. It is just a wonderful little instrument.

F. K. WEISER,  
Haskell, Oklahoma.

Gridleak received and tested out, and find it is the only variable leak I ever used that is really variable.

Enclosed find \$1.50 for which please send me another one.  
F. E. STALTON,  
Box 240, Ardmore, Okla.

I think it is about the best grid leak I have ever used. Have made quite a few sets and this beats them all. Get DX very plainly and clearly.

WM. HEBERSON,  
2510 N. Franklin St.,  
Philadelphia, Pa.

This leak is used in King George's Palace and by the U. S. Shipping Board; over 270,000 sold in last four months

Price, \$1.50

Specified  
for the  
Diamond of  
the Air

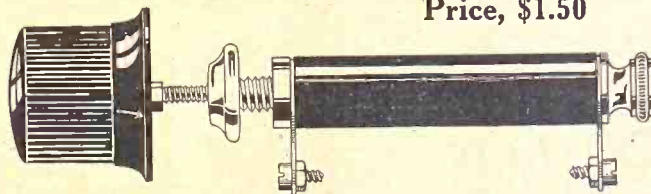

¼ to 10  
Megohms

Bretwood, Ltd., London, Eng., Sole Patentees and Owners

More DX, Clearer Reception, Smoother Control in Regenerative Sets Assured

The Bretwood Variable Grid Leak may be installed in any set in five minutes by single hole panel mounting.

**The North American Bretwood Co., 145 W. 45th St., N. Y. City**  
Sole Distributors for United States

### NOTE TO RADIO MANUFACTURERS

Write for Wholesale Rates

A set with a FIXED Grid Leak may work perfectly where tested, while it needs a VARIABLE Grid Leak so that set may be adjusted to the locality where used.

THE NORTH AMERICAN BRETWOOD CO.,  
145 West 45th Street, New York City.

Gentlemen: Enclosed find \$1.50 for which you will please send me one Bretwood Variable Grid Leak prepaid. Satisfaction guaranteed or my money back after trial within ten days of receipt by me.

NAME .....  
STREET ..... CITY .....  
STATE .....



*“Your radio is always top notch.  
What do you do to keep it so full  
of pep?”*

KEEPING your “B” batteries full of pep, without frequent renewals, is simply a matter of using the right size Evereadys for your particular set with a “C” battery\*.

The rule which determines the right size “B” batteries to use is so simple no one can make a mistake, and once learned it definitely settles the question of “B” battery service and economy.

On 1 to 3 tubes — Use Eveready No. 772.

On 4 or more tubes — Use the Heavy Duty “B” Batteries, either No. 770, or the even longer-lived Eveready Layerbilt No. 486.

On all but single tube sets — Use a “C” battery.

When following these rules, No. 772, on 1 to 3 tube sets, will last for a year or more, and Heavy Duties on sets of 4 or more tubes, for 8 months or longer.

These life figures are based on the established fact that the average year-round use of a set is 2 hours a day.

A pair of Eveready No. 772's for a 5-tube set

instead of 2 Eveready No. 770's or 2 Eveready Layerbilts No. 486—looks at first glance like an economy because of lower first cost. But in a few months the 772's will be exhausted and have to be replaced. After the same length of time the Eveready No. 770's or the Eveready Layerbilts No. 486 will still be good for many more months of service.

We have prepared for your individual use a new booklet, “Choosing and Using the Right Radio Batteries,” which we will be glad to send you upon request. This booklet also tells about the proper battery equipment for use with the new power tubes.

\*NOTE: In addition to the increased life which an Eveready “C” Battery gives to your “B” batteries, it will add a quality of reception unobtainable without it.

Manufactured and guaranteed by  
NATIONAL CARBON Co., Inc.  
New York San Francisco  
Canadian National Carbon Co., Limited  
Toronto, Ontario

Tuesday night means Eveready Hour—9 P. M., Eastern Standard Time, through the following stations:

- |                  |                  |
|------------------|------------------|
| WEAF—New York    | WEAI—Cincinnati  |
| WJAR—Providence  | WEAR—Cleveland   |
| WEEI—Boston      | WVJ—Detroit      |
| WTAG—Worcester   | WGN—Chicago      |
| WFI—Philadelphia | WOC—Davenport    |
| WGR—Buffalo      | WCCO—Minneapolis |
| WCAE—Pittsburgh  | St. Paul         |

KSD—St. Louis  
Pacific Coast, Eveready Program,  
KGO—San Francisco, 8 to 9 P. M.



LEFT—No. 486,  
for 4, 5 or more  
tubes. \$5.50.



RIGHT—Eveready Dry Cell Radio “A” Battery, 1½ volts.

# EVEREADY

## Radio Batteries

—they last longer