

May 15 1926

# RADIO

Reg. U. S. Pat Off.

# WORLD

Vol. 9. No. 8. ILLUSTRATED Every Week

**GAINING EFFICIENCY IN  
SUPER-HETERODYNES**

*How to Arrange Aerial  
For the Utmost DX*

**THE TRUTH ABOUT COILS**

*Sunset Effect on Signals*

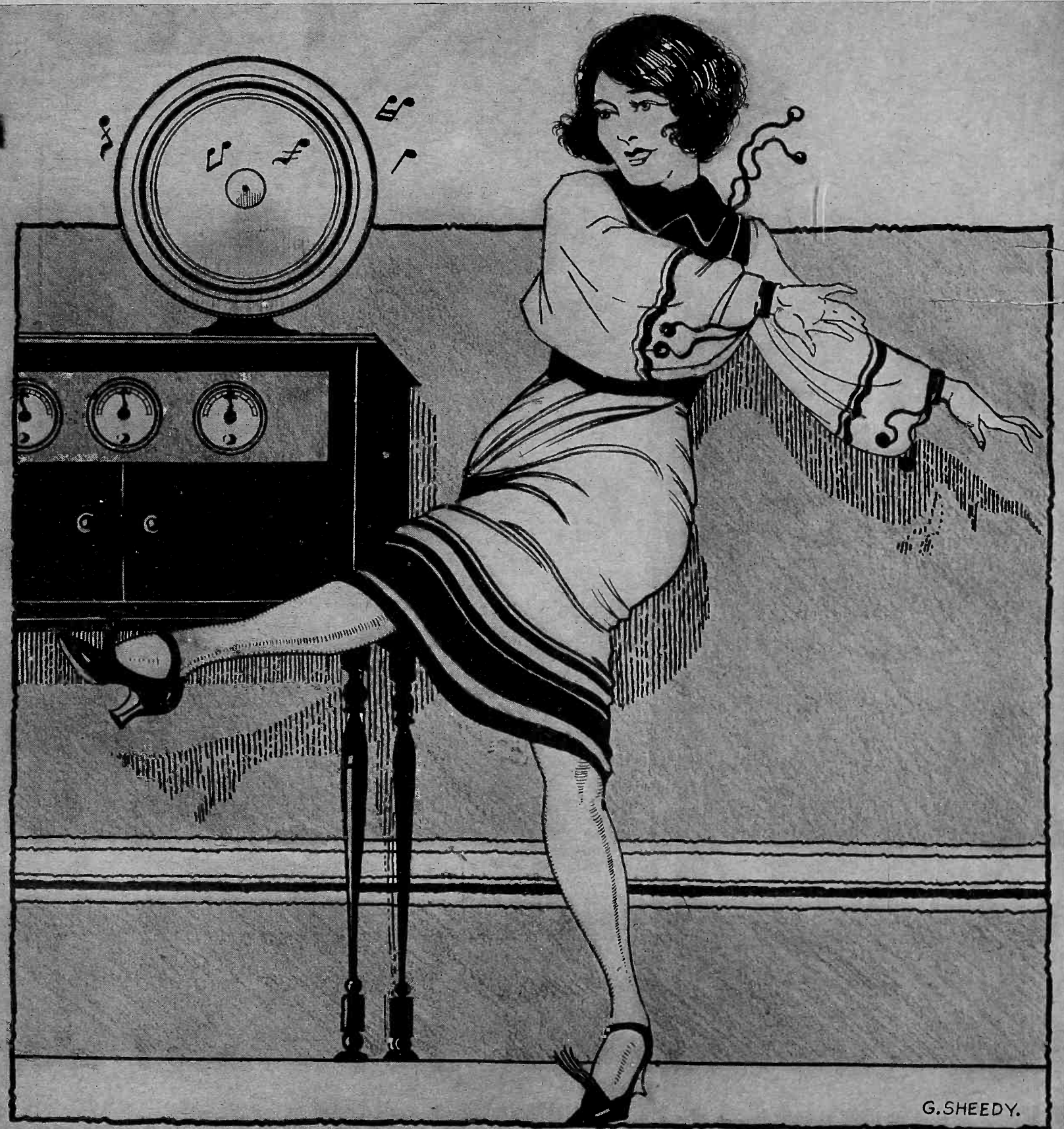

G.SHEEDY.

THE CHARLESTON—OF COURSE

# IT DOES THE TRICK!

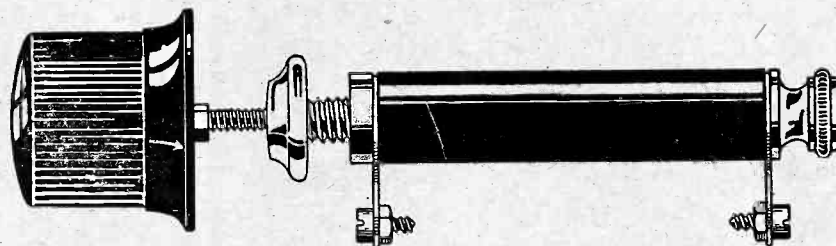

## *The Bretwood Variable Grid Leak*

(Bretwood, Ltd., Sole Patentees and Owners)

Guaranteed Precision Range  $\frac{1}{4}$  to 10 Megohms

**Brings in More Distant Stations — Affords Greater Volume — Improves Tone Quality! Fits Any Set, Panel or Baseboard. Price, \$1.50**

### *“Nothing Better”*

The North American Bretwood Co.

For some time I have seen in the Radio World your advertisement of the Bretwood Grid Leak, as well as some of your testimonials, and I decided to try one of them at the first opportunity which presented itself last night.

I own a 5-tube factory built set. During the last three days I could not get a sound out of it due to what I thought was a terrific spell of static, but which was caused by a defective grid leak. The noise was indeed so terrible that rather than hear such a racket I turned off the set and went to bed.

To-day, as luck would want it, I happened into a store and saw a Bretwood Variable Grid Leak on display. I decided to try it immediately. The results were absolutely gratifying. Other sets in the neighborhood are not getting anything at all, while I have brought in a great number of stations with speaker volume, with a socket aerial. I must say for the benefit of those who have not tried your grid leak that there is nothing better in this line.

ALFONSO FABRIS ARCE,  
4116 Ave. R, Galveston, Tex.

## The North American Bretwood Co.

Telephone, BRYant 0559

145 West 45th Street, N. Y. City

*Sole Distributors for United States*

North American Bretwood Co., 145 West 45th St., N. Y. City.

Gentlemen: Enclosed find \$1.50. Send me at once one Bretwood Variable Grid Leak on 5-day money-back guarantee.

NAME .....

ADDRESS .....

CITY ..... STATE .....

*Inquiries Solicited from the Trade*

# RADIO WORLD

[Entered as second-class matter, March, 1922, at the post office at New York, N. Y., under Act of March 3, 1879]

A Weekly Paper Published by Hennessy Radio Publications Corporation from Publication Office, 145 West 45th St., New York, N. Y. Just East of Broadway Phones: BRYant 0558 and 0559

Vol. IX. No. 8. Whole No. 216.

May 15, 1926

15c per copy, \$6.00 a year

## Super-Heterodyne Results Brought Up to Maximum

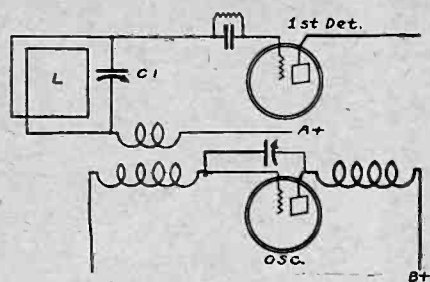

FIG. 1

The Hartley oscillator for a Super-Heterodyne. The coupling coil is the one connected to loop.

By Herman Bernard

Associate, Institute of Radio Engineers

MANY users of Super-Heterodynes must have noticed that the loop circuit tunes broadly and that the selectivity burden falls upon the oscillator. This tuning condition is due to the Super-Heterodyne action taking place after the loop tuning is accomplished. First the signal frequency is tuned in, and if we stop there we have a tuned impedance input, which is always broad, whether it be a loop or a single-winding coil connected to aerial and ground. The next tuning operation concerns the oscillator, which is tuned to a frequency not far removed from that of the broadcasting station's wave, but the difference between the two, subtracting either one from the other, gives the much higher wavelength, known as the intermediate or medium frequency. It is between the audible and the signal frequencies.

The assumption that a loop is more selective than an outdoor antenna is not well founded. It may be but usually is not. Whenever you use an external loop, meaning thereby one which is not wound around the inside of the cabinet and fixed there, you have a tuning control, because the loop should be turned in the direction of the station desired to be heard. This is known as the directional quality of the loop. Also, the tuning condenser across the loop must be varied for different wavelengths. Hence each loop entails two controls.

### Fixed Loop Inefficient

It may happen that, with many local stations, all-sufficient volume is obtained without rotating the loop. The same position may be maintained not only for locals but for some distant stations. This led to the enclosed type of loop being introduced, but the efficiency factor naturally declined, because the directional effect is noticeable indeed on weak signals, and to be denied the advantage is about the same as being shielded from weak stations. They don't come in. Just as much selectivity may be ob-

tained from an outdoor aerial as from a loop, if the coupling between antenna coil and secondary of the tuned input circuit is sufficiently loose. It is incredible to some how far distant from the secondary this primary coil may be. In one receiver, for instance, the distance is nearly three inches, but that is rather a wide space.

### Reduction of Noise Pickup

The reason for large separation, of course, was the reduction of the static level, as compared with the signal level, since the Super-Heterodyne is so sensitive that in many instances an outdoor aerial results in a noisy receiver. With wide separation between primary and secondary, the Super-Heterodyne, operated on an outdoor antenna, of course has no directional effect, unless some slight effect is obtained due to the direction in which the aerial runs and the point where the lead-in is taken. This is never more than meagre with a receiving aerial.

You have one less thing to move than if you were using a loop, and you have as much selectivity, probably more, unless you are using a long antenna. For a Super-Heterodyne a 30-foot aerial is long enough, usually, and if it is outdoors greater pickup may be accomplished, if desired, by increasing the height of the aerial. But an indoor wire of that length is ample.

The objection to using an outdoor aerial with a Super-Heterodyne is radiation. To prevent radiation, which means sending out squeals that are received in others' sets, a stage of tuned radio-frequency amplification, properly neutralized, may be placed ahead of the first detector. This greatly increases selectivity, but inaugurating that quality in a part of the circuit independent of the oscillator circuit. Indeed, if one builds a Super-Heterodyne for the sole object of receiving far-distant stations with speaker volume, he may be disappointed unless he makes the circuit, prior to the oscillator action, fairly selective. This may be done by the addition of the stage of tuned radio-frequency or, without adding an extra tube, by introducing regeneration in the first detector stage. The regeneration sharpens the selectivity peak very considerably and adds likewise to the sensitivity.

### Limits of Super-Heterodyne

Without regeneration or tuned RF the Super-Heterodyne, operated on a loop, need not be expected to exceed in distance and other performance, the good models of five 5- and 6-tube TRF receivers. Indeed, one very strong point in favor of the Super-Heterodyne is its ability to perform, when operated on a loop, as well as the good TRF receivers, of fewer tubes, operating on a suitable

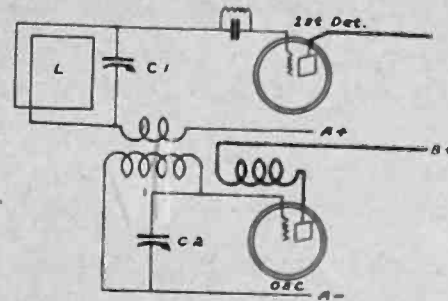

FIG. 2

The Meissner system of oscillation.

outdoor antenna. Hence the Super-Heterodyne is admirably adapted to use in an apartment house in a large city or under similar conditions of air congestion and obstacles to outdoor antenna erection.

In searching out the far-distant stations, however, on either loop or outdoor antenna, the Super-Heterodyne needs the regenerative action in the first detector, or the stage of tuned RF. When regeneration is introduced it need not be of the variable sort, since critical regeneration is not necessary. All that is required is sufficient feedback whereby the input tuning is sharpened.

### Regeneration Method

If a loop is used, and this advantage is sought, a small fixed condenser may be connected from the plate of the first detector to one terminal of the loop, while the grid return connection, instead of being made from a terminal of the loop winding, is made to a tap on the loop. If a 14-turn loop is used the tap may be at the fourth turn. Thus four turns of the loop are in the plate circuit and 10 turns in the grid circuit, although the tuning condenser is across the entire loop winding. The fixed condenser may be .0001 or .00025 mfd., or something on that order. Its capacity depends somewhat on the location of the tap, so a little experimenting here will prove of value. The connection results in the establishment of a shunt capacity feed or Hartley oscillator system in the first detector.

### The Squeal Means DX

From the foregoing it may be supposed that the seekers after extreme DX must have a Super-Heterodyne that is of the squealing variety, and this indeed seems to be the case. If all one desires is a set that will operate well from a loop, and equal or exceed in performance a 5-tube set operated from an outdoor aerial, then this regenerative feature is unnecessary.

As all the pickup one should require may be derived from a loop, and regeneration will diminish the broadness in the input circuit, the DX hunter will confer

# Weak Spots Strengthened

a favor upon his neighbors, and indeed upon persons perhaps miles away, by using only a loop, if he intends to incorporate regeneration. While a loop radiates, it does not do so to any great extent, the radiation being confined very often to a matter of yards. Theoretically it is infinite, as are all radio waves.

The mere inclusion of regeneration will not prove a panacea, however, because of all the circuits wherein impediments to the desired goal may arise, the Super-Heterodyne seems to lead. This applies particularly to such receivers as are home-constructed. No specific exception is made of factory-made Super-Heterodynes, however, because persons who buy them, of their own volition expect more than they should, due to price of set and the number of tubes used. Besides, if they do not know how to tune the set properly their results may be very poor. The use of the double effect of the oscillator, for instance, is something that needs to be understood and mastered.

A station may be brought in at a given setting of the first detector input, C1 in Fig. 2, and at either of two settings of the oscillator condenser, C2, because in one instance the oscillator frequency is subtracted from the modulator frequency, while in the other instance the modulator frequency is subtracted from the oscillator frequency. In either instance, sum or difference, the answer is the same intermediate frequency.

## Options Valuable

Often station beat notes and other interference may be eliminated by changing over to the other oscillator setting, or, apart from interference, volume may be better one way than another. As a general rule one setting or the other—upper or lower oscillator dial reading—will give generally superior results over the tuning scale, hence if one properly rotates C1 and C2 in unison, the return to a previous station, though one is seemingly on another band, will be avoided. An exception is that if the set tunes to sufficiently low wavelengths, harmonics of broadcast frequencies may be picked up. An harmonic is a multiple of the fundamental or broadcast frequency, or a fraction of the wavelength. A station transmitting at 500 meters, for instance, which is the fundamental wavelength, has its second harmonic at 250 meters.

## Violation of Rules

Stations should not send out anything except the fundamental, which is the first harmonic, and it is against the rules of

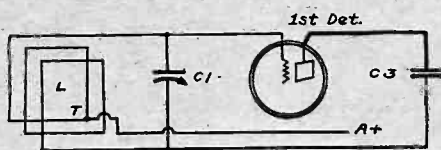

FIG. 3  
The regenerated loop circuit.

the Department of Commerce to do otherwise, but some infract the rules, and second harmonics are on the air frequently. This becomes a nuisance indeed when the second harmonic of some powerful local drowns out other stations whose fundamental is at or near the same wavelength as the other's harmonic. Then cutting through the local's harmonic is the barrier to distance reception in addition to other obstacles.

When this condition exists to the point of nuisance it is all the more necessary to have an ultra-selective receiver, for then the opportunity is best for tuning out interfering harmonics, as well as overlapping fundamentals.

Every one knows the behavior of his receiver when tuning in locals, especially powerful ones, for the words and music come in with a fine boom, delightful to hear. One hopes for such volume and clarity from distant stations, but the hope is in vain, for it can not be done, and there is no present indication that it ever will be done. The locals therefore take more than their share of the air, in a practical sense. Stations the country over are separated, as to frequency, by 10,000 cycles, and as each emits probably a total sideband of 5,000 cycles, there are, in theory, 5,000 cycles to spare. This is the silent area on the dial between stations.

## The Safety Margin

Local stations that come in strong occupy more than the allotted share of the dial. Putting it differently, in practice these stations use more than the theoretical channel. The drowning effect of their power, if there were two stations, one 10,000 cycles from the other, would result in one hearing both stations at the same time, no matter if the receiver were manually tuned to only one of them. Fortunately, the minimum separation (10,000 cycles) prevails only with stations separated by considerable distance, and the power question does not arise as to channel neighbors. But it does arise on another score—the operation of the receiver so as to produce excellent quality for local reception, while the quality on distant reception is merely the best that

one may obtain under the circumstances, though it be none too good.

It must be conceded that quality and distance do not go hand in hand and that anyone with a penchant for hearing the far-off stations is willing to forego quality, as to them. But how about locals? Is he willing to have a receiver so selective as to bring in distance with great consistency, at the expense of injuring the quality of reception from local stations? Extreme selectivity, of course, makes the resonance curve—frequency plotted against dial setting—so sharp that a slice is taken off the 5,000 cycle margin. When that happens quality begins to fly away.

The answer is that the power of the locals, the spreading effect whereby their waves occupy more space than conventionally supposed, takes care of the quality aspect, and there is no reason, on the quality score, for having any change-over system for making the set utilize fewer tubes and tune less sharply. Economy of tubes and watts would be some reason for such a switching arrangement, but the quality argument is not a good reason.

## Two Excellent Oscillators

Feeling that selectivity is safe, therefore, one need inquire only as to the further means of making the set suitably selective. The oscillator's important part in this performance has been mentioned. The tube used as the oscillator should be the best one you have for the purpose. Also the oscillator system should be a good one. Two of the best ones are shown in Figs. 1 and 2. One is the Meissner and the other is the Hartley. Each has advantages over the other. Each has disadvantages. The Hartley is prone to be over-rich in harmonics of its own fundamental oscillator frequency. It may diminish in comparative efficiency somewhat on lower wavelengths. On the other hand the Meissner method may give you all too bountiful oscillation at these higher frequencies. On the question of body capacity effects, the Hartley may develop some, but the Meissner is relatively free from these, if the stator plates of the condenser are connected to grid. Tendency toward self-harmonics may be reduced in the Hartley hookup by diminishing the plate voltage. One should use about the same voltage as would be employed if this were a detector circuit. The same holds true of the other method.

## Use Small Coupling

With the oscillator functioning well, indeed with virtually everything tip-top, a frequent source of failure to achieve much is due to the coupling coil. Reverse the connections thereto and see if results improve. There is usually a marked difference between the right way and the wrong way. Also, if this coil has many turns of wire the set's efficiency is reduced. Always couple with a very few turns. Usually about 5 will be plenty. Many turns mean much capacity coupling, besides the inductive coupling, and consequent tendency toward absorption by the modulator circuit. This absorption obtains when the modulator and oscillator are tuned to the same frequency. It is common for the modulator to stifle all the oscillatory power of the oscillator, hence prevent reception when the dials are thus set. Under these conditions you are not supposed to get reception, anyway, because there should be no beat note, but in practice the loop circuit, unless regenerated, will tune so broadly that strong signals will pass right into the grid of the first detector.

## 20 Billions of Electrons Occupy 1/100,000 of an Inch

The name electron tube is derived from the fact that the action of the tube is due to very small particles of matter called electrons. An electron is much smaller than an atom and is the building block of which atoms are constructed. An idea of the extremely small size of the electron may be obtained from the estimate that in a spherical globule of copper having a diameter of one one hundred-thousandth of an inch, there are about 20 billion electrons. The atom was formerly regarded as the smallest particle of matter which could exist. Something like 25,000 hydrogen atoms would have to be placed in contact in a row to make up a length of one ten-thousandth of an inch. The

weight of an electron is only about one two-thousandth of the weight of a hydrogen atom. The fact that the electron carries a charge of negative electricity makes possible the use of vacuum tube in radio communication.

A tube containing a filament and an additional metal (plate) is commonly called a two-element tube, with the filament as one electrode and the plate as the other. The plate is positively charged while the filament is negatively charged. Thus the electrons are attracted from the filament to the plate and a flow of current takes place. The grid is the third element in the tube commonly used today. This controls the flow of electrons

# Set Needs Matched Aerial

By John F. Rider

Member, Institute of Radio Engineers

THE acceptance by the radio fraternity in general of a standard aerial, a certain length of aerial wire, insulators and ground clamp, has led many radio fans to believe that there exists a standard aerial of a certain length which could be used with all types of receivers, irrespective of the number of tubes. That conclusion is wrong. In many instances great dissatisfaction results.

The selective powers of the majority of receivers are definitely limited. That condition exists with all radio receivers. And since the selectivity factor is governed to a very great extent by the amount of power received from the broadcasting station and passed into the receiver, it stands to reason that to obtain the desired degree of selectivity it is imperative that the amount of power passed into the receiver be limited.

## Must Limit Pickup

And as the aerial comprises the pickup system by means of which the energy is obtained from the ether and passed into the receiver, one can see very readily that the pick-up with the aerial must be within definite limits, which in turn means that the aerial must possess definite physical dimensions, since the amount of energy pick-up is dependent upon the length and height of the aerial. The location of the pick-up system at this time is neglected.

The next important factor is the signal to static ratio. A weak signal free of strays and extraneous noises may be more readily amplified than a loud signal with which are simultaneously received various loud interfering noises. The reason for this lies in the effective amplifying powers of a radio receiving system.

## Foreign Noises Present

In every receiver and amplifier there are present various noises, due to slight leakage between units carrying potentials, voltage fluctuations of potential sources, tube noises, slight regeneration even in the audio frequency stages, microphonic contacts between connecting units, and other causes, and all of these are amplified to their fullest extent when the receiving system is "pushed" so as to afford the greatest output. Now, if the original signal received is made up of the desired signal and other noises, the amplification of the inherent noises and those received with the signal would tend to offset any advantage by having a large pick-up system and loud signals. If the amplifying powers of the receiver are reduced so as to diminish internal noises, the incoming signal current made up of the desired signal and the interfering noise will still be amplified uniformly. But if the pick-up system is reduced so that only a small fraction of the original signal intensity is picked up, but free of interfering noises, the amplifying system may be "pushed" slightly, since the signal is free of interference, and the ratio of amplification of the inherent noises and that of the signal is such that the signal will be amplified sufficiently to afford satisfactory reception, and the noise level will be low.

## "Custom Tailoring" Needed

As to the use of a standard aerial with all receivers, it is out of the question. Each type of receiver requires an aerial of certain physical dimensions if the utmost is to be obtained from the receiver. Of course similar receivers, with identical degrees of sensitivity, require similar aerials, but dissimilar receivers require different aerials. Take for example

## His Aerial 'Way Up

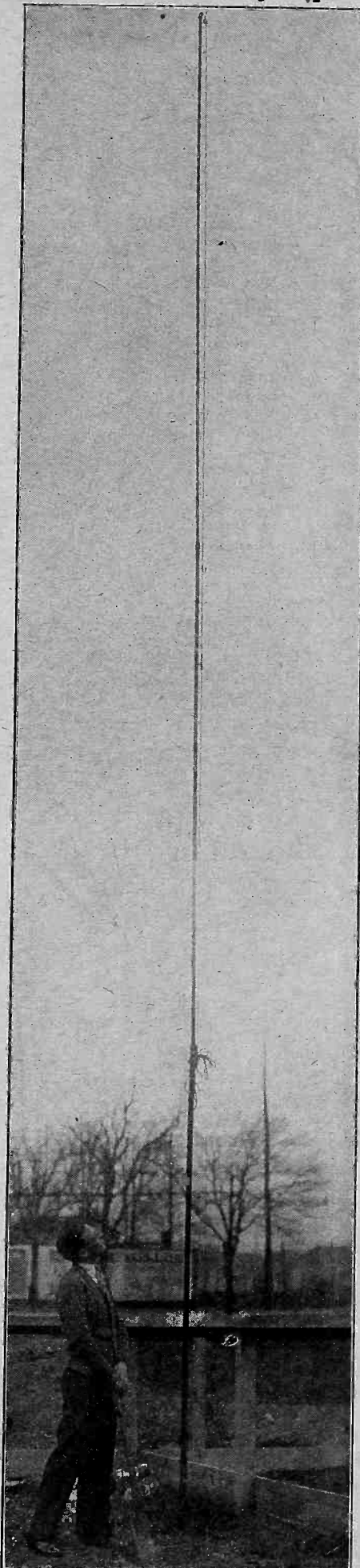

(Hayden)

A BROOKLYN (N. Y.) fan made sure his aerial would be high enough. He installed a 45-foot iron pipe mast.

any 6-tube radio receiver, utilizing three stages of tuned radio frequency amplification non-regenerative detector and two stages of transformer-coupled audio frequency. Would the standard aerial required for a 3-tube receiver, made up of a regenerative detector and two stages of audio frequency amplification, be suitable for the 6-tube receiver specified? No. While it is true that the use of the long aerial would result in a large amount of volume, this volume would result in other actions that would discount the advantages gained through the use of such a sensitive receiver. For instance, many distant stations would not be heard while locals were on the air, because the excessive pick occasioned by the long aerial and the sensitiveness of the receiving system would drown out the distant station.

## How DX Is Drowned Out

The energy due to the local station would be so great in the various tuning circuits that the resonance curve would be broad enough to overlap that of the distant station. In this way the advantage of the great sensitivity of the receiver, so far as the reception of distant station is concerned, would be lost entirely. Some fans may not be in accord with me on this subject, contending that a receiver utilizing three stages of tuned radio frequency amplification should possess sufficient selective powers to cut through the locals.

The contention is entirely correct, since the average receiver which contains three stages of tuned radio frequency amplification is sufficiently selective to cut through the locals, providing that the local's received energy is not excessive. It should be realized that during the time the local broadcasters are in operation, the receiver also is responsive to the distant station, when tuned to its wavelength, but the reason for the lack of reception is that locals overlap. Many fans hear distant stations only when the locals are off.

A reduction in the energy input into the receiver by pruning the aerial almost invariably solves this trouble, although the volume of the distant station is slightly reduced, but the fact remains that the distant station is satisfactorily received free of local interference.

## Reason for Poor Selectivity

The so-called selectivity trouble with many 5 and 6-tubed tuned radio frequency receivers is, in my opinion, attributable directly to excessive energy input. And the reason for this excessive input is an aerial of more than the required length. And in turn, the reason for the excessively long aerial is the failure to consider the sensitivity factor of the receiver and adherence to the idea that it is necessary to utilize every inch of the aerial wire available.

This subject has another angle, pertaining to the selection of aerials for receivers of medium selectivity powers when located in highly congested areas, such as large cities wherein are numerous powerful broadcasting stations. Were one to render final decision upon this question from the data given in the preceding paragraphs, selectivity would be very poor with receivers such as the regenerative receiver, since the longest aerial is prescribed for this type of receiving system.

## The Author's Rule

Adherence to the following rule will at all times prove beneficial:

"The more sensitive the receiver, the smaller the aerial should be."

# The Truth About Coil Fields

By J. E. Anderson

Consulting Engineer

THERE has been considerable talk about fieldless inductances. It has crept into advertising copy, into headlines, into popular articles, and even into the more serious technical articles. Fieldless inductances! These oddities fall into the same category as dry water, non-alcoholic alcohol, brilliant darkness, weightless weight, and other similar absurdities.

Inductance is, by definition, the total magnetic field, or the total number of lines of magnetic induction, that is associated with an electric circuit when unit current is owing in that circuit. Hence if an electric circuit is fieldless it is also non-inductive. But no circuit can be non-inductive, for if it is a complete circuit, current will flow, or would flow with the proper emf, and the lines of magnetic induction cannot be dissociated from the current.

## May Minimize Field

Circuits, or rather the conductors whereof circuits are made, can be so arranged as to minimize or intensify the inductance. Certain portions of a circuit may be so constructed as to contain nearly all the inductance in the entire circuit, or they may be so constructed that their inductance is negligible in comparison with the inductance in the rest of the circuit. If a conductor is so arranged that it contains nearly all the inductance it is called a lumped or concentrated inductance. If it is so constructed as to have a negligible inductance it is called non-inductive.

A coil having many turns is a concentrated inductance. If the coil has an iron core the inductance is still more concentrated. If the conductor is wound back over itself in the manner of wire-wound standards of resistance, the device becomes non-inductive, or very nearly so. The latter is as fieldless as it is possible to get it in practice. But a concentrated inductance, no matter what particular shape of the coil, is not fieldless, otherwise it would not be an inductance.

Another idea about coils is that the field is limited to a very small space about the coil. In any practical coil the field extends to infinity no matter what the inductance value or shape of the coil may be. It is true that the intensity of the field is very much greater close to the coil than it is far away, but the intensity does not become zero at any finite distance away from the coil. The intensity of the magnetic field about a long straight conductor, such as a stretched wire which is carrying a current, is proportional to the current and inversely proportional to the distance away from the wire. This distribution of intensity of magnetic flux is different, of course, for lumped inductances, but the intensity is never zero.

It is therefore idle to talk about certain distances beyond which the magnetic intensity is zero, a favorite exercise in which many indulge when discussing the proper placement of coils relative to condensers and other metal objects in a radio receiver.

## Placement of Coils

The coils should be placed with respect to metal bodies in such a manner that the metal is in a weak portion of the field of the coil, or in such a manner that the most extensive sectional planes of such metal bodies are parallel with the direction of the magnetic field. The first is usually attained by keeping the metal bodies away from the coil a few inches;

## More Heat for the Iron



SOMETIMES a soldering iron reaches that stage of exasperating malperformance where it does not heat up sufficiently. Turns of bare No. 16 wire, wound as shown, often cures this defect.

the second by turning the coil in a suitable manner.

Some time ago there appeared an article in a journal devoted to radio which explained and illustrated the effect of shape of coils on the magnetic field. Two coils of equal inductances were taken, one of which was long and narrow and the other short and wide. The magnetic fields about the coils were represented in the usual manner by means of lines. The long coil had two lines of induction, and they clung closely to the winding. The short coil had four lines of induction, and they were spread out wide. The conclusions were that the long and narrow coil had a small field and would therefore be preferable for use in crowded places, and that the short coil was not suitable for this purpose, since it had a much more extended field. Whatever the value of the conclusions, they were reached by taking two coils of equal inductance and then stating that one had twice the number of lines of induction. Just another way of proving that one equals two!

## Three Types of Coils

Consider the fields of three typical inductance coils, the single layer solenoid, the astatic pair, and the toroidal coil, all of the same inductance value. Since they all have the same inductance, they all have the same fields as regards to quantity but not as regards shape of field, or as regards the distribution of the magnetic lines of induction. The field of the single layer solenoid has circular symmetry about its axis, that is, the coil may be rotated about its axis without changing the intensity of magnetization at any point around it. The intensity of its field externally is quite high, and for this reason this coil is never spoken of as a fieldless coil.

The astatic pair is made up of two equal single layer solenoids placed side by side and connected in series aiding. A similar coil is made by winding the turns into loops like a figure eight. The intensity of the external field for this case is not so great as that for the solenoid but it is not zero, except along the perpendicular bisector of the line which joins the centers of the two separate coils or loops. The magnetic field extends to infinity.

## Some Legerdemain

Illustrations have appeared to show how the magnetic field is confined in this type of coil. First two separate solenoids have been given with lines of force threading through the coils in every direction. In one coil the direction of the lines of force is up and in the other it is down, a necessary condition for the series aiding connection. Then the two coils are placed side by side and connected up for series aiding. Presto, and all the lines of force of each coil, except those threading through the other, disappear. That leaves the coil combination without an

external field, naturally. All astatic coils leave a considerable external field. If they did not, they would be almost useless for radio purposes, for they would not be much better for tuning purposes than non-inductive resistances.

Now we come to the toroidal coil. This is the coil that is usually referred to as fieldless. Nearly all of the external part of the field is neutralized by doubling the wire back over itself, in effect at least. Enough wire has to be used to make the internal, or saved, part of the field equal to the inductance required.

## Fieldless Coil a Fallacy

The major portion of the magnetic field is confined to the space inside the annulus. But it is not fieldless. There is even a weak external field associated with a toroid. This comes from the fact that each turn on the annulus is not a perfect circle whose plane is at right angles to the ring. The wire is wound diagonally like a screw. This fact makes the annulus itself in effect a circular loop of wire whose diameter is the mean diameter of the annulus. This loop will have an inductance, or a field, which is essentially of the same form as that given by a circular loop of plain wire.

There seems to be a general belief that capacity depends on voltage. Here is a typical manner in which this belief manifests itself. ". . . Anything besides air between the wires, especially along where the voltage is high, changes the capacitance between the wires . . ." Such statements are often made in connection with the discussions of the distributed capacity of coils.

## Capacity Wrongly Judged

The idea seemingly is that as long as the two conductors are at the same or nearly the same potential the capacity between the conductors is unaffected by the dielectric that is placed between them: but if the two conductors are at widely different potentials the capacity is greatly increased by the dielectric constant of the material placed between them. If there is any variation of capacity with voltage it is a second or higher order effect. Aside from this possibility, capacity is a property of a condenser which depends on the dimensions of the conductors and on the distance apart of the conductors. It also depends on the dielectric constant, that is, on the specific electric inductivity of the material of the insulator. The dimensions involved do not change with voltage; not in a good condenser, at least, in which the conductors are clamped. Neither does the property of the insulator change with voltage.

## High Losses the Reason

It is true that potential is used in deriving the formulas for the capacity of various condensers or conductors. But the quantity, or the electric charge, is used simultaneously. When the derivation is complete nothing but a dimension, a length, and the dielectric constant, remains. What has led to the fallacy is probably that more current will pass through a given capacity if the voltage is high, and hence that the losses in the dielectric will be greater when the voltage is high. Thus in the case quoted above, nothing should be placed between the two wires where the voltage is high because the losses in any dielectric placed there would be greater than if the same body of dielectric were placed between the wires when the voltage is low. The effect on the capacity between the wires would be the same no matter where the thing is inserted between them.

## Rubber Bands As Support Keep Tube Free of Microphonic Effects

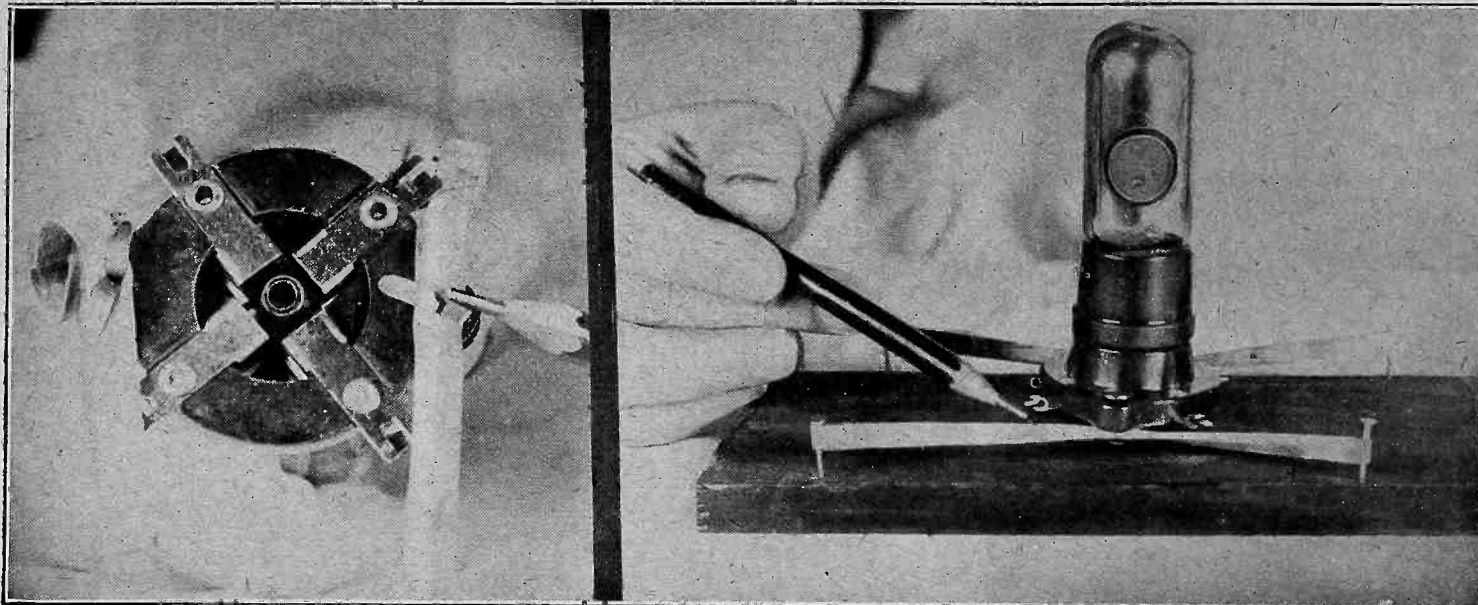

(Hayden)

PERSONS troubled with microphonic noises may use a pair of strong rubber bands to apply a remedy. The bands, tacks and paper clips are all that are required. The clips are placed through the holes where the screws are to be inserted. Four thumb or carpet tacks are placed about 1" from socket in a square. The rubber bands are slipped over the heads of the tacks. The points of the tacks are then pushed through the center of the rubber band loops. The rubber bands should be of sufficient tightness to keep the socket in a springy position.

## Keep 1" Margin in Shield

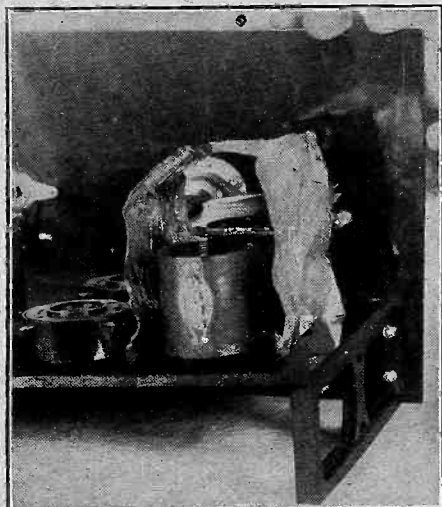

(Hayden)

WHEN PLACING coils in a shield, keep them at least 1" from the sides of the shield. In a complete shield the coil is enclosed by two more walls, the 1" separation still being kept. Tin-foil may be successfully employed as shield material, but copper, either solid sheet or insect netting type, may be utilized. This prevents the coils acting as loops and minimizes stray coupling effects. It is getting to be very popular.

## Increases Selectivity

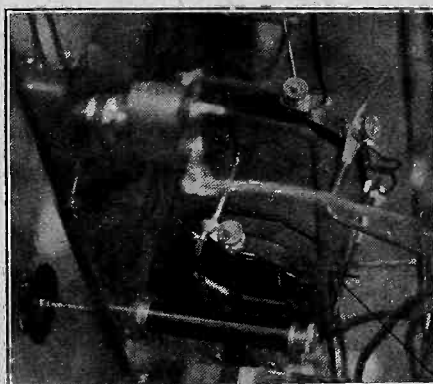

BY taking turns off the primary of an interstage coupler, as shown above, the selectivity of the set may be increased. Arrow points to primary.

## Spring Clip Holds Solder and Prevents Smearing

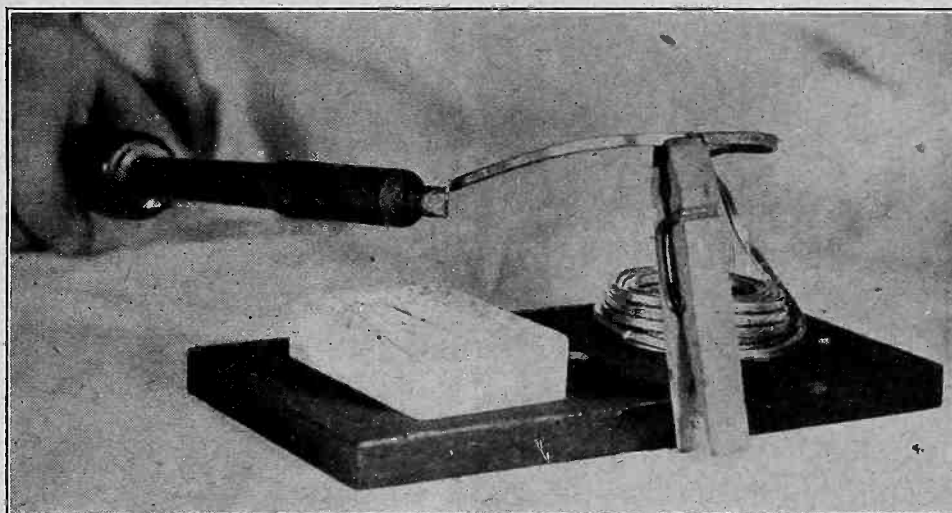

PROBLEM: How to get some one else to hold the self-fluxing solder when you're all alone. Solution: See photograph. The method prevents smearing by the flux.

## UX Socket Precaution

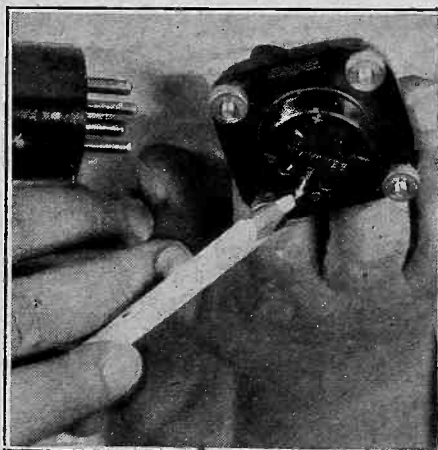

(Hayden)

WHEN using the U. V. type of tube in the new U. X. socket be sure to place tube with its pin over the white arrow in the socket before plunging the tube in. Otherwise blown out tubes may result, due to putting B battery across the filament. This arrow innovation is employed on a majority on the sockets on the market today.

## Station Is Floated



(International News Reel)

THE NEW marine broadcast ship Mu-1 on blocks at the shipyards at Wilmington, Del. just before it took to the water where it will operate as a regular broadcast station (WRMU). The ship is owned by Douglas Rigney.

# Signal Intensity Goes Down With Sun, Returning Soon

The following report from the Bureau of Standards, was prepared by Dr. J. H. Delinger, C. B. Joliffe and T. Parkinson.

The work here described is the third extensive program of cooperative radio observations conducted by the Bureau of Standards on radio signal fading and on the conditions affecting distance range of broadcasting.

At the beginning of the 1925 season, the Bureau of Standards invited a number of qualified laboratories to participate in the beginning of a cooperative program of measurements. The general program contemplates measurements of the several quantities: field intensity, fading, direction variations, polarization and atmospheric.

## Fading a Fruitful Field

In 1925 the work was largely confined to fading measurements. This quantity was selected both because the apparatus required is relatively simple and because fading phenomena promise to shed the most light on wave characteristics.

The work was mainly at the broadcast frequencies because transmissions with uninterrupted carrier are not so readily available in other parts of the frequency spectrum. Results at other than broadcast frequencies, and field intensity and direction observations, where mentioned herein, are therefore considered as incidental to the principal aim of the 1925 work, which was the study of fading phenomena in the broadcast range.

## Graphic Records Taken

The general plan of the work was the arrangement of special transmissions in each of which a certain station transmitted continuously during a specified period, and the taking of graphic records simultaneously by the observing laboratories.

Twenty laboratories were engaged in this work. About 20 others expressed interest in the work and made some effort to begin observations. The results of some of the tests have been described in previous special reports by the Bureau or in articles that some of the cooperating observers have published.

The method of measurement used a receiving set, of any type, plus a sensitive direct-current galvanometer used with a detector in such a way as to measure variations in the received carrier wave current.

Records were in some cases made by visual observation of galvanometer deflections, taking readings several times a minute and plotting these afterward on coordinate paper. Very good records showing the major variations have been obtained in this way. Automatic continuous records were obtained in most of the work, however. These were easier for the observer, and showed up the smaller fluctuations which sometimes proved significant. A number of records made during some of the sunset fading tests, for instance, showed a rapid periodic swing starting about fifteen minutes after the local sunsets at the observing points and lasted approximately a half hour.

All of the laboratories sent their graphical records to the Bureau of Standards where they were analyzed. The analyses consisted of the taking of averages from the records and preparation of condensed graphs from these of both intensity and fluctuation.

## Eclipse Results

The observations during the eclipse showed, as expected, a condition inter-

mediate between daytime and nighttime transmission. The perceptible variation due to the eclipse lasted for about an hour and consisted of a decrease in the field intensity to a minimum followed by an increase to a maximum and then a subsidence to normal.

The several sunset tests showed a similar decrease followed by an increase superposed, however, on a marked general increase of signal intensity in the transition from daytime to nighttime conditions. The time required for transition from normal daytime field intensity to normal nighttime field intensity at the particular frequencies used is about 2 to 3 hours beginning about 1 to 1½ hours before sunset and ending 1 to 1½ hours after sunset.

## General Conclusions

All of the records showed short-period and long-period fading fluctuations. A large number of detailed results for different times, directions and places were obtained. The small amount of direction observations and places were obtained. The small amount of direction fluctuation arious sunset fading tests lead to the following general conclusions:

1. Short period fading (periods of a few seconds to 8 or 10 minutes) is not the same on record made simultaneously at distances of a few kilometers.

2. The same is true of long period changes (10 minutes to several hours).

3. Records of the same transmission made on successive days at the same receiving point bear little resemblance.

4. There is no correlation between intensity and fluctuation changes.

5. There is no consistent correlation between good reception and the relation of the transmission path to the direction of isobars or isotherms as shown on weather maps covering the test periods.

6. Averaging a number of sunset records made over a period of two weeks shows a rise of intensity starting over an hour previous to sunset, a drop or less-

## Clean Up Soldered Joint



(Hayden)

IT is always a good plan to clean newly soldered joints, to remove flux. Denatured alcohol serves the purpose.

ing of the rate of increase before or during sunset at the receiving point, and a rise during or after sunset to a nighttime value reached an hour to two hours after sunset. This value is not necessarily the night maximum which may occur much later. In the case of north-south transmission the increase of intensity during the sunset period is continuous.

7. Averaging fluctuation changes shows in general greater fluctuation at night than during daytime, the daylight value often being close to zero while the night value in rare instances, mounts to 3.5 times the mean intensity.

8. On the KDKA average records there is a consistent correlation between the ratio of day-to-night intensity and distance from the transmitting station.

9. A correlation also between the ratio of day-to-night fluctuation and distance appears on the average records for KDKA.

10. On a single set of 24-hour tests the maximum intensity appears at about the same time, the four hours preceding sunrise, for observers within 1,000 km. of the transmitting station.

11. Measurement of direction shifts during some of the tests indicate in general direction shifts are accompanied by fading of the short period type.

(Copyright, 1926, by Stevenson Radio Syndicate)

CONSTRUCTION OF THE 4-TUBE A-A RECEIVER, by Herbert E. Hayden, appeared in RADIO WORLD dated Nov. 21. 15c per copy, or start your subscription with that number.

## Half-Dozen Celebrities Heard at Same Presentation



ALL HEARD on same night, these artists gave the audience a great treat during the Atwater Kent Radio Hour. At left is Phillips Carlin, announcer of WEA. The operatic and concert performers (left to right) are: Allen McQuahae, tenor; Katherine Meisle, contralto; Maria Kurenko, soprano; Louise Homer, contralto; Frances Alda, soprano, and John Powell, pianist.



# Radio University

A FREE Question and Answer Department conducted by RADIO WORLD for its yearly subscribers only, by its staff of Experts. Address Radio University, RADIO WORLD, 145 West 45th St., N. Y. City.

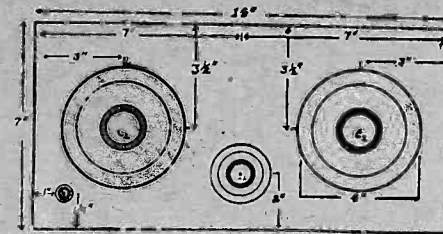

FIG. 323

The panel layout for the Harkness.

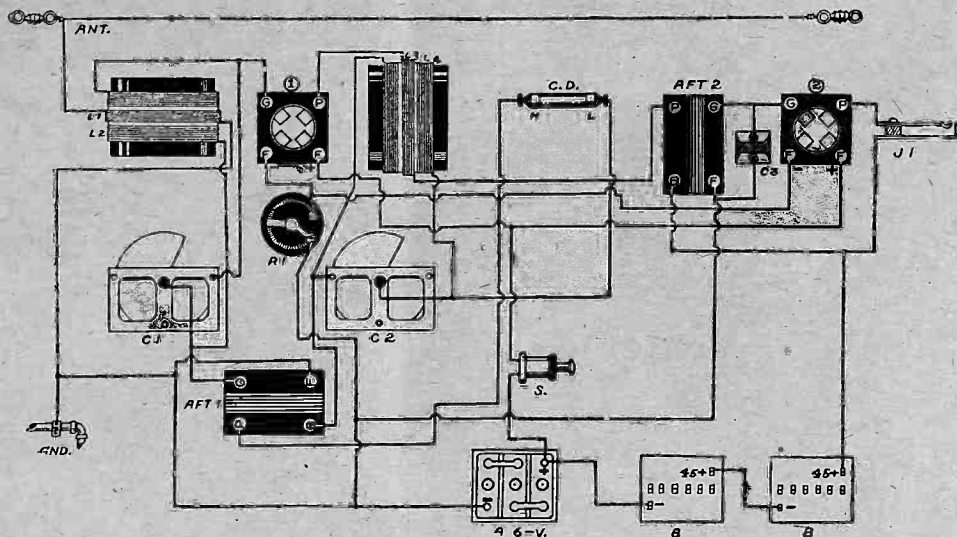

FIG. 322

The picture diagram of the old type Harkness reflex, requested by J. P. Savarese. Note that the coils are placed at right angles to each other. They should also be placed directly on the end plates of the condenser, with about a 2" separation, between the coil and the condenser.

I HAVE obtained the wiring directions of the old type Harkness reflex from the April 17 issue of RADIO WORLD (Radio University). Although the description is O. K., I, having little radio knowledge, would like to have a picture diagram of this receiver, with the constants of the apparatus, all mentioned. A panel layout would also be appreciated.—J. P. Savarese, 152 East 123rd St., N. Y. C.

Fig. 322 shows the picture diagram of this receiver. Fig. 323 shows the panel layout. L1 and L3, the primaries, consists of 10 turns. L2 and L4 consists of 62 turns. No. 22 double cotton covered wire is used. Tubings 3" in diameter and approximately 2 1/2" in height, are used. First the secondary winding is put on a tubing. A piece of empire cloth or heavy manila paper is then placed over the center of the secondary winding. Over this insulation, the primary is wound. The windings should be very tightly wound. The number of turns on these secondaries are such, that when shunted by .00035 mfd. variable condensers, having a minimum capacity of .0001 mfd., the entire waveband from 200 to 550 meters, will be covered. AFT1 is a high ratio type, about 6 to 1. AFT2 is a low ratio type, about 3 to 1. If another stage of transformer coupled audio frequency amplification is added, a low ratio transformer should be used. R1 is a 6 ohm rheostat. S is the filament switch. CD is the fixed crystal detector. H indicates the high potential point, while the low potential point is indicated by L. C3 is a .001 mfd. fixed condenser. It will be found that this condenser, with some type of transformers, distortion is prevented, while with others, it has no effect, except to cut the volume down.

\* \* \*

WHERE CAN I get commercial information about the B battery eliminator described in the March 27 issue of RADIO WORLD by Capt. P. V. O'Rourke?—A. J. Stubler, 113 East Franklin St., Baltimore, Md.

Write to C. E. Jacobs, 2803 North Kedzie Ave., Chicago, Ill.

\* \* \*

MY FRIEND informed me that it is injurious to hook up a fresh B battery

with an old one. Is this true? Why?—F. Han, 341 West 45th St., N. Y. City.

Your friend is correct. The high internal resistance of a run-down battery, when connected in the same circuit as that of the new battery, which has a low internal resistance, will resist the flow of current through the circuit, heating up the cells in the new battery, causing them to deteriorate, shortening the life.

\* \* \*

PLEASE GIVE a description of a 5-tube receiver, employing a stage of untuned radio frequency amplification, two stages of tuned radio frequency amplification, a non-regenerative detector followed by two stages of transformer coupled audio-frequency amplification. The secondaries of the RFT for the detector and the RF stages should be shunted by a double condenser, each section having a capacity of .0005. Please give the constants of the coils and condensers.—P. Kramer, 939 Longwood Ave., N. Y. C.

The untuned RFT may be of any standard type, which will cover the waveband of from 200 to 550 meters. Consider the primaries as L1 and L3; the secondaries as L2 and L4; the double condenser as C1; a ballast controlling the filament of the first tube as R1; a rheostat controlling the filament of the second tube as R2; another rheostat controlling the filament of the detector tube, as R3; a ballast controlling the filaments of both audio tubes, as R5; the grid condenser as C2; the grid leak as R4; the first audio-frequency transformer as AFT1; the second audio-frequency transformer as AFT2. Now the primaries, L1 and L3, consist of 10 turns wound on a basket weave form with fifteen 1/4" diameter spokes in a 3/4" diameter. L2 and L4, the secondaries, consist of 50 turns. These are wound on the under two and over two method, e.g., a wire is brought under two spokes and then over two spokes, etc. No space is left between the primary and the secondary windings. R2 and R3 are both 6 ohm rheostats. R5 is a 1/2 ampere ballast resistor. R4 is a 4 megohm grid leak.

C2 is a .00025 mfd. fixed grid condenser. Both AFT1 and 2 are of a low ratio, with large primary windings. Now as to the wiring. It is suggested that you take a pencil and paper and make a schematic diagram from the wiring directions, before attempting to wire the set. It will be less confusing and will speed the work up to a considerable degree. The P post of the untuned RFT goes to the antenna post. The B post goes to the ground post. The G post goes to the G post on the first socket. The F minus post goes to the A minus post on a terminal strip. The F minus post on this socket goes to a terminal of R1. The other terminal goes to the A minus post, or to the same place the F minus post on the untuned RFT was connected. The F plus post is connected to the F plus terminals of all the other sockets. This common terminal goes to a terminal filament switch. The other terminal of this switch goes to the A plus B minus post on a terminal strip. The beginning of the primary winding, L1, goes to the P post on the first socket. The end of this winding goes to a B plus post on a terminal strip, labelled 67 1/2 volts. The beginning of the secondary winding, L2, goes to the common rotor terminal of the double condenser, C1 and to the arm of the rheostat R2. This arm also goes to the arm of rheostat, R3. This common terminal goes to the A minus C plus post. The resistance wire terminals of both these rheostats, respectively, go to the F minus posts on both sockets. The end of the secondary winding, L2, goes to one set of the stationary plates of C1 and to the G post on the second socket. The other terminal connecting with the stationary plates of C1 goes to one terminal of C2 and to the end of the secondary winding, L4. The beginning of the primary winding, L3, goes to the P post on the second socket. The end of labelled 67 1/2 volts. The other terminal of the fixed grid condenser, C2, goes to the G post on the third socket (detector) and also to one terminal of the grid leak, R4. The other terminal of the leak, goes to the F plus post on the same socket. You will note here, that although there is a common negative return for both the RF and the detector tubes, the actual grid return of the detector tube is positive. This is done by bringing the leak in shunt to the grid and the positive side of the filament, instead of in shunt to the grid condenser as is usually done. This method is used because a -01A type tube requires a positive grid return. If a soft tube, such as the -00 type is used, then the grid leak can be shunted across the condenser. The P post on AFT1 goes to the P post on the detector socket. The B plus post goes to the B plus post on the strip, labelled 22 1/2 to 45 volts. The G post on this same AFT goes to the G post on the fourth socket, which holds the first audio tube. The F minus posts of AFT1 and 2 are connected to C minus. The P post on AFT2 goes to the P post on the fourth socket. The B plus post goes to the bottom terminal of a single circuit jack, which goes to the B plus post on the strip, labelled 90 to 112 volts. The G post on AFT2 goes to the G post on the last socket. The P post on this socket goes to the top terminal of a single circuit

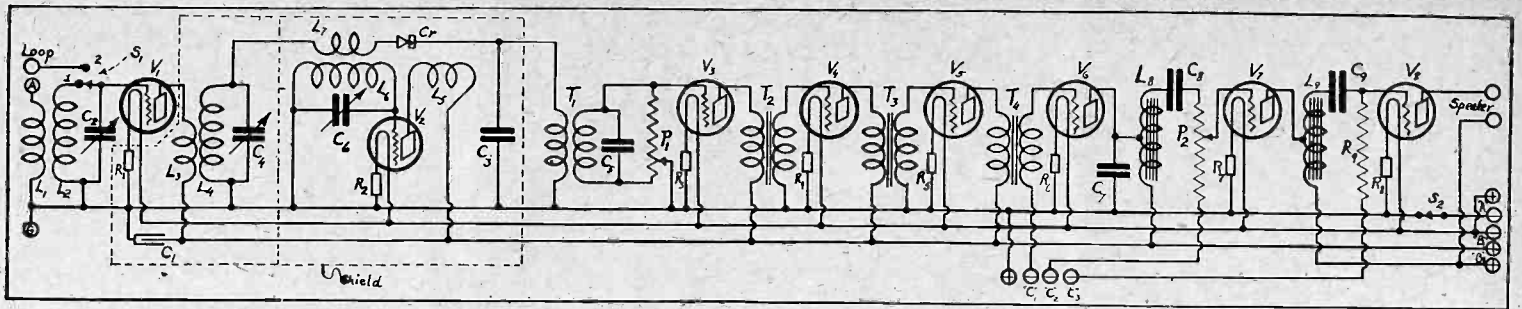

FIG. 324  
The circuit diagram of the DX Super-Heterodyne, requested by Karl Gray.

jack. The F minus posts of both these sockets are connected together. They go to a terminal of a ballast resistor, R5, which is of the 1/2 ampere type. The other terminal of this resistor, goes to the A minus C plus post. This completes the actual wiring. Now, there are several hints as to successful operation that may help. If the signals are weak, a condenser of .001 mfd. capacity may be connected between the plate of the detector tube to the A minus post. A 20 turn coil, shunted by a .0005 mfd. variable condenser in series with the antenna may also build up the signal strength. Of course, changing the position of the tubes and also the varying of the voltages may increase the volume of the signals. Rheostats, R2 and R3, have a great deal to do with the controlling of the volume. The C minus battery, should be, if 90 volts are to be used, of the 4.5 volt type. If about 112 volts are used, then it should be of the 6 volt type. The two RF coils, are mounted at right angles to each other, while the untuned RFT is mounted in any convenient position. A comparative short antenna can be used. This set is very selective and is a bit difficult to tune, if great care is not taken.

**KINDLY GIVE** a list of parts required to build the 6-tube Neutrodyne receiver, printed in the April 24 issue of RADIO WORLD on page 22.—Otto J. Havel, 7802 21st Ave., Brooklyn, N. Y.

One antenna coupler, L1L2, (10 turn primary, 45 turn secondary, 3/4" tubing, No. 22 DCC wire), two neutroformers, L3L4; L5L6, (same primary and secondary winding as L1L2. Secondary winding tapped at 10th turn from filament end). Three .0005 mfd. variable condensers, C1, C2, C3; two 3/4 ampere ballast resistors, R1, R2; two midget neutralizing condensers, N; three .25 mfd. fixed condensers, C5, C6, C7; three .1 megohm resistors, R4, R6, R8; one 1 megohm resistor, R5; one .5 megohm resistor, R7; one .25 megohm resistor, R9; one .00025 mfd. grid condenser, C4; one 2 megohm grid leak, R3; one filament switch, S; three 4" dials; one 7x26" panel; six sockets; one baseboard, 6x24x1/4", or one sub-panel, 2 1/2 x 23" and connecting wire, A, B and C bat-

teries, angle brackets, screws, nuts, terminal strip, etc.

**CAN A** loop be used with the 5-tube Super-Heterodyne described in the April 17 issue of RADIO WORLD by Jasper Jellicoe? If so, please describe the method of insertion, so that it may be cut in or out.—Arthur Strawhacker, 3719 Cypress Ave., Cleveland, O.

A loop can be used, but the results will not be very good. That is, only the local and stations about 75 miles distant will be heard with loud speaker volume. The beginning and the end of the secondary of the antenna coupler are detached from their respective positions. This means that the variable condenser, C1, is connected in series with the low potential point of the crystal and the beginning of the grid coupling coil, L3. Across these terminals, the loop is connected. The condenser will be shunted across these terminals. Binding posts may be connected at these points, so that a bus bar may be strapped across, if the antenna and the ground are to be used, instead of the loop. Small single pole single throw knife switches can be connected in series with these straps, for cutting in or out.

**I AM** going to build the 1925 Diamond of the Air, but before doing so, would like to know if a low ratio AFT can be used in the first and second stages, or if a high ratio should be used in the first stage and a low ratio in the second stage?—Andrew Tokar, 9702 Aetna Road, Cleveland, O.

You will get louder signals, when a high ratio AFT is used in the first stage and a low ratio AFT in the second stage, but you will get much better quality reception when two low ratio AFT are used.

**I WOULD** like to have the circuit diagram of a Super-Heterodyne, employing a stage of radio-frequency amplification, the regulation oscillator, a crystal as the first detector, three stages of intermediate frequency amplification, a second tube detector, with a grid bias battery, instead of a leak and condenser and two stages

of auto-transformer coupling.—Karl Gray, Cheyenne, Wis.

Fig. 324 shows the circuit diagram of a receiver which you desire. L1L2 and L3L4 are tuned radio-frequency transformers. The primaries, L1L3, consist of 11 turns. The secondaries, L2L4, consist of 68 turns. Forms 2" in diameter and 4" high are used. L5L6L7 constitutes an oscillating coil. Any commercial type may be used. The plate and the grid windings are made on a form 2 1/8" in diameter. L5, the plate coil, consists of 35 turns. L6, the grid coil, consists of 39 turns. The tickler coil, L7, is wound on a form 1 1/4" in diameter. This consists of 10 turns. No. 24 silk over cotton covered wire is used for all windings. T1 is the filter transformer. T2, T3 and T4 are the intermediate transformers. L8 and L9 are the auto-transformers. P1, P2 and R9 500,000 ohm potentiometers. C2 and C4 are a double condenser. Each section has a capacity of .0005 mfd. C6 is a .0005 mfd. variable condenser. C3 is a .001 mfd. fixed condenser. C8 and C9 are 1 mfd. fixed condensers. C1 is a .0001 mfd. fixed condenser. A carborundum fixed crystal detector is used. The first five tubes should be of -99 type. The 6V -199 Amperites should then be used here. The last three tubes should be the -01A type.

**I AM** enclosing the circuit diagram of a reflex receiver, which I have built. L1 and L3, the primaries, consist of 10 turns, wound on a form 3 1/2" in diameter. L2 and L4, the secondaries consist of 46 turns. There is no space left between the primary and the secondary windings. C1 and C2 are .0005 mfd. variable condensers. C3 is a .001 mfd. fixed condenser. CD is the crystal detector. Now, although in most reflexes it is recommended that a high ratio AFT be used in the reflexed stage and a low ratio AFT in the regular AF coupling stage; I have reversed these positions. Is it possible that this placement would cause the receiver to give poor volume? What else beside this change might increase the volume of this receiver?—F. L. Keats, 353 Union Ave., Elizabeth, N. J.

Reverse the AF transformers. Reverse the secondary winding of the first or reflexed AFT. Reverse the leads of the crystal detector. Increase the plate voltage. Take the fixed condenser C3 out of the circuit.

**I WOULD** like to have the circuit diagram, with constants, of a selective and voluminous crystal detector receiver, using carborundum as the crystal and a potentiometer in series with a battery to control the voltage applied to the crystal, for volume and sensitivity control.—Craig Drainston, Great Neck, L. I., N. Y.

Fig 326 shows the electrical diagram of such a receiver. L1, is a loading coil, consisting of 50 turns wound on a tubing 3 1/4" in diameter, using No. 22 double cotton covered wire as the conductor. It is tapped at every fifth turn, bringing the taps to a total of 10. Five of these are placed so that they can be cut in or out of the antenna, while the other five are connected, so that they may be cut in or

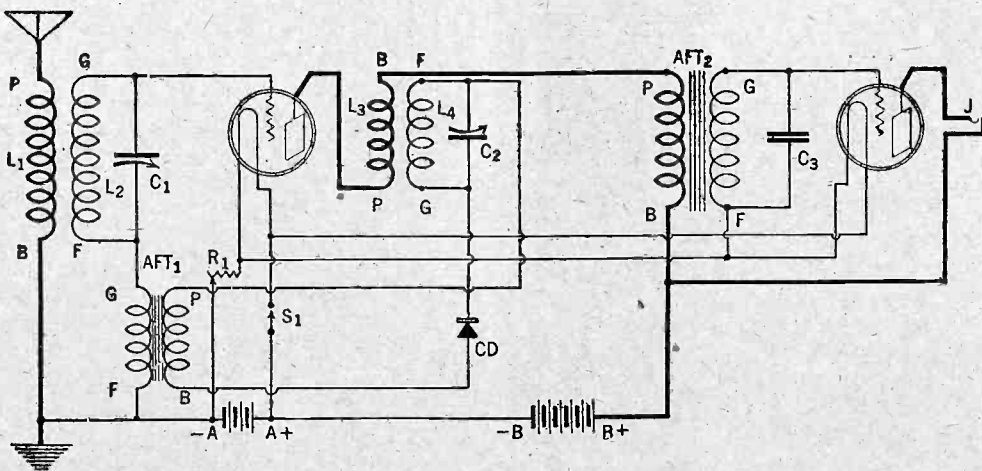

FIG. 325  
The circuit diagram of the receiver Mr. F. L. Keats enclosed.

out of the variable condenser circuit, C1. L2 is a 15-turn primary, wound on a tubing  $3\frac{1}{4}$ " in diameter, but tapped at every second turn, three of which are placed in the condenser circuit and two in the ground circuit. C1, the antenna tuning condenser is of the .0005 mfd. type. L3, is a 45-turn coil wound on the same tubing as L2, the primary. There is a  $\frac{1}{4}$ " separation between the two windings. This coil is tapped at every fifth turn for the last 20 turns. This means that there will be 4 taps. C2 is also a .0005 mfd. variable condenser. The potentiometer which is in shunt to the battery is of the 400 ohm type. The battery consists of six  $1\frac{1}{2}$ -volt dry cells connected in series, giving a total of nine volts. CD, represents the crystal detector. A .001 mfd. fixed condenser shunts the phones, which have a total resistance of about 3,000 ohms.

\* \* \*

I HAVE a double condenser, having a capacity of .001 mfd., that is, each section has a capacity of .0005 mfd. I also have a transformer which has a 3-to-1 ratio, three .1 megohm and one .5 megohm resistors. A circuit diagram of a 5-tube receiver, using this double condenser to shunt the secondary of a radio-frequency transformer, in a stage of tuned RF amplification and the secondary of a second RFT in the detector circuit, which is non-regenerative, followed by a stage of transformer and two stages of resistance coupled AF amplification, is requested. Now I would like to have a switching arrangement, whereby a loop can be switched in and the antenna ground switched out. I have a filament control jack, which I would like to use also. It is a single circuit type. The coil data, etc., would be appreciated. — Henry Seivers, Providence, R. I.

Fig. 327, shows the diagram of a receiver, based around the principles you have stated. The primaries, L1 and L3, consist of 10 turns, wound on a form  $3\frac{1}{4}$ " in diameter. L2 and L4, the secondaries consist of 45 turns. Each primary and secondary is wound on a separate tubing. About a  $\frac{1}{4}$ " separation should be left between the primary and the secondary windings. No. 22 double cotton covered wire should be used. LJ is the loop jack, it being an ordinary double circuit type. R1 and R2 are both 6 ohm rheostats, the resistance wire being of the type, that will pass at least  $\frac{1}{4}$  ampere without any heating up. C2 and C4 are .001 mfd. fixed condensers. C3 is a .00025 mfd. grid condenser. R4 is a 2 or 3 megohm grid leak. The stators of the variable condenser are connected to the end of the secondary windings of both RFT, e.g., one stator to the end of the secondary winding, L2, through the loop jack, and the other stator to the end of the secondary winding, L4. The common rotor is connected to the beginnings of

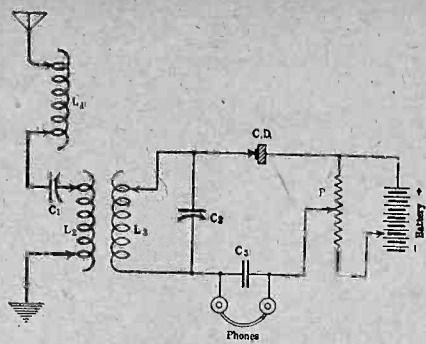

FIG. 326 The electrical diagram of the crystal receiver.

the secondaries, L2 and L4. When connecting up the loop jack, be careful to connect the frame to the negative side of the filament. R3 is a  $\frac{1}{4}$  ampere ballast resistor. R5, R6 and R7 are all .1 megohm resistors, while R8 is a .5 megohm resistor. C5 and C6 are both .25 mfd. fixed condensers. FCJ is the filament control jack, so wired, that when the plug is inserted in the jack, the amplifier tubes light up. The plates of the radio frequency amplifier and the last audio amplifier tubes receive one voltage, e.g., 90 volts (B plus No. 2). The

plate of the detector tube receives 45 volts (B plus No. 1). The plates of the first and second audio tubes receive 135 volts (B plus No. 3).

\* \* \*

SOMEHOW OR other I misplaced my Jan. 30 issue of RADIO WORLD, in which a discussion of Litz wire was given by Sidney E. Finkelstein. Now I would like to have a photograph of the six types of coils tested by the Bureau of Standards, with the data as to which one of these coils is the best to use. A small discussion of what wire was found to be best in the tests will also be appreciated. — Roy Carroll, Tannersville, N. Y.

Fig. 328, shows the photograph of the six coils tested and compared by the Bureau of Standards. The loose basket weave and the single layer coils were found to be approximately equal and also the best of the six coils, the loose basket weave having a small edge. The 32 strand of No. 38 enameled wire, litz wire, was found to be best for broadcast use, with No. 24 double cotton covered wire running a close second, the actual difference between the two being in price. The litz wire is about 7 times as expensive as the double cotton covered. The honeycomb coil was found to be the worst of the six, with the bank wound or two layer solenoid, next. The spider

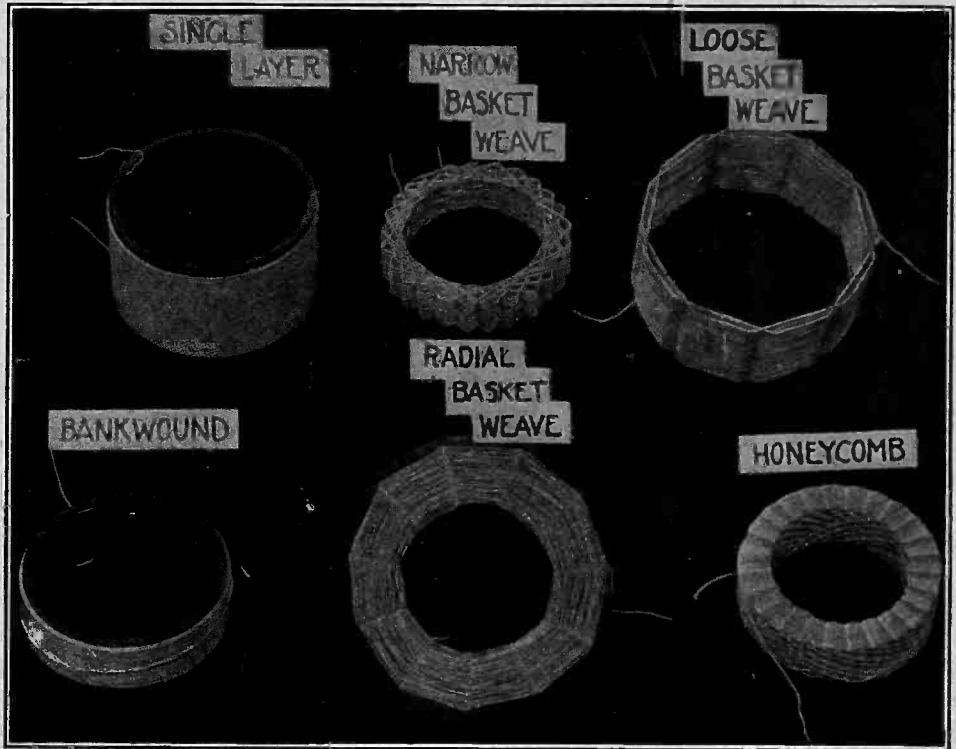

FIG. 328. The photograph showing the six coils tested and compared by the Bureau of Standards.

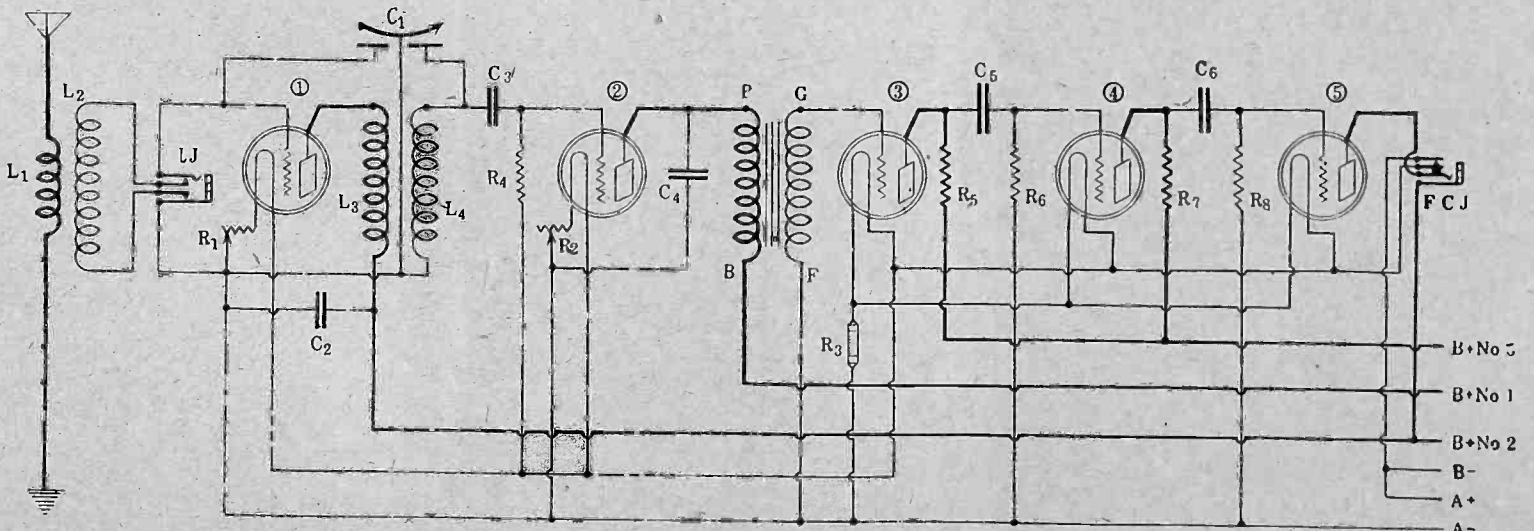

FIG. 327. The schematic diagram of the 1-control receiver, requested by Mr. Henry Seivers.

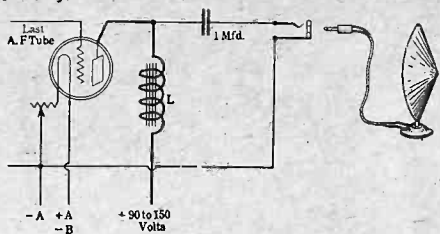

FIG. 329. The electrical diagram demonstrating how to hookup a cone speaker, so as to keep the direct current off the speaker windings.

weave or radially basket weave and the narrow basket run in between the four coils first mentioned.

\* \* \*

I HAVE a cone speaker and am informed that by connecting the B battery directly to the speaker magnets as is commonly done, they will become demagnetized very shortly. Is this right? (2) If so, a diagram showing how to hook the speaker up, so as to prevent the magnets from becoming demagnetized would be very much appreciated.—Ruth Jacobson, 2003 Walton Ave., Bx., N. Y. City.

(1)—Yes, this is true. The direct current is placed on the magnets, which is injurious. (2)—Fig. 329, shows the electrical diagram of such a hookup. L is a 200 henry choke coil. The top prong which formally went to the plate of the last tube, now goes to one terminal of a fixed condenser. The bottom terminal of the jack goes to the A minus post, instead of the B plus post. In this manner D. C. is fed to the magnets only.

\* \* \*

I WOULD like to have the circuit diagram of a 3-tube receiver, employing a 3-circuit tuner and two stages of transformer coupled AF amplification. The AF tubes should be so arranged that a simple switching device can shut the filament power of the last tube off and connect the plate of the first AF tube to the B plus. This eliminates the jack, which I find to be troublesome. A high resistance should be shunted across the secondary of the first AGFT, so that the volume can be controlled. The coil, data, etc., with a panel layout, would also be appreciated.—Robert Klugh, Jamestown, N. Y.

Fig. 330 shows the circuit diagram of this receiver, while Fig. 331 shows the panel layout. L1, the primary is wound on a tubing 3/4" in diameter and consists of 10 turns. No. 22 double cotton covered wire is used. A 1/4" space is then left and the secondary, L2, is wound. This consists of 45 turns. The tickler is wound on a tubing 2 3/4" in diameter and consists of 36 turns, using No. 26 single silk covered wire as the conductor. This

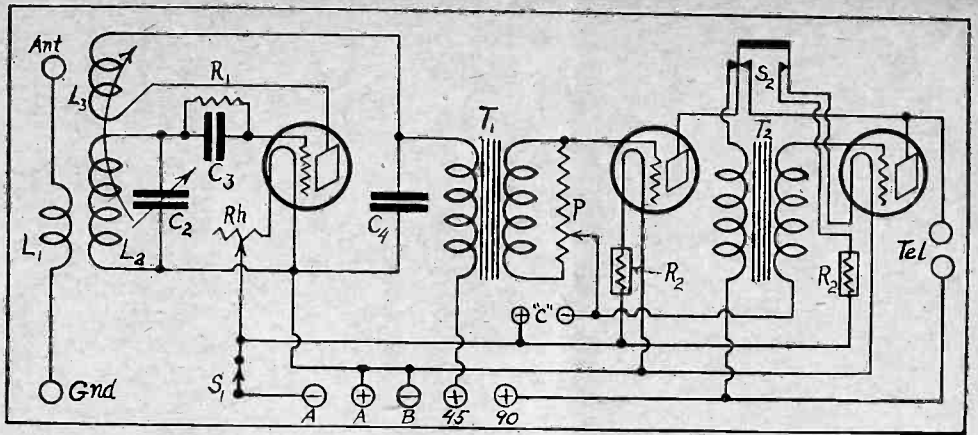

FIG. 330. The electrical diagram of the 3-tube set, requested by Mr. Robert Klugh.

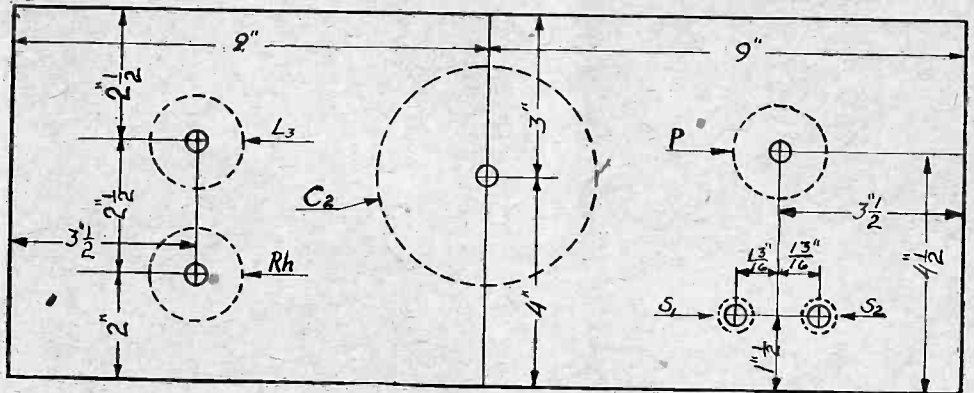

FIG. 331. The panel layout.

is wound in two 18-turn sections, a 1/4" space being left between the windings. This is for the tickler shaft. C2 is a .0005 mfd. variable condenser; C3 is a .00025 mfd. grid condenser, while R1 is a 2 megohm grid leak. Rh is a 10 ohm rheo-

stat. C4 is a .001 mfd. fixed condenser. T1 and T2 are both low ratio AFT. P is a 500,000 ohm potentiometer. R2 are 1/4 ampere ballast resistors. S2 is the special switching arrangement. A 4.5 volt C battery should be used.

### Stations Let Licenses Lapse and Meet Trouble

Stations which permit their licenses to expire without attempting to renew them immediately are having a hard time of it with the Department of Commerce. Through carelessness a number of stations failed to renew their licenses and they were automatically cancelled. In attempting to set aside the cancellation, the stations are compelled to show that they are rendering a definite public service.

#### CALL LETTERS CHANGED

WCBQ, Nashville, Tennessee, to WBAW. The station is owned by the First Baptist Church.

WHAV, Wilmington, Delaware, to WDEL. The station is owned by the Wilmington Electric Specialty Company.

### Magnetic Field of a Coil

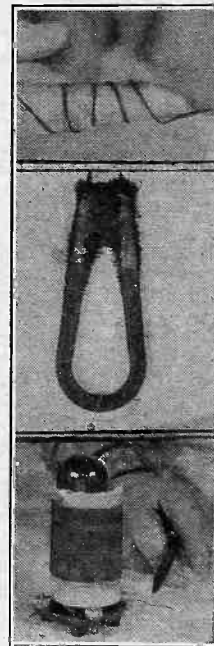

In a solenoid winding, when the current enters at the point occupied by the thumb in Fig. 1, the end of the winding indicated by the finger tip will be the North Pole of the magnetic field. A small piece of iron placed in this field at the thumb would be pulled thru to the finger end due to the magnetic path.

A fan will get some visual idea of what is meant by magnetic field if he will dip a small horseshoe magnet in iron filings. The filings take position shown in Fig. 2.

FIGS. 1, 2, 3 shown in Fig. 2.

Notice the greatest field is at the tips of the magnet (pole ends) and the strength diminishes as we approach the top or bend in the magnet.

"Can the electrons in a tube be yanked out faster?"

When the tube is surrounded by a small coil as shown, the terminals of the coil being connected to a suitable battery, a field is produced which causes greater filament emission (Fig. 3). The same effect can be produced by holding a horseshoe magnet against the side of the bulb.

1926 DIAMOND OF THE AIR BOOKLET with full instructions to make the Diamond, with blue print, 50c. Newsdealers and radio dealers can get supply from American News Co. and its branches. RADIO WORLD, 145 W. 45th St.

## Join RADIO WORLD'S University Club

And Get Free Question and Answer Service for the Coming 52 Weeks.  
This Service for Yearly Subscribers ONLY

Have your name entered on our subscription and University lists by special number. Put this number on the outside of the forwarding envelope (not the enclosed return envelope) and also put at the head of your queries. If already a subscriber, send \$6 for renewal from close of present subscription and your name will be entered in Radio University.

[In sending in your queries to the University Department please paragraph them so that the reply can be written under or alongside of each query. Write on one side of sheet only.]

RADIO WORLD, 145 West 45th Street, New York City.

Enclosed find \$6.00 for RADIO WORLD for one year (52 Nos.) and also enter my name on the list of members of RADIO WORLD'S University Club, which gives me free information in your Radio University Department for 52 ensuing weeks, and send me my number indicating membership.

Name .....

Street .....

City and State .....

# WHAT VALUE OF RHEOSTAT TO EMPLOY

A 2-ohm rheostat should be used for two UV200 tubes, four UX112 tubes, seven or eight UV201A tubes or six, seven or eight WD12 tubes.

A 3-ohm rheostat should be used for three UX112 tubes, five or six UV201A tubes or four or five WD12 tubes.

A 6-ohm rheostat should be used for one UV200 tube, two UX112 tubes, three or four UV201A tubes and two or three WD12 tubes.

A 10-ohm rheostat should be used for one UX112 tube, two UV201A tubes, eight UV199 tubes or one WD12 tube.

A 15-ohm rheostat should be used for seven UV199 tubes.

A 20-ohm rheostat should be used for one UV201A tube or six UV199 tubes.

A 25-ohm rheostat should be used for five UV199 tubes, a 30-ohm rheostat for four UV199 tubes, 40-ohms for three UV199 tubes, 60-ohms for two UV199 tubes and 100 ohms for one UV199 tube.

—Yaxley Mfg. Co.

## What About Shielding? Fan Questions Answered

The consensus of Super-Heterodyne fans who have written me concerning this subject is that removing the shielding improves the set. One said that removing a strip of shielding between the IF and the RF parts of the circuit improved the set 300 per cent. Another said that by removing a shield between the oscillator and the RF amplifier and modulator coils improved it greatly. By doing so, however, one million and one squeals were introduced for every ten divisions of the dials. In the first case it was possible to isolate thousand-mile stations from among the squeals; in the second case it was possible to squeeze in a local station now and then between the squeals. It all depends on what is meant by improvement. I am planning a Super-Heterodyne for myself now and I contemplate thorough shielding, inside and out. If I don't get enough squeals to satisfy me, I'll rip the shielding out until a satisfactory balance has been effected. Shielding improves selectivity; shielding doesn't improve selectivity; shielding increases sensitivity; shielding doesn't increase sensitivity. That is my honest opinion about shielding. Shielding does kill the squeals, that I know.

—J. E. Anderson.

## High Plate Voltage Improves RF Circuit

By-pass condensers across batteries aid in neutralizing the set, they help to conserve energy by keeping the radio frequency currents out of the batteries and other high-resistance devices, and they also help to obtain regeneration.

If radio frequency amplifiers are employed they should be used as such; not merely to make the receiver a 5-tube set. To use a tube as an amplifier the filament current should be normal, the plate voltage should be fairly high, and the grid voltage must be adjusted to fit the plate and filament voltages used as well as the purpose of the tube.

Exact tuning of the various circuits to the frequency of the desired signal is of paramount importance in getting DX.

# Get Rid of Distortion; Watch the AF Channel

Is your set distorting? If so, a poor audio amplifier or too much regeneration, or both, are the likely causes. Audio-transformers more than a year old are likely to be distorters, because transformer design has made great progress since then. Resistance coupled audio amplification gives the purest tones. Three stages are needed. Two good, large transformers make a splendid AF amplifier.



The bass viol, the soprano and the piano reproduce wretchedly on a poor audio amplifier, but a barytone, a saxophone or a banjo behaves passably.

# Pound of Salt to Gallon of Water Aids Ground

"The salt of the earth" added to water in proper portions, makes an exceptionally good improvement in conductivity for "grounds" where rods and pipes have been driven into the earth for use with radio receivers.

An experiment conducted by engineers in the Crosley radio laboratory showed that a strong solution of common table salt, about one pound to a gallon of water, poured in the immediate vicinity of the pipe or rod driven into earth, will give added conductivity. The conducting powers of the soil which surrounds the rods and pipes makes radio "ground" connections good or bad. A dry ground is not as good as a wet one and the salt solution forms an electrolyte when mixed with the natural mineral salts of the earth.

### Salt Solution Ideal

Dry earth is not a good conductor of electricity while a wet ground is the ideal way to make a connection when no other form, such as a water pipe in the home, is available. This salt solution will be found ideal for use on farms where there

is no modern plumbing or while on camping trips in dry country.

When using the radio receiver in summer and the earth is dry, use the solution to a greater extent than would be the case when the earth is moist from rains. The solution should be used when the receiver is to be used in dry weather, while an occasional bucket of water will give additional moisture when the receiver is about to be used.

## Radio Helps Church, Preacher Tells Flock

The Rev. Dr. Minot Simons, preaching at All Souls' Unitarian Church, New York City, said:

"The radio will cooperate and not compete with the church. The people who stay away from the inspirations of a church service in order to get it comfortably and lazily at home are the people who spend most of their Sundays at home anyway. The radio is helpful and satisfactory up to a certain point, but there are qualities in a religious service which cannot be sent over the air."

# R. C. A. Has New Detector; Tube Called Best Yet

A new detector tube, the UX200A, is about to be marketed by the Radio Corporation of America, Elmer E. Bucher, general sales manager, announced. It is understood Cunningham will have a tube just like it, the CX200A.

In size the new tube resembles the -01A type. The bulb is smoke colored, instead of silvery, due to the special gas inside. The filament voltage is 5 and the filament drain .25 ampere. The filament is XL (thoriated tungsten). The plate voltage should be 45 or less.

"The UX200A tube has a greater sensitivity than any existing special detector tube," said Mr. Bucher.

It may be used in any receiver of the storage battery type without change or special adjustment.

### Nearly Equals Extra RF

Actual tests with typical receivers indicate that UX200A provides an increase in volume nearly equal to an additional radio frequency amplifier stage, without distortion or loss of tone quality. The sensitivity is likewise increased.

Mr. Bucher pointed out that a detector having the efficiency of the new radiotron was not essential to the operation of the Super-Heterodyne where the sensitivity with the ordinary form of detector tube goes to the limit of that which is practically usable; for it is well known that the Super-Heterodyne provides a high sensitivity level through its intermediate frequency stages which amplify at a single frequency wavelength. As there is, therefore, no necessity for this new type of tube in this class of receivers, it will not be marketed in the dry battery form.

### Great Demand in Sight

The recommended grid leak and condenser are 2 megohms and .00025 mfd. The rheostat should be 10 ohms. The plate drain at 45 volts is 2 milliamperes. The plate impedance is 28,800 ohms.

The new tube meets a demand started on a big scale when the Sodian D21 was marketed more than a year ago. The Connecticut Telephone & Electric Co. made that tube, but Westinghouse bought the patent and took the tube off the market.

Mr. Bucher said: "The UX200A radiotron is the result

of long and extensive study and development with the detection aid rectification of radio frequency energy by the research engineers of the R. C. A.'s manufacturing associates, the General Electric Company and the Westinghouse Company."

The 200A overcomes the objections laid against the formerly popular-200 soft detector-critical filament and plate voltages and large A current consumption (1 ampere at 5 volts).

Recently H. P. Donle, inventor of the Sodian tube, brought out a new tube that develops even greater detecting efficiency than the Sodian D21. It is manufactured by the Donle-Bristol Corporation, Meriden, Conn.

## New Heavy Duty Power Tube Brought Out

To provide still greater power from the storage-battery receiver, yet without the need for alternating-current-supply, a new tube, UX171, has been put on the market. This tube, although no larger than the UX112, is capable of supplying large volume of undistorted output to the loud-speaker. It is intended for use only in the last stage of an audio-frequency amplifier. The announcement of the new tube was made by Mr. Bucher.

The 171 tube may be operated from a 6-volt storage battery through a 5 or 6 ohm rheostat, or, if preferred, may be operated from a 5-volt source of alternating current supply.

The maximum plate potential of this new tube is 180 volts. The negative grid bias or C battery should be 40.5 volts for the full 180 volt plate potential, with correspondingly less grid potential for lower plate potentials. The following table gives the recommended values and also shows the approximate DC plate current (in milliamperes) for each value of plate and grid voltages:

Plate Voltage	Grid Bias	Plate Current
180	40.5	20
157.5	33.0	18
135	27.0	16
90	16.5	10

It will be noted that the plate current drain, even under the large bias, is heavy.

So powerful is the output from the new 171 when operating at its full capacity that it is imperative that a transformer or choke and by-pass be placed between the tube and the loud-speaker. Accordingly, it is recommended that the plate current, or output from this power tube, be delivered to an audio-frequency choke of from 10 to 30 henries, shunted across the output, together with a 2 to 6 microfarad by-pass condenser in one lead to the loud-speaker and a direct connection for the other lead, an arrangement already in extensive use.

### May Use Transformer

If preferred, the output may be delivered to the primary of a 1-to-1 output transformer, the secondary of which is connected with the loud-speaker. In either event, the direct current from the tube will not flow through the loud-speaker. The purpose of the transformer is to insulate the loud-speaker from the high voltage used on the plate of the tube and thus keep the high potential within the cabinet which houses the set. Only the desirable AC component will be passed. This operates the loud-speaker.

The new power tube is provided with the UX base which fits all standard Navy bayonet type sockets (the old type sockets), as well as the new push type or universal sockets (the UX sockets).

The characteristics of the 171 follow:  
Appearance.....Same as 112  
Base.....Large Standard UX type  
Filament Voltage .....5  
Filament Current .....0.5 ampere  
Plate Voltage .....90-180  
Negative Grid Bias.....16½ to 40½ volts  
Plate Current.....10-20 milliamperes

[For method of connecting choke coil and condenser see Fig. 329 on page 12 of this issue.]

## Listening-in Called Real Meter of Taste

By RT. REV. JAMES E. FREEMAN, Bishop of Washington

God's greatest gift is the gift of utterance wisely used. Listening-in has become one of the most popular occupations of the day. The whole world through radio has been resolved into a vast whispering gallery. The time is coming when a voice speaking in Washington will be heard in the remotest corners of the remotest parts of the world.

It is my taste and my choice that determine what I shall hear. Tastes are more disclosed today in listening-in than in any other occupation. We are living in an age where discrimination is enormously demanded that we may grow mentally and physically.

## Dr. Loewe New Claimant for First Broadcast

Although Frank Conrad, of the Westinghouse Electric and Manufacturing Co., East Pittsburgh, Pa., is known as the "father of broadcasting, KDKA being the call letters of the first station of its type, a letter written in 1920 in New York by Dr. Siegmund Loewe, famous German scientist, has been brought forth to show that this title should go to the doctor. David L. Loewe, brother of the doctor, has given a statement that Dr. Loewe was the first man to demonstrate broadcasting, this being in New York City. The brothers own a tube factory in Germany.

## Amateur Station Heard World Over

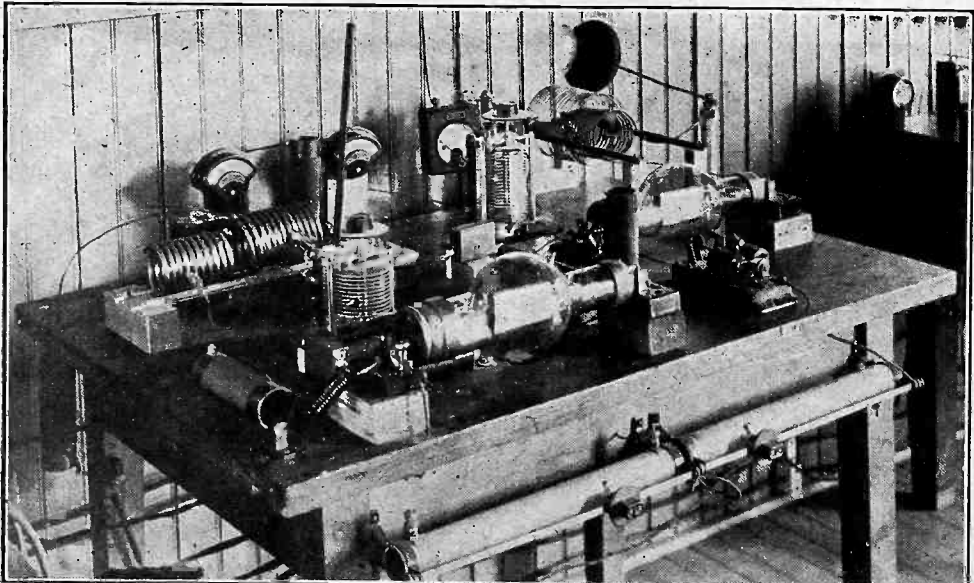

THE 40-meter transmitter of station 2CXL which has been heard all over the world. (Kadel & Herbert).

# Five Interesting Hookups

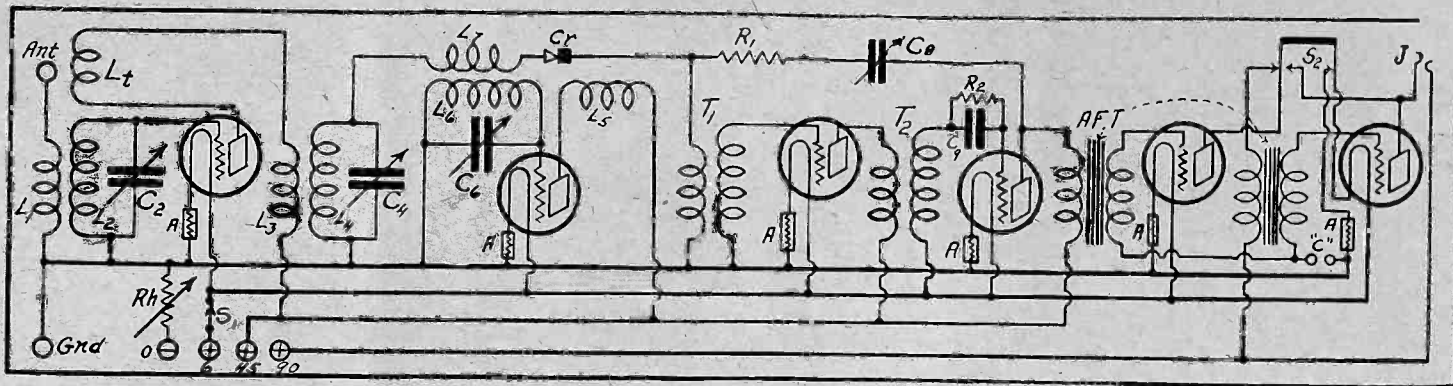

THE CIRCUIT diagram of the 6-tube set described by J. E. Anderson in the July 18 issue of RADIO WORLD. The first tuning unit, comprising the primary winding, L1, the secondary winding, L2 and the plate coil, L3, may be any 3-circuit tuner having the secondary shunted by a .0005 mfd. variable condenser, C2. C2 and C4 are a double condenser, each section having a capacity of .0005 mfd. C6 is also a .0005 mfd. variable condenser. R1 is a 100,000 ohm resistance, while C8 is a midget variable condenser. A crystal is used as the first detector, this being indicated by the letters, Cr. It will be noted that the stage of RF ahead of the oscillator and detector is regenerative. This gives the set its wonderful sensitivity.

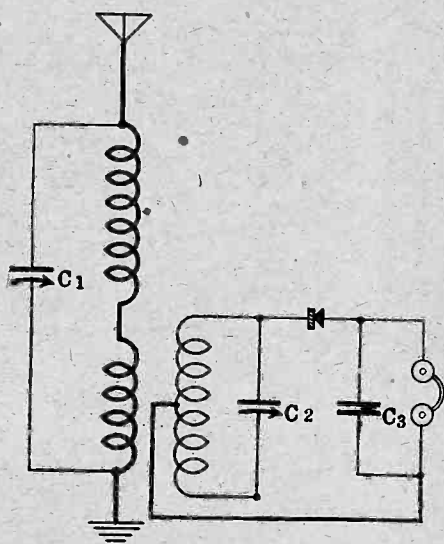

THE ELECTRICAL diagram of a crystal receiver that can be logged. With this set it is possible to receive signals from local stations with good volume. Complete data on how to build this marvelous little receiver were given in the Feb. 13 issue of RADIO WORLD.

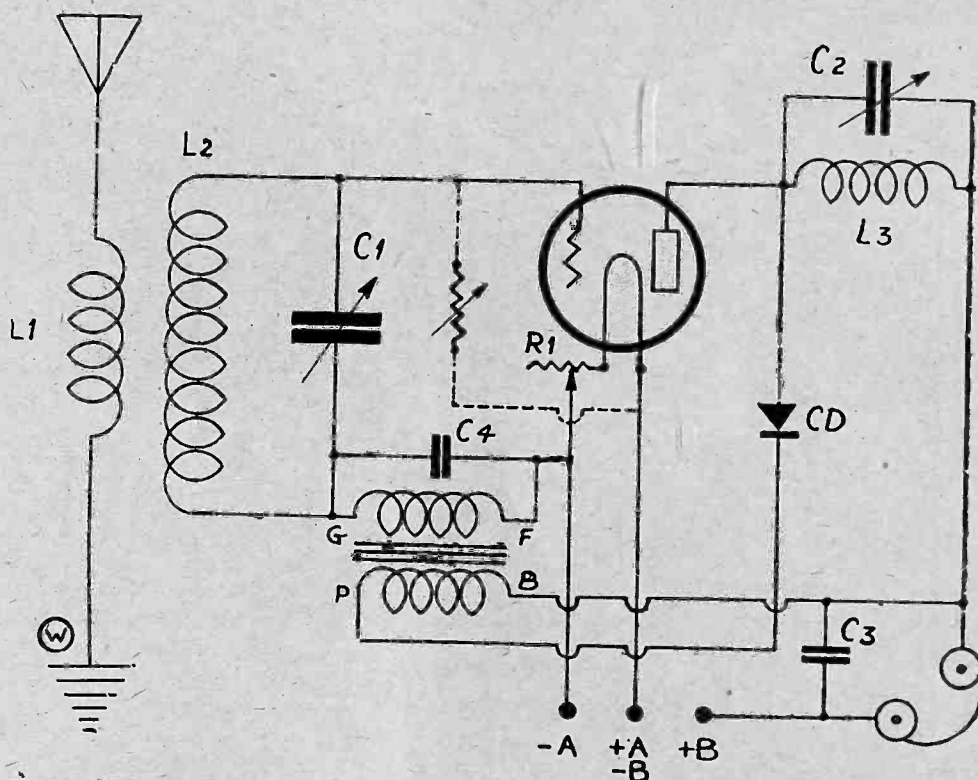

HERE WE have the circuit diagram of one of the most popular of reflexes printed in RADIO WORLD. This was described by Feodor Rofpatkin in the Feb. 21, 1925 issue. L1L2 constitute the primary and secondary windings of a tuned RFT, whose secondary is shunted by a .0005 mfd. variable condenser. L3 is a special plate coil, shunted by a condenser suited for the constant of this coil.

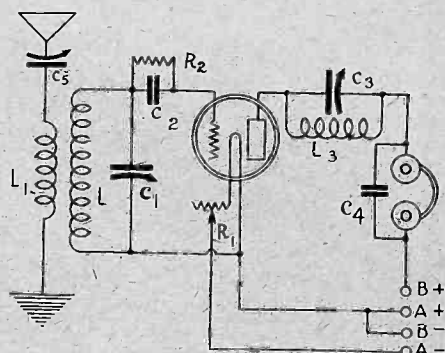

THE ELECTRICAL diagram of a 1-tube receiver. The plate of this tube in this circuit is tuned by a .0005 mfd. variable condenser, C3. This condenser is in shunt to a fixed inductance, L3, which consists of 35 turns of No. 22 double cotton covered wire wound on a tubing 3" in diameter. C5 is also a .0005 mfd. variable condenser. This condenser improves the DX ability of this receiver. The rheostat, R1, is a 6-ohm type.

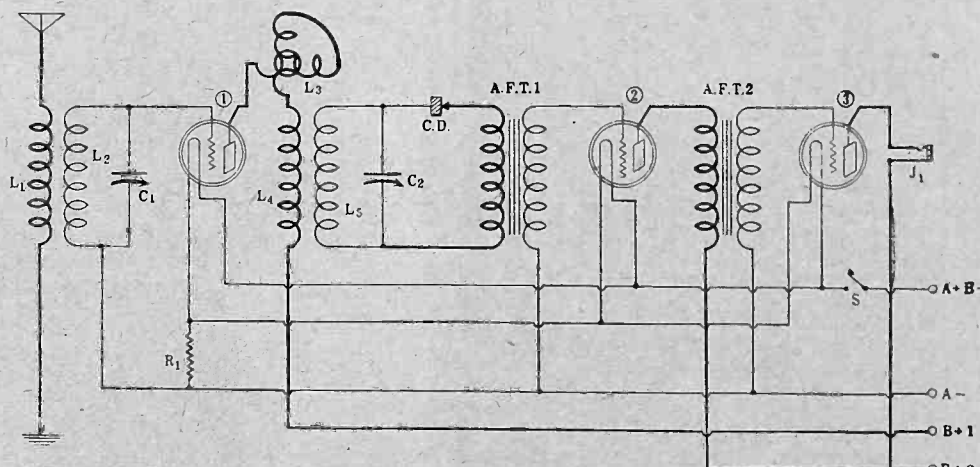

THE CIRCUIT diagram of a 3-tube receiver, using a plate variometer. A crystal is the detector, followed by two stages of transformer coupled audio frequency amplification. This set was described by Lewis Winner in the Dec. 5 issue of RADIO WORLD.

# Acoustician Secret Hero of Many Artistic Feats

PITTSBURGH

Considering the many channels that contribute to a typical KDKA program, the station is not unlike a great river and its tributaries.

The tributaries of a radio station, however, do not take care of themselves. They require manifold and expert attention. And that's where the radio acoustician and the radio operator enter the scene.

When the listener turns his dial and gets the announcement, "This is Westinghouse Station KDKA at Pittsburgh" the subsequent number may come to him from any one of 45 pick-ups maintained by the station in Pittsburgh and its boroughs.

## Process of Equipment

These pick-ups in concert halls, clubs, hotels, schools and churches are sources that present more than a few difficulties to J. Frazier, manager of KDKA, and his operating staff.

The operator and acoustical expert coming to the location of the new pick-ups are confronted with the initial task of determining what will be the most advantageous spot for the microphone.

The process of equipping the new place means not alone the technical work of setting up the machinery, checking up on characteristics of the room, etc., but it also necessitates a kind of dress rehearsal.

## On the Job Early

If it happens to be a Sunday morning church service the radio operator and acoustician are at work while the choir is still asleep. Hours before the song or sermon can go on the air there is a try-out to be staged. When the test program reaches the central station satisfactorily that pick-up is labeled O. K. and he operators drive on to the next.

In the case of most of KDKA'S studio tributaries this operation must be repeated for each program as it is impracticable to keep permanent equipment at 45 different points.

After the program has reached the pick-up microphone it is first amplified and then relayed by telephone line (it may be 15 or 30 miles) to the main studio

in East Pittsburgh. Here is the station's filtering room where the song, sermon, address, or orchestra selection is, so to speak, placed under the "microscope."

## Many Questions

"Is the number coming in too softly or too loudly? Does the speaker's voice sound natural? Would his listening friends recognize the speaker? Are the basses overwhelming the soprano or are the sopranos singing rings around the baritone?"

These, and many more, are the questions behind the activity in the filtering room.

The filtering room is the diagnosing room of radio broadcasting. The acoustician is the diagnostician; the radio operator is the surgeon.

The person who directs this business of tone analyses and doctoring must be an individual who understands radio apparatus as well as music.

## Popcke Is the Man

At KDKA the position is held by A. Popcke.

Some months ago a Pittsburgh musician was the recipient of letters from radio auditors complimenting him on the excellencies of his new organ.

"It just can't be compared with the old one," they wrote.

These people were very kind about writing but nevertheless they had to be disappointed; they were told there was no new organ. Just new draperies in the room that contained the organ. That was all. The unsung radio acoustician had been on the job.

## Unwept, Unhonored and Unsung

The work of engineers is lauded. Artists are showered with letters of praise and tenderness; announcers are worshipped and glorified but alas, for the unsung radio acoustician. He is a faithful and important contributor to the success of the program and yet—

Nobody writes to him

He is not praised by listeners

He is almost unknown; he works behind the scenes.

# Good Time Had By All But Remote Control Men

Did you ever stop to think when you hear WRNY broadcasting just how much difficulty there is, how much complexity there is, in sending any program from a remote point to the control room of the station?

Two men, an operator and an announcer, start from the station an hour before the program is to be broadcast, carrying with them two black fibre suit cases in which are contained all the essential apparatus necessary to broadcast. In the suit cases are microphones, batteries, extensions, phones, spare tubes, and last but not least is the amplifier which multiplies the volume of the program thousands of times in order that it may overcome the resistance of the telephone lines.

With this apparatus they proceed to the point of broadcasting, and then comes the hardest part of the job. This is the

setting up of the apparatus in the right place for the best results, and arranging the microphones so that they will pick up the voices or instruments of the artists in the best possible manner.

In some cases, take for instance a banquet, there is a crowd of hectic diners, all out for a good time, and the little matter of broadcasting doesn't worry them in the least. They may be very much in the way, but it is the job of the remote control operator to arrange the microphone without disturbing any of them.

This having been done, and the amplifier having been set up and tested, the remote control operator calls up the station and informs the operator there that he is ready for a complete test through the station amplifier. There are two telephone lines to every point where remote broadcasting is to be done, and if one of the lines should fail, the other can be used to broadcast over.

## For Fishing For Waves

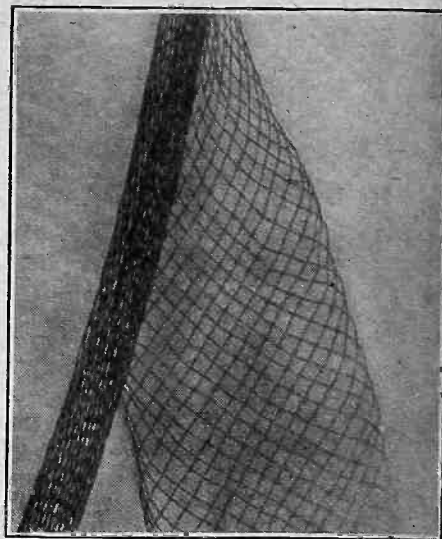

"LET'S go fishing," said the young man, pointing to the net on the sand. But that had nothing to do with this picture, which shows No. 25 stranded enamelled aerial wire as it is strung and as it looks when spread out.

## Nobel Winner a Fan



(Kadel & Herbert)

SELMA LAGERLOF, Sweden's famous woman writer, in the study in her country home, near Stockholm. Miss Lagerlof is the only woman who received the Nobel award for literature.

## A Loop on a Door

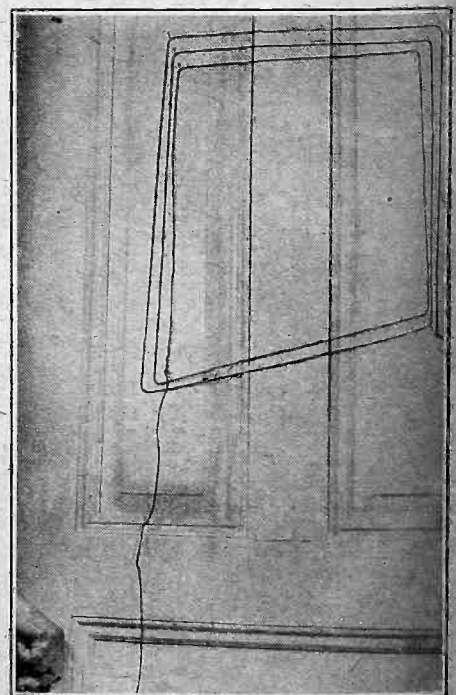

(Hayden)

AN improvised loop may be made by putting a few turns on a door, to bring in locals.



### Invalid Composer Broadcasts Thanks



(Kadel & Herbert)

**JANET BULLOCK WILLIAMS**, well known teacher and composer of music who for the last several years has been confined to bed, due to paralysis, sends her own message of appreciation through station WOR, after she had heard the premiere of her operetta "Niebelungen Ring, Jr.," a travesty on Wagnerian music. She composed the piece while in bed.

### DeForest Enlightened



**DAVID L. LOEWE**, of the Loewe Audion Co. of Berlin, explains to **Dr. Lee De Forest** (at right) the functioning of the Loewe Multiple Tube. Dr. De Forest invented the three-element vacuum tube; Siegmund Loewe, David's brother, invented the tube that has a detector and two audio stages inside, including all parts and wiring, except the tuner.

### His Ear to the Ground

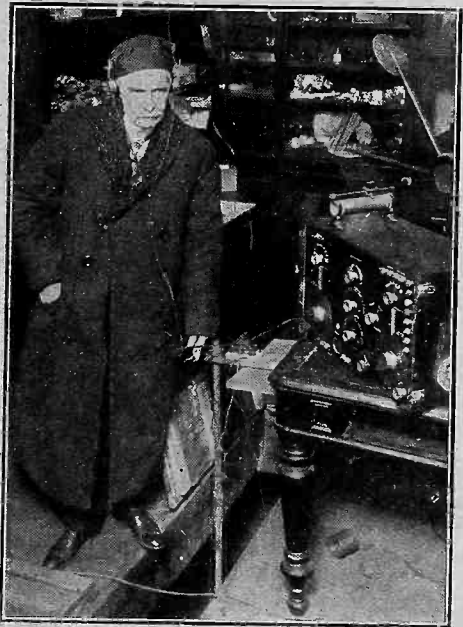

(Wide World)

**DR. J. HARRIS ROGERS**, who discovered the possibilities of radio reception via the earth, rather than through space, is shown above tuning in with an antenna loop.

## WEAF Pays Orchestras Up to \$400-an-Hour Rate

There has been considerable discrepancy in amounts reported to have been paid to orchestras and others for radio appearances. It is quite true that many stations do not pay their talent but it is also equally true that others pay them well.

For instance, it has been learned upon reliable authority that one orchestra appearing for WEAf in New York City and allied stations receives \$265 for an hour. Such an appearance sometimes requires as many as three rehearsals, inas-

much as the day has passed when a first-class orchestra simply plumps down into a station and begins to play.

Another orchestra at WEAf receives \$300 an hour, two others, \$325 an hour each, another \$350 an hour; and still another \$400 an hour, usually depending upon the number of men in the orchestra. A popular string trio receives \$75 an hour and a quartet \$100. A well-known male singer gets \$40 an appearance. If he is accompanied by an orchestra, this, of course means an extra charge.

## International Broadcast Chain Started in Europe

Europe is to enjoy superlative DX programs by international telephonic relays. Experiments to that end by the Comité Consultatif International des Communications Téléphoniques à Grand Distance, headquarters in Paris have proven successful.

In a letter to Eric H. Palmer of the Reed-Eisemann Radio Corporation, who visited Europe as official observer during the international broadcast tests, Arthur R. Burrows, Secretary General of the Union Internationale de Radiophonie,

Geneva, writes enthusiastically of the results obtained in the broadcasting of the speeches at the last meeting of the League of Nations council.

"I am told that the effect was really impressive for those at a distance," reports Mr. Burrows. "Five countries took part. The Swiss had a specially prepared line to serve Geneva, Lausanne, Berne, and Zurich. The French had two lines, one for the Assembly current and a second for control purposes, which was split at the French frontier to feed two circuits."

### Old Home Changeth

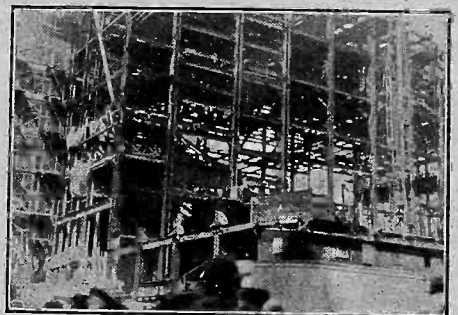

**THE new Paramount Theatre Building**, now erecting on Broadway, Forty-third to Forty-fourth Streets, New York City, is on the site formerly shared by **RADIO WORLD**, whose new address is 145 West Forty-fifth Street.

# RADIO WORLD

REG. U.S. PAT. OFF.



Radio World's Slogan: "A radio set for every home."

TELEPHONE BRYANT 0558, 0559

PUBLISHED EVERY WEDNESDAY

(Dated Saturday of same week)

FROM PUBLICATION OFFICE

HENNESSY RADIO PUBLICATION CORPORATION

145 WEST 45th STREET, NEW YORK, N. Y.

(Just East of Broadway)

ROLAND BURKE HENNESSY, President

M. B. HENNESSY, Vice-President

FRED S. CLARK, Secretary and Manager

European Representatives: The International News Co.

Breems Bldgs., Chancery Lane, London, Eng.

Paris, France: Brentano's, 8 Avenue de l'Opera

San Francisco: Lloyd B. Chappell, 656 O'Farrell St.

EDITOR, Roland Burke Hennessy

MANAGING EDITOR, Herman Bernard

TECHNICAL EDITOR, Lewis Winner

CONTRIBUTING EDITORS, John F. Rider, J. E. Anderson

## SUBSCRIPTION RATES

Fifteen cents a copy. \$6.00 a year. \$3.00 for six months. \$1.50 for three months. Add \$1.00 a year extra for foreign postage. Canada, 50 cents.

Receipt by new subscribers of the first copy of RADIO WORLD mailed to them after sending in their order is automatic acknowledgment of their subscription order. Changes of address should be received at this office two weeks before date of publication. Always give old address; also state whether subscription is new or a renewal.

## ADVERTISING RATES

### General Advertising

1 Page, 7 1/4" x 11"	462 lines	\$300.00
1/2 Page, 7 1/4" x 5 1/2"	231 lines	150.00
1/4 Page, 8 1/2" D. C.	231 lines	150.00
1/4 Page, 4 1/2" D. C.	115 lines	75.00
1 Column, 2 1/4" x 11"	154 lines	100.00
1 Inch		10.00
Per Agate Line		.75

### Time Discount

52 consecutive issues	20%
26 times consecutively or E. O. W. one year	15%
4 consecutive issues	10%

WEEKLY, dated each Saturday, published Wednesday. Advertising forms close Tuesday, eleven days in advance of date of issue.

## CLASSIFIED ADVERTISEMENTS

Ten cents per word. Minimum 10 words. Cash with order. Business Opportunities ten cents per word, \$1.00 minimum.

Entered as second-class matter March 23, 1922, at the Post Office at New York, N. Y., under the Act of March 3, 1879.

MAY 15, 1926

## THE REBUS

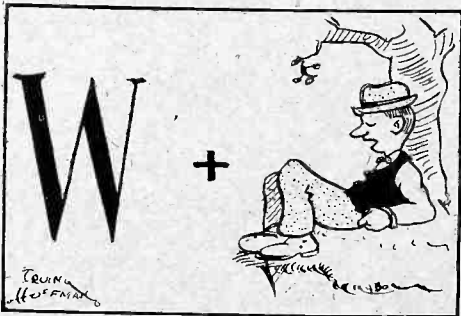

CAN you decipher what station this rebus stands for?

## Prisoners in Atlanta Use 50 Radio Receivers

To make life a little less onerous to prisoners in the Federal penitentiary at Atlanta, Ga., Warden John W. Snook permits the operation of some fifty radio receiving sets. Only during music hour between 6 and 7 p. m. are loud speakers permitted, but practically all of the sets have wires attached with earphones in different cells, at which convicts can listen in.

## Publisher As a Broadcaster

THE dissemination of news by broadcasting is an important function much neglected. While several stations do broadcast news bulletins, the extent of this service is limited. The stations that render it are few and often far apart. Nothing has such a general interest as news, so radio is missing one of its biggest opportunities. Your jazz orchestra may play "A Cup of Coffee, a Sandwich and You," and the anti-jazz element will feel perturbed. Or a fancy soprano and gusty tenor may unite on "Laissez-moi Contempler Ton Visage," from "Faust," and the jazzites will feel offended. Hymns may bore the free-and-easy, yet negro spirituals, not much different, delight them. Broadcast plays tantalize some. There is no possibility of doing anything that will delight everybody, where the audience may run into the hundreds of thousands. The nearest thing to pleasing everybody is in broadcasting news, for on that, one interest combines. What was the verdict in the great criminal trial of the moment? What did the President say about the League of Nations resolution? Well, what do you know about that—a philanthropist gives \$10,000,000 to charity! The doings of the whole world will filter through the microphone. This internationalizes broadcasting to a new and marked extent.

The fact that William Randolph Hearst is pressing his application for station licenses in eleven cities naturally means that he hopes to get more news into the microphone. Mr. Hearst, as a news analyst and indeed missionary, is one of the keenest in the United States, and he has imparted an education along this line to his editors. Thus, with a Hearst paper in each of the eleven cities, he seeks to supplement each of these with a microphone.

These cities are New York, Chicago, Baltimore, Washington, San Francisco, Seattle, Detroit, Boston, Albany, Rochester and Syracuse. Each Hearst paper in these cities has the service of one or more of Mr. Hearst's own news syndicates that cover the world with searching thoroughness. Thus Mr. Hearst as a broadcaster would enable his stations to do what no other chain of stations can do, for there is a property interest in news, and stations are unable to buy the privilege of broadcasting an adequate amount. Some who appropriated news were stopped by a still greater public interest in news. Far from being competitive, the microphone will be the blood brother of the printing press. While the sale of "extras" may not go up, for the microphone will be a prompter and less expensive "extra" by itself, general newspaper circulation is bound to be stimulated, on a firmer basis than a mere bash ever established, and that is what counts.

The radio public will welcome the Hearst genius for news, as well as the editorial comment on the doings of the world.

The Hearst chain of stations, of course, would present a well-balanced program, with entertainment and education aplenty, merely giving news its proper place, which it has not yet enjoyed in broadcasting.

Mr. Hearst is a skilled producer, so the combination of theatrical and news talents is a happy one indeed.

Let us hope that a way will be found promptly to grant the licenses and wavelengths that will enable an unstintingly conducted chain of stations to render public service through the microphone.

## PICTURES RADIOED REGULARLY

Regular commercial transmission of pictures by radio has been inaugurated by the Marconi Wireless Company of London and RCA of N. Y. City.

## Jovial Announcer



AUSTIN RAHE, humorous announcer of station WMCA, at the "mike." His jovial manner of announcing the various artists has earned him, the well deserved title, of "The Announcer With the Smiling Voice." Mr. Rahe claims the distinction of knowing every orchestra leader in N. Y., which accounts for the many witty ditties, he springs, when they appear at the station.

## Coughing Sounds Like Samson Rocking Temple

A listener recently remarked that the thoughtless coughing and clearing of throats of speakers into the microphone was as bad as static. He spoke of a well-known clergyman who had a habit of doing this and remarked that he was sure that this divine was doing it unconsciously. This was intended as a reminder to speakers when they are coughing or clearing their throats at least to turn away from the microphone.

The use of increased power, which greatly amplifies every sound, makes it more and more necessary for radio speakers to give thought to such details.

## Bureau Has 3 Vacancies, Pay Ranges Up to \$3,800

To fill vacancies at the Bureau of Standards, where some of the most important radio research work in the country is being carried on, the Civil Service Commission announces open competitive examination for a physicist at a salary of \$3,800; an associate physicist, \$3,000; and an assistant physicist, \$2,400.

Competitors will be rated in optional subjects of radio, electricity, mechanics, and others. Receipt of applications will close June 8 and full information and application blanks will be given from the Civil Service Commission, Washington, D. C.

## Strauss Prefers "Mike" to Concert or Opera

According to reports filtering from Vienna, Richard Strauss, the composer, prefers appearing on the air to personal appearance in concert halls or opera conducting.

At any rate, it is said his only Vienna appearance this season will be to accompany Franz Steiner, radio artist, when Steiner broadcasts.

# De Mott Outlines Path For Big Sale of Receivers

[The following address was delivered before the Radio Manufacturers Association at their convention in Atlantic City.]

By R. W. De Mott

President Radio Magazine Publishers' Association, Inc.

At the inception of the Radio Magazine Publishers Association there were any number of good radio magazines in the field covering practically every phase of the radio industry. There were some published exclusively for the radio amateur, others for the broadcast listener who built his own sets and those of his friends, others for the broadcast listener who knew a little of the theory of radio, but who would never attempt to build a set, relying upon a manufactured model and using his knowledge of radio to improve or get the utmost efficiency out of his set. There were other magazines devoted exclusively to the radio trade, the dealer and jobber, and still others which covered all of these markets simultaneously, reaching both the consumer and the trade.

One of these publications had been in existence since 1913, another since 1915, another since 1917, still another since 1919, and new ones were starting up every week—all striving to do their bit toward the fostering and furtherance of the radio industry, and each independently and honestly working toward the one goal, that of increasing the market for radio products, parts, accessories and complete sets, and the education of the public to the semi-technical side of radio so that the man or woman who had just purchased a set would know how to properly operate that set and it would stay sold.

### Every Little Bit Helps

Every radio publication that has ever been published, every piece of radio literature that has ever been put out, has created and helped to build up the radio market, which today has assumed such tremendous importance as to be one of this country's leading industries.

I need not remind you that radio could not have accomplished in four short years what it has if it had not been for the nucleus of radio fans around which the whole structure of the radio industry is built. This nucleus was created and enlarged by the radio magazines, some of which have been at it since the old days of wireless—the days of the spark gap and the coherer. It would be ridiculous to suppose that any group of publications which had been in the radio business long

before there were such things as complete factory-built receiving sets for broadcast reception could fail to know something about the radio market.

### List of Members

The leading radio magazines of the country realizing the importance of their work, and the vast benefits which they could accomplish by concerted instead of haphazard methods, united in the formation of the Radio Magazine Publishers Association as it exists today. Our members stretch from the Atlantic Ocean to the Pacific and include the following magazines: "Amateur Radio," "Citizens Radio Call Book," "Q. S. T.," "Radio," "Radio Age," "Radio Broadcast," "Radio Dealer," "Radio Digest," "The Radio Home," "Radio International," "Radio News," "Radio Review," RADIO WORLD, "Radiocast Weekly," "Retail Radio," "Radio Dealer Year Book," and "Science and Invention." These magazines represent a combined circulation of more than 2,052,000 copies monthly. Think of it—more than two million copies monthly. And yet there are those who say that the radio magazines go only to the radio fan who wouldn't buy a complete manufactured set. Why, there aren't more than 50,000 radio amateurs in the country. Allowing another 300,000 for broadcast fans, who buys the remaining 1,702,000 copies of our circulation? Yet set manufacturers, if you had cultivated this market and sold last year only one set to each of our readers, could have cleaned out practically the entire output of sets manufactured during this year.

Furthermore, and in addition to this, don't forget that our readers buy or build an average of two sets every year—the life of a radio set with our readers is only six months.

Passing over routine matters, let me state that the purposes and aims of the association fall into three classifications and we have accomplished much along all three lines.

First, we have aimed by co-operative work to standardize our individual Laboratory Services so that these laboratories will not only perform a genuine service to our readers in giving them the results of tests made on new and improved apparatus, but will give to each and every manufacturer, whether of parts or complete sets, the means of obtaining outside independent tests of his merchandise that would cost him hundreds of dollars if he were to go to a commercial laboratory. Today a manufacturer, let's say he makes

transformers, can receive from any one of the laboratories of our members an unbiased report and a chart or curve on the performance of his transformers, absolutely free. Not only does this laboratory work of our members save manufacturers who take advantage of it many hundreds of dollars a year, but it makes the marketing of his goods easier, because it strengthens public confidence in his merchandise among our readers, and with the radio trade.

### Co-operation, Second Point

The second branch of our activities embraces the co-operative efforts of all of our members toward educating the public to the intricacies of radio. Our aim is not only to arouse public interest in radio reception, but to so educate them through our editorial columns that they will know how to handle a set after they have bought it. When goods are sold to people who know nothing about radio, the goods are often condemned and do not remain sold, while sales made to readers of radio magazines are assured of staying sold.

Through our mutual co-operation we have devised ways and means for increasing our circulations and getting new blood into the radio industry. As a result the great majority of the members of the Radio Magazine Publishers Association are finding right at this time such an increased demand for radio magazines that they have had to very materially increase their distribution of copies *this summer*. This means the creation of a bigger market for you.

The present structure of the radio market is based upon interest aroused by the radio magazines, and we are continually striving to stimulate further public interest in radio, not merely to make one sale, but continually to create demand for improved radio apparatus—both complete sets and standard parts and accessories.

### Third Stage is Statistical

The third phase of our activities consists in the preparation of statistics covering the radio market and the education of manufacturers and their advertising agencies as to the definite place the radio magazines have in their distribution scheme, whether the manufacturer be a maker of parts, accessories or complete, factory-built sets. In many cases we have been successful. It is a strange fact, and one worthy of careful consideration by every set manufacturer that every make of set that has been successful this year has been advertised in radio magazines, while on the other hand the big failures this year are among the group who ignored the radio magazines in their sales campaigns.

The presentation of such facts to manufacturers and advertising agencies in par-

(Concluded on page 20)

## WHY PARTS BUSINESS IMPROVES

By Dan Napoli



# Big Season For Leaders, Is Freshman's Prophecy

Net profits of \$343,147.11 before taxes, for the first quarter of 1926 are reported by the Chas. Freshman Co., Inc. A statement by the President, Chas. Freshman, accompanies this report. He says:

"In reviewing the first quarter's business of 1926, we wish to point out that the net profits, \$343,147.11, before taxes, are after the company's absorption of adjustment on price concessions of retail dealers' stocks when our list prices were reduced on February 8, 1926.

"Our net earnings for this quarter show a substantial increase over the first quarter of 1925, which were \$304,915.82, based

on sales of radio sets retailing at much higher prices. As an example, the popular set which retailed at \$60 in the first quarter of 1925, is now being sold at \$38.50.

"The general outlook for the radio industry for the coming season is highly satisfactory for well financed companies on a solid foundation. General conditions in our industry have been greatly improved by the reduction of the number of manufacturers through the elimination of some of the less firmly established producers. Competition will tend to be on a more healthy basis in the future."

## COMING EVENTS

**JUNE 1 to DEC. 1**—Sesqui-Centennial, Industrial Arts Bldg., Philadelphia, Pa., with concurrent radio exposition. J. C. Johnson, manager, 1560 B'way, N. Y. City.

**SEPT. 10 to 17**—National Radio Exposition, Grand Central Palace, New York City. American Radio Exposition Co., 1560 Broadway, New York City.

**SEPT. 13 to 18**—Third Radio World's Fair, Madison Square Garden, New York City. G. Clayton Irwin, manager, Times Bldg., N. Y. City.

**OCT. 11 to 17**—Fifth Annual Chicago Radio Show, Coliseum, Chicago, Ill. G. Clayton Irwin, manager, Times Bldg., N. Y. City.

## Crosley Gets New Home for His Label Plant

Powel Crosley, Jr., owner of The National Label Company, has just purchased a new site for the erection of a modern printing plant, at the northwest corner of Colerain avenue and Brashears street, Cincinnati.

The National Label Company not only prints labels for some of the largest industrial concerns in the country, but prints the literature and labels for The Crosley Radio Corporation, which is also owned by Mr. Crosley.

## Business Opportunities Radio and Electrical

Rates: 10c per word; Minimum, \$1.00; Cash with order

**WOODWORKING AND RADIO CABINET** plant, fully equipped with practically brand new machinery; individual motors, Blowers spraying outfit, plenty of lumber, over 1,000 finished and unfinished cabinets, hardware, finishing materials; very cheap rent; bargain to quick purchaser. 20 Mill Road, Jersey City, N. J.

**ELECTRICAL ENGINEER, MANUFACTURING** experience, developing electrical mechanical devices, inventions, seeks part or full time connection; have suitable laboratory. Box 1000, Radio World.

**WILL, FINANCE, BATTERYLESS RADIO;** write full particulars. Box 2000, Radio World.

**VICTROLA-RADIO STORE FOR SALE** IN city of 40,000, 30 miles from New York; established 10 years; capable of netting \$10,000 per year; cash required \$18,000; valuable franchise; reason, other interests. Box 3, RADIO WORLD.

**OUTSTANDING ACCOUNTS FINANCED;** liberal terms, lowest rates; confidential; quick service assured. Mercantile Factors Corporation, 230 5th Av., N. Y. C. Phone Ashland 9506

**BATTERY - IGNITION - RADIO SERVICE;** moneymaker for right party; established 5 years; sacrificing for \$1,500 to quick buyer; stock and fixtures worth double. Phone Raymond 0422, Brooklyn, N. Y.

**METAL ARTICLES, STAMPING, ASSEMBLING,** finishing, dies and tools for economical quantity manufacturing. n Metal Craft Co., 306 East 40th, N. Y. C.

## New B Battery Unit Marketed by See Jay

After months of experimentation the See Jay Battery Company has perfected and placed on the market a new B Battery Power Unit. This is a combination alkaline element B battery, of the well-known See Jay quality, and trickle charger, all in one. The charger is connected to batteries and light socket, making a permanent battery supply with all charging troubles eliminated. Due to the special transformer having separate independent coils and therefore needing no electrical connections with outside mains it is not necessary to remove the battery from the set while charging. This is a valuable feature. The battery unit is shipped dry with solution and can be safely sent to any part of the world. All See Jay batteries and units are constructed from genuine alkaline elements and connected with their own non-corrosive connective. Literature on this unit may be had on application from See Jay Battery Company, 915 Brook Avenue, New York City. Mention RADIO WORLD.

## Rix Radio Expands

Due to the growth of their business, the Rix Radio Supply House, of 5505 Fourth Avenue, Brooklyn, N. Y., has opened another store and warehouse at 72, 74 and 76 Cortlandt Street, New York City. Here a complete stock is carried, especially the new and hard-to-get parts. Anything and everything used in radio, including complete kits and sets of parts for every known circuit, is carried. Specials lists will be sent to those interested. Mention RADIO WORLD.

## Aerovox Brings Out Wire Wound Resistance

In modern practice when resistances are used it has been found desirable to use metallic wire on account of its permanence, uniformity and current carrying qualities. The Aerovox Wireless Corporation have placed on the market a compact wire-wound resistance, of their usual high quality, which meets every requirement for use in all kinds of battery eliminators. This unit is of 10,000 ohms, is 4" long, having a resistance of 2,5000 ohms per inch of length, and is so constructed that several lengths can be taken off as required. These units are also made to carry current up to 250 milliamperes, the size depending upon the resistance and the amount of current it is required to carry. Further details can be had from Aerovox Wireless Corporation, 493 Broome Street, New York City. Mention RADIO WORLD.

## DE MOTT'S SPEECH

(Concluded from page 19)

ticular, has been one of our chief aims. It is a shame how little most advertising agencies in the past, and right today, have known about radio magazines. It isn't all personal interest in our own publications that induces our members to strive to keep these facts before you. It is a blow to the whole radio industry every time a large advertiser of radio sets fails, after having wasted his own and very often the public's money in a campaign founded upon ignorance.

### An Economical Method

And I want to state right now, that there is no known method today for the sale of radio apparatus, including complete sets, that is as economical as a campaign that is first based upon selling the fan through his own magazine. Every fan influences, as you all know, the radio purchases of his friends' apparatus. Every one of you probably has been asked dozens of times during the past year, "What's a good set to buy?" We have constantly striven to keep these salient facts regarding the radio market before you manufacturers, as much for your own good as ours.

The radio business as it exists today is unlike any other business in this country, and don't let anyone tell you differently. You can't market radio sets or parts as you would Uneeda Biscuits or automobiles. It is a ticklish market, as everyone in the radio industry knows. And it is going to remain so for the next ten years.

The days of experimenting, the days of new circuits, the wild, hectic changes that have been a feature of the past are far from over. What has gone before is only a very small part of what is to come. Radio sets will be vastly simplified, made more compact and more stable. The day of "you press the button and we'll do the rest" is nowhere in sight.

### Television on Way

Radio television is coming—in fact, it is here. Already the transmission of photos taken by land wire and by radio is an accomplished commercial fact. You can take a photo today to the American Telephone & Telegraph Co. and they will transmit it for you to Chicago. You can take a picture to the Radio Corporation of America and they will radio it to London. So it is only a few steps to the transmission of moving scenes. Radio television, as I have already said, is here, but it is in the laboratory stage, and it remains only to put it upon a commercial plane to give the radio industry an impetus such as it has never before known. The engineers know that there are no unsurmountable obstacles to commercial television—they know, as you and I know, that before long we will be able to sit down at our receiving sets and see, as well as hear, the World's Series being played in Pittsburgh or Washington. Today radio is sightless, even as the movies are dumb. Television will give to radio the missing sense, and it takes no imagination to predict what that will mean to the industry. Those with present day sets must either change or add to them, or scrap the old and buy new.

Those who are tired of radio programs or are so fed up on the sameness of radio reception will find their appetites whetted anew. Suppose you do hear the same song sung twice. If a reproduction of the artist actually accompanies the rendition of the song it will be different. What keeps the interest of the public alive in the theatre? The actual sight of the actors themselves as well as the spoken or sung word.

# Resale Price Bill Aimed at Deceivers

By F. A. D. Andrea

As manufacturers of one of the leading brands of radio receiving sets, it has been our pleasure to have enjoyed a substantial growth during the last four years and our success we attribute in a large measure to the extended advertising we have done on our trade marked merchandise.

In the retail radio industry there have been a large number of opportunists who have taken fullest possible advantage of the heavy demand which at times has existed for radio receivers, and which in the face of the rapid growth of the industry has often run far ahead of the available supply.

### Trade on Trade-Mark

Obviously under these conditions a shrewd retail merchant could resort to many tactics not strictly sanctioned by legitimate business procedure, and could even establish conditions to his own temporary benefit which are not of benefit to the manufacturer nor to the industry at large.

Lack of sophistication on the part of the purchasing public leaves the shrewd merchant broad latitude as regards the scope of his activities.

Not only our trade marked brand, but several other prominent manufacturers have suffered considerably through unethical retailers featuring this trade-marked merchandise in their advertising and at prices often considerably less than those which will permit the retailer to show a living profit, the object being not to sell the trade-marked merchandise

which is advertised, but rather to attract trade to the store by the seeming bargain in his trade-marked merchandise, and then switching the customer into the purchase of some other and inferior brand on which the retailer makes perhaps an exorbitant profit.

### Distrust is the Result

Obviously the trade-marked merchandise when subjected to advertising at seemingly bargain figures by several dealers in the same city, and perhaps at a different price by each one of these dealers, establishes distrust in the minds of the purchasing public as to the actual value of the trade-marked merchandise, and in consequence the manufacturer and legitimate dealer are bound to suffer.

Again, it is manifest that if a well-advertised trade-marked article is used merely as bait to entice a customer into the store, and an endeavor is then made to sell other merchandise, it is decidedly unfair treatment.

The Capper-Kelly resale price bill, now before Congress, is drawn along lines which with reasonable certainty would prevent the undesirable procedures above outlined and in consequence the bill has our hearty indorsement.

By the terms of the bill, articles may be sold by the retailer or jobber at lower prices than prescribed by the vendors if the manufacturer discontinue dealing in such articles or cease to do business or shall become bankrupt. Under a reasonable system of resale price maintenance it is claimed that producer, wholesaler and consumer benefit. The consumer is protected in the purchase of identified merchandise.

# Power Problems Likened To Railroads' Car Snarl

By Sidney Z. Mitchell

President, Electric Bond and Share Co.

The use of super power is economical for the same reason that joint efforts on car use are economical for railroads.

### Car Borrowings

The fluctuating requirements of industry and the seasonal movements of commodities mean that each railroad at certain times requires many more cars than it ordinarily uses. Instead of spending huge sums to purchase additional rolling stock which would lie idle most of the time, each road, through interconnection and interchange, is today able to borrow from other roads (which do not at the time have a similar peak demand) sufficient cars to promptly and adequately meet its emergency requirements.

We have all had the experience of watching freight trains made up of cars carrying the names of a dozen different railways, but few of us ever stop to inquire by what system and through what methods the rolling stock of these diversely owned and diversely operated systems are all brought together on a single track.

The answer, as I have indicated, is that long ago the railroads of the United States adopted the principle of interconnection and interchange as a means of

eliminating waste and of improving their service to the public.

### A Big Saving

Recently one of the leading railroad authorities was asked to estimate what annual saving to the railroads and to the public had been brought about through the system of interconnection and car exchange and his answer will give you some conception of the importance to any industry of the intelligent use of its equipment.

According to this authority, the saving secured through the interchange of freight cars on the railroads amounts, at an extremely conservative estimate, to not less than \$1,500,000,000 a year.

According to this same authority, if there were no interconnections between the various railroads, and if the cars of one railroad were not used on the tracks of another, it would mean that the aggregate rolling stock of all the railroads would need to be doubled. This alone would represent an additional investment of at least \$3,600,000,000 and the interest on this vast sum at 5 per cent. would amount to \$180,000,000 a year.

### STATIC LEVEL RISES

WASHINGTON.

According to experts of the Navy Department, there was a great increase in atmospheric interference to radio reception during March.

## Literature Wanted

THE names of readers of RADIO WORLD who desire literature from radio jobbers and dealers are published in RADIO WORLD on request of the reader. The blank below may be used, or a post card or letter will do instead.

Trade Service Editor,

RADIO WORLD,  
145 West 45th St., N. Y. City.

I desire to receive radio literature.

Name .....

City or town .....

State .....

Are you a dealer? .....

If not, who is your dealer?

His Name .....

His Address .....

- O'Brian & Mohr, Brockton, Mass. (Dealers).
- J. R. Williams, Monrovia, Cal.
- Schumann Motor Co., Waukesha, Wis. (Dealers).
- Reginald A. Vernham, 32 Lincoln Road, Walkerville, Ont., Canada.
- Joe V. Ost, 312 Foote Ave., Bellevue, Ky.
- Waynesburg Radio Shop, Waynesburg, Ky.
- W. J. Stevens, 1017 Peneston St., New Orleans, La.
- M. Orvey Jeglum, Grand Forks, N. D.
- C. R. Angell, Grand Rapids, Michigan (Dealer).
- Beane & Rogers, 404 Baltimore, Jackson, Tenn.
- H. W. Aeyer, 126 Valentine St., Glendale, L. I., N. Y.
- Dale Johnson, Box 312, Cambridge, Ill.

## Freed Calls Two Shows At Once "A Spectacle"

"The spectacle of two radio shows going on simultaneously must not be repeated. The position of the industry on this point is sound. By united action the industry can eliminate this undesirable situation, and that from next year on there will be only one radio show in New York, representative of the entire industry.

"To attain that end, the Radio Exhibition Corporation has been formed.

"Not a single officer will profit by a successful exhibition. The show will be conducted for the public and the industry alone—with no other object. No pecuniary interest will be the underlying factor, as quite naturally is the case with shows privately conducted.

"We are going ahead in a constructive, energetic manner, and we believe that behind us is the force of public opinion."  
—Joseph D. R. Freed.

## New Corporations

- West End Supply Co., N. Y. City, radios and autos, \$10,000; D. Halpern, E. Stempel, C. Rabinowitz (Atty., A. J. O. Hoschek, 1,540 Bway, N. Y. City).
- Mayolan Radio Corp., N. Y. City, 10 common, no par; R. R. Mayo, C. B. Deming, L. H. Mingen (Atty., U. S. Corp., 150 Bway, N. Y. City).
- M. Rabinowitz & Sons, N. Y. City, \$10,000; M. and M. and D. Rabinowitz (Atty., P. Poger, 1,457 Bway, N. Y. City).
- General Radio & Talking, Wilmington, Del., radios, talking machines, \$100,000 (John H. Short, Wilmington, Del.).
- Roth Radio, N. Y. City, 200 shares, \$100 each, 200 common, no par; A. S. Bursky, I. Wertz (Atty., C. Benowitz, 15 West 44th St., N. Y. City).
- Albin Radio Co., N. Y. City, \$4,000; A. Eisenstat, M. Stoller, C. Ollstein. (Atty., D. L. Spring, 7 East 42d St., N. Y. City).

### STORAGE BATTERY CAPITAL REQUIRED

to market new storage battery construction which has valuable features doing away with defects of present batteries; fully covered by patents, has had satisfactory test for over two years; one of largest battery jar manufacturers has reported favorably after testing thoroughly at their own plant; especially suitable for radio use, an ideal proposition for radio manufacturer who wishes to include the battery with the set. Box 234, Radio World.

COMPLETE LIST OF BROADCASTING STATIONS appeared in RADIO WORLD dated May 1. Sent on receipt of 15c. or start sub. with that number. RADIO WORLD, 145 W. 45th St., N. Y. C.

# Guesswork is Painlessly Extracted by Laboratory

By James H. Carroll

Radio has taken its place among the arts and sciences with the establishment of the fully equipped radio laboratory. Fans have awakened to the necessity of tested radio apparatus. The pioneers among set builders can readily remember the days when, full of enthusiasm, the new super circuit diagram before them, they rushed out to gather armfuls of parts and equipment and went to it, with no idea of calibrating the various parts and synchronizing them all through the circuit. Calibrating a loop and fitting the loudspeaker to the needs of the output was unheard of. Standards of voltage, current, inductance, capacity, etc., were unknown quantities to them.

Numerous private laboratories have been established to minister to the needs of the individual, also proving invaluable to the radio manufacturer whose requirements extend beyond the limits of his own laboratory equipment.

## Where Theories Are Tested

There is a good baker's dozen of real, honest-to-goodness laboratories, conducted by highly-trained men wherein the working quarters are marvels of modern efficiency, equipped with the finest obtainable instruments that perform miracles of measurement. Here the weaver of loops may test out his theories of inductance and capacity; the finder of frequencies may obtain the exact values of his revolutionary coil; the Harum of harmonies may find out the use or mayhap the uselessness of his wonderful audio transformers or desistance couplification, while plain John Smith can find out why his super will not "supe," and have it pepped up so it will do tricks.

There is a fee, but it is generally low, and is commensurate with the worth of the work performed. And with it comes the knowledge that the work is done right and will not have to be done over again. This is a highly technical branch and as in all radio practice the axiom obtains: "It pays to buy the best." This applies to service as well as to parts.

The giant strides made by radio advancement are exemplified by the feats performed in these laboratories. Their experiments, aside from the regular work of the day, are responsible for many of the short cuts to better radio. One well-known laboratory head recently in photographing audio waves made valuable discoveries regarding comparative efficiency of audio coupling. The researches of these laboratories come under many heads and the activities are varied.

## R F Research Important

One of the most important is radio frequency research. There are two standard means of deriving radio frequencies; one by means of a 1,000 cycle tuning fork, the other by standing waves on wires. In the former, a tuning fork is kept vibrating by means of a vacuum tube and a series of tubes is made to oscillate in synchronism with harmonics of the tuning fork. In this way, radio frequency power is generated at frequencies which are exact multiples of 1,000 cycles. In the other method, standing waves of about 60,000-000 cycles, approximately five meters wavelength, are produced on a pair of parallel wires and the wavelength is measured directly by a tape. By means of oscillators whose harmonics are kept in synchronism with the 5-meter wave, lower

frequencies are produced. Therefore, radio frequency power is generated at frequencies which are exact fractions of 60,000,000 cycles. The two methods overlap and serve to check each other. Wave meters are by this means calibrated by tuning to these known frequencies.

## The Whole Gamut Run

Here we have an example of the exacting procedure of laboratory practice and of the brains and skill that go into it. Voltage in all its ramifications is traced; current and its effects are analyzed; inductance and capacity are studied and measured. Through an exact series of tests results can be mathematically plotted on paper and the exact performance of a radio apparatus or receiver be precisely shown before its operation. And these tests are uniformly accurate.

Voltage standards, in another example of research, cover the range from a millionth of a volt to 50,000 volts at radio frequency. These standards are used to measure the voltage in a loop caused by a radio signal from across the seas or from the coast, to measure the voltage in loud speakers, or to measure the antenna voltage of a high power transmitter from the infinitesimal to the Niagara of radio power. Imagine the delicacy, the accuracy and the price of the infallible instruments used in laboratory practice. Therefore, the laboratory comes as another boon to the sincere seeker after radio truth and progress. There are many standard laboratories of this kind and among the best equipped for all classes of radio research are those of Rossiter, Tyler and McDonnel, Inc., H. and F. Radio Laboratories, The Superadio Co., Radio Construction Laboratories, and John F. Rider.

## SPECIALTY CO. MOVES

The Specialty Service Company have moved to larger offices at 575 Atlantic Avenue at Fourth Avenue, Brooklyn. This firm, of which Julian Loeb is president, covers the Brooklyn and Long Island territory for some of the best known manufacturers in the country.

## PIONEER ENLARGES LINE

The Pioneer Radio Sales Company, Tribune Building, New York City, have been appointed the factory representatives of the Metropolitan area for the Webster Super B Eliminators, manufactured by the Webster Company, of Chicago. They are also representatives for the Super Ball Antenna Company, of Green Bay, Wis., in this territory.

## PLEASED WITH 3 TUBER

RESULTS EDITOR:

I have completed the 3-tube 3-circuit set as described by Capt. P. V. O'Rourke in Oct. 10 RADIO WORLD and wish to thank him for the wonderful receiver.

I have had splendid results with it and am including a list of several distant stations I have received in the week I have operated it:

KOA, Denver; WOAI, San Antonio; WOAW, Omaha; WRR, Dallas; KWWG, Brownsville.

KDKA comes in with as much volume as our local WOWO, of Ft. Wayne.

Am using two 199 tubes and one 120 tube and on nearly all of the sixty-two stations I have logged I could use a loud speaker.

HAROLD BABB,  
Warren, Indiana.

# STATION ON WORLD TOUR FOR TESTING



(James Englander)

**WARNER BROTHERS'** portable broadcasting station, 6XBR, started on a tour around the world from the Warner Station, KFWB. From left to right in front of the truck are Louise Fazenda, Ernst Lubitsch, director; Monte Blue, with the microphone, and Patsy Ruth Miller.

From Los Angeles to New York and across the Atlantic to London and back to Los Angeles again by way of Kobe. That, in part, is the territory which will be covered by the only portable radio broadcasting station of its kind in the world, 6XBR.

The huge truck was given the starting word by Betty Warner, 6-year-old daughter of Harry M. Warner, president of Warner Brothers Pictures, Inc. The station was christened The Betty Warner.

Amateur and commercial radio operators will have an opportunity to obtain awards for the most accurate report sent to Warner Brothers at Hollywood on code conversations between the portable station and its mother plant, KFWB, the movie city.

Portable station 6XBR has been assigned the official call letters 6KY to be used when the station broadcasts in code. For musical programs which the portable station will broadcast during its tour the plant will use 6XBR.

During the tour 6XBR will broadcast on a wavelength of 105 meters and will use 40 meters for code. The power will be 250 watts.

6KY will communicate with KFWB in Hollywood every night from 11 until 12 o'clock P. M. (standard time of whatever section of the country 6XBR may happen to be in).

The trip in the United States is with the sanction and cooperation of the Department of Commerce. The present itinerary includes the following cities: Santa Barbara, San Francisco, Oakland, Portland, Seattle, Spokane, Walla Walla, Boise, Salt Lake, Denver, Hastings, Lincoln, Omaha, Kansas City, Decatur, Chicago, Indianapolis, Columbus, Cleveland, Youngstown, Pittsburgh, Washington, Philadelphia and New York.

At the conclusion of the American tour the station will be shipped overseas, and if suitable arrangements can be made with the radio governing bodies of England, France, Germany, Spain and Italy, 6XBR will make tests in those countries, thence to the Orient, Australia, the Philippines, Hawaiian Islands and back to Hollywood.

**"LOOK UP DOWN"**

For  
**SERVICE**

A Complete Radio Testing Laboratory for the  
Corrections of Radio Troubles!

**CHAS. W. DOWN**

**SUPER-HETERODYNE SPECIALIST**  
711 - 8th Ave., New York, N. Y.

**MICA FIXED  
AND  
BY-PASS CONDENSERS**



**ELECTRODYNE CO.,  
INC.**

2378 THIRD AVENUE, N. Y. C.

**FENWAY  
for  
DX!**

**Why Postpone Building It?**

FENWAY BLUEPRINTS and FENWAY RADIO SERVICE render it simple—easy—for you to build one of these receivers. And they cost so little, \$3.00 postpaid, for full sized drawings—25x40 in.—showing the complete layout, wiring diagrams, drilling dimensions, data for making your own coils and copper cans, list of parts, etc.

FENWAY FREE SERVICE SAVES YOU from \$5.00 to \$50.00 on trouble-shooting. For example: From the time you start building your laboratory set, and until it is finished and working properly, you have the advice and help of the designer himself. You simply can't go wrong.

So, send today for your DX blueprints—  
Fenway means DX. Winter or Summer!

**Fenway Radio & Research  
Laboratory**

890 Eighth Ave., New York, N. Y.

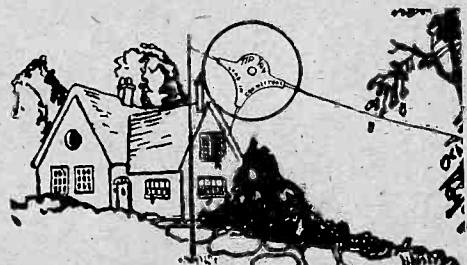

**Tip-Top** LEAD-IN CONNECTOR

**GOES ON IN A JIFFY  
MAKES PERFECT CONTACT**

About the TIP-TOP CONNECTOR

Makes Perfect Contact—Holds the wires securely in place and provides a large contact surface. Cannot come loose as hand connections do.

Goes On in a Jiffy—Only a screw driver needed. Band the antenna wire, and form an eye in end of lead-in wire.

Eliminates Loose Lead-wire connections with their resulting noises and other objectionable features.

Helps Volume and Distance—Through reducing resistance in the path from antenna to set.

Will Last for Years—Made of brass. Cannot corrode or rust.

At your dealers or mailed prepaid for 25c.

**J. F. Doolan Manufacturing Corporation**  
62 W. 45th St., New York City

**Index to Radio World**

Issues of November 21, 1925, to May 8, 1926

The DX Super-Heterodyne, an 8-tube receiver, with diagrams by J. E. Anderson.

A Set That Stresses Quality, a 4-tube quality receiver, by Lewis Winner.

A 3-Tube Regenerative Set, using a resistance to control the regeneration, by Percy Warren.

An Exposition of Earphones, by Sidney E. Finkelstein.

The 4-Tube A-A Receiver, Part II, by Herbert E. Hayden.

Full Text of Hoover's Address to the Fourth National Radio Conference.

Laboratory Tests on the 1926 Diamond, by Herman Bernard.

**NOVEMBER 28**

The Zero Potential Loop, by Frank Freer.

A 1-Tube Regenerative Receiver, by J. E. Anderson.

A Study of AF Amplification, by William H. Fortington.

A Discussion of the AF Circuit used in the 1926 Model Diamond, by Herman Bernard.

A Summing Up of The Results of The Fourth Radio Conference, by Herbert C. Hoover.

The Reinartz Plug-in SW Set, by Lewis Winner.

Table for Conversion of Frequencies and Meters.

**DECEMBER 5**

A Toroid RF Set, Using a Crystal as a Detector, by Lewis Winner.

Pointers on Batteryless Sets, by William H. Fortington.

A 70-to-1208 Meter, 5-Tube Receiver, by Robert Force.

A Study of Ohms Law, As Applied to Tube Circuits, by J. E. Anderson.

1926 Diamond Wiring Kinks Solved, by Herman Bernard.

**DECEMBER 12**

The See-Saw, a Model 3-Tube Circuit, by P. E. Edelman.

Housing the Pressley Super-Heterodyne, Part I, by Herbert E. Hayden.

A Simple B Battery Eliminator, Part I, by Lewis Winner.

Getting Results With The Powertone; Matching of Dials, by Herman Bernard.

An Analyses of the 1926 Diamond, by John F. Rider.

**DECEMBER 19**

The Lemnis Entertainer, A 6-Tube Receiver, by Edward Spiegler.

A Discussion of Trouble Shooting, by Brainard Foote.

A 5-Tube Quality Receiver, by Lewis W. Feldman.

Some Pointers on Dials, by Sidney E. Finkelstein.

A Continuation of the Analyses of the Diamond, by John F. Rider.

Transformers and Chokes for B Eliminator, Part II, by Lewis Winner.

Housing the Pressley Super-Heterodyne, Part II, by Herbert E. Hayden.

**DECEMBER 26**

The Regenerative Wave Trap, by John F. Rider.

The 5-Tube Tuned RF Set, by Capt. P. V. O'Rourke.

A Cabinet B Eliminator, Part III, by Lewis Winner.

A Study of Types of Receivers, by J. E. Anderson.

Housing the Pressley Super-Heterodyne, Part III, by Herbert E. Hayden.

**JANUARY 2, 1926**

The 2-C Set For Simplicity, a 5-Tube Receiver, by Capt. P. V. O'Rourke.

A Chemical B Eliminator, by Lewis Winner.

A Study of Multiple Condensers, by Herman Bernard.

A Discussion of The Proper Voltage Required For The Tubes in The 1926 Diamond, by John F. Rider.

**JANUARY 9**

The 4-Tube DX Symphony Set, by Irving Witz.

Single Control Compensation, by Herman Bernard.

Tuned Antenna Used In a Special 1-Tube Receiver, by Lewis Winner.

Taking Care of Batteries, by Capt. P. V. O'Rourke.

A 4-Tube Toroid Receiver, by Chester Charlton.

**JANUARY 16**

A Clinical Study of Low-Loss Coils; A Discussion of the Bureau of Standards Report, by Herman Bernard.

A 5-Tube Quality Receiver, by J. E. Anderson.

The Raytheon Power Unit, by Lewis Winner.

Making a Box Loop, by Herbert E. Hayden.

**JANUARY 23**

The 4-Tube Diamond Set, by Herman Bernard.

The Antennatrol, Part I, by Herbert E. Hayden.

A Study of The Life of B Batteries, by Sidney E. Finkelstein.

An Extensive Study of Battery Types, by Lewis Winner.

Eliminating Noises in Receivers, by E. P. Peck.

Testing Your Set on a Loop.

**JANUARY 30**

An Individual AF Amplifier, by Herbert E. Hayden.

A Discussion of Hi-Mu and Power Tubes, by F. R. Join.

A Study of Litz, 32-38, No. 24 and 28 DCC Wires, When Used on Coils in Broadcast Receivers, by Sidney E. Finkelstein.

Trapping Out Super-Power, by Capt. P. V. O'Rourke.

Completing the Antennatrol, Part II.

Discussion of The AF Amplifier Used in the Diamond, by John F. Rider.

The Diamond University (3 pages).

**FEBRUARY 6**

The Fenway, a 9-Tube Super-Heterodyne or 4-Tube Regenerator, Part I, by Leo Fenway.

The Loud Boy, a 1-Tube Regenerative Receiver, by Herman Bernard.

The Diamond University.

**FEBRUARY 13**

An Economical 5-Tube Receiver, by J. E. Anderson.

A Selective Crystal Set, by Herman Bernard.

Trouble Shooting For Novices, by M. B. Strook.

The 2d Step in the Fenway, Part II, by Leo Fenway.

A Discussion of AF Amplification, by Dr. A. N. Goldsmith.

**FEBRUARY 20**

The Victoreen, an 8-Tube Super, Part I.

A Real 3-Tube Quality Set, by Brainard Foote.

Definitions for Novices.

The Completion of the Fenway, Part III, by Leo Fenway.

**FEBRUARY 27**

The 4-Tube DX Dandy, Part I, by Herbert E. Hayden.

Curing Noises in the Set, by J. E. Anderson.

Definitions for the Novices.

Distortion Elimination in AF Amplification, by Dr. A. N. Goldsmith.

Fenway Trouble Shooting, Part IV, by Leo Fenway.

The Victoreen, Part II.

A Coupler for a Loop in a Super, by Herbert E. Hayden.

Tubes For the Diamond, by Herman Bernard.

**MARCH 6**

The Old Salt, a 1-Tube, 1-Dial Set, by Capt. P. V. O'Rourke.

The Chemistry of Batteries, by A. R. Reid.

An Astatic Crystal Set, by Frank Freer.

Wiring the Victoreen, Part III.

The 4-Tube DX Dandy, Part II, by Herbert E. Hayden.

Diamond Efficiency Data, by Herman Bernard.

The KB-8, a 5-Tube Receiver, Part I, by M. B. Sleeper.

A Comparative Study of the Crystal and the Tube as Detectors, by John F. Rider.

The Tectron B Eliminator, Part I, by Lewis Winner.

My Experiences with Super-Heterodyne Sets, Part I, by J. E. Anderson.

Curing Victoreen Trouble, Part IV.

**MARCH 20**

A Super-Heterodyne De Luxe, by J. E. Anderson.

My Experiences with Super-Heterodyne Sets, Part II.

A 2-Tube Speaker Set, by Percy Warren.

Testing AF Quality, by John F. Rider.

Making a Pickle-Bottle Coil, by Herbert E. Hayden.

The KB-8, Part II, by M. B. Sleeper.

The Choke Coils for the Tectron B Eliminator, Part II, by Lewis Winner.

The Goat at the Mike, a humorous discussion of broadcasters, by Herman Bernard.

**MARCH 27**

An Economical 4-Tube Set, by Edgar T. Collins.

A 1-Hour 3-Tube Set, by Chester Charlton.

An All-Wave 4-Tube Regenerator, by McMurdo Silver.

(Concluded on page 26)

**FIXED RESISTORS**

**Micamold**

**FIXED CONDENSERS**

Specified for the Fenway. Superb in all circuits. Accurate, Constant in Value, Indestructible. "Made of Mica and Moulded in Bakelite."

At Good Radio Stores.

**MICAMOLD RADIO CORP.,**  
Flushing and Porter Aves.,  
Brooklyn, N. Y.

ACCURACY GUARANTEED  
-VALUES REMAIN CONSTANT

MOULD UNDER PRESSURE OF 50 TONS

# Many Turns, Low Capacity, Problem in AF Transformer

While the average fan is fairly well posted on the subject of determining what represents efficiency in radio frequency work, when he comes to the audio frequency amplifier he is often in the dark. Only a short while ago the fan concerned himself mostly with the turns ratio, getting a high ratio transformer for the first stage and a lower ratio transformer for the second stage. And when he wanted more volume, he was generally at a loss to know just how to get it without introducing distortion.

As to the transformer choice, one should be guided less by the ratio than by the inductance, which should be large, the distributed capacity, which should be small, and the amplification, which should be even. The ratio is a consideration, but it is not the most important.

### Ear Will Tell

Naturally, a transformer that has the fundamental merits which result in a practically even amplification over the audible range will make its superiority obvious to the ear. A test made with earphones will give different results than one made with a speaker.

When judging a transformer, one must consider also the speaker.

Normally the speaker will handle the low notes very well, and likewise the transformer will amplify them evenly.

### Once Stopped, Lost Forever

As much inductance is desirable in the transformer, both primary and secondary, unless some special design is used, the distributed capacity will be rather large, and this condenser effect, especially in the secondary, will bypass some of the higher frequencies, particularly the harmonics, that give the voice its individuality and naturalness. What the transformer stops will never get to the speaker, hence even the best of speakers will scarcely have a chance to prove their superiority. If anything, they seem worse than poorer ones, because the better ones emphasize by the fidelity of their reproduction the shortcomings of the transformer, which a poorer speaker would smother to some extent.

The object is to have a transformer that

not only will do justice to an orchestra piece but also to a coloratura soprano, and with sufficient volume, even great volume, where it is desired.

One method is to employ push-pull amplification, whereby two tubes equally share the load. A secondary tapped at the middle, while enabling push-pull connection, often provides disappointing results, because the voltage and the amperage of the output are not apace. The secondary windings should be separate, that is, inductive instead of conductive

coupling should be employed. Then both outside terminals do not have to go to grid connections, which is the vice of the midtap method, and brings on distortion.

### Load, Clear Signals

The push-pull stage may be placed wherever desired, although it is most commonly used in the final stage. If it is preceded by one transformer stage it will be of advantage only if the preceding transformer was not a good one. Where two straight transformer stages are used the quality result should be excellent, and if it is not so, look to the transformers.

The push-pull method is most desirable as the third stage, where the volume will be very great. And yet the signals will be clear and pure.

## Long Distance Radio

Only \$295



### 30,000 SATISFIED OWNERS

Getting stations 200 miles away on Lambert Radios. No batteries or tubes required. A real Radio—not a toy or attachment. One to four can listen at once. If your dealer doesn't carry Lambert Radios, write us for literature.

LEON LAMBERT RADIO CO.

Kaufman Building Wichita, Kansas

Liberal Offer to Dealers—Write Us Today

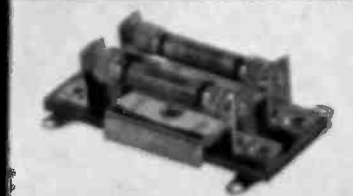

## AEROVOX "Best Better"

### RESISTOFORMERS

Tested and approved by M.I.T., Yale, Radio News, Popular Radio, and Popular Science. Used by over 200 of America's leading radio manufacturers.

AEROVOX WIRELESS CORP. 175 W. 42nd St., New York

Branch Office: 10 South Main Street, Boston, Mass. 1000 Broadway, New York, N.Y. 1000 Broadway, New York, N.Y. 1000 Broadway, New York, N.Y.

## HARD RUBBER

SHEET—ROD—TUBING Special Hard Rubber Parts Made to Order RADION HARD RUBBER PANELS ANY SIZE

Wholesale Retail NEW YORK HARD RUBBER TURNING CO. 217 Centre Street New York

## GET THE OFFICIAL BOOKLET ON HOW TO BUILD Radio World's 1926 Model DIAMOND OF THE AIR

The text of the official Diamond booklet was written by HERMAN BERNARD, designer of the 3-tube circuit which offers the most in selectivity, volume, tone, quality and D.K. Price, per copy

50c

### CERTIFIED BLUEPRINT

FREE with every copy of THE OFFICIAL Booklet. Bernard's circuit is an every booklet and every blueprint. Both sent FREE to new 1926 subscribers. Ask your dealer FREE.

News and Radio Dealers: Send to publication office for Wholesale Prices. Or order direct from American News Co., Inc., 18 Varick St., N. Y. C., or American News Co. Branches in other cities.

RADIO WORLD, 16 W. 4th St., N. Y. C.

Enclosed find 50c. Send me copy official Diamond Booklet, with FREE blueprint. Or both free with \$1.00 for yearly subscription.

NAME \_\_\_\_\_ ADDRESS \_\_\_\_\_ CITY \_\_\_\_\_ STATE \_\_\_\_\_

**FREE** BOY'S LIFE INVENTORS IF YOUR INVENTION is new and useful to is patentable. Send me your sketch. Z. H. POLACHEK, 78 Wall St., New York Reg. Patent Attorney-Engineer

## RADIO WORLD'S PREMIUM SUBSCRIPTION OFFER For NEW RADIO WORLD Subscribers Ordering NOW

Radio World has made arrangements

- To offer a year's subscription FREE for any one of the following publications with one year's subscription for RADIO WORLD
- RADIO NEWS or -BOYS' LIFE or
- POPULAR RADIO or -RADIO DEALER or
- RADIO BROADCAST or -RADIO (San Francisco) or
- SCIENCE AND INVENTION or -RADIO AGE or
- COLLIER'S

This is the way to get two publications

- for the price of one
- Send \$1.00 today for RADIO WORLD
- for one year (regular price)
- for 12 numbers
- and select any one of the other
- two publications for twelve months
- Add \$1.00 a year extra by
- Canadian or Foreign Postage.
- Present RADIO WORLD subscribers
- can take advantage of this offer by
- extending subscriptions one year
- if they send renewal NOW.

### RADIO WORLD'S SPECIAL TWO-FOR-PRICE-OF-ONE SUBSCRIPTION BLANK

RADIO WORLD, 16 West 4th Street, New York City

Enclosed find \$1.00 for which send me RADIO WORLD for twelve months (12 numbers), beginning \_\_\_\_\_ and also without additional cost, Radio Broadcast, or Popular Radio, or Radio News, or Science and Invention, or Radio Dealer, or Radio (San Francisco), or Radio Age, or Boys' Life, or Collier's (or \$1.00 for two yearly subscriptions).

Indicate if renewal: \_\_\_\_\_ Name: \_\_\_\_\_ Offer Good Until: \_\_\_\_\_ Street Address: \_\_\_\_\_ June 9, 1926 City and State: \_\_\_\_\_



# An Antenna Coupler for the Super-Heterodyne

To make an inductive antenna coupler for Super-Heterodyne, get the following material:

Two 10 x 17 1/2" spindle sink drains purchased in novelty store; fifteen feet of stranded bare copper antenna wire; brown stain or varnish.

Take one of the sink drains and saw

off two sections containing four spindles for the sides. Take the other and make three ten inch sections of three spindles each. These form the top, bottom and middle braces by dovetailing the three spindles into the three spaces made by the four outside spindles. Drive 1/2-inch fine brad nails at the points of intersection of the three braces with the uprights. This makes a rigid frame for the wire.

Cut the wire off at the ends so that the end clipped will be tightly wrapped, solder tightly and wipe off smooth for about one



DX OWL

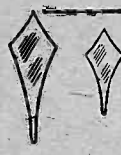

EUREKA JR.

Right to the Point.  
Eureka Dial Pointers  
Polished Nickel or Gilt  
10c Each  
DX Owl Nickel.....10c  
DX Owl Goldplated..15c  
At your dealers or sent  
direct for stamps.  
C. W. BUTTS, INC.  
42 Hedden Place  
East Orange, N. J.

## How to Build

### THE FENWAY

The famous DX set that, by the turn of a switch, is a 4-tube tuned RF set, with regeneration, or a 9-tube Super-Heterodyne! Remarkably sensitive!

Described by Leo Fenway himself in the February 6, 13, 20 and 27 issues, including trouble shooting. Send 60c for all four issues, or send \$6 for year's subscription and get these four copies FREE!  
RADIO WORLD, 145 W. 45th St., N. Y. C.

## The AIRGAP SOCKET

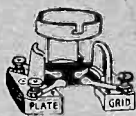

The gap prevents closed circuit, inter-coupling, feedback and undesirable capacity (which causes the squeaks and howls), resulting in more stable circuit, sharper tuning, clearer and louder reception.

Electrically and Mechanically It's Perfect  
Sent direct if your dealer cannot supply you, 75c each.

AIRGAP PRODUCTS CO., Mfr.  
9 Campbell Street Newark, N. J.  
IT GETS THAT LAST MILE

## A Home-Made Leak



(Hayden)

AN EMERGENCY grid leak may be made by drawing a pencil line on the scratchpiece of a book of paper matches and putting the strip on a fixed condenser. The heavier the line the greater the resistance.

## BRUNO DEVELOPS A NEW CONDENSER

Extremely high efficiency and compactness mark Bruno's newest product—a straightline frequency condenser that is of full rated capacity. This condenser successfully "uncrowds the air" by maintaining equal dial separation for equal frequency difference. Price of .0005...

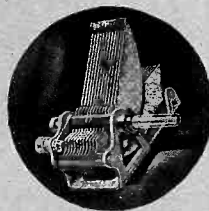

\$4.00

## Something New!

### A Versatile Tube!



The New Switch Tube

Inquiries Invited from the Trade

First time offered to the public! The new Switch Tube is a Power Tube or a regular —O1A Tube, at your option. Just turn the tiny switch in the base to convert it from one to the other. Also, if you burn out the —O1A filament, the tube is still just as good as before, because you simply switch over to the Auxiliary Filament! Works from 6-volt source. Draws .25 amp. as —O1A and .5 amp. as power tube. .... \$3.00

## BRUNO LOW-LOSS COILS

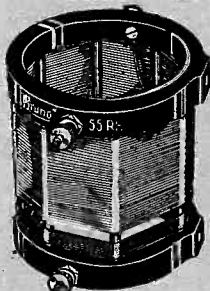

Bruno "99" or "55" RF Transformer. \$3.00



Bruno "99" Tuning Coil ..... \$5.50

## POWERTONE KIT

Complete Parts for the 5-tube 1-dial set described in Radio World, April 17. Bruno 99 RF, Bruno 99 Tuning Coil, Bruno Light Switch, Bruno Dial, Double Condenser, panel, sub-panel, sockets, Bruno brackets, etc. Price ..... \$24.50

Bruno Slo-Moshen Vernier Dials \$2.00

Bruno Magic Dial for SLC Condensers \$2.50

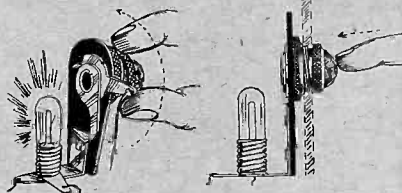

The Bruno Ruby Light Switch is a combination A battery switch and pilot light. When the knob is turned to the right, the bulb lights up, the set is on. When the knob is pressed, the set is turned off. Single hole panel mount. Price, less bulb..... 75c

Send for Our New Bulletin No. 702. It will Amaze You!

## STREAMLINE SLF CONDENSERS

.0005, .00035 or .00025

10,000 of Them! We Bought Out Streamline's Stock.  
Any Capacity—Same Price

\$1.95

B-C-L RADIO SERVICE CO., 223 Fulton Street, N. Y. City

## FOR CLEAR, QUIET "B" POWER



## RADIO Storage "B" Battery

24 Cells 24 Volts  
Economy and performance unheard of before. Recharged at a negligible cost. Delivers unflinching power that is clear, pure and quiet. Approved and listed as Standard by leading Radio Authorities, including Pop. Radio Laboratories, Pop. Sci. Inst., Standards, Radio News Lab., LoFax, Inc. and other important institutions. Equipped with Solid Rubber Case, an insurance against acid and leakage. Extra heavy glass jars. Heavy rugged plates. Order yours today!  
SEND NO MONEY Just state number of batteries is received. Extra offer: 4 batteries in series (96 volts), \$10.50. Pay expressman after examining batteries. 5 per cent discount for cash with order. Mail your order now!

WORLD BATTERY COMPANY  
1219 So. Wabash Ave., Dept. 82 Chicago, Ill.  
Makers of the Famous World Radio "A" Storage Battery  
Prices: 6-volt, 100 Amp. \$11.95; 120 Amp. \$12.95; 140 Amp. \$14.00.  
All equipped with Solid Rubber Case.

World STORAGE BATT. RES.

Set your Radio Dials at 210 meters for the new 1000 watt World Storage Battery Station, WSBC, Chicago. Watch for announcements.

WOKA WFAA WGN WJZ KHU KGO WFAE WJW KOK

## Warsaw Opens Its Official Station



(Underwood & Underwood)

**COUNT SKRZYNSKI**, Polish Premier, opening the ceremony, initiating the inauguration of the Polish broadcasting station at Warsaw. To the right of the Count is the Minister for Education, St. Grabski, and to the left is the Minister of Interior, Raczkiewicz.

### INDEX (from page 23)

- A Practical Chemical B Supply, by Capt. P. V. O'Rourke.
- The Frequency Dials, by Herman Bernard.
- Neutralization of the KB-8, Part III, by M. B. Sleeper.
- Tectron B Eliminator Trouble Shooting, by Lewis Winner.
- APRIL 3—ANNIVERSARY NUMBER**
- The Bernard Portable, an 8-Tube Super-Heterodyne portable, Part I, by Herman Bernard.
- How to Get DX, by Capt. P. V. O'Rourke.
- Adjustment of Grid Bias, by J. E. Anderson.
- A Compact B Supply, by Lewis Winner.
- Loudspeaker Requisites, by Dr. A. N. Goldsmith.
- APRIL 10**
- A Super-Heterodyne from an Old Set, by Caesar King.
- A Stabilized TRF Receiver, by Roger Ferris.
- The T-A 4-Tube Receiver, by Raymond C. Wells.
- DC B Eliminators, Part I, by Lewis Winner.
- Bait That Coaxes in DX, by J. E. Anderson.
- The Bernard Portable, Part II, by Herman Bernard.
- APRIL 17**
- The New 1-Dial Powertone, by Capt. P. V. O'Rourke.
- The Power Booster Set, by Mary C. Drew.
- A 5-Tube Super-Heterodyne, by Jasper Jellicoe.
- Smoothing Out the Tickler, by Jackson Lee.
- The Action of Transformers, by Lewis Winner.
- A Neutralized TRF Set, by Ben Aplin.

- Wiring the Bernard Portable, Part III, by Herman Bernard.
- Etiquette of Listening-In, by Dr. A. N. Goldsmith.
- A Discussion of the RCA Receivers.
- APRIL 24**
- A 4-Tube All Wave Set, Part I, by Capt. P. V. O'Rourke.
- The Novice's Nook by the Beginner's Friend.
- Controlling Feedback, by Barney Feete.
- Curing Bernard Portable Trouble, Part IV, by Herman Bernard.
- Discussion of the Arguments on the Dill-Vestal Copyright Bill.
- Details of Wiring the DC B Eliminator, Part II, by Lewis Winner.
- MAY 1**
- Discussion of The New 3-in-1 Loewe Audion, by Herman Bernard.
- An Analyses of Detection, Part I, by J. E. Anderson.
- The Aero All-Wave Set, Part II, by Capt. P. V. O'Rourke.
- The Coils for the Fenway, by Leo Fenway.
- News About Zenith Victory As To "Piracy" of Wavelength, Dill-Vestal Bills, etc.
- MAY 8**
- The Aid of By-Pass Condensers, by John F. Rider.
- Reflexed Resistance AF, by Theodore Kerr.
- The Key to Selectivity, by K. B. Humphrey.
- A Study of Detection, by J. E. Anderson.
- Four Pages of Q. and A.
- Seven Pages of Up-to-Date Radio News.
- Winding a Loop on a Cardboard Frame.

### BAR MITZVAHE BROADCAST

Said to be the first time in radio history, the Jewish confirmation ceremony, known as the "Bar Mitzvahe," was broadcast through station WRNY, New York City.

### BEAUTY-QUALITY-LOW PRICE

TYPE 5SS •  
5-Tube Toned Radio Frequency. **\$45**  
TYPE 6RR  
6-Tube Resistance Coupled Audio Tuned Radio Frequency **\$50**

*If your dealer cannot make immediate delivery we will ship direct from factory*

**American Interstate Radio Service**  
183 Greenwich Street, New York City  
Distributors, Jobbers, Dealers, write for special trade terms.

### VEBY HIGH-MU TUBES

Made especially for Resistance Coupled Amplifiers. Now you can get more volume with greater clarity.  
A. F. 20 for the 1st and 2nd Stage.....\$3.00  
A. F. 6 Power Tube for 3rd Stage..... 4.50

### VEBY RADIO CO.

47-51 Morris Avenue Newark, N. J.

### New and Improved FRESHMAN MASTERPIECE

AT AUTHORIZED  
FRESHMAN DEALERS ONLY

## ACCUSTI-CONE SPEAKER

FROM FACTORY TO YOU

19-inch Full Size **\$7.50**  
full floating cone

Would cost \$30 in a retail store. You save by buying direct. It is superior to any speaker made. Try it in your home; if not satisfied, return and get money back.

**Accusti-Cone Laboratories**  
96 Church St. New York

# RADIO WORLD'S QUICK-ACTION CLASSIFIED ADS.

10 CENTS A WORD. 10 WORDS MINIMUM. CASH WITH ORDER

**LONG DISTANCE CRYSTAL SET PLANS, \$1.00.** Loudspeaker volume. Patent pending. Write Burgess, 618 3d St., S. W. Washington, D. C.

**SELL AND INSTALL RADIO SETS.** With a \$25 capital we can put you in the radio business and show you how to earn a hundred or two a week. For full details write Columbia Print, Radio Division, 143 West 45th St., New York City.

**THE CONTROL OF FEEDBACK,** by Barney Feete, appeared in RADIO WORLD dated April 24. Sent on receipt of 15c, or start sub. with that issue. RADIO WORLD, 145 W. 45th St., N. Y. C.

**THE AERO ALL-WAVE SET,** by Capt. P. V. O'Rourke, appeared in RADIO WORLD dated April 24 and May 1. Sent on receipt of 30c. RADIO WORLD, 145 W. 45th St., N. Y. C.

**600 MILE RADIO, \$2.95. NO BATTERY** nor tubes needed. Always ready. Fully guaranteed. 200,000 sold. No screeching nor grinding. Real radio, no toy. Sent postpaid. Order one today. Crystal Radio Company, Wichita, Kansas.

### BULLDOGS

**BEAUTIFUL REGISTERED BULL PUPS, \$15.** Bulldogs, 501 Rockwood, Dallas, Texas.

**"ME WANTS MORE DX"**—worth framing. This is the front page of RADIO WORLD dated March 6. If you haven't a copy, get this number and you will find that this youngster with the earphones is one of the cutest little kids you ever saw, except your own, of course. 15c per copy, or start sub. with that number. RADIO WORLD, 145 W. 45th St., N. Y. C.

**THE BERNARD PORTABLE SUPER-HETERODYNE** appeared in RADIO WORLD dated April 3, 10, 17 and 24. Sent on receipt of 60c, or start your subscription with April 3 issue.

**WIRELESS IN THE HOME** by Lee deForest, sent on receipt of 15c. The Columbia Print 145 W. 45th St., N. Y. C.

**KILOCYCLE-METER CHART,** appeared in RADIO WORLD dated May 1. Sent on receipt of 15c, or start sub. with that number. RADIO WORLD, 145 W. 45th St., N. Y. C.

**A PAYING POSITION OPEN** to representative of character. Take orders shoe, hosiery direct to wearer. Good income. Permanent. Write now. Tanners Shoe Mfg. Co., 5-710 C St., Boston, Mass.

**SPECIAL DISCOUNTS ON SETS AND parts.** Send for price lists. Martien Radio Shop, Galion, Ohio.

**THE 5-TUBE SUPER HETERODYNE SET,** by Jasper Jellicoe, appeared in RADIO WORLD dated April 17. Sent on receipt of 15c. RADIO WORLD, 145 W. 45th St., N. Y. C.

**CONSTRUCTION OF RADIO PHONE AND TELEGRAPH RECEIVERS** by M. B. Sleeper, sent on receipt of 75c. The Columbia Print, 145 W. 45th St., N. Y. C.

**DESIGN DATA FOR RADIO TRANSMITTERS AND RECEIVERS** by M. B. Sleeper, sent on receipt of 75c. The Columbia Print, 145 W. 45th St., N. Y. C.

TEAR OFF AND MAIL TODAY

# 8 Week's Trial Subscription, \$1.00

KEEP ABREAST OF THE LATEST  
RADIO DEVELOPMENTS

**RADIO WORLD**  
145 WEST 45th ST. NEW YORK CITY

# Good Back Numbers of RADIO WORLD

The following illustrated articles have appeared in recent issues of RADIO WORLD:

- 1925:
- Aug. 29—A Set a Baby Can Build, by Herbert E. Hayden. A Fine Meter Switchboard, by Lewis Winner.
  - Sept. 12—The 1926 Model Diamond of the Air (Part 1), by Herman Bernard. A 25-to-110 Meter Receiver, by Sidney E. Finkelstein.
  - Sept. 19—Diamond of the Air (Part 2), by Herman Bernard. A Tube B Battery Eliminator, by Louis Winner.
  - Oct. 24—A Phonograph Cabinet Set, by Lewis Winner. The Thoroughbred, by Herbert Hayden (Part 2).
  - Oct. 31—The 4-Tube Pathfinder, by S. E. Finkelstein. How to Make a Simple Loop, by Herbert E. Hayden.
  - Nov. 7—A 3-Tube Dry-Cell Circuit, by Capt. P. V. O'Rourke. One of the Best Crystal Sets, by Herbert E. Hayden. 1-Tube DX Set, Herman Bernard.
  - Nov. 28—The Zero Potential Loop, by Frank Freer. The 1-Tube Headset Receiver, by J. E. Anderson. A Discussion of AF Amplification, by Wm. Fortington.
  - Dec. 5—A Toroid RF Set, Using Crystal, by Lewis Winner. The Diamond of the Air (In Text and Diagram), by Herman Bernard.
  - Dec. 12—A Self-Contained Receiver, by H. E. Hayden (Part 1). B Battery Eliminator, by Lewis Winner (Holiday Gifts No.).
  - Dec. 26—The Regenerative Wave Trap, by John F. Rider. The 5-Tube Tuned RF Set, by Capt. P. V. O'Rourke.
- 1926:
- Jan. 2—The 2-C Set for Simplicity, by Capt. P. V. O'Rourke.
  - Jan. 9—The 4-Tube DX Symphony Set, by A. Irving Witz. A Skillfully Made 1-Dial Set, by Herman Bernard.
  - Jan. 16—Anderson's 5-Tube Quality Receiver, The Raytheon B. Eliminator, by Lewis Winner.
  - Jan. 23—The 4-Tube Diamond of the Air, by Herman Bernard. B Batteries Last Six Months, by S. E. Finkelstein.
  - Jan. 30—An Individual AF Amplifier, by H. E. Hayden. The Antennatrol, by Herbert Hayden (Part 2). Trapping Out Super-Power in New Jersey, by Capt. P. V. O'Rourke.
  - Feb. 6—The Fenway (4 or 9 tubes), by Leo Fenway (Part 1). The Great 1-Tube DX Set, by Herman Bernard.
  - Feb. 13—Anderson's 5-Tube Economical Receiver, Trouble Shooting for Novices, by M. B. Stock. The Fenway, by Leo Fenway (Part 2).
  - Feb. 20—The 8-Tube Victoreen, by Herbert E. Hayden. The Fenway, by Leo Fenway (Part 3). Quality Stressed in 3-Tube Set, by Brainard Foote.
  - Feb. 27—The 4-tube DX Dandy, by Herbert E. Hayden. Umbrella Aerial for DX, by Hugo Gernsback. Part 2 of The Victoreen.
  - Mar. 6—The 1 tube Set, by Capt. O'Rourke. The Chemistry of Batteries, by A. R. Reid. The Victoreen Set (Part 3), by Herbert E. Hayden.
  - Mar. 13—The Non-Regenerative Browning-Drake Set, by M. B. Sleeper. The Tectron Eliminator (Part 1), by Lewis Winner. Curing Victoreen Trouble, by Herbert E. Hayden.
  - Mar. 20—The Super-Heterodyne, by J. E. Anderson. A 2-Tube Speaker Set, by Percy Warren. The Browning-Drake Set (Part 2), by M. B. Sleeper. A 2-tube Eliminator, by Lewis Winner.
  - Mar. 27—An Economical 4-Tube Set, by Edgar T. Collins. A Practical B Battery, by Capt. P. V. O'Rourke. Tectron Trouble Shooting, by Lewis Winner.
  - April 3—The Bernard Portable, by Herman Bernard (Part 1). How to Get Dx, by Capt. P. O'Rourke. A Compact B Supply, by Lewis Winner.
  - April 10—The Bernard Portable, by Herman Bernard (Part 2). Two Eliminators for DC, by Lewis Winner. A Super From An Old Set, by C. King.
  - April 17—The New 1-Dial Powertone, by Capt. P. V. O'Rourke. The Bernard Portable (Part 3), by Herman Bernard. The Action of Transformers, by Lewis Winner.
  - April 24—All Waves on One Set, by Capt. P. O'Rourke. Bernard's Portable (Conclusion). Control of Feedback, by Barney Peete.
  - May 1—New Multiple Tube, by Herman Bernard. The Aero All-Wave Set, by Capt. O'Rourke. Kilocycle-Meter Chart. Official List of Stations. An Analysis of Detection, by J. E. Anderson.
  - May 8—A Study of Detection, by J. E. Anderson, Part 2. To Wind a Loop on a Card-board Frame. How to Reflex Resistance AF, by Theo. Kerr.

Any copy, 15c. Any 7 copies, \$1.00. All these 29 copies for \$4.00, or start subscription with any issue. RADIO WORLD, 145 W. 45th St., N. Y. C.

## Talks on Topics Weekly

## Odd Set

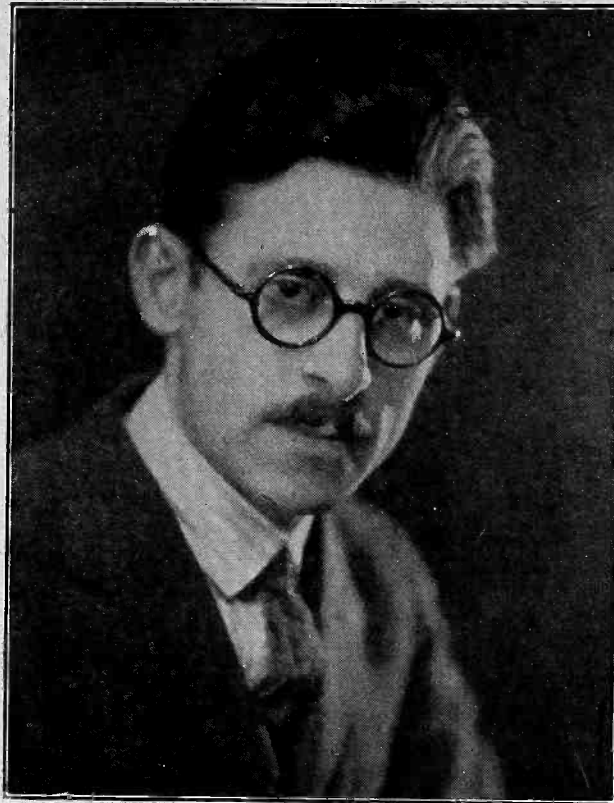

MICHAEL L. SIMMONS, motion picture critic and author, broadcasts on picture topics from WFBH each Friday at 5:45 p. m. WFBH is the Warners Theatre Studio, New York City. Mr. Simmons is associate editor of the "Exhibitors Daily Review."

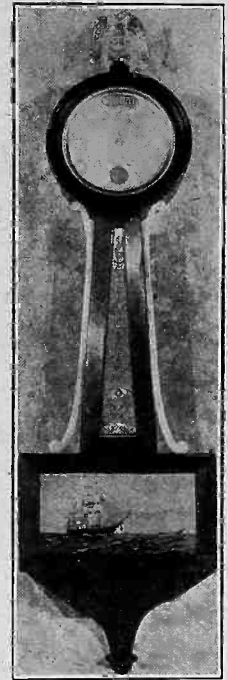

(Hayden)

AN enterprising fan made a radio set to fit in a banjo clock. The single dial is at top, where the clock face was. The set is below, behind the pendulum ornament.

### GEM TUBE

A Guaranteed Radio Tube Within Reach of All. Every tube guaranteed. A tube for a dollar of \$2 value. A trial order will convince you as it has thousands of others. Send your orders at once. Orders sent C.O.D. parcel post.



1.00

Type 200  
Type 201-A  
Type 199  
Type 199-A with Standard Base  
Eac'  
Dealers, Write for Discounts

GEM TUBE CO.  
Dept. W, 200 B'way, N. Y. C.  
220 So. State St., Chicago, Ill.  
Lafayette Bldg., Detroit, Mich.

### THE VICTOREEN

How to build this 8-tube Super-Heterodyne described in February 20, 27, March 6 and 13 issues of RADIO WORLD. Send 60c for all four copies. Send \$6 for year's subscription and get these four copies FREE!

RADIO WORLD  
145 W. 45th St. New York City

TABLE FOR CONVERSION OF FREQUENCIES AND METERS appeared in RADIO WORLD dated May 1, 1925. Sent on receipt of 15c, or start your sub. with that number. RADIO WORLD, 145 W. 45th St., N. Y. C.

### "DIAMOND of the Air" PANELS



All Drilled and Engraved Worth \$4.00  
\$1.60 ea. C.O.D.  
Cortlandt Panel Engraving Co.  
79 Cortlandt Street New York City

### KILL STATIC

GET TONE QUALITY  
All summer control volume instantly — from a whisper to maximum. Smooth out powerful locals. Dampen annoying noises with a

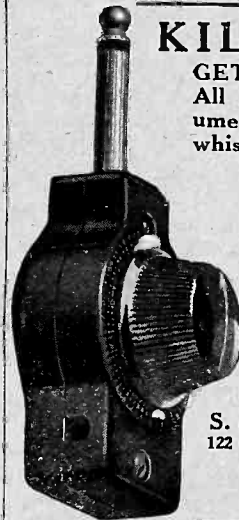

Centralab  
Modulator Plug  
Instantly attached to any set. Improves any Loud Speaker Sent Postpaid on receipt of \$2.50  
S. & H. INC., Sales Div.  
122 Greenwich St., N. Y. C.  
Approved by RADIO WORLD Laboratories

1926 DIAMOND OF THE AIR BOOKLET with full instructions to make the Diamond, with blue print, 50c. Newsdealers and radio dealers can get supply from American News Co. and its branches. RADIO WORLD, 145 W. 45th St.,

RADIO WORLD'S  
Fifth Annual Vacation Number  
June 12th

# The Detection Principle In Super Heterodynes

[Parts I and II of this article by J. E. Anderson on detection were published in the May 1 and 8 issues. Part III, the conclusion follows.]

There are three main products of a modulator of any of these types; first, the carrier frequency; second, the summation frequency; third, the difference frequency. The summation frequency is the sum of the carrier and the modulating frequency; the difference frequency is simply the difference between them. In broadcasting, all of these frequencies are transmitted, and the summation and difference frequencies are so nearly equal to the carrier that no differentiation between them is made in ordinary broadcast receivers. In the Super-Heterodyne they are widely different. The modulating frequency is of the same order of magnitude as the carrier frequency; the summation frequency is approximately twice as great as either of the components. The difference frequency is comparatively very small. In ordinary broadcast reception one tuned circuit, or filter, can pick out all the three parts; in the Super-Heterodyne one filter can pick out only one component. The filter may be tuned to any one of the three main components. If it is tuned to the carrier, that is, to the frequency of the local oscillator, nothing is received because this does not carry any audio frequencies. It may be tuned to the summation frequency. This does carry audio frequencies, and the original broadcast matter may be received on this summation frequency. But nothing would be gained especially by doing that, and a great deal would be lost because an amplifier tuned to this high frequency would be less efficient and more troublesome than an amplifier tuned to the original modulated carrier. The filter is usually tuned to the difference frequency, which also carries the original broadcast matter. Since this frequency is very low, comparatively, an amplifier tuned to this is very efficient and not very troublesome. While the difference frequency is only one of the two side frequencies locally generated, it carries both of the side bands of the original carrier frequency broadcast.

### Where Mixing Fails

Just one more statement regarding whether the Super-Heterodyne modulator or first detector is, or should be, oper-

ated as a detector. The alternative is to operate the tube as an amplifier. If it were, and if its characteristic were perfectly straight over the region involved, the two waves, the signal wave and the locally generated wave, would pass through it independently of each other, both being amplified. There would be no more modulation or mixing of the two than there is modulation in the ether of light waves or radio waves of different frequencies, or of two distinct sound waves in air, or of two independent waves in water. They pass through the same medium, cross each other with a simple how do you do, and go on their way unaffected by the meeting. The modulation of two sound waves of different frequencies often

heard in music takes place in the ear of the observer.

Which is the better detector method, the grid bias or the leaky condenser? The consensus is almost unanimous for the leaky condenser. But it depends somewhat on purpose and conditions. For weak signals the leaky condenser method is unquestionably far superior, provided that the plate potential, the grid potential, the capacity of the grid battery and the resistance of the grid leak have been properly coordinated. For very strong signals the method is not so good on account of the tendency for the grid to block. For such signals the high grid bias method is more stable in operation, and it is just about as sensitive provided that the grid bias has been carefully adjusted. In cases where the difference between the carrier frequency and the modulating frequency is not great the grid bias method is, in my opinion, superior for reasons already pointed out.

Bring in Europe on a  
**Victoreen "Super"**  
Write for Layout and Parts List  
**THE GEORGE W. WALKER CO.**  
6515 Carnegie Avenue Cleveland, Ohio

## FREE RADIO CATALOG



Just off the press! Our second catalog for 1926. 100 pages of parts, accessories, kits and sets—all the best and the latest. A copy is yours for the asking. Just drop us a line—do it today!

DEPT. PM  
**CHICAGO SALVAGE STOCK STORE**  
509 S. State Street CHICAGO, U. S. A.

22½ volt rechargeable "B" Storage Battery  
**\$2.95**  
includes chemical



45 volts, \$5.25; 90 volts, \$10.00; 112½ volts, \$12.50; 135 volts, \$14.75; 157½ volts, \$16.80. Truly, the biggest buy today. Easily charged on any current, including 32-volt systems. Any special detector plate voltage had. Tested and approved by leading authorities such as Popular Radio Laboratories. Over 3 years sold on a non-red tape, 30-day trial offer with complete refund if not thoroughly satisfied. Further guaranteed 2 years. Knock-down kits at great savings. Complete "Hawley" "B" battery charger, \$2.75. Sample cell, 35c. Order direct—send no money—simply pay the expressman cost on delivery. Or write for my free literature, testimonials and guarantee. Same day shipments. B. Hawley Smith, 318 Washington Ave., Danbury, Conn.

## FENWAY

—for DX

Winter or Summer the Fenway is a consistent DX-getter. Naturally, you want to own one of these super-sensitive receivers. Fenway Blueprints show you how to build a laboratory set.

PRICE OF COMPLETE SET OF BLUEPRINTS—\$3.00 Postpaid  
Others Give Their Radio Prints Away FREE!—Fenway Prints Cost You \$3.00—WHY?

Radio Division, The Columbia Print  
147 West 45th Street New York City

### JAYNXON TONE BRIDGE

GETS THE REAL TONE VALUE FROM LOUD SPEAKER

Direct Battery Current Spoils a Speaker—A JAYNXON TONE BRIDGE Saves It! Perfect volume control without change of quality. Reduces static interference.



**\$10.00** Post-Paid  
A Jaynxon Product "Gets the Tone—From Horn or Cone"

Matches Tube Impedance to All Speakers  
**JAYNXON LABORATORIES**  
57 DEY STREET NEW YORK CITY  
Approved by RADIO WORLD Laboratories

### 1925 BACK NUMBERS OF RADIO WORLD WANTED

Mail us copies of any of the following 1925 issues of RADIO WORLD, and we will send you a copy of a current issue for every copy sent us: January 10, February 21, March 21, 23, April 4, 11, 25; May 16, 23, 30; June 6, 13, 20; July 4, 11, 18, 25; Aug. 8, 15, 22; Sept. 5, 26; also Jan. 23, 1926.

## FILL OUT AND MAIL NOW

### SUBSCRIPTION BLANK

# RADIO WORLD

RADIO WORLD 145 West 45th Street, New York City (Just East of Broadway)

Please send me RADIO WORLD for ..... months, for which please find enclosed \$.....

SUBSCRIPTION RATES:  
Single Copy ..... \$ .15  
Three Months ..... 1.50  
Six Months ..... 3.00  
One Year, 52 Issues ..... 6.00  
Add \$1.00 a Year for Foreign Postage; 50c for Canadian Postage.

**S. HAMMER RADIO CO.**  
303 Atkins Avenue, Brooklyn, N. Y.  
Please send me FREE, Your NEW  
**RADIO CATALOG**

Name .....  
Address .....  
City ..... State .....

FILL OUT AND MAIL

# The Oscillator as Used in W. E. Super-Heterodyne

The circuit diagram shown is a form of the Hartley oscillator. With this system, a great oscillatory action of the tube is obtainable. A fixed condenser of about .006 mfd. may be shunted between the opposite ends of the plate and grid coils which are connected to the rotary and stationary plates of the variable condenser. This will cause the tube to oscillate more readily, giving the variable condenser a greater controlling range. The coil in series with the grid of the detector tube is for coupling with the grid of the oscillator coil, so that energy may be transferred.

This oscillator and first detector arrangement are similar to that employed in

the Super-Heterodyne used by the American Telephone and Telegraph Co. for measuring field strengths at broadcast frequencies. The receiver was designed by Western Electric.

This oscillator detector arrangement may be hooked in to take the place of other oscillator detector circuits, in Supers. The grid coil may consist of 36 turns wound on a tubing 3" in diameter, while the plate coil may consist of 34 turns wound on the same tubing with a 1/8" separation between the two. About No. 26 single silk covered should be used. The oscillator condenser should have a capacity of .0005 mfd.

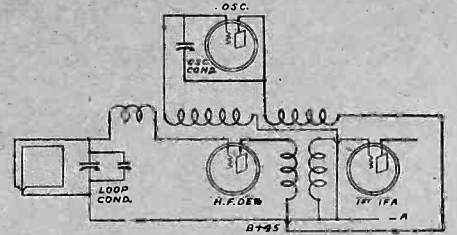

**FREQUENCY CHANGING system used in Western Electric Super-Heterodyne.** The extra condenser on the loop is a parallel vernier and one like it (not shown) is used on the oscillator condenser.

## Special \$25,000 Organ In Remodelled WBBM

CHICAGO

A new \$25,000 specially designed broadcasting Barton Pipe Organ; a completely remodeled and enlarged studio; important additions and changes in the musical staff.

These are some of the developments announced by Charlie Garland, broadcasting director, in connection with the recent change in policy of Station WBBM, the Stewart-Warner Air Theater, Chicago.

The new organ was built by the Bartola Musical Instrument Company of Chicago, who for a number of years have specialized in pipe organs used in broadcasting. In the new instrument are incorporated changes dictated by past experience in broadcasting stations. It has been specially designed by Dan Barton, originator of this type of organ.

The installation of this instrument together with additions to the staff has made necessary the remodeling of the studio. The new arrangement is designed to give the Air Theater the most up-to-date studio possible. There will be a large waiting room for artists and listeners separated from the studio itself by plate glass windows. In addition there will be a specially designed sound proof announcer's booth that will enable announcers to concentrate on their work and will eliminate studio noises and interruptions.

## Reading is First Road To Seek Radio Goodwill

The Reading Company, the first railroad in the country to enter the broadcasting field, gave its first concert over Station WJZ, where the Reading Seashore Band was on the air from 9 to 10 p. m. It is planned to give a program every Monday night at the same hour.



# No Noises!

Tones clearer, voices more distinct, and volume greater with—AMPERITE. No moving parts. It brings the utmost out of each individual tube. Specified in all popular construction sets. Price \$1.10.

*Radiall Company*

Dept. R.W.-5, 50 Franklin Street, New York City



Write for FREE Hook-ups

# AMPERITE

REQ. U.S. PAT. OFF.

The "SELF-ADJUSTING" Rheostat

## Join the Happy Diamond Family!

Build This Famous 5-Tube Set and Know Real Quality Reception!

Easy to Build, Easy to Tune!

Herman Bernard, designer of this wonder circuit, has written an illustrated booklet on "How to Build RADIO WORLD'S 1926 Model Diamond of the Air." Send 50c and get this booklet, including a full-sized wiring blueprint. Also name plate, FREE.

### Outstanding Features of Set:

- (1) Fans, charmed by tone quality, sensitivity and selectivity, report speaker reception of far-distant stations with great volume.
- (2) A 2-tube earphone set, a 5-tube speaker set, and a separate 3-stage audio-amplifier for immediate use with any tuner, are combined in one.
- (3) No rheostats are used.
- (4) The set is inexpensive to construct and maintain.

### What the Circuit Is

The 1926 Diamond consists of one stage of tuned radio-frequency amplification, regenerative detector, one transformer-coupled audio stage, and two resistance audio stages—the utmost from five tubes!

### Follow Bernard

You can't go wrong if you follow the directions as written by the designer himself, as contained in the booklet. The diagrams, including blueprint, are guaranteed 100% accurate. Play safe!

Send \$6 for year's subscription and get booklet blueprint and nameplate FREE.

[Newsdealers or radio dealers, order the booklets with blueprints included, in quantity, direct from American News Co. or branches.]

**RADIO WORLD**  
145 West 45th St., New York City

## NEW 1926 FREE RADIO GUIDE

Newest Edition Ready

Shows the latest circuits, the newest developments in radio at startlingly low prices. Get the parts you want here and save money. The best in parts, kits, sets and supplies. Orders filled same day received. Write for free copy NOW; also please send names of one or more radio fans.

BARAWIK COMPANY, 102-140 So. Canal St., Chicago.

We Specialize in Complete Kits  
The M. & H. Engineering Service Will Supply Parts or Complete Sets of Any Hook-Up

DESCRIBED IN THIS OR ANY OTHER RADIO MAGAZINE

M & H SPORTING GOODS CO.  
512 Market St. Philadelphia, Pa.

Alden Processed



Sockets and Dials

ALDEN MANUFACTURING CO.

Dept. S-5 Springfield, Mass.

## PHONOGRAPH OWNERS!

Convert your phonograph into the latest amazing electrical machine. Startling in its life-like reproduction of the new electrically recorded records. For a few dollars and several hour's time you may have the world's greatest talking machine. Operates on dry cells or lamp socket. Building plans by Hartman and Jenkins, formerly with Westinghouse Electric & Mfg. Co. and Western Electric Co. \$1.00 cash or C.O.D. Absolute satisfaction guaranteed. E. E. Hartman, 738 Garfield Ave., Kansas City, Kansas.

## Vacuum Tubes Rebuilt \$1.00 each

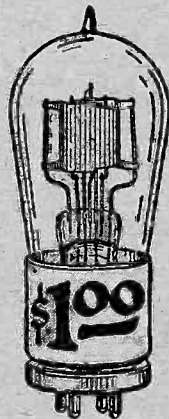

POSITIVELY GUARANTEED equal to new tubes in every respect. Money will be refunded if tubes prove unsatisfactory for any reason other than burn-outs.

Send us your broken and burned out tubes by parcel post. (Not necessary to insure or guard against breakage.) We make return shipments by parcel post C.O.D. and try to maintain 24-hour service.

**HARVARD RADIO LABORATORIES**

200 Old Colony Avenue South Boston, Mass.

The world's greatest variable grid leak, distributed by the North American Bretwood Co., is selling enormously, and is giving universal satisfaction. Get more out of your set by using the Bretwood Grid Leak. Mailed for \$1.50. Radio Division, The Columbia Print, 145 W. 45th St., N. Y. C.

# RADIO NEWS

Regular Subscription Rate \$3 the Year

## BIG SPECIAL OFFER

**\$2.00 Value for \$1.00**

**Your Choice of Either of These Valuable Premiums.**

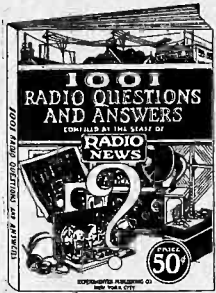

### 1001 Radio Questions and Answers

A brand new book filled to the brim with a priceless array of selected Questions and Answers that are necessary to every one in the construction, care and maintenance of modern sets, including information on hundreds of simple and complex circuits in common use today.

Contains 116 pages, 300 illustrations, size 9x12 inches—a big book for every radio man.

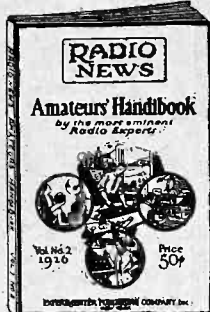

### Amateurs Handbook

The "RADIO NEWS" Amateur Handbook is a large 116-page magazine size book containing a wide, varied and carefully selected array of the finest and most helpful radio articles that have appeared in the pages of Radio's Greatest Magazine, **RADIO NEWS**.

The cream of practical, up-to-the minute circuits and miscellaneous information and data is culled from **RADIO NEWS** and presented in compact form in this book. It embraces every phase of radio, but particularly the new and more practical receivers and circuits developed for modern reception.

Radio News has been radio's greatest and biggest magazine since the very beginning of radio broadcasting. It is the outstanding authority in the radio industry, carrying more new developments, more detailed drawings and more news than any other radio periodical. Some of the regular features are liberal prize offers, an attractive rotogravure section, articles by Hugo Gernsback and other foremost writers, departments giving Standard Hook-ups, Radio Patents, etc. In short, Radio News covers everything worth while in the radio field.

**SEND ONLY \$1.00 FOR SIX MONTHS' TRIAL SUBSCRIPTION TO "RADIO NEWS"—and take your choice of either of the two valuable premiums shown in this advertisement.**

*If you desire both premiums send \$2.00 for a full year's subscription.*

**EXPERIMENTER PUBLISHING CO., Inc.**

53 Park Place (Dept. W.)

New York, N. Y.

**DON'T MISS THIS BOOK—Fresh from the Press!**

# "500 RADIO WRINKLES"

**A big book full of short cuts, hints and practical ideas**

The 500 RADIO WRINKLES BOOK is a very comprehensive compilation of the best time and money saving hints that can be effected. Under fifteen separate and distinct headings, the entire field of radio apparatus and instruments has been covered in simple, understandable language. It is divided into sections covering Antennae, Batteries, Coil Mountings, Condensers, Crystal Detectors, Inductances, Lightning Protectors, Loop Antennae, Loud Speakers, Resistances, Sockets, Switches, Transformers, Vernier Dials. There are no ifs nor buts to complicate directions. The Beginner as well as the more advanced radio man will soon find that this book contains a veritable storehouse of practical, inexpensive hints toward improving his radio apparatus.

**Large Size 9x12 Inches, 100 Pages, Illustrated**

*If your dealer cannot supply you, write direct to*

**EXPERIMENTER PUBLISHING CO., Inc.**

53 Park Place

(Dept. W)

New York, N. Y.



**PRICE 50c.**

**ON ALL NEWSSTANDS**

100 PAGES  
SIZE 9x12 INCHES

# RADIO WORLD'S

## Fifth Annual Vacation Number

### JUNE 12th

A radio doubles vacation joys, gives baseball and all sports results, play by play; there are no dull, rainy days at seashore or mountains with a radio.

Thousands of RADIO WORLD'S readers are now most interested in installing radio in their bungalows, summer cottages, pleasure boats, camps and hotel rooms. This Vacation Issue of June 12th will give the latest and best information on portables, battery eliminators, DX getters, new sets and hookups.

Advertisers  
read this



RADIO WORLD is  
the only national  
WEEKLY.

The one radio publi-  
cation giving quick,  
immediate results.

RADIO WORLD'S  
readers are buying  
NOW.

Offer to send them  
your goods direct  
from factory—many  
of them live miles  
from a radio dealer.

You will be surprised  
and amazed at the big  
direct returns that  
RADIO WORLD'S  
advertisements give.

## The Trade's Best Opportunity to Build a Big Sales Demand

RADIO WORLD is now the only illustrated national radio fan weekly. RADIO WORLD is the only publication having 100,000 weekly readers, most of whom are *experimenters* in radio. RADIO WORLD'S readers build sets for the fun of it, the thrill of the successful experiment, and when something new comes along they start all over again with a new set, and they not only build sets but buy sets as well.

"Drops of water wear away the hardest granite." Even a small advertisement in RADIO WORLD brought to our readers' attention week by week, fifty-two times a year, wears away trade resistance and brings a brand or trade-mark to the buyers' attention so persistently it creates real demand. RADIO WORLD gives you a service that no other publication can, because it is a radio *service* publication.

Fiction magazines of general circulation supply the best fiction; newspapers, even small-town papers, give good radio programs, but only RADIO WORLD gives real weekly radio service information—the newest things in radio, the latest and best hookups, the last word in battery service and elimination, etc. In other words, RADIO WORLD is the only national radio weekly, and its 100,000 weekly fan readers who are constant buyers of radio can give you the biggest result for your advertising dollar.

RADIO WORLD is dated each Saturday, is on the news-stands the previous Wednesday, and closes each Wednesday noon, ten days in advance of date of issue. Results are

quicker from RADIO WORLD than any other radio publication. A single inch message can be delivered in RADIO WORLD to the 100,000 people most interested in radio throughout the United States in ten days for ten dollars.

RADIO WORLD gives its advertisers every possible editorial co-operation. The set builder as a rule follows as closely as possible the laboratory models of radio tuned circuits in which the manufacturer's article is specified, and in this way it is constantly creating a demand, and new users for radio parts and accessories.

In regard to factory-made sets, we take various leading sets from week to week, giving full and detailed information regarding each particular set, creating not only a demand for the goods but showing the buyer in advance how to get the best possible results from the set, making the buyer a pleased and satisfied customer that will recommend your set to his friends. To get any real joy out of radio, one should know something about radio. RADIO WORLD fifty-two times a year is putting joy into radio reception by giving useful radio information—nothing else—no programs, no fiction—*just all radio*.

To sell the retailer is important, but not the most important thing. The big idea is to move your goods off the dealers' shelves. It has been proven over and over again that RADIO WORLD, with its week-by-week advertising urge, can best do this at the lowest cost. May we send you the proof? RADIO WORLD, 145 W. 45th St., New York.

Summer schools, camps, hotels throughout the country receive and preserve RADIO WORLD'S Vacation Issues.

Thousands of extra circulation—no increase in advertising rates: Page \$300, Column \$100, Inch \$10.

Extra color red FREE on full page advertisements if copy is received by Tuesday morning, June 1st.

**LAST ADVERTISING FORMS CLOSE JUNE 2nd**

FRED S. CLARK, Advertising Manager

**Radio World, 145 W. 45th St., New York**

**The Newest Up-to-the-Minute Radio Set—It has Never Been on a Dealer's Shelf—Most Selective. A Wonderful DX Getter. Sold on a Guarantee of Satisfaction or Money Back.**

**Volume Control—Perfect Calibration—Range 180-550**

# BST-6

**B-for Beauty  
S-for Selectivity  
T-for Tone purity  
6-its 6 tubes for distance**



**The BST-6. 2 Feet 4 Inches Long. 9 Inches Inside Depth. 8 3/4 Inches High.**

**T**HIS marvelous six-tube tuned radio frequency receiver is Self-Equalized and built of low-loss materials throughout. Its clear, rich tone of astonishing volume is a revelation. The circuit consists of two stages of tuned radio frequency, tube detector and three stages of balanced audio amplification. Air cooled rheostats and universal sockets are used.

Modified straight line frequency variable condensers are employed, insuring separation of the low wave length stations. **PERFECT CALIBRATION—STATIONS ONCE TUNED IN CAN ALWAYS BE LOGGED AT THE SAME DIAL POINT.**

The BST-6 works best with a 75 to 100 foot aerial, 6 volt "A" storage battery, two 45 volt "B" batteries, 4 1/2 volt "C" battery, six 201-A tubes and any good loudspeaker.

### Specifications

- Bakelite Panel, Walnut Finish—
- With Etch-O-Gravure and Gold Decorations—
- Bakelite Sub-Base—
- Kurz-Kasch Bakelite-Walnut Pointers; Gold-filled, to Match—
- Kurz-Kasch Bakelite Gold-filled Rheostat Knobs—
- Lubree Straight Line Frequency Condensers—
- Special Coils; Double Silk Solenoids—
- Shore Audio Transformers—
- Caswell-Runyan Two-tone Walnut-Finished Cabinet.

### LOG OF BST-6

**Taken on a Fifteen-Foot Aerial in One-Half Hour by Al. Kraus, 996 Aldus Street, New York City.**

WSBC .....	10	WGY .....	50
WBBR .....	16	WMAK .....	51
WEBH .....	49	WMSG .....	11
WHT .....	55	WOC .....	85
WCCO .....	61	WFAA .....	78
WSB .....	66		

### SELECTIVITY

I live within four blocks of WLWL, and since the opening of this station have had great difficulty in choking them off my old set. Even after employing a wave trap I could still hear WLWL around the entire dial and was told by several friends that living so near this powerful station it would be impossible to entirely cut them out with anything less than a super-het. It was a very agreeable surprise, therefore, when I installed my new BST-6, to find that while WLWL came in on 25 I could tune in WRNY on 21 and entirely cut out WLWL. **This is certainly real selectivity.**—F. S. Clark, 350 West 55th Street, New York City.

### Guarantee

*Satisfaction or Money Back*

Each receiver is tested and retested, boxed and inspected before leaving factory, and guaranteed to reach you direct in perfect condition. Workmanship throughout guaranteed the best. Assembled by experts.

### Immediate Delivery

**Direct from factory to you  
No dealers' or middlemen's profits**

**\$40.00**

**SAFETY FIRST!**—Why buy obsolete models, or radio failures at department store "bargain sales" when a BST-6, the latest achievement in radio, can be bought direct from the factory with no department store profit added? Here is a real bargain, sold you with a guarantee of satisfaction or money back.

Send Check or P. O. Money Order to

**COLUMBIA PRINT,**

Radio Division, 143 West  
45th St., New York City

**RADIO WORLD Guarantees the Responsibility of This Advertiser**