

# SHORT-WAVE HOOKUPS!

OCT. 10

1925

# RADIO WORLD

Title Reg. U.S. Pat. Off.

15 CENTS

139-185  
Vol. 8. No. 3 ILLUSTRATED Every Week

## THE 3-TUBE 3-CIRCUIT TUNER

*Described for the Novice by Capt. Peter V. O'Rourke*

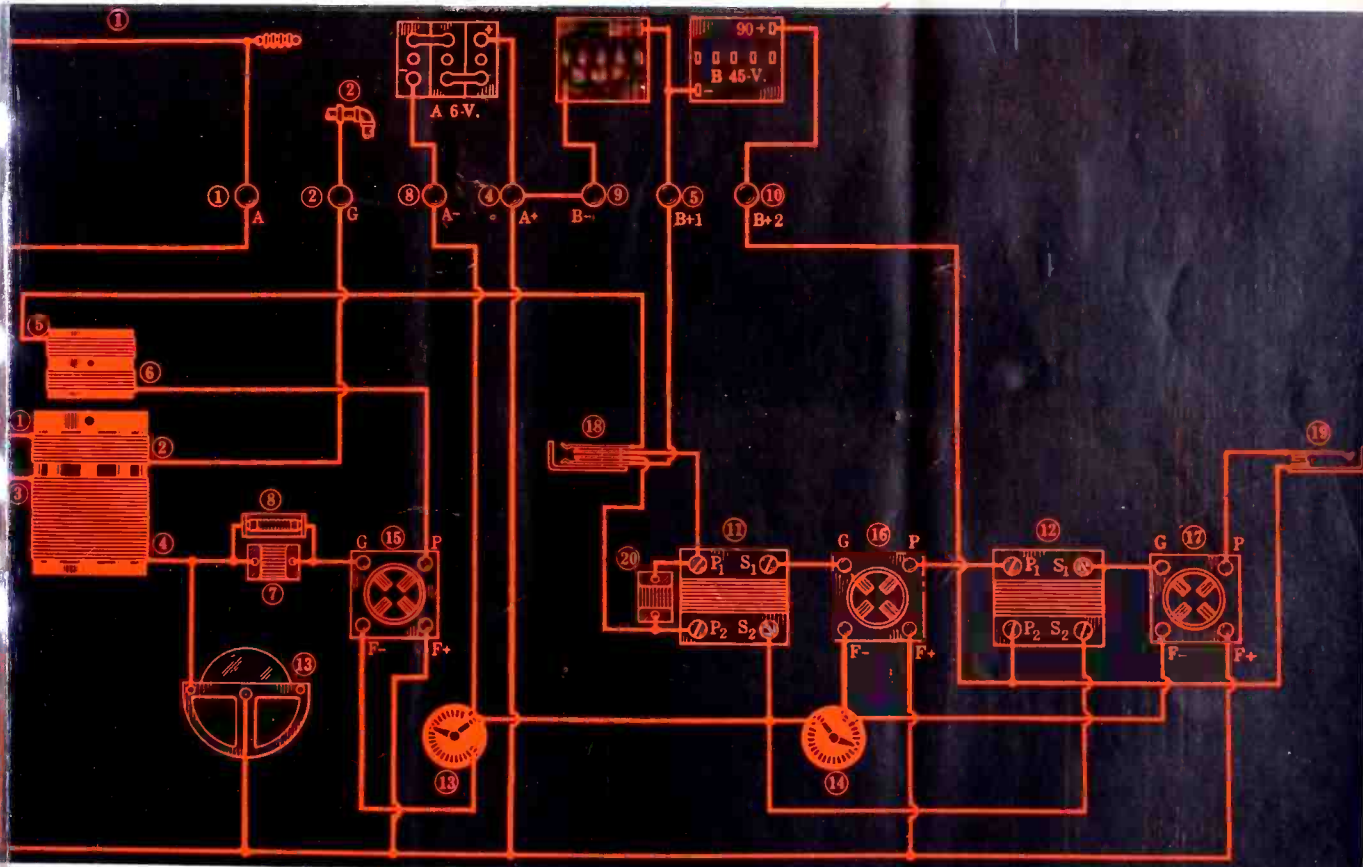

A BLACK-AND-RED PRINT picture diagram of the 3-circuit tuner. See page 5.

HOW TO WIRE THE THORDARSON-WADE  
*AF Hookups for Amplifying Low Notes*  
THE 6-TUBE SET THAT THRILLED JACK

NEW IMPROVED  
**FRESHMAN MASTERPIECE**  
 AT AUTHORIZED FRESHMAN DEALERS ONLY

**LESTRON**  
 THE REAL 110 VOLT  
**TUBE**  
 Works Without Batteries  
 FOR A. C. or D. C. NO REWIRING  
 LESTEIN CORPORATION  
 2 BROADWAY N. Y. CITY

**RADIO DE LUXE**  
 THE CLEARFIELD 6 TUBE  
 Encased in plate glass cabinet. Tuned Radio Frequency with Resistance Coupled Amplifiers \$115  
 tion. True Tone Quality. List Price... \$115  
 Write for Illustrated Booklet.  
 Sherman Radio Mfg. Corporation  
 112-114 Trinity Place New York, N. Y.  
 Dealers write for our proposition.

**KESTER Radio SOLDER**  
 (Rosin-Core)  
 If your dealer cannot supply you  
 send us 25c in postage  
**CHICAGO SOLDER COMPANY**  
 CHICAGO, U. S. A.

**"HOW TO MAKE—"**

- The following illustrated constructional articles have appeared in recent issues of RADIO WORLD:
- Sept. 6, 1924—A simplified Neutrodyne with Grid Biasing Detector, by J. E. Anderson.
  - A Low Loss Wave Stud, by Brewster Lee.
  - Sept. 27—A 1-Tube No Crystal Reflex, by Lieut. P. V. O'Rourke.
  - Dec. 13—The World's Simplest Tube Set, by Lieut. P. V. O'Rourke.
  - Dec. 20—A 1-Tube DX Wonder, Rich in Tone, by Herman Bernard. An Interchangeable Detector, by Chas. M. White.
  - Dec. 27—A 2-Tube Variometer Set, by Lieut. P. V. O'Rourke.
  - Jan. 3, 1925—A 3-Tube Portable That Needs No Outdoor Aerial, by Abner J. Gelula.
  - Jan. 17—A \$25 1-Tube DX Wonder, by Abner J. Gelula.
  - Jan. 24—A Selective \$15 Crystal Set, by Brewster Lee. A Variometer-Tuned Reflex, by Abner J. Gelula. An \$18 1-Tube DX Circuit for the Beginner, by Edwin Rofnaitkin.
  - Jan. 31—A Regenerative Neutrodyne for More DX, by Abner J. Gelula. A Transcontinental 7-Tube Set, by M. E. Wright. An Experimental Reflex, by Lieut. P. V. O'Rourke.
  - Feb. 14—A Super-Sensitve Receiver, by Chas. H. M. White. A Honeycomb RFT for DX, by Herbert E. Hayden.
  - Feb. 21—A 1-Tube Reflex for the Novice, by Feodor Rofnaitkin. A Set for Professional Folk, by Lieut. P. V. O'Rourke. A Honeycomb Crystal Receiver, by Raymond B. Wallis.
  - Feb. 28—A Set That Does the Most Possible, With 6 Tubes, by Thomas W. Benson. Three Resistance Stages of AF on the 3-Circuit Tuner, by Albert Edwin Sonn.
  - March 7—Storage B. Battery, by Herbert E. Hayden. Benson's Super-Heterodyne. Ideal Coils for Best Circuits, by J. E. Anderson.
  - March 14—The Reflected 3-Circuit Tuner That You Can Log, by Herman Bernard. The Right Way to Put Coils and Condensers in a Set, by Rvri C. Caldwell.
  - March 21—A Variable Leak, by Herbert E. Hayden. A 4-Tube, 3-Control Set That Gets the Most DX, by Lieut. P. V. O'Rourke.
  - March 28—The Improved DX Detector, by Herbert E. Hayden. A 3-Tube Reflex for the Novice, by Feodor Rofnaitkin.
  - April 18—The Diamond of the Air (Part 3), by Herman Bernard. The 7-Tube Presley Super-Heterodyne (Part 1), by Thomas W. Benson. An Easy D. Call, by Jack Norwood.
  - May 9—A Set to Cut Strife, by Feodor Rofnaitkin. Toroid Circuit with Resistance AF, by E. I. Sidney. A Push-Pull AF Amplifier, by Lt. Peter V. O'Rourke.
  - May 16—A 3-Tube Reflected Neutrodyne, by Percy Warren. The Roby Portable, by Herbert E. Hayden. One Tube More for Quality, by Brewster Lee.
  - June 6—The Smokestack Portable, by Neal Fitzslan. A and B Battery Eliminators, Using DC (Part 1), by P. E. Edelman. A Wavemeter, by Lewis Winner. Full List Broadcasting Stations.
  - June 13—Simple Short-Wave Circuits, by Herbert E. Hayden. A Simple Push-Pull Rheostat, by A. C. G. Fren. A and B Battery Eliminators, Using AC (Part 2), by P. E. Edelman. A Portable Super-Heterodyne, by Wainwright Aster.
  - June 20—The Diamond as a Reflex, by Herman Bernard. A 2-Tube Portable Reflex, by Herbert E. Hayden. A Reflex for 93 Type Tubes, by L. R. Borhley.
  - June 27—The Pocketbook Portable, by Burton Lindheim. The Power House Set, by John L. Munson. Lesson on Learning the Code.
  - July 4—The Handsome Portable, by Herbert E. Hayden. The Freedom Reflex, by Capt. P. V. O'Rourke. 8 Tube Super-Heterodyne, by Abner J. Gelula.
  - July 11—The Baby "Super," by J. E. Anderson. A 1-Dial Portable Receiver, by Capt. P. V. O'Rourke.
  - July 18—Anderson's 6-Tube Super-Heterodyne. The 3-Tube Marconi Receiver, by Percy Warren. A Good Battery Connector, by Herbert E. Hayden.
  - July 25—A Dynamic Radio Amplifier, by P. E. Edelman. An Antiradiation Toroid Set, by Capt. P. V. O'Rourke. Crystal Sets for Work Today, by Lewis Winner. Construction of the Diamond Described for the Novice, by Herman Bernard.
  - Aug. 1—Enormous Volume on DX Stations, by Sidney E. Finkelstein. The Metropolitan Local Set, by J. E. Anderson. 4-Tube DX Divided Circuit, by Herbert E. Hayden. Series and Parallel Effects, by Herman Bernard.
  - Aug. 8—The Evolution Reflex, by Capt. P. V. O'Rourke. The Midset—A 3-Tube Set in Sewing Machine Cabinet, by Herbert E. Hayden. How to Build Your First Set, by Herman Bernard. 2 Year-Old Wins DX Stake, by Lewis Winner.
  - Aug. 15—A 2-Tube Speaker Reflex, by Brewster Lee. Capt. P. V. O'Rourke's Favorite Audio Amplifier. A Set for the Novice, by Lewis Winner. The Loop Jack in the Diamond, by Herman Bernard.
  - Aug. 22—The 5-Tube Diamond, by Sidney E. Finkelstein. A Home-Cooked Tantalum Coil, by George R. Hostetter. The Electrostatic Regenerator, by Percy Warren. Crystal Sets That You Can Log, by Herman Bernard.
  - Aug. 29—The 1-Dial Power-tone, by Herman Bernard. A Set a Baby Can Build, by Herbert E. Hayden. A Fine Motor Switchboard, by Lewis Winner. A Powerful 1-Tube Set, by Percy Warren.
  - Sept. 5—The Loop Model Power-tone, by Herman Bernard. A 5-Tube Geared Receiver, by Lewis Winner. The 1X120 Model Diamond, by Capt. P. V. O'Rourke.
  - Sept. 12—The 1926 Model Diamond of the Air, by Herman Bernard. An Oscillating Wavemeter, by J. E. Anderson. A 25-to-110 Meter Receiver, by Sidney E. Finkelstein.
  - Sept. 19—Diamond of the Air (Part 2), by Herman Bernard. A 1-Dial, 2-Tube Speaker Set, by Percy Warren. A Tube B Battery Eliminator, by Lewis Winner. A Home-Made Volume Control, by Herbert E. Hayden.

**What becomes of the bass notes in your radio set?**



The "Lost Octave"  
 The deep low notes of the grand organ, bass viol, tuba, English horn and other instruments are practically "lost" in ordinary amplification.

While the better transformers amplify quite evenly over the entire upper and middle registers of the musical scale, from about 60 cycles downward, there is a pronounced loss of amplification, as indicated above. Poorer transformers begin to drop off in amplification even higher on the scale with the result that lowest notes disappear entirely.

There is no variation in amplification over the entire range of musical frequencies with Thordarson Autoformers. No note is too low—no note is too high to be fully amplified by the Autoformer. In addition there are three other advantages.

**Four great improvements in amplification!**



Full amplification of those bass notes hitherto largely "lost"! Greater clarity on all signals! Improved reception of distant programs! Better volume control!

These are the four advantages achieved by this latest Thordarson development—the Autoformer.—Thordarson has succeeded in utilizing, for the benefit of your radio set, the same principle used in the line amplifiers adopted by the more recent high-powered broadcasting stations. The excellent quality of these stations (due to perfect amplification) offers conclusive proof of Autoformer effectiveness.

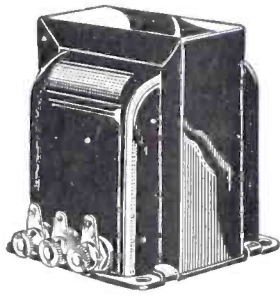

The Latest Thordarson Development

As the world's oldest and largest exclusive transformer makers, we have led for years in extending the amplifying range of transformers to lower and lower frequencies. In the Autoformer, we have finally perfected an instrument capable of bringing out the full depth of tone and full amplification of even the lowest notes played on any instrument. The Autoformer is an all frequency amplifier—which means it will amplify with even magnitude ALL notes within range of human ear. This has been accomplished by an ingenious adaption of capacities, impedances and resistances—developed and perfected by the Thordarson laboratories. Only Thordarson builds the Autoformer.

UNCONDITIONALLY GUARANTEED

**THORDARSON**  
*Autoformer*  
 Trade-Mark Registered

All Frequency Amplifier

Autoformer amplification is for those who seek the finest reproduction of programs to be had. It may be used with any set in place of the regular audio transformer hook-up. Full directions, with diagrams, for building a Thordarson Autoformer Amplifier are supplied with each instrument. Or

Write for the Autoformer Hook-up Bulletin—Just Out!

Thordarson Radio Transformers include: Audio Frequency (sub-panel or top mounting types) 2-1, \$5; 3 1/2-1, \$4; 6-1, \$4.50. Interstage Power Amplifying, \$8 each. Power Amplifying, pair, \$13. Autoformers, \$5 each. All Thordarson Products are unconditionally guaranteed. Dealers everywhere. We ship direct upon receipt of price only if dealer cannot supply.

**THORDARSON ELECTRIC MANUFACTURING CO.**  
 Transformer specialists since 1895  
**WORLD'S OLDEST AND LARGEST EXCLUSIVE TRANSFORMER MAKERS**  
 Chicago, U.S.A.

# RADIO WORLD

[Entered as second-class matter, March, 1922, at the post office at New York, N. Y., under the Act of March 3, 1879]  
A Weekly Paper Published by Hennessy Radio Publications Corporation from Publication  
Office, 145 West 45th Street, New York, N. Y.      Telephones: BRYant 0558, 0550

Vol. VIII. No. 3. Whole No. 185.

October 10, 1925

15c per copy, \$6.00 a year

## Hookups for the Short Waves Circuits That Have Stood the Test of Time

**Capacity Feedback Favored as Against the Inductive Tickler for Reception Under 85 Meters—Plug-in Coils Afford Most Efficient Way of Covering Band From 15 to 110 Meters Although Other Methods Work.**

By Percy Warren

WHETHER short waves ever will be used for general broadcasting it is nevertheless true that much fascination attaches to the reception of programs sent simultaneously with the regular transmission on higher waves by such stations as WGY, Schenectady, and KDKA, East Pittsburgh.



PERCY WARREN

Whenever these stations or others are on the air with programs on short waves it is usually much easier to pick them up at a distance than on their standard waves. One reason, of course, is the distance-travelling facility with which short waves are somehow endowed. Another is that the blanketing effect of having other powerful stations on adjoining or other channels nearby is absent. While both of the stations mentioned use considerable power, even 500-watt stations, if much nearer the point of reception, may prevent one from hearing the more powerful ones on the standard waves. It is commonly expressed as the problem of cutting through locals.

### The Schedule Problem

While it is easier to pick up short-wave signals from stations far away than it would be if those same stations were fished for on the broadcast belt, one should have some idea what he is going after. Unfortunately here enters an element of uncertainty. Both WGY and KDKA use several short wave lengths and KDKA changes from one to the other. WGY has a schedule, while KDKA, if it has any schedule, manages to conceal it.

Some of the short-wave stations that send out programs or special experimental modulation, use waves as short as 26 meters or less. Examples are the experimental call stations attached to the A. H. Grebe outfit at Richmond Hill, N. Y.

It is assumed that one will not try

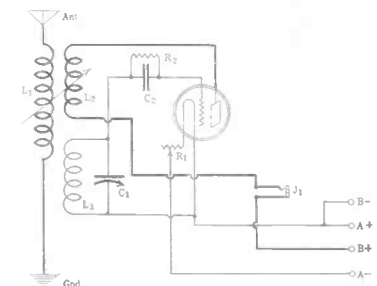

FIG. 1, the Meissner circuit for short-wave work.

particularly to get reception from these, but that the KDKA and WGY wavelengths are the main attraction. Hence the coil and condenser data given in this article are such that one should reasonably expect to pick up the desired stations on at least one short-wave that is being used.

One method that enjoys a favor is the use of interchangeable coils for covering specific bands. This is particularly attractive to amateurs, that is, that great and powerful group to which radio broadcasting owes so much—the "hams," as they call themselves. They listen in for code principally, but the broadcast listener will find no appeal here. If a set tunes from 60 to a little over 100 meters the B. C. L. will get considerable enjoyment without the necessity of changing coils. Even a fixed coil will give you a greater wavelength range, so that such experimental work as is conducted by KFKX, KOA, KDKA and WGY will be receivable.

As the program itself in most instances is the same as on the standard wave, one will hear the announcer telling the call letters of the broadcasting station. Then, of course, when the broadcasting station is cut out and the announcer's voice is carried only on the ultra-frequency, you will hear him tell the short-wave call, which is always an experimental "X" call. Thus, WGY generally uses the calls 2XAF (38 meters) and 2XK, 109 meters. Usually both these calls, hence both wavelengths are used at once and it may be difficult for the listener to determine just what wave he is bringing in. But this won't worry him much.

### WGY Schedule for "X" Work

The following P. M. schedule for the WGY experimental broadcasting on short waves for both 38 and 109 meters, will serve as a guide:

Friday, 5:30 to 7:30; 9 to 11:30.

Saturday, 9:30 to 10.

Sunday, 6:30 to 10:30.

Monday, 5:30 to 8:30.

Tuesday, 5:20 to 7:30; 9 to 11:30.

Wednesday, 5:30 to 7:30.

Thursday, 5:20 to 7:30; 9 to 11:30.

KDKA may be fished for during the hours it is on the air as a broadcasting

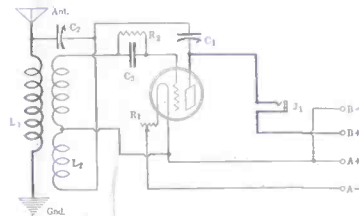

FIG. 2, the modified Meissner.

station, the X calls being on waves of perhaps 63, 49 and 24½ meters, but there's no telling which for a given instance.

WJZ once in a while picks up a foreign program or some other broadcasting and transmits it to New York City on some short wave for retransmission on its regular broadcast wave. It has used 40, 80 and 110 meters for this purpose.

A more extensive system of covering the short-wave bands on which programs are sent out will be taken up at another time, but for the present we will concern ourselves with sets that do not require any substitution of condensers or coils.

### The Colpitts

Of all the short wave circuits I believe the simplest and one of the most efficient is the Colpitts. (Fig. 3). Colpitts did nothing as to designing this receiver, but his principle is involved, and it is this principle which lends to the success of this set.

L1, the primary and the secondary coil, is wound as one. There are 20 turns on this coil, it being wound on a form 3½" in diameter and 4" high, with No. 18 bell wire. There should be ⅜" spacing between each turn. C1, the variable condenser, is one which has a maximum capacity of .000375 or thereabouts. Usually there are 17 plates in such a condenser. C2 is a midget variable condenser, the capacity of it being .00005 mfd. By taking this condenser off, the coupling between the antenna and the plate is nil. When this is done the volume of the receiver is decreased a great deal, but the selectivity of the receiver increased. C3 is a 2-megohm grid condenser. R2 is a 10-ohm resistance. The tube used is 201A and the current on the plate is 45 volts. The soft tubes will not work satisfactorily.

There are two controls on this set. The coil L1 is tapped at every fifth turn. The arm of these taps is brought to the stator plates of the midget condenser, while the taps are brought to the coil proper. This receiver is the loudest of all.

### The Reinartz

The next in line as far as volume and distance is concerned is the very popular Reinartz set, Fig. 4. The coupling coil, L1L2, is wound on a spider-web form. The primary is wound right next to the hub, which is 2" in diameter. The outside diameter is 5". There are 4 turns wound for the primary. Take a tap off and continue the winding. Wind 2 more

# Short-Wave Sets Compared

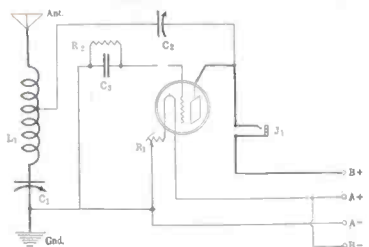

FIG. 3, the Colpitts receiver. The broken grid lead was not intended.

turns, take a tap, continue winding 10 turns, taking a tap at every second turn. This will give you 5 taps when concluded.

Continue the winding until 15 turns are made. Take a tap at every third turn. This means that there will be five taps made. The first winding (10 turns) was for the grid coil, while the last winding made was for the grid return (15 turns). Bring the arm that goes to the 10-turn taps to the stator plates of the variable condenser C1. Bring the beginning of the coil to the grid condenser and to the leak. The other portion of the coil and condenser goes to the grid post terminal on the socket. The arm that connects to the 15-turn winding goes to the minus post of the A battery and to the F minus post on the socket. The last tap made on the 15-turn winding goes to the stator plates of the variable condenser C3. The stator plates of the same condenser go to the plate post of the socket. L3, the RF choke coil, consists of 300 turns of No. 36 enameled wire wound on a 1 1/2" form. One end of this coil goes to the plate post of the socket, while the other terminal goes to the top terminal of the single-circuit jack J1. The bottom terminal goes to the B plus. R2 is a 10-ohm rheostat and controls the filament of the UV200. There are 22 1/2 volts or less placed on the plate of this tube. The A minus terminal also goes to the ground terminal. The beginning of the primary goes to the antenna and the end to the ground.

From the above it will be noted that there are two controls beside the two switch points. The rheostat is connected in the positive lead of the A battery. If you wish to use the 201A, place the rheostat in the negative leg and increase the voltage on the plate to 45. This receiver as well as the Colpitts radiates to a great extent.

The next receiver to be described is the Modified Meissner. This is also a radiator. L1 is a 4-turn coil wound on a 3 1/2" form, with No. 18 bell wire, spaced 1/8" apart. L2 may be wound on the same form, if the form used for winding the primary is large enough. If not, wind L2 with 15 turns of No. 18 bell wire on a form 3 1/2" in diameter. At the seventh turn take a tap. Connect the beginning of the antenna winding to the antenna and the end to the ground. The antenna post also goes to the stator plates of midget variable condenser C2, which has a capacity of .0005 mfd. The tap that

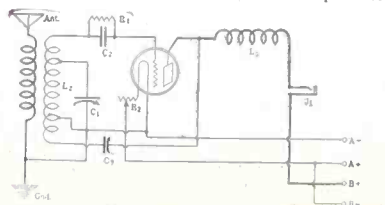

FIG. 4, the Reinartz short-wave receiver.

was made at the seventh turn goes to the plus lead of the A battery and to the F plus post on the socket. The beginning of the coil L2 goes to the grid condenser and to the leak, while the other ends of these parts goes to the grid post of the socket. The end of this coil goes to the stator plates of the variable condenser C1, which has a capacity of .000375 mfd., although .00025 will do. The rotor plates of this condenser go to the plate post on the socket. This same terminal also goes to the top terminal of the single-circuit jack. The rheostat is placed in the negative lead of the A battery. The tube used here is the 201A. There is only one control in this set and that is the variable condenser.

### The Meissner

Another short-wave receiver is the Meissner. This is a fine one. It is simple to operate, radiates very little, and is a great distance-getter. The volume is not so great as on the others, but then again there is more selectivity. Here the 3-circuit tuner can come into use. Here L1 is a 4-turn aperiodic primary, wound on a form 3 1/2" in diameter, with No. 18 bell wire, spaced 1/8" apart. Leave 1/2" and wind L3, the grid coil. There are 16 turns wound here. Use the same wire and em-

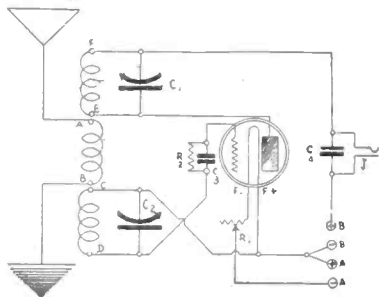
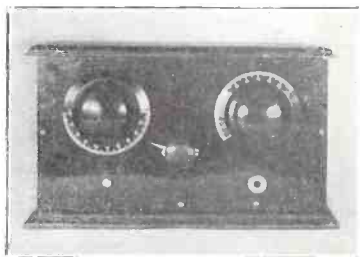

FIG. 6, a circuit with combined capacitive and inductive feedback.



VIEW of the 3-circuit tuner (inductive tickler) when made on a 7x10" panel for short-wave work.

ploy the same spacing idea. L2, the tickler, is wound on a form 2" in diameter and 2" high. It contains 10 turns, of No. 16 enamel covered wire spaced every 1/8". The variable condenser C1 has a capacity value of .00035 mfd. The stator plates of this condenser go to the beginning of the winding and then goes to the rotor plates of this same condenser. The stator plates also go to the grid condenser and to the grid leak. The other components of these two articles go to the grid post on the socket. The beginning of the tickler winding goes to the top terminal of the jack while the end of this winding goes to the plate post on the socket. The bottom of the jack goes to the B plus post. There are two controls on this receiver, the variable condenser and the tickler.

All these receivers will tune from perhaps 10 meters to 110 meters.

Fig. 6 shows a circuit where all three windings of the coil are on one form.

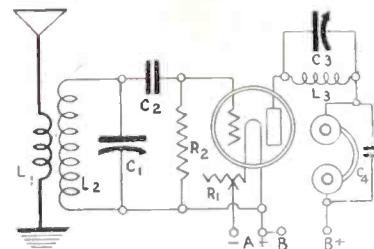
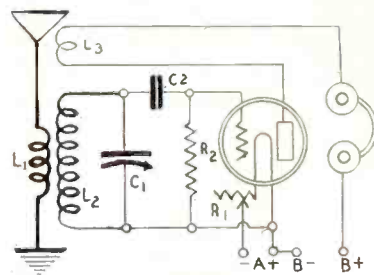

FIG. 5, (top), the 3-circuit tuner, made useful for short waves by the extent of the inductances. Fig. 7, the tuned plate regenerative set.

The aerial coil AB is wound in the center of a 3" diameter tubing, 3 1/2" high. It consists of 5 turns of No. 20 double cotton covered wire, spaced the thickness of the wire and insulation. That is, take two pieces of the wire and wind them side by side, then remove one of the wires, leaving the space between the remaining winding equal to the thickness of the wire, with its insulation, that has just been removed. The used coil is anchored at drillholes. The coil EF consists of 14 turns of the same kind of wire, but it need not be spaced. It is wound 3/4" above the aerial coil, on the same form, and occupies the relative position as shown in the diagram. The secondary CD consists of 17 turns of the same kind of wire, which is spaced as was the aerial coil. If any question of spacing arises, always space wind the secondary. With the two other windings this is not important.

The grid leak is 2 megohms, while the grid condenser is .00025 mfd. The tube may be of the 99 or 201A type. In fact, any oscillatory tube will work. C4 is .00025 mfd. J is a single-circuit jack.

### The 3-Circuit Tuner

Fig. 5 is the standard 3-circuit tuner. It has an inductive coil for feedback. This does not always prove so easy to handle on the short waves, particularly under 75 meters, but it will work. One trouble to be expected here is body capacity effects. The coil, so far as primary and secondary are concerned, is wound like the one previously mentioned. The tickler is wound on a 2" diameter tubing 2" high and consists of 18 turns of No. 24 double silk covered wire. If regeneration is too free remove turns from the tickler.

### Tuned Plate

When the tuned plate method is used (Fig. 7) an aerial coupler is wound as previously stated and the plate coil is made up as a separate item, wound with the same number of turns as was put on the secondary. All the secondary windings are of the same inductances in these three circuits. The variable condensers used are .00025 mfd., but .00035 mfd. may be used by those having this particular capacity on hand.

The space between primary and secondary winding is 1/8" in each case.

# The 3-Tube, 3-Circuit Tuner

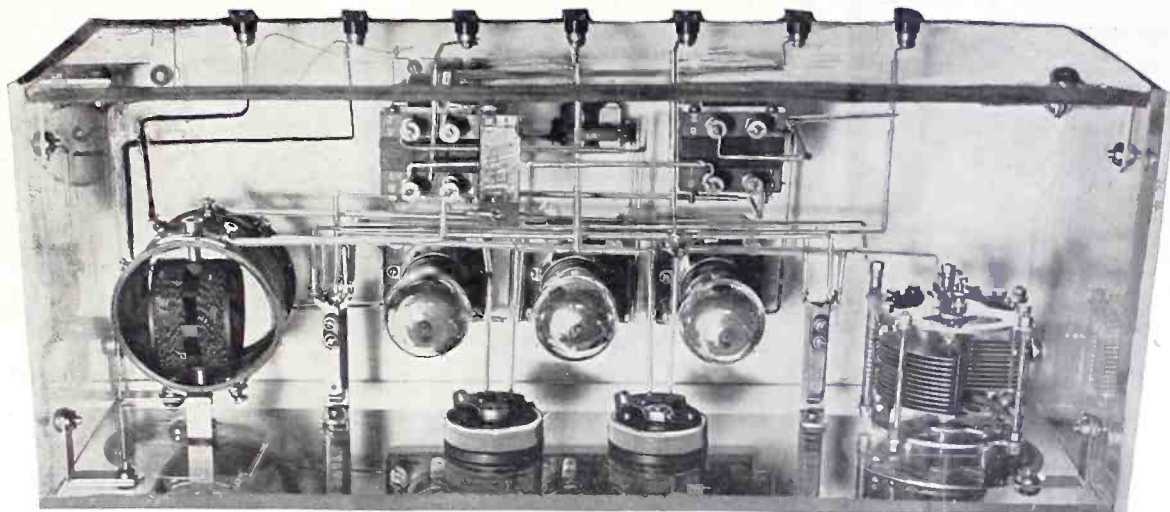

A VIEW of the completed 3-circuit tuner. This one was made in a glass cabinet, the front serving as panel. (Kadel & Herbert).

By Capt. P. V. O'Rourke

AS THE set that offers the most for the money and affords both the delight of distant-station reception and all the volume one could ask, the 3-circuit tuner leads all other inexpensive receivers, when the radio amplifier is followed by two stages of transformer-coupled audio. It is a circuit that is standard and excellent, and it is the one speaker set that the novice is most inclined to build. From that point on he may advance to other hookups that embody audio amplification for speaker operation, but he had better start with the 3-circuit tuner. If he uses good coils, condenser and transformers he will have a receiver that will do his heart good, and it will not cost him much more than \$35, including cabinet, but not speaker.



CAPT. PETER V. O'ROURKE

## Theory of the Set

The principle of operation of this receiver is that the radio impulses are collected by the antenna-ground system and as this is joined to the respective terminals of the small winding on the stationary form of the coil, points 1 and 2 on the front cover picture diagram, all waves flow in this circuit. In fact, even the short waves are there, meaning those as low as 25 meters, and the tuning effect is produced solely by the variable condenser, 13, which is connected across the large winding on the stator form of the coil. The small winding is called the primary (1 and 2) and the large winding the secondary (3 and 4). The tuning condenser is rotated and thus the desired frequency is established. The condenser charges and discharges the current delivered to it at a rate of speed depending on how much or little of the rotary plates is enmeshed with the stator plates (capacity setting). When the frequency of the condenser action corresponds to the frequency of an incoming signal, then the smoothest path is established for that incoming frequency, and the set is said to be tuned to that frequency or wavelength.

Continuing with a discussion of the radio

## LIST OF PARTS

- One 7x18" panel.
- One 3-circuit tuning coil, 1, 2, 3, 4, 5, 6.
- One .0005 mfd. variable condenser, 13.
- One .00025 mfd. fixed grid condenser, with clips, 7.
- One .00025 mfd. fixed bypass condenser, 20.
- One 20-ohm rheostat, 13.
- One 10-ohm rheostat, 14.
- One 2-megohm grid leak, 8.
- Three standard sockets, 15, 16, 17.
- One double-circuit jack, 18.
- One single-circuit jack, 19.
- Two 4" dials, with pointers.
- Accessories: Three 6-volt tubes, one 90-ampere hours or more, A battery, two 45-volt B batteries, one pair of earphones, one speaker, one jack plug, one cabinet, 100 ft. 7-strand aerial wire, 50 ft. No. 14 insulated leadin wire, ground clamp, lightning arrester, terminal strip, bus bar, solder, nuts, screws, hardware, baseboard.

impulses, meaning those fluctuations too fast to be audible, we find that the tuned input is made to the grillwork inside the tube known as the grid. To establish a return path for this current a connection is made to the A battery, in most cases to A+, because nearly all detector tubes function better when this grid return is to positive. With amplifiers, both radio and audio, the opposite is true.

The grid condenser 8 is placed between the actual grid and the end of the secondary, point 4. It serves a blocking purpose, principally, that is, it keeps the direct current of the A battery off the grid. The leakage would be too great from grid to A battery if this condenser were not there, although the tube still would detect, but rather feebly. There must be some leakage, because otherwise an excessive amount of negative electrons would accumulate on the grid. Hence we use the grid leak, 8, which should be about 2 megohms. For reception of distant stations with best volume and clarity a variable grid leak should be used, although for local signals only, say signals from stations 50 miles away or less, the advantage of a variable grid leak will not be quite so obvious.

As the input of any tube always is to the grid, so the output always is from the plate, which is usually a flat piece of

shell metal. It is inside the vacuum tube, too. The plate in the 3-circuit tuner is connected to one terminal of the rotary coil, point 6, and the other terminal of this coil, 5, is joined to the outside spring of the double-circuit jack, 18. The right angle or solid frame of this jack is connected to B plus, usually 45 volts, and this connection is ever present, whether earphones are used when plugging in at this jack, or whether the current is allowed to flow into the first audio transformer, 11, when the plug is not in the jack.

## Control of Feedback

The location of the rotary coil, called a tickler, is such that no matter how it is varied it is nearly always in inductive relationship to the secondary. The degree of coupling—the comparative tightness or looseness of coupling—determines the rate of feedback, and this must vary for respective frequencies. Thus, while the tuning condenser is the wavelength control, the tickler is the regeneration of feedback control—a volume adjustment. The radio impulses emitted by the plate are returned to the grid circuit (secondary), where they serve the purpose of building up the radio signal. In other words, regeneration is a form of radio-frequency amplification. A regenerative 1-tube set has about the same amplifying factor as a 3-tube non-regenerative set, where the first two tubes are RF amplifiers and the third tube is the detector. No audio is considered in this comparison.

At this point it becomes obvious that the reception range of the 3-circuit tuner is favorably comparable with that of the Neutrodyne. But there is this difference: the Neutrodyne set, using no regeneration, tunes in quietly at all settings of the condensers, whereas in a regenerative set, if there is too much feedback, there will be a squeal. By turning back the tickler this squeal may be eliminated and only the voice or music heard. Such a squeal is not only heard in the producer's receiver but emitted from the antenna. That constitutes radiation. Neighbors' sets pick up this squeal as interference, so it is important to tune in without squealing, so far as this can be done. With locals it is easy, but when one is hunting DX it is probably impossible to tune in except by the squealing or, as it is called, beat note method.

The built-up radio signal gains in power until the maximum point is reached, and

(Concluded on next page)

## Directions for Wiring the 3-Tube 3-Circuit Set

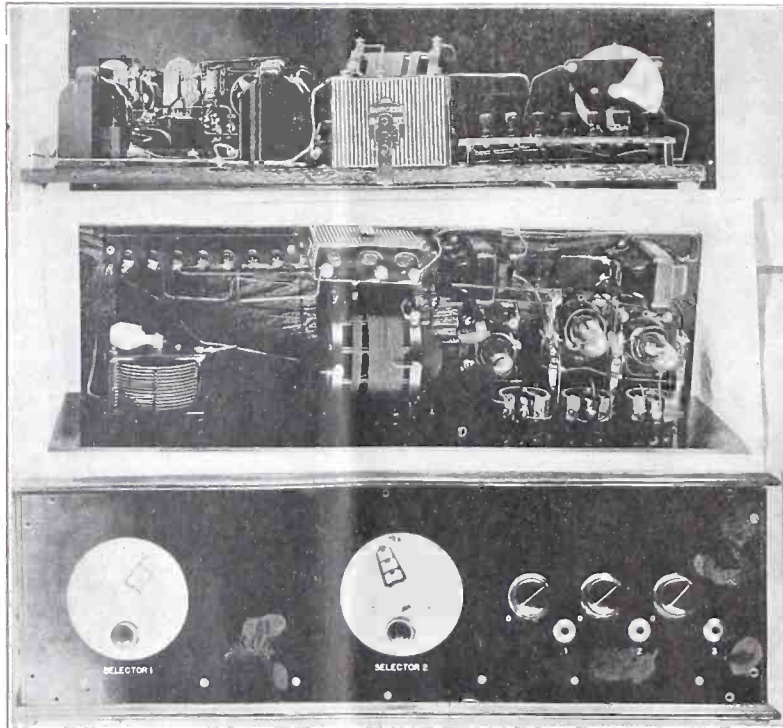

IF A 7x24" panel is used the 3-tube 3-circuit tuner may be constructed also as shown above. Here, however, a  $4\frac{1}{2}$ -volt C battery was used. This is optional. It would be connected with C+ to A-, while C- would connect to the F or equivalent 4 or S2 posts of the two AFT, the connection direct from these posts to A- being removed first. The above design embodies a separate rheostat for each AF tube, but that is not necessary, and also has an A battery switch. (Hayden.)

then it starts all over again. This is true of all regenerative action. The effect of regeneration is to reduce the apparent resistance in the circuit, and selectivity amounts mainly to the reduction of resistance, that is, the opening of the pathway for one particular frequency to the exclusion of all others. The resistance is low for the desired frequency and high for all other frequencies.

It will be noticed, therefore, that the plate output has two components, (a) radio, which has been discussed, and (b) audio, which we will take up now.

### Audio Action

The radio current flows independent of the audio current. The tube action is such that it chops up the radio wave, leaving only the audio component and some escaping radio current. It is the function of regeneration to utilize this otherwise escaping current, which would be wasted without this advantageous incorporation of its effects.

The audio component passes through the tickler, too, but there is no collision, since one is almost unthinkably rapid, say from 500,000 to 1,500,000 alternations a second, while the other is much less rapid, say up to 10,000 cycles per second. The frequencies below 10,000, to a certain point, are audible. Thus the tube has gotten rid of the radio wave and left only the audio wave, as it was produced originally at the microphone. The whole action may be regarded as simultaneous, it is so rapid. The speed is 186,000 miles per second, the speed of light.

The audio current is alternating, too, as is evidenced by the expression "cycles." It has a frequency. Anything with a frequency is alternating. The other kind of current is direct, and this is used to

light the filaments and to supply a positive potential to the plate of the tubes (function of A and B batteries).

### Into the Amplifier

The audio current is delivered to the primary of the first audio transformer, the return connection being made to B plus 45. The current is transferred to the secondary by induction, that is, through the air space, and put into the grid of the first audio amplifying tube. Sometimes a fixed condenser, 20, about .00025 mfd., is necessary across the first transformer's primary, to by-pass the radio currents around the transformer when the transformer is in the circuit. When earphones are used it might not be necessary at all to include this condenser. That is why it is all right to have the circuit hooked up as shown, so that the condenser will be in use only when the audio circuit is.

The secondary of the AFT is connected with G or S1 post to grid of the succeeding tube and with S2 or F post to negative A battery. The plate of the first audio tube is connected as was its predecessor and the other connections are the same, too, except that the B voltage is higher. The plate of the last tube connects to the spring of the single-circuit jack, 19, the frame or right-angle of which goes to B plus amplifier voltage, usually 90.

The picture diagram (Fig. 1) shows the connections for making this receiver, while the finished product is revealed in all its glory and glass cabinet in Fig. 2. It is not necessary to have a glass cabinet. A hard rubber panel and a wooden cabinet are just as good.

### The Data on the Coil

Any of the commercial 3-circuit tuning coils, nearly all of which are wound with

a secondary to be tuned with a .0005 mfd. variable condenser, will work very well in this set. In different coils the tickler may be in different positions. In some cases it will be found right on top, near the primary, in others the shaft for the tickler will enter the stator where the separation exists between primary and secondary. These are minor considerations and do not affect the operation of the receiver to any extent worthy of discussion at this time.

The coil, if not a commercial product, may be wound at home. Get a  $3\frac{1}{2}$ " diameter tubing, 4" high, be it cardboard, hard rubber, fiber, Bakelite, insuline, Radion or anything else, and use No. 22 single cotton covered wire. Put on 10 turns for the primary (1 and 2). Leave  $\frac{1}{4}$ " space and then wind 45 turns of the same kind of wire in the same direction. on the secondary, 3 and 4. The four terminals should be anchored in parallel pinholes or drillholes. The tubing should be about 4" long safely to accommodate the wire.

The tickler may be wound on any size form that will rotate inside the stator. A good size would be  $2\frac{3}{4}$ " diameter,  $2\frac{1}{2}$ " high. The same kind of wire may be used. Put on as much as the form will stand, without putting one turn atop the other. Remember to leave a space between half sections of the continuous tickler winding so that the shaft will be inserted. A better practice would be to use No. 24 single silk covered wire and put on 34 turns, 17 on either side of where the shaft will be introduced, the diameter being as specified.

The coil is all that can be made at home with ease and speed.

### Connections to Strip

In the picture diagram, 1 represents the aerial and 2 the ground, the cold-water pipe being used as ground, not the hot-water pipe. A binding post strip, known as a terminal strip, is used, and it has seven posts. These are for aerial (1), ground (2), A minus (8), A plus (4), B minus (9), B plus No. 1, 45 volts (5), and B plus No. 2, 90 volts, (10).

### Rheostat Precaution

In connecting the rheostats 13 and 14, be sure to connect the arm terminal (where a common connection is made between arm and winding by a connecting strip on the rheostat) to the battery and the other terminal to F minus on the socket. In the case of 14 the socket connection will be to two points, one for each audio socket, as the same rheostat actuates both audio tubes.

The only other point to stress is that the stator plates of 13 go to one side of the grid condenser and to the end of the secondary, at 4, while the rotor plates go to A minus and to the beginning of the secondary at 3.

## Listeners Being Banded In New Service League

A national fraternal body of radio broadcast listeners is being formed by New York radio enthusiasts with headquarters in Aeolian Hall. The organization, known as the National Radio Service League, will take an active interest in legislative matters, either local or national, which will affect the welfare of the millions of owners of radio receiving sets.

**HOW TO BUILD THE POWERTONE.** 1 dial, 5 tubes, described in RADIO WORLD, issues of Aug. 29 and Sept. 5. Powertone Trouble-shooting, Sept. 12. Send 15c for all three. Special diagrams and "blueprint in black" included among the many illustrations. RADIO WORLD, 145 West 45th St., N. Y. City.

**A DYNAMIC SET.** Enormous Power on 3 Tubes, by P. E. Edelman. An Anti-Radiation Toroid Set, by Capt. P. V. O'Rourke. Four Crystal Hook-ups, by Lewis Winner. Other features in RADIO WORLD dated July 25, 1925. 15c a copy, or start your subscription with that number. RADIO WORLD, 145 West 45th St., N. Y. City.

# The DX Set That Thrilled Jack

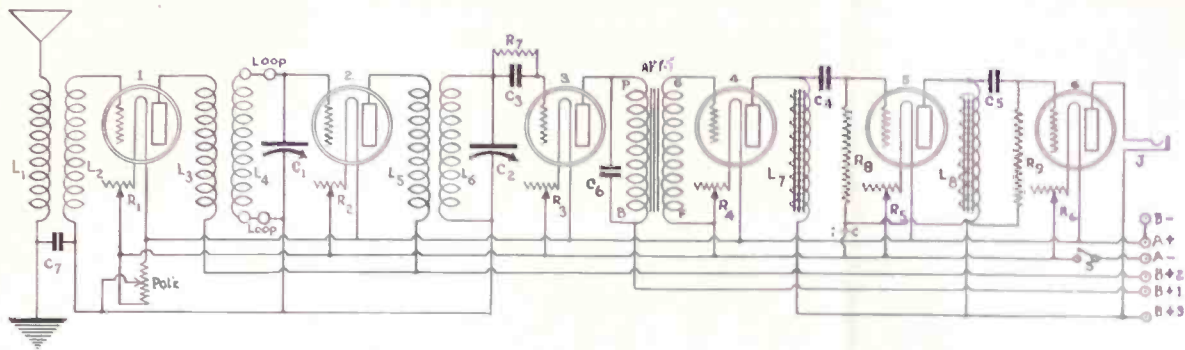

FIG. 1, showing the electrical diagram schematically.

By Lewis Winner

Associate, Institute of Radio Engineers

PART I.

"COMING over to my house tonight to hear my new radio set?"

"Oh no, I can't possibly make it," replied my friend, Jack.



LEWIS WINNER

"Say, listen, you'd better come over."

"Why? Is the receiver so marvelous?"

"If I tell you it works wonderfully you probably will not believe me, 'cause you've heard the same story so many times. The best thing to do is to come over and see

and hear it for yourself."

"All right, old man, I'll be up at 9:30 P. M."

"That's fine, Cul." I had met Jack in the street on my way home from work. I hurried home and prepared for the test. I guess you know what I mean. As soon as you boost a set to a friend, telling him how much distance and volume you get, the thing won't work when he comes up. Either the batteries are run down, the aerial has collapsed, the tubes have become paralyzed or some one jarred the set and broken a connection, all of which you don't know anything about until embarrassed. So the best thing to do is to tune her up. In about a half hour I had her as fit as a first fiddle. That is I had logged quite a few distant stations which came in with extreme volume on the speaker. Of course I realized that this set would work all the time, but I am a bit superstitious, and took no chances.

R-r-r, R-r-r. (Denoting ringing of door bell).

"Ah-hah, that must be Jack," I said. "Mother, please don't bother. I'll answer the bell."

I was tuning-in a distant station at that time but rushed to the door. I greeted Jack effusively.

In Comes the DX

"This is Station WOC, Davenport, Iowa. The last selection that you heard was entitled, 'Remember,' Irving Berlin's latest success."

That's what Jack heard on entering the parlor.

"Huh? You don't mean to say that you are pulling in Davenport at this time of the night, when all the locals are on?" queried Jack, in astonishment.

"Yes, sir, that's the old station itself."

"Well, that IS great. See if you can

get any others," he encouraged. "Sure, Mike. Which one do you want?" "Aw, quit joshing. The way you talk, one might think that you can get any station that you desire."

"That's right. Listen, there's WOAW, Omaha, Nebraska."

With a little careful manipulation of the dials I soon succeeded in tuning in the star station of the evening.

"This is KNX, Hollywood, California, broadcasting on a wavelength of 337 meters. The first number on this special hour of jazz music will be 'I Miss My Swiss,' played by Abe Lyman's Coconut Grove Orchestra."

"Let me get at that magic set," exclaimed Jack.

"Sure, the pleasure is all yours," I replied full of confidence, knowing that he would be able to pull in the stations with the same ease that I had done.

"Boy, this is great!" (This from him half an hour later).

While he was at the dials, he tuned in WMC, WFAA and WDAF with extreme ease.

"Winner, I think that is the most convincing of tests that I have ever seen or heard demonstrated. I wish to thank you for asking me to come over. I have never heard such reception on any receiver. One would imagine that the person was right in the house—and especially from such distant stations!"

"Is that set for sale?" "No, sir."

"Well, where can I get the dope on how to build such a set?"

"Right here. You are the first person that is going to get this information. Here's a pencil and paper. Now get busy."

"Are you going to give me all the details on how to make this set, so that when I take these notes home, and build the set, I will have one just like yours?"

"Righto."

"I think I have an idea on how you can give the data, which will simplify matters very much," remarked Jack.

"Let's have it."

"I'll ask you questions about the different parts of the set, and by your answers I will obtain all the information. You know I have only a meagre knowledge of radio and therefore the less technical the data are the better I'll like it."

"Here's the electrical and picture diagram, so that you can follow me," I said, handing him the papers.

"What kind of a set is it?"

"It is a 6-tube, tuned radio-frequency receiver. There are two steps of radio-frequency amplification. The first stage is not tuned, and the second stage is tuned. This means that the secondary of the transformer in the first stage, or where the first tube is, has no variable capacity to tune it, while the secondary

of the second radio-frequency transformer is tuned by a variable condenser. The detector is non-regenerative. That is, the grid and the plate of the tube that rectifies or brings the signals out so that you can hear, are not coupled or brought together in any way. The next three tubes are the audio-frequency amplifiers. The first audio-frequency amplifier employs the standard method of coupling the plate of one tube to the grid of the other tube by means of a transformer. The next two tubes employ a different plan. The plate of one tube is coupled to the grid of the other tube by means of a choke coil.

"The current flowing from the plate of tube 4 through the choke coil L7 manufactures voltage across the ends of the coil. This same voltage is placed upon the grid of tube 5, through the big fixed condenser C4 and also across the grid leak R8. The same thing happens with the plate and the grid of tube 6. This type of audio-frequency amplification gives us that beautiful clear tone."

"Why is it that you didn't use the whole six tubes when you listened to the local stations?"

"Because the loop was being used to receive the energy. Since the first stage of radio-frequency amplification is untuned, there is no condenser there to tune the loop. The loop is all wire, or nearly a pure inductance. The transformer is also an inductance. Well, there must be something in the form of a capacity which is variable to tune these inductances, and that is not there, so we don't use this tube. Didn't you notice that when you attached the loop to the six tubes, the signals did not get any louder?"

"Yes, that's true."

"And, didn't you notice that when you were listening to distant stations, the aerial helped a great deal. Also that you had to use this extra tube in order to get these distant stations?"

"Righto."

"Therefore, when listening to local station you may use the five tubes with the loop. When listening to distant stations, use the six tubes and the antenna."

"Why do you get a squeal when you turn up the arm of the rheostat that lights the filament of the second tube, when using the loop?"

"This is due to negative bias placed on the radio-frequency tube, and also to the feedback between the grid and the plate elements of this same tube. The feedback is accomplished by placing fewer turns on the primary of the third radio-frequency transformer, the inductance of which is much less than that of the loop. The grid bias is obtained by the potentiometer."

"The same thing happens also when the first rheostat is turned on also, doesn't it?"

"Yes, but once the filament temperature





# Getting Low Notes Amplified

## Choke Coil Coupling Capable of Doing It

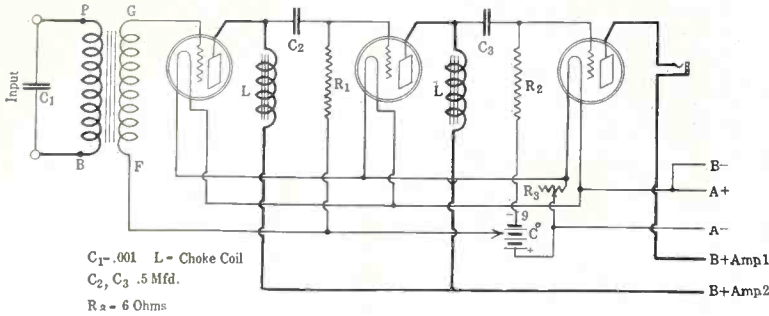

FIG. 8, one transformer stage and two steps of choke coil coupling.

[Part I of J. E. Anderson's comparison of audio hookups was published last week, issue of October 3. Part II, the conclusion, is published herewith.]

By J. E. Anderson

Consulting Engineer

PART II

STRICTLY speaking it is really only the voltage across the grid leak which is impressed on the second grid, but this differs only slightly from the voltage across the choke if the condenser is large. The amplification per stage of such an amplifier is equal to the product of the Mu of the tube and the impedance of the choke coil divided by the sum of the plate output impedance and the impedance of the choke coil. For example, suppose the choke coil has an inductance of 350 henries and negligible resistance. Then the impedance at 1,000 cycles is 2.2 megohms. Again suppose that the tube has a Mu of 8 and that it is operated under conditions that make its plate impedance 12,000 ohms. This makes the amplification 7.97. Eight is the maximum obtainable with this tube and this arrangement. At one hundred cycles per second the plate impedance is only .22 megohm, and this makes the amplification 7.59. The difference between these two is less than 5%. Even at as low a frequency as 50 cycles per second the amplification is 7.22 times.

If the resistance of the choke coil had been taken into account the amplification at the low frequencies would have been even more favorable. These figures show that the choke coil coupled circuit is capable of amplifying the low notes very nearly as well as the middle notes. For the higher frequencies the impedance of the choke may decrease on account of the distributed capacity of the winding, but this does not affect the amplification to any appreciable extent within the audible range. Hence a choke coil coupled circuit amplifies uniformly over the entire tonal scale, that is, provided the choke coil is large enough and does not have too much distributed capacity.

For a choke coil the secondary of any audio-frequency transformer may be used, or better still, the two windings connected in series aiding.

Plate Voltages Computed

Another form of voltage amplifier is the resistance coupled circuit, a stage of which is shown in Fig. 5. This circuit is identical with the choke coil coupled amplifier with the exception that a non-inductive resistance is used in the plate circuit in place of the choke coil. The implication of such an amplifier may be determined in the same way as that of a choke coil

coupled circuit. It is equal to the product of the Mu of the tube and coupling resistance R1 divided by the sum of the plate output impedance of the tube and the coupling resistance R1. For example suppose that the Mu of the tube is eight, that the coupling resistance R1 is 100,000 ohms, and that the tube is operated so that the plate impedance is 12,000 ohms. The product of the Mu and the coupling resistance is then 800,000 and the sum of the plate impedance and the coupling resistance is 112,000 ohms. Hence the voltage amplification is 800,000/112,000, or 7.14 times. This factor is the same for all frequencies because the Mu of the tube, the plate impedance, and the coupling resistance are all constants independent of frequency. Hence a resistance coupled amplifier does not introduce any distortion over the tonal scale, and it does not introduce any appreciable harmonics as long as the tube is not overloaded.

With respect to freedom from distortion the resistance coupled amplifier has no equal. However, the circuit is the most expensive to operate. It amplifies less per stage than any of the other circuits and it requires a much higher plate voltage to make it operate satisfactorily. The greater part of the plate supply voltage is dissipated in the coupling resistance, and the effective plate voltage is that which is dissipated in the internal resistance of the tube. This is only a fraction of the total voltage applied when the tube is operated so as to give the best stepup of signal voltage. The plate resistance is about twice as great as its AC impedance. Hence for the case given above the resistance is 24,000. The total resistance in the plate circuit is then 124,000 ohms. Hence the effective plate voltage is only 24,000/124,000 of the applied voltage, that is, .193 of the voltage applied at the B battery terminals. Hence it would take an applied voltage of 232 volts before the effective voltage on the plate would be 45 volts. Fortunately a resistance coupled amplifier will operate satisfactorily with an effective plate much less than 45 volts.

High-Mu Tubes Help

The use of a high Mu tube helps to boost the voltage amplification obtainable from a resistance coupled amplifier, but not in proportion to the increase of the Mu. The reason for this is that a high Mu tube has a very much higher internal impedance. A certain tube having a Mu of 20 has a plate impedance of 40,000 ohms. If the coupling resistance is 100,000 ohms, the amplification is 20x100,000/140,000, or 14.3 times. This is just twice the amplification obtained previously with a tube having a Mu of eight, whereas the ratio of the two Mu's

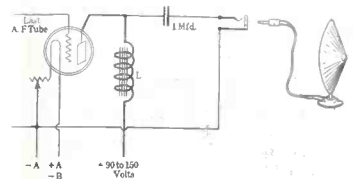

FIG. 7, the output of the final AF stage modified by a large choke coil and a stopping condenser. This is a filter circuit.

is 2.5. The effective plate voltage for the high Mu tube is 4/9 of the applied B battery voltage, so that the latter would only have to be about 100 volts to make the effective voltage 45 volts. Both from the amplification obtainable and the saving in the first cost of B battery it is decidedly advantageous to use high Mu tubes.

High Mu tubes may also be used when the choke coil method of voltage amplification is used. For a tube having a Mu of eight with a 350 henry choke in the plate circuit and a plate impedance of 12,000 ohms the amplification was found to be 7.97 and 7.59 at 1,000 and 100 cycles per second respectively. For the high Mu tube these factors become 196 and 16.9 respectively, which are comparable with those obtainable with a good transformer and a tube of lower Mu.

The effective plate voltage for a given applied voltage is much greater for choke coil coupled circuits than for resistance coupled. The 350 henry choke may have DC resistance of 7,000 ohms or less. Then the effective plate voltage for the low Mu tube would be .773 of the applied, and for the high Mu tube it would be .92 of the applied voltage.

In each of the circuits shown (Fig. 8, 9, 10, 11), a condenser and a grid leak are employed. In calculating the amplification for these circuits it was assumed that these had no effect. They do have some effect, of course, but if both the grid leak resistance and the condenser are large this effect is negligible. The grid leak resistance has no detrimental effect on quality, but it decreases the amplification slightly. The condenser has the effect of suppressing the low frequencies more than the high. Hence this introduces a certain amount of distortion. However, if the value of the condenser is 1 mfd. or more the distortion is negligible. A condenser as low as .006 mfd., found in some circuits, will introduce about as much distortion as the direct coupling avoids.

The 2-Transformer Hookup

The amplifier in a receiver may be composed of two or more stages of the various methods of amplification discussed above. These stages may all be alike or they may be combinations of the various types. In Fig. 6 is shown an amplifier consisting of two stages of transformer coupling. This is capable of great volume, and two stages are sufficient to operate a loud speaker. If the transformers are good the quality will also be good although it may not be as good as that from some of the other types of coupling. Sometimes this amplifier is modified in the output circuit of the last tube in the manner shown in Fig. 7. A filter consisting of a large choke coil L in parallel with, and a large condenser is series with AC speaker, is used to separate the DC component from the AC component in the plate current. Only the AC is sent through the speaker. This arrangement has certain advantages over the ordinary connection but it has also

# Where to Use the Hi-Mu Tubes

## Quality vs. Quantity in Audio Hookups

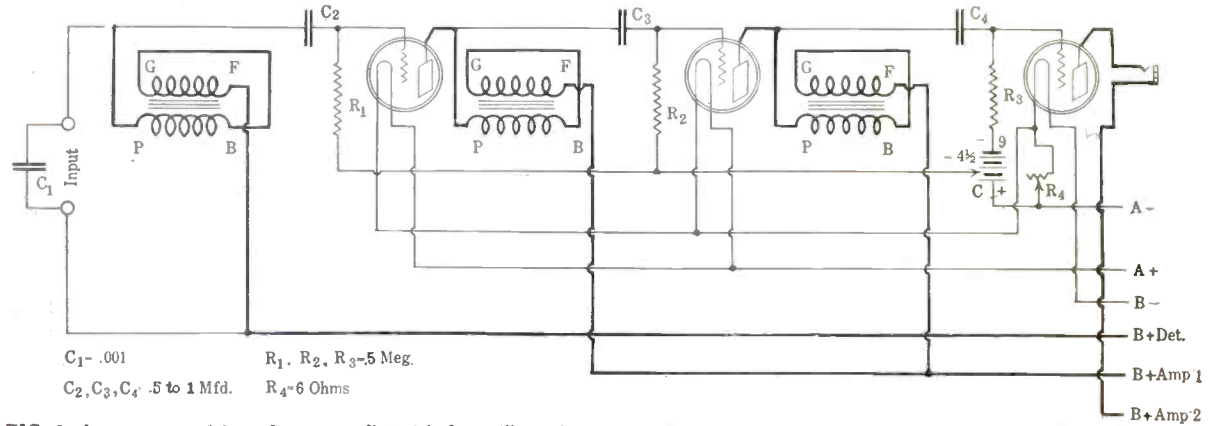

FIG. 9, three stages of impedance coupling (choke coil), with a particular brand of regular AF transformer used. Normally connect B and F for series-aiding effects.

disadvantages. It helps to minimize battery noises, and it also protects the armature windings of the loud speaker from burn-outs, since only the AC is allowed to flow through them. But the choke coil must have a very high inductance with a minimum of distributed capacity and the series condenser must have a very large capacity or the low notes will be suppressed by this arrangement.

### Choke Coil Hookups

In Figs. 8 and 9 are shown two amplifiers each using two stages of choke coil coupling and one stage of power amplification. These two amplifiers are alike except that the one shown in Fig. 8 is choke coil coupled to the detector while the other is transformer coupled to it. The first is capable of slightly better quality than the second, provided the choke coils and the stopping condensers are large; and the second circuit is capable of greater volume than the first, provided the stepup ratio of the transformer is greater than two to one. Either of the two will give enough volume to operate a speaker if 201A tubes are used. If high Mu tubes are used in the two voltage amplifiers the volume will be very great. In Fig. 8 the choke coils used are ordinary audio-frequency transformers in which the two windings have been connected in series aiding. While the particular transformers used required that B be connected to G to obtain series aiding, most transformers require that B and F be connected together.

The two above circuits may be modified in the last stage, or power amplifier, in the manner shown in Fig. 7. The additional choke coil should have at least 350 henries and the condenser should not be smaller than 1.0 mfd. These limits may also be set for the other choke coils and condensers used in these circuits.

There is also an amplifier consisting of two stages of resistance coupling and one stage of power amplification. The input to the first resistance coupled tube, or voltage amplifier, is by means of an audio-frequency transformer. This allows the detector to operate efficiently and at the same time a voltage stepup is obtained before impressing the signal on the voltage amplifier tubes. There is a slight sacrifice in quality for a gain in volume, but the increase in distortion is not appreciable if a good transformer is used. This particular combination of amplifiers may be regarded as one of the best from

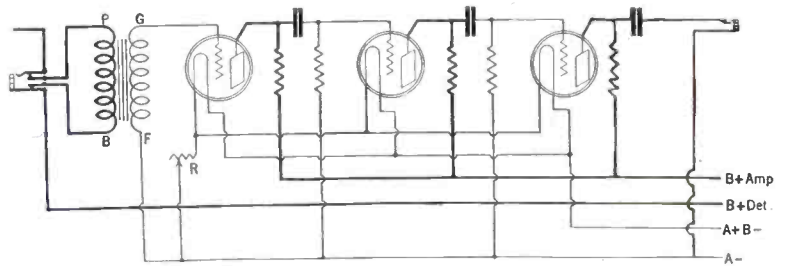

FIG. 11, the Bernard audio hookup, showing the extra resistor (in the plate of the last tube) and the method of keeping the B battery current out of the speaker windings, which thus handle only AC.

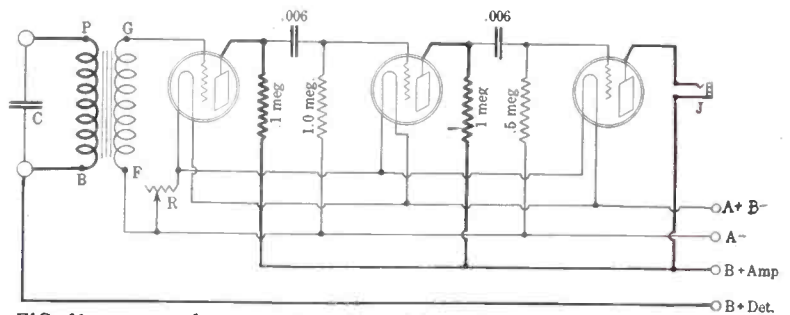

FIG. 10, one transformer stage and two steps of resistance coupling. The .006 condensers will do, but larger ones are preferable.

the point of view of volume and quality.

This amplifier may be modified in a manner somewhat similar to that used in Fig. 7, a method which was introduced by Herman Bernard in his 1926 model of The Diamond of the Air. A resistance of the same value as the coupling resistances is introduced in the plate circuit of the last tube through which the plate voltage is supplied to the tube. (Fig. 11.) A stopping condenser is connected in series with the loud speaker to keep the DC out of the speaker windings. There is a slight loss in volume when this arrangement is used, due to part of the AC flowing through the resistance. (This effect is inappreciable when a choke coil is used.) For this reason the condenser connected in series with the loud speaker should be larger than it needs to be for the coupling condensers in the voltage

amplifiers. These condensers should not be less than .25 microfarad. They may be smaller for resistance coupling than for choke coil or auto-transformer coupling.

The last condenser, if used, as in the Bernard hookup, should not be less than 1.0 mfd. and preferably as high as 4 mfd.

The advantages of the Bernard method of coupling the speaker to the output tube are that the tubes operate with the same grid and plate potentials and that no special arrangement is necessary to adjust these voltages, for instance, no C battery.

HOOK-UPS!—A lot of them, some of which are sure to suit your purpose, appeared in RADIO WORLD dated Aug. 15. 15c. a copy, or start your subscription with that number. RADIO WORLD

# Determining Series-Aiding

## By the Simplest Method of Testing

### How a Jack Works

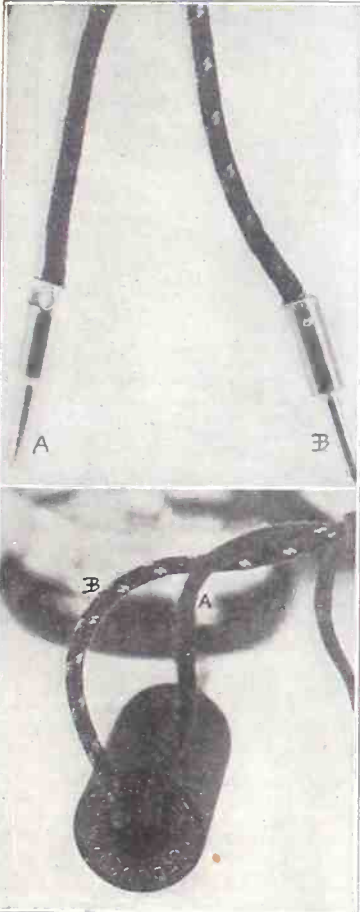

THE PHONE TIPS, A and B in top photo, go respectively to plate and B plus in a tube output circuit. The battery lead is usually identified by a stripe or by dots on the insulation. The leads enter the jack housing as shown in lower photo.

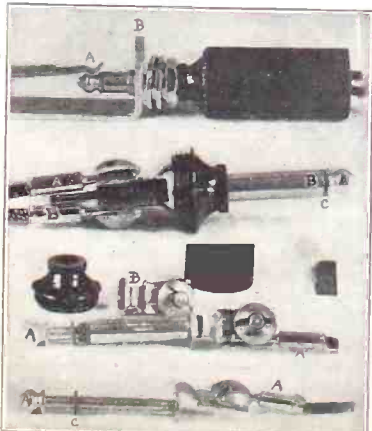

THESE photos locate A and B, also C, the insulating ring

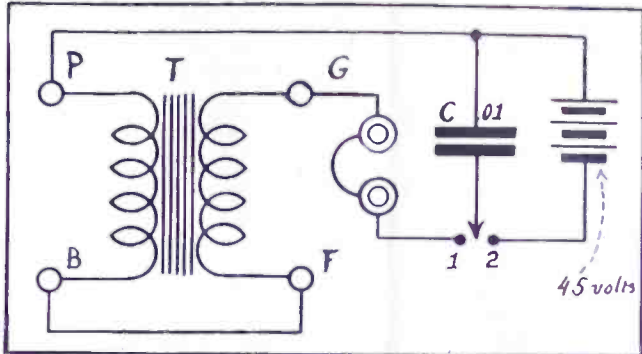

DIAGRAM for testing an AF transformer when it is used as a choke coil, to determine which way affords series-aiding relationship

### The Net Effective Result With Proper Connections is Remarkably More Efficient

When audio-transformers are used as coupling choke coils in impedance coupled audio-frequency amplifiers it is very important that the two windings be connected in series aiding rather than in series opposing. It would be better to use the secondary winding alone than to use the two windings in series opposing, but if the two windings are in series aiding the performance of the receiver will be much better than if the secondary alone were used. Hence it is important to know how to connect the windings to get them in series aiding. The markings on the transformer terminals are not a safe guide because all manufacturers do not mark their products the same way. However, the majority of them mark their transformers so that if the terminal marked B is connected to the terminal marked F the windings will be in series aiding. Some transformers have their terminals numbered from one to four. Usually these will be connected in series aiding if terminal No. 2 is connected to terminal No. 3. Again other transformers are marked P1 and P2 on the primary side and S1 and S2 on the secondary. These will usually be connected in series aiding if P2 is connected to S1. But, as was stated above, these markings are not reliable. It is necessary to find some means of determining the proper connection.

One method is to connect the transformer to a vacuum tube in such a manner as to form a simple Hartley oscillator. As a first trial join terminals B and F together and connect the junction to the filament of the tube. Then connect terminal to G to the grid and terminal P to the negative of the plate battery. To complete the circuit connect the positive of the B battery to the headset and then the other terminal of the headset to the plate of the tube. Light the tube and listen. If the circuit squeals the transformer windings are in series aiding. If the circuit does not squeal, reverse one pair of leads to the transformer terminals and listen again. If the circuit now squeals the windings are in series aiding.

A much simpler way of determining the series aiding connection is outlined in the accompanying drawing. It is based on the

oscillatory discharge of a charged condenser through an inductance and a resistance. The equipment needed for the test is a battery of about 45 volts, a fixed condenser of about .01 microfarad, a two-way switch, a headset, and the transformer to be tested. Connect these parts into a circuit as shown. First throw the switch to point No. 2 to give the condenser a charge of 45 volts. Then quickly transfer the switch to point No. 1. The charged condenser C now discharges through the headset and the transformer windings. The discharge is highly damped but the oscillations persist long enough to give the nature of the pitch of the oscillations. Charge and discharge the condenser in rapid succession a number of times until the pitch of the sound in the headset is firmly fixed in the mind. Then reverse one pair of leads on the transformer and repeat the process of charging and discharging. The pitch is now different; it may be higher or lower. The connection which gives the lower pitch is the series aiding.

The reason why the pitch changes is evident. The frequency of the oscillations or the pitch of the sound, depends on the capacity of the condenser and on the total inductance in the circuit. The capacity does not change when the leads are reversed, neither does the inductance of the headset. The inductance of the transformer changes, however. If L1 is the inductance of the primary winding, L2 the inductance of the secondary, and M the mutual inductance between the two windings, then the series aiding inductance of the transformer is  $L1+2M+L2$  and the series opposing inductance is  $L1-2M+L2$ . The difference is  $4M$ , which is a considerable change. It is enough to very noticeably change the pitch of the sound in the headset.

The sound to listen for is that which is ordinarily called the "click." The duller it sounds the lower is the pitch.

This method of determining the series aiding connection requires nothing which the fan does not already have, or only that which will be required for the receiver he is about to build. The switch indicated does not have to be one which is purchased in a store. It is simply an insulated lead running from the condenser, which may be rapidly moved from one point to the other. It is important that the condenser be well insulated, (including the switch lead unless this side of the condenser is grounded) otherwise the charge which the condenser picks up on point No. 2 will leak off before the switch reaches point No. 1.

# The Coils and the Wiring

## For the Thordarson-Wade Set

[Part I of this constructional article was published last week, issue of October 3, and Part II, the conclusion, is printed herewith. Trouble-shooting will be discussed in next week's issue, the Fall Buyers' Number, dated October 17.]

### PART II.

By Herman Bernard

Associate, Institute of Radio Engineers.

TWO tuning coils are used in the Thordarson-Wade set. Each one is a radio-frequency transformer, consisting of two windings, the primary and the secondary. The Aero Coil Wave Trap Unit was used in each instance. In each a tap is brought out to a lug on the skeleton low-loss form of the commercial product, but no wired connection is made to the tap point of the first coil (on L2) in hooking up the set. The

form diameter is  $3\frac{3}{4}$ " and thereon is wound the secondary, as follows: 14 turns are put on and a tap is taken, then 46 more turns are put on, total 60 turns. The winding is continuous. The point at the 14th turn is exposed by scraping off a little of the insulation. The wire used is No. 22 double cotton covered. The primary is wound inside the secondary and consists of 6 turns. It is placed at what will be the low potential end, that is, it occupies relatively the same position as do the 14 turns. The primary winding is spaced  $\frac{1}{8}$ ". The diameter of the primary is  $2\frac{3}{4}$ ". It takes some ingenuity to contrive the primary so as to preserve the  $\frac{1}{8}$ " spacing and place the primary securely inside the secondary. Also, the commercial form used has two thin insulation rings at the end and four supporting insulation rods. This affords a 95% air dielectric and puts the coil in the forefront of low-loss design.

The winding for L1L2 will be without tap, or, if tapped, this junction point will be ignored, while the secondary L4 must have the tap, so that the regeneration connection may be made thereto.

The secondary in each case is wound with no spacing except that afforded by the insulation on the wire itself. The axial length of the secondary in each case will be about  $2\frac{3}{8}$ ".

The same number of turns on about the same diameters, using the same kind of wire, will give approximately the same inductance in all cases and will enable tuning to be satisfactorily accomplished with .0005 mfd. variable condensers across the secondaries and a .00025 mfd. variable condenser for feedback. The tuning condensers are C1 and C2, while the regeneration condenser, .00025 mfd., is C3. These were shown in the schematic diagram of the wiring, and also in the picture diagrams (Figs. 1 and 2) published last week.

#### Laying Out the Panel

The dimensions of the panel are  $7 \times 24$ ". A photograph of the panel view was published last week. The instruments on the panel are two rheostats, potentiometer, three variable condensers (all these on a central line,  $3\frac{1}{2}$ " from top and bottom), the switch and the jack, these two being  $1\frac{1}{2}$ " from bottom. The distances from the left are 3", for RF tuning condenser,

C1; 8" for detector input tuning condenser, C2; 13" for regeneration condenser, C3;  $17\frac{1}{2}$ " for RF rheostat, R1; 20" for the potentiometer, and  $22\frac{3}{8}$ " for the detector rheostat, R2. This leaves the center shaft of the detector rheostat  $1\frac{3}{8}$ " from the right-hand side of the panel. The jack is lined up perpendicularly in respect to the detector rheostat mounting hole while the switch S is similarly placed under the RF rheostat. This accounts for everything that will be on the panel excepting two items. The dial pointers will be mounted so that the point is right next to the dial, but not touching it, in each case, and the screws for mounting the panel on the cabinet will be placed so six are evenly distributed.

The panel instruments should be mounted before any of the wiring is attempted, and this will therefore constitute the first assembly job.

#### The Baseboard

One may use a  $7 \times 23$ " baseboard, but in that case there will be no room for the conventional binding post strip or terminal block. Those desiring to terminate the set leads at such a strip should use an  $8 \times 23$ " baseboard and be sure, when purchasing a cabinet, to get one that has sufficient depth inside, to allow room for the protruding binding posts if the strip is mounted at right angles to the baseboard. However, the strip may be mounted parallel with the baseboard, in which case an 8" depth would suffice for both baseboard and cabinet.

In the original model no binding post strip was used for batteries but instead the set leads were connected direct to the cable. A small two-post strip, which can be made at home very easily, was used for the aerial and ground leads. The hard rubber strip was  $1 \times 2\frac{1}{2}$ ". The binding posts were mounted thereon, also one end of two brackets or Z-angles, which were  $\frac{3}{4}$ " high and had two end tips extending  $\frac{3}{8}$ " at right angles to the  $\frac{3}{4}$ " height, but in opposite directions to each other. A piece of brass  $1\frac{1}{4}$ " long,  $\frac{1}{2}$ " wide, will lend itself readily to bending to these dimensions.

#### Mounting the Bretwood Leak

The variable grid leak is mounted upright on the baseboard. The socket centers are  $2\frac{1}{2}$ " from the back of the panel. All sockets are in alignment. The RF socket is between the RF condenser and the detector condenser. The detector socket is between the detector condenser and the regeneration condenser. The first AF socket is just to the left of the regeneration condenser, when you look at the back of the set. Sockets (4) and (5), for second and third audio, are mounted right next to each other, as close as possible. The center of socket (4) is  $2\frac{1}{2}$ " to the left of the switch shaft hole.

The coils may be mounted on the baseboard, likewise the sockets, resistor mountings, Bretwood variable leak and auto-transformers. The first and second stage auto-transformers are mounted parallel with the panel, while the third and last one is at right angles to the others. (Fig. 6). One of the by-pass condensers (all large-capacity fixed condensers go by that name) may be mounted on top of the final auto-transformer, and it is perhaps preferable that this be the last .25 mfd. instrument, so that the 1.0 mfd. condenser may be mounted to left of the jack, looking at the set from the rear. This leaves two by-pass condensers to be accommodated, both .25 mfd. One is placed on top of the first auto-transformer and the

other mounted upright at left of the second AT, so that the greater room will be taken up on a perpendicular plane, where there is plenty, rather than on the horizontal plane, where there is not too much. The auto-transformers will place themselves, so to speak, if the previously expounded precautions are taken and the photographs consulted. The mounting for the ballast resistor has to be accommodated. The C battery connections will be taken up in the wiring directions.

Fig. 6 shows the coil mounting very clearly and also brings home the idea of how to mount the auto-transformers. It also shows a lead that seems common to the three variable condensers. In fact, however, this busbar strip is connected to the frame of the Wade variable condensers used in the original model. This frame is wholly unconnected to either the stator or rotor plates, hence when grounded forms a shield. The lead is therefore brought to ground. Body capacity effects are thus eliminated. The dotted line in Fig. 2, published last week, represents this shielding connection, which should be omitted unless the Wade condensers, or some other type that has a frame insulated from both sets of plates, is used.

The grid condenser is soldered, one side to the grid post of the detector tube socket and to bottom of the perpendicularly-mounted variable grid leak, the other side of both the leak and the condenser going to the high potential end of the secondary L4. This will be explained in detail later.

It will be found that the coils, when mounted as clearly shown in Fig. 6, are about  $8\frac{1}{4}$ " apart, measured only from actual winding, at their farthest points, while the minimum distance between the two coils is about  $2\frac{1}{2}$ " between actual windings. Notice that the coil forms are supported by mounting brackets. These are supplied with Aero coils and are nickel-plated.

Some persons may possess three .0005 mfd. condensers. They may use those three, but should make the tap at the 8th turn on L4, instead of at the 14th turn, due to the extra capacity in the condenser C3.

#### Wiring Directions

The wiring of the set is relatively easy. Those who can not read the schematic diagram (Fig. 1) quite so readily should consult the picture diagram (Fig. 2). They are the same. In Fig. 1 the ballast resistor seemed to read "R," instead of "R3," due to an imperfection in the engraving, so consider it R3. It is shown as R3 in the picture diagram. There is no R elsewhere in either diagram, so no confusion can result.

First wire the filament circuit. The A plus lead is brought from battery to one side of the switch, the other side of which is joined to the F plus posts of all five sockets. A minus is connected to only three points, so far as the filament wiring goes: (a), to one side of the ballast resistor R3; (b), to one side of the detector rheostat, R2; (c), to one side of the RF rheostat, R1. The open sides of those three instruments are connected as follows: R3 to the F minus posts of all three audio sockets, R2 to the F minus post of the detector socket and R1 to the F minus post of the RF socket. In Figs. 1 and 2 the sockets are enumerated: (1) RF; (2) detector; (3), first audio; (4), second audio; (5), third audio. When the connections are made up to this point the filament wiring is completed. You may try out the tubes and see whether they



Herman Bernard

# Exceptionally Lucid Data

## For Wiring the 5-Tube Quality Set

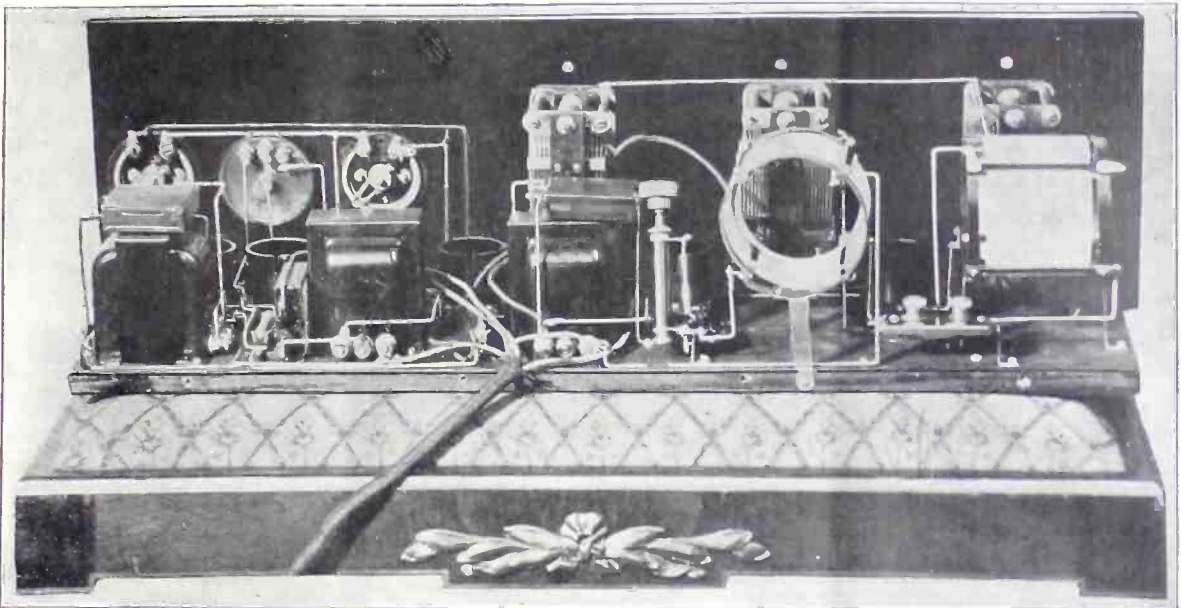

FIG. 6, rear view showing up particularly the manner of mounting two of the 0.25 mfd. condensers atop the auto-transformers, and clarifying the rheostat and potentiometer wiring. The shield lead is shown running from center to right and connecting the frames of the variable condensers to ground. The flexible leads to the coils are made from the rotor plates of the condensers, because they have a back-and-forward motion. The top part of the leak should go to the coil L4 and the bottom part to the grid of the detector socket. Note the aerial-ground connecting binding post strip. Instead of a strip for the battery connections the leads are established direct from instruments to cable cords. Identify each cord by some marking when you wire up. (Foto Topics).

light and whether the two rheostats change the brilliancy of the two tubes they are supposed to control and the switch turns all five tubes on and off. In wiring the rheostats select that rheostat terminal which is joined to the movable arm as the one that goes to A minus, the other rheostat terminal going to F minus in both cases.

### Coil Connections

In the commercial coils, considering L1L2, the terminals are identified, as P, B, F, G and T. As previously explained, no connection is made from the set to T in this case. P goes to aerial, B to ground, F to minus A and G to grid of tube (1). Expressed otherwise, the beginning of the primary L1 goes to aerial, the end to ground; the beginning of the secondary L2 goes to negative A and the end to the grid of the RF tube. Also connect the rotor plates of C1 to negative A battery and the stator plates to grid.

The interstage transformer, L3L4, is connected, P to plate of tube (1), B to B plus 45 volts, F to the rotor plates of both C2 and C3, and G to grid. Told otherwise, the beginning of the primary L1 goes to plate, the end to B plus; the beginning of the secondary, L4, to the rotor plates of both C2 and C3. Note carefully that the usual grid return connection established at this point (commonly A positive in a detector circuit) is NOT made to battery or to anywhere other than to the rotor plates of the two condensers, C2 and C3. The tap (T on commercial transformers) goes to A positive. This is 14 turns from the rotor plate connection. The end of the secondary L4 goes to the stator plates of C2, to one side of the variable grid leak and to one side of the grid condenser C4. The other side of the grid condenser is joined to the grid post of socket (2). In connecting the leak, be sure that the lug near the knob (that is, the point nearest

where your hand may be when adjusting the leak), goes to the coil and the lower lug to the grid condenser. This avoids body capacity effects even if the hand touches the metallic connecting point of the leak.

The plate of the detector tube (2) is soldered to the stator plates of C3 and to the P post of the first Thordarson auto-transformer. The G post of this instrument goes to one side of the 0.25 mfd. condenser. The B post goes to the B plus 45-volt lead. This is the detector voltage as well as the RF plate voltage. The free side of this fixed condenser goes to the grid of the first audio tube (3) and to one side of a 0.5 meg. grid leak. This leak takes a single mounting. The other side of the leak will be discussed later. The plate of the second audio tube (4) is connected as was the previous stage to P on an auto-transformer, B going however to another B plus lead, representing 135 volts. G goes to one side of the second 0.25 mfd. condenser, the other side of which connects one extreme terminal of the potentiometer, a Centralab 0.5 meg. instrument, rated commercially in the equivalent value, 500,000 ohms. The pointer or midpost of the potentiometer is connected to grid of tube (4). The plate of tube (4) goes to P on the third auto-transformer, B goes to B plus 135 volts, while G goes to one side of the remaining 0.25 mfd. condenser. The other side of that condenser goes to the grid of tube (5) and to one side of a 0.5 meg. fixed leak. The plate of that tube is joined to the hooked spring of the single circuit jack, J, while the right-angle of that jack goes to B plus 135 volts.

There still remain eight connections as a part of the wiring. The open ends of the three leaks (two fixed leaks and the potentiometer that is used as a variable leak) are joined together, and a flexible lead connected to this busbar strip. This

flexible lead is for C minus. At some convenient point tap the A minus lead in the set and bring out another flexible lead. This is for C plus. When the C battery is installed, with C plus to A minus and C minus to the common lead for the leaks, the test will be made for the correct bias. Usually 6 volts will be about right, although up to 12 may be tried, and the ear used as a guide when you tune in.

Three more set connections remain: (1) the by 1.0 mfd. condenser, located next to the jack, is connected, one side to B plus 135 volts, the other side to A minus. This is somewhat different from the accustomed connection but is correct.

### Safety First

One more left, but do not try that until you have done some preliminary testing. See that the rheostats work properly and that the ballast resistor functions. Use the switch to turn the tubes on or off as a unit. Then try the rheostats additionally. Finally satisfied up to this point, disconnect the A battery negative. Connect B minus to A plus. Insert one tube in one socket only. If the tube lights, quickly remove the tube and find the short circuit, remedy it, and try again. If the tube does not light in the first socket place it in one socket after another, being sure that no glimmer results. This much attended to, restore A minus to its proper place and leave B minus and A plus connected to each other (but not to A minus). Again go through the single-tube-in-a-single-socket test, with the switch at an "off" position. If no light results, then attach aerial to its post, insert the speaker cords in a plug, insert the plug in the jack and tune in.

### Getting Best Results

Do not be disappointed if first results are poor. It is surprising how bad they

(Continued on page 24)

# Radio University

**A** QUESTION and Answer Department conducted by RADIO WORLD for its Readers by its staff of Experts. Address Letters to The Radio University, RADIO WORLD, 145 West 45th St., New York City.

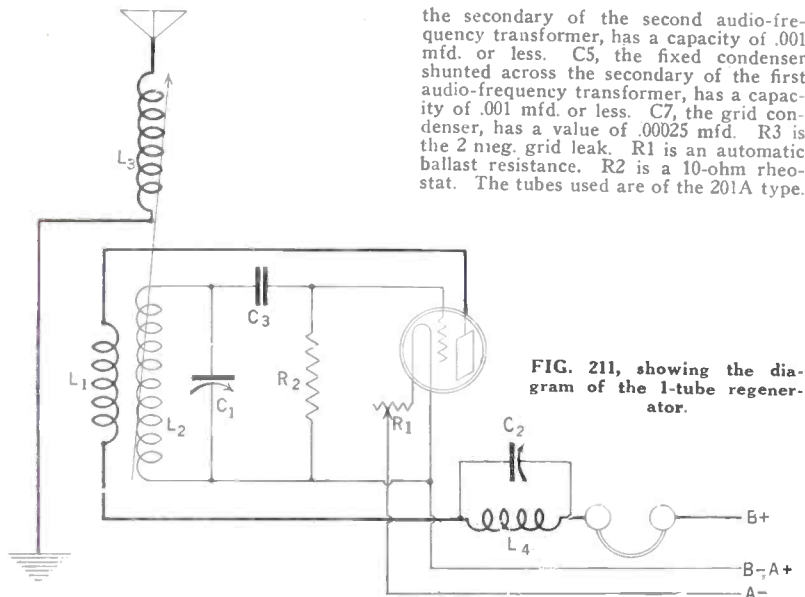

FIG. 211, showing the diagram of the 1-tube regenerator.

**I** WOULD like to have the diagram of a 1-tube regenerative set, employing a tuned aerial winding.—R. R. Humpins, Gavelytown, Tex.

Fig. 211 shows the electrical diagram of such a receiver. L1 is wound on a form 3½" in diameter, and 4" high, and contains 30 turns. L2 is wound on the same tubing and immediately adjoining L1, contains 35 turns. Use No. 22 DCC wire when winding these coils. L3 the variable primary is wound on a form 2½" in diameter, and 2" high, and contains 10 turns. No. 22 DCC wire is used when winding this form also. L4 the plate coil is wound on a form 3½" in diameter and 3" high, and contains 25 turns. Again use No. 22 DCC wire to wind this coil. C1 is a .0005 mfd. variable condenser. C2 is also a .0005 mfd. variable condenser. C3 is the grid condenser and has a value of .00025 mfd. R2 is a grid leak, having a resistance of 2 megohms. R1 is a 10-ohm rheostat. The tube used is a UV201A or similar type. Use 45 volts on the plate of this tube.

**I** WOULD like to have the diagram of a 3-tube reflex receiver of extreme volume —R. S. Transort, Titenville, Fla.

Fig. 212 shows the diagram of a 3-tube reflex receiver. L1, the primary of the radio-frequency transformer, is wound on a form 3½" in diameter and 4" high. It contains 10 turns, and is wound with No. 22 DCC wire. L2 is wound on the same tubing and contains 46 turns. There is ⅛" left between the primary and the secondary. L3 and L5 have the same number of turns as L1. L4 and L6 contains the same number of turns as L2. These coils are all wound on forms 3½" in diameter and 4" high, using the same kind of wire. The variable condensers C1, C2, and C3 have a maximum capacity of .0005 mfd. The first audio-frequency transformer may be of the high ratio type, while the second may be of the low ratio type. C4, the condenser shunted across

the secondary of the second audio-frequency transformer, has a capacity of .001 mfd. or less. C5, the fixed condenser shunted across the secondary of the first audio-frequency transformer, has a capacity of .001 mfd. or less. C7 the grid condenser, has a value of .00025 mfd. R3 is the 2 meg. grid leak. R1 is an automatic ballast resistance. R2 is a 10-ohm rheostat. The tubes used are of the 201A type.

There are 45 volts placed on the plate of the detector tube. On the plates of the amplifier tubes put 67½ volts or more.

**WOULD LIKE** to build the 1926 Diamond but would like the following information: (1) Can I use the Uncle Sam tuning coil? (2) Would the Acme A-2 be O. K. in the audio-transformer coupled stage. (3) Can two 30-ohm rheostats be used? (4) If a 3" inside diameter basket weave coil is used, how many turns should be wound for the RFT? (5) What kind of wire should I use?—H. J. Bauer, 624 S. Pearl St., Columbus, O.

(1) Yes. (2) Yes. (3) Yes, provided you use the 199 tube. (4) There are 12 turns wound for the primary and 57 turns for the secondary. (5) No. 18 DCC wire.

**I** HAVE built The Diamond and obtain wonderful results on wavelengths up to

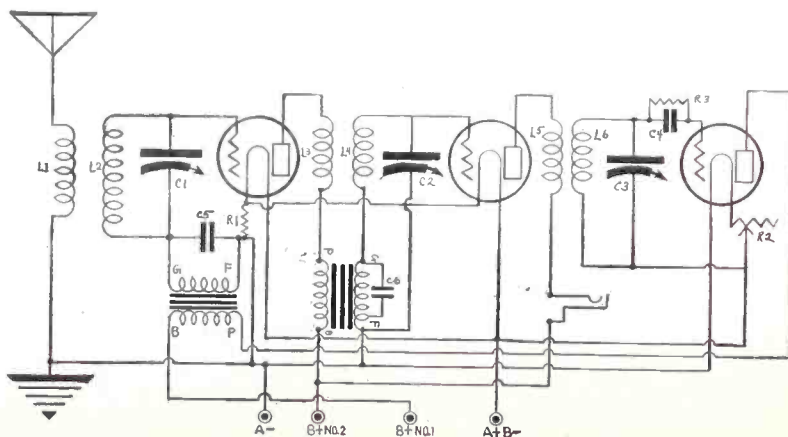

FIG. 212, showing the electrical diagram of the 3-tube reflex.

400 meters, but above that the signals are barely audible.—F. E. Leppert, Glenwillow, Ohio.

Place a .001 mfd. variable condenser across the antenna and the ground terminals of the set. Add 6 more turns to the primary of the antenna coupler.

**WHERE** should the tickler be placed in any 3-circuit tuner. Should it be placed near the primary or near the secondary? —R. R. Perry, 17 Marion Ave., Providence, R. I.

The tickler should be placed near the low potential of the secondary windings, but this makes little practical difference.

**WHERE** can I obtain the coils for the Diamond?—Ellis Leonard, Hewins, Kan. See advertising columns.

**WILL YOU** please give me a diagram of a 1-tube reflex receiver, employing a crystal as a detector?—H. Julsons, Manhattan Roadway, Kan.

Fig. 210 shows the electrical diagram of such a receiver. L1, the primary of the first radio-frequency transformer, is wound with 8 turns of No. 22 DCC wire on a form having a 3½" diameter and 4" height. L2 is wound separately on the same form, and contains 50 turns. There is no spacing between L1 and L2. C1 is a .0005 mfd. variable condenser. L3 is wound with 8 turns of No. 22 DCC wire on a 3½" form, 4" high. L4 is like L2. C4 is a .0005 mfd. variable condenser. D is the crystal detector. The audio-frequency transformer should be of the high-ratio type (6 to 1). C3 is a fixed condenser having a capacity of .001 mfd. C2, the other fixed condenser, is also a .001 mfd. type. The tube used is the 201A or a similar hard tube, such as the 199. There are 45 volts on the plate of this tube. R the rheostat has a resistance of 10 ohms, using a 6-volt battery to supply the filament current.

**I** HAVE built The Diamond of the Air, but can obtain no volume. I am using 23-plate condensers. The primary of the antenna coil consists of ten turns, the secondary consists of 45 turns, wound on a 3" tubing. The primary of the 3-circuit tuner has ten turns, the secondary consists of 45 turns. The tickler does not help any at all. There are 30 turns on this coil. (2) How many meters will this receiver tune to? I have changed leads on the tickler, but with no better results.—T. Casassough, 1013 E. Walnut St., Louisville, Ky.

(1) Add 10 turns to the tickler coil. Put more voltage on the plate of the detector tube. (2) This set will tune from 195 to 575 meters.

**MAY THE** C300 be used as a detector, and the UV201A used as the AF and RF



# Device Records Broadcasting



THIS 4-tube reflex records the broadcast music on a magnetized wire, thus making possible the reproduction of this same music on future occasions. As the music is received the impulses are recorded on a moving magnetized wire (shown at bottom), and by running the wire between two magnets, connected to an amplifier, the music can be used, while the impression remains on the wire. The record is not permanent, but it will last for several months. Note the tiny electric motor which winds and unwinds the wire (extreme lower left of set) and the wire running between the two magnets, which are the media for making the record and reproducing. Lorraine Hark holding it. (Kadel & Herbert)

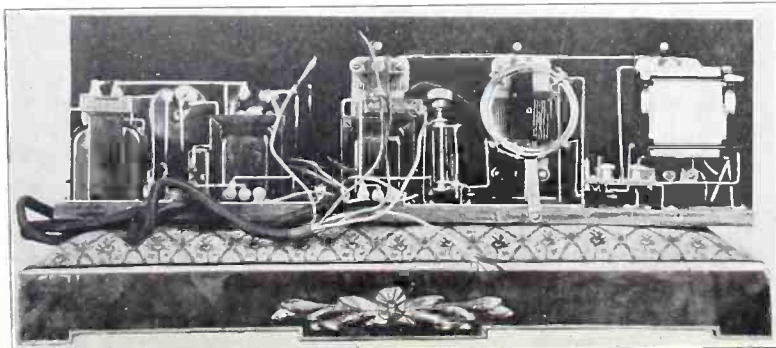

THE back view of the Thordarson-made set. Note the battery cable.

# Compact



FRANK DONDA, a radio fan, of L... cabinet is of plate glass. The set is a... but one control and Donda seriously e... and that London is "almo

# A Set in a



A LIGHTHOUSE SET—A novel 3-tu... work of Alex. Goldstein. The detector... and the two stage amplifier is inside... the loud speaker. The photograph sh... Lighthouse.

# Chicago "Strike" Off; Monday Nights Silent

CHICAGO.

The silent Monday night rule is being observed by the two suburban station



# 1-Dial Set

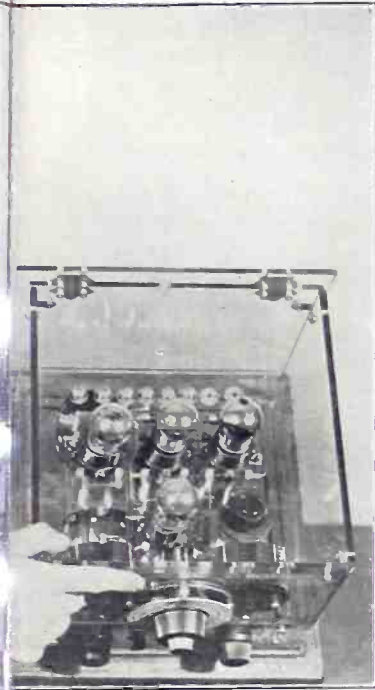

Island City, N. Y., built this set. The tube, tuned radio-frequency model, having as that he has reached Honolulu with it, local." (Kadel & Herbert)

# Radio Knife Demonstrated

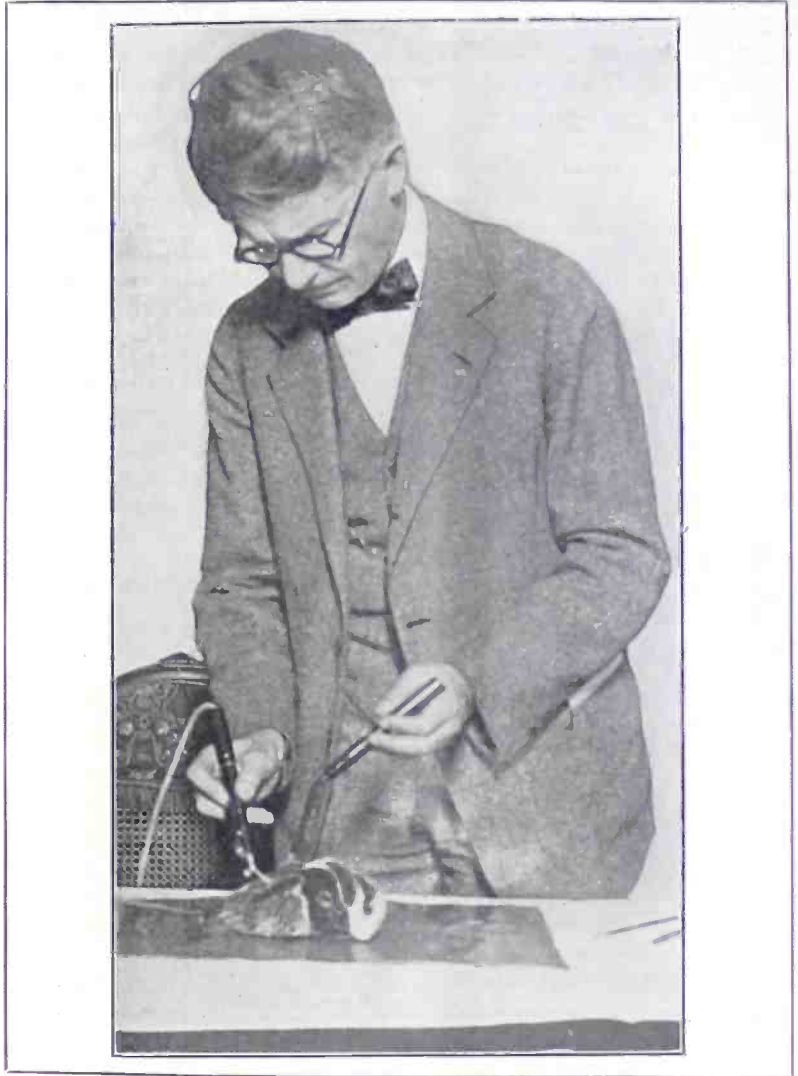

BEFORE a gathering of eminent X-ray specialists, Dr. A. Mutscheller of New York demonstrated the original radio knife. This instrument is energized by a powerful high-frequency current and is used in treating cancers and other growths.

# Lighthouse



et, built in the form of a lighthouse, is the mounted in the glass enclosure at the top window of the lighthouse, is the bell of Miss Mildred Fuder operating the Radio (Kadel & Herbert)

# Vision Transmitted by Radio

AFTER years of futile experimenting, wireless vision is becoming a reality. Light falling on a light sensitive cell sets up a pulsating current. The current is strong in the high lights, low at the half tones and nil at darkness. Reception is done by reversing the process. Photo shows Alfred Baird of London, the inventor, transmitting his own image. (International Newsreel)

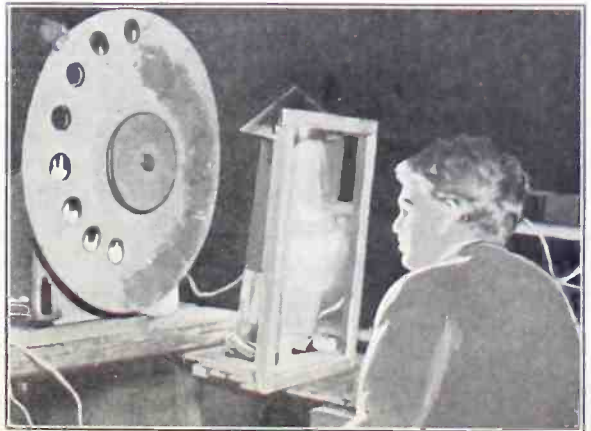

that had been violating it. They are WWAE, Joliet, and WCBD, Zion City. The Broadcast Listeners Association had threatened to "strike" if these two stations persisted in spoiling DX hunting expeditions.

# THE KEY TO THE AIR

## KEY

Abbreviations: EST, Eastern Standard Time; CST, Central Standard Time; MST, Mountain Standard Time; PST, Pacific Standard Time;

How to tune in a desired distant station at just the right time—Choose your station from the list published herewith. See what time division the station is under (EST, CST, etc.); then consult the table below. Add to or subtract, as directed from the time as given on the PROGRAM. The result will be the same BY YOUR CLOCK that you should tune in, unless daylight saving time intervenes, as explained below.—The table:

If you are in	And want a station in	Subtract	Add
EST	CST	.....	1 hr.
EST	MST	.....	2 hrs.
EST	PST	.....	3 hrs.
CST	EST	1 hr.	.....
CST	MST	.....	1 hr.
CST	PST	2 hrs.	.....
MST	EST	2 hrs.	.....
MST	MST	1 hr.	.....
MST	PST	.....	1 hr.
PST	EST	3 hrs.	.....
PST	CST	2 hrs.	.....
PST	DST	1 hr.	.....

## FRIDAY, OCTOBER 9

WAAM, Newark, N. J., 263 (EST)—11 AM to 12; 7 PM to 10:30.  
 WAHG, Richmond Hill, N. Y., 316 (EST)—12:30 to 1:05 PM; 7:30 to 11:05 PM.  
 WAMD, Minneapolis, Minn., 243.8 (CST)—12 to 1 PM; 10 to 12.  
 WBBM, Chicago, Ill., 226 (CST)—8 to 10 PM.  
 WBBR, New York City, 272.6 (EST)—8 PM to 10.  
 WBOQ, Richmond Hill, N. Y., 236 (EST)—7:30 PM to 11:30.  
 WBZ, Springfield, Mass., 333.1 (EST)—6 PM to 11.  
 WCCO, St. Paul and Minneapolis, Minn., 416.4 (CST)—9:30 AM to 12 M; 1:30 to 4; 5:30 to 10.  
 WCAE, Pittsburgh, Pa., 461.3 (EST)—12:30 to 1:30 PM; 4:30 to 5:30; 6:30 to 11.  
 WDAF, Kansas City, Mo., 365.6 (CST)—3:30 to 7 PM; 8 to 10; 11:45 to 1 AM.  
 WFAF, New York City, 492 (EST)—6:45 AM to 7:45; 11 to 12; 4 PM to 5; 6 to 12.  
 WEAR, Cleveland, O., 390 (EST)—11:30 AM to 12:10 PM; 3:30 to 4:10; 8 to 11.  
 WFAO, Ohio State University, 293.9 (EST)—8 PM to 10.  
 WEEI, Boston, Mass., 476 (EST)—6:45 AM to 7:45; 2 PM to 3:15; 5:30 to 10.  
 WENC, Berrien Springs, Mich., 286 (CST)—9 PM to 11.  
 WFAA, Dallas, Texas, 475.9 (CST)—10:30 AM to 11:30; 12:30 PM to 1; 2:30 to 6; 6:45 to 7; 8:30 to 9:30.  
 WFBN, New York City, 272.6 (EST)—2 PM to 6.  
 WGBS, New York City, 316 (EST)—10 AM to 11; 1:30 PM to 4; 6 to 7:30.  
 WGCC, New York City, 252 (EST)—2:30 PM to 5:15; 8 to 11.  
 WGES, Chicago, Ill., 250 (CST)—7 to 9 PM; 11 to 1 AM.  
 WGN, Chicago, Ill., 370 (CST)—9:31 AM to 3:30 PM; 5:30 to 11:30.  
 WGR, Buffalo, N. Y., 319 (EST)—12 M to 12:45 PM; 7:30 to 11.  
 WGY, Schenectady, N. Y., 379.5 (EST)—1 PM to 2; 5:30 to 10:30.  
 WHAD, Milwaukee, Wis., 275 (CST)—11 AM to 12:15 PM; 4 to 5; 6 to 7:30; 8:30 to 10.  
 WHAS, Louisville, Ky., 399.8 (CST)—4 PM to 5; 7:30 to 9.  
 WHN, New York City, 360 (EST)—12:30 PM to 1; 2:15 to 5; 7 to 11; 12 to 12:30 AM.  
 WHO, Des Moines, Iowa, 526 (CST)—7 PM to 9; 11 to 12; 12:30 to 1:30; 4:30 to 5:30; 6:30 to 9:30.  
 WHT, Chicago, Ill., 400 (CST)—11 AM to 2 PM; 7 to 8:30; 8:45 to 10:05; 10:30 to 1 AM.  
 WIP, Philadelphia, Pa., 508.2 (EST)—6:45 AM to 7:15; 10 to 11 PM to 2; 3 to 5; 6 to 7.  
 WJY, New York City, 405 (EST)—7:30 PM to 11:30.  
 WJZ, New York City, 455 (EST)—10 AM to 11; 1 PM to 2; 4 to 6; 7 to 10:30.  
 WLIT, Philadelphia, Pa., 395 (EST)—12:02 PM to 12:30; 2 to 3; 4:30 to 6; 7:30 to 1 AM.  
 WLW, Cincinnati, O., 422.3 (EST)—10:45 AM to 12:15; 1:30 to 2:30.  
 WMCA, New York City, 341 (EST)—11 AM to 12 M; 6:30 PM to 12.  
 WNYC, New York City, 526 (EST)—3:45 PM to 4:45; 6:20 to 11.  
 WOA, Omaha, Neb., 526 (CST)—12:30 PM to 1; 5:45 to 7:10; 9 to 11.  
 WOC, Davenport, Iowa, 484 (CST)—12:57 PM to 2; 3 to 3:30; 5:45 to 12.  
 WOR, Newark, N. J., 405 (EST)—6:45 AM to 7:45; 2:30 PM to 4; 6:15 to 7.  
 WPAK, Fargo, N. D., 283 (CST)—7:30 PM to 9.  
 WPG, Atlantic City, N. J., 299.8 (EST)—7 PM to 8:30; 10 to 12.  
 WQJ, Chicago, Ill., 448 (CST)—11 AM to 12 M; 3 PM to 4; 7 to 8; 10 to 2 AM.  
 WRC, Washington, D. C., 469 (EST)—9 AM to 10; 12 PM to 1; 5 to 7.  
 WREO, Lansing, Michigan, 285.5 (EST)—10 PM to 11.  
 WRNY, New York City, 258.5 (EST)—11:59 to 2 PM; 7:59 to 9:45.  
 WSB, Atlanta, Ga., 428.3 (CST)—12 M to 1 PM; 2:30 to 3:30; 5 to 6; 8 to 9; 10:45 to 12.  
 WSBP, St. Louis, Mo., 273 (CST)—12 M to 1 PM; 3 to 4; 7:30 to 10; 12 PM to 1 AM.

WWJ, Detroit, Mich., 352.7 (EST)—8 AM to 8:30; 9:30 to 10:30; 11:55 to 1:30; 3 to 4; 6 to 7; 8 to 10.  
 WKDA, Pittsburgh, Pa., 309 (EST)—6 AM to 7; 9:45 to 12:20 PM; 1:30 to 3:30; 3:30 to 11.  
 KFGE, State College of Wash., 348.6 (PST)—7:30 PM to 9.  
 KFDY, Brookings, S. D., 273 (MST)—8 PM to 9.  
 KFI, Los Angeles, Cal., 467 (PST)—5 PM to 10.  
 KFKX, Hastings, Neb., 288.3 (CST)—12:30 PM to 1:30; 9:30 to 12.  
 KFNF, Shenandoah, Iowa, 268 (CST)—12:15 PM to 1:15; 3 to 4; 6:30 to 10.  
 KFOA, Seattle, Wash., 455 (PST)—12:30 PM to 1:30; 4 to 5:15; 6 to 11.  
 KGO, Oakland, Cal., 261.2 (PST)—11:10 AM to 1 PM; 1:30 to 3; 4 to 7.  
 KGW, Portland, Oregon, 491.5 (PST)—11:30 AM to 1:30 PM; 5 to 11.  
 KHJ, Los Angeles, Cal., 405.2 (PST)—7 AM to 7:15; 12 M to 3:30 PM; 5:30 to 11:30.  
 KJR, Seattle, Wash., 484.4 (PST)—10:30 AM to 11:30 AM; 1 PM to 6:30; 8:30 to 11.  
 KNX, Hollywood, Cal., 337 (EST)—11:30 AM to 12:30 PM; 1 to 2; 4 to 5; 6:30 to 12.  
 KOA, Denver, Col., 322.4 (MST)—11:45 AM to 12:30 PM; 3:30 to 4:15; 6 to 10.  
 KOB, State College of New Mexico, 348.6 (MST)—11:55 AM to 12:30 PM; 7:30 to 8:30; 9:55 to 10:10.  
 KOIL, Council Bluffs, Iowa, 278 (CST)—7:30 PM to 8:45; 11 to 12 M.  
 KPO, San Francisco, Cal., 429 (PST)—7:30 AM to 8; 10:30 to 12 M; 1 PM to 2; 4:30 to 10:30.  
 KSD, St. Louis, Mo., 545.1 (CST)—4 PM to 5.  
 KTHS, Hot Springs, Ark., 374.8 (CST)—12:30 PM to 1; 8:20 to 10.  
 KYW, Chicago, Ill., 536 (CSTSD)—6:30 AM to 7:30; 10:55 to 1 PM; 2:25 to 3:30; 6:02 to 7:20; 9 to 1:30 AM.  
 CNRA, Moncton, Canada, 313 (EST)—8:30 PM to 10:30.  
 CNRE, Edmonton, Canada, 516.9 (MST)—8:30 PM to 10:30.  
 CNRS, Saskatoon, Canada, 400 (MST)—2:30 PM to 5.  
 CNRT, Toronto, Canada, 357 (EST)—6:30 PM to 11.

## SATURDAY, OCTOBER 10

WAAM, Newark, N. J., 263 (EST)—7 PM to 11.  
 WAHG, Richmond Hill, N. Y., 316 (EST)—12:30 PM to 1:05; 12 to 2 AM.  
 WAMD, Minneapolis, Minn., 243.8 (CST)—12 M to 1 PM; 10 to 12.  
 WBBM, Chicago, Ill., 226 (CST)—8 PM to 1 AM.  
 WBBR, New York City, 272.6 (EST)—8 PM to 9.  
 WBOQ, Richmond Hill, N. Y., 236 (EST)—3:30 PM to 6:30.  
 WBZ, Springfield, Mass., 333.1 (EST)—11 AM to 12:30 PM; 7 to 9.  
 WCAE, Pittsburgh, Pa., 461.3 (EST)—10:45 AM to 12 M; 3 PM to 4; 6:30 to 7:30.  
 WCCO, St. Paul and Minneapolis, Minn., 416.4 (CST)—9:30 AM to 12:30 PM; 2:30 to 5; 6 to 10.  
 WFAF, New York City, 492 (EST)—6:45 AM to 7:45; 4 PM to 5; 6 to 12.  
 WEEI, Boston, Mass., 476 (EST)—6:45 AM to 7 AM.  
 WEAR, Cleveland, O., 390 (EST)—11:30 AM to 12:10 PM; 3:30 to 4:10; 7 to 8.  
 WEMC, Berrien Springs, Mich., 286 (CST)—11 AM to 12:30 PM; 8:15 to 11.  
 WFAA, Dallas, Texas, 475.9 (CST)—12:30 PM to 1; 6 to 7; 8:30 to 9:30; 11 to 12:30 AM.  
 WFBN, New York City, 272.6 (EST)—2 PM to 7:30; 11:30 to 12:30 AM.  
 WGBS, New York City, 316 (EST)—10 AM to 11; 1:30 PM to 3; 6 to 11.  
 WGCC, New York City, 252 (EST)—2:30 PM to 5:15.  
 WGES, Chicago, Ill., 250 (CST)—7 PM to 9; 11 to 1 AM.  
 WGN, Chicago, Ill., 370 (CST)—9:31 AM to 2:30 PM; 3 to 5:57; 6 to 11:30.  
 WGY, Schenectady, N. Y., 379.5 (EST)—7:30 PM to 10.  
 WHAD, Milwaukee, Wis., 275 (CST)—11 AM to 12:30 PM; 4 to 5; 6 to 7:30.  
 WHAR, Atlantic City, N. J., 275 (EST)—2 PM to 3; 7:30 to 9.  
 WHAS, Louisville, Ky., 399.8 (CST)—4 PM to 5; 7:30 to 9.  
 WHN, New York City, 360 (EST)—2:15 PM to 5; 7:30 to 10.  
 WHO, Des Moines, Iowa, 526 (CST)—11 AM to 12:30 PM; 4 to 5:30; 7:30 to 8:30.  
 WHT, Chicago, Ill., 400 (CST)—11 AM to 2 PM; 7 to 8:30; 9:30 to 1 AM.  
 WIP, Philadelphia, Pa., 508.2 (EST)—7 AM to 8; 10:20 to 11; 1 PM to 2; 3 to 4; 6 to 11:30.  
 WJY, New York City, 405 (EST)—2:30 PM to 5; 8 to 10:30.  
 WJZ, New York City, 455 (EST)—9 AM to 12:30 PM; 2:30 to 4; 7 to 10.  
 WKRC, Cincinnati, O., 326 (EST)—10 to 12 M.  
 WLWC, Cincinnati, O., 422.3 (EST)—9:30 AM to 12:30 PM; 7:30 to 10.  
 WMAK, Lockport, N. Y., 265.5 (EST)—10:25 AM to 12:30 PM.  
 WMCA, New York City, 341 (EST)—3 to 5 PM; 6:30 to 2.  
 WNYC, New York City, 526 (EST)—1 to 3 M; 7 to 11.  
 WOAW, Omaha, Neb., 526 (CST)—10 AM to 1; 2:15 to 4; 9 to 11.  
 WOC, Davenport, Iowa, 484 (CST)—12:57 PM to 2; 5:45 to 7:10; 9 to 12.  
 WOO, Philadelphia, Pa., 395.2 (EST)—11 AM to 1 PM; 4 to 5; 10:55 to 11:02.  
 WOR, Newark, N. J., 405 (EST)—6:45 AM to 7:45; 2:30 PM to 4; 6:15 to 7:30; 8 to 11.

WQJ, Chicago, Ill., 448 (CST)—11 AM to 12 M; 3 PM to 4; 7 to 8; 10 to 3 AM.  
 WPG, Atlantic City, N. J., 299.8 (CST)—7 PM to 12.  
 WRC, Washington, D. C., 469 (EST)—1 PM to 2; 6:45 to 12.  
 WREO, Lansing, Mich., 285.5 (EST)—10 PM to 12.  
 WRNY, New York City, 258.5 (EST)—11:59 to 2 PM; 7:59 to 9:30; 12 M to 1 AM.  
 WSB, Atlanta, Ga., 428.3 (CST)—12 M to 1 PM; 3 to 5 to 6; 10:45 to 12.  
 WWJ, Detroit, Mich., 352.7 (EST)—8 AM to 8:30; 9:30 to 11; 11:55 to 1:30 PM; 3 to 4.  
 WKDA, Pittsburgh, Pa., 309 (EST)—10 AM to 12:30 PM; 1:30 to 6:30; 8:45 to 10.  
 KFI, Los Angeles, Cal., 467 (PST)—5 PM to 11.  
 KFKX, Hastings, Neb., 288.3 (CST)—12:30 PM to 1:30; 9:30 to 12:30.  
 KFNF, Shenandoah, Iowa, 268 (CST)—12:15 PM to 1:15; 3 to 4; 6:30 to 10:30.  
 KFOA, Seattle, Wash., 455 (PST)—Silent.  
 KGO, Oakland, Cal., 261.2 (PST)—11 AM to 12:30 PM; 3:30 to 5:45; 7:30 to 9.  
 KGW, Portland, Oregon, 491.5 (PST)—11:30 AM to 1:30 PM; 6 to 7; 10 to 11.  
 KHJ, Los Angeles, Cal., 405.2 (EST)—7 AM to 7:30; 10 to 1:30 PM; 2:30 to 3:30; 5:30 to 2 AM.  
 KJR, Seattle, Wash., 484.4 (PST)—1 PM to 2:45; 6 to 6:30; 8:30 to 10.  
 KNX, Hollywood, Cal., 337 (PST)—1 PM to 2; 6:30 to 2 AM.  
 KOA, Denver, Colo., 322.4 (MST)—11:30 AM to 1 PM; 7 to 10.  
 KOIL, Council Bluffs, Iowa, 278 (CST)—7:30 PM to 9.  
 KPO, San Francisco, Cal., 429 (PST)—8 AM to 12 M; 2 PM to 3; 6 to 10.  
 KSD, St. Louis, Mo., 545.1 (CST)—7 PM to 8:30.  
 KTHS, Hot Springs, Ark., 374.8 (CST)—12:30 PM to 1; 8:20 to 10:30.  
 KYW, Chicago, Ill., 536 (CST)—11 AM to 12:30 PM; 4 to 5; 7 to 8.  
 CKAC, Montreal, Canada, 411 (EST)—4:30 PM to 5:30.  
 CNRO, Ottawa, Ontario, Canada, 435 (EST)—7:30 PM to 10.  
 PWX, Havana, Cuba, 400 (EST)—8:30 PM to 11:30.

## SUNDAY, OCTOBER 11

WBBM, Chicago, Ill., 226 (CST)—4 PM to 6; 8 to 10.  
 WBBR, New York City, 272.6 (EST)—10 AM to 12 M; 9 PM to 11.  
 WCCO, St. Paul and Minneapolis, Minn., 416 (CST)—11 AM to 12:30 PM; 4:10 to 5:10; 7:20 to 10.  
 WDAF, Kansas City, Mo., 365.6 (CST)—4 PM to 5:30.  
 WFAF, New York City, 492 (EST)—3 PM to 5; 7:20 to 10:15.  
 WEAR, Cleveland, O., 390 (EST)—3:30 PM to 5; 7 to 8; 9 to 10.  
 WFBH, New York City, 272.6 (EST)—5 PM to 10.  
 WGBS, New York City, 316 (EST)—3:30 PM to 4:30; 8 to 10.  
 WGCC, New York City, 252 (EST)—8 PM to 11.  
 WGES, Chicago, Ill., 250 (CST)—5 PM to 7; 10:30 to 12 M.  
 WGN, Chicago, Ill., 370 (CST)—11 AM to 12:45 PM; 2:30 to 5; 9 to 10.  
 WGR, Buffalo, N. Y., 379.5 (EST)—9:30 AM; 7:15 to 8 PM.  
 WGY, Schenectady, N. Y., 379.5 (EST)—9:30 AM to 12:30 PM; 2:35 to 3:45; 6:30 to 10:30.  
 WHAD, Milwaukee, Wis., 275 (CST)—3:15 PM to 4:15.  
 WHAR, Atlantic City, N. J., 275 (EST)—3:30 PM to 3:45; 7:50 to 10; 11:15 to 12.  
 WHN, New York City, 360 (EST)—1 PM to 1:30; 3 to 6; 10 to 12.  
 WHT, Chicago, Ill., 238 (CST)—9:30 AM to 1:15 PM; 5 to 8.  
 WIP, Philadelphia, Pa., 508.2 (EST)—10:45 AM to 12:30 PM; 4:15 to 5:30.  
 WJZ, New York City, 455 (EST)—9 AM to 12:30 PM; 2:30 to 4; 7 to 11.  
 WKRC, Cincinnati, O., 326 (EST)—6:45 PM to 11.  
 WMCA, New York City, 341 (EST)—11 AM to 12:15 PM; 7 to 7:30.  
 WNYC, New York City, 526 (EST)—9 PM to 11.  
 WOO, Jamestown, N. Y., 275.1 (EST)—9 PM to 11.  
 WOO, Philadelphia, Pa., 508.2 (EST)—10:45 AM to 12:30 PM; 2:30 to 4.  
 WPG, Atlantic City, N. J., 299.8 (EST)—3:15 PM to 5; 9 to 11.  
 WQJ, Chicago, Ill., 448 (CST)—10:30 AM to 12:30 PM; 3 PM to 4; 8 to 10.  
 WREO, Lansing, Michigan, 285.5 (EST)—10 AM to 11:30.  
 WRNY, New York City, 258.5 (EST)—3 PM to 5; 7:59 to 10.  
 WSBF, St. Louis, Mo., 273 (CST)—9 to 11 PM.  
 WWJ, Detroit, Mich., 352.7 (EST)—11 AM to 12:30 PM; 2 to 4; 6:20 to 9.  
 WKDA, Pittsburgh, Pa., 309 (EST)—9:45 AM to 10:30; 11:55 to 12 M; 2:30 PM to 5:30; 7 to 11.  
 KFNF, Shenandoah, Iowa, 268 (CST)—10:45 AM to 12:30 PM; 2:30 to 4:30; 6:30 to 10.  
 KOA, Denver, Colo., 322.4 (MST)—10:55 AM to 1 PM; 4 PM to 5:30; 7:45 to 10.  
 KOIL, Council Bluffs, Iowa, 278 (CST)—11 AM to 12:30 PM; 7:30 to 9.  
 KGW, Portland, Oregon, 491.5 (PST)—10:30 AM to 12:30 PM; 6 to 9.  
 KHJ, Los Angeles, Cal., 405.2 (EST)—10 AM to 12:30 PM; 6 to 9.  
 KJR, Seattle, Wash., 484.4 (PST)—11 AM to 12:30 PM; 4 to 5; 7 to 9.  
 KTHS, Hot Springs, Ark., 374.8 (CST)—11 AM to 12:30 PM; 2:30 to 3:40; 8:40 to 11.

MONDAY, OCTOBER 12

WAAM, Newark, N. J., 263 (EST)—11 AM to 12 M; 7 PM to 11.
WAHG, Richmond Hill, N. Y., 316 (ESTDS)—12:30 M to 1:05 PM; 7:30 to 12.
WAMB, Minneapolis, Minn., 243.8 (CST)—10 PM to 12.
WBBM, Chicago, Ill., 226 (CST)—6 PM to 7.
WBBR, New York City, 272.6 (ESTDS)—8 PM to 11.
WBZ, Springfield, Mass., 333.1 (EST)—6 PM to 11:30.
WCAE, Pittsburgh, Pa., 461.3 (EST)—12:30 PM to 1:30; 4:30 to 5:30; 6:30 to 12.
WCCD, Zion, Ill., 344.6 (CST)—8 PM to 10.
WCCO, St. Paul and Minneapolis, Minn., 416 (CST)—9:30 AM to 12 M; 1:30 PM to 6:15.
WDAF, Kansas City, Mo., 365.6 (CST)—3:30 PM to 7; 8 to 10; 11:45 to 1 AM.
WEAF, New York City, 492 (EST)—6:45 AM to 7:45; 4 PM to 5; 6 to 11:30.
WEAR, Cleveland, O., 390 (EST)—11:30 AM to 12:10 PM; 3:30 to 4:10; 7 to 8.
WEEL, Boston, Mass., 476 (EST)—6:45 AM to 7:45; 10:45 to 11:45.
WEMC, Berrien Springs, Mich., 286 (CST)—8:15 PM to 11.
WFAA, Dallas, Texas, 475.9 (EST)—10:30 AM to 11:30; 12:30 PM to 1; 2:30 to 6; 6:45 to 7; 8:30 to 9:30.
WFBH, New York City, 272.6 (EST)—2 PM to 6:30.
WGC, New York City, 252 (EST)—2:30 PM to 11; 1:30 to 3:10; 6 to 7:30.
WGES, Chicago, Ill., 250 (CST)—3 PM to 8.
WGCP, New York City, 252 (EST)—2:30 PM to 5:18; 8 to 10:45.
WGN, Chicago, Ill., 370 (CST)—9:31 AM to 3:30 PM; 3:30 to 5:57.
WGR, Buffalo, N. Y., 319 (EST)—12 M to 12:30 PM; 2:30 to 4:30; 7:30 to 11.
WGY, Schenectady, N. Y., 379.5 (EST)—1 PM to 2; 5:30 to 8:30.
WHAD, Milwaukee, Wis., 275 (CST)—11 AM to 12:15 PM; 4 to 5; 6 to 7:30; 8 to 10.
WHAR, Atlantic City, N. J., 275 (EST)—2 PM to 5; 7:30 to 9.
WHAS, Louisville, Ky., 399.8 (CST)—4 PM to 5; 7:30 to 9.
WHN, New York City, 360 (EST)—2:15 PM to 5; 6:30 to 12.
WHO, Des Moines, Iowa, 526 (CST)—12:15 PM to 1:30; 7:30 to 9; 11:15 to 12.
WHT, Chicago, Ill., 400 (CST)—11 AM to 2 PM; 7 to 8:30; 10:30 to 1 AM.
WHY, Philadelphia, Pa., 508.2 (EST)—7 AM to 8:1 PM to 2; 3 to 4.
WJZ, New York City, 455 (EST)—10 AM to 11; 1 PM to 2; 4 to 5:30; 6 to 6:30; 7 to 11.
WKRC, Cincinnati, O., 326 (EST)—8 PM to 10.
WLIT, Philadelphia, Pa., 395 (EST)—12:02 PM to 1; 2 to 3; 4:30 to 6; 7:30 to 11:30.
WLW, Cincinnati, O., 422.3 (EST)—10:45 AM to 12:30 PM; 1:30 to 2:30; 3 to 5; 6 to 10.
WMAK, Lockport, N. Y., 265.5 (EST)—8 PM to 12.
WMCB, New York City, 341 (EST)—11 AM to 12 M; 6:30 PM to 12.
WNYC, New York City, 526 (EST)—3:15 PM to 4:15; 6:20 to 11.
WOAW, Omaha, Neb., 526 (CST)—12:30 PM to 1:30; 5:45 to 10:30.
WOC, Davenport, Iowa, 484 (CST)—12:57 PM to 2:30; 5:45 to 6.
WOO, Philadelphia, Pa., 508.2 (EST)—11 AM to 1 PM; 4:40 to 6; 7:30 to 11.
WOR, Newark, N. J., 405 (EST)—6:45 AM to 7:45; 2:30 to 4; 6:15 to 11:30.
WPAK, Fargo, N. D., 283 (CST)—7:30 PM to 9.
WPG, Atlantic City, N. J., 299.8 (EST)—7 PM to 11.
WQJ, Chicago, Ill., 488 (CST)—11 AM to 12 M; 3 PM to 4; 7 to 10.
WRC, Washington, D. C., 469 (EST)—9 AM to 10; 12 M to 2; 6:15 PM to 6:30.
WREO, Lansing, Michigan, 285.5 (EST)—10 PM to 11.
WRNY, New York City, 258.5 (EST)—11:59 AM to 2 PM; 7:30 to 11.
WSB, Atlanta, Ga., 428.3 (CST)—12 M to 1 PM; 2:30 to 3:30; 5 to 6; 8 to 9; 10:45 to 12.
WSP, St. Louis, Mo., 273 (CST)—12 M to 1 PM; 3 to 4 to 7; 7:30 to 10:30; 11:55 to 1:30 PM; 3 to 4; 6 to 10.
WKDK, Pittsburgh, Pa., 309 (EST)—6 AM to 7; 9:45 to 12:15 PM; 2:30 to 3:30; 5:30 to 10.
KFAE, State College of Wash., 348.6 (PST)—7:30 PM to 9.
KFL, Los Angeles, Cal., 467 (PST)—5 PM to 11.
KFKX, Hastings, Neb., 288.3 (CST)—12:30 PM to 1:30; 5:15 to 6:15; 9:30 to 12:30.
KFNF, Shenandoah, Iowa, 266 (CST)—12:15 PM to 1:15; 3 to 4; 6:30 to 10.
KFOA, Seattle, Wash., 455 (PST)—12:45 PM to 1:30; 4 to 5:15; 6 to 10.
KGO, Oakland, Cal., 361.2 (PST)—9 AM to 10:30; 11:30 AM to 1 PM; 1:30 to 6; 6:45 to 7; 8 to 1 AM.
KGW, Portland, Oregon, 491.5 (PST)—11:30 AM to 1:30; 3 to 8.
KHJ, Los Angeles, Cal., 405.2 (PST)—7 AM to 7:15; 12 M to 1:30 PM; 5:30 to 10.
KJR, Seattle, Wash., 384.4 (PST)—1 PM to 2:45; 6 to 6:30; 7 to 11.
KNX, Hollywood, Cal., 337 (PST)—12 M to 1 PM; 4 to 5; 6:30 to 12.
KOB, State College of New Mexico, 348.6 (MST)—10:55 AM to 12:30 PM; 7:30 to 8:30; 9:55 to 10.
KOIL, Council Bluffs, Iowa, 278 (CST)—7:30 PM to 10.
KPO, San Francisco, Cal., 428 (PST)—10:30 AM to 12 M; 1 PM to 2; 2:30 to 3:30; 4:30 to 10.
KSD, St. Louis, Mo., 545.1 (CST)—7:30 PM to 10.
KTHS, Hot Springs, Ark., 374.8 (CST)—12:30 PM to 1; 8:30 to 10.

KYW, Chicago, Ill., 536 (CSTDS)—6:30 AM to 7:30; 10:55 to 1 PM; 2:15 to 3:30; 6:02 to 7.

TUESDAY, OCTOBER 13

WAAM, Newark, N. J., 263 (EST)—11 AM to 12 M; 7 PM to 11.
WAHG, Richmond Hill, N. Y., 316 (EST)—12 PM to 1:05 AM.
WAMB, Minneapolis, Minn., 243.8 (CST)—12 M to 1 PM; 10 to 12.
WBBM, Chicago, Ill., 226 (CST)—8 PM to 12.
WBOQ, Richmond Hill, N. Y., 236 (EST)—3:30 PM to 6:30.
WBZ, Springfield, Mass., 333.1 (EST)—6 PM to 11.
WCAE, Pittsburgh, Pa., 461.3 (EST)—12:30 PM to 1:30; 4:30 to 5:30; 6:30 to 11.
WCCO, St. Paul and Minneapolis, Minn., 416.3 (CST)—9:30 AM to 12 M; 1:30 PM to 4; 5:30 to 10.
WDAF, Kansas City, Mo., 365.6 (CST)—3:30 PM to 7; 11:45 to 1 AM.
WEAF, New York City, 492 (EST)—6:45 AM to 7:45; 11 to 12 M; 4 PM to 5; 6 to 12.
WEAR, Ohio State University, 293.9 (EST)—8 PM to 10.
WEAR, Cleveland, O., 390 (EST)—11:30 AM to 12:10 PM; 3:30 to 4:10; 6:45 to 7:45.
WEEL, Boston, Mass., 476 (EST)—6:45 AM to 8; 3 PM to 4; 5:30 to 10.
WEMC, Berrien Spring, Mich., 266 (CST)—8:15 PM to 11.
WFAA, Dallas, Texas, 475.9 (EST)—10:30 AM to 11:30; 12:30 PM to 1; 2:30 to 6; 6:45 to 7; 8:30 to 10.
WFBH, New York City, 272.6 (EST)—2 PM to 6:30; 11:30 to 12:30 AM.
WGBS, New York City, 316 (EST)—10 AM to 11:30 PM to 3; 6 to 11:30.
WGCP, New York City, 252 (EST)—2:30 PM to 5:15.
WGES, Chicago, Ill., 250 (CST)—7 PM to 9; 11 to 1 AM.
WGN, Chicago, Ill., 370 (CST)—9:31 AM to 3:30 PM; 5:30 to 11:30.
WGR, Buffalo, N. Y., 319 (EST)—11 AM to 12:45 PM; 7:30 to 11.
WGY, Schenectady, N. Y., 379.5 (EST)—11 PM to 2:30; 5:30 to 7:30; 9:15 to 11:30.
WHAD, Milwaukee, Wis., 275 (CST)—11 AM to 12:15 PM; 4 to 5; 6 to 7:30.
WHAS, Louisville, Ky., 399.8 (CST)—4 PM to 5; 7:30 to 9.
WHAR, Atlantic City, N. J., 275 (EST)—2 PM to 3; 7:30 to 9; 11:15 to 12.
WHY, New York City, 360 (EST)—12:30 PM to 1; 2:15 to 3:15; 4 to 5:30; 7:30 to 10:45; 11:30 to 12:30 AM.
WHO, Des Moines, Iowa, 526 (CST)—12:15 PM to 1:30; 7:30 to 9; 11:30 to 12.
WHT, Chicago, Ill., 400 (CST)—11 AM to 2 PM; 7 to 8:30; 10:30 to 1 AM.
WIF, Philadelphia, Pa., 508.2 (EST)—7 AM to 8 PM to 2; 3 to 4:30; 6 to 11.
WJY, New York City, 405 (EST)—7:30 PM to 1:30.
WJZ, New York City, 455 (EST)—10 AM to 11; 1 PM to 2; 4 to 6; 7 to 11.
WKRC, Cincinnati, O., 326 (EST)—6 PM to 12.
WLIT, Philadelphia, Pa., 395 (EST)—11 AM to 12:30 PM; 2 to 3; 4:30 to 7.
WLW, Cincinnati, O., 422.3 (EST)—10:45 AM to 12:30 PM; 1:30 to 2:30; 3 to 5; 6 to 11.
WMAK, Lockport, N. Y., 265.5 (EST)—8 PM to 12.
WMCB, New York City, 341 (EST)—11 AM to 12 M; 6:30 PM to 12.
WNYC, New York City, 526 (EST)—3:45 PM to 5; 6:50 to 11.
WOAW, Omaha, Neb., 526 (CST)—12:30 PM to 1:30; 5:45 to 10.
WOC, Davenport, Iowa, 484 (CST)—12:57 PM to 2:30; 5:45 to 10.
WOO, Philadelphia, Pa., 508.2 (EST)—11 AM to 1 PM; 4:40 to 6; 7:30 to 11.
WOR, Newark, N. J., 405 (EST)—6:45 AM to 7:45; 2:30 PM to 4; 6:15 to 11:30.
WPAK, Fargo, N. D., 283 (CST)—7:30 PM to 9.
WPG, Atlantic City, N. J., 299.8 (EST)—7 PM to 11.
WQJ, Chicago, Ill., 488 (CST)—11 AM to 12 M; 3 PM to 4; 7 to 10.
WRC, Washington, D. C., 469 (EST)—9 AM to 10; 12 M to 2; 6:15 PM to 6:30.
WREO, Lansing, Michigan, 285.5 (EST)—8:15 PM to 11.
WRNY, New York City, 258.5 (EST)—11:59 AM to 2 PM; 4:30 to 5; 8 to 11.
WSB, Atlanta, Ga., 428.3 (CST)—12 M to 1 PM; 2:30 to 3:30; 5 to 6; 8 to 9; 10:45 to 12.
WSP, St. Louis, Mo., 273 (CST)—12 M to 1 PM; 3 to 4; 7:30 to 10:30; 11:55 to 1:30 PM; 3 to 4; 6 to 10.
WSTP, St. Louis, Mo., 273 (CST)—12 M to 1 PM; 3 to 4; 8 to 10; 11:30 to 1 AM.
WVJ, Detroit, Mich., 352.7 (EST)—8 AM to 8:30; 9:30 to 10:30; 11:55 to 1:30 PM; 3 to 4; 6 to 10.
KDKA, Pittsburgh, Pa., 309 (EST)—9:45 PM to 12 M; 1:30 PM to 3:20; 5:30 to 10:45.
KFL, Los Angeles, Cal., 467 (PST)—5 PM to 11.
KFKX, Hastings, Neb., 288.3 (CST)—12:30 PM to 1:30; 5:15 to 6:15; 9:30 to 12:30.
KFMO, Fayetteville, Ark., 299.8 (CST)—9 PM to 10.
KFOA, Seattle, Wash., 455 (PST)—12:30 PM to 1:30; 4 to 5:15; 6 to 11.
KGO, Oakland, Cal., 361.2 (PST)—11:30 AM to 1 PM; 1:30 to 3; 4 to 6:45; 8 to 1 AM.
KGW, Portland, Oregon, 491.5 (PST)—11:30 AM to 1:30 PM; 5 to 11.
KHJ, Los Angeles, Cal., 405.2 (PST)—7 AM to 7:15; 12 M to 1:30 PM; 5:30 to 11.
KJR, Seattle, Wash., 384.4 (PST)—9 AM to 6:30 PM; 8:30 to 1 AM.
KNX, Hollywood, Cal., 337 (PST)—9 AM to 10; 1 PM to 2; 4 to 5; 6:30 to 12.

WEDNESDAY, OCTOBER 14

WAAM, Newark, N. J., 263 (EST)—12:30 PM to 1:05; 7:30 to 11:05.
WAHG, Richmond Hill, N. Y., 316 (EST)—12 M to 1:05 PM; 8 to 12.
WAMB, Minneapolis, Minn., 243.8 (CST)—12 M to 1 PM; 10 to 12.
WBBM, Chicago, Ill., 226 (CST)—8 PM to 10.
WBBR, New York City, 272.6 (EST)—6 PM to 10.
WBZ, Springfield, Mass., 333.1 (EST)—6 PM to 11.

WCAE, Pittsburgh, Pa., 461.3 (EST)—12:30 PM to 1:30; 4:30 to 5:30; 6:30 to 11.
WCCO, St. Paul and Minneapolis, Minn., 416.3 (CST)—9:30 AM to 12 M; 1:30 to 4; 5:30 to 11.
WDAF, Kansas City, Mo., 365.6 (CST)—3:30 PM to 7; 8 to 9:15; 11:45 to 1 AM.
WEAF, New York City, 492 (EST)—6:45 AM to 7:45; 11 to 12 M; 4 PM to 5; 6 to 12.
WEAR, Ohio State University, 293.9 (EST)—8 PM to 10.
WEAR, Cleveland, O., 390 (EST)—11:30 AM to 12:10 PM; 3:30 to 4:10; 6:45 to 7:45.
WEEL, Boston, Mass., 476 (EST)—6:45 AM to 8; 3 PM to 4; 5:30 to 10.
WEMC, Berrien Spring, Mich., 266 (CST)—8:15 PM to 11.
WFAA, Dallas, Texas, 475.9 (EST)—10:30 AM to 11:30; 12:30 PM to 1; 2:30 to 6; 6:45 to 7; 8:30 to 10.
WFBH, New York City, 272.6 (EST)—2 PM to 6:30; 11:30 to 12:30 AM.
WGBS, New York City, 316 (EST)—10 AM to 11:30 PM to 3; 6 to 11:30.
WGCP, New York City, 252 (EST)—2:30 PM to 5:18; 8 to 10.
WGES, Chicago, Ill., 250 (CST)—7 PM to 9; 11 to 1 AM.
WGN, New York City, 316 (EST)—10 AM to 11:30 PM; 1:30 to 4; 6 to 7.
WGN, Chicago, Ill., 370 (CST)—9:31 AM to 3:30 PM; 5:30 to 11:30.
WGR, Buffalo, N. Y., 319 (EST)—12 M to 12:45 PM; 2:30 to 4:30; 6:30 to 11.
WGY, Schenectady, N. Y., 379.5 (CST)—5:30 PM to 7:30.
WHAD, Milwaukee, Wis., 275 (CST)—11 AM to 12:15 PM; 4 to 5; 6 to 7:30; 8 to 10.
WHAS, Louisville, Ky., 399.8 (CST)—4 PM to 5; 7:30 to 9.
WHN, New York City, 360 (EST)—2:15 PM to 5:30; 7:30 to 11; 11:30 to 12:30 AM.
WHO, Des Moines, Iowa, 526 (CST)—12:15 PM to 1:30; 7:30 to 9; 11:30 to 12:30 AM.
WHT, Chicago, Ill., 400 (CST)—11 AM to 2 PM; 7 to 8:30; 10:30 to 1 AM.
WHY, Philadelphia, Pa., 508.2 (EST)—7 AM to 8:1 PM to 2; 3 to 4.
WJZ, New York City, 455 (EST)—10 AM to 11; 1 PM to 2; 4 to 6; 7 to 11:30.
WKRC, Cincinnati, O., 326 (EST)—8 PM to 10.
WLIT, Philadelphia, Pa., 395 (EST)—12:02 PM to 1; 2 to 3; 4:30 to 6; 7:30 to 11:30.
WLW, Cincinnati, O., 422.3 (EST)—10:45 AM to 12:30 PM; 1:30 to 2:30; 3 to 5; 6 to 10.
WMAK, Lockport, N. Y., 265.5 (EST)—8 PM to 12.
WMCB, New York City, 341 (EST)—11 AM to 12 M; 6:30 PM to 12.
WNYC, New York City, 526 (EST)—3:15 PM to 4:15; 6:20 to 11.
WOAW, Omaha, Neb., 526 (CST)—12:30 PM to 1:30; 5:45 to 10:30.
WOC, Davenport, Iowa, 484 (CST)—12:57 PM to 2:30; 5:45 to 10.
WOO, Philadelphia, Pa., 508.2 (EST)—11 AM to 1 PM; 4:40 to 6; 7:30 to 11.
WOR, Newark, N. J., 405 (EST)—6:45 AM to 7:45; 2:30 PM to 4; 6:15 to 11:30.
WPAK, Fargo, N. D., 283 (CST)—7:30 PM to 9.
WPG, Atlantic City, N. J., 299.8 (EST)—7 PM to 11.
WQJ, Chicago, Ill., 488 (CST)—11 AM to 12 M; 3 PM to 4; 7 to 10.
WRC, Washington, D. C., 469 (EST)—9 AM to 10; 12 M to 2; 6:15 PM to 6:30.
WREO, Lansing, Michigan, 285.5 (EST)—8:15 PM to 11.
WRNY, New York City, 258.5 (EST)—11:59 AM to 2 PM; 4:30 to 5; 8 to 11.
WSB, Atlanta, Ga., 428.3 (CST)—12 M to 1 PM; 2:30 to 3:30; 5 to 6; 8 to 9; 10:45 to 12.
WSP, St. Louis, Mo., 273 (CST)—12 M to 1 PM; 3 to 4; 7:30 to 10:30; 11:55 to 1:30 PM; 3 to 4; 6 to 10.
WSTP, St. Louis, Mo., 273 (CST)—12 M to 1 PM; 3 to 4; 8 to 10; 11:30 to 1 AM.
WVJ, Detroit, Mich., 352.7 (EST)—8 AM to 8:30; 9:30 to 10:30; 11:55 to 1:30 PM; 3 to 4; 6 to 10.
KDKA, Pittsburgh, Pa., 309 (EST)—9:45 PM to 12 M; 1:30 PM to 3:20; 5:30 to 10:45.
KFL, Los Angeles, Cal., 467 (PST)—5 PM to 11.
KFKX, Hastings, Neb., 288.3 (CST)—12:30 PM to 1:30; 5:15 to 6:15; 9:30 to 12:30.
KFMO, Fayetteville, Ark., 299.8 (CST)—9 PM to 10.
KFOA, Seattle, Wash., 455 (PST)—12:30 PM to 1:30; 4 to 5:15; 6 to 11.
KGO, Oakland, Cal., 361.2 (PST)—11:30 AM to 1 PM; 1:30 to 3; 4 to 6:45; 8 to 1 AM.
KGW, Portland, Oregon, 491.5 (PST)—11:30 AM to 1:30 PM; 5 to 11.
KHJ, Los Angeles, Cal., 405.2 (PST)—7 AM to 7:15; 12 M to 1:30 PM; 5:30 to 11.
KJR, Seattle, Wash., 384.4 (PST)—9 AM to 6:30 PM; 8:30 to 1 AM.
KNX, Hollywood, Cal., 337 (PST)—9 AM to 10; 1 PM to 2; 4 to 5; 6:30 to 12.

THURSDAY, OCTOBER 15

WAAM, Newark, N. J., 263 (EST)—11 AM to 12 M; 7 PM to 11.
WAHG, Richmond Hill, N. Y., 316 (EST)—12:30 PM to 1:05.
WAMB, Minneapolis, Minn., 243.8 (CST)—12 M to 1 PM; 10 to 12 M.
WBBM, Chicago, Ill., 226 (CST)—8 PM to 10.
WBBR, New York City, 272.6 (EST)—3:30 PM to 6:30.
WBZ, Springfield, Mass., 333.1 (EST)—6 PM to 11:45.

(Continued on page 30)

### A THOUGHT FOR THE WEEK

Remember always: Tubes are tubes! They are not cast-iron devices that can be thrown around like hammers. They cannot be mistreated like a shrinking wife. They are delicate instruments and should be so handled. Think of this the next time you go to your dealer with a kick and a demand for a new tube. And never forget that tubes are tubes!

# RADIO WORLD



Radio World's Slogan: "A radio set for every home."

TELEPHONES: BRYant 0558, 0559  
 PUBLISHED EVERY WEDNESDAY  
 (Dated Saturday of same week)  
 FROM PUBLICATION OFFICE  
 HENNESSY RADIO PUBLICATIONS CORPORATION  
 ROLAND BURKE HENNESSY, President  
 M. B. HENNESSY, Vice-President  
 FRED S. CLARK, Secretary and Manager  
 145 WEST 45th STREET, NEW YORK, N. Y.  
 (Between Broadway and Elth Ave.)  
 European Representatives: The International News Co.  
 Brema Bldgs., Chancery Lane, London, Eng.  
 Paris, France: Brontano's, 38 Avenue de l'Opera.  
 San Francisco, Lloyd B. Chappell, 656 O'Farrell St.

EDITOR, Roland Burke Hennessy  
 MANAGING EDITOR, Herman Bernard

#### SUBSCRIPTION RATES

Fifteen cents a copy, \$6.00 a year, \$3.00 for six months, \$1.50 for three months. Add \$1.00 a year extra for foreign postage, Canada, 50 cents.  
 Receipt by new subscribers of the first copy of RADIO WORLD mailed to them after sending in their order is automatic acknowledgment of their subscription order. Changes of address should be received at this office two weeks before date of publication. Always give old address also. State whether subscription is new or a renewal.

#### ADVERTISING RATES

General Advertising		
1 Page, 7 1/2" x 11"	462 lines	\$300.00
1/2 Page, 7 1/2" x 5 1/2"	231 lines	150.00
1/4 Page, 4 1/2" x 7"	115 lines	75.00
1 Column, 2 1/2" x 11"	154 lines	100.00
1 inch		10.00
Per Agate line		.75
Times Discount		
52 consecutive issues		20%
26 lines consecutively of E. O. W. one year		15%
4 consecutive issues		10%

WEEKLY, dated each Saturday, published Wednesday. Advertising forms close Tuesday, eleven days in advance of date of issue.

#### CLASSIFIED ADVERTISEMENTS

Ten cents per word. Minimum, 10 words. Cash with order. Business Opportunities 50 cents a line; minimum, \$1.00.

Entered as second-class matter, March 28, 1922, at the Post Office at New York, N. Y., under the act of March 3, 1879.

OCTOBER 10, 1925

## THE WEEKLY REBUS

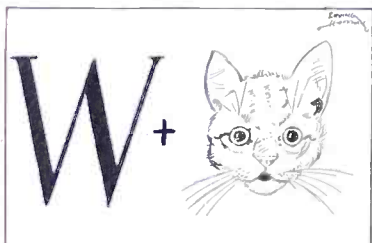

Frank Farmer, 3816 Canon St., Oakland, Cal.  
 Don Flounce, 1213 West 9th St., Cisco, Tex.  
 Arthur Bolduc, 8 High St., Biddeford, Me.

### REMOVAL NOTICE!

Radio World  
 has moved to more spacious offices at  
 No. 145 W. 45th St., near Broadway,  
 New York City.

Telephones: BRYant 0558, 0559

# Solution of Mounting Problems for the Set Jack Admired

(Concluded from page 8)

holding holes. These are 1/2" from the center of the large hole, and are situated on each side of this same hole. These holding holes are 1/8" in diameter. The jack as you see is in the right-hand corner. The hole for this jack is 2" from the right-hand edge. 1 3/16" from the bottom drill a 3/8" hole. Fourteen inches from the left-hand edge and 1 3/16" from the bottom drill a hole for the switch, S. The dimensions for the brackets are a bit difficult and I would advise you to follow me closely. If you will look at the picture diagram you will see that there are two holes on the top and two on the bottom, but the ones I used on the set only have one hole at the bottom and one at the top. This is the way most of them look. The hole on the bottom left is 7/8" from the edge, and 19/32" from the bottom. The hole on the top, and same side, is 5 1/32" from the bottom hole. The diameters of these holes is 1/4". Now on the other side, right hand, 7/8" from the edge, and 19/32" from the bottom drill a hole. On the top and 7/8" from this same edge, and 5 1/32" from the bottom hole drill another hole. The diameters of these holes are 1/4", the same as the others. That is all the drilling there is to be done on the panel."

### The Socket Shelf

"How about that socket shelf?"

"The drilling dimensions for this shelf, and also the sub-base, require your closest attention. First take the six sockets. The shells of these sockets as you notice are 1 1/2" in diameter. The bottoms containing the binding posts are 1 3/4" in diameter. The length of the shelf is 23". The width of this shelf is 3". The binding post strip is 23" long and 2 1/2" wide. This as you see is mounted upright against the socket shelf. Take the shelf and lay it on the table. Now on the right-hand side place three sockets. These are for the AF amplifier tubes and are placed 2" apart. The socket nearest the right-hand edge is also 2" from this edge. These are also 1/4" from the top and the bottom elongated edges. This means that the socket will be in the middle of the shelf. Screw these sockets down. There are two mounting holes on each side of the sockets that I used, one on each side. There are still three sockets to be placed on the shelf. Socket 3, which holds the detector tube, is 2" from socket 4 (the socket holding the first AF amplifier tube). All sockets are in the same line. The fixed condenser and the grid leak are placed in between sockets 2 and 3, the spacing being 2 3/4". Between the sockets 1 and 2, 1 being the socket holding first radio-frequency amplifier, and 2 being the tube holding the second radio-frequency tube, is the potentiometer, which is 1 1/2" from the two outside diameters of sockets 1 and 2. The last socket, 1, is placed 2" from the left hand edge. Between the sockets 5 and 6, place the grid leak R9 and the fixed condenser C5. Between the sockets 4 and 5, place the grid leak R8 and the fixed condenser C4. The grid leak is held in a pair of special holders. The length of the grid leak, in the holder is 2". This means that it is placed 1/4" from each of the elongated edges. The

condenser can be placed in a grid leak holder as I have it, or flat on the shelf. The grid leak R8 and the condenser C4, are placed in the same manner.

### Transformer Mounting

"If you will look at the picture diagram you will notice AFT 1 looks bigger than the rest of the transformers. It really isn't, as you see in the actual receiver. In order to know which transformers I am talking about, suppose you letter them L8, L7, and AFT 1. Now, L8 is placed underneath the shelf, between sockets 5 and 6. This takes up 2". The next transformer, L7, is also placed underneath the shelf, but between sockets 4 and 5. The last transformer, labelled AFT 1, is placed underneath the shelf, exactly between sockets 3 and 4. The space that the transformer takes up is 2". Now right underneath socket 1, place one of the ends of the elongated portions which contains the hole for mounting the screw, 1/2" away from the outside diameter of the socket. This is done so that the transformer can be mounted without the screw hitting the socket. The other end containing the hole will be left unmounted. This necessitates that the one screw holding this transformer be made tight. The last thing to be done on this shelf is the mounting of the angle irons on the shelf. These angle irons are for holding the binding posts, and the rheostats. This is placed 1/2" both from the right and the left hand edge. This will necessitate drilling a 3/4" hole on each side.

"The shelf containing the rheostats and the binding posts is now taken into hand. If you would place this shelf right underneath the socket shelf, R6 would fall underneath socket 6, R5 underneath socket 5, and R6 underneath socket 6. The centers of the rheostats and the sockets are then in the same line. In other words, R6 is 2 1/2" from the right-hand edge, R5 is 3" from R6, R4 is 3" from R5. Now as to the binding posts. These may be on a strip or be a set of individual binding posts. There are 12 posts required, viz., B+, No. 3, B+, No. 2, B+, No. 1, A+, B-, A-, Ant., Gnd., and four posts with no markings. If you are going to use the strip as I did you will only have to place them 3" from AFT 1, and 3/8" from the top and the bottom of the elongated portion. This will take up 7" of the shelf. Right over the B+ No. 3, B+, No. 2, B+, No. 1, A+, B-, place the four binding posts which are not marked. Each marked post is underneath the unmarked post. The last rheostat, R1, is placed 1 1/2" from the left hand edge. This shelf is placed snug up against the angle irons on the socket shelf. Note where the holes of this iron hits the post shelf. Make dots at these points. Now take the shelf off, and drill the holes. When you mount the two shelves, one edge flush up against the other, the ends of the screws will have to be cut off, otherwise they will hit!"

[Part II, the conclusion, will be published next week.]

HOW TO BUILD THE POWERTONE, 1 dial, 5 tubes, described in RADIO WORLD, issues of Aug. 29 and Sept. 5. Powertone Trouble-shooting, Sept. 12. Send 15c for all three. Special diagrams and "blueprint in black" included among the many illustrations. RADIO WORLD, 145 West 45th St., N. Y. City.

## Attention Radio World Subscribers!

Subscribers will note that the end of their subscriptions is indicated on the labels on wrappers. If your wrapper shows the date later than the current issue, you are behind in your subscription. Please send payment for renewal. Thank you!  
 RADIO WORLD, 145 West 45th Street, New York City.

# A Compact 1-Tube Reflex

By Franz von Stiefel

THE 1-tube reflex for the novice, originally described in the February 21 issue of RADIO WORLD, and which stirred up considerable comment because one reader said it would not work, and that it was a sin and a shame to publish such a hookup, is indeed a good set. It may be made in very compact form, even on a 7x10" panel, if spider-web coils are used. I prefer a 7-14" panel. Two variable condensers, a rheostat and clips or a single-circuit jack will appear on the panel.

The spider-web coil is wound with No. 22 single cotton covered wire. Aerial is connected to F in Fig. 2 and ground to B. The beginning of the secondary winding (at the hub) goes to grid of the tube and the end of the secondary to A minus, through the audio transformer secondary.

### The Plate Coil

The plate coil L3 has the same number of turns as the secondary L2, but is wound on a separate form. C1 and C2 are .0005 mfd. variable condensers. C3 is .001 mfd. and C4 is .00025 mfd. or smaller. The crystal detector may be of the fixed type, such as the Carborundum.

Any trouble encountered in not reaching the desired waves may be remedied by the insertion of a fixed condenser in series or in parallel with the aerial circuit to remedy the trouble. If the set does not tune low enough, place a .001 mfd. fixed condenser as shown in Fig. 3, above the caption "short wave." This is series connection. If you do not get satisfaction on the higher waves, then insert the same valve condenser, instead, in parallel with the primary, as shown above the caption "long wave."

These directions apply also to the question of insufficient volume on the waves at either extreme.

In connecting the variable condensers, join the stator of C1 to the grid and the rotor to the other end of L2, while the C2 stator goes to plate.

### The AF Transformer

Any audio transformer you happen to have about the house will suffice for this circuit, and as it is designed to be a particularly inexpensive outfit it will not

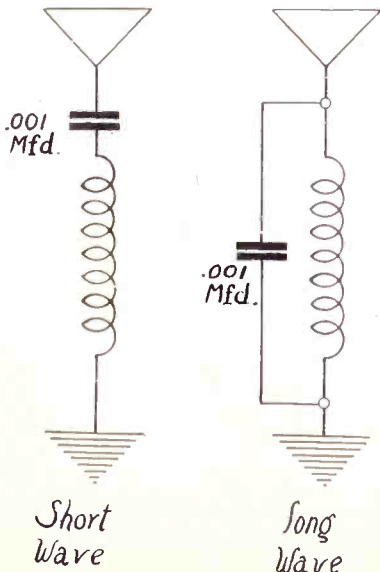
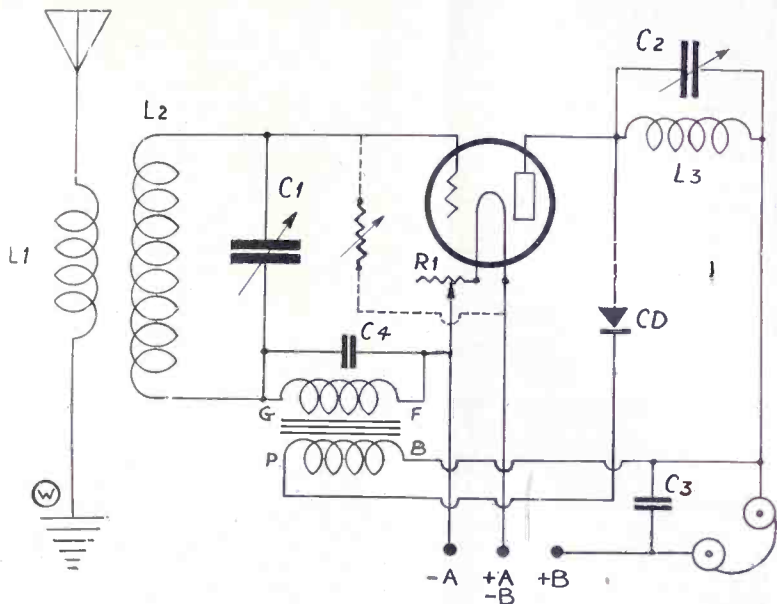
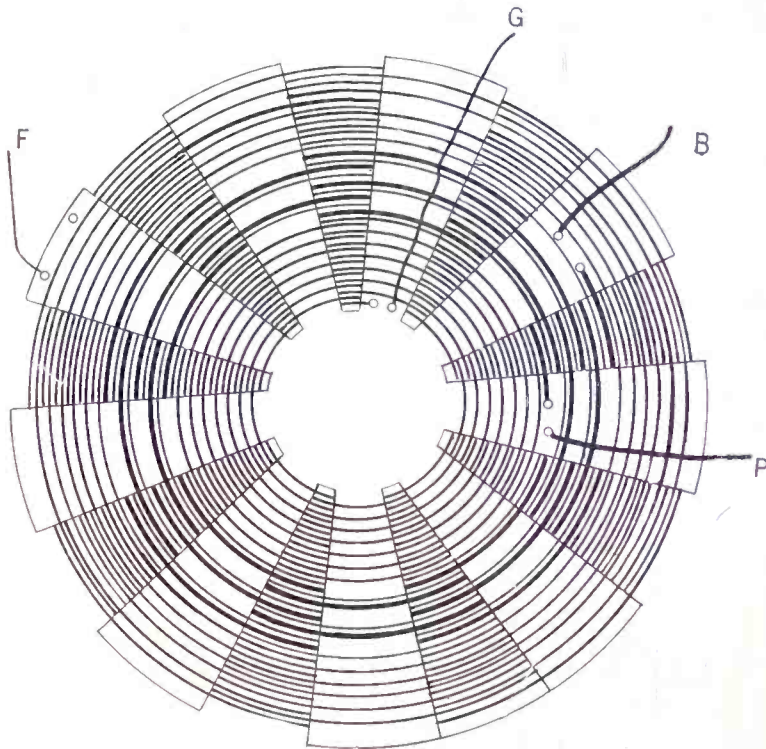

FIG. 3, how to remedy wavelength range trouble.



THE 1-TUBE REFLEX (Fig. 1), using a regenerative tube in the RF stage and a crystal detector. The antenna coupler may be a spider-web coil (primary L1 = PB in Fig. 2, secondary, L2 = GF in Fig. 2). The variable grid leak prevents audio feedback.



THE COIL that will afford compactness for the aerial coupler is wound on a spider-web form about 5" outside diameter. The secondary has 50 feet of No. 22 SCC wire. After winding six or seven turns of the secondary wind the 12-foot primary simultaneously with the continuation of the secondary. When the primary wire gives out wind the rest of the secondary alone. (Fig. 2.)

be necessary to purchase any of the higher-priced transformers. It is a good, economical circuit, but if real money is to be spent on parts it would be preferable to build some other kind of set, say one that would work a speaker on dis-

tant stations, like the 1926 Diamond of the Air or the Thordarson-Wade Set. Fig. 1 is for earphone service only.

The set will bring in distance and will reproduce signals with gratifying sweetness.

### Literature Wanted

THE names of readers of RADIO WORLD who desire literature from radio jobbers and dealers are published in RADIO WORLD on request of the reader. The blank below may be used, or a post card or letter will do instead.

Trade Service Editor,  
RADIO WORLD,  
145 West 45th St., N. Y. City.

I desire to receive radio literature.

Name .....

City or town.....

State .....

Are you a dealer?.....

If not who is your dealer?.....

His Name .....

His Address .....

## Save 20 to 50% FREE RADIO CATALOG

LATEST IN **HOOK-UPS** AND **RADIO**

Get the lowest rock-bottom prices on radio parts, sets, kits. New Free Radio Catalog and Guide—timely of standard, reliable, guaranteed goods. Over 100 latest hook-ups and illustrations. Be sure to get this titillating book before you buy. It puts money in your pocket. Saves you as much as half on a set. Also please include name of radio fan. Send letter or postal NOW.

**THE BARAWIK COMPANY**  
103-140 S. Canal St., Chicago, U. S. A.

## Free LOG also RADIO CATALOG

**SAVE**  
on all the latest standard radio merchandise! No exceptions. Our 1926 Beautifully Illustrated Catalog **JUST OFF THE PRESS!!** Everything new in Radio AT SLASHED PRICES. Write for it today, before you buy anything. Delay means losing exceptional chance to participate in this great bargain-sale. Rush your name and address at once and get also a **LOG BOOK FREE**.  
**ECONOMY RADIO SALES COMPANY**  
288 6th Ave., Dept. E, New York  
Deal Direct and Save Real Money

## A NEW SUPER-HET KIT \$17.50

With Perfectly Matched Transformers and Filter



This is a SUPERADIO Product—Your Guarantee of Satisfaction!

The most selective, the most powerful, longest ranged, finest toned 8 tube super ever designed. Intermediate transformers matched to identical peaks and filter toned to same peak. Kit includes Antenna Coupler, Oscillator Coupler, Special Variable Condenser, Tuned Input Transformer, 3 matched intermediate transformers and hardware. Complete with booklet, diagrams and full sized working drawings which positively assure perfect success. Order now. Only \$17.50.

### SAVE MONEY ON THIS COMPLETE OUTFIT

Every Kit Made Up of Individually Tested Parts as Follows:

Superadio Inductance and Transformer Kit, 2 Heath Radiant Condensers, 2 Keystone Audio Transformers, 8 Benjamin Sockets, 2 Carter Rheostats, 1 potentiometer, all necessary fixed condensers, 2 "Meritts" Grid Leaks, 1

Mounted Binding Post Board, 1 Base Board, 1 Drilled Panel, 2 "Dialog" Vernier Dials, 2 Truflux Rheostat Dials, 3 Carter Jacks, 1 Carter Filament Switch, Soldering Lugs, Buss Wire and wood screws, diagram and Instructions.

**\$73.50**

Write for our free Radio Catalog of newest parts

**William A. Welty Company, 36 So. State St., Dept. 605, Chicago**

# THE RADIO TRADE

## Export Comparison

	1924.	1925.
January	\$331,000	\$784,000
February	302,000	477,000
March	287,000	604,000
April	299,000	853,000
May	295,000	677,000
June	307,000	670,000
July	297,000	---
August	541,000	---
September	567,000	---
October	769,000	---
November	948,000	---
December	1,080,000	---

## ROSENBERG'S DATA BOOK

The 1925-1926 Radio Advertisers' Data Book, a volume of rates and other information for national advertisers, has just been issued by its publishers, Arthur Rosenberg Co., Inc., New York.

## ULTRA-VERNIER TUNING CONTROL

A VERNIER DIAL ON WHICH YOU CAN PENCIL RECORD THE STATIONS. GEARED 20 TO 1. SILVER FINISH \$2.50—GOLD FINISH \$3.50

PHENIX RADIO CORP., 116 E. East 25 St., N. Y. C.

## \$100.00 A Week Up

Experienced Radio Men wanted to operate factory branches. We guarantee big money and a wonderful future.

Write giving full details to

**BARFIELD RADIO COMPANY**  
13 Tillary St. Dept. W.R. Brooklyn, N. Y.

## A RECHARGEABLE "B"

WITH A STRONG GUARANTEE

The SEE-JAY BATTERY has met all tests and is endorsed and recommended by the Washington Information Service Bureau and more than 20,000 satisfied users. Genuine Alkaline connected elements; strictest Government test passed and recommended. No drilling or wiring. Connectors crimped under 1,000-pound pressure. Save time, temper and money. 100-volt unit, \$5.00; 140-volt, \$8.00. Why buy more? Complete assembled batteries, solution separate, shipped dry. 100-volt, \$12.00; 140, \$16.00. See-Jay unit sold on money-back guarantee. Write for literature and send 20c for improved sample cell. SEE-JAY Battery Co., Dept. W, 915 Brook Ave., New York. Mail order service.

WHOLESALE AND RETAIL

Several features which were not in the 1924 issue have been included. The contents include advertising rates, circulation and other data regarding radio consumer and trade publications, as well as of all the periodicals of the allied trades, including automotive, electrical, hardware, music, talking machine and sporting goods.

The radio dealer and jobber sales situation, and the radio manufacturers' merchandising and advertising problems are treated both editorially and graphically.

Several of the more thorough radio trade surveys are summarized, and a complete picture of the industry's present development and estimated future growth is presented.

A full-page map of the United States shows the relative "radio strength" of the different states.

## OCCUPIES LARGER QUARTERS

Despite the recent enlargement of their factory, increased pressure of business has caused the Cortlandt Panel Engraving Co., to move their plant to 79 Cortlandt Street, New York City, right next door to their former quarters at 81. New machinery of the latest and best design is being installed and this concern will now be able to take care of any kind of panel work in any quantity. Rush work will also be a specialty. They have been very successful in preparing complete panels for RADIO WORLD'S 1926 Model Diamond of the Air, the new Thoradson-Wade set, the Pressley and other excellent circuits.

## MAKES SOLDERING A PLEASURE

A radio soldering fluid is being put on the market by the Imperial Soldering Fluid Co., 81 Cortlandt Street, New York City. By just applying the fluid with any solder a neat and durable joint is quickly and easily made. No scraping is necessary and no paste or flux need be used.

Tested and Approved by RADIO WORLD Laboratories

## S. HAMMER RADIO CO.

303 Atkins Avenue, Brooklyn, N. Y.  
Please send me FREE, Your NEW RADIO CATALOG

Name .....,  
Address .....,  
City ....., State .....,  
FILL OUT AND MAIL

## Business Opportunities Radio and Electrical

10 cents a word. \$1.00 Minimum.

**RADIO PARTS** manufacturing concern; great opportunity for man; \$5,000; established customers of the entire United States and Canada; large profits; season starting. Box 100, RADIO WORLD.

### RADIO

Wanted—Partner with \$5,000 to join me in taking over plant fully equipped manufacturing radio sets, transformers, A and B battery eliminator and other parts; opportunity lifetime for any one waiting get into radio. Box 200, RADIO WORLD.

### RADIO DEPARTMENT

To Lease—In Department Store! Ample space and surroundings on second floor; present stock to be taken over at market prices; splendid opportunity for live-wire radio man. ADAMS, WERTHEIMER CO., Fordham Road and Concourse, New York City.

### LET US BE YOUR FACTORY

Do not use your funds to buy machinery and equip a plant; we are thoroughly equipped in machines and have broadest experience in building dies and tools for economical production; will make your parts or build your complete device; make use of our facilities and experience. Interstate Mechanical Laboratories, 521 West 57th Street, New York City. Phone Columbus 5321.

## Coming Events

OCT. 3 to 10—Radio Exposition, Arena, 46th and Market Streets, Philadelphia, Pa., G. B. Boden-hof, manager, auspices Philadelphia Public Ledger.

OCT. 5 to 10—Second Annual Northwest Radio Exposition Auditorium, St. Paul, Minn. Write 515 Tribune Annex.

OCT. 5 to 11—Second Annual Radio Show, Convention Hall, Washington, D. C. Write Radio Merchants' Association, 233 Woodward Bldg.

OCT. 10 to 16—National Radio Show, City Auditorium, Denver, Colo.

OCT. 12 to 15—South Texas Radio Exposition, Post-Dispatch (KPRC), Houston, Tex.

OCT. 12 to 17—Boston Radio Show, Mechanics' Hall. Write to B. R. S., 209 Massachusetts Ave., Boston, Mass.

OCT. 12 to 17—St. Louis Radio Show, Coliseum. Write Thomas P. Convey, manager, 737 Frisco Bldg., St. Louis, Mo.

OCT. 12 to 17—Radio Show, Montreal, Can., Canadian Expos. Co.

OCT. 17 to 24—Brooklyn Radio Show, 23d Regt. Armory. Write Jos. O'Malley, 1157 Atlantic Ave., Brooklyn, N. Y.

OCT. 19 to 25—Second Annual Cincinnati Radio Exposition, Music Hall. Write to G. B. Boden-hof, care Cincinnati Enquirer.

OCT. 24 to 31—First Annual Rochester Times-Union Radio Exposition, Convention Hall, Rochester, N. Y. Write Howard H. Smith, care Times-Union.

NOV. 2 to 7—Radio Show, Toronto, Can., Canadian Expos. Co.

NOV. 3 to 8—Radio Trade Association Exposition, Arena Gardens, Detroit. Write Robt. J. Kirschner, chairman.

NOV. 7 to 14—Second Columbus Radio Show and Electrical Exposition. Write Lewis Hill, Dispatch, Columbus, O.

NOV. 19 to 25—Milwaukee Radio Exp., Civic Auditorium. Write Sidney Neu, of J. Andrae & Sons, Milwaukee, Wis.

NOV. 17 to 22—4th Annual Chicago Radio Exp., Coliseum. Write Herrmann & Kerr, Cort Theatre Bldg., Chicago, Ill.

## NEW CORPORATIONS

Kardon Radio Corp., N. Y. City, 250 shares, \$100 each; 1,000 common, no par; R. M. Brown, J. M. Dixon, P. Kardon. (Atty., J. Marx, 342 Madison Ave., N. Y. City.)

Keystone Radio Co., East Orange, N. J., supplies, \$10,000; Theodore H. Wilkinson and Ernest H. Lewis, East Orange, N. J. (Filed by the company.)

Falcon Radio Corp., Union City, N. J., radio supplies, \$20,000 in preferred and 500 shares, no par, common; Walter Leichter, Dora Brody, Max Levitin, Weehawken. (Atty., Peter N. Perretti, Passaic, N. J.)



THE MOST WONDERFUL SOLDERING FLUID ON THE MARKET

**SOLDER**  
the New Way With  
**Radio Soldering Fluid**

A fluid that will make the amateur a professional. No brazing. Solders any metal. No more paste. No corroding.

Just apply FLUID with any Solder  
25c per bottle; 30c mailed  
**IMPERIAL SOLDERING FLUID CO.**  
81 Cortlandt Street New York

## Wade Low Loss Condenser

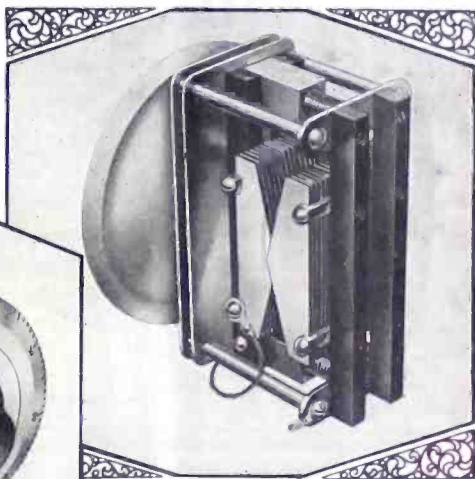
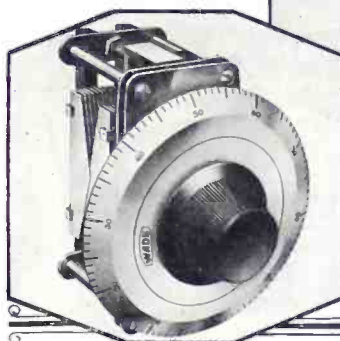

## WIDE SEPARATION of STATIONS MAKES TUNING EASY!



The Wade variable condenser marks a drastic advance in construction and compels so complete a revolution in all previous ideas of efficiency with many exclusive features.

Special plate construction spreads stations evenly over a 360 degree dial and gives a wider separation of stations than rotor plate types of straight line frequency condensers using standard 180 degree dials.

Separately grounded from both sets of plates shields the condenser from all body capacity effects—a vital feature, exclusively in Wade condensers.

The Wade condenser gives lowest minimum capacity and wider tuning range. Covers the entire broadcast band and down below 200 meters.

All Wade condensers are equipped with 360 degree, silvered, 4-inch, vernier dials, 32:1 ratio, giving the finest possible control with absolutely no back-lash.

Its small size, ruggedness, and single hole mounting make Wade the most desirable condenser on the market.

All sizes, complete with 4-inch vernier dial, for:

Short Wave  
.000125 mfd.  
**\$7.50**

.00025 mfd.  
**\$7.75**

.0005 mfd.  
**\$8.00**

At your dealers, otherwise send purchase price and you will be supplied postpaid.

## WADE RADIO CORP.

1819-C BROADWAY

NEW YORK

## For Tones that are True



Does the bass drum of a band "boom" or "bump" over your loud speaker?

## Listen to the VITALITONE

\$30 and \$15

ROSSITER & CO. Inc.  
136 Liberty St. New York

# ACME

for amplification

CRYSTAL SETS FOR USE TODAY, by Lewis Winner with diagrams in RADIO WORLD, dated July 25, 1925. 15c a copy, or start your subscription with that number. RADIO WORLD, 145 West 45th St., N. Y. City.

### HOOK-UPS

A lot of them, some of which are sure to suit your purpose, appeared in RADIO WORLD dated August 15. 15c a copy, or start your subscription with that number. RADIO WORLD, 145 West 45th St., N. Y. City.

# "Bruno" POWERTONE



"It Has a Soul for Music."

One Dial, Five Tubes, Fine Selectivity and Volume and Great Signal Quality. Set in Cabinet.

**\$39.50**

(Licensed under Hogan patents)

Boxed Kit, \$29.50

Inquiries Invited from the Trade

**Bruno Radio Corporation**  
221 Fulton St., N. Y. City

## Tuning the Thordarson-Wade

(Concluded from page 13)

can be, just as surprising as how wonderfully fine they will be. Choking may result—dull, suppressed, distorted signals. Adjust the potentiometer until the signals clear up considerably. Adjust the Bretwood leak to the same purpose. Once these two are adjusted they may be left will be all that you could ask or expect, that way. Next, if choking is still in evidence, reduce the resistance in the grid of the final tube. Put in a 0.25 meg. fixed leak, or, if you have a 0.1 meg. leak, use that. Finally if not at first—you will hear signals the like of which may never have greeted your ears before when they were attuned to a radio receiving set.

### Tuning

The wavelength controls are the two variable condensers, C1 and C2, and they will read alike, or nearly so, all through the range of wavelengths. The regeneration control will be approximately the same, but can not be expected to keep in step. At first you may have to tune in a

station by the whistle, but soon you will learn how easy it is to scent the signal before half enough regeneration is supplied, and you will cut down radiation considerably.

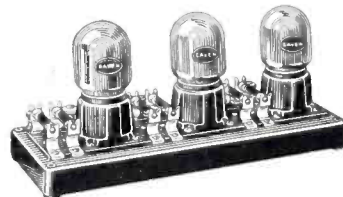

## HELP FOR SET BUILDERS

TO PROCURE the best results use Resistance Coupled Amplification. Daven engineers have made it easy. Hook up a Daven Super-Amplifier. Adds three stages of audio amplification—Daven Resistance Coupled—no labor of assembly—no distortion—perfect reception.

Daven precision-built unit with Bakelite base. Wonderful assembly. Compact, beautiful—\$15.00. Knock-down Kit—\$9.00.

For more volume, without distortion, use two Daven High Mu Tubes—\$4.00 each, and one Mu-6 (for last or output stage)—\$5.00.

Mail the coupon for complete information.

"The Star of Merit"

**DAVEN RADIO CORPORATION**

Resistor Specialists

Reg. U. S. Pat. Off.

Newark

New Jersey



Get the Handbook of Resistance Coupled Amplification at Dealer's 25c. By mail 50c.

FOR DEALERS: Send your letter-head and we will have our nearest distributor communicate with you.

THE BIG LITTLE THINGS OF RADIO

**FREE! Send Us Your Name To-Day**

**RADIO**  
The Heart of the Home

Complete Catalog of radio sets, radio kits, parts and accessories. Also valuable information and instructions on radio.

Save 15 to 16% SATISFACTION GUARANTEED

**RANDOLPH RADIO CORPORATION**  
159 North Union Ave., Dept. 27 Chicago, Ill.

The World's Largest Exclusive Radio Mail Order House Will Send You This Wonderful Book **FREE**

64 illustrated pages containing thousands of bargains in radio sets, semi-finished sets and radio kits of all styles, sizes and approved circuits. **5-tube sets as low as \$29.50.** Beautiful models of the very latest designs and types. Elaborate console models with loud speakers built right in cabinets of genuine mahogany and walnut. **All sets guaranteed.** Coast to coast receiving range. Also contains everything in radio supplies, including batteries, chargers, loud speakers, transformers, condensers, rheostats and any other parts you may want for improving your set or building a new one. Guaranteed saving to you of 1/4 to 1/2.

### The Biggest Five-Tube Value on the Market

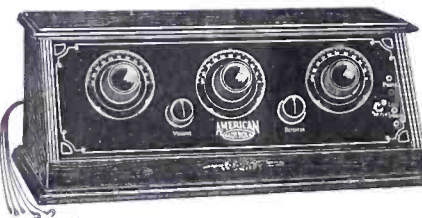

**AMERICAN RADYNOLA**  
**5 TUBE SET**  
**\$29.50**

fully built and wired. Beautiful mahogany cabinet of latest sloping panel design. Constructed of finest low-loss condensers, coils and sockets. Bakelite baseboard, panels and dials. **Regular \$75 value. Price only \$29.50.** Transportation charges extra. Shipping weight 26 lbs.

This set with all accessories including tubes, loud speaker, storage battery, B batteries, aerial and ground equipment, **\$59.75.** Shipping weight 100 lbs. Complete instructions with set. Satisfaction guaranteed.

WRITE FOR CATALOG TODAY

**RANDOLPH RADIO CORPORATION, 159 North Union Ave., Dept. 27 Chicago, Ill.**

## RADIO WORLD'S 2-For-Price-of-1 Subscription Offer For NEW RADIO WORLD Subscribers Ordering NOW

Radio World has made arrangements

—To offer a year's subscription **FREE** for any one of the following publications with one year's subscription for **RADIO WORLD**

- RADIO NEWS or —RADIO DEALER or
- POPULAR RADIO or —RADIO JOURNAL or
- RADIO BROADCAST or —RADIO (San Francisco) or
- SCIENCE AND INVENTION or —THE EXPERIMENTER or
- RADIO AGE

This is the way to get two publications

- for the price of one;
- Send \$6.00 today for **RADIO WORLD**
- for one year (regular price
- for 52 numbers)
- and select any one of the other
- nine publications for twelve months.
- Add \$1.00 a year extra for
- Canadian or Foreign Postage.
- Present **RADIO WORLD** subscribers
- can take advantage of this offer by
- extending subscriptions one year
- if they send renewals **NOW.**

### RADIO WORLD'S SPECIAL TWO-FOR-PRICE-OF-ONE SUBSCRIPTION BLANK

RADIO WORLD, 145 West 45th St., N. Y. City.

Enclosed find \$6.00, for which send me **RADIO WORLD** for twelve months (52 numbers), beginning..... and also without additional cost, Radio News, or Popular Radio, or Radio Broadcast, or Science and Invention, or Radio Dealer, or Radio (San Francisco), or The Experimenter, or Radio Journal, or Radio Age (or \$10.00 for two yearly subscriptions).

Indicate if renewal.  
Offer Good Until  
October 25, 1925

Name .....  
Street Address .....  
City and State .....



**LIST OF PARTS**

One 7x24" panel.  
 One 8x23" baseboard.  
 One radio-frequency tuning unit, L1L2 (Aero Wave Trap Unit).  
 One interstage RF tuner, tapped, L2L3 (Aero Wave Trap Unit).  
 Two .0005 mfd. variable condensers, C1, C2 (Wade, with dials).  
 One .00025 mfd. variable condenser, C3 (Wade, with dial).  
 One .00025 mfd. grid condenser, C4 (Dubilier).  
 Three 0.25 mfd. "by-pass" condensers (Dubilier).  
 One 1.0 mfd. by-pass condenser (Dubilier).  
 Two 20-ohm rheostats, R1, R2 (Bruno).  
 One ¼-ampere ballast resistor, R3 (Veby).  
 Three auto-transformers (Thordarson).  
 One variable grid leak, R4 (Bretwood).  
 One 0.5 meg. fixed leak (Veby).  
 One 0.5 meg. potentiometer (Centralab).  
 One 0.1 meg. leak (or 0.25 or 0.5 meg.) for last tube (Veby).  
 Three dial pointers.  
 Five sockets.  
 One A battery switch.  
 One single-circuit jack.  
 One battery cable with Glamzo markers (A+, A-, etc.).  
 Accessories: One 2-post strip with two Z-angle brackets for aerial-ground; two 4½-volt C batteries; three 45-volt B batteries; one 6-volt A battery, 100 amp. hr. or more; five 6-volt tubes; flexible lead for C minus connection; another for A minus to C plus; aerial wire, 50 ft. No. 14 insulated leadin wire, cabinet, speaker, lightning arrestor, busbar, lugs, solder, hardware.

B-C-L

B-C-L

**Opening-of-the-Season Sale!**



"Bruno"  
 "99" 3-circuit tuner  
 wound on quartzite with specially designed tickler. Used in the Diamond. Wound for .0005.

**\$5.50**



"Bruno"  
 "55" matched pair Frequency coil for use with the "99".  
 Wound for .0005

**\$3.00**

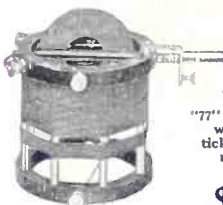

"Bruno"  
 "77" 3-circuit tuner with pancake tickler. Smooth regeneration control.

**\$5.50**



"Bruno"  
 short wave coil tunes from 25-110 meters. Wound on Quartzite glass, minimizing losses.

**\$5.50**

**Complete Kit for 1926 Diamond. Drilled and engraved panel. Federal AFT \$39.50**

**Thordarson-Wade. Complete Kit of official parts \$41.50**

VARIABLE CONDENSERS	
Hammariand, 43 pl. vernier	\$2.95
Manhattan low-loss, .0005 vern.	2.75
U. S. Tool .00025, .00035, .0005, all vernier	1.95
Wade .0005, 98; .00025	7.75
General Instrument, No-Loss, Pyrex-isolantite, all capacities	each, 2.95
Amsco Allocating SLF .00035	3.75
Amsco Allocating SLF .0005	3.95
DIALS	
Apex vernier	1.45
Marko halfline vernier	1.95
Venus 4" vernier	1.95
Kurz Kash Bakelite 4"	50c
AUDIO TRANSFORMERS	
Thordarson Autoformer	4.25
Federal 65, 65A	3.75
Erla 3-to-1, 6-to-1	3.50
Thordarson 2-to-1	3.50
Thordarson 6-to-1	3.10
Thordarson 3-to-1	2.95
Jefferson Star 6-to-1	2.10
Jefferson Star 3-to-1	1.85
Rauland Lyric	6.95
General Radio	3.95
Crescent 6-to-1, 3-to-1	1.95
Acme 4½-to-1, A2	2.50

FIXED CONDENSERS	
Dubilier 2.0 mfd.	\$1.45
Dubilier 1.0 mfd.	1.00
Dubilier 0.25 mfd.	75c
Dubilier .006 mfd.	55c
General Instrument .001, .0005, .00025	45c
Grid Condenser .00025, with clips	50c
Grid Condenser .00025, with clips, and 2-meg. leak	80c
SOCKETS	
Bell, standard Navy and 99	45c
UX Adapters (Na-aid)	35c
SPEAKERS	
Amphon type	4.50
Baldwin type, C unit (without horn)	3.25
Crosley Musicone	13.50
RHEOSTATS	
"Bruno" 6, 10, 20, 30 ohms	50c
Patent, all sizes	59c
Cutter-Hammer 6 ohm	48c
Amsco 6, 20 or 30 ohms	69c
Amerlitas for 199, 201A or 200 or equal tubes	95c

**For SHORT WAVES. Sidney E. Finkelstein's 2-tube, 25 to 110 meter Receiver Kit. \$12.95**

**Venus Straight Line Frequency Condensers**  
 .00025 \$1.95  
 .00035 \$2.10  
 .0005 \$2.25

COILS	
"Bruno 66" 3-circuit tuner	2.25
"Bruno" Filter	2.25
Clartoner	3.50
Erla Balloon Circfold (toroid)	3.65
Bruno coils for Roberts' Knockout	9.00
MISCELLANEOUS	
Clartostat	1.95
Dubilier Duratron (fixed RF transformer)	9.50
Crosley Pup	30c
5-lead battery cable	45c
Firth SC & DC jacks	30c
Pronto A battery switch	22c
Columbia 3-honeycomb coil mount, geared	95c
Carborundum Fixed Crystal	1.50
Short-wave RF choke coil	1.25
Amrad Variometer (new type)	1.25
Freshman B Eliminator (AC)	20.00
Freshman rectifying AC tube	2.50
Freshman B Eliminator (DC), needs no tube	17.50
Daven 3-stage resistance audio amplifier unit (factory made)	12.50
Centralab 500,000-ohm pot	1.65
Baseboard 6½x17"	25c
"Bruno" brackets, per pair	1.00

TUBES	
Venus Volttron 201A, 99 types	1.45
R. C. A. tubes UV201A, UV199, WD12, UX120	2.25
HARD RUBBER PANELS	
7x10 .60e 7x18	1.00
7x12 .70e 7x21	1.25
7x14 .80e 7x24	1.50
For 1926 Diamond, 7x24" drilled and engraved	\$2.65
COMPLETE KITS	
"Bruno 77" 3-tube DX	\$19.50
Ambassador 3-tube	17.50
Roberts' Knockout	33.50
Browning-Drake	32.45
Bernard Audio Amplifier	10.50
LEAKS	
Bretwood Variable Grid Leak	1.50
Fixed leaks, all values	30c
BALLAST RESISTORS	
Veby ¼ amp.	50c



**WD-11 Radiotron**  
 REG. U. S. PAT. OFF.

LISTEN IN every Friday at 7 P. M. and hear Herman Bernard, managing editor of RADIO WORLD, discuss "Your Radio Problem," from WGBS, Gimbel Bros., New York City, 315.6 meters.

RECENT BACK NUMBERS of RADIO WORLD, 15 cents each, or any seven for \$1. Address Circulation Manager, RADIO WORLD, 1403 Broadway, New York City.

1925 BACK NUMBERS OF RADIO WORLD WANTED  
 Mail us copies of any of the following 1925 issues of RADIO WORLD, and we will send you a copy of a current issue for every copy sent us: January 10, February 7, March 21, 28; April 4, 11; May 30.

*We Have Everything in Parts or Sets*

**B-C-L RADIO SERVICE CO.**  
 223 FULTON ST. N. Y. CITY  
 DEPT. W 1010

Send for FREE Catalogue

Expert Technical Q. & A. Service FREE

# The Regenerative Theory of the Thordarson-Wade

The method of obtaining regeneration in the Thordarson-Wade circuit is based on the Hartley oscillator, and this method is often used by amateurs in transmitting circuits on account of its simplicity and

effectiveness. It is the Hartley oscillator with parallel feed, so-called because the plate voltage is supplied the tube through a circuit which is in parallel with the high frequency circuit. In the Hartley oscillator the tuning condenser is connected across both the tickler and the grid coil so that the tickler becomes a part of the tuned circuit. In the simplest form there is only one coil, one terminal of which is connected to the grid and the other to the plate. The filament is connected to a tap on this coil.

### Location of the Tap

When the circuit is used primarily as an oscillator this tap should be somewhere between one-third and one-half the way up from the plate end of the coil, but when the circuit is used for a regenerative receiver it is best to put the tap just a few turns away from the plate end of the coil. If the tap is too close to the grid the effective input voltage will be low, the tuning and the control of regeneration will be very critical, and there will be a great deal of hand capacity effect. But if the tap is only a few turns from the plate end these disadvantages are minimized. A shielded condenser (C3) prevents hand capacity.

Regeneration is controlled by means of this .00025 mfd. variable condenser. This is the usual by-pass condenser which is ordinarily connected directly between the ground and the plate. In this case it is connected between the plate and one end of the tuning coil so that the current that is ordinarily by-passed is made to flow through a small portion of the tuning coil. The greater this portion of the coil is, up to about one-half of the number of turns in the coil, the greater will regeneration be, but the number of turns included in the by-pass circuit should never be greater than required to obtain satisfactory operation.

### Determining Factors

The number of turns required not only depends on the value of the variable by-pass condenser, but also on the distributed capacity of the head set or transformer windings in the plate circuit of the detector, on the filament temperature, on the

grid leak and condenser, on the quality of the tuned circuit, and on the frequency of the incoming signals. The adjustment should be made at normal filament current and for a signal which requires that the tuning condenser be set at maximum. Then the turns should be adjusted so that when the by-pass or regeneration control condenser is set at about 75% of its maximum the circuit will just oscillate.

### SOLVED!

#### —THE "B" BATTERY PROBLEM

Throw away your "B" Batteries and install a Kellogg Trans-B-Former. It gives you "B" Battery current direct from your electric light socket at the trifling cost of one-fifth of a cent per hour. Gives better reception—no interferences. Write for details.

Trans-B-Former

Kellogg Switchboard & Supply Co.  
1066 West Adams Street Chicago, Ill.

### DAVID GRIMES

#### Super-Selective RADIO

Baby Grand Duplex Model..... \$59.50  
Empire Model..... 100.00  
Italian Renaissance Model..... 100.00  
David Grimes Super-Tone Loud Speaker... 25.00  
Ask a Grimes Dealer for Demonstration  
David Grimes Radio & Cameo Record Corp.  
1571 Broadway New York, N. Y.

## RADIO AGENTS WANTED 5 Tube Demonstrator FREE!

Earn \$25 to \$100 a week, part or full time. Everyone a prospect. Complete line standard sets and accessories, \$5 to \$40. Write today for illustrated catalog and exclusive selling plan for live dealers and community agents. 20TH CENTURY RADIO CO., 1101 Coca Cola Bldg., Kansas City, Mo.

## RADIO DEALERS!

We announce a partial list of our representation of the following dependable radio lines, and solicit your orders. Prompt service at all times. Write for discounts and literature.

Silver-Marshall	Town Crier Speakers
Vaxely	Amperites
Narco	Sams'n Transformers
Mortrose Sets and Con-	Nelside
densers	Siekles Coils
Nazley	Carter
Coco Radio Tubes	Gem Radio Tubes
Pacnet	Micamid
Premier Elec. Co.	Fitch Speakers
Precise	

**Maurice Schwartz & Son**

RADIO DISTRIBUTORS

710-712 BROADWAY SCHENECTADY, N. Y.

# THE TODD "B" BATTERY

MOST ECONOMICAL  
The 100 Volt Unit  
OUTFIT EVER BUILT

# Facts!

- 1—TODD "B" BATTERY challenges any substitute battery to equal it in performance.
- 2—With a TODD "B" reception is the clearest obtainable.
- 3—TODD "B" has tens of thousands of satisfied users.
- 4—Most economical both in cost and up-keep.
- 5—Recharging cost—practically nil.
- 6—The ONLY Radio Product, since Radio achieved popularity, to "hold its own."
- 7—A product absolutely GUARANTEED against mechanical defects.
- 8—A battery O'Ked and recommended by Radio Authorities and the PRESS.
- 9—Accredited as being "the everlasting 'B' battery."
- 10—A product the Radio world is proud of.

Don't Fail to Own One. Price \$21.00 with A. C. Charger.

**THE TODD ELECTRIC CO., Inc.**

36 W. 20th Street  
(Tel. Watkins 9286)  
New York

## GOLD SEAL TUBES

One man tells another actual performance has built Gold Seal popularity. Everywhere and guaranteed. All types—Standard base. **\$2.50**

**GOLD SEAL PRODUCTS CORP.**  
250 PARK AVENUE New York



### Long Distance Radio \$2.95

Lambert's newest crystal success. No tubes. No batteries. No grief. Always ready. Works 600 miles. Fully guaranteed. We pay postage. Order direct from this ad. Leon Lambert, Wichita, Kansas.

## Get Your Coil Connections Right

When You Build

## The Powertone

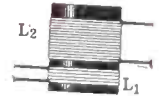

Construction of this 1-dial, 5-tube quality receiver fully described and illustrated, with "blue print" in black" included, in Aug. 29 and Sept. 5 issues. Special discussion of how to connect the coil terminals. Trouble-shooting in this set, Sept. 12 issue. Send 45c. Get all three.

### RADIO WORLD

145 West 45th St., N. Y. City

## The New and Better Diamond of the Air

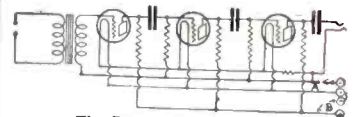

The Bernard Audio Amplifier

DX, Selectivity, Volume and Quality  
—All Marvelously Combined in  
RADIO WORLD'S 1926 Model

## DIAMOND OF THE AIR

5 tubes, including Bernard AF hookup, Sept. 12, 19 and 26 issues of RADIO WORLD, including picture diagrams of wiring.

Send 45c. for these three numbers or start your subscription with the Sept. 12 issue. Send \$6 for yearly subscription and get these three issues FREE. Address: Circulation Manager, RADIO WORLD, 145 W. 45th St., New York City.



# Siam Makes It Unanimous in Radio League of Nations

WASHINGTON.  
Even Siam has fallen to the lure of the radio. The first important broadcasting

entertainment to be given in that country was made recently by the Signal Corps of the Army, sending from Bangsus and consisted of cavalry band selection and news items provided by the Bangkok Times, says consular advices to the Department of Commerce. There were five receiving stations located at Rua Hin, Ayudhys, Korat, and at two of the official palaces. The experiment lasted for three hours and is reported to have been very satisfactory, the program being heard by all the receiving stations.

**FREE BOOKLET FOR INVENTORS**

IF YOUR INVENTION is new and useful it is patentable. Send me your sketch. Z. H. POLACHEK, 70 Wall St., New York.  
Reg. Patent Attorney-Engineer

**LOUD SPEAKER RECEPTION**  
from either coast on three tubes.

Blueprint and instructions.....\$1.00  
Necessary low loss coll.....\$2.50  
Beautiful finished instrument.....\$35.00

**S. A. TWITCHELL CO.**  
1930 Western Avenue Minneapolis, Minn.

**Jones MULTIPUG**  
THE STANDARD SET CONNECTOR

**HOWARD B. JONES**  
616 S. CANAL STREET CHICAGO

**FREE two unusual RADIO CATALOGS**

**FOR "FANS"** new 64-page Radio Catalog including all the best and latest Kits, Parts and Accessories for broadcast receiving sets. Lowest prices in the country.

**FOR "HAMS"** NEW 32-page booklet of army and navy transmitting apparatus and miscellaneous specialties for "hams", such as W. E. Choate Colls, Generators, Resistance Boxes, etc.

More than 1,000,000 fans and hams make our store their headquarters—get these books and find out why.

Write for either or both

509 South State Street CHICAGO SALVAGE STOCK STORES Dept. R. W. 6 Chicago Ill.

The Bangkok Times printed an article on the results of the trial from which the following excerpts were taken:

"The attempt made on the part of the newly formed Signal Corps of the Army to broadcast the news of the day to five receiving stations, three of which were in the provinces seems to have met with success. The best time for listening in is at the hour when most folks are content to be asleep, but in the cool weather the early evening hours prove favorable; in the hot months they are impossible, the atmospheric disturbance after sunset being too great to allow of any measure of success with small plants. It is possible that with the advent of the rains the evening hours may again prove suitable for listening in, but that has yet to be determined. In the hot months the best time has been found to be from 4 to 6 a.m.

Chelmsford has been heard in Bangkok, and music broadcast from Calcutta has been danced to here and heard plainly in Krabin. Signals from wireless stations in Manila, Hongkong and Saigon have also been picked up."

For the present, however, the tests are entirely official and it is pointed out that a regular public broadcasting service is not to be expected for some time.

## Navy Day Exercises To Be Widely Broadcast

WASHINGTON.  
Navy Day, which will be observed October 27, will be broadcast through a nation-wide hookup of stations which will enable the entire country to listen in. Plans are being made for broadcasting with a view of getting information before as many persons as possible. The plans also contemplate programs of national significance from several large independent stations as well as a multiplicity of local programs arranged between the District Commandants and the smaller stations.

**PANELS**  
RADION and HARD RUBBER  
RETAIL ANY SIZE WHOLESALE  
PRICE LIST MAILED ON REQUEST

**HARD RUBBER SHEETS—RODS—TUBING**  
Special Hard Rubber Parts Made to Order.  
Send Sample or Sketch for Quotation.

**NEW YORK HARD RUBBER TURNING CO.**  
212 CENTRE ST. NEW YORK

**MEGGIT RESISTOR**

To build the most perfect Resistance Coupled Amplifier it is essential to use Meggit Resistors and Grid Leaks—they are noiseless, moisture proof and accurate in resistance.

Send 10c for booklet on Resistance Coupled Amplification with circuit diagrams.

**COLE RADIO MFG. CO.**  
Bloomfield N. J.

**EVERY SET BUILDER NEEDS THIS**

**"Morsing Bus-Bar Union"**

Makes for quick assembling. Repairs can be made by using Morsing Bus-Bar Union without taking set apart.

Assemble round or square Bus-Bar and solder three wires at a time. Order No. 1 for No. 14, No. 2 for 12 wire. Send 25 cents for enough for building one set, or ten dozen for \$1.00.

**Newark Watch Case Material Co.**  
15 Ward Street Newark, N. J.  
DISTRIBUTORS WANTED

**CROSLEY**

RADIO CATALOG FREE  
Describes fully the complete line of radio frequency sets, regenerative sets (licensed under Armstrong U. S. Patent No. 1,113,149) and parts.  
Write for Catalog Today.

**THE CROSLEY RADIO CORPORATION**  
POWEL CROSLEY, Jr., President  
7408 Sassafras Street Cincinnati, Ohio

**Mailing Lists**

Free

Will help you increase sales. Send for FREE catalog giving counts and prices on classified names of your best prospective customers — National, State, Local — Individuals, Professions, Business Firms.

99% Guaranteed by refund of 5c each

**ROSS-Gould Co.** SEN. ST. Louis

**COMING! Out Next Week!**  
**RADIO WORLD'S**  
**4th Annual Fall Buyers' Number!**  
Dated October 17, 1925. Last form closes October 6  
**EVERY READER A BUYER OF RADIO GOODS**

Advertisers have found that Radio World's FALL BUYERS' NUMBER of former years were business-bringing issues. The 1925 FALL BUYERS' NUMBER will be much better than the former issues, as our regular editions now are improvements over those of former years.

Use space in this goods-selling issue and reach the thousands of purchasers of sets and parts who are contemplating buying radio goods for the first time, or are about to change their radio equipment.

Regular advertising rates in force for an enlarged edition and sale.

Advertising rates: \$300 a page, \$150 one-half page, \$75 one-quarter page, \$100 1 column, \$10 per inch.

If copy for page is received by October 5, it will be printed, on request, in an extra color without extra cost.

Get in your order and copy now for Radio World's 4TH ANNUAL FALL BUYERS' NUMBER, and cash in on its profit-making circulation.

### Restriction of Ships Indorsed by Hoover

WASHINGTON.

Convinced that the elimination of ship radio signals within the broadcasting bands will constitute a great boon to radio fans in this country, the Commerce Department signified its willingness to enter into reciprocal relations with British and Canadian authorities to prohibit the vessels of the countries named from using wavelengths of 300 to 450 meters when within 250 miles of the United States, Canada and the British Isles.

Ever since the development of radio broadcasting on an important scale, the Commerce Department has been deluged with complaints from owners of radio sets relative to the great interference encountered from ship signals.

Instructions were sent by the Commerce Department to U. S. Supervisors of Radio and others interested, asking all operators of United States to discontinue the use of the wavelengths named when within the specified distance of the coasts of Canada, British Isles, and the United States.

### NEW STATIONS

WASHINGTON.

Seven class A and one class B broadcasting stations were licensed by the Department of Commerce. They follow:

#### CLASS A

Call	Location	Meters	Watts
KTBR	Brown's Radio Shop, Portland, Oregon	263	50
WDCH	Dartmouth College, Hanover, N. H.	256	100
WJBL	Wm. Gushard Dry Goods Co., Decatur, Illinois	270	500
WFRL	Robert Morrisson Lacey, Brooklyn, N. Y.	205.4	100
KFXM	Neches Electric Company, Beaumont, Texas	227	10
KFBU	Bishop N. S. Thomas Laramie, Wyoming	270	500
WPRC	Wilson Printing & Radio Company, Harrisburg, Penna.	215.7	100

#### CLASS B

WJAZ	Zenith Radio Corporation, Mt. Prospect, Ill.	322.4	1500
------	--	-------	------

## Opening WLWL, Cardinal Hayes Praises the Influence of Radio

Station WLWL, at the church of the Paulist Fathers, 59th Street and Columbus Avenue, is one of New York City's newest broadcasters. Cardinal Hayes opened the station. In his speech, which was broadcast, he congratulated the Paulist Fathers on employing the radio as an agent of dispensing truth to the world. He cautioned that the works of science were so powerful that those who undertook to operate so far-reaching an instrument as the radio had a moral responsibility to use a privilege with reverence and in the interests of the public. However, he said, the correct use of the radio offered increased opportunities for service.

### Football Schedule

Football will have a prominent place on the program of WEAF this Fall. The following is the schedule of matches to be broadcast through WEAF and other stations in the chain:

- Saturday, Oct. 17, Army vs. Notre Dame, Yankee Stadium, N. Y.
- Saturday, Oct. 24, University of Pa. vs. University of Chicago, Franklin Field, Phila.
- Saturday Oct. 31, Yale vs. Army, New Haven, Conn.
- Saturday, Nov. 7, Harvard vs. Princeton, Princeton, N. J.
- Saturday, Nov. 14, Princeton vs. Yale, New Haven, Conn.
- Saturday, Nov. 21, Harvard vs. Yale, Cambridge, Mass.
- Thursday, Nov. 26, Cornell vs. University of Pa., Franklin Field, Phila.
- Saturday, Nov. 28, Army vs. Navy, Polo Grounds, N. Y.



The Bretwood Variable Grid Leak



# THAT KNOB

means more to you even than the type of circuit you use. Sets that lack pep gain volume and vigor. Sets that were disappointing on distant reception bring in stations thousands of miles away. Sets that crackled and distorted turn pure and beautiful in tone. Put this leak in any set and marvel at the difference.

### North American Bretwood Co.

Telephone: Bryant 0558

145 West 45th Street

New York City

Members of the Trade, Write for Particulars.

North American Bretwood Co., 145 W. 45th St., New York City:—Enclosed find \$1.50. Send one Bretwood Variable Grid Leak, prepaid, on 10-day money-back guarantee.

Name .....

Street .....

City..... State.....



#### HOOK-UPS

A lot of them, some of which are sure to suit your purpose, appeared in RADIO WORLD dated August 15. 15c a copy, or start your subscription RADIO WORLD, 145 West 45th St., N. Y. City. tion with that number.

RADIO NOVELTY EXTRAORDINARY—Working partner wanted; Canadian territory available; exceptionally meritorious article; small capital. Box 102, Radio World.

RADIO HORN MANUFACTURER, many orders on hand, desires partner, outside man, with about \$5,000 cash, or will sell. Box 101, Radio World.

**Buy Tubes by Name**

**WD-11 Radiotron**

REG. U.S. PAT. OFF.

THE MONEY BACK STORE OF CORTLAND ST.

# CITY RADIO

## 79 CORTLAND ST.

PHONE RECTOP 533A

Dept. RW, New York City, N. Y.

Immediate service on Mail Orders. Orders shipped same day received. Every purchase guaranteed by the oldest radio store in New York.

---

**Thordarson-Wade Kit, \$42.50**  
Endorsed by Herman Bernard

---

Daven Super Amplifier Kits (new).....\$11.45  
Exide Sto. Bat. 100 amp. rubber case 12.95  
Sterling 100 rubber case, 2-yr. guar. 10.25  
Freshman Eliminators—D.C., \$17.50  
Freshman Eliminators—A.C., 20.00

Claroat 1.70  
Freshman Kit, Regular \$17.50..... 8.95  
Complete Bremer Tully Kit, including Drilled and Engraved Bakelite Panel \$9.50  
Amperites..... .79  
Eria Balloon Coils, set of three..... 8.95  
Eria Kits, complete coils and condensers 16.50  
Amsco Cond. str. line frs., .0005..... 3.35  
Morrison Units adj. 3.25  
Sterling double reading meter, 0-8 and 0-120..... 2.75  
Magnavox Horn M4..... 12.25  
Federal Trans. 65 and 65A..... 3.15  
Bremer-Tully Nameless Kit..... 16.95

Send name and address for our latest Radio Catalogue and radio map of the world

## THE KEY TO THE AIR

(Concluded from page 19)

WCAE, Pittsburgh, Pa., 461.3 (CST)—12:30 PM to 1:30; 4:30 to 5:30; 6:30 to 11.  
WCBF, Zion, Ill., 344.6 (CST)—8 PM to 10.  
WCCO, St. Paul and Minneapolis, Minn., 416.4 (CST)—9:30 AM to 12 M; 1:30 PM to 4; 5:50 to 10.  
WEAF, New York City, 492 (EST)—6:45 AM to 7:45; 11 to 12 M; 4 PM to 5; 6 to 12  
WEAR, Cleveland, O., 390 (EST)—10:30 AM to 12:10 PM; 3:30 to 4:15; 7 to 11.  
WEEL, Boston, Mass., 467 (EST)—6:45 AM to 7:45; 1 PM to 2; 2:30 to 10.  
WFAA, Dallas, Texas, 475.9 (CST)—10:30 AM to 11:30; 12:30 PM to 1; 2:30 to 6; 6:45 to 7; 8:30 to 9:30; 11 to 1 AM  
WFBH, New York City, 272.6 (EST)—2 PM to 7:30.  
WGBS, New York City, 316 (EST)—10 AM to 11; 1:30 PM to 4; 6 to 10:30.  
WGCP, New York City, 316 (EST)—2:30 PM to 5:15.  
WGES, Chicago, Ill., 250 (CST)—5 PM to 8; 10:30 to 1 AM  
WGN, Chicago, Ill., 370 (CST)—9:31 AM to 3:30 PM; 5:30 to 11:30.  
WHAD, Milwaukee, Wis., 275 (CST)—11 AM to 11:30; 6 PM to 7:15; 8:30 to 11.  
WGR, Buffalo, N. Y., 319 (EST)—12 M to 12:45 PM; 2 to 4; 7:30 to 11.  
WHAD, Milwaukee, Wis., 275 (CST)—11 AM to 12:15 PM; 4 to 5; 6 to 7:30; 8 to 10.  
WHAR, Atlantic City, N. J., 275 (EST)—2 PM to 3; 7:30 to 10.  
WHAS, Louisville, Ky., 399.6 (CST)—4 PM to 5; 7:30 to 9.  
WHN, New York City, 360 (EST)—2:15 PM to 5; 7:30 to 11; 11:30 to 12:30 AM.  
WHO, Des Moines, Iowa, 526 (CST)—7:30 PM to 9; 11 to 12.  
WHT, Chicago, Ill., 400 (CST)—11 AM to 2 PM; 7 to 8:30; 10:30 to 1 AM.  
WJY, New York City, 405 (EST)—7:30 PM to 11:30  
WJZ, New York City, 455 (EST)—10 AM to 11; 1 PM to 2; 4 to 6; 7 to 12 M.  
WLT, Philadelphia, Pa., 395 (EST)—12:02 PM to 12:30; 2 to 3; 4:30 to 6; 8:30 to 9.

WLW, Cincinnati, O., 422.3 (EST)—10:40 AM to 12:15 PM; 1:30 to 5; 6 to 8; 10 to 11.  
WMAK, Lockport, N. Y., 265.5 (EST)—11 PM to 1 AM.  
WMCA, New York City, 341 (EST)—11 AM to 12 M; 6:30 PM to 12.  
WNYC, New York City, 526 (EST)—3:15 PM to 4:15; 6:50 to 12.  
WOAW, Omaha, Neb., 526 (CST)—12:30 PM to 1:30; 5:45 to 11.  
WOC, Davenport, Iowa, 484 (CST)—12:57 AM to 2 PM; 3 to 3:30; 4 to 7:10; 8 to 9.  
WOR, Newark, N. J., 405 (EST)—6:45 AM to 7:45; 2:30 PM to 4; 6:15 to 7.  
WPG, Atlantic City, N. J., 299.8 (EST)—7 PM to 11.  
WQL, Chicago, Ill., 448 (CST)—11 AM to 12 M; 3 PM to 4; 7 to 8; 10 to 2 AM.

## The VEBY Resistors Are STANDARD

Guaranteed within 10% of commercial rating; they remain of constant value.

**VEBY RADIO COMPANY**  
47-51 Morris Avenue Newark, N. J.

## THE RAMBLER SIX A REAL PORTABLE

Volume, Clarity, Portability, Durability and Beauty Unequaled

Lightest in weight. 21 pounds.  
Smallest in size. 14x9 1/2 x 9 3/4 inches.

LIST PRICE..... **\$80.00**

If your dealer cannot make immediate delivery we will ship direct from factory same day your money order or check is received.

**American Interstate Radio Service**  
183 Greenwich Street, New York City  
Distributors, Jobbers, Dealers, write for special trade terms.



**CONDENSERS  
VARIABLES  
RHEOSTATS**

AMSCO PRODUCTS, Inc. New York City

### Developed for Those Who Demand the Best

#### Apex Vernier Dials

are constructed on exhaustively tested and truly scientific principles and are engineered to meet the precise requirements of experts—consequently they more than meet the expectations of the average radio user. They bring in distant stations with alacrity and positiveness seldom encountered and provide control and accuracy essential to full radio enjoyment. They impart a degree of elegance that creates a marked improvement in the appearance of any set. Clockwise or counter clockwise.

Royal Brass Finish, 4 in. \$2.00; 3 1/4 in. \$1.65  
Satin Silver Finish, 4 in. 2.50; 3 1/4 in. 1.90  
DeLuxe Gold (24K) 4 in. 3.00; 3 1/4 in. 2.50

#### Apex Rheostat Dials

are little brothers to Apex Vernier Dials. Accurate, handsome—a necessity to satisfactory operation, beauty of appearance.

Royal Brass Finish..... \$ .75  
Satin Silver Finish..... .85  
DeLuxe Gold (24K)..... 1.00

If your dealer is unable to supply you, order direct from us.

**APEX ELECTRIC MFG. CO.**  
1410 W. 59th St., Dept. 3 Chicago

## Antena-Mat

A unique device placed under telephone receiver acts as a perfect aerial.  
Does away with need of outside aerial, loop or tape. Absolute satisfaction guaranteed or money back. Place a dollar in envelope and mail at our risk.

**T. M. CAVEN COMPANY**  
2367 Crest Avenue, Astoria, O., N. Y.  
Tested and approved by Radio World

## GEM TUBE

A Guaranteed Radio Tube Within Reach of All

Every tube guaranteed. A tube for a dollar of \$2 value. A trial order will convince you as it has thousands of others. Send your orders at once. Orders sent C.O.D. parcel post.

Type .199A  
Type .199  
Type .200  
Type .201A  
(with standard base) **EACH \$1.00**

Dealers, Write for Discounts

**GEM TUBE CO.**  
Dept. W, 200 B'way, N. Y. C.  
220 So. State St., Chicago, Ill.  
Lafayette Bldg., Detroit, Mich.

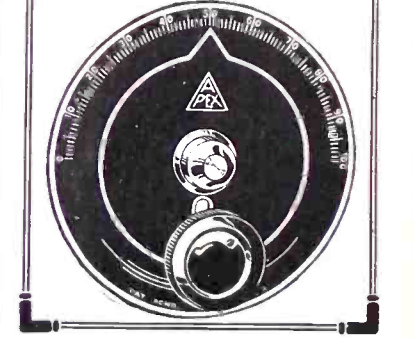
**HOOK-UPS!**—A lot of them, some of which are sure to suit your purpose, appeared in RADIO WORLD dated Aug. 15. 15c a copy, or start your subscription with that number. RADIO WORLD, 145 West 45th St., N. Y. City.

# RADIO WORLD'S QUICK-ACTION CLASSIFIED ADS.

10 CENTS A WORD. 10 WORDS MINIMUM.

**"ATLAS" LOUDSPEAKERS**, 2 1/4 inches high, 10 1/4 inches Bell, Adjustable, Guaranteed. Limited supply at \$10 each, were \$25. New England Products Co., Meriden, Conn.

**MAKE \$100 WEEKLY** in spare time. Sell what the public wants—long-distance radio receiving sets. Two sales weekly pays \$100 profit. No big investment, no canvassing. Sharpe of Colorado made \$95 in one month. Representatives wanted at once. This plan is sweeping the country—write today before your county is gone! Ozarka, Inc., 126-J. West Austin Ave., Chicago, Ill.

**BABY PORTABLE SET.** How to make it. See RADIO WORLD dated May 16. 15c per copy, or start your subscription with that number. RADIO WORLD.

**CRYSTAL SETS FOR USE TODAY**, by Lewis Winner, with diagrams, in RADIO WORLD, dated July 25, 1925. 15c a copy, or start your subscription with that number. RADIO WORLD, 1493 Broadway, New York.

**PATENTS**—Write for free Guide Books and "Record of Invention Blank" before disclosing inventions. Send model or sketch of your invention for our Inspection and Instructions Free. Terms reasonable. Radio, Chemical, Mechanical, Electrical and Trademark experts. Victor J. Evans & Co., 924 Ninth, Washington, D. C.

**BATTERY ELIMINATORS**, Radio Sets. Bargains. G. Sims, Lake, New York.

**AGENTS WANTED TO SELL** standard radio apparatus. Write us at once if interested. Radio Development and Engineering Co., 180 Broadway, New York.

**HOW TO BUILD THE POWERTONE**, 1 dial, 5 tubes, described in RADIO WORLD, issues of Aug. 29 and Sept. 5. Powertone Trouble-shooting, Sept. 12. Send 15c for all three. Special diagrams and "blueprint in black" included among the many illustrations. RADIO WORLD.

**GLASS PANELS** add a novelty to any set. Two methods for making holes in glass. Price one dollar. Coldyear Specialty Co., Sutherland, Oregon.

**DINING AND SLEEPING CAR CONDUCTORS** (White). Exp. unnecessary. We train you. Send for book of Rules and application. Supt. Railway Exchange, Sta. C, Los Angeles.

**COMPLETE LIST OF BROADCASTING STATIONS** appeared in RADIO WORLD dated Oct. 3, 1925. 15c per copy, or start your subscription with that number. RADIO WORLD, 145 W. 45th St., N. Y. C.

**A 1-CONTROL PORTABLE**, by Capt. P. V. O'Rourke; A Baby Super-Heterodyne, only 4 Tubes, by J. E. Anderson; A More Powerful Diamond, Still only 4 Tubes, by Herman Bernard. Other features in RADIO WORLD, dated July 7, 1925, 15c a copy, or start your subscription with that number. RADIO WORLD.

# Officials Hail Programs Endowed by Atwater Kent

WASHINGTON.

Gratification over the announcement by A. Atwater Kent, radio manufacturer, of Philadelphia, that the world's leading

grand opera soloists and concert artists will be heard over the radio in a series of Sunday evening concerts this winter, was expressed by government officials who are fostering the development of broadcasting.

The concerts, which will be broadcast to millions of listeners through station WEAF, New York, and other stations with which it is connected, is strongly in accord with Secretary Hoover's appeal for better radio programs, it was said at the Department of Commerce.

The department has given much thought to the improvement of programs that go out on the air. Secretary Hoover is said to feel that in view of the millions of individuals it reaches, radio should not be regarded simply as a luxury and something to play with, but that it should render a distinct public service in the character of programs it carried into the home, and that the influence should be uplifting. The contribution by Mr. Kent, of the services of artists of the first degree to radio, it is felt in Washington as well as in other cities, is a big step toward raising the standard of radio programs. Expressions of approval are heard in many quarters that influence different phases of our national life.

### Benefits great

Dr. John J. Tigert, United States Commissioner of Education, expressed the belief that the bringing of the best class of music into homes, which the series will do, would be of great educational value to radio audiences. He said:

"The benefits of hearing the best music are so great that I have always favored making it available to the greatest number of persons possible. Arrangement of this series marks the attainment of an important milestone in this direction, because it will make a vastly greater number of Americans acquainted with the best music and the best musicians.

"Americans recently have taken an increased interest in music, as is exemplified by their support of many worthy bands and organizations of community opera companies. I believe the broadcast-

ing of radio concerts by internationally-noted artists will stimulate that interest, and do much to increase America's contribution to the sphere of music."

Speaking for the homes represented in the National Congress of Parents and Teachers, Mrs. Arthur C. Watkins, of Washington, D. C., Executive Secretary of that organization, said:

"By carrying the best class of music into homes, radio will enable thousands of persons, who otherwise might scarcely ever hear the great concert artists, to know and appreciate their voices and talent. This will add immeasurably in the forming of musical ideas, especially by the young.

"In my own home, we are especially glad to hear that grand opera artists will be on the air Sunday evenings."

"The new program will appeal to the farmers," said Dr. Gilbert. "The farmer is one of us. He has his library, his radio and his phonograph, and he has the best records made by the opera stars."

**THOUSANDS OF BARGAINS**  
FACTORY GUARANTEED HDSE. BY MAIL  
Genuine New Radioron or Cunningham Tubes  
CV-189-200-201A-WD-11-12..... \$1.98  
C299-300-301A-C11-12.....  
Flash Burgess or Eveready "B" Batteries  
22 1/2 Volt large size \$1.30-1.45 Volt large size \$2.80  
Write for Free new Complete Catalog on  
Sets and Parts  
STONE ELECTRIC CO., 714 Pine St., St. Louis, Mo.  
All Mds. F.O.B. St. Louis, Mo. Dept. W

**HERCULES  
AERIAL MAST**

20 Ft. Mast \$10  
40 Ft. Mast \$25  
60 Ft. Mast \$45

All steel construction complete with guy wires and masthead pulley. We pay the freight S. W. HULL & CO., Dept. E3  
2048 E. 79th St., Cleveland, O.

**FREE**  
Write for Literature and Blueprint

**OUR NEW CATALOGUE**  
Just completed—listing hundreds of BARGAINS, will be mailed to you upon receipt of name and address—  
GET YOUR NAME ON OUR MAILING LIST  
**SIMPLEX RADIO SUPPLY CO.**  
806 LAFAYETTE AVE. Dept. D ST. LOUIS, MO.

**SIMPLEX**  
CATALOG  
OF  
RADIO  
BARGAINS

**A REAL AUDIO AMPLIFIER**

That does the work  
**Only \$7.00**  
Postpaid

Will positively increase the range and volume of any tube or crystal set three or four times. In-audible signals built up to speaker volume. Complete as illustrated, including tube. Best parts and workmanship. Satisfaction absolutely guaranteed.

**TRELLCOTT CO.**  
2118 Hale Avenue  
Louisville, Ky.

**A Special Combination!—**  
**The Powertone**  
Licensed Under Hogan Patent  
with  
**Bretwood Variable**  
**Grid Leak**  
In the Set  
The Great 5-Tube 1-Dial Receiver Equipped with the Sensational Leak.

**\$41.00**

**RADIO DIVISION, COLUMBIA PRINT**  
145 WEST 45th STREET  
New York City

**RADIO MANUFACTURERS  
INVENTORS  
EXPERIMENTERS**

Mechanical Consultants. We develop your ideas, make models and manufacture.  
(Mechanics assigned to work under customer's supervision if desired)

**MANUFACTURERS' & INVENTORS' ELECTRIC COMPANY**  
228 West Broadway (Smith Bldg.), New York City

## You Can Make \$100 Weekly Selling Radio



**Demonstrate once—results mean sure sales!** Sell what everybody wants—radio at low prices. Coast to coast reception—4, 5 and 7-tube instruments.

**12 Selling FREE! Lessons**  
Establish a business of your own. Start in spare time—evenings. Sales course in 12 lessons and 10 radio service lessons teach you everything.

**J. Natheson Ball, Pres.**

**3100 Men Are Now Doing It!**  
Success with over 3,100 men proves merit of our proposition. \$100 weekly net unswerving—many Ozarka men make more in spare time!

**Free Book!** Write me personally—tell me about yourself. I'll see that my 64-page book, Ozarka plan No. 100, is sent you without cost. Please mention the name of your county. Mail the coupon!

**OZARKA INCORPORATED**  
122 Austin Avenue E Chicago, Illinois

Gentlemen: 10-25

I am greatly interested in the FREE BOOK "The Ozarka Plan" whereby I can sell your radio instruments.

Name.....  
Address..... City.....  
County..... State.....

STATEMENT OF THE OWNERSHIP, MANAGEMENT, CIRCULATION, ETC., REQUIRED BY THE ACT OF CONGRESS OF AUGUST 24, 1912.

Of Radio World, published weekly at New York N. Y., for Oct. 1, 1925.

State of New York,  
County of New York, ss.:  
Before me, a Notary Public, in and for the State and County aforesaid, personally appeared Roland Burke Hennessy, who, having been duly sworn according to law, deposes and says that he is the Editor of the Radio World, and that the following is to the best of his knowledge and belief, a true statement of the ownership, management (and circulation, if a daily paper, the circulation) etc., of the aforesaid publication for the date shown in the above caption, required by the Act of August 24, 1912, embodied in section 411, Postal Laws and Regulations, printed on the reverse of this form, to-wit:

1. That the names and addresses of the publisher, editor, managing editor, and business managers are: Publisher, Hennessy Radio Publications Corp., 145 W. 45th St., N. Y. C.; editor, Roland Burke Hennessy, 145 W. 45th St. N. Y. C.; managing editor, Herman Bernard, 145 W. 45th St., N. Y. C.; business manager, Fred S. Clark, 145 W. 45th St., N. Y. C.

name and address must be stated, and also immediately owning or holding one per cent. or more of total amount of stocks. If not owned by a corporation the names and addresses of the individual owners must be given. If its name and address, as well as those of each individual member must be given). Hennessy Radio Publications Corp., 145 W. 45th St., N. Y. C.; Roland Burke Hennessy, 145 W. 45th St., N. Y. C.; Mrs. Mary McArthur, 1888 East 82nd Street, Cleveland, Ohio.

3. That the known bondholders, mortgagees, and other security holders owning or holding 1 per cent. or more of total amount of bonds, mortgages, or other securities are: If there are none, so state.

4. That the two paragraphs next above, giving the names of the owners, stockholders, and security holders, if any, contain not only the list of stockholders and security holders as they appear upon the books of the company, but also, in cases where the stockholder or security holder appears upon the books of the company as trustee or in any other fiduciary relation, the name of the person or corporation for whom such trustee is acting, is given; also that the said two paragraphs contain statements embracing and belief as to the circumstances and conditions under which stockholders and secur-

ity holders who do not appear upon the books of the company as trustees, hold stock and securities in a capacity other than that of a bona fide owner; and that affiant has no reason to believe that any other person, association, or corporation has any interest direct or indirect in the said stock, bonds or other securities than as so stated by him.

5. That the average number of copies of each issue of this publication sold or distributed through the mails or otherwise, to paid subscribers during the six months preceding the date shown above is..... weekly. (This information is required from..... only).

ROLAND B. HENNESSY, Editor.

(Sworn to and subscribed before me this 30th day of September, 1925).

Notary Public, New York County, New York, County Clerk's No. 180, New York County Register's No. 6185. Term expires March 30, 1926.

Note.—This statement must be made in duplicate and both copies delivered by the publisher to the postmaster, General (Division of Classification), Washington, D. C. The publisher must publish a copy of this statement in the second issue printed next after its filing.

**EVEREADY HOUR**  
**EVERY TUESDAY AT 9 P. M.**  
*Eastern Standard Time*  
 For real radio enjoyment, tune in the  
 "Eveready Group." Broadcast through  
 stations—

<b>WEAF</b> New York	<b>WSAI</b> Cincinnati
<b>WJAR</b> Providence	<b>WWJ</b> Detroit
<b>WEEI</b> Boston	<b>WCCO</b> Minneapolis
<b>WFI</b> Philadelphia	<b>WOC</b> St. Paul
<b>WGR</b> Buffalo	<b>WOC</b> Davenport
<b>WCAE</b> Pittsburgh	<b>WCTS</b> Worcester

# ECONOMY

No ONE size or type of battery can be economical on every type of receiving set. That's why Eveready Radio Batteries are made in different sizes and types—so that every radio user can enjoy the economy that is to be had by fitting exactly the right Eveready Battery to his receiver. For owners of sets with five, six, eight or more tubes, and power amplifiers, there is the extra-large, powerful and unusually long-lasting Eveready "B" Battery No. 770. There is an Eveready dealer nearby.

*Manufactured and guaranteed by*  
**NATIONAL CARBON COMPANY, INC.**  
 New York San Francisco  
 Canadian National Carbon Co., Limited, Toronto, Ontario

## EVEREADY

### Radio Batteries

*- they last longer*

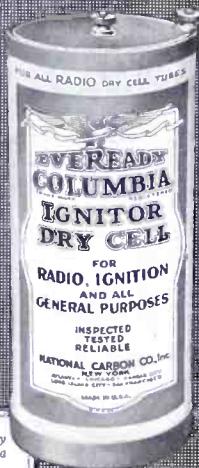

Eveready Columbia Ignitor "A" Battery, the proven dry cell for all radio dry cell tubes 1½ volts

No. 766  
 22½-volt  
 Large  
 Horizontal  
 Price \$2.00



No. 770  
 45-volt  
 Extra-Large  
 Vertical  
 Price \$4.75