

# A SUPER-NEUTRODYNE

By  
*Byrt C. Caldwell*

# RADIO WORLD

Title Reg. U. S. Pat. Off.

## LOOPS

By *B. J. Bongart*

Which type of loop is best? Why? Full data on how to make a loop and why its use improves mid-summer reception.

### Getting a Strangle Hold on Static

By *Brewster Lee*

VOL. 5. No. 17. ILLUSTRATED EVERY WEEK

Duet, with one singer in England, the other in United States, via radio!

### Full List of Advance Radiocast Programs

Where is the Detector in the 4-Tube Super-Heterodyne? Why are no grid condenser and leak used? Some trouble-shooting hints, too, for this sensational circuit.

By *Herman Bernard*

### Solving Your Panel Troubles

The Passing of the Lonely Bivouac, a vivid word picture of radio ridding the lonesome solitudes of their dread.

By *Joseph Mulvaney*

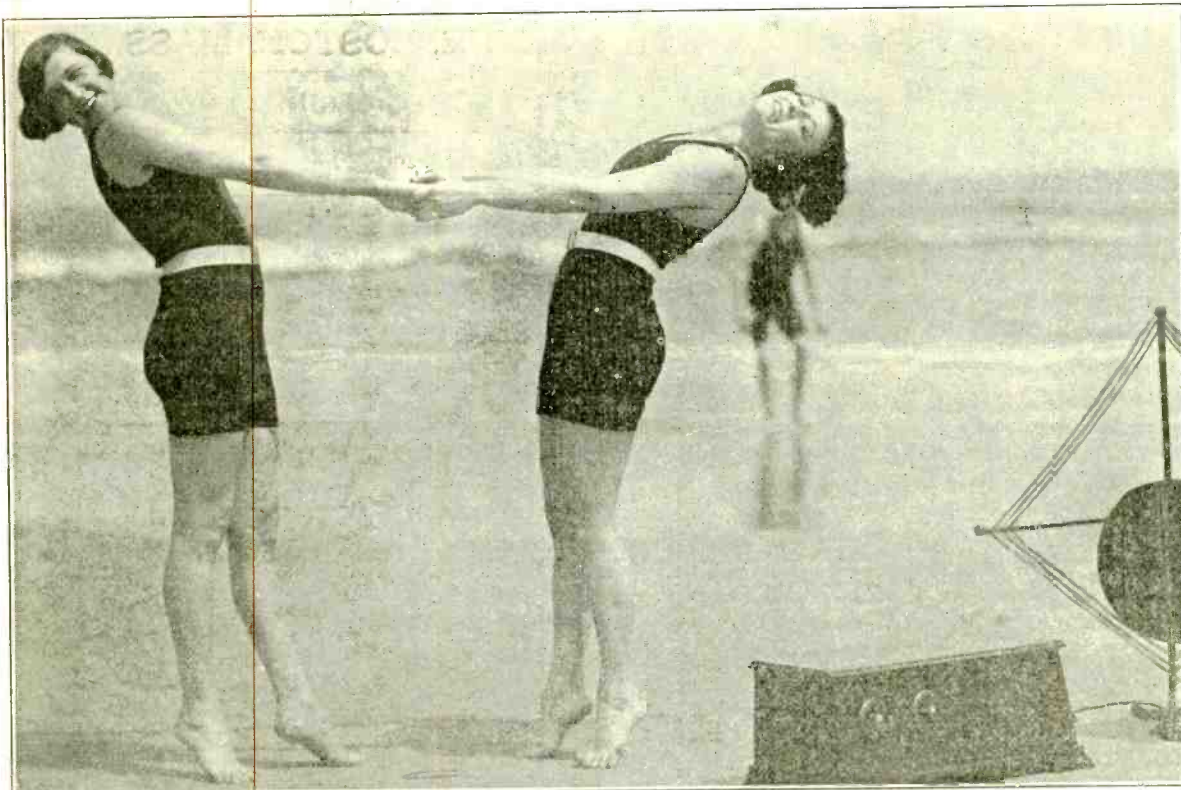

(Atlantic Foto)

### A DASH OF MID-SUMMER PEP

These two attractive vacationists at Atlantic City, Martha Breesh and Edna Jameson, do a Nymph-like dance on the beach, to the tune of a fox trot that comes over the radio. Health and beauty depend on judicious exercise, say these two girls, and they rate beach dancing to radio music as the apex of judiciousness.

## AUTOGRAPHED PORTRAIT OF "ROXY"

## TIPS ON THE SUPERDYNE

By  
*N. N. Bernstein*



**TOWER'S**  
**Scientific**  
 WEIGHS ONLY 8OZ  
 Perfect Tone Makes  
**\$2.95**  
 Plus a few cents postage



**OUR \$200,000.00 COMPANY STANDS SQUARELY BACK OF EVERY HEADSET**

**WORLD'S GREATEST HEADSET VALUE**

now \$2.95, with Notable Improvements  
 Longer Cord (full 5 feet), Stronger Magnets, Higher Resistance, Increase of Sensitivity, Perfect Tone Mates  
 EVERY SET TESTED BY LICENSED RADIO OPERATORS

*Send no money - Order on a Post-Card*  
 THE TOWER MFG. CO., Dept. D. 88 BROOKLINE AVENUE, BOSTON, MASS.

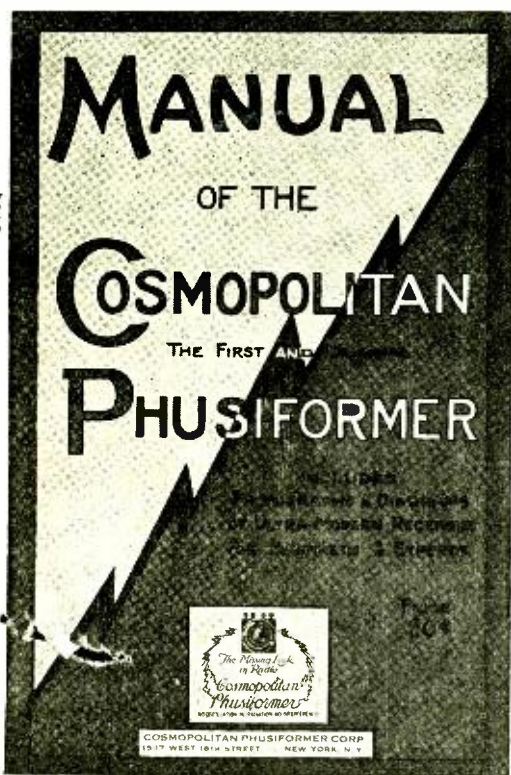

60 Pages of Descriptions, Photographs, Diagrams, Advice on the Use of  
*"the year's greatest development"*  
 PRICE, FIFTY CENTS  
**COSMOPOLITAN PHUSIFORMER CORP.**  
 15-17 WEST 18th STREET, NEW YORK



Bakelite, Engraved, Nickel-plated with legs  
 Panels Cut, Drilled, Engraved  
 Dealers Write for Terms  
**CORTLANDT PANEL ENGRAVING CO.**  
 31 Cortlandt Street New York City

**NEW TUBES**  
**MANUFACTURERS' SALE**  
 Price, \$2.25 each  
 All Types—All Guaranteed  
 Send No Money—Pay Postman  
**WALTER SCOTT & CO.**  
 636 HIGHLAND AVE., NEWARK, N. J.

**Super**  
**CRYSTAL**  
 NEW NON-METALLIC HOUSING ELIMINATES  
 SCRATCHES AND SQUEALING  
 Wonderful new crystal—has millions of sensitive spots—long life—cannot short-circuit.  
**FITS ANY STANDARD DETECTOR**  
 At your dealer—otherwise send purchase price and you will be supplied postpaid. Write for Reflex circuit 187.

**50¢**  
**Chas. Freshman Co. Inc.**  
 Radio Condenser Products  
 106 Seventh Avenue, New York City

**HENLEY'S 222 RADIO CIRCUIT DESIGNS—**  
 A fine book for the novice and the expert. Mailed on receipt of \$1.00. The Columbia Print, 1493 Broadway, New York City.

# RADIO WORLD

[Entered as second-class matter, March 28, 1922, at the Post Office at New York, N. Y., under the Act of March 3, 1879]

A Weekly Paper Published Every Wednesday and Dated Saturday, by Hennessy Radio Publications Corporation from Publication Office, 1493 Broadway, New York, N. Y. Phones: Lackawanna 6976 & 2063.

Vol. V. No. 17. Whole No. 121

July 19, 1924

15c. per copy, \$6.00 a year

## A Two Control Super-Neutrodyne

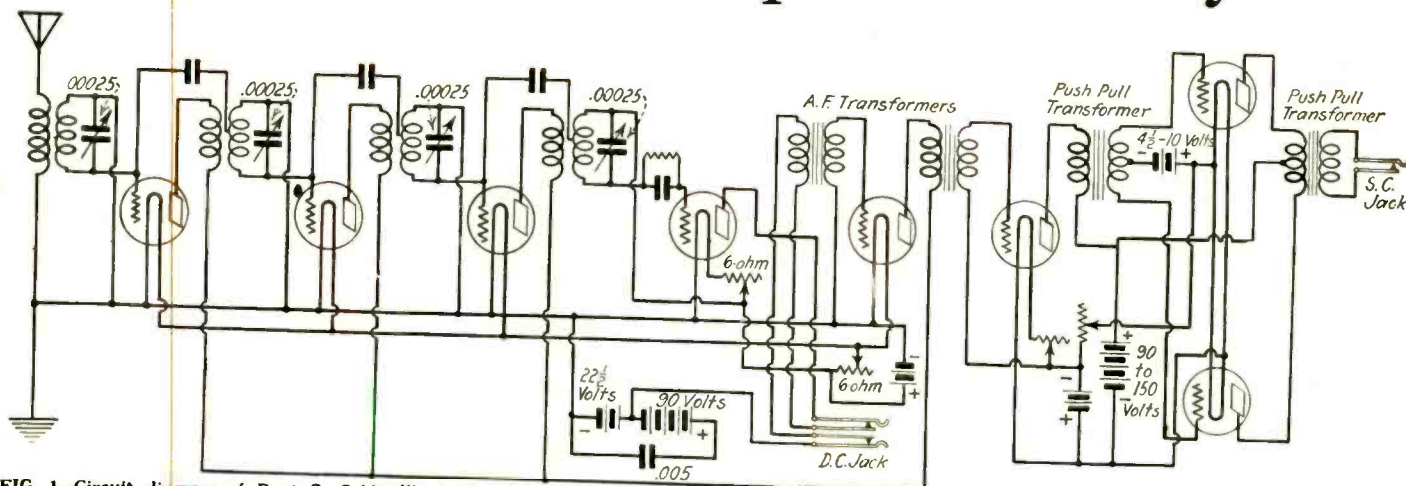

FIG. 1—Circuit diagram of Byrt C. Caldwell's 8-tube Super-Neutrodyne, which is operated with only two controls. There are three stages of neutralized, tuned RF, detector, two stages of AF and one stage of push-pull audio amplification.

By Byrt C. Caldwell

SEVERAL weeks ago the writer promised an 8-tube Neutrodyne receiver similar in design to the Super-Six Neutrodyne described in RADIO WORLD, issue of April 26. The present article describes the construction of the 8-tube circuit. Although it has two more tubes, it has one less control, namely, two. The radio-frequency part of this receiver has the same number of stages as the Super-Six, but three of the condensers are geared together, instead of two, simplifying control considerably. The two additional tubes are used as one stage of push-pull amplification, which allows perfect reception on the loud speaker of stations at least 1,000 miles distant, and often several thousand miles away.

The writer would advise against the beginner, or anybody but a person who has had a fair amount of experience, constructing this receiver, as it is not easy to make properly, unless one is familiar with radio construction.

There are three stages of regulation Neutrodyne tuned radio-frequency amplification. This would ordinarily require four controls, but as we have geared three of them together, but two are needed. Fig. 2 shows the method of gearing the condensers together. A sub-panel, 5" x 15", is required for this, and it is mounted on the baseboard, about 2 inches in back of the front panel. Three 5½" gears may be used, or three 3" gears, and two 2½" gears. The 2½" gear method is illustrated. The gears are placed on the shafts of the condensers in place of dials, and if the smaller gears are used, shafts will have to be mounted in the sub-panel half way between the condensers.

Fig. 1 shows the hook-up which, although it appears rather complicated, is simply three stages of the regular Neutrodyne RF amplification, detector, two stages of audio-frequency amplification and one stage of push-pull audio amplification.

To many push-pull amplification is a revelation

"Clear as a bell" is the description which might be applied to this type. Music and speech are amplified in all their natural tone, without the tube noises and the "rushing," common in amplifiers.

A 7" x 30" panel is required, and this should be marked for drilling by means of a template.

The receiver should be wired and carefully soldered. It is neutralized in the regular fashion. The hardest part of making this receiver is the setting of the three condensers together. In the article on the Super-Six Neutrodyne, vernier condensers were used, but as it is advisable to use the new low-loss condensers, the extra plate type of condenser cannot be used. For this reason the condensers must be set together as follows by tuning in on a local station.

When all are set so that the station is at its loudest, tighten the set screws in the gears. Then tune in a distant station. Loosen the set screws, and very carefully move the condensers until the station is again tuned in to its loudest. Now tighten the set screws again. This sounds easy, but it is, in reality, quite a feat. It will be noticed that the last three dials, which do not tune as sharp as the first, are geared together, and that the first is tuned by itself. You will find that tuning is extremely sharp. Although the two controls simplify operation, you will have to use utmost care if you do not wish to pass the distant stations. Vernier dials are almost a necessity.

A separate rheostat is used for the detector tube, and one is used for the first four amplifier tubes. A separate rheostat is used for each of the last two stages of amplification. Although separate batteries are shown as being used for the last two stages, the same one may be used if desired.

The trouble with most of the super-sensitive receivers has been that distance reception has never been satisfactory. Push-pull amplification, however, seems (Concluded on next page)

# Getting a Strangle Hold on Static

By Brewster Lee

STATIC electricity is generated in the air, the soundest theory possibly being that it is caused by the friction of air currents of different temperatures. The electricity collects usually in clouds, and accumulates up to the capacity of the cloud, or it may collect and hold itself together as a positive charge of static electricity. When a positive charge is created a similar negative charge is built up to equalize it. The discharge takes place when the positive and negative charges are near enough together. We see the heavier form of static in the form of lightning between clouds or from clouds to earth. On cloudless nights when static is prevalent, we can only hear the discharges on the radio receiver, even though the disturbance is taking place many miles away and out of sight.

These disturbances are spread over a large band of wavelengths, heard mostly from 150 to 20,000 meters, which covers all transmitting wavelength bands from amateurs to high-powered trans-oceanic transmitters. It is claimed by many radio amateurs that on 100 meters and vicinity, where a few American high-power radiocast stations retransmit their programs, that very little static is heard. While this may not be strictly true as regards static, it is nevertheless a fact that on wavelengths around 100 meters there is so little disturbance as compared with the higher waves that one is led to believe that static does not reach down that far. It does, but there are so few receivers operating that low, and so few transmitters, that there is little or no interference from other stations or other receiving sets that are noisy.

Much of the disturbance heard in thickly populated

districts and laid to static is not static at all, but electric discharges from electric train and trolley lines, lighting circuits, power houses, telegraph and telephone lines, etc., to say nothing of the next door set that is continually breaking into oscillation with crackle and squeal.

The great problem is to eliminate the actual static, which has thus far not been accomplished for all practical purposes. The greatest honor in radio awaits the inventor of a real anti-static machine that will be applicable to all receivers, from radiocast outfits to the great trans-oceanic stations.

One of the most successful methods of reducing static is the resonance wave coil system, developed in the Bureau of Standards at Washington, and in the U. S. Signal Corps. It consists in effect of a long tube about 3 inches in diameter wound with about 3,600 turns of fine insulated wire. A metal tube about one third the length of the coil fits over one end, and is grounded. The function of this tube is to drain off all static and undesired signals. A metal collector tube is slipped over the other end of the coil and adjusted to pick up the desired wave length. When the collected ring is adjusted for a certain wave length, the other metal tube is placed so as to pick up the other waves and carry them into the ground. This system is rather bulky and very critical.

For radiocast wavelengths, the following tube dimensions will be practical, although they may be changed slightly to suit local conditions. Wind 1,800 turns of No. 32 DCC wire on a 20-inch tube 3 or 3½ inches in diameter. Over this winding wrap and glue a sheet of thin paper. The guard tube can be made of brass 12 inches long and large enough to slide easily

(Concluded on next page)

## One Dial Actuates Three Condensers

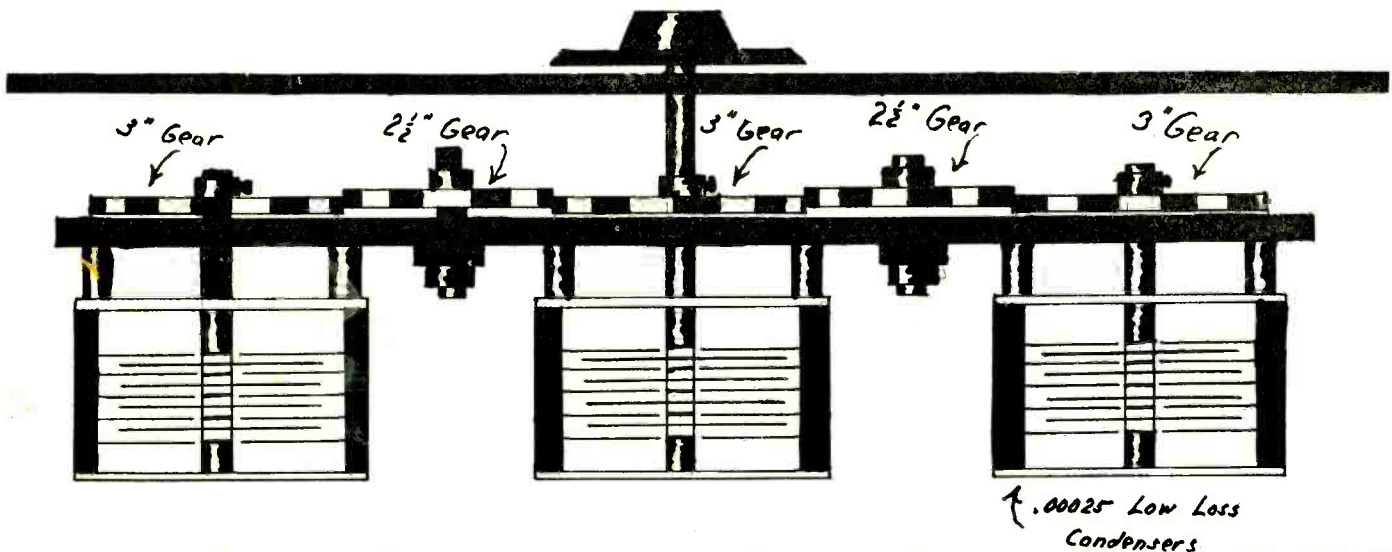
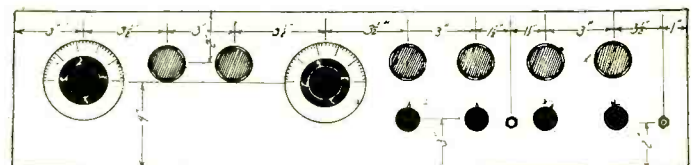

FIG. 2—How the three condensers controlling the secondaries of the neutroformers are geared together, so as to be operated with a single control. The second control is the dial of the condenser that tunes the detector.

## Distance Is Assured On This Circuit

(Concluded from preceding page)

to have solved this problem. The three stages of tuned radio-frequency amplification assure you of distance and the push-pull amplification assures you of good loud speaker results on these distant stations. And



PANEL LAYOUT of the Super-Neutrodyne.

when you consider the quality, you will realize you have a circuit worth while.

# Devices for Overcoming Static

(Concluded from preceding page)

over the coil. The collector ring is also brass and cut 4 inches long. The collector ring must be slit lengthwise. This can be done with a hacksaw. The guard ring is grounded, and the collector ring connected to the antenna post of the receiving set.

Another method of decreasing static in the receiver is by the use of a filter system, commonly called a wave

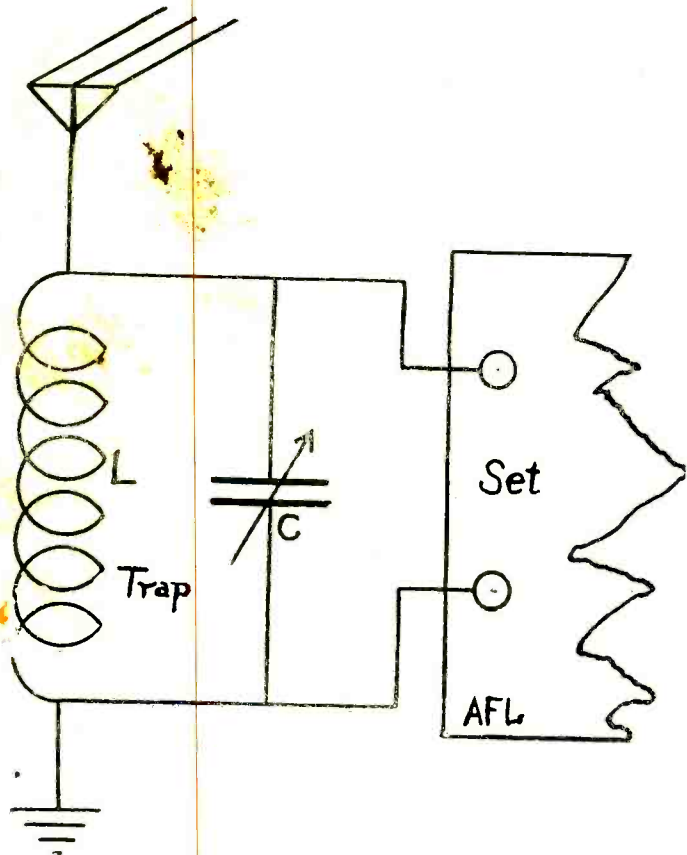

FIG. 1—Wave trap circuit employing a simple coil and low-loss condenser, which outfit may be added to any receiving set using an aerial and ground. The wave trap is tuned to almost the same wave length as the signal desired to be heard. The trap allows the undesired disturbances to pass more or less directly to the ground without entering the receiving set proper.

trap. Fig. 1 shows the way the coil and condenser are connected with the set, antenna and ground. The coil L is made as follows: Procure a tube 3 inches in diameter by 2 inches long. Bakelite, radion or hard rubber is preferable to cardboard tubing. Wind 50 turns of No. 22 DCC wire and terminate, leaving about five inches for connecting to the condenser, a 23-plate (.0005 mfd.) instrument of the low-loss type. Vernier adjustment is not necessary. The coil and condenser are wired in parallel, and both connected to the antenna and ground posts on the set. Although this system adds one tuning control to the set, it repays itself in adding selectivity and slightly decreasing interference.

Still another type of interference eliminator, which is not very common, is shown in Fig. 2. This is an iron core choke coil in series with a large capacity condenser. This is another filter system and might be called a low frequency by-pass. The coil is made of a ½ square inch iron core built up of laminated iron, about 4½ to 5 inches long. A few layers of wax or paraffined paper are wrapped about the core, and upon it is wound one-half pound of No. 30 DCC wire. This is the choke coil.

The condenser has a capacity of .5 mfd., such as used in land telephone work and other low potential circuits.

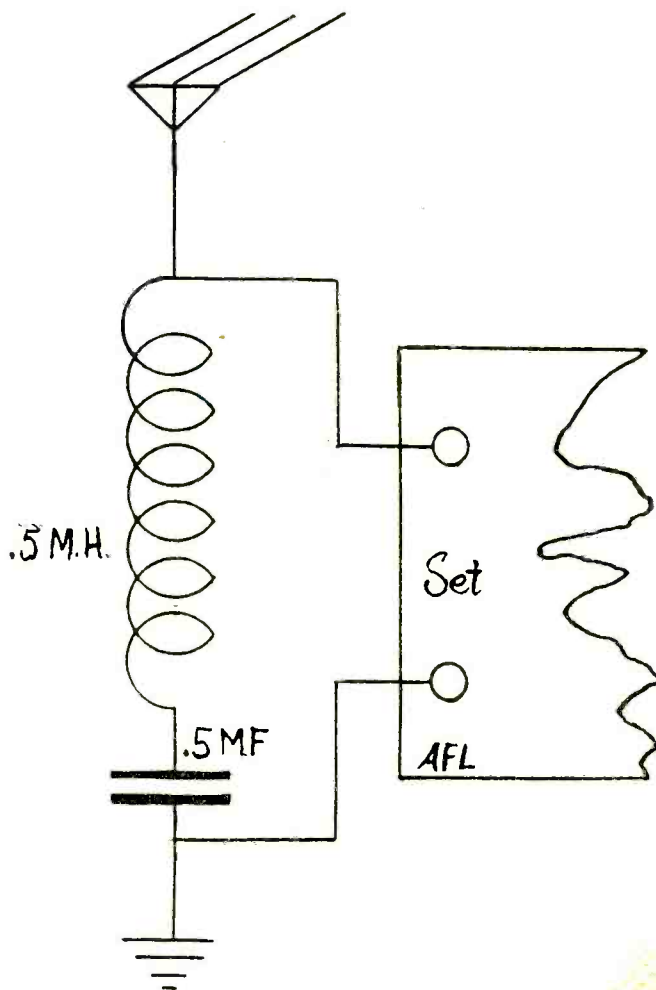

FIG. 2—Low frequency by-pass arrangement which allows the passage of very low frequency disturbances through the choke coil and high capacity condenser. The adjustment of this unit remains fixed. This same coil and condenser may be connected from the plate of the detector tube to the negative filament lead. It was found by placing the unit in this position that a substantial amount of artificial static (from car lines, motors, etc.) was lost.

The coil and condenser are connected in series, and the outside points hooked to the antenna and ground binding posts as shown in the diagram, Fig. 2. This system allows impulses of very low frequency to pass, without allowing the high radio-frequency signals to leak through.

An old stunt, used extensively in regions where static is particularly heavy, and provided for on some commercial sets, is the use of a very small air gap between two metallic points placed on the antenna and ground binding posts of the receiver. A simple method is to fasten a bit of No. 14 bare wire on to the antenna and ground binding post, thereby shortcircuiting them. Cut this wire in the middle with a wire clipper, leaving a tiny air gap between the two points. They should be as close together as possible, without touching, of course. During thunderstorms, or when heavy static is prevalent, sparks will sometimes jump across the air gap without going to the set at all, because electricity always takes the shortest and easiest route to the ground. If the resistance of the small air gap is less than the resistance of the primary inductance of the receiver, the change will naturally jump the gap. Exactly the same principle is used in all lightning arrestors, they consisting of nothing more or less than a small air gap.

An infallible remedy for static, however, is something yet to be devised, or at least made public. It may be greeted by the salutation: "Welcome, stranger!"

# Why No Grid Leak in the 4-Tube "Super-Het," and Where's the Detector?

By Herman Bernard

**T**HE theory of the 4-tube Super-Heterodyne, the circuit brought out by RADIO WORLD, is well to have embedded in one's mind, both for thoughtful construction of this sensational receiver and for trouble shooting.

In this circuit, one stage of RF is used, and the first tube, at extreme left in the diagram, Fig. 1, performs this function. It will be noted that a loop is used, but as some may prefer an outdoor aerial they may satisfy their desire as follows:

Substitute the outdoor aerial and a variocoupler for the loop. Connect the aerial to the beginning of the coupler stator or primary, the end of this winding being connected to the ground. The variable 17-plate condenser C<sub>1</sub> shunts the secondary or rotor of the coupler, the stator plates of the condenser going to the grid, and the rotor plates of the condenser to the mid-point of the potentiometer. If a low-loss condenser is used, connect the ground to the stator, as the stator is usually at ground potential in such condensers. For Mid-Sum-

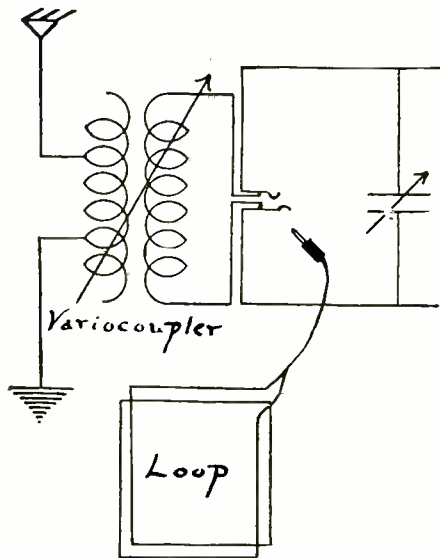

FIG. 2—How to use an outdoor aerial instead of a loop with the 4-tube Super-Heterodyne, as fully explained in the accompanying text. Instead of a loop you will need a variocoupler of any standard make, an aerial and a ground. The primary of the coupler may be tapped top and bottom. The rotor of the coupler is shunted by C<sub>1</sub>, the 17-plate variable condenser. The top secondary lead in diagram at left goes to the grid of the first tube, the end going to the midpoint of the potentiometer. By using a jack, with the loop ends in the plug, aerial or loop may be used at will.

mer reception, however, a loop is to be preferred to an aerial, because it can rid reception of interference and give better tone quality, though cutting down distance and volume. Under good conditions, using a loop, the circuit should bring in 800 miles on the speaker.

The use of taps on the primary of the variocoupler is optional. If used at all, tap at the first three or four points available on the coupler and at the last three or four. This would require two switch arms. The assembly is simplified by using a double switch of commercial manufacture, the tap screws being already mounted, and only the instrument requiring mounting.

The tap switches tune the primary roughly. The variable condenser tunes the grid circuit, the rotor of the coupler assisting in this function and contributing to the tuning of the primary by varied mutual inductance through coupling.

Now we come to the oscillator, O. Here the grid and plate circuits are capacitatively tuned together, by the variable condenser C<sub>3</sub>, 43 plates, through the oscillator coil. As the end of L<sub>3</sub> goes to the rotor plates of C<sub>3</sub>, and the beginning of L<sub>2</sub> to the stator of C<sub>3</sub>, the grid and plate of O are thus tuned through variable C<sub>3</sub>.

**The grid return, it will be noticed, is to an artificial ground potential, through C<sub>3</sub>. This artificial grid return is as follows: We have 90 volts on the plate of tube O. This puts a 90-volt positive charge on the plate of C<sub>3</sub>**

**nearest 4C. The law of condensers is that if one plate is positive the other must be negative in relation to its mate. That being so we have a -90 approximate voltage on the plate of C<sub>3</sub> nearest L<sub>2</sub>. This therefore gives the necessary negative potential and grid return for efficient operation of the oscillator.**

Meanwhile what is going on?

The receiver is tuned to the incoming wave, say 492 meters. Through the oscillator coil and H, this wave is heterodyned (or changed in frequency) to 50,000 meters. The higher the meters, the lower the frequencies, since meters measure the length of the wave in distance, and cycles measure its length in point of time—the number of waves that pass a given point in a second. It's like firing off a pistol at regular intervals—the longer the distance between bullets in meters, the fewer the number of bullets that pass a bystander per second (frequency).

Thus, due to the number of turns in the honeycomb coil H that give it a natural period or wavelength suitable for this purpose, the incoming wave is converted to 50,000 meters, or 6,000 cycles.

In the Super-Heterodyne it is possible thus to change the incoming wave to any wavelength on which the oscillator sends on the changed frequencies to a detector tube. If the oscillator output is at radio frequency, hence inaudible, there must be provision for rectifying the signal. But if the heterodyning is done on a frequency within the audible range—well, it is audible, so what further need for making it audible?

In other words, the heterodyning and "minus detection" (if you may call it such) both take place in the tube O. Indeed, it is the same function, for to heterodyne, in this case, is to hear the signals.

But another interesting point arises. If there are two stages of audio-frequency amplification (and the diagram, Fig. 1, shows the two), where is the first AF transformer? Well, this circuit employs the doubling-up principle twice—once in the oscillator, where the equivalent of detection also occurs, and once again in the honeycomb coil, where the signal, here changed to 50,000 meters, is simultaneously amplified. Since the wavelength is within the audible range, the amplification must be at audio frequency. Plain, everyday AF!

Everything on the right-hand side of the coils H is conventional. Nothing on the left-hand side seems to be. And how about the grid leak and condenser?

Strictly speaking, there is no detection, since the incoming wave is changed to an audible frequency by heterodyning, instead of by usual rectification. No detector is necessary, because there is nothing to detect—no inaudible frequencies left! That is a good solution, isn't it? Get rid of the RF by heterodyning! All other Super-Heterodynes change the frequency, but still keep it at radio frequency. What's the use? Make it audio frequency so you can listen to it right away—without extra tubes—and call it a day! Then you need no grid

(Concluded on next page)

# Find the Detector in This Circuit!

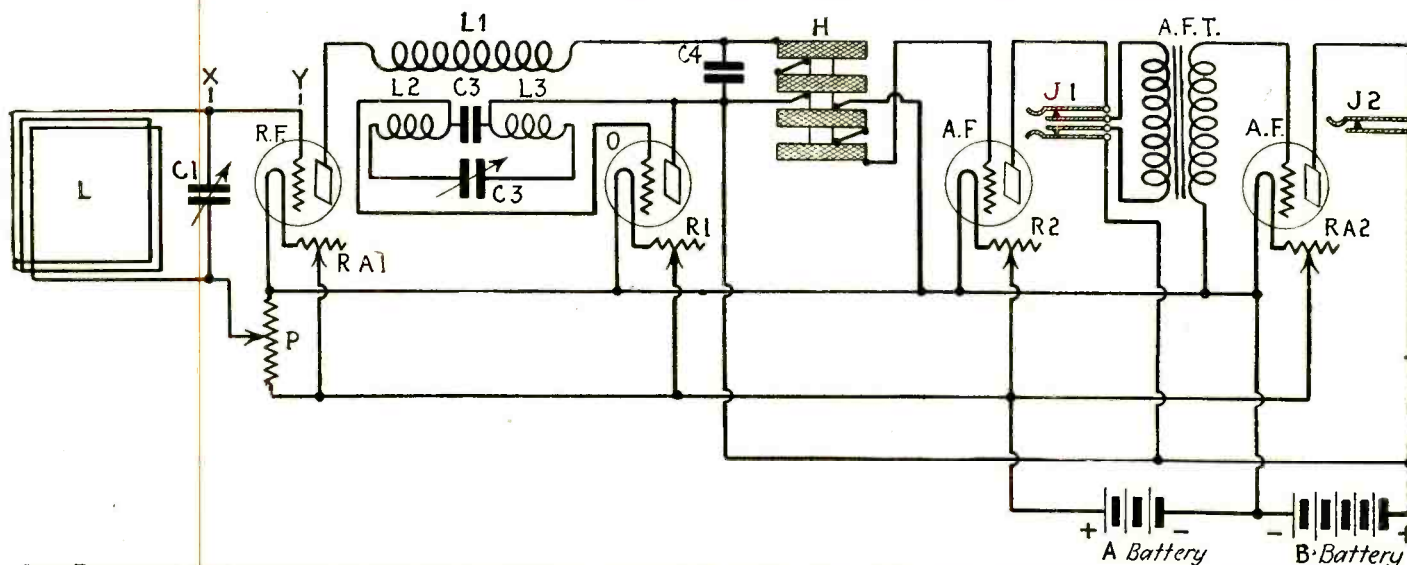

**PASTE THIS ON THE INSIDE OF YOUR CABINET LID** so you can check up the wiring of the 4-tube Super-Heterodyne on a trouble-shooting expedition (Fig. 1). This diagram also may be used in constructing the set, reference being made to the directions for wiring, published herewith. The oscillator coil (L1, L2 and L3) is to be made by the constructor, winding directions being given in the accompanying text. H consists of four honeycomb coils, 1,500 turns each. Two of these coils are connected in series for the primary and the other two in series for the secondary. The two 3,000-turn coils are mounted one atop the other. To sharpen tuning, insert variometer in lead XY.

condenser, because that is an adjunct strictly of detection. No grid leak is needed, either, because of the grid accumulating no excess negative charge.

The potentiometer should be 400 ohms, preferably. It does not short-circuit the A battery leads because the resistance in the potentiometer is too high.

In Fig. 1 all four rheostats are connected in the A+ lead. Some experimenters prefer the A+ running through the rheostat for a detector tube and the A- for an amplifying tube. The writer, in practice, has encountered no difference in results, and recommends that Fig. 1 be followed.

In looking for the cause of trouble, first see whether you have the plate of the oscillator tube properly connected. For guidance, directions for wiring are published herewith.

See whether the first AF-RF transformer is properly connected. The top coil, 1,500 turns, should be in series with the next 1,500-turn coil. The next two coils likewise are in series. The beginning of a honeycomb coil always emerges from under the winding. The end is on the outside. Be sure the coils are so put together, one atop the other, that the end of each coil points in the same direction as the end of the other coils. Thus you may feel sure that all the windings are in the same direction. Then connect the end of the top coil to the beginning of the next coil. Connect the end of the third coil to the beginning of the fourth.

Reverse the connections to the secondary of H to see if reception improves.

If troubled with interference, insert a variometer in the lead marked X and Y. As no detection occurs, and the incoming wave is rendered audible by heterodyning, the tuning cannot be expected to be as sharp as in the usual Super-Heterodyne. The variometer will help, but it may not be the final solution. Some changes, slight in point of labor, but considerable in point of improved selectivity, are to be expected. The circuit is novel, hence presents opportunities to experimenters who enjoy blazing a trail.

### THE OSCILLATOR COIL

On a 3" diameter bakelite or hard rubber tube, 4" long, wind three coils, L1, L2 and L3. Starting  $\frac{3}{8}$ " from the top, wind 10 turns of No. 24 DSC wire, for L1. Cut the wire, leaving 4" or so for connection. Leave  $\frac{3}{4}$ ", wind 35 turns of the same kind of wire. Cut as before. Leave  $\frac{1}{4}$ ", wind 35 turns again, same kind of wire.

## Wiring Directions for the Four-tube Super-Heterodyne

1. Connect the beginning of the loop L as follows: (a) to the stator plates of the 17-plate variable condenser C1; (b), to the grid of the first tube, at extreme left.
2. Connect the end of the loop as follows: (a), to the movable plates of the condenser C1; (b), to the mid-point of the 400-ohm potentiometer P.
3. Connect the A+ to one of the terminals of P and the A- to the other terminal and run the A- direct to all tube sockets and the A+ to one side of each rheostat, the other side of the rheostats going to the A+ on the tube sockets. (Rheostats are marked RA1, R1, R2 and RA2 in Fig. 1.) Connect the A- and the B-.
4. Connect the plate of the first tube (at extreme left in diagram) to the beginning of L1.
5. Connect the end of L1 as follows: (a), to one side of the fixed condenser C4; (b), to the beginning of H.
6. Connect L2 as follows: (a), the beginning goes to the stator plates of the 43-plate variable condenser; (b), the end goes to one side of the fixed condenser C3, and (c), to the grid of tube No. 2.
7. Connect the beginning of L3 as follows: (a), to the plate of the second tube; (b), to the remaining open side of C4; (c), to the B+; (c), to the end of the primary (the two series-connected 1,500-turn HC coils) at H.
8. Connect the end of L3 to the movable plates of the variable condenser C3.
9. Connect the secondary of the coil H (the last two series-connected 1,500-turn HC coils) respectively (a) to the grid of the third tube and (b) to the A-.
10. (a) Connect the plate of the third tube, an outside leaf of J1, the corresponding inside leaf going to the P or P1 of the commercial AF transformer; (b), the B+ 90 volts goes to the other outside leaf, the corresponding inside one going to the P2 or B on the transformer; (c), the S1 or G on the transformer to the grid of the fourth tube, and the S2, or F, to the F-.
11. Connect the plate of the fourth tube to one side of the jack J2, the other side of the jack going to the B+ 90 volts.

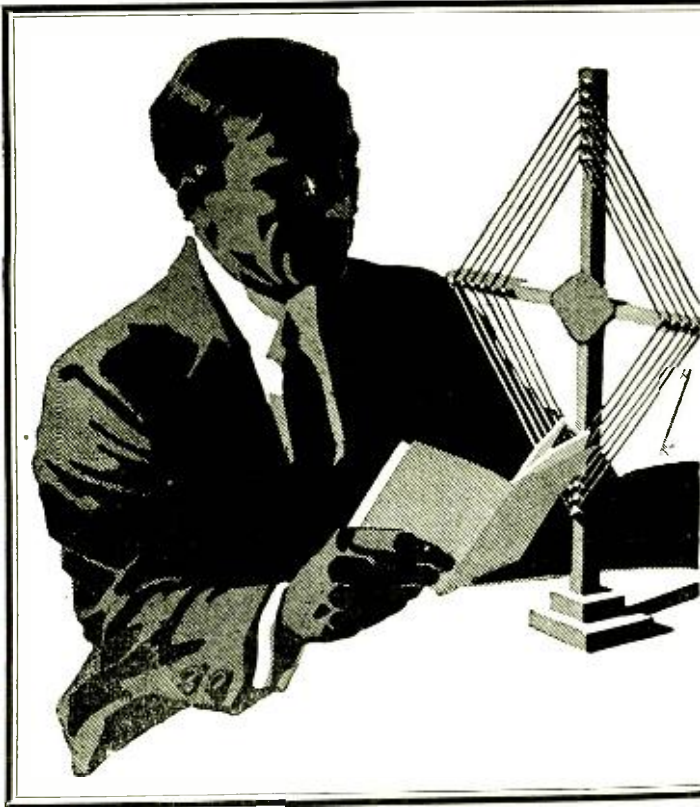

# LOOPS

By *B. J. Bongart*

Radio Engineer

*The ideal loop is of the box type and has no horizontal turns—How a loop improves the quality of Mid-summer reception.*

**I**N Mid-Summer fans seek the loop for reception. It is commonly known that the loop has some outstanding qualities, chiefly the comparative freedom from static effects, and also certain directional qualities, making it possible to tune in or out stations or change the volume of reception by merely turning the loop a fraction of an inch to one side or the other.

The fan who first uses a loop on his set that previously was operated with the usual outdoor antenna will notice a diminution of volume, although a somewhat better quality of reception.

It is often said that a loop will do as much as an outdoor antenna and the man who says this generally proves it with his logbook showing the stations he gets. On investigation it will be found that his set is a multi-tube affair of some sort, and thus capable of superior performance with a loop as against a 3 or 4-tube set with an outdoor antenna. For distance reception one needs either tubes en masse or an outdoor antenna. The more experienced fan prefers the loop, even if it cuts down the range of the receiver somewhat. The man who wants quality rather than extreme DX will always have the loop.

From the various loops advocated and used two types stand out most prominently. These are the so-called pancake loop (Fig. 1) and the box loop (Fig. 2). The pancake loop is not as efficient as the box type, and is preferred only because it is cheaper. The box type has a greater pick-up and far greater directional effect than the pancake type because the turns of the box type are spread out more. Furthermore, in the pancake form the turns are smaller towards the middle than at their extreme ends. Also the outer turns of this form of loop obstruct the inner ones, whereas in the box type all turns are of the same length and do not obstruct one another.

Contrary to general belief the pointed side of the loop receives (Fig. 1) and not the broad side. Fig. 3 shows how the radio waves strike the pancake loop A and the box loop B and why the box type offers a broader surface, and therefore greater inductance. A loop turned broadly towards the radio waves (Fig. 4) is ineffective because the waves strike both sides of the loop at A and

B at the same instant, and thus neutralize one another. The inductance of the loop is caused by the time interval, however minute, as the waves strike first at A and then at B (Fig. 3.) Theoretically, the greater the distance between points A and B, the greater the inductance. In practice, however, this is not so, as a few inches will suffice to cause enough induction, so there is no need to make the loops wide and unwieldy.

Practically all the standard loops of today are diamond-shaped (Figs. 1 and 2). This is not a really efficient form, because while there is a considerable time interval at points A and B, yet as the turns at A and B meet at a center at C and D it can readily be seen that the diamond-shaped loop is efficient only at its approximate center and for a short distance above and below the center point. At points C and D, where

*(Continued on next page)*

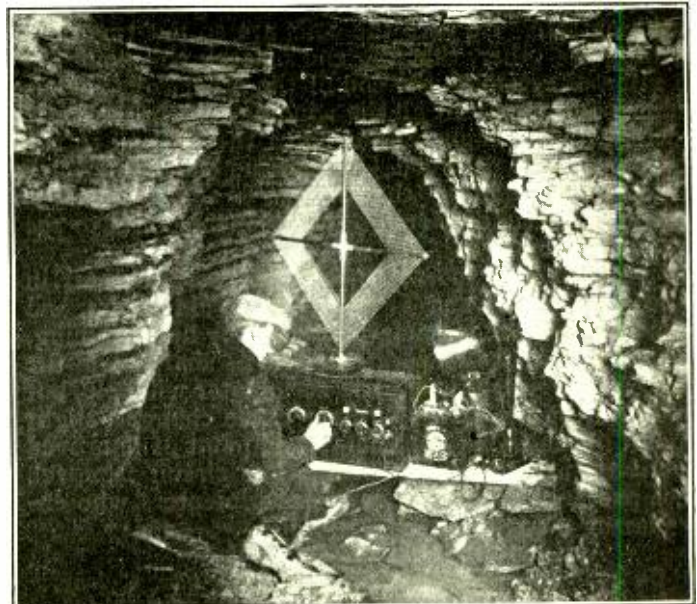

(Fotograms)

**EVEN DISTANT STATIONS** were brought in, though faintly, with this loop, 120 feet underground, in a tunnel, at Rocky River, O. Locals came in strong. A diamond-shape, concentrically wound loop was used. Ralph Walton, president of the Power Radio Co., is manipulating the dials.



# Which Loops Are Best, and Why

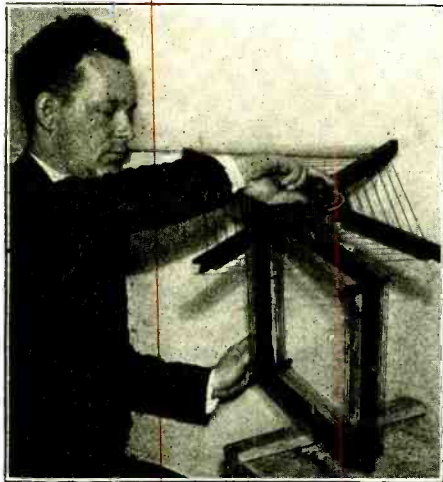

(Foto Topics)

*"In the Ideal Loop the wires are vertical—The Loop is of the Box Form and the vertical wires are spread in such a manner that each turn faces the incoming wave directly*

"SEVERAL forms of trick loops have been developed," says B. J. Bongart in the accompanying article, "such as a loop within a loop, a horizontal loop above a vertical one, etc. These forms serve no useful purpose." At right, Helena M. Obermiller, with a variometer loop made just for fun. At left, Harry Herzog, of Brooklyn, N. Y., with a horizontal-vertical loop.



(Kadel &amp; Herbert)

A LOOP WITHIN A LOOP

(Continued from preceding page)

the turns of the loop meet, there is little distance between the two halves of the loop, so that naturally the inductance is practically nil, and at the very points of C and D it is absolutely zero. The diamond form has been adopted because it gives the loop increased height. Although the distance between points C and D is only 24" (which is the usual height of loops), the wires bulging out at points A and B have an actual height, or rather length, of 34". Thus a greater height is gained without making the loop too high and clumsy, and the greater the height the more surface is brought in contact with the waves, thereby increasing the inductance. But the upper as well as the lower part of the diamond being practically without inductance, the gain in wire length by making the loop in the shape of a diamond is partially offset by the end losses at C and D.

The square loop (Fig. 5) is free from end losses, all turns being equi-distant, but as only the vertical wires are active (the horizontal ones causing no appreciable inductance at all) this is not a good form of loop to use, as 50 per cent of the wire is practically wasted.

The end losses inherent in the diamond form of loop as well as the waste of wire in the ordinary square type of loop have long been recognized and constructors have sought means to overcome these faults (Fig. 6). It has been the desire to retain the vertical lines of the square loop somewhat without the wasted horizontal wires, also the length of the wires of the diamond shape of loop, and yet to mitigate the tip losses of this form. A and B (Fig. 6) are attempts in this direction, and while they both are an improvement, they do not fully overcome the fault.

The tubular loop (Fig. 7) may be used where conservation of space is of prime importance. Fans who have sets built into a cabinet of large size, such as the console or talking machine type, may use this loop as it can be built into the cabinet proper and so makes the loop very compact. The tube should be 6" in diameter, and, if possible, up to 24" in height. It may be either cardboard or bakelite. A wooden plug must be inserted at both ends of the tube for a swivel and a dial or knob at the upper end, so that the tube may be turned about for directional effect. The tube should be wound for 120° on two sides in such a way as to leave a space of 60° between the two windings, the windings to be vertical. They should never extend to the full circumference (360°), as this would kill the directional effect.

The ideal loop is shown in Fig. 8. The wires are all

vertical with the exception of the one interconnecting turn from A and B, and, of course, the return leads to the receiver. This loop is also of the box form and the vertical wires are spread in such a manner that each turn faces the incoming radio waves directly, rather than have one turn obstruct the other, as is the case in the pancake form of loop. Also all wires are of the same length and thus of equal efficiency. It can readily be seen that this form of loop has all the advantages of any other form. While the overall dimensions may not be less than those of other forms, the space necessary to gain directional effect is far less than with the other forms in that the loop is only 12" wide.

The duo-lateral is the most efficient commercially developed. It needs practically only one-half the length of wire necessary for the other forms. With a center tap (Fig. 9) a certain amount of energy is fed back to the loop circuit, so that the loop resistance is considerably lowered, thereby increasing selectivity and strength of signals to a very considerable extent. The feedback is to be controlled by a small condenser of from 10 to 20 microfarads. Fans intending to use the center tap loop on their receiver must change the hookup a little (Fig. 9) to accommodate the third tap. This change will be more than worth while as the signals will come in far stronger and the selectivity will be improved greatly.

Fig. 10 shows a fairly efficient but non-directional loop which may be built inside of the ordinary 7" cabinet. The wiring is all vertical except, of course, the leads of either end. The windings are on the two side walls as well as about two-thirds of the back wall, leaving one-third of the back wall free in order to have a spacing between the halves of this loop so as to cause inductance. The wire is continuous, however. The wiring may be done over glass-topped tacks, such as may be bought in any hardware store. The tacks are driven into the two side and rear walls of the cabinet spaced about 1/2" apart. Insert of Fig. 7 illustrates how the wiring is done around the tacks. The length of wire needed is from 70 to 85 feet. If the cabinet is too small to permit using this length of wire in a single winding, a double winding may be used. This length of wire will cover all wave lengths from 225 to about 600 meters. If the cabinet is higher than 7" the turns could, of course, be longer and greater efficiency would result.

Several forms of "trick" loops have been advocated, such as a loop within a loop, a horizontal loop above a vertical one, etc. These forms serve no useful purpose.

(Concluded on next page)

# How to Wind Various Forms of Loops

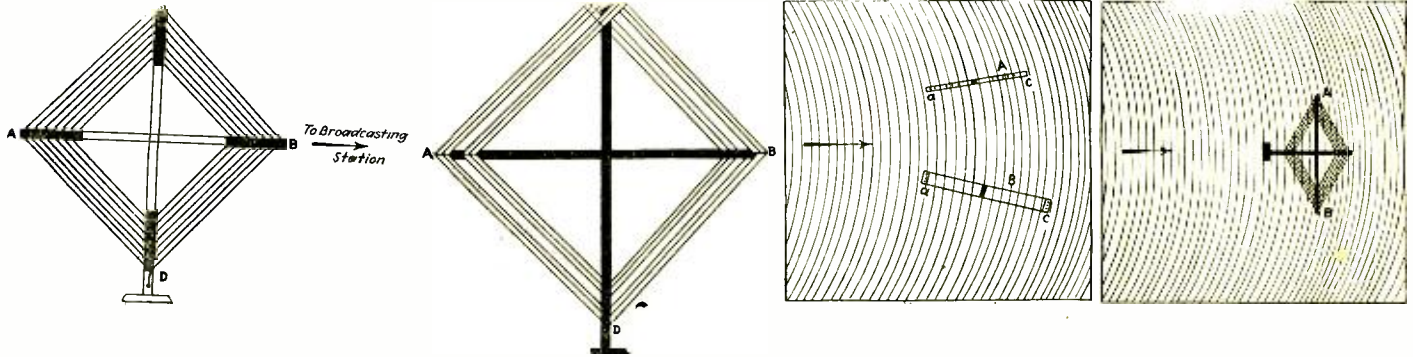

LEFT TO RIGHT—Fig. 1, pancake loop, the commonest form used. Arrow shows how to point loop to broadcasting station. Note it is NOT to flat side that faces the station. Fig. 2, box loop, somewhat more efficient. Fig. 3 shows how inductance is obtained. The time interval as the waves strike A and B is responsible for inductance. Thus the box loop A offers a broader area to the waves than pancake loop B. Fig. 4, wrong way to point loop, broadside toward station, causing no inductance, as waves strike A and B simultaneously.

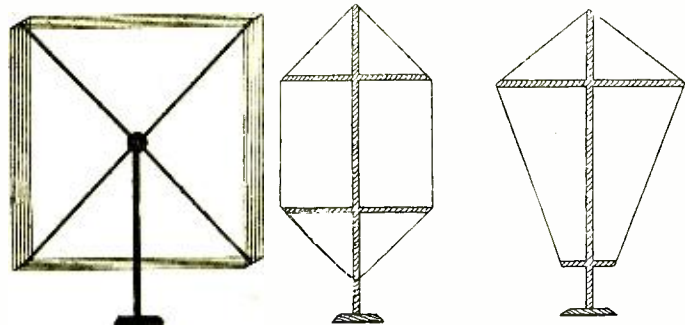

FIG. 5 (at left), square loop, better than pancake type, and practically free from eddy losses, yet not a good loop. Fig. 6 (in two forms) shows compromise loops.

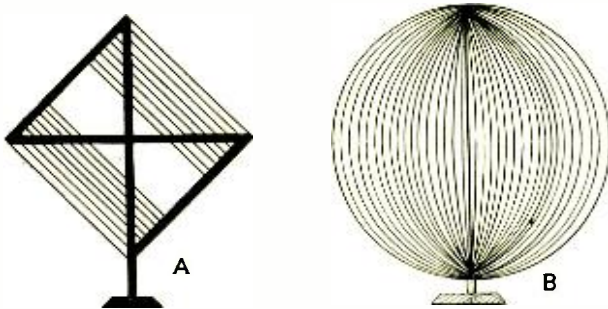
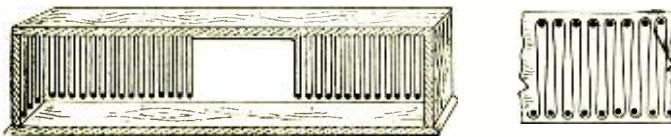

FIG. 10 (top), loop to be wound inside of the ordinary 7 inch cabinet. While not very directional, except by moving the entire cabinet about, the loop will work satisfactorily and is compact for portable sets. At right, top view. Fig. 11, freak loops (A), tilted loop; (B), globular loop. Not recommended.

(Concluded from preceding page)

As the pointed side of the loop receives, nothing is gained by having an inner loop that rotates separately. Also, since only the vertical wires induce, it is of no avail to have a complete horizontal loop above or below a vertical one. Weird forms of loops are devised now and then, such as loops tipped at an angle, and the globular loop that catches the waves coming and going!!! (Fig. 11).

Now as to the wire used for loops. Practically everything from bare wire to the finest imported Litzendraht (Litz wire) is used for loops. Various claims are made for particular kinds of wire. No advantage is gained by using single or double cotton and silk covered wire, the bare wire (copper) may be employed with equal results, only the arms of the loop must be made of an insulating material, such as bakelite or hard

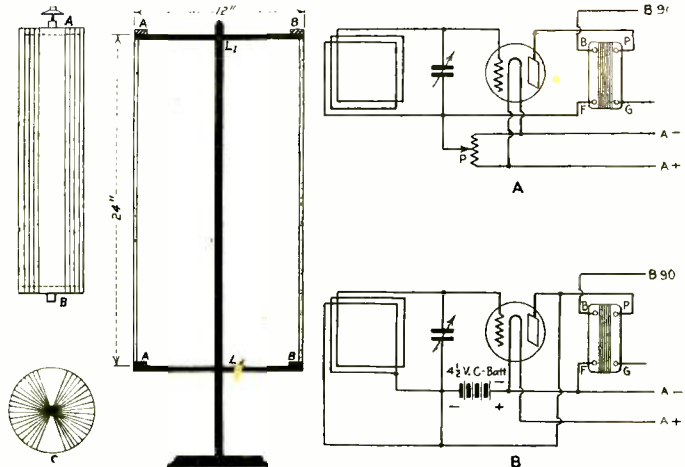

FIG. 7 (at left), tubular loop, wound on 6 inch tube, the turns 120 degrees on each side, allowing 60 degrees between turns. Handy for inside cabinet mounting. Lower circle shows top view. Fig. 8 (center), the ideal loop, box type, no horizontal turns. A row of 6 turns of wire at both outer ends, with an inner row of 5 turns spaced exactly between and to the rear of the outer turns. No obstruction, a narrow loop, only 12 inches wide needing only small space for turning. When used with a center tap feed-back, highly inductive and very selective. Fig. 9, two ways of connecting loop. Top (A), outer turn to grid, inner to filament through potentiometer; (B), 3-tap loop, outer turn to grid, inner to plate and center to filament-, with C battery between. No potentiometer. Note variable condensers tune loops.

rubber, or tipped with such material to prevent the bare wire from coming into contact with the wooden arms of the loop. If insulated cable is used the arms of the loop need not be insulated. The U. S. Bureau of Standards found that stranded wire has a higher resistance ratio than a single wire, unless each strand is separately insulated and thereby prevented from coming into direct contact with other parallel wires. Ordinary lamp cord is just about as efficient as imitation Litz, hence the cheaper lamp cord may be used as well. The imported genuine Litzendraht is the best—if each single strand is insulated. When, however, several strands are wound together and then insulated, no material results can be expected by using the rather expensive Litzendraht. For collapsible loops a stranded wire of thin strands known as tinsel should be used rather than a wire of heavy strands, since the tinsel wire is more flexible and more readily admits folding. Insulated wire should be used for these loops. For stationary loops bare wire will do as well or better. Always use wire of the greatest outside diameter possible, never less than 28 B & S and preferably 14 B & S or at least not less than 20 B & S if best results are wanted. The length of wire needed for the various types of loops is from 60 to 110 ft. The ideal loop (Fig. 8) needs less than 50 ft. to give it a capacity for wave lengths of from 200 to 600 meters, sufficient for all broadcast reception.

# An Intimate View of Roxy as He Is

**R**OXY! What a thrill of pleasure the name brings to radiocast listeners! Roxy stands for Roxy the Generous, Roxy the Amiable, Roxy the Sincere, Roxy the Lion-Hearted, Roxy the Great! In other words, S. L. Rothafel, of the Capitol Theatre, New York City, who announces the programs of his "gang" from WEAF each Sunday night. And herewith RADIO WORLD publishes a special autographed studio portrait of Roxy, an excellent likeness of the man whose cheery greeting, "Hello Everybody," is constantly enjoyed by millions.

And who is this man Roxy?

Fifteen years ago as a young man, just out of the Marine Corps, he was the poor but proud proprietor of a little moving picture house down the alley and one flight up the

back stairs in the mining town of Forest City, Pa. Recently he celebrated his tenth anniversary on Broadway; four of those years have been spent as director of

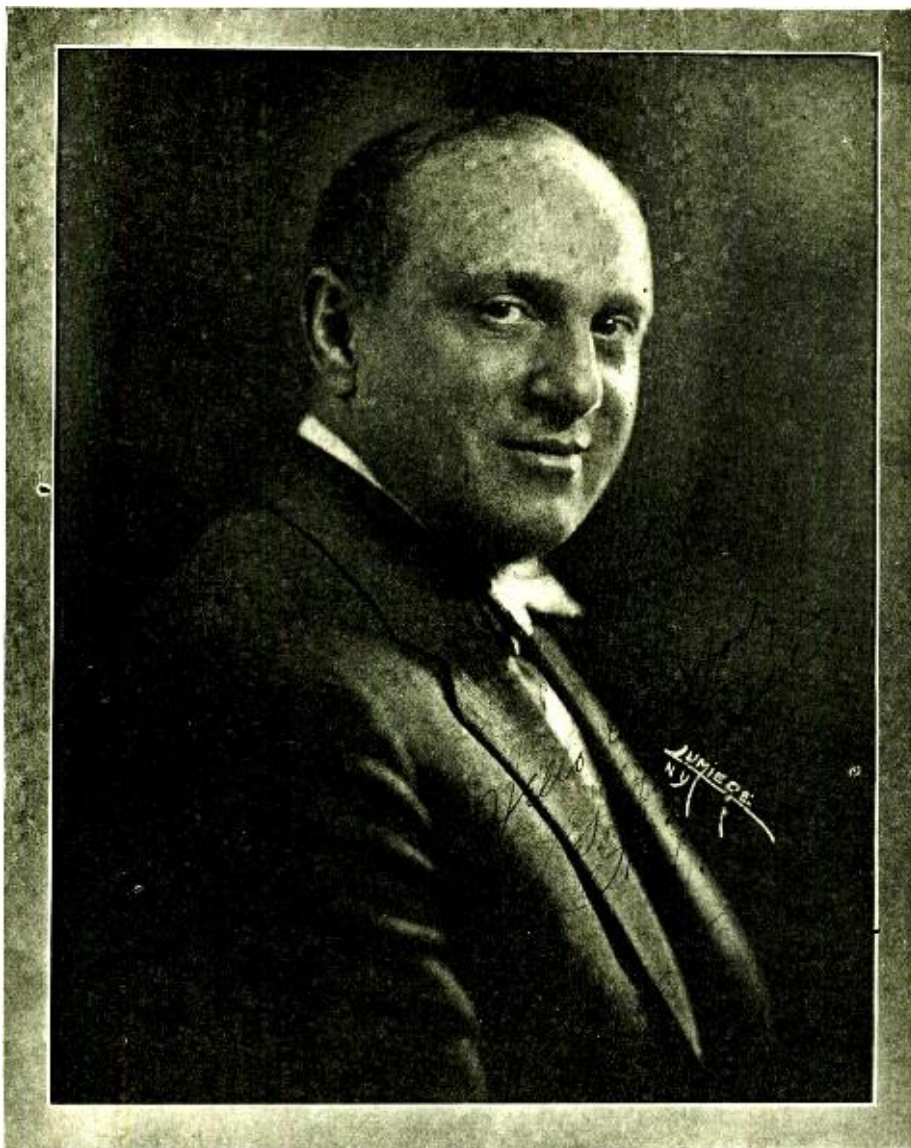

**GOOD-NATURED, GENEROUS ROXY**, who has a radio audience of 3,000,000. "Hello Everybody" is his radiocast greeting from WEAF each Sunday night. His adieu is "Good Night. Pleasant dreams. God bless you!" But everybody would rather hear him say hello than good-by. This special portrait was obtained by RADIO WORLD so those readers desiring to frame a picture of Roxy may do so.

the Capitol, the biggest motion picture theatre in the world.

Roxy works and sleeps in shifts. He is down at noon, stays until 5, sleeps after dinner until 10 and is down again at 11 o'clock, working through until 3 or 4 in the morning.

His radio activities have drawn heavily upon his time. With the "gang" the fine string musicians and soloists of the Capitol, he makes three or four personal appearances each week. Besides that his radio mail averages between 300 and 400 letters a day, most of them repeating to him what he says in closing his Sunday night concert: "Good night. Pleasant dreams. God bless you." Each of these letters he answers.

With the "gang" he broadcasts each Sunday evening from the Capitol Theatre studio through WEA F. Some-

thing like 3,000,000 people listen to his voice once a week. In the last four months he has raised \$125,000 for his radio fund for disabled veterans.

## Duet With Singers 3,000 Miles Apart

**T**HE first international duet, with one singer on this side of the Atlantic and the other in England, will be sung during the First Radio World's Fair, September 22 to 28, inclusive. The fair will be held in Madison Square Garden and the 69th Regiment Armory, nearby, in New York City. Miss Edith Bennett, concert singer, will warble from domestic shore, and probably a man will sing the opposite role in the British Broadcasting Company's station in London. The simultaneous, two-way transmission will probably be on a short wave, because better results are obtainable in that way over distance. So you'd better prepare to tap the primary of your variocoupler for short waves! Tuning to the wavelengths, you may get both voices at once, though they're 3,000

miles apart. It was announced this week that the First Radio World's Fair will transmit from its own station, the antenna probably being on a statue in Madison Square Park. However, a portable transmitting station may be erected—a decided novelty—and experiments begun in a few weeks, so that all apparatus will be in condition for the big event on which the ears of two nations will be trained. Managers U. J. Herrmann and James F. Kerr have been compelled to enlarge the New Inventions Section to a size which will allow the exhibition of 100 devices. Among the noteworthy American discoveries to be shown will be at least three different instruments designed for the purpose of radiocasting photographs in motion. Europe will also be well represented in this

department. Several Continental inventors will display new inventions of a most unusual character. Half a dozen recognized wireless engineers are now busily engaged trying to perfect systems for radioing pictures and Herrmann and Kerr have high hopes of being able to broadcast the world's first program of "Radio Motion Pictures" on the opening night of the exposition.

Sixty nationally known manufacturers of the United States will have de luxe exhibits at the big fair and England, France, Belgium, Italy, Switzerland and Austria will have proper representation in the Foreign Section. Exhibiton booths of elaborate construction will fill both big buildings to which there will be but one admission charge.

# Superdyne Lauded to the Skies by Readers Who Have Built the Set

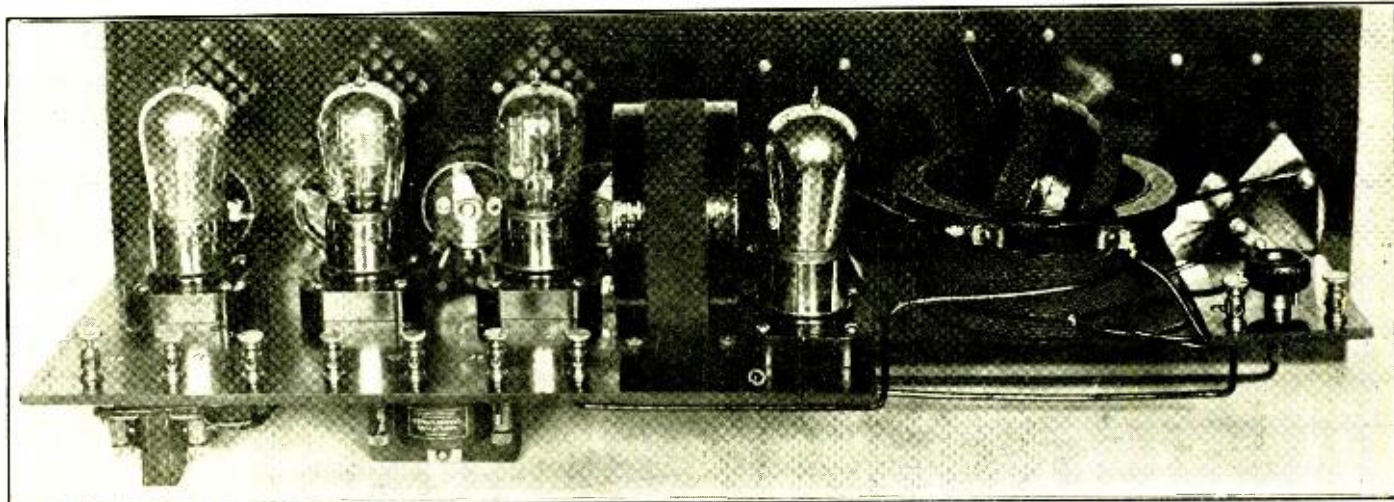

REAR VIEW of Superdyne constructed by C. Frederick O'Connor, the panel view being published on the next page. Note the coupler design. All wiring in the detection and amplifier stages is done beneath the sub-panel, upon which the AF transformers are also fastened. This makes the finished product very neat.

## Helpful Suggestions for Superdyne Owners

By N. N. Bernstein

Technical Editor.

HAVING written the article on how to construct the Superdyne set, published in RADIO WORLD, issues of May 17, 24 and 31, and an article on Superdyne trouble shooting, it is very interesting and gratifying to receive correspondence from experimenters who have built the outfit with success. While it is true some radio fans, beginners mostly, encountered difficulties, which they were unable to overcome without aid from the RADIO WORLD University Department, some of the more experienced were able to turn out a set, following directions, that gave them at once the most satisfaction ever derived from a receiving outfit.

One of the most common difficulties encountered by the novice is inability to make the Superdyne tune sharply. This occurs quite often when the receiver is located within a few miles of several radiocasting stations, as for example, in New York City. On the other hand, reports have come in stating that the Superdyne tunes very sharply even in New York City. The reason for this seems somewhat obscure, but it must be remembered that the Superdyne is a very sensitive set, and though located adjacent to large steel buildings will still pick up enough energy to operate the loud speaker with great volume, so much so, in fact, that the shielding effect of the buildings is not noticed. Where the path of the radio wave is unobstructed so much energy will be collected as to spread out over apparently all wave lengths on the tuner. This can be eliminated to some extent by lessening the number of turns of wire of the aperiodic primary. It may be necessary even to leave only one complete turn instead of the usual four or six. This will be sufficient, with the ordinary outdoor antenna, to operate the receiver with good efficiency.

In the country, where there are no adjacent buildings

or elevated lines, it become desirable to get as much energy as possible out of the air. The available amount can then be increased by putting ten to twenty turns on the aperiodic primary, thus causing a greater amount of induction to the grid of the radio-frequency tube.

Another frequent obstacle to the full enjoyment of the Superdyne is that the radio-frequency tube goes into oscillation in the middle of reception. That is, while listening to a program, a heavy discharge of static, or a "squealer" being tuned nearby, will "spill" the circuit over with a click, necessitating retuning. There are two methods of overcoming this. One is to tune the set just a bit under the point of saturation, so that the heavy discharge will not be enough to cause the spill. The best way is to connect a variable grid leak from the grid post of the detector socket to the positive A battery post of the same socket. Once carefully adjusted, this leak may remain fixed, and the blocking effect eradicated.

Letters have come in praising the Superdyne above any other set. The letters published herewith tell their own story:

U. S. S. ORION

Train Squadron One—Fleet Base Force  
Enroute, Hampton Roads, Va. to  
Cardiff, Wales,  
16 June, 1924

EDITOR, RADIO WORLD:

I HAVE constructed the Superdyne as per constructional data furnished by you, using the aperiodic 4-turn antenna coil over the secondary. I am pleased to say that I consider this circuit a wonder, especially for volume and pureness of tone. I have compared it with two Super-Heterodynes, Reflexes and other hook-ups and find it far superior in tone. In fact, it is a joy to listen in.

I am using a .00025 grid condenser with a Bradley-Leak connected from the grid to the positive filament.

(Concluded on next page)

# How Readers Obtained Best Results

*"A Wonder"—"Has Them All Cheated"—"Exceptional"*  
So Say Readers Who Have Built the Superdyne

(Concluded from preceding page)

It might interest you to know that on the trip across the Atlantic I have not been out of touch of broadcasting stations, either on one side or the other.

Yours very truly,

A. H. MILES,  
Lieut. Comdr. USN  
Comdg. USS Orion

EDITOR, RADIO WORLD:

**H**EREWITH are two photos of a Superdyne receiver I built and which is giving exceptional service. You will please note the coupler design, allowing variable stator coupling and made from formica tubing and red fiber shellaced black.

C. FREDERICK O'CONNOR,  
1323 Lind St., Wheeling, W. Va.

EDITOR, RADIO WORLD:

**D**URING May you published articles about the Superdyne circuit and its action. I built this circuit, following your directions, and wound my own coupler and plate coil, inserting one stage of audio. This was all right for local (Chicago) stuff on the loud speaker and for Eastern stations; also for Pacific coast stations on head phones. But it was too faint for loud speaker on distant stations, so I added another stage of audio (first stage transformer 5-to-1, second stage 3½-to-1) but it howled like a dog out in the cold. I used all sorts of fixed condensers across the transformers, all sorts of grid leaks, variable and pencil type, and all sorts of tubes, all to no advantage.

Then I tried the idea of a sub-panel and putting the transformers under the audio tubes beneath the panel. That gave plenty of space (4 inches) between coupler and plate coil, also 4 inches from rotor shaft of condensers to coupler shaft. I shortened the grid and plate leads on all tubes and transformers, put in new full-voltage B batteries and tried it out again. It worked as if Mr. Tuska himself had made it. It is more than satisfactory. Noon-day reception on a 30-foot indoor aerial included WLW, WHB, WFAA, WOAW, KDKA and others, from 260 to 1,000 miles from Chicago. Night reception seems to have no limit. I find by using a 20-turn loop, 2 feet on each side and attaching only one end to the aerial binding post, I reduce static to minimum and the reception is nearly as good as from an outside aerial, with much more clarity. Not having UV199 tubes, as your hook-up called for, I use RF, UV201A; detector, UV200; two audios, UV201A. For RF I used a 6-ohm rheostat; detector a variable Bradleystat and detector a Bradley grid leak. For audio I used one variable Bradleystat for two tubes. I have built nearly every circuit ever published, including all the reflexes, but not the Super-Heterodyne. The Superdyne has them all cheated. As for Reflex, I built a Grimes Inverse Duplex and it was a wonder. All these stations I have mentioned

came in on a home-made loud speaker. When the Neutrodyne craze came out I built several and still have a Neutrodyne for the family. But when I crawl into the workshop in the attic I hook up the Superdyne and get real DX service and don't take off my hat to any of these birds with even 6-tube sets. Also the beauty of the Superdyne is that it will tune through the local stations (we have eight of them) and get anything on the continent.

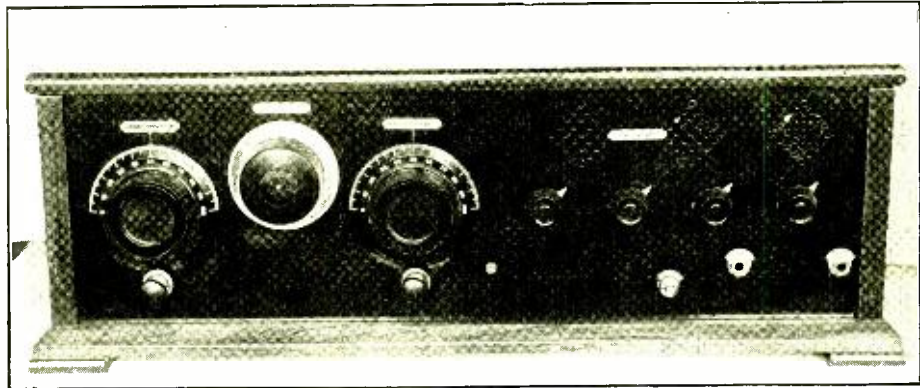

PANEL VIEW of Superdyne built by C. Frederick O'Connor, an efficient set constructed with a great display of talent.

I built this Superdyne five or six times before I made it work perfectly. But when it does work—oh! my! The volume is more than other sets with three stages of audio.

I am so well pleased with the results that to tell you about it in a few words is beyond me.

Respectfully,

L. P. GAYLORD,  
4743 Warwick, Ave.,  
Chicago, Ill.

EDITOR, RADIO WORLD:

**H**AVING just constructed the Superdyne from the directions in the RADIO WORLD and also having noticed that some fans have not had the best results, I feel that I owe it to this receiver to send you the results which I have had in just a few night. The following stations have been received, using only the first three tubes. volume is too loud on all four: WOC, KYW, KDKA, WLW, WKY, WHAA, WOAW, KSD, WHB, WDAP, WCAL, KFLE, WBZ, WFAA, KGO, KFI, KHJ, WOAI, WOS, WMC, WCB, WSAI, WHAZ, WOR, WGR, WBAP, KFKX, WTAS, WPAC, WCK, WOQ, WSB, WJAZ, WMAK, WFAM, WHAS, PWX, WWJ, WTAY, WJAR, WSAB, WOO, CFCA, WDAR, WJAD, WMAY, WGY, WCAP, WAAW, WOAN, WSAI, WLAG, WTAM, CKAC, KFIX, WEA, WIP, WEW, WRM.

I constructed the set of the best parts, those suggested in the RADIO WORLD, and wired it according to the directions. I am convinced that it is the best receiver which I have ever used. I find that it is very critical and highly selective. Just last night, with static very heavy, I tuned out WHAS and listened to the program from PWX, which was a concert by the Stringed Orchestra.

LLOYD J. HILL.

Community High School,  
Litchfield, Ill.

# The Passing of the Lonely Bivouac

By Joseph Mulvaney

"DAY after day, week after week, month after month, he lived through the loneliness, with the surge of the sea ever beating in his ears, from the rocks at the foot of the lighthouse, the shrill cries of the gulls rising above it, now and again a siren from a passing steamer, but never the sound of human voice and so—"

\* \* \*

"Under the white heat of the tropic sun, reflected and magnified by the shimmering white sands for countless miles around them, the little caravan staggered on. The single white man in the procession of human and animal skeletons was still in the lead, wavering with weakness, when above the heat clouds, leagues ahead, vague outlines of tall palms formed—or seemed to form! Was this the end of the long trail, or an oasis, almost as welcome, or just another of those horrible mirages? If only a voice could direct them from the false toward the—"

\* \* \*

"Gripped in the frozen fingers of the bergs, the gallant Adventurer was swept slowly but irresistibly onward as the ice fields cracked into acre areas under the spring sun. There was food enough for a few weeks and furs aplenty, for the few survivors of the ill-starred expedition, but where they were they could only guess. Safe navigation had been impossible for months and—"

So we have read through countless tales of imaginative prose drawn from scores of stories authenticated in history. So we will read no longer. Radio is the reason! The perfection of wireless communication is eliminating loneliness from fact and fiction, too. The isolated keeper of the light may listen to a President's inaugural, a symphonic concert, a Broadway revue in his hours of idleness. He may tune in on the words and music of the whole world, and his wife may teach his daughter to dance to the latest jazz king's latest syncopation. Louis Tracy could not make "The Pillar of Light" stand up for a moment today!

Our intrepid and impeccable Englishman no longer needs wonder whether it is the city of gold, an oasis of plenty, or a mad-denying mirage. He will know just where he is going every minute he is on his way and if the radio directions cannot be followed, he need only broadcast a call for assistance, whether he is striking through Mongolia, Arabia or the American sand-strewn wastes. Half the heroism of "Under Two Flags" would be wanton nonsense; "King Solomon's Mines" would be easily achieved, and "The Sheik" would be rele-



(Kadel & Herbert)

THE LIGHTHOUSE KEEPER is lonesome no more. The radio set brings him in contact with teeming centers of population, even in mid-Summer.

gated to burlesque by readers conversant with radio.

As for our half-crazed Arctic explorers, seized in the drifting berg, sweeping toward the polar wilderness, unknowing whither, they fall right out of the field of fiction. There would not be an hour from the start of their expedition when they would be out of touch, beyond conversational distance of their friends in New York or San Francisco. They could call rescuing parties the moment the ice fields closed in on them, they could report their scientific discoveries by the air lines, they could even send copyrighted stories to the newspapers and have their checks awaiting them when they returned safely and happily. "The Frozen Pirate" would not have any excuse for being more than chilled today!

Going they are and forever, that brave

company of valiant souls with whom we adventured from the fire-side for so many years. They ruled the land and sea for centuries, and ruled it right merrily. We deemed them supermen, whom we know now to have been less than mortal. They were indeed "of the earth, earthy," and they have given way to the lords of the air, the celestials.

Few of the greatest survived to see the passing of their dynasty. Mayne Reid, Fenimore Cooper, Ouida, Clark Russell, Frank Norris—all are gone. Rider Haggard survives, and Kipling, and a few others, but they have turned from their old fields of conquering the solitudes and have become sages of literature. The newer knights of the quill have left the earth and are sweeping through the air with their stories, and for them the sky is literally the limit!

Well for us that they lived while they lived, just as it was well for us that the figures of history who inspired them lived and strove within their earthly limitations. If Isabella had been able to cheer Columbus and his caravels by radio on their conquest of the western ocean, the discovery of America might have been less an achievement, surely. If Pizarro, Cortez, Balboa, De Sota, Hudson and the other mighty mariners were ever within ear-shot of their sovereigns and supporters, would any of us ever have thrilled to the tales of their exploits?

Yet, isn't it better to feel the throb of the heart with Paul Revere on his ride through Middlesex, to cheer Sheridan on to Winchester, to cross the plains with Lewis and Clark, to battle on through the decades with the other fighting men in memory to-day than never to have known them?

Still, Peary's achievement of the Pole, Stanley's quest into Africa, Jameson's raid on the Transvaal, would have been mightily simplified or rendered unnecessary altogether if radio ruled the air only a few years earlier. The terrific hazard of the overland trails in the covered wagon days would have been eliminated. The menace of the Indian tribes, the massacres of the Oriskany and the Little Big Horn, the everlasting loneliness of wilderness and watery wastes would be non-existent.

The Alamo of Bowie and Crockett would have never fallen into Mexican hands, and a thousand mysteries of history would long since have been solved. What happened to Andre on his balloon flight to the Pole? Where did the lost colony of Roanoke go? Who was the Man in the Iron Mask? What was the fate of Johann Orth, Archduke of Austria, who spurned a kingdom for an actress bride? Radio would have revealed every one of these secrets and countless more that to-day are blank pages on the record.

## Three Plans for Meeting Radiocasting Costs Discussed

PERHAPS no other question affecting the public interest is being considered by the radio industry at large with a greater study than the question: "Who is to pay for radiocasting?"

There is a very strong feeling that the expense of radiocasting programs and the payment of our leading artists in the professional field should be borne by those companies manufacturing or otherwise profiting by the sale of radio apparatus. At the same time, the public stand ready to contribute to a general fund which will in return give them still greater benefits as

listeners-in. The three plans most generally discussed are as follows:

1. That a fund be subscribed by the radio industry for the support of musical, artistic and educational programs.
2. That a fund be subscribed by public contributions.
3. That a low tax be placed upon the manufacture and sale of radio apparatus to be applied to a broadcasting fund.

The Executive Committee of the A.R.A. is of the opinion that the radio laymen or

the public generally to whom an appeal will be made for subscriptions are the ones to whom all plans must be submitted for a choice, although it is by no means certain that the expense problem will be solved entirely by any one or all of the foregoing proposals.

### What Is Your Favorite Hookup?

DRAW it and send diagram to RADIO WORLD, 1493 Broadway, N. Y. C.

# Mid-Summer Radio Dominates Roaring Surf, Bosky Dell and Neck of Woods, Spreading Its Impartial Joy



(Foto Topics)  
THEY are having a raft of Mid-Summer radio fun. Instead of attending the National Democratic Convention in person, this group and many others like it transported their portable set to a raft at City Island, N. Y., where they heard the bang of the chairman's gavel without perspiring.

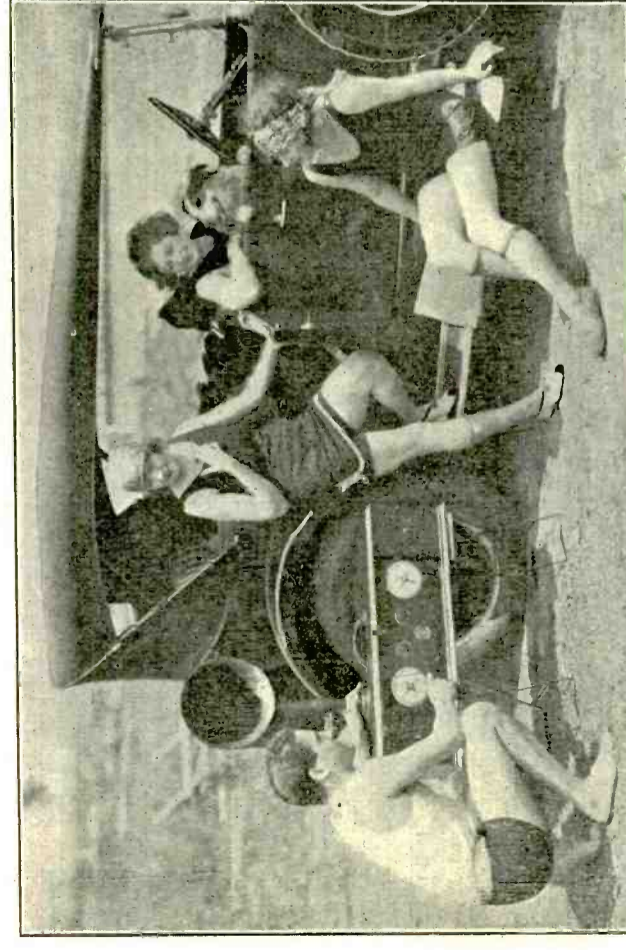

COME ON! LET'S GO! is the cry when the sun starts coming down in heat waves. So the host and guests pile into the machine and spin down to where the water waves splash and where they can hear the radio waves in comfort through their Super-Heterodyne.

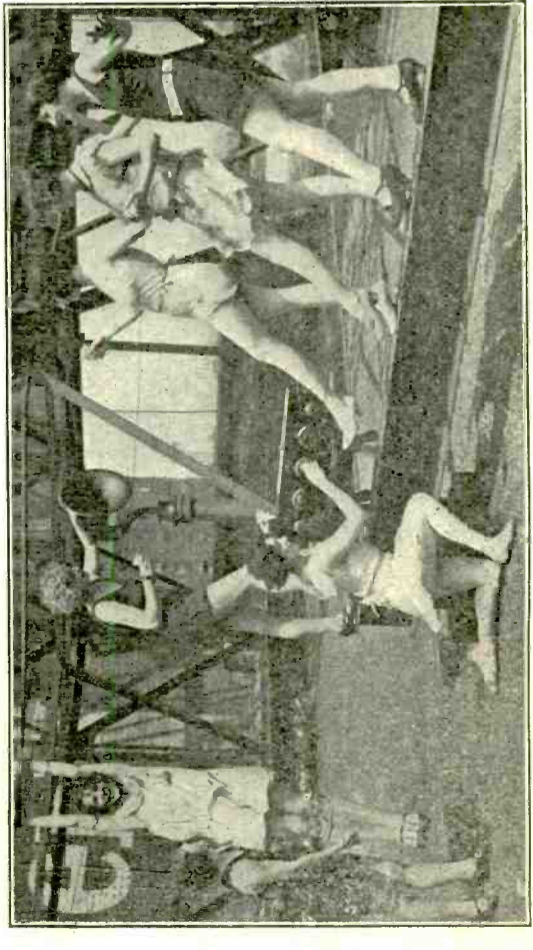

(Kadel & Herbert)  
THIS IS HOW stage girls keep cool while going through their steps. The heat problem is solved by taking the portable radio up to the roof and tuning in on any convenient station that suits. This scene is an everyday occurrence now on many New York office building roofs.

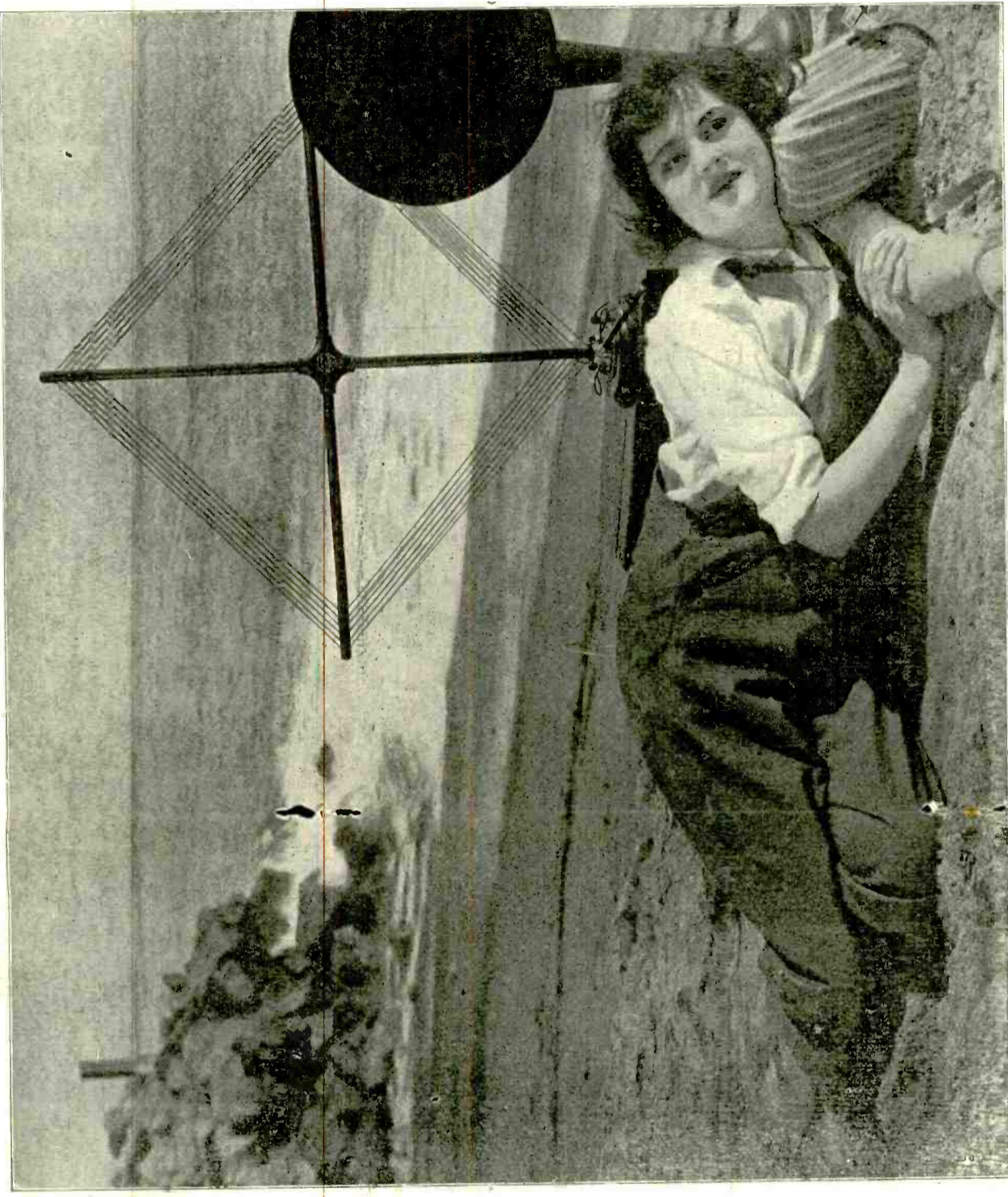

IN VENICE, California, movie actress, Sylvia Breamer, rests up between shots by listening to the cooling ocean waves and the inspiring radio waves at the same time. Portable sets are very popular with the movie folk, especially with a loop to improve Mid-Summer reception. Cooled physically by the breeze and mentally by the radiocast music, the actors and actresses, even in costume, spend an enjoyable rest period.

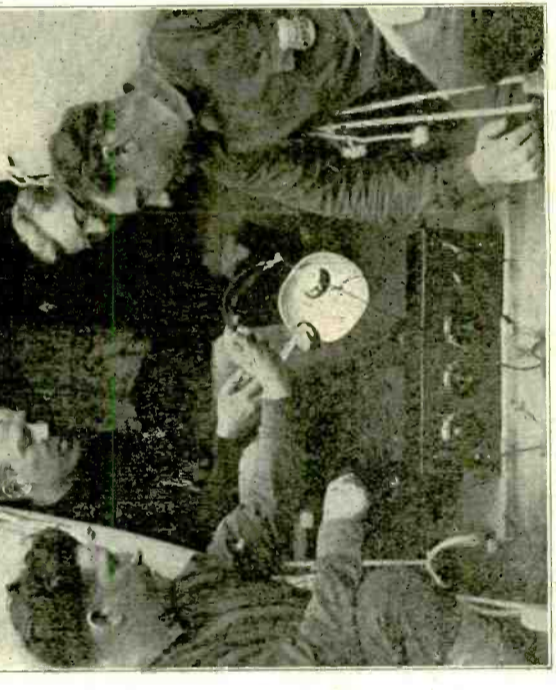

(Foto Topics)  
MEMBERS of the New York police force in training camp utilize a tin dish pan from the mess kit for a loud speaker.

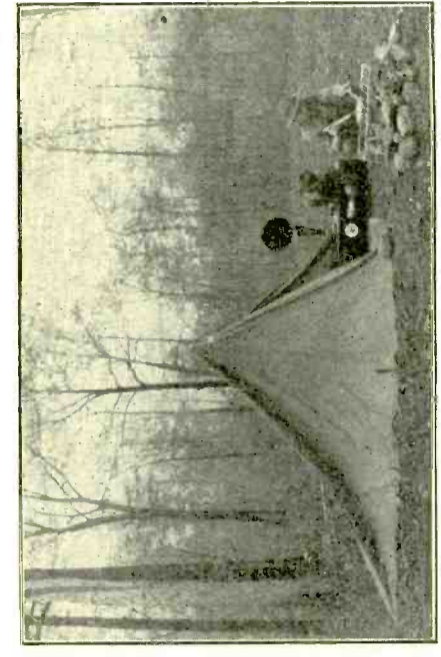

(Boy Scout Foundation)  
THE BOY SCOUTS certainly know what to take along on a camping trip. A good radio set, a small tent and a quiet spot in the woods provide a pleasant resting place for these two Scouts in Mid-Summer. Why not? If they are listening to some radiocast station that's telling how to fry bacon and eggs? That seems to be the all-absorbing question in the above photograph. At right, two Boy Scouts tuning in and transcribing code in Central Park, New York City, as part of their Mid-Summer fun.

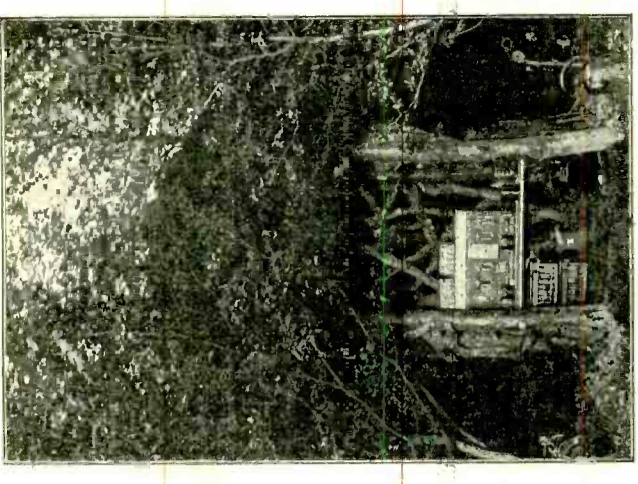

(International Newsreel)  
AT LAST the nightingale is persuaded to appear before the microphone! The transmitter (above), is in an English garden.

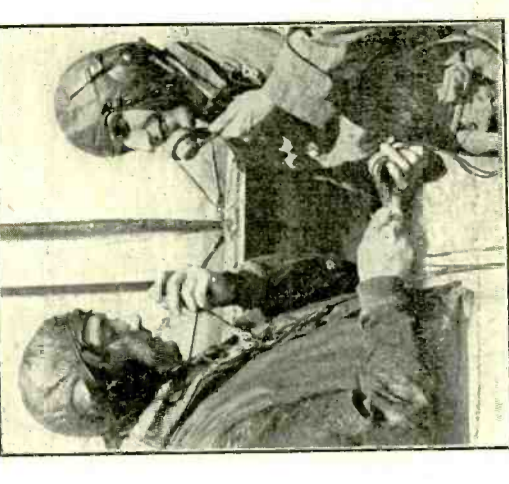

(International Newsreel)  
L.T. B. W. WRIGHT, announcer, and L.T. Donald Bruner, pilot of the first radiocasting airplane, which flew over Washington in a special test.



(Foto Topics)  
THE BOYS SCOUTS getting code in the park.





# RADIOCAST PROGRAMS

## Thursday, July 17

**KDKA, Pittsburgh, 326m (920k), E. S. D. S. T.—** 6 P. M., baseball scores; dinner concert. 6:03 P. M., "Epeminondas and His Auntie," for the radio children. 6:45 P. M., helps to teachers of Sunday School classes, Captain Cover Johnson. 7 P. M., baseball scores; sport review by James J. Long. 8 P. M., concert by Westinghouse Band; Chester Sterling, basso. 9:55 P. M., time signals; weather forecasts; baseball scores.

**KYW, Chicago, 536m (560k), C. S. D. S. T.—** 5:02 P. M., news; financial and final markets. 5:45 P. M., children's bedtime story. 6 P. M., dinner concert broadcast from Congress Hotel. 7 P. M., "Twenty Minutes of Good Reading," by Rev. C. J. Fernin. 7:20 P. M., musical program, artists and program announced. 8:15 P. M., "Safety First" talk by Mr. Z. C. Elkirk of Chicago Motor Club. 9 P. M., "At Home" program.

**WBZ, Springfield, Mass., 337m (890k), E. S. T.—** 6 P. M., Leo Reisman, Hotel Lenox ensemble. 6:30 P. M., songs by Bill Coty and Jack Armstrong. 6:40 P. M., Leo Reisman and his Hotel Brunswick orchestra. 7 P. M., results of games, Eastern, American and National leagues. 7:05 P. M., letter from the New England Home-stead, "At the Theatres," with A. L. S. Wood, dramatic editor. 7:30 P. M., bedtime story for the kiddies. 7:40 P. M., concert by children for children. 9 P. M., Earl Oliver, baritone; Elizabeth Bates, accompanist. 9:30 P. M., Marie Rice, soprano; Juliette Houle, accompanist. 10:55 P. M., time signals; weather reports.

**WLAG, Minneapolis, 417m (720k), C. S. T.—** 2:10 P. M., Woman's Club hour, "French Cookery," Bernice Bell. 2:40 P. M., matinee program. 4 P. M., magazine reading, "A Son of Jezebel." 6 P. M., baseball scores and dinner hour concert by Geo. Osborn's Nicollet Hotel orchestra. 7:30 P. M., farm lectures.

**WLW, Cincinnati, 423m (790k), C. S. D. S. T.—** 3 P. M., market reports. 4 P. M., piano solos by Miss Adelaide Apiel. 10:30 P. M., unusual program by Messrs. Mason and Fricke, banjoists. 10:25 P. M., violin solos by Lowell Cristy, accompaniments by Miss Anne Cockburn. 10:35 P. M., concert by the Mastropolo Trio; violin solos and duets for cello and violin; Miss Rossina Arico, at the piano. 11 P. M., popular program by the Doherty Melody Boys.

**KHJ, Los Angeles, 395m (760k), P. T.—** 6 P. M., Art Hickman's concert orchestra. 6:45 P. M., children's program; Elizabeth Kurkjian and Louise Carter, pianists; bedtime story by Uncle John. 8 P. M., program, courtesy of the Platt Music Co. 9 P. M., program, courtesy of the Retail Controllers' Association of Los Angeles, Daniel Nelson Clark, of the Radio Journal, speaker. 10 P. M., Art Hickman's dance orchestra.

**WNAC, Boston, 278m (1080k), E. S. D. S. T.—** 10:30 A. M., WNAC women's club talks. 1 P. M., Colonial orchestra. 6:30 P. M., WNAC dinner dance. 8 P. M., program to be announced.

**WOR, Newark, N. J., 405m (740k), E. S. D. S. T.—** 3 P. M., concert by the orchestra of S. S. President Harding, United States Lines. 6:15 P. M., Albert E. Sonn, technical editor, weekly talk on "Radio for the Layman." 6:30 P. M., "Music While You Dine," Tom Cooper's Country Club orchestra. 7:20 P. M., resume of the day's sports.

**WHN, New York, 360m (830k), E. S. D. S. T.—** 6 to 7 P. M., Around the Alamac's Festive Board, Olcott Vail's trio; jests by the toastmaster; talks and songs by renowned folk; dance music by Paul Specht's Alamac orchestra. 7 P. M., "Sport Period," by Thornton Fisher. 9:30 P. M., Chas. Strickland's Palisades Park orchestra. 10 P. M., original recitation by Wm. J. Stuart. 10:10 P. M., Harry Hock and his Entertainers. 10:30 P. M., Roseland dance orchestra. 11 P. M., Fritz Leyton singing. 11:10 P. M., Buddy Truly singing. 11:20 P. M., Sylvia Brown, popular songs. 11:30 P. M., Original James Boys from the El Fey Club.

**WDAR, Philadelphia, 395m (760k), E. S. D. S. T.—** 12 noon, organ recital from Stanley Theatre; features from the studio; Arcadia Cafe concert orchestra. 2 P. M., Arcadia Cafe concert orchestra; artist recital from studio. 4:30 P. M., artist recital from studio. 5 P. M., question period in series of educational talks delivered under auspices of Peirce School of Business Administration. 5:45 P. M., baseball scores.

**WJZ, New York, 455m (660k), E. S. D. S. T.—** 5:30 P. M., state and federal agricultural reports; Farm and Home reports; closing quotations, N. Y. Stock Exchange. 7 P. M., Gotham Hotel concert orchestra. 7:20 P. M., financial developments of the day. 7:30 P. M., Gotham Hotel concert orchestra. 8 P. M., weekly French lesson. 8:30 P. M., Wanamaker concert from the Wanamaker Auditorium. 9:30 P. M., "Safety Talk," by Charles E. Hill. 9:40 P. M., 258th Field Artillery Band. 10:30 P. M., Hotel Majestic orchestra.

**WJY, New York, 405m (740k), E. S. D. S. T.—** 8:15 P. M., "A Night in India," principals: J. Lewis Reid, Angelo Caramore; soloists, Queen Trafford, Milton J. Cross; incidental music, Ben Wilson's string and reed orchestra.

**WRC, Washington, 469m (640k), E. S. T.—** 5:15 P. M., instruction in international code. 6 P.

M., children's hour by Peggy Albion. 7:45 P. M., a talk on motoring, auspices American Automobile Association. 8 P. M., piano recital. 8:15 P. M., song recital by Hattie Herfurth, contralto. 8:30 P. M., musical program. 9 P. M., dance program by Pete Macias' L'Aiglon orchestra. 9:55 P. M., time signals; weather forecasts.

**WEAF, New York, 492m (610k), E. S. D. S. T.—** 11 A. M., talk on "Appetites and Olives," by Frank Gulden; musical program; market and weather reports. 4 to 6 P. M., Jamsa Nash; tenor; Rhea Leddy, mezzo-soprano, accompanied by Margaret Kaye; children's program. 6 to 12 P. M., dinner music from Rose Room, Hotel Waldorf-Astoria; mid-week services of Greater New York Federation of Churches; Rudolph Thomas, pianist and group of artists; Beulah Rowland, contralto; Jordan Cohan, pianist; Vincent Lopez and his orchestra from Roof Garden, Hotel Pennsylvania.

**WCAE, Pittsburgh, 462m (650k), C. S. D. S. T.—** 12:30 P. M., news; weather reports. 3:30 P. M., baseball scores. 4:30 P. M., stock market reports; the Sunshine Girl. 6:30 P. M., dinner concert. 7:30 P. M., Uncle Kaybee. 7:45 P. M., baseball scores. 9:30 P. M., musical program by Julia Saam and co-operating artists. 11 P. M., late concert.

**WGI, Medford, Mass., 360m (830k), E. S. D. S. T.—** 7 P. M., closing stock market reports; agriograms; Boston police reports. 7:15 P. M., code practice; Citizen's radio period. 7:30 P. M., evening program: talk by Geoffry L. Whalen, the "Radio Movie Man." 7:45 P. M., Bernie and his Bunch. 8:15 P. M., musicale; weather report.

**WIP, Philadelphia, 509m (590k), E. S. D. S. T.—** 6:05 P. M., dinner music by the Kentucky Serenaders orchestra. 6:45 P. M., U. S. Dept. of Agriculture livestock and produce market reports. 7 P. M., Uncle Wip's bedtime stories and roll call for the children. 8 P. M., "Timely Talk to Motorists," by Gene Hogle. 8:15 P. M., concert by Comfort's Philharmonic orchestra; soloist, Loda Goforth, soprano. 8:45 P. M., "What the Wild Waves are Saying," picked up by a microphone placed amidst the breaking waves. 8:50 P. M., Murphy's minstrels broadcast direct from the WIP control station on the Steel Pier, Atlantic City. 9:30 P. M., concert by Vessella's concert band; soloist, Rita Aprea, soprano. 11:05 P. M., dance music by Harvey Marburger and his Keith Vaudeville orchestra.

## Friday, July 18

**WMAQ, Chicago, 448m (670k), C. S. D. S. T.—** 4 P. M., sports results. 6 P. M., Chicago Theatre organ recital. 6:30 P. M., Hotel LaSalle orchestra. 8 P. M., nature study club talk by Barnett Harris. 8:15 P. M., weekly wide-awake club program, directed by Mrs. Frances M. Ford. 9:15 P. M., young ladies chorus of Dvorak Park.

**KGO, Oakland, Cal., 312m (960k), P. T.—** 1:30 P. M., N. Y. Stock Exchange and U. S. Weather Bureau reports. 3 P. M., musical program and a few moments with new books by Wilda Wilson Church. 6:45 P. M., stock exchange and weather reports; news items.

**KDKA, Pittsburgh, 326m (920k), E. S. D. S. T.—** 5:30 P. M., organ recital by Paul Fleecker, Cameo motion picture theatre. 6 P. M., baseball scores; dinner concert. 6:30 P. M., an Uncle Wiggley story for the children. 6:45 P. M., news bulletins. 7 P. M., baseball scores. 7:30 P. M., address by United States Bureau of Mines. 7:40 P. M., National Stockman and Farmer market reports. 8 P. M., "Pennsylvania Railroad System Night," program by Altoona Band; triple quartet from the Car Service Division. 9:55 P. M., time signals; weather forecast; baseball scores.

**KYW, Chicago, 536m (560k), C. S. D. S. T.—** 5:45 P. M., children's bedtime story. 6 P. M., dinner concert broadcast from Congress Hotel. 7:20 P. M., talks, auspices American Farm Bureau Federation; "From the Beginning of Time," by Mrs. S. K. Maddux; "Why We Encourage Calf Clubs," by Frank W. Harding. 8 to 11:30 P. M., midnight revue.

**WBZ, Springfield, Mass., 337m (890k), E. S. T.—** 6 P. M., dinner concert by the WBZ trio. 7 P. M., results of games, Eastern, American and National leagues. 7:05 P. M., "Steering Mechanism," auspices Automobile Club of Springfield; current book review by R. A. MacDonald. 7:30 P. M., bedtime story for the kiddies. 10 P. M., concert by Chickering & Sons, Stanley Cross, bass; Marjorie Posselt, violinist; Cecil J. Hall, accompanist. 10:55 P. M., time signals; weather reports. 11 P. M., concert by WBZ trio; Miss Glenn Robinson, pianist.

**WLAG, Minneapolis, 417m (720k), C. S. T.—** 2:10 P. M., Woman's Club Hour, "Problems of the Neighborhood," B. F. Baldwin, of the Community Fund. 2:40 P. M., magazine reading, "Fifty," by Virginia Dale. 6 P. M., baseball scores and sport hour. 7:30 P. M., farm lectures. 8:15 P. M., band concert, direct from Como Park, St. Paul; Fred Albrecht's band. 11 P. M., program, Geo. Osborn's Nicollet Hotel orchestra; Nels Swenson, bass.

**WOC, Davenport, Ia., 484m (620k), C. S. T.—** 9 A. M., opening market quotations. 10:55 A. M., time signals. 11 A. M., weather and river forecast. 11:05 A. M., market quotations. 12 noon, chimes concert. 12:15 P. M., weather forecast. 1 P. M., closing stocks and markets. 7 P. M., sport news and weather forecast. 8 P. M., musical program, "Harmony Serenaders" orchestra of Clinton, Iowa. 9 P. M., weekly tourists' road bulletin.

**WLW, Cincinnati, 423m (790k), C. S. D. S. T.—** 11 A. M., weather forecast and business reports. 1:30 P. M., market reports. 3 P. M., stock quotations. 4 P. M., special program, T. C. O'Donnell, editor of Writers' Digest, lecture on "Practical Lessons in Writing."

**KHJ, Los Angeles, 395m (760k), P. T.—** 6 P. M., Art Hickman's concert orchestra. 6:45 P. M., children's program; bedtime story by Uncle John. 8 P. M., program, courtesy of the Hellman Commercial Trust and Savings Bank. 10 P. M., Art Hickman's dance orchestra.

**WNAC, Boston, 278m (1080k), E. S. D. S. T.—** 10:30 A. M., WNAC women's club talks. 1 P. M., Shepard Colonial orchestra. 4 P. M., Shepard Colonial orchestra. 6 P. M., children's half-hour. 6:30 P. M., WNAC dinner dance, Checker Inn orchestra. 8 P. M., program to be announced.

**WOR, Newark, N. J., 405m (740k), E. S. D. S. T.—** 6:15 P. M., Agnes Leonard in songs for the children. 6:30 P. M., "Man in the Moon" stories for children by Josephine Lawrence and William F. B. McNeary. 7 P. M., joint program by Phil Abrams, pianist, and George Koty, banjoist. 7:20 P. M., resume of the day's sports.

**WHN, New York, 360m (830k), E. S. D. S. T.—** 6 P. M., Around the Alamac's Festive Board; Olcott Vail's trio; jests by toastmaster; talks and songs by renowned folk; dance music by Paul Specht's Alamac orchestra. 7 P. M., "Sport Period," by Thornton Fisher. 9:30 P. M., Chas. Strickland's Palisades Park orchestra. 10 P. M., original recitations by Wm. J. Stuart. 10:05 P. M., joint song recital by John H. Eckles, baritone, and Blanche Smith Eckles, soprano. 10:30 P. M., Roseland dance orchestra. 11 P. M., Henry Cogert and Sol. Hirsch, songwriters. 11:15 P. M., Ross Fowler, baritone. 11:30 P. M., Original James Boys from the El Fey Club.

**WDAR, Philadelphia, 395m (760k), E. S. D. S. T.—** 4:30 P. M., dance program by Bobbie Lee and his Cotton Pickers. 5:45 P. M., baseball scores. 7:30 P. M., Dream Daddy with the boys and girls; Stanley features. 8 P. M., book review by Arnold Abbott; artist recital. 8:15 P. M., dance music from Young's Million Dollar Pier, Atlantic City. 8:30 P. M., Emmett Welch Minstrels, broadcast from the Million Dollar Pier. 9:15 P. M., Benson Chicago orchestra; Victor Record artists. 9:30 P. M., Charley Fry and his Million Dollar Pier orchestra. 10 P. M., Arcadia Cafe concert orchestra; Benson Chicago orchestra; Charley Fry and his Million Dollar Pier orchestra; recital of theatrical and star entertainers.

**WJZ, New York, 455m (660k), E. S. D. S. T.—** 5:30 P. M., state and federal agricultural reports; Farm and Home reports; closing quotations N. Y. Stock Exchange; foreign exchange quotations; Evening Post News. 7 P. M., Hotel St. Regis Copenhagen quartet. 7:20 P. M., financial developments of the day. 8 P. M., Lenore Masselle, soprano. 8:15 P. M., Goldman band concert, from Mall, Central Park, Wagner-Tschaikowsky program, Waino Kauppi, cornetist. 10 P. M., "Marshal Foch's Counter Attack," George Laval Chesterton. 10:15 P. M., the Radio Franks—Wright and Bessinger. 10:30 P. M., Harold Stern and his Hotel Belleclair Tower orchestra.

**WJY, New York, 405m (740k), E. S. D. S. T.—** 7:30 P. M., Leonard Nelson and his Knickerbocker Grill orchestra, direct. 8:15 P. M., Looseleaf Current Topics by Dr. William H. Allen. 8:45 P. M., time pop question game. 9 P. M., Emma J. DuBois, trumpeter; Clara M. DuBois, accompanist. 9:15 P. M., Piedmont trio. 10 P. M., Piedmont trio.

**WRC, Washington, 469m (640k), E. S. T.—** 3:10 P. M., song recital by Arthur McCormick, baritone. 3:20 P. M., "Beauty and Personality," by Elsie Pierce. 3:25 P. M., current topics, editor of "The Review of Reviews." 3:35 P. M., piano recital by Ethel Grant. 3:50 P. M., the Magazine of Wall Street. 4 P. M., song recital. 5:15 P. M., re-transmission of time signals and weather forecasts. 6 P. M., stories and songs for children by Peggy Albion and Mary Frances Glenn.

**WEAF, New York, 492m (610k), E. S. D. S. T.—** 11 A. M., talk by Dr. Louis Sternberg on "Bronchial Asthma," auspices of the Health Speakers Service; Roger Whitman, editor of Country Life, on "Building a Home"; market and weather reports. 4 P. M., Ruth Cathryn Rohlfis, soprano; children's program. 6 P. M., dinner music from the Rose Room, Hotel Waldorf-Astoria; Viola Sherwood, soprano, accompanied by Charlotte Hirsch; the Happiness Boys—Billy Jones and Ernest Hare; battery talk by George C. Furness; B. Fischer's "Astor Coffee" dance orchestra.

**WCAE, Pittsburgh, 462m (650k), C. S. D. S. T.—** 3:30 P. M., baseball scores. 4:30 P. M., special children's program, conducted by the Sunshine Girl. 6:30 P. M., dinner concert from William Penn hotel. 7:30 P. M., Uncle Kaybee. 8 to 9:30 P. M., baseball scores. 9:30 P. M., Bohemian musical program.

**WGI, Medford, Mass., 360m (830k), E. S. D. S. T.—** 7:15 P. M., closing stock market reports; code practice; Boston police reports. 7:30 P. M., evening program, selected verses by Mr. Charles L. H. Wagner, radio poet. 7:45 P. M., concert by the Boston concert company.

**KSD, St. Louis, 546m (550k), C. S. T.—** 8 P. M., Silverman's orchestra concert, broadcast direct from Lyric Skydome.

**WIP, Philadelphia, 509m (590k), E. S. D. S. T.—** 3:05 P. M., visiting artists and chats with celebrities. 3:30 P. M., concert by Comfort's Philharmonic orchestra; soloists, Loda Goforth, soprano; Edwin McKnight, xylophone soloist. 6 P. M., weather forecast. 6:05 P. M., dinner music by Eddie Elkins' orchestra from the El Kadia Gardens. 6:45 P. M., Agriculture livestock and produce market reports. 7 P. M., Uncle Wip's bedtime stories and roll call for the children.

## Saturday, July 19

**KDKA, Pittsburgh, 326m (920k), E. S. D. S. T.—** 5:30 P. M., dinner concert by KDKA Little Symphony orchestra. 6 P. M., baseball scores; (Continued on page 18)

# Mid-Summer Radio Dominates Roaring Surf, Bosky I



(Foto Topics)

THEY are having a raft of Mid-Summer radio fun. Instead of attending the National Democratic Convention in person, this group and many others like it transported their portable set to a raft at City Island, N. Y., where they heard the bang of the chairman's gavel without perspiring.

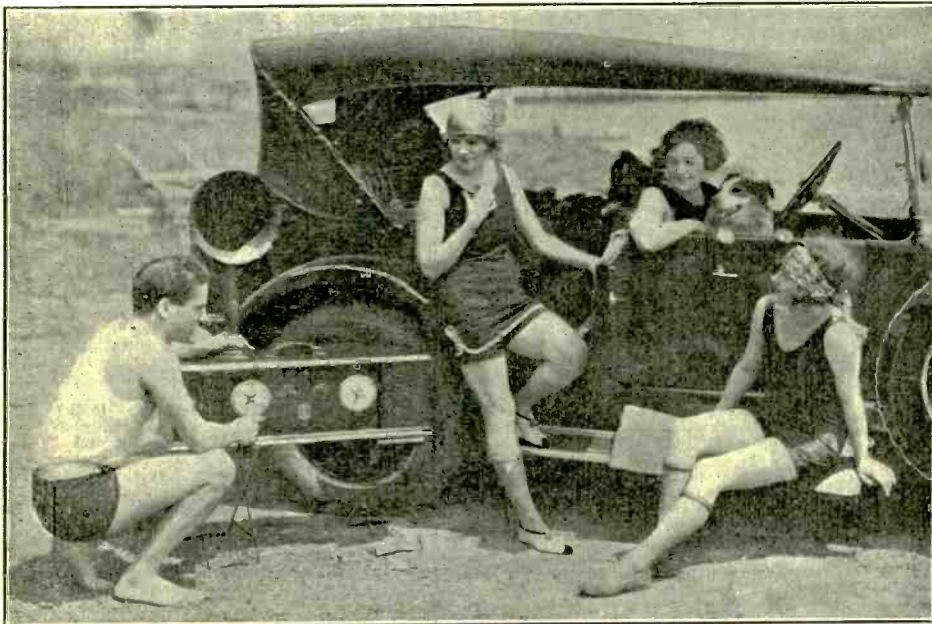

COME ON! LET'S GO! is the cry when the sun starts coming down in heat waves. So the host and guests pile into the machine and spin down to where the water waves splash and where they can hear the radio waves in comfort through their Super-Heterodyne.

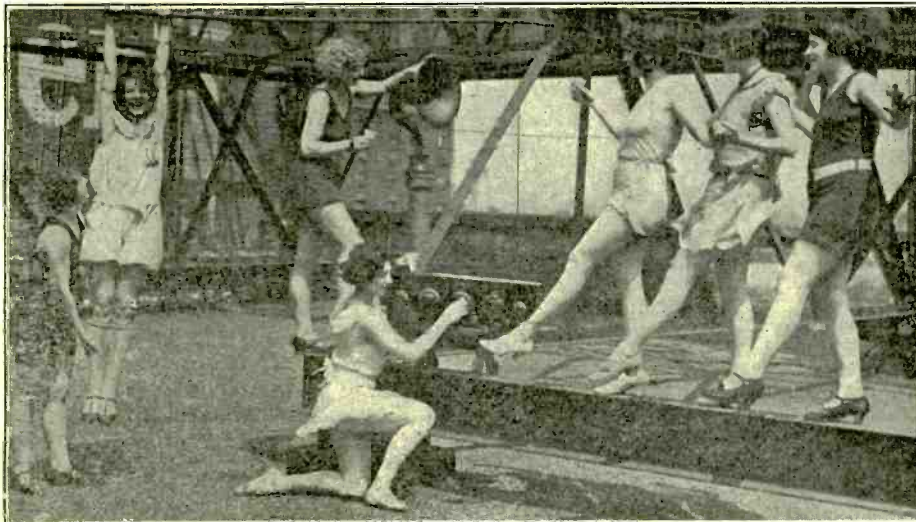

(Kadel & Herbert)

THIS IS HOW stage girls keep cool while going through their steps. The heat problem is solved by taking the portable radio up to the roof and tuning in on any convenient station that suits. This scene is an everyday occurrence now on many New York office building roofs.



IN VENICE, California, Sylvia Breamer, movie ac

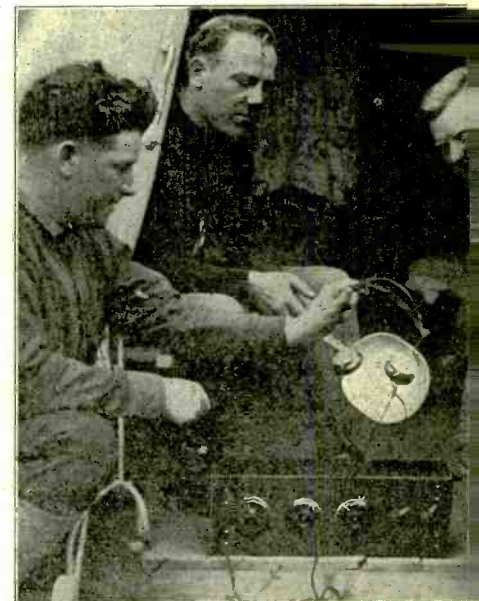

(Foto Topics)

MEMBERS of the New York police force in train dish pan from the mess kit for a lo

# Dell and Neck of Woods, Spreading Its Impartial Joy

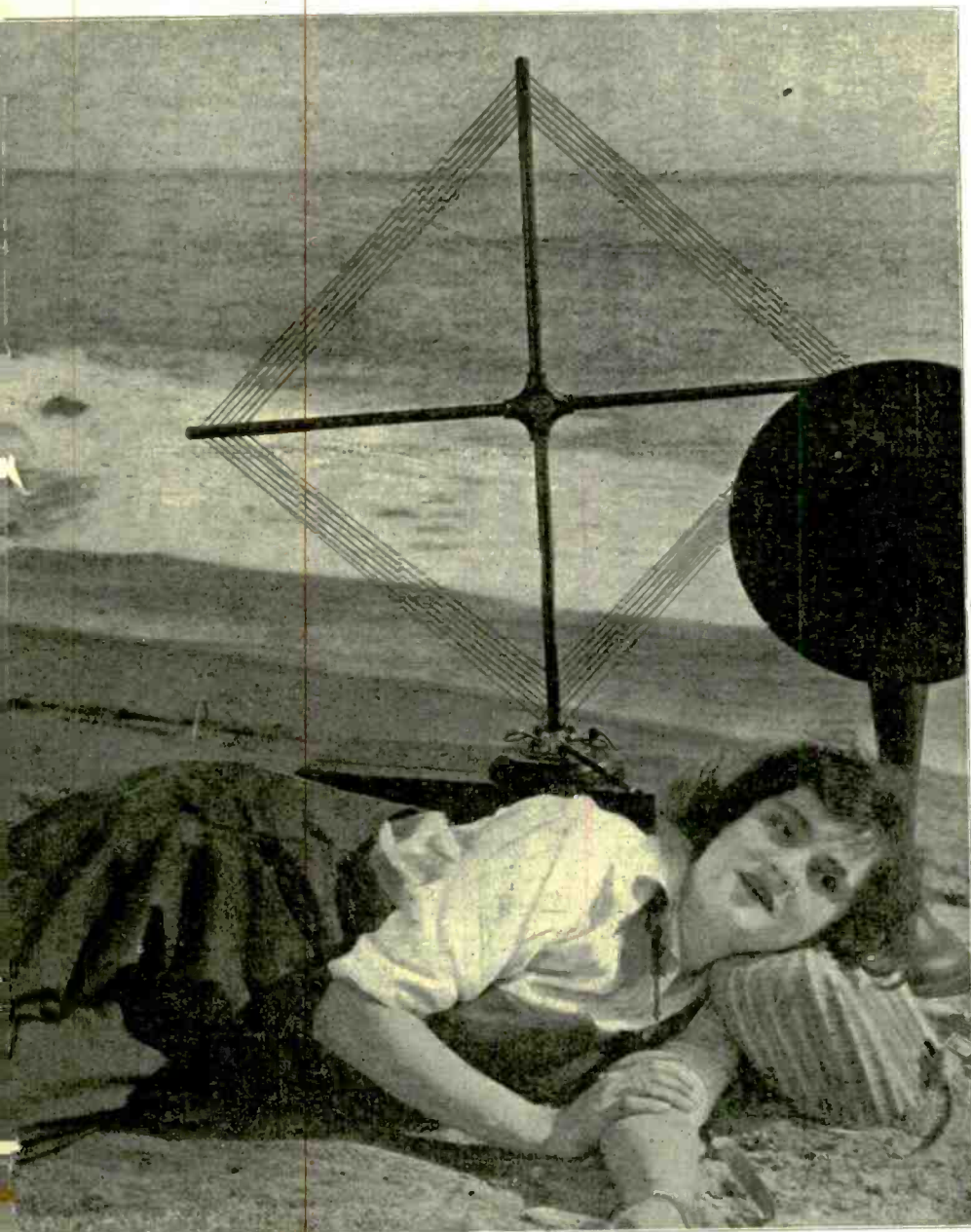

ress, rests up between shots by

listening to the cooling ocean waves and the inspiring radio waves at the same time. Portable sets are very popular with the movie folk, especially with a loop to improve Mid-Summer reception. Cooled physically by the breeze and mentally by the radiocast music, the actors and actresses, even in costume, spend an enjoyable rest period.



ing camp utilize a tin ad speaker.



(Boy Scout Foundation)

**THE BOY SCOUTS** certainly know what to take along on a camping trip. A good radio set, a small tent, and a quiet spot in the woods provide a pleasant week-end outing for these two Scouts in Mid-Summer. Wonder if they are listening to some radiocast station that's telling how to fry bacon and eggs? That seems to be the all-absorbing question in the above photograph. At right, two Boy Scouts tuning in and transcribing code in Central Park, New York City, as part of their Mid-Summer fun.



(International Newsreel)

**AT LAST** the nightingale is persuaded to appear before the microphone! The transmitter (above), is in an English garden.



(International Newsreel)

**LT. B. W. WRIGHT**, announcer, and Lt. Donald Bruner, pilot of the first radiocasting airplane, which flew over Washington in a special test.



(Foto Topics)

**THE BOYS SCOUTS** getting code in the park.

# Quality Reception on Deresnadyne

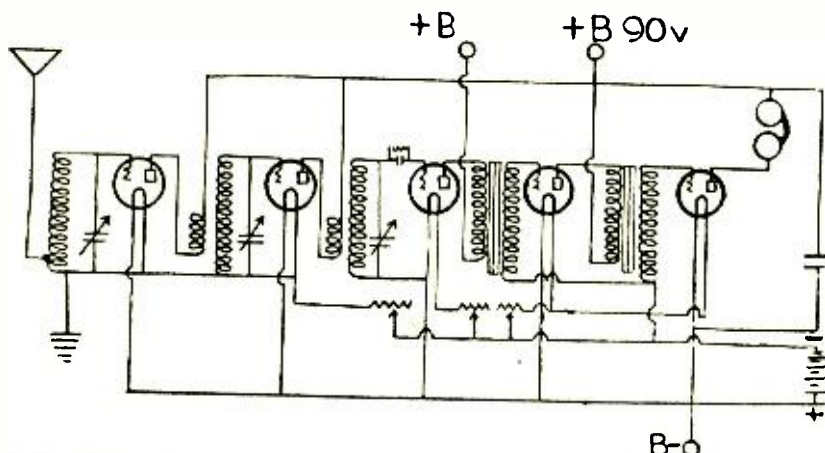

FIG. 1—The RF transformers are wound on spider-web coils with No. 28DSC wire. The primary is six turns near the hub of the spider, which is  $1\frac{1}{4}$  inches in diameter; the secondary consists of sixty-two turns of the same size wire, wound in the same direction. The outer end of the secondary is connected to the grid, the inner end of the secondary to the filament close to the tube socket. The outer end of the primary is connected to the plate and the inner end of the primary is connected to the terminal of the B battery. The three tuning condensers are at the left evenly spaced with the dials about six inches from center to center. Below each condenser is bracketed a shelf two inches wide and six inches long extending toward the rear of the cabinet. The first transformer used for coupling the antenna to the first tube has only one winding of 62 turns. This winding has a tap 15 turns from the inner end. The grid of the first tube connects to the outer end of the winding, the antenna connects to the tap and the inner end connects to the filament of the first tube and the ground. The grid return of the radio frequency tubes connect to the negative side of the filament while the detector return connects to the positive.

THE Deresnadyne receiver (Fig. 1) is the invention of E. A. Beane and E. F. Andrews, of Chicago. The first sets were constructed in the early part of 1923. The

development work has been carried on continuously from that time, culminating in the commercial Deresnadyne receiver of today. The circuit it-

self is similar to that of standard tuned radio-frequency hookups, differing in the omission of certain parts heretofore considered necessary and in the proportioning and placing of the parts.

Perhaps its most impressive feature is its beautiful and clear reproduction. This superior tone quality is, however, attained without the slightest sacrifice of volume or distance. It is extremely selective, tuning sharply enough to eliminate any ordinary interference, even in congested areas, and at the same time avoiding the critical sharpness which makes tuning difficult. Another outstanding feature is its freedom from undesired oscillations that produce whistling and distortion.

These qualities are attained not by the addition of complicated and delicate apparatus, but solely through the proper designing, proportioning and placing of the basic elements necessary in any tuned radio-frequency circuit. The specially designed radio-frequency transformers have their primaries constructed for low impedance. This constitutes the deresonated plate circuit from which the Deresnadyne derives its name. The plate, circuit which includes the primary of the transformer, is designed so as never to approach too closely to resonance at broadcasting wavelengths. The transformers are also placed with relation to one another so that the proportions and interrelations throughout the set eliminate oscillation over the entire wavelength band to be covered.

## Programs

Saturday, July 19 (continued from page 15)

dinner concert. 6:30 P. M., Little Miss Merry Heart, songs for children. 6:45 P. M., news bulletins. 7 P. M., baseball scores. 7:15 P. M., farm program arranged by National Stockman and Farmer. 7:40 P. M., market reports. 8 P. M., concert by KDKA Little Symphony orchestra, and Barbara Wellman, contralto. 9:55 P. M., time signals; weather forecast; baseball scores. 10 P. M., concert.

KYW, Chicago, 536m (560k), C. S. D. S. T.—5:02 P. M., news, financial and final markets. 6 P. M., dinner concert broadcast from Congress Hotel. 8 P. M., talk by Vivette Corman, Home Economics Dept. 8:05 P. M., Youth's Companion, short stories, articles and humorous sketches. 8:20 P. M., musical program.

WBZ, Springfield, Mass., 337m (890k), E. S. T.—6 P. M., Schraft's symphony ensemble. 6:30 P. M., Leo Reisman Hotel Lenox ensemble. 7 P. M., results of games, Eastern, American and National leagues. 7:10 P. M., Leo Reisman and his Hotel Brunswick orchestra. 7:30 P. M., bedtime story for the kiddies. 7:40 P. M., concert by Hotel Kimball trio. 9 P. M., Leonard Doersam, baritone; Florence Doersam, pianist and accompanist. 9:30 P. M., Harmonica solos by Harry Cummings. 10:55 P. M., time signals; weather reports.

WLAG, Minneapolis, 417m (720k), C. S. T.—7:30 P. M., business messages. 8:15 P. M., municipal concert from Lake Harriet, Minneapolis. 11 P. M., dance program, Geo. Osborn's Nicollet Hotel orchestra; Wendell Hall, of N. Y., soloist.

WOC, Davenport, Ia., 484m (620k), C. S. T.—9 A. M., opening market quotations. 10:55 A. M., time signals. 11 A. M., weather and river forecast. 11:05 A. M., government bulletins. 11:15 A. M., closing market quotations. 12 noon, chimes concert. 12:15 P. M., weather forecast. 7 P. M., sport news and weather forecast. 9 P. M., orchestra program, the Palmer School Radio orchestra.

WLW, Cincinnati, 423m (709k), C. S. D. S. T.—11 A. M., weather forecast and business reports. 1:30 P. M., market reports.

KHJ, Los Angeles, 395m (760k), P. T.—6 P. M., Art Hickman's concert orchestra from Biltmore Hotel. 6:45 P. M., children's program presenting Prof. Walter Sylvester Hertzog; bedtime story by Uncle John. 8 P. M., program, courtesy of Mrs. J. L. Hunter, San Juan Inn, San Juan Capistrano, presenting Julie Kellar, harpist, and her trio. 10 P. M., Art Hickman's dance orchestra from Biltmore Hotel.

WNAC, Boston, 278m (1080k), E. S. D. S. T.—10:30 A. M., WNAC women's club talks. 1 P. M., dance, broadcast from Checker Inn. 6:30 P. M., WNAC dinner dance, broadcast from Hotel Westminster. 8:15 P. M., dance music, State Ballroom orchestra. 9:15 P. M., dance music, Hotel Westminster orchestra. 10:15 P. M., dance music, Copley Plaza orchestra.

WOR, Newark, N. J., 405m (740k), E. S. D. S. T.—6:15 P. M., "Music While You Dine," Ernie Krickett's Cinderella orchestra. 7:20 P. M., resume of the day's sports. 8 P. M., concert by the Felice string quartet. 8:30 P. M., recital by

William L. Guggolz, baritone. 8:45 P. M., Col John T. Martin, veteran of '98 and World War, in an address, "Americanism." 10 P. M., Gotham entertainers of New York.

WHN, New York, 360m (830k), E. S. D. S. T.—6 P. M., Around the Alamac's Festive Board: Olcott Vail's trio; jests by Toastmaster; talks and songs by renowned folk; dance music by Paul Specht and his Alamac orchestra. 7:30 P. M., musical program: 8 P. M., Jimmy Flynn, tenor, popular songs. 8:15 P. M., George Joy and Clarence Gaskill, popular program. 8:30 P. M., Emma Soltis, concert violinist; Ludwig Antonelli, accompanist. 8:50 P. M., Big Brother period. 9 P. M., Ellen Montague Cross concert company. 9:30 P. M., Joseph C. Wolfe, baritone. 9:45 P. M., Fitzpatrick Brothers, singing old time melodies. 10 P. M., special man's program. 11 P. M., musical program to be announced. 11:30 P. M., Jimmy Clarke and his Entertainers.

WJZ, New York, 455m (660k), E. S. D. S. T.—5 P. M., Clementine Rigo, soprano. 5:30 P. M., State and Federal agricultural reports; Farm and Home reports; closing quotations N. Y. Stock Exchange; foreign exchange quotations; Evening Post news. 7 P. M., Waldorf-Astoria orchestra. 8 P. M., "The Radio Telescope or Directional Receiving," by Dr. Alfred N. Goldsmith, Chief Broadcast Engineer, R. C. A. 8:25 P. M., Stadium concert by New York Philharmonic orchestra. 10:30 P. M., Paul Specht's Club Lido Venice orch.

WRC, Washington, 469m (640k), E. S. T.—5:15 P. M., instruction in international code. 6 P. M., children's hour by Peggy Albion. 7:45 P. M., Bible talk. 8 P. M., a talk on radio. 8:15 P. M., song recital by William Stanley Quinn, baritone. 8:30 P. M., piano recital to be announced. 8:45 P. M., song recital by Elsie V. Lang, contralto. 9 P. M., musical program. 9:30 P. M., concert of Hawaiian music. 9:55 P. M., time signals and weather forecasts.

WEAF, New York, 492m (610k), E. S. D. S. T.—4 to 6 P. M., dance music by Bob Fridkin's orchestra; Mary Rowe Davis, contralto. 6 to 12 P. M., dinner music from the Rose Room, Hotel Waldorf-Astoria; Harry W. Niles, bass; Yola Powell, soprano, accompanied by Mme. Florence Wessell; Vladimir N. Droydoff, Russian pianist; Gladys Gavreau, violinist; Vincent Lopez and his orchestra from Roof Garden, Hotel Pennsylvania.

WCAE, Pittsburgh, 462m (650k), C. S. D. S. T.—3:15 P. M., baseball schedule; results of games. 6:30 P. M., dinner concert from William Penn Hotel. 7:30 P. M., Uncle Kaybee. 7:45 P. M., baseball scores; vocal selections by Lew Kennedy, baritone; Miss Irene Setzler, piano. 9:30 P. M., musical program popular dance music, Brown's Original orchestra.

WGI, Medford, Mass., 360m (830k), E. S. D. S. T.—7:15 P. M., code practice; New England weather forecast; New England crop notes. 7:30 P. M., talk on current events by David M. Cheney; musicale; weather reports and time.

KSD, St. Louis, 546m (550k), C. S. T.—8 P. M., Missouri Theatre orchestra and specialties broadcast direct from Missouri Theatre.

WIP, Philadelphia, 509m (590k), E. S. D. S. T.—6:05 P. M., dinner music, Kentucky Serenades. 6:45 P. M., Agriculture livestock and produce market reports. 7 P. M., Uncle Wip's bedtime stories and roll call for the children. 8 P. M., concert by Comfort's Philharmonic orchestra; soloists, Loda Goforth, soprano. 8:45 P. M., "What the Wild Waves are Saying," picked up

by a microphone placed amidst the breaking waves. 8:0 P. M., concert by Vessella's concert band; soloist, Rita Aprea, soprano. 10 P. M., dance music by Bob Leman's dance orchestra. 11:05 P. M., organ recital by Karl Bonawitz, broadcast from the Germantown Theatre.

## Sunday, July 20

KYW, Chicago, 536m (560k), C. S. D. S. T.—10 A. M., Sunday morning service broadcast from St. Chrysostom's Episcopal Church. 1:30 P. M., studio chapel service radiocast from studio. This service furnished by the Chicago Church Federation.

WFAA, Dallas, Tex., 476m (630k), C. S. T.—6 P. M., radio Bible class, William M. Anderson, pastor First Presbyterian Church, teacher; Bible study and Gospel song. 9 P. M., sacred song recital by choristers from East Dallas Christian Church.

WDAF, Kansas City, 411m (730k), C. S. T.—Baseball scores at 3:30, 4, 4:30 and 5 o'clock. 4 P. M., program broadcast from the Newman Theatre.

WOS, Jefferson City, Mo., 441m (680k), C. S. T.—8 P. M., union open air religious services broadcast from the capitol lawn; music by the Missouri State Prison band.

KGW, Portland, Ore., 492m (610k), P. T.—6 P. M., church services conducted by Piedmont Presbyterian Church, W. Bergen, pastor.

WGY, Schenectady, 380m (790k), E. S. T.—9:30 A. M., service of First Reformed Church, Schenectady, sermon by the Rev. Dr. Clayton J. Potter. 7:30 P. M., concert by New York Philharmonic orchestra from Lewisohn Stadium, New York.

WHAS, Louisville, Ky., 400m (750k), C. S. T.—9:57 A. M., organ music. 10 A. M., church service, auspices Methodist Temple, Dr. Charles A. Humphrey, pastor; music by the choir; Miss Jane Graves, organist. 4 to 5 P. M., concert, direction of Mrs. Jane Webster Murrell.

WOAW, Omaha, Neb., 526 (570k), C. S. T.—9 A. M., Radio Chapel service, conducted by Rev. R. R. Brown, pastor of Omaha Gospel Tabernacle; Marie Danielson, soloist; Mrs. Albert McIntosh, pianist. 9 P. M., musical chapel service, courtesy Third Presbyterian Church.

WGI, Medford, Mass., 360m (830k), E. S. D. S. T.—5 P. M., Twilight program, "Adventure Hour," by Youth's Companion; musicale; talk under auspices Greater Boston Federation of Churches, by Rev. Earl E. Harper; vocal duets by Rev and Mrs. Harper.

KGO, Oakland, Cal., 312m (960k), P. T.—3:30 P. M., concert by KGO Little Symphony orchestra and soloists, Carl Rhodehamel conducting.

WIP, Philadelphia, 509m (590k), E. S. D. S. T.—7:30 P. M., evening service, broadcast direct from Holy Trinity Church, Rev. Floyd W. Tomkins, D.D., rector. 9:30 P. M., special Sunday evening concert, with prominent soloists, broadcast from the WIP control station on the Steel Pier, Atlantic City.

## Monday, July 21

WMAQ, Chicago, 448m (670k), C. S. D. S. T.—4 P. M., sport results. 6 P. M., Chicago Theatre organ recital. 6:30 P. M., Hotel LaSalle orchestra.

WFAA, Dallas, Tex., 476m (630k), C. S. T.—12:30 P. M., address, Hon. Charles F. Greenwood, president the San Jacinto Society, on "Texas and Her Civil Government." 8:30 P. M., musical re-

(Continued on next page)

# MARCONI PREDICTS REVOLUTION IN RADIO

ROME.

**N**O more power stations, because short-wave radiocasting will render them unnecessary. Waves will be so short they will be measured in centimeters. Directional radio will be the thing—waves sent in a single direction, like a beam of light, instead of in all directions at once. The waves will be so short that they will be static-proof! The cost of radiocasting thus will be greatly reduced.

These predictions were made by Guglielmo Marconi, wireless inventor, in an address before the scientists of Rome in the Capitoline Building.

Senator Marconi also announces his discovery that the intensity of wireless signals varies with the mean height of the sun over the region between the sending and receiving stations. What effect the sun has on the wireless waves is also still wrapped in mystery, he concluded.

LONDON.

The world will be served by a single system of radiocasting, it was predicted today before the World Power Conference in a joint contribution made by W. J. Brown of Metropolitan Cities, Great Britain, and Dr. W. H. Easton of the Westinghouse Company of the United States.

The system, it was stated, would be based on the use of inaudible short waves sent out by large stations and caught by small local stations, which would radiocast on audible wave lengths.

## Programs

(Continued from preceding page)

cital, J. M. Cox and His Male and Mixed Quartets in gospel songs.

**CKAC, Montreal, 425m (710k), E. S. D. S. T.—** 1:45 P. M., classical concert from Mount Royal Hotel. 4 P. M., weather; stocks; news. 4:15 P. M., music.

**WDAF, Kansas City, 411m (730k), C. S. T.—** Baseball scores at 3:30, 4, 4:30, 5 and 6 o'clock. 3:30 P. M., the Star's radio trio. 5 P. M., weekly Boy Scout program, presented by Kansas City Council. 5:50 P. M., marketgram; weather forecast; time signal and road report. 6 P. M., address, Clay Harvey; address, speaker from Univ. of Kansas; children's story and information period. Carl Nordberg's Plantation Players. 8 P. M., program by the Star's radio orchestra and the WDAF minstrels.

**WHAZ, Troy, N. Y., 380m (790k), E. S. T.—** 9 P. M., Marshall Athletic Club in solo, quartet and minstrel chorus numbers, with popular songs by little Dorothy Donohue.

**WOS, Jefferson City, Mo., 441m (680k), C. S. T.—** 8 P. M., address, "Cattle Insects and Their Control," and "Roquefort Cheese from Cows' Milk," by Colonel Arthur T. Nelson, State Market Commissioner. 8:20 P. M., musical program by the Missouri State Prison orchestra.

**KGW, Portland, Ore., 492m (610k), P. T.—** 11:30 A. M., weather forecast. 3:30 P. M., literary program by Portland Library Association. 7:15 P. M., police reports. 7:30 P. M., baseball scores; weather forecast; market reports. 8 to 10 P. M., concert by pupils of Mitylene Fraker Stites.

**WGY, Schenectady, 380m (790k), E. S. T.—** 1 P. M., music and food hints from the U. S. Department of Agriculture. 5 P. M., produce and stock market quotations; news bulletins; baseball results. 5:15 P. M., review of week's sports, "Joe" Haubner. 7:40 P. M., baseball results. 7:45 P. M., musical program.

**WHAS, Louisville, Ky., 400m (750k), C. S. T.—** 4 to 5 P. M., selections by Alamo Theatre orchestra; police bulletins; weather forecast; "Just Among Home Folks," daily humorous column; Dick Quinlan's Golden Derby orchestra; late news bulletins. 4:50 P. M., local livestock, produce and grain market reports. 4:55 P. M., baseball scores. 5 P. M., Central Standard time announced.

**WOAW, Omaha, Neb., 526m (570k), C. S. T.—** 6 P. M., popular half hour. 6:30 P. M., dinner program by Randall's Royal orchestra. 9 P. M., dance program by Bob Lee's Imperial Jazz Band.

**KGO, Oakland, Cal., 312m (960k), P. T.—** 3 P. M., studio musical program. 4 P. M., Henry Hal-

(Concluded on page 28)

## Marching Onward

**T**HE Super-Heterodyne's popularity is growing. Readers of RADIO WORLD have evinced a keen interest in a recent Super-Heterodyne using only four tubes, and concerning which a theoretical discussion and trouble-shooting article appears in this issue. Now, how would you like a 4-tube Super-Heterodyne, with crystal detector giving that wonderful clarity and purity of tone for which the crystal is famous? The usual

two stages of audio-frequency amplification are included in the four tubes. In next week's RADIO WORLD, dated July 26, out July 23, Charles H. M. White, consulting engineer, presents as interesting a Super-Heterodyne as you would run across in a year. Three stages of radio-frequency amplification, oscillator, crystal detector and two stages of AF are the wonderful combination in Mr. White's circuit. As Mr. White was a professor of engineering at Massachusetts Institute of Technology, and has been an ardent radio experimenter since boyhood, you can well imagine he has an interesting and authoritative article ready for you. His circuit operates on a loop, of course, though aerial may be used. His article is entitled "A 4-Tube Reflexed Super-Heterodyne."

Another expert will give you a crystal hook-up to delight you—just a plain, honest-to-goodness crystal circuit, using tapped variocoupler, added to which are one stage of transformer-coupled AF and two stages of resistance-coupled AF. Thus the clear volume of one transformer stage is amplified without any distortion by the resistance method. A. P. Peck is "simply wild" about the results he gets from this hook-up. Read his article, "1,000 Miles on a Loud Speaker," and learn why. RADIO WORLD readers have great confidence in Mr. Peck, and that confidence was largely increased when, in RADIO

WORLD, issue of July 12, he sprang his remarkable one-tube double reflex—RF, detector and AF all on one tube. He is working on something equally sensational and—well, more about that another week.

"Sidelights on the Metaform," by Walt S. Thompson, Jr., gives some interesting observations on the functioning of this remarkable receiver by the brilliant inventor of the method himself. RADIO WORLD readers will remember that in the issues of this magazine, June 21 and 28, this new system of reception—"better than the Super-Heterodyne"—was first presented to the world. Those more advanced in radio will be particularly interested in Mr. Thompson's sure-footed treading of untrammelled paths.

"A Demonstration Receiver," by Byrt C. Caldwell, describes an excellent hook-up for those desiring great volume. Radio retailers who want volume that really attracts customers should have a set like this to demonstrate real results. The grating barking of some receivers in stores, operated mainly to attract passers-by, is repulsive. Why noise, instead of voluminous, beautiful tones? After reading this article by this gifted radio enthusiast one might well ask: "Why noise?" Even in one's home many a person likes tremendous volume, yet is unwilling to sacrifice quality. Mr. Caldwell has a circuit that satisfies that large element.

"The Grid Return," by N. N. Bernstein, Technical Editor, a full discussion of what and why it is; "A Simplified Terminal Strip," and other features also will be published in the July 26 issue.

## RADIO WORLD

15 Cents

Illustrated

ISSUE OF JULY 19, 1924

Vol. 5. No. 17.

A Weekly Paper Published Every Wednesday and Dated Saturday, by Hennessy Radio Publications Corporation from Publication Office, 1493 Broadway, New York, N. Y. Phones: Lackawanna 6976 and 2063.

## TABLE OF CONTENTS

A Two-Control Super-Neurodyne, by Byrt C. Caldwell. (Illustrated).....	Page 3
Getting a Strangle Hold on Static, by Brewster Lee. (Illustrated).....	Page 4
Why No Grid Condenser or Leak in the 4-Tube Super-Heterodyne? Where's the Detector? By Herman Bernard. (Illustrated).....	Page 6
Loops, by B. J. Bongart. (Illustrated.) How to Make Loops. Which Type Is Best and Why. The Loop Aids Mid-Summer Reception.....	Page 8
Special Portrait of Roxy, Autographed for RADIO WORLD Readers, with An Intimate Verbal Sketch.....	Page 11
The Superdyne Lauded to the Skies by RADIO WORLD Readers. (Illustrated.)	
Tips to Superdyne Owners, by N. N. Bernstein, Technical Editor.....	Page 12
The Passing of the Lonely Bivouac, by Joseph Mulvaney. (Illustrated.)	
How the Lonely Haunts of Man Have Been Humanized by the Radio.....	Page 14
Advance Radiocast Programs.....	Page 15
Mid-Summer Radio Activities Told in Pictures.....	Pages 16 and 17
The Deresadyne Circuit. (Illustrated).....	Page 18
Marconi Predicts Radio Revolution.....	Page 19
Solving Your Panel Troubles. (Illustrated).....	Page 20
The Radio University. Questions and Answers. (Illustrated).....	Page 21
The Radio Trade.....	Page 22

A THOUGHT FOR THE WEEK—Through my radio both fun and instruction come to my eager ears as through a constant miracle. In the city I hear the programs from the countryside. On vacation, I hear the voice of the city as it pierces the heart of the country.

# RADIO WORLD

Title Reg. U. S. Pat. Off.

TELEPHONE: LACKAWANNA 2062, 6976

PUBLISHED EVERY WEDNESDAY

(Dated Saturday of same week)

FROM PUBLICATION OFFICE,

HENNESSY RADIO PUBLICATIONS CORPORATION

BOLAND BURKE HENNESSY, President

M. B. HENNESSY, Vice-President

FRED S. CLARK, Secretary and Manager

1493 BROADWAY, NEW YORK, N. Y.

New York Representatives: James H. Carroll, W. H. Oke,

Circulation Manager: David Yokel.

Boston Representative: Chas. H. M. White, 18 Stuart

Street, Boston, Mass.

Chicago Representative: Mat H. Friedman, 519 East 60th

Street, Chicago, Ill.

Cincinnati Representative: Samuel H. Jaffee, 1117

President Bank Bldg., Cincinnati, O.

European Representative: The International News Co.,

Broom's Bldgs., Chancery Lane, London, Eng., Paris,

France, Brentano's 22 Avenue de l'Opera.

EDITOR, Roland Burke Hennessy  
MANAGING EDITOR, Herman Bernard  
TECHNICAL EDITOR, N. N. Bernstein

## SUBSCRIPTION RATES

Fifteen cents a copy. \$6.00 a year. \$2.00 for six months. \$1.50 for three months. Add \$1.00 a year extra for foreign postage. Canada, 50 cents.

Receipt by new subscribers of the first copy of RADIO WORLD mailed to them after sending in their order, is automatic acknowledgment of their subscription order. Changes of address should be received at this office two weeks before date of publication. State whether subscription is new or a removal.

## ADVERTISING RATES

FLAT RATE—Page, 7 1/2x11", \$150; half page, 3 1/2 D. C. or 5 1/2x8 col., \$75; quarter page, 4 1/2 D. C., \$37.50; one col., 3 1/2x11", \$50—\$5 per inch. Back cover page, two colors, \$250. Preferred positions 20% extra.

## CLASSIFIED ADVERTISEMENTS

Five cents per word. Minimum, 10 words. Cash with order.

Entered as second-class matter, March 23, 1922, at the Post Office at New York, New York, under the act of March 3, 1879.

JULY 19, 1924

## Why the Superdyne is so Popular

THE enduring and even growing popularity of the Superdyne can be ascribed mainly to its extremely fine tone quality. Those who appreciate quality of that sort go almost into paroxysms of joy in telling of the wonderful results. Also, the sensitivity of the Superdyne compares favorably with that of the Super-Heterodyne. Some constructors report getting great distances, most say that middle distance is all they get or desire. That the radio public clings so devotedly to Superdyne, and gives it a niche in the Radio Hall of Fame, instead of dropping it for something else, is a verdict that carries great weight. There are other splendid circuits—Super-Heterodyne, Neutrodyne, Reflex and the like—but it is praise enough that the Superdyne has been given its place among the best.

## QUERY

NOW that the 4-Tube Super-Heterodyne (using no detector at all) is here, will there ever be a 3-Tube Super-Heterodyne? What do you think?

## Solving Panel Troubles

ONE of the most serious and expensive difficulties in panel work is the mounting of moving parts so that they will rotate smoothly. This is due to inaccurate drilling, resulting in the movable shaft binding. In the case of a variable condenser or variocoupler the instru-

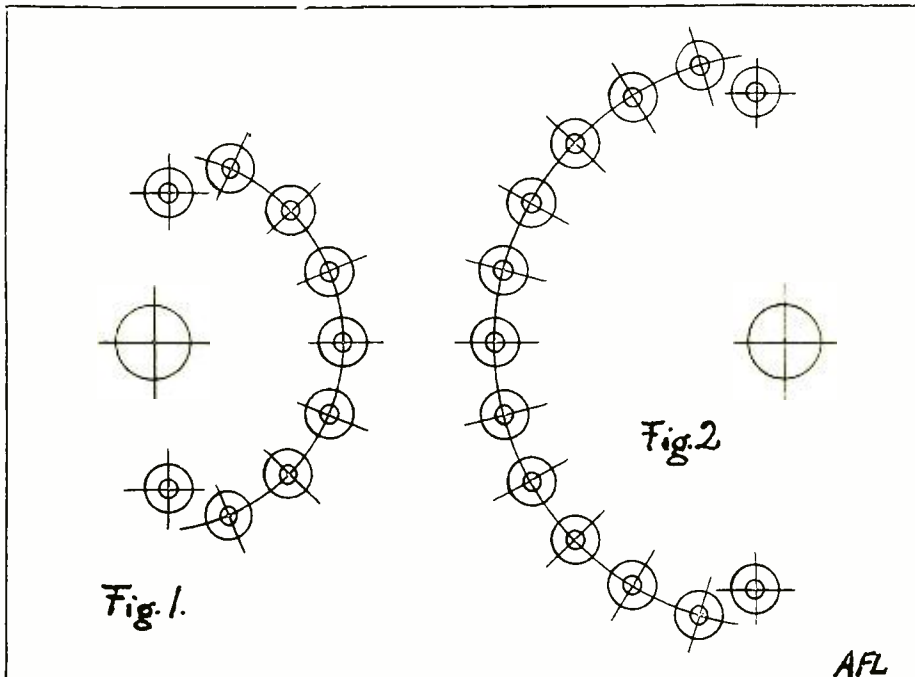

TEMPLATE for drilling for tap switch with 3/4-inch contact arm (Fig. 1), and template for 1 1/2-inch arm (Fig. 2.)

ment may be ruined in this way. At least, the rotor will move stiffly, perhaps condenser rotor plates slide against the fixed plates, and general disgust arise. If templates are furnished by the manufacturer, and care is exercised in following the markings precisely, this difficulty is avoided. Unfortunately, some manufacturers do not furnish templates, though it would be to their commercial interest to do so. If confronted with the annoyance of absentee templates, you must make your own. Fasten the machine screws to the instrument. Take a piece of stiff cardboard and drill a hole the size of the shaft of the part you are going to mount. This is normally 1/4 inch.

Then insert the shaft through the hole and press the cardboard simultaneously against the machine screw heads. If you press them one at a time you may draw the cardboard on a bias and thus mount the part wrongly after all. For the same reason do not use light paper. The impression on the cardboard will not be very distinct, but the circumference of the screw heads will be plainly visible, and

probably the slot mark will show up, too. At any rate, you will have sufficient guidance for determining the center of the impressions. Pierce this center with a pin. Then decide where the part is to be mounted on the panel, drill the shaft hole, insert the part "inside out," so the shaft protrudes through the FRONT of the panel, and slide the home-made template onto the shaft. Then with a fine drill, or center punch, mark your panel for drilling for the machine screws.

As considerable expertness is required even to accomplish this seemingly easy mounting, it often happens that if two holes must be drilled for the screws, one will be perfect, the other off center about 1-32 of an inch, just enough to occasion the same old perilous trouble of biased mounting. To remedy this, use a slightly larger size drill for the imperfect hole. You will find that the one perfect hole gives a good grip on one end of the part and that a thoroughly serviceable

(Concluded on page 25)

## Sharing a Sorrow

SORROW knows no station. It comes to the lowly and the mighty—and always it should be shared by others, so that the burden of those stricken may be made lighter, if only by so little as the weight of a single loving thought. And so to President Coolidge and Mrs. Coolidge go the sympathy and love of a whole nation. Let us hope that He who, two thousand years ago, also lost a son, may give them strength to look back smilingly at the happy years that have been, and to remember tenderly a boy's young and eager face, and to meet the coming years with clear vision and true fortitude.

THE EDITOR.

# The Radio University

**A** Question and Answer Department conducted by RADIO WORLD for its Readers by its Staff of Experts. Address Letters to Radio University Department, RADIO WORLD, 1493 Broadway, New York City.

I see in your May 17 issue a diagram of the Superdyne circuit. Will you kindly advise me where I can obtain complete data on the Superdyne and explanation of what causes the first tube to block, and how to prevent it? I would like to get all the information possible on this circuit.—Earl E. Teater, Box 286, Steubenville, Ohio.

Complete constructional data and technical discussion of how the circuit works was published in RADIO WORLD for May 17, 24 and 31, July 5 and 12. An article is in this issue, too. You should be able to get all the information desired from these numbers.

In RADIO WORLD for June 14 a hook-up is published of a Super-Power 4-tube reflex set which I intend to build, but would like the following questions answered before I start. 1—Where is the point marked X on the diagram. I am unable to locate it. 2—What is meant by the term loosening and tightening the coupling between the primary and secondary of the coupler. 3—Can I use a variocoupler having twelve primary taps, and a basket weave rotor in this circuit instead of the coupler mentioned?—Henry W. Pfeil, 154 Chester St., Buffalo, N. Y.

The point X is shown in RADIO WORLD for July 5 in Fig. 22 in the University Department. 2—Loosening and tightening the coupling of a variocoupler is accomplished simply by turning the rotor. When the windings are parallel, the coupling is tight, and when placed at right angles, the coupling is loose. The variations are between these two points. 3—Yes, the variocoupler you have will be satisfactory in this circuit, provided you are able to take off the necessary number of turns of wire as directed in Byrt C. Caldwell's article.

Being a constant reader of RADIO WORLD, it gives me great pleasure to send in a circuit diagram of a set I have constructed which will surprise the most skeptical for its volume, clarity and easy tuning qualities. I am sure that all the readers of the RADIO WORLD University Department will try this new circuit.—Chas. Blumensheid, 102 Ogden Ave., Jersey City, N. J.

We are pleased to publish your circuit herewith, Fig. 24, with a list of the parts necessary to build the same:

The aperiodic primary is a 1,500-turn honeycomb coil. The tube may be a UV199 heated with a

circuit telling how it works and what results are obtained.

I observed in RADIO WORLD, issue of June 21, the article on Thompson's Metaform receiver, but failed to see in the list of parts the diameter of the fixed couplers and the size of the wire. Please publish the above information.—Wilson M. Butler, 201 North Front St., Milton, Pa.

For the Metaform, the size of the tubes may be 3 or 3½" diameter, wound with No. 24 DSC wire. The primary may be wound next to the secondary or placed within the secondary in the same manner as is done in making the neutroformers for Neutrodyne sets.

In regard to the Super-Heterodyne by Chas. H. M. White, in RADIO WORLD for May 17, what changes would I have to make to use a 23-plate condenser instead of the 43-plate variable as called for in the circuit?—S. L. Finch, Lookaba, Okla.

It is not advisable to use a 23-plate condenser when the circuit specifically calls for a 43-plate. The best and safest thing is always to stick to the directions.

In RADIO WORLD, issue of June 28, you have an article by B. J. Bongart on a 4-tube Super-Heterodyne. In checking up the wiring diagram, Fig. 1, with Fig. 3, I find that the markings do not correspond. Please inform me what changes are necessary.—H. C. Molson, care Morris Radio Shop, 32 East 3rd St., Mt. Vernon, N. Y.

An article in RADIO WORLD, issue of July 12, answers your query. Also see article in this issue.

In RADIO WORLD for June 23, 1923, you published a hookup of interest to the vacationist. I would like to build this receiver for code reception. How many turns of wire will I have to add onto the coils in order to bring up the wave length sufficiently?—Ivan H. White, 315 Joseph St., Charleston, W. Va.

You should add 15 turns apiece to each coil. This will enable the set to tune up to over 600 meters. Use the same size wire that the rest of the coils are wound with.

I intend to build the 4-tube Super-Heterodyne by B. J. Bongart, as published in RADIO WORLD. 1—Which is the pickup coil? 2—Which tubes do you prefer, and is it essential to a separate rheostat for each tube? 3—What is the resistance of the potentiometer? 4—What is the proper B battery

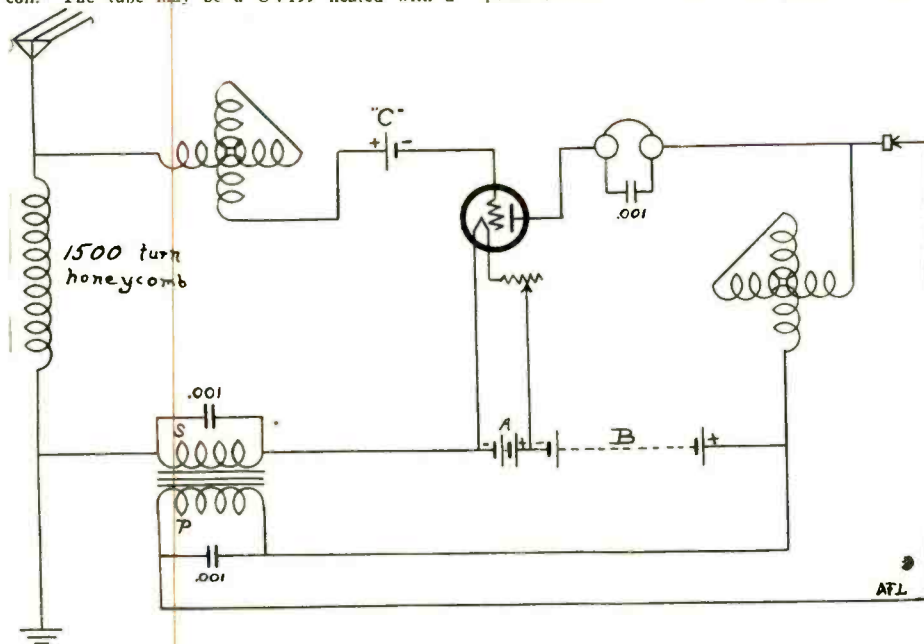

FIG. 24—Diagram of the Autoflex circuit, designed by Charles Blumensheid, 102 Ogden Ave., Jersey City, N. J. In effect, it is a regenerative reflex receiver employing an aperiodic primary consisting of a 1,500-turn honeycomb coil. This circuit should give wonderful selectivity and volume, but a little patience must be had when learning to tune with the variometers. The latter may be of any good make. For portable use a UV199 tube with dry-cell batteries may be used, but better results will probably be had if a UV201A or similar tube is employed. The C battery, which has a very long life, may be permanently wired into the circuit from one end of the first variometer direct to the grid binding post on the tube socket. This will insure a short grid lead, which is very important.

4½-volt A battery. The B battery is 22½ to 45 volts, and in the latter case the C battery is 4½ volts. The crystal detector may be fixed or adjustable. The three .001 mfd. fixed condensers should have mica dielectric. Two standard variometers, any good make, are used, and the circuit is complete, with a pair of good earphones. The designer of the circuit calls it the Autoflex. RADIO WORLD would like to hear from fans who build this

voltage to use? 5—Could I use DCC wire of the same gauge instead of the silk-covered wire for winding the coils?—A. R. Marshall, 1379 Lexington Ave., New York City.

1—The top winding of ten turns is the pickup coil and corresponds to L1 on the wiring diagram. 2—UV201A tubes or the new Schicklering tubes will be satisfactory. The second or oscillator tube

(Concluded on page 25)

## MAGNAVOX Radio Products



New model

R3—\$35.00

Current consumption in the new Magnavox Reproducer R3 is so low that it is an unimportant factor.

This feature, combined with the new Volume Control, makes the new R3 indispensable for use with every radio receiving set.

### Magnavox Reproducers

- R2 with 18-inch curvex horn \$50.00
- R3 with 14-inch curvex horn \$35.00
- M1 with 14-in. curvex horn. Requires no battery for the field . \$30.00
- M4 Latest Magnavox Reproducer. Requires no battery . \$25.00

### Magnavox Combination Sets

- A1-R consisting of electro-dynamic Reproducer with 14-inch curvex horn and 1 stage of amplification \$59.00
- A2-R consisting of electro-dynamic Reproducer with 14-inch curvex horn and 2 stages of amplification \$85.00

### Magnavox Power Amplifiers

- A1—new 1-stage Power Amplifier \$27.50
- AC-2-C—2-stage Power Amplifier \$50.00
- AC-3-C—3-stage Power Amplifier \$60.00

Magnavox products can be had at Registered Magnavox Dealers everywhere. Write for new 32-page catalogue.

The Magnavox Company  
Oakland, California

New York Office: 350 West 31st Street

Canadian Distributors

Perkins Electric Limited  
Toronto Montreal Winnipeg

## Convention Means More Radio Sets Sold in Future

*Thousands of Persons, Formerly "Not Interested" or Only Luke-Warm, Become Enthusiasts*

SO many persons who were luke-warm to radio, or "not interested" in it, were won over by the thrills of listening in on the Democratic Convention that the trade is bound to reap cumulative benefit therefrom. Sets sold "for the convention" tell only part of the story. Thus tremendously increasing the number of satisfied customers or listeners—the biggest asset any industry has—means more and more sets will be sold on the strength of it. A good thing, too, is that radio is on a par with the automobile. You can buy any well-known make of auto and get your money's worth. It works and satisfies. That's to be expected of an industry more than 7 times as old as radio. But when you can truly say it of a two-year old, like radio, it's a fine tribute. So, gleeful that they were won over, the fans whose acquisition can be laid to the convention will grow.



(Kadel & Herbert)

EN ROUTE to London, where they now are, delegates to the convention of the Associated Advertising Clubs of the World, had a great time on shipboard listening to music and speeches from their home towns, via radio. Photo shows P. L. Thompson, President of the National Advertisers, and H. H. Charles, President of the New York Advertising Club. One of the official delegates is Fred S. Clark, secretary and manager of RADIO WORLD.

# The Radio Trade

## Exclusive Distributor Appointed by Magnavox

TO place the sale of their products on a still firmer basis, The Magnavox Company has appointed the Wholesale Radio Equipment Co., of New York City and Newark, N. J., as exclusive Magnavox distributors in the New York Metropolitan District. A number of Magnavox dealers already have been registered.

## Two Arrested As Tube Bootleggers

DETECTIVE Henry Wittel, the radio expert at the Astoria precinct, New York City, believes that he has solved part of the radio trouble that has existed in his part of the city. The residents of the district have been complaining that their radio sets refused to operate. Robert Donady of 155 Fifth avenue, Astoria, had a little more difficulty than others, and he was particularly annoyed because he had bought an expensive outfit and had it installed by experts. Several days ago he took the apparatus apart looking for trouble and came to the belief that it existed in his tubes. These were labelled "Radio Corporation of America." He took the tubes to the company's office in Manhattan and he was told that the tubes, although bearing the trademark, were not manufactured by the corporation. Donady reported to Detective Wittel and Wittel went out and arrested Benjamin Birnbaum and Joseph Haberman, who were selling radio parts at 426 Broadway, Astoria.

Both men were taken before Magistrate Conway in the Long Island City Police Court charged with selling tubes wrongly labeled and were held for examination.

## MARKETS RESISTANCE COUPLER

THE Alpine Radio Corp., 28 Barclay street, New York City, recently organized, is introducing a new resistance coupler of its own manufacture. J. W. Gibson, vice-president and sales manager, stated that quantity production enables the concern to assure prompt delivery on all business.

## Population of U. S. 112,826,000

THE National Bureau of Economic Research, Inc., gave out figures a few days ago showing that the population of these United States was 112,826,000 on Jan. 1, 1924. This is an increase of 1,934,000 for the year ending December 31, 1923.

Radio dealers, how many of these millions are you going to sell to during the balance of this year? The public has been in a radio-buying mood for a long time. It is still. Its up to you to get your share. Start now to do it. Don't wait until the cool weather comes around again. Every month is a radio month.

## STERNFIELD AND DUNGAN GO IN BUSINESS TOGETHER

CHARLES B. STERNFIELD, who has been connected with the Standard Radio Corp., and Kromer Bros. Radio Stores of Chicago, for the past year and one half, has left them to engage in business for himself with G. R. Dungan, formerly of the Reliance Radio Sales, under the name of Dungan-Sternfield Radio Sales. Both men are well known in the radio market of Chicago and are handling a number of exclusive agencies for factory outputs.

## New Corporations

H. Annabel Electric Co., Queens, N. Y., \$5,000; H. and A. J. Annabel, M. E. Pideon, Attorney, E. J. Ashmead, Jamaica, N. Y.

Boston Radio Sales Corp., New York City, \$10,000; M. Klist, N. B. Siegler, Attorney, H. Bregman, 291 Broadway.

Williamson Battery Co., Wilmington, Del., manufacturing, estimated \$20,500,000. Coporation Trust Co. of America.

Majestic Radio Corp., New York City, \$10,000; I. Hetenberg, W. Strom, C. F. Lesser, Attorney, E. M. Ostrow, 56 John St.

Arcony Radio Co., New York City, \$5,000; O. Schwitzer, A. Schachter, H. Shapiro, Attorney, I. E. Kanner, 365 Broadway.

Radio Amusement Corp., New York City, slot machines, \$10,000; D. Blum, B. Zelenke, M. Hammerstein, Attorney, L. Friedman, 1540 Broadway.

Maxim Radio and Electric Co., New York City, \$25,000; L. S. Shiro, R. L. Lake, M. E. Comerford, Attorney, E. V. Daly, 32 Liberty St.

## NEW YORK STATE'S NEW RADIO CORPORATIONS SET RECORD

ALBANY, N. Y.

Figures given out by the Secretary of State show that in June more companies received charters for the manufacture and sale of radio parts and sets than during any six-month period.

MANUFACTURER RADIO WANTED by sales agency selling jobbers and chain stores, metropolitan area and New York State; commission basis. Box 444, Radio World.

## Literature Wanted

THE names of readers of RADIO WORLD who desire literature from radio jobbers and dealers, are published in RADIO WORLD, on request of the reader. The blank below may be used, or a post card or letter will do instead.

Service Editor,  
Radio World,  
1493 Broadway, New York City.

I desire to receive radio literature.

Name .....

City or town .....

State .....

Any particular kind of literature preferred? .....

.....

.....

.....

.....

.....

.....

.....

.....

.....

.....

.....

.....

.....

.....

.....

.....

.....

.....

.....

.....

.....

.....

.....

.....

.....

.....

.....

.....

.....

.....

.....

.....

.....

.....

.....

.....

.....

.....

.....

.....

.....

.....

.....

.....

.....

.....

.....

.....

.....

.....

.....

.....

.....

.....

.....

.....

## Coming Events

JULY 21 TO 26—Radio show, Burlington, Vt., auspices of R. C. A.

AUG. 16 TO 21, INCLUSIVE—Pacific Radio Exposition, Civic Auditorium, San Francisco, under auspices of Pacific Radio Trade Association, Herbert E. Metcalf, Magnavox Co., Oakland, Cal., president. A. S. Lindstrom is chairman of the exposition executive committee, assisted by C. C. Langevin, H. W. Dickow, F. J. Cramm and P. L. Jensen.

SEPT. 22-28—First Annual International Radio Show, Madison Square Garden, New York City.

OCT. 2-11—Exposition, Grand Central Palace, New York City, under auspices of American Radio Exposition Co.

NOV. 3-8—Third Annual National Radio Show, Grand Central Palace. S. L. Rothafel (Roxy) and "his gang" will broadcast from the convention.

NOVEMBER 24 TO 30, INCLUSIVE—International Radio Week.

DECEMBER 1 TO 6 INCLUSIVE—Boston Radio Exposition, Mechanics Building, Boston.

## Business Opportunities Radio and Electrical

Rates: 40c a line; Minimum 3 lines.

EXPERIENCED retail salesman, former manager of large New York City chain store, seeks opening as store manager or sales promotion expert. H. L., Box 600, Radio World.

WE DESIGN AND MAKE ANY SPECIAL machine you want; perfect inventions; make models, dies, manufacture. Box 333, Radio World.

ELECTRIC CONCERN wants party with \$10,000; absolutely secured; \$45,000 signed bonded city contracts on hand. Box 555, Radio World.



# BANG! GO THE PRICES!

THIS GENUINE FIVE TUBE RECEIVER

On A  
Ten Day  
Trial



\$49.75

WITH  
TUBES

## MONEY BACK GUARANTEE

The most beautiful and efficient receiver, built in a beautiful 7x24 mahogany cabinet with an engraved panel.

If, within ten days, you find that this receiver is not equal in distance and volume to any of the highest priced five tube sets, or if you feel that you did not get twice your money's worth, send it back as shipped, and we guarantee to return your money.

### PRICES

RECEIVER with Tubes.....	\$49.75	Music Master Loud Speaker.....	\$25.00 (with set only)
Phonograph Attachment.....	3.50	Special Type Loud Speaker.....	12.00 (with set only)
115 Amp. Storage "A" Battery.....	14.50 (with set only)	Ear Phones.....	2.25 (with set only)
45 Volt Large "B" Battery.....	2.00 (with set only)	Complete Aerial Set.....	5.00

## SIDBENEL RADIO

27 AND 29 WEST MT. EDEN AVENUE, NEW YORK CITY

### Selznick Announces His Technical Chiefs

THE General American Radio Corporation, 345 Madison Avenue, New York City, concerning whose incorporation RADIO WORLD published complete announcement last week, issued the following statement, through Lewis J. Selznick, president:

"The patents which the corporation has acquired are those of John Adam Yuncck. Mr. Yuncck will be closely identified with the concern, in addition to turning over to it his discoveries which are so important to the entire trade because of the situation that has existed with reference to tubes up to now. Mr. Yuncck will be in personal charge of the manufacture of General American Radio's tubes.

"The Engineering Staff will be headed by Dr. Frederick W. Zons and R. D. Hickok. Dr. Zons was for five years chief chemist to the Westinghouse Lamp Company, for three years Chief Chemist and manager of the New Process Gas Mantle Company, and has more recently been the consulting chemist to the Edison Storage Battery Company, and manager of the Incandescent Lamp Supply Laboratories. Dr. Zons will act as Consulting Chemical Engineer of the G. A. R. Mr. Hickok's post will be that of Consulting Physical Engineer.

"In a short time I will announce a list of eight corporations being taken over by General American, constituting the largest amalgamation that has yet taken place in the trade. G. A. R. will have been so constituted and built from the day of its organization that it will be in a position to manufacture and sell everything connected with radio, including parts of all sorts, complete receivers, and tubes. An an-

nouncement fully covering the line, which will be ready for the market in the early Fall, will be issued shortly, along with details of an advertising campaign."

### Polyplug Put on Market; Makes Secure Contact

THE Polyplug, product of the Polymet Manufacturing Corp., 70-74 Lafayette street, New York City, is a serviceable jack plug that eliminates the nuisance involved in attaching phone tips. Using the Polyplug you need unscrew no cap and fasten no phone tip with any special motion. You simply insert the phone tips in the apertures of the plug and a spring wire secures them. The harder you press the phone tips into the openings, the firmer the spring's grasp. The positive pole is plainly stamped on the sleeve contact. The contact is firm always. The phone tips may be pulled or jarred without disturbing the actual contact. The tips can be easily removed by straight tension. Thus change from headphone to speaker is made safe and easy. The plug is small, dependable and sturdy.

### FOUR ARE ADDED TO CHICAGO'S RADIO COMMITTEE

CHICAGO.

FOUR new members have been named for the Mayor's Radio Commission. They are Herbert M. Frost, chairman of the Radio Manufacturers' Association; Frank Reichmann, president of the Winkler-Reichmann Co.; Frank H. McDonald, president of the National Listeners' Association, and Wilson J. Wetherbee.

### AND SO IT GOES

NEW BRITAIN, CONN.

THE music establishment of Widener's, Inc., Main street, is being remodeled to care for the radio business being done by the concern. Two booths formerly used for phonograph demonstrations are being removed to give additional room for display of radio sets. One of the officials of the concern recently stated that the radio end of the business has been climbing steadily, which caused it to rush the remodeling recently started.

### PIED PIPER BOOMS BUSINESS

GENEVA, N. Y.

C. D. Ferris, music dealer of this city, attracted considerable attention to his display of Radiolas by parading down the main street on a Saturday evening with a Super-Heterodyne in one hand and a loud speaker in the other. The music from the set soon caused a large crowd to congregate. It boomed the radio business in the town.

### SOUTHWEST JOBBERS ORGANIZE

DALLAS, TEX.

THE Southwest Radio Jobbers' Association has been formed in the city and is laying plans for a Southwest Radio Show here early in the fall. The officers of the organization are: L. F. Philo, of Houston, president; J. G. Cummings, of San Antonio, vice-president, and A. I. Folsom, of Dallas, secretary and treasurer.

## SUPERDYNE



ORIGINAL GLOBE COILS  
(Single Mounting)

Wound with silk wire on bakelite to correct specifications. C. O. D. Parcel Post ..... **\$6.25**

Complete 4-Tube Set, K. D. Panels Drilled, Fitted ..... **\$35.00**

GLOBE RADIO EQUIPMENT  
217 W. 125TH ST. NEW YORK CITY

HOW TO CONSTRUCT THE SUPERDYNE, described by N. N. Bernstein, Technical Editor, in RADIO WORLD, issues of May 17, 24 and 31. The three issues mailed on receipt of 15c, stamps or coin, sent to RADIO WORLD, 1493 Broadway, New York City.

## S-U-P-E-R-D-Y-N-E

### SPECIALISTS

Our Own Coils—guaranteed..... **\$6.50**  
Kit (Flawless Condensers, Coils and Diagram) ..... **19.50**  
Complete Parts, Assembled with Diagram... **65.00**  
Superdyne Advice Free. Mail Orders Solicited.

WALLACE RADIO COMPANY, Inc.  
135 LIBERTY STREET NEW YORK CITY

A ONE-TUBE SET YOU CAN LOG, cost of construction \$25. Two honeycomb coils and two condensers used. Full data in RADIO WORLD, issue of July 12. Send 15c for a copy.

### RADIO WORLD SELLING OUT ON THE NEWS-STANDS

Had your newsdealer sold all of his supply of RADIO WORLDS when you tried to get your copy?

Newsdealers are selling out on RADIO WORLD all over the country. Be sure to have a complete file of RADIO WORLD. You can do so by subscribing.

If you wish, you may send your yearly subscription order through your newsdealer.

Subscribe, so that you won't miss any copies. Radio World, 1493 Broadway, New York City.

# Radio Cultivates Taste for Better Music

RADIO has quickened enthusiasm for musical harmony, according to Prof. Peter W. Dykema, of the University of Wisconsin School of Music. Professor Dykema declared that there is a tendency on the part of the big radio audiences to demand a better class of music. He attributes much of this change to radio.

"Radio has made its way into every little town and hamlet in the country and into thousands of homes," Professor Dykema said. "With increasing interest in the modern discovery the public is coming to appreciate better music because of the varied programs broadcast by radio stations. There are over 500 licensed broadcasting stations in the United States, and music plays a prominent part in the programs. Musical programs that are broadcast generally are selected with a view to giving the public variety. This has led the public to request the higher class music."

Radio also is influencing a change in the so-called jazz music, which Professor Dykema declares shows interesting modern influences.

"Largely through the influence of radio, jazz has become refined and harmonious," he said. "Jazz is changing with the change in musical demands of the public. There is no need for a substitute for jazz music, be-

cause it is losing the barbarous, shrill characteristics which it first possessed."

**ACH SHARP TUNER**

DIFFICULT TUNING  
MADE EASY

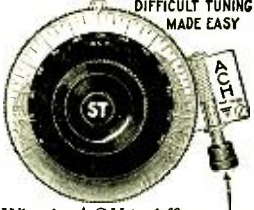

**Mail Orders Prepaid** Why the A.C.H. is different  
 3 in. DIAL \$2.50 (150-10-1)  
 4 in. DIAL \$3.00 (215-10-1)  
 5/16 REG. 1/4-3/16 BUSHINGS 25 EACH

Send for Circular B

**A. C. Hayden Radio & Research Co.**  
 Brockton, Mass., U. S. A.

**Burnt-Out Tubes Replaced for \$2.50**



A Wonderful Tube for Your Superdynamo.  
*The Only Tube with a Written Replacement Guarantee Against Breakage or Blowout.*

Burnt-out, Defective or Broken Tubes of any brand or make whatever will be replaced by a brand new (not refilled) Royaltron Tube, at a cost of only \$2.50.

*It is with the Object of Advertising the MERITS of ROYALTRON Tubes, that we make the above unusual offer.*

Every ROYALTRON Tube is accompanied by a money-back guarantee.

*Approved by the Radio News and World Laboratories*

**ROYAL MANUFACTURING CO.**  
 Department W. O.

205 BROADWAY NEW YORK

Dealers, distributors and agents, write or wire immediately for unusual proposition.

## Letters From Our Readers

EDITOR, RADIO WORLD:

AT this time there is considerable discussion of "portable" sets. An important distinction is to be made in the use of this term, viz., many sets are "portable" for purposes of carrying to a camp and being operated in a stationary position, while a few rare designs are intended for operation on moving automobiles or railway trains.

This affects the Freshman variable condenser, which is a good condenser for portable sets but not for sets which are being moved about.

We would suggest that the word "portable" be restricted to receiving sets which are actually carried about and used in transit, and that the word "transient" be used for such which are used wherever carried.

CHARLES FRESHMAN COMPANY, INC.  
 Research Department.

RADIO STORE FOR SALE—Excellent location, Bronx, near subway station; low rent; owner has other business; price reasonable. Box 720, 11 East Fordham Road, N. Y. C.

**\$25 FOR \$10**

THE FAMOUS  
**BEL - CANTO**  
 ACOUSTICAL LOUD SPEAKER  
 Direct from Factory to You.  
 Delivered free C. O. D. to your door.  
**Bel-Canto Mfg. Co.**  
 General Office and Factory: Dept. R.W.,  
 417-419-421 E. 34th St., N. Y. City  
 Telephone Vanderbilt 8959

**"SUPER-HET"**  
**THAT GOT SCOTLAND**  
 Build Your Own "Rolls-Royce"  
**SPECIAL KIT OFFER**

Kit comprising 3 Reos Intermediate Transformers, 1 Reos 10,000 meter Coupler, 1 Reos Oscillator Coupler... **\$39.50**

Dealers write for special offer.  
 If your dealer cannot supply you, send his name and your remittance direct to

**SUPER-SALES-SERVICE**  
 Mail Order Department: 214 WEST 34th STREET  
 Factory: 112 CHAMBERS STREET  
 NEW YORK CITY

FREE! Descriptive Catalogue on request.

**"ROLLS ROYCE"**  
**RADIO TUBES**



Like their name, significant of quality. Durable and powerful. Bring in distance with a maximum of volume and clearness.

Type 208—5 volts, 1 ampere Detector Tube  
 Type 201A—5 volts, .25 ampere Amplifier and Detector  
 Type 199—3-4 volts, .04 ampere Amplifier and Detector  
 Type 198—3-4 volts, .06 ampere With Standard Base—Amplifier and Detector  
 Type 12—1 1/2 volts, .25 ampere Platinum Filament—Amplifier and Detector

of Radio Tubes' **\$2.50**  
 ALL TYPES

Type 202 Five (5) Watt Transmitter ..... \$3.00  
**EVERY TUBE GUARANTEED**  
 to work in Radio Frequency. Especially adapted for Neutrodyne, Reflex and Super Heterodyne Sets.  
 Shipped Parcel Post C. O. D.  
 When ordering mention type.

**Rolls Royce Tube Co.**  
 21 Norwood St. Dept. W Newark, N. J.

*A mid-summer subscription offer*

## Subscribe NOW and Receive Another Radio Publication Without Extra Cost

Radio World has made arrangements

- to offer a year's subscription for
- any one of the following publications
- with one year's subscription for
- RADIO WORLD;
- RADIO NEWS or
- POPULAR RADIO or
- RADIO BROADCAST or
- WIRELESS AGE or
- RADIO DEALER or
- RADIO (San Francisco).

This is the way to get two publications

- for the price of one!
- Send \$6.00 today for RADIO WORLD
- for one year (regular price
- for 52 numbers)
- and select any one of the other
- six publications for twelve months—
- Add \$1.00 a year extra for
- Canadian or Foreign postage.
- Present RADIO WORLD subscribers
- can take advantage of this offer by
- extending subscriptions one year NOW.
- Or order thru your newsdealer.

---

**RADIO WORLD'S SPECIAL TWO-FOR-PRICE-OF-ONE SUBSCRIPTION BLANK**

RADIO WORLD, 1493 Broadway, New York City.

Enclosed find \$6.00, for which send me RADIO WORLD for twelve months (52 numbers, beginning .....  
 and also without additional cost, Radio News, or Popular Radio, or Radio Broadcast, or Wireless Age, or Radio Dealer, or Radio for twelve months, beginning ..... Put a circle around the other publication you want.

Indicate if renewal  Name .....

This Offer Good  Street Address .....

Until  City and State .....

August 1, 1924

# The Radio University

(Concluded from page 21)

and the third or first audio tube need separate rheostats. The first and last tubes can be run on one rheostat. 3—The potentiometer preferably should have a resistance of 400 ohms. 4—90 volts will operate the circuit efficiently. 5—Yes, the cotton-covered wire could be used on the coils. See article in RADIO WORLD, issue of July 12, and another in this issue.

1. I have constructed an Ultra-Audion set and although the locals come in fine I get no distance. I am using a Sleeper variometer and a 43-plate condenser with one step of AF. Is the 43-plate condenser too big? Am using 22½ volts on the detector and 45 on the amplifier, both WD-11 tubes. 2. I want to build a transformer-coupled RF set and use Acme transformers. I wish to tune with a loop antenna, shunted with a 23-plate condenser. What is the limit you would advise as to the number of RF stages to use? Are four stages practical, or would they give me trouble? I want to use UV199 tubes. Must I use separate B batteries for each unit? Can I use three rheostats, or will it be better to use one for all tubes? Is there any advantage in using a potentiometer? Will this set tune from 250 to 550 meters? Can I follow the article in RADIO WORLD for October 13, 1923, describing a set similar to this, to which another stage of RF may be added? Will 3 stages of AF amplification be all right with this set? Is the Heath condenser a good one to use in this circuit?—Austin Reibel, 1317 North Ave., Elizabeth, N. J.

1. The Ultra-Audion circuit is not supposed to be a DX getter, but is excellent for local work.

This explains your failure to get distance. The Sleeper variometer is excellent here, but the 43-plate condenser is too large. Use a 23-plate. 2. You should use a 43-plate condenser to tune the loop antenna to cover the entire broadcasting range. Three stages of RF should be sufficient for all purposes, providing they are carefully assembled and wired with very short leads. Four stages, although practical, would probably be a little too much unless you were expert in set construction. It is advisable to use separate B batteries to avoid possible stray high frequency currents to leak from RF to AF amplification stages. The potentiometer is essential in this circuit, as it is the medium for stabilizing the entire circuit. The article you mention, together with diagram, is what you want. Two stages of AF are enough for any set. The Heath condensers are good.

Regarding the Transcontinental Reflex, by Byrt C. Caldwell, published in RADIO WORLD for May 3: 1—Do you use standard tubes, UV200 for the detector and UV201A for the audio-frequency amplification? 2—What type of radio-frequency transformer is best in this set? 3—Can stations be logged?—E. Criswell, 308 Chestnut St., Philadelphia, Pa.

1—All three tubes are amplifiers, a crystal being used for detection. The tubes should preferably be UV201A type or equal for best results. 2—There are a number of good radio-frequency transformers on the market. See advertising columns. 3—Providing the same antenna is used, stations will be found at the same place on the dials.

I built one of the Superdyne sets described by N. N. Bernstein in RADIO WORLD for May 17, 24 and 31, and it is the finest set I have had to date. The signals are loud and clear and the tone is wonderful. There is one thing I would like explained. When tuning a station and the loudest point is reached sometimes the tube will block, a loud click will be heard, and I will have to tune the set all over again. What is the cause of this?—A. H. Stearns, 883 River St., Troy, N. Y.

The reason for the tube blocking is that you use a trifle too much negative feedback. When adjusting the rotor keep it a trifle under the point where the loudest signal comes in, then tune with the condenser.

I intend to build the Superdyne. 1—Will this circuit work well with C299 tubes? 2—Will Eria audio transformers, 6½ and 3½ ratio, be satisfactory, and in what order are they to be placed? 3—Will 23-plate condensers be suitable with C299s? 4—Please state what changes are necessary, if any, to use the C299 tubes.—George Abbott, 14603 Shaw Ave., East Cleveland, O.

1—Yes, the C299 tube, which is practically the same as the UV199, will work efficiently with the Superdyne. 2—The transformers mentioned are good. The 6½ ratio goes in the first and the 3½ ratio in the second audio-frequency stage. 3—The 23-plate condensers are just right for the Superdyne. The size of a condenser has nothing to do with the type of tube used. 4—To use C299 tubes, a 4½-volt A battery is required, the voltage to be regulated by 30-ohm rheostats.

## PEIRCE SCHOOL of Business Administration

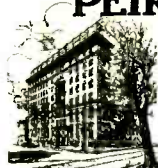

Two-Year Business Administration Course (college-grade) contains as many credit hours of instruction as usual college course of four years. One who takes this course in three years is ready for business two years sooner than one who takes a four-year course.

Accounting Course prepares for C. P. A. examinations. Executive Secretary Course. Stenographic Secretary Course. Pleasant living accommodations; both sexes. 60th Year Book. Six weeks' Summer School—June 30 to August 8. PEIRCE SCHOOL OF BUSINESS ADMINISTRATION Pine Street, West of Broad Philadelphia

### \$15 Set Gets 2,000 Miles

The Essex Radio Special, the receiving set with a condenser, gets you more distant stations clearer and sweeter than sets costing ten times its price. \$15 Set complete with cabinet, without tube or batteries. \$20 Set complete with cabinet, tube and batteries.

### ESSEX RADIO SERVICE

617 West 125th St. New York Detailed information on request.

### Perpetual Radio Fuse \$2.50

\$100.00 reward if you can blow your tubes with this protector in your street according to our instructions. SUPER ULTRADYNE Transformers, complete set including blue print.....\$16.00 ULTRA SYNCHRODYNE Cells, set of three...\$7.00 Including blue print. With condensers.....\$17.00 DEALERS and JOBBERS: We have an attractive territory proposition. THE STANLEY RADIO COMPANY, Manufacturers Cleveland, Ohio 2947 Lorain Avenue

## HOW TO MAKE THE

???????

What shall we call it?

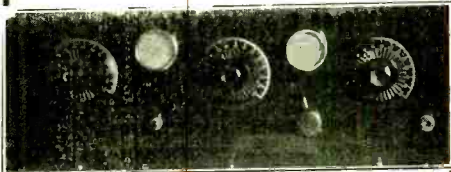

After a great deal of experimenting and testing, we have evolved what is undoubtedly the most sensitive, most selective, and most satisfactory two tube receiver which has ever been designed. In fact, it is more sensitive than any three tube receiver, more so than all but a few, a very few, four and five tube receivers.

The receiver uses but two tubes, and yet it is extremely sensitive, equal in this respect to the five tube tuned radio frequency receivers such as the neutrodyne. By that we mean that under ordinary good conditions, the receiver will bring in stations from all over the country on the loud speaker! And with but two tubes!

SELECTIVITY. No more selective receiver has ever been made. Local stations may be tuned out, and stations a thousand miles or more can be tuned in without the least interference, even if their wavelengths are but a few meters apart.

-tone. A crystal detector is used, and as a consequence, the tone is perfect. There is no howling, and no radiation.

PRICE. At the cost of an ordinary two tube receiver, you can make this super-sensitive, super-selective super receiver. In the directions, instructions are given, so that with a little work, and at no cost, you can use low priced apparatus, and so change this, that it is equal in efficiency to the highest priced equipment. This alone is worth the price of the direction many times over.

If you are going to build a receiver, if you build receivers for others, or if you are going to build any kind of a receiver, you should order today.

We sell the complete outfit of parts for this receiver, assembled, ready for wiring, or we sell the receiver, ready for operation, with a guarantee of perfect results.

When you order your directions, suggest a name for this wonderful receiver. As soon as a satisfactory name is received, we shall present to the person who suggested it, one of these receivers, made from the best parts which money will buy. Will you be the winner? Order now!

PRICE—Complete instructions, book-up, diagrams, etc., etc.

**\$1.50**

Dealers! Write us for prices on this lightning seller.

**The Biltmore Radio Co.**

Dept. W-4

Boston 30, Mass.

## RADIO MAP FREE

Big Broadcasting Station List.

Also Radio Bargain List. Just Out.

**The RADIO SHACK**

America's Largest Radio Dealers Dept. RW-7-19 55 Vesey St. New York

## COAST TO COAST

Every Turn **STAR** No A Tap **COIL** Soldering

SEND FOR LITERATURE **STAR RADIO PRODUCTS CO.** 711 S. DEARBORN ST. CHICAGO, ILL.

## Cleartone Clear-o-Dyne Model 70

Only a Few Weeks Old—and Fully Approved

Beautiful and Efficient

**\$75.00**

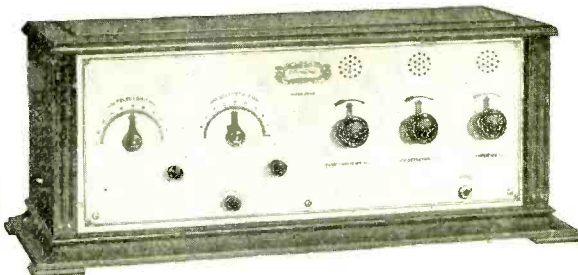

4 Tubes Selective Long Range Logable

The new Clear-o-Dyne model 70 has been enthusiastically received and heartily approved by hundreds who say that this wonderful receiver performs better than any four tube set ever tested.

The beautifully etched gold finished panels and the distinctive Cleartone solid mahogany cabinets together with the features of selectivity, log-ability and loud speaker volume means a source of education and a real pleasure for all. Send to us for complete circular matter and our special offer.

DEALERS and JOBBERS: You will want our line of loud speaker receiving sets, all of which are guaranteed and are of finest material and workmanship. Our interesting proposition will be sent upon receipt of your request for detailed information.

Model 80 Super Clear-o-Dyne.....	\$120.00	Super Clear-o-Dyne Model 182.....	\$190.00
Model 60 .....	60.00	Clear-o-Dyne Model 70.....	75.00
Model 61 .....	75.00	Clear-o-Dyne Model 71.....	90.00
Model 62 .....	120.00	Clear-o-Dyne Model 72.....	135.00

**The Cleartone Radio Company : : Cincinnati, Ohio**

# Radioists Hear Nomination

THE Democratic Convention's nomination of John W. Davis for President was heard by 3,000,000 radioists and almost as many heard the nomination of Charles W. Bryan for Vice-President.

To bring signals of adequate volume from the convention to the antenna of WGY the sound energy picked up by the microphones in New York was amplified at six different points on the journey. WGY, in co-operation with WJZ and using its own Western Union remote-control wire system, radiocast all the sessions of the convention.

As the voice or other sound was picked

up by the microphones in the Garden and converted into electrical vibrations, an amplifying unit built up the energy to counteract for the loss sustained in transmission over wires to the studio of WJZ, New York City. At the control room of WJZ the signal was amplified for feeding to the air and part of the energy normally fed to the station was diverted by wire to the Walker Street Terminal of the Western Union in New York City. Here the signal was boosted or amplified for the third time and sped on its way Schenectady-ward. At Sedgwick Avenue, where the control wire leaves the New York City cable and goes into an open wire, strung on poles, a fourth amplification took place. This fourth stage gave the signal sufficient strength to reach the control room of WGY. There a fifth stage of amplification was applied to the signal to overcome line loss over the quarter-mile of wire between the control room and power station.

**"RADECO FOR SECURITY"**  
 RADECO SAFETY FUSES 50 CENTS EACH  
 At Your Dealers or by Mail, Postpaid  
 RADIO EQUIPMENT CO., 20 Stuart St., Boston

## Why Not Reach Out

with your crystal set? There's music on your aerial every night from stations far away! I have shown thousands of people how to hear long distance programs without tubes. Write me today.

LEON LAMBERT  
 562 South Volusia, Wichita, Kan.

## TUBES REPAIRED \$2.50

**GUARANTEED**  
 ALL STANDARD TYPES 24 hour service  
 WD-11—WD-12 Mail Orders  
 UV-199—UV-200—UV-201A Sent Parcel  
 Post C.O.D.  
**RADIO TUBE SERVICE CO.**  
 239 Centre Street, near Grand New York City

**RADIO RECORD**  
 Keep a Permanently bound record of all stations you have received and how you received them.  
 Radio Record 5 1/2" x 14"—600 lines. All broadcasting stations listed, and indexed with space for new stations—\$1.00 Postpaid.  
**THE BEADLE PRINTING CO.**  
 MITCHELL SOUTH DAKOTA  
 Applause Cards 60 for \$1.00 Postpaid.

## Conventionalities

TWENTY radio stations linked to the microphones in Madison Square Garden by 3,156 miles of telephone wires carried the voices and cheers of the Democratic delegates back to their home towns, no matter where those towns were.

A TAXICAB DRIVER installed a radio set in his cab so that delegates he carried back and forth from the Garden and the Waldorf-Astoria could keep in touch with the convention. The antenna was strung on the roof of the cab and two pairs of phones were provided. No extra charge was made for the radio service.

THE LOCAL loud speakers at the Garden did not always bring a speaker's voice to the ears of a delegate sitting right under the historic roof. There were "dead spots" aplenty. Yet this same speaker's voice, radiocast, was heard all over the United States!

A JOKE that soon became trite in the

galleries was one on William Jennings Bryan. When he would visit the area occupied by delegates from some particular state, and air his views for their benefit, a galleryite would say: "WJB is radiocasting again."

THE POWER of radio in making millions attend the proceedings with keen interest has led to the suggestion that the proceedings of Congress be radiocast so that every citizen could be informed and follow federal affairs. Radio has put a keener interest in politics, and when the boy and girl in grammar school studies history it will be much easier for them to understand how presidential candidates are chosen, because they heard it all done on the radio.

**WHAT IS AN INVENTION?**  
 How to obtain a patent and other valuable information is supplied in our FREE Booklet.  
 Write for a copy today  
**MANUFACTURERS PATENT CO., Inc.**  
 70 WALL STREET, NEW YORK

**FAHNESTOCK CLIPS**  
 "Popular Wherever Radio Is Used"  
 14 Sizes in Beautiful Display Case  
 Dealers write for big money-making proposition.  
**FAHNESTOCK ELECTRIC CO.**  
 Long Island City, L. I.

**SOMETHING NEW**  
 Green Radio Applause Cards  
 Bound in Book Form  
 with stubs on which records of Radio Artists are kept after card is detached and sent, a Log Book and Card combined, all for 1c. 25 CARDS 25c.  
 Sent by mail postpaid. No stamps. Address  
**PLATTSBURGH RADIO SUPPLY CO.**  
 PLATTSBURGH, N. Y.  
 DEALERS: Write for sample and terms.

**PETER J. CONSTANT, INC.**  
 91 Seventh Ave. New York City  
 Direct Factory  
**DISTRIBUTORS FOR**  
 38 Leading Manufacturers

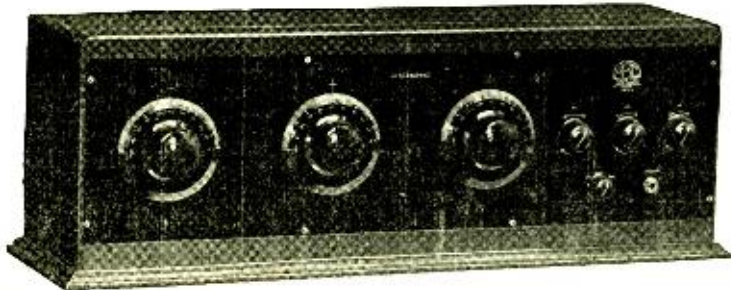

## AN EPOCH MAKING ACHIEVEMENT

*Establishing a New Standard in Radio*

Unequaled clarity and beauty of tone. Remarkable distance and tremendous volume. Knifelike selectivity. Absolute freedom from oscillation. These universally desired qualities are made possible by the inventions of E. F. Andrews and E. A. Beane, covering the "DE-RES-NA-DYNE" principle.

The DERESNADYNE circuit is the first tuned radio-frequency circuit in which the undesired oscillations that produce whistling and distortion are completely eliminated simply by the proper proportioning and placing of the fundamental elements of the circuit. The DERESNADYNE principle has given to radio that which is desired above all else—perfectly clear, quiet, natural, undistorted reproduction, together with greater volume,

distance selectivity and ease of operation. The Andrews DERESNADYNE has enthused every radio authority who has tested it.

Write for complete information.

**ANDREWS RADIO COMPANY**  
 327 South La Salle Street  
 CHICAGO ILLINOIS



## Resistance Coupled Amplification

The tone quality from a DAVEN RESISTANCE COUPLED AMPLIFIER is the most perfect known to the radio art.

The Daven Resisto-Coupler, illustrated, greatly simplifies the construction in building up one of these distortionless amplifiers. Sold everywhere ..... \$1.50

Read our booklet, "RESISTORS—THEIR APPLICATION TO RADIO RECEPTION," by Zeh Bouck.

Price 15 cents  
**DAVEN RADIO CORP.**  
 "RESISTOR SPECIALISTS"  
 9 1/2 Campbell Street  
 Newark, N. J.

# How to Mount Tap Switches On Panel

(Concluded from page 20)

purchase on the other end is achieved through the oversized drill hole. Be sure always to countersink for machine screws, otherwise the dial will scrape against the screwheads. Do not use a large drill to bore partly through a smaller-sized space as a makeshift for a countersink. For a quarter you can buy a steel countersink, with 1/4 inch shank that fits your hand-drill, and it will be one of the best investments you ever made.

Granting that you have properly mounted the rear, you can now secure the dial to the shaft so that the dial fits against the panel, and is perfectly parallel to it. Hence you will hear no grating, as if of a bent wheel against a fender, when you turn the dial, unless the dial itself is warped. If it is warped, immediately exchange it for a good dial. A warped

dial is fit only for the discard. If your dial is in good condition, and you find it scrapes against the panel, put a few sheets of paper against the panel, remount the dial and pull the pieces of paper out.

Tap switches are another source of trouble. The chief difficulties are (a) the nuts in the rear of the panel interfere with one another; (b) the taps work loose; (c) the taps are mounted awry and do not make satisfactory contact with, or actually miss, the switch arm. Here are the remedies: (a) When marking the panel, allow 3/8 inch straight line distance between the centers of the holes for the machine screws; (b) do not drill oversized holes for any tap screws, nor wobble the drill, nor drill fast, so that heat induces more than normal spreading of the panel that always results around any hole drilled; (c) measure the correct distance between the center of the shaft of the movable arm and the arm's contact surface. This is almost always 1 1/2 inches, but verify this for the particular instrument you intend to use. Again resorting to cardboard, drill a hole the size of the shaft, insert the shaft, and move the switch arm against the cardboard, using pressure. This will enable you to measure the distance between the center of the shaft hole and the circumference of the circle described by the tip of the movable arm. This measurement can be done directly on the panel, so that a shiny semi-circle is described, but it is better to follow the template system.

The end stops of the panel switch are important. They should be mounted 3/8 inch from the first and last taps, but not on the aforementioned circumference. Taking the first tap as an example, draw a line bisecting the circumference. This gives you a diameter, or, if you carry the line only half way, a radius. Put a right-angle against the diameter or radius (a ruler will do) and move the side nearest the circumference until the two are 1/8 inch apart. Then measure 1/8 inch down and center punch for the end stop.

All this, of course, is aside from the problem of how best to dispose of the instruments themselves. This problem is inseparably linked with the wiring.

A good plan, when using a baseboard, is to do as much of the wiring as possible before the baseboard is finally fastened to the panel. The builder is torn between two options—mounting parts on the panel first, or doing some of the wiring. The safest course is first to plan your panel layout on paper, not necessarily in template fashion, but just generally. Then mount all such parts as variocouplers, variometers and variable condensers. If a tap switch is to be used (and most often it can be most advantageously dispensed with) have done with that task next. The wires that will connect the tap screws to the taps on the inductance coil should be soldered to lugs and fastened to the screws before the coil is mounted. Working backwards, with decisions forced upon you by your own lack of foresight, is one of the chief causes of inefficient results. Also, in this case, keeping the soldering iron away from the soft circumference of tap screw holds safeguards you from melting the hard rubber and widening the holes so that the tap screws become loose. The variable

parts being well and properly mounted as aforesaid, with due regard for the baseboard, an inch or more of room will remain at the bottom, so that not only will a baseboard clear that distance, but if the cabinet has a strip at the bottom to stop the panel from bending back, the bottom of the baseboard will clear the slight elevation. This precaution should be taken at the ends of the baseboard, too, and parts mounted accordingly. If 1/2 inch freeboard is provided all around, that is, 1/2 inch clear panel space on each of the four sides of the panel, even with the baseboard on, you will have clear sailing.

Now you reach the point where the wiring on the baseboard may be carried forward.

**BRISTOL AUDIOPHONE**  
**MORE THAN A LOUD SPEAKER**  
 Bristol Audiophone, Sr., 15-in. Horn. **\$30.00**  
 Bristol Audiophone, Jr., 11-in. Horn. **\$22.50**  
 Bristol Single Stage Power Amplifier. **\$25.00**  
 Write for Bulletin 3006-W  
**The Bristol Company**  
 Waterbury, Conn.

**Federal** Standard  
**RADIO** Products  
 Over 130 standard radio parts, each bearing the Federal iron-clad performance guarantee.  
 Write for Catalog.  
**FEDERAL TELEPHONE & TELEGRAPH CO.**  
 Buffalo, N. Y.

**USE EVEREADY**  
**Radio Batteries**  
*-they last longer*

**Free Mailing Lists**  
 Will help you increase sales  
 Send for FREE catalog giving counts and prices on thousands of classified names of your best prospective customers—National, State and Local—Individuals, Professions, Business Concerns.  
**99% Guaranteed by refund of 5¢ each**  
**ROSS-Gould Co.** 313 N. 10th St. St. Louis

**Some Good Service Articles in 1924**  
**Back Numbers of Radio World**  
**Neutrodyne Article**  
 By R. L. Dougherty, March 15, 22, 29  
**Construction of a Battery Charger**  
 By Walt S. Thompson, March 29, April 5  
**Spider Web Neutrodyne**  
 By Byrt C. Caldwell, April 12  
**Amplidyne**  
 By Thomas W. Benson, April 19  
**Camper's Portable Set**  
 By J. E. Anderson, April 26  
**Power-Amplification**  
 By Chas. H. M. White, April 26  
**Neutrad Radio Frequency Unit**  
 By Walt S. Thompson, May 3  
**Explanation of Super-Heterodyne**  
 By Walt S. Thompson, May 3  
**Short Wave Adapters**  
 By J. E. Anderson, May 10  
**Simplified Super-Heterodyne**  
 By Chas. H. M. White, May 17  
**Superdyne**  
 By N. N. Bernstein, May 17, 24, 31  
**Improved Super-Heterodyne**  
 By J. E. Anderson, May 31, June 7, 14 and 21  
**New Double Superdyne**  
 By J. E. Anderson, June 14  
**New Metreform Receiver**  
 By Walt S. Thompson, June 21 and 28  
**King George's Set, with Diagram**  
 By Chas. H. M. White, June 14  
 Any copy, 15c. Any 7 copies, \$1.00, or start your subscription with any date, Radio World is \$6.00 per year (\$2 per copy), \$3.00 six months, \$1.50 three months.  
**RADIO WORLD, 1493 Broadway, N. Y. C.**

**IS YOUR NEUT RIGHT?**  
 To revitalize unneutralizable Neutrodyne, we devised this Kladaq Coast-to-Coast Circuit. Use same panel, etc., as Neut, except three less parts. Merely rewire. Success certain. Necessary stabilizer. 22 feet gold sheathed wire, circuit and complete, simple instructions—\$5.00 prepaid. Many have already rebuilt their Neuts—and written wonderful testimonials. Thousands will do it. Be FIRST—have the finest five tube set in your neighborhood, revitalize others' Neuts. Description, etc.—10c. Radio Lists—2c. Stamps accepted.  
**KLADAG LABORATORIES, Kent, Ohio**

**The Ultimate Radio Receiver**  
**THE FLEX-O-DYNE CO.**  
 1674 Broadway (At 52nd St.)  
 New York, N. Y.  
 Circle 4589

**VACATION RADIO**  
 PORTABLE SETS  
 PARTS ACCESSORIES  
 MAIL ORDERS  
 Send for Price List  
**SUNBEAM**  
 71 THIRD AVE. NEW YORK CITY

**HENLEY'S WORKABLE RADIO RECEIVERS**  
 An Authoritative 240-Page Book on Practical Receiving Sets of Modern Design with Complete and Explicit Directions for Building Them.  
 Written and Edited by a Staff of Radio Engineers of Practical Experience and Best Theoretical Training.  
**Price \$1.00** 150 Diagrams and Illustrations  
 Specially made for this book.  
 THIS new book contains complete and detailed descriptions of many types of receivers which, by long experience, have proved to be the most satisfactory from the viewpoints of selectivity, sensitivity, convenience and economy of operation, dependability, and signal quality. It gives in greatest detail, circuit and wiring diagrams, panel and baseboard layouts, and drilling templates, so that any amateur may build a successful receiver from the directions given.  
 It also includes a discussion on the principles underlying each circuit, and shows clearly how to test and calibrate the receivers.  
 In order to help the Workable Radio Set builder, who may not be familiar with the conventional symbols used in hooking up a set, each of the receiving sets is illustrated by a complete full page diagrammatic drawing, showing just where to attach the wires, location of condensers, rheostats, transformers, vacuum tubes, plugs, jacks, etc.  
**THE COLUMBIA PRINT**  
 1493 BROADWAY NEW YORK CITY

**The Popular Neutrodyne!**  
 This receiver is rapidly becoming the "Old Reliable." A five-tube tuned radio frequency set that any inexperienced fan can operate.  
 SEE RADIO WORLD for March 15, 22 and 29, and get all the details which will enable you to build this reliable and powerful five-tube neutrodyne outfit. The three copies for 45c, or sent free if you send \$6.00 for yearly subscription. NOW!  
**RADIO WORLD, 1493 Broadway, N. Y. C.**

**GET THOSE SUPERDYNE COPIES**  
**THE Superdyne Circuit**, brought up to date in diagrams and text, in **RADIO WORLD** for May 17, 24, 31. Per copy, 15c; the three copies, 45c, or start your subscription with the first number, **RADIO WORLD, 1493 Broadway, New York City.**  
**M. B. SLEEPER RADIO DESIGN & CONSTRUCTION FOR EXPERIMENTERS, REP. FLEX & RADIO FREQUENCY, \$1.00.** The Columbia Print, 1493 Broadway, N. Y. C.

# Programs

## Monday, July 21

(Concluded from page 19)

stead's Hotel St. Francis dance orchestra. 6:45 P. M., stock exchange and weather reports; news items. 8 P. M., educational program, with musical numbers; courses in agriculture, Spanish, music, economics and literature.

**WWJ, Detroit, 517m (580k), E. S. T.—10:25 A. M.**, weather forecast. 11:55 A. M., time relayed by the Western Union. 12 P. M., Detroit News orchestra. 3 P. M., Detroit News orchestra. 3:50 P. M., weather forecast. 3:55 P. M., market reports and baseball scores. 7 P. M., Detroit News orchestra. 7:30 P. M., concert by Schmeman's concert band.

## Tuesday, July 22

**WMAQ, Chicago, 448m (670k), C. S. D. S. T.—4 P. M.**, sport results. 6 P. M., Chicago Theatre organ recital. 6:30 P. M., Hotel LaSalle orchestra. 8 P. M., Harry Hansen, literary editor the Daily News. 8:30 P. M., Babson report. 8:40 P. M., French lesson. 9 P. M., talk by the United States civil service commission. 9:15 P. M., Ruth Ellen Zeigler, pianist; Mme. Mia Sikova Giermann, operatic soprano.

**WFAA, Dallas, Tex., 476m (630k), C. S. T.—12:30 P. M.**, address, DeWitt McMurray, editor the Semi-Weekly Farm News, spreading humor, pathos and fellowship. 8:30 P. M., band from Plano, Texas. 11 P. M., Miss Agnes Weeks, pianist, and Mrs. Juanita Blair Price, singing.

**CKAC, Montreal, 425m (710k), E. S. D. S. T.—4 P. M.**, weather; stocks; news. 7 P. M., kiddies' stories in French and English. 7:30 P. M., Rex Battle and his Mount Royal Hotel concert orchestra. 8:30 P. M., variety program from La Presse studio. 10:30 P. M., Joseph C. Smith and his Mount Royal Hotel dance orchestra; specialties by Jos. Smith, violinist.

**WDAF, Kansas City, 411m (730k), C. S. T.—Baseball scores at 3:30, 4, 4:30, 5 and 6 o'clock. 3:30 P. M.**, the Star's radio trio. 5:50 P. M., marketgram; weather forecast; time signal; road report. 6 P. M., piano lessons by Miss Maudellen Littlefield; address, Clerin Zumwalt, M. A.; children's story and information period; Carl Nordberg's Plantation Players. 11:45 P. M., (Nighthawk Frolic), The Riley-Ehrhart Winnwood Beach orchestra.

**KGW, Portland, Ore., 492m (610k), P. T.—11:30 A. M.**, weather forecast. 3:30 P. M., children's program. 7:15 P. M., police reports. 7:30 P. M., baseball scores; weather forecast; market reports. 8 P. M., concert arranged by Seiberling-Lucas Music Co.

**WGY, Schenectady, 380m (790k), E. S. T.—1 P. M.**, music and address, "Summer Lampshade for Electric Lighting Fixtures," courtesy Society for Electrical Development. 5 P. M., produce and stock market quotations; news bulletins; baseball results. 6 P. M., dinner music by Joseph A. Chickene and his Clover Club orchestra. 7:40 P. M., baseball scores. 7:30 P. M., concert by the New York Philharmonic orchestra, Willem van Hoogstraten, conductor. 10:15 P. M., organ recital by Stephen E. Boisclair.

**WHAS, Louisville, Ky., 400m (750k), C. S. T.—4 to 5 P. M.**, Dick Quinlan's Golden Derby orchestra; police bulletins; weather forecast; "Just Among Home Folks," daily humorous column; selections by Alamo Theatre orchestra; late news bulletins. 4:50 P. M., local livestock, produce and grain market reports. 4:55 P. M., baseball scores. 7:30 to 9 P. M., concert by the Tropical Hawaiian trio; late news bulletins; baseball scores; Central Standard time.

**WOAW, Omaha, Neb., 526m (570k), C. S. T.—6 P. M.**, popular half hour. 6:30 P. M., dinner program by Hook's Harmony Masters. 9 P. M., program given, courtesy B. P. O. E. Lodge, featuring the Omaha Elks' band.

**KGO, Oakland, Cal., 312m (960k), P. T.—4 to 5:30 P. M.**, concert orchestra of Hotel St. Francis. 6:45 P. M., stock exchange and weather reports; news items. 8 P. M., Arion Trio; Annabelle Jones Rose, contralto; Max Schmidt, accordion solos; Wyle Doran, baritone. 10 P. M., to 1 A. M., Henry Halstead's Hotel St. Francis dance orch.

**WWJ, Detroit, 517m (580k), E. S. T.—10:25 A. M.**, weather forecast. 11:55 A. M., Arlington time. 12 noon, Detroit News orchestra. 3 P. M., concert by Schmeman's concert band. 3:50 P. M., weather forecast. 3:55 P. M., market reports and baseball scores. 5 P. M., baseball scores. 7 P. M., Detroit News orchestra. 7:30 P. M., concert by Schmeman's concert band, broadcast from Belle Isle Park.

**WMAQ, Chicago, 448m (670k), C. S. D. S. T.—4 P. M.**, sports results. 6 P. M., Chicago Theatre organ recital. 6:30 P. M., stories for children by Miss Katherine Waller. 8 P. M., weekly Northwestern University lecture. 8:40 P. M., travel talk by Clara E. Laughlin. 9 P. M., talk from a Chicago charity. 9:15 P. M., Mabel Arline Hansen, soprano; Mrs. Wayne Misener, contralto; Bernice Lucille Weber, pianist.

**WFAA, Dallas, Tex., 476m (630k), C. S. T.—12:30 P. M.**, musical program by the Red Head Girl of the Dallas Journal.

**CKAC, Montreal, 425m (710k), E. S. D. S. T.—1:45 P. M.**, Mount Royal Hotel luncheon concert. 4 P. M., weather; stocks; news. 4:15 P. M., concert.

**WDAF, Kansas City, 411m (730k), C. S. T.—Baseball scores at 3:30, 4, 4:30, 5 and 6 o'clock. 3:30 P. M.**, the Star's radio trio. 5:50 P. M., marketgram; weather forecast; time signal; road report. 6 P. M., address, weekly health talk; children's story and information period; Carl Nordberg's Plantation Players. 8 P. M., program presented by Miss J. Poindexter, Mrs. Jennie Schultz and other soloists.

**WOS, Jefferson City, 441m (680k), C. S. T.—8 P. M.**, address, "Marketing the Apple Crop," by T. J. Talbert, Professor of Horticulture. 8:20 P. M., musical program by the Miller County Old Time orchestra.

**PWX, Havana, 400m (750k), E. S. T.—8 P. M.**, concert at the Malecon band stand by the General Staff Band of the Cuban Army, Captain Jose Molina Torres, band leader.

**KGW, Portland, Ore., 492m (610k), P. T.—11:30 A. M.**, weather forecast. 3:30 P. M., talk by Jeanette P. Cramer, home economics editor of The Oregonian. 7:15 P. M., police reports. 7:30 P. M., baseball scores, weather forecast and market reports. 8 P. M., concert. 10 P. M., dance music by George Olsen's Metropolitan orchestra.

**WGY, Schenectady, 380m (790k), E. S. T.—11:30 A. M.**, stock market report. 11:40 A. M., produce market report. 11:45 A. M., weather report. 11:55 A. M., time signals. 5 P. M., produce and stock market quotations; news bulletins; baseball results.

**WHAS, Louisville, Ky., 400m (750k), C. S. T.—4 to 5 P. M.**, selections by Alamo Theatre orchestra; police bulletins; weather forecast; "Just Among Home Folks," daily humorous column; Dick Quinlan's Golden Derby orchestra; late important news bulletins. 4:50 P. M., local livestock, produce and grain market reports. 4:55 P. M., baseball scores. 5 P. M., Central Standard time. 7:30 to 9 P. M., concert, auspices of Nicholas Bohn; late news bulletins; baseball scores; Central Standard time.

**KGO, Oakland, Cal., 312m (960k), P. T.—1:30 P. M.**, New York Stock Exchange and U. S. Weather Bureau reports. 3 P. M., musical program. 4 to 5:30 P. M., concert orchestra of Hotel St. Francis. 6:45 P. M., stock exchange and weather reports, and news items.

**WWJ, Detroit, 517m (580k), E. S. T.—10:25 A. M.**, official weather forecast. 11:55 A. M., time relayed by the Western Union. 12 Noon, Detroit News orchestra. 3 P. M., concert by Schmeman's concert band. 3:50 P. M., weather forecast. 3:55 P. M., market reports and baseball scores. 5 P. M., baseball scores. 7 P. M., Detroit News orchestra. 7:30 P. M., concert by Schmeman's concert band, broadcast from Belle Isle Park.

**KGW, Portland, Ore., 492m (610k), P. T.—11:30 A. M.**, weather forecast. 3:30 P. M., children's program. 7:15 P. M., police reports. 7:30 P. M., baseball scores, weather forecast and market reports. 10 P. M., dance music by George Olsen's Metropolitan orchestra.

**WGY, Schenectady, 380m (790k), E. S. T.—1 P. M.**, music and humorous reading. 5 P. M., produce and stock market quotations; news bulletins; baseball results. 5:15 P. M., report on condition of New York State highways. 5:30 P. M., organ recital by Stephen E. Boisclair. 7:15 P. M., baseball scores. 7:30 P. M., concert by New York Philharmonic orchestra. 8:30 P. M., a few mo-

ments with new books, William F. Jacob, librarian. 9 P. M., program of Polish music; chorus selections.

**WHAS, Louisville, Ky., 400m (750k), C. S. T.—4 to 5 P. M.**, Dick Quinlan's Golden Derby orchestra; police bulletins; weather forecast; "Just Among Home Folks," daily humorous column; selections by Alamo Theatre orchestra; late news bulletins. 4:50 P. M., local livestock, produce and grain market reports. 4:55 P. M., baseball scores. 5 P. M., Central Standard time. 7:30 to 9 P. M., concert by Carl Zoeller's Melodists.

**WOAW, Omaha, Neb., 526m (570k), C. S. T.—6 P. M.**, dinner program by Red Oak orchestra; Miss Louise Artz pianist. 9 P. M., program by Red Oak (Iowa) Municipal band.

**KGO, Oakland, Cal., 312m (960k), P. T.—4 P. M.**, concert orchestra of Hotel St. Francis. 6:45 P. M., stock exchange and weather reports, and news items. 8 P. M., three-act drama, "Kindling," direction of Wilda Wilson Church; music between acts by Musaeus Trio.

**WWJ, Detroit, 517m (580k), C. S. T.—10:25 A. M.**, weather forecast. 11:55 A. M., Arlington time. 12 Noon, Detroit News orchestra. 3 P. M., concert by Schmeman's concert band. 3:50 P. M., weather forecast. 3:55 P. M., market reports and baseball scores. 5 P. M., baseball scores. 7 P. M., Detroit News orchestra. 7:30 P. M., concert by Schmeman's concert band, broadcast from Belle Isle Park. 10 P. M., dance music by Jean Goulette's orchestra.

## RADIO CRYSTALS

MOUNTED, UNMOUNTED, BULK

Packed under your own label if desired.

Dealers and Jobbers—Write us for lowest prices on Quality Crystals.

MELODIAN CO. OF AMERICA  
INDEPENDENCE, MISSOURI

## CROSLEY

RADIO CATALOG FREE

Describes fully the complete line of radio frequency sets, regenerative sets (licensed under Armstrong U. S. Patent No. 1,113,149) and parts.

Write for Catalog Today

THE CROSLEY RADIO CORPORATION  
POWELL CROSLEY, Jr., President  
6402 Alfred Street Cincinnati, Ohio

## PRE-AMPLIFIER

A Radio Frequency Amplifier of

TREMENDOUS POWER

Gets distance, volume, less static.

Attachable to any receiving set.

Price complete with tube, \$25.00.

Send for Circular

S. A. TWITCHELL

1930 Western Avenue Minneapolis, Minn.

WE REPAIR

## RADIO TUBES

WD-11 .. \$2.50	DV-2 .... \$2.50
WD-12 .. 2.50	DV-6A .. 2.50
UV-200 .. 2.50	UV-199 .. 2.50
UV-201 .. 2.50	C-299 .. 2.50
C-300 .. 2.50	UV-201A .. 2.50
C-301 .. 2.50	C-301A .. 2.50
DV-6 .... 2.50	Marconi .. 2.50
DV-1 .... 2.50	Moorhead .. 2.50
6 v. Plain Detector .. 2.50	
6 v. Plain Amplifier .. 2.50	

Mail orders solicited and promptly attended to.

Dealers and agents write for special discounts.

H. & H. RADIO CO.

P. O. Box 22-B

Clinton-Hill Station Newark, N. J.

## THERE IS A BRAND-NEW CRAM'S RADIO MAP

(New Edition)

Just issued with all the very latest broadcasting stations and information.

ALL THE STATIONS OF THE  
UNITED STATES AND CANADA

Sale 100 miles to the inch  
in two colors—Size 3 1/2x2 1/2"

PRINTED ON HIGH-GRADE MAP PAPER  
UP-TO-THE-MINUTE INFORMATION  
INDICATING ALL AMATEUR AND STAN-  
DARD BROADCASTING STATIONS  
WITH COMPLETE INDEX OF STATIONS  
35c (POSTPAID)

THE COLUMBIA PRINT

1493 BROADWAY NEW YORK CITY

## TELEDYNE

The most satisfactory radio circuit yet developed.

M-V Teledyne Kit consisting of:

1 tuning inductance mounted on .00025 variable inductance.

1 variable unit comprising the R. F. Plate coil, detector grid coil and regeneration coil.

Price \$9.00

Satisfaction guaranteed.

Send for free circular.

Johbers—Dealers Write for discounts.

Mississippi Valley Radio Co.

203 Pine St., St. Louis, Mo.

10c Brings You  
Our New  
48-Page Radio Catalog  
Includes Thousands of  
Unequalled Radio Bargains

Send a dime for your copy, today!



CHICAGO SALVAGE STOCK STORE  
Dept. W6, 500 South State Street  
CHICAGO

# New York's Municipal Station on Air; Next Comes Hotel Majestic

WNYC, municipal radiocasting station of the City of New York, went on the air with some stirring music by the Police Band and a speech by former Commissioner Grover A. Whalen, who instituted the station. William Wirt Mills, his suc-

cessor as Commissioner of Plant and Structures, is in charge of the station, the wavelength of which is 526 meters.

The Hotel Majestic, Broadway and Seventy-second street, New York City, will be on the air soon. The Hotel McAlpin is said to be planning similar activities.

Edward Panchard, vice-president of the Majestic, first saw the possibilities of a broadcast station in connection with his business. The station is testing its equipment under the call 2XBG. The wave length that will be used is 268 meters. Broadcasting will be done three times a week, between the hours of nine and eleven at night. Additional concerts may be given from time to time at midnight.

The station studio, located near the grill room of the hotel, is beautiful. It is richly decorated and one of its novel features is the entire absence of any visible microphones. Instead, the "mikes" are hidden in the draperies, through which all the broadcast activities can be seen. As the studio is absolutely sound proof, a radio receiver is provided for the guests in order that they can hear as well as see what is going on. The station is in charge of James L. Lockwood.

## MAHOGANITE and BLACK RADION PANELS

DIALS, KNOBS, TUBING, SOCKETS MAHOGANITE BINDING POSTS

"THAT SPECIAL SIZE" FOR YOUR PHONOGRAPH, PORTABLE OR SUPER

ALL STOCK SIZES WHOLESALE RETAIL

Send for Complete Price List

New York Hard Rubber Turning Co. 212 Centre Street New York City

## NEUTRODYNE PARTS

Full set of Neutrodyne parts. Variable Condensers with dials, and Neutrodyne **\$13.25**

Above parts are Genuine Workrite Neutrodyne parts, made under Hamelina patents.

Complete parts for three tube Neutrodyne tuner, (tubes, batteries, or phones not included), drilled panel, tube sockets, rheostats, fixed condensers, jack, binding posts, wire, spaghetti, and blue prints.

**COMPLETE FOR \$19.95**

Postage additional on all shipments.

Ask for our price list.

Send no money—Order by postcard—Pay the Postman.

**RADIO SURPLUS STORES**

HELENA, MONTANA

## "GET HASTINGS, NEB." We Will Mail Free the Hook-up of "Killoch Kilo Koupler"

Most Wonderful Coil

A CIRCUIT WELL WORTH WHILE! Build a two-tube set, one stage of R. F., using neutrodyne principle and detector. Full details in Radio World, issue April 12. Send 15 cents.

**David Killoch Company**

Dodge Building, 45 West Broadway Corner Park Place, New York City

## The "Goode" Two-o-One

# A

*Le Ton d'argent*



Guaranteed

BY MAIL ONLY

**\$2.39**

Postpaid

## QUARTER AMPERE AMPLIFIER-DETECTOR RADIO TUBE

GUARANTEED SATISFACTORY

All "GOODE" Tubes Sold Direct to the Consumer—No Dealer Profits

ONE—"Goode" Detector-Amplifier ..... **\$2.39**

THREE—"Goode" Detector-Amplifiers ..... **\$6.42**

(All postage prepaid)

The "Goode" Two-o-One A Tube amplifies or detects. It is a quarter ampere, six volts, standard base silvered tube.

Send express or postal money order or New York draft to—

**The Goode Tube Corporation**

EVANSVILLE INDIANA

## Albert Greene Sings from WOR

ALBERT GREENE, operatic tenor, of Boston, gives his first radio recital at station WOR, Newark, N. J., on Wednesday evening, July 16. Mr. Greene, whose natural gift of voice may soon be classed with the most enjoyable, has studied in Boston, and is now continuing his studies at the Metropolitan. Besides giving successful private recitals, Mr. Greene has appeared in several operas at the Metropolitan.



Are you getting DX?

This book will show you how to get more!

It tells all about vacuum tubes and how to control them so as to get greatest D X, most volume and longest life from tubes and batteries. How to get maximum regeneration, clearest signals. Tells how vacuum tubes work.

IT'S FREE! WRITE FOR IT TO

**D X INSTRUMENT CO.**

Dept. RW-721

Harrisburg, Penna.

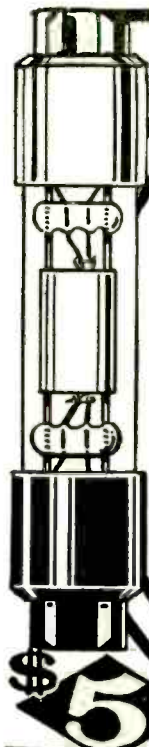

## London Hawaii -Porto Rico

A Canadian amateur (T. A. Crowe, Calgary), operating on three Myers Tubes, heard the concert broadcast by J. L. O. London, England, and picked up Hawaii and Porto Rico the same evening. (Calgary Herald, April 1st). Are you getting results like this? You can with

## Myers Tubes

Practically Unbreakable

They banish the noise that spoils reception and give wonderful volume and clarity to long-distance messages. Myers Tubes function perfectly as Detectors, Amplifiers and Oscillators. You can't break 'em unless you deliberately try. Two types: Dry Battery and Universal for storage batteries. (4 volts)

Demand Myers Tubes at your dealers or send price and be Supplied postpaid. See words 'Made in Canada' on each tube. Others not guaranteed.

Complete with clips ready to mount. No extra equipment required.

**E. B. Myers Co. Ltd.**  
*Radio Vacuum Tubes*

240 CRAIG STREET, W. MONTREAL, CANADA



# Radio Adds 5,000 Words to the Language

RADIO has enriched the English language by at least 5,000 terms, according to Dr. Frank H. Vizetelly, managing editor of the New Standard Dictionary. He says that radio, like each new science, brings in its wake a host of new terms and gives new meanings to old words.

Today it is not uncommon to hear persons referring to "frequency control," "variable condensers," "oscillator-grid current-meters," and thousands of other terms that have become general in their use, due to the growth and development of radio. A definition of these new terms is indispensable to one who would understand radio, and it is natural to look for this information in the dictionary.

"You ask me to tell you what radio has added in the coining of words," said Dr. Vizetelly. "It seems to me that some new term is introduced every day. From a general survey of the subject I should not be surprised to find that the language had been enriched in one way or another by at least 5,000 terms.

"Lately I have been more concerned about the correct use of prepositions and conjunctions than about the terminology that the radio 'fan' frequently finds himself battling with," said Dr. Vizetelly. "Should one 'tune in' or 'tune up'? Does one 'listen in,' or just do what everybody tells them to do by telephone—'listen'?"

"What do you say?"

## MID-SUMMER MAGIC

THERE are no lonely hours now,  
For radio has come.  
And sable night has taken flight,  
The air is all ahum.  
And loneliness has gone somehow,  
Grey sadness takes to wing.  
The world doth shout, and all about  
Sweet voices call and sing.

THE invalid in prison chair  
No longer sad-eyed weeps;  
For there's a song for every throng,  
As evening shadow creeps.  
A poem here, some music there,  
For every listening ear.  
So who shall say each, passing day  
Has not its meed of cheer?

AND now Mid-Summer brings new joy  
For out the radiant sky  
For rich, for poor, on sea or moor,  
Is radio close by.  
Near purling brook, or torrent's noise  
In valley, on the hill,  
The good, the bad, the gay, the sad  
Know radio's new thrill.

AND so, fair summer, lush and sweet,  
Has joy not known before.  
For every one beneath the sun  
May share in nature's store.  
So listen in and gladly greet  
The eerie sounds that go  
To make life's game more rare, less tame—  
A world of radio!

R. B. H.

## THE BROOKLYN RADIO SERVICE CO.

**BROOKLYN**  
577 Myrtle Ave.  
Send Money Order ONLY!

**MAIL ORDER DEPT.**

**LOUD SPEAKERS**

Magnavox, M-1	\$21.95
Pathe	11.95
Manhattan	18.00
Music Master	24.95
Magnavox, R-3	24.50

Plugs Included

**TRANSFORMERS PUSH PULL**

Como Duplex	\$9.90
All American	9.50
Modern	10.00

**DIALS**

Ameco, 2"	\$0.30
Ameco, 3"	.40
Ameco, 4"	.75
De Forest, 3"	.55
De Forest, 4"	.40
Pathe, 2"	.40
Pathe, 3"	.40
Pathe, 4"	.55
Federal, 3"	.50
Federal, 4"	1.15

**RHEOSTATS**

Filkostat	\$1.50
Fada	.60
Ameco (all styles)	.85
C Hammer, 6 Ohm	.75
Bradleystat	1.40
Paent	.75
Klosser	.85
Federal No. 18	.75

**TRANSFORMERS AUDIO**

Star, 3 to 1	\$2.80
Star, 6 to 1	2.95
U. V. 712	5.20
Modern, 4 to 1	3.95
Modern, 10 to 1	4.40
Acme	3.25
All American	3.35
Federal No. 65	4.80
Thordarson, 8 1/2 to 1	2.80
Thordarson, 8 to 1	3.20
Jefferson No. 41	3.20
Amertran	4.55
Eria, 3 to 1	3.75
Eria, 6 to 1	3.95
Federal No. 220	3.25

**TRANSFORMERS RADIO**

Cote Cells	\$0.69
Acme R-2, 3, 4	3.25
Acme 30K Super-Heterodyne	4.20
Atwater Kent	3.80
Tri Coil A	1.80
Eria R-flex	3.25
Rasia RT6	3.00
Rsla CR	3.25
Owl	.85
UV 1714	3.80
RR 1716	6.75

**CHARGERS**

Rectigon, 2 Amp	\$14.40
Rectigon, 5 Amp	22.40
Tungar, 2 Amp	14.40
Tungar, 5 Amp	22.40
Acme A, 2 Amp	9.75
Acme A & B, 2 Amp	11.20
Ward Leonard, D. C.	8.75

**PHONES**

Western Elect.	\$9.45
Federal	4.50
Scientific	2.75
Baldwin Type C	7.25
Ambassador	3.88
N. & K.	5.50
Freet	3.25

**SOCKETS**

Fada	\$0.70
Tilman	.35
De Forest	.55
Bell	.65
Huotick Falls	.60
Paent, 199	.40
Federal	.75
General Radio	.85
Warkrite, 189	.60

**BROOK-RAD "B" BATTERIES**

A "B" Battery with an unconditional guarantee. Tested and approved by the Tribune Institute. NOTE OUR PRICES, 4 SIZES:

2 1/2" Small	\$1.00	45 Volt Medium	\$2.00
2 1/2" Large	2.00	45 Volt Large	3.75

Allow us to quote on any parts or standard sets.

### ULTRADYNE

the improved Super-Heterodyne  
Send 50c for book giving complete details of drilling, assembling, wiring and tuning 6 and 8 tube ULTRADYNE Receivers.

50c

Thomas Radio Corp., 5-9 Beekman St., N. Y. C.

For Maximum Amplification Without Distortion and Tube Noises use the well known

### Como Duplex Transformers

Push-Pull  
Send for literature.

COMO APPARATUS COMPANY

446 Tremont St. Boston, Mass.

## MAGNAVOX

R 3 or M 1

### \$21.95

THE RADIO EXCHANGE

511 Seventh Street, Sioux City, Iowa

**Did You Get Anniversary Number?**  
Anniversary Number of Radio World, dated April 5. A few copies left. Larger than usual. Special features. 15 cents per copy. Mailed on receipt of price, or start your subscription with that number. Radio World, \$6.00 per year (\$2 nos.), \$3.00 six months, \$1.50 three months. Radio World, 1493 Broadway, N. Y. C.

# RADIO WORLD'S QUICK-ACTION CLASSIFIED ADS.

5 CENTS A WORD. 10 WORDS MINIMUM. TELEPHONE YOUR CLASSIFIED IF IN A HURRY.  
RADIO WORLD'S PHONE NOS. ARE LACKAWANNA 2062-6976.

**RADIO SET BUILDERS** buy your tubes direct; big discount on small quantities. Cleveland Tube Exchange, 3313 Carnegie Avenue, Cleveland, Ohio.

**\$3.95 — TUBES — \$3.95**

**GUARANTEED NEW GENUINE RADIO-TRANS.** ALL TYPES SENT POSTAGE PREPAID. GENERAL SALES SERVICE, ONSET, MASS.

**PATENTS**—Write for free Guide Books and Record of Invention Blank before disclosing inventions. Send model or sketch of your invention for our prompt Examination and Instructions. No charge for the above information. Radio, Electrical, Chemical, Mechanical and Trademark experts. Victor J. Evans & Co., 294 Ninth, Washington, D. C.

**PATENTS**—SEND DRAWING OR MODEL FOR EXAMINATION AND OPINION. Booklet free. WATSON E. COLEMAN, Patent Lawyer, 644 G Street, Washington, D. C.

**BOY WANTED** to build sets, particularly Neutrodyne and Ambassadors. Call in person. Alonzo, 445 East 9th St., New York City.

**HOW TO KILL RADIATION**—See RADIO WORLD, February 23, March 1 & 22, April 12, 1924. 15c a copy. RADIO WORLD, 1493 Broadway, New York City.

**CRAM'S RADIO MAP IN TWO COLORS**—Best map on the market, 35c. The Columbia Print, 1493 Broadway, N. Y. C.



# By H. P. DAVIS

"The Father of Broadcasting"

## DX Marvels the Next Few Years Have In Store for Us



H. P. DAVIS, vice-president of the H. Westinghouse Electric and Manufacturing Company, is known as "the Father of Broadcasting," because it was he

who had KDKA established in East Pittsburgh—the pioneer broadcasting station of the world.

IN the past few months, the public has heard much regarding radio repeating without realizing, perhaps, just what this extraordinary achievement of radio engineering means to the future of radio. If the public knew that, when the first radio repeating was successfully accomplished, the entire course of future radio development had been changed and the practically unlimited possibilities of radio broadcasting had at last been opened, it would have given the idea even more attention than was granted when announced.

Radio repeating is the "open sesame" to world-wide wireless and will make possible the receiving of programs from any part of the globe, with the same ease with which we now hear programs from stations located only a few miles from the radio receiver.

Naturally, before world-wide wireless is a reality, there will have to be installed special stations in various parts of the globe and these stations must be located advantageously.

Radio repeating, when it was first successfully accomplished by the Westinghouse Company, was the outcome of the development of short-wave transmitting. Short-wave transmitting means the sending of radio signals on a wavelength of 100 meters or lower. Because this wavelength is so low, it is not heard on the ordinary receiver and we shall, therefore, call it the inaudible wave. The ordinary broadcasting wavelength band from 250 meters to 600 meters is heard, of course, on the ordinary receiver, and we shall term it the audible wave. Inaudible wave transmitting forecasts the following radio development.

Certain well-designed central stations will be located at the world centers. These stations will be equipped to transmit on the audible or the inaudible wave length or both, as desired. The audible wave transmitter need not have excessive power, so that its operation will not interfere with distant tuning by adjacent receivers, if desired.

These transmitters will not need any more power than the leading stations of the United States today.

The inaudible transmitters, however, may be highly powered to give them the ability, when necessary, to maintain a constant range. As their signals will be transmitted on the inaudible wavelength, the power used

will not cause interference with receivers. There will be located, at advantageous points, inaudible wavelength repeating stations whose sole duty it will be to receive these inaudible waves from the central stations and pass them along. These repeating stations will act as "Booster" stations to amplify over and over again the inaudible signals.

Certain other stations, and there may be as many of these as desired, will be equipped with short-wave receivers with which it is possible to pick up the short-wave signals and repeat them on a low-power audible wave. These stations, which are to serve local districts only, will merely repeat the signals caught on the low wavelength and rebroadcast for the benefit of the listeners in their immediate vicinity. These local broadcasters, therefore, need only a small amount of power.

### The New Type 54

# SLEEPER

## MONOTROL

Reg. U. S. Pat. Off.

**Grimes Inverse Duplex System**

The only set that has 3 stages of tuned radio frequency on one tuning dial. 23 other important improvements.

Write for booklet "W." It's FREE.

**SLEEPER RADIO CORPORATION**  
88 Park Place New York

### Latest Developments in the SUPERDYNE CIRCUIT In Text and Diagrams

RADIO WORLD dated May 17, 24 and 31 contains a series of three articles covering all the angles of the famous Superdyne Circuit. The original Superdyne Circuit articles appeared in Radio World last December, and the three issues in which they appeared are now completely out of print. That is the reason why we have published the Superdyne series in the May 17, 24 and 31 issues. 15c. per copy, three for 45c., or start your subscription with any number.

**SPECIAL SUBSCRIPTION:** Send \$6.00 for one year's subscription and we will send you our issues of May 17, 24 and 31 as a premium.

RADIO WORLD, 1493 Broadway, N. Y. City

Write Today For Descriptive Folder of the

# NEW HOWARD 5-TUBE NEUTRODYNE

This Remarkable Set has Created a Sensation Among Radio Enthusiasts. Beautiful Walnut Cabinet with Special Howard Neuroformers, Tube Sockets and Rheostats.

Licensed by Independent Radio Manufacturers, Inc. Pat. March 27, 1923 and April 1, 1924. Hotetime Pat. Nos. 1,450,080 and 1,489,228. Other Patents Pending.

**HOWARD MFG. COMPANY**  
4248 No. Western Ave. Chicago, Ill.

### RADIO and OTHER TECHNICAL BOOKS YOU NEED

Radio Teleg. and Telephone Receivers for Beginners .....	\$0.75
Design Data for Radio Transmitters and Receivers—M. B. Sleeper.....	.75
Wireless in the Home—DeForest.....	.15
Commercial Type Radio Apparatus—M. B. Sleeper .....	.75
A B C of Vacuum Tubes—Lewis .....	1.00
Operation of Wireless Telegraph Apparatus .....	.35
Lessons in Wireless Telegraphy.....	.35
Radio Hookups—M. B. Sleeper.....	.75
Construction of New Type Trans-Atlantic Receiving Sets—M. B. Sleeper .....	.75
1922 Consolidated Call Book.....	.50
Radio Telephony .....	3.00
Radio Tel. & Tel.....	1.00
How to Pass Government Examinations .....	.50
How to Make a Standard C W Set.....	.35
How to Conduct a Radio Club.....	.50

Any book sent on receipt of price, postpaid. 20% discount on any two books of same title. The whole list of 15 books sent for

## \$9.40

**THE COLUMBIA PRINT**  
1493 Broadway, New York City

### SUPER-HETERODYNE FOR YOU!

An improved Super-Heterodyne at a low price, complete, with map, complete wiring hook-up, schematic assembly of parts, wave length calibration chart, accurate panel specifications, detail of intermediate frequency transformer construction, how to wind all the coils, and complete constructional information so that anyone can build the outfit, in RADIO WORLD for May 31, June 7, 14, and 21. 15c a copy. The four copies for 60 cents, or start your subscription with May 31.

RADIO WORLD, 1493 Broadway, N. Y. C.

# Improve your set with an ACME "lowest loss" condenser

*Because of low losses and sharp tuning practically all the currents on the antenna can now be used*

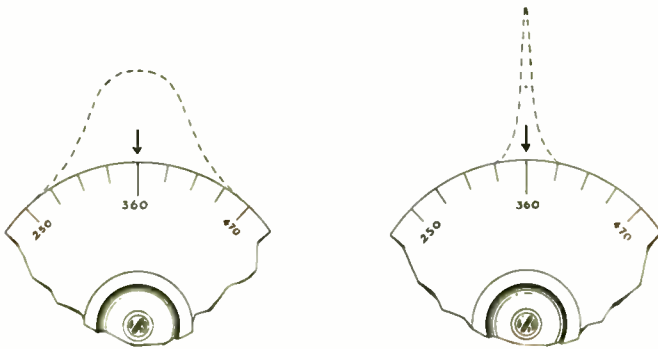

**Which one is your  
tuning circuit  
—the hump or the peak?**

**H**ERE are the curves of two tuning circuits. The hump has a high loss condenser and the peak a low loss condenser. Both receive broadcasting, but the peak receives local and distant stations without interference, while the hump receives only the nearby stations with interference. The new Acme Condenser will change your tuning circuit from a hump to a peak.

The Acme engineers have been working for two years to bring out a condenser which would give the Radio experimenters sharp tuning and minimum losses. The new Acme Condenser has these fundamental advantages and also has many new improvements in structure and equipment. See the illustration with explanation, and, for more information, write to us for booklet—"Amplification without Distortion," which contains many diagrams and helpful hints on how to build and get the most out of a set.

ACME APPARATUS COMPANY  
Dept. 127 Cambridge, Mass.

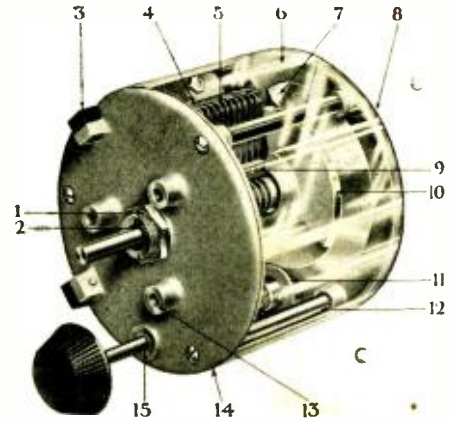

- 1—Steel brass cone bearings, adjustable.
- 2—Lock nut for bearing.
- 3—Highest grade hand rubber Dielectric in that part of the field to prevent losses.
- 4—Brass separator to which both rotary and stationary plates are soldered, making continuous circuit for each.
- 5—Brass silver-plated plates; rotary plates logarithmic.
- 6—Dust-proof covering.
- 7—Stops at extreme end of movements.
- 8—Coiled connection between shaft and heads allowing lubrication of bearings.
- 9—Brass separator to which both rotary and stationary plates are soldered, making continuous circuit for each.
- 10—Counterweight which balances rotary plates.
- 11—Noiseless friction Vernier control, seven to one ratio.
- 12—Brass separators to prevent twisting and to take strain off Dielectric.
- 13—Panel mounting holds for 120 degree spacing.
- 14—Metal heads.
- 15—Steel bushing to prevent wear on Vernier shaft. ALL parts are of non-rusting metal, except steel bearing, which is covered with nickel-plated protective surface. End plate capacity is .000016 m.f., full capacity is .0005 m.f. Price, \$6.50.

*Cut out and send this coupon*

ACME APPARATUS COMPANY,  
Dept. 127 Cambridge, Mass., U. S. A.  
Gentlemen: I am enclosing 10 cents (U. S. stamps or coin) for a copy of your book, "Amplification without Distortion."

Name .....

Street .....

City ..... State .....

# ACME ~for amplification