

The Nite Owl Special, by Anderson (See Inside)

15c. a Copy ^{Vol-3} _{No-67} July 7 1923 \$6.00 a Year

RADIO WORLD

Title Reg. U. S. Pat Off.

ILLUSTRATED

EVERY WEEK

RADIO ADDS TO THE PLEASURES OF THE SEASHORE



(C. Photonews)
A group of bathers at Rye Beach, N. Y., doing a little fancy stepping to the tune of radio music received on a new type portable set which needs neither antenna nor ground.

Summer Tips to Summer Fans, by Dougherty (See Inside)



**Pruden Reliable
Radio Specialties
For Good Results**

Dealers write today for
our interesting proposition.
FREDERICK H. PRUDEN, Inc.
993 Bergen Ave., Jersey City, N. J.

WD-11 WD-12

**UV201A
\$3.75**

25c. allowed on old tubes
Rebuilt Equal to New Guaranteed
IMMEDIATE DELIVERY

Mail Order Only
Radio Tube Service Co.
41 WEST 32D STREET NEW YORK, N. Y.

PATENTS

To the Man with an Idea

I offer a comprehensive, experienced, efficient service for his prompt, legal protection, and the development of his proposition.

Send sketch or model and description, for advice as to cost, search through prior United States patents, etc. Preliminary advice gladly furnished without charge.

My experience and familiarity with various arts frequently enable me to accurately advise clients as to probable patentability before they go to any expense.

Booklet of valuable information, and form for properly disclosing your idea, free on request. Write today.

RICHARD B. OWEN
Patent Lawyer

32 Owen Building, Washington, D. C.
2276-P Woolworth Bldg., New York City

THE BOY MECHANIC



**700 THINGS FOR
BOYS TO DO**

480 Pages—700 Articles
800 Illustrations—Cloth

Price \$2.00 Prepaid

**The Ideal Book
for the
Wide-Awake Boy**

All the things described in this volume have actually been built or experimented with by boys. The ideas contained in "The Boy Mechanic" would more than keep a boy occupied until he grows up and also be an incentive to original thinking and achievement.

The Most Interesting Boys' Book

Unlike so many other books of a somewhat similar nature, it is not confined to only one or a few subjects, but describes 700 different things boys can make and do in the fields of mechanics, electricity, sports, arts and crafts work, magic, etc.

An unusually generous book; size 7 by 10 in. and 1 1/2 in. thick; printed from large, clear type on high grade book paper and durably bound in cloth. Attractive four-color cover design.

Wholesome, Practical, Instructive

Besides telling how to make scores of things useful about the house, full and complete directions are given for constructing hundreds of things which appeal to the heart of every boy.

Many hours of enjoyment are in store for the boy who becomes possessor of this book.
Price \$2.00 Prepaid to Any Address

THE COLUMBIA PRINT
1493 Broadway New York City

Another Appreciative Subscriber Heard From

Editor RADIO WORLD: In your April 14th issue there appeared an interesting article by Arthur S. Gordon entitled "Build Me," giving details for a very clever set.

At the time this issue came out I was in the throes of construction, being at work upon a two variometer set. I had my variocoupler, inductance switch and condenser all in and was about ready to purchase the variometers when along came your article and changed everything. I read the article very carefully and while I could not follow the exact instrument placings I could follow the hook up. So I built the set and it's a wonder! I used a Pioneer coupler, Walnart 43 condenser back panel inductance, Acme transformer cartridge grid condenser and leaks in triple mount, wiring two grid mounts in series giving me a variance of grid from one to five by using several grid cartridges of different values.

I have a beautiful set in golden oak cabinet carefully wired and it has been admired for beauty of finish by all who have seen it. And it works beautifully sweet and clear.

Before I had an aerial up I hooked it to the bed springs. One night got Memphis WMC, another night WHB Kansas City and another night WOAY Birmingham, all on the bed springs. I have just put up an aerial and through a bank of static that has camped around here with the present heat wave I enjoyed San Antonio WOAI Sunday evening concert clear as a bell. So all in all this answers your query on page 6 of April 14 issue: "Why do you read RADIO WORLD?"

I believe the fundamental desire of the public generally is to be enlightened upon the intricacies of radio; to have their small knowledge of the art given food upon which to develop a better understanding of it. This RADIO WORLD is doing. I see every issue. It is only deserving that it should be as popular as it is.

W. RITT CHANDLER.

Box 716, Clarksdale, Miss.

Broadcasting Popularizes at Least One Song

In an article on radio and the music industry written for *The Music Trades*, E. F. McDonald, Jr., of the Chicago Radio Laboratory, quotes this interesting incident:

A typical example of the effect of broadcasting on vocal music was furnished by the testimony volunteered at the first meeting of the National Association of Broadcasters when Mr. Wendell Hall, a song writer, made the declaration that "Mellow Moon," which he had written, made no appreciable headway in the hands of a publisher who resorted to the usual avenues open to publishers for exploiting a new musical creation. There was practically no sale. Then Mr. Hall began singing "Mellow Moon" at KYW and WDAP broadcasting stations. He stated that in the month of April the sale of "Mellow Moon" jumped to 100,000.

Making the Set Was Easy!

LITTLE JOE had completed his crystal receiving set and had made it "work." His astonished and proud mother said to him:

"Wasn't it very hard to do all this?"
"Naw," said Joe; "most of it was easy as anything."

"What was the hardest part of it?" she asked.

"Gettin' eight plunks out of pa," said Joe.—*Exchange.*

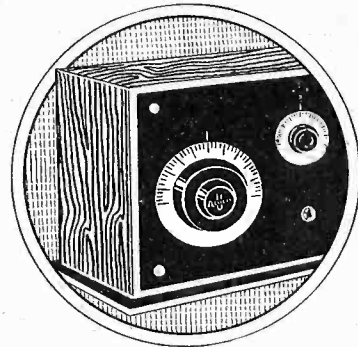

**ABSOLUTE TUNING
PRECISION
with**

ACCURATUNE

MICROMETER CONTROLS

An accurate tuning instrument ten times more efficient than any vernier device. Micrometer control within the dial itself permits hair splitting adjustments never before possible. Operates every plate of condenser and eliminates necessity for vernier plate. Fits any standard 3/16" or 1/4" instrument shafts. Attractive and durable. Silvered dial with neatly engraved graduations. Black or brown bakelite knobs. If your dealer cannot supply you send \$3.50 direct to us for this wonderful instrument. Fixt-Post Inductance switch and Rheostat dials to match.

MYDAR RADIO CO.

9-B Campbell St., Newark, N. J.

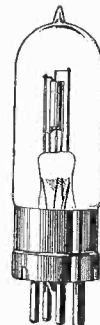

WE REPAIR

WD-11, \$3.50

AND POSTAGE

**Also other vacuum
tubes, excepting
VT-1 and VT-2.**

Mail orders solicited and promptly attended to.

H. & H. RADIO CO.

514 Clinton Avenue Newark, N. J.

2000 MILES ON ONE TUBE!

Easily made by anyone. No trick circuit. Few parts. Distance, Volume, Selectivity.

Guaranteed to work or your money refunded. Complete parts, including drilled panel, bulb, phones, batteries and diagram, only.....\$12.95

Circular free.

Scientific Radio Laboratory

25 THIRD AVENUE NEW YORK

Construction of New Type Transatlantic Receiving Sets

By M. B. SLEEPER

Fully Illustrated. Price 75 Cents

IN addition to the listening to ships and broadcasting stations on short wave lengths there is a peculiar fascination about listening to the high-power telegraph stations of England, France, Germany, Russia and Italy as well as those located in the Pacific Ocean and the Oriental Countries. It is much easier to do this than most people imagine. The sending is very slow, a feature of assistance to the beginner in telegraphy. Several types of receiving sets for this task are described. Detectors, amplifiers, oscillators, etc., for long distance reception are also described. Suggestions for the operation of relays by the signals and the reproduction of them on a phonograph are given. In addition there is some valuable data on home made wavemeters for testing and experimenting.

Sent P. P., prepaid, on receipt of price, by

THE COLUMBIA PRINT

1493 BROADWAY, NEW YORK CITY

RADIO WORLD

[Entered as second-class matter, March 28, 1922, at the Post Office at New York, N. Y., under the Act of March 3, 1879]

A Weekly Journal, Published Every Wednesday and Dated Saturday, by Hennessy Radio Publications Corporation from Publication Office, 1493 Broadway, New York, N. Y. Telephone: Bryant 4796.

Vol. III, No. 15. Whole No. 67

July 7, 1923

15c. per copy, \$6.00 a year

The Nite Owl Special

By J. E. Anderson, M. A.

IF you are in pursuit of the elusive DX signals that nightly fill the ether, you are also in pursuit of new circuits with which to bag your game; and here is one which undoubtedly will interest you. It will coax the signals from the farthest recesses of the ether and literally hurl them against your ear drums, and you don't have to guess what call letters were used as missiles either. But the circuit is somewhat difficult to manipulate at first and is likely to become a storm center in the neighborhood until the operator has learned to obtain maximum signal strength without generating a lot of "birdies." With a little practice it is possible to tune it in on almost any signal and bring it to the very brink of oscillation without once letting it "spill over."

The new feature of this circuit lies in the interstage coupling which was first suggested to me by Mr. W. A. Marrison, of the Western Electric Company, who has obtained remarkable DX results with a circuit similar to the one described here. Using this type of coupling between two stages of radio-frequency amplification and between the second stage and a tuned crystal detector, he picked up stations 1,500 miles away on a very small indoor antenna, and the circuit was extremely selective. The present circuit is not nearly so selective, but it is easier to manipulate and not nearly so critical. There are several means

by which the regeneration may be easily controlled. A glance at the accompanying diagram will show that the circuit consists of one stage of radio-frequency amplification and a detector and that the two tubes are coupled by a tuned auto-transformer. Thus the plate circuit of the first tube is tuned and this makes the first stage regenerative. The reaction between the plate circuit and the grid of this tube may be regulated by varying the amount of inductance in the plate circuit. For this purpose the interstage inductance coil is tapped at about every five turns and the plate lead of the first tube tied to one of these taps. Maximum reaction is obtained when the plate is tied to the upper end of the coil and minimum reaction when it is

connected to the lower end. As the reaction is reduced the coupling between the two tubes is also reduced, but at the same time the ratio of transformation is increased. The plate potential of the first tube is supplied through the windings of the interstage inductance coil and hence the grid condenser of the detector tube serves the double function of blocking the grid current of detector and preventing the plate potential of the first tube from reaching the grid of the second. Therefore the insulation of this condenser should be of the highest order. The grid leak resistance of the detector is connected directly from the grid to the positive side of the filament. The values of these two elements do not differ from those used in other circuits. The condenser C_3 is a by-pass across the "B" battery and serves the usual purpose of furnishing a low impedance path for the high frequency currents. Its

value should not be less than .005 mfd. Condenser C_4 serves a similar purpose for the detector tube, but its value needs to be not greater than .001 mfd. The detector tube, as shown in the drawing is not regenerative but if desired it may be made so by one of the usual methods. If this is done the first tube should be operated at a point considerably below regeneration, or the circuit will be entirely unmanageable.

The two inductance coils in this circuit should be somewhat larger than is customary in order to

obtain regeneration on the longer broadcasting wave lengths. From 60 to 75 turns on a 3.5 inch tube is about the minimum for the antenna coil and 60 turns on the same size tube for the interstage coil. The antenna coil should be tapped so that it may be varied in steps of from two to five turns and the interstage coil in steps of five turns.

These large coils require small condensers. Twenty-three plate condensers may be used but 11-plates are better. It will be found that signals come in loudest when small values of capacity and large values of inductance are used and the smaller condensers will give the necessary fine variation in tuning. This com-

(Concluded on next page)

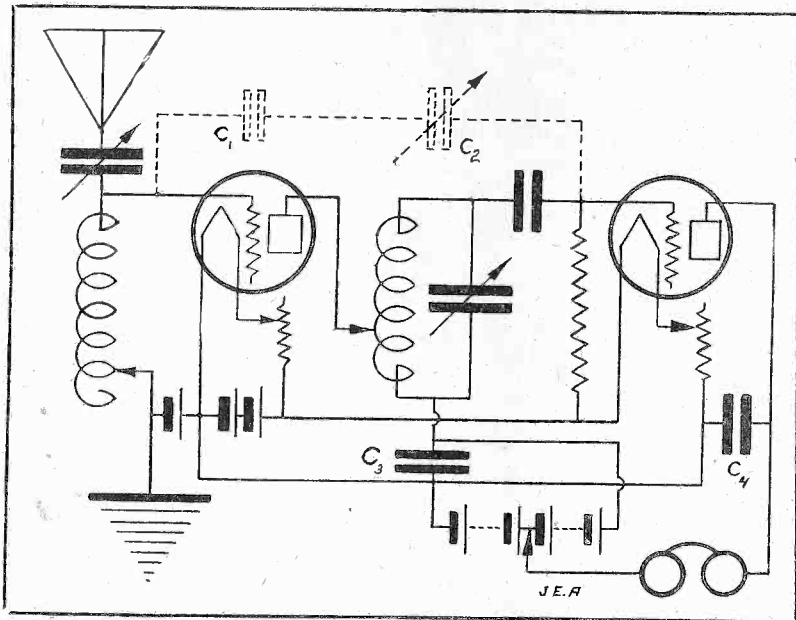

Circuit diagram of receiver utilizing super-tuned radio-frequency. The neutralizing capacities are optional, but will aid in reception if used.

Studying Radio Code While Asleep

By Carl H. Butman

WASHINGTON, D. C.—Studying radio code while asleep may be the boon many amateurs are awaiting to insure a higher rate of reception. In any event, this method of instruction has been tried in the Naval Air Station at Pensacola with the result that backward students have improved their speed.

Due to the fact that many of the embryo aviators, who receive their radio instruction at the Pensacola Naval Air Station, have been unable to copy at a rate of twenty words a minute, the novel method of continuing to send to them while they are asleep, with their receivers in place, has improved their speed when awake.

The method, which was devised by Chief Radio Mate Phinney, in charge of radio instruction, gives every indication of becoming practical and valuable, naval radio experts believe, although some of them want to observe personally its application.

Chief Phinney, who is a student of the old school and served in the war as a commissioned officer, claims that the plan will aid in teaching students high-speed reception while asleep, increasing their facility in receiving in a fraction of the time ordinarily required in wakeful hours. Several students who were in danger of flunking their radio have been saved that ignominy, he claims, by instruction while they slept in their "ear-muffs." Subconsciously they continued to listen-in. The inventor conceived the idea of subconscious instruction following a personal experience. While practicing receiving at a rate of thirty-five words a minute, he fell asleep, but the mechanical transmitter continued to send to him. When he awoke, he declared he was able to receive at the thirty-five word rate, although previously he could only copy at twenty and

twenty-five. His theory is that during his few hours of slumber his sub-conscious mind was trained to receive at the higher speed.

Skepticism greeted his early proposals of sleep instruction, but now even the skeptics admit the plan is workable. Requirements in the radio section of the flying school provide that within six months students acquire a speed of twenty words per minute before they can become pilots. This is a bugbear to many. In the last class several students proved difficult subjects and as a last resort the new method was tried to boost their speed.

Before they turned in, these students adjusted their head receivers and soon after "taps," an expert operator began to send at a rate of about ten words in excess of their capacity to receive. All through the night the messages in code went on, the operator at the key being relieved from time to time. In their conscious hours the following day, most of the students were able to receive messages at the speed sent to them while they slept.

Here is an opportunity for amateurs to improve their speed by picking up some naval ship or station sending code at night and sleeping with their "ears to the air" as it were. Many amateurs, as well as commercial operators, have experienced the aggravating continuation of the "dit-da-da" long after they have ceased to listen in, following a long session of receiving. This is practically the reverse of the method proposed, in that it is the continued operation of the subconscious mind and ear, which have adapted themselves to a code speed, although the messages have ceased. Some amateurs plan to try the method, as they all find a maximum speed point in reception which they are unable to pass for some time.

(Concluded from preceding page)

bination renders the circuit less selective than it would be if large condensers and small inductances were used, and for this reason only the very best condensers should be used and special precautions should be taken to select coils that have a low distributed capacity and low effective resistance.

This circuit is liable to raise a veritable bedlam of noises while tuning it unless this is very carefully done. To tune the circuit to any wave length within its range use as small values of inductance as possible both in the antenna and the plate of the first tube, and vary both the variable condensers until both circuits are in exact resonance with the desired wave length. If it starts to oscillate reduce the inductance some more and tune again. When both circuits are in tune the strength of the signal may be increased by gradually increasing the inductance in the antenna or plate circuits and re-tuning. A variation in the plate inductance of the first tube will have little effect on the tuning of the interstage coil as will be seen from the connection in the drawing. Two taps will soon be found on either coil such that the circuit will oscillate on one while it will not on the tap just below. If the signal is satisfactorily loud on the tap on which it will not oscillate this should be used, otherwise the first tap on which it will oscillate should be used. The oscillations may then be stopped by detuning one of the circuits slightly.

A third method of controlling the regeneration is

suggested by the dotted lines in the drawing. Since the neutrodyne principle is a means of neutralizing the cause of regeneration in a circuit of this nature, it is evident that it may also be used to control the amount of regeneration. This may be done by inserting a small neutrodyne condenser between the two grids of the circuit and varying its capacity over the necessary range. This condenser must be very small and it must be capable of very fine variation in capacity. The finest variation in capacity may be obtained by connecting a small fixed condenser in series with a large variable one. In my experimental circuit C_2 was a variable 23-plate air condenser, but an 11-plate or a 3-plate will do equally well. C_1 was made by twisting together the ends of two pieces of No. 22 double silk covered wire. One to three turns were found to be sufficient.

If greater selectivity than this circuit will give is desired a double circuit tuner may be used in the first stage. But this circuit is extremely difficult to manipulate owing to its critical nature. However, it may be controlled in a similar manner to the single circuit tuner discussed above. It may further be stabilized by keeping the antenna circuit accurately in tune with the secondary and the interstage coils and by increasing the coupling between the antenna and the secondary. But these conditions, unfortunately, will cause greatest re-radiation and interference with neighboring sets when it does oscillate.

Skyscrapers Absorb Radio Waves

By C. W. Tucker

ARE you in a dead spot? Quite a lot is being heard these days about dead spots. Baltimore cannot hear Washington radio stations. Pittsburgh radio stations are silent to Cleveland's ears. Yonkers hears New Jersey stations much better than New York City stations, although it is on the outskirts of the city.

An interesting study of this matter has been made by Bell System engineers in connection with the trans-

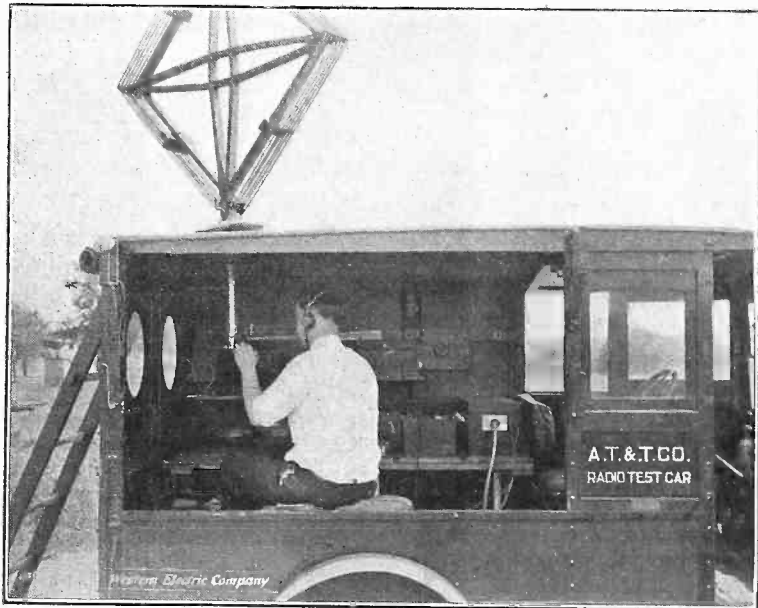

Fig. 1. Western Electric test car which recently made efforts to solve the problem of "dead spots" in radio reception around New York City.

mission from stations 2XY at 24 Walker Street, 2XB at 463 West Street and 2XW on the Municipal Building, New York City. As will be seen from the chart herewith there is a sharp decline in the strength of the radio fields of each of these stations in an almost direct northeasterly direction. The fields are very much weaker in an east and southeast direction, than they are on the west side. The line of the weakest field in the northeasterly direction is directly over a mass of skyscrapers in the Times Square district, while in the southeasterly direction, it leads over the skyscrapers in lower Manhattan and the eastern end of Brooklyn. For this reason, it has been assumed that the steel in these buildings absorbs the radio waves.

This chart is really made up of two maps. The circle and the lines have no reference to distance but to the field strength of the broadcasting stations in microvolts per meter. The lines show the direction in which the readings were taken. The black dots represent the strength of the field in that particular direction. The lines connecting these dots do not represent the strength of field between the dots but are merely drawn in to show which station the dot represents.

Special measuring apparatus was developed in the Bell System Laboratories of the Western Electric Company for measuring the field strength of the different broadcasting stations. Essentially the process is one of measuring the current produced in a calibrated antenna by the incoming radio waves. Since these currents are very small they cannot be measured directly but a comparison method is necessary. An oscillator in the measuring set produces a small but measurable radio-frequency current, a very small part of which is picked off by a calibrated potentiometer

and fed into the antenna. A receiving set also connected to the antenna is used as an indicator to tell when the currents produced in the antenna by the distant and local sources are equal.

Where the transmitting station is co-operating or under control, the distant and local signals may be introduced separately and alternately and their efforts on the receiving set compared by means of an indicating instrument attached to the output of the receiving set.

When the transmitting station is not co-operating, the use of a loop antenna permits it to be cut out when the local signal is introduced by turning the loop 90° to the directional blind spot. If desired, the antenna may be cut off entirely, and the comparison made directly against the local source feeding into the receiving set.

One of these measuring sets was made up and mounted in an automobile truck. The loop antenna is placed on top. This set was used in making a study of the field strength of the broadcasting stations mentioned above. It was found that at 400 meters these stations are handicapped in transmitting through the maze of steel structures of Manhattan. Also, it is ap-

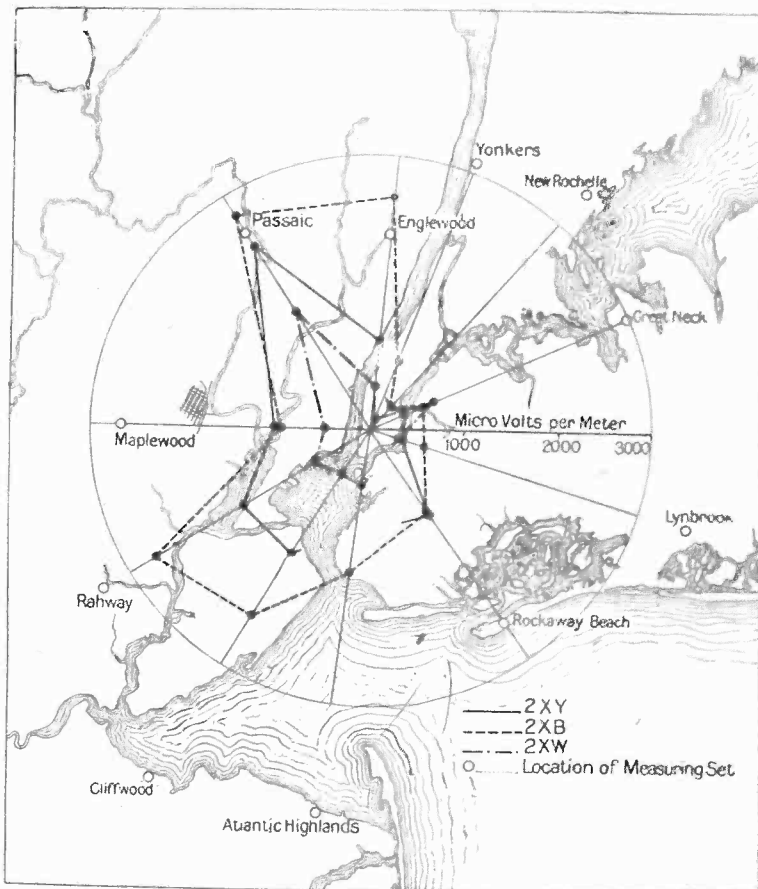

Fig. 2. Map showing the results in field strength of various stations taken at several places for the tests on "dead spots."

parent that the two high buildings are less favorable sites than the 14-story building at 2XB.

The results obtained demonstrated that field measuring sets are valuable experimental tools. For this reason, a set was built employing the Western Electric "N tube" or what is properly known as the "peanut tube" throughout. This outfit, together with the loop, which is collapsible, can be placed in two suitcases such as are used by traveling salesmen for carrying samples

Dr. MacMillan Begins His Arctic Voyage— Radio Reports Received



Dr. MacMillan in Arctic costume—parka and mukluks

THE 89-foot schooner "Bowdoin," bearing Dr. Donald B. MacMillan and his party on their way to resume scientific work and explorations in the Arctic, sailed from Wiscasset, Maine, on June 23. The work begun on the Baffin Land expedition, from which Dr. MacMillan returned in September with the greatest collection of scientific and magnetic observations ever made in the Arctic, will be continued in Ellesmere Land, Northern Greenland. While he expects to return in fifteen months, Dr. MacMillan may be compelled to stay until the fall of 1925.

The party includes three who were on the previous trip. These are Ralph P. Robinson of Merrimac, Mass.,

assistant; Thomas J. McCue of Brigus, Newfoundland, mate, and Richard Goddard of Winthrop, Mass., sent by the Carnegie Institute to continue the observations in terrestrial magnetism and atmospheric electricity which he began in Baffin Land.

The others are Donald H. Mix of Bristol, Conn., an expert radio operator, sent by the American Radio Relay League, composed of 15,000 amateur operators in the United States; W. F. Lewis of East Lynn, Mass., cook, and John Jaynes of Somerville, Mass., an engineer.

Abram Broomfield, an expert driver of Eskimo dogs, will be picked up at Jack Lane's Bay, near Davis Inlet, Labrador, for his second trip on the schooner.

The "Bowdoin" is expected to reach Etah about August 20. At Cape Sabine the vessel will be allowed to freeze in for the winter, 660 miles from the North Pole.

The principal exploration will be a dog team trip over the ice cap of Ellesmere Land, an elevation of 4,000 feet, and down the other side into Eureka Sound, where big coal deposits which Dr. MacMillan found in 1914 will be investigated.

F. H. Schnell, traffic manager of the American Radio Relay League, announces that WNP (wireless North Pole), the "Bowdoin's" call, will transmit on wave lengths of 185, 220 and 300 meters. Donald H. Mix, radio operator on the "Bowdoin," will stand by from 10 P. M. to midnight for press reports from Arlington; at midnight for reports from NSS; from 1 A. M. to 2:50 A. M. he will communicate with amateurs; 3 A. M. to 4:59 A. M. he will attempt to work stations operating under a limited commercial license, and from 5 A. M. to 7 A. M. he will again try amateurs.

Messages with the prefix "urgent" will be used in emergencies and the amateur receiving such a message will be advised as to its disposition.

The first message from the "Bowdoin" was received at A. R. R. L. headquarters in Hartford, Conn., the day after she sailed. The words sent by Mr. Mix were clearly heard and reported by hundreds of amateur stations.

Before sailing Dr. MacMillan was asked the objects of his present voyage. He is reported as saying:

"The Carnegie Institute again is sending its representative, Richard Goddard of Winthrop, Mass., to make a study of terrestrial magnetism and atmospheric electricity. We also intend to study ornithology, glaci-

ology and botany and to obtain a series of educational photographs of bird and animal life.

"In addition, millions of radio users will be interested in our radio experiment in seeking to keep in constant communication with the outside world through the aurora or northern lights. Many experts have contended that this is impossible. This experiment should eliminate speculation and substitute certainty.

"We hope that our radio experiments and study of atmospheric electricity will help to throw some further light on the effect of atmospheric conditions on radio reception and transmission."

Dr. Donald B. MacMillan, D. Sc., F.R.G.S., the leader of this expedition, was formerly a professor at Bowdoin College and was first induced to go to the Arctic by Peary. He accompanied Peary on the expedition on which Peary reached the Pole and has been back to the Arctic seven times since. Dr. MacMillan was the guest of honor at a dinner given at the Hotel Sherman, Chicago, last spring, by U. J. ("Sport") Herrmann, who incidentally is the owner of the Chicago Radio Show, one of the owners of the Boston Red Sox, and a well known Chicago yachtsman. This dinner was a private affair, attended by prominent naval officers and city officials.

During his talk Dr. MacMillan told of the hardships of the Arctic. He said that the greatest hardship is not, as is commonly supposed, the intense cold—which sends the mercury sometimes as low as 60° below zero—that it is not the privations (for on one expedition which Captain MacMillan commanded he demonstrated that he and his crew could live for a year on nothing but the food which sustains the Eskimo), but that the greatest hardship is the awful solitude—everything going out and nothing coming in. Mr. Herrmann, who from the start has been intensely interested in radio, inquired why he, MacMillan, did not take along a radio set. Dr. MacMillan replied that it would take up too much space. There developed a considerable discussion of just what radio would do, in which discussion Dr. MacMillan became greatly interested. As an outcome he arranged to install both sending and receiving sets aboard the "Bowdoin" and converted the entire forward end of the fore-castle into a radio room.

Dr. MacMillan takes with him, installed in the fore-part of the ship, a Zenith long distance standard broadcast receiving set with a wave length range of from 150 to 900 meters, and equipped with three-stage amplifier and loud speaking apparatus, as well as a Zenith long wave receiving set with a maximum wave length of 20,000 meters. With these two sets reception will be possible of not only amateur telegraph and phone stations and radiophone broadcasting stations, but also naval and commercial transoceanic stations from which press reports, time signals, weather forecasts, etc., can be secured.

The transmitting equipment consists of a Zenith 500 cycle interrupted-continuous-wave set, using two 250-watt transmitter tubes and the Armstrong regenerative circuit. This apparatus is mounted very compactly in semi-panel form with all necessary meters, and is supplied with current by two gas engine driven Delco generator units entirely separate from the regular power plant of the ship.

The ship's antenna is of peculiar construction, due to the fact that the "Bowdoin" depends for part of its

(Concluded on next page)

Radio and the Woman *By Crystal D. Tector*

FRIEND HUSBAND has come back from his fishing trip brown as a berry and twice as hungry as he ever was. He collected a store of radio information from the guide who had a wonderful set up in his cabin on the lake. F. H. said that he did not have to even use his little set because "Pop," as he called the guide, happened to be a rabid amateur, with a transmitter and a wonderful receiver. Now nothing will do but for us to get a license and a transmitter and start in to "mess up the ether." Well, you can take it for granted that he will be the only one that uses it, because I have no intention of making our neighbors wish that we were in South America, because of spoiling their evening's DX listen-in.

* * *

He sent me a telegram the day before he left and we both received it two days after he got here. That gave him a great laugh and he said, "Well, supposing that I had been sick and wanted you to come up. I could have passed out before you would ever hear about it." The young fellow that gave it to us, however, explained by saying that it was routed through New

Jersey, instead of New York, and landed up in Roselle Park instead of our town, and like a letter it had been floating around until it found us. Wonder if you would call that a magnetic field?

Handy in Warm Weather

WEARING your phones in the warm weather sometimes proves discomforting, due to the heat. This can be alleviated and the wearing of phones made a comfort even in the warmest of weather. The method to pursue in doing this is: Get two rubber sponges at the nearest drug or 5 and 10 cent store. Cut a hole in the center of each sponge and place them on the head set. Then the phones can be worn and the rubber sponge will keep you nice and cool, and prevent the phones from pressing tightly against your ears.

(Concluded from preceding page)

motive power on sails and is of comparatively short length. A stem to stern antenna is used, passing over the main mast and foremast, the lead-in dropping through the foredeck to the radio quarters. In order to insure good ground, steel and copper plates have been riveted to the hull and in addition, connections have been made to the propeller shaft through the engine and to the supply of coal which is carried partly as ballast and for emergency use.

The Government has assigned wave lengths of 200, 300 and 400 meters and has also given permission for Station WNP to use whatever wave length it may find necessary for experimental purposes.

It might be interesting to figure out just how Uncle Sam would move against an ice-bound ship in the Arctic, hundreds of miles from civilization, if its wave length were found to interfere with that of other sending stations!

The American broadcasting station which will be used to send messages to Dr. MacMillan is the new Zenith-Edgewater Beach Hotel Broadcasting Station WJAZ, which incidentally is the most powerful broadcasting station in the country, having 4,000 volts and 10 kilowatt output. This station will not only be used to give Dr. MacMillan and his crew of seven entertainment and news of the day, but it will also be used by the families of Dr. MacMillan and his crew when they desire to send messages to those aboard the "Bowdoin" in the frozen north.

There is a period of 141 days in the Arctic during which a message sent at midnight must pass through hundreds of miles of sunlight before it reaches darkness. It will be interesting to see what effect these peculiar conditions of the Arctic have on radio communication. Up to the present time it has been thought that the so-called auroral band would act as a powerful deterrent in transmitting radio messages. At all events, there is no record of a message ever having been transmitted from the north through it. It will be interesting to learn to what extent the auroral band will interfere, and it is quite possible that scientific data of great importance will be gathered about the Aurora Borealis, which has always been a mystery. Never before have all the amateurs of the country focused their receiving

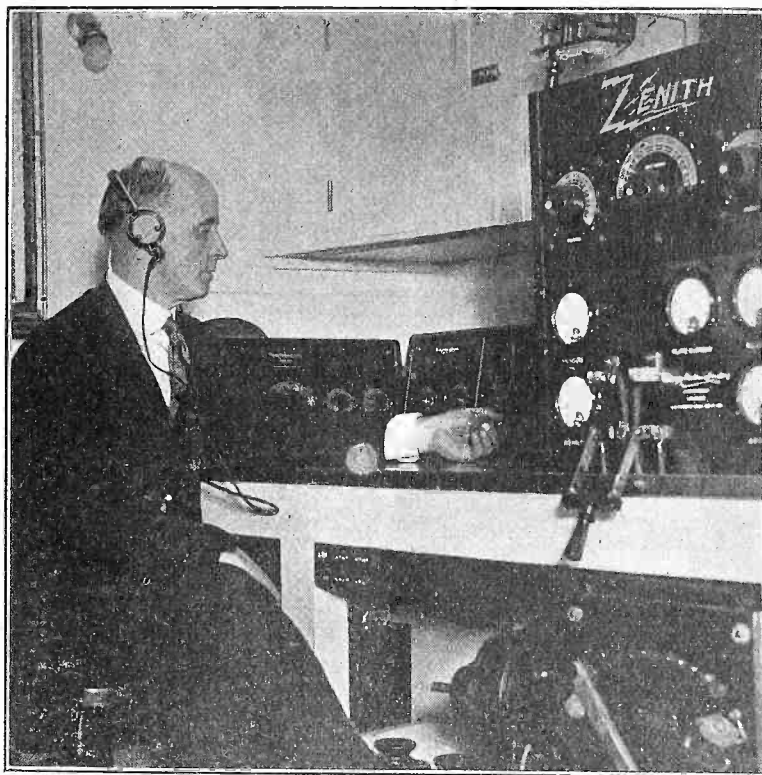

Dr. MacMillan in the radio room of his Arctic vessel "Bowdoin."

sets upon a single isolated station in the frozen north. It will be interesting to learn what portions of the country receive these messages clearly and what portions do not receive them at all.

Dr. MacMillan on his expedition primarily intends to study terrestrial magnetism. He will also co-operate with the Weather Bureau and Professor V. B. Ekerold, the distinguished Norwegian meteorologist, who helped establish the wireless weather station at Jan Mayen Island off the coast of Greenland.

Get the
BASEBALL SCORES ALL SUMMER
Take a Radio Set along with you.

"Broadcast Central" with Special Land Lines Covers the Country

LOCATED in the heart of New York's musical and theatrical district, where entertainment of the highest order is ever available, "Broadcast Central" offers to the American public the most elaborate radio programs, with a degree of faithfulness in reproduction that marks the beginning of a new era in radio broadcasting. The wires which tower 400 feet above the street on Aeolian Hall, at Fifth avenue and 42nd street, provide two antennas, and this super-station will transmit two broadcast programs simultaneously on different wave lengths.

The closing of station WJZ at Newark, New Jersey, operated jointly by the Radio Corporation of America and the Westinghouse Electric & Mfg. Company, coincided with the opening of "Broadcast Central." The well-known call WJZ was retained for transmission from the Aeolian Hall station on 455 meters, while the call WJY will be used for the other wave length of 405 meters, both of which wave lengths have recently been allocated.

The new station is fitted with a double antenna and

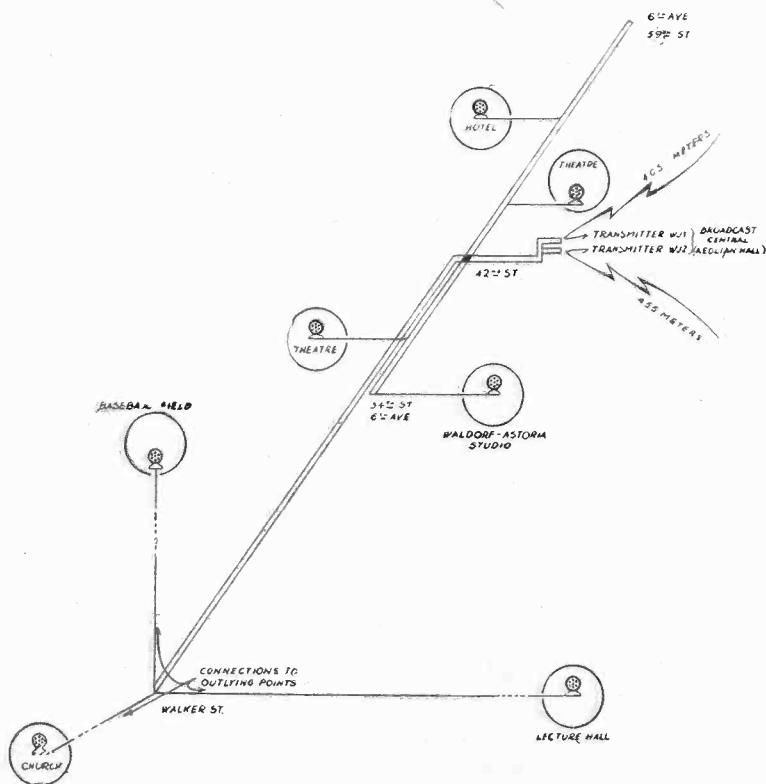

Fig. 1. Outside private cable system of "Broadcast Central" enabling WJZ and WJY to transmit direct from distant points as shown.

two independent transmitters which will permit a dual program to be broadcast; one of classical or serious entertainment, the other of popular airs, dance music and lectures.

The Radio Corporation of America has made a thorough analysis of the types of programs best suited to the requirements of the public and this study has revealed the fact that generally the radio public may be divided into two classes—those who prefer classical or similar entertainment and those desiring dance music and popular airs.

Not only will transmission be carried on from the two studios which are a part of the station, but the main recital hall of Aeolian Hall has been connected to a switchboard in the station thus providing at frequent intervals another source of the finest music obtainable.

To guard against interruption in programs, two spare transmitters are installed together with the nec-

essary controlling apparatus which will enable the operator to make an instantaneous change from one set to another should any trouble develop.

"Broadcast Central" is a model station both in electrical design and operating facilities, incorporating the most advanced ideas of RCA engineers. One of the outstanding improvements is the "checking up" of the broadcast programs for clearness in transmission. This is accomplished by a "moving picture" device con-

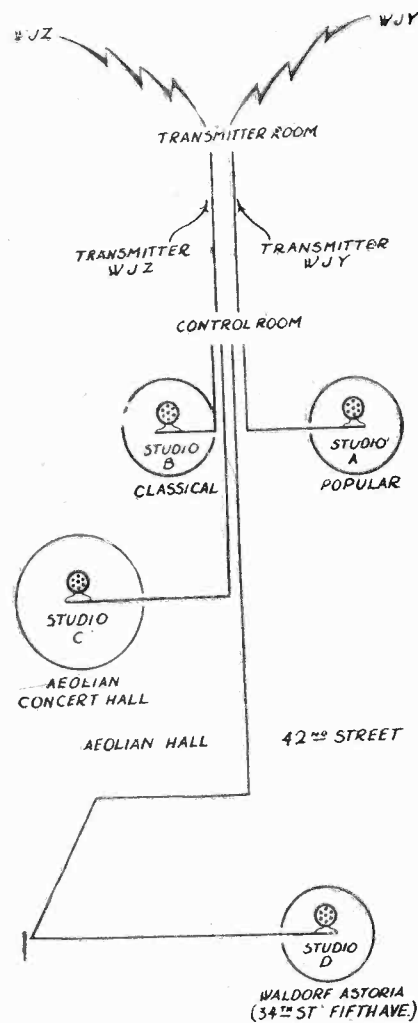

Fig. 2. Studio system of "Broadcast Central." The two studios located on the sixth floor of Aeolian Hall, the studio of the concert hall and that of the Waldorf-Astoria are all connected by private cables and can be plugged in from the control room.

ected with the antenna which shows at a glance the perfection in reproduction of music or voice as the radio waves leave the antenna. Any distortion occurring during a rendition may be instantly corrected by the operator who watches the electrical vibrations as they radiate into space.

The following summary of outstanding facts about "Broadcast Central" will be of interest:

Call Letters: WJY designates the 405-meter transmission, while WJZ designates the 455-meter transmission.

Location: Heart of New York's musical district where the finest of entertainment is ever available. (29 West 42d St., N. Y. City).

Towers: There are two self-supporting steel towers erected on the roof of the building. They are each 115 feet high and their total weight is 15 tons.

(Continued on next page)

Who's Who in Radio Inspection

EVERY amateur and broadcaster should know the officials of the Radio Section of the Department of Commerce in his district, so that he can get advice, keep in touch with new regulations and not be imposed upon by bogus representatives.

At headquarters in Washington, Chief Supervisor of Radio W. D. Terrell is in charge under Secretary Hoover and Commissioner Carson. Mr. Terrell is assisted by W. E. Downey, Supervisor of Radio. In the nine districts with headquarters as shown, the following men are in charge:

District	Headquarters	Supervisor of Radio
1st	Boston	C. C. Kolster
2nd	New York	Arthur Batcheller
3d	Baltimore	R. Y. Cadmus
4th	Atlanta	R. Y. Cadmus (until relieved by Van Nostrand)
5th	New Orleans	Theodore G. Deiler
6th	San Francisco	J. F. Dillon
7th	Seattle	O. R. Redfern
8th	Detroit	S. W. Edwards
9th	Chicago	E. A. Beane

Some recent changes in the personnel of the districts have been made. A. F. Parkhurst, Assistant Radio Inspector at Detroit, has been transferred to the 9th District at Chicago. Assistant Inspector H. S. Pyle has been appointed to work in the Detroit office, replacing Mr. Parkhurst. Assistant Inspector L. E. Richwien, of the Baltimore office, has been detailed to the 7th District at Seattle. It is planned to open the office at Atlanta as the headquarters of the 4th District soon, and Radio Inspector Wallis Van Nostrand, Jr., now at Norfolk, will probably be designated as supervisor of this division.

Radio Interference Disappearing

OFFICIALS of the Department of Commerce report that the schedule of new wave lengths for broadcasting stations has met with a cordial reception throughout the country, and that improvement in reception is noted almost everywhere.

All nine Radio Supervisors report satisfactory results in the allocation of the Class B and A wave lengths, stating that almost all listeners-in are experiencing better reception than ever before in summer time, even with atmospherics at their height. Last summer they point out some five hundred stations were operating on 400 and 360 meters, whereas today the B stations have some nearly 40 exclusive national waves, and the A stations have thirty-one waves assigned individually in the nine radio districts.

The real success or improvement brought about by the wave allocation will not be fully appreciated until later in the fall.

Over three hundred of the old stations continue in Class C, satisfied apparently to operate on 360 meters. Experts of the department express some surprise at this condition; they hoped for early applications for transfers to Class A and B with independent wave lengths. Although no new stations are being licensed under Class C the fact that over three hundred stations, scattered all over the country, continue to transmit on the 360 meter wave tends to maintain interference which it was expected would be eliminated to a greater degree.

A member of the radio section pointed out to the writer that if the radio receivers would use shorter, single wire antenna and listen in on the shorter wave Class A stations, some atmospherics would be eliminated. Reception should be better. The use of loops and indoor aerials is also recommended.

(Concluded from preceding page)

Antenna: Consists of two independent sections supported between towers. Height above street level is 350 feet. The two sections of wires have individual "lead-ins" to the transmitting house on the roof.

Wave Lengths: Each section of antenna is energized by an individual transmitting set permitting a double programme to be broadcast on two wave lengths without mutual interference. This combination of two independent aerials with associated equipment permitting simultaneous broadcasting is an exclusive feature of "Broadcast Central."

Studios: One studio has been provided for each transmitting channel, one for classical music, the other for popular airs, lectures, etc. In addition, special wires are installed from the main recital hall of the building direct to transmitting house on the roof. On certain occasions special events or recitals will be broadcast direct from this large hall.

Emergency Equipment: For each channel there are two complete transmitting sets. These spare sets may be connected into the circuit of each antenna by the simple manipulation by a switch. This provision will prevent any interruption of programmes through the failure of any transmitting set.

Device "Checks Up" Programme Broadcast: A new device inserted in the antenna circuit of each channel indicates the clarity of transmission. The operator in charge can, at a glance, actually observe the degree of perfection in the reproduction of a programme. A switchboard near this instrument enables the operator to correct any distortion in transmission that may occur.

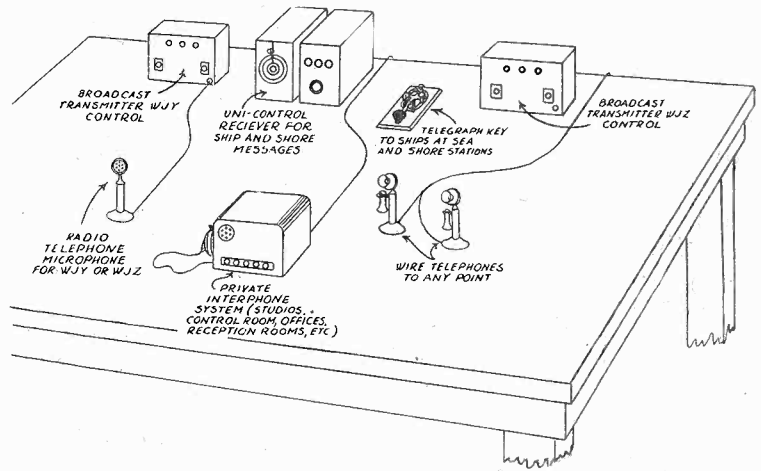

Fig. 3. Transmitter room communication table at "Broadcast Central." This is the "heart of the station" as it is from here that the control of both stations is covered. Each station has two channels through which it transmits, and both are controlled from this table. Here the chief operator sits and regulates the transmission at the same time listening in on ship length so as to be able to shut down immediately in case of an SOS.

The Heart of "Broadcast Central": The control equipment located in the transmitting room on the roof is the heart and nerve centre of the system. The operators have before them a microphone through which they can talk by radio telephony, a key by which they can converse in dot-dash telegraphy and telephone equipment which provides communication with any point in the United States. An inter-communication system provides for internal communication between studios and transmitting room.

RADIO PRIMER

INTERFERENCE. One of the common troubles experienced by the radio fan these days is interference. It is experienced mostly by the single tube sets, or crystal sets. This is because of the fact that neither of these two types is capable of very sharp tuning.

To illustrate tuning and interference and what is meant by it, it is best to depart from radio principles and go back to elementary physics.

If we take two musical instruments, such as two violins, and tune each of them exactly the same, we can cause one to vibrate independently by simply plucking a string of the other or drawing the bow across one of the strings. This is because when we pluck one of the strings it vibrates and causes the surrounding air to vibrate. The second string picks up these vibrations, and vibrates with them. Now if we place our finger on the string and shorten it, and pluck

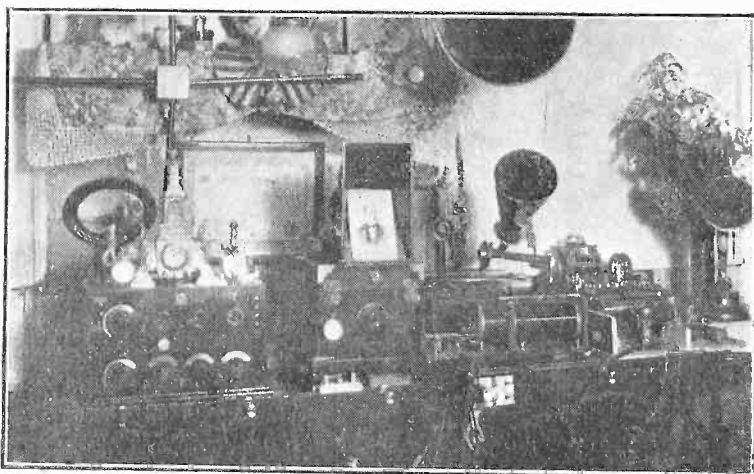

Impressive station of James F. McEvoy, 37 Fourth Street, New Brighton, Staten Island. He started in last July with a simple crystal set and now is the possessor of numerous sets, including a three stage R. F. set for loop work.

the string again, we will find out that the second violin will not vibrate. We have shortened the string, causing it to give out vibrations of much shorter length and higher speed, and they do not affect the second. That illustrates sharp tuning.

Now if we take a third violin and tune it the same as the other two, we can cause the second violin to vibrate from two different sources. If we take the first violin and cause it to send out intermittent vibrations by stopping and plucking its string, the other two will vibrate intermittently in unison. If we cause the first and third violins to vibrate, the first violin intermittently and the third continuously, the second one will vibrate continuously, due to the fact that the third one is interfering with the vibrations of the first and all three being tuned the same they all respond to the same note or wave length.

Now if we carefully tune the first two just a little bit higher or lower, we can cause either one of them to vibrate in unison by plucking them, and at the same time the note from the third will not have any effect on them. The reason is that they now do not respond to the same vibrations as the second and therefore no interference is caused.

A radio set is practically the same. If two stations are transmitting on the same wave length or frequency, a third station that is receiving will hear them both, and because they are both transmitting on the same wave he will be unable to hear either one distinctly on account of his receiver responding to the ether vibrations of both at the same time.

If we therefore lower the wave length of one of the transmitters it is then possible for the third station to pick either one at random—if the receiver is capable of sharp tuning. A crystal set will pick up signals over a fairly broad band of wave lengths, and while it may receive one a good deal louder than any of the others, it is still possible to hear the others when the strong station pauses or stops.

A great deal of the so-called interference would be stopped if the owner of a receiver learned to tune it properly, or if it is a single circuit receiver it can be stopped or decreased by the use of a shorter antenna or energy collector.

Methods of decreasing interference. A lot of interference can be eliminated at the receiving end. That is, of course, when reception is desired from stations that are not on exactly the same wave length. If two stations are both transmitting on the same wave length tuning is impossible. But where one station is higher than the other, and signals from both stations are heard at the same time, it is possible in most cases to eliminate one and only hear the other.

As before stated, the shortening of the antenna to around 80 feet will help. Then the amount of wire used in the wiring of the receiving set should be as short as possible.

A lot of receivers do not use tuned secondaries, or ticklers. If the tickler or secondary is tapped at about half its usual value and a two bladed shorting switch used, it will help the tuning immensely. Then along the same method, if instead of a single blade switch being used for the primary or antenna tuner a double blade switch is used and fixed in such a manner that it will short two of the following sections of unused wire, it will eliminate dead end effect and accordingly sharpen the tuning of the receiver. The use of extra capacity in any of the circuits should be omitted as far as possible, and where a circuit does not call for condensers, nothing can be gained by their use. Fixed condensers should never be used across inductances that are used for tuning as their use broadens the tuning considerably, sometimes to such an extent that tuning is practically impossible.

Three New Class A Stations Licensed

THREE new Class A Broadcasters were licensed by the Department of Commerce during the past week, and seven stations were transferred from Class C on 360 meters to Class A status.

New Class A Stations

Call	Station	Meters	Kcys	Watts
KFHU	—Sateren, M. G., Mayville, N. D....	261	1150	50
WRAG	—Radio Shop of Newark, Newark N. J.	233	1290	50
WSAG	—Davis, Loren V., St. Petersburg, Fla.	244	1230	10

Transferred from Class C to Class A

Call	Station	Meters	Kcys	Watts
KFDD	—St. Michael Cathedral, Boise, Idaho	252	1190	10
WDAJ	—Erwins Electric Co., Parsons, Kan... ..	258	1160	15
WHAD	—Marquette University, Milwaukee, Wis.	280	1070	100
WIAB	—Joslyn Automobile Co., Rockford, Ill.	252	1190	50
WMAT	—Paramount Radio Corp., Duluth, Minn.	266	1130	25
WQAN	—Scranton Times, Scranton, Pa....	280	1070	100
WWB	—Daily News Print Co., Canton, Ohio	268	1120	200

New York Department Store Broadcasts Musical Comedy

RADIO fans had the opportunity of hearing a unique musical comedy on the night of June 28, when "Once Upon a Time," written and produced by employees of R. H. Macy & Co., Inc., New York City, was broadcast from Station WJY. The performance was given on the 405 meter wave length.

Richard Barriscale, brother of Bessie Barriscale, film star, is the author of the play and its hero. A number of tuneful songs written by Jack Straus, son of the president of Macy's, Ralph Goldstein, and Mr. Barriscale were rendered, among them: "When You Smile," "Hearts Are Trumps," "Hitch Your Wagon to a Red Star," "He's Getting Better Day by Day," "You'll Think of Me Sometimes," "May-Ga-Lanka Blues," and "Macy Mine."

The operetta was originally produced last month at the Central Opera House under the auspices of the Community Club, an organization of Macy employees. A great deal of attention was attracted to it at the time by the Beauty Chorus, whose pictures were later featured in newspapers throughout the country.

Another hit was a burlesque on the Floradora Sextette by six husky delegates from the store's delivery department, who donned ballet costumes to lend an air of realism to their performance.

One of the comedians heard in the broadcasting was Guy Somers Mitchell, who was formerly in vaudeville with the song and dance team of Somers and Le Grand. Mr. Mitchell took the part of the Sphinx of Gizeh.

The play was condensed for broadcasting purposes by Miss M. C. Sidney, head of Macy's Department of Training, who was formerly on the stage. Mrs. V. C. Sidney, her mother, who is one of the characters of the play, had a long theatrical career under the stage name

of Vida Crowley. During the war she was in France with the Y. M. C. A. canteen service.

Miss Kathleen Graelish, who played the double part of Sally and Irene, has been heard over the radio before. So has William Francis. Both collaborated in the Christmas stories sent out by WJZ.

Frank Logan, assistant radio buyer at Macy's,



Guy Somers Mitchell and some of the girls from R. H. Macy's "tuning up" before broadcasting the play "Once Upon a Time" from Station WJY, New York. The entire production was written and staged by employees of R. H. Macy & Co., New York City.

coached the characters on the essentials of a good broadcasting voice. Miss Phyllis Reid assisted Miss Sidney in the rehearsals. Musical numbers were rendered by Julius Lenzberger's orchestra.

Summer Tips to Summer Fans

By R. L. Dougherty

NOW that the season has started and many amateurs and fans have packed their radio sets into trunks or constructed portable sets to take on their cars or up to their camps, a lot of funny troubles will arise that will seem to have no solution and will tend to discourage the fan.

These little troubles are of such nature that they will sometimes mystify you, even though they may not seem to have any direct bearing on the receiver's range. The first and foremost of these troubles will be noticed when the receiver will respond only to signals from one direction and "lay down" on the station that is supposed to be the strongest in the section. "Why, I can't even get a peep out of XYZ, and yet I get that weak station ZYX O. K.," will be the sad story. Well, the reason for this is that there is some condition in the surrounding country that is causing the signals of one station to be absorbed whereas the other station is not bothered. A look around the country will generally reveal a heavily wooded hill or a forest which is causing the trouble. This cannot be remedied without moving the location of the set to the other side of the disturbing factor, and when that is done, no signals will be received from the opposite

direction, due as before to certain signal absorption.

The next and most troublesome aspect will be found when a ground is wanted. If you are camping, near a stream of course a good ground will be perfectly easy, or if you are using a loop receiver it will not bother you at all, but in cases where it will seem that you have a perfect ground, your set will sometimes act peculiarly, and the tuning will be extremely sharp, too much so for comfort, and the signals will be weak and unsteady. If after a heavy rain the signals are noticed as increased and the tuning nearer to normal, you will know that your ground, no matter how good it looks is poor. A good way in which to assure yourself of a positive ground is to dig a small hole about a foot wide and three or four feet deep. Into this place on the bottom a layer of soaking wet charcoal, ashes or anything that will hold moisture. Then take the ground wire and solder it to an old tin can, which you have first soldered to a piece of tin or old iron. Place this in a hole and pour plenty of water around it—fill the hole up a couple of times with water and let it soak into the ground. Then put more damp earth or earth and charcoal around it and leave it alone, except for keeping it soaking wet all the time.

Homemade Sets for the Government Lighthouse Service

By Arthur G. Shirt

PLANS for a complete radio receiver and instructions for building it have been issued by the Bureau of Lighthouses, Washington, D. C., for the information of the Field Employees of the Lighthouse Service. The receiver was designed by Mr. A. W. Tupper, Assistant Engineer of the Bureau, and was developed mainly along the lines of simplicity and ease of construction, sacrificing nothing, however, which would tend to make it more efficient. Mr. Tupper spent several months investigating a number of the simpler forms of regenerative circuits published in the many radio magazines before he evolved the set which he now recommends. The results of his investigation have been published in a Departmental circular, have been supplemented with blueprints, and are now ready for distribution to the lighthouse keepers and to others in the service who have evidenced their interest.

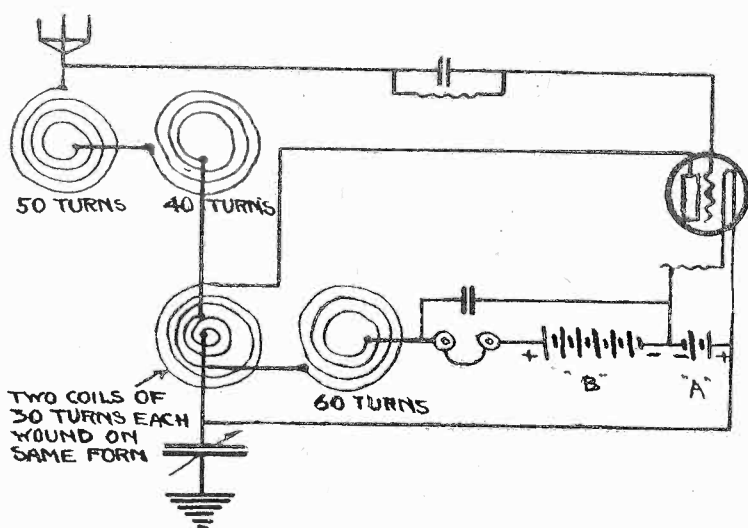

Circuit diagram of the lighthouse set. There are four spiderweb coils used. The one in the plate circuit has two windings, as shown, to supply feedback.

The set recommended is a single circuit regenerative receiver which makes a somewhat novel use of two spider-web variometers. One variometer is used to vary the inductance in the antenna circuit, while the other not only tunes the plate circuit, but also secures regeneration by acting as a feedback inductance. This novel effect is obtained by winding an extra antenna inductance of 30 turns on the primary form of the plate variometer. Inductance is thereby set up between the antenna circuit and the oscillating circuit, varied by the movable secondary of the plate variometer.

This particular arrangement was finally decided upon as being best suited to a homemade set for the following reasons: The instruments involved are easily constructed from materials that are readily obtainable. The parts which must be purchased are inexpensive, excepting, of course, the detector tube and headphones. There are no critical values of the various parts which must be tested and adjusted until an ideal arrangement is obtained. The tuning is simple. The signals are loud and clear when there is no interference, and for a single circuit the selectivity is very good.

Six or more of these sets have been constructed in the course of testing the circuit, and the results obtained from them have been consistently satisfactory. While being tested in Washington, concerts were picked up from Boston, Chicago, Detroit, Kansas City,

Atlanta, Davenport and sometimes Havana, Cuba. The number of turns on the various coils has been determined by actual tests and they are adapted for use with antennae in the neighborhood of 100 feet in length. The tubes recommended are of the dry-cell variety, and the cabinet is constructed so that the batteries incidental with such tubes are hidden from sight in a compartment at the base of the set. There is room in this compartment for storing an extra dry cell. The instructions contained in Circular Letter No. 2, which describes the set, are written in plain, non-technical language, and are complete in every detail.

The Panel

The panel should be a piece of close-grained wood $\frac{1}{4}$ -inch thick. Before placing in the cabinet lay out all holes, taking measurements from blueprint, which is one-half actual size. Put rheostat and condenser in place to be sure the holes are in the proper places, then remove instruments and put panel in the oven and heat thoroughly to drive out all moisture, but be careful not to scorch. While panel is still hot, give it a thorough coat of thin shellac on both sides and all edges and in the holes. Let dry for 24 hours and give it two more coats of shellac at least 12 hours apart. *Do not paint this panel with ordinary paint.* If a color is desired, stain the panel with a spirit stain or water color stain before baking.

After the third coat of shellac is dry, cover the inside portion of the panel that is above the shelf with tin-foil, which may be stuck to the panel with shellac. While the shellac is still soft, scrape the tin-foil away from around all holes through the panel, so that no metal parts of condenser, rheostat, binding posts, or any of the wiring or wire terminals will touch the tin-foil.

Making the Grid Leak

Take a piece of photographic film (or heavy paper, if no film is obtainable) and cut it to the size of the grid condenser, making a hole in each end to correspond with the holes in the condenser where the connection wires are attached as previously described. Thoroughly roughen the surface of the film with sandpaper (after scraping off all traces of any picture which may have been on it) and with a soft pencil make a heavy wide mark around both holes, and draw a heavy pencil line from one hole to the other, then secure this to one side of the grid condenser by the screws with which you make the wire connections, being sure that the head or nut of each screw touches the pencil mark you made around each hole. After you have succeeded in tuning in a station, try out the grid-leak by making the pencil lines heavier or erasing them partly until the clearest and loudest signal is obtained. The amount of this grid-leak depends on the qualities of the detector tube, some tubes requiring no grid-leak at all, others requiring a heavy, broad pencil mark.

The instructions for constructing and erecting antennae and for making ground connections are furnished on a separate sheet. Four blueprints accompany the present circular, showing in detail how the apparatus is assembled and wired, as well as the methods of winding the spider-web coils. No provision is made for the addition of one or two steps of amplification, that being left to the skill and other requirements possessed by employees of the Lighthouse Service.

This Crystal Detector Set Has Many Advantages

By Ervin J. Trojan

[The set described below, says the author, has been thoroughly tested and found worth while and its merit proved by public approval. Large numbers of these sets are in use in Chicago and are giving satisfactory service.—Editor, RADIO WORLD.]

DURING the early part of 1921, when radiophone broadcasting first appeared, development of receiving sets was pushed feverishly; so feverishly indeed, that some devotees of the ether waves were neck-deep in superregenerative sets and other highly complex circuits before they even realized that a simple crystal detector would also receive radiophone signals.

Of course, a crystal detector set will not receive long distances and its output of sound is limited. But where such a set can be used within 15 or 20 miles of a moderately powerful broadcasting station, these drawbacks are very slight. And deep down in our inner consciousness we might even concede that a local concert, heard over a good crystal set, will sound better than one a thousand miles away, heard over an engineering marvel, but slightly mixed with interference and fading.

For the novice who wishes to begin enjoying the pleasures of ether-borne music, or for the person who wishes to make his first set, a crystal detector set is recommended. It will not cost much, it is sure to work, and it will serve as a stepping stone to the more complicated and expensive sets. The initial cost of such a set is very low; its upkeep is nil; it is simple to

range with a 60 foot aerial is approximately 300 to 500 meters.

The material required for the construction of this set will be as follows: $\frac{1}{4}$ inch whitewood, two pieces each, $1\frac{1}{4}$ inch by $5\frac{3}{4}$ inch, $1\frac{1}{4}$ inch by $4\frac{1}{4}$ inch, $4\frac{3}{4}$ inch by $5\frac{3}{4}$ inch; 4 binding posts; 2 switch levers, $1\frac{1}{4}$ inch radius; 1 crystal cup; 1 detector stand; 1 radiocite crystal; 12 contact points; 4 switch stops; 2 oz. No. 26 D. C. C. wire.

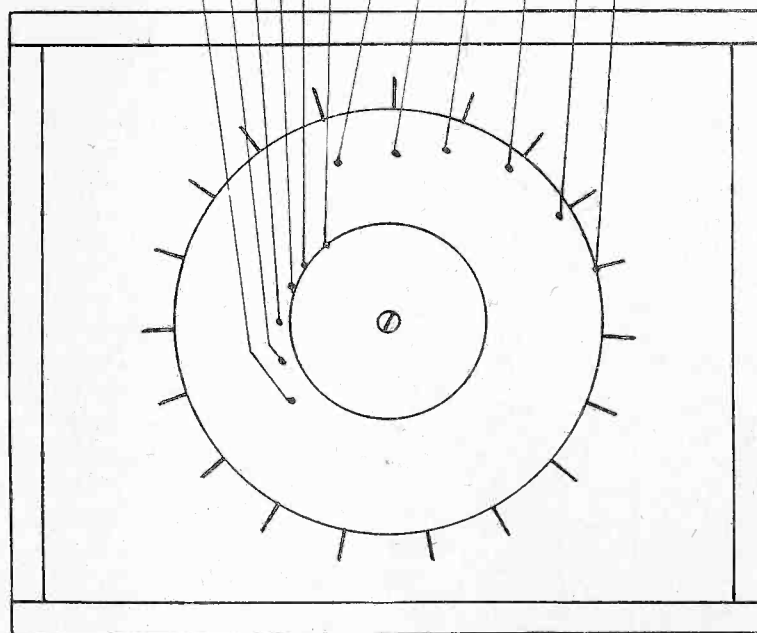
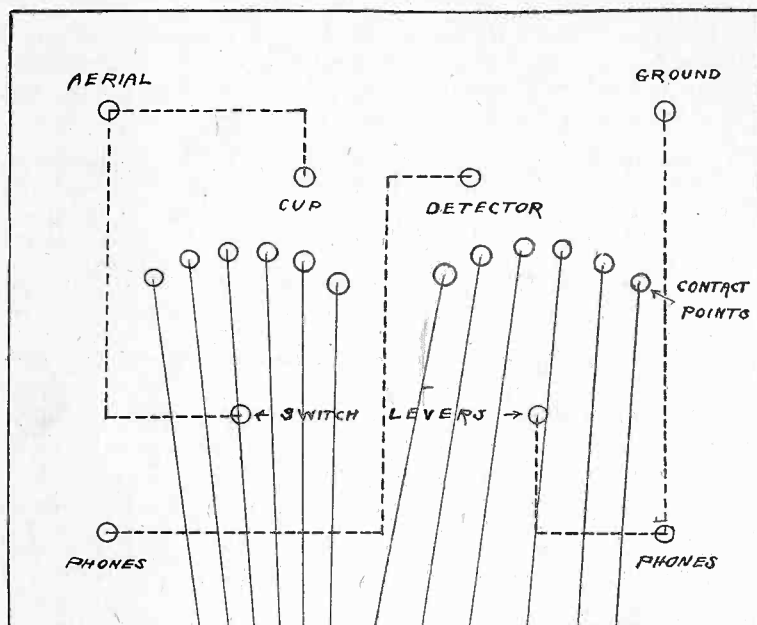

Fig. 2—Arrangement of instruments inside cabinet.

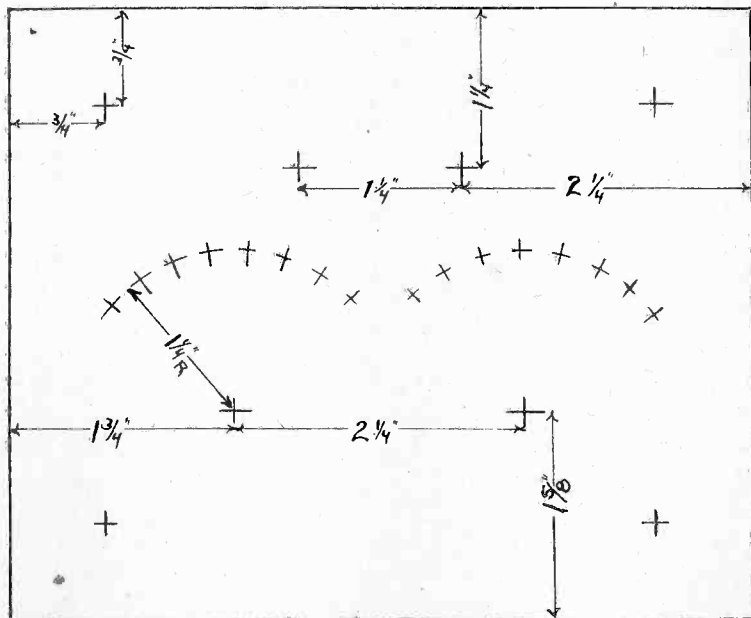

Fig. 1—Panel layout for an efficient crystal set.

construct and to operate; it is non-interfering and all but insensible to static; for clarity of tone it has no superior.

The writer will describe a small crystal detector set which has proven very popular, largely because of its pleasing design, low cost and efficiency. The complete set is about the size of an ordinary book, and has but three controls—adjustable crystal detector, coarse and fine tuning switches. The wave length

Drill one of the large pieces of wood, which will be the panel, according to Fig. 1. Construct the box as in Fig. 2, gluing and nailing all joints except the panel, which should be fastened temporarily with four small brads. Sandpaper well, stain to the desired color and apply at least two coats of varnish or shellac. Then remove the panel and assemble the various parts on it. After assembly the panel should be wired from

(Concluded on next page)

RADIOGRAMS

WORLD NEWS HAPPENINGS BRIEFLY
PHRASED FOR OUR BUSY READERS

The automobile industry set a new production record in May by turning out 350,180 passenger cars and 42,983 trucks, according to figures from the Department of Commerce. Now let's see that they're all radio equipped!

Dr. W. R. Whitney, director of the research laboratory of the General Electric Company, was recently elected a member of the corporation of the Massachusetts Institute of Technology for a term of five years. He was graduated from the institute in 1890.

Station WOR, operated by L. Bamberger & Co., Newark, N. J., has arranged to have the New York *Morning Telegraph* broadcast, every Monday evening, its moving picture news and reviews. The series of talks, which will be called "Current Motion Pictures," is scheduled to begin on the evening of July 9.

Boy Scouts of America National Council, consisting of 1,300 representative business and professional men from all parts of the United States, will hold its thirteenth annual meeting on July 8 and 9 at Palisades Interstate Park, New Jersey. It is expected that Station WEAJ will broadcast the proceedings and activities of July 9 to the whole country.

Dr. Lee De Forest, inventor of the phono film and manufacturer of radio equipment, returned from Europe last week with the impression that English newspapers were boycotting the broadcasting of news items and that members of the British theatrical and musical professions were opposed to radio broadcasting. He pointed out that there were but eight broadcasting stations in England and that the government had declined to issue any more permits.

Station WHAH, operated by Hafer Supply Company, Joplin, Mo., is now working on 250 watts.

Dr. Samuel Wesley Stratton, president of the Massachusetts Institute of Technology, Cambridge, Mass., received the honorary degree of Doctor of Laws from Harvard University at the recent annual commencement.

A correspondent of WGY who has beautiful faith in the efficacy of radio in the capture of criminals, recently requested the General Electric Company station to announce that a reward of \$50 would be paid for the arrest of the "parties" guilty of chipping words off the family grave stone.

College students are working in the places of striking shop craftsmen in the Olean, N. Y., shops of the Pennsylvania Railroad. The students are from Purdue University, Pennsylvania State and Ohio State universities and technical schools. They are studying engineering, and went to Olean for practical experience. The railroad has asked the colleges and universities by radio for men seeking work in the courses they are studying.

All records for wireless transmission and reception were broken on the recent trial trip of the S.S. "Leviathan." On the last of the five days' run the four radio operators—Lieut. John R. Irwin, Elmo N. Pickerill, Anthony Tambourino and Raymond J. Green—were about exhausted. General Manager David Sarnoff, of the Radio Corporation of America, who was one of the guests aboard and who began his radio career at the key, jumped in and helped in transmitting, easing the strain on his men.

(Continued from preceding page)

underneath, as shown by the dotted lines. The schematic diagram appears in Fig. 3.

The tuning inductance used is popularly known as the "spiderweb." This form of winding has perhaps the lowest distributed capacity of any. Here it might

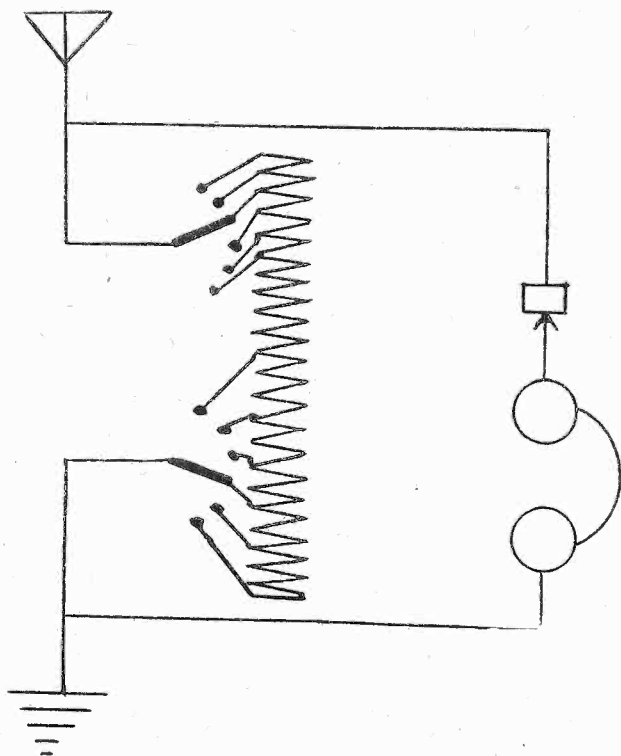

Fig. 3—Circuit diagram of receiver of Trojan's crystal set.

be advisable to add that no tuning inductance, of whatever form, should ever be coated with any varnish, shellac or cement. These substances all have a higher specific capacity than air, and will impair the efficiency of the coil. The spiderweb is made by cutting out of heavy pressboard or 1/32 inch fiber two disks, each 1 1/2 inch in diameter. Lay one of these disks on a

flat surface and space on it radially 19 wooden spokes, 1/16 inch in diameter by 2 inches long. A round type of hardwood toothpick answers admirably for this purpose. Pour glue over the ends on the disk, and place the other disk on top. Place a heavy weight on the finished form and let dry. This makes a winding form of ample rigidity and light weight. To wind the coil, make a reference mark on the tip of one of the spokes, and starting at that spoke, weave the wire in and out between the spokes, skipping two spokes at a time. When twice around make a loop in the wire about 1/8 inch in diameter. Wind two more turns and make another loop. Repeat until five loops have been made. This constitutes the fine adjustment. Now wind twenty turns, and make a loop. This is the body of the coil. Next wind eight turns and make a loop. Repeat four more times, but instead of making the last loop, cut off the wire. This constitutes the coarse adjustment. The coil should now have six taps at the inner end, and six taps at the outer end. Fasten this coil inside the box to the bottom with a small brass screw, and solder short wires from the taps to the contact points on the panel, as shown. See that these lead wires do not touch each other, and fasten the panel to the box permanently.

The crystal recommended is tellurium sulphide, better known by its trade name of "Radiocite." It is not quite as sensitive as a good crystal of galena, or lead sulphide, but it is more reliable and will give satisfactory results. Always handle the crystal with forceps; handling with the fingers will deposit oil and perspiration on the sensitive surface of the crystal and impair its usefulness. Should this happen, however, the crystal can be cleaned with alcohol or soapy water. Crystals should not be mounted in lead or low melting solder, as any heat much above body temperature will injure them.

This set, if properly constructed, will give as good results from local stations as a simple vacuum tube detector.

A Combination of Two Methods of Regeneration

By C. White, Consulting Engineer

BEFORE I start this article I want to thank the many amateurs who have written to me concerning my super amplifier, and I want to say that all letters will be taken care of in the proper way. I greatly appreciate the confidence my readers have placed in me and I shall be glad to perform a similar service for them whenever it is necessary. There are many surprises in store for you along the radio line. I am working up several new things in my laboratory at present, and as soon as I can get the goods in the hands of a reliable manufacturer and working in a commercial way, I shall write up some new applications and circuits. When anything new appears in my articles in the way of radio parts and you can not obtain them readily in your locality I am always willing to put you on the right track if you will address me in care of RADIO WORLD and enclose return postage. Many letters have come to me recently from radio dealers, and I want to welcome this type of correspondence.

The circuit to be taken up in this article is a modification of a circuit published under my name not so long ago. The improvement consists in the substitution of variometers in place of tapped and immovable coils. This addition goes far to make the circuit more effective and efficient in tuning. In reality there is a combination of two types of regeneration—namely, the two variometer feed back method and the electromagnetic tickler coil arrangement. Then again, a resistance R is inserted in the filament-grid circuit of the detector tube and is very effective in controlling regeneration with the new UV199 tube. The potentiometer P permits shifting from the positive to the negative side of the filament to obtain the best results. Some claim that the new tube works much better when it is connected up to the negative side of the filament on the grid return, while the manufacturers and others claim just the reverse. Personally I have found that in the majority of cases the negative side gives a little better results than the positive. The potentiometer P permits you to try either condition without disconnecting anything. The resistance R and the potentiometer P should each have a resistance of 400 ohms. In order to cut down noise in adjusting and tuning with these resistance units it is better to use a carbon pile type of rheostat or potentiometer although from the theoretical standpoint a wire type will work just as well. The condensers C-1 and C-2 are air variables having 23 plates apiece. A vernier attachment on both condensers is recommended. The coil F consists of 60 turns in all with the last 300 turns tapped for every ten turns for switch points and, if it is so desired, more frequent tapping of the coil can be resorted to although three taps will suffice. The variometers V-1 and V-2 are nothing more than the ordinary standard type of short wave variometers.

The theoretical action of this circuit can be briefly surveyed as follows. The incoming signal impinging on the antenna is tuned in through the circuit composed of the condenser C-1 and the variometer V-1. The signal current flowing in the tuned circuit produces a voltage drop across V-1 which is picked off by the filament-grid circuit of the detector tube for detection or rectification. The grid leak and grid leak condenser H help to make the tube action correct and

greatly aid detection. Energy is fed back to the tuning circuit by means of the variometer V-2 in the plate circuit and the circuit composed of the coil F and the condenser C-2. This backward transfer of energy helps to compensate for the resistance of the tuning circuit and thus causes a large amount of current to flow in it, hence increasing the voltage drop across V-1 and the signal becomes many times stronger than if regeneration is not used. The reason for the use of the circuit F and C-2 is that although regeneration is possible by means of two variometers alone still it is almost next to impossible to tune and hold the regenerative point without causing the tube to spill over and oscillate. By this new method we can approach regeneration by means of

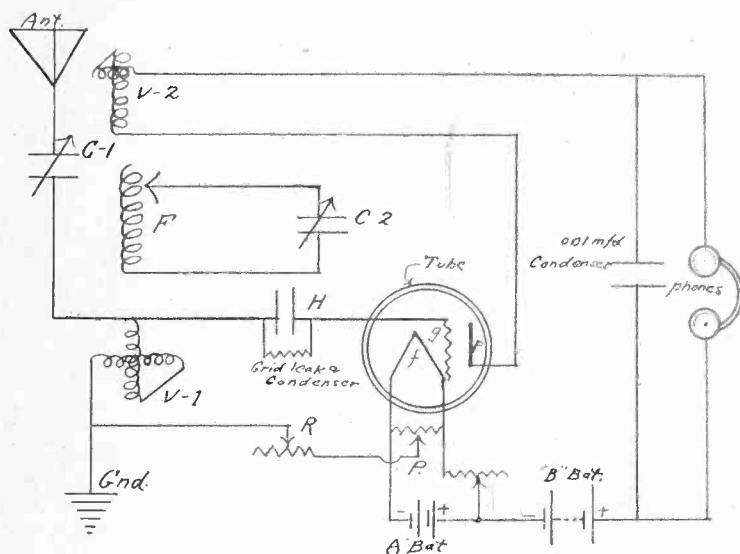

Circuit diagram of a very selective and easily controlled receiver.

the variometer V-2 and we can hold or adjust to more critical or super-regeneration by tuning the circuit F and C-2. The core on which F is wound should be about four inches in diameter and should be placed between the two variometers. It should be wound with No. 22 D.C.C. magnet wire and, figuring 20 turns to an inch of tube length, then about four inches of tubing will be needed.

To successfully construct this tuner much experimental or cut and try work must be done. If regeneration is not obtained the variometer connection V-2 should be reversed or the coil F should be turned around the other way. Try reversing each separately and both together and note the results of each trial. You will observe that one particular combination is much superior to all the others. It is far better and more certain to try out your connections in this manner than to rely on any set rule of direction of windings or the like. Then again, you learn far more by trying things out for yourself to a certain extent than by blindly following some set rule of thumb method. But there are some little precautions or tips that will help to make your set just a little better. For instance, the movable plates of the condenser C-1 should be connected to the antennae and the fixed plates to the grid or V-1 side. By so doing you will greatly diminish body capacity in tuning and the circuit will not howl when you touch the condenser dial.

Soldiers, Sets, Sea Views, Soubrettes, S for Radio W

The Radio West I

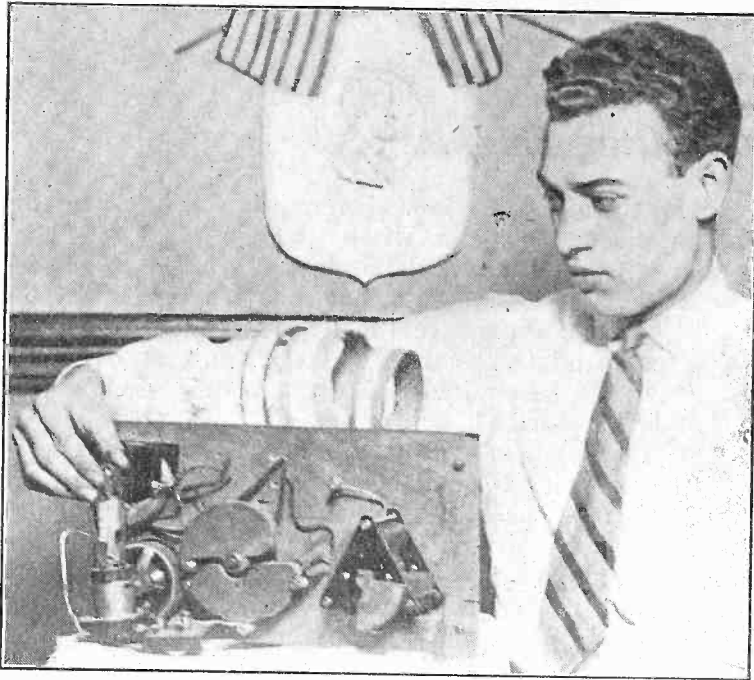

(C. Photonews)
Emanuel Laufer, of New York City, and his one tube receiver with which he hears France. As can be seen the set uses three single layer coils as primary, secondary and tickler with all the tuning done by two variable condensers. Laufer was one of the first to pick up the French amateur station 8AB during the tests, and has continually picked him and other foreign amateurs up since that time.

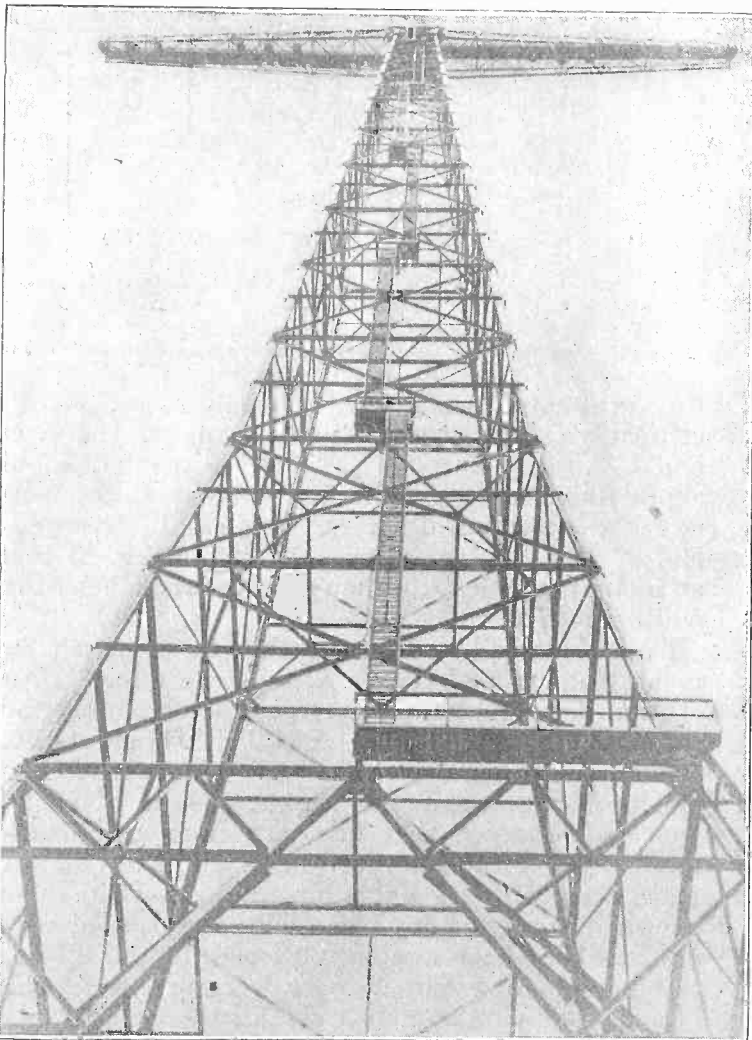

(C. Kadel and Herbert)
A worm's-eye view of one of the giant 652-foot towers of the transoceanic station of the Radio Corporation of America at Port Jefferson, L. I. These towers are self-supporting, needing no guy wires or other supports and are the largest radio towers used by any commercial radio station. There are 72 towers arranged in the form of a wheel, six to each spoke and with twelve spokes. By this arrangement it is possible to communicate with radio stations in every corner of the globe simultaneously, due to the directional effect being taken into consideration. Each set of towers has its own transmitters and control, or they can all be hooked together for special work.



(C. P. and A. Photos.)
United States Signal Corps experts at Camp Alfred Vail, N. J., experimenting with extremely short wave lengths of 15 and 25 meters. This is because they can easily carry the apparatus necessary for transmission and reception over the terrain into very small sections.

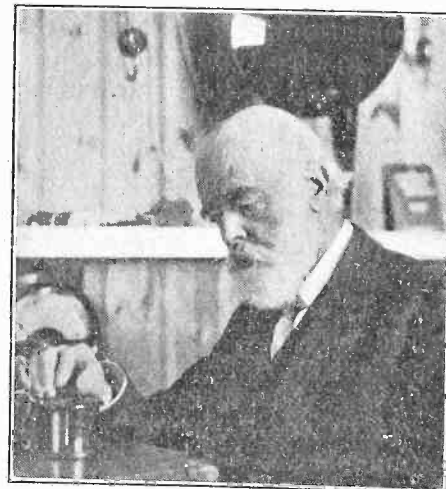

(C. Kadel and Herbert)
Sir Oliver Lodge, eminent philosopher and scientist, who is an old timer at the radio game, and whose early experiments had much to do with radio, is here shown watching the effects of some of his latest experiments on a receiver.

*Captions by
Robert L.
Dougherty*

Scientists, and Everything Pictured Here World Readers

Point of the Army



g with short wave receiving and transmitting over small loops. This here are 115 men and officers of the United States Army at Camp their energies are devoted to transmission and reception over the status used for these waves is extremely portable and two men can waves. Note the fact that the loop is portable and can be folded two feet in length.

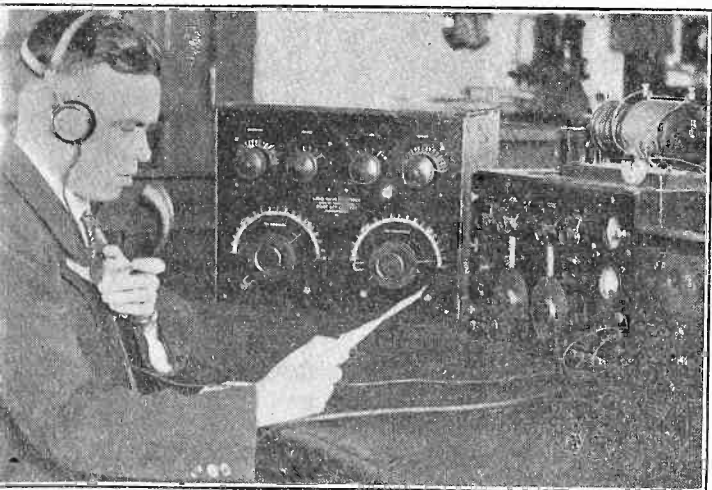

(Photograms)
Bauer, of the Post Office Department Radio Station at Washington, broadcasting information to the farmers. It is through this station the farmers are able to get all the latest crop prices and news interest, such as the fighting of various seasonal plagues. The status shown on the table are the receivers, the transmitters being in separate room. The call of the station is WWX and is listened to by farmers throughout the country,

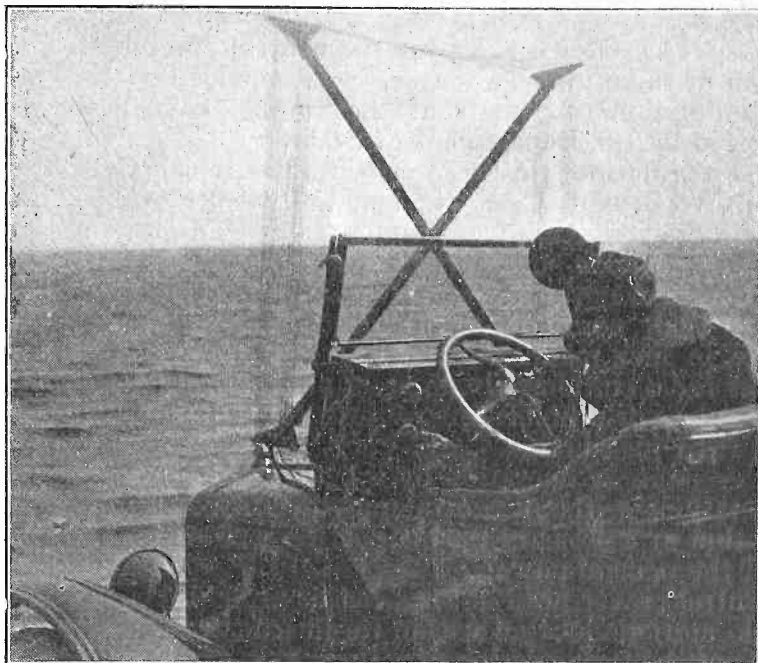

(C. Kadel and Herbert)
Even "Henry" is not immune from the radio spirit. This radio enthusiast has equipped his Ford with a loop receiver and intends to listen in even when beside the sad, sad sea waves.



(C. Underwood and Underwood)
Roso Parnass, former Follies beauty and her champion bull "Bon-Chonco" being entertained at Rye Beach, N. Y., by their portable loop receiver. The pup must like the program judging by the "pick-up" angle of his ears.

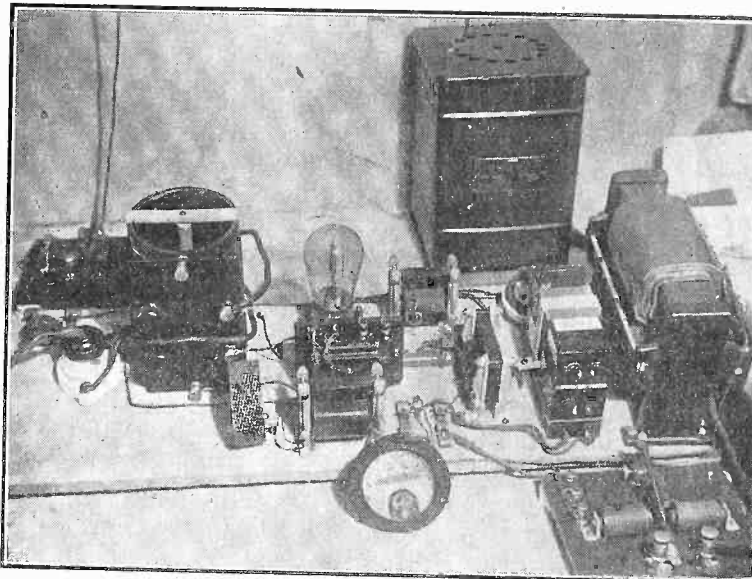

(C. Photonews)
Five watt A. C. Transmitter built by E. Wilbur, a New York amateur. By simply plugging a double wire into the light socket it is possible to operate this set on C. W., I. C. W. or phone. Both filament and plate current are supplied by the transformer on the extreme right.

First Wartime Radio Code Drafted

INTERNATIONAL rules for the control and operation of radio in time of war, as propounded by the Commission of Jurists at the Hague, have been announced by the Department of State.

These regulations, in the preparation of which Capt. Samuel W. Bryant, U. S. N., and Col. Geo. S. Gibbs, U. S. A., assisted American Commissioners Moore and Washburn, provide substantially that:

In time of war the working of non-belligerent radio stations shall continue to be organized, as far as possible, in such manner as not to disturb the services of other radio stations. Belligerent and neutral powers may regulate or prohibit the operation of radio stations within their jurisdiction.

The erection or operation by a belligerent power of radio stations without neutral jurisdiction constitutes a violation of neutrality on his part as well as on the part of the neutral power.

A neutral power need not restrict or prohibit the use of radio stations located within its jurisdiction, except to prevent the transmission of information destined for a belligerent concerning military operations and except as further prescribed. All restrictive or prohibitive measures taken by a neutral power shall be applied impartially by it to the belligerents.

Belligerent mobile radio stations within a neutral state must abstain from all use of their radio apparatus. Neutral governments are bound to prevent such use.

The transmission by radio by a vessel or an aircraft, whether enemy or neutral, when on or over the high seas, of military intelligence for the immediate use of a belligerent is deemed a hostile act and will render the vessel or aircraft liable to be fired upon. A neutral vessel or neutral aircraft which transmits, when on or over the high seas, information destined for a belligerent concerning military operations shall be liable to capture. The Prize Court may condemn the vessel or aircraft, if it considers that the circumstances justify condemnation. Liability to capture of a neutral vessel or aircraft on account of the acts referred to is not extinguished by the conclusion of the voyage or flight on which the vessel or aircraft was engaged at the

time, but shall subsist for a period of one year after the act complained of.

In case a belligerent commanding officer considers that the success of the operation in which he is engaged may be prejudiced by the presence of vessels or aircraft equipped with radio installations in the immediate vicinity of his armed forces or by the use of such installations therein, he may order neutral vessels or neutral aircraft on or over the high seas; to alter their course to prevent their approaching the armed forces under his command; or not to make use of their radio transmitting apparatus while in the immediate vicinity of such forces.

A neutral vessel or aircraft, which does not conform to such direction, exposes itself to the risk of being fired upon. It will also be liable to capture, and may be condemned by the Prize Court.

Neutral mobile radio stations shall refrain from keeping any record of radio messages received from belligerent military radio stations, unless such messages are addressed to themselves. Violation of this rule will justify the removal by the belligerent of the records of such intercepted messages.

Belligerents are under obligations to comply with the provisions of international conventions in regard to distress signals and distress messages so far as their military operations permit. Nothing in these rules shall be understood to relieve a belligerent from such obligation or to prohibit the transmission of distress signals, distress messages and messages which are indispensable to the safety of navigation. The perversion of radio distress signals and distress messages prescribed by international conventions to other than their normal and legitimate purposes constitutes a violation of the laws of war and renders the perpetrator personally responsible under international law.

Acts not otherwise constituting espionage are not espionage by reason of their involving violation of these rules. Radio operators incur no personal responsibility from the mere fact of carrying out the orders which they receive in the performance of their duties as operators.

Inter-Continent Relay by North Pole Radio

HARTFORD, CONN.—The expedition to the Arctic in charge of Dr. Donald B. MacMillan will keep in touch with all civilized countries in the Northern Hemisphere by radio. This is the belief of Kenneth B. Warner, secretary of the American Relay League, the amateur organization which furnished a radio operator for the polar party which left Wiscasset, Me., last week on their voyage to Ellesmere Land.

So convinced is he that messages from WNP, the radio station on MacMillan's schooner, will reach amateurs in other countries beside the United States that he has notified amateurs in England and France to be on the alert. He estimates that either one of these two countries is about equally distant to Ellesmere Land as the average point in the United States.

He has pointed out that the distance between Ellesmere Land and England is far less than the distance between the Middle West and England, which was covered many times during the amateur Trans-At-

lantic tests of last year. At this time the amateur station operated by Irving Vermilya, New Bedford, Mass., succeeded in sending fourteen complete messages to an amateur in England.

The failure to establish direct two-way communication between American amateurs and those in England and France may now resolve itself into an inter-continent relay by way of the North Pole. For example, messages from amateurs in this country may be sent to Donald H. Mix, operator on MacMillan's ship, and relayed by him to amateurs in any of the Northern European countries. Similarly amateurs across the Atlantic can relay through the station in the far North.

Already Mr. Vermilya and other American amateurs, whose records have been the envy of all operators, are getting their sets in readiness to communicate with members of the exploring party and are looking forward to what may be the most spectacular radio feat which has yet been attempted.

Latest Radio Patents

Radio Receiving Circuits

No. 1,457, 447: Patented June 5, 1923. Patentee: John Mills, Wyoming, N. J.

THIS invention relates to radio-receiving circuits, and particularly to that type employing the principle of successive detection.

The term "successive detection" as here used is given its usual signification as involving the function of stepping down the frequency of the received radio-frequency waves to an intermediate high frequency by one detecting operation and employing a subsequent detecting operation to obtain the low frequency modulating component. According to the present invention the wave to be received and an auxiliary radio wave

distant station, the circuits associated with said source and the receiving circuits constituting the terminal circuits of a complete two-way channel. A system characterized generally by the production of intermediate frequency waves at the receiver will be designated an "intermediate frequency system," the specific type in which the auxiliary wave source has a double function, as described, being correspondingly designated a "modified intermediate frequency system." A receiving circuit having means for stepping down the frequency of its normally received wave by combination with an auxiliary frequency wave, whether said auxiliary wave has the additional function

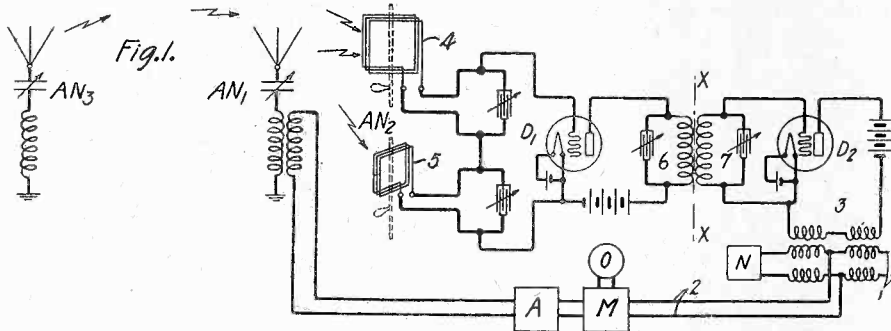

John Mills' system of alleviating interference by means of intertuned receivers.

are received and impressed together upon the input circuit of the first detector, by which the first frequency reduction is accomplished. The auxiliary wave is given such a frequency that, by combination with the normally received wave, there will result in the output circuit of said detector an intermediate frequency wave having a desired periodicity. The auxiliary wave source may have its sole function as above indicated or it may combine this function with that of a source for transmitting waves to the

mentioned or not, will be designated an "intermediate frequency receiving circuit." The auxiliary frequency source will be designated as a "local" source, and its circuit as the "local transmitting circuit."

The principal object of the present invention is to provide a means whereby, in an intermediate frequency receiving circuit, a regular amount of auxiliary radio carrier wave may be impressed on the input circuit of the first detector without detriment to reception from the distant station.

Audio-Frequency Coupling Transformer

No. 1,457,619: Patented June 5, 1923. Patentee: Samuel Cohen, Brooklyn, N. Y.

THE main object of this invention is to provide an efficient audio-frequency transformer of superior utility and applicability to transformers similarly used in radio electrical arts.

The essential points in obtaining an efficient audio-frequency coupling transformer are, briefly, the following: The ratio of the reactance to the resistance should be a maximum; the ratio of number of turns in the primary winding to the number of turns in the secondary winding should be a maximum; the degree of coupling between the primary and secondary windings should be a maximum; the leakage reactance of the core and windings should be a minimum; no external magnetic field should exist when the transformer is in operation in order to prevent stray fields from producing coupling between transformers and neighboring electrical apparatus and thereby preventing the generation of electromotive forces of audio-frequency; the coupling transformer in toto should have minimum physical dimensions.

It is the aim of this invention to accomplish the above-mentioned design and arrangement in a practical manner and yet

approaching theoretical perfection as near as possible.

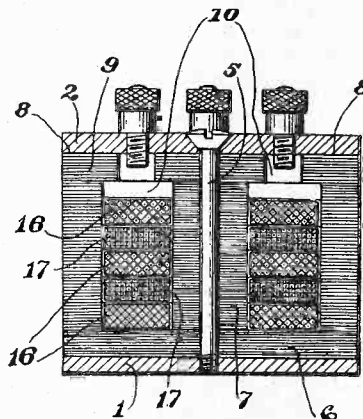

New method of transformer construction, using several sectional windings for primary and secondary, allowing maximum coupling.

To many anxious inquirers: **RADIO WORLD** has no free list. One copy is sent as a voucher to each advertiser or advertising agent represented in current issues. All other copies are paid for on subscription or through the news trade.

Amplifier

No. 1,457,814: Patented June 5, 1923. Patentee: Howard I. Becker, Schenectady, N. Y.

THE present invention relates to amplifiers of the electron discharge type, and more particularly to magnetically controlled amplifiers. One of the objects of the inven-

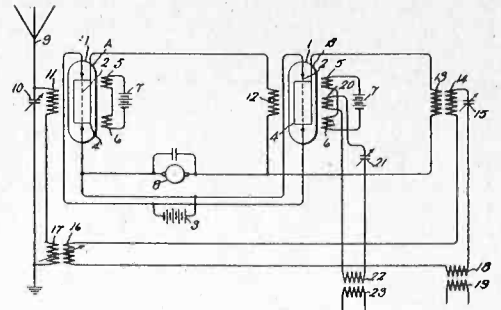

Amplifier providing successive amplification of small currents in a single tube.

tion is to provide a simple and efficient circuit connection of magnetically controlled amplifiers whereby a high degree of amplification may be obtained. A more specific object of the invention is to provide an amplifying system in which successive amplification of small currents may be produced in a single device.

Balancing Circuits

No. 1,457,336: Patented June 5, 1923. Patentee: Herman A. Affel, Brooklyn, N. Y.

THIS invention relates to signaling circuits, and more particularly to arrangements for translating low frequency signals into higher frequency carrier currents and vice versa.

In multiplex transmission systems employing carrier currents it is customary to separate the east and west channels of a carrier transmission circuit in a manner similar to that employed in the case of the so-called 22 type telephone repeaters. A circuit of this type involves balancing the carrier frequencies by means of an artificial line for simulating the main transmission line at the carrier frequencies. A low frequency balance is usually also provided in connection with the terminal signaling circuit to maintain the oppositely directed channels conjugate at low frequency. The translation of the ordinary signaling fre-

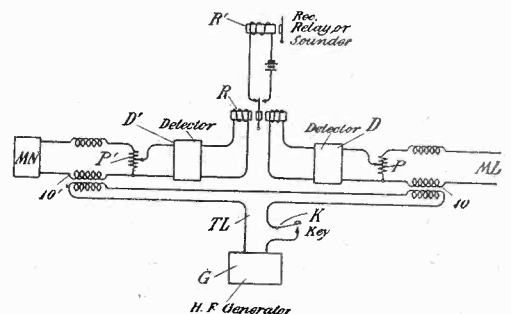

Means of balancing both sides of a carrier wave in transmission.

quencies into carrier frequencies and vice versa is carried out independently of the balancing circuit. In accordance with the present invention the frequency translation is made an integral part of the balancing circuit by locating the translating device, which may be either a modulator or demodulator, in the circuit on either side of the point of neutralization between the real and artificial line. Consequently the energy of an outgoing transmission, for instance, which it is desired to balance with reference to the receiving channel, undergoes a change in frequency before the balance is effected. An arrangement of this character renders it possible to balance the circuit without maintaining a high degree of balance in the artificial line or network for both high frequency phase and magnitude.

Answers to Readers of Radio World

IN relation to loading sets for higher wave lengths, how is it possible to load the Flewelling super circuit for higher waves? Can they be loaded for waves up to 25,000 meters? Is it possible to load a 4-tube reflex circuit up to that wave?—H. R. Loring, General Delivery, Bellaire, Ohio.

You cannot efficiently load a circuit of the Flewelling type up to that high wave length. It is not necessary for you to use a circuit of this type to reach the high wave lengths. To do it right you should use the three-circuit, honeycomb circuit, whereby you can easily reach the high waves, and get POZ and FL, and all the other high-power stations on one tube. These stations are of such extremely high power that it is not necessary to even use a tube; but, by means of a tickler, or slipping contact wheel, in the detector circuit, they can be reached by a crystal detector, using the double-circuit crystal hook-up with the larger honeycombs.

If you desire to load a reflex circuit it will be necessary for you to get special radio-frequency transformers that encompass this band of wave lengths. They are not generally manufactured, so it will be necessary for you to have them made to order; but no advantage would be gained by their use, as then only the extremely long wave lengths of from about 15,000 to 25,000 meters could be received.

* * *

I have made up the Cockaday circuit recently described in RADIO WORLD by R. P. May, and am in trouble in the following manner: When I leave the phone condenser off my set squeals and the signals are muffled, and when the condenser is in the signals are clear but weak. The tuning is sharp, but I can only get each station at a definite setting of the dials. A definite setting has to be used for each separate station. The set does not seem to be regenerative at all, and I wonder if reversing the B coil might be the cause. I have been using WD-11 tubes, with 22½ volts on the plate.—B. R. White, 641 Washington Avenue, New York City.

One of the features of this set is the regeneration without any of the effects, such as re-radiation of signals. The fact that you are using the WD-11 tubes would account for the weak signals, as this set does not operate successfully on the dry-cell tubes. Better results can be had if it is worked with the U. V. tubes. Reverse your B coil, as suggested and shown in the diagram. If this coil does not run in the same direction as the other coils the coils oppose each other, and that will cause the trouble you mention.

* * *

I have recently built a Stockleburg Pup Set and have obtained wonderful results. I have trouble, however, with body capacity, and have to operate it very carefully, otherwise the set howls like a "pup." Would placing the honeycomb coil in the position shown be of any help in removing this? Should the copper foil ground be grounded? Where? Would better results be obtained if the variable condenser was removed from the front of the panel by placing wooden blocks between the condenser and the panel? Should the leads be insulated by spaghetti or rubber tubing? Would lining the cabinet with copper foil be of any benefit in removing the body capacity effect?—J. L. McNabb, 826 Ann Street, Columbus, Ohio.

Placing the coil in the position shown in the sketch you send would probably help it a little. You should ground the panel shielding to the ground post of the set. It would probably help if the condenser is

mounted as suggested, but in that case a non-metallic rod would have to be used to manipulate it, as otherwise the mounting would not have any effect as the use of a metal rod would carry the body capacity to the set through the metal just the same as if you did not mount it in the manner described. It is not absolutely necessary to insulate the leads except where they cross at extremely close quarters, and in that case they should be insulated. Lining the cabinet in the manner suggested would obviously help in the elimination of the disturbing capacity effect. In this case the entire cabinet should be grounded, but take extreme care that no part of it touches the shielding.

* * *

In RADIO WORLD for April 21 you describe a double-control switch in connection with a circuit by Arthur Gordon. I note that the negative B battery is connected to the negative A lead, and have had my connection on the positive A lead. Which is correct?—E. V. R. Harris, Woodstock, N. B., Canada.

The circuit will work either way. Better results are sometimes had with the connection you mention, but it is a matter of experiment, and can easily be determined which works best by simply shifting the leads of your A battery.

* * *

In connection with the combined transmitting and receiving circuit published in RADIO WORLD for May 19, what is the capacity of the grid leak? Would better results be had by the use of a power tube in this circuit?—William T. Deasy, 74 Quericus Avenue, Willimantic, Conn.

The grid leak should be 1.5 megohms resistance. A variable one will suit the purpose. You can use a power tube with this circuit if you wish. This will allow you to use more power in your plate circuit and consequently reach further.

* * *

I constructed the Cockaday receiver according to your description and circuit diagram in RADIO WORLD for May 12, but find that I cannot get anything but a dull hum or click. This is more pronounced when I turn the tube off. Could this be caused by using a faulty socket?—Herman C. Menes, 4 Otisfield Street, Roxbury, Mass.

The fact that you get a dull hum or buzz in your circuit is an indication that you have a break somewhere in the circuit. This could be caused by a faulty socket, the prongs making poor contact with the nipples of the tube. Go over your circuit very carefully, testing out each connection, to see if there is not a faulty contact. Examine all your movable contacts, such as tap leads, and you will probably find your trouble.

* * *

Is the enclosed circuit a good one? Will a tube detector be more efficient than a crystal detector? Is it possible to use two variometers, coupler, etc., with this circuit instead of the loop and condensers? Where can I purchase resistances of 500 to 2,000 ohms?—E. L. Mason, Essex, N. Y.

The circuit you enclose is the reflex circuit used in the De Forest D7 set. It is possible to use a tube detector with this circuit, but better and clearer reception will be had if the crystal is used. The tube will add but little to the operating sensitivity of the set, and the signals will most probably be much distorted when it is used. Stick to the diagram. You cannot combine this set with a variometer and coupler, though you can use a coupler as a tuner with an

antenna and ground, but the variometers are useless in this circuit. Write to any of the radio supply houses advertising in RADIO WORLD.

* * *

Kindly publish a correct circuit diagram of the De Forest D7 loop set. In RADIO WORLD for June 2 you published a ship receiver using the Grimes inverse duplex reflex receiver. Can I use U. V.-200 tubes with this receiver? Can I use dry-cell tubes? Is it advisable to use a three-stage amplifier in connection with the De Forest? They are to use dry cells.—Walter H. Spieler, 19 Mystic Avenue, Somerville, Mass.

For the De Forest reflex we refer you to the Answers to Readers column in our issue for June 23, where you will find the circuit requested. It is not desirable to use U. V.-200 tubes with this circuit as the tubes have to perform the work of amplifiers. The last or detector tube can be a soft tube, but otherwise use the amplifying tubes. It is possible to use the dry-cell tubes with this circuit, but results will not be as good when these tubes are used as when the regular large plate surface tube is employed.

There should be no need for adding more amplification to a set of the De Forest type. You will obtain three steps of radio and two of audio-frequency amplification with such an outfit, which is all that is necessary. More than this will distort the signals, and the added expense is not warranted. More than two steps of audio-frequency or three steps at the most tend to rob the signals of their clarity, and you will obtain nothing but a lot of noises.

* * *

Kindly advise me where I can get a diagram of a three-circuit set using two variometers and a coupler in connection with a panel diagram and two stages of audio-frequency. Is it necessary to shield the panel? Does it make any difference if the two variometers are of different makes?—William J. Watt, 104 Commercial Street, Rochester, N. Y.

We refer you to RADIO WORLD for June 30, where you will find the necessary data for the construction and operation of a regenerative set for which you ask. For proper operation the set should be shielded, preferably with copper foil or screening. It should not make much difference if the two variometers do not vary too greatly in size. The smaller one, or the one with the least number of turns, should be put in the grid circuit.

* * *

I constructed the Stockleburg Pup Set described in RADIO WORLD for May 5, but cannot seem to get any regeneration. Kindly explain why I can only get results when tapping the coil at the eleventh turn.—E. Cutris, P. O. Box 718, City Hall Station, New York City.

You should tap your coil at the inside of the honeycomb. Start at the inside and count the turns, not the layers, as otherwise you will not get the correct amount of wire in your plate circuit. This accounts for the fact that you have to tap it at the eleventh turn. It will give you plenty of regeneration when tapped right.

* * *

Please send me the correct hook-up for the set described by Ortherus Gordon that appeared in the January 20 issue of RADIO WORLD.—C. W. Gildner, Pittsburgh, Pa.

The hook-up as it appeared is correct.

Using the MAGNAVOX

IT is the Magnavox owner who gets the utmost service from Radio.

While the Radio enthusiast constantly strives to better his receiving equipment, Magnavox Reproducers and Power Amplifiers are units which no other apparatus can replace.

The only correct principles of sound reproduction and amplification are embodied in Magnavox construction.

Magnavox Reproducers and Power Amplifiers can be used with any receiving set of good quality. Without Magnavox, no receiving set is complete.

Magnavox R2 Reproducer and 2 stage Power Amplifier (as illustrated)
\$115.00

R2 Magnavox Reproducer with 18-inch curvex horn: the utmost in amplifying power; requires only .6 of an ampere for the field \$60.00

R3 Magnavox Reproducer with 14-inch curvex horn: ideal for homes, offices, etc. . . . \$35.00

Model C Magnavox Power Amplifier insures getting the largest possible power input for your Magnavox Reproducer.

AC-2-C, 2-stage, \$55.00
AC-3-C, 3-stage, \$75.00

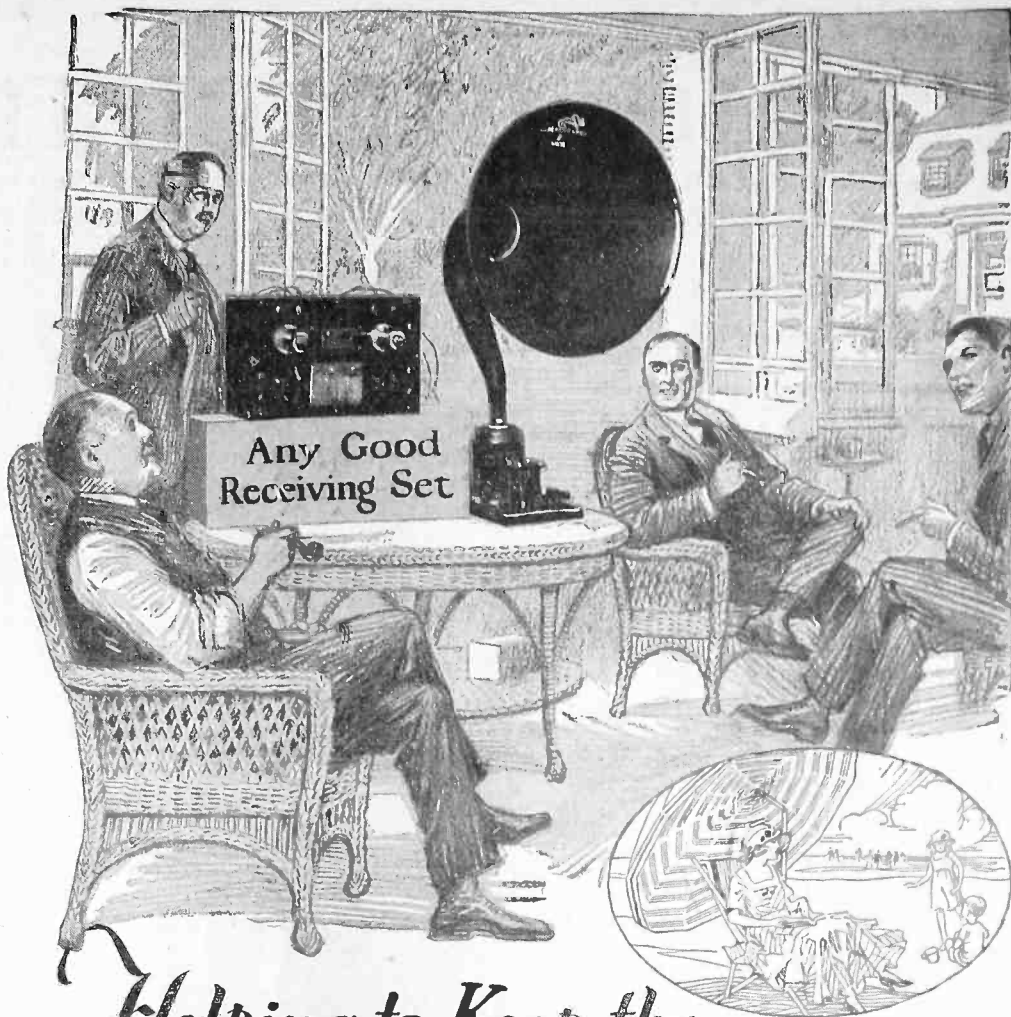

*Helping to Keep the
"Stay-at-Homes" happy*



RADIO has banished that dull, lonely evening idea once and for all—the "stay-at-home" nowadays can choose his own brand of entertainment from a number of programs practically every hour.

But a Radio set is only as good as its reproducer—make sure you have the Magnavox (electro-dynamic) Reproducer Supreme.

Magnavox products can be had of good dealers everywhere. Send for copy of unusual booklet.

The Magnavox Co., Oakland, California
New York: 370 Seventh Avenue

MAGNAVOX
Radio
The Reproducer Supreme

THE RADIO BUSINESS IS GETTING INTO FINE SHAPE. AS FORBES SAYS: "THE BEST STEEL IS THAT WHICH HAS UNDERGONE THE HARDEST POUNDING."

Radio Merchandising

Advertising Rates: Display, \$5.00 an inch, \$150.00 a page. Classified Quick-Action Advertising, 5 cents a word.

Telephone Bryant 4796

Radio Literature Wanted

Manufacturers of and dealers in radio apparatus and accessories are notified that literature and catalogues describing their products have been requested, through the Service Editor of RADIO WORLD, by the following:

- Burke Hennessy, 30 Fifth Avenue, New Rochelle, N. Y.
 H. R. Whaley, 220 North Tod Avenue, Warren, O.
 Tom Kolonsh, 607 North Eighteenth Street, Omaha, Neb.
 Charles Glatz, 850 Stebbins Avenue, Bronx, N. Y. (Makes sets to order.)
 H. Adams, 27 Converse Street, Wakefield, Mass.
 A. S. Diehl, Box 154, Lake Arthur, La.
 Elden Peterson, P. O. Box 95, Winthrop Harbor, Ill. (Consumer and retailer.)
 Frederick James Hellmer, E.E., 6211 Toledo Avenue, Detroit, Mich. (Builds and designs sets.)
 J. L. Bostian, 8 Hammond Place, Elnhurst, L. I., N. Y. (In market for home set costing \$150 to \$200.)
 H. B. Helein, 526 Church Street, New Britain, Conn. (Makes radio sets.)
 H. D. Burrall, care U. S. Forest Service, Magdalena, New Mexico.
 Ervin F. Schubel, R. 2, Lake Beulah, Wis. (Possibly may become a retailer.)
 Bernard S. Shay, 3016 Holmes Avenue, South, Minneapolis, Minn. (Will soon open radio store and shop. Wants first-class parts.)
 G. A. Fassnacht, 5616 Second Avenue, South, Minneapolis, Minn.
 R. O. Lamb, 18 Trenton Avenue, Swissvale Station, Pittsburgh, Pa. (Neighborhood supply dealer.)
 J. J. De Back, 38 Arbutis Street, Rochester, N. Y. (Interested in both receiving and transmitting.)
 Marks Bros., 2312 Eighth Avenue, New York City. (Dealers.)
 F. Elphick, 706 Hudson Avenue, Secaucus, N. J. Simplex Radio Supply Co., 1806 Lafayette Avenue, St. Louis, Mo. (Wholesale and retail mail-order house.)
 R. J. Russell, 5013 Baltimore Avenue, West Philadelphia, Pa.
 L. Seltzer, 272 Saratoga Avenue, Brooklyn, N. Y. Essex Mfg. Co., 117 Mulberry Street, Newark, N. J. (Jobbers and dealers.)
 W. A. Wynne, 120 South Salisbury Street, Raleigh, N. C. (Dealer.)
 W. F. Kuhn, 2209 South 39th Street, St. Louis, Mo.
 Dr. F. M. Cooper, 14 South Weber Street, Colorado Springs, Colo. (Soon be in market for parts for one or two portables.)
 Tillman Products Co., 473 Hudson Avenue, Brooklyn, N. Y. (Manufacturers. In market for molded rheostat bases, sockets and crystal detector bases only.)
 John Logan, 1955 Morengo Ave., South Pasadena, Calif.
 W. Gilbertson, Hickson, North Dakota.
 Dean French Taylor, 43 Black Rock Turnpike, Bridgeport, Conn.
 L. A. Wallace, Engineer's Office, Beaufort County Road Commission, Washington, North Carolina.
 C. W. Thomas, Huntingdon, Quebec, Canada. Swain Solon, Shenandoah, Iowa. (Dealer.)
 Michael Moss, 2275 Morris Ave., Bronx, N. Y.
 J. Lawton Ellis, Jr., electrical engineer, Allendale, South Carolina. (Radio service.)
 Wm. Messinger, 238 Eighth Ave., N. E., North St. Paul, Minn.
 John L. Heath, Box 395, Derby Line, Vermont. (Builds, repairs and installs sets.)
 H. B. Phinny, 310 West First Street, Oil City, Pa.
 W. H. Burnham, 727 Tremont Street, Boston, Mass.
 George Kotz, 5534 Pemberton Street, West Philadelphia, Pa.

The first of these names were printed in Radio World dated April 21, and have continued in each issue since. Any copy 15c. Any 7 copies for \$1.00 Radio World, 1493 Broadway, N. Y.

Investigates Broadcasting in England

M. C. RYPINSKI, vice-president of C. Brandes, Inc., and chairman of the radio section of the Associated Manufacturers of Electrical Supplies, returned from Europe last week on the "Homeric." Before the British Broadcasting Society he explained American broadcasting methods and will shortly give talks in New York, Pittsburgh and Chicago, over radio, on British broadcasting methods. Mr. Rypinski says that the opportunity to investigate the British broadcasting situation was most helpful and interesting.

The British public have been quick to take the idea, and as this public numbers fifty million or more their interest in radio



M. C. Rypinski, of New York City, who investigated broadcasting in Great Britain

broadcasting is bound to be fraught with important developments.

He was also impressed with the unified control over broadcasting vested in the British Broadcasting Company, which is an association of about 500 radio manufacturers (membership open to any bona fide British manufacturer), acting under the supervision of the Postmaster General. This unified control obviates duplication of expense, minimizes interference and should develop a very high standard of broadcasting program and operation.

Radio Trade Opportunities

PROSPECTIVE purchasers of radio equipment in Riviere du Loup, Quebec, Canada, have filed inquiries with the Department of Commerce, Washington, D. C., as to exporters in the United States. The names and full data are available upon application under Trade Opportunity 6888. Other inquiries on radio parts have also been received from London and may be referred to as No. 6908.

No. 6,862 refers to an agency for radio equipment and apparatus desired in Newcastle, Australia.

New Radio and Electric Firms

Electro Company, New York, has increased its capital stock from \$4,000,000 to \$4,750,000.

Consolidated Telegraph and Electrical Subway Co., New York City, will issue 37,500 shares preferred stock and 442,500 shares common stock, both of no par value.

Cesar Electric & Radio Corp., New York City, \$50,000; P. Dicesare, W. H. Grote. (Attorney, F. S. Marsell, 154 Nassau St.)

Albany Radio Corp., Albany, N. Y., has increased its capital stock from \$10,000 to \$50,000.

Berling Magneto Co., Buffalo, N. Y., \$40,000; W. J. Daetsch, W. E. Barrett. (Attorney, N. C. Kropp, Buffalo.)

American Broadcasting Corp., New York City, \$5,000; C. Tepper, S. H. Gore. (Attorney, I. M. Sackin, 152 West 42d St.)

The Plateau Valley Light & Power Company, Colbran, Colo.; capital stock, \$100,000; Clarence L. Fenn, George Bullock and M. R. Groves.

The Cambridge (Ohio) Light & Power Company; capital stock, \$75,000; Frank M. Taylor, Robert S. Ashe and Wilfred Jessup.

R. V. English Electrical Co., Buffalo, N. Y.; \$10,000; J. M. Mead, R. V. English, E. W. Hartung. (Attorney, H. P. Miller, Buffalo.)

Ambrose Diehl Electric Co., Uniontown, Pa., has increased its capital stock from \$150,000 to \$275,000.

Sprague Electrical Supply Co., 39 Spring Street, Waterbury, Conn. (Wholesale.)

Arrow Supply Co., 107 North 7th Street, Philadelphia, Pa. (Wholesale.)

W. M. Rosenthal, 726 Atlantic Avenue, Atlantic City, N. J.

Edward S. Peacock, 215 West Washington Street, South Bend, Ind.

Allison Cash Hardware Co., Allison, Ia. Meredith Hardware Co., 721 West Grand Avenue, Des Moines, Ia.

E. C. Harkness, 1630 North Capital Street, Washington, D. C.

UNITED STATES DISTRICT COURT, SOUTHERN DISTRICT OF NEW YORK: No. 34404 In Bankruptcy.

C. HYMAN BATNER, Bankrupt. TO THE CREDITORS OF THE ABOVE NAMED BANKRUPT:

Pursuant to Southern District Rule 22 you are hereby notified that the Receiver, Attorney for Receiver and Petitioning Creditors, and the Appraisers herein, have filed petitions in writing for allowances for services rendered the estate of the above named bankrupt, as follows:

GABRIEL I. LEWIS, receiver's commissions	\$30.26
Allowance to ARCHIBALD PALMER, attorney for Receiver	60.52
Disbursements	1.00
BERNARD J. MCCORRY, appraiser	10.00
ARTHUR C. SMITH, appraiser	10.00
CLIFFORD G. LUDVIGH, appraiser	10.00

YOU ARE HEREBY NOTIFIED that the said applications for services rendered said estate, will be brought on for hearing before me as Referee, at my office, No. 2 Rector Street, City of New York, on July 12th, 1923, at 1 P. M., at which meeting the said matter will be heard and such recommendation made as may be just and proper.

SEAMAN MILLER, Referee in Bankruptcy.

Dated, June 25th, 1923.

Dry Cell Tubes Increase Portability of Radio Sets

By Gerald McSweeney

A YEAR ago the idea of taking a radio receiving set on one's vacation was usually regarded as very impractical and somewhat inconvenient. The ordinary crystal receiving set was not satisfactory and the tube set was bulky and inconvenient. Now, however, the developments of the past year not only make it possible but advisable to carry a radio set to camp or summer resort.

As a result of the application of the single dry cell battery such as the WD-11 it is now possible to use a vacuum tube set in places remote from storage battery charging facilities such as the isolated farm, the seashore and the summer camp.

There is no limit to the lengths we may now go. The disciple of Izaak Walton can take his outfit with him to some shady nook, and if the fish are not biting well, he can while away the hours listening to the soothing strains of music a la radio from a broadcaster miles distant, or he can take in a lecture on how to fish, or hear a discussion on the fall styles in evening wear, not to mention the baseball scores. The portable transmitter, installed at the camp, will insure that he does not miss the dinner bell.

The canoe, the motor boat, the automobile, and even the motorcycle of the ambitious camper will this summer be equipped with a radio receiver, and no matter where you go, you will be within easy range of one or more broadcasters.

No argument is necessary to convince the reader, well informed on radio matters that the messy 6 volt storage battery is poorly adapted to portable radio sets on account of weight, bulk and the necessity of having to provide frequent charging means. The actual weight reduction is approximately 40 pounds—lesser weights are often the determining factor in the selection of camp equipment.

Most of the interference handicaps usual to cities and congested centers due to steel structures and power lines are dissipated in the great open spaces and with the exception of intense summer static conditions splendid results may be expected due to the high sensitivity of the vacuum tube receiver. Through processes recently developed the Westinghouse WD-11 and WD-12 dry cell tubes has been

perfected to the point where if not mistreated its life is in the neighborhood of 1,000 hours.

The characteristics of WD-11 and WD-12 are identical the only difference being WD-11 is equipped with special base for which it requires an adapter for use in standard sockets. WD-11 is equipped with standard base.

In constructing these tubes the tungsten filament is replaced by a platinum filament coated with salts that will allow greater electron omission with less battery capacity—this development has made possible a tube having all the desirable qualities of an untreated tungsten filament tube which can be operated from the power supplied from a common dry battery. The WD tubes are exhausted to an extremely high vacuum and they do not depend on enclosed gas for their detecting properties. They are thus not critical in any adjustment either to filament, current, plate voltage or to the constants of the circuit in which they are used.

Another advantage is that the dry cells necessary to operate the tube can be purchased for about forty cents and they are rarely difficult to procure even in the smallest of villages or country stores. Therefore, if your power runs out it is very easy, cheap and convenient to replenish.

The farmer now can enjoy with his suburban and city brother the daily weather, time and market reports as well as the many entertaining and instructing features provided by more than 600 broadcasting stations.

The research laboratories devoted to the radio field have concentrated on broadcasting receiving apparatus in an endeavor to broaden the field of application. It remained for Westinghouse to improve the mechanical features of the dry battery tube set and to make it a commercial success.

The outstanding advantage of the tube set is that it uses the antenna current to control relatively large amounts of energy supplied by a local battery while the crystal set is directly dependent on the received energy. The advantage of a set equipped with WD-11 or WD-12 tubes is its adaptability to a convenient and compact source of energy.

fine tuning, as one complete turn of the micrometer control only moves the dial a hair line, and it is therefore possible to get an adjustment that is impossible by the usual methods. This will prove to be a great help in a set that needs fine controls, and, inasmuch as it is handsomely engraved and constructed, should be a welcome addition to any set.

Will a Reliable Wholesaler Please Reply

Editor, RADIO WORLD: We carry a general side line of radio supplies, we are buying and selling for cash, but so far have not found a reliable wholesaler that does business in a regular, dependable manner. They either ask prices that are too high or the product is poor. Can you suggest a way to overcome this condition?

Where can we obtain a list of reliable wholesalers only? We would be thankful to you for the above solutions.

JOS. C. HEINTZ.
12 Sixth Street, New Dorp, N. Y.

Coming Events

AMERICAN RADIO EXPOSITION, Grand Central Palace, New York City, October 6 to 13, 1923. J. C. Johnson, general manager.

ANNUAL HOME AND CITY BEAUTIFUL EXPOSITION, featuring radio exhibits, Atlantic City, N. J., June 16 to September 8, 1923.

Broadcasting Post Cards

THE Pacific Screw Company, 645 N. E. 53rd Street, Portland, Oregon, dealers in radio supplies, have prepared two postal cards for use in acknowledging receipt of broadcasts and for replies to enable receiving stations to know what their outfits are picking up. The forms adopted seem to fulfill the purposes intended. The cards are supplied by the dozen or in quantities.

Radio Improvements in Mexico

THE Mexican Government intends to change the apparatus used in its wireless stations from spark to continuous wave, according to information reaching the Department of Commerce. With the present spark sets, it is reported that the Mexican stations can communicate only with two European stations; one at Nauen, Germany, and the other Lafayette, at Bordeaux, France. Equipment for four modern transmission stations of continuous-wave type have been ordered from Germany at a cost of \$200,000. They will be installed at Mexico City, Merida, Vera Cruz and Tampico. The old spark stations will be transferred to the Islas Marias; LaPaz, Lower California; Guadalajara, Jalisco, and Acapulco, Guerrero.

Radio Committee of Supply Jobbers' Association Reports

AT a general meeting of the Electrical Supply Jobbers' Association, held at Hot Springs last month, the following recommendations were presented by the Radio Committee and unanimously adopted by the association:

That manufacturers of radio material supply their distributors with standard size 8½ by 10 inch price and data sheets.

That defective tubes and radio material returned to manufacturers, where such returns are permitted, be credited rather than replaced, in the interest of economy, by the elimination of handling small shipments, as in most cases the distributor has already made replacement or adjustment with the dealer.

That all portions of inside of instruments depending on the strength of panel for support be reinforced by extra individual support of such unit so mounted to prevent breakage by rough handling.

That manufacturers pack and ship receiving sets in individual cartons or crates of sufficient strength to permit reshipment in original package.

That all manufacturers of receiving sets of a value of \$25 or over supply these sets with a serial number to facilitate the tracing of lost or stolen sets, and that the serial number and catalog number appear on the outside of the container, where it will appear to the best advantage in stocking on distributors' and dealers' shelves, and further recommends that manufacturer, distributor and dealer use serial numbers on their invoices.

That the present practice of allotting radio material on which the demand exceeds the supply be changed to conform to the practice of manufacturers of other lines handled by distributors, thereby rewarding distributors who create business and placing supplies where the demand is most urgent.

Dubilier's Annual Report

THE Dubilier Condenser and Radio Corporation, New York City, for the year ended April 30, 1923, reports a balance of \$63,588, after expenses, taxes, preferred dividends and sinking fund reserve, which is equal to 48 cents a share earned on the 131,000 shares of common stock outstanding. The income statement for the year shows sales of \$516,058; operating expenses, taxes, etc., \$425,938, and net operating profit, \$93,588. The corporation's total surplus stands at \$73,588.

The Accurate Micrometer Control Dial

A NEW micrometer control dial manufactured by the Mydar Radio Company, Newark, N. J., embodies several novel and helpful features that will prove of advantage to the owner of a set who desires fine tuning. The dial proper is of aluminum-finished brass with an extra large knob for coarse tuning. On top of this larger knob there is a smaller one. By an ingenious arrangement of gears located inside the larger knob it is possible to get extremely

KELLY WAVE SUSTAINING COIL

Eliminates Aerials, Loops and Danger from Lightning

Fit Inside Set

The Kelly Wave Sustaining Coil will work perfectly in any tube set. The coil being sealed under a vacuum, it eliminates STATIC and all interferences.

Price \$4 Each



Makes It Portable

Simple to connect. One lead to terminal marked aerial, the other to A or B battery—That's all.

Dealers, write for special terms.

Manufactured by

JOS. GELB COMPANY, 250-258 West 54th Street, New York

"B" BATTERIES

Depleted "B" Batteries are usually the cause of your trouble in receiving: Eliminate it. Buy your "B" Batteries direct from Manufacturer. No old stock batteries, but fresh tested batteries, with a 100 per cent. efficiency, at the following low prices, which are 50% less than list price.

	Large	Medium	Small
22½ Volt plain	\$1.25	\$1.00	\$0.70
22½ Volt variable	\$1.38	\$1.13	\$0.75
45 Volt plain	\$2.50	\$1.75	—
45 Volt variable	\$2.75	\$2.00	—

Any other type of battery made to order. Send Money Order or Order for C.O.D.

ROSENDAL & CO., 2 Stone Street, New York

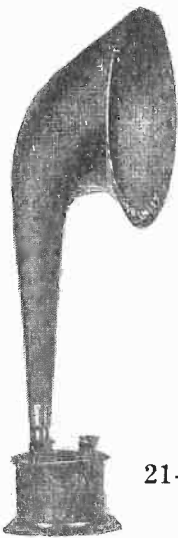

The Trinity Loud Speaker

TYPE "A1"
\$25.00

21-in. Fiber Horn

The only device of its kind in the Radio field

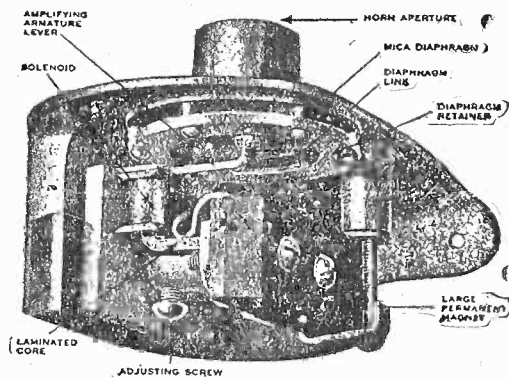

Type "B" \$12.50

Study the illustration carefully and you will understand why it produces full, clear, natural tones with perfect reproduction of all vocal and instrumental music. May be used with phonograph. No storage battery required.

The Trinity Loud Speaker is an instrument that combines the best qualities of a phonograph reproducer in combination with electro magnetic principles best fitted for radio amplification. Absolutely perfect reproduction of all music and speech without distortion. The volume may be regulated from that required for a room in your home to a tremendous output that can be heard hundreds of feet out of doors by simply increasing "B" battery voltage. No storage batteries required. The instrument is of a heavy duty type and is guaranteed fully by the manufacturers.

Ask your dealer for demonstration—if he cannot we can.

TRINITY RADIO CORP.

168-"B" DARTMOUTH STREET

BOSTON, MASS.

FILL OUT AND MAIL NOW

SUBSCRIPTION BLANK

RADIO WORLD

RADIO WORLD

1493 Broadway, New York City

Please send me RADIO WORLD for months, for which please find enclosed \$.....

SUBSCRIPTION RATES:

Single Copy	\$.15
Three Months	1.50
Six Months	3.00
One Year, 52 Issues.....	6.00
Add \$1.00 a Year to Foreign Postage; 50c for Canadian Postage.	

Milwaukee Radio Amateur's Club

MUCH interest in the Zenith receptor has been aroused among members of the Milwaukee Radio Amateurs' Club, Inc. Several have built models according to the specifications given before a recent club meeting by R. H. G. Mathews, 9ZN, engineer of the Chicago Radio Laboratory, and have reported favorably on the receiver's merits. Among these were E. T. Howell, Sc.M., vice-president, and the club's recently appointed assistant treasurer; F. W. Catel, 9DTK, some time an operator for the now defunct United Wireless Telegraph Company.

A good share of one of the season's last meetings was taken up with a discussion of the super-heterdyne receptor, with E. T. Howell, 9CVI, and H. F. Wareing, pre-war 9AEX and president, leading.

At the final meeting for the season of 1922-23 Business Manager L. S. Hillegas-Baird read Dr. D. B. McMillan's parting message to A. R. R. L. members. This statement was prepared by Dr. McMillan shortly before he left for the Arctic regions, taking an A. R. R. L. member and radio operator with him.

Regular weekly meetings on Thursday evenings will be resumed by the society about the middle of September. The club's directors and officers will hold several mid-summer meetings, at which plans will be formed for the fall membership campaign. A society consisting of 100 per cent of the local radio amateurs and members of the American Radio Relay League, Inc., is the goal to be set in the membership drive. The club's office, to which all general correspondence should be addressed, is 601 Enterprise Building, Milwaukee, Wis.

Broadcasting in 1874

RADIO broadcasting is a development of the past three years but the broadcasting of music goes back a great many years. George S. Pierson, a consulting engineer of Kalamazoo, Mich., writing to WGY, the Schenectady, N. Y., station of the General Electric Company, acknowledging his enjoyment of many programs, tells of a broadcasting stunt enacted by the students of Union College on a frosty March night in 1874.

The generator, he explains, was what is commonly known as a horse fiddle, a great wooden box on the main floor of a circular building, now the library, then in course of construction and roofless. The top boards of the box were well resined and a plank 38 feet long used as the fiddle bow was also resined. With six men standing on the plank, the bow was drawn back and forth across the edges of the box. No one in Schenectady slept that night and the terrifying notes of the mammoth fiddle were heard five miles away.

Mr. Pierson also describes, as a parallel to the progress of radio, a demonstration of the telephone which was made in 1874 in a Schenectady church. An admission fee was charged. A telephone line was strung from pulpit to gallery. The audience was invited to listen into the wonderful invention, but, according to Mr. Pierson, no two people were able to agree on what was said over the wire.

Station WDT Reopens in New Quarters

Station WDT is now located in new quarters at 510 West Twenty-third Street, New York City, under the direction of Vaughn De Leath. This broadcasting station is operated by the Ship Owners' Radio Service, Inc., and the Premier Grand Piano Corporation. It is planned to produce WDT programs of unusual merit.

THE COMO

DUPLEX TRANSFORMERS

Something really new in Audio Amplification. (See article in RADIO WORLD, June 9, by C. White, on "A Super Amplifier.") We guarantee more volume and infinitely better quality than is possible with any other transformer on the market.

Sold only in matched pairs
PRICE \$12.50 PER PAIR
Send for descriptive literature

Como Apparatus Company
 168 DARTMOUTH STREET
 BOSTON, MASS.

Westinghouse WR21

4 Volt \$3.50

UV-201-A	\$4.10
WD-11	5.95
WD-12	5.95
UV-199	5.95

Brandes Superior Phones..... \$5.50
 Original Baldwin Double..... 7.75
 Knock Down Loop Aerial, Complete.. 1.45

Money Order or Check Must Accompany Order

J. J. KELLEHER

"The Radio Man on the Square"

14 Union Square N. Y. City

GUARANTEED REPAIRS

Broken and Burned Out
VACUUM TUBES

W.D.-11 not accepted for repair

Your dealer should know, but if he does not, send direct to

HARVARD RADIO LABORATORIES
 Boston 9, Mass.

Tubes returned parcel post C. O. D.

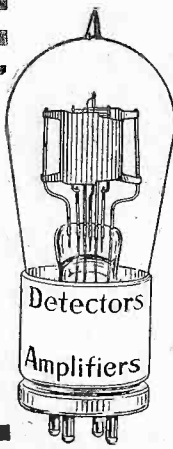

THE GOODMAN



PATENT PENDING

The Niftiest Short Wave Tuner on the Market Only \$6.00 & PP on 1 lb. Send for pamphlet.

L. W. GOODMAN

DREXEL HILL, PA.

The GOODMAN is really a high grade instrument, well and sturdily constructed. The PANEL and FANS are GENUINE BAKELITE—the best material known for the purpose.

RADIO WORLD

TELEPHONE, BRYANT 4706
 PUBLISHED EVERY WEDNESDAY (Dated SATURDAY OF SAME WEEK)
 FROM PUBLICATION OFFICE,
 1493 BROADWAY, NEW YORK, N. Y.
 BY HENNESSY RADIO PUBLICATIONS CORPORATION

ROLAND BURKE HENNESSY,
 President and Editor
M. B. HENNESSY, Vice-President
FRED S. CLARK, Secretary and Manager
 1493 BROADWAY, NEW YORK, N. Y.

European Representative: The International News Co., Breems Bldgs., Chancery Lane, London, Eng.
 Paris, France: Brentano's, 37 Avenue de l'Opera.

Managing Editor Technical Editor
 Stephen L. Coles Robert L. Dougherty

Field Representatives:
 New York—Arnold D. Friedman, W. H. Oke.
 Chicago—Stevens & Baumann, Inc., First National Bank Building.
 Los Angeles—Stevens & Baumann, Inc., Higgins Building.
 San Francisco—Stevens & Baumann, Inc., Holbrook Building.

SUBSCRIPTION RATES

Fifteen cents a copy. \$6.00 a year. \$3.00 for six months. \$1.50 for three months.
 Add \$1.00 a year extra for foreign postage. Canada 50 cents.
 Receipt by new subscribers of the first copy of RADIO WORLD mailed to them after sending in their order, is automatic acknowledgment of their subscription order.

ADVERTISING RATES

One page: One time—\$150.00.
 Half, Quarter, Third and Two-thirds pages at proportionate rates.
 One inch, one time—\$5.00. Per agate line \$0.40.
 On four consecutive issues, 10% discount.
 On thirteen consecutive issues, 15% discount.
 Cover and preferred-position rates made known on application.
 Terms: 30 days net. 2% 10 days.

CLASSIFIED ADVERTISEMENTS

Five cents per word. Minimum, 10 words.
 Discount of 10% on 4 consecutive issues—15% on thirteen consecutive issues. Cash with order.

Entered as second-class matter, March 28, 1922, at the Post Office at New York, New York, under the act of March 3, 1879.

IMPORTANT NOTICE

While every possible care is taken to state correctly matters of fact and opinion in technical and general writings covering the radio field, and every line printed is gone over with a scrupulous regard for the facts, the publisher disclaims any responsibility for statements regarding questions of patents, priority of claims, the proper working out of technical problems, or other matters that may be printed in good faith and on information furnished by those supposed to be trustworthy. This statement is made in good faith and to save time and controversy in matters over which the publisher cannot possibly have control.

Rubber in Tremendous Demand

To make the thousands of various rubber articles, the majority of which are essential to public convenience, more than 250,000 tons of crude rubber are required to supply the world market. Since rubber must be taken from certain tropical trees in the form of latex, or sap, which is more than 60 per cent water, it takes 224,000,000 gallons of the milky fluid to produce the tonnage required to supply the rubber manufacturing industry.

The rubber latex or milk is not an emulsion, as is commonly supposed, but a fluid in which are suspended microscopic particles of solid rubber matter. These particles are so numerous and their powers of adhesion are so great that one gallon of the white rubber-tree sap contains enough of the rubber globules to form a minute thread 372 miles long.

On the rubber plantation the tree milk or latex is treated with a dilute acid solution as soon as it is brought in by the tappers. The acid serves to dissolve the properties which hold the rubber particles suspended in the fluid. This brings the rubber to the surface, where it can be skimmed off just as cream is skimmed off milk.

The value of the plantation rubber to the industry has been tremendous. Scientific care of plantations and extensive study of methods for handling the latex have produced a dependable rubber which the manufacturer can study and compound with the assurance of more uniform service results in the product he makes from it.

YOU SAVE 50% OF THE USUAL COST

WORLD BATTERIES FOR RADIO



6 Volt \$10.00
60 Amps.
6 Volt 12.50
80 Amps.
6 Volt 14.50
100 Amps.
6 Volt 16.00
120 Amps.

A Better Battery Cannot Be Built

The best of material—careful construction by skilled mechanics—makes a battery that will give a long life of hard service.

A written two (2) year guarantee. You take no chances with a World Battery—it is the most satisfactory battery you can get and you save 50%.

Mail Your Order Today

We ship C. O. D. subject to inspection, or will allow 5% discount for cash with order. All orders shipped same day as received.

WORLD BATTERY CO.
 Dept. 17, 1219 So. Wabash Ave.
 Chicago, Ill.

GUARANTEED 2 YEARS

RUSONITE

CRYSTAL RECTIFIER

MULTIPOINT
 (Patent Pending)

A Synthetic CRYSTAL DETECTOR sensitive over its entire surface. Eliminates all detector troubles. Extraordinary clearness and volume. Endorsed by radio experts and press for both REFLEX CIRCUITS and CRYSTAL SETS. Sold in sealed packages only.

Price, postpaid, mounted, Sensitive-ness guaranteed **50c**

RUSONITE CATWHISKER
 14-Karat Gold Multiple contact. Supersensitive **25c**

Order from your dealer or direct from us.
RUSONITE PRODUCTS, 21 Park Row, N. Y.

FROM 180 to 700 METERS

Have you that range of selectivity? With a COAST COUPLER as part of your equipment it is easy. Why don't you try it? By sending \$5.00 you will receive postpaid a COAST COUPLER and one of our famous hook ups which we guarantee will do all that is claimed for it.

DEALERS INVESTIGATE

THE COAST COUPLER COMPANY
 245 East 7th St. Long Beach, California



"VERILOUD" SYNTHETIC RADIO CRYSTAL

ON APPROVAL FOR 30¢
ZOBEL-STEIN LABORATORIES
 322 9TH ST. BROOKLYN, N.Y. SOUTH 2650

Extra Sensitive Tested Radio Crystal

PREPAID 30 CENTS

Each One Tested and Guaranteed

RADIO PARTS COMPANY

Lock Box 56 DUNELLEN, NEW JERSEY

"Leviathan" Establishes Marine Radio Records

In addition to making world speed records during her recent trial trip, the "Leviathan" established three marine radio records for volume of traffic, range of transmission and reception and for operation of duplex telegraph and telephone system. Under the personal supervision of David Sarnoff, vice-president of the Radio Corporation of America, and G. Harold Porter, general superintendent, the radio operators received and transmitted an estimated total of 750,000 words, or 15,000 a day, the greater vol-

ume press dispatches. Mr. Sarnoff, himself an expert operator, frequently sat at the key in facilitating the quick transmission of press dispatches.

"On this trip," Mr. Sarnoff said to a New York Times correspondent, "there were more messages sent and received daily on the ship than are handled every twenty-four hours between the United States and any one European country. On Saturday, the last day at sea, everything known in radio science was employed to handle the tremendous volume of business, and the transmission was expedited by the use of the duplex simultaneous sending and receiving apparatus so that four operators were working at the same time.

"Due to the position of the ship in tropical waters and the heat wave along the coast, the static was abnormal, in fact during all my experience as an operator prior to becoming an executive I never have listened to static of such force and intensity. As a result, for the first time in the history of marine radio, was it necessary to use the Cape Cod station and divert it from European communications to the 'Leviathan.' The power and wave length of reception was then increased from 2 kilowatts and 1,600 meters to 200 kilowatts and 16,000 meters. The effect of nature-static was thus overcome by the inventive genius of man."

Mr. Sarnoff said that in diverting the European service of the Cape Cod station to another station, the Radio Corporation had placed at the command of the "Leviathan" radio facilities on land costing approximately \$2,000,000.

From the first night out of Boston the radio office was swamped with personal, official and press messages. E. N. Pickerrill, chief radio officer, and John R. Irwin, Anthony Tamburino and R. J. Green, operators, worked in four-hour shifts at the keys. In the tropical waters, where the static interfered the most and messages were heard indistinctly on land, Mr. Sarnoff directed three stations to listen in. With more than a hundred correspondents on board, the passengers, among them some of the leading business and financial men of the country, yielded to the press on the question of order of despatch.

"We did not have a single kick from the passengers who were informed that their messages would be delayed in order for the correspondents to get their messages to land," Mr. Sarnoff said. "They felt, as I did, that the newspaper men should be given precedence because they were talking to the American public, which naturally was interested in the performance of the ship."

Radio Outlet Moves

THE Radio Manufacturers' Outlet Corporation has removed from 505 Fifth Avenue to 123 Liberty Street, New York City.

Radio Guild Advises FILKOSTAT

THE Radio Guild of New York announces that after extensive tests it has adopted in its new "Radiolian" Receivers, the Filkostat in place of wire rheostats or other filament controls. The Filkostat has taken the country by storm this summer largely because it eliminates tube noises.



Make Your Set The Sensation of Your Town! with

The RADIOXOR

SIMPLE INEXPENSIVE CERTAIN

Can be attached to any set, operating head phones or loud speaker, crystal or Vacuum Tubes, Loop, Plug or Outdoor Aerial.

Send your name, address and type of set on a post card for details.

Selling like wildfire, so act promptly. Orders filled in order of receipt.

WILLART SALES CO.
Worlds Tower Building
110 West 40th Street
New York City

THE FAMOUS SLEEPER TWINS
THE FIXED COUPLER AT \$4.00
THE VARIOMETER AT \$6.50

The fixed coupler is the first real improvement in loose or variocouplers in ten years. Looks like the variometer—a wonderful pair.

Sleeper Radio Corporation
88 W Park Place New York City

Freshman FIX-O

A Fixed Resistance Leak Combination—4 in ONE



Freshman Condenser Leak Mounting Freshman Fixed Leak SAFE-T HANDLE Price Complete **65c**

Furnished in any value of resistance from 1/2 to 10 Megohms

Separate Condenser and Mountings 40c
Separate Leaks with Safe-T Handle 30c

At your dealers. Otherwise send purchase price and you will be supplied without further charge.

Chas. Freshman Co. Inc.
Radio Condenser Products
106 SEVENTH AVENUE NEW YORK



Send us your Burnt-out Tubes

We Repair

- U. V. 200..... \$2.75
- U. V. 201..... 2.75
- C. 300..... 2.75
- C. 301..... 2.75
- W. D. 11..... 3.50

Fine Workmanship Quick Service
Mail Orders Promptly Attended to

Badger Radio Tube Repair Works
4913 North Ave. Milwaukee, Wis.

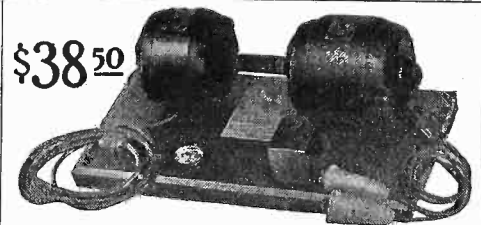

RECHARGE YOUR OWN BATTERIES

WHY pay out good money constantly for recharging batteries when the Ohio Motor Generator will do it quickly at a slight expense. This inexpensive home charging outfit keeps your Radio in service all the time and pays for itself—by charging your neighbors' batteries. It is noiseless, gives no trouble, and will even recharge totally exhausted batteries quickly. The set is made up of the celebrated Ohio A C motor and D C generator wound for 6-10 volts. The motor and generator have ball bearings and are of the highest grade construction. It has none of the troubles common to cheap charging sets and will last a lifetime. It will charge quickly any three cell automobile or Radio "A" battery. Furnished complete on a substantial base with ammeter and field rheostat to adjust the charging rate from one to twenty amperes. The motor is for 60 cycle, 110 volt service and is complete with ten foot cord and attachment plug ready for instant connection and operation. Full instructions provided.

Motor and generator can be specially wound to charge six cell batteries or other unusual conditions.
Price \$38.50 f. o. b. Cleveland. Ship by Express C. O. D., weight sixty pounds. Send your order today and stop paying good money for recharging. Your money back quick if not satisfactory.
NOTE:—If your service is other than 60 cycle, 110 volt, ask for special price.
THE OHIO ELEC. & CONTROLLER CO.
CLEVELAND OHIO

Fifty-two issues for \$6.00. Subscription Department, RADIO WORLD, 1493 Broadway, New York City.

WOULD YOU LIKE TO RECEIVE RADIO ADVERTISING MATTER?

Are you in the market for radio goods of any kind, either as a consumer, a distributor or a retailer? If so, send us your name and address on a post card and we will see that your name reaches the right people so that you will receive pamphlets, circulars, etc., regarding the goods you want.

ADDRESS SERVICE EDITOR, RADIO WORLD

FADA RECEIVING TUBE RHEOSTAT
75¢



Over a million and a half sold and in use proving its value. FADA Handbook only 4 dimes.
F. A. D. ANDREA, INC.
1381 W. Jerome Ave., N. Y. C.

FADA RADIO EQUIPMENT

Explanation of Radio Time Signals

FROM many inquiries received at Station WOC, Davenport, Iowa, it is evident that the average listener does not understand how to make use of the time signal as transmitted at eleven o'clock each day from the Davenport station. The following explanation has been prepared by the director of WOC:

The series of dots which you hear at that time represent the Government time signal received direct from the Naval Observatory at Washington, D. C., by Western Union, and are broadcast for the purpose of giving all listeners the correct time each day.

By observing the following instructions you will be able to make use of this service:

The time signal is transmitted in a series of dots, each dot representing a second. Beginning, usually, at three minutes before eleven o'clock (Central Standard Time), 29 dots are transmitted, representing the first 29 seconds of that particular minute, and the 30th second is omitted; 25 dots are then transmitted, which represent the first 25 seconds of the last half of that particular minute, and the last 5 seconds of the half minute are omitted. The next minute is transmitted in exactly the same way—that is, 29 and skip 1, 25 and skip 5. On the last minute of the hour, the first half minute is sent the same, that is, 29 and skip 1, and the last half minute is sent out 20 dots and the last 10 are omitted, although in some instances you may hear 21 or 22 dots with 8 or 9 omitted, as the case may be. At the end of this 8 or 9-second interval you will hear a long dash, which represents the exact time, eleven o'clock (Central Standard Time). By watching the difference above noted, you can tell when you are listening to the last minute of the hour rather than any of the others.

The code which follows the final dash is simply a station call.

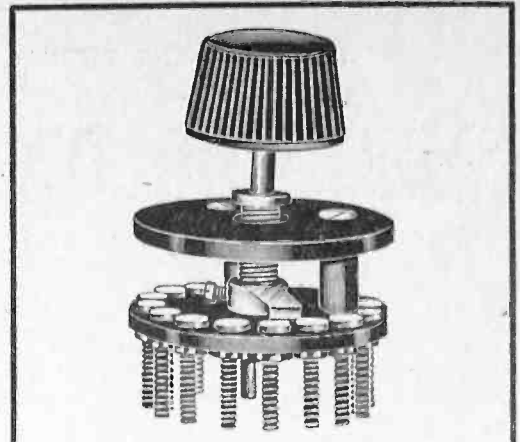

12 Point Back Mounting Inductance Switch SPECIAL 75c

AETACO Condensers	
43 Plate Condenser.....	\$1.75
23 Plate Condenser.....	\$1.35
17 Plate Condenser.....	\$1.25
11 Plate Condenser.....	\$1.00
3 Plate Condenser.....	60c.

Two-Tube Portable Set

(Tubes Included)
Consisting of 1 23 P Condenser and Dial, 1 150 to 600 Meter Inductance Coil, 1 6 Ohm Rheostat with Automatic Control for Amplifying Tube, 1 Audio Frequency Amplifying Transformer, 1 Standard Double Socket, 1 Mica Grid Condenser, 1 Tubular Grid Leak and Holder, 1 Detector Tube, 1 Amplifying Tube, 1 Pair Federal Phones, A and B Batteries.

All Connections Automatic, enclosed in 7x7½ Mahogany Finished Cabinet and Formica Panel.

A Very Special Bargain at **\$30.50**
American Radio Stores
235 Fulton Street New York City

WOULD YOU LIKE TO RECEIVE RADIO LITERATURE? Are you in the market for radio goods of any kind, either as a consumer, a distributor or a retailer? If so, send us your name and address on a post card and we will see that your name reaches the right people so that you will receive pamphlets, circulars, etc., regarding the goods you want. Address SERVICE EDITOR, RADIO WORLD, 1493 Broadway, New York City.

10 DAY SUNBEAM SPECIAL

NEW TUBES
GUARANTEED GENUINE
IN ORIGINAL PACKAGES

U. V. 200	\$3.95
U. V. 201A	\$5.50
U. V. 199	\$5.50
W. D. 11	\$5.50
W. D. 12	\$5.50
W. E. VT2	\$6.00
W. E. Peanut.....	\$6.50
W. E. 216-A.....	\$9.50

Add 25c. Postage and Insurance
SUNBEAM QUALITY goods, to complete the COCKADAY CIRCUIT. One guaranteed, accurate set of coils consisting of one plain and one Bank-wound coil sent postpaid for.....\$2.75

FANS! Buy Your Summer and Winter Supply Now—This Price Is Rock Bottom.

SUNBEAM ELECTRIC CO.
71 THIRD AVENUE NEW YORK

Cram's Radio Broadcasting Map of United States and Canada

With all the new allocations and changes recently brought out. Scale, 100 miles to the inch; in two colors—Size 34x28.

PRINTED ON HIGH-GRADE MAP PAPER WITH ALL UP-TO-THE-MINUTE INFORMATION BY WHICH YOU CAN LOCATE ANY BROADCASTING OR HIGH POWER STATION. A COMPLETE INDEX OF THE ARMY, NAVY AND BROADCASTING STATIONS.

The Most UP-TO-DATE MAP out!
35c. (Postpaid)

THE COLUMBIA PRINT
1493 BROADWAY, NEW YORK CITY

Six Months Subscription for Radio World and Popular Radio or Wireless Age, or Radio (San Francisco) for the Price of a Subscription for Radio World Alone

This Is a Special Offer for the Summer Only:

DO IT NOW!

Radio World for six months (26 numbers) is.....	\$3.00
Popular Radio at 20c a copy for six months would be.....	1.20
	\$4.20
or	
Radio World for six months.....	\$3.00
Wireless Age (or Radio) at 25c a copy, for six months.....	1.50
	\$4.50

Send us remittance for \$3.00 and we will send you Radio World for six months and Popular Radio, or Wireless Age, or Radio (San Francisco) for six months, to one or different addresses, or send through your newsdealer.

This offer is good only for one month from date.

Take advantage of this offer today and send in the accompanying subscription blank. If you are already a subscriber you can take advantage of the offer by sending us \$3.00 and renewing your subscription for six months beyond your present date of expiration.

Special Combination Offer of Radio World and Popular Radio or Wireless Age or Radio

RADIO WORLD, 1493 Broadway, New York City.

Enclosed find remittance for \$3.00, for which send me Radio World for six months, beginning with issue dated and Popular Radio, or Wireless Age, or Radio for six months beginning with issue dated.....and it is understood that there is to be no extra charge of any kind. Please mail copies to the following address:

If you wish you may send us \$6.00 for Radio World for one year (52 issues), and Popular Radio or Wireless Age or Radio for twelve months, both postpaid. This offer good only if mailed by July 23, 1923.

Name

Street Address

City and State.....

DO YOU WANT TO BUY, SELL OR EXCHANGE RADIO OR OTHER GOODS? TRY THIS
DEPARTMENT AT 5c A WORD

RADIO WORLD'S QUICK-ACTION CLASSIFIED ADS

This department is intended for everybody who wants quick action on short announcements covering the buying, selling, exchanging or general merchandising in the radio field. Readers of RADIO WORLD will find that it pays to read these columns every week. Advertisers will get a ten-day service here—that is, copy received for this department will appear in RADIO WORLD on the news-stands ten days after copy reaches us.

The rate for this RADIO WORLD QUICK-ACTION CLASSIFIED AD. DEPT. is 5c. per word (minimum of 10 words, including address), 10% discount for 4 consecutive insertions, 15% for 13 consecutive insertions (3 months). Changes will be made in standing classified ads. if copy is received at this office ten days before publication. RADIO WORLD CO., 1493 Broadway, N. Y. C. (Phone, Bryant 4796).

IF YOU WANT to save and make money, join National Supply Co. and buy anything in hardware line at reduced prices. Write immediately for particulars. Combination Box 254, New Alexandria, Pa.

WANTED—Second-hand radio set. Cheap. Full particulars to A. Browne, 3 W. 104th St., N. Y.

REFLEX FANS—New Reflex uses TUNED radio frequency. Greater selectivity. Better control. Send \$1 for plan and specifications. E. F. Nelson, 727 West 8th St., Junction City, Kansas.

FOR SALE—U. S. 3 Bulb Navy Set. Can be seen Room 326, 1493 Broadway, N. Y. C. Will sell at right price to consumer or dealer.

AGENTS, crew managers, \$20 daily distributing bamboo self-filling fountain pens; imported; something new; everybody going wild; sample free. SPORS CO., Lesueur Center, Minn.

RADIO MANUFACTURERS—South America is the coming field. Have your catalogs, booklets and bulletins translated into Spanish by a specialist. Submit English originals for estimate. TECHNICAL, Box 126, Trinity Station, New York City.

GRAM'S RADIO BROADCASTING MAP of the UNITED STATES AND CANADA. Scale 100 miles to the inch. In two colors, size 34x28. Printed on high-grade map paper, up-to-the-minute information, indicating all amateur and standard broadcasting stations, with complete index to stations. 35c postpaid. The Columbia Print, 1493 Broadway, New York City.

DYNAMO BUILDING FOR AMATEURS—Or How to Construct a Fifty Watt Dynamo.—By Arthur J. Weed. A practical treatise showing in detail the construction of a small dynamo or motor, the entire machine work of which can be done on a small foot lathe. Dimensioned working drawings are given for each piece of machine work, and each operation is clearly described. This machine, when used as a dynamo, has an output of fifty watts; when used as a motor it will drive a small drill press or lathe. It can be used to drive a sewing machine on any and all ordinary work. The book is illustrated with more than sixty original engravings, showing the actual construction of the different parts. Price, \$1.00. THE COLUMBIA PRINT, 1493 Broadway, New York City.

SUPER-SIMPLICITY CIRCUIT—1,000 to 1,500 miles on one tube, one control, 150 to 25,000 meters. No rheostat, storage battery, vario coupler, variometer, 3-coil mounting, variable inductance, taps or radio frequency. Nothing to guess about. Complete hook-up and particulars, \$1.00. No checks. Build your own. Save 50% and get better results. RADIO EXPERIMENTAL LABORATORY, Box 194A, Berkeley, Calif.

CASH FOR OLD GOLD, Platinum, Silver, Diamonds, Liberty Bonds, War, Thrift, Unused Postage Stamps, False Teeth, Magneto Points, Jobs, Any Valuables. Mail in today. Cash sent, return mail. Goods returned in ten days if you're not satisfied. OHIO SMELTING CO., 337 Hippodrome Bldg., Cleveland, Ohio.

OLD MONEY WANTED—\$2.00 to \$500.00 EACH paid for hundreds of Old and Odd Coins. Keep all old money. Send 10 cents for New Illustrated Coin Value Book, 4x6. You may have valuable coins. Get posted. We pay CASH. CLARKE COIN COMPANY, Ave. 83, Le Roy, N. Y.

Build your sets with quality parts and get sure results. Radio Parts Co., Box 56, Dunellen, N. J.

CHEAPEST TO BUILD—Easiest to tune. Get particulars Rokay Single Control Hook-up. Describe your set. Rokay Electric Company, Ingo-mar, Ohio.

VACUUM TUBES REPAIRED. Reasonable. Send for our price list. Vacuum Electric, Station C, Toledo, Ohio.

EVERY RADIO FAN should have these two books, "101 Receiving Circuits" and "Six Successful Receiving Sets." By M. B. Sleeper. They are the most up-to-date radio books for the fan who likes to make his own, and will help you out and save you many times their cost. Both books are full of illustrations. Price, 50c. each, with 10c. extra for postage, or both for \$1.00 sent postpaid. COLUMBIA PRINT, 1493 Broadway, New York City.

WIRING A HOUSE. By Herbert Pratt. Shows a house already built; tells just how to start about wiring it; where to begin; what wire to use; how to run it according to insurance rules; in fact, just the information you need. Directions apply equally to a shop. Sixth edition. COLUMBIA PRINT, 1493 Broadway, N. Y. C. Price, 35 cents.

HONEY COMB COILS—35, 50 or 75 Turn, 40c, Each Mounted, \$1.25; Special Windings to Order. Tapped Honey Combs, 3c per Tap. Crystals—Honest John's Old Fashioned Crystals, "Thunder Note" (Pyrites) and "Wonder Rock" (Galena). Tested, guaranteed and individually boxed. Each Crystal as big as a walnut. Biggest value in radio, 25c each. Small Pyrites or Galena Crystals for mounting, 75c per pound. Dealers and jobbers, write for special quotations. Factory agents wanted in some States. HONEST JOHN MFG. CO. (Dept. RW.), 1509 East 11th Street North, Portland, Ore.

MAGNAVOX TYPE R3—Latest curvex, improved acoustic models, in original sealed factory cartons. List \$35. Introductory offer \$25. RADIO CENTRAL, Dept. W, Abilene, Kans.

TWO FOR THE PRICE OF ONE—Send \$3.00 now for six months' subscription (26 numbers) for Radio World during the coming month and we will send you also Popular Radio or Wireless Age or Radio for six months without any extra charge. Or send \$6.00 now and we will send you Radio World for one year (52 numbers) and Popular Radio, or Wireless Age or Radio for one year. These offers not good after July 23, 1923. If you are already a subscriber you can take advantage of this offer by renewing from the end of your present subscription. Sub. Department, RADIO WORLD, 1493 Broadway, New York City.

WANTED—Omnigraph in good working condition. Box 435, Hardin, Montana.

RADIO DEALERS ! ! !

Have you seen the list of Camps and Camp Directors which started in the MAY 12 issue of RADIO WORLD? Here is a list of all the Camps and Directors of camps in the United States, and is of essential value to any Radio Merchant who is anxious to enlarge his summer business. Get these people interested in installing radio sets in their camps for the benefit of the campers. Any single copy, 15c; or the four issues for 60c. RADIO WORLD, 1493 Broadway, New York City.

HAVE A BRAND NEW RADIO INVENTION that every radio fan needs and will buy, as it greatly adds to the efficiency of his set. Need money to advertise and buy new material. Will you join inventor with some cash and share in the big profits? W. B. GRAHAM, 125 West 74th Street, New York City.

HOOK-UP AND CIRCUIT HOUNDS

Did you miss it? Do you want it? If you do you can get it by writing in to Radio World for any one of these back numbers, as per dates:

Reinartz circuit for 2 tubes.....	Jan. 13
Good 2 tube WD-11 Circuit for DX.....	Jan. 27
Satterlee Circuit.....	Feb. 3
G. W. May's Wonder Circuit.....	Feb. 17
Power Amplifier Circuit.....	Feb. 24
Reflex Circuits.....	Feb. 24
Flewelling Super Circuit.....	Feb. 24
Multi-tube Reflex Circuits.....	March 3
One tube Superregenerative.....	March 3
Lewis Three Tube Circuit.....	March 10
Regenerative Radio Frequency Circuit for 5 tubes.....	March 24
Hazeltine Neutrodyne Receiver.....	March 31
2VK'S Transmitter circuit.....	April 21
Compact Universal Receiver.....	April 28
Stockelburg Pup receiver.....	May 5
Cookaday receiver.....	May 12
Improved Grimes Circuit, A. D. Turnbull's Long Distance Circuit, Combined Receiver and Transmitter, Improved 1 tube Reinartz.....	May 19

Any number for 15c. Any 7 numbers for \$1.00. All 14 numbers for \$2.00. Or start subscription with any number. Radio World, 1493 Broadway, New York City.

RADIO FANS

Do you want to sell your old set?
Do you want to exchange anything for something?
Do you want to buy something?

If so, why don't you use the Classified Department of Radio World? You can get fine results for five cents a word, minimum ten words. Your message will reach thousands including other fans, dealers, etc., etc.

Try Radio World's Classified Department
for your personal radio and other needs.

RADIO WORLD, 1493 Broadway, New York City

REPRESENTATIVES WANTED BY RADIO WORLD ALL OVER THE UNITED STATES AND CANADA

Send us your name and address and say that you want to become our representative. We will show you how you can represent RADIO WORLD in your locality and at the same time make money for yourself. We would particularly like to hear from those who are handling the "Saturday Evening Post."

Address Circulation Dept., Radio World, 1493 Broadway, New York

Some Good DX Records

Some Crystal Record—Look Out, You One-Tube Fans

From Guy Simmons, Jr., 515 Clifton Street, Conway, Ark., Radio 5WW.

I NITE OWL section for some time, especially in those who use a crystal. I am sending you a list of stations which I have heard in about two months' time.

Station	Distance Miles	Station	Distance Miles
KSD	285	WFAA	300
KLZ	750	WLAJ	370
KFAF	750	WAAP	325
KDKA	800	WPE	310
KLW	550	WHAS	450
WOC	475	WLAG	700
WOS	260	WCAL	670
WHB	310	WMAJ	310
WSB	470	WOAW	475
WGM	470	WBAY	1,070
WBAF	330	WEAF	1,070
WDAF	310	WLW	525
WDAJ	470	WMC	150
WWJ	725	WOAI	550
WCX	725	WAAW	475
WSY	350	WDAP	550
WGY	1,130		
WJZ	1,050	Total	18,880
WWAC	370		

A total of 35 stations.

I attribute all my success to a good aerial and ground and to GOOD connections. Let's hear some more crystal records. Will be glad to correspond with anyone interested in crystal work.

His Second Appearance—A Full-Fledged Owl

From Willis Nye, 310 E. Sonoma Ave., Stockton, Cal.

I 'VE appeared in your column once before, and thank you for your recognition and privilege to join the DX Nite Owl fraternity. Here is some fairly good dope. Will try to do better next time.

Local DX—KGO, Los Angeles, Cal.; KJS, Los Angeles, Cal.; KOG, Los Angeles, Cal.; KFCL, Los Angeles, Cal.; KSL, San Francisco, Cal.; KLB, Pasadena, Cal.; KUY, El Monte, Cal.; KDPT, San Diego, Cal.

Medium DX—KMO, Tacoma, Wash.; KDZQ, Denver, Colo.; KDZR, Bellingham, Wash.; KDZL, Ogden, Utah; KFAU, Boise, Idaho; KFAJ, Denver, Colo.; KFDL, Denver, Colo.; KDYS, Great Falls, Mont.; CFAC, Calgary, Canada; KFHR, Seattle, Wash.; KFBL, Everett, Wash.; KDZE, Seattle, Wash.

Real DX—WMAQ, Chicago, Ill.; WOAI, San Antonio, Texas; WDAF, Kansas City, Mo.; WGAQ, Shreveport, La.; WFAY, Independence, Kan.; CFCA, Toronto, Canada.

Also get "oodles" of amateurs on 200 meters. On 800 the commercial stations crash in and rattle my diaphragm. Will answer all cards.

Not Half Bad—? Eh?

From Thornton Higgins, 7313 St. Lawrence Ave., Chicago, Ill.

I AM an interested reader of RADIO WORLD, especially the page devoted to the DX fans.

To date I have heard stations in 26 states and 2 in Canada. The set I am using is homemade, with one step of audio-frequency. The following are the stations heard:

CFCA, KDKA, KFDL, KLZ, KOP, KSD, KYW, WAAF, WAAP, WAAS, WAAW, WAAZ, WBAD, WBAH, WBAP, WBU, WBZ, WCAH, WCAE, WCAS, WCK, WCX, WDAD, WDAF, WDAP,

WDAJ, WDY, WEAB, WEAC, WEAJ, WFAA, WFAY, WGAN, WGAK, WGAS, WGF, WGM, WGR, WGY, WHAK, WHAO, WHAS, WHAZ, WHB, WIAC, WIP, WIAX, WJAZ, WJZ, WLAG, WLAL, WLK, WLW, WMAQ, WMB, WMC, WMU, WNJ, WOAW, WOC, WOR, WOS, WOZ, WPA, WPA, WQAA, WSAH, WSY, WSB, WTAS, WWAY, WWJ, WIAO, 2XI, 3XW, 9AB, 9AGN, 9BBG, 9BU.

"RADIO TUBES REPAIRED"

Work Guaranteed
W. D. 11 and 12 \$3.25
U. V. 201 A
SIX VOLT TUBES
DETECTORS \$2.75
AMPLIFIERS \$3.00
Radio Tube Laboratories
776 Broad Street Newark, N. J.

PATENTS

promptly procured. Trade Marks designed & registered
FREE INVENTION RECORDING BLANK
Phone Vanderbilt 7212

FREE MANUFACTURERS PATENT CO. INC.
BOOK 520 FIFTH AVE. NEW YORK

Fifty-two issues for \$6.00. Subscription Department, RADIO WORLD, 1493 Broadway, New York City.

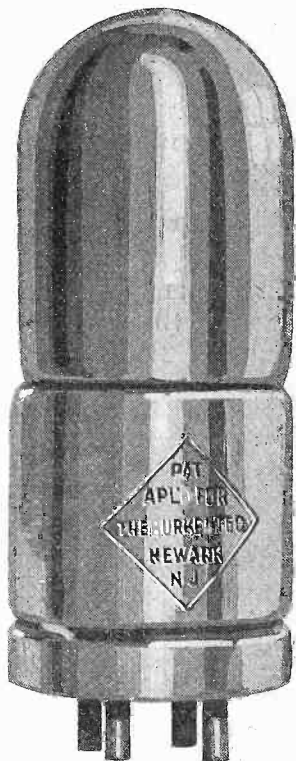

Price \$2.50 Prepaid
Money Order, Check or C. O. D.

SAVE YOUR \$6.50 TUBES AND BATTERIES

FOR LOCAL RECEPTION USE

THE BURKE UNIVERSAL DETECTOR

FITS YOUR TUBE SET

NO CHANGE OF HOOK-UP NECESSARY

REQUIRES NO BATTERIES

CANNOT BURN OUT

TESTED AND GUARANTEED

MAIL ORDERS PROMPTLY FILLED
IF YOUR DEALER DOESN'T CARRY THEM

Address

ACADEMY SALES CO.

924 KINNEY BUILDING

NEWARK, N. J.

¶ "Radio," the San Francisco magazine, is a very excellent publication. We have made arrangements with the publishers by which we are able to offer for a limited time only a six months' subscription for RADIO WORLD at the regular price of \$3.00 and also "Radio" for six months without extra cost.

¶ Send your \$3.00 at once, as this offer is open only until July 30, 1923.

----- CUT OUT AND MAIL TODAY -----

Special Radio World and "Radio" Subscription Blank

RADIO WORLD, 1493 Broadway, New York City.

Enclosed herewith find \$3.00 for which please send RADIO WORLD for six months beginning with issue of and "Radio" for six months, beginning with issue of There is to be no other charge to me.

You may, if you wish, send remittance for \$6.00 and receive RADIO WORLD for one year (52 issues) and "Radio" for one year without extra cost. This offer good only until July 30, 1923.

Name
Street Address
City and State.....

Here's Your Radio Library!

Useful Technical Articles Published in 1922 Issues of RADIO WORLD

See prices at end of this page

APRIL 1.

A 500-Mile Radiophone Employing a 5-Watt Tube, by Frank A. Hahnel.
"Tell Me, Please, How Will This Set Receive?" by E. L. Bragdon.
Short Cuts in Receiver-Circuit Design, by O. C. Roos.
Making a Short-Wave Regenerator, by Fred. Chas. Ehlert.

APRIL 8.

Do You Know Your Receiving Equipment, by James D. Gordon.
Why a Crystal Is Called a Rectifier, by Walter Emmett.
Is Radiotelephony Dependable? by O. C. Roos.
Mounting Crystals in Your Detector, by E. L. Bragdon.
Storage Batteries for Radio, by Fred. Chas. Ehlert.

APRIL 15.

First Principles of Electricity as Applied to Radio, by John P. Miles.
Your Storage Battery, by E. L. Bragdon.
What Makes Radio Possible, by Edward Linwood.
Ground Connection as Vital as Antenna, by Fred. Chas. Ehlert.

APRIL 29.

Valuable Pointers on Aerial Construction, by Edward Linwood.
What Is Meant by Tuning, by E. L. Bragdon.
Radio-Frequency Amplification and Regeneration, by Frank Armstrong.
Honey-Comb Coils and Condensers, by Edward Linwood.
Charging the Storage Battery, by E. L. Bragdon.
How to Construct the Variocoupler, by Frederick J. Rumford.

MAY 6.

The Advantages of Radio Frequency, by Harold S. Potter.
How to Construct, Protect and Operate a Storage Battery, by George W. May.
The Beginner's Catechism, by Edward Linwood.
Tuning and What Is Meant by It, by Fred. Chas. Ehlert.
New Frequency Amplifier Brings Faintest Waves in Strong, by G. W. May.

MAY 13.

My Practical V. T. Detector and Two-Stage Amplifier, by Frederick J. Rumford.
The Principles of Radiotelegraphy, by Walter J. Howell.
The Reason for the Loop Aerial, by George W. May.
Tuning and What Is Meant by It, by E. L. Bragdon.
The Beginner's Catechism, by Edward Linwood.

MAY 27.

The Beginner's Catechism, by Edward Linwood.
How to Make Your Own Condenser, by George W. May.
Tuning as Applied to Telegraphy, by Walter J. Howell.
Why the Condenser Doesn't Condense, by E. L. Bragdon.
Making Signals Louder with Two-Stage Amplifier, by George W. May.

JUNE 3.

The Cost of a Single-Circuit Receiver, by Howell W. Miller.
The Beginner's Catechism, by Edward Linwood.
How to Compute and Build a Fixed Condenser, by E. L. Bragdon.
Design for an Amateur's Receiving Set, by C. White.
Simple Method of Recharging a Storage Battery, by John Grayson.

JUNE 10.

Radio Receiver for Short Waves, by George W. May.
How to Filter Atmospheric Conditions, by C. White.
The Messenger Boys of Broadcasting, by E. L. Bragdon.
Are You a Member of the N. O. D. C.? by E. L. Bragdon.
The Beginner's Catechism, by Edward Linwood.
How to Construct One- and Two-Slide Tuning Coils, by George W. May.

JUNE 17.

The Vacuum Bulb's Start in Life, by C. White.
How to Select the Right Set, by E. L. Bragdon.
The Beginner's Catechism, by Edward Linwood.
Test of Inductance Coils, by Fred. Chas. Ehlert.
Short Waves from a Simple Receiver, by Stanley Bryant.

JULY 1.

Novel Unit-Detector and Amplifier, by Frederick J. Rumford.
Why You Must Use a Condenser, by C. J. Williams.
How Wave Lengths Travel, by Fred. Chas. Ehlert.
Radio World's Revised Dictionary, by Fred. Chas. Ehlert.
The Beginner's Catechism, by Edward Linwood.
Use of the Vacuum Tube Detector, by George W. May.

JULY 8.

Radio's Place in the Phenomena of Nature, by E. L. Bragdon.
The Function of the Loose Coupler, by Charles H. Plath.
Armstrong's Superregenerative Amplifier Fully Explained, by John Kent.
Operating a Transatlantic Station, by Fred. Chas. Ehlert.
The Beginner's Catechism, by Edward Linwood.
Reducing Strays and Static, by Fred. Chas. Ehlert.

JULY 15.

Assembling a Detector and Two-Stage Amplifier, by H. S. Stanford.
Combined Radio and Audio Frequency Amplification, by C. White.
The Beginner's Catechism, by Edward Linwood.
Locating Your Aerial, by Harold Day.
Facts for Beginners, by Fred. Chas. Ehlert.

JULY 22.

When Your "Movies" Come by Radio, by Stanley Bryant.
Underlying Principles of the Vacuum Tube, by George W. May.
Practical V-T Detector Panel, by Frederick J. Rumford.
Revised Radio Dictionary, by Fred. Chas. Ehlert.
The Beginner's Catechism, by Edward Linwood.
Importance of Aerials to Radiation, by C. White.

JULY 29.

The Vacuum Tube as a Transmitter, by Charles H. Plath.
My 20-Kilowatt Tube and its Uses, by Irving Langmuir.
Importance of the Capacity Switch, by E. L. Bragdon.
The Truth about Lamp-Socket Aerials, by Harold R. Hart.

AUGUST 12.

The Work of the Audio-frequency Transformer, by George W. May.
Practical Measurements of Capacity and Inductance, by W. A. Dickson.
Experimenting with Armstrong Circuit Produces Unusual Hook-up, by Dr. O. S. Kelly.
How to Secure Perfect Regeneration, by Fred. Chas. Ehlert.

AUGUST 19.

How to Build a Portable Field Buzzer, by De Witt H. Thompson.
Using Two Tubes for Receiving, by C. White.
The Storage Battery as an Important Factor in Radio Reception, by Donald Van Wyck.
The Use of Capacity in a Circuit, by George W. May.
The Beginner's Catechism, by Edward Linwood.

AUGUST 26.

How to Build a Spider-Web Receiver, by Frederick J. Rumford.
My Detector and One-Step Amplifier, by Fred. Chas. Ehlert.
The Beginner's Catechism, by Edward Linwood.
Hints for Fans, by C. F. Rye.

SEPTEMBER 2.

Generating C-W for Transmission, by C. White.
Wonders of Radio-Frequency Amplification, by H. S. Potter.
How to Connect the Electric-Light Socket Aerial, by John Kent.
Practical Circuits for Regenerating Loud Signals, by O. S. Kelly.

SEPTEMBER 9.

Radio Ideas for the Amateur to Test Out by Carl Masson.
How to Make a Practical Wave-Meter, by Frederick J. Rumford.
How to make a Honey-Comb Coil with a Two-Stage Amplifier, by Fred. Chas. Ehlert.
Perfect Short-Wave Radio-Frequency Amplification, by George W. May.

SEPTEMBER 16.

How to Make a Two-Tube Superregenerator, by Frederick J. Rumford.
Methods of Amplifying Radio Signals, by E. Bradbury.

Voice Distortion in Vacuum-Tube Receivers, by W. A. Dickson.
Charging a Battery—from a French Radiologist's Point of View, by Marius Thouvaia.
Working Diagrams for Beginners.

SEPTEMBER 23, 1922

New V T Hook-up Worth Testing Out, by P. F. Metzler.
New Method for Lighting Filaments, by C. White.
Why the Radio Compass Is the Fighting Element of Science, by Ortherus Gordon.
Complete Table of Symbols Used in Radio Reception, by Fred. Chas. Ehlert.
The Radio Primer, by Edward Linwood.
Complete Method for Building an Electron-Tube Detector Unit, by Experts of the United States Bureau of Standards.

SEPTEMBER 30, 1922

Increasing the Wave Lengths of a Receiving Set, by George W. May.
The Importance of the Variometer to a Receiving Set, by Donald Van Wyck.
Successful Stunts of an Amateur Radiologist, by C. F. Rye.
Employing Jacks with a Two-Stage Amplifying Receiver, by Fred. Chas. Ehlert.

OCTOBER 7.

Superheterodyne Receiver as Applied to the Armstrong Superregenerative Circuit, by Charles R. Leutz.
Constructing a Radio-Frequency Regenerator, by C. White.
Why the Open Antenna Is Best for the Radio Listener, by C. D. Wagoner.
Broadcasting Stations of United States and Canada.
The Radio Primer for the Beginner, by Lynn Brooks.

OCTOBER 14.

Neat Home-Made Tube Socket, by Gordon S. Arthur.
Vessels Now Guided Through Fog by New System of Radiotelegraphy, by Ortherus Gordon.
What Makes the Receiver Work, by Donald Van Dyck.
Using the Variocoupler in a Short-Wave Receiver, by George W. May.
Regenerative V-T Receiver for Short Waves, by Fred. Chas. Ehlert.

OCTOBER 28.

A simple Super-regenerative Receiver, by Harold S. Potter.
Vacuum Type of Arrester Safe, by Fred. Chas. Ehlert.
How to Make Your Aerial Function, by Horace Beers.
How to Avoid Interference When a 360 Meter and a 400 Meter Station Are Operating Simultaneously, by C. W. Horn.

NOVEMBER 4.

Receiver for Amplifying Weak Signals, by Horace Beers.
How to Learn the Code, by Ortherus Gordon.
Detectors—and How They Work, by Donald Van Wyck.

NOVEMBER 18.

Radio Devices You Should Understand, by John Kent.
The Counterpoise, by Frederick J. Rumford.
Changing Inductance and Capacity, by Fred. Chas. Ehlert.
The Importance of Understanding and Testing Radio Apparatus, by C. White.
Operating a Three-Unit Honeycomb Regenerative Receiver, by John Kent.

DECEMBER 9, 1922

Why Radio Frequency Amplifies Signals, by Donald Van Wyck.
Capacitively Coupled Receivers, by A. O. Curtis.
Efficient Crystal Set, by C. H. Plath.
How to Prepare Hard Rubber Sheet for Your Panels, by W. S. Standiford.

DECEMBER 16, 1922

How to Put a Vernier on Your Condensers, by Ortherus Gordon.
A New Three Slide Regenerative Tuner Hook-Up, by R. L. Dougherty.
Factors That Affect the Range of Transmitters, by B. R. Cummings.
New List of Broadcasters Recently Licensed.

DECEMBER 23, 1922

A New Application of the Power Amplifier, by Frederic W. Proctor.
My Simple Inexpensive Receiver, by O. White.

DECEMBER 30, 1922

How to Make a Single-Blade Vernier, by Ortherus Gordon.
Peanut-Tube Hook-ups I Have Used Successfully, by P. F. Metzler.

Any single copy of Radio World, beginning with No. 1, mailed on receipt of 15 cents postpaid. Any seven issues for \$1.00. The above 32 numbers sent for \$4.50. Or send \$6.00 for 1 year (52 numbers) and have your subscription start with any number. Radio World, 1493 Broadway, New York.

"My 'Sunshine' Friend"

TO foster good fellowship, like the hand-clasp of a trusted friend; like the buddies who were comrades in arms; like he who helps when things go wrong—I recommend my 'sunshine' friend — Ridgways Tea."



AWARDED THE HIGHEST HONORS OBTAINABLE

Gold Medal
San Francisco 1915

Grand Prize
San Diego 1916

Ridgways Tea

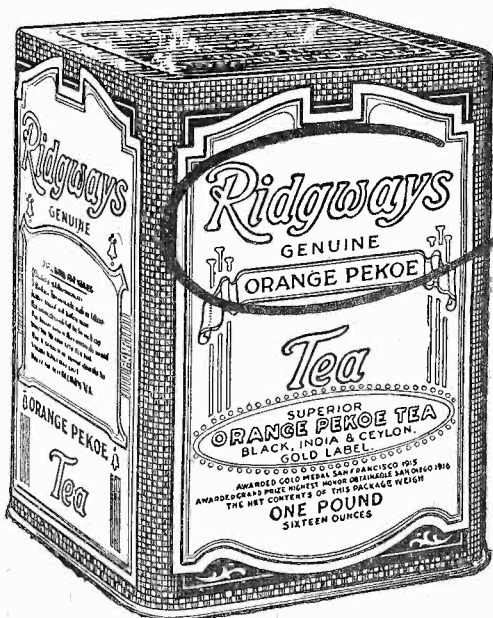

Genuine

Orange Pekoe Tea

Sold in 1 lb., 1/2 lb., 1/4 lb. and 15c Tins

A GENEROUS SAMPLE WILL BE SENT ON REQUEST

Address: Ridgways Tea Co., Dept. B,
60 Warren Street, New York.

The Finest Tea the World Produces

IF YOU ARE INTERESTED IN RADIO YOU NEED THESE BOOKS

Radio Books for Your Vacation

Telling How to Operate a Radio Set—How to Build a Set—Principles of Vacuum Tubes and Other Radio Problems

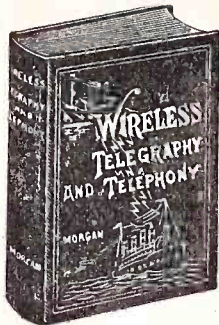

Wireless Telegraphy and Telephony Simply Explained

By ALFRED P. MORGAN

One of the most complete and comprehensive treatises on the subject ever published. A study of its pages will enable one to master all the details of the wireless transmission of messages. The author explains in simple language the theory and practice of wireless telegraphy and telephony. 154 pages, 156 engravings.....PRICE \$1.50

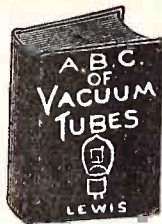

The A B C of Vacuum Tubes Used in Radio Reception

By E. H. LEWIS

Assoc. I. R. E., and Radio Instructor

Written particularly for the person who "knows nothing about radio," but who would like to gain an understanding of the elementary principles of operation of vacuum tubes and various circuits in which they are used for the reception of radio-telegraph signals and radio-telephone music and speech. Illustrated.....PRICE \$1.00

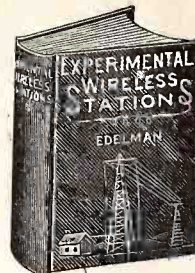

Experimental Wireless Stations

By P. E. EDELMAN

Tells how to make apparatus to not only hear all telephoned and telegraphed radio messages, but also how to make simple equipment that works for transmission over reasonable long distances. Then there is a host of new information included. The first and only book to give you all the recent important radio improvements, some of which have never before been published. 392 pages, 167 illustrations....PRICE \$3.00

☐ The 3 Books for \$5.00 to One or Different Addresses

Any of These Books Sent Prepaid on Receipt of Price

ADDRESS **THE COLUMBIA PRINT**

ROOM 326, NO. 1493 BROADWAY, NEW YORK

Two New and Valuable Radio Helps

Two new and remarkably good radio books by M. B. Sleeper—one is entitled "Six Successful Radio Sets," with design data and instructions for receiving sets specially selected for exceptionally long distance reception. The other is "101 Receiving Circuits," being a most complete compilation of diagrams including circuits for a generative, superregenerative, Reinartz, Flivver, Flewelling, super-heterodyne, reflex and radio frequency sets. Each book mailed on receipt of fifty cents and ten cents extra for postage. Both books for \$1.00 and no extra charge for postage. The Columbia Print, 1493 Broadway, New York City.