

See Valuable Hook-ups Inside

15c. a Copy

April 14

\$6.00 a Year

52 Numbers

1923.

# RADIO

Title Reg. U. S. Pat. Off.

# WORLD

ILLUSTRATED

WEEKLY

WILL TRANSMIT SIMULTANEOUSLY ON TWO WAVE LENGTHS

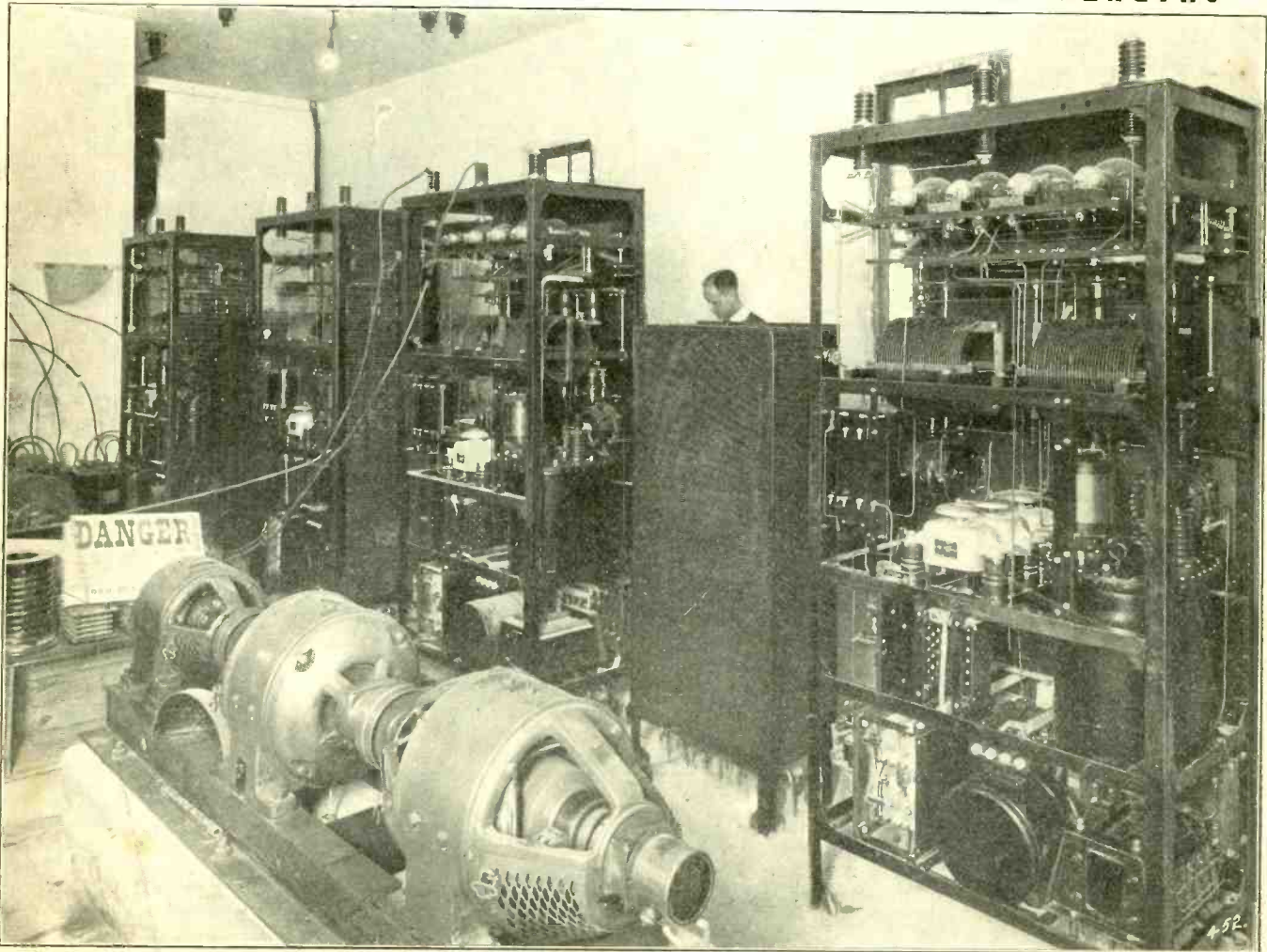

(C. Radio Corporation of America)

The first interior view of the new broadcast station now in process of construction by the Radio Corporation of America atop Aeolian Hall, New York City. This station probably will be in operation early in June

and will make possible simultaneous transmission on two wave lengths. The station is owned and will be operated by the Radio Corporation of America. It is the last word in broadcasting development and equipment.

Any One Can Build the Set Described on Page 4



Your Sincerely

# Greenwich Radio Co.

185 GREENWICH STREET

NEW YORK, N. Y.

**TUBES**  
Western Electric VT 2.....\$8.00

**PHONES**  
Berwick Supreme 2200 Ohms..\$3.45  
Stromberg Carlson .....\$4.95



Moulded Variometers \$2.95  
Loud Speaker \$17.50

**TRANSFORMERS**  
For 1½ Volt Tube.....\$2.95

SEND MONEY-ORDER, INCLUDING POSTAGE—ALL GOODS GUARANTEED

## WILLARD

4/14/23

WILLARD RADIO CO.

Dept. R. W., 291 Broadway, New York

### REINARTZ CIRCUIT

EVERY PART COMPLETE

1 Reinartz wound coil, 1 tube socket, 1 rheostat, 1 23-plate .0005 MFD variable condenser, 1 13-plate .00025 MFD variable condenser, 3 inductance switches, 10 switch points and nuts, 4 switch stops and nuts, 2-3" dials, 8 binding posts, 1 variable grid leak, 1 .002 MFD phone condenser, necessary bus bar wire, 1 high grade RADION panel and diagram and complete instructions.....

**\$10.00**

### FLEWELLING CIRCUIT

EVERY PART COMPLETE

2 honeycomb coils, 1 2-coil mounting, 2 coil plus, 3 .006 condensers, 1 variable grid leak, 1 grid leak, 1 23-plate .0005 MFD variable condenser, 1 Vernier rheostat, 1 tube socket, 8 binding posts, 20 feet bus bar wire, 1 high-grade RADION panel, 1 3" dial and the Radio Digest Booklet on Operation and Construction of Circuit.....

**\$11.00**

### CONDENSERS

3 Plate Variable; value, \$1.75.....\$1.05  
13 Plate Variable; value, \$2.50.....1.20  
23 Plate Variable; value, \$3.50.....1.35  
43 Plate Variable; value \$4.50.....1.85

13 Plate VERNIER; value, \$5.50.....\$3.75  
23 Plate VERNIER; value, \$6.00.....4.00  
43 Plate VERNIER; value, \$6.50.....4.25

Reinartz Coils; value, \$2.50.....1.75

V. T. SOCKETS—Nickel brass sleeve, composition base; value, \$1.00; special at.....50

Ball Bearing Inductance switch; value, 75c; special at.....30

Honeycomb Coils, 50 turns, mounted...95  
Honeycomb Coils, 75 turns, mounted...1.00

Double Coil Mountings.....2.45  
Triple Coil Mountings.....3.35

Audio-Freq. Transformers.....2.75

FILAMENT RHEOSTAT — Condensite base; value, \$1.10; special at.....70

FILAMENT RHEOSTAT with 2½" dial; value, \$1.50; special at.....85c

Potentiometer with knob; value \$1.75; special at.....1.00

Potentiometer with 2½" dial; value, \$2.15; special at.....1.15

BEST QUALITY JACKS, Single circuit; value, 65c; special at.....30  
Double circuit; value, 90c; special at.....45

VARIOCOUPLER — Celeron condensite and Litz Wire wound secondary; value \$4.50; special.....3.25

THREE-INCH DIALS—Unbreakable—heat resisting composition—high finish; special.....30

TWO-INCH DIALS—Same design—for rheostats and potentiometer; special...25

EXTRA SPECIAL — Telephone 3000 Ohms Headsets; \$9.00 value; reduced to.....3.50

RAYMOND VERNIER RHEOSTATS — Value, \$1.50; special.....95

Aluminum Loud Speaking Horn—Nickel Plated; list \$8.00.....3.75

Write for our Catalog No. 7 illustrating and describing all our products.

Every article advertised above is guaranteed both by the manufacturer and by us—Mail orders filled immediately—transportation PREPAID on all orders of \$5.00 or over east of the Mississippi River. All others include postage.

## De Forest Radio Control Sold to Detroit Auto Interests

President Charles Gilbert, of the De Forest Radio Telephone & Telegraph Co., Jersey City, N. J., announced on April 6 that a controlling interest in the company had been sold to a group including Edward T. Jewett of the Paige Motor Car Company, Frank W. Blair, President of the Union Trust Company of Detroit; A. C. Allyn, president, and Theodore Luce, vice-president, of A. C. Allyn & Co., bankers, of Chicago and New York, and William H. Priess, inventor of the Priess circuit used in the De Forest reflex set. In a statement Mr. Gilbert said:

"Certain automobile interests who realize the rapid growth and the strong position of the De Forest company through the ownership of the De Forest audion patents, recently became interested in radio as an attractive field for future development, and opened negotiations for the purchase of this controlling interest. As a result there will be a material increase in the cash capital and the resources of the De Forest company, which will enable it greatly to extend its present field of operation. The new company will retain the services of Dr. Lee De Forest for a period of ten years as consulting engineer, with the rights to his radio inventions during that period. The De Forest audion and other basic patents owned by the De Forest company are used by the American Telephone and Telegraph Company, the Radio Corporation, the General Electric Company and the Westinghouse Company. De Forest patents have been used in transcontinental telephony and transoceanic radio."

## President Obregon Receives Spanish Concert from United States

President Obregon of Mexico listened in for the first time to a radio concert in Spanish broadcast from Station KSD of the St. Louis "Post Dispatch," in St. Louis, Mo. The President and the "Lady of the Land" were delighted with the results. So much so that they decided to equip Mexican White House with two R. C. Type Westinghouse receivers of American make.

Reduces Static to a Minimum



## Good Bye Aerials!

USE

## Short Cut Antenna

An ingenious device that takes the place of aerials, loops, electric light plugs, etc.

Postpaid, Anywhere, for \$5.00

Satisfaction Guaranteed

## Short Cut Radio Corp.

243 West 54th St. New York

## TUBES REPAIRED

### WD-11

\$3.50 AND POSTAGE

and other Vacuum Tubes, such as U. V. 200, U. V. 201, U. V. 201A Repaired and Guaranteed.

(No V. T. 1 or V. T. 2)

Mail Orders Solicited and Promptly Attended To.

## H. & H. RADIO CO.

512 Clinton Ave. Newark, N. J.

## RADIO BROADCASTING MAP

FOR the benefit of those interested in Radio and those who are becoming interested, Rand McNally & Company have prepared a publication containing a wealth of information of greatest value. It shows in the most comprehensive way, the location of the broadcasting stations, gives their classification, the call letters, wave lengths, ownership, etc., of each. Everyone who wishes to get the maximum pleasure and enjoyment from Radio should have a Rand McNally Radio Map of United States. It is complete, accurate and up-to-date. The Rand McNally Radio Map of United States is 24x30 inches in size. The locations of broadcasting stations are shown by distinctive symbols. The call letters of each station are given, also the wave lengths of each. The Radio Districts with numbers are shown in red and the Radio Relay Divisions are in blue. Time zones are included. Alphabetical lists of stations and alphabetical lists of call letters are in the margins. Convenient pocket form with cover.

Price 35c Each

### THE COLUMBIA PRINT

1493 BROADWAY NEW YORK CITY

Use an ELECTRAD DIODE TUBE and get real results. Tube and socket, Special Price..... **\$2.50**

**PHONES**  
\$8.00 Brandes Superior Phones.....\$5.95  
\$8.00 Federal Phones.....5.25  
\$5.50 Murdock Phones, 3000 Ohms.....4.35  
\$5.50 Rice Phones, 3000 Ohms.....4.35  
\$12.00 Baldwin Phones.....8.95  
\$6.00 Single Baldwin.....4.50

Acme Transformer.....\$3.95  
Bakelite Sockets......59  
Cortlandt Special Sockets......39  
Rheostat Special......49

**TUBES**  
\$6.50 DeForest Detector and Amplifier...\$5.95  
\$6.50 U. V. 201.....5.95  
\$6.50 Cunningham 301.....5.75  
1½-Volt Tube, guaranteed.....4.75

\$5.00 Fischer Variometer.....\$2.10  
\$5.00 Fischer Variocoupler.....2.10  
23 Plate Variable Condenser.....1.85  
43 Plate Variable Condenser.....2.35  
W.D. 11 Transformer.....3.45

## Cortlandt Radio Co., 80 Cortlandt Street, New York City

Mail Orders Promptly Filled—Include Postage and Money Order



VOLUME THREE OF  
**RADIO WORLD**

[Entered as second-class matter, March 28, 1922, at the Post Office at New York, N. Y., under the Act of March 3, 1879]

A Weekly Journal, Published Every Wednesday and Dated Saturday, by Hennessy Radio Publications Corporation from Publication Office, 1493 Broadway, New York, N. Y. Telephone: Bryant 4796.

Vol. III, No. 3. Whole No. 55

April 14, 1923

15c. per copy, \$6.00 a year

## Neat and Efficient Amateur CW Station

*By Ray Bright*



(C. Photonews, N. Y.)

R. L. Koerner's long distance station 2CRQ, New York City

**T**HOSE of you who listen in for DX CW will recognize the call of 2 CRQ, the station of R. L. Koerner, New York City. That is, of course, if you live within 1,500 miles of New York and own anything outside of a crystal set. Well, now that you have heard about the record of this 10-watt station, you are privileged to take a peek at it as well as the owner of the station.

Of course, the most interesting part of the station is the transmitter, which is located directly over the Reinartz receiver on the left of the picture. It is a two tube outfit, with an output of 10 watts. Two 20-watt kenotron rectifiers are used to supply the plate voltage. The Heising system of modulation is employed and the transmitter can be used either for phone, when one tube is used as an oscillator and one as a modulator, or for CW when both tubes are used as oscillators. With special reference to the transmitter, it will be seen that there are three meters used. The one on the extreme left is a milliammeter, used in the plate circuit. On the right is a voltmeter to check

up on the filament current, while above the transmitter is the thermo-couple radiation meter to allow a check on the current being radiated. As seen in the illustration there are two receiving sets used in the station. The one directly under the transmitter is the well known and widely used Reinartz circuit. By close reference to the picture it can be seen that it is connected to an outside amplifier from which the loud speaker is supplied. The other is a long wave receiver, with two stages of amplification.

It is interesting to note the remarkable strides that have been taken in the design and operation of amateur stations in the past few years. It used to be that in order to even have your station noticed you had to have rotary gaps and OT's sprawled all around the room, threatening to electrocute anybody who didn't sit right in the plum center of his chair. Now, with apparatus such as shown, 1,500 to 3,000 miles is an everyday occurrence. Such a thing as being heard in France and England has lost even its original thrill, and is looked upon as ordinary procedure.

# "Build Me!" Cries This New Two-Unit Receiver

By Arthur S. Gordon

A RADIO receiving set which will challenge the interest of all radio amateurs is the one-step amplifier described in the present article. It is so clearly designed that the veriest novice need not hesitate to build it according to plans. The set is extremely handsome, its initial cost is moderate and its upkeep, because of the dry cell tubes used, is negligible.

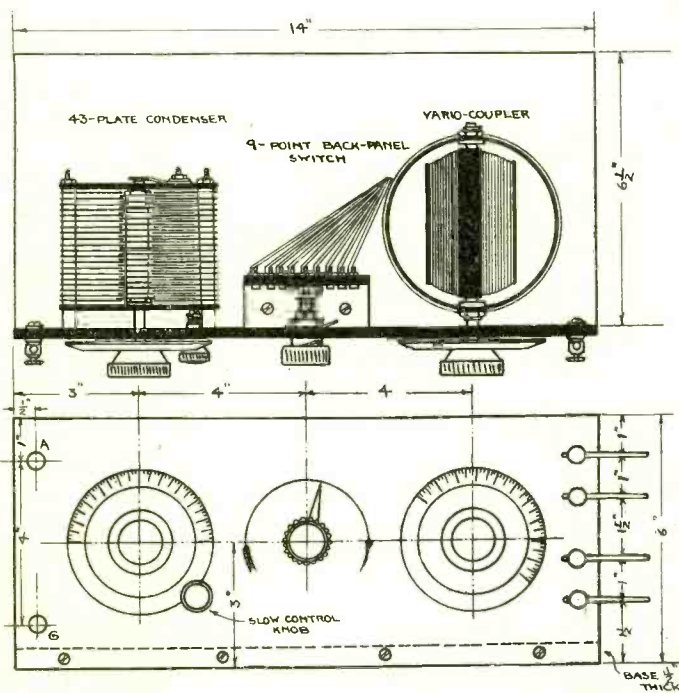

Fig. 1. First section of the two-unit set. This is only the tuning apparatus. The detector and amplification panel are separate.

The coils include all the new broadcasting wave lengths from 200 to 600 meters, with enough inductance to spare for a slight emergency. The receiver is made in two somewhat unusual units which are joined together by four connecting wires to make the arrangement complete. The first unit is called the tuning unit. It consists of a variable condenser, a variocoupler, and a back-panel switch for varying the number of turns on the primary on the variocoupler. The second unit—the electron unit—consists of the tubes, rheostats, telephone jacks, the grid-leak condenser and the audio-frequency transformer.

This is not the usual arrangement, but it has the charm of being distinctive as well as entirely logical. Briefly its advantages are these: The electron unit is perhaps the one that will remain the same as long as the amateur uses dry cell tubes. It is, in a sense, a detached portion of the receiver, having a form of permanency that the other portion does not have. For styles and ideas in tuning devices often change, and it is altogether possible that the amateur may later wish to install another standard type of coupler. It may even be the case that a tuning device of his own design needs trying out. All this will necessitate an almost complete re-building of the tuning unit. In such a case, the electron unit may be disconnected and removed from the scene of replacement, ready at any moment to be reconnected to any combination of tuning devices the amateur decides to install.

The hook-up used is the justly famous single circuit Armstrong regenerative, using the rotor, or movable coil of the variocoupler, as a feed-back inductance. This circuit has been proved and tried in a thousand different ways. It is the basic circuit from which amateurs begin a fascinating career of experimentation. The popularity of this circuit is an adage, and this, combined with its truly remarkable results, make it ideal for the radio beginner. Be neither timid nor alarmed because of the extra tube. One stage of amplification is not only desirable, but inevitable; and this article will explain fully the necessary steps for its complete installation.

## The Tuning Unit

The first section of this receiver is called the tuning unit because in it are included only those instruments necessary for bringing in or tuning out a station. It consists of three instruments. They are mounted on a panel from left to right in the order named: Variable condenser, inductance switch and variocoupler. Fig. 1 shows the exceptionally neat arrangement with all the elements drawn to scale. The variable condenser is any standard 43 plate condenser, with or without a vernier attachment. A vernier is an extra device which permits of very fine adjustment and should the prospective builder buy, or already have, a condenser that is not fitted with such a device, it is recommended that a minute control knob be fitted to the dial of the condenser, in order that very slight variations may be secured. Such a knob is shown in place in Fig. 1. It may be bought very cheaply at any radio store.

The inductance switch is a back-panel device with nine switchpoints, each going to a tap in the primary winding of the variocoupler. These switchpoints are mounted in the usual semi-circle on a separate piece of bakelite, which stands 5 inches high and 3 inches in a vertical position one inch to the rear of the panel.

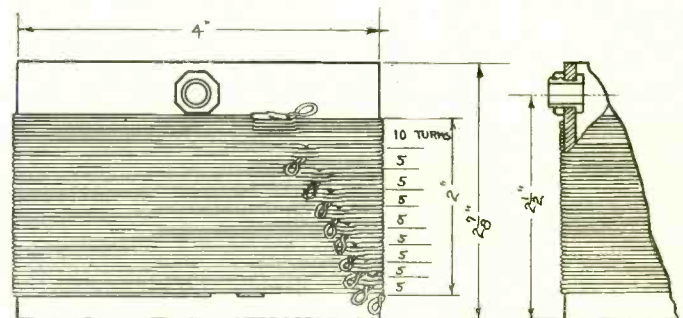

Fig. 2. Detailed sketch of the primary of the coupler, showing the manner in which taps are to be taken. If a fibre tube is used to wind the coil, the brass bushing will be unnecessary.

They are connected with the taps on the coils by straight pieces of bare copper wire or bus bar. The switch is controlled from the face of the panel by a standard switch knob, which is changed over a trifle so that its arm is in the rear instead of in the front of the panel.

The variocoupler is of a favorite type and is selected for use in this set because of its extreme ease of construction. There are other more intricate ways of making variocouplers, and there are other forms of

(Continued on next page)



(Continued from preceding page)

tuning devices; in fact, so many that the prospective builder is bewildered as to which is the best. Nothing is claimed for this particular tuner that is not claimed for others, excepting that it has been designed to receive on the increased number of wave lengths now released for broadcasting work. The number of turns have been closely figured out so that there is a minimum of dead end effect, which is a detrimental element caused by the proximity of the unused portion of the coil to that portion which is at that moment in tune with the incoming signals. It is extremely selective, as many as six different stations being received with

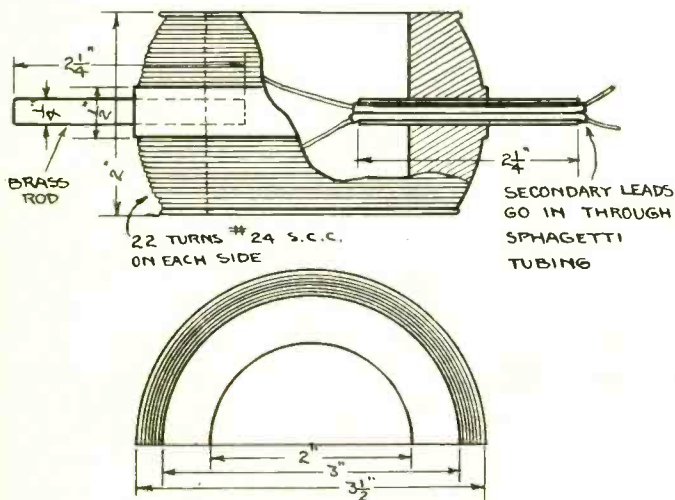

Fig. 3. The rotor of the coupler. The leads are brought out through the hollow tubing, eliminating copper-braided "pigtail" connectors.

one-half turn of the rotor, the condenser remaining untouched at the time.

The two coils of the coupler are the primary and the secondary, the last mentioned being in this case the tickler coil as well. The primary is wound on a 4-inch cardboard or bakelite tube with 50 turns of No. 22 s. c. c. copper wire. There are nine taps taken from the coil, the first being after the initial ten turns, the others in succession every five turns thereafter. The beginning of the coil is also twisted into tap form, and later connected to the aerial binding post. The holes for the shaft on which the secondary revolves, are drilled 2 1/2 inches from the bottom of the winding. They should be large enough, in the case of a cardboard tube, to take some sort of brass or fibre bushing, as

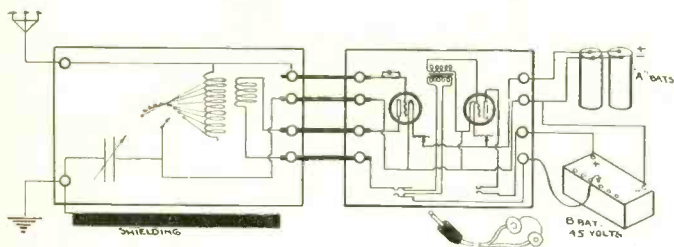

Fig. 4. Schematic diagram illustrating the wiring of the two units. Looks intricate, but is easy when you study it awhile.

shown in the detailed sketch of the primary, Fig. 2. A bakelite tube does not need this bearing surface.

The movable coil is wound either on a ball or on a cardboard tube. Forty-four turns of No. 24 s. c. c. copper wire are required, 22 turns to go on each side of the spindle hole. The spindle, or shaft, on which the rotor turns is of two separate pieces, one of which must be brass or copper tubing. It is through this tubing that the secondary leads come out into the remainder of the circuit. Fig. 3, which is a detailed sketch of the rotor, shows this clearly.

In winding the secondary on a ball, there is an unavoidable break in the wire at the center of the form, where the turns cross over from one side to the other. Starting at any side of the rotor, it is easy enough to wind the 22 turns uphill, but when it comes to crossing over and winding the next 22 turns downhill, the trouble begins. If you cross immediately to the outer edge and begin the second half of the winding as you did the first, you disturb the continuous flow of current through the coil. The only way to do is to start separate windings at each edge, and join the two inside ends at the center of the ball, either inside or outside the form. Be sure that the turns on both sides of the rotor are wound in the same direction.

The assembly of the tuning unit is indicated in Fig. 1. The panel on which the instruments are mounted is 14 inches by 6 inches high. It is of hard rubber or composition board, is lined with tinfoil on its inside face, and is fastened to a wooden base 14 inches long by 6 1/2 inches wide. The tinfoil is to eliminate the disturbing effects of an annoyance known as "body capacity." The foil is cut away at various places so that it does not touch any instrument or part of an instrument. It is cut away from the binding posts and no wires are allowed to touch it. The only connection it has with the remainder of the set is a tinfoil lug which connects the shield with the ground binding post of the panel. Without this connection, the purpose of the shield would be nullified.

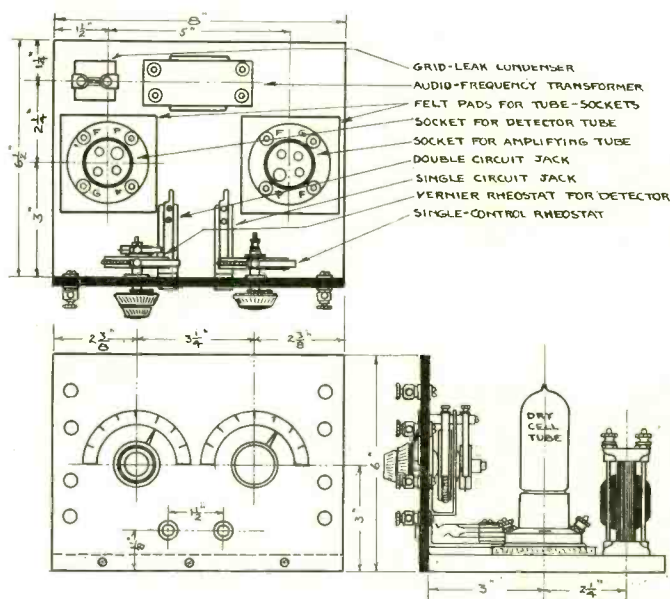

Fig. 5. The detector-amplifier unit, showing arrangement of instruments, as well as dimensions for duplicating the layout.

There are six binding posts on the face of the panel. One each for the aerial and ground on the left edge, and four others on the right edge. These four are the terminals of the tuning unit, and connect with a corresponding four on the left edge of the electron unit. The inside wiring for the tuning unit is shown in Fig. 4, which also continues the hook-up into the second section of this interesting receiver.

### The Electron Unit

This unit will appear to the uninitiated to be almost hopelessly intricate. Such is not the case, and after you have read the following explanation and carefully examined Fig. 5, which is an assembly drawing of the electron unit, you will have no difficulty in constructing this particular part of the set. Read slowly and take in every word of the description.

There are two tubes used in this set, both of which  
(Continued on next page)



## Why Do You Read Radio World?

The number of readers of RADIO WORLD has increased so appreciably during the past few months and there has been such a renewed demand for the paper on the newsstands in New York City and throughout the entire country that the editor is curious to know what particular features of RADIO WORLD appeal to this big army of readers.

Will you drop us a postal and let us know what you like most in RADIO WORLD?

Every publisher must work hand in hand with every reader of his paper in order to know just how and why his publication is making a hit.

Will you let us know why you read RADIO WORLD?

Address The Editor, RADIO WORLD, 1493 Broadway, New York City.

*(Continued from preceding page)*

are dry cell tubes, which do not need a storage battery for their operation. One tube is the detector of radio signals, while the other is the amplifier of those signals. The tubes are exactly alike in mechanical construction, differing only in the use to which they are put. For this use, they are interchangeable. The filament of the detector tube is fed with electricity by means of a vernier rheostat, which permits very gradual increase or decrease of current. A fine adjustment of this nature is necessary for the most efficient operation of the dry cell tube because, when used as a detector, its filament demands are very "fussy." On the other hand, however, a single control rheostat is used in connection with the filament of the amplifying tube, for it has been proved by practice that a close control here is not necessary.

These two rheostats are mounted on the front of the panel so that they occupy the central position. Beneath them are two telephone jacks, the one at the left, underneath the vernier rheostat, being a double-circuit affair, so constructed that when the telephone plug is inserted it automatically cuts out the amplifying tube. The receiver then operates on the detector tube alone. When the telephone plug is withdrawn from the double-circuit device and placed in the other jack, the amplifier gets in the circuit again, and the complete receiver does its utmost.

There are two other instruments left unexplained—the grid-leak condenser and the audio-frequency transformer. The grid-leak condenser, while a small instrument, is a very important part of the set. It is really a combination of two separate instruments, as its name indicates. Both these instruments, the condenser and the grid-leak, are subject to variations according to the particular tube used as a detector, and for this reason, no set value of either capacity or resistance can be given. The proper values can only be hit upon by experimentation. Perhaps a fixed condenser of .00025 mfd. and a variable grid-leak having a range of from one to five megohms, is the best possible combination. An instrument containing these values can be readily purchased.

The audio-frequency transformer is a matter of choice. There are six or seven types on the market which have been designed especially for use with the dry cell tube. These are, of course, the latest design in transformer construction embodying refinements and improvements not found in earlier models. For this reason these especially constructed instruments are recommended. In buying an audio-frequency transformer ask for and get the very best of its kind. It

may cost a little more, but the superior results are worth it.

Mounting all these instruments on the panel and baseboard of the electron unit is a simple matter. The arrangement shown in Fig. 5 is not only extremely neat and symmetrical, but is also expertly designed to give the utmost volume without a quiver of distortion. There are no tube and amplifier noises to this set, excepting those caused by excessive regeneration, which are eliminated by turning down the rheostats. Note that the tube sockets are glued to square pieces of felt, which in turn are glued to the baseboard. These pads, about 1/2-inch thick, take up the shocks due to knocks and bumps and also eliminate the annoying metallic sounds which would otherwise come from the dry cell tube. To aid this elimination, the wires going to the four binding posts of the tube socket are of flexible material.

The back-panel wiring, while honestly intricate, is not beyond the ability of the modestly ambitious amateur. Fig. 4 gives the hook-up as adapted to the construction of the electron unit, showing eight binding posts on the face of the panel, four of which connect the unit to the tuning panel, while the other four are for the two batteries, the "A" and the "B." The "A" battery consists of two No. 6 dry cells connected in parallel as shown so that their combined output does not exceed 1 1/2 volts. The "B" battery is a 45 volt cell with the usual taps for varying the output. The entire "B" battery current is used in the plate circuit of the amplifier, but the amount which goes into the plate circuit of the detector is varied by a flexible wire which comes from the lowest of the four battery binding posts and goes to the taps of the "B" battery as required.

As an aid in tracing the connections the entire hook-up is given in Fig. 6. In this form it is perhaps more familiar to the reader. To make it more so to those who may not know offhand the radio symbols, the names of the various instruments are given along with the conventional signs.

### Now for Results!

The particular set described above was made for Mr. Harold Slater, of Fall River, Mass. With a single wire aerial eighty feet long and thirty feet high, he received consistently all stations within the area bounded by a circle drawn through Kansas City, Mo., and Havana,

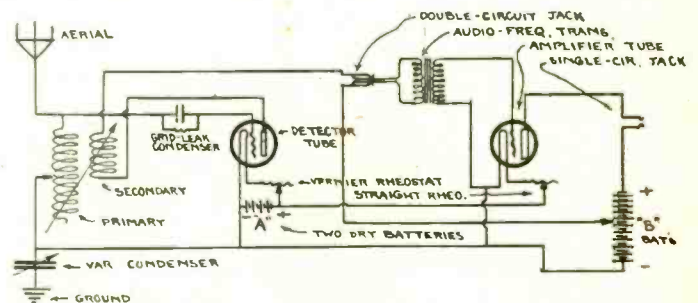

Fig. 6. Hook-up used in the set described in the accompanying article. It is highly selective as well as simple to operate.

Cuba. The range of this set, therefore, is approximately 1,500 miles, enough to reach half-way across the continent from either coast. The volume with which stations not over 500 miles distant were received made it possible to use a horn, a conch-shell, or a small megaphone for loud speaking, attached of course directly to the phones. With such an arrangement music could be heard plainly across a 30-foot room. These results are yours for the trouble—or the fun—of building a duplicate of Mr. Slater's neat and efficient outfit.



## "Iowa" is Dead, But Radio Control Secrets Live

**T**HE U. S. S. "Iowa," first radio controlled battleship in the world, went to a gallant death last week in the deep reaches of Panama Bay, sunk by gunfire from her younger but more powerful sister, the U. S. S. "Mississippi." Her flag was not flying—naval guns are never trained on the flag—though she was still an American vessel designated as Coast Battleship No. 4. She was sacrificed in the interests of radio control and naval gunnery.

Her loss amounts to nothing, however, compared with the results of the radio control experiments carried out successfully, and although she carried some valuable and confidential radio control instruments, the radio experts of the navy say no secrets were lost. They had learned all that was possible about controlling the old battleship, so she was turned over to the gunnery and ordnance experts as a mobile target.

Within a short time another ship could be fitted with radio control, and it is understood that many improvements are planned. Rumor has it that one of the laid-up destroyers will probably soon be assigned for radio control experiments and equipped with highly improved apparatus. But which of these fast scouts of the navy will be used has not been decided. Only the allotment of funds and a month or two of time are needed, it is understood. Radio equipment is ready awaiting assembly and installation. By equipping for radio control a high-speed vessel, capable of making at least twenty knots excellent practice could be given the gunners of the navy, it is claimed. The ship would be controlled from a mother craft by radio and maneuvered while under fire.



(Navy Official Photograph)

The U. S. S. "CB4," first radio controlled man-of-war, formerly U. S. S. "Iowa," sunk during naval maneuvers in Panama Bay.

## Washington Gets RCA Broadcasting Station

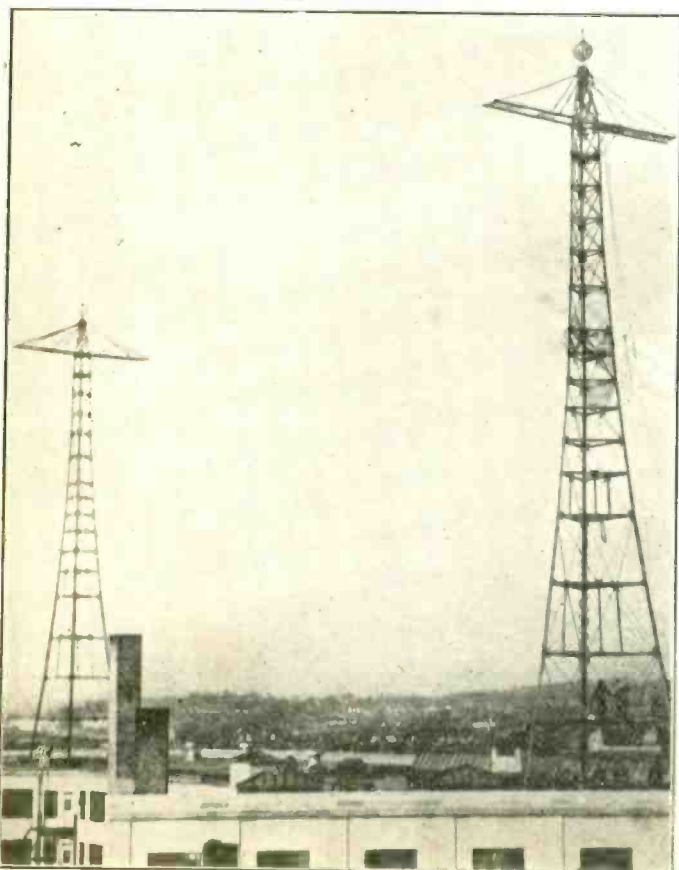

(C. International Newsreel)

New Washington, D. C., Broadcasting Towers.

**P**RACTICALLY the whole continent will be able to hear a new broadcasting call, as yet unassigned, when the RCA station at Washington, D. C., opens up in June. Other than that the station will be of the highest order and latest type, the Radio Corporation refuses to state. Judging from rumors, however, its voice should reach to every corner of the country as well as some of the insular possessions. The new station is located at 14th Street and Park Road known in Washington as Mount Pleasant.

Through the co-operation of the Riggs National Bank and Chas. H. Tompkins, two one-hundred foot fabricated steel towers have been erected on the roofs of the Riggs and Tompkins Buildings in the highest section of Washington where they will serve as new and modern landmarks for the Capital.

The towers have a slight curvature which will give them somewhat the appearance of small Eiffel towers. Their construction is unusual, in that they have three legs instead of the customary four. This reduces wind resistance and makes for stability. A thirty-six foot cross-arm near the top of each tower supports four antenna wires each twelve feet apart. The distance between the towers is 220 feet and the effective radiating length of the antennae 160 feet.

The studio, the reception, transmitting and apparatus rooms are on the second floor of the building. Two motor-generator units will insure an adequate power supply and two tube transmitters will make possible flexible, smooth running programs. It is hoped that the station will be in operation and ready to serve Washington and the surrounding territory within two months.

# Telephone Type Condensers of Large Size

By C. White, Consulting Engineer

THE recent development of reflex and other more advanced types of circuits has required the use of rather larger size condensers. Previously the amateur radio fan has been concerned only with condensers up to .006 micro-farads as a very large size. The employment of .25 and .5 condensers was practically unknown for the average use in receiving apparatus until the desirability of confining audio- and radio-frequency currents to certain parts of the circuit and prevent them from wandering where they were of

condenser depends. It can be noticed that as we increase S, the plate area, the capacity will be directly increased, and likewise as the number of plates is increased the capacity increases. But as we increase the thickness of the dielectric or insulation D, the capacity becomes less. Then it is quite evident that to obtain a high capacity the thickness of the insulation should be as small as possible, the dielectric constant K should be large, the number of plates should be a maximum, and the area S of one side of a plate must be augmented, until the desired size is obtained. The values of the terms in the equation are in inches and square inches.

Now, for example, let us take the design of a particular size of condenser and run through the complete analysis. Say that it is desired to construct a .25 microfarad condenser. The first thing necessary is to choose the kind of dielectric or insulation to be used, its thickness, the size of the plates, and then from the formula we can easily substitute and determine the number of plates or layers the condenser must have in order to give the wanted capacity. Mica is the ideal substance to use for an insulator, but owing to its high cost it is almost prohibitive. A mica insulated condenser of high capacity, such as 1.0 microfarad, would cost about \$15 or more. Hence we must use another substance which is not so good electrically, but less expensive and still capable of serving the purpose. Such a substance is oiled or paraffined paper. This paper can be prepared from a sheet of ordinary heavy tissue paper which is dipped in hot paraffine and allowed to dry. It will be necessary to use two sheets of paraffined tissue paper between two adjacent plates owing to the thinness of one sheet. For plates, thin tinfoil can be used. The

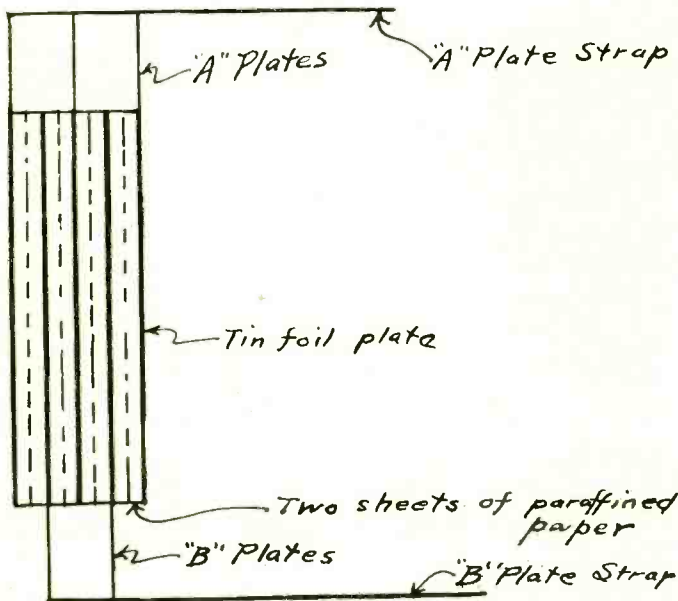

Fig. 1. Diagram showing general method of construction in "piling up" a condenser.

little or no value to the working of the circuit was apparent. In other words, these large condensers are only used as by-pass condensers and not for tuning. Owing to the fact that their employment in amateur radio reception is quite recent it is difficult to obtain them from the ordinary radio dealer; but within a short time I am confident that a .5 mfd. condenser will be as easy to get as a .006. In telephone work, however, the use of relatively large capacities has been constantly practiced since the earliest days of telephone application.

It is an almost common belief that the capacity of a condenser is solely dependent upon the number of plates. This is quite wrong, because the thickness of the insulation and the quality of the insulation are equally as important factors. It is possible to purchase a 43 plate condenser that has less capacity than another 23 plate size. The formula for the design of a condenser is as follows:

$$C = \frac{2.25 \times K \times S \times (N-1)}{10,000,000 \times D}$$

Where: C is the capacity in microfarads desired.  
S the area of one side of a plate.  
N the total number of plates.  
D the thickness of insulation between two adjacent plates.  
K the dielectric constant for the insulation used.

From the above formula it is at once apparent upon which factors the capacity of the parallel plate type of

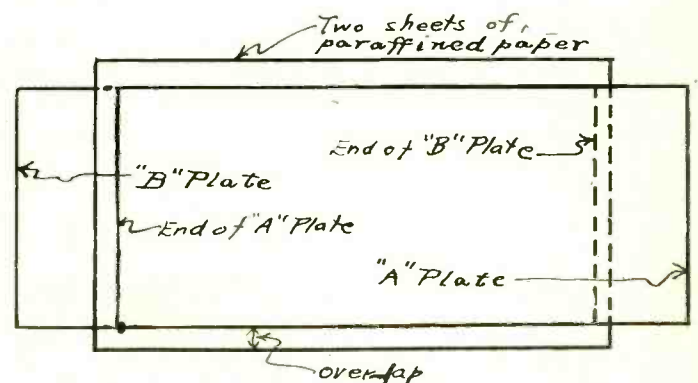

Fig. 2. General idea of how the tinfoil and wax paper should be cut and placed in making a condenser.

dielectric constant, K, for paper so treated is about 2.5. The next factor to determine is the size of plate, S. If S be small then the condenser will require more layers, so it is advisable to choose a size which will make the most convenient size condenser. A good choice would be about 2 by 4 inches for effective or contact area with the insulation. Of course, the actual size of the tinfoil sheets should be two by 4½ inches in order to allow enough tinfoil overhanging to strap the A and B groups together as illustrated in Fig. 1. Now let us substitute in the formula and solve for N, the number of layers or plates. K is 2.5 for paraffined paper; S we have chosen as 8 square inches; and D, for two sheets of the treated paper is .002 inches. Solving for N we find that 111 sheets of tinfoil are necessary.

(Continued on next page)



# A Remarkably Simple, Efficient and Flexible Receiving Set

By Robert L. Dougherty

**W**HEN a man designs a set he tries to accomplish three important things in his construction. The first is efficiency, the second is simplicity, and the third is flexibility. If he can make a set embodying all of these he is perfectly satisfied with himself and also with his results.

A set that embodies all these fine points, as well as quite a few others, was recently built by A. S. Mawhinney, 801 Riverside Drive, New York City. The set itself at first glance would seem to be the conventional three unit honeycomb coil receiver, but upon further inspection, quite a number of novel features assert themselves.

One of the remarkable points of this set is its absolute absence from capacity squeals and howls, and even thought regeneration is used, the coils and condensers can be handled without fear of even detuning distance stations which is an accomplishment in itself.

The set proper when analyzed for flexibility, is really three sets in one, all controlled by means of a single switch. First, it is an extremely efficient three-unit honeycomb regenerative set, which can be used with aerial and ground. With this phase, two steps of audio-frequency can be used. Next, by means of the switch shown in the illustration herewith next to the right hand condenser dial, one can throw on two stages of radio-frequency and use either antenna and ground, with regeneration, or a loop. Then last but not least, it can be used as a triple loop circuit set, by simply removing the honeycomb coils, and plugging in a special loop. The remarkable ease with which any of these circuits are used, and also the remarkable efficiency with which it works, make it a wonderful set.

In the March 24th issue of RADIO WORLD, on page 11, under the heading of "A Fire Escape Antenna" an illustration of the inside of this set was shown. By referring to the picture, it will be seen that five tubes are used. The anti-capacity switch is located directly under the first tube and next to the condenser, and permits either detector and audio-frequency, or radio-frequency, detector and two stages of audio.

Over 112 stations have been copied with this set, using a loop antenna and as is the habit of the builder, phones are taboo, the loud speaker being used exclusively. All long distance reception has been verified

by telegram. The furthest reception is Los Angeles, which has been heard clearly on the loud speaker, and a telegram testifies to the fact that the reception was not just a freak, as it has been done numerous times.

Another remarkable feature of the set, and one that is important is the fact that although five tubes are used, there are only 45 volts used on the plates, and although 60 to 100 can be used, it functions efficiently on 45. The Los Angeles reception was accomplished on that plate voltage. In combining radio-frequency with regeneration, it is remarkably quiet, and there is

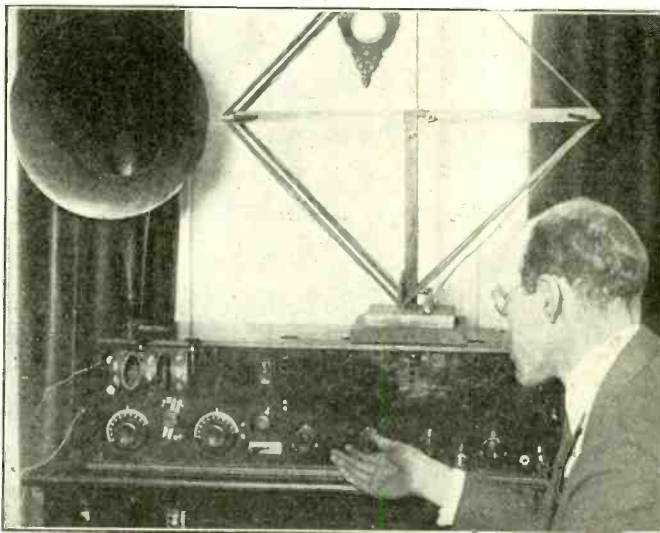

(C. Kadel and Herbert)

A. S. Mawhinney operating the set on which he heard Los Angeles, Cal., from New York City.

a brilliance to the signals that is startling. The reception is entirely free from tube noises, such as crackling, squealing and howls, which is due to the method of hooking up the transformers, and also the method of mounting them on the sub-panel.

When a man can construct a set that is flexibility itself, free from all capacity howls, (you can't make this set howl except by turning the filaments up too bright), and is as efficient as this one is, he truly can say that he has accomplished his aim.

(Continued from preceding page)

But, for average use, it would be close enough to build the condenser by placing on layers until the whole condenser has reached a certain thickness. With thin tinfoil about .0005 inches in thickness, the whole condenser would have to be built up until about ¼-inch thick.

The actual construction data is as follows: Cut 2 ¾ by 4 ¼-inch strips from a sheet of the prepared paper, and cut 2 by 4 ½ strips of tinfoil. Start laying the condenser as shown in Fig. 2, taking especial care throughout the construction to see that in no place do the A and B groups of plates touch each other. The paper should be allowed to overlap the two sides of the plates that are not used for the connecting straps so as to prevent short circuiting two adjacent plates or sheets of tinfoil. Start with a sheet of tinfoil, then two sheets of paper, then another sheet of foil of the B group—

that is, with the end hanging over on the other side. About every third tinfoil sheet it is advisable to roll or press the excess paraffine out of the paper by means of a rolling pin or similar object. After the desired thickness has been reached, the condenser can be made rigid by placing two sheets of heavy cardboard on end side and tying the same tight, thus keeping the condenser pressed together. After the plates are strapped together, thus forming the A and B groups, the whole condenser can be placed in a paper or wooden box which can be filled with paraffine to keep moisture out.

If it is desired to construct a condenser four times larger than the one just described it is only necessary to lay plates and paper until four times the thickness has been attained. If it is desired to make one only one-tenth as large the thickness should only be about one-tenth the size of the .25 mfd. condenser. Other sizes can be made in similar proportions.



## Second Radio Conference Recommendations Accepted by Secretary Hoover

**S**ECRETARY HERBERT HOOVER, of the Department of Commerce, last week issued the following official statement which is of great importance to all radio users and enthusiasts:

The recommendations by the Radio Conference represent a step in ideal development of measures for the prevention of interference in public broadcasting.

The report recommends making available all wave lengths from 222 to 545 meters for public broadcasting, the various possible bands to be assigned to different stations so as not only to reduce direct interference but also to build up zonal regions of distribution.

The department fully accepts the recommendations of the conference, but there are a number of difficulties in placing the plan abruptly into action: First, the hardship that it may cause to various stations to move arbitrarily to new wave lengths; second, the difficulties introduced by the ship-to-shore communication which are now working to some extent on 300 meters and also on 450 meters.

The conference recommended that the ultimate development for ship communication be to assign for the general purpose of shipping the whole wave area from 600 to 800 meters, different bands being allotted within this area for different shipping purposes. The distress signals from ships now work on 600 meters and the radio compass works on 800 meters. The ship-to-shore communications on 300 and 450 meters are altogether commercial traffic and would be more advantageously carried on with less interruption than today if these services were given the entire field around 700 meters.

In order to make progress in this direction of developing the area from 600 to 800 for ship communication, it is proposed that all ships and all shore stations used for ship communications shall cease using 450 meters between the hours of 7 and 11 p. m., but may use 700 meters at this or any other time. The 300 meters wave length now assigned under the International Convention is very little used and will be used for inland broadcasting, and it is not expected that the ships will avail themselves of the International Agreement in this particular, as it has not proved of practical advantage except to a limited extent.

For internal broadcasting the department proposes to cooperate with the various stations with a view to developing a systematic assignment of wave lengths to the various stations within the broad confines of the recommendations of the conference. In order to carry this out without hardship the following classification of stations will be made:

**Class A stations**—that is, stations equipped to use power not exceeding 500 watts. In this class it is proposed that the radio inspectors, in cooperation with the station owners, shall assign distinctive wave lengths to each station so far as is possible in the area from 222 to 300 meters. No station will be required to change from 360 unless it so desires.

**Class B stations**—that is, stations equipped to use from 500 to 1000 watts. In this class it is proposed to similarly offer to license these stations on special wave lengths from 300 to 345 and from 375 to 545 meters, having regard to the maintenance of some ship work on 450 meters as outlined above and again no station will be required to change from 360 unless it so desires.

**Class C stations**—comprising all stations now licensed for 360 meters. In this class no new licenses will be issued for stations on 360 meters until the plan is entirely realized. Stations which do not wish to move under the general plan may remain at 360 meters, but they will necessarily be subject to some interference at best. It is thought that by the above plan the stations can be gradually brought into accord without hardships.

Under the plan amateurs are given the whole area from 150 to 220, instead of being fixed upon 200 with special licenses at 375. The special licenses hitherto issued for amateurs at 375 will now be issued at 220. Certain special cases will be taken care of otherwise. It is proposed, in cooperation with the amateur associations, to develop an assignment of wave bands in classifications so as to somewhat relieve the present interference among amateurs. It will be remembered that the number of wave bands which can be used among the short wave area assigned to the amateurs is greater in proportion than among the longer wave lengths, and these arrangements expand in the area hitherto assigned to amateurs.

## Seven New Broadcasting Stations Licensed

Seven new broadcasting stations were licensed on 360 meters during the week ending March 31. They are as follows:

| Call | Station                                     |           |
|------|---|-----------|
| KFGL | Arlington Garage, Arlington, Oregon         | 5 watts   |
| KFIF | Benson Tech. Student Body, Portland, Oregon | 200 watts |
| WWAJ | Columbus Radio Club, Columbus, Ohio         | 10 watts  |
| WRAK | Economy Light Co., Escanaba, Mich.          | 200 watts |
| KFFR | Kirk, Jim, Sparks, Nevada                   | 10 watts  |
| WRAS | Radio Supply Co., McLeansboro, Ill.         | 20 watts  |
| WSAP | Seventh Day Adventist Church, New York City | 250 watts |

The following 29 broadcasting stations were deleted during March:

| Call | Station   |
|------|---|
| KHD  | Aldrich Marble & Granite Co., The C. F., Colorado Springs, Col. |
| WEAW | Arrow Radio Laboratories, Anderson, Ind.                        |
| KFGG | Astoria Budget, Astoria, Ore.                                   |
| WMB  | Auburn Electrical Co., Auburn, Me.                              |
| KFCC | Auto Supply Co., Wallace, Idaho.                                |
| WEAC | Baines Electric Service Co., Terre Haute, Ind.                  |
| KXS  | Braun Corporation, The, Los Angeles, Cal.                       |
| WCAP | Central Radio Service, Decatur, Ill.                            |
| KDYV | Cope & Cornwell Co., Salt Lake City, Utah.                      |
| KNX  | Electric Lighting Supply Co., Los Angeles, Cal.                 |

|      |   |
|------|---|
| KFBV | Ford, Clarence O., Colorado Springs, Col.     |
| KDZM | Hollingworth, E. A., Centralia, Wash.         |
| KON  | Holzwasser, Inc., San Diego, Cal.             |
| KQP  | Hood River News Co., Hood River, Ore.         |
| KLP  | Kennedy, Colin B. Co., Inc., Los Altos, Cal.  |
| WAH  | Midland Refining Co., El Dorado, Kan.         |
| WDAH | Mine & Smelter Supply Co., El Paso, Tex.      |
| WLAM | Morrow Radio Co., Springfield, Ohio.          |
| WRAJ | Pickering Co., M. H., Pittsburgh, Pa.         |
| WOAQ | Portsmouth Radio Ass'n, Portsmouth, Va.       |
| WBAB | Potter, Andrew J., Syracuse, N. Y.            |
| KDZQ | Pyle, William D., Denver, Colo.               |
| WGAB | QRV Radio Co., Houston, Tex.                  |
| KFAS | Reno Motor Supply Co., Reno, Nev.             |
| KDZL | Rocky Mountain Radio Corp., Ogden, Utah.      |
| WFAS | United Radio Corp., Fort Wayne, Ind.          |
| WFAD | Watson, Weldon Motor Supply Co., Salina, Kan. |
| KOG  | Western Radio Electric Co., Los Angeles, Cal. |
| WOAY | Wilder, John, Birmingham, Ala.                |

## Broadcasting Continues Popular

**D**URING the month of March broadcasters increased to 609, but 29 withdrew and their licenses were cancelled leaving, with 21 new stations licensed, a total of 580 operating stations. Of these, thirty are Class B stations on 400 meters and the balance on 360 meters. There they will remain until applications for transfer to the two new classes are received and they are "sorted" out and assigned new waves by the Department.



# Resolutions Adopted by the Second National Radio Conference

**A**T the conclusion of the Second National Radio Conference, recently called to meet in Washington, D. C., by Secretary Hoover, of the Department of Commerce, the following resolutions were adopted and have just been promulgated by the Department of Commerce:

That this conference, and the Department of Commerce subsequently, follow the practice of expressing wave frequency in kilocycles per second, with wave length in meters in parentheses thereafter.

That in assigning a wave band of 10,000 cycles to each Class A broadcasting station they be distributed over five zones throughout the country such that no stations in adjacent zones are closer together in frequency than 20 kilocycles, and that within each zone there be ten stations separated by 50 kilocycles.

That only one wave frequency be assigned to a Class A broadcasting station, which should transmit exclusively on the wave frequency designated and reserved exclusively for that station.

That every broadcasting station should be equipped with apparatus as a tuned circuit coupled to the antenna and containing an indicating instrument or the equivalent for the purpose of maintaining the operating wave frequency within 2 kilocycles of the assigned wave frequency.

That the Department of Commerce establish qualifications for Class A broadcasting stations, including a general minimum and locally suitable maximum power and a quality of program that will warrant assignment of a territorial wave frequency to each particular station, and that the qualifications be similar to those required of the present Class B broadcasting stations.

That the Department of Commerce in its discretion assign Class B broadcasting station licenses in which wave frequencies shall be specified and in which the power ratio between the Class A and B stations shall be at least 2 in so far as is practical for a given locality.

That in granting licenses it is recommended that the Department of Commerce limit the use of power where undue interference would otherwise be caused.

That reading of telegrams or letters by broadcasting stations be not construed as point to point communication so long as the signer is not addressed in person and so long as the text matter is of general interest.

That simultaneous re-broadcasting shall be permitted only on a broadcasting wave frequency, and with the authorization of the original broadcaster and the Department of Commerce.

That the Department of Commerce be requested to insist upon the suppression of harmonic and other parasitic radiation from all radio stations, as for example, by requiring the installation, if necessary, of coupled circuit transmitters at the earliest feasible date.

That spark transmitting apparatus be replaced as rapidly as practicable by apparatus which will produce a minimum of interference.

That the amateur organizations of the United States study the time requirements of the broadcasting of religious services on Sunday and by mutual arrangement with the broadcasters determine upon silent periods which will make possible the reception of such religious services in any given locality.

That when the government conducts services similar to commercial services for which waves or wave bands have been assigned, the government stations shall use the said waves or wave bands.

That the Government have the exclusive use of a band one kilocycle wide centered at each of the following frequencies, 92, 83, 81, 78, and 76 kilocycles, so far as is consistent with public service generally.

That where a line-radio installation produces interference with the reception of signals from beyond the state such line-radio station shall require a license from the Department of Commerce.

That the subject of interference caused by devices not used for radio communication purposes and which are not subject to the present radio law be referred to the projected Sectional Committee of the American Engineering Standards Committee and that in the meantime the members of the conference offer to the Department of Commerce their cooperation in the solution of such immediate problems as may be of a character in which their aid could be of value.

That, in the judgment of the Second National Radio Conference, the prevention of "wilful or malicious interference," as provided for by Section 5 of the Act of August 13, 1912, and the minimization of interference, as provided for by Article 8 of the International Convention, require that the Department of Commerce shall, in its discretion, withhold or rescind station licenses to transmit on specified wave frequencies, at certain times, and on definite powers, and with certain types of transmitters and when, in the judgment of the Department of Commerce such interference would result

or does result; and that it is the clear and manifest intent of Section 1 through 4, and Regulations 10, 12 and 18 of Section 4 of the said Act to give the Department of Commerce such authority to withhold or rescind licenses where such interference will result or does result; and that the Second National Radio Conference believes that a decision by the Courts validating the above views will be greatly in the public interest; and that the Second National Radio Conference expresses its willingness to advise and assist the Department of Commerce in the support of the above resolutions in the event of litigation.

That a copy of the foregoing motion be sent to each concern, organization or association engaged in manufacture of radio equipment, or broadcasting by radio or otherwise interested in radio communication with a request for an expression of approval or disapproval of the motion and an agreement to abide by its provisions.

That the Second National Radio Conference desires to emphasize the limited facilities available for radio broadcasting, and the un-economic and tentative basis of present-day broadcasting, and that the Conference urges the consolidation in each locality of those desiring the establishment or maintenance of broadcasting and those interested in broadcasting in that locality; to the end that broadcasting conducted in each neighborhood by such a local association will

## Lionel Bigman's One Tube Set

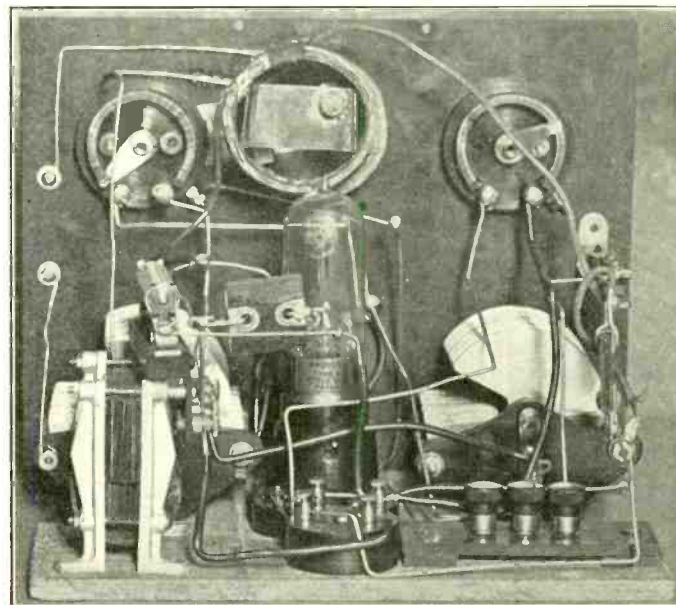

(C. Kadel & Herbert)

This one-tube reflex set, built by Lionel Bigman, of New York City, is inexpensive and well worth constructing. It uses a fixed crystal for detector and one tube with reflex action on the plate circuit. For DX reception this set is especially good and remarkable results have been obtained. Local stations have been heard 50 feet from the phones on the loop.

receive public support and be handled in an economic and permanent fashion.

That the great expansion of radio communication has not been accompanied by a proportional increase in the radio personnel and facilities at the disposal of the Bureau of Navigation and Standards of the Department of Commerce, and that the resulting strain on the inspection and technical forces of the Department of Commerce has been excessive, and has even forced the omission of important activities and investigations, and that the Second National Radio Conference strongly recommends that additional appropriations be granted to the Department of Commerce for its radio inspection personnel and equipment and for its research personnel and facilities. That a committee of three be appointed to wait upon the Secretary of Commerce to present the urgency of this need and the importance of the early provision of funds for these bureaus.

That the present conditions of radio interference with non-local reception and the resulting public dissatisfaction urgently require that the recommendations of the conference be accepted by the Secretary of Commerce and put into early operation by the Department of Commerce.



# The Functions of the Grid Condenser

By *W. S. Thompson, E.E.*

**G**RID condensers can be purchased for such a small sum that many radio enthusiasts neglect this most important part of their receiving set. It is the purpose of this article to discuss the functioning of this piece of apparatus and to clear up some misunderstandings prevalent concerning its use.

As most radio fans are familiar with the theory of a triode vacuum tube, the author will assume that all

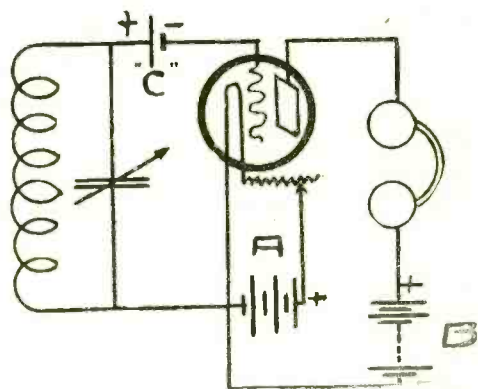

Fig. 1. Fundamental circuit for connecting triode vacuum tube as a detector without using a grid condenser.

his readers understand how a change of potential on the grid controls a flow of current in the plate circuit. Before the grid condenser was first applied to a radio receiving set, the vacuum tube was used as a detector in an entirely different manner than is customary today. The lead from the secondary of the coupling transformer was taken directly to the grid as shown in Fig. 1, using a "C" battery to keep the normal potential of the grid negative with respect to the filament. In order to explain how this arrangement detected and rectified signals, it will be assumed that the signals consist of a series of wave trains as shown in Fig. 2. As this series of wave trains might represent a modulated sustained wave, the discussion will apply equally well for code or phone transmission. Fig. 3 consists of a plate current-grid potential characteristic curve of a modern receiving tube plotted in the conventional manner. The vertical line, E', represents the normal grid potential as fixed by the C battery in the grid circuit. The horizontal line I' represents the current flow



Fig. 2. Conventional method for representing a series of wave-trains sent by a transmitting station.

in the plate circuit when there are no signals being received. An incoming wave train has been plotted on the line E' and the effect of this incoming wave on the plate current has been plotted on the line I'. A careful examination of the curvature of the characteristic curve will show that when the grid is made positive by a positive half-cycle of the incoming wave, the effect upon the plate current is to increase it more than it is decreased by the grid being made negative by a negative half-cycle. The result of this is that the average value of the fluctuations of the plate current is increased above normal as shown by the dotted line. This increase of the average value of the plate current causes the diaphragm in the telephone to move, and hence causes a sound. The frequency of this sound wave depends upon the number of wave trains received per second. It can be seen, therefore, that due to the

sharp knee of the characteristic curve at the operating point the very high frequency radio waves are converted into an audio-frequency sound in the telephones. The normal potential of the grid with respect to the filament is kept negative in this case in order to keep the operating point on the lower knee of the characteristic curve.

When a grid condenser with a grid leak is inserted in the grid circuit, an entirely different action takes place, although it accomplishes the same result. Fig. 4

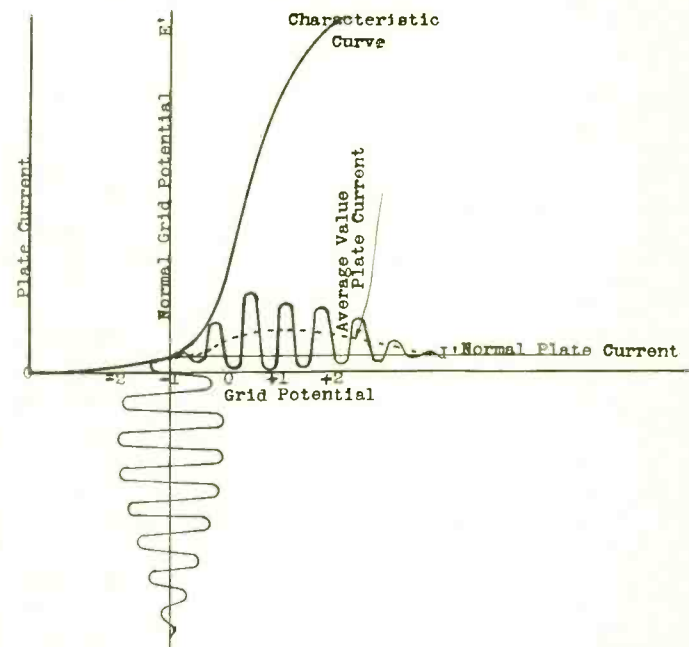

Fig. 3. Plate current-grid potential characteristic curve of triode tube showing rectification of an incoming wave-train.

gives the fundamental hook-up, using a grid condenser in conjunction with the tube to detect signals which will again be assumed to consist of a series of wave trains in order to simplify the discussion. It should be noted that the grid circuit is connected to the positive terminal of the A battery and that there is no C battery used to maintain the potential of the grid at any value. Fig. 5 consists of the grid current-grid poten-

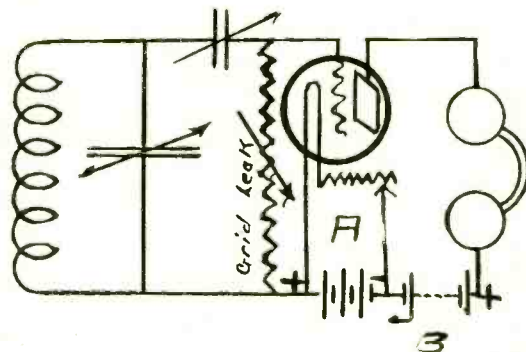

Fig. 4. Fundamental circuit for connecting triode vacuum tube as a detector using a grid condenser with leak.

tial characteristic curve of a receiving tube, because it is upon the shape of this curve that the detecting action depends. The normal potential of the grid depends upon the value of the grid leak and the RI drop in the filament, so that they should be of such a value that

(Continued on next page)



## Just to be in Fashion

If each page of this week's issue of RADIO WORLD were to be placed end to end the edition would reach from Times Square, New York City, to the Post-Dispatch Building, St. Louis, Mo.

The amount of ink used on this week's issue of RADIO WORLD, represented by the same amount of black paint, would be sufficient to paint the New York City Hall and the Aquarium, San Francisco, Cal.

If each revolution of the three presses that were required to print this week's issue of RADIO WORLD were reduced to running footage it would cover the distance between New York City and Portland, Ore.

We do not guarantee that these figures are correct, but as it is the fashion these days for publishers to make such comparisons, we offer them as interesting if not particularly precise.

(Continued from preceding page)

the operating point on the curve will be at P. This point P being on the sharp knee of this curve, it will be seen that a positive half-cycle of the wave train will cause a larger increase of grid current than a negative half-cycle will cause a decrease of grid current. This action will cause an accumulation of negative electrons on the grid side of the grid condenser and this accumulation of negative charges will make the potential of the grid negative and hence cause a decrease of plate current. When a wave train has passed and been rectified, the negative charge will leak from the grid condenser through the grid leak and the potential of the grid will again become normal. Thus it can be seen from Fig. 6 that each wave causes a decrease of plate current, the frequency of which depends upon the number of wave trains received per second.

Comparing the two methods, the reader will note that with no grid condenser, the detector action depends upon the operating point on the plate current-grid potential curve and that each wave train causes an increase of plate current, while the detector action using a grid condenser with a grid leak depends upon the operating point on the grid current-grid potential curve, and that each wave train causes a decrease of plate current. The majority of modern receiving sets use the grid condenser method because it is more sensitive, using the receiving tubes which are available to the average amateur. However, some of the oxide-coated filament tubes would be better detectors using the no grid condenser method.

In designing the grid condenser and grid leaks, there

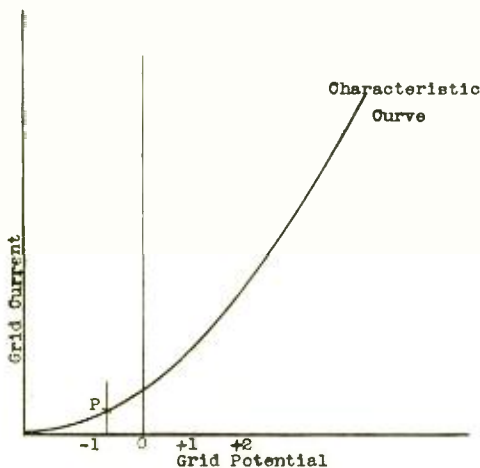

Fig. 5. Grid current-grid potential characteristic curve of a triode vacuum tube showing operating point on knee of the curve.

are several very important factors which must be considered and a great many more which affect the operation of the tube in one way or another but are not important enough to materially decrease its efficiency. The grid condenser must be designed to conform to two limits; that is, it must be small enough so that the accumulation of negative charge will materially affect the potential of the grid and also it must be small enough so that the accumulated charge will leak off

during the time between wave trains. The other limiting factor is that the condenser must be large enough so that it will not rob the grid of signal voltage. If the capacity of the grid condenser was too small the signal voltage across the grid-filament would be very small due to the fact that when two condensers are in series with a source of electromotive-force the voltage across each is inversely proportional to the capacity of each. In other words, the smaller of the condensers will have the largest voltage drop so the grid condenser should be large enough to give most of the signal voltage to the grid-filament capacity in order to get the largest change of potential on the grid. The values of grid condensers used today are therefore the largest values that will operate efficiently with a given tube.

The value of the grid leak depends upon the value of the condenser used and should be of such a value

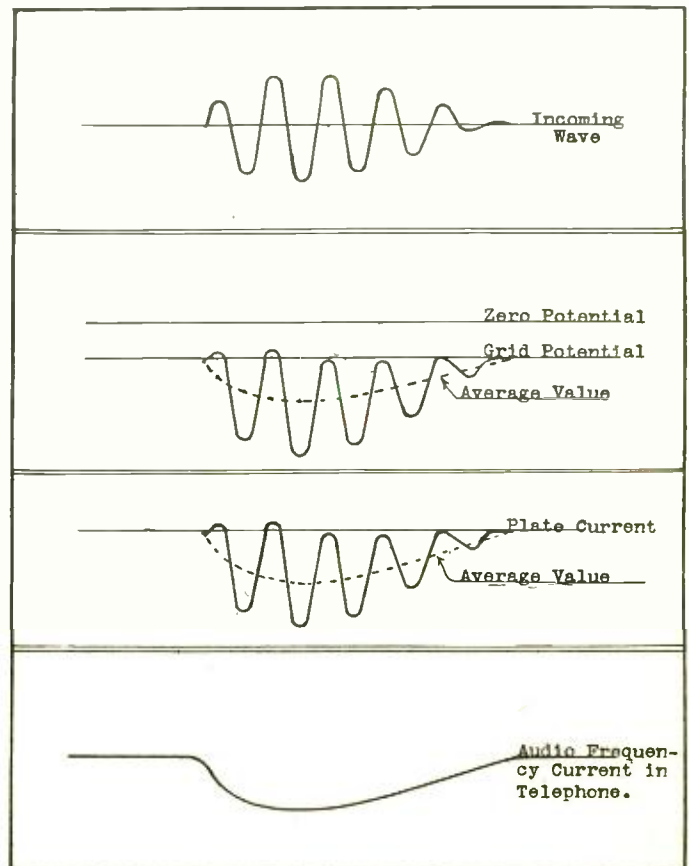

Fig. 6. Showing the effect of an incoming wave on the grid potential and the plate current when a grid condenser is connected in series with the grid.

that the accumulated charge will leak off between each successive wave train without making it so small in resistance that the charge will not accumulate in the condenser.

The only method for obtaining the correct values for the grid condenser and the grid leak without going very deeply into mathematical equations is to experiment with a given tube until best results are obtained.



# Radio and the Woman

By Crystal D. Tector

**A** YOUNG financier who lives right around the corner from me decided that he wanted a set, but not having money enough to get one conferred with some of his fellow "money masters" and they floated a stock issue to the amount of \$25.00. The stock was ten cents per share, and he will have 249 partners in his venture. Of course, the young man will have to be repaid for all his trouble, so the set will be installed in his house, and his partners will have to come over to listen in. Well, J. Pierpont Morgan had to have a start and radio evidently gave this young man an idea in high finance that will benefit him in later life. Just imagine if, 60 years from now, he can look around his spacious office in some downtown bank building and say: "Well, radio certainly gave me this!"

\* \* \*

'Member last week, girls, I threatened to publish my DX letter if I received any encouragement? Well, here I am, and I am proud of it because it was all on one 216A tube, using my Flewelling and a hundred foot antenna without ground: KSD, St. Louis, so loud that I thought it was Ridgewood; WBAP, Fort Worth, Texas; WGM, Atlanta, Ga.; WSB, Atlanta, Ga.; WDAP Chicago, Ill.; WGY, Schenectady N. Y.; KFEP, Denver, Colo.; WMZ, Memphis, Tenn.; WDAF, Kansas City, Mo.; WIP, Philadelphia; PWX, Havana, Cuba, and of course WEA, WJZ, WHN, WAAM and a score of other nearby stations. Now if some of the girls don't send in some of their DX records, I shall be sadly disappointed as I at least want to publish one letter a week. The editor says that one letter a week is all I can publish, so you had better address me early in the week if you want to get into my column.

\* \* \*

Now that the nice, balmy spring days are coming, F. H. is very loathe to stay in the house, and at the

same time he doesn't want to have the loud talker out on the porch. So he ran a couple of wires from the set outside to the rail, and put a couple of weatherproof jacks under the rail. Now he can sit outside in comfort with a pair of phones over his ears and listen to all the concert, and I 'spect he gets thirty winks between programs. He said that the only drawback is that he can't tune it, and has to listen to what I pick out for him. Well, I will use some of that good judgment, and imitate the operator in the Ritz Apartments over in Newark, N. J., and then see if I can't keep him satisfied. You girls understand, of course, how hard that is when he comes home with that "Oh, I'm so tired, go away and let me sleep," sort of a feeling.

\* \* \*

Musical shows are usually dedicated to the "tired business man," but entertainment by radio is claimed as the boon of the "weary working woman" who is characterized no longer as "poor working girl" since the "listen-in" privilege came to her.

While awaiting a conference with a busy man the other day, I chanced to mention radio to his stenographer, momentarily enjoying a breathing spell.

"Oh, gee! Ain't it the grandest thing? You know ever since I got my set, I stay home nights and rest up while I listen in. Night after night I used to think I was enjoying myself dancing my feet off or blinking at the movies. But now, I hit the couch, clamp on the ear muffs and tune her in. This gives my feet and eyes a chance to get rested, you see, and transfers the strain to my ears.

"Believe me, I take it easy nights since radio broadcasting got so good. I know the announcers by their first names and their calls like the typewriter keys. When I get sleepy I turn her off and slide into dreamland."

## Radiograms

The Bureau of Standards is trying to discover the cause of certain "dead spots" in the ether which form barriers to successful radio transmission in various areas in the United States.

\* \* \*

The farm strike in Norfolk, England, continues to be accompanied by unusual features. One of these was the use of a wireless broadcast to circulate the appeal of the farmers' union for strike-breakers.

\* \* \*

Thousands of radio fans who were listening in on an opera broadcast by a station in Boston, one evening last week, were surprised when the concert was abruptly discontinued while distress messages from a burning vessel at sea were copied. The opera was resumed after an interruption of fifteen minutes.

\* \* \*

Cold light, the ideal of research engineers, is reported to be a step nearer realization through the laboratory experiments of a young French scientist, Emile Risler. His procedure is to coat glass tubes, drawn to the fineness of a hair-like filament, with a phosphorescent substance and pass an electric current through the tubes, causing them to produce a brilliant light, the color varying according to the phosphorescent material used.

\* \* \*

At a cost of \$11,200,000 the New York Telephone Company will erect a new building in New York City on the block bounded by West, Barclay, Washington and Vesey streets. It will be 29 stories high and is expected to be completed by July, 1925. Offices, administration quarters and space for two or three future central telephone exchanges will be provided. In the new building the company expects to accomplish many economies through centralization of personnel.

A radio club is being organized among the local employees of the Standard Oil Company of Ohio at Cincinnati.

\* \* \*

A quartet of trained canary birds is a feature of one of the broadcasting programs. Those birds better be careful not to sing copyrighted notes, or that composers' organization will be after them for a fee.

\* \* \*

Radio is being used by the New York State Tax Commission this year to spread information about the State income tax, which is due on April 15. One talk by experts of the Income Tax Bureau has already been broadcast by WGY, Schenectady, N. Y.

\* \* \*

Harry Holzworth, keeper of the five-mile crib in Lake Erie off Cleveland, Ohio, was last week saved by radio from probable death by pneumonia. His two companions wirelessed for help and a coast guard boat made a thrilling transfer of the sick man to shore.

\* \* \*

A comparatively large part of Edward Cressy's "Discoveries and Inventions of the Twentieth Century" is devoted to the marvelous progress of communication by radio. This book, which is imported by E. P. Dutton & Company, New York City, may be considered as a sequel to "Routledge's Discoveries and Inventions of the Nineteenth Century."

\* \* \*

J. C. Rosenthal, general manager of the Society of Authors, Composers and Publishers of America, Inc., of New York City, said last week that about fifty of the radio broadcasting stations of the country had begun to negotiate with the society for the privilege of continuing to broadcast the copyrighted work of the composers and song-writers who belonged to the organization.



# The Radio Primer A 2-in-1 Receiving Set

For Thousands of Beginners Who  
Are Coming Into Radio Circles

By S. F. O'Bryan

## Weekly A B C of Radio Facts and Principles Fully and Clearly Explained

By Lynn Brooks

**W**HAT is the difference between series connection and parallel connection of batteries?

When batteries are connected in series the voltage is that of one cell multiplied by the number of cells, but the amperage is that of any one of the cells in the group. When batteries are connected in parallel, the voltage is that of any one of the parallel groups, but the amperage is the sum total of one cell multiplied by the number of cells in the group.

\* \* \*

*When should series connection be employed?*

Series connection should be used when voltage, or pressure of current, is desired and not amperage.

\* \* \*

*When should parallel connection be employed?*

If amperage, or quantity of current, is desired from batteries they should be connected in parallel.

\* \* \*

*How should dry cells be connected to operate the WD-11 for long life?*

As the tube in question only takes 1.5 volts, it is necessary to hook up the cells in parallel. As the life of the batteries is three times as long when two cells are hooked in parallel, it is advantageous to connect them in this way.

\* \* \*

*Can six-volt tubes be operated by using dry cells connected in series?*

If the tubes are to be operated over a short period of time they can be operated by connecting four dry cells in series, or eight cells in series parallel, but the life of the batteries will be so short that they will last only a very few hours.

\* \* \*

*Is it possible to increase the selectivity of a receiver by the use of variable condensers?*

By placing a condenser in either the antenna or ground lead of a receiver, a set may be made to tune closer; but if it is not selective, the condenser will not help very much. When a set tunes broadly the general trouble may be credited to distributed capacity, which cannot be alleviated by introducing additional capacity. It is much more efficient to tune a set by inductance than by capacity.

\* \* \*

*They use the expression "normal rate of discharge" when talking about storage cells or accumulators. Please explain it.*

This expression is meant to express the number of amperes that safely can be drawn from the cell without injury to the plates. To obtain this value, divide the ampere-hour capacity of the cells by the hour rating.

\* \* \*

*What is the cause of sulphating of storage cells?*

Sulphating is a term applied to a cell when a snow white deposit is formed on the plate. It is due to letting the cells stand too long on discharge, or from serious over-charging.

**T**HE accompanying diagram shows the hook-up of a receiving set designed to work either with or without an aerial. When an aerial is used, switch "S" is placed on point "B" and the switch in the ground lead is closed giving a modified form of ultra-audion circuit that gives wonderful results. The variable condenser then tunes extremely sharp and the grid leak requires close adjustment to obtain the best results.

During heavy spark interference, the antenna may be dispensed with. Switch "S" is then changed to point "A," the other switch is opened, and we have an old tried and true no-aerial circuit that will bring in 'phone and CW through a thunder storm, although the range is, of course, much less than when the first method is used. The inductance between plate and grid now tunes sharply, while the variable condenser and grid leak are less critical.

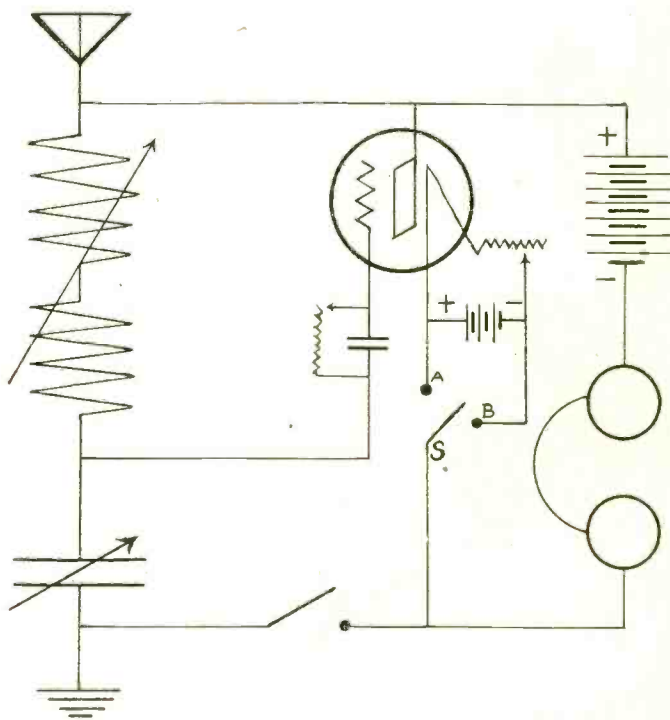

Hook-up for receiving set to work with or without an aerial.

The average amateur will have no difficulty in making and using this little set as standard parts may be utilized throughout. The variable condenser may have either 23 or 43 plates, and would preferably have a vernier adjustment. The grid condenser and the batteries will be determined by the type of tube used, while the inductance may take any convenient form so long as it can be tuned sharply. A variometer, or a variocoupler with its windings connected in series, will both give good results, but the writer obtained the best results by using two spider-web coils, each wound with 45 turns of stranded wire. This wire was made by twisting six strands of No. 36 wire together, but regular "Litz" would undoubtedly be better. The coils were connected in series as shown, and mounted in the conventional manner to give a variometer tuning effect.

The experimenter who builds this set will find that by using a 1½ volt tube and spider-web inductances as recommended, he can have a remarkably efficient outfit that will be small enough to make a practical vacation time traveling companion.



# Ubiquitous Camera Man to Get Radi



(C. Photonews, N. Y.)

Here's an idea put forward by Pierson Mapes. A honeycomb coil in inductive relation with a variometer in a single circuit receiver, and you never have trouble making the signals come pounding in.

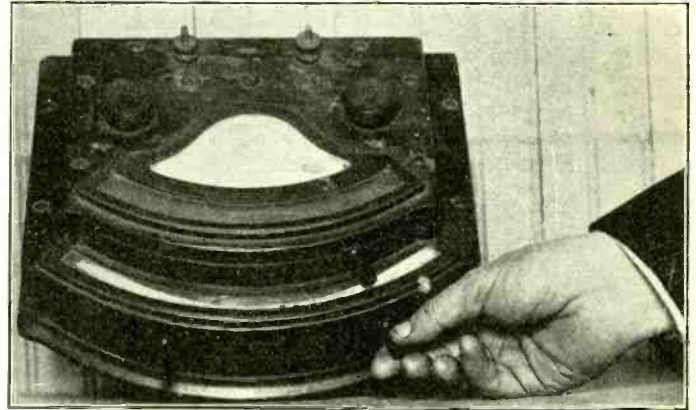

(C. Photonews, N. Y.)

Radio Fans, this is a radio receiver of the vintage of 1904, and was thought at that time to be the very height of perfection. It was used by the U. S. Navy. It is called the Massie "resonophone" and is a three-slide tuner with crystal detector. How different is this dusty antique from the efficient tuners and regenerative sets of today. The only question is, will ours be looked upon in the same manner 20 years from now.



(C. Fotograms)

Here it is fellas, the radio set that didn't cost a single penny. Herbert M. Richardson, Minneapolis, Minn., recently made a set out of spare parts as follows: Top of a salad box, six paper fasteners, two paper clips, one safety pin, a piece of galena and some spare wire laying around. Well, when you can go out in the back yard and pick up a radio set, there is no reason for people shying at the very thought of buying one. If you haven't got a back yard, ask your nearest neighbor and maybe he will oblige you by letting you "hunt up a radio set."



(C. International Newsreel)

Mr. Newton Hill, of Piqua, Ohio, although confined to his bed for 13 years with rheumatism, is not helpless in every sense of the word. He is known as the "Magazine Man" because of the fact that he solicits magazine subscriptions via mail and makes a good living. He recently had a powerful receiver installed to keep his quiet hours pleasantly occupied.

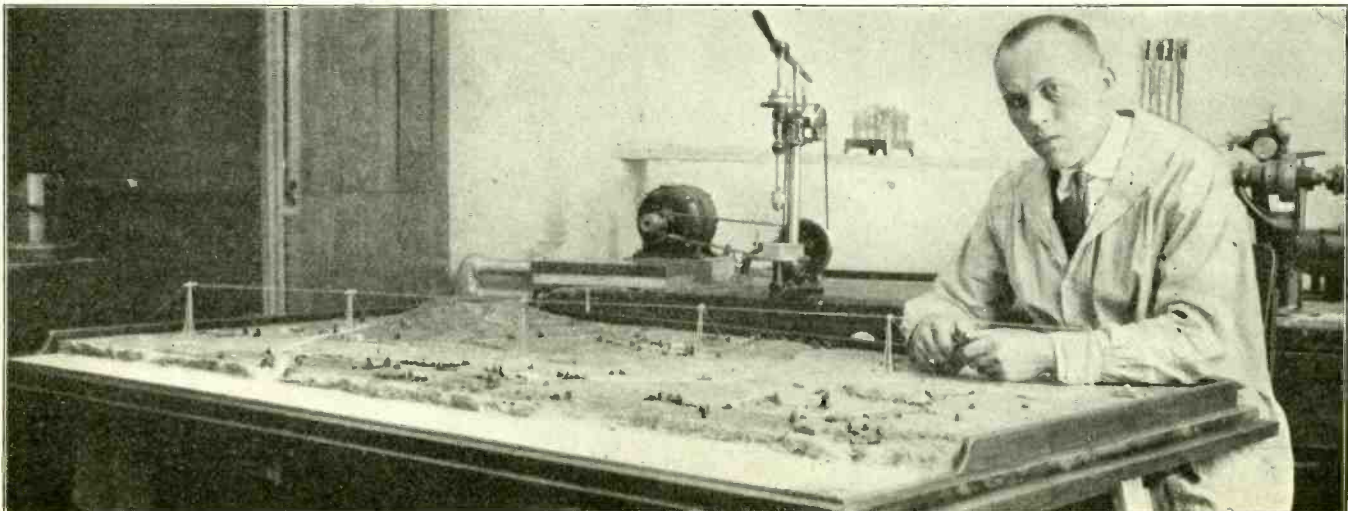

(C. International Newsreel Photo)

A model of the Radio Corporation's high power transatlantic radio station at Rocky Point, Long Island. The model is built on the scale of one inch to 100 feet, and shows the lofty antennae towers, power house and an exact replica of the landscape, even to the trees. The model will be exhibited at the Gothenberg Tercentenary Exposition in Sweden, and is to be used as a model for a station to be erected there.

*Caption  
by  
Robert L  
Dougher*





# en Box the Compass o Pictures



(C. International Newsreel)

Fellows, meet F. H. Schnell, traffic manager of the ARRL Eastern District! The league has just launched a plan to record interference of all kinds on broadcast waves between 360 and 400 meters every evening from 7 to 10:30 and will have the co-operation of 300 of the best known amateurs who will act as observers and file their reports. If your transmitter isn't "kickin' right" on 200, you'd better watch out, or F. H. will get his Wouff Houng out and chase you around the block.



(C. Photonews)

Emergency panel on board the S. S. "Rochambeau" which supplies the set from storage cells in case of accident to the regular ship current which normally operates the set.

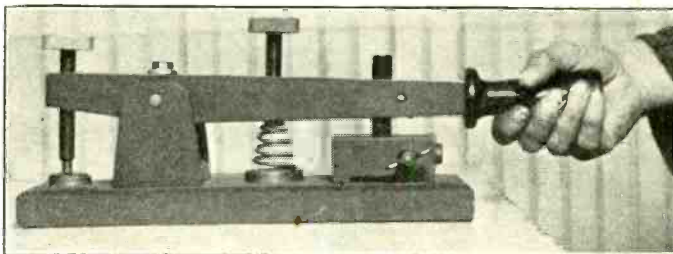

(C. Photonews, N. Y.)

This funny looking key once was the latest thing in the field of wireless. It is one of the old time pump keys and had to be worked in the manner shown. How different from the little arc-proof key of today which handles all kinds of current without sticking!

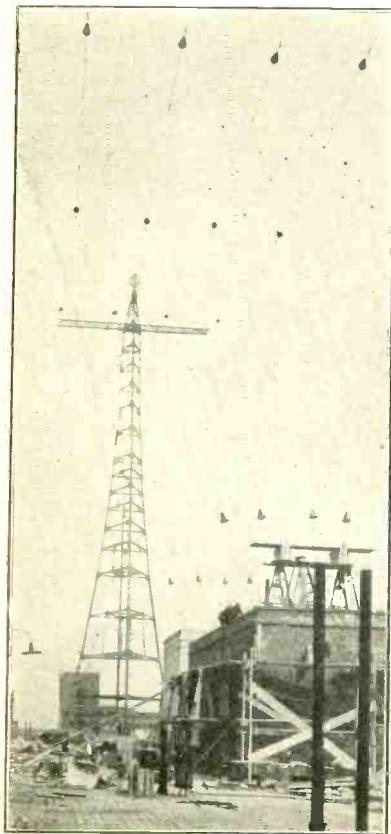

(Radio Corporation of America)

The completed antenna system at Aeolian Hall, New York. Two separate groups of wires will be used in connection with two transmitters making possible simultaneous transmission on two different wave lengths.



(C. Underwood and Underwood)

Little Miss Sheila Caulfield, of London, England, whose life was saved after a serious operation because her father told her that "Uncle Arthur," of the London broadcasting station, wanted to talk to her over the radio. The doctors attribute her marvellous fight for life to her desire to hear "Uncle Arthur" talk to her on her own radio set.



# Answers to Readers

1. Should the condensers in the article published by C. White in RADIO WORLD for March 24, 1923, be .25 mfd. or should they be .00025 mfd.?

2. Should the R. F. Transformers for 360-400 meter range be air core or iron core?—G. T. Foster, 140 Lancaster St., Albany, N. Y.

1. These condensers are shown in the right capacity, namely, .25. They are telephone condensers. See article on condensers by A. White in this issue.

2. The R. F. transformers should be preferably air core for best results.

\* \* \*

Is there any manner in which a crystal detector can be used with a variometer and variable condenser?—Malcolm Douglas, Webb, Okla.

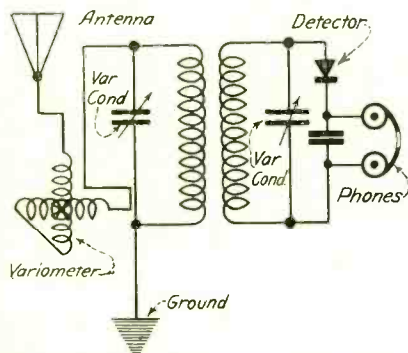

Hook-up requested by Malcolm Douglas, Webb City, Okla., using a coupler, variometer and crystal detector.

You can incorporate the apparatus you mention in the hook-up given herewith.

\* \* \*

1. Does the Western Electric Co. make a five watt power or transmitting tube?

2. In hook-ups where they specify a .0005 variable condenser, can I use a .001?

3. Can the Western Electric 216 A tube be used in power amplifiers and what plate voltage can be used on them?—A. Gilburg, 1319 N. Chestnut Street, Spokane, Wash.

1.-3. There is a tube called the 216 A, manufactured by the Western Electric Co. that can be used as a 5 watt tube, and this tube is also the one used on the power amplifiers. When used as a power amplifier tube, 60 to 90 volts is used on the plate.

2. Where a .0005 variable condenser is specified, you can use a .001, but you will obtain finer tuning by the use of the smaller condenser.

\* \* \*

1. Would it be necessary for two amateurs living in the country to have licenses for operating transmitters made out of two Ford coils, the sets to be used solely for the purpose of learning the code? We live a mile apart.

2. What apparatus would be necessary for this purpose?

3. Is there a flow of current from the B battery when the filament is extinguished?

4. What is the advantage of the honeycomb coil sets over the variocoupler variometer type?

5. Where are stations 9YS and 5XZ located?—Kenneth H. Jones, London Mills, Illinois.

1. It is necessary to have a license whenever signals are transmitted, no matter what apparatus is used.

2. The apparatus necessary will be a battery, or other source of current, key, Ford or spark coil, helix or tuner, condenser.

3. There is no flow of current when the filament is turned off.

4. The advantage of the honeycomb coil sets over the variometer type is flexibility, as the wave range is not limited to a comparatively small band, but may be varied at the listener's will from 150 to 25,000 meters.

5. Station 5XZ is listed as St. Charles College, Grand Coteau, La. Station 9YS is listed as Wesleyan University, Illinois.

\* \* \*

1. Can Cunningham 301A tubes be used in reflex circuits as shown by Mr. Thompson in your magazine?

2. Can jacks be employed to cut out tubes in case reception is too loud?

3. Can the 400 ohm and 2,000 ohm resistances be purchased on the market?

4. What make of radio-frequency transformers would you recommend?—Thomas McLaren, Jr., 129 Pearl Street, Boston, Mass.

1. These tubes can be used as the amplifiers, but where a tube is used as a detector it is best to use a soft tube.

2. No. In order to accomplish this you would have to use an automatic switching system, because the detector must always be the last tube, and every circuit would have to be changed if you intended using fewer tubes.

3. These resistances can be purchased.

4. We do not recommend competitive makes of apparatus through these columns, but buy the best you can and be sure of your results.

\* \* \*

I want a hook-up for two WD-11 tubes which will bring in the distance stations. What parts are necessary for this set?—Jack D. Leseman, Charleston, S. C.

We refer you to RADIO WORLD for January 27 where you will find the information you desire on page 5 under the heading "How to make a two tube DX set" by John Kent. This also contains a list of the necessary parts.

\* \* \*

Kindly furnish me with a hook-up for the following apparatus: One variocoupler, one variometer, two variable condensers, crystal detector, phone condenser, phones.—John O. Lee, Box 573, care of PSC, Davenport, Ia.

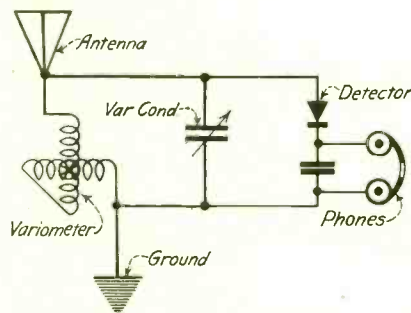

Crystal detector hook-up requested by J. O. Lee using a variometer as a tuner.

The hook-up you request is published herewith. Two condensers are not necessary.

\* \* \*

What type of tube should be used for the Flewelling circuit? Can a Cunningham 301A be used? What plate voltage is necessary?—B. Maxwell Cox, Stafford Springs, Conn., Box 785.

A hard tube should be used for this circuit, such as the 201, or the 216A, or 301A as you suggest. The plate voltage should be 45 to 90 volts.

## Radio Corporation of America Has Good Year

THE Radio Corporation of America, in its annual report for 1922, issued for publication last week, reveals the stupendous strides taken during the year toward the development of its vast system of world-wide wireless, outlines its comprehensive program for expansion in all parts of the world, and points out that the public interest in wireless, as shown by the demand for broadcasting, has been almost limitless. The report shows that America leads the world in radio.

To meet the great, popular demand for instruments for reception of broadcast programs the sales department of the Radio Corporation expanded from about fourteen persons to 200, and about 15,000 dealers now handle RCA products. The gross sales for the year were \$14,409,557, including the high-power station to the Swedish Government, and seven medium-powered vacuum tube telegraph transmitters for use by the Tropical Radio Telegraph Company in this country, Guatemala, Honduras, Nicaragua, Costa Rica and Panama.

In addition to the increased enthusiasm and efficiency among the personnel of the company there were three outstanding events on the human side of the operation of the Radio Corporation. One was the visit of Senator Marconi, inventor of the first system of wireless communication, as the guest of the corporation; a second was the creation of the new office of Managing Director of International Relations, to which office Mr. Edward J. Nally was elected, and the third was the taking of Mr. Nally's place as President by Major General James G. Harbord, Deputy Chief of Staff of the United States Army, and noted overseas commander and organizer. In the financial section the report says:

"The corporation's financial position has been further strengthened during 1922. Current assets have increased \$3,775,984, and exceed the current liabilities by \$5,997,966. The current liabilities, amounting to \$2,688,941, represent indebtedness for merchandise, materials, and federal income tax. The corporation has no bonded debt.

"The total of plant and equipment, \$12,711,348, remains substantially the same as last year, while the reserve for depreciation and obsolescence of plant has been increased by \$529,376, and now amounts to \$1,347,705. The amortization of patents reserve, after charging patents expired, now stands at \$2,405,376, and represents the depreciation to December 31, 1922, indicated by the schedule founded on the life of such patents.

"After providing for depreciation of plant and inventory the operations for the year resulted in a net profit of \$2,974,579, which has been allocated, in the main, to reserves for patents and federal income tax, the balance having been applied against organization expense.

"The profits were not sufficient up to December 31, 1921, to meet patent amortization called for by the schedule, and it was necessary to charge \$1,666,284 against common stock equity. The total of \$2,480,576, transferred from 1922 earnings, provides for 1922 patent amortization and the restoration of the above amount to common stock equity.

"The corporation's capital stock consists of 3,955,974 shares of 7 per cent. preferred stock of \$5 par value and 5,734,000 shares of common stock of no par value, against which latter there is shown on the balance sheet an equity of \$13,660,163, which is approximately \$2.38 a share. No dividend was paid during the year 1922 on either the preferred or the common stock. The 7 per cent. preferred stock becomes cumulative January 1, 1924."



# The DX Nite Owls

THE editor of RADIO WORLD will be pleased to receive sketches of hook-ups drawn carefully in black ink or heavy pencil from the "DX Nite Owls" who send in records with a view to publishing them.

Send hook-ups of your sets, provided they contain something unusual. Send, also, the names of the various makes of apparatus you are using.

Make your letters brief and informative. Write on one side of the paper only.

The letters and hook-ups will be published in the earliest possible numbers of RADIO WORLD.

## Some DX Dope from the Navy

From C. R. Spicer, U. S. Naval Radio Station, Pt. Loma, San Diego, Calif.

AM enclosing you a hook-up of a set I have been using for a long time and also a little data along with it.

Hook-up is single circuit, but it does the work and gets the results and that in my estimation is what counts. Instruments necessary are as follows:

- 1 Variocoupler (Rewind Rotor and Stator if necessary).
- 1 Variable Condenser, 23-plate, .0005.
- 1 Grid Leak, 3 Megohms.
- 1 Grid Condenser, .00025.
- 1 Fixed or By-Pass Phone Condenser.
- 1 Tube, Socket and Filament Rheostat.

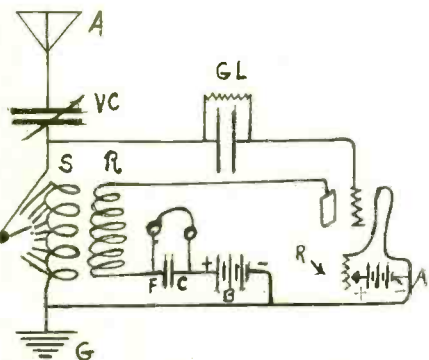

C. R. Spicer's hook-up. He is in favor of re-winding the variocoupler, as described below.

"A" and "B" batteries and pair of good phones.

Get best results with 40 volts on "B" battery.

Am using at present an antenna 150 feet High and 175 long, single wire, but this length and height is unnecessary.

With this hook-up I have received the following stations from the Naval Radio Station here at Pt. Loma, San Diego, Cal.: KDKA, WGY, WOC, WSB, WMC, WWJ, WOR. (During special test with KHJ) WHB, WDAP, WBAF, WFAA, KYW, KSD and others. This list not including Pacific Coast Stations for they are too numerous. Stations mentioned of course do not tear the shack down when they open up, but comfortable reading is assured.

A word about the variocoupler. The Primary tubing is 5 inches in diameter with 60 turns 22 DCC were tapped every 6 turns. The rotor is 4 inches in diameter around with 40 turns of 22 DCC.

Although being within reach of some mighty fine apparatus I have not used any navy instruments.

## Seventy-five Isn't Half Bad as a Beginning!

From Guy Esmond, 13 Grotto Court, Watervliet, N. Y.

I am a subscriber for your magazine, and, wishing to join your Nite Owls am sending

what I think is a pretty good record for a one tube set with coupler and condenser:

WNJ, Albany; WSY, Alabama; WOK, Arkansas; WNAC, Boston; WGR, Buffalo; WDAP, Chicago; KYW, Chicago; WMAQ, Chicago; PWX, Havana; WDAK, Connecticut; WDAP, Chicago; WNAJ, Chicago; WDAJ, Georgia; WGM, Georgia; WSB, Georgia; WLK, Indiana; WOC, Iowa; WDAX, Iowa; WKAA, Iowa; WJAF, Indiana; WHAS, Kentucky; WDAD, Kansas; WHAN, Kansas; WEAD, Kansas; WDAF, Missouri; WLAP, Kentucky; WMAK, Lockport; WWI, Michigan; WHAH, Missouri; WIAP, Mass.; WMAF, Mass.; WGI, Mass.; WWJ, Mich.; KOP, Mich.; KSD, Mich.; WMAT, Minn.; WMAJ, Missouri; WMB, Maine; WBZ, Mass.; WLAQ, Mich.; WBAD, Minn.; WEAA, Mich.; WLB, Minn.; WFAQ, Missouri; WCX, Mich.; WHB, Missouri; WEAJ, N. Y. C.; WJZ, New Jersey; WOR, New Jersey; WBT, North Carolina; WMAC, N. Y.; WMAH, Nebraska; WHAM, Rochester, N. Y.; WVP, N. Y. (Bedloes Island); WAAM, New Jersey; WLAD, Nebraska; WRW, Tarrytown, N. Y.; WJAX, Ohio; WLW, Ohio; WLAL, Oklahoma; WWB, Ohio; WEAO, Ohio; KDKA, Pittsburgh; WFI, Philadelphia; WIP, Philadelphia; WCAU, Philadelphia; WCAE, Pittsburgh; WOO, Philadelphia; WQAA, Parkersburg, Pa.; KQV, Pittsburgh; WDAR, Philadelphia; WEAN, Providence, R. I.; WGAM, S. Carolina; WGY, Schenectady, N. Y.; WRL, Schenectady, N. Y.; WHAZ, Troy, N. Y.; WDAA, Tenn.; WMZ, Tenn.; WCM, Austin, Texas; WDAG, Amarillo, Texas; WHAJ, W. Virginia; WEAE, Virginia; WIAO, Wisconsin; WHA, Wisconsin. I have been working my set for five months and have heard these stations quite a few times.

\*\*\*

## Hitting Them on "The Fairway"

From C. Cutbell, 112 Chatterton Parkway, White Plains, N. Y.

THE enclosed "Radio Golf Score" record was made by me on the evening of Feb. 22, 1923. I am using an "Aerola Sr." with one-step of A. F. amplification, and I think this one "beats 'em all." As can be seen I average 6,000-8,000 miles per night.

Time, First Half, 7:30-8:30—7:30, WJZ, Newark, N. J., 50 miles; 7:35, WEAB, New York, N. Y., 35; 7:40, WMAB, Round Hill, Mass., 200; 7:50, WLAB, Carrollton, Mo., 1,075; 7:55, WPO, Memphis, Tenn.,\* 1,000; 8:00, WOR, Newark, N. J., 50; 8:05, WHAZ, Troy, N. Y., 200; 8:10, WWJ, Detroit, Mich., 600; 8:12, KDKA, Pittsburgh, Pa., 375; 8:15, WOY, Schenectady, N. Y., 175; 8:17, WBZ, Springfield, Mass., 175; 8:20, WCAE, Pittsburgh, Pa., 375; 8:25, WEAN, Providence, R. I., 150; 8:30, KYW, Chicago, Ill., 800 miles.

One-half hour intermission.  
Time of Second Half, 9:00 to 10:30—9:00, KSD, St. Louis, Mo.,\* 1,100 miles; 9:07, WOC, Davenport, Iowa, 1,100; 9:15, WSB, Atlanta, Ga., 800; 9:20, WOAP, Chicago, Ill., 800; 9:25, WJAX, Cleveland, O., 600; 9:30, WHAS, Louisville, Ky., 700; 9:40, WJAR, Providence, R. I., 160; 9:45, WKB, Kansas City, Kansas,\* 1,250; 9:50, WLW, Cincinnati, Ohio, 625; 9:55, WGI, Medford Hillside, Mass., 250; 10:00, WNAC, Boston, Mass., 200; 10:05, CFCA, Toronto, Canada, 600; 10:15, WIP, Philadelphia, Pa., 125; 10:20, WGM, Atlanta, Ga., 800; 10:25, PWX, Havana, Cuba,\* 900 miles.

\*Stations heard first time.

## MAGNAVOX Pioneers in the Radio Field

IT was in 1913 that the Magnavox electro-dynamic receiver made its first public demonstration, when telephone communication was held between Denver and New York—a revolutionary advance.

The rise of radio broadcasting found Magnavox apparatus already perfected and in successful use.



### R 2 Magnavox Radio with 18-inch horn



THIS instrument is intended for those who wish the utmost in amplifying power: for large audiences, dance halls, etc., but requires only .6 of an ampere for the field.

Price, \$60.00

### R 3 Magnavox Radio with 14-inch horn

SAME in principle and construction throughout as Type R-2.

Is ideal for use in homes, offices, amateur stations, etc.

Requires one ampere field current from your filament battery.

Price, \$35.00

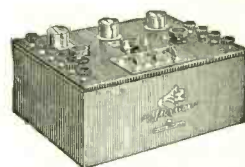

### Magnavox Power Amplifier—Model C

CAN be used with any "B" Battery voltage which the power tube may require for best amplification.

AC-2-C, 2-Stage ..... \$55.00  
AC-3-C, 3-Stage ..... \$75.00

The facilities and experience back of each piece of equipment bearing the Magnavox trade mark are unrivalled anywhere in the world.

Magnavox products may be had of good dealers everywhere.

Write to us for illustrated booklet

The Magnavox Company  
Oakland, California

New York Office: 370 Seventh Ave.



# Latest Radio Patents

## Actuator for Electric Appliances

No. 1,446,652: Patented Feb. 27, 1923. Patentee: Shiras Morris, Hartford, Conn.

THIS invention relates to what might be broadly termed an actuator for an electric appliance, such as is utilized in wireless work. Such an appliance that is in common use involves a spindle, which is turned by an actuator or dial.

There is in every-day use a wireless cabinet equipped with a spindle with which is associated a knob. This knob in the old structure is attached to its spindle by a binding screw, which is exceedingly objectionable in that it left a metal part exposed. It has been essayed to cover the knob by a cap, which is usually of the same composition as that of the knob, the two parts being usually detachably associated by interengaging threads so as to present what might be considered a duplex cap or dial for a spindle. I provide an actuator or dial for a spindle in one piece from suitable composition, and its exterior has no objectionable

projections, yet, by virtue of the invention, when such an actuator is connected with a spindle the latter can be rotated readily

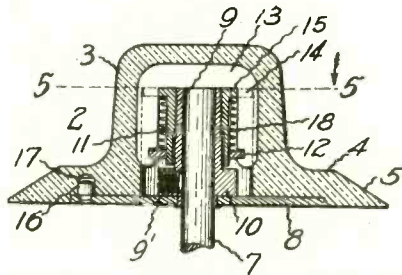

Morris' insulated actuator for radio electric appliances.

when desired—for instance, in tuning—and it also may be quickly taken from the spindle.

## System of Ether Wave Control

No. 1,447,779: Patented March 6, 1923. Patentee: John Hayes Hammond, Jr., Gloucester, Mass.

Some of the objects of this invention are to provide an improved transmitting station

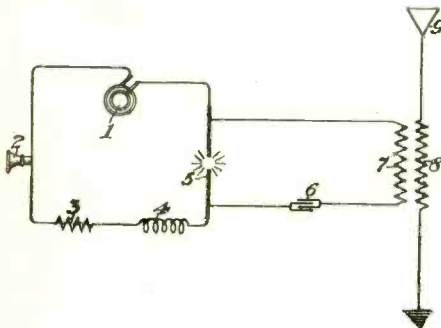

Diagrammatic representation of John Hayes Hammond, Jr.'s, system of ether wave control.

for radiant energy; to provide an improved receiving station for radiant energy; to provide a transmitting station, including means for continuously emitting electro-radiant waves of constant amplitude at high frequency, and a device for increasing the amplitude of certain of said waves at will in response to and in accordance with sound waves in combination with a receiving station, including a telephonic receiver responsive to said waves of increased amplitude, and a signaling device unresponsive to said waves of constant amplitude, but responsive to said waves of increased amplitude; and to provide other improvements.

## Plural Modulation and Demodulation Circuits

No. 1,447,204: Patented March 6, 1923. Patentee: Lloyd Espenschied, Queens, N. Y.

This invention relates to the transmission of signals and more particularly to systems for the multiplex transmission of radio signals.

One of the features of the invention resides in improved methods and means for

securing selectivity between a plurality of signaling channels.

Another feature of the invention relates to methods and means whereby the interval between successive signaling channels may be reduced to a minimum.

Still another feature of the invention has reference to the provision of means and methods whereby the frequency intervals between signaling channels may be fixed or determined either at the transmitting station or receiving station, or both.

These features, together with other features of the invention more fully hereinafter appearing, are realized in a method of operation whereby multiplex channels are collected at the sending station and separated at the receiving station at frequencies which are low, compared with the frequencies used in actual transmission between stations. The essential principle underlying this method is that of a frequency step up and a frequency

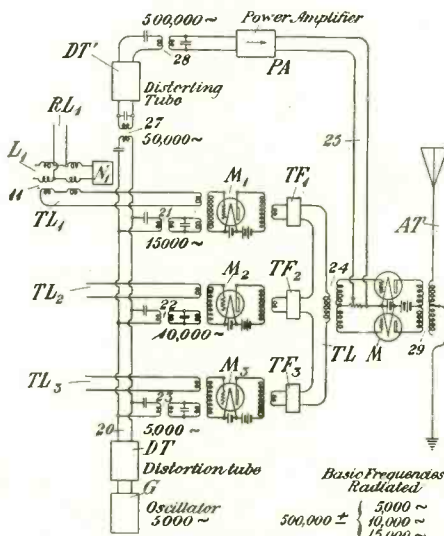

Illustrating Espenschied's plural modulation and demodulation circuit invention.

step down of a plurality of channels in common, in accordance with addition and subtraction of frequencies by modulation.

## A Two-Way Conversation Over 2,000 Miles

By Jeffrey J. Dingman

CFCN, the radio broadcasting station of the W. W. Grant Radio Ltd., at Calgary, Alberta, Canada, which recently accomplished the remarkable feat of conducting a continuous two-way conversation 2,000 miles overland with WHAZ, Troy, New York has a modulating output power of 2,000 watts. When the record breaking conversation with Troy was held Mr. Grant was operating under difficulties and on only 1,000 watts output, and with a generator which has just undergone repairs and was working at only 75 per cent of the full power.

Operation of the rejuvenated set, now one of the most powerful on the continent, was delayed by a devastating fire which destroyed the plant of the W. W. Grant Radio Ltd. CFCN, however, is now equipped with four 500 watt tubes, which were especially manufactured in Montreal, as well as with a specially designed amplification system carrying two 50 watt tubes. A new generator has also been installed and the power of the station has been multiplied four times.

Peculiarly enough, in spite of the vision which might arise in the reader's mind, CFCN is no pretentious establishment. It is a little shack situated on Crescent Heights, in the north end of the city of Calgary, and at a high elevation. Prominent radio engineers from all over the continent who have visited the station here have been amazed to find lacking that which they anticipated, a monumental establishment, with ornate reception rooms and rooms for the talented artists who nightly provide the entertainment for radio enthusiasts the continent over.

The receiving set used to pick up signals from WHAZ, the broadcasting station of the Rensselaer Polytechnic Institute at Troy, on the night of January 12 last when the feat was accomplished, is a Grant-Northern Electric, four tube set, with two stages of radio frequency, one detector and one audio frequency tube. The writer was at the station on the morning of January 13 and could easily hear WHAZ with the headphones held more than two feet away. Hundreds of Calgary and Alberta radio enthusiasts advised CFCN by long distance telephone that they had picked up snatches of the broadcast from WHAZ, while of course they heard the CFCN broadcast in its entirety.

Hundreds of letters poured into the station following the record breaking conversation, one coming from a resident of the Bronx, New York City, who heard Mr. Grant and the Rensselaer Tech both on the night of the record breaking talk. Another came from Alaska, while the majority were from the provinces of Canada and the Western United States.

Achievement of this feat marked an epoch in radiophone broadcasting and established a record for Canada and the United States. If this could be done while CFCN was operating under difficulties and on half of its present output, it is considered that much more marvellous achievements can be attained. At the present time Mr. Grant is negotiating with several far distant stations with a view to arranging a test which will shatter his own record.

W. W. Grant was former chief of the radiophone station of the Canadian government at High River, Alberta, and served with distinction in the European war, having acquired several patents for inventions tending to improve radiophone receiving apparatus, which were utilized to advantage on the battlefields of France. At present he is also operating CHBC, The Morning Albertan station at Calgary.



The Welsh **PEANUT** Detector Tube  
W. T. 501—\$2.00

Can be used in any tube set or to convert any crystal set into tube set. Used on 3 dry cells or one 6-V "A" battery.  
Write for booklet

**RADIO RESEARCH GUILD**  
40 Clinton St. Newark, N. J.

**WHERE SPACE IS LIMITED**

The Na-ald Small-space Socket is moulded from genuine Condensite. Requires but small space for mounting. Special slot reinforcement; virtually unbreakable. No excess metal to interfere with efficiency. Phosphor bronze contacts. Cannot be affected by heat. Exceptional value.  
Equal in quality to any socket using bottom contact.

Attractively boxed. Display container furnished for dealer's counter.

**ALDEN MFG. CO.**  
Formerly Alden-Napier Co.  
Dept. L, 52 Willow Street,  
Springfield, Mass.

**NA-ALD**

No. 401  
\$5 each  
3 for \$1.00

**RUSONITE**  
CRYSTAL RECTIFIER  
MULTIPOINT  
(Patent Pending)

A Synthetic CRYSTAL DETECTOR sensitive over its entire surface

Eliminates all detector troubles. Extraordinary clearness and volume. Endorsed by radio experts and press. Sold in sealed packages only. Join the ever-increasing Rusonite fans.

Price, postpaid, mounted  
Sensitiveness guaranteed **50c**

**RUSONITE CATWHISKER**  
14-Karat Gold Multiple contact.  
Supersensitive **25c**

Order from your dealer or direct from us.  
Rusonite Products Corp., 21 Park Row, N. Y.

**PROTECTION**

**TELERADIO FILAMENT PROTECTORS**

For detector and amplifying tubes. Price, Single Pole 60c., Double Pole, 80c. Renewal fuses 10c. each.

**TELERADIO LIGHTNING ARRESTERS**  
Electrical No. 5837

The only ARRESTER approved by National Board of Fire Underwriters, which retails for \$1.00.  
At your Dealers—Otherwise Send Purchase Price and Give Dealer's Name.

**Teleradio Engineering Corp.**  
486 Broome St., New York  
Makers of Teleradio Supersensitive Phones

**PATENTS**

**To the Man with an Idea**

I offer a comprehensive, experienced, efficient service for his prompt, legal protection, and the development of his proposition.

Send sketch or model and description, for advice as to cost, search through prior United States patents, etc. Preliminary advice gladly furnished without charge.

My experience and familiarity with various arts frequently enable me to accurately advise clients as to probable patentability before they go to any expense.

Booklet of valuable information, and form for properly classifying your idea, free on request. Write today.

**RICHARD B. OWEN, Patent Lawyer**  
32 Owen Building, Washington, D. C.  
2276-P Westworth Bldg., New York City

**Solution for Broadcasting Difficulties Offered**

AN advanced step to eliminate interference between broadcasting stations was taken when the "power-staggered-wave-length-broadcasting plan" was presented by the National Radio Chamber of Commerce to the Hoover conference last week in Washington.

The National Radio Chamber of Commerce has been studying the broadcasting situation for over a year. At the public hearing the power plan was recommended almost in its original entirety, being one of the most constructive suggestions submitted, and meeting with general approval.

Briefly, the "power-staggered-wave-length-broadcasting plan" contemplates the use of three major bands of wave lengths. Broadcasting would be divided into three main divisions, according to the type of program furnished. Programs covering lectures, talks, reports, etc., would be broadcast on a particular wave length band. Classical musical programs would be broadcast on another wave length band, while popular musical programs would be confined to still another wave length.

In addition, the country would be divided into broadcasting districts. Broadcasting stations would operate simultaneously on the three major wave length bands. The plan has been so worked out that there is ample variation in wave lengths, and no two broadcasters will interfere with each other.

In fact, three broadcasters may operate simultaneously in one district without interference, as well as several other broadcasters, in accordance with the time schedule arrangements. The idea back of the whole plan is to give the public what they want when they want it. The receiving sets are tuned to the program desired.

The power plan as recommended by the National Radio Chamber of Commerce was originated by Harold J. Power, of Medford Hillside, Mass. Mr. Power is vice-president of the American Radio and Research Corporation. He was a pioneer in the development of radio, and has devoted much of his time to study of the broadcasting situation, being an active member of the special Broadcasting Committee of the National Radio Chamber of Commerce.

**WDAP Proves Its Power in Unusual Way**

RADIO history was made recently through the efforts of Thorne Donnelly and Elliot Jenkins, in charge of broadcasting at Station WDAP, Drake Hotel, Chicago. While the letters WDAP are merely a designation by the government for this station alone, they have been most appropriately interpreted as meaning "We Do Atlantic-Pacific" in view of the extremely wide range of "pick up" from this powerful inland station, which has been designated as the official broadcasting station of the Chicago Board of Trade.

On the S. S. "Berengaria," clearing 600 miles a day, which sailed from New York January 30th, Miss Florence McDonald had installed a receiving set. From January 30th to February 4th, every day at appointed hours, messages were flashed vocally by Mr. Donnelly, heard and recognized aboard the "Berengaria."

Each time an erroneous statement regarding the length of the Berengaria would be made (newspaper men picked the number haphazard out of a hat a few minutes before the broadcasting) and each time came back the answer from the steamship giving the incorrect length as well as the correct length, now 250 miles out, then 725 miles out, again 1286 miles out, again 1824 miles and so on until the maximum distance was reached. This was the first successful attempt to reach a voyaging ship from an inland station, on a predetermined schedule. No special tubes were used by the Drake station nor in the receiving set.

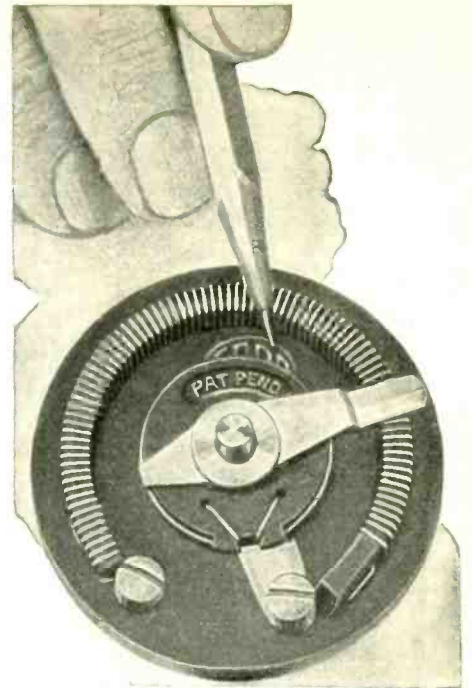

**Fada Rheostats and Potentiometers**

Over a million and a half FADA receiving tube rheostats alone were manufactured during 1922.

FADA vernier rheostats and potentiometers are fast becoming the favorite with the radiophans who construct their own receivers.

|  |        |
|--|--------|
| 120-A Rheostat (5 ohm)...              | \$0.75 |
| 121-A Power Rheostat (1 1/4 ohm) ..... | 1.20   |
| 150-A Vernier Rheostat (5 ohm) .....   | 1.25   |
| 151-A Vernier Attachment.              | .50    |
| 152-A Potentiometer (200 ohm) .....    | 1.00   |
| 153-A Rheostat (8 ohm)...              | 1.00   |
| 154-A Potentiometer (400 ohm) .....    | 1.00   |
| 155-A Vernier Rheostat (8 ohm) .....   | 1.50   |

Send 10c. for FADA Handbook

**F. A. D. Andrea, Inc.**  
1581-W Jerome Avenue  
New York City





**Rexite Synthetic Crystals**

Sensitive over the entire surface.

Dealers—Write for unusual proposition.

**THE AIREX COMPANY**

218 Centre Street

New York

**The dials with absorption losses reduced to a Minimum**

Specially designed cross-section insures minimum loss. Enamel, graduation and numbers are particularly clear. Knob so shaped that fingers do not interfere with easy, accurate reading.

Na-ald dials are moulded from genuine Na-ald material. Rheostat heat will not affect them. They run true; cannot warp.

3-INCH DIAL 35c  
2-inch dial for rheostat potentiometer use, 50c;  
5/8" dial, 75c.

Send stamp for literature.  
**Alden Manufacturing Co.**  
Formerly Alden-Napier Company  
52 Willow St., Springfield, Mass.  
Dept. L.



**Radio and the Coast Guard Save a Lightship Man**

RADIO, a coast guard cutter, and a lifeboat launched through an unusually rough surf at night were instrumental last week in saving the life of John H. Steel, member of the crew of the Fenwick Island lightship, thirty miles off the southeast coast of Cape May, N. J. Early in the evening a message was received at the naval radio station at Cape May from the lightship stating that Steel had been stricken with acute appendicitis and that his life was in danger. The message was relayed to Captain R. C. Weightman, of the cutter Kickapoo, who immediately put out to the lightship in a sea running high. Steel was swung aboard and taken to the Delaware Breakwater, where Captain Lynch, of the Lewes coast guard station, notified in advance, called out the station crew and brought the lifeboat safely through. A waiting automobile took Steel to the government hospital at Lewes, where an operation was performed. Attending surgeons said later that Steel would recover.

**Radio Station Heard 8,000 Miles**

TO be heard 8,000 miles is the record of the radio broadcasting station erected by the International Western Electric Company at the Brazilian Centennial Exposition at Rio de Janeiro," said Col. N. H. Slaughter, one of this company's radio engineers just returned from Rio. "Our signals were heard by a government radio station in Honolulu. This is the long distance record for a 500 watt radio transmitter."

This broadcasting station was installed shortly after the opening of the Brazilian Exposition at Praia Vermelha, a suburb of Rio de Janeiro, where the National Telegraphs, the government bureau of communications, had established as an official section of the Exposition, a special building for radio exhibits. The apparatus used is a standard 500 watt radio transmitter identical with that at WEA, WCC, WSB, and other well-known stations equipped with Western Electric apparatus.

The antenna is of a very unusual type. It is a six wire cage antenna extending 500 feet above the station, the upper end being suspended from a cable strung between the tops of two mountains, Urca and Babylonia, near the famous Sugar Loaf Mountain.

The programs broadcast by this station were received at the exposition and amplified by the Western Electric public address system for the enjoyment of the thousands of visitors there.

This station, SPE, was also used in a point-to-point radio demonstration between Rio de Janeiro and Sao Paulo, 225 miles distant. The speeches of the Brazilian Minister of Agriculture and other government officials and music were transmitted to Sao Paulo where they were received and amplified for a loud speaker which made the entertainment audible to the crowds gathered there. This is also a remarkable feat, as the tests were made in summer and in the daytime when radio transmission is most difficult. In addition the country between is exceedingly mountainous and is covered by a thick tropical verdure which absorbs an excessive amount of the energy passed from one station to another. It proved to be the most difficult location as yet encountered by this company's radio engineers. Their findings will prove an interesting page in the history of radio development.

**PARTS PRICES SLAUGHTERED**

CASH WITH ORDER  
PARCEL POST PREPAID

- \$6.50 Guar. 1 1/2 Volt Tubes (detector and amplifier) for dry cells.....\$4.95
- 5.00 Detector Tubes, guar..... 2.75
- 6.00 Amplifier Tubes..... 3.50
- 1.75 3 Plate Variable Condenser..... 1.25
- 3.75 23 Plate Var. Cond. Molded Ends..... 1.49
- 4.75 43 Plate Var. Cond. Molded Ends..... 2.75
- 1.00 Rheostat..... .39
- 1.50 Klossner Vernier Rheostat..... 1.19
- 5.50 W. D. 11 Transformer and for all dry cell tubes..... 4.50

- \$4.75 Phones, 2200 ohms, splendid receivers.....\$3.75
- 1.00 3-in. Hard Rubber Dial..... .35
- .90 V. T. Sockets..... .60
- 1.50 2 1/2 V. Cyclone B. Batteries..... .89
- 1.75 2 1/2 V. Cyclone B. Batteries..... 1.25
- 4.75 Thordarson Amp. Transformer..... 3.75
- 5.50 Acme Amp. Transformer..... 4.10
- 3.75 Vario Couplers..... 1.75
- 7.00 All Wave Coupler, 3000 Meters..... 6.95
- 5.00 Variometers..... 2.75

To avoid delays check items and total amount.

**B. B. RADIO COMPANY**

2202 MERMAID AVENUE

Dept. W.

BROOKLYN, N. Y.

All Deliveries Made Within Two Days

**DELICATE SOLDERING**

Both the manufacturers' and amateurs' problem on all fine work is readily solved by the instrument constructed for this particular purpose.

**THE POST SOLDERING IRON**

Platinum Heating Unit—Interchangeable Tips—Universal Current  
(Large and Small)

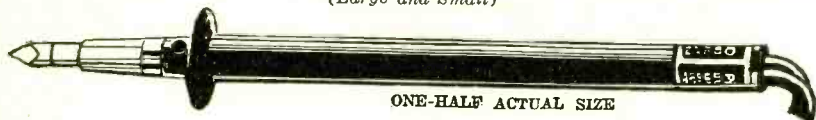

ONE-HALF ACTUAL SIZE

\$6.00

From Your Dealer or Write

Awarded Certificate of Excellency, N. Y. Evening Mail Radio Institute

**POST ELECTRIC COMPANY, (Div. 509) 30 E. 42nd St., New York**

**First for Price, Quality and Service**

All standard merchandise guaranteed.

This is one of the numerous testimonials to the service which we render.

Sunbeam Electric Co., New York City—

12 Wave Ave., Wakefield, Mass.

Feb. 12, 1923.

Gentlemen—Permit me to express my appreciation in the way my recent order was handled for a set of Berwick phones and Dictograph Speaker, both of which were highly satisfactory. Again thanking you for the very prompt attention given my order and for the high grade material supplied. I am  
Very truly,  
(Signed) EDW. L. NUTE.



**SUNBEAM**

- Dictograph Loud Speaker.....\$13.20
- Dictograph Phones..... 5.75
- Federal Phones..... 4.75
- Federal Transformers 226 W..... 5.55
- Federal Potentiometer..... 1.25
- Cutler-Hammer Rheostats..... 1.85
- Cutler-Hammer Ver. Rheostats..... 1.25
- Klossner Vernier Rheostats..... .79
- Acme Transformers..... 4.25
- Ajax Socket-Rheostats..... 1.75

- R. C. Transformers U.V. 712..... \$6.25
- R. C. Transformers U.V. 1714..... 5.75
- Baldwin Loud Speaker Unit..... 4.75
- De Forest Triple Coil Mtg., Type L.C. 100..... 5.85
- Radiant Condensers with geared Vernier—  
43 plate..... 6.00  
23 plate..... 5.00
- Bakelite V.T. Socket..... .49
- Freshman Variable Grid Leak..... .69
- Firth Phone Plugs..... .75

Coil Only 3 Layer, Bank Wound, Silk Wire (Hook-up Furnished with Coil)... \$3.25

Sunbeam Long Wave Variocoupler, 150 to 3000 Meters, Complete with Solid Bakelite Variometer Mounted.....\$11.95

Select your set and write us for prices. We'll do the rest.

**SUNBEAM ELECTRIC COMPANY**

71 THIRD AVE. (Bet. 11th and 12th Sts.)

NEW YORK

Farm Lighting Plants at Bargain Prices. For Yachts, Motor Boats and Country Homes.

**Teaching by Radio to Be Tried Via WJZ**

STUDENTS in the Haaren High School, New York City, will have the distinction of being the first to hold a class without an instructor present. Mr. H. W. Leyenberger, an instructor in machine accounting, will be located in the Waldorf Studio of the Radio Corporation—Westinghouse Station WJZ—and will conduct the class in accounting from there.

This novel experiment, which is taking place with the approval and under the auspices of the Board of Education of New York, is for the purpose of showing how radio can become a great factor in the educational field, both from the instruction and administrative viewpoint.

The experiment will take place on 360 meters. There has been installed in the Haaren High School classroom, where there are thirty accounting machines, a receiving set with loud speaker equipment. Mr. Leyenberger will give specific instructions by radio to the class, who will perform the operations indicated. Another receiving set will be located at the Board of Education in the office of the Associate Superintendent, Dr. Clarence E. Meloney, who is in charge of the high school. He and the other superintendents may then listen to this instruction along with many thousands of people equipped with receivers, working at that time.



**PATENTS**

promptly prepared. Trade Marks registered in the U. S. and abroad. Call or write. **FREE ADVICE.** Phone, Vanderbilt 7312.

**FREE MANUFACTURERS PATENT CO., INC.**  
ROOM 520 FIFTH AVE. NEW YORK

**FREE**

Illustrated Booklet on Radio Frequency Amplification with circuit diagrams and operational characteristics. By **LESTER L. JONES**, Formerly Expert Radio Aid, U. S. N.

**DANZIGER-JONES, INC.**

(Sole Licensees)  
143W PRINCE ST., NEW YORK, N. Y.

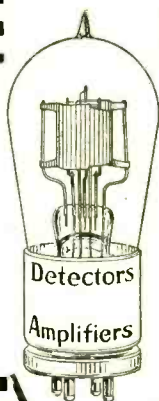

**GUARANTEED REPAIRS**

Broken and Burned-Out

**VACUUM**

**TUBES**

W.D.-11 not accepted for repair

Your dealer should know, but if he does not, send direct to

**HARVARD RADIO LABORATORIES**

Boston 9, Mass.

Tubes returned Parcel Post C. O. D.



The Niftiest Short Wave Tuner on the Market Only \$6.00 & PP on 1 lb. Send for pamphlet.

**L. W. GOODMAN**  
DREXEL HILL, PA.

The GOODMAN is really a high grade instrument, well and sturdily constructed. The PANEL and FANS are GENUINE BAKELITE—the best material known for the purpose.

**Auxiliary Condensers**

THE operation of radio receiving sets can be improved by the use of a very simple and cheap condenser connected across the telephone receivers and a similar one connected in series with the antenna, according to the Bureau of Standards of the Department of Commerce. Longer waves can be received by the use of a very simple type of loading coil. The coil is particularly useful in connection with the single-circuit receiving set.

The auxiliary condenser which is used in series with the antenna, and the loading coil, may also be used when the crystal detector is replaced by an electron tube detector unit, or when an amplifier is added to the receiving set.

The condenser used in series with the antenna makes it convenient to tune to wave lengths less than 300 meters. The condenser used across the telephone receivers increases the intensity of signals which are received from some radio stations. The loading coil enables the equipment to respond to wave lengths above 600 meters, up to about 3,000 meters. Time signals from high power stations can thus be received. The use of the loading coil also increases the receiving distance of the equipment, because many of the higher power stations use longer waves.

**Mr. Albright Points Out an Error**

EDITOR, RADIO WORLD; I have just received the March 17 issue of RADIO WORLD, in which you published my article, "How to Build a One-Tube, Dry-Cell Set." I notice that the cut of the circuit shows a connection between the aerial and ground across the inductance coil. It seems that you have reproduced this cut from the pencil drawing, so I must have shown it so. The set will not function if this connection is made; and, in justice to the many fans who will try this circuit out, I wish that you would call their attention to this error.

I have written to about a hundred and fifty fans who have asked me for the circuit, and I have advised them to get RADIO WORLD and read the article.

Thanking you in advance for calling your readers' attention to the error, I remain

Very truly yours,  
Englewood, Colo. P. F. ALBRIGHT.  
March 30, 1923.

**RADIO TUBES REPAIRED**

"Guaranteed Equal to New"

**FOUR DAY SERVICE**

6 V. Detectors, \$2.50; Amplifiers, \$2.75;

5 Watt Power Tubes, \$4.00

Refilled Tubes Always in Stock

Our repaired tubes speak for themselves.

**Radio Tube Laboratories, Inc.**

776 Broad Street Newark, N. J., U. S. A.

**Standard Merchandise at Cut Rate Prices**

|                                   | List Price | Our Price |
|-----------------------------------|------------|-----------|
| Framingham Plain Rheostats.....   | \$ .75     | \$ .65    |
| Framingham Vernier Rheostats..... | 1.25       | 1.10      |
| Klesner Vernier Rheostats.....    | 1.50       | .90       |
| Klesner Vernier with Dial.....    | 1.50       | 1.30      |
| Freshman Variable Grid Leak.....  | 1.00       | .70       |
| Rapco W.D.-11 Transformers.....   | 5.00       | 3.95      |
| One Two-Way Plugs.....            | 1.00       | .75       |
| Pilot Plugs.....                  | 1.00       | .65       |
| Workrite Variometer.....          | 3.50       | 2.99      |
| Workrite Variocoupler.....        | 3.50       | 2.99      |
| Workrite Headphones.....          | 8.50       | 7.00      |
| Workrite Loudspeakers.....        | 12.00      | 10.00     |
| 3" Dials.....                     | 1.00       | .85       |
| Rapco Phonograph Attachment.....  | 1.00       | .70       |

CASH OR MONEY ORDERS WITH ORDER. RAPCO PAYS ALL PARCELS POST CHARGES.

**RADIO PRODUCTS CO.**

147 West 23rd Street, New York City, N. Y.

**"The Little Wonder"**

FOR BOYS AND GIRLS

**CRYSTAL SETS**

Unassembled-Net **\$3.50**

Catches distinctly everything broadcasted within 30 miles. We also manufacture the "Little Wonder" assembled set at \$5.00.

GUARANTEED TESTED CRYSTALS

Galena 15c Radiosite 20c

Write for Free Catalog

It lists all our radio parts and supplies.

**Holloway Elec. Supply Co., Inc.**  
238 Third Ave. New York City

**TO GET THAT DISTANT STATION**

**USE A COAST COUPLER**

This coupler is designed along strictly scientific lines, and is the result of eighteen months' experiment. Wound with green silk covered wire on Bakelite tubing. Very selective.

Following are a few of the many DX stations received with this coupler, and detector tube only, at Long Beach, California:

- PWX, Havana, Cuba
- WWJ, Detroit, Mich.
- WSB, Atlanta, Ga.
- WDAP, Chicago, Ill.
- CFCN, Calgary, Can.
- WBAP, Ft. Worth, Texas



Make All Remittances Payable to

Our adaptation of a popular hook-up furnished with coupler. Coupler fully guaranteed when hooked up according to instructions.

Coupler and diagram, sold only under our money back guarantee. Mailed anywhere in the United States upon receipt of \$5.00. Post Office or Express money order.

**COAST COUPLER COMPANY**  
321 WEST SEVENTH ST. LONG BEACH, CALIFORNIA



**ECLIPSE RADIO CORP.**  
414 WEST 42nd STREET  
One of Our Specials!  
**\$45.00 WRIGHT SET, \$26.75**  
Here's a set that will solve your long distance problems. Have you seen the "Wright" Hook-up? Come in and inspect it. Complete with tube and B and A batteries.  
A complete line of all standard Radio Supplies at lowest-in-the-city prices.

**B Batteries That Last for Five Years**  
**SIDBENEL RADIO EQUIP. MFG. CO.**  
25 Mt. Eden Ave. 25R New York City

**WE REPAIR YOUR VACUUM TUBES**  
W. D. 11.....\$3.50 U. V. 201 A.....\$3.75  
U. V. 200 & 201 3.00 De Forest A. P. 3.00  
De Forest D. V. 6.....\$3.75  
Our 1-1/2 V. Detector Tubes, \$4.50, are excellent.  
MAIL ORDERS SOLICITED  
**ABALENE RADIO COMPANY**  
416 Broadway, New York City Tel. Canal 5127

**Additional Mail Order Specials**  
Prices on items in last week's issue of Radio World still hold good.

**CONDENSERS**

| Selling Price                       |
|-------------------------------------|
| U. S. Tool—43-P. Vernier.....\$5.00 |
| D. X. Vernier—43-P.....4.50         |
| American—43-P.....2.75              |
| A. Z. Magnus—43-P.....2.00          |
| AETACO—43-P.....1.75                |
| AETACO—23-P.....1.35                |
| AETACO—11-P.....1.00                |
| All 3-Plate Condensers......60      |

**TRANSFORMERS**

**Radio Frequency**

|                                |
|--------------------------------|
| Federal with Mount.....\$5.50  |
| Radio Corp. UV 1714.....5.20   |
| Radio Service RT62RT8.....5.00 |
| Mu-Rad with Mount.....2.00     |

**Audio-Frequency**

|                             |
|-----------------------------|
| Radio Corp UV712.....\$5.60 |
| Federal.....4.50            |
| General Radio.....3.75      |
| Acme.....3.50               |
| Thordarson.....3.00         |
| W. D. 12.....3.50           |
| Creco.....2.45              |
| Amertran.....5.50           |
| DeForest.....3.00           |

**POTENTIOMETERS**

|                        |
|------------------------|
| Federal.....\$0.85     |
| Radio Corp.....1.75    |
| General Radio.....2.45 |
| A. R. S......50        |
| Framingham.....1.10    |

**American Radio Stores**  
235 Fulton Street New York City  
All orders must include postage, and all checks must be certified.

**New Offer of Westinghouse Stock**

THE Westinghouse Electric and Manufacturing Company, at a directors' meeting held last week, authorized the sale of \$14,962,530 additional common stock, which will be offered to stockholders at a subscription price of \$53 a share, to the extent of one share of new stock for each five shares now held. The offer will be made to stockholders of record April 16. Payment for the stock must be made in full by May 31.

Guy E. Tripp, Chairman of the Board of Directors, has issued a letter to stockholders, in part as follows:

"Your company has a large amount of unfilled orders on hand, and is taking additional orders in large volume. In addition the directors believe that there will be a still further enlargement in the demand for your company's products, due to the public attention which is now being directed toward hydroelectric developments, steam railroad electrification, industrial electric manufacturing processes, further development of activities in the radio field, and a widening use of electricity for other purposes, all of which would stimulate still greater activity in your various manufacturing lines.

"After applying the proceeds of the sale of the new issue of common stock the net quick assets of the company, as of March 31, 1923, will amount to \$105,000,000."

**Gen. Harbord Says Production of WD-11 Tubes Is Nearing Demand**

Rumors have been spread that the manufacturers of the WD-11 tube have been holding back production and have as often been denied. Gen. Harbord, president of the Radio Corporation of America, last week issued this statement:

"I give you my word there is no truth in that charge. I have heard it before, and there is no basis for it. On the contrary, we are trying to increase the production of the WD-11 tubes as much as possible. Why should we not? We asked for a production of 7,500 a day of those tubes as long ago as the middle of February. They have now reached a production of 5,000 a day, and in about two weeks I hope they will have reached a production of 10,000 a day. Then the demand will be taken care of very quickly. There have been many blasphemous and scandalous things said about us, on the theory that we were holding up production, but I assure you we are doing our best to meet the demand."

**General Electric Reports a Tremendous Business**

THE annual report of the General Electric Company, as of December 31, 1922, shows total income of \$30,794,966, as compared with \$28,676,683 in 1921, and net income from sales of \$22,736,281, as against \$21,676,683. Profit available for dividends was \$26,231,019, compared with \$21,652,812 in 1921. Cash dividends were \$14,073,628, as against \$13,409,522 the previous year. This left a surplus in excess of cash dividends of \$12,157,391, as compared with \$8,243,290 in 1921. Total surplus was \$73,167,047.

Net sales billed\* were \$200,194,294, as against \$221,007,991 in 1921; but cost of sales declined to \$177,458,012, as compared with \$199,331,308 the previous twelve months. Orders received were \$242,739,527, compared with \$179,721,680 in 1921, an increase of 35 per cent. Unfilled orders at the end of the year were \$76,220,000, as against \$45,391,000 at the close of 1921.

**STANDARD APPARATUS**  
At Attractive Prices. Watch This Column EACH WEEK. It Will Pay You.

**Complete Parts to BUILD YOUR OWN TUBE SET, \$15.00**

|                       |                              |                                  |
|-----------------------|------------------------------|----------------------------------|
| Shamrock Variocoupler | Socket                       | Switch Lever and Switch Points   |
| 3 Inch Dial           | Grid Leak and Grid Condenser | 23 Plate Variable Condenser      |
| 7 x 12 Bakelite Panel | Rubber Binding Posts         | (Made by John Firth)             |
| Klosner Rheostat      | 12 Feet Buss Bar Wire        | Complete Book of Latest Circuits |

A GUARANTEED 1 1/2-Volt TUBE FREE with ABOVE PARTS

**CABINETS** These are carefully constructed of genuine mahogany, hand rubbed. The tops are hinged for easy access to interior. They are made to fit your parlor.

|                   |                   |                   |
|-------------------|-------------------|-------------------|
| 7 x 10.....\$3.35 | 7 x 14.....\$3.75 | 7 x 24.....\$4.50 |
| 7 x 12.....\$3.50 | 7 x 18.....\$4.00 |                   |

**PHONES** N & K. German manufacture, 6000 ohms resistance. Nowhere at any price can you equal the supreme sensitiveness of these phones, and we stand ready to demonstrate this claim to your satisfaction. **\$5.75**

**HEAD SETS**

| List Price                        | Our Price |
|-----------------------------------|-----------|
| \$8.00 Brandes.....Superior.....  | \$5.50    |
| 8.00 Dictograph.....              | 5.75      |
| 8.00 Federal 2200 Ohms.....       | 4.85      |
| 7.50 Stromberg Carlson.....       | 4.75      |
| 6.00 Frost 3000 Ohms.....         | 4.25      |
| 6.00 Royaltone.....               | 3.75      |
| 5.50 Murdock Type 57.....         | 4.10      |
| 12.00 Western Electric 509W.....  | 9.50      |
| 12.00 Baldwin Type C, Master..... | 8.50      |
| 6.00 Baldwin Type C, Single.....  | 4.00      |

**LOUD SPEAKERS**

|                                |          |
|--------------------------------|----------|
| \$161.00 Western Electric..... | \$145.00 |
| 55.00 Western Electric.....    | 50.00    |
| 45.00 Magnavox (New Type)..... | 31.50    |
| 40.00 Callophone.....          | 30.00    |
| 20.00 Dictograph.....          | 15.00    |
| 15.00 Britannia.....           | 12.50    |

**MISCELLANEOUS SPECIALS**

|                                     |                                   |                             |
|-------------------------------------|-----------------------------------|-----------------------------|
| Firth 23 Plate Condenser.....\$1.30 | Firth Crystal Detectors.....1.00  | 180° Variocoupler.....2.79  |
| Firth Triple Sockets......90        | Brach Lightning Arrestor.....1.25 | Variometers.....2.75        |
| Firth Double Sockets......70        | Bulldog Phone Plugs.....1.00      | Vernier Rheostats.....1.35  |
| Millard Rheostats......45           | Three Coil Mountings.....3.50     | 11 Plate Condenser.....1.35 |
| Double Phone Cords......60          | Two Coil Mountings.....2.75       | 43 Plate Condenser.....2.15 |
| Fada Type Switch Levers......23     | Single Coil Mountings......50     | W D 11 Sockets......30      |

**AUDIO TRANSFORMERS**

| List Price                     | Our Price |
|--------------------------------|-----------|
| \$7.00 Federal.....            | \$5.60    |
| 7.00 Radio Corp U. V. 712..... | 5.60      |
| 6.50 Rasia.....                | 5.10      |
| 4.50 Thordarson.....           | 3.00      |
| 6.00 Ampex W. D. 12.....       | 3.95      |
| 5.00 General Radio.....        | 4.35      |
| 6.00 Jefferson.....            | 5.00      |
| 7.00 Amertran.....             | 5.95      |
| 5.00 Acme.....                 | 4.10      |

**PANELS**

| List Price        | Our Price         |
|-------------------|-------------------|
| 7 x 10.....\$1.35 | 7 x 15.....\$1.95 |
| 7 x 12.....1.45   | 7 x 18.....2.50   |
| 7 x 14.....1.85   | 7 x 24.....2.95   |

**HARD RUBBER—Grade A**

|                   |                   |
|-------------------|-------------------|
| 7 x 10.....\$0.90 | 7 x 18.....\$1.45 |
| 7 x 15.....1.35   | 7 x 24.....1.90   |

Full Line of ALL STANDARD SETS and ACCESSORIES at Greatly Reduced Prices  
Write for Our Quotations.  
All Mail Orders Shipped on same day as received. Send Money Order including Postage.

**STUYVESANT RADIO CORPORATION**  
15 E. 14TH STREET, NEW YORK CITY Bet. 5th Ave. and Union Square



## Parts to Make Up REINARTZ CIRCUIT

This circuit is exceptionally quiet in operation. Works on small or indoor aerial. Very selective. Brings in long distance.

|                                |             |
|--------------------------------|-------------|
| 1 Reinartz Coil                | .....\$2.00 |
| 1 23 Plate Condenser           | ..... 1.75  |
| 1 13 Plate Condenser           | ..... 1.15  |
| 1 Socket (Condensite)          | ..... .60   |
| 1 Rheostat Vernier             | ..... 1.25  |
| 3 Switch Levers, Fada Type     | ..... .57   |
| 16 Contact Points              | ..... .16   |
| 1 Grid Condenser               | ..... .15   |
| 8 Binding Posts                | ..... .32   |
| 1 Bakelite Panel               | ..... 2.50  |
| 5 Lengths Bus Wire             | ..... .20   |
| 1 Audion Tube UV 200           | ..... 3.99  |
| 1 22½ V. B Battery             | ..... .98   |
| 1 6 V. 60 Amp. Storage Battery | ..... 9.50  |
| 1 Cabinet, Mahogany Finish     | ..... 3.75  |

Total..... **\$28.83**

Our specialty is making up complete assortment of parts for Flewelling, Reflex, and other circuits.

### WE SELL:

|   |             |
|---|-------------|
| 45 V. "B" Batteries (each)              | .....\$2.25 |
| 6 V. 60 Amp. Marko's Battery            | ..... 9.50  |
| U. V. 200 Tubes                         | ..... 3.95  |
| U. V. 201 Tubes                         | ..... 5.50  |
| U. V. 201A Tubes                        | ..... 6.50  |
| Nathaniel Baldwin Type C, Double Phones | ..... 8.50  |
| Nathaniel Baldwin Type C, Single Phones | ..... 4.50  |
| Brands (Superior) Phones                | ..... 5.95  |

All orders must be accompanied with a money order, postage included.

## GRAND RADIO CO.

1789 Third Ave. 1714 Second Ave.  
NEW YORK CITY

|   |             |
|---|-------------|
| Edison 1½ Volt A Battery                      | .....\$4.75 |
| 150-3000 Meter Couplers with free diagram     | ..... 4.00  |
| 45 Volt B Batteries                           | ..... 1.75  |
| 22½ Volt B Batteries                          | ..... .75   |
| Ames Audio Transformers                       | ..... 3.00  |
| Special W.D.-11 Transformers                  | ..... 3.00  |
| King Variometer                               | ..... 2.25  |
| Small Type Variometer                         | ..... 1.75  |
| Coupler, 14 taps, Pig Tail Connection         | ..... 1.25  |
| Tru-Tone Loud Speaker                         | ..... 4.75  |
| 23 Plate Condensers                           | ..... 1.25  |
| 3 Plate Vernier                               | ..... .75   |
| Radiette Crystal Sets (as loud as a tube set) | ..... 5.00  |

3 lengths of bus wire free with every \$3.00 order or over.

## WHITE RADIO CO.

123 E. 23rd St. New York City  
Cash with Order—Wholesale, Retail

## YOU DX HAMS!

Have you seen the hook-up with complete panel layout in full size and all construction details in RADIO WORLD No. 43, dated Jan. 30?

This hook-up actually goes out and draws the distance in, and lays it at your table.

All that is necessary is to lay the full-page diagram of the panel on your own panel and drill and mark your holes. Simple, isn't it?

If you haven't this copy, send 15 cents to Radio World, 1493 Broadway, New York, N. Y., and copy will be mailed you. Or start your subscription with that number.

## RADIO WORLD

TELEPHONE, BRYANT 4786  
PUBLISHED EVERY WEDNESDAY (Dated SATURDAY OF SAME WEEK)  
FROM PUBLICATION OFFICE,  
1493 BROADWAY, NEW YORK, N. Y.  
BY HENNESSY RADIO PUBLICATIONS CORPORATION

ROLAND BURKE HENNESSY,  
President and Editor

M. B. HENNESSY, Vice-President  
FRED S. CLARK, Secretary and Manager  
1493 BROADWAY, NEW YORK, N. Y.

European Representative: The International News Co., Breams Bldgs., Chancery Lane, London, Eng.

Managing Editor: Stephen L. Coles  
Technical Editor: Robert L. Dougherty

### SUBSCRIPTION RATES

Fifteen cents a copy. \$6.00 a year. \$3.00 for six months. \$1.50 for three months. Add \$1.00 a year extra for foreign postage. Canada 50 cents.

Receipt by new subscribers of the first copy of RADIO WORLD mailed to them after sending in their order, is automatic acknowledgment of their subscription order.

### ADVERTISING RATES

One page: One time—\$150.00.  
Half Quarter, Third and Two-thirds pages at proportionate rates.

One inch, one time—\$5.00. Per agate line \$0.40.

On four consecutive issues, 10% discount.  
On thirteen consecutive issues, 15% discount.  
Cover and preferred-position rates made known on application.

Terms: 30 days net. 2% 10 days.

### CLASSIFIED ADVERTISEMENTS

Five cents per word. Minimum, 10 words. Discount of 10% on 4 consecutive issues—15% on thirteen consecutive issues. Cash with order.

Entered as second-class matter, March 28, 1923, at the Post Office at New York, New York, under the act of March 3, 1879.

### IMPORTANT NOTICE

While every possible care is taken to state correctly matters of fact and opinion in technical and general writings covering the radio field, and every line printed is gone over with a scrupulous regard for the facts, the publisher disclaims any responsibility for statements regarding questions of patents, priority of claims, the proper working out of technical problems, or other matters that may be printed in good faith and on information furnished by those supposed to be trustworthy. This statement is made in good faith and to save time and controversy in matters over which the publisher cannot possibly have control.

## A Good Thing—Pass It Along!

An especially valuable article is that published in this issue of RADIO WORLD on the construction of a new form of two unit radio receiver. In writing this description of the set as well as in the careful drawing of the plans, the author has taken nothing for granted except to assume that the reader has a slight knowledge of an aerial and knows one radio instrument from another. This article is just the thing for an established amateur to turn over to a comrade who has not a radio set but who is thinking of building one. The more advanced readers of RADIO WORLD can further the common cause by telling prospective amateurs about this interesting article.

## How to Drill Holes in Glass

Grind a three-cornered file to a sharp point and use it as a drill after first pouring turpentine on the glass at the point where the hole is to be.

## FOR ONLY \$7.00

You get all the parts necessary to build complete

# OUR RADIO PUP SET

We get favorable comments from all who have built it.

IT HAS MADE GOOD! THE BEST BUY OF ITS KIND EVER ASSEMBLED!

We have all the "Hard-to-Get" Radio Supplies at Prices That Are Right.

MAIL ORDERS PROMPTLY FILLED

Electric Service Engineering Co., 105 West 47th Street, New York  
Bryant 2743

## Which are you?

A small timer or do you bat in the Big League?

Do you like to reach over states and pull in the breezy line from the far West or hot stuff from down in Texas, or maybe the business twang of the good old East? Now that you've answered this questionnaire, remember that if you want Distance you want instruments built for Distance.

## A Word to the Wise: Buy DX Instruments from D-X-Radio

### Audio Frequency Transformers

Thordarson, \$2.45 Navy Type D, \$3.95  
Acme, \$4.00

Genuine "Bull Dog Grip" Plug, 65c

### RHEOSTATS

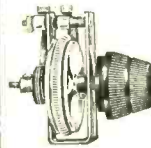

Genuine Cutler Hammer Product. Necessary for fine adjustment. Reg. Price, \$1.50. Our Price .....\$1.25  
Cutler Hammer Plain, regularly sold at \$1.00. Our Price .....80c.  
D. X. List, \$1.00—Our Price .....60c.

### Mail Order

Write out your choice and pin a Post Office Money Order to it. Mail at once to our Mail Order Department. Checks or stamps not accepted. Merchandise shipped postpaid East of the Mississippi.

For Free Catalogue Write Dept. 84D

# D-X-Radio Co.

123 Liberty St. New York City

## GET STATIONS

You Never Heard Before

If you want real distance and clear signals you must use the

## FRESHMAN

Variable Resistance Leak

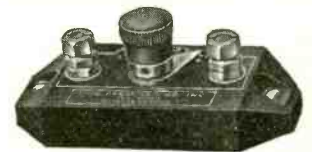

The latest and most essential part of an efficient tube set.

COMBINED WITH .00025 MFD. MICON CONDENSER ..... **\$1.00**

Affords an unbroken range—Zero to 5 Megohms. Clarifies signals, Lowers filament current, Eliminates hissing, Increases battery life.

VARIABLE RESISTANCE LEAK WITHOUT CONDENSER ..... **75c**

At your dealers—otherwise send purchase price and you will be supplied postpaid.

Chas. Freshman Co., Inc.  
106 Seventh Ave. New York City

PROLONGS LIFE OF TUBES

## AMPERITE

AUTOMATIC FILAMENT CURRENT ADJUSTER  
ELIMINATES RHEOSTATS  
EXPELS ALL TUBE TROUBLES

FROM YOUR DEALER OR  
RADIALL COMPANY  
99 WARREN STREET NEW YORK \$1.10 WITH MOUNTING



DO YOU WANT TO BUY, SELL OR EXCHANGE RADIO OR OTHER GOODS? TRY THIS DEPARTMENT AT 5c A WORD

# RADIO WORLD'S QUICK-ACTION CLASSIFIED ADS

This department is intended for everybody who wants quick action on short announcements covering the buying, selling, exchanging or general merchandising in the radio field. Readers of RADIO WORLD will find that it pays to read these columns every week. Advertisers will get a ten-day service here—that is, copy received for this department will appear in RADIO WORLD on the news-stands ten days after copy reaches us.

The rate for this RADIO WORLD QUICK-ACTION CLASSIFIED AD. DEPT. is 5c. per word (minimum of 10 words, including address), 10% discount for 4 consecutive insertions, 15% for 13 consecutive insertions (3 months). Changes will be made in standing classified ads. If copy is received at this office ten days before publication, RADIO WORLD CO., 1493 Broadway, N. Y. C. (Phone, Bryant 4796).

**TUBE SET, \$5.50.** Vernier Rheostat, Variable Condenser, Dial, Coil, Leak, Socket, Posts, Panel, Wire, Instructions. Circuit has heard 1,000 miles. Kinsman, 4625 N. Hermitage, Chicago.

**EVEREADY** storage battery, 90 amperes, 6 volts, \$13.00. Brandes phones, \$6.00, postpaid. William Wilcox, 349 West 52nd St., New York City.

**RADIO FREQUENCY AMPLIFICATION.** Get the best results with radiophone reception. Long distance reception, purity and volume of tone reproduction, static reduction and selectivity. We have working plans, blue prints, with exact specifications of parts to assemble to construct a three tube set. Gives marvelous results. Save worry and experimentation in building one of these sets. Any amateur can build. Guaranteed results. Sent for \$1.00, postpaid. Research Laboratories, Carthage, Mo.

**MAGNAVOXES** in original boxes, brand new. List, \$45.00. Our price is less than wholesale. Shipped in any quantity at \$29.50. We ship the day your order arrives. Leumas Laboratories, 309 Fifth Ave., New York.

**THE ANNIVERSARY NUMBER** of Radio World was increased in size and an exceptional issue. A few copies left at 15c. each, or you may start your subscription with that number. Radio World, 1493 Broadway, New York.

**WOULD YOU LIKE TO RECEIVE RADIO LITERATURE?** Are you in the market for radio goods of any kind, either as a consumer, a distributor or a retailer? If so, send us your name and address on a post card and we will see that your name reaches the right people so that you will receive pamphlets, circulars, etc., regarding the goods you want. Address SERVICE EDITOR, RADIO WORLD, 1493 Broadway, New York City.

**SWISS VOLTMETER 3-0-3.** Stained wood case, brass hinges, catches and spring terminals on Ebonite panel, carrying strap, three gravity cells; weight eight pounds, 11x8x5 1/2x4 1/2 inches. Best cash offer or consider exchange. Fred P. Honnan, Halifax, Canada.

**EXCHANGE LETTERS** with friends everywhere. Pleasant pastime. Information for stamp. Smith, Box 3125, M. Portland, Ore.

**CHEAPEST TO BUILD**—Easiest to tune. Get particulars Rokay Single Control Hook-up. Describe your set. Rokay Electric Company, Ingomar, Ohio.

**RAND-McNALLY RADIO MAP OF UNITED STATES**—Is 28 x 30 inches in size. The locations of broadcasting stations are shown by distinctive symbols. The call letters of each station are given, also the wave lengths of each. The Radio Districts with numbers are shown in red and the Radio Relay Divisions are in blue. Time zones are included. Alphabetical lists of stations and alphabetical lists of call letters are in the margins. Convenient pocket form with cover. Price, 35c. The Columbia Print, 1493 Broadway, New York City.

**DO YOU WANT TO SAVE MONEY** in making your set? Send for the Jan. 27 issue of RADIO WORLD, containing a full-page drawing of how to make filament control rheostats, as well as an easily understandable text, which makes the construction easy. 15c a copy, or start your subscription with this issue. RADIO WORLD, 1493 Broadway, New York.

**STATEMENT OF THE OWNERSHIP, MANAGEMENT, CIRCULATION, ETC., REQUIRED BY THE ACT OF CONGRESS OF AUGUST 24, 1912.**

Of Radio World, published weekly at New York, N. Y., for April 1, 1923.  
State of New York.  
County of New York, ss:

Before me, a Notary Public, in and for the State and County aforesaid, personally appeared Roland Burke Hennessy, who, having been duly sworn according to law, deposes and says that he is the Editor of the Radio World, and that the following is, to the best of his knowledge and belief, a true statement of the ownership, management (and if a daily paper, the circulation), etc., of the aforesaid publication for the date shown in the above caption, required by the Act of August 24, 1912, embodied in section 443, Postal Laws and Regulations, printed on the reverse of this form, to wit:

1. That the names and addresses of the publisher, editor, managing editor, and business managers are: Publisher, Hennessy Radio Publications Corporation, 1493 Broadway, N. Y. C.; editor, Roland Burke Hennessy, 1493 Broadway, N. Y. C.; managing editor, Stephen L. Coles, 1493 Broadway, N. Y. C.; business manager, Fred S. Clark, 1493 Broadway, N. Y. C.

**SUPER-SIMPLICITY CIRCUIT**—1,000 to 1,500 miles on one tube, one control, 150 to 25,000 meters. No rheostat, storage battery, vario coupler, variometer, 3-coil mounting, variable inductance, taps or radio frequency. Nothing to guess about. Complete hook-up and particulars, \$1.00. No checks. Build your own. Save 50% and get better results. RADIO EXPERIMENTAL LABORATORY, Box 194A, Berkeley, Calif.

**BEAUTIFUL WHITE TEETH**—YOU can have beautiful white teeth without toothbrush, pastes or powders. No matter how badly discolored your teeth are, this harmless secret will make them white. Economical, sanitary. Price, 25c. AMERICAN SALES CO., Box 1278, San Francisco, Calif.

**CASH FOR OLD GOLD, Platinum, Silver, Diamonds, Liberty Bonds, War, Thrift, Unused Postage Stamps, False Teeth, Magneto Points, Jobs, Any Valuables.** Mail in today. Cash sent, return mail. Goods returned in ten days if you're not satisfied. OHIO SMELTING CO., 337 Hip-podrome Bldg., Cleveland, Ohio.

**MANUFACTURERS**—Rights on absolutely the best crystal detector yet developed for sale. Seven to eleven sensitive spots always in reserve. Low manufacturing cost. RADIO EXPERT, 77 Walnut St., Norfolk, Va.

**EXCHANGE JOLLY, INTERESTING LETTERS** through our club. Stamp appreciated. Betty Lee, Inc., 4254 Broadway, New York City

**OLD MONEY WANTED**—\$2.00 to \$500.00 EACH paid for hundreds of Old and Odd Coins. Keep all old money. Send 10 cents for New Illustrated Coin Value Book, 4x6. You may have valuable coins. Get posted. We pay CASH. Clarke Coin Company, Ave. 83, Le Roy, N. Y.

**IF YOU ARE A REGULAR RADIO fan** and like to hear the stations in the four corners of the United States come in with a bang, then you will want the Flewelling Circuit. If you do, send 15c for RADIO WORLD, issue of Feb. 24, which contains complete description and directions for the manipulation of the circuit. RADIO WORLD, 1493 Broadway, New York.

**MODEL MAKING**—By Raymond Francis Yates. A new book for the mechanic and model maker. This is the first book of its kind to be published in this country, and all those interested in model engineering should have a copy. The first eight chapters are devoted to such subjects as Silver Soldering, Heat Treatment of Steel, Lathe Work, Pattern Making, Grinding, etc. The remaining twenty-four chapters describe the construction of various models such as rapid fire naval guns, speed boats, model steam engines, turbines, etc. 400 pages. 301 illustrations. Price, \$3.00. The Columbia Print, 1493 Broadway, New York City.

**STANDARD ELECTRICAL DICTIONARY**—By Prof. T. O'Connor Sloane. Just issued an entirely new edition brought up to date and greatly enlarged—a reference book this work is beyond comparison, as it contains over 700 pages, nearly 500 illustrations, and definitions of about 6,000 distinct words, terms and phrases. The definitions are terse and concise and include every term used in electrical science. 767 pages, 477 illustrations. (See page 18 for fuller description.) Price, \$5.00. The Columbia Print, 1493 Broadway, New York City.

2. That the owners are: (Give names and addresses of individual owners or, if a corporation, give its name and the names and addresses of stockholders owning or holding 1 per cent or more of the total amount of stock): Hennessy Radio Publication Corp., 1493 Broadway, N. Y. C.; Roland Burke Hennessy, 1493 Broadway, N. Y. C.; M. J. McArthur, Statler Hotel, Cleveland, Ohio.

3. That the known bondholders, mortgagees, and other security holders owning or holding 1 per cent or more of total amount of bonds, mortgages, or other securities are: (If there are none, so state.) None.

4. That the two paragraphs next above, giving the names of the owners, stockholders, and security holders, if any, contain not only the list of stockholders and security holders as they appear on the books of the company but also, in cases where the stockholder or security holder appears upon the books of the company as trustee or in any other fiduciary relation, the name of the person or corporation for whom such trustee is acting, is given; also that the said two paragraphs contain statements embracing affiant's full knowledge and belief as to the circumstances and conditions under which stockholders and security holders who do not appear on the books of the company as trustees, hold stock and securities in a capacity other than that of a bona fide owner; and this affiant has

**VACUUM TUBE RESULTS WITH A CRYSTAL SET!**—Cover distance with a "PT" ULTRA-SENSITIVE CONTACT in your crystal detector. Beats gold and other ordinary catwhiskers. DOES NOT JAR OUT. Using the "PT," Myrle Wood heard over 43 broadcasting stations in a thousand mile radius! Other users testify: "Heard new stations on first adjustment. Has all advantages you claim. Receives music so loud it hurts my ears." The "PT" has received 3,300 miles through static. Price only twenty-five cents. "PT" CRYSTAL CONTACT COMPANY, Box 1641, Boston, Mass.

**WIRING A HOUSE.** By Herbert Pratt. Shows a house already built; tells just how to start about wiring it; where to begin; what wire to use; how to run it according to insurance rules; in fact, just the information you need. Directions apply equally to a shop. Sixth edition. COLUMBIA PRINT, 1493 Broadway, N. Y. C. Price, 35 cents.

**HOW TO BECOME A SUCCESSFUL ELECTRICIAN**—By Prof. T. O'Connor Sloane. An interesting book from cover to cover. Telling in simplest language the surest and easiest way to become a successful electrician. The studies to be followed, methods of work, field of operation and the requirements of the successful electrician are pointed out and fully explained. 202 pages. Illustrated. Nineteenth revised edition. Cloth. Price, \$1.50. The Columbia Print, 1493 Broadway, New York City.

**BUILDERS AND EXPERIMENTERS.** Do you know that the Reflex circuit is one of the most interesting circuits to construct? You can not guess how much fun you are missing if you fail to try out at least one of these circuits. See RADIO WORLD issues of Feb. 24 and March 3. They contain two fine articles by W. S. Thompson, with plenty of new Reflex circuits to experiment with. Don't miss these! 15c a copy. RADIO WORLD, 1493 Broadway, New York City.

**TWENTIETH CENTURY BOOK OF RECIPES, FORMULAS AND PROCESSES**—Edited by Gardner D. Hiscox. This book of 800 pages is the most complete book of recipes ever published, giving thousands of recipes for the manufacture of valuable articles for every-day use. Hints, helps, practical ideas and secret processes are revealed within its pages. It covers every branch of the useful arts and tells thousands of ways of making money and is just the book everyone should have at his command. The pages are filled with matters of intense interest and immeasurable practical value to the photographer, the perfumer, the painter, the manufacturer of glues, pastes, cements and mucilages, the physician, the druggist, the electrician, the dentist, the engineer, the foundryman, the machinist, the potter, the tanner, the confectioner, the chiropodist, the manufacturer of chemics, novelties and toilet preparations, the dyer, the electroplater, the enameler, the engraver, the glass worker, the gold-beater, the watchmaker, the jeweler, the ink manufacturer, the optician, the farmer, the dairyman, the paper maker, the metal worker, the soap maker and the technologist in general. A book to which you may turn with confidence that you will find what you are looking for. A mine of information up-to-date in every respect. Contains an immense number of formulas that everyone ought to have that are not found in any other work. New edition. 807 octavo pages. Cloth binding. Price, \$4.00. The Columbia Print, 1493 Broadway, New York City.

no reason to believe that any other person, association, or corporation has any interest direct or indirect in the said stock, bond, or other securities than as so stated by him.

5. That the average number of copies of each issue of this publication sold or distributed, through the mails or otherwise, to paid subscribers during the six months preceding the date above shown is \_\_\_\_\_ weekly. (This information is required from daily publications only.)

ROLAND BURKE HENNESSY, Editor.

(Sworn to and subscribed before me this 31st day of March, 1923.

KARL E. GOTTFRIED.

Notary Public, New York County, New York County Clerk's No. 304. New York Registers No. 4228. Commission expires March 30, 1924.

Note.—This statement must be made in duplicate and both copies delivered by the publisher to the Postmaster General (Division of Classification, Washington, D. C., and retain the other in the files of the post office. The publisher must publish a copy of this statement in the second issue printed next after its filing.



We Will Mail You One



COMPARE IT WITH WHAT YOU ARE NOW USING OURS IS BETTER MAIL US 30 CENTS IF NOT Return it at Our Expense

ZOBEL-STEIN LABORATORIES  
322 9TH ST. BROOKLYN, N.Y. SOUTH 2650

*We Recommend For Investment*

**HENNESSY  
RADIO  
PUBLICATIONS  
CORP.**

8%  
**PREFERRED STOCK**

(Publishers Radio World)

*Complete details sent free upon request*

**Frank T. Stanton & Co.**

*Specialists in  
Wireless Securities Since 1917.*

**35 Broad St. New York**  
Tel. Broad 5819-1670-3641

Fifty-two issues for \$6.00. Sub. Department, Radio World, 1493 Broadway, New York City.

**RADIO WORLD INSPIRES  
HIGH PRAISE**

Editor Radio World:

It is both a pleasure and an honor to congratulate you upon the successful completion of the first year of RADIO WORLD.

We know of no other magazine in the whole wide world that gives so much up-to-date radio news and wireless information as RADIO WORLD. Indeed, we know of only one other weekly wireless publication, and that is the official organ of the Wireless Society of London.

We believe that RADIO WORLD easily stands at the head of all the wireless publications. We are subscribing to twenty of them. We have two subscriptions with you and are proud to maintain our file complete from Volume 1, Number 1 on.

We wish you continued success from a literary as well as a financial standpoint, and it seems to us that anyone interested in radio or wireless, once he has seen RADIO WORLD, should not hesitate to subscribe to it.

Monthly publications are all right, but what radio fan wants to wait a month to read something new?

Yours very truly,  
P. C. KULLMAN & CO.

New York City,  
March 31, 1923.

**British to Investigate Transatlantic Wireless Phone**

WITH a view to investigating the possibility of developing commercial wireless telephony across the Atlantic Ocean the Postmaster General of Great Britain has appointed a committee, which includes Admiral Sir Henry Jackson, Major General F. H. Sykes and a number of technical experts, to advise what practical steps may be taken in the premises. The Postmaster General says it is understood the telephone authorities in the United States are willing and anxious to co-operate.

**Radio Fan Goes to See Opera After Broadcast**

AFTER hearing the broadcasting of the Wagnerian opera "Die Meistersinger" several weeks ago from the Radio Corporation-Westinghouse Station WJZ in Newark, N. J., John E. DeShazo, a Newark fan was so impressed that he decided to see the opera first hand. Here is a case where radio helped to popularize the opera and the sale of tickets for the theatre. Mr. DeShazo bought seats to see "Tannhauser" which was broadcast from WJZ not long ago.

**PRICES  
REDUCED**

ON

Saturn  Products

HAVING had more than the anticipated success in the sale of our goods, we are pleased to inform the trade that the correspondingly larger output caused lower production cost, and consequently we are now in a position to lower our list prices.

THIS reduction is for the United States only and went into effect Feb. 28th.

**The New Prices Are:**



**The Saturn  
Automatic  
Radio Plug**

The Plug with the RED SEAL

**\$1.25**

**The Saturn "PERFECT" Jack**



- No. 1. Single Circuit, Open . . . \$0.50
- No. 2. Single Circuit, Closed . . 0.55
- No. 3. Double Circuit, Closed . . 0.70
- No. 4. Single Filament Control 0.75
- No. 5. Double Filament Control 0.80

Now the best at the price of common goods

**The Saturn Mfg. & Sales Co., Inc.**  
Dept. R. W.  
48 Beekman Street  
New York, N. Y.

**FILL OUT AND MAIL NOW**

SUBSCRIPTION BLANK

**RADIO WORLD**

RADIO WORLD

1493 Broadway, New York City

Please send me RADIO WORLD for ..... months, for which please find enclosed \$.....

SUBSCRIPTION RATES:

Single Copy ..... \$ .15  
Three Months ..... 1.50  
Six Months ..... 3.00  
One Year, 52 Issues ..... 6.00  
Add \$1.00 a Year to Foreign Postage, 50c for Canadian Postage.



IF YOU ARE INTERESTED IN RADIO YOU NEED THESE BOOKS

# RADIO BOOKS THAT HELP YOU

Telling How to Operate a Radio Set—How to Build a Set—Principles of Vacuum Tubes and Other Radio Problems

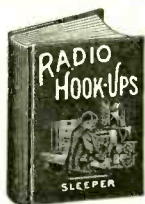

## Radio Hook-Ups

By M. B. SLEEPER

A book that gives you not only clear diagrams for all kinds of telephone and telegraph receiving and transmitting sets, but simple descriptions of each circuit shown and spaces for notes of results obtained.

PRICE 75c.

## Construction of New Type Transatlantic Receiving Sets

By M. B. SLEEPER

There is a peculiar fascination about receiving radio messages from the high-power stations of England, France, Germany, Russia and Italy, as well as those located in the Pacific Ocean and the Oriental countries. Several types of simple receiving sets for this purpose are described, with detectors and amplifiers to accompany them. Suggestions are also given for operating relays and reproducing the signals on a phonograph. Schedules of operating time for high-powered stations are given. In addition, there is some valuable data on home-made wavemeters for testing and experimenting . . . . .PRICE 75c.

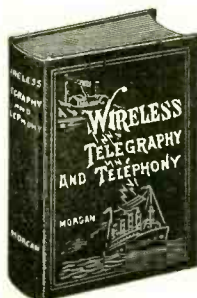

## Wireless Telegraphy and Telephony Simply Explained

By ALFRED P. MORGAN

One of the most complete and comprehensive treatises on the subject ever published. A study of its pages will enable one to master all the details of the wireless transmission of messages. The author explains in simple language the theory and practice of wireless telegraphy and telephony. 154 pages, 156 engravings. . . . .PRICE \$1.50



## Design Data for Radio Transmitters and Receivers

By M. B. SLEEPER

The only book that gives tables and data for designing, receiving and transmitting apparatus so that you need no knowledge of mathematics. It's the first book a beginner buys after he has learned the use of his phone receiver. . . . .PRICE 75c.

## Construction of Radiophone and Telegraph Receivers for Beginners

By M. B. SLEEPER

The man who wants to feel the real thrill of accomplishment, and who is not satisfied in the merely making use of what others have done for him, builds his own radio apparatus. Radio men can follow the data in "Radio Phone and Telegraph Receivers" with full confidence, because each piece of apparatus described was first made, tested and found efficient before the final design was accepted. Special receivers, both crystal and audion, are shown in detail. Regenerative circuits as well as audio and radio frequency amplifiers are described with clear photos, diagrams, and working drawings prepared especially for the novice and the man who wants to receive the radio telephone broadcast. A special feature is the phonograph type radio set and the loud speaker. Fully illustrated. . . . .PRICE 75c.



## The Radio Experimenter's Handbook

By M. B. SLEEPER

Throughout the preparation of this book, one purpose was kept in mind—Answer the Practical Questions of the "Novice," of the "Beginner," and the more advanced "Student." This book will help in the selection or construction of simple apparatus for the transmission and reception of radio telegraph and telephone signals. In the chapters on radio receivers the simplest crystal, the simple audion, and the regenerative types are described in quite some detail. The question of antennas, both for transmitting and receiving, are taken up. A good many helpful suggestions are given which will be of considerable aid to the experimenter. 16 chapters. Fully illustrated. . . . .PRICE \$1.00



## The A B C of Vacuum Tubes Used in Radio Reception

By E. H. LEWIS

Assoc. I. R. E., and Radio Instructor

Written particularly for the person who "knows nothing about radio," but who would like to gain an understanding of the elementary principles of operation of vacuum tubes and various circuits in which they are used for the reception of radio-telegraph signals and radio-telephone music and speech. Illustrated. . . . .PRICE \$1.00

## How to Make Commercial Type Radio Apparatus

By M. B. SLEEPER

This book describes in detail many commercial types of spark and vacuum tube telephone transmitting and telegraph and phone receiving equipment of all kinds. The experimenter will be able to get a world of ideas for the design and construction of his next piece of radio equipment from the very clear descriptions and the 92 clearly illustrated figures. . . . .PRICE 75c.

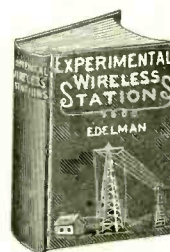

## Experimental Wireless Stations

By P. E. EDELMAN

Tells how to make apparatus to not only hear all telephoned and telegraphed radio messages, but also how to make simple equipment that works for transmission over reasonable long distances. Then there is a host of new information included. The first and only book to give you all the recent important radio improvements, some of which have never before been published. 392 pages, 167 illustrations. . . . .PRICE \$3.00

☐ Any of These Books Sent Prepaid on Receipt of Price  
The 11 Books for \$10.00, to One or Different Addresses

ADDRESS **THE COLUMBIA PRINT**  
ROOM 326, NO. 1493 BROADWAY, NEW YORK



# "My 'Sunshine' Friend"

FOR refreshment, like a draught from a mountain spring; like the open door to cheerful hospitality; like the hush of the evening after the rush of the day—I recommend my 'sunshine' friend—  
Ridgways Tea."

AWARDED THE HIGHEST HONORS OBTAINABLE

Gold Medal  
San Francisco 1915

Grand Prize  
San Diego 1916



## Ridgways Tea



# *Genuine*

## Orange Pekoe Tea

Sold in 1 lb., 1/2 lb., 1/4 lb. and 15c Tins

A GENEROUS SAMPLE WILL BE SENT ON REQUEST

Address: Ridgways Tea Co., Dept. B,  
60 Warren Street, New York.

## The Finest Tea the World Produces



**The Most  
Economical  
Tube Made.  
Burns Only  
.15 Amp.**



**A Tube of  
the Highest  
Quality and  
Workman-  
ship.**

# AN ACHIEVEMENT IN TUBES!

The DELTA is a three-volt dry cell tube, using a 22½ Volt B Battery.

No Grid Leak or Grid Condenser is necessary.

Composition Delta Midget Socket. Nickel plated Case. Spring Brass Contacts. Finely Finished, Handsome Appearance.....40c each

Standard Socket Adapter. Brass Casing. Composition Base. Sure Contacts. 75c each.

**WARNING -- Do not be deceived with imitation "peanut" tubes -- ask for DELTA, the one that is always reliable.**

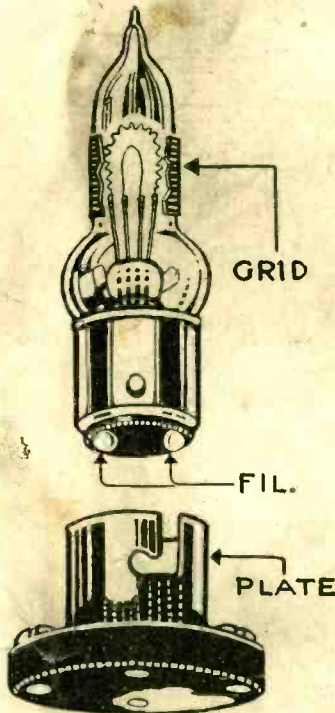

Reg. U. S. Pat. Office  
(Exact Size Tube and Socket)

With a single circuit regenerative tuner, Stations WDAP (Chicago, Ill.), WOC (Dav- enport, Iowa), WWJ (De- troit, Mich.), and intermedi- ate stations were received in a single evening in our lab- oratory in Newark, N. J.

Regular Hook-Up and Our Own Conversion Hook-Up Included Free with Every Tube.

The Delta can be used as a Detector in any successful circuit.

*The name DELTA is on every box that contains our tube. Insist on seeing our trade mark DELTA.*

**The Price Is Only**

# \$2.50

**Guaranteed  
1000 Hours' Service.**

The Delta tube is new. Some dealers have not stocked up yet. So we will ship you, even an individual tube, or as many as you want, same day order is received.

### A FEW OF OUR DISTRIBUTORS

M. & M. Co.  
500 Prospect Avenue  
Cleveland, Ohio

S. S. S.  
Electric Sup. Co.  
65 West 18th Street  
New York City

Berman Radio Co.  
645 Atlantic Avenue  
Boston, Mass.

Kaploy & Ross  
1144 Andolph Street  
Detroit, Mich.

Hampton  
Radio Sales Co.  
839 Market Street  
Philadelphia, Pa.

Dealers, Jobbers and Distributors, Write Us For Quantity Discounts

*Convert That Old Crystal Set Into a Delta Tube Set*

**Same Volume  
As Larger,  
More Expensive  
Tubes**

## DELTA MIDGET TUBE CO.

241 Market Street

Newark, N. J.

**No Tube  
Noises or  
Distortion.  
Clear as a  
Crystal**