

THE GREAT NATIONAL RADIO WEEKLY—15c

# RADIO WORLD

I L L U S T R A T E D

APRIL 15c  
29, A COPY  
1922 1 year, \$6.00  
6 mos., 3.00  
3 mos., 1.50



(c. Underwood & Underwood.)

They radioed from an airplane for charity. Dr. Belvin W. Maynard, flying parson; Jeanette Vreeland, operatic singer, and Thais Magrane on Easter Sunday went up in a Fokker, and their appeal for the American Legion's \$2,500,000 fund was heard from the air.

*In this issue:*  
Clearly  
Explained—  
Aerials, Tuning,  
Variocoupler,  
Storage Battery

Radio  
Primer

OUR AIM IS  
SERVICE

HOW TO CONSTRUCT AERIALS—By Edward Linwood

# KEEP UP TO THE MINUTE ON RADIO!

Read the three interesting and instructive books by

**James R. Cameron**

whose Text Books are used and endorsed by the U. S. Army, Navy and Dept. of Public Instruction.

## HOW TO BUILD YOUR OWN RADIO SET

Full instructions with diagrams and drawings which make it easy for beginner to build his own set.

**25 Cents**

## RADIO DICTIONARY

Words and Terms relative to Radio parts and equipment clearly defined—with Tables and information.

**50 Cents**

## RADIO FOR BEGINNERS

A book that deals with the subject from A. to Z written so that the amateur can understand it.

**\$1.00**

BUY THE FROM YOUR DEALER TODAY OR DIRECT FROM

**Technical Book Co.** 130 West 42nd St. New York

# Naco Radio Receiving Sets

**\$20.00**  
complete without  
condenser



**\$25.00**  
complete with  
condenser

For clear hearing and pleasing tone use a NACO set.

## *Naco Radio Accessories*

Telephones. Knocked down sets. NACO long distance sets are of the highest quality.

STATE MANAGERS WANTED.

*"We are building our radio business for the future, not only for today. Courtesy and discretionate prices prevail"*

***National Motor Accessories Corporation***

1446-1448 Woolworth Bldg., NEW YORK CITY

# RADIO WORLD

[Copyright, 1922, by Radio World Co., New York, N. Y.]

A WEEKLY JOURNAL, PUBLISHED EVERY WEDNESDAY AND DATED SATURDAY BY RADIO WORLD COMPANY, FROM PUBLICATION OFFICE, 1493 BROADWAY, NEW YORK, N. Y.

Vol. I. No. 5.

April 29, 1922

15c. per copy, \$6.00 a year

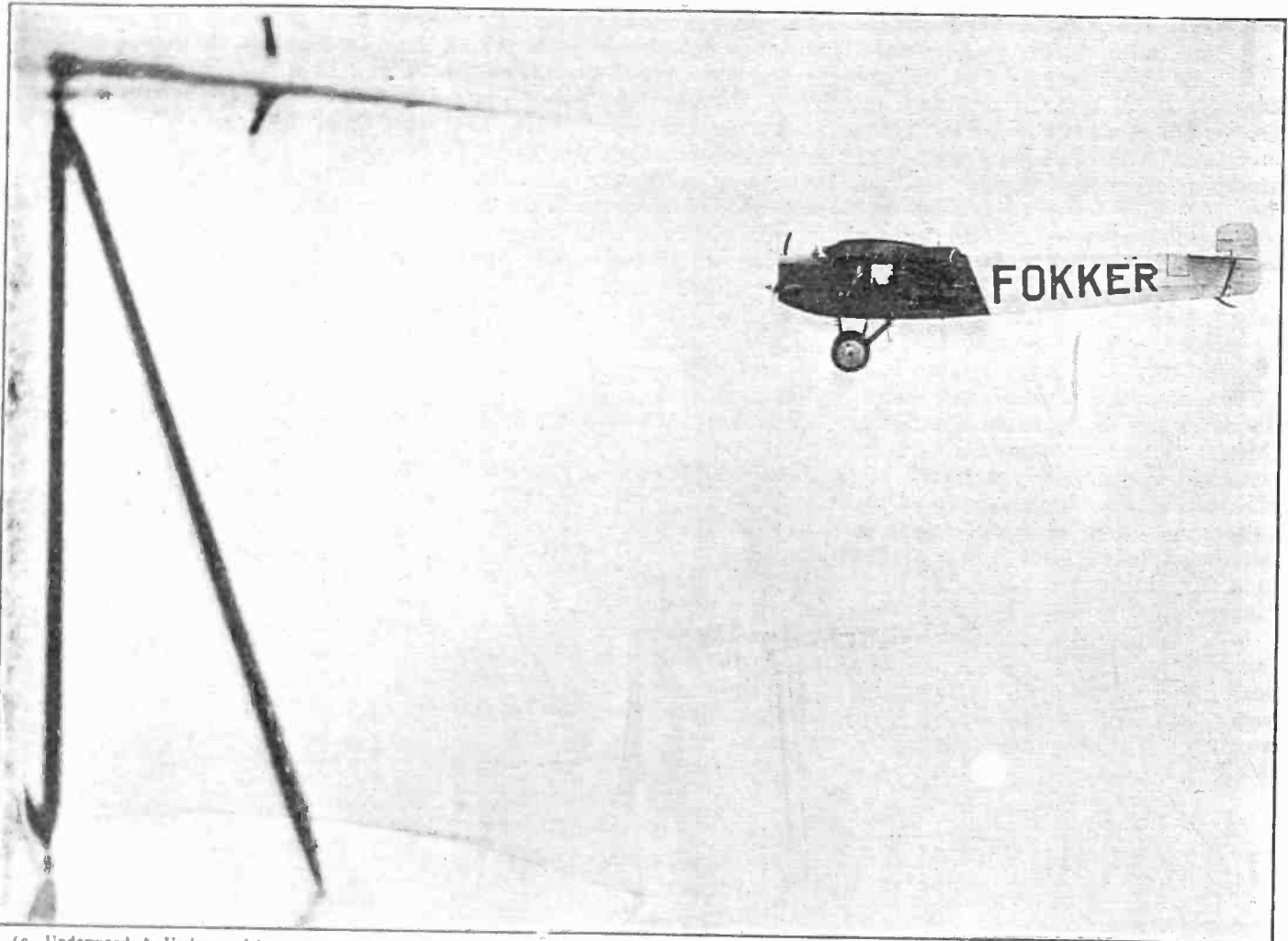

(c. Underwood & Underwood.)

The high-powered passenger Fokker, piloted by Bert Acosta, in which Dr. Maynard, Miss Vreeland and Miss Magrane, pictured on our front cover, broadcasted on 507 meters using a 50-watt, General Electric tube-transmitter.

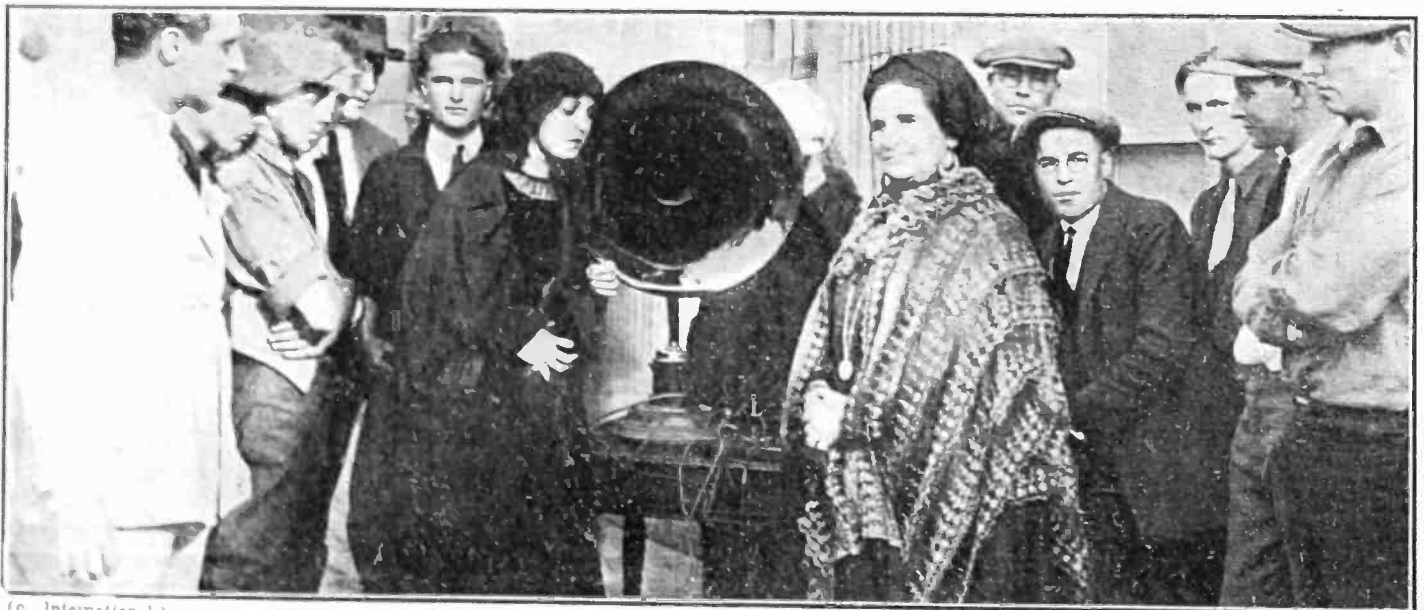

(c. International.)

Moving-picture performers and other cinema workers at the numerous studios in Hollywood, California, derive much pleasure listening in during their idle moments.

# KEEP UP TO THE MINUTE ON RADIO!

Read the three interesting and instructive books by

## James R. Cameron

whose Text Books are used and endorsed by the U. S. Army, Navy and Dept. of Public Instruction.

### HOW TO BUILD YOUR OWN RADIO SET

Full instructions with diagrams and drawings which make it easy for beginner to build his own set.

**25 Cents**

### RADIO DICTIONARY

Words and Terms relative to Radio parts and equipment clearly defined—with Tables and information.

**50 Cents**

### RADIO FOR BEGINNERS

A book that deals with the subject from A. to Z written so that the amateur can understand it.

**\$1.00**

BUY THE FROM YOUR DEALER TODAY OR DIRECT FROM

**Technical Book Co.** 130 West 42nd St. New York

# Naco Radio Receiving Sets

\$20.00  
complete without  
condenser

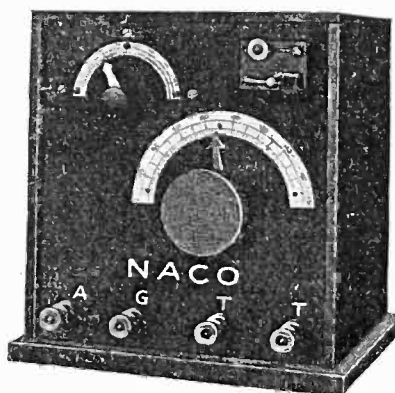

\$25.00  
complete with  
condenser

For clear hearing and pleasing tone use a NACO set.

## *Naco Radio Accessories*

Telephones. Knocked down sets. NACO long distance sets are of the highest quality.

STATE MANAGERS WANTED.

*"We are building our radio business for the future, not only for today. Courtesy and discretionate prices prevail"*

## *National Motor Accessories Corporation*

1446-1448 Woolworth Bldg., NEW YORK CITY



# RADIO WORLD

(Copyright, 1922, by Radio World Co., New York, N. Y.)

A WEEKLY JOURNAL, PUBLISHED EVERY WEDNESDAY AND DATED SATURDAY BY RADIO WORLD COMPANY, FROM PUBLICATION OFFICE, 1493 BROADWAY, NEW YORK, N. Y.

Vol. I. No. 5.

April 29, 1922

15c. per copy, \$6.00 a year

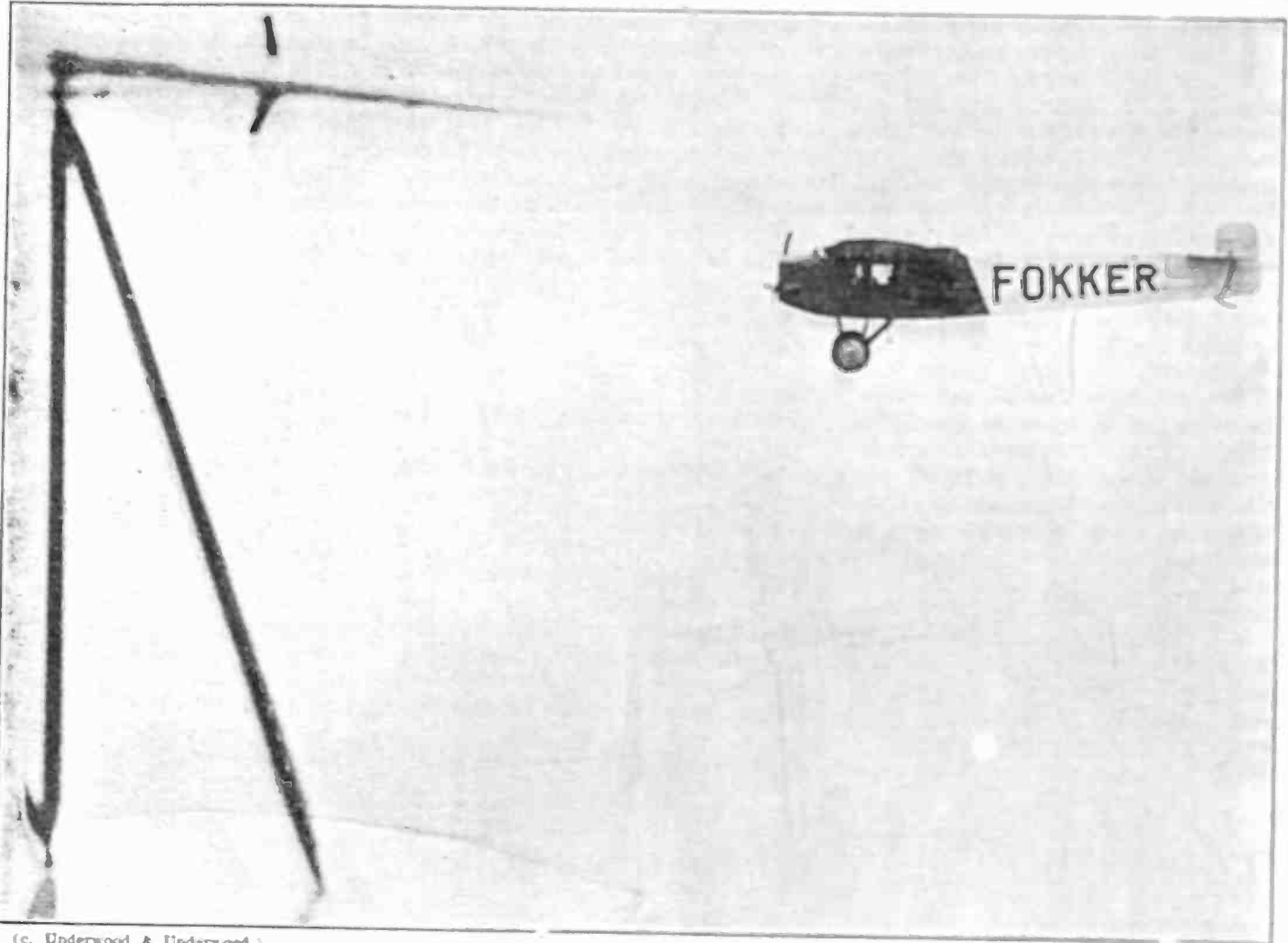

(c. Underwood & Underwood.)

The high-powered passenger Fokker, piloted by Bert Acosta, in which Dr. Maynard, Miss Vreeland and Miss Magrane, pictured on our front cover, broadcasted on 507 meters using a 50-watt, General Electric tube-transmitter.



(c. International.)

Moving-picture performers and other cinema workers at the numerous studios in Hollywood, California, derive much pleasure listening in during their idle moments.

# Earl C. Hanson

Inventor of the Vactuphone and the Audio Piloting System for Vessels

By George H. Flint

**T**HE remarkable development of radio, during recent years, has been largely due, declare experts, to the introduction and improvement of a little instrument, the invention of Mr. Lee De Forest. The inventor originally named it "audion." British writers have referred to it as "ionic valve" or "thermionic valve." In America it is known as the "vacuum tube" or "electric tube." In popular parlance, it might be called the "little miracle worker."

With this little instrument, Earl C. Hanson, inventor of the vactuphone, plans to do some wonderful things. The vactuphone is an instrument for aiding the deaf. Mr. Hanson is also the inventor of the apparatus which enables vessels to enter and leave New York harbor in a fog, without the aid of an ordinary pilot.

Mr. Hanson is one of the most remarkable men in radio. He was born in California, twenty-nine years ago. When a little boy, he was experimenting in electricity. While he was a pupil in a Los

Angeles grammar school, he built a wireless telephone with which he talked over short distances. At St. Paul's Preparatory School, later, he continued his experiments. In 1911, when but nineteen years old, he invented a system of wireless transmission. This invention is the basis of important patents he now holds. During the World War, he gave the United States and its Allies the use of his inventions including his audio piloting system for the guiding of vessels through fogs and mine fields.

Probably a million dollars has been spent on the development of the miracle-working vacuum tube. Several hundred patents have been taken out to protect it in the various phases of its progress.

In the center of the vacuum tube is the filament—a fine tungsten wire. The spiral around it is called the grid. The little metal-cylinder is the plate. The grid amplifies the energy received from the electrons—those invisibly minute particles which many scientists consider the

final unit into which all matter can be divided.

The grid controls the pressure of the electrical current. When powerful vibrations are employed, a great volume of sound is the result; but it is unintelligible because of the hissing and sputtering. The little grid in the tube controls the energy coming into it. The result is clarity as well as volume—a smooth reproduction of natural vibrations as those made by the voice in speaking.

Now, in amplifying, it is not necessary to work with one tube only. The current may be passed from one to another. Therefore the vibrations—the sounds being transmitted—become greater and greater in power.

It is estimated that one unit of electrical energy is increased ten times by means of the vacuum-tube amplifier. If one unit of electrical energy is increased ten times by means of the vacuum-tube amplifier—think what will happen after it has passed through six tubes and amplified a million times!

## This Will Make Your Signals Louder

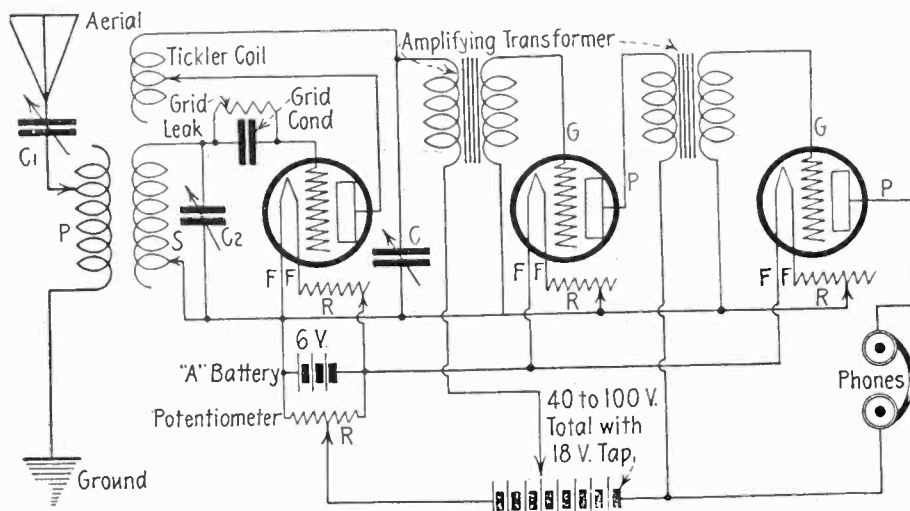

Detector and two-step amplifier showing necessary connections for the reception of weak signals. Drawn by F. Newman.

**I**T is a well-known fact that, for maximum amplification the characteristics of an intervalve tone-frequency amplifying-transformer must be such as to fit the output impedance of the preceding tube in a cascade

amplifying-set. There is an allowable variation of the constants of the transformer when loaded on the secondary by an amplifying tube; but, nevertheless, the maximum signal is obtained from a transformer de-

signed especially to fit the output impedance of the tube with which it is used.

In general, a tone-frequency amplifier-transformer should occupy the same position in the output circuit of a vacuum tube as the receiving telephone. The terminals P and F of transformer may be connected to the plate-circuit terminals which ordinarily are connected to the telephone receiver. The secondary terminals should connect to the grid and filament of the following tube of a multi-stage amplifier. A circuit using two stages of tone-frequency amplification is shown herewith. This circuit makes use of the detecting qualities of radio-ton UV-200. In all radio amplifier-circuits the insulation of all apparatus connected to the secondary must be as perfect as possible. Leakage from the grid to the filament of the amplifier tubes through the socket, mounting panel, wiring, or otherwise, will decrease the amplification—that is, lessen the volume and intensity of the supply. The diagram herewith was designed for use with intervalve tone-frequency amplifying-transformers.

# Radio World's Hall of Fame



(c. Underwood & Underwood)

## EARL C. HANSON

Inventor of the Vactophone, an instrument for aiding the deaf; also the Audio Piloting System, which enables deep-sea vessels to enter and depart from New York harbor in a dense fog, without the aid of a regular pilot. Both inventions are operated by the vacuum tube, such as he holds in his hand.

# Radio Progress in Foreign Lands

By Pierre LaSalle

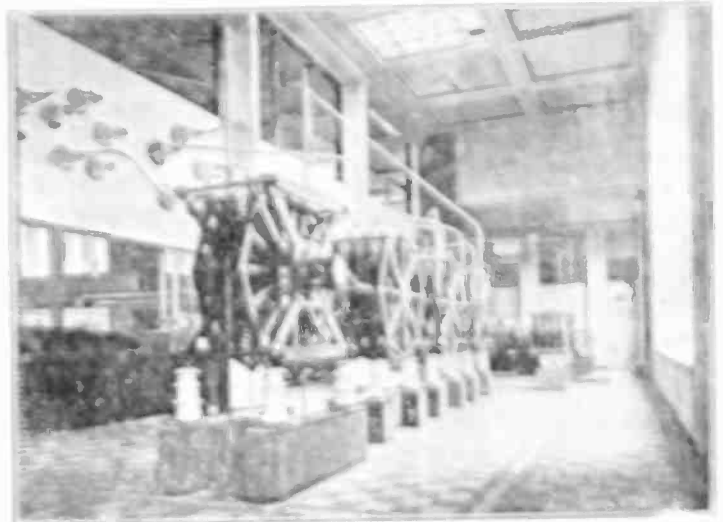
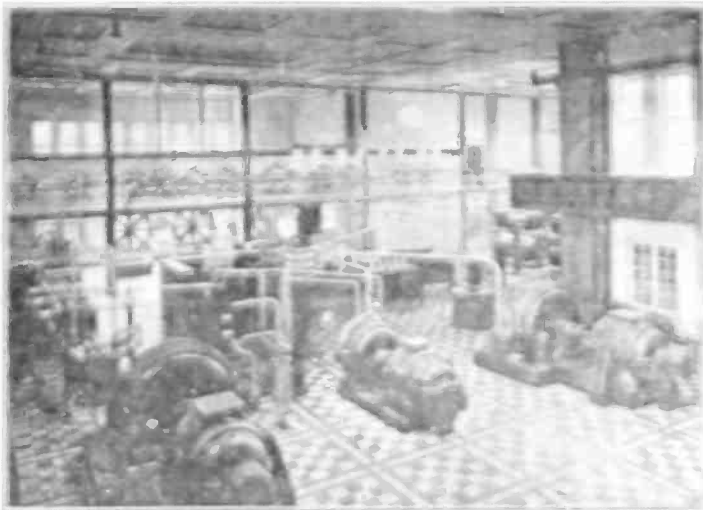

(1) The well placed equipment of the powerful trans-Atlantic station at Nauert, Germany. (2) The massive induction coils which send out the powerful signals to all parts of the universe

More than a year ago, when the wireless telegraph station at Nauert, Germany, was first opened, it has been awarded European honors. It is the first station in the world that has been awarded these honors. It is the first station in the world that has been awarded these honors. It is the first station in the world that has been awarded these honors.

The first wireless telegraph station in the world was established in 1843. It was the first station in the world that has been awarded these honors. It is the first station in the world that has been awarded these honors. It is the first station in the world that has been awarded these honors.

The various parts of the world are shown in Figure 2.

CZECHOSLOVAKIA is now to be a wireless telegraph station. It is the first station in the world that has been awarded these honors. It is the first station in the world that has been awarded these honors. It is the first station in the world that has been awarded these honors.

The main station will be equipped with high frequency generators. It is the first station in the world that has been awarded these honors. It is the first station in the world that has been awarded these honors. It is the first station in the world that has been awarded these honors.

Underway station will be the first wireless telegraph station. It is the first station in the world that has been awarded these honors. It is the first station in the world that has been awarded these honors. It is the first station in the world that has been awarded these honors.

At Kralupy, a district of Prague, a radio station with a radius of 400 kilometers is now being operated. At Brno, Moravia, a radio station with a range of 1,000 to 1,500 meters has just been tested.

For communication between Slovakia and Prague, as well as the first, a new radio station is being

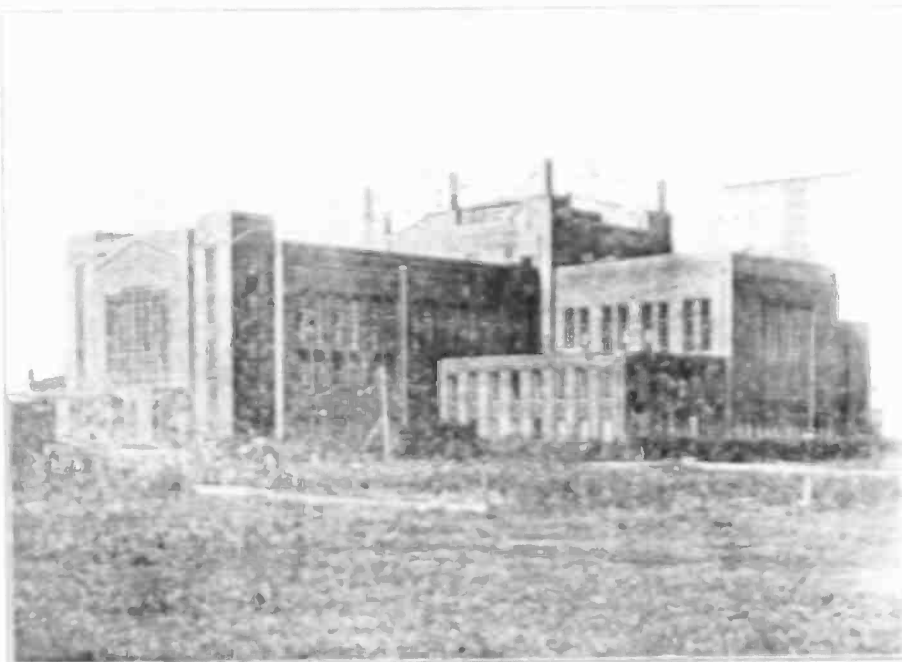

(3) Massive buildings of the powerful trans-Atlantic Station at Nauert, Germany. The company operating this plant claims that it is the first European station to transmit commercial traffic across the Atlantic ocean



# Cornell's Equipment for Instruction

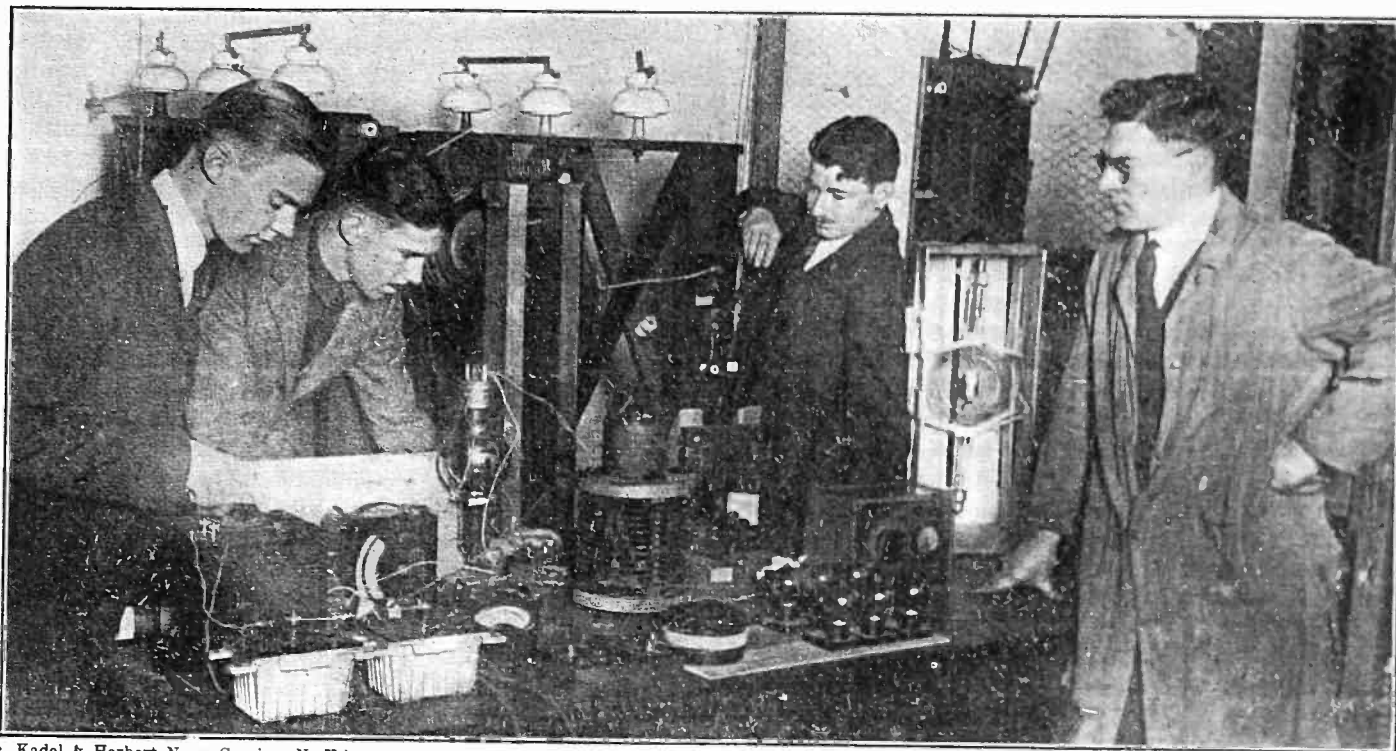

(c. Kadel & Herbert News Service, N. Y.)

You will be as much interested in this photograph as are the students who posed in the course of their work. It shows a section of the laboratory at Cornell University where instruction is given in the underlying principles of radio. Not only are men made familiar with the high theoretical phases of the art, but they are sent to the test and experimental rooms where most of the practical knowledge of connecting-up instruments is unveiled. Professor B. K. Northrop, of Cornell, is here photographed with his students. An experiment in the operation and maintenance of vacuum tubes is being made.

(Continued from preceding page)

erected at Kosice, Slovakia, and another, at Bratislava, will be operated for the benefit of the Danube shipping and the International Danube Comm. now sitting there.

A radio sending and receiving station has been projected for Liberec (Reichenberg). It is expected that it will be completed by August 20. The State Telegraph Office at Karlovy Vary (Carlsbad) also contemplates the erection of a small station there before the season at the baths opens.

Because of the importance of radio communication to aerial navigation, the Czechoslovak Ministry of Post and Telegraph and the Ministry of National Defense are now building a station with a range of 1,000 kilometers at Kbely near Prague, the starting point of air planes for Paris and Warsaw. In Western Bohemia, at Pilsen or Cheb a station for operation in connection with the air service for Paris will also be established, and another in Northeastern Bohemia for use in connection with the aerial route to Warsaw. The Prague, Brunn, Bratislava, and Kosice, radio stations will also serve air fleets, it is said. The Ministry of National Defense is now building a system for defense.

In view of these advances in radio development, bankers and industrial concerns in Czechoslovakia expect, within a short time, to be receiving information by wireless from the bourses of London, Paris, Berlin, Zurich, Amsterdam and New York.

**F**RANCE has established wireless telegraph posts at Rouen. Pilot boats on the River Seine will be used to transmit messages relating to maritime affairs and the promotion of port services, according to the Department of Commerce. The pilot boats, it is reported by United States Consul M. B. Kirk, of Rouen, will transmit by wireless the arrival of all vessels coming up the Seine on every tide and will instruct the pilot vessels where to place ships on their arrival.

Three pilot boats, have been equipped with radio, using continuous waves averaging 520 meters. Ground stations employ 720 meters with an intermittent spark, except at night when as in commercial work 600 meter waves are used. When merchant vessels are not equipped with radio urgent messages are transmitted for them to their brokers through the Post Office for 40 centimes per word.

"Civilization Is Communication," Says Admiral Moffet

**U**SING a modern version of Kipling's "Civilization is Transportation" as his inspiration, Rear-Admiral William Moffett, Chief of Naval Aviation, said recently while broadcasting over the Naval radiophone: "Civilization is Communication. By this new wonder, the radio telephone, unnumbered millions of the uneducated, as well as the educated, can now be directly reached; we can disseminate information and knowledge as never dreamed of before. We are on the threshold of a new era, and are beckoned on by two wonderful hands—radio and aviation. May we all do our best by them, not only for science's sake but for our country's. Radio and aviation go hand in hand in the annihilation of space."

Recalling the legend of Jason's ship, "Argo," with its prow of talking oak which, in time of need, advised the argonauts of their proper course, Admiral Moffett said that, today, the airplane equipped with radio was more wonderful than this mythological ship for the airplane is not only guided by a voice but can communicate continually with its base on land or sea.

# Valuable Pointers on Aerial Construction

By Edward Linwood

**W**ITH the newspapers carrying many yarns about the use of the loop aerial as a direction finder this question is asked by many amateurs, "Will my aerial receive better in one direction than in another?" Perhaps he wonders if his aerial is slung in the correct direction to receive his favorite broadcasting station. There is an answer to his question which every man can work out for himself.

Loop aerials are not the only types that show a preference of direction. As a matter of fact, every aerial except the simple vertical-aerial has directional characteristics.

If a single wire is erected vertically into the air and if it were possible to support such a wire without guys of any sort, this antenna would receive signals from all directions equally well. But since guy wires are essential, this perfect condition of reception is not attainable except under unusual circumstances.

The aerial most in favor with amateurs is the type known as the "inverted L." This consists of a wire strung horizontally between two supports of approximately equal height with a lead-in wire connected to one extreme end and carried to the tuning coil. Now, if the average person

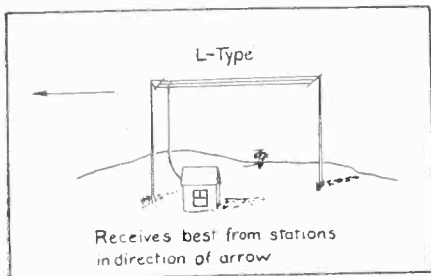

Drawn by E. L. Bragdon.

were to be asked his opinion of the most efficient direction in which this aerial should be pointed, the answer, in nine cases out of ten, would be: "It would be pointed in the direction of the open end."

This is incorrect. The inverted L antenna will give the strongest signals in the direction *away from* the open end.

This statement should not be taken to mean that an inverted L aerial is wrongly erected if it fails to point toward at least one of the broadcasting stations. Taking into consideration the fact that the amateur likes to hear the greatest *number* of stations from

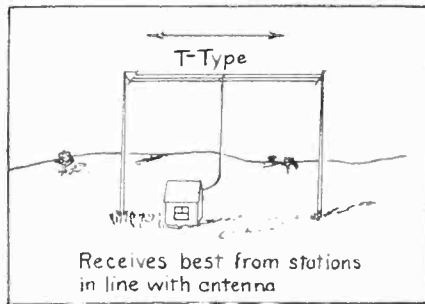

Drawn by E. L. Bragdon.

everywhere the L type will fill his needs best, for while it is best for one direction its ability as a receiver of signals from other directions is nearly as good. Assuming that it receives best in the direction away from its open end, and calling that performance 100 per cent., it is probable that its performance in the exact opposite direction would be 75 per cent., a difference that is certainly not worth worrying about.

Following the inverted L, antenna comes the type known as the T antenna. This type consists of a flat top made up of one or more wires strung horizontally or nearly so to the ground level and a lead-in wire connected to the exact mid-point of the flat top. This aerial has two open ends. Suppose, for example, that the aerial points north and south. If signals are coming from the north, the south end of the antenna will do most of the "picking up" of impulses.

If the signals come from the south, then the north half of the T aerial will do most of the reception. Thus the T aerial is equally good for both directions in which it points. But for other directions, such as east and west in the imaginative aerial above, its ability is lacking.

At this point, having understood the characteristics of the chief forms of antenna, it is a simple matter to see that the ideal aerial system for a receiving station would be a series of T aerial laid out like the spokes in a wheel interconnected with switches in such a way that any one of the separate T aerials could be connected to the receiving set, the choice depending on the direction from which it is desired to receive signals. But an antenna system as elaborate as this would be expensive to build and more expensive in up-keep. It is doubtful if the stunt would be worth the trouble it would demand when completed for operation.

## From a French Amateur

**W**ITH the entire world grasping the radiophone, it seems that amateurs in foreign lands are anxious to get hold of some American ideas, while, on the other hand, we are seeking to grasp theirs for comparison.

So, for the American, RADIO WORLD herewith shows two circuits which some of our readers may like to try out. They are French in idea and design.

No. 1 shows a radio-frequency circuit using amplifying transformers for amplification. This circuit seems to look good; but RADIO WORLD would like to hear from any amateur who may attempt this circuit. The aerial and primary circuit are not shown; but the circuit shows everything concerned from the secondary up to the final secondary of the amplifying transformer which was intended for the detector circuit.

If one wishes to use this circuit he

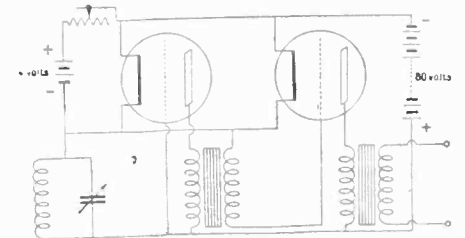

Two steps of radio frequency to be coupled to detector circuit, using amplifying transformers.

should be careful of the last transformer secondary used, so as not to get confused.

No. 2 shows another circuit in which resistance coupling is used as a means of transformation of power. As these circuits are only in their infancy, wonderful results cannot be expected as these circuits are only for experimentation.

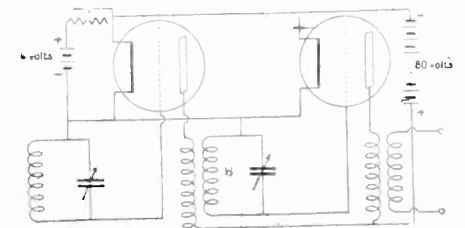

Two steps of radio frequency using resistance coupling replacing the amplifying transformers.

Radiotelephony has made possible the voice contact with an audience of thousands and tens of thousands without the necessity of assembling humanity under one roof. It is pre-eminently a home acquisition, bringing news, music and other attractions.

# What Is Meant by "Tuning"

By E. L. Bragdon

NO man, in any art, makes quicker progress than the raw amateur who buys a set on Monday morning, tunes in on any (broadcasting) station, Monday evening, and qualifies as a capable radio-trickster before Sunday dawns. "Microhenries" sound more to him like a trick *non de plume*; but he uses the term whenever he can slide it into the conversation without perceptible jar.

He is the man who will read a Bureau of Standards report from cover to cover without flinching, even though all he knows when he finishes is that the monograph is about radio.

But there are hundreds—yes, thousands—of beginners who prefer to take the early steps with greater caution. They refuse to talk in radio terms unless they know whereof they speak. If they don't know, they ask questions; and if they don't understand the answer, they'll ask someone else to explain. Their start, to be sure, is not as flashy as that of the other amateurs, but they surely get there in the final roll call. It is to these men, particularly, that this article on the "whys" and "wherefores" of *tuning* is dedicated.

If you have read many treatises on the fundamentals of radio you must have been struck by the ease with which the writer passes over the act of tuning with a simple twist of a phrase. It usually goes like this:

"After connecting the lead-in wire to the aerial binding post, and the ground wire to the post marked 'ground,' adjust the tuner until signals are heard."

Because tuning is so simple and because it comes as second nature to an experienced man, it is assumed that the novice will grasp it as quickly. The amateur can follow directions—and does; but he appreciates knowing "why." He is a querist.

In tuning a radio circuit, there are two factors to be considered; in fact, *tuning* means the adjusting of these two factors. They are *Inductance* and *Capacity*.

Induction is produced when a current is sent through one wire, or coil of wire, which rests in the vicinity of another wire or coil of wire. The wire containing the current flow is circled by rings of magnetism.

The effect is the same as if a myriad of smoke rings were made to pass around and around a rod. These rings

of magnetism, called magnetic flux, are present in greatest number if the current flow is changed in any way—that is, decreased, made zero or made a maximum. If the second coil is brought near the rings, a separate current will be set up in it although there are no metal connections between them.

The current in the second coil is called the *induced current*, and the act of producing it is called *Induction*.

Capacity is difficult to define in simple words. It is one of the most elusive of electrical properties.

Perhaps if it is pictured as an electric strain, its understanding will be reached more quickly.

Up to this time, practically all electric terms have had some reference to a conducting metal. Capacity really deals with insulating materials. In fact, an insulator is the basis of all capacity.

If a piece of glass is coated on both sides with a sheet of tinfoil, silver, copper, or any other metal and a terminal of a battery or generator connected to each side the glass will take up a certain portion of the electricity and will continue to collect it until it will stand no more. At that point, it will disgorge the electric charge. That it is the glass and *not* the tinfoil or other metal that collects and holds the charge, may be verified by removing the metal sheets and testing the

glass. It will be found that the charge is in, or on, the glass.

Physicists believe that the molecules of the glass are separated by the electricity, the positive going to one side and the negative to another. This sets up strains in the glass which remain until both sides are connected by a wire. This act restores the molecules to their original and normal position, and the rearrangement causes the discharge of the electrical energy.

Capacity is the electrical property produced when a glass plate is thus charged.

A radio circuit, as has been said, previously, consists of a combination of Inductance (coil of wire) and Capacity (insulator faced by conductors) in varying proportions. The exact proportion of the Inductance and Capacity determines the wave length.

Assuming as an example that the Inductance is equal to 100 and the Capacity to 10, producing thereby a wave length of 100 meters, then if the inductance is reduced to 75, the wave length will be changed unless, at the same time, the capacity is increased to  $12\frac{1}{2}$ .

These figures are used only as a basis for the example.

Now, tuning consists in maintaining this balance between capacity and inductance, or in adjusting the two factors to obtain the wavelength.

## Doctor's Motor Car with Radio Set

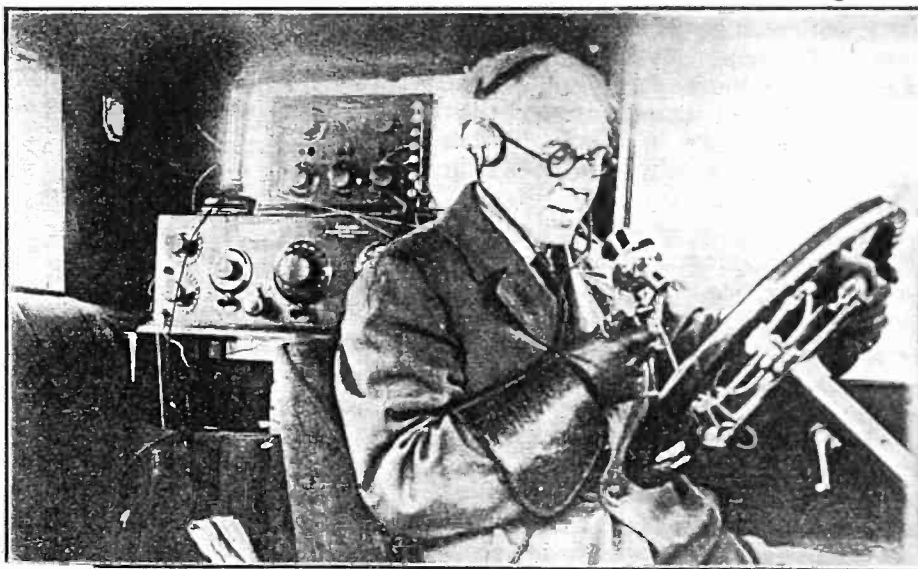

(c. International)

Dr. David Cottrell is said to be the first Chicago physician to have his motor-car equipped with a radio set, so he may receive messages after visiting a patient.

# Radio Progress in Foreign Lands

By Pierre LaSalle

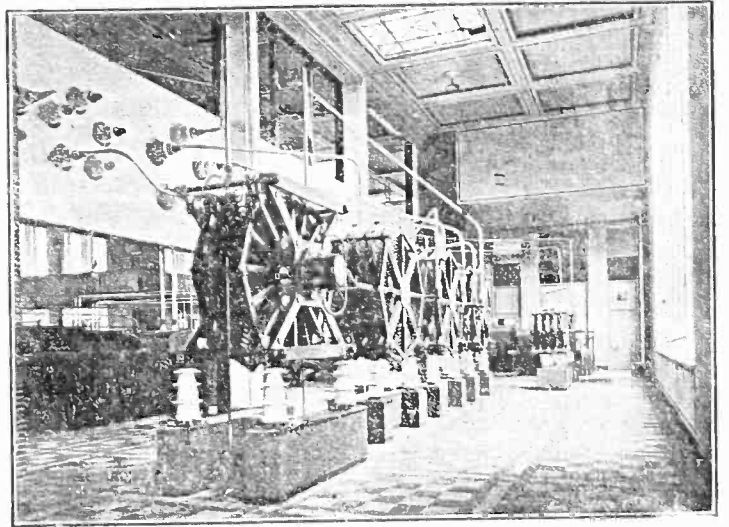
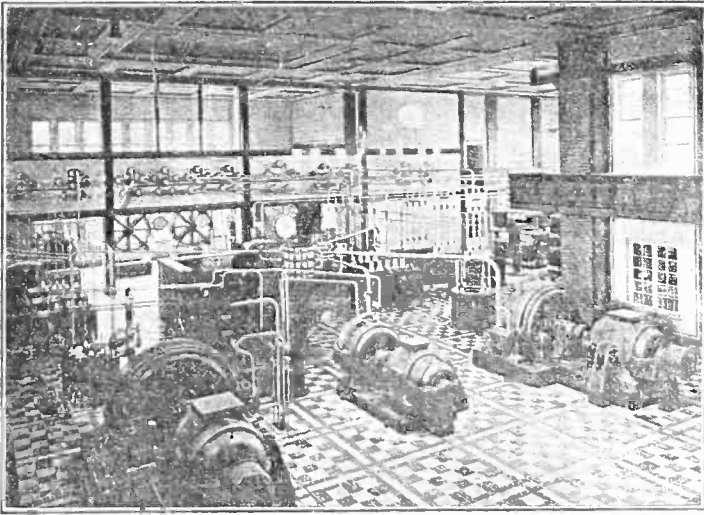

(1) The well-placed equipment of the powerful trans-Atlantic station at Nauen, Germany. (2) The massive inductance coils which send out the powerful signals to all parts of the universe.

MUCH has been said about various American radio stations, but little credit has been awarded European listeners. If one remembers that some years back, a powerful radio-station was erected and opened at Sayville, Long Island, by the Atlantic Communication Company, which employed the well-known Telefunken system of transmission. This station was built in order to operate directly with the German station at Nauen, Germany. When completed, trans-Atlantic radio-communication service was established. These were

the first two stations to operate on a commercial business across the Atlantic. These messages were distinctly heard.

The accompanying illustrations show the buildings and interior of the station. Figure 3 shows great buildings which make up the powerful trans-Atlantic station at Nauen. The high tower with its antennas are seen in the background.

Figure 1 shows one section of the interior with its layout of machinery. The large inductances which set up the energy on various wave-

lengths to be sent to the various parts of the world are seen in Figure 2.

CZECHOSLOVAKIA is soon to have a central and subsidiary wireless system according to a report from C. S. Winans, U. S. Consul at Prague. The Ministry of Post and Telegraph of Czechoslovakia has followed all the latest developments in radio, sending engineers to foreign countries to study operating systems. When weather conditions are favorable, a large station will be built at Podedbrady, Bohemia, where the natural features are said to be ideal.

The main station will be equipped with high-frequency generators (Léotour-Bethenod type) producing 50 KW in the antenna. The entire station will be able to produce additional energy up to 100 KW at the antennas. If the work demands it, an additional 50 KW set will be installed. Two towers, 150 meters in height, will be erected. It is estimated that the radius will be about 4,000 kilometers.

Podedbrady station will be the main sending-station for Prague, but a small station equipped with electron lamps will also be erected there by the State Post and Telegraph Office.

At Kral Vinohrady, a district of Prague, a radio station with a radius of 400 kilometers is now being operated. At Brunn, Moravia, a radio plant having a range of 1,000 to 1,500 meters has just been tested.

For communication between Slovakia and Prague, as well as the Orient, a new radio station is being

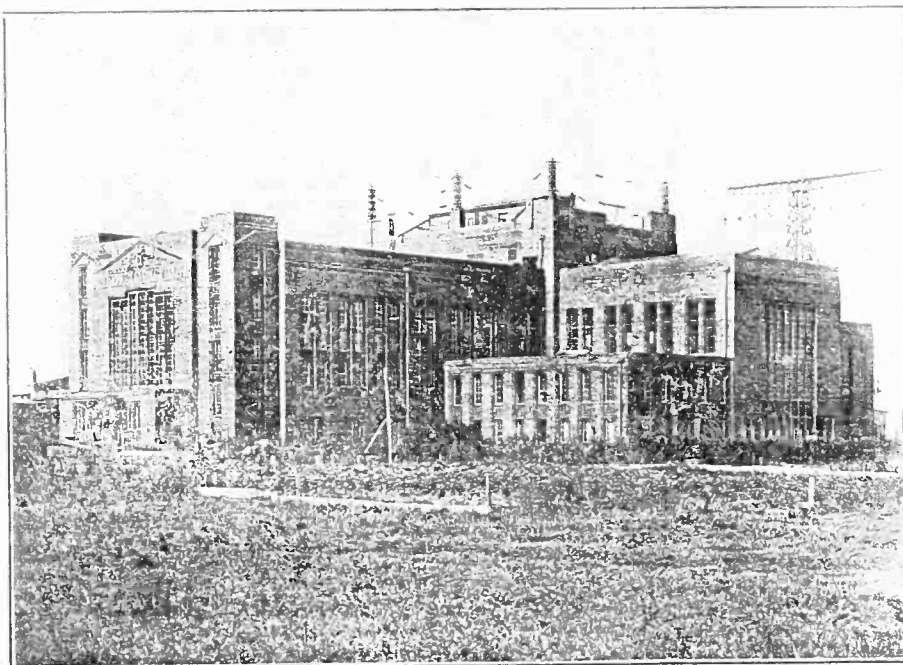

(3) Massive buildings of the powerful trans-Atlantic Station at Nauen, Germany. The company operating this plant claims that it is the first European station to transmit commercial traffic across the Atlantic ocean.



# Cornell's Equipment for Instruction

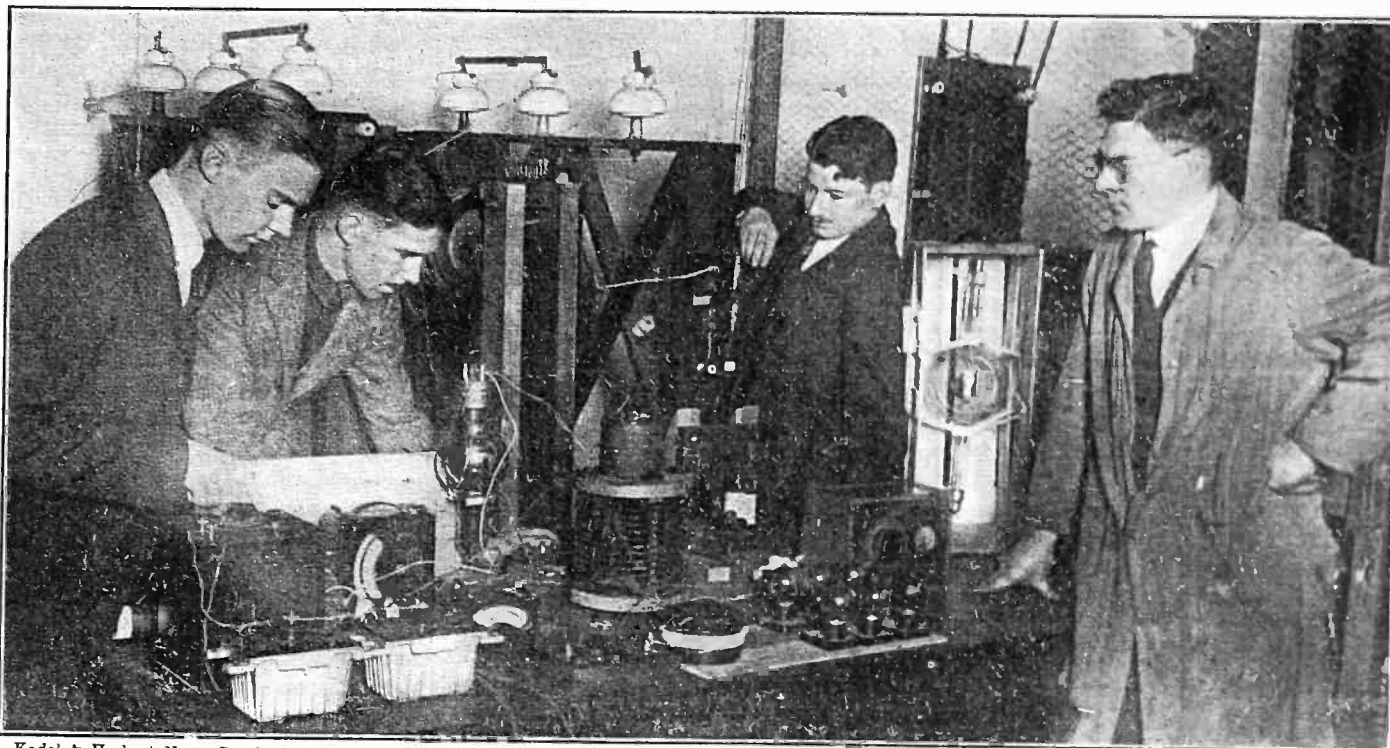

(c. Kadel & Herbert News Service, N. Y.)

You will be as much interested in this photograph as are the students who posed in the course of their work. It shows a section of the laboratory at Cornell University where instruction is given in the underlying principles of radio. Not only are men made familiar with the high theoretical phases of the art, but they are sent to the test and experimental rooms where most of the practical knowledge of connecting-up instruments is unveiled. Professor B. K. Northrop, of Cornell, is here photographed with his students. An experiment in the operation and maintenance of vacuum tubes is being made.

(Continued from preceding page)

erected at Kosice, Slovakia, and another, at Bratislava, will be operated for the benefit of the Danube shipping and the International Danube Comm. now sitting there.

A radio sending and receiving station has been projected for Liberec (Reichenberg). It is expected that it will be completed by August 20. The State Telegraph Office at Karlovy Vary (Carlsbad) also contemplates the erection of a small station there before the season at the baths opens.

Because of the importance of radio communication to aerial navigation, the Czechoslovak Ministry of Post and Telegraph and the Ministry of National Defense are now building a station with a range of 1,000 kilometers at Kbely near Prague, the starting point of air planes for Paris and Warsaw. In Western Bohemia, at Pilzen or Cheb a station for operation in connection with the air service for Paris will also be established, and another in Northeastern Bohemia for use in connection with the aerial route to Warsaw. The Prague, Brunn, Bratislava, and Kosice, radio stations will also serve air fleets, it is said. The Ministry of National Defense is now building a system for defense.

In view of these advances in radio development, bankers and industrial concerns in Czechoslovakia expect, within a short time, to be receiving information by wireless from the bourses of London, Paris, Berlin, Zurich, Amsterdam and New York.

**F**RANCE has established wireless telegraph posts at Rouen. Pilot boats on the River Seine will be used to transmit messages relating to maritime affairs and the promotion of port services, according to the Department of Commerce. The pilot boats, it is reported by United States Consul M. B. Kirk, of Rouen, will transmit by wireless the arrival of all vessels coming up the Seine on every tide and will instruct the pilot vessels where to place ships on their arrival.

Three pilot boats, have been equipped with radio, using continuous waves averaging 520 meters. Ground stations employ 720 meters with an intermittent spark, except at night when as in commercial work 600 meter waves are used. When merchant vessels are not equipped with radio urgent messages are transmitted for them to their brokers through the Post Office for 40 centimes per word.

**"Civilization Is Communication," Says Admiral Moffet**

**U**SING a modern version of Kipling's "Civilization is Transportation" as his inspiration, Rear-Admiral William Moffett, Chief of Naval Aviation, said recently while broadcasting over the Naval radiophone: "Civilization is Communication. By this new wonder, the radio telephone, unnumbered millions of the uneducated, as well as the educated, can now be directly reached; we can disseminate information and knowledge as never dreamed of before. We are on the threshold of a new era, and are beckoned on by two wonderful hands—radio and aviation. May we all do our best by them, not only for science's sake but for our country's. Radio and aviation go hand in hand in the annihilation of space."

Recalling the legend of Jason's ship, "Argo," with its prow of talking oak which, in time of need, advised the argonauts of their proper course, Admiral Moffett said that, today, the airplane equipped with radio was more wonderful than this mythological ship for the airplane is not only guided by a voice but can communicate continually with its base on land or sea.

# Valuable Pointers on Aerial Construction

By Edward Linwood

WITH the newspapers carrying many yarns about the use of the loop aerial as a direction finder this question is asked by many amateurs, "Will my aerial receive better in one direction than in another?" Perhaps he wonders if his aerial is slung in the correct direction to receive his favorite broadcasting station. There is an answer to his question which every man can work out for himself.

Loop aerials are not the only types that show a preference of direction. As a matter of fact, every aerial except the simple vertical-aerial has directional characteristics.

If a single wire is erected vertically into the air and if it were possible to support such a wire without guys of any sort, this antenna would receive signals from all directions equally well. But since guy wires are essential, this perfect condition of reception is not attainable except under unusual circumstances.

The aerial most in favor with amateurs is the type known as the "inverted L." This consists of a wire strung horizontally between two supports of approximately equal height with a lead-in wire connected to one extreme end and carried to the tuning coil. Now, if the average person

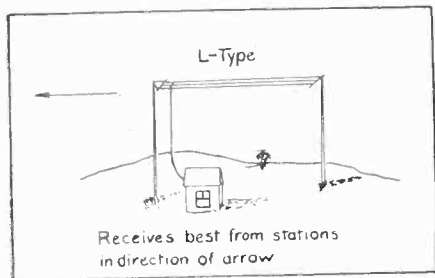

Drawn by E. L. Bragdon.

were to be asked his opinion of the most efficient direction in which this aerial should be pointed, the answer, in nine cases out of ten, would be: "It would be pointed in the direction of the open end."

This is incorrect. The inverted L antenna will give the strongest signals in the direction *away from* the open end.

This statement should not be taken to mean that an inverted L aerial is wrongly erected if it fails to point toward at least one of the broadcasting stations. Taking into consideration the fact that the amateur likes to hear the greatest *number* of stations from

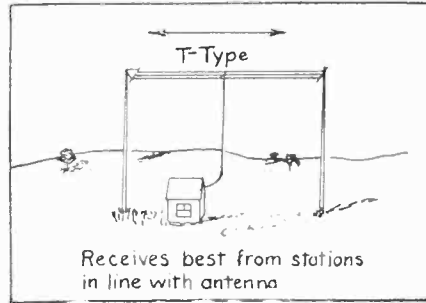

Drawn by E. L. Bragdon.

everywhere the L type will fill his needs best, for while it is best for one direction its ability as a receiver of signals from other directions is nearly as good. Assuming that it receives best in the direction away from its open end, and calling that performance 100 per cent., it is probable that its performance in the exact opposite direction would be 75 per cent., a difference that is certainly not worth worrying about.

Following the inverted L antenna comes the type known as the T antenna. This type consists of a flat top made up of one or more wires strung horizontally or nearly so to the ground level and a lead-in wire connected to the exact mid-point of the flat top. This aerial has two open ends. Suppose, for example, that the aerial points north and south. If signals are coming from the north, the south end of the antenna will do most of the "picking up" of impulses.

If the signals come from the south, then the north half of the T aerial will do most of the reception. Thus the T aerial is equally good for both directions in which it points. But for other directions, such as east and west in the imaginative aerial above, its ability is lacking.

At this point, having understood the characteristics of the chief forms of antenna, it is a simple matter to see that the ideal aerial system for a receiving station would be a series of T aerials laid out like the spokes in a wheel interconnected with switches in such a way that any one of the separate T aerials could be connected to the receiving set, the choice depending on the direction from which it is desired to receive signals. But an antenna system as elaborate as this would be expensive to build and more expensive in up-keep. It is doubtful if the stunt would be worth the trouble it would demand when completed for operation.

## From a French Amateur

WITH the entire world grasping the radiophone, it seems that amateurs in foreign lands are anxious to get hold of some American ideas, while, on the other hand, we are seeking to grasp theirs for comparison.

So, for the American, RADIO WORLD herewith shows two circuits which some of our readers may like to try out. They are French in idea and design.

No. 1 shows a radio-frequency circuit using amplifying transformers for amplification. This circuit seems to look good; but RADIO WORLD would like to hear from any amateur who may attempt this circuit. The aerial and primary circuit are not shown; but the circuit shows everything concerned from the secondary up to the final secondary of the amplifying transformer which was intended for the detector circuit.

If one wishes to use this circuit he

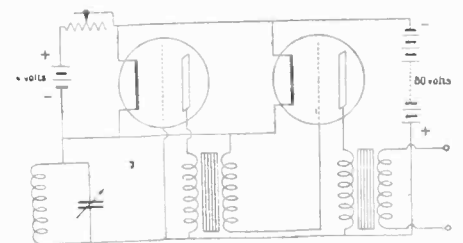

Two steps of radio frequency to be coupled to detector circuit, using amplifying transformers.

should be careful of the last transformer secondary used, so as not to get confused.

No. 2 shows another circuit in which resistance coupling is used as a means of transformation of power. As these circuits are only in their infancy, wonderful results cannot be expected as these circuits are only for experimentation.

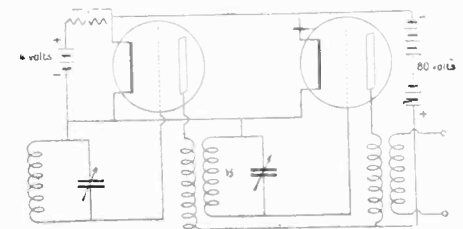

Two steps of radio frequency using resistance coupling replacing the amplifying transformers.

Radiotelephony has made possible the voice contact with an audience of thousands and tens of thousands without the necessity of assembling humanity under one roof. It is pre-eminently a home acquisition, bringing news, music and other attractions.

# What Is Meant by "Tuning"

By E. L. Bragdon

NO man, in any art, makes quicker progress than the raw amateur who buys a set on Monday morning, tunes in on any (broadcasting) station, Monday evening, and qualifies as a capable radio-trickster before Sunday dawns. "Microhenries" sound more to him like a trick *non de plume*; but he uses the term whenever he can slide it into the conversation without perceptible jar.

He is the man who will read a Bureau of Standards report from cover to cover without flinching, even though all he knows when he finishes is that the monograph is about radio.

But there are hundreds—yes, thousands—of beginners who prefer to take the early steps with greater caution. They refuse to talk in radio terms unless they know whereof they speak. If they don't know, they ask questions; and if they don't understand the answer, they'll ask someone else to explain. Their start, to be sure, is not as flashy as that of the other amateurs, but they surely get there in the final roll call. It is to these men, particularly, that this article on the "whys" and "wherefores" of *tuning* is dedicated.

If you have read many treatises on the fundamentals of radio you must have been struck by the ease with which the writer passes over the act of tuning with a simple twist of a phrase. It usually goes like this:

"After connecting the lead-in wire to the aerial binding post, and the ground wire to the post marked 'ground,' adjust the tuner until signals are heard."

Because tuning is so simple and because it comes as second nature to an experienced man, it is assumed that the novice will grasp it as quickly. The amateur can follow directions—and does; but he appreciates knowing "why." He is a querist.

In tuning a radio circuit, there are two factors to be considered; in fact, *tuning* means the adjusting of these two factors. They are *Inductance* and *Capacity*.

Induction is produced when a current is sent through one wire, or coil of wire, which rests in the vicinity of another wire or coil of wire. The wire containing the current flow is circled by rings of magnetism.

The effect is the same as if a myriad of smoke rings were made to pass around and around a rod. These rings

of magnetism, called magnetic flux, are present in greatest number if the current flow is changed in any way—that is, decreased, made zero or made a maximum. If the second coil is brought near the rings, a separate current will be set up in it although there are no metal connections between them.

The current in the second coil is called the *induced current*, and the act of producing it is called *Induction*.

Capacity is difficult to define in simple words. It is one of the most elusive of electrical properties.

Perhaps if it is pictured as an electric strain, its understanding will be reached more quickly.

Up to this time, practically all electric terms have had some reference to a conducting metal. Capacity really deals with insulating materials. In fact, an insulator is the basis of all capacity.

If a piece of glass is coated on both sides with a sheet of tinfoil, silver, copper, or any other metal and a terminal of a battery or generator connected to each side the glass will take up a certain portion of the electricity and will continue to collect it until it will stand no more. At that point, it will disgorge the electric charge. That it is the glass and *not* the tinfoil or other metal that collects and holds the charge, may be verified by removing the metal sheets and testing the

glass. It will be found that the charge is in, or on, the glass.

Physicists believe that the molecules of the glass are separated by the electricity, the positive going to one side and the negative to another. This sets up strains in the glass which remain until both sides are connected by a wire. This act restores the molecules to their original and normal position, and the rearrangement causes the discharge of the electrical energy.

Capacity is the electrical property produced when a glass plate is thus charged.

A radio circuit, as has been said, previously, consists of a combination of Inductance (coil of wire) and Capacity (insulator faced by conductors) in varying proportions. The exact proportion of the Inductance and Capacity determines the wave length.

Assuming as an example that the Inductance is equal to 100 and the Capacity to 10, producing thereby a wave length of 100 meters, then if the inductance is reduced to 75, the wave length will be changed unless, at the same time, the capacity is increased to 12½.

These figures are used only as a basis for the example.

Now, tuning consists in maintaining this balance between capacity and inductance, or in adjusting the two factors to obtain the wavelength.

## Doctor's Motor Car with Radio Set

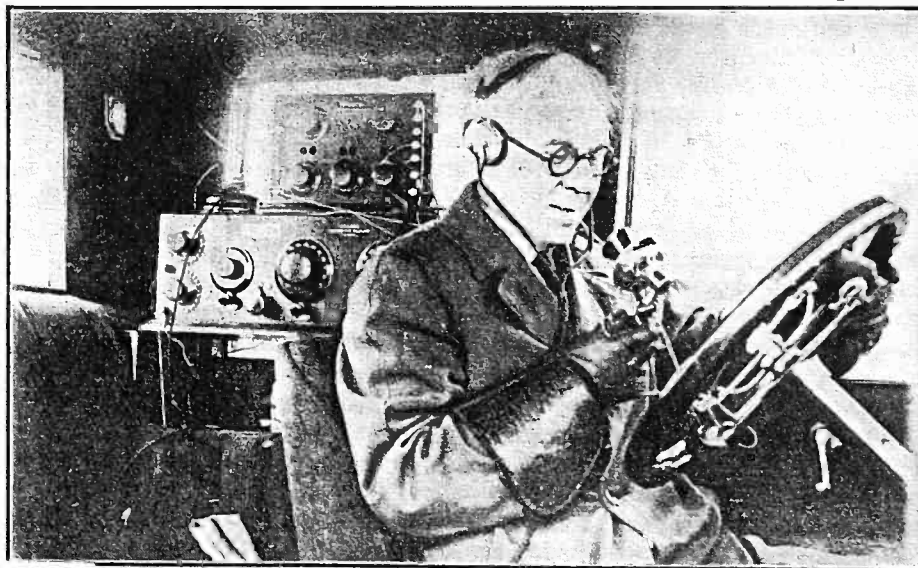

(c. International)

Dr. David Cottrell is said to be the first Chicago physician to have his motor-car equipped with a radio set, so he may receive messages after visiting a patient.

# Radio, Once a Fad, Becomes a Business

By Carl H. Butnam

**R**ADIO which started as a scientific experiment only, recently became a craze; but now, certainly, it is rapidly approaching the status of a business, or, perhaps, a profession.

Even the experts do not dare estimate the number of receiving stations, although 600,000 has been hazarded as a fair guess. Most of them say that the output of the manufacturer only, is the limit to which, receiving stations will go. It is known, however, that there are 18,690 sending stations in operation to-day. This surprising figure was reached on April 15, and includes commercial, ship, and amateur stations licensed by the Department of Commerce. Of the total, 15,907 are land stations, of which 678 are commercial, the balance being amateurs and special amateurs.

There are ten trans-oceanic companies operating in this country. There are 120 other stations licensed to operate from city to city, while 30 "PG" stations are licensed to communicate from the coast to ships.

The number of limited commercial stations, commonly called broadcasting stations, which send out radio telephonic entertainment, market and weather reports, reached 182, on April 15; but other applications are on file, and the daily mail brings dozens of them. There were only 67 such stations on March 10, showing an increase of nearly 3-1/3 a day. Thirty-two were issued during the past week. Special stations total 534, comprising 213 experimental, 123 technical, mostly colleges, and 198 special amateur stations. There are to-day 15,031 regularly licensed amateurs transmitting, and of course receiving also, all of whom are licensed through their district inspectors in the 9 districts into which the country is divided for their convenience.

American ships, to the number of 2783, are carrying radio and are listed as ship stations. This number is nearly four times the total ships which were licensed before the World War, and indicates the growth of radio on the high seas.

The radiotelephone is rapidly coming into ordinary business life:

Among the 32 new broadcasting stations licensed recently, Los Angeles secured eight, including one license for a laundry and dye works. St. Louis opened three stations, one of which is operated by the local Chamber of Commerce. Six newspapers

took out broadcasting licenses bringing the total number daily papers sending news and entertainment to 23.

There are many radio corporations, electrical manufacturing equipment companies sending entertainment; but there are also hardware and department stores, oil, stone, and motor dealers, as well as chambers of commerce, municipalities, churches, and colleges.

The following licenses were issued during the past weeks, April 7-22:

WMB—Auburn Electrical Co., Auburn, Me.  
 WEB—Benwood Company, Inc., St. Louis, Mo.  
 WDZ—James L. Bush, Tuscola, Ill.  
 WPE—Central Radio Co., Inc., Kansas City, Mo.  
 WCK—Stix-Baer, Fuller St., St. Louis, Mo.  
 KNR—Beacon Light Co., Los Angeles, Cal.  
 KXS—Braun Corporation, Los Angeles, Cal.  
 WAAH—Commonwealth Electric Co., Inc., St. Paul, Minn.  
 KZI—Irving S. Cooper, Los Angeles, Calif.  
 WAAJ—Eastern Radio Institute, Boston, Mass.  
 KON—Holwasser, Inc., Los Angeles.  
 WAAL—Minnesota Tribune Co., Minneapolis, Minn.

WAAG—Mullins Electric Co., Tacoma, Wash.

WAAM—I. R. Nelson Co., Newark, New Jersey.

KSS—Prest and Dean Radio Research Lab., Long Beach, Cal.

WAAO—Radio Service Co., Charleston, W. Va.

KNV—Radio Supply Company of California, Los Angeles, Cal.

KJC—Standard Radio Co., Los Angeles, Cal.

WSB—Atlanta Journal Co., Atlanta, Ga.

KQP—Blue Diamond Electric Co., Hood River, Ore.

KUS—City Dye Works & Laundry Co., Los Angeles, Cal.

WAAG—Elliot Electric Co., Shreveport, La.

WAAK—Gimbel Bros., Department Store, Milwaukee, Wis.

WAAR—Groves-Thornton Hardware Co., Huntington, W. Va.

KXD—Herald Publishing Co., Modesto, Cal.

WAAZ—Hollister Miller Motor Co., Emporia, Kansas.

KWH—Los Angeles "Examiner," Los Angeles, Cal.

KOQ—"Modesto Evening News," Modesto, Cal.

WAAQ—New England Motor Sales Co., Greenwich, Conn.

WAAE—St. Louis Chamber of Commerce, St. Louis, Mo.

KOE—"Spokane Chronicle," Spokane, Wash.

## Inexpensive Radio Set Made By Woman

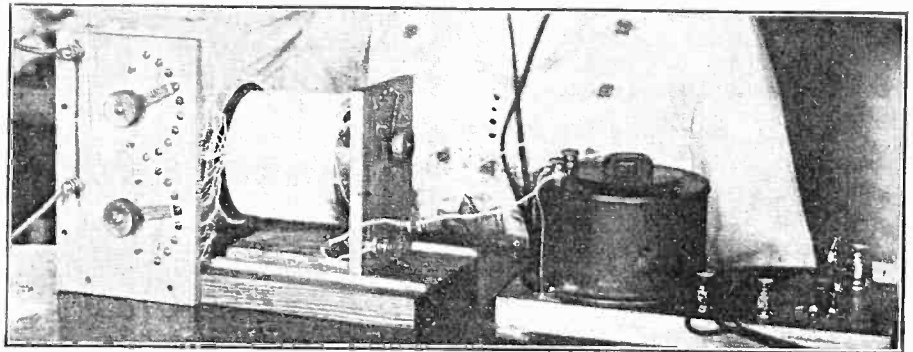

(Underwood & Underwood.)

This radio outfit was built by the Bureau of Standards, Washington, D. C., and the total expenditure was \$13. It is operated by Mrs. W. F. Harlow of the Radio Division.

**M**OST every amateur, to-day, is building, or contemplating building a loose coupler so he may be able to pick up the various broadcasting stations now sending out concerts. The accompanying illustration shows a home-made loose coupler, made by a woman and tested out successfully. The primary winding has sufficient taps to cover the wave lengths of the broadcasting stations, while, with the aid of the secondary winding, variable condenser and detector circuit, the builder was able to hear various con-

certs. The coupler was made up at a very low cost giving her the experience of manufacturing one of her own receivers.

## Grocer Advertises By Radio

In Des Moines, Iowa, there is a grocer who talks to his customers by radiophone, giving them prices on staple goods and advertising his special sales. Many customers within a good radius listen to his reports, spread the news to their neighbors.



# Naval Radio in War and Peace

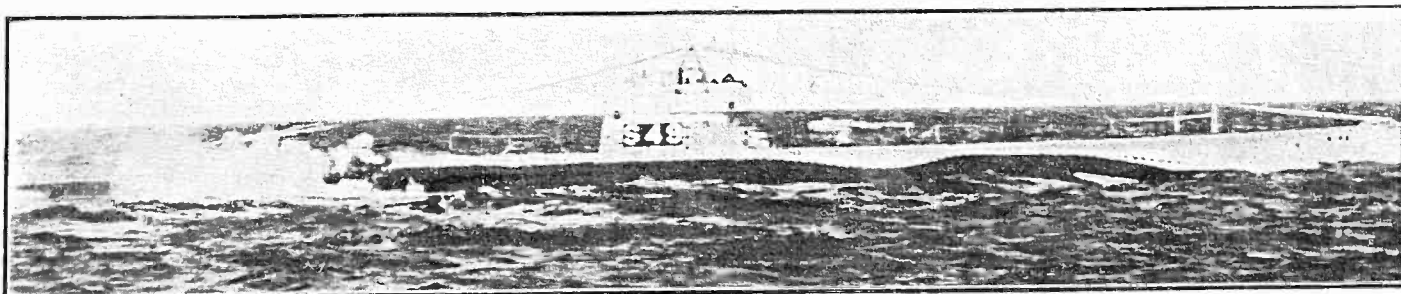

(c. Kacel & Herbert News Service)

Radio played such an important part that in wartime Uncle Sam has improved his equipment to a degree whereby a submarine may work like a battleship. In former years, the radio antenna was carried on masts that had to be taken down before the boat could submerge. Now the latest and most modern submarine, S-49, carries the antenna with the "sub," and the entire craft submerges in 45 seconds. This is a great advantage to the submarine, saving time for a quick getaway in case of disaster.

NAVAL Radio Compass Stations serve a multitude of purposes both in peace times and during war. It has been unofficially reported to the Navy Department that, during the past winter, fourteen large merchant-vessels were saved from destruction by the Navy's Radio Compass Stations. Due to the severe storms on the Atlantic, ships were often unable to determine accurately their positions on approaching the coast. By simply calling by radio the nearest fixed-compass station, and asking for bearings, they were given their positions accurately. It is estimated that fourteen ships thus aided would otherwise have been wrecked.

The Navy maintains along the coasts of the United States, well-equipped compass stations, the total cost of which is not more than

\$1,000,000. It is estimated that, during times of peace, the value of ships saved from destruction during three months of bad weather, will more than offset the total cost of installation and maintenance of all the radio compass stations of the Navy.

If an enemy ship, 500 miles off the coast, sends a radio message, the coast compass-stations immediately determine the direction of this message. This direction in degrees is sent to a central office where the exact position of the enemy may be located.

During the World War, the British located many enemy submarines by this method. During the night, German submarine-commanders were very loquacious, and talked by radio with other submarines and with their home bases. The British compass stations, located on the coasts of

England, Scotland, and Ireland, obtained radio compass bearings of these submarine radio-messages, plotted the bearings, and determined the position of the submarine. Proper orders were issued to all allied ships in order that they could avoid the areas where the radio showed submarines to be. Every time a ship left an Allied port, the commanding officer was given the latest submarine information obtained by the use of the radio compass. A great many ships were saved by these compass stations, not only from submarine attack but also from grounding.

The radio compass is also used by aircraft flying up and down the coasts. In bad weather, the aircraft frequently finds its base by asking the radio-compass station for a bearing. Receiving the bearing of the station, the pilot flies directly toward it.

## Combined Radio for Talking

AN interesting experiment in the transmission of the voice from ship to shore and vice-versa through the double medium of the radiophone and the wire telephone took place recently when passengers aboard the United States liner "America" spoke to a group in the rooms of the American Telephone and Telegraph Company at 24 Walker St., via the Western Electric wireless experimental station at Deal Beach. Save for occasional defects in articulation, due to interference and atmospheric conditions, the experiment was successful.

Continuous attempts have been made since the development of the radiotelephone to make practicable uninterrupted conversation over both wire and wireless. On the Pacific Coast, a test was made when the voice was carried continuously from the California mainland to the Catalina Islands via wireless and wire—one subscriber of a telephone company

speaking to another without either of them journeying to a radio transmitting station. It is in this direction that informed observers look for the highest practical usefulness of the new mode of communication.

### Receiving Without Batteries

THE public will be enlightened regarding a new method of receiving with ordinary electron tubes for amplifying, but without a battery, which has been developed by the experts of the Bureau of Standards. Briefly the scheme is to utilize a 60 cycle lighting current for both filaments and plates of the electron tubes. The amplifier recommended in the report has three radio-frequency stages, and two audio-frequency stages, and requires a crystal detector. A 60-cycle current when used in an ordinary amplifier carries a strong hum, or ripple, offering serious interference with messages, but this is eliminated by

balancing resistances, grid condensers, and special grid leaks of comparatively low resistance, a telephone transformer in the output circuit and a crystal detector instead of an electron tube. It is said that the amplification was as good with alternating current as with direct. The complete set is light and compact for use.

### Naval Pacific

#### Service Extended

President Harding has signed the bill extending the use of Naval Radio service across the Pacific for commercial and press purposes until June 30, 1925. This extension, however, does not apply to messages designated for China, as that service terminates on January 1, 1924, on account of international wireless agreements. The signing of this bill relieves many business concerns and news services, especially on the Pacific Coast, as the present commercial facilities are said to be inadequate and expensive, due to the congestion of other despatches.

# Radio-Frequency Amplification and Regeneration

By Frank Armstrong

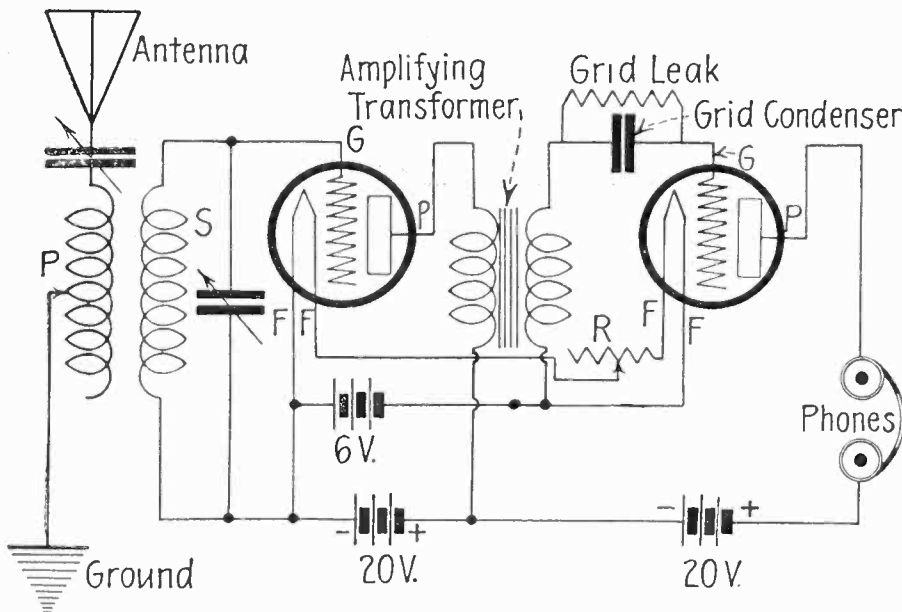

Radio-frequency circuit showing one tube as a radio-frequency amplifier and a detector tube for rectification and amplification. Drawn by S. Newman.

MANY requests have been received by RADIO WORLD seeking information on two important subjects: regeneration and radio-frequency amplifiers. These two subjects are headliners in radio. One of them (regeneration) being in practical use to-day; the other (radio-frequency amplifiers) is still in a stage of experimentation. Referring to regeneration, the accompanying diagram explains in itself this remarkable circuit. One realizes that a tube must be used

secondary circuit so it may perform its duty. There are a number of regeneration circuits, but the diagram herewith published is one of the many by which results can be expected.

In taking up radio-frequency amplification, we show one stage of radio frequency where the weak signals are amplified and then sent through the detector circuit for rectification and amplification. Two tubes are shown, but the amateur should remember that many hundreds of amateurs are experimenting with this idea and some excellent results have been secured. However, as stated, it is only in experimentation, and we feel, that in the near future, radio frequency will be playing an important part.

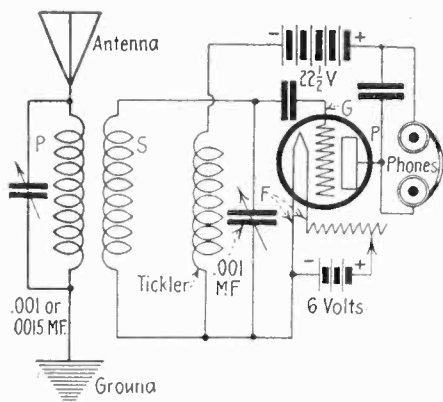

Regenerative diagram employing a tickler coil in the plate circuit. Drawn by S. Newman.

as a step towards this term, but the main fact must be realized that we must have some means of feeding back the signal for regeneration.

This is better known as a tickler coil. It is connected in series with the plate circuit and fed back to the

## Ziegfeld Objects to Radio

Actors and actresses under contract to F. Ziegfeld, Jr., the theatrical producer, in future will have to decide between their desire to talk over the radiophone and working for him. He has announced that his performers must not under any circumstances raise their voices for those who are listening in at their radio sets. He contends that radio performances cheapen the reputations of the artists and detract from the box-office attendance.

What a novelty it is to be entertained without having had to pay war tax!

## A Circuit for Amateurs to Experiment with

A NUMBER of amateurs have written to RADIO WORLD in regard to regeneration and the various circuits pertaining to this term.

It is evident that many amateurs have tried out various circuits, but feel that there are still more to be experimented with. To keep the ama-

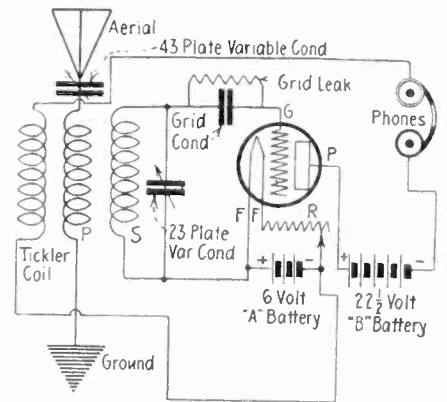

Circuit employing tickler coil set to produce regeneration. Drawn by S. Newman.

teur on the table we show, in the accompanying diagram, a regenerative circuit employing a tickler coil in the plate circuit. This circuit RADIO WORLD would like to have tried out. Do so and make your report to us. Let us know what results you obtained.

The diagram being self-explanatory should be another circuit for the experimenter.

## Must Be Tuned to C. W.

C. W., being constant in amplitude, does not dampen out and is, therefore, known as an undamped wave. The discontinuous wave, on the other hand, not being constant in amplitude, dampens out quickly and is, therefore, known as the damped wave. The first is a much better medium for bridging great distance at small cost, and, therefore, is slowly supplanting the older method. Then, too, it has decidedly selective qualities not readily attributed to the spark system. In other words, a radiated C. W., when intercepted by the receiving station, is so sharp and constant in character that the receiver must be tuned exactly to its wave length, otherwise it will not affect the instrument. When we consider that there are to date 13,835 amateur transmitting stations in the United States, and nearly 300,000 receiving units, this sharpness of tuning is a most important factor in eliminating interference between stations; indeed, in time to come it must supersede entirely other less selective methods of transmission.

# Delivering a Lecture at Tufts' by Radio

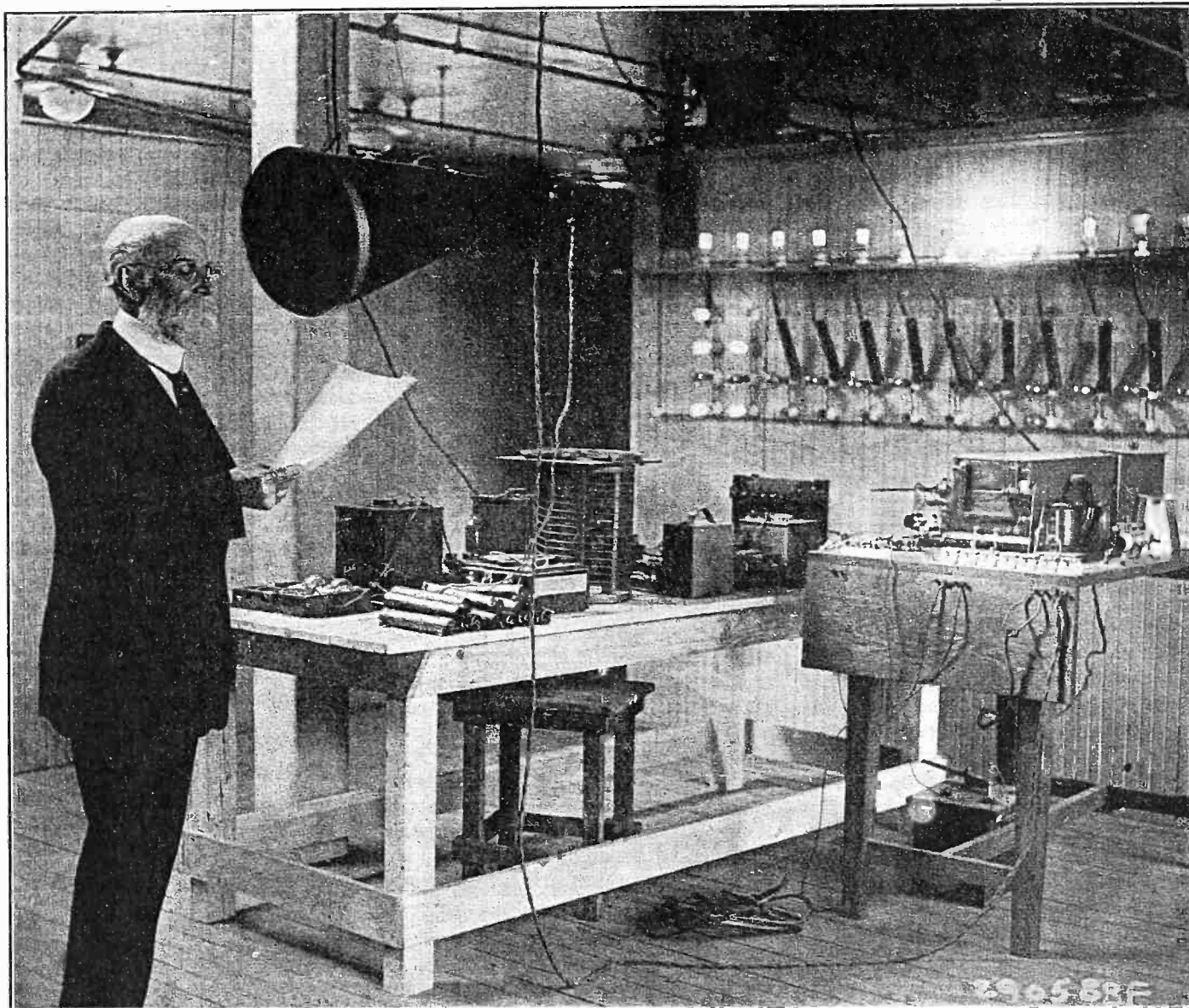

(c. Underwood & Underwood.)

Professor Charles Ernest Fay, dean of Tufts College, Boston, Mass., delivering a radio lecture to scores of listeners. Dr. Fay officially opened Tufts College radio educational department and was photographed reading his address into a large horn-shaped microphone in the American radio and research laboratories at Medford Hillside, Mass. Tufts College was the first institution of learning in the United States to introduce a course in radio.

## Do Not Overlook the Amateur

By Burt B. Barsook

**T**HERE has been considerable talk regarding the amateur—what he has done and what he is doing has probably received far less attention than he has really deserved.

If we go back into the history of all successful inventions and appliances, we will not fail to find that the amateur was at the bottom of every conceivable mechanical device that has proven its merits in practical usage.

The amateur in the radio line is, by no means, to be overlooked at a time when, perhaps, more real practical ideas will be developed than at any

other time in the history of wireless telegraphy or telephony. If you are interested in radio, get all the ideas you can. In the *RADIO WORLD* you will find some very valuable information, and you will find a lot more by talking to the young man or woman who has done experimenting with either the bulb or crystal sets.

This is aimed chiefly at the wisecracks who do not believe in talking to an amateur who can really impart some very valuable information to them. There are men of wide experience in the radio world who have knowledge

far surpassing the amateur it is true; but do not overlook the amateur if you are desirous of obtaining information that may be of material value to you. There are amateurs—many of them—who can run rings around technically trained men in the radio field.

## Shipping by Radio

A. D. Lasker, chairman of the Shipping Board, has joined the radio fans and purchased a receiving set, which he has installed in his home on 18th Street, in Washington, D. C. Recently, he talked from his office to the captain of a shipping-board vessel 100 miles off New York.

# The Radio Primer

## A. B. C. of Radio for the Beginner Who Must Have the Facts Put Plainly and Tersely, and all Terms Fully Explained

### Radio Terms at a Glance

**PRIMARY.** The name used to designate the outer coil of a loose coupler, variocoupler or transformer. The primary is more correctly given to the winding into which an electric current is sent, whether it be the inner or the outer coil, but in radio receiving sets it is practically always the outside coil.

**SECONDARY.** The name used to designate the inner coil of a loose coupler, variometer, or transformer. It is, more correctly, that coil from which the current is taken after it has been sent through the primary. So far as electric operation is concerned, the primary or secondary could be either the inner or the outer coil.

**CAPACITY.** One of the properties or states of electricity. Capacity is produced when two conductors insulated from each other are connected to the sides of an electric circuit. The electricity does not jump from one conductor to the other, through the insulator, but it does strain the latter. When the insulator has been strained to its limit, it automatically dumps its charge. Capacity is one of the essen-

tials of a radio circuit the other being inductance, previously defined.

**DISTRIBUTED CAPACITY.** If a receiving set is to produce the finest clearest results with the least interference from other stations, it is absolutely essential that the inductance and capacity be under close control. A variable condenser supplies capacity in controllable quantities, and if the inductance were pure inductance the wave length of the set would be a certain definite figure. But with most tuning coils there is some capacity between the individual turns of wire. Thus, instead of having one circuit containing an inductance coil and a condenser, which is the ideal condition, the amateur is confronted with one principle circuit of this nature and numerous miniature circuits composed of the inductance between turns of the tuning coil and capacity between the same turns. In non-technical terms, this condition has the effect of giving the set more than one wave length. It broadens the wave and makes close tuning practically impossible.

Thus we have the peculiar state of the layers in reverse order, as: 1, 3, 2, 5, 4, and so on.

Not all coils of this type carry the name of "honeycomb." This was originally a trade name given to the coils by one of its inventors. Since then other coils, very similar in general scheme, but embodying slight rearrangements in wiring method and procedure, have made their appearance. The names given them are "banked coils," "lateral," or "duo-lateral."

To show how compact these coils are, a coil which can be used to tune in a transmitting station sending on 14,000 meters will be only slightly over an inch in thickness and about four inches in diameter.

\* \* \*

*What is the variable condenser?*

A variable condenser consists of a number of semi-circular metal plates arranged in two sets. One set is stationary; the other can be moved on a pivot so that they enter between the stationary plates but without touching them. All the stationary plates are connected and, likewise, the rotating plates. The plates may be of aluminum, brass, or any other metal that retains its shape.

\* \* \*

*What does the variable condenser do?*

The variable condenser supplies an electrical quantity called *capacity*. Radio circuits are made up of Inductance and Capacity. Tuning coils supply much of the inductance while condensers are depended upon to supply the capacity. Perhaps a clearer idea of capacity would be gathered if a condenser were to be considered as a miniature storage-battery which catches and holds the minute electrical impulses until there are sufficient to make an impression on the head phones.

\* \* \*

*How does a variable condenser store the impulses?*

Strange as it may seem, it is not the metal plates in a condenser that hold the impulses but, rather, the air between the plates. When the impulses come in from the aerial and are transferred to the detector circuit by simple tuner, loose coupler, variometer, or variocoupler, the

## Honeycomb Coils and Condensers

*By Edward Linwood*

*What is a honeycomb coil?*

**I**N the descriptions of the other types of tuning coils, it has been evident that to obtain the required amounts of wire for long wave lengths would have necessitated large or long coils of bulky construction. Although the first thought would be to wind the coils in more than one layer, radio engineers know that when this is done the final result is never what it should be, due to a quantity known as "distributed capacity." This term means that each wire, with its neighbor, forms a miniature condenser; and while these condensers are all right in their place, they do not belong in a tuning coil, particularly when they are spread "all over the lot." If the capacity were con-

centrated, the objection would no longer hold; but this is not so.

It was while endeavoring to wind tuning coils in more than one layer, that the manufacturers found that if wires which should be neighbors were arranged so that they were only distant acquaintances the windings could be piled one upon another in a condensed space. Thus the honeycomb coil was born.

This coil derives its name from the peculiar appearance of the finished coil. In winding these tuning inductances none of the wires are ever parallel. They cross each other always at an angle. In some of the coils those wires, which should be in the second layer—that is, next to the first layer—are lifted up while the third layer takes their place.



## The Radio Primer (Continued)

# Charging the Storage Battery

By E. L. Bragdon

**I**N many parts of the country, house-lighting circuits are fed from electric generators of direct current instead of from an alternating current.

Radio amateurs thus situated are already supplied with the kind of current required to charge storage batteries. For, as was emphasized in preceding installments, storage batteries are storehouses for direct current only. If alternating current is the only kind at hand, then some type of current rectifier must be resorted to in order to change the electric flow from alternating to direct. If direct current is available, the amateur need

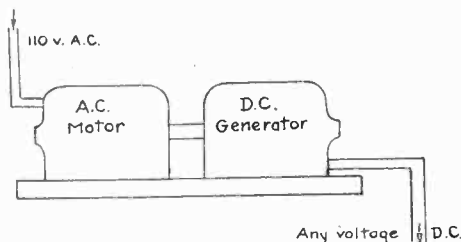

A. C. motor and D. C. generator for converting alternating current to direct current. This is one method used to charge storage batteries if proper resistances are used. Drawn by E. L. Bragdon.

only regulate the voltage and current and he has a first-rate charging layout.

It also happens frequently that the amateur uses in his workshop an electrical machine known as a motor generator. This machine is, as its name implies, a combination of motor and generator. The motor is connected to the alternating current-socket and when rotating, drives a direct-current generator which is placed on the same steel shaft with it. The current from the generator of a motor generator can be used for charging storage batteries in the same way exactly that a direct current house-lighting circuit would be used.

The connections are shown in diagrams on this page.

To use direct current from either source ordinarily demands some device which will cut down the voltage from that which is generated to that which is suitable for the battery. Radio batteries are, for the most part, of 6 volts while the direct current supply lines are either 110 or 220 volts. Motor generator sets are more often designed to produce the same direct current voltage, namely, 110 or 220, but sometimes they are specially wound to supply a voltage that is suitable for storage batteries. In all cases where the voltage supplied is more than 6, some sort of *resistance* must be placed in series with the battery to eat up the excess voltage.

The excess is always dissipated as heat. Knowing this, it is evident that when batteries are charged from a 110 or 220 volt line the cost is considerably more than when a rectifier is used, since so many volts pressure must be done away with and wasted. Garages and battery charging firms get around this weak point by charging many batteries at a time. Thus, if the charging station was equipped with 110 volts direct-current it could hook up eighteen 6-volt batteries and charge them together. The pressure would then be divided equally between the batteries and there would be no need for the wasteful resistance.

Usually when it becomes necessary to reduce the voltage the resistance is inserted in the form of the rather old-fashioned carbon type incandescent lamp. Lamps are handy resistances, and inexpensive to replace. By inserting the proper sizes it is possible to charge the battery with current having the correct voltage. The following example will show how to figure the resistance needed for this purpose,

assuming that the supply line is 110 volts.

The radio battery is a 6 volt battery. The supply line is 110 volts. This means the the difference between the two voltages or 104 volts must be

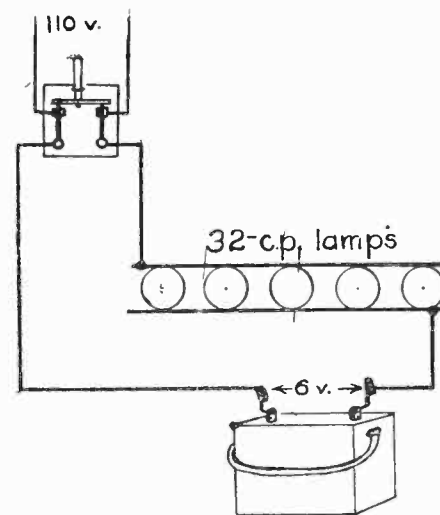

Diagram for charging storage batteries when 110 volts direct-current is available. Notice the lamps that are used for resistances for charging. Drawn by E. L. Bragdon.

dissipated in some way. Now, by an unalterable law of electricity, known as Ohm's Law, the resistance of a circuit is equal to the voltage divided by the current. The battery we are charging is a 90 ampere-hour battery and it is marked for a charging rate of 5 amperes. The problem then is to provide 5 amperes and 6 volts at the battery terminals. Using Ohm's Law: Resistance (in ohms) equals voltage (6) to be wasted (104), divided by amperes (5). which gives: Resistance—21 ohms, approximate.

A 32-candle-power carbon incandescent-lamp has a resistance of 105 ohms. When connected to a 110-volt line, approximately, one ampere of current flows through the filament.

With these figures to work on, it is evident that if we connect five of the lamps to the 110-volts line, in such a way that one ampere flows through each individual lamp we will have five amperes passing through all together. But when the lamps are connected in the same way—this way being called "in pallel"—the resistance of all five lamps together will be one-fifth of the resistance of one lamp. Therefore the total resistance would be 105 divided by 5 = 21 ohms, which is the exact resistance required. By connecting the lamps as shown in the diagram the battery would be charged with the six volts pressure and at the rate of five amperes.

(Continued from preceding page)

sounds are made up of little trains of waves. These trains come in to the metal plates of the condenser, but they cannot jump across from one set of plates to the other. Thwarted at that, they are still able to strain or twist the air between the plates. This action is the same as is seen when a piece of soft rub-

ber is twisted in the hands. So long as the pressure is maintained, the twist will remain; but if one hand is removed, the rubber returns to its former shape and size. In the condenser, the waves strain the air and the air holds the strain until it has stood all that it can. Then it "back fires," to use a common term.

# Radio as I

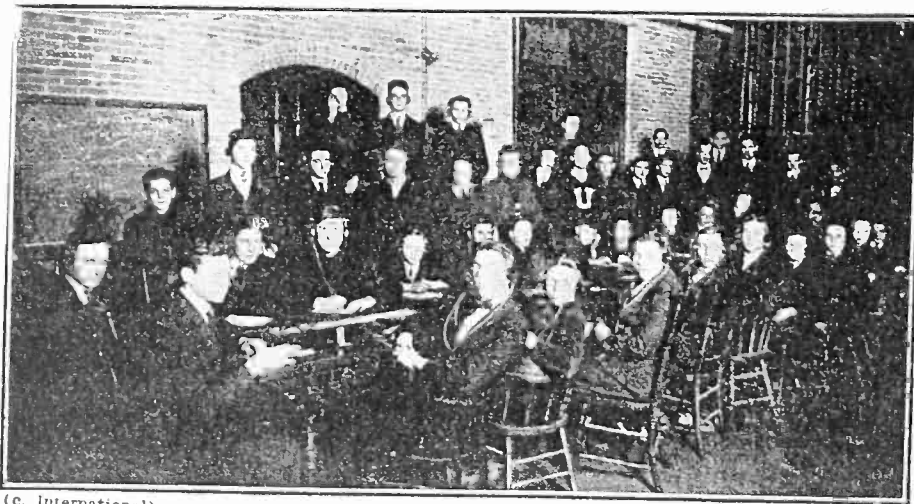

(c. International)

Radio class of Union College, Schnectady, N. Y. Outsiders may attend this class without charge.

(Right) Miss Elizabeth Bergner is the radio instructor at the Lane Technical High School, Chicago—one of the first public schools to make radio a part of its curriculum. Miss Bergner is one of the most advanced radioists among women, but her pupils are all very young men.

(c. International)



(c. Underwood & Underwood)

Constance Talmadge, moving-picture actress, and her director, Sidney Franklin, using radio to direct a picture.

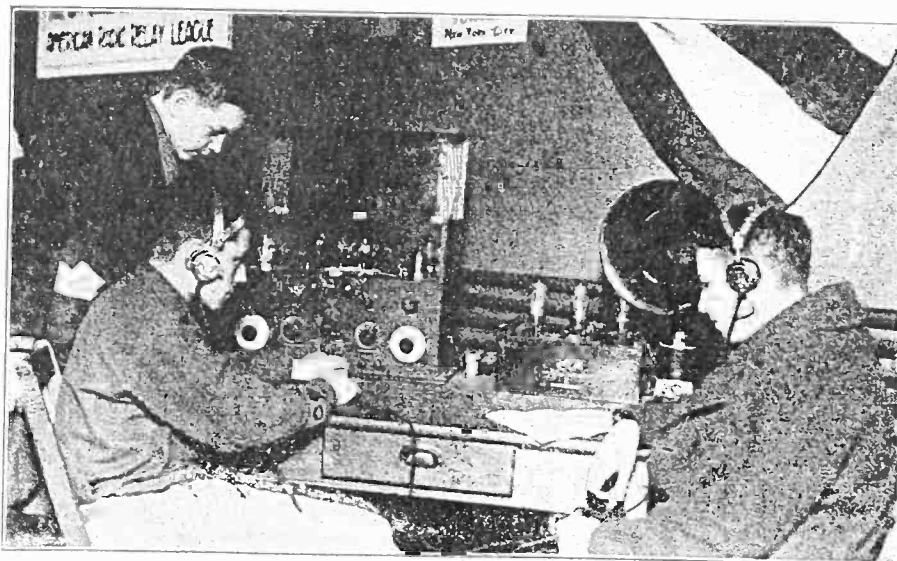

(c. Underwood & Underwood)

Boy Scouts are among the most active radioists. Here are (left to right) William Hodson, William McAllister, and F. Postkooke, considered experts by their brother scouts.



# Figures in the Week's Events

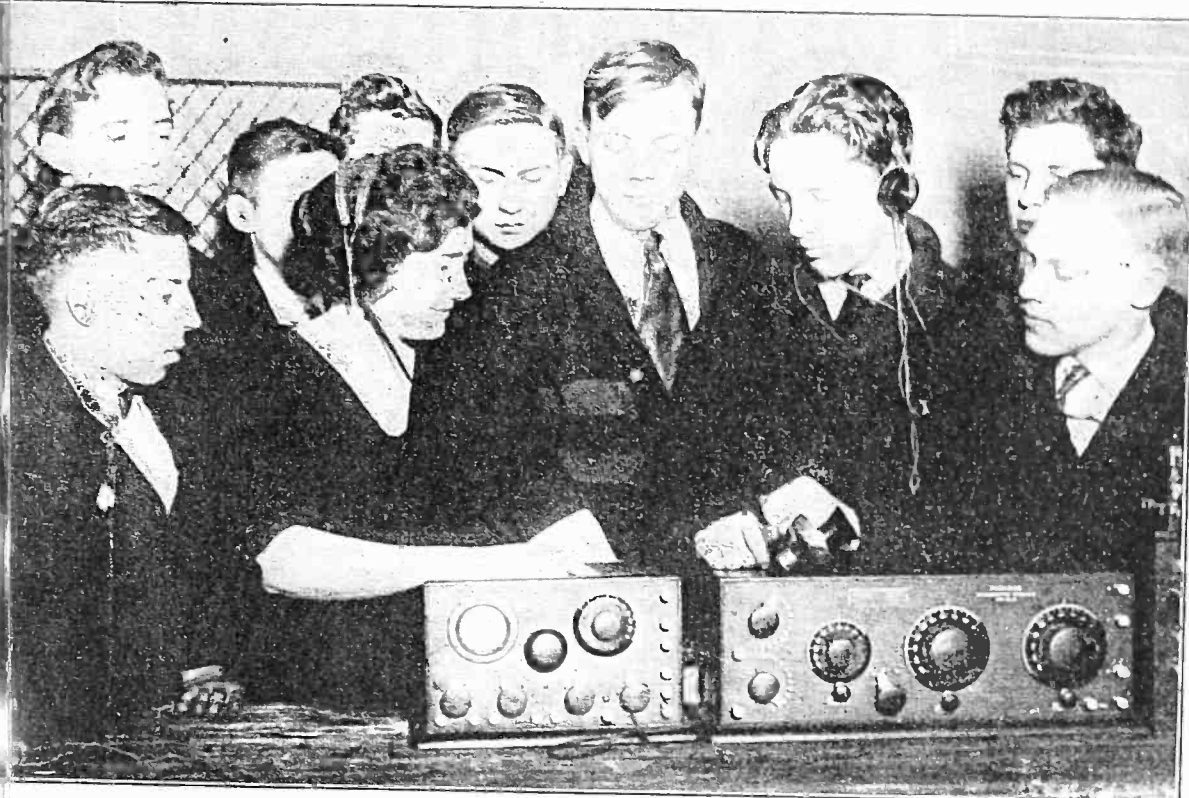

(c. Kadel & Herbert News Service, N. Y.)  
 The boys living in the cities where apartment houses are the rule, must first get the landlord's permission before they can set up aerials. Then there is no stopping them! When the wires are set the tall buildings are a great advantage in receiving, due to their extreme height.

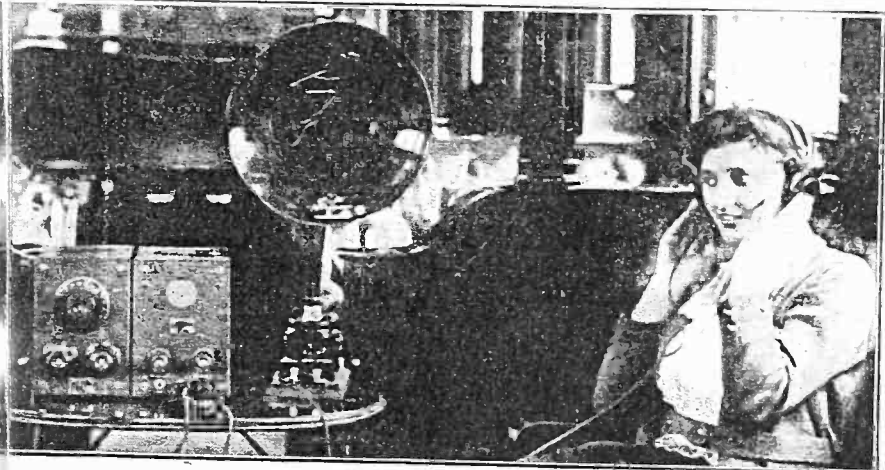

(Left) Here is proof of the vast strides being made by radio. Two women passengers in the club car of a fast train on the Northwestern Railway, running west from Chicago, "listening in" while a concert comes over the ether. The western railroads are some laps ahead of their eastern rivals in adopting radio.  
 (c. International)

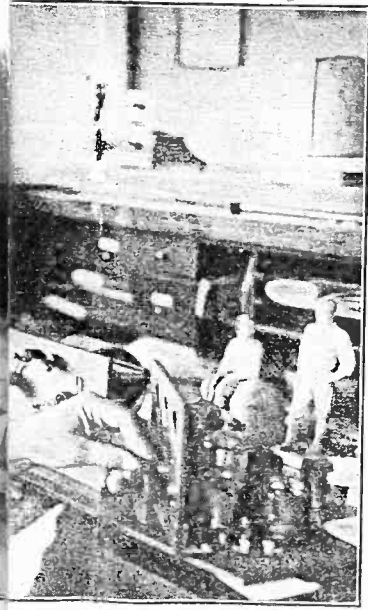

(Left) Clark Griffith, leader of the Washington "Senators" is a radio as well as a baseball "bug." Here he is receiving the scores of the out-of-town American League games.  
 (c. International)

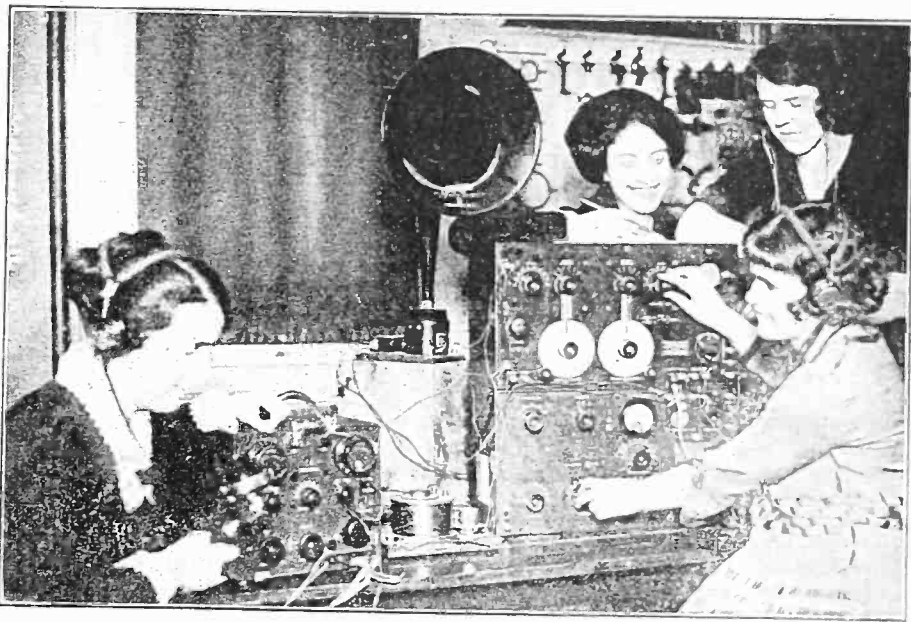

(Right) Students at Radcliffe College, Cambridge, Mass., and their very up-to-date radio set. From left to right, Miss Katherine Miller, Salem, O.; Miss Margaret Cunningham and Miss Susanne Dunn, Erie, Penn.; Miss Eleanor Brennan, at the extreme right, is "tuning in."  
 (c. Underwood & Underwood)



# Radio Merchandising

## Associated Advertising Clubs Uphold Radio World's Policy

**Y**OU will doubtless be interested and pleased to know that the first two issues of your new publication have been discussed by the National Vigilance Committee and that we heartily commend your vigorous editorial stand in behalf of truth in radio advertising and merchandising. We assume that it will be your policy to keep out of your paper all advertisers who do not adhere to the common truth, or who advertise wares which are unworthy of confidence.

We shall be glad to co-operate with you to the limit of our ability along these lines. We invite you to ask us for information when needed and refer to us known or suspected cases with such facts as you have.

Heretofore we have worked in old fields. This is our first opportunity to work from the start in a new industry of importance.

We believe we can further the radio industry and the radio public a very great service by doing all in our power to keep the field clean from the start. Probably 100 per cent. efficiency is too much to hope for, but with your co-operation and that of others similarly-minded, we can hope to maintain a high standard.

Doubtless you know of our work; but, perhaps, a few lines on the subject will be of interest. We are not a commercial institution. On the contrary, we represent

### This Firm Is "Radioizing" Phonographs

The phonograph is proving an ideal "speaker" for concerts and speeches sent by radio. The scientifically designed tone-chambers turned out by leading manufacturers enable a number of people in a room to hear, with remarkable clearness, everything "brought in" with a receiving-set having two or more steps of amplification.

The Essex Wireless Specialty Co., 31 New Street, Newark, N. J., manufacturers of the E. S. X. Wireless Talking Machine Attachment, has made exhaustive tests in employing the phonograph as a loud speaker. In a letter to the Trade Department of RADIO WORLD, this firm says:

"This attachment enables the owner of a radio receiving-set and a phonograph to utilize the carefully and expensively constructed tone-chambers, employed in the phonograph of today, as a loud speaker. In attaching the E. S. X., all that is necessary is to remove the sound reproducer from the talking machine and replace it with our instrument, allowing the leg to rest on the turntable. This insures proper height, which is absolutely essential in order to obtain full volume of sound."

The E. S. X. attachment permits the phones, or receivers, from any standard make of head set, and fits all the standard makes of talking machines. This firm seems to have produced an appliance that will "radioize" the phonograph.

225 advertising clubs and an individual membership of advertising men totaling some 25,000. Ten years ago, the advertising profession represented by our association adopted the truth emblem and organized the National Vigilance Committee to fight for it. Our work is known and endorsed, to-day, by leaders in every line of industry and by all divisions of advertising and Governmental agencies. Our salaried staff includes men experienced in this work, backed by extensive records and a nation-wide chain of local bureaus.

We know very little about the radio industry as such to-day. We hope to know a great deal about it to-morrow. We stand four-square on the proposition that radio advertising must adhere to the truth, whether it be in the realm of merchandising, financing or service. We are willing to serve as the standard bearers, and we call to the colors, every clean-minded man who believes in the truth policy and who realizes that it will be a big thing for the industry, and a big thing for the business of advertising to keep the radio field clean from the start. Such men will, no doubt, readily agree with our view that it will be a great setback to the industry to have the public interest now so widely manifested, diminished by untruthful and extravagant claims. — NATIONAL VIGILANCE COMMITTEE, Associated Advertising Clubs, by H. D. Robbins, chairman.

### IXE Claims Broadcasting Record

Editor, RADIO WORLD: With reference to the second issue of your magazine, which we think is a decided improvement on the first:

We note the item entitled "First to Broadcast," apparently an article emanating from the Publicity Department of the Radio Corporation or Westinghouse. The exact source of the item is not what interests me, but from reading the item one is apt to gain a false impression.

It is true KDKA was the first to broadcast Sunday church services regularly, but this corporation, operating a station in Medford Hillside, IXE, was the first to broadcast a regular daily schedule, when police reports for the City of Boston were sent out every night together with musical programs.

This "first" business is a mighty hard thing to prove. DeForest was broadcasting intermittently in 1915, and so were we. KDKA was the first to broadcast weekly, but we were the first to broadcast daily, which is quite a difference.

Please don't think that we are unmindful of the tremendous impetus to radio given by the Westinghouse stations. We realize they are preeminently leaders in broadcasting work, as must anyone else. My point simply is that this corporation was the first to broadcast on a regular daily schedule and is entitled to the proper credit

### Mayor May Open Brooklyn Show

Mayor Hylan has been invited to open the radio show at the Brooklyn Ice Palace, May 6. This show promises to be a radio event of unusual interest. An antenna New York City, will be used.

This show will mark the first annual exposition of the Electrical Contractors' Association.

One of the contests announced will be conducted by the Brooklyn Council, Boy Scouts of America, who have been active in radio development for some time.

A motor generator for the operation and transmission of messages has been given the Brooklyn Contractors by the Crocker-Wheeler Company, Ampere, N. J. These are the motors used by the United States Government on aircraft and ships.

### Communicate With Them

Editor, RADIO WORLD: Will you kindly advise as to who are the manufacturers of the following equipment for radio purposes, together with their addresses:

De Veau Loud Speaking sets.  
Bowman Airophone Radio Receivers.—GATELY-HAIRE CO., INC., 356 Broadway, Albany, N. Y.

\* \* \*

Editor, RADIO WORLD: We are at present molding a large assortment of parts for radio apparatus and we are writing in case you get calls from your advertisers for such articles. We are making in Celluloid, Composition and Bakelite.—AUBURN BUTTON WORKS, INC., by C. H. Woodruff, Auburn, N. Y.

\* \* \*

We are arranging to sell radio apparatus, as our Mr. Maxwell H. Hite is a practical electrician, having been electrician for the Pennsylvania Railroad, New York, and Philadelphia, for a number of years prior to taking up the auctioneering profession. He had considerable experience with wireless in years gone by, hence anything you facturers who need experienced sales agents can do to aid us in connecting with manu- will be greatly appreciated by MAXWELL H. HITE & SON, 422 S. 13th St., Harrisburg, Pa., per Wayne E. Hite

### On the "Must" List

Editor, RADIO WORLD: I bought a copy of RADIO WORLD at a newsstand and found it to be about the best ever. In fact, it is without a peer in the field of radio publications.

My check for six dollars is enclosed. Put my name on the "must" list.

—DR. H. RILEY SPITLER, 2 Stotler Bldg., Eaton, Ohio.

as such. Our programs have been surpassed by the Westinghouse stations; but they are steadily improving as everyone in New England knows, and soon will be on a par at least with those of any station.—AMERICAN RADIO AND RESEARCH CORPORATION, Medford Hillside, Mass., H. M. Taylor, Advertising Manager.



## Radio Merchandising (Continued)

### Will All New Firms Join This List?

**R**ADIO WORLD wants to keep its Radio Merchandising Department up to the minute in order that it will be of value to all engaged in every phase of the radio trade—a trade that is increasing daily, that will engage millions in capital create huge payrolls for skilled workers of both sexes, and draw considerable money from the fast-growing army of radio fans; for the day is certain to dawn when, so far as the American home is concerned, radio will be as popular as the phonograph, if not more so.

We begin in this number the publication of a list of dealers and jobbers in radio supplies in the United States. The list is classified by geographical sections, beginning with New England States. Watch for the name of your firm in your particular territory. If it is not recorded here, send it in for publication. It may mean business to you. Also send along any trade notes of interest—anything that may be of value to the radio trade.

Simply address your letter: "Editor RADIO WORLD, 1493 Broadway, New York."

#### North Atlantic States

(Continued)

B. & H. Radio Supplies, Paterson, N. J.  
Paul R. Collier, 154 E. Front St., Plainfield, N. J.

F. S. Katzenbach & Co., Trenton, N. J.  
Adams-Morgan Co., Upper Montclair, N. J.

Emerson Radio Apparatus Co., West Hoboken, N. J.

J. & M. Elec. Co., Amsterdam, N. Y.  
Colby's Telegraph School, Auburn, N. Y.  
Parlor City Electric Co., Binghamton, N. Y.

Radio Testing Station, 25 Sturges St., Binghamton, N. Y.

Kimley Elec. Co., 290 Winslow Ave., Buffalo, N. Y.

McCarthy Brothers & Ford, Buffalo, N. Y.

Bangert Electrical Co., Inc., Freeport, N. Y.

Hamburg Radio Supply Co., Hamburg, N. Y.

Bangert Electrical Co., Inc., Hempstead, N. Y.

White Electric Service, Hudson, N. Y.  
Bangert Electrical Co., Inc., Jamaica, N. Y.

Radio Supply Co., Mt. Vernon, N. Y.  
A. K. Laing Radio Co., Pelham Manor, N. Y.

Hickson Electric Co., Rochester, N. Y.  
R. Schmidt & Co., Rochester, N. Y.

Northern Electric Co., P. O. Box 371, Schenectady, N. Y.

Hughes Electrical Corp., Syracuse, N. Y.

Mohawk Electrical Specialty Co., Syracuse, N. Y.

American Electric Appliance Co., 235 Fulton St., N. Y. City.

J. F. Arnold, 2082 Lexington Ave., N. Y. City.

Beacon Radio & Electric Co., 246 Greenwich St., N. Y. City.

Broadway Electric Novelty Co., 324 Bowery, N. Y. City.

Bronx Radio Equipment Co., 687 Courtlandt Ave., N. Y. City.

John M. Cross Co., Radio Dept., 859 7th Ave., N. Y. City.

Economy Products Corp., 253 Broadway, N. Y. City.

Electric Service Engineering Co., 105 W. 47th St., N. Y. City.

Empire Radio & Equipment Co., 271 W. Brooklyn, N. Y.

John Firth & Co., 18 Broadway, N. Y. City.

H. Goldberg, 1373 3rd Ave., N. Y. City.

Hoyt Elec. Co., 686 Lexington Ave., N. Y. City.

The Haynes Radio Shop, 629 Lexington Ave., N. Y. City.

Howells Cine Equipment Co., 729 7th Ave., N. Y. City.

Hygrade Electrical Novelty Co., 41 W. 125th St., N. Y. City.

Kelly & Phillips, 312 Flatbush Ave., Brooklyn, N. Y.

Liberty Radio Co., Church and Liberty Sts., N. Y. City.

Long Island Wireless Telephone Co., 1173 Gates Ave., Brooklyn, N. Y.

Meade Bakelite & Radio Apparatus Co., 522 Central Ave., Brooklyn, N. Y.

Mutual Purchasers Ass'n., 2 Stone St., N. Y. City.

N. Y. Wireless Telephone Co., 82 Flatbush Ave., Brooklyn, N. Y.

Phenix Radio Supply Co., Room 29, 16 Court St., Brooklyn, N. Y.

Radio Co. of N. Y., 1674 Broadway, N. Y. City.

Radio Service & Mfg. Co., 110 W. 40th St., N. Y. City.

Radio Specialty Co., 96-98 Park Place, N. Y. City.

Radio Stores Corp., 146 W. 34th St., Store 16, Pennsylvania Arcade, N. Y. City.

Rooney Co., 1451 St. Nicholas Ave., N. Y. City.

Charles G. Rosewall, 93 Flatbush Ave., Brooklyn, N. Y.

Ashtabula Radio Sales Co., 49 McGovern Ave., Ashtabula, O.

(To be continued)

#### New Broadcasting Station

Editor, RADIO WORLD: We wish to inform you that the K & L Electric Company has opened a broadcasting station at 427 Olive Street, McKeesport, Pennsylvania.

The particulars are as follows: Call letters, WIK. Wave length, 360 meters. Schedule of operation, Sunday 1:30 to 2:30 p.m., 6:30 to 7:00 p.m.; and 6:30 to 7:00 p.m., daily. 9:30 to 10:30 Tuesday and Thursday. Range, 500 miles.—K. & L. ELECTRIC COMPANY, per Hunter J. Lohman, manager

#### Klosner Moves

The Klosner Improved Apparatus Company originators and sole manufacturers of the Klosner Vernier Rheostat, has moved to its new and enlarged offices at 2024 Boston Road, New York City. Its new factory is now in full production and immediate shipments are being made. The Klosner Company is arranging to manufacture other radio specialties and will shortly have an announcement to make regarding their new products.

### New Radio Firms and Corporations

Radio Supply and Service Corp., Manhattan, \$5,000; R. F. Alfaro, M. Droder, J. T. Simms. (Attorneys, Gold & Unger, Equitable Building, 120 Broadway, New York, N. Y.)

Seaboard Radio Corp., Manhattan, \$10,000; I. R. and S. Isaacs. (Attorney, S. S. Isaacs, 266 Grand St., New York, N. Y.)

Radiogem Corp., Manhattan, make wireless apparatus, \$10,000; T. Banilower, S. Holtzman. (Attorney, H. S. Wallenstein, 233 Broadway, New York, N. Y.)

Simon Radio Corp., Del., 500 shares preferred stock, \$100 each; 1,500 common, no par value; rep., T. I. O'Malley, 42 Broadway, New York, N. Y.)

Washington Radio Corp., radiophones, \$250,000; David L. Riordan, Jacob N. Halper, R. S. Knapp, Washington. (Capital Trust Company of Delaware.)

Atlantic Radio Corp., Wilmington, Del., apparatus, \$200,000. (Register and Transfer Co.)

Radio Distributing Corp., apparatus, \$100,000; Frank Jackson, Dover, Del. (Capital Trust Co. of Delaware.)

Superior Radio Inc., Philadelphia, apparatus, \$100,000. (Corporation Guarantee and Trust Co., Philadelphia, Pa.)

Newfane Electric Co., \$20,000 to \$100,000.

Standard Radio Corp., Wilmington, Del. Receive and utilize electromagnetic waves, \$500,000. (Corporation Trust Co. of America.)

Broadcast Radio Corp., Manhattan, \$20,000; E. Friedman, A. H. Kestenbaum, D. Wachsstock. (Attorney, M. M. Helfgott, 35 Nassau St., New York, N. Y.)

Wireless Appliance Corp., Manhattan, 1,000 shares common stock, no par value; active capital, \$5,000; L. Freed, S. E. Stott, H. J. Conhaim. (Attorney, J. H. Buck, 2 Rector St., New York, N. Y.)

Louisville Hydro Electric Co., Wilmington, Del., \$1,000,000. (Corporation Trust Co. of America.)

General Radio Corp., Philadelphia, radiophones, \$1,000,000. (Corporation Guarantee and Trust Co., Philadelphia, Pa.)

Short Cut Radio Corp., New York, apparatus, \$100,000. (U. S. Corporation Co.)

Pioneer Radio Corp., Manhattan, \$20,000; M. G. Stark, J. Freidman, F. W. Kristeller. (Attorneys, Watson, Kristeller & Swift, 58 William St., New York, N. Y.)

Rex Radio Sales Corp., Manhattan, \$5,000; S. Prince, L. Frank, A. Greenwald. (Attorney, I. Lowenbraun, 116 Nassau St., New York, N. Y.)

Rex Radio Sales Corp., Manhattan, \$7,500; M. L. Urdang, J. Forman, (Attorney, A. Lipton, 150 Broadway, New York, N. Y.)

Rialto Radio Corp., Manhattan, \$10,000; J. D. Basson, J. La Rose, A. Meyer. (Attorney, A. Falck, 2 Rector St., New York, N. Y.)

Radio Publishing Corp., Manhattan, \$300,000; C. J. Glidden, E. P. Brinegar, C. R. Carpenter. (Attorney, F. J. Knorr, Albany, N. Y.)

Radio Winding Corp., Bronx, \$10,000; E. A. Gersbach, A. Lemlein, H. B. Salzberg. (Attorney, P. Lewenson, 5 Beekman St., New York, N. Y.)

Wizard Battery Co., Manhattan, \$10,000; J. L. Lotsch, M. Lanzit, E. Friberg. (Attorneys, Schechter & Lotsch, 34 Wall St., New York, N. Y.)

# Radio and the Woman



(c. Underwood & Underwood)

The second lady in the land, Mrs. Calvin Coolidge, wife of the Vice-President of the United States, is one of the most ardent radio fans in Washington.

**D**O you know that a certain famous costumer on the Place de la Madeleine, Paris, is the first dressmaker to use the radiotelephone in his designing rooms? It seems to me that this belief in the inspirational value of music reveals not only artistic, but keen business sense.

\* \* \*

It is interesting to note that an automobile club plans to make wireless the medium for informing motorists of the conditions of roads so that travellers starting on a trip will be prepared for every emergency. What feminine member of any motoring party wouldn't be glad to know in advance just what amount of comfort a contemplated journey portends?

\* \* \*

A woman living on a lonely western ranch writes that her only entertainment comes by radiophone.

\* \* \*

When the choice lies between a radio concert or a victrola or phonograph, many prospective brides are showing decided preference for the first named. One girl who, far in advance of the wedding date, has been presented with a handsome talking-machine, even contemplates having it remodeled to hold a receiving set.

\* \* \*

A dedication on the flyleaf of a book

on wireless telegraphy, states that it was a certain woman's encouragement and assistance in the gathering and preparation of material for the voice that enabled the author to write the book.

\* \* \*

What earthly chance has the profiteer in eatables, when righteously indignant housewives offer incontestable proof that his inflated prices do not agree with their latest "Marketing for the home" radio report?

\* \* \*

It is not so much a question now as to whether or not little Mary or John shall take turns winding up the talking machine, as it is who shall have use of the head set.

\* \* \*

Among the dainty home-furnishings of a certain prospective June bride, is as cleverly designed a receiving-set cover as ever has been seen in the somewhat *passe*, silk-and-gold hoop-skirted lady whose beruffled gown has hitherto effectively concealed disfiguring telephones.

\* \* \*

With so many interesting accounts coming in of the radio activities of boys' clubs, it is surprising that so enterprising an organization as the Girl Scouts cannot show a record of equally successful experiments. I prophesy, however, that by the end of

the summer, events will prove these practical, energetic girls to be as progressive as ever mere males could be.

\* \* \*

Mary Allan Stuart, authoress of many published juvenile poems, lays emphasis on the fine courtesy and splendid co-operation extended her by officials of the Westinghouse station. On May 1 some of her poems are to be broadcasted. Her "George, the Engineer," will be enjoyed by all who happen to listen in.

\* \* \*

Looking into the future, I am certain that it will be well for the girl about to select a career to consider thoroughly the possibilities for progress and remuneration in this new, fertile, and uncrowded field.

\* \* \*

One who has wearied of her job of playing a piano in a motion-picture house, voices her belief that when her resignation is accepted, the theater's up-to-date business manager is going to entertain his future audiences by means of wireless telephony.

\* \* \*

To the intelligent, energetic woman forced to live within her own small circle through devotion to home and children, the radiotelephone will bring soul's surcease.

\* \* \*

One dear girl, who, because of ill health, is forced to miss her last term at school, plans to do two things this summer: one is, that since her receiving set is the only one in the neighborhood in which she lives, she intends to cover the expense of a tutor by money made from running a tea room whose chief attraction will be a radio concert. The other is to pay close attention to lectures and educational talks broadcasted, so that with knowledge gained from these added to what she has already derived from her tutor's instructions, she will be prepared to face the stiffest sort of examination next fall.

\* \* \*

A little woman living in Huntington, West Virginia, sends word that, on Sunday last, her amateur receiving-set enabled her to listen in on a church service held in East Pittsburg. On Tuesday night, she enjoyed a Westinghouse concert.

\* \* \*

Feminine fancies in my mail: A student, who evidently intends taking up the study of wireless very seriously, bemoans the fact that though the meaning of the various



(c. Keystone View Co.)

One housewife finds the radiophone an aid in her daily work. Gramophone selections were transmitted from the Marconi Wireless Telegraph Station at Writtle, Essex, England, on a wave length of 700 meters. The music went into dozens of homes where radios were installed—to the delight of the women who did the housework.

kinds of rays, namely: "actinic," "light," "heat," "electric" and "X-rays," are clear enough, the wave terms puzzle her. Consequently she asks for a letter which will differentiate "pressure" waves from "electric" waves.

A school girl writes to ask if the word "oscillatory" as used when referring to "an oscillatory circuit" was derived from the verb—osculatory.  
\* \* \*

One who signs herself "A Chorus Girl" wants me to inform her as to

whether or not our terms, "electric wave," "coils," "wave lengths," and so on have anything to do with a coming mode of hair dressing.  
\* \* \*

A nervous invalid who prefers to introduce herself as "Not a Spiritualist," says that though she is intensely interested in this new science and is eagerly awaiting the installation of a receiving set which she has purchased, she still entertains a few tremors regarding the various "mediums" to which we so often refer. She asks just what do we mean by that.  
\* \* \*

A farmer's wife writes to ask if the term "auto-jigger," which so many amateurs use, really relates to wireless or if it is a new Ford joke.  
\* \* \*

A woman mineralogist writes that lack of time has prevented her from taking up the study of radio, but that a recent allusion of ours to certain "crystals" has made her investigate.  
\* \* \*

A girl who describes her occupation as being that of a 'cello player in an orchestra, asks what we mean when we use the phrase, "out of tune."  
\* \* \*

A young accountant wishes me to explain the difference between "statics" and "statisticks." Just a little difference.—R. R. G.



(c. Fotograms, N. Y.)

Miss Winifred Taylor, of New York, goes in for two amusements at the same time—her canter and radio. Of course, she must have aërials and a ground wire; but every radio set is not complete in a photograph. If passengers can listen in while traveling on a passenger coach, what is to prevent a young lady from utilizing radio while taking her morning canter through the park.

# RADIO WORLD'S QUICK ACTION CLASSIFIED ADS

This department is intended for everybody who wants quick action on short announcements covering the buying, selling, exchanging or general merchandising in the radio field. Readers of RADIO WORLD will find that it pays to read these columns every week. Advertisers will get a five-day service here—that is, copy received for this department will appear in RADIO WORLD on the news-stands five days after copy reaches us.

The rate for this RADIO WORLD QUICK ACTION CLASSIFIED AD. DEPT. is 5c. per word (minimum of 10 words, including address), 10% discount for 4 consecutive insertions, 15% for 13 consecutive insertions (3 months). Changes will be made in standing classified advs., if copy is received at this office before 4 P. M. on any Thursday preceding date of publication. RADIO WORLD CO., 1493 Broadway, New York City. (Phone, Bryant 4796.)

**ROGERS RECEIVING RADIOMETER:** New patented variometer for panel mounting. Simple, compact, efficient, \$4.00. Build your own receiver. Two radiometers one variable condenser, directions and wiring diagram, mailed upon receipt money order \$10.00. Rogers Radio Company, 5133 Woodworth St., Pittsburgh, Penna.

**Government Positions.** Men, women, 18, over. Wanted for Railway Mail, Postoffice, other Government positions. Examination soon. Salary \$1,400-\$1,500 year. Experience unnecessary. Particulars free. Write Columbia School of Civil Service, 383 Pope Bldg., Washington, D. C.

**HIGH GRADE ANTENNA WIRE.** Best quality, 7 strand No. 22 trimmed copper, non corrosive antenna wire. Only 19 per foot. The Kehler Radio Laboratories. Dept. W. Abilene, Kansas.

**HAVE YOU A RADIO SET?**—If not try my system in getting one. I sell at reduced prices, batteries, tools, sporting goods, merchandise of all kinds. Try me. Anderson, 340 Park Ave., N. Y.

**CODE CHARTS**—Containing alphabet, number, punctuation and Q abbreviations. Two sizes, 12 x 16 @ 25 cents and 24 x 30 @ 50 cents. If your dealer does not handle them, we will mail them postpaid upon receipt of price. H. C. Wiley, 48 Monroe St., Hartford, Conn.

**WE BUY** second hand radio goods, any description. Columbus Shop, 874 Columbus Ave. (103d). Open evenings to 10 o'clock.

**LEUMITE** the ultra-sensitive detector crystal, postpaid 25c. **LEUMAS LABORATORIES**, 311B Fifth Ave., New York.

20,000 Meter Loose Coupler, \$12.00; Navy Crystal Detector, \$2.00; De Forest Weatherproof Model Detector, \$1.50. Act quickly. Jones, Hamilton Beach, N. Y.

**HAWK-CRYSTAL SETS—HAWK** Complete with head sets and aerial. Guaranteed 25 miles. Special \$15.00. Expert layouts of Regenerative Sets and Radio Devices Free. **HAWK RADIO SUPPLY CO.**, 558 Melrose Ave., Bronx. Opp. Miner's Theatre.

**Amateurs' attention.** We are four blocks from the Grand Central. We have sets for immediate delivery, also tubes, phones, variometers, couplers, condensers, etc. Mail orders receive prompt attention. Evenings 7 P. M. Murray Hill Electric Co., 214 East 38th St.

Receipt by new subscribers of the first copy of RADIO WORLD mailed to them after sending in their order, is automatic acknowledgment of their subscription order and payment therefor.—(Adv.)

**FOR SALE**—Beautiful Quartered Oak Rolltop Secretary Desk and Typewriter. Desk to match very little used. S. D. Hayden, 1493 Broadway, Room 223.

- 100 ft. 7 strand Copper Aerial Wire .....\$ .71
- 100 ft. Hard Drawn Copper Aerial Wire.... .49
- Aerial Insulators ..... .23
- Nickel Plated Binding Posts ..... .04
- 22 1/2 Volt small "B" Battery ..... .90
- 22 1/2 Volt large "B" Battery ..... 1.40
- 22 1/2 Volt large variable "B" Battery ..... 1.90
- 45 Volt Double size Variable "B" Battery 2.80
- Nickel Plated Conntanct Points .....doz. .20
- Nickel Plated Switch Arms ..... .57
- Brach Lightning Protectors ..... 2.37
- Porcelain Vacuum Tube Sockets ..... .58
- 1/4 inch Slider and 10 inch Rod ..... .45
- Coils wound on Tube ..... .75
- Croust Detectors, (N. Y.) ..... 1.20
- Mounted Tested Galena ..... .25

**LIBERTY RADIO CO.**  
Church and Liberty Streets, New York City, N. Y.  
Phone Rector 3432

**RADIO LICENSES**—Our booklet tells you how to obtain a government transmitting license, 20 cents. Howard Frazier, 5714 Hazel Ave., Philadelphia.

**WANTED**—Agencies for available radio parts or material. Distribution and office services. Experimenters avoided. M. W. Schneider, 96 Warren St., Rm. 206, N. Y. C.

**Radio parts production.** We produce dielectric, metal, screw machine parts. Workmanship and assembly unquestioned. Definite propositions only. M. W. Schneider, 96 Warren St., Room 206, N. Y. C.

Complete your files by getting the first numbers of RADIO WORLD and save them so that you can have 52 copies bound at the end of the year. If your newsdealer cannot supply you with the copies he can get back number through the American News Co. and its branches, or copies at 15 cents each, will be sent direct from publication office, or better still, subscribe and have your subscription start. **RADIO WORLD CO.**, 1493 Broadway, New York, N. Y. (Adv.)

Subscribe for Radio World by the year and be sure of not missing an issue. (Adv.)

**Audion receivers direct from manufacturer,** handsome cabinet, bakelite panel and dials, 150 meters to 3,000 meters. \$29.50 unassembled \$20 postpaid. Crystal sets in cabinet \$10 unassembled \$7 postpaid. Stamp for full details of these and other outfits, dealers supplied, agents wanted. Edward T. Collins, 8522-101 Richmond Hill, L. I., N. Y.

**We buy old gold, silver, platinum, coins and stamps.** Walters Co. 1540 North 58th St., Philadelphia, Pa.

## RADIO BOOKS ALL UP TO DATE

- Design Data for Radio Transmitters and Receivers, by Sleeper. Price 75c.
  - Experimental Wireless Stations, by Edelman. Price \$3.00.
  - Wireless Telegraphy and Telephony Simply Explained, by Morgan. Price \$1.50.
  - The A B C of Vacuum Tubes used in Radio Reception, by E. H. Lewis. Price \$1.00.
  - Radio Hook-Ups, by Sleeper. Price 75c.
  - Construction of New Type Transatlantic Receiving Sets, by Sleeper. Price 75c.
  - How to Make Commercial Type Radio Apparatus, by Sleeper. Price 75c.
  - Construction of Radiophone and Telegraph Receivers for Beginners, by Sleeper. Price 75c.
  - FREE!** Catalogue of Radio, Automobile and Other Books. Sent Free on Request. Liberal Discount to Supply Houses
- THE NORMAN W. HENLEY PUB. CO.**  
2 West 45th Street  
Take Elevator to Sixth Floor. Visit us at Travelers Show, Booth 103, where books can be seen.

## SUBSCRIPTION BLANK



**RADIO WORLD CO.**

1493 Broadway, New York City.

Please send me RADIO WORLD for ..... months, for which please find enclosed \$ .....

**SUBSCRIPTION RATES:**

- Single Copy .....\$ 15
- Three Months ..... 1.50
- Six Months ..... 3.00
- One Year (including Special Nos.) ..... 6.00
- Postage Paid.
- Add \$1.00 a year for Foreign and Canadian Postage.



# RADIO WORLD

PUBLISHED EVERY WEDNESDAY (DATED SATURDAY OF SAME WEEK)  
FROM PUBLICATION OFFICE, 1493 BROADWAY, NEW YORK, N. Y.

BY RADIO WORLD COMPANY

ROLAND BURKE HENNESSY, Editor and Proprietor - - - - - 1493 Broadway, New York  
FRED S. CLARK, Manager - - - - - 1493 Broadway, New York

ASSOCIATE EDITORS:

ROBERT MACKAY - - - - - FRED. CHAS. EHLERT  
CENTRAL-WESTERN ADVERTISING REPRESENTATIVES:  
W. B. ZIFF CO., 608 S. Dearborn St., Chicago

SUBSCRIPTION RATES

Fifteen cents a copy. \$6.00 a year. \$3.00 for six months. \$1.50 for three months.  
Add \$1.00 a year extra for postage to Canada and foreign countries.

Receipt by new subscribers of the first copy of RADIO WORLD mailed to them after sending in their order, is automatic acknowledgment of their subscription order and payment therefor.

ADVERTISING INFORMATION

MECHANICAL REQUIREMENTS:

Size of page: 12 inches deep—9 inches wide.  
Size of type page: 10 1/4 inches deep—7 1/4 inches wide.  
Three columns, 147 lines each—441 lines to the page.

CUTS:

All plates should be mounted. We can use screens up to and including 133. We prefer 120 screen half tone. We cannot use matrices.

ADVERTISING RATES:

One page: One time—\$150.00.  
Half, Quarter, Third and Two-thirds pages at proportional rates.  
One inch, one time—\$5.00. Per agate line, \$0.40.  
On four consecutive issues, 10% discount.  
On thirteen consecutive issues, 15% discount.  
Terms: 30 days Net. 2% 10 days.

CLASSIFIED ADVERTISEMENTS:

Five cents per word. Minimum, 10 words. Discount of 10% on 4 consecutive issues—15% on thirteen consecutive issues. Cash with order.

Cover and preferred-position rates made known on application

Application for Second Class Privilege Applied for through Post Office, New York, N. Y.

IMPORTANT NOTICE:

While every possible care is taken to state correctly matters of fact and opinion in technical and general writings covering the radio field, and every line printed is gone over with a scrupulous regard for the facts, the publisher hereby disclaims any responsibility for statements regarding questions of patents, priority of claims, the proper working out of technical problems, or other matters that may be printed in good faith and on information furnished by those supposed to be trustworthy. This statement is made in good faith and to save time and controversy over matters over which the publisher cannot possibly have control.

# Radiogleanings

OVER 600,000 persons in the United States now own apparatus with which to receive radio messages

About one-tenth of the population of the United States can be served by WJZ., the Newark, New Jersey, broadcasting station.

The physics department of the University of Wisconsin broadcasts over a radius of sixty miles in broad daylight and further at night.

Considering comparatively short distances, the cost of wireless-telephone receiving-apparatus is about \$1 for every mile of distance from the transmitter.

The report that Iowa and Nebraska farmers may listen to broadcasting from Newark, Pittsburgh, or New Orleans would imply that the middle westerner is expected to use a multiplex-vacuum-tube radio-equipment.

The remarkable growth of the radio art for all sorts of purposes, has caused considerable confusion in the air and inefficiency in all radio service. This must be overcome.

The oldtime amateur radio operator knows most of the broadcasting stations by the sound of their sparks. Some are identified by the peculiar note of the spark transmitter, others by the high speed with which messages are sent, and so on.

According to the Western Electric Company, some of its broadcasts from the roof of the West Street Building, New York, have been heard 3,000 miles away. The longest recorded distance was the pick-up of the steamer "E. L. Drake," 1,000 miles west of San Francisco.

The proficiency of United States Navy operators was proved recently when a competitive radio-drill was held among the destroyers of the Pacific fleet. Seventy-three ships were represented. Six squadrons attained 100 per cent., one 99 per cent. None had a record below 83 per cent.

California with 26 broadcasting stations, heads the list of States; Pennsylvania ranks second with 11; New York, third, with 9.

Demands of summer campers already indicate that radio sets will take the place of cameras and phonographs this year.

## A Sample General Electric Program

FRIDAY, APRIL 28.

SPECIAL PROGRAM

11:30 P.M. EASTERN TIME

Medley of Popular Airs—from "Bombo" Jolson.

Cain's Castle Orchestra under direction of R. E. MacDermott, pianist. W. J. Healy, violin; E. Von Hyning, violin; T. Nessler, cornet; J. Maly, cello; C. Rowe, saxophone; Al. Voight, saxophone; C. B. Roberts, flute; K. E. Snell, bass; E. Shear, Xylophone and drums.

Venetian Love Moon.....Feist  
Cain's Castle Orchestra.

Kentucky Blues .....Feist  
Saxophone Duet—C. Rowe and Al. Voight.

Good Bye Shanghai—Fox Trot....Remick  
Cain's Castle Orchestra.

Teasing .....Stern  
Xylophone Solo—E. G. Shear.

(a) Sapphire Seas .....Whitmark  
(b) Angel Child .....Lang

Cain's Castle Orchestra.  
La Campanella .....Liszt

Piano solo, "Duo Art," by Ferruccio Busoni.

No use Crying—Fox Trot .....Hirsch  
Cain's Castle Orchestra.

## Advertiser Gets 500 Replies from One Half-Page Advertisement in Radio World

### Howells Cine Equipment Co., Inc. Executive Offices

729 SEVENTH AVE., NEW YORK, U. S. A.

April 19th, 1922.

RADIO WORLD,  
1493 Broadway,  
New York City.

Gentlemen:

We wish to state we have received over five hundred inquiries, within the last few days, from the half-page advertisement which we put in your "Radio World," issue of April 15th, 1922.

I think this sure is some advertising medium.

Very truly yours,  
HOWELLS CINE EQUIPMENT CO., INC.  
By (Signed) J. C. HORNSTEIN,  
General Manager

G

JCH

## Stations Worked and Heard

RADIO WORLD, in this issue, inaugurates a new department, "Stations Worked and Heard," and will publish the lists of all amateurs who keep a record of what comes over the ether waves into their receivers. When preparing your list write it out similar to the one appended:

Be sure to give your own call and write out the calls you receive, separating them in groups. Special attention should be given as to whether spark, phone, or C. W. was received.

E. Brown, and W. T. Scott, 2127 Steven's Court, N. W., Washington, D. C.

Heard: April 1 to 15. CW,—1 CN, 1 YK, 1 ARY, 1 AWB, 1 BGF, 1 BQE, 1 BTC, 1 BQE, 1 BTC, 1 BWJ, 1 CIK, 1 BTL, 1 ICNF.

2 RY, 2 WT, 2 ZK, 2 AWF, 2 BEA, 2 BEH, 2 BGI, 2 BML.

3 BZ, 3 CC, 3 IL, 3 ZY, 3 AJO, 3 BOF, 3 BXA.

4 BQ, 4 CO, 4 GL, 4 ZC.

5 DA.

8 AO, 8 DV, 8 IQ, 8 PO, 8 QZ, 8 RQ, 8 gE, 8 ZR, 8 ANB, 8 AOO, 8 ASK, 8 BDU, BCJ, 8 BEF, 8 BIL, 8 BPU, 8 BSY, 8 CAZ, 8 CBJ.

9 CT, 9 ARK.

KYW, KDKA, NOF, WGY, WJZ, WOH, WWJ.

# Answers to Readers

WITH a crystal receiver-set, I can pick up the music from Newark clearly. The aerial is a single wire about 100 feet long. On bringing the set to Brooklyn, I found out that I was unable to pick up Newark; but due to the fact that I was using a shorter aerial of 50 feet, spark signals were audible. Could you tell me what might have been the trouble?—J. C. K., Brooklyn, N. Y.

Your aerial is too short. A double wire will not make it 100 feet long. The broadcasting may be picked up in certain sections of New York very well, but there are certain sections that are practically dead, and due to the high buildings and steel bridges, a greater part of the energy is absorbed. Would advise you to put in a vacuum-tube outfit for better results.

\* \* \*

Is any danger from lightning on an inside aerial?—C. J. S., East Orange, N. J.

No; there will be no danger, but would advise you to ground any aerial whether inside or outside.

\* \* \*

In reference to the single five-watt tube-set in the RADIO WORLD of April 1, 1922, can 500 volts direct current, stepped down to 350 volts, be used in place of 220 volts and 130 volts "B" battery? Can the whole 500 volts be used or is it too high?—H. P., Town of Union, N. J.

You can probably secure an extended replay to your question by corresponding with the writer of the article, Frank A. Hanhel, 214 East 38th Street, New York.

\* \* \*

I have a set which has a wave-length of 175 to 1,000 meters, and would like to know if I can secure something that will increase my wave length from 1,000 meters to 3,000 meters?—C. A. H., Staunton, Va.

Visit your nearest dealer and ask if you can purchase any loading coils that will carry you to the wave-lengths desired. They should be inserted in series with primary and secondary windings of coupler.

Could a two-step amplifier be added to a set using one vacuum tube? Will a single-wire aerial, 75 feet long, be as good as one of the same length composed of two?—A. R. D., Paterson, N. J.

You may add as many amplifiers as you desire, in connection with tube for detector. A single-wire aerial will give you same results as a two-wire aerial composed of the same length.

\* \* \*

Do all regenerative circuits come under the Armstrong patent?—C. H. P., Brooklyn, N. Y.

The Armstrong patent is a basic patent and covers all circuits pertaining to regeneration; or, in other words, anyone who employs any type of a feed-back directly or indirectly in the plate circuit, is infringing on his patents. Recent court decisions seem to uphold this patent as standard. All regenerative circuits are practically Armstrong circuits.

\* \* \*

I have a receiving set comprising the following equipment. Loose coupler, crystal detector, variable condenser, phones, and a fixed condenser. I receive signals from spark stations very clearly; but, somehow, cannot pick up the music. What seems to be the trouble?—C. L. E., Flatbush, N. Y.

Use your variable condenser in series with your antenna; this, in turn, would give you a range so as to reduce your wave length down to the desired wave. Experiment awhile. With a few trials you

Owing to the large numbers of questions received from readers it is impossible to answer all in this number. Your replies will appear in the next or future numbers of Radio World.

should succeed. Be sure you have your fixed condenser shunted around your telephones.

\* \* \*

Please tell me what method I could use to tell the polarity of the d. c. supply in my home. I have 110 volts d. c., and wish to cut it down for charging.—G. S., Philadelphia.

Make sure you have d. c. before you start to do anything. This information can be had by simply asking the company who supplies the current. If they advise you that d. c. is available, simply take a raw potato, peel it and place your two leads into the potato keeping them about an inch apart. The result will be that a green spot will appear around the positive wire. Another method is to place the two leads in a glass of water, also keeping them apart. As a result, the negative wire will form bubbles which will rise to the surface. A wise stunt is to place, or tie, a knot in the positive wire, as this is a symbol used by all radio experts.

\* \* \*

Would there be any advantage in using two galena detectors?—G. M., Detroit.

Using two crystals will be of no advantage to you with such an arrangement. This will benefit you if you care to have a spare detector to use in case one gets oiled and spunky.

\* \* \*

Is No. 22 wire O.K., for a variometer? Should the stator and rotor have the same amount of wire on it?—J. M. K., Hoisington, Kansas.

This size is advisable, but No. 24 would be more suitable. There must be just as many turns on the stator as on the rotor.

\* \* \*

How far can I receive on a crystal set from a broadcasting station?—W. D., Grantwood, N. J.

You cannot expect to receive over 25 miles with a good crystal detector. You might be able to receive a little farther under ideal conditions, but you could not depend on a distance beyond that mentioned.

\* \* \*

Can I use a 2,000-ohm and 3,000-ohm receiver? How can I connect them?—H. M. G., Kingston, N. Y.

These receivers can be connected in series, but should be of the same ohmage.

\* \* \*

My receiving set consists of the following apparatus. A spider web-inductance, a vacuum tube, a socket, and rheostat complete, a fixed condenser, a variable condenser, and a set of 2,000-ohm phones. My aerial is 75 feet long, can I hear WJZ? Will red-seal batteries, which are usually used for bell work, be serviceable for my vacuum tube, instead of a large storage-battery used for automobiles?—H. L., New York City.

You describe your apparatus, but we are without a diagram of your circuit. However, if your set is hooked up correctly, you should hear WJZ. Regarding your batteries: secure a storage battery, as dry batteries will last you only a short time. In case you should add an amplifier, your

storage battery could supply the necessary current to light the tubes. By all means get a storage.

Can I use a step-down transformer that has steps from 3 volts to 24 volts, for current to operate a spark coil that has a spark length of  $\frac{1}{2}$  inch?—A. H. E., Brooklyn.

Yes. You can use a step-down transformer with a spark coil. Proper care should be taken in adjusting the vibrator for satisfactory results, using approximately about six volts.

\* \* \*

Show a hook-up using three honey-comb coils, variable condenser, and a audion detector?—A. C., New Haven, Conn.

The hook-up for these instruments, appeared in RADIO WORLD No. 4, dated April 22, 1922.

\* \* \*

When a tickler coil is used, is it necessary to have it near the receiving coils or loose coupler, or can it be placed anywhere on the panel?—O. E. C., Galion, Ohio.

The tickler coil should be mounted so that the coupling between this coil and the secondary is adjustable.

\* \* \*

Could A. C. be used for the filament or grid of a 50-Watt-power tube?—M. V. E., Amagansett, N. Y.

A. C. may be used to light the filament of a power tube; but a D. C. voltage is needed for the grid voltage.

\* \* \*

Can one step of radio-frequency amplification be attached to any type of audion receiving set?—S. E. M., Cincinnati, O.

A one-step frequency amplifier may be used with any type of audion receiving-set. For long-waves resistance coupling may be used. For short waves use a tuned circuit.

\* \* \*

Will a metal roof have any effect on the aerial which, I would say, is about ten feet over the tin roof?—M. H. C., Albany.

If your roof is grounded, then the antenna would have only the effective height if the wires were only ten feet above the ground. The grounded roof would really bring the ground up to your antenna.

\* \* \*

Advise me regarding the following set which I have constructed. I would like to know if the set is wired for best results. What capacity I should use for fixed condenser?—H. S. T., Troy, N. Y.

Your diagram is completely wrong. In RADIO WORLD, No. 6, (published May 6), we will present a correct detector and two-step amplifier, the proper method of wiring and all other necessary data.

\* \* \*

We are unable to have a roof aerial and want advice on a loop. Have an idea that by having a 2-foot loop, we can put the loop outside a third-story window, have open space of 100x50 feet in rear. With an eight-story building on one side, can we get Newark on a crystal-detector set. Do you think this possible? How much wire is needed on the loop?—H. C. H., New York City.

See RADIO WORLD No. 2, page 20, for loop aerials; also No. 4, page 6.

\* \* \*

Can I add a two- or three-coil mounting with proper coils to increase the wave length of a short-wave regenerative set?—C. F. Y., Pottstown, Pa.

RADIO WORLD of April 22, page 4, explains your question fully.

# How to Construct the Variocoupler

By Frederick J. Rumford, A. I. E. E.

**T**HE variocoupler is a very efficient piece of wireless apparatus. It really takes the place of the loose coupler. It is primarily used for simple two-circuit receiving outfits in conjunction with either a crystal detector or a vacuum tube. It is also used extensively in regenerative receivers in conjunction with a pair of variometers, namely the grid and the plate, with a vacuum tube.

This variocoupler is easily made up at little expense. First the builder must purchase two gray seamless cardboard tubes of the following dimensions: The primary, or stator, is  $4\frac{7}{8}$  inches in outside diameter and 2 inches in length. When he has obtained these tubes, he should take the primary tube and measure down from the top  $\frac{3}{8}$  of an inch and drill so as to allow for the passing through of the  $\frac{3}{16}$  of-an-inch-diameter brass shaft. He will then take the secondary tube and drill in the exact center for the same purpose. He must drill also in the primary tube the following holes: Measuring down about  $\frac{1}{2}$  inch from the top, half way between the two shaft holes, a hole for a binding post and another hole  $1\frac{1}{8}$  inches from the bottom. This hole is for the second binding post. There are still two more hole to be drilled in the primary tube. These are for the purpose of securing the angle brackets which will hold the variocoupler to its base. These holes are left to the amateur's judgment. Now, there are

two holes to be drilled in the secondary tube  $\frac{1}{4}$  of an inch in from each edge. These holes are for the two necessary binding posts. After all the holes have been drilled in both tubes, the amateur should give both tubes a couple of good coats of shellac, inside and outside, and then let them dry.

He is then ready to wind the primary coil which, in this particular instance, should be wound with No. 24 D.C.C. magnet wire, starting  $\frac{3}{4}$  of an inch from the top and continue for 2 inches with taps taken at the following turns—the 10th, 18th, 28th, 36th, 40th, 54th, 64th, and the 74th, the last tap, making 74 turns in the whole winding. The starting and the finishing points are fastened, or connected, to the binding posts mentioned above.

The completed coil is then given a couple of coats of good shellac and left to dry.

Now that the primary tubes are wound, he should proceed to the winding of the secondary tube which, in this particular instance, is wound with No. 28 D.C.C. magnet wire. He should start the winding  $\frac{1}{4}$  inch in from the edge and continue until he has covered one-half inch which will make 24 turns. He must continue on with the winding after leaving the usual one-half inch space in the center for the shaft until he has covered another half-inch of winding which should bring him  $\frac{1}{4}$  of an inch from the end. He must connect the start

and the finish of his windings to the binding posts on the tube itself. The secondary has 48 turns of wire in all. After the secondary coil is wound completely, it should be given several good coats of shellac and then left to dry.

The builder must now purchase a length of 10/24 threaded shaft, or brass rod, and force it through the holes provided for it in both the coils, having the nuts forced tight up against the walls on the inner and outer sides of the secondary tube and also at the outer wall of the primary tube. These nuts may be soldered to the shaft, which will prevent their working loose, as the secondary is rotated within the primary tube.

He should now purchase a Clapp-Eastham, 3-inch dial—this is suitable for the  $\frac{3}{16}$ -inch shaft—and screw the dial firmly upon the shaft at the front end of the coil, or variocoupler. The variocoupler is then completed with the exception of the panel which the taps should connect to the contacts thereon and the mounting. The above exceptions are left to the amateur's own judgment.

This outfit is good for about 500 meters. The wave-length can be increased by shunting a fixed condenser across the secondary posts. Use a condenser of a given capacity.

An outfit similar to this would cost the purchaser from \$4.00 to \$10.00 if he were to buy it in a radio supply store, already made up.

## Will Antenna and Aerials Be "Scrapped?"

The so-called loop-antenna is increasing in popularity, and a number of amateurs are experimenting with plans to cut out the sky-high antenna. In fact, there seems to be a growing tendency to get away from the antenna. This is feasible, provided one has a complete set of vacuum-tube amplifiers.

The beginner is also assured that he cannot do without the aerial; but evidence is being gathered that any fairly accomplished amateur, equipped with a regenerative receiving-set modern type, may pick up messages with a compact tuning-coil, and omit the aerial to which this part of the apparatus is usually attached. Putting his aerials in position is the one phase of installation found most troublesome.

## "Rah-Rah!" Boys Put 'em Over the Ether



(c. International)

Howard Coy, Raymond Cowley, Howard Brideman, and Harry Hardin, University of Southern California glee club now entertain their friends and relations by broadcasting their college songs.

# Answers to Readers

**W**ITH a crystal receiver-set, I can pick up the music from Newark clearly. The aerial is a single wire about 100 feet long. On bringing the set to Brooklyn, I found out that I was unable to pick up Newark; but due to the fact that I was using a shorter aerial of 50 feet, spark signals were audible. Could you tell me what might have been the trouble?—J. C. K., Brooklyn, N. Y.

Your aerial is too short. A double wire will not make it 100 feet long. The broadcasting may be picked up in certain sections of New York very well, but there are certain sections that are practically dead, and due to the high buildings and steel bridges, a greater part of the energy is absorbed. Would advise you to put in a vacuum-tube outfit for better results.

\* \* \*

Is any danger from lightning on an inside aerial?—C. J. S., East Orange, N. J.

No; there will be no danger, but would advise you to ground any aerial whether inside or outside.

\* \* \*

In reference to the single five-watt tube-set in the RADIO WORLD of April 1, 1922, can 500 volts direct current, stepped down to 350 volts, be used in place of 220 volts and 130 volts "B" battery? Can the whole 500 volts be used or is it too high?—H. P., Town of Union, N. J.

You can probably secure an extended replay to your question by corresponding with the writer of the article, Frank A. Hanhel, 214 East 38th Street, New York.

\* \* \*

I have a set which has a wave-length of 175 to 1,000 meters, and would like to know if I can secure something that will increase my wave length from 1,000 meters to 3,000 meters?—C. A. H., Staunton, Va.

Visit your nearest dealer and ask if you can purchase any loading coils that will carry you to the wave-lengths desired. They should be inserted in series with primary and secondary windings of coupler.

Could a two-step amplifier be added to a set using one vacuum tube? Will a single-wire aerial, 75 feet long, be as good as one of the same length composed of two?—A. R. D., Paterson, N. J.

You may add as many amplifiers as you desire, in connection with tube for detector. A single-wire aerial will give you same results as a two-wire aerial composed of the same length.

\* \* \*

Do all regenerative circuits come under the Armstrong patent?—C. H. P., Brooklyn, N. Y.

The Armstrong patent is a basic patent and covers all circuits pertaining to regeneration; or, in other words, anyone who employs any type of a feed-back directly or indirectly in the plate circuit, is infringing on his patents. Recent court decisions seem to uphold this patent as standard. All regenerative circuits are practically Armstrong circuits.

\* \* \*

I have a receiving set comprising the following equipment. Loose coupler, crystal detector, variable condenser, phones, and a fixed condenser. I receive signals from spark stations very clearly; but, somehow, cannot pick up the music. What seems to be the trouble?—C. L. E., Flatbush, N. Y.

Use your variable condenser in series with your antenna; this, in turn, would give you a range so as to reduce your wave length down to the desired wave. Experiment awhile. With a few trials you

Owing to the large numbers of questions received from readers it is impossible to answer all in this number. Your replies will appear in the next or future numbers of Radio World.

should succeed. Be sure you have your fixed condenser shunted around your tele-phones.

\* \* \*

Please tell me what method I could use to tell the polarity of the d. c. supply in my home. I have 110 volts d. c., and wish to cut it down for charging.—G. S., Philadelphia.

Make sure you have d. c. before you start to do anything. This information can be had by simply asking the company who supplies the current. If they advise you that d. c. is available, simply take a raw potato, peel it and place your two leads into the potato keeping them about an inch apart. The result will be that a green spot will appear around the positive wire. Another method is to place the two leads in a glass of water, also keeping them apart. As a result, the negative wire will form bubbles which will rise to the surface. A wise stunt is to place, or tie, a knot in the positive wire, as this is a symbol used by all radio experts.

\* \* \*

Would there be any advantage in using two galena detectors?—G. M., Detroit.

Using two crystals will be of no advantage to you with such an arrangement. This will benefit you if you care to have a spare detector to use in case one gets oiled and spunky.

\* \* \*

Is No. 22 wire O.K., for a variometer? Should the stator and rotor have the same amount of wire on it?—J. M. K., Hoisington, Kansas.

This size is advisable, but No. 24 would be more suitable. There must be just as many turns on the stator as on the rotor.

\* \* \*

How far can I receive on a crystal set from a broadcasting station?—W. D., Grantwood, N. J.

You cannot expect to receive over 25 miles with a good crystal detector. You might be able to receive a little farther under ideal conditions, but you could not depend on a distance beyond that mentioned.

\* \* \*

Can I use a 2,000-ohm and 3,000-ohm receiver? How can I connect them?—H. M. G., Kingston, N. Y.

These receivers can be connected in series, but should be of the same ohmage.

\* \* \*

My receiving set consists of the following apparatus. A spider web-inductance, a vacuum tube, a socket, and rheostat complete, a fixed condenser, a variable condenser, and a set of 2,000-ohm phones. My aerial is 75 feet long, can I hear WJZ? Will red-seal batteries, which are usually used for bell work, be serviceable for my vacuum tube, instead of a large storage-battery used for automobiles?—H. L., New York City.

You describe your apparatus, but we are without a diagram of your circuit. However, if your set is hooked up correctly, you should hear WJZ. Regarding your batteries: secure a storage battery, as dry batteries will last you only a short time. In case you should add an amplifier, your

storage battery could supply the necessary current to light the tubes. By all means get a storage.

Can I use a step-down transformer that has steps from 3 volts to 24 volts, for current to operate a spark coil that has a spark length of ½ inch?—A. H. E., Brooklyn.

Yes. You can use a step-down transformer with a spark coil. Proper care should be taken in adjusting the vibrator for satisfactory results, using approximately about six volts.

\* \* \*

Show a hook-up using three honey-comb coils, variable condenser, and a audion detector?—A. C., New Haven, Conn.

The hook-up for these instruments, appeared in RADIO WORLD No. 4, dated April 22, 1922.

\* \* \*

When a tickler coil is used, is it necessary to have it near the receiving coils or loose coupler, or can it be placed anywhere on the panel?—O. E. C., Galion, Ohio.

The tickler coil should be mounted so that the coupling between this coil and the secondary is adjustable.

\* \* \*

Could A. C. be used for the filament or grid of a 50-Watt-power tube?—M. V. E., Amagansett, N. Y.

A. C. may be used to light the filament of a power tube; but a D. C. voltage is needed for the grid voltage.

\* \* \*

Can one step of radio-frequency amplification be attached to any type of audion receiving set?—S. E. M., Cincinnati, O.

A one-step frequency amplifier may be used with any type of audion receiving-set. For long-waves resistance coupling may be used. For short waves use a tuned circuit.

\* \* \*

Will a metal roof have any effect on the aerial which, I would say, is about ten feet over the tin roof?—M. H. C., Albany.

If your roof is grounded, then the antenna would have only the effective height if the wires were only ten feet above the ground. The grounded roof would really bring the ground up to your antenna.

\* \* \*

Advise me regarding the following set which I have constructed. I would like to know if the set is wired for best results. What capacity I should use for fixed condenser?—H. S. T., Troy, N. Y.

Your diagram is completely wrong. In RADIO WORLD, No. 6, (published May 6), we will present a correct detector and two-step amplifier, the proper method of wiring and all other necessary data.

\* \* \*

We are unable to have a roof aerial and want advice on a loop. Have an idea that by having a 2-foot loop, we can put the loop outside a third-story window, have open space of 100x50 feet in rear. With an eight-story building on one side, can we get Newark on a crystal-detector set. Do you think this possible? How much wire is needed on the loop?—H. C. H., New York City.

See RADIO WORLD No. 2, page 20, for loop aeriels; also No. 4, page 6.

\* \* \*

Can I add a two- or three-coil mounting with proper coils to increase the wave length of a short-wave regenerative set?—C. F. Y., Pottstown, Pa.

RADIO WORLD of April 22, page 4, explains your question fully.



# How to Construct the Variocoupler

By Frederick J. Rumford, A. I. E. E.

**T**HE variocoupler is a very efficient piece of wireless apparatus. It really takes the place of the loose coupler. It is primarily used for simple two-circuit receiving outfits in conjunction with either a crystal detector or a vacuum tube. It is also used extensively in regenerative receivers in conjunction with a pair of variometers, namely the grid and the plate, with a vacuum tube.

This variocoupler is easily made up at little expense. First the builder must purchase two gray seamless cardboard tubes of the following dimensions: The primary, or stator, is  $4\frac{7}{8}$  inches in outside diameter and 2 inches in length. When he has obtained these tubes, he should take the primary tube and measure down from the top  $\frac{3}{8}$  of an inch and drill so as to allow for the passing through of the  $\frac{3}{16}$  of-an-inch-diameter brass shaft. He will then take the secondary tube and drill in the exact center for the same purpose. He must drill also in the primary tube the following holes: Measuring down about  $\frac{1}{2}$  inch from the top, half way between the two shaft holes, a hole for a binding post and another hole  $1\frac{1}{8}$  inches from the bottom. This hole is for the second binding post. There are still two more hole to be drilled in the primary tube. These are for the purpose of securing the angle brackets which will hold the variocoupler to its base. These holes are left to the amateur's judgment. Now, there are

two holes to be drilled in the secondary tube  $\frac{1}{4}$  of an inch in from each edge. These holes are for the two necessary binding posts. After all the holes have been drilled in both tubes, the amateur should give both tubes a couple of good coats of shellac, inside and outside, and then let them dry.

He is then ready to wind the primary coil which, in this particular instance, should be wound with No. 24 D.C.C. magnet wire, starting  $\frac{3}{4}$  of an inch from the top and continue for 2 inches with taps taken at the following turns—the 10th, 18th, 28th, 36th, 40th, 54th, 64th, and the 74th, the last tap, making 74 turns in the whole winding. The starting and the finishing points are fastened, or connected, to the binding posts mentioned above.

The completed coil is then given a couple of coats of good shellac and left to dry.

Now that the primary tubes are wound, he should proceed to the winding of the secondary tube which, in this particular instance, is wound with No. 28 D.C.C. magnet wire. He should start the winding  $\frac{1}{4}$  inch in from the edge and continue until he has covered one-half inch which will make 24 turns. He must continue on with the winding after leaving the usual one-half inch space in the center for the shaft until he has covered another half-inch of winding which should bring him  $\frac{1}{4}$  of an inch from the end. He must connect the start

and the finish of his windings to the binding posts on the tube itself. The secondary has 48 turns of wire in all. After the secondary coil is wound completely, it should be given several good coats of shellac and then left to dry.

The builder must now purchase a length of 10/24 threaded shaft, or brass rod, and force it through the holes provided for it in both the coils, having the nuts forced tight up against the walls on the inner and outer sides of the secondary tube and also at the outer wall of the primary tube. These nuts may be soldered to the shaft, which will prevent their working loose, as the secondary is rotated within the primary tube.

He should now purchase a Clapp-Eastham, 3-inch dial—this is suitable for the  $\frac{3}{16}$ -inch shaft—and screw the dial firmly upon the shaft at the front end of the coil, or variocoupler. The variocoupler is then completed with the exception of the panel which the taps should connect to the contacts thereon and the mounting. The above exceptions are left to the amateur's own judgment.

This outfit is good for about 500 meters. The wave-length can be increased by shunting a fixed condenser across the secondary posts. Use a condenser of a given capacity.

An outfit similar to this would cost the purchaser from \$4.00 to \$10.00 if he were to buy it in a radio supply store, already made up.

## Will Antenna and Aerials Be "Scrapped?"

The so-called loop-antenna is increasing in popularity, and a number of amateurs are experimenting with plans to cut out the sky-high antenna. In fact, there seems to be a growing tendency to get away from the antenna. This is feasible, provided one has a complete set of vacuum-tube amplifiers.

The beginner is also assured that he cannot do without the aerial; but evidence is being gathered that any fairly accomplished amateur, equipped with a regenerative receiving-set modern type, may pick up messages with a compact tuning-coil, and omit the aerial to which this part of the apparatus is usually attached. Putting his aerials in position is the one phase of installation found most troublesome.

## "Rah-Rah!" Boys Put 'em Over the Ether



(c. International)

Howard Coy, Raymond Cowley, Howard Brideman, and Harry Hardin, University of Southern California glee club now entertain their friends and relations by broadcasting their college songs.

# Dealers!

We Offer for  
Immediate Delivery  
in Quantity Orders  
**FEDERAL JR.**

With Head Sets  
**DE FOREST EVERYMAN**

With Head Sets  
**DE FOREST RADIOPHONE**

With Head Sets and Tubes

**Radio Stores Corp.**

150 W. 34th Street,  
NEW YORK CITY

## 20% TO 33 1/3% OFF ON RADIO SUPPLIES

That's the club's motto  
**CLUB'S OBJECT**

Saving of dollars and a united voice to  
be reckoned with in matters of interest to  
Radio Amateurs.

Membership fee, the small sum of 25  
cents per month.

Membership blank mailed upon request.

**CORUBIA ELECTRICAL  
PURCHASING CLUB**

145-147 East 23rd St.,  
Bet. Lexington & 3rd Ave., N. Y. C.

## RADIO SUPPLIES

Immediate Delivery

Blinding Posts	.....50c.	doz.
Variometers, Mahogany	.....\$5.00,	each
Vario Couplers	.....\$4.50,	each
Galena Tested Crystal	.....15c.,	each
Switch Points	.....35c.,	doz.
Dials	.....\$1.00,	each
Galena Cup	.....10c.,	each

Other Supplies

Money Order Must Accompany  
Order.

**BURT B. BARSOOK**

Brevoort Hotel, CHICAGO, ILL.  
Dealers Write For Prices.

## Receiver Magnets Remagnetized While You Wait

If your ear pieces are weak you can not  
hear the concerts distinctly. Let us re-  
magnetize them for you. Single phones  
35c.; double, 50c. Any type radio equip-  
ment repaired. Complete sets and parts  
built to order.

**P. RICHARDS**

204 W. 76th St., Near Broadway  
Phone Schuyler 0140

## Radio Sets and Supplies

Head Sets, Vacuum Tubes, Acme  
Transformers, Dials, Switch Points,  
"B" Batteries, Insulators, Etc.

**N. Y. RADIOPHONE CO.**

32 Union Square New York City

RADIO WORLD IS READY FOR  
YOU EVERY WEDNESDAY

## Air Mail and Radio

The Post Office Air Mail Service is  
planning to equip its big trans-con-  
tinental planes with radiophones. The  
first one to be so equipped was flown  
to Washington from Chicago, re-  
cently, in just two minutes over six  
hours. Pilot E. Hamilton Lee made  
the trip of 715 miles at the rate of  
119 miles an hour.

This type of mail plane will be  
equipped with both receiving and  
sending radiophones having a radius  
of 200 miles, so that the pilot may  
keep in touch with the station he is  
leaving and the one to which he is  
flying.



## THE HOME RADIO

HOW TO MAKE AND USE IT

By A. Hyatt Verrill

At last! A simple explanation of the mak-  
ing and use of a home radio outfit. Every  
step in construction is carefully directed and  
illustrated with numerous working diagrams.  
Get your copy to-day. Clothbound book.

Postpaid for 75 cents.

Broadcasting Guide, 25 cents.

**Radio Educational Service**

200 5th Ave., R. 416, New York City

## The Ball Game at Home

At the opening game between the  
Washington "Senators" and the New  
York "Yankees," a Washington  
"Herald" writer covered the story,  
probably for the first time in history,  
with a radiophone. From the time the  
first batter stepped to the plate until  
the last one went out, all local radio  
fans got the game inning by inning,  
if they listened in. Hereafter, when  
the Washington team is in its home  
town the radio reporter will cover  
the game for all who cannot attend.

## DEALERS

Send for free samples of our Window Dis-  
play Signs and Cartoons featuring RADIO  
EQUIPMENT.

Attractive, snappy result getters.

Merchants Signs Service Co.,  
48 Zabriskie St., Jersey City, N. J.

# VARIOMETERS

(Unwired)

Unwired Variometer blocks. Wood turned Cup Mahogany, Ball  
made of white wood. Nicely trimmed and ready for wiring. Can  
be had in all sizes varying from 200 meters to 500, especially  
adapted for Short wave reception. Prices upon request in any  
size lots, also sold separately. Workmanship guaranteed.

**The Ever Ready Woodworking Co.**

810-12 EAST 5th STREET NEW YORK

Telephone Orchard 5585

IN USING

## THE "GREWOL" RADIO DETECTOR

All Troubles Are Eliminated

This Detector Is Always Set and Ready

PRICE, \$2.00

Dealers write for proposition.

**RANDEL WIRELESS CO.**

9 CENTRAL AVENUE, NEWARK, N. J.

Sole United States Distributors

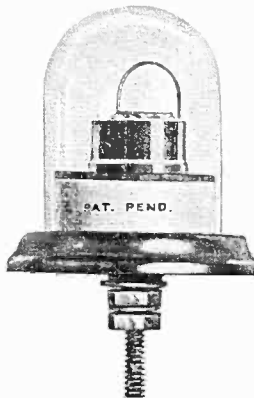

(Actual Size)

## Radiotelephone Will Become a Necessity

There are people living to-day, not so very old at that, who can remember when there were only fourteen or so telephones in the largest cities, says "Radio Broadcasting News." These people also remember the curiosity which centered around these installations, and the fact that there was nobody to talk to over them, particularly if the other twelve or thirteen people with telephones were strangers. Calling central for the time of day was quite a diversion in those days and the proud youngster given the honor perhaps still remembers the incident.

After a time the telephone became a fad of the well-to-do; then it gradually was accepted by the business houses; then it went into private homes and today it is a necessity of our civilization. Millions of telephone calls are now made hourly in the United States.

The development of radio telephony has now passed the fad stage and while it is not yet a necessity, it is in the intermediate period, where it is being taken into the homes of all classes of people. Its greatest expansion and usefulness is yet to come.

### The Pinnacle Reached

When the president of the American Telephone and Telegraph Company, from his home in Connecticut, conversed with the captain of the United States liner "America," 370 miles out from New York, says the New York "World," the highest pinnacle apparently was reached in the development of wireless communication. The imagination can not go much farther without accepting telepathy as being among the practical possibilities. There will be great improvements, of course, in radiotelephony, but no radical change in the essential features seems likely. It is estimated that 200,000 persons heard the conversation between the telephone company officer and the captain of the steamer. They were amateur radio operators who "listened in." The absence of privacy in radio communication is objectionable, and may prevent its wholly superseding the "old-fashioned" telephone and telegraph.

Receipt by new subscribers of the first copy of RADIO WORLD mailed to them after sending in their order, is automatic acknowledgment of the receipt at this office of their subscription order and payment therefor.



**BULBS**  
Amplifier \$6.50  
Detector \$5.00

DeFOREST EVERYMAN SETS  
PINK-A-TONE SETS

Complete with Phones **\$25**

Variometers **\$5.00**

Variocouplers

"B" Batteries, 22½ volts . . . . . \$ .80

Moulded and Nickel sockets . . . . . .75

3-inch Moulded Dial . . . . . 1.25

Dealers: Get prices on Amplitone.  
All supplies in stock.

### STAMPED METAL DIALS

Bevel Edge — Excellent appearance — Fine proposition for dealers or manufacturers of sets—Price low.

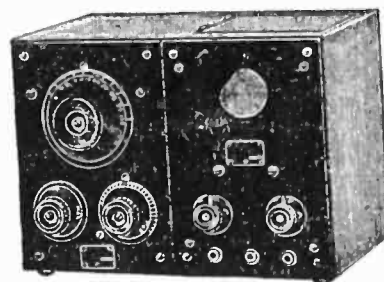

Price, \$130.00

**BEACON RADIO & ELECTRIC CO.**  
246 Greenwich St., New York City

## MAKE HAY WHILE THE SUN SHINES

DEALERS AND DISTRIBUTORS

Place your orders now for prompt delivery for

### THE GRIN VARIABLE CONDENSER

.001 M. F.  
43 Plate  
\$4.75

.0005 M. F.  
23 Plate  
\$4.25

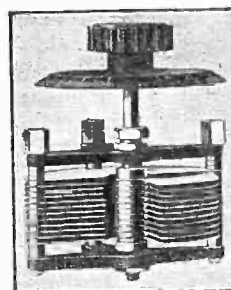

A CONDENSER BUILT TO SATISFY GROWING DEMANDS

### VIZZO PRODUCTS CO.

THOS. PELLEGRIN, Sales Manager

1263 BEDFORD AVE., SALES OFFICE: BROOKLYN, N. Y.  
FACTORY: SHELTON, CONN.

### ATTENTION AMATEURS

A complete line of high grade radio material backed with quick service has built up a remarkable radio trade.

**The Quaker Light Supply Co.**  
728 ARCH STREET,  
PHILADELPHIA, PA.

### THE N. Y. GLOBE Said

on April 15th

There is a little pocket volume now on the bookstands called "The A B C of Radio," that contains more nourishing mental food for the wireless beginner than anything that has yet come to our attention. It starts one right with a simplicity that is delightful and encouraging. It is certain to educate and is well worth buying and keeping as a handbook of ready reference. 40 cents in leatherette.

MARTIN H. RAY

Publisher

165 Broadway, New York

**LOOK**

The "Junior" Crystal Detector

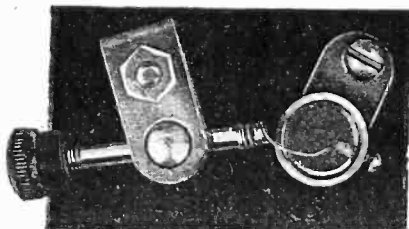

THESE  
**CRYSTAL DETECTORS**  
Are The Very Best For Constant  
Satisfactory Results.

Lowest of All in Price  
Dealers and Jobbers Write For  
Proposition

**WALTER H. SAMUEL**  
400 BELLVILLE AVE.  
Bloomfield, New Jersey

**Get Our Prices First**

On

Variometers  
Vario-couplers  
Variable condensers and  
Cabinets

Mail orders promptly attended to

**MARTIN MFG. CO.**

942 JEFFERSON AVENUE  
BROOKLYN, N. Y.

Phone: Bushwick 6793

**Wireless "B" Battery****For Wireless**

No wires used in any of its construction

**ENCO**

Variable and Refillable

**"B" BATTERY**For refills use standard flashlight unit cells,  
17 cents, each

Write for Descriptive Circular

**ENCO ELECTRIC NOVELTY  
COMPANY, INC.**

603 W. 130th St., New York City

IF YOU ARE LOOKING FOR

**RADIO** Sets or  
Supplies**Visit MODELL'S**  
191 FULTON ST.  
Cor. Church, New York**RADIO CABINETS**

Manufactured

in any Style, Size or Quantity

**A. E. CHERNACK & CO., INC.**

314 E. 75th ST., NEW YORK

Phone Rhineland 2747

**RADIO WORLD**

Is on the Newsstands

Every Wednesday

15 cents a copy

**Antenna not Dangerous**

One of the first questions which comes into the mind of the would-be radio user concerns lightning, says G. K. Thompson, radio superintendent of the Armad Company, in the New York "American." "Will my antenna attract lightning and cause my home to be struck?" he asks. To the general public wireless and lightning seem to be twin brothers, probably because the manifestations of both are uncanny and mysterious.

Hoisting a radio antenna over your property does not endanger your dwelling, your instruments or your family if a few simple precautions are observed

So far as your radio installation is concerned, you should harbor no fear that it will attract lightning. You should make it a point, however, to install such safety devices as will render harmless the currents induced in your antenna by lightning striking in the neighborhood.

**Shorter Words Needed**

The time has arrived when the nomenclature and terminology of wireless communication should be revised and simplified, says the New York "World." For wireless or radiotelegraphy and telephony there should be substituted a single short word. Appropriate verbs meaning to send or receive such a message also should be coined. The mistakes made in coining names for other recent inventions should be avoided. The automobile was first called the "horseless carriage." "Automobile" is an unsatisfactory substitute because its length causes variation in the pronunciation, some persons placing greatest emphasis on the first syllable and others on the penult. "Aeroplane" was also an awkward word, generally mispronounced. The War Department did well to change it to "airplane." It is to be hoped that such errors will not be made in devising the terminology of wireless communication.

**A Correction**

Editor, RADIO WORLD: RADIO WORLD, April 1 issue, page 20, under caption "Where to Reach U. S. Radio Inspectors in Various Districts," states licenses and information can be obtained from the Radio Inspector, Room 205, Citizens Bank Building, Norfolk, Virginia.

You are advised the office at Norfolk comes under this office and all correspondence should be addressed to the Radio Inspector at Baltimore.

To avoid confusion and delay in receiving correspondence, it is requested that you make this correction in your next issue.—R. Y. CADMUS, Radio Inspector.

**NOVO****"B" BATTERIES**

FOR YOUR RADIO SET

All standard sizes 22½ to 105 volts.



For Sale by Leading Dealers

**NOVO MFG. CO.**

NEW YORK—424-438 W. 33rd St.

CHICAGO—531 So. Dearborn St.

Select your supplies from our complete stock of radio parts. All standard makes at popular prices.

Complete sets from

**\$15.00 up****PARK ROW CYCLE****& RADIO CO.**

29 Park Row, N. Y. C.

Opp. Post Office Basement Store

**RADI-O-PLATE**

The popular black composition board for panels—dielectric strength unaffected by dampness.

SIZES

6x12x¼	.....	\$ .60
12x12x¼	.....	.85
7x18x¼	.....	.90
12x18x¼	.....	1.25

Mail orders filled

**TRINITY ELECTRIC CO.**

42 Greenwich St.

New York City

Bowling Green 7512

**PAPER TUBES FOR WIRELESS**ALL SIZES ON HAND  
FOR IMMEDIATE DELIVERY  
WHOLESALE AND RETAIL**BAEHM PAPER CO., INC.**  
219 FULTON STREET NEW YORK  
Bet. Church and Greenwich Sts.**RECEIVING SETS**

Bought from us are installed by experts assuring you most satisfactory results.

**RADIO CO. of NEW YORK**

1674 BROADWAY

Cor. 52nd St., New York City.

**Expert Radio Wiring and Installations**

Complete Line of Receiving Sets and Radio Apparatus

**K. R. SCHULLSTROM**

30 E. 59th St., Bet. 5th and Madison Ave.

Phone Plaza 9425-9426



**RADIO****THE 20th CENTURY ENTERTAINER**

For the Automobilst, Motor Boat enthusiast and Camper.

Westinghouse Aeriola Sr., \$65.00

"It's a portable Regenerative Receiving Set."

Detector Tubes, \$5.00

Western Electric Head-phones, \$15.00

Radio Outfits, Supplies and parts

**THOMAS J. WARD**

117 West 33rd N. Y. City

Opposite Gimbel's

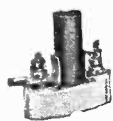
**THE BEST PROTECTION AGAINST LIGHTNING****"JACOBUS" VACUUM****TYPE J. S. W. AERIAL PROTECTOR**

This improved lightning arrester is absolutely positive, efficient protection against the heaviest lightning storms. Approved by the National Underwriters to replace lightning and ground switches. Its simplicity, easy installation and forget-proof feature recommends it especially for the amateur.

**ELIMINATES SWITCHES**

Receiving stations with JACOBUS Protectors do not require lightning or ground switches. Protection every minute of the day and night. No worry about throwing switches.

**GOOD FOR INNUMERABLE DISCHARGE**

Discharges of lightning or static on the JACOBUS do not affect its life. After conducting a discharge to the ground, the tube is ready for another operation. Does not weaken or in any way affect the efficiency of the set.

\$2.00 From Electrical Dealers Sent Direct

**APEX ELECTRICAL SPECIALTY CO., Inc.**  
77-B Orange St., Newark, N. J.

**BAKELITE PANELS**

Cut to any size.

We Supply Manufacturers and Dealers. Immediate Delivery.

Any Quantity.

**POSTER & CO.**

58 West 39th Street

Dept. A

Phone—Fitzroy 2736



Make your own **RADIO RECEIVING SET**. ENJOY the concerts, market reports, latest news, etc., as sent out by large broadcasting stations.

This NEW Copyright book "EFFICIENT RADIO SETS" shows how to make **INEXPENSIVE** set for receiving wireless broadcastings. Sent postpaid for 25c. Address J. C. Dorn, Pub., 725 S. Dearborn St., Dept. 106, Chicago.

**Radio Not a Fad**

WHEN we worry about where the advertisers of to-morrow are going to come from we forget that a sudden industrial or social development can produce a flock of new advertisers overnight, says "Printer's Ink." This has happened several times in the history of advertising.

The breakfast-food died out as a craze, but it left us several permanent advertisers who have made their products staple articles in our diet. The motor transport development has produced vastly more advertising in a few years than did the old buggy, in its entire career. The agricultural co-operative movement, laughed at a few years ago, has already given us several large advertisers. Brewers were large advertisers. Prohibition wiped them off the publisher's prospect list. But in their stead new advertisers in the soft drink, confection and other fields have arisen. The increase in tobacco, cigar and cigarette advertising since prohibition alone probably makes up for the advertising lost through the Eighteenth Amendment.

And now comes the radio. Just one year ago who would have dreamed that the radiophone would to-day be the subject of such widespread advertising! The merchandising attention being given to this new means of communication is perfectly astonishing. Stores are opening up whole departments devoted to it. Additional trade papers specializing in the subject are being founded. Newspapers are giving whole sections to it. Column after column of advertising of radio equipment is being run. Already the radiophone and its appurtenances are advertised articles of no mean proportions.

Is this just another fad that will run its day and die out? We don't think so. Railroads were not a fad. The "horseless carriage" was thought to be, but nevertheless it soon revolutionized transportation. The telegraph, the telephone, wireless, the airplane were all regarded as impractical toys, but they have established themselves as vital parts of our civilization. The radiophone will probably have the same experience.

Anyway, the radio is only a part of the electrical movement. Electricity has already given us dozens of well-advertised products. There are probably as many more waiting discovery. New uses, like the radiophone, will be harnessed to electricity. These uses and the products growing out of them will contribute amazingly to the ranks of to-morrow's advertisers.

Radio World every Wednesday. 15c a copy

**PHONOTACH**

Phonograph Connection  
Adjust it in a minute

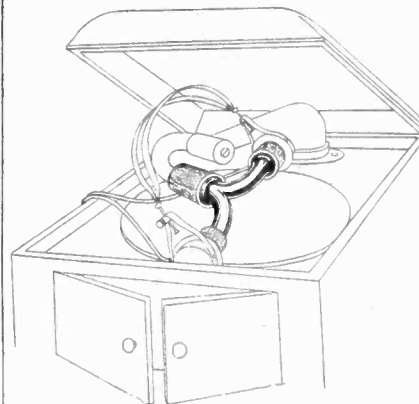
**A new and better LOUD SPEAKER**

at a very low cost  
**NO DISTORTION—FULL VOLUME OF SOUND—CLEAR AND MELLOW**

Send for one To-day  
**PRICE, ONLY, \$2.50**

At your dealer or by mail

Distributor

**WM. A. MILLS**

103 Park Ave.,  
New York.

**AMATEURS**

VARIOMETERS .....\$5  
TUNING COILS .....\$3  
SWITCH LEVERS .....50c.  
VARIOCOUPERS .....\$5-\$6  
VARIABLE CONDENSERS .....\$4-\$5  
SWITCH POINTS .....0.3c., each  
Special complete receiving outfit with phones, antennae and insulators, \$30. Mail orders filled promptly.

**CLARK & TILSON**

51 East 42nd Street

NEW YORK CITY

Tel. Vanderbilt 5462

**BOYS DO NOT FAIL**

To obtain your copy of these instructions. Worth many times the small amount we ask. How to construct a variometer, how to construct a variocoupler and an amplifying transformer. Detailed instructions of either for fifteen cents or put four dimes in an envelope and get the three with diagrams of connections for your set. Save money by constructing your own. We have left no details to guess about. We enclose list of all parts how much of each to get and where to obtain same.

**Newco Radio & Electrical**

Supply Co.

Stratford, Conn.

**VARIOCOUPLER, \$3.00**

175 to 600 meter variocoupler wound and tapped; rotor and shaft in place, ready for panel. Postpaid, \$3.00. Mounted in Cabinet, \$16.00.

**OLIVER YARRINGTON**

135 West 83rd St., New York, N. Y.



EQUIP your receiving set with the Magnavox Radio—the only reproducer constructed on electro-dynamic principle. Write for booklet and name of nearest dealer.

**THE MAGNAVOX CO.**  
Oakland California  
370 Seventh Ave., N. Y.

Radio brings it  
**MAGNAVOX**  
tells it

## RADIO

"The Popular National Radio Journal"

All that its name implies  
Get a copy from your radio dealer or  
news stand today—20c.

PUBLISHED BY  
**Pacific Radio Pub. Co., Inc.**  
Pacific Bldg., San Francisco

## FREE THIS MONTH

VACUUM TUBE  
**WIRELESS RADIOPHONE**  
AND CODE SET

Also the Wonderful OMNIGRAPH for learning the Code, and best Theory Text Books given FREE with our Professional Home Course.

**LEARN WIRELESS**  
AT HOME IN SPARE TIME  
The demand for experts exceeds supply.  
Pays Big Money  
Pays \$125 to 250 monthly up to \$10,000 a year or more.

Nationally recognized as foremost Wireless Institute. Wireless offers an opportunity of a lifetime to the man who is awake.



**FREE** LEARN-O-GRAPH code sender & Text Books. Special — Low Cost — Quick, Simple. **AMATEUR WIRELESS COURSE**, qualifying you for Amateur License.

New Stock Radiophones for immediate Delivery Call and Hear Our Wonderful Amplifier.

Free Booklet—"How to Become a Wireless Operator."  
**NEW YORK WIRELESS INSTITUTE**  
154-X—Nassau St., New York City

## PHONES—

**OUTFITS and PARTS**  
On Hand.

"C" RADIO JACK  
158 Fulton St., N. Y. C.

## Special Dealer Proposition on

Federal Juniors and all Radio parts and apparatus. Very comprehensive stock on hand.

**SIGNAL SYSTEMS**  
**SERVICE CO.**

1 E. 42nd St., New York City

## RICHMOND ELECTRIC CO.

Auto, Electric and Magnet Wires, Electrical  
Specialties  
Wholesale Only  
181 McDougal St.,  
Brooklyn, N. Y.

## NEWSDEALERS ATTENTION!

Many of your customers will want the first three issues of Radio World. Your wholesaler may have a few copies on hand. Inquire. If you cannot get back numbers write us and we will try to supply you so that your customers will have a complete file of Radio World from the first issue.

If you happen to have a few copies on hand, keep and display them and you will find that they will sell. Very shortly it will be impossible to get back numbers of these earlier issues.

Radio World, 1493 Broadway,  
New York City.

RADIO INVENTIONS  
and other ideas promptly patented by reliable Patent Attorneys & Engineers. Call or write. FREE ADVICE.



Subscribe for **RADIO WORLD**  
Yearly, \$6.00; six months, \$3.00; three months, \$1.50. (Adv.)

## Manufacturer's

Distributers of Everything

## RADIO

**REX RADIO SALES CORP.**  
1452 Broadway, New York

## RADIO PHONE \$20. & 25. RECEIVERS

Complete, including phone and aerial. Guaranteed clear, and distinct. Made by radio experts. Coils only \$1.25. Mail orders filled promptly.

**RADIO PHONE SUPPLY CO.**  
804 Ninth Avenue, New York  
Phone Circle 2470

**RADIO SUPPLIES** **RADIO SUPPLIES**  
We Carry a Full Line of  
**RADIO GOODS**

Head Sets, Vacuum Tubes, Vario Couplers, Variometers, Transformers, Tuning Coils, Dials, Knobs, Bakelite Panels.  
Phones in stock.

Radio Sets Made to Order. Aerials put up.  
**SUNBEAM ELECTRIC COMPANY**  
71 3rd Ave. Bet. 11th & 12th St., New York  
Phone Stuyvesant 2890 Estab. 12 Years

## RADIO PANELS

Cut exactly to size and shipped within 12 hours. ¼ inch thick, \$.01½c. per square inch; 5/16 inch, .02c. Made of the highest grade black fibre. This material possesses high dielectric strength, is inexpensive, unbreakable, easy to work and takes a nice finish. Special offer 6x8x¼, 50c. We pay postage.

**RADIO INSTRUMENT & PANEL CO.**  
Box 75, Cicero, Illinois

# Radio Parts

We carry in Stock

**BINDING POSTS**

**DIALS**

**VARIABLE CONDENSERS**

**VARIO-COUPERS**

**CRYSTAL DETECTORS**

**CRYSTAL SETS**

SEND 25c. FOR LARGE CATALOGUE

## Robin Radio Mf'g., Co.

47 WARREN ST., NEW YORK CITY

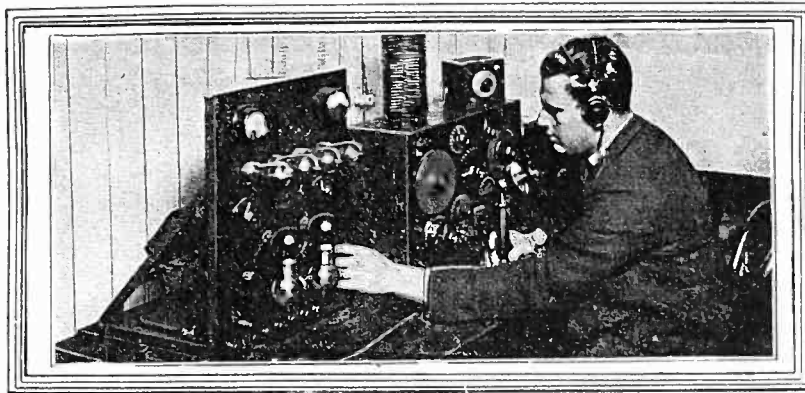

# Become a Radio-trician

**Learn at home the greatest profession of today and the future. Become a master of radio installation, operation, maintenance repair, mechanics, design, inspection, salesmanship and invention.**

**T**HE world is aflame with Radio. Never before in the history of the country has an industry leaped to the forefront as rapidly as this great, new science. Hundreds of thousands of radio receiving sets are in operation—tens of thousands of sending stations will be erected—and this enormous craze is permanent. Even today manufacturers are months behind their orders! Improvements are being made every day which must increase the demand for radio equipment to even *greater* proportions than now.

Men of foresight, men of vision know what this means. Never before has there been such an opportunity. Radio-tricians are needed today everywhere. More and more will be needed as the demand for radio installation, radio operation, radio maintenance, radio repair, radio salesmanship becomes greater and greater.

Wherever you go, there are hundreds of radio sets to be installed—wherever you go, thousands upon thousands of dollars worth of radio equipment is being sold—wherever you go, there are radio sets to repair; and if you seek adventure, there are radio sending stations calling to you from ships and land stations all over the world.

## The Pioneer School

The National Radio Institute has a record of over

8,000 students. It is the pioneer school. It teaches every phase of radio from the ground up. It teaches by means of actual practice, actual assembling of a radio outfit, actual operation of radio equipment. It teaches by problem and principle so that National Radio-tricians are in demand everywhere.

Here is a profession which is paying enormous earnings to men all over the country today—a profession that will make hundreds of men wealthy—a profession far more lucrative than that of any other technical or mechanical employment you can secure.

## What will you do?

The world is aflame with radio. What are you going to do to “cash in” on the demand for men, for equipment, for experience? Are you going to sit idly by wondering what it is all about, or are you going to make the most of this, the greatest opportunity presented to men of ambition in 50 years?

Write at once for the complete catalog to the National Radio Institute. This is the turning point in your life. Upon your decision *this instant* may depend your entire future. Mail the coupon, or write a letter **NOW—for your own sake!**

## NATIONAL RADIO INSTITUTE

*Radio Headquarters*

Dept. 1090

N. W., Washington, D. C.

NATIONAL RADIO INSTITUTE, *Radio Headquarters*  
Dept. 1090 N. W., Washington, D. C.

Please send me your book telling how I can become a Radio-trician through your Home Study Course, in my spare time. I am enclosing 10c (stamps or coin) to cover cost of packing and mailing.

Name .....

Address..... City..... State.....

Copyright, 1922, National Radio Institute

# The Twentieth Century ALADDIN'S LAMP

## RADIO

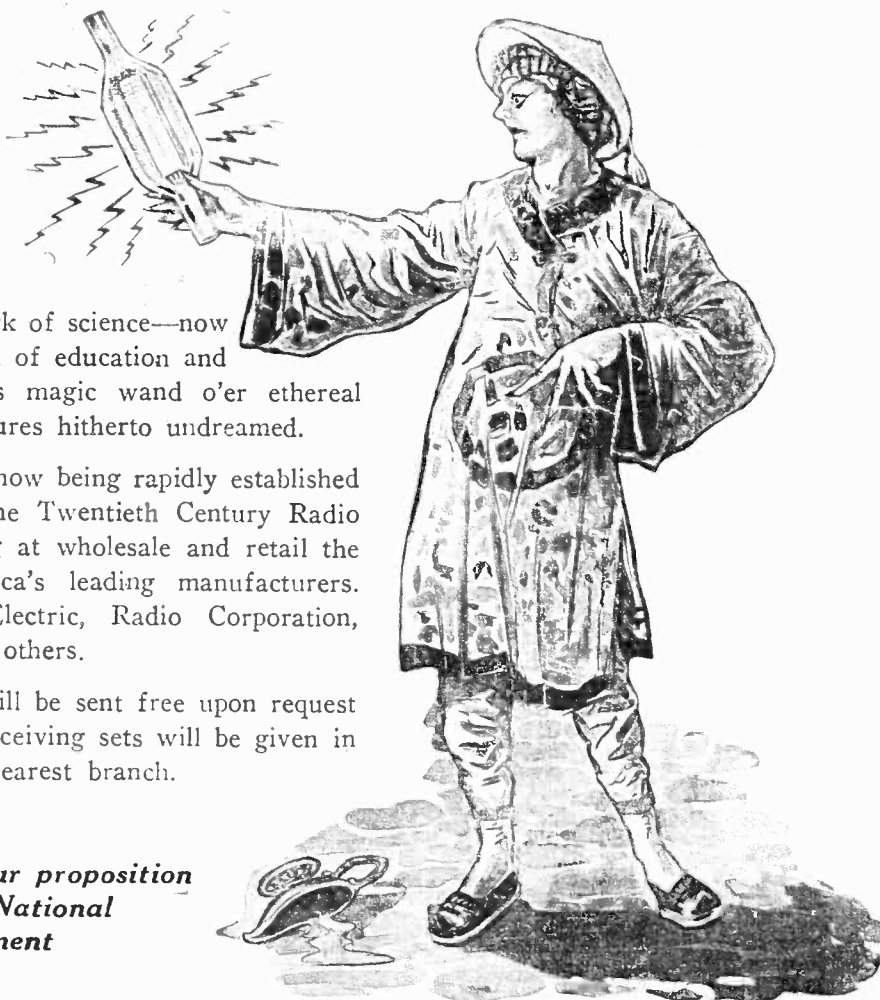

—the enchanted masterwork of science—now unfolds a vast new wealth of education and entertainment, flashing its magic wand o'er ethereal oceans, broadcasting treasures hitherto undreamed.

From its new branches now being rapidly established throughout the country, the Twentieth Century Radio Corporation is distributing at wholesale and retail the radio products of America's leading manufacturers. Westinghouse, General Electric, Radio Corporation, AeroFone, Magnavox and others.

Descriptive pamphlets will be sent free upon request and a demonstration of receiving sets will be given in the radio parlors of the nearest branch.

*Dealers may learn of our proposition  
by writing to the National  
Sales Department*

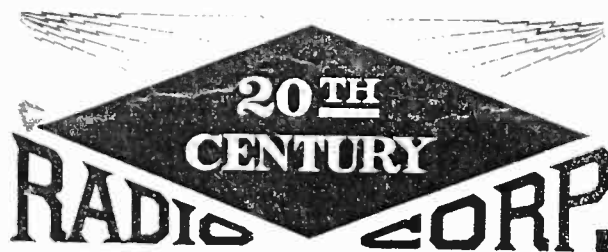

Executive Offices, 565 Fifth Avenue, New York, N. Y.  
Straus Building, Suite 710, Murray Hill 6548-49-50

#### Branches

Newark, Conn.    Newark, N. J.    Brooklyn, N. Y.    White Plains, N. Y.    Detroit, Mich.  
17 High Street    587 Broad Street    102 Flatbush Avenue    2-4 Mamaroneck Ave.    2311 Woodward Ave.

### NATIONAL RADIO DISTRIBUTORS