

USA

# RADIO *and Television* TODAY

COPYRIGHT DEPOSIT.



Keep 'em  
Happy  
With Radio  
Gifts!



## NOVEMBER

P. R. MALLORY & CO. Inc.

# MALLORY

## Replacement VOLUME CONTROLS

The  
Greatest Advance  
Ever Made in  
Tapped Controls

THE PERFECT SIZE FOR  
EVERY APPLICATION!



Completely New  
...And All-Mallory

PRECISION-BUILT LIKE  
A FINE WATCH!



MORE RUGGEDNESS  
THAN YOU'VE EVER  
SEEN BEFORE!



AN A-C SWITCH  
THAT SNAPS ON AND  
STAYS ON!



You've probably been up a tree over this matter of tapped controls.

But this new Mallory Tapped Replacement Volume Control has put an end to confusion and worries!

Entirely new mechanically and electrically, this control gives you everything you've looked for! Installation is easy and foolproof. The shafts can't pull or twist loose. The A-C switch *snaps on*. There's no assembly work required!

What's more—Mallory controls mean quiet operation... smooth attenuation... gradual increase or decrease of volume. 16 controls fill 85% of your replacement needs. See them at your Mallory distributor's today—and they will be *your* controls from now on!

*Save your old Aluminum parts. It is patriotic to give them to National Defense.*

P. R. MALLORY & CO., Inc., INDIANAPOLIS, INDIANA



Only A Few Copies  
of MYE Left!

Don't Miss Out! Order Yours Today!

Phone Your Distributor Now!

There's A Growing Swing To  
Mallory Replacement Condensers!

Complete coverage... color-coding for instant voltage-identification of paper tubular condensers... mounting features that others have tried to copy... long-life construction... all help account for this swing to Mallory. No other line of replacement condensers gives you such complete and dependable coverage!



More  
than ever  
—INSIST ON

P. R. MALLORY & CO. Inc.

# MALLORY

APPROVED  
PRECISION PRODUCTS

VIBRATORS • VIBRAPACKS • CONDENSERS •  
VOLUME CONTROLS • ROTARY SWITCHES •  
SINGLE AND MULTIPLE PUSH BUTTON SWITCHES  
• RESISTORS • RADIO HARDWARE



HERE'S PROOF  
THAT BUYERS PREFER...

# Emerson

with "Miracle Tone"

Reprinted  
from **NEW YORK WORLD-TELEGRAM**

## Emerson Big Radio Seller

A reader study of radio buying habits just completed by a newspaper here indicates that Emerson radio sets for use in the home have been purchased predominantly by the public during the last three years. Of all home radios bought in the first six months of 1940, more than 25 per cent were Emerson. This represents a substantial increase over 1938 and 1939, when Emerson also led the field with over a 19 per cent purchase preference for each of those years.

This reproduction from an article in the NEW YORK WORLD-TELEGRAM of October 16, tells the whole story. In one of the world's most competitive markets, EMERSON out-sells all other home radios. That's proof of leadership! Emerson will out-sell them all in your store, too!



## Here Are 3 Great Reasons Why Emerson Leads!



Model 413

### GETS EUROPE DIRECT

6-Tube AC-DC Superheterodyne . . . International Broadcasts, Standard Broadcasts and Police . . . 6" Oval Dynamic Speaker . . . AVC . . . Tone Control . . . Band-Spread Slide-Rule Dial . . . Handsome two-toned bakelite cabinet.



Model 428

3-WAY PORTABLE—Plays on Own Power, on AC, on DC  
6-Tube Superheterodyne . . . 6½" P.M. Dynamic Speaker . . . AVC . . . DeLuxe luggage type case with removable hinged door; simulated leather in choice of 5 colors.



Model 447

AUTOMATIC PHONORADIO — for Continuous Playing of 10" or 12" Records  
7-Tube AC Superhet. (Incl. Extra Rectifier) . . . Standard Broadcasts and Police . . . 6½" Dynamic Speaker . . . Feather-Weight Tone Arm . . . Table model of selected walnut veneers.

There Are 50 Great New 1942 Models — Write Your Distributor Today for Full Details

EMERSON RADIO AND PHONOGRAPH CORPORATION • 111 Eighth Avenue, New York, N. Y.

# Every FARNSWORTH Model

*A standout in design and value*



**THESE TWO TOP THE LIST  
FOR CHRISTMAS GIFTS**



**Model CK-58**—Attractive single player combination. 5 tubes. Smartly styled two-section cabinet of selected walnut veneers. Outstanding value!



**Model CK-66**—A compact, moderately priced combination. 6 tubes. Farnsworth "Velvet Action" Automatic Record Changer. Beautiful two-section cabinet of walnut veneers.

EVERY MODEL is a display model and value leader. And they've "wow-ed" the public just as they won the acclaim of the wholesale and retail trade. There'll be many a Christmas stocking this year, proudly "filled" with a Farnsworth—the superb instrument "Known for Tone."

Now, more than ever, Farnsworth quality counts. Call your distributor today. Or write Farnsworth Television & Radio Corporation, Fort Wayne, Indiana.



**The Washington (CK-75)**  
Meets the long-felt need for an attractively designed cabinet which can be placed anywhere—alcove, library, dining room or den—fits under the window. Farnsworth "Velvet Action" Record Changer and record storage compartment.

**The Compton (CK-73) (right)**  
Offering the utmost in luxurious listening comfort, this charming version of a chair-side combination is a beautiful example of Farnsworth modern styling. Farnsworth "Velvet Action" Record Changer.



**The Chippendale (CK-111)**—This handsome Farnsworth combination is authentic Chippendale styling. Farnsworth "De Luxe" Automatic Record Changer, Play Control and record storage.



**The Georgian (CK-93)**—Solid top and luxurious lines characterize this impressive combination. Farnsworth "De Luxe" Automatic Record Changer, Play Control and record storage compartment.

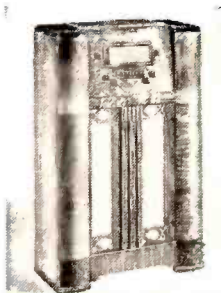

**Model CC-90**—9 tubes. Wide range electric tuning. Connection for television or FM adaptor. 12-inch dynamic speaker.



**Model CC-70**—7 tubes (9-tube performance). Wide range electric tuning. 12-inch dynamic speaker.



**The Regent (CK-91)**—A smart modern masterpiece. "De Luxe" Automatic Record Changer and record compartment.



**The Corinthian (CK-74)**—A divided top cabinet of dignity and simplicity. Farnsworth "Velvet Action" Record Changer. This year's value leader.



**The Sheraton (CK-92)**—A superb reproduction of authentic period design. Farnsworth "De Luxe" Automatic Record Changer, Play Control and record storage.

**FARNSWORTH** Known for Tone. MAKERS OF RADIO AND TELEVISION TRANSMITTERS AND RECEIVERS, THE CAPEHART, THE CAPEHART-PANAMUSE AND FARNSWORTH PHONOGRAPH-RADIO COMBINATIONS

Collier's  
FIVE CENTS - 1941

# ANOTHER BIG BOOST FOR THE SERVICEMAN!



Your service man will make your old Radio  
**PERFORM BETTER - LAST LONGER**

**Can the weather & humidity in a city...**  
The weather in a city can be a major factor in the life of a radio. It can cause the tubes to overheat, the contacts to corrode, and the tuning to drift. A good serviceman will know how to adjust for these conditions and make your radio perform better than ever.

It is no secret to you for the fact that your radio is not working as well as it used to. The reason is that the tubes are getting old and the contacts are becoming loose. A good serviceman will know how to adjust for these conditions and make your radio perform better than ever.

It is no secret to you for the fact that your radio is not working as well as it used to. The reason is that the tubes are getting old and the contacts are becoming loose. A good serviceman will know how to adjust for these conditions and make your radio perform better than ever.



RCA Test Equipment makes radio servicing easier and more accurate. It includes a variety of test sets, including the RCA Radio Tester, which is a complete radio service check-up set. It is a complete radio service check-up set. It is a complete radio service check-up set.



SECOND IN A SERIES of forceful, informative advertisements giving the public the facts about radio servicing and servicemen, this full-page, two-color ad will appear in Collier's for November 15.

"JUST what the industry needed! It's the biggest break for the radio service business in years! . . ." Unprecedented enthusiasm, interest and acclaim have been pouring in from all parts of the country since the appearance of the RCA advertisement, "WHAT YOU SHOULD KNOW ABOUT RADIO SERVICE," in the October 11 issue of *Collier's* . . . an advertisement that told *three million* Americans the facts about radio service.

Radio servicemen, dealers and distributors all said: "Give us more like it!"

And RCA is doing just that! The advertisement

reproduced above will appear in *Collier's* for November 15. A third advertisement is scheduled for December. The American public is being reminded not *once*, but *three times*, of the vital job that the competent, honest, radio serviceman is performing today . . . a campaign that helps the public, the industry, and you!

Ask your distributor for a reprint of the advertisement above.

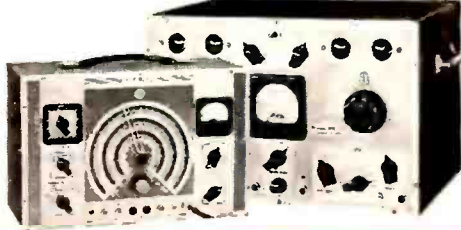

WHERE ELSE CAN YOU OBTAIN THIS SUPPORT?



## Tubes and Test Equipment

RCA Manufacturing Co., Inc., Camden, N. J., U. S. A. • A Service of Radio Corporation of America  
In Canada: RCA Victor Company, Ltd., Montreal

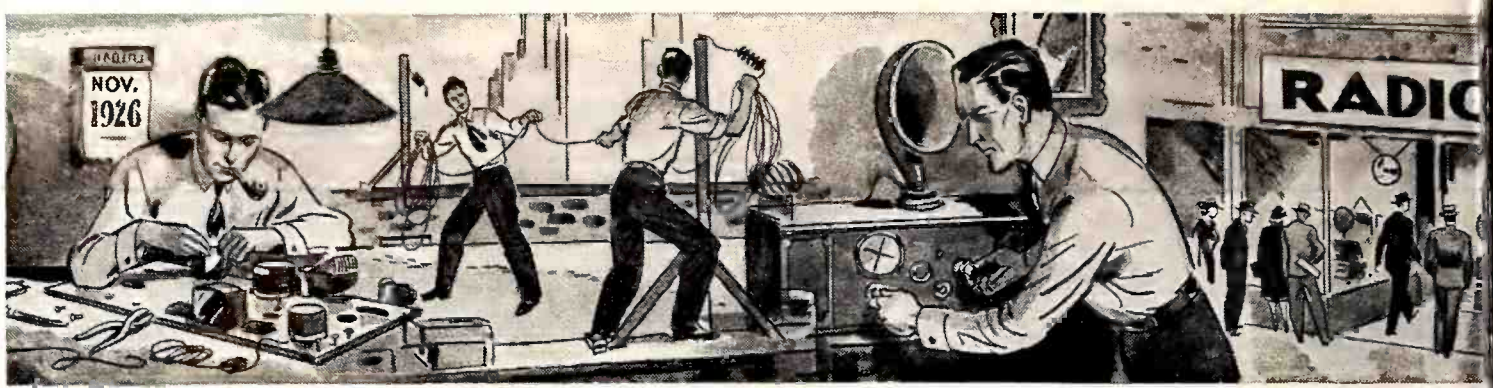

# *The Story of Two Novembers...*

This is November—and our Birthday Month:  
The Fifteenth Birthday of Network Broadcasting  
—But this isn't just a story about us.

This story is about some things that grew up with us  
Between two Novembers, 15 years apart . . . a story  
that's bigger than we are,  
And we know it.

It isn't only something on a calendar.

And it isn't the sort of thing that you can analyze  
By counting the colored counties on a map.

Though a map's one way to look at it . . .

A map can show you how, for instance,  
In nearly every county of America,  
We can bring our people together, as into one room  
—Out in Montana, down in Rhode Island, across the  
plains of Texas—

When the President speaks to the people . . . when  
the destiny of the nation rests with the people  
. . . or when the people want to be told  
The facts that a people should hear.

Yes—and a map can make you feel, perhaps,  
How rich and poor, strong, weak, young, old  
(But Listeners all!)  
Are gathered today into a transcendent unity  
Beyond achieving in that other November  
15 years ago. We have removed forever  
Cracker-barrel sectionalism . . . misunderstandings  
between City and City, State and State.  
And something has been born that was not here  
before.

Other generations may have dreamed  
What these last 15 years have made come true:  
The pioneer, rolling westward through days of dust  
And days of snow,  
May have dreamed how some day we should end





The isolation of geography,  
 Binding New York to Cheyenne with the speed of  
 light: hurtling darkness and storm, and through  
 wind and lightning speaking  
 From the Atlantic to the Pacific, with

One voice  
 To one nation  
 Indivisible!

\* \* \*

But the story isn't only in the maps . . .  
 It's in the people, after fifteen years.  
 It's a pattern in the people.

One-fourth of our people have lived with Network  
 Broadcasting  
 Since the day they were born . . .  
 And more than a third of us have lived with it  
 Since we were five years old.

Count *that*, when you measure  
 The strength, the power, the influence  
 Of Network Radio today  
 On the minds of Americans!  
 It's a pattern in the people . . . Look around you.

It's a pattern in their living: their waking, their work-  
 ing: their leisure and laughter: their dancing and  
 buying. They get up to network radio, and they go  
 to bed to network radio.

It's a habit . . . and you can't erase it.

\* \* \*

During these 15 years, the National Broadcasting  
 Company has become a part of America.

*It belongs.*

Let's say it simply:—

For 15 years, the National Broadcasting Company  
 has been proud of its job. It's been a big job, and  
 we've tried to give our best to it. We must have.  
 For today, as every day since November 15, 1926,  
 more American families listen to NBC programs  
 than to those of any other broadcasting system!

## NATIONAL BROADCASTING COMPANY

A Radio Corporation of America Service



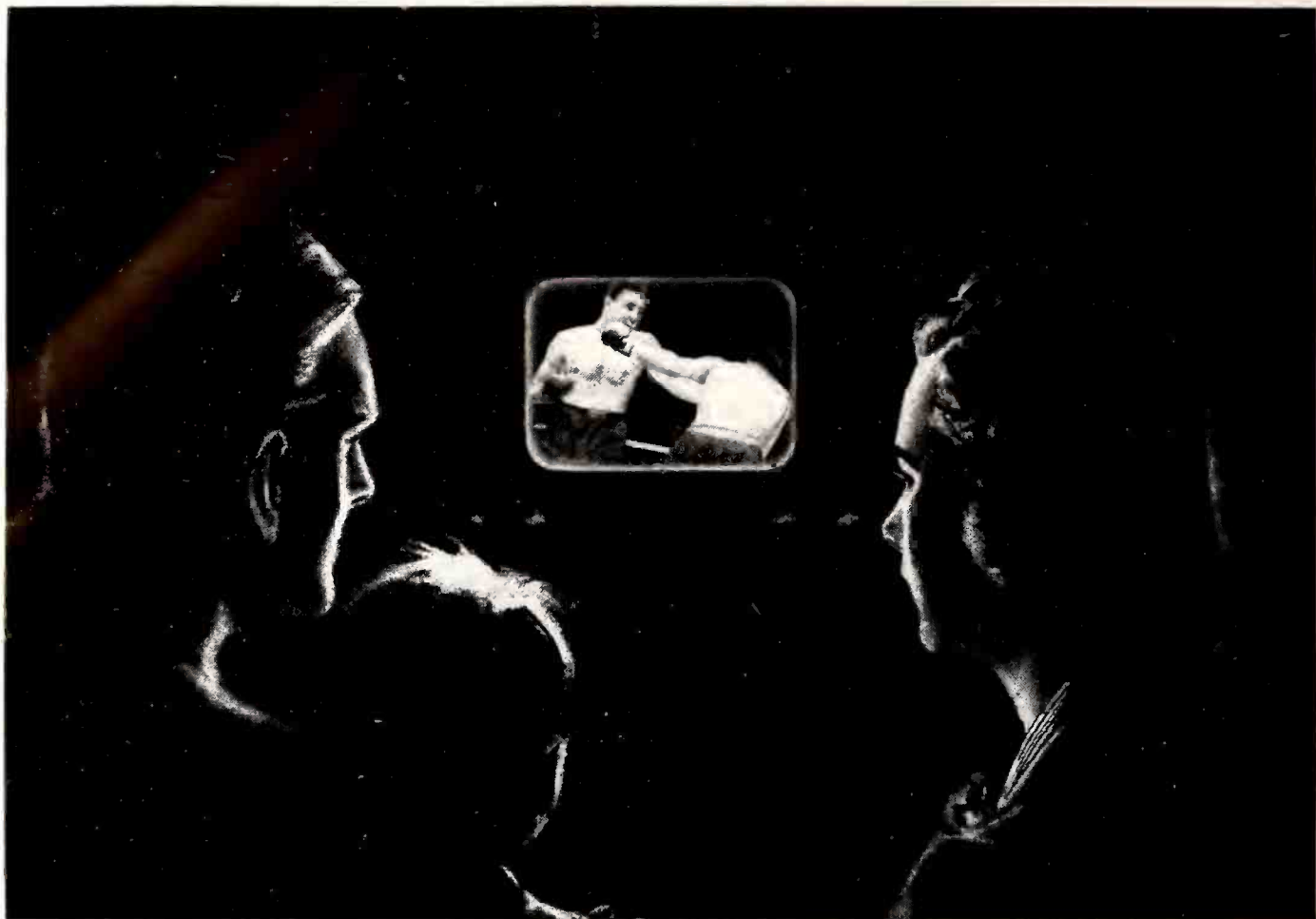

*Thanks to Radio Research*

## Thousands now Look as they Listen!

On the New York air, these nights at 8:30 o'clock, it's television curtain time. It is estimated that 5,000 television receivers—all front-row seats—are lined up, mostly in homes and public places, to see the shows—the matinees and evening performances—15 hours of entertainment a week from the NBC studio stage and from fields of sport.

Study of statistics gathered by the NBC pioneer television station WNBT, which began commercial programs July 1, reveals that the video audience in the Metropolitan area already numbers about 18,000 in the afternoon and 30,000 in the

evening. On the average, more than 55% of the sets are turned on in the daytime and 80% at night. Seeing by radio is as simple as listening, as far as the receiver manipulation is concerned.

The programs range from fashion shows to prize fights, from spelling bees to a Wild West rodeo, from baseball to travelogues, and from football to illustrated news; while songsters, dancers, magicians, dramatists and bands add to the variety. That people can sit sixty miles away and look in on Madison Square Garden to watch the rodeo. To see a bucking bronco throw its cowboy

rider across the wavelengths is one of the wonders of this age.

Electronic research in RCA Laboratories has put the television shows into space. Electronics—that science which makes miraculous use of infinitesimal bits of electricity—is continuing radio's advance across the threshold of the "Television Age."

The main gateway through which television has emerged to become a service to the public is RCA Laboratories. It is from this magic realm that new wonders in radio sightseeing will come to give this and future generations new and dramatic visions.



### **RCA LABORATORIES**

A Service of the Radio Corporation of America, Radio City, New York.

*Other RCA Services:* RCA Manufacturing Co., Inc. • Radiomarine Corporation of America • RCA Institutes, Inc. National Broadcasting Company, Inc. • R.C.A. Communications, Inc.



WHERE RECEPTION IS DIFFICULT . . . . .

THEY DEPEND UPON **RAYTHEON** TUBES  
ON THE SUPER CHIEF

Los Angeles to Chicago in 39 hours and 45 minutes on the streamlined Santa Fe Super Chief! One of America's fastest and most luxurious trains . . . Motion Picture Stars, famous writers and internationally known industrialists all ride the Super Chief.

Radio reception on the Super Chief must be the best obtainable . . . that is why the Santa Fe chose RAYTHEON TUBES. They knew they could depend upon RAYTHEONS to deliver peak performance at all times.

There must be a good reason why so many service-men and dealers are turning to RAYTHEON TUBES for replacement . . . You can have the answer by asking your RAYTHEON distributor today. Remember, for all the extra quality . . . RAYTHEONS Cost No More!

*Raytheon Production Corp.*

NEWTON, MASS. · NEW YORK · CHICAGO · LOS ANGELES · ATLANTA



WORLD'S LARGEST EXCLUSIVE RADIO TUBE MANUFACTURERS

# LETTERS TO THE EDITORS

## Posts Up Radio Today for All to Read

Editor, RADIO TODAY:

In regard to the unfair article in *Readers Digest*, I wish to thank you and congratulate you on being the only magazine in the radio field to really go to bat for the service man.

Radio repair service is the most abused technical business in this country today. Some of the other papers in the radio field evidently agree with *Readers Digest*.

Thank you again for your loyalty to the trade. Your editorials are posted in my shop for all to read.

Martin DeAlvaro

1160 Glendon Ave.  
Westwood Village, Cal.

## Every Effort Made to Explain FM Fully

Editor, RADIO TODAY:

In your issue of September, under the heading "What FM Means To Me," Mr. Sayre Ramsdell makes the following statement:

"Notwithstanding the air of mystery that has, consciously or unconsciously, been thrown around FM by some of those who have been actively promoting it, the fact is that FM is not new and it is not complicated."

The record shows that neither of the two parts of this statement by Mr. Ramsdell is in accord with fact. No air of mystery has been thrown around FM. On the contrary, every effort has been made to explain it fully to everyone in the art.

On November 6, 1935, I presented a paper before the Institute of Radio Engineers in New York City entitled "A Method of Reducing Disturbances in Radio Signaling By a System of Frequency Modulation." This paper was published in the Proceedings of the Institute in May, 1936, and it describes the system of broadcasting which has become known to the public as "Frequency Modulation" and as FM. This lecture has been repeated by me on over two score occasions in cities ranging from Coast to Coast in the United States and Canada. During the discussion which followed each one of these lectures, I have answered every question that was ever asked and their number runs into the hundreds or thousands. Many of your readers have been present during these discussions, which have lasted well into an hour, to say nothing of the informal questioning which continued after the end of the meeting.

I have given some hundred demonstrations, public and private. No one who asked for a demonstration was ever refused one and the Philco Company ought to know this because, in June, 1936, three of their representatives, at their request, came to my laboratory at Columbia University and had the FM system fully explained and fully demonstrated to them. It is hardly necessary to add that thousands

of letters from all parts of the world concerning the FM system have been received and duly answered.

The record also negatives Mr. Ramsdell's statement that FM is not new. Mr. Ramsdell endeavors to confuse this term with the Frequency Modulation that was in the text books when I was a student in college. Let us see what the technical world thought about those systems of modulation.

### EARLY COMMENTS

In the Proceedings of the Institute of Radio Engineers of February, 1922, in a paper emanating from the laboratories of our greatest communication company, concerning the theory of modulation appears the statement that "Consequently this method of modulation (frequency modulation) inherently distorts without any compensating advantages whatsoever."

Likewise, in the Proceedings, under date of July, 1928, appears the statement by the same writer in discussing a form of frequency modulation signaling that

".....static, like the poor, will always be with us."

In 1937, in one of the leading text books of the country appears the statement:

"Frequency Modulation is not particularly satisfactory as a means of transmitting intelligence."

It is, therefore, quite clear that since the FM system does not distort, but, on the contrary, has better quality than any other system, and since it is substantially immune to static, it must be different from the frequency modulation systems which were referred to in the previous quotations. The explanation of that difference, together with the history of Frequency Modulation from 1909 on to the making of the FM invention, will be found in my paper in the Proceedings of the Institute of Radio Engineers of May, 1936. Those



"But, my good man, I won't pay \$4.50 for a new transformer. The Readers Digest says you fix radios with 5-cent parts."

of your readers who wish to examine into this subject are respectfully referred thereto.

The remaining part of Mr. Ramsdell's article is, I believe, covered by my statement in your last issue.

Very truly yours,

Edwin H. Armstrong

Columbia University  
New York, N. Y.

## A Code for the Radio Serviceman

Editor, Radio Today:

In line with the commotion caused in the radio servicing field by the *Reader's Digest* article, I have prepared a code of ethics for servicemen which may prove interesting to you from an editorial standpoint.

To have my shop properly equipped for prompt, accurate service in making old radios perform better and last longer.

To advise every customer regarding every repair job as I myself would want to be advised if I were the customer.

To have a minimum repair charge in order to assure adequate compensation for minor jobs which, in the aggregate, take a great deal of my time and require considerable skill—thus protecting both my customer and myself.

To make every job that I do worthy of the great Radio industry of which I am a part.

To avoid any misrepresentation, or exaggeration and to operate at all times on an ethical, professional basis which is the only basis on which the confidence of my customers and hence my own successful future can be built.

To test tubes carefully, recognizing that probably half the radios now in operation could be greatly improved simply by replacing tubes that have deteriorated through long hours of wear.

To use only standard parts of proved quality.

To live fully up to any claim I may advertise, to abide by my estimates and to adjust any rightful complaints cheerfully and completely.

To support and maintain the highest standards of my profession, to participate in the worthwhile affairs of my community, and to be a good citizen and a good business man to the best of my ability.

To live and let live—never to knock a competitor for the sake of my own personal gain.

To make no promises I do not expect to live up to fully.

H. P. Bridge

1324 Walnut St.  
Philadelphia, Pa.

## Bouquets and Brickbats

Editor Radio Today:

I am sending in my renewal subscription today, primarily because of the excellent technical section that you maintain in RADIO TODAY. The articles combine practical value with interesting theoretical analysis. Please continue them.

G. Sorensen

Berkeley, Calif.

# ZENITH PRESENTS

## A POWERFUL MERCHANDISING PROGRAM

### IN TUNE WITH THE TIMES



#### POWERFUL NATIONAL MAGAZINE ADVERTISING

Millions of messages will blanket the entire United States with the Zenith quality story all during the big Christmas selling season.

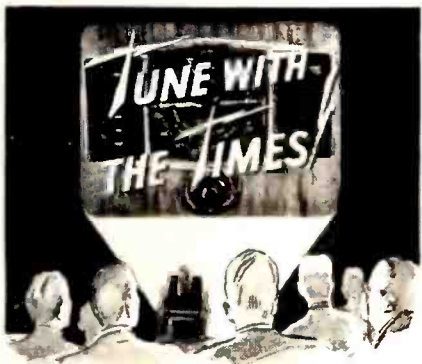

#### DRAMATIC SALES TRAINING SOUND FILM

Designed to help you sell quality in today's market. Dramatic, full of human interest! Don't miss it—The biggest thing of its kind.



#### COMPLETE RADIO MERCHANDISING PLAN BOOK

Chuck full of ideas — complete information on how to get your selling in "Tune with the Times"—Read every word of it.

Zenith is ready with the most complete radio merchandising program in the radio industry today. A program in "Tune with the Times." Not a warmed over program from the past season—but one that is completely new and designed specifically to help you sell a satisfactory volume under today's conditions—Another Zenith "First"—an aggressive program for hard hitting wide awake dealers who want to get back to real honest to goodness radio selling.

#### You Must Re-establish Quality Selling

Today's selling problems call for a new selling strategy. You must get back to quality selling and realize a full profit on every sale you make. The plus features of the 1942 Zenith line give you sharply defined advantages for this quality type of selling—and give your customers readily apparent "Reasons Why" for buying Zenith. Bracket for bracket, model for model, you'll find the Zenith line in tune with the times!

#### Zenith Has a Full Fall and Christmas Selling Program for You

Pictured to the left of this advertisement are but a few of the powerful merchandising aids Zenith has for you—Strong national magazine advertising, a dramatic hard hitting sales training film, a complete merchandising book to help you "cash in" in greatest measure on today's market . . . plus a line of quality radios with every important bracket adequately covered to appeal to the most people. In the '42 Zenith line continued maintenance of quality is evident in every model—and sustained public confidence is assured.

#### Write, Wire or Phone Your Zenith Distributor for Full Particulars

Learn all about the fast moving hard hitting Zenith program—how it will benefit you in your daily selling and how it will help you maintain the dollar volume you need for a profitable retail operation.

**IT'S THE TALK OF THE INDUSTRY**

THE SAME QUALITY  
THAT HAS GONE  
INTO ZENITH  
RADIOS FOR OVER  
A QUARTER OF A  
CENTURY ALSO  
GOES INTO EVERY  
ITEM ZENITH BUILDS  
FOR DEFENSE

**ZENITH RADIO CORPORATION—CHICAGO**

AMERICA'S OLDEST MANUFACTURER OF FINE RADIOS FOR THE HOME

# RADIO TODAY'S PUBLISHERS TAKE OVER RADIO RETAILING

CALDWELL-CLEMENTS, INC.  
PLAN EXPANDED SERVICE  
FOR GROWING RADIO  
INDUSTRY

## *Radio Men Facing Changed Conditions*

With the affairs of the nation and the industry undergoing a persistent and rapid change—with new methods, policies and developments vitally affecting every function of radio,—we believe it is imperative that all who are engaged in radio merchandising and servicing should have the utmost help in meeting the serious problems that confront them. Having this as a major objective if not a responsibility, Radio Today has explored every possible avenue of greater service to the reader, giving due regard to contemporary services.

## *Field's Two Leading Magazines*

The outcome has been a merger of radio's two leading magazines—RADIO RETAILING and RADIO TODAY. For this purpose, Radio Retailing has been purchased by Radio Today and the consolidated magazines will be published by Caldwell-Clements, Inc., under the name "Radio Retailing Combined with Radio Today."

Unlike most mergers, this one involves no "weak sister," no "lame duck." It brings together the two largest and most successful publications in the field—by no mere coincidence both members of the Audit Bureau of Circulations.

From every viewpoint it was evident that if these two publications were combined in one great merchandising and servicing publication, the reader and the advertiser would have numerous advantages which neither publication alone could offer. It would mean unified, intensified service and a greater degree of helpfulness to the largest group of jobbers, dealers and service dealers ever brought together in a merchandising and servicing publication.

## *Benefits to Readers and Advertisers*

Unprecedented as this step may appear, it was inevitable if the interests of the trade are to be held paramount. It not only gives the reader the benefit of two great magazines in one, but will give him more actual help in half the reading time.

That Radio Retailing again comes under the direction of the two men who originally launched it in 1925, and who during its first ten years supervised its editorial and publishing operations, gives assurance that the best traditions of both publications will be continued in the new Radio Retailing combined with Radio Today.

In December, Caldwell-Clements will publish Radio Retailing in its present form as an interim issue for subscribers to both magazines. In January, however, the first issue of the new consolidated magazine will make its appearance, greatly stepped up in service and attractiveness.

## BIGGER THINGS AHEAD FOR RADIO

For we of Caldwell-Clements, Inc., see big things ahead for radio during the present Emergency. And we envision even greater radio achievements to come, when the war clouds have rolled away.

Today under the Defense Program, the radio industry and trade are resolutely tackling the job of building and holding morale for the whole nation.

With 55 million radio receivers scattered from coast to coast, in the cities and in the remote places, on farms and in isolated spots, radio must be depended on for molding 140 million people into unified convictions and united purpose. To renew and replenish these sets, radio dealers have a patriotic duty unique in the merchandising field.

And the radio service engineers who keep these channels of communication open by repairing and maintaining the receiving sets of the nation, are doing a first-line job of national defense.

**Field  
Measured  
in Billions**

Preliminary statistics already compiled by Radio Today show that the domestic radio industry in 1941 totalled a billion dollars.

Meanwhile, radio invention and development are expanding at an unprecedented rate under the impetus of the Emergency. Thousands of new men are being trained for radio jobs with Uncle Sam. Only last week, a second billion dollars was allotted to the Army Signal Corps for new equipment, mostly radio.

Radio methods are finding new uses in munitions making, steel processing and general manufacture of Defense needs.

Frequency modulation, television, facsimile, and ultra-shortwave applications offer new services to the home which will bring tremendous post-War activity for the radio industry and trade.

For eventually, of course, *all these new radio inventions* and radio processes will *find their way into everyday civilian use*, for the greater enjoyment and convenience of the average man, in ways now undreamed of. Radio will come into its own!

**"Radio  
Publishing  
Headquarters"**

It is with this prospect that the Caldwell-Clements organization assumes the new responsibilities that come with taking over Radio Retailing,—making our office in future, Radio Publishing Headquarters.

We see a big job to be done for the radio industry. A big job to be done in a big way,—through the forthcoming consolidated magazine,—and through new services for radio which will develop as the time is ripe.

M. CLEMENTS,  
O. H. CALDWELL,  
*Publishers.*

480 Lexington Avenue,  
New York, N. Y.



## How to sell this De Luxe Radio-Phonograph Combination!

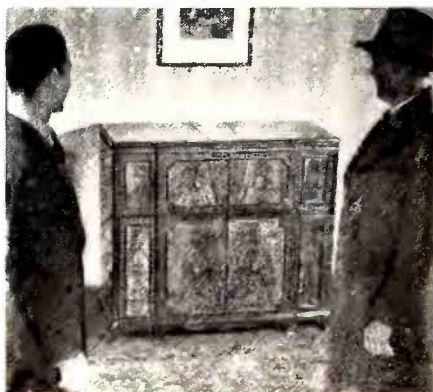

**"This instrument brings you great music as the masters meant it to be heard!"**

When you sell the Stromberg-Carlson "Georgian Model," you are selling an instrument that looms above all other radio and phonograph combinations as Beethoven towers over the world of music. Demonstrate it as a jeweler would show the finest watch made.



**"You get FM, standard, and short wave broadcasts—but with a difference!"**

The purity and fidelity of its reception and reproduction is without equal. Explain to your customer that with the exclusive "full-floating," Coaxial Speaker system every whisper and overtone of the program is held intact, without distortion. Remind him that the exclusive Acoustical Labyrinth blots out "radio-set boom," keeps tones brilliant.



**"Its record changer is one of the finest made...and there is no better pick-up!"**

The "Georgian Model's" phonograph plays both 10" and 12" records, mixed in any order, and stops automatically after the last record. Demonstrate how extended fidelity for records is obtained by pushing any FM button. Discuss the efficiency of the feather-light, permanent point pick-up that has no needles to change, and lengthens record life.



**"You'll be proud of this instrument and its performance for years and years!"**

Your customer will want to know that the excellence of the "Georgian Model" extends from the authentic Georgian walnut (or mahogany) cabinet, down to the most hidden, soldered connection. His investment has enduring value. And always he has the satisfaction that, "There is nothing finer than a Stromberg-Carlson!"

# STROMBERG-CARLSON

ROCHESTER, NEW YORK

\*Licensed under Armstrong FM Patents

A FINER RADIO FOR STANDARD PROGRAMS—THE ONLY RADIO FOR FM AT ITS BEST

# RADIO *and Television* TODAY

## "Make This a Radio Xmas!" —Radio Magic

As we go to press, Radio Magic completes 100 weekly programs describing and demonstrating new uses of radio and radio tubes. These programs are conducted by Editor Caldwell of RADIO TODAY, with dramatic episodes by Gordon Nugent of the NBC script division, and are directed by Cyril Arnbrister, with William Spargrove announcing.

Radio Magic is heard every Friday evening at 7:15 p.m. EST over WJZ and the stations of the NBC Blue network, coast to coast.

Future topics in the Radio Magic series are:

- Nov. 21. The Electron Telescope. No. 101.
- Nov. 28. Radio in Toyland. No. 102.
- Dec. 5. Why Your Gift Should Be a Radio. No. 103.
- Dec. 12. 40th Anniversary Marconi's Trans-Atlantic Signal. No. 104.
- Dec. 19. Radio Magic in the Home. No. 105.
- Dec. 26. Sound Speeds Up 'Defense. No. 106.

Radio Magic periods preceding the holidays will each carry reminders and suggestions to listeners to "Give a Radio for Christmas."

## "Keeping 'em Happy" on Radio Today's Cover

The question of who should get a radio gift this Christmas is pretty well settled by the fact that there are some 1,000,000 men in our new Army, and most of them are happier if they have receivers in their bunks. The idea of radio dealers doing their aggressive best to make it a "patriotic holiday" is illustrated on the front cover of this issue, where you see the folks at home being sold a radio, having in mind the boys in camp. The soldiers are at Ft. Dix, N. J., pictured by Keystone.

An example of what action has been taken by dealers elsewhere in the military market is seen in a report by Lynn H. Murray, president and general manager of the Delmar Radio Shop, St. Louis, Mo., who calls it "a wide-open opportunity for almost any radio dealer" at Christmas or any other time.

Since the inception of the present selective service program, the Delmar Radio Shop has constantly advertised small personal radios for use in army cantonments—thus offering the young man suddenly called from the comforts of his own home the privilege of radio, music, and news during his training period. With thousands of young men being constantly called in to service from week to week, there

---

## WHAT RADIO MEANS TO ME

For me radio means going to the theatre, seeing a ball game, meeting President Roosevelt and knowing my country better,—all by simply owning a radio. Many were the times that I gratified my desires to do all the above things.

Radio means the happiness of the masses, and happiness is a thing I most certainly wish on my fellow-man. Happiness may be acquired in various ways, but the one, composite way is through radio. We may hear a famous play; we may give ear to the best symphony orchestras; or we may listen to our favorite team running away to a triumphant victory on the football field.

But, above all, radio has come to mean to me the Voice of America. And a pleasant, advising voice it is.

Gratefully yours,  
S. T. M.

From a letter to NBC.

---

are actually two excellent markets created, according to Mr. Murray. First, of course, is that of the young men themselves—many of whom think of a small radio immediately upon notification of their appointment. Second, there is an excellent market among parents, friends, and other relatives of drafted young men, who see in the small radio an ideal “going away” gift for him.

“While there may be some restrictions on the use of small radios at defense cantonments over the country,” Mr. Murray explained, “at present, most of the young men going away report that there are no such strict rules as ‘no music’ or any other form of entertainment restrictions. Many camps have fixed ‘lights out’ regulations, of course, but the recruit is entitled to play his radio for his own satisfaction.”

#### WATCH NEWSPAPERS

Delmar has been appealing constantly for this “going-away” business by means of newspaper advertising, window displays, and telephone campaigns. Mr. Murray and his three salespeople watch all St. Louis newspapers closely for announcements of young men in varying businesses whose numbers have called them into service. As soon as any such instance is recorded, Mr. Murray himself calls the family of the young man—asking any member of the family who answers the telephone whether they are receptive to the idea of a radio as a gift for their “new soldier.” Most, of course, are pleased with the suggestion; whereupon Mr. Murray imme-



Ben Abrams of Emerson has been appointed radio's representative of the OPM Advisory Committee to Floyd Odlum. Emerson recently celebrated production of its 5,000,000th set.

diately invites them down to visit his shop. He is now showing over 40 choices in small radios from \$9.98 up to \$30. All are light, portable, and foolproof—thus adapted to the more or less rugged demands of Army life. Mother and father, or the entire family “chip” in to provide the set—and the young conscript is always highly pleased.

In his main show window, Mr. Murray has kept a display of some 20 small sets, around blown-up pictures of some of the country's most out-

(Continued on page 56)

### New Attacks on Fair Trade Laws

The fair trade laws, providing for minimum resale prices of trade-marked merchandise, are now being attacked again by powerful interests, according to word from Crichton Clarke, general counsel for the American Fair Trade Council, 36 W. 44th St., New York City. These interests are the ones “which had profited by ‘loss leader’ and ‘bargain bait’ practices, using nationally advertised trade-marked merchandise for the purpose.”

Resale price maintenance is legally established by fair trade laws in 45 states, and by the Miller-Tydings enabling act. Vigorous agitation for the repeal of these statutes is nevertheless growing so intense that the Council is preparing for an emergency, and is working to develop a new appreciation of price maintenance among consumers and their representatives in federal and state legislatures.

### NBC and CBS Start Suit Against FCC

Both NBC and CBS have filed injunction suits in the Federal courts, seeking to enjoin the FCC from enforcing its new “anti-monopoly” rules. Meanwhile the Mutual group, which had earlier greeted the Commission's orders as an emancipation proclamation for smaller stations, has also entered into the legal battle, intervening on behalf of the government.

The new FCC regulations, while somewhat amended from the original form of last June, still would prevent any local radio station from aligning itself exclusively with a single network—a restriction which NBC and CBS regard as a “death sentence” to the operation of present networks under the American system of broadcasting.

The Stromberg Carlson company, owner of station WHAM, Rochester, N. Y., is one of the independent station owners which has joined with NBC in its suit to declare that the FCC orders exceed any legal authority granted by Congress to the Commission.



Larry F. Hardy, new manager of Philco Corp.'s home set division.

### Manufacturers Join RMA March

Out of the grind and the buzz of radio's peak production period, are coming more and more manufacturers to join the pace-setting Radio Manufacturers Association. RMA now has its largest roster since 1932; the increase follows a vigorous campaign by the membership committee chairman, E. Alschuler, Chicago. Then, too, the Association has launched special priorities activities as well as new information services.

New RMA members include Sonora Radio & Television Corp., Chicago; Wilcox-Gay Corp., Charlotte, Mich.; Chicago Molded Products Corp., Chicago; Solar Mfg. Corp., Bayonne, N. J.; and National Fabricated Products, Inc., Chicago.

### FM Audiences Expand

A new count on the number of FM sets now in use in U. S. homes has lately been taken, and the total is around 120,000. Assuming that certainly several persons listen regularly to each receiver, it is safe to say that the total audience for the country's FM stations is well over a quarter of a million people. These figures were compiled by the national trade association, FM Broadcasters, Inc., 52 Vanderbilt Ave., New York City.

FM's biggest play is of course in the New York area, where 25,000 to 30,000 sets are being enjoyed by listeners. New England has 10,000 receivers and Detroit and Los Angeles are rated at 6,000 apiece. The figures increase abruptly as new stations go on the air; in Philadelphia it is reported that some 5,000 receivers were ready shortly after FM programs started. The total of FM commercial transmitters now approved by FCC is 60.



## GE Creates Radio Dep't under Vice-president Baker

Significant of the increasing importance which the General Electric Company, largest electrical manufacturer in the world, is placing upon radio and television, is the new Radio Department just set up as a major division of the company, under the direction of Dr. W. R. G. Baker who has been appointed vice-president in charge of radio.

This new department will combine all activities in the manufacture of transmitters and receivers, at both Schenectady and Bridgeport, headed up by Dr. Baker who has been active in the GE organization for nearly a quarter-century, specializing in both radio and industrial electronic applications.

### EARLY IN RADIO

After being graduated from Union College in Schenectady Dr. Baker joined the General Electric research laboratories in 1917 and some years later was made designing engineer in charge of transmitters. In 1924 he took charge of designing all radio products and in 1926 found himself supervising development, design and production. Since 1939 he has been manager of the radio and television department.

To the radio industry as a whole, Dr. Baker has rendered important service as a director of the RMA and as the chairman of the recent Television Systems Committee of the industry, laying the foundations for present television operations. He is the head of the RMA Engineering Division, and also supervisor of the important new Materiel Bureau which under L. C. F. Horle is working on substitutes for Defense shortages.



Dr. Ray Manson, Stromberg g.m., who played host to the IRE meeting at Rochester, Nov. 10-12.



Dr. W. R. G. Baker, new GE vp. in charge of radio, has received testimonial dinners at Schenectady and Bridgeport. Here he is lined up with Al Brandt, G. A. Henyan and I. J. Kaar.

## New Service Association at New York

Under the leadership of John F. Rider, an association of radio servicemen is being launched in New York City, and may also include electrical-appliance servicers, as the result of a threat on the part of the local Edison company to enter the electrical and radio servicing fields.

The purpose of the new association is to foster public confidence in the radio-maintenance industry, and to protect the interests of its members. Following are the planks in the new association's platform, under which the association proposes to:

1. Financially guarantee to the public work done by its members.
2. Establish standard trade practices that will be beneficial and equitable to its members and the public.
3. Establish a program acquainting the public with the problems of maintenance and establish cordial relations between the public and association member.
4. Provide legal advice for the benefit of the Association and its members.
5. Act as a clearing house for all complaints, employing a paid inspector to determine whether the work was properly done.
6. Provide an insurance plan for bonding its members and insuring the services rendered.
7. Prepare technical standards for its membership and shop owners and employees actually engaged in service work shall be required to pass a qualifying test.
8. Maintain an educational program providing, if necessary, a school for the benefit of the personnel of Association members.
9. Provide an advisory service to its members in matters relating to advertising, business practices, etc.
10. Prepare a code of ethics which

shall be maintained by its membership.

*Officers of the new association are:*

President—John F. Rider, publisher and author, radio service books; vice president—Edward Lowe, radio and electrical appliance dealer; treasurer—Charles Ollstein, radio jobber.

*Board of directors:*

For the jobbers—Charles Ollstein, Sanford Samuells; Rene Jacobs, Dale Radio Co.; Ben Burns, Hornbeam Sales Co.

For appliance dealers—Edward Lowe, New Rochelle, N. Y.; Paul E. Jaffe, Jamaica, N. Y.; Chet A. Wagner, Yonkers, N. Y.

For the service men—Fred Horman, Manhattan; Leon Rubin, Manhattan; George Duvall, Brooklyn. Milton Zee, Brooklyn; Charles Wardlow, Long Island; Anthony Nespole, Queens; Henry M. Lutters, Bronx; Bernard Krasner, Yonkers.



John F. Rider, leader in the new service association launched in New York City.

# THIS CHRISTMAS IS DIFFERENT!

Traditionally, the period between Thanksgiving and Christmas is the annual high-tide of retailing.

This is true in radio as it is in almost all other lines, and will be true this year as it has in the past.

Some new factors make their appearance this year, which must have a marked effect on holiday merchandising, must be carefully considered and acted upon.

Employment has reached a new high in our history, now surpassing the peak of 1929.

Earnings too are higher. Buying power is up. And a long pent-up consumer buying power is up—a long pent-up consumer buying surge is under full headway.

But in radio, and in many other

lines, demand is now equal to, or greater than, the available supply.

No longer is the radio man's problem finding customers for his radio in stock, but rather it is the problem of finding radios for his customers.

That changes the whole merchandising approach and plan.

No longer does the dealer fear that his price will be cut by his competitor in the next block, and his selling effort serve only to send a customer to the "get it for you wholesale" artist.

No longer must customers be lured to your store by lower prices, long trades, or other similar devices of retailing.

Gone, too, should be the retailing outlook which sells a \$9.95 radio with the same gusto and superlatives which

once were reserved for the best.

This year when there will be more customers than radios—dealers should make every sale count.

Some dealers will not even display a compact under \$29.95.

All should put real selling effort behind phono-radio combinations and FM.

Dealers and their salesmen should again study their better sets, learn their features, their advantages, their selling points and sell them with enthusiasm.

## SWITCH THE EMPHASIS

*Don't sell price, sell performance,* knowing full well that your customer has the money.

*Don't sell down, sell up,* knowing full well that your customers are looking up and buying up.

It's true that not all your customers have forgotten the "price" habits of the last decade, but the smart dealer will search out those who have.

And where will they be found?

Look back over your customers of 6 to 10 years ago. The purchasers of consoles, record players, combinations are in the market now for newer and better sets, the higher priced ones.

Look back over your customers of three to seven years ago. Those who then could not afford a fine set, who compromised on a compact because of price, now have the price and still have the urge for that better set.

Search these people out with your window displays, your advertising, your direct mail, your phone calls.

Search out not only your own such customers, but those too of your competitors.

This replacement market is the one on which radio dealers must hang their "profit hats" this year.

Forget the "package" sets, they will not only take care of themselves, but also take a customer out of the market.

More than ever before it will be necessary to *have* your radios in stock before you can sell them.

## CHART YOUR COURSE

No small part of successful merchandising this Holiday Season will be the planning and buying of your stock.

Not so important as in former years will be the breadth of your assortments. But far more important than usual, will be the depth of your stock, the availability for immediate

(Photos by Ewing Galloway, left; and Black Star)

Gift shoppers this year can afford finer radios.





Once the customers see how the shelves of small radios are emptying, they think about the national emergency and snap up the sets faster than ever.

delivery of the models you display and sell. Ample reserve stocks must support your selling display.

Once again "pride of ownership" and "performance" become very important factors in selling radio.

Real worth — dependability — now are far more important than "gadgets" in consummating a sale.

Most of the radios sold this year are going to replace sets which were bought several years ago.

Permanence of cabinet styling and dependability of design and construction should be emphasized in advertising, display and selling, because the increasing restrictions on consumer production are fast making the public more conscious of the desirability of completing their purchases *now*, on an investment basis.

And that too is a strong point to make in your selling efforts.

Many dealers have expressed some concern, lest the drastic reduction in

radio production, reduce their merchandise and their sales, and threaten their business integrity.

There appears no good reason for this concern at this time for two reasons.

First, because those irregular sources of distribution which short-circuit the regular retailer will be the first to dry up, will probably absorb this reduction and make little change in the next few months, in dependable dealers' sales.

And second, this holiday season can, and by smart dealers will, be used to add other lines.

#### EXTRA LINES

Music, musical instruments, pianos, records all are lines which are particularly adaptable by radio dealers.

Some or all of these should be included in the holiday merchandising plans.

Beyond any question the current

high tempo of consumer purchasing is not going to continue indefinitely, may well begin to ebb within the next 60 days.

It becomes particularly important then, that full advantage be taken of this holiday season, this seasonal flood tide of buying, to prepare for the ebbing which must certainly come.

More than usual, dealers should go into this holiday season with complete and precise plans, with deep stocks and with no let-up in promotional and selling effort.

Go after prospective customers, and sell them as hard, as when customers were scarce and sales were hard to make.

Make advertising, displays, promotions come together in one co-ordinated and continuous effort.

*Sell up*—but base your selling on worth, too.

In the large cities and their suburban areas, FM lends itself to real promotional efforts.

Automatic phono-radio combinations can be successfully promoted in any section, and are now such important factors in the radio business they merit your best selling efforts.

Though we can't see too far ahead —by all the indexes—this should be the greatest holiday season—from the retailer's point of view—of which there is record—

1929 will be *second* best from now on.

And you should be *fully prepared* with *well-thought-out complete plans*.

### Gift Buyers Vote For Radio

When radio men emerged from the holiday merchandising rush last year, they were able to make some conclusions which serve as good guidance for Christmas sales plans this year. For instance: in 1940 the big St. Louis department store Stix, Baer & Fuller polled 4,275 persons to find out "What do you want for Christmas?" The survey was made among six representative groups of people and it turned out that radios, especially portables, were named among the favorites in all six.

Among the men, portable radios ranked first and electric shavers second. High school girls ranked the receivers as third, the first and second preferences being sweaters and record players and records. It was interesting to note that the high school group rated the radios higher than either the "wives" or the "business women." And among the youngsters aged 7 to 13, the girls listed small sets higher than the boys.

The St. Louis store used the poll results effectively in holiday promotions, because it was able to say that "we know what people want for Christmas." Also, the display men knew exactly what merchandise to spot in the ground-floor gift display space.

# RADIOS FOR CHRISTMAS

NEW MODELS TO START YOUR HOLIDAY SALES ROLLING!



**GE LFC-1228**

★ A 12-tube, 3-band (FM, standard BC and shortwave) radio-phonograph with 3 built-in Beamscope antennas, is housed in an 18th Century cabinet. Roll out drawer for the automatic record changer which plays twelve 10 in. or ten 12 in. records, also has a mechanism to reject a record after it has begun to play. Permanent point sapphire stylus. Record storage compartment. 10 in. dynamic speaker. General Electric Co., 1285 Boston Ave., Bridgeport, Conn.—RADIO TODAY.



**Sonora AC combo console**

★ Phono-radio superhet has 7 tubes and AC circuit. Tunes 2 full bands, 535 to 1720 kc, and 5.65-18.3 mc. (foreign). Built-in Sonorascope 10 in. concert dynamic speaker. Automatic record changer in "Open Sesame" tray, has crystal pickup and lifetime needle and plays twelve 10 in. or ten 12 in. records. Walnut cabinet. Sonora Radio & Telev. Corp., 325 N. Hayne Ave., Chicago, Ill.—RADIO TODAY.



**RCA "Fly-Weight" portable**

★ Model 26BP, a new light-weight portable made possible by new small components, tubes and a new molded process and material used to produce the compact case. Operates on AC-DC or battery. Roll front, metal grille, 6 tubes, built-in Magic Loop antenna and separate detachable antenna for use in locations where portables are frequently inoperative. RCA Mfg. Co., Camden, N. J.—RADIO TODAY.



**Philco 1016**

★ A 4-band, 16-tube combo radio housed in a walnut 18th C. Georgian cabinet with tilt-front. Remote control of radio and phonograph. Permanent floating jewel plays any record on a beam of light. Automatic rec. changer plays ten 12 in. or twelve 10 in. records. Stroboscopic pitch and tempo control. 12 push buttons, electro dynamic speaker. Covers Standard BC, American and foreign shortwave, state police, amateur, aircraft, etc.; and FM. Uses Philco FM system, has separate built-in FM aerial. Philco Corp., Tioga & C Sts., Philadelphia, Pa.—RADIO TODAY.



**Zenith Trenton model**

★ Number 14H697, home recorder and automatic radio-phonograph combo in genuine mahogany finish receives American and foreign broadcasts and FM with genuine Armstrong FM circuit. Automatically plays fourteen 10 in. or twelve 12 in. records. Sapphire needle. Radiorgan, Rotor Wavemagnet features. 12 in. high-fidelity speaker. Zenith Radio Corp., 6001 Dickens Ave., Chicago, Ill.—RADIO TODAY.



**Crosley Glamor-tone Radios**

★ FM console model 22CA is a 12-tube AC superheterodyne with 4 bands—Europe, Orient, America, FM—5-18 mc., 1.6-5 mc., 550-1600 kc., 42-50 mc. Has Crosley Master Tone Control with 6 tone buttons, 14 in. super-concert speaker, 6 push buttons, giant magna-loop antenna, full-view "giant circle" dial. Walnut cabinet. The Crosley Corp., 1329 Arlington St., Cincinnati, Ohio—RADIO TODAY.

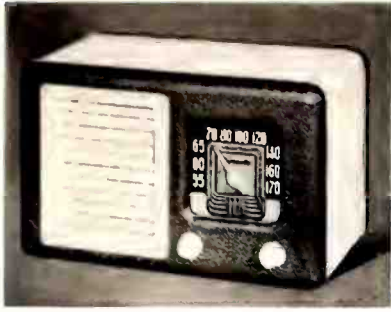

**Motorola Vita-Tone model**

★ The 51X17 series uses 2-tone leather effect covered cabinet. Ivory knobs and louvre grilles. 3 different cabinet color combinations—ma-noon and ivory, green and ivory and brown and tan. Disappearing handle. 5-tube AC-DC superhet with a self-contained "Aero-Vane" loop antenna. 10¼ in. wide, 6¼ in. high and 5¼ in. deep. Galvin Mfg. Corp., 4545 Augusta Blvd., Chicago, Ill.—RADIO TODAY.



**Emerson model 421**

★ A 5-tube superheterodyne in walnut bakelite cabinet. Has 4 knob controls, 6-inch oval dynamic speaker and an inclosed "super-loop." Two watts beam power output. Illuminated full-vision slide-rule dial. Emerson Radio & Phonograph Corp., 111 Eighth Ave., New York, N. Y.—RADIO TODAY.



Ewing Galloway



**Knight automatic combo**

★ 6-tube phono-radio combines 3-band radio reception (5.25 to 10.25 mc., 11.5 to 16 mc., and 540 to 1600 kc.) with automatic record reproduction. Superhet circuit, 5½ in. dynamic speaker, built-in loop. Record changer plays 10 and 12 in. records, crystal pickup, lifetime needle. Walnut table-model cabinet, 110-120 v., 60 cycles, AC. Allied Radio Corp., 833 W. Jackson Blvd., Chicago, Ill.—RADIO TODAY.



**Pilot AM-FM set**

★ An 8-tube AC-DC table model with standard broadcast 550 to 1700 kc. and genuine Armstrong FM with limiter circuits. Known as model T-301 it has special aerial circuit for provision of doublet antenna. Walnut cabinet. \$67.50. Pilot Radio Corp., 3706 36 St., L. I. City, N. Y.—RADIO TODAY.

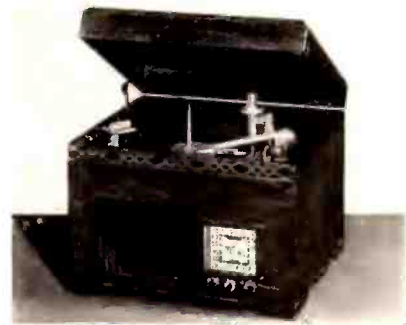

**Garod radio-phonograph**

★ Model 3P85, 8-tubes, 3-band AC combination with automatic record changer. Also available for AC-DC operation with 10 or 12 tube chassis. American and foreign broadcasts, 12 in. electro-dynamic speaker, built-in loop antenna. Available in walnut or mahogany with divided lid. Garod Radio Corp., 70 Washington St., Brooklyn, N. Y.—RADIO TODAY.

# HOLIDAY

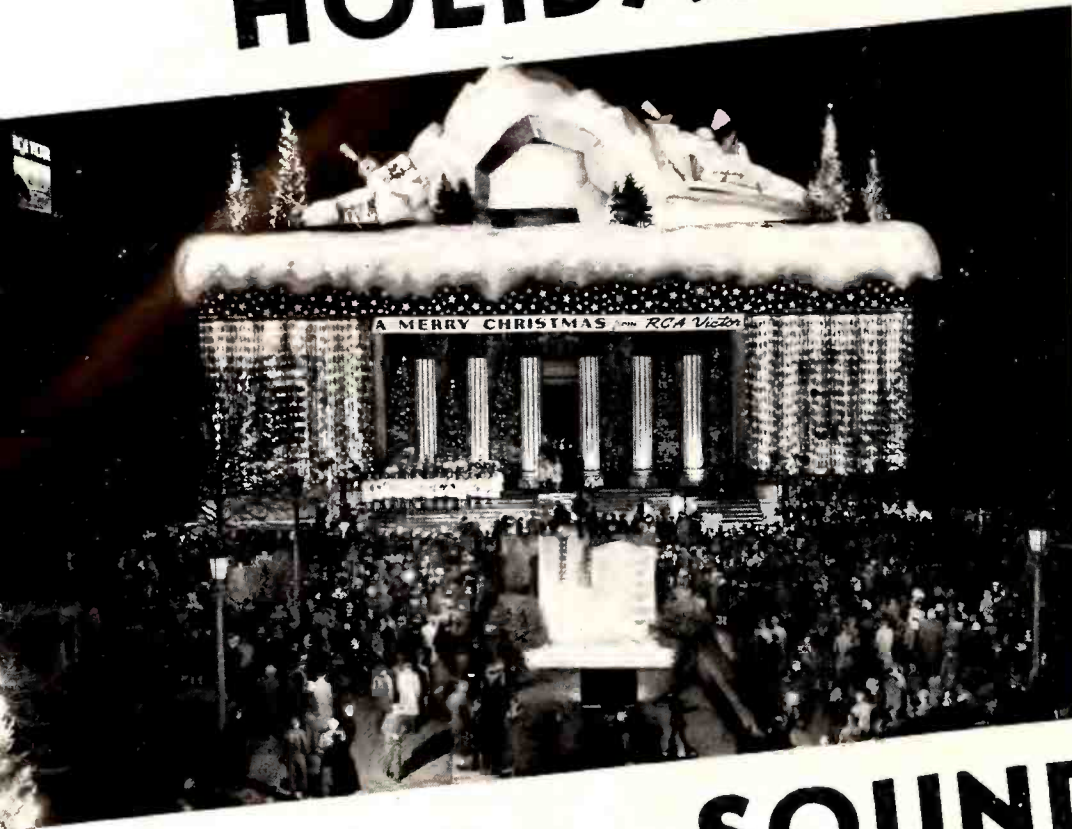

tion and maintenance. Robert Sweeney, sound expert in Beckley, W. Va., has operated such a set-up for a number of years. The sound system in that town covers about eight city blocks with speakers mounted on the street-light poles. The story of this installation is in *RADIO TODAY* for November 1940.

If a good sound system, designed for a city's needs, is made available for either hire or purchase, it is sure to find wide usage throughout the year in a variety of occasions.

Sound for every occasion is exemplified by sound specialist, Tom Rand, of Hendersonville, N. C. Rand's sound systems are a major part of this Southern town's holiday celebrating. Throughout the rest of the year, street dances, etc., receive a boost from his p.a. equipment.

"Pay me when I get through if you're satisfied" is his slogan. Scores

A sound system helps the RCA employees at Camden celebrate Christmas in nearby Johnson Park.

# SOUND JOBS

Every indication points toward a bigger and better Christmas season—one in which sound systems and public address units will play a large part.

All over the country, sound men are lining up the community Christmas program committees, the merchant groups who plan to sponsor holiday campaigns, and individual retailers with a special message to put across. These sound experts are making new plans with their last year's customers. They are selling new projects with the success of previous installations.

In the smaller and medium sized communities, the local newspapers usually start the Christmas campaign idea with the merchants backing up the plan with gift drawings, free turkey, etc. The sound man should be sure to get his name and sound service before the readers of the issues of the paper which first describe the plans for the current year. Since most business firms will be considering their part in the events during this time, your sound experience and name will be where they can connect it with their plans.

## CITY JOBS

Sound installations for the holidays, range from 10-watt units for small stores or departments of larger stores to high powered jobs for distribution of Christmas music along the city streets. Rent as many of the

small complete units as you have available, and supervise the large installations.

Many cities purchase a sound system for use along its streets and pay the local sound man for the installa-

Last of the cable-cars and Webster-Rauland sound bring Christmas carolers to Seattle citizens.

of satisfied customers attest the value of this phrase, so Rand's equipment is in constant demand.

The p.a. outfit consists of six Atlas Sound parabolic baffles with 12 in. speakers, and ingenious mounting

arms for set-up on trees, telephone poles, buildings or whatever support is offered; an assortment of mikes and stands; and a 60 watt class AB amplifier using 6L6G's in push pull.

#### CHIMES COLLECT CASH

Annually, the day before Thanksgiving, Rand sets up his amplifier and an automatic record-changer in the office of the Chamber of Commerce and busies himself erecting the six speakers and baffles to cover six blocks along Hendersonville's Main Street. From Thanksgiving through Christmas, chimes, carols, and other appropriate selections sweeten the moods of shoppers and merchants daily.

"The Chamber of Commerce has long been alive to the possibilities, the vital necessity, of sound to put an event over," says Tom Rand, "and it took little persuasion to sell them on my equipment and services. From the start, they agreed it was more advantageous for them to rent, rather than buy, and we agreed to a flat rate per month. My equipment has earned its cost many times over."

and Fall on Main Street. One dazzlingly illuminated city block is roped off and several thousand spectators line the sidewalks or watch from wooden benches lining the street.

A seven-piece orchestra, on a dais, is supplemented by an official announcer and two callers who direct the intricate patterns of the increasingly popular "square dances." Despite an understandably high noise level, the sound system adequately covers the 39,000 square feet with only four speakers and baffles working off the 60 watt amplifier.

#### SELLS RECORDINGS TOO

Turning back the calendar to a C. of C. sponsored Annual Singing Convention at the high school Auditorium, May 18th and 19th, attended by outstanding groups of singers from both Carolinas, Georgia, and Tennessee, Rand furnished the sound. For this occasion, four mikes were employed on the stage, two speakers handling the sound inside and four speakers supplying the overflow on the campus. From 8,000 to 10,000

persons attend these annual singing conventions.

Alive to profit opportunities, Rand makes recordings of each competing group of singers, which he sells to them.

During the week of September 20th, the annual Western North Carolina Fair takes place in Hendersonville. Eighteen counties are represented, and this p.a. specialist heads up the activities with sound for the grandstand.

#### OTHER PROSPECTS

Tom Rand is the sound half of Radio and Sound Service, 127 East 4th Avenue, Hendersonville, and in addition handles the company's record department. Ed Blythe handles the radio service work.

Churches are using more and more chime amplification equipment. With the relatively inexpensive chime recordings and tubular chimes available, sound men have ideal set-ups to offer for rent or sale. These prospects should be contacted now to sell or rent a sound system, or to check over their old installation.

Department stores are turning strongly toward the animated window displaying of toys. The accompanying sound effects are delivered to the crowd through small speakers mounted outside. The sound is a great attention-getter in such an arrangement.

Sound men will find many jobs to be done during the coming holidays. The time to act is now. Make your plans early, get your equipment in shape, and sell the jobs.

Hendersonville, N. C., responds to the music delivered through Tom Rand's p.a. system. Atlas Sound speakers can be seen at left above crowd.

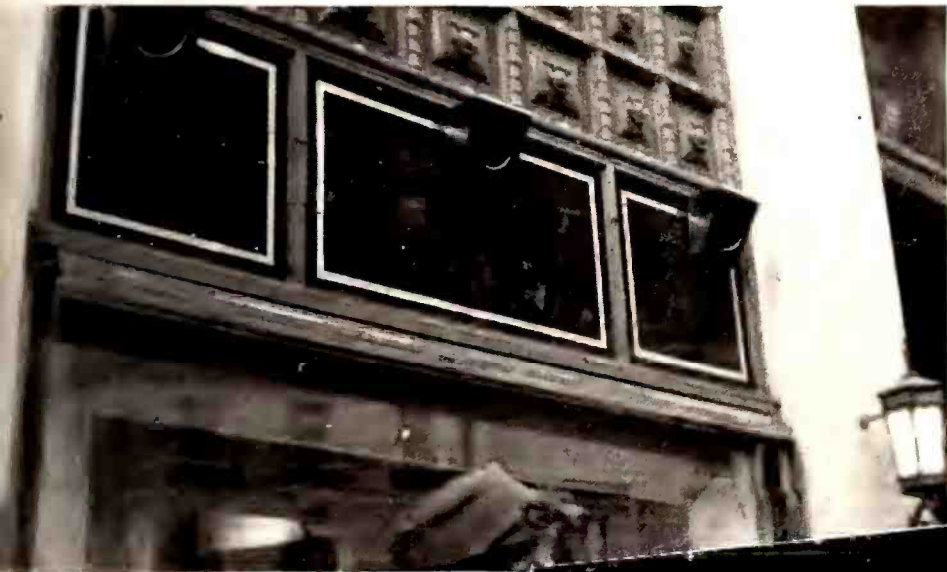

Department stores use sound systems to increase appeal of window displays, especially the animated toy shows.

"I advise every sound man to cultivate his Chamber of Commerce and thoroughly sell them on sound. A study of its possibilities, as exploited by our Chamber of Commerce, will help any sound man collect handsome dividends."

#### C. OF C. USES SOUND

One of the events beside the holiday festivities sponsored by the Chamber of Commerce of Hendersonville, N. C., is the annual series of "block and square dances" held every Monday night during the Summer





The up-to-the-minute sales room of Austin Appliance Co., where the smaller sets are now being reserved for those who actually can't afford bigger ones.

# COLORADO DEALER BEATS SHORTAGES

## VIGOROUS "SELL-UP" POLICY SAVES THE DAY IN DENVER

"I'd like to sell you that set, but I don't know whether we will have it in stock for a couple of months."

That statement, made in answer to the prospect who wants a certain model, is heard more and more in radio stores. It brings up one of radio's main problems today—merchandise shortages which prevent the dealer from capitalizing on an otherwise excellent market.

Austin Appliance Co. of Denver, Colorado, one of the mountain city's major radio outlets, long ago realized the effect which government priorities would have on availability of radio stocks. Unlike other dealers caught by surprise, the management has developed an effective merchandising program to offset lack of stocks. To date, according to James Austin, assistant manager of the firm, and the son of its president, W. E. Austin, the company has lost only a few radio sales through inability to supply the correct set.

Whereas Austin at one time received its radio stocks in large shipments often totaling a carload in a season, it now must place advance orders, and wait for the sets involved

to be manufactured. Denver, like other cities, has enjoyed a huge increase in the radio market with better salaries and "loose money" as the chief contributing factors. This market quickly exhausts stocks of low or medium-priced radio sets, unless the dealer "does something about it."

### NEW POLICY

What Austin has "done about it" is to develop a balanced selling program whereby the store can keep up a minimum of lower-priced radios, sell more in the ordinarily high-priced brackets, and equalize turnover on the entire stock to the point that when one price line approaches a low inventory point, it can switch to another until the latter is built up to a reasonable operating stock. In this way, according to Mr. Austin, the store has never run out of stock in any desired set, and has been able to convince manufacturers that it is entitled to more sets than their close "budgeting" of production usually involves.

First, the company took the unusual step of slowing down its ad-

vertising promotion. Radios at this store were always advertised over the air, with a daily "spot announcement" radio arrangement ranging from one to three short commercials daily. But in the face of priority-tightening of sources of supply, Austin has cut this advertising to a bare minimum.

### MORE DOLLARS PER SALE

Next, Austin Appliance Company is making a determined effort to step up its average price sale—in compensating for lack of stock by selling more of the slower-moving lines. Carrying both low and medium priced lines, the store emphasizes quality and its service shop, with a slogan "When we sell a radio we buy a friend." Steady promotion doubled volume of 1939 in 1940, and is expected to double again this year. However, this volume was built on an average selling price of \$79 for floor models, \$24 for mantel models, and \$17 for midget sets. Today, Austin is striving mightily to retain stocks of radios at those prices for the purchasers who cannot afford to pay more—and to shift the bulk of purchasing into higher price brackets which take the "pressure" off the moderately priced sets.

Executives and salesmen have been instructed to explain frankly to customers the likelihood of supply shortages, and to make every effort to raise the customer's desire to a better-priced set. For example, the store is slowly trading up floor-model customers from a \$79 set to a \$90 model,

table-model set prospects from \$24 to \$30 and \$35, midget radios up to \$25 from the basic average sale of \$17. The fact that more money is in circulation; plus the general uneasiness of the public over war conditions and supplies have added powerful incentive to the sales talks. It has not been difficult to compensate all radio sales to allow the store to maintain its minimum stock of lower priced sets. Significantly, a large percentage of better-priced sales are for cash; whereas those for minimum-price radios are invariably time-pay-

*(Continued on page 60)*

### EMERGENCY IN THE MOUNTAINS

1. Radio advertising and promotion are more carefully planned.
2. Salesmen have explicit and detailed instructions for "selling up."
3. The bigger trade-in allowances on higher priced sets are emphasized.



# Feature **PHILCO** for Christmas!

Now, everything is ready for your Christmas selling! The finest, most saleable Philco line ever offered, plus a sparkling window display . . . new Christmas rotogravure section . . . a special series of dealer ads! Use them . . . feature Philco to profit best from the Christmas selling season!



PHILCO 1013  
RADIO-PHONOGRAPH

**O**NLY Philco offers these modern, saleable radio-phonograph features: Music on a Beam of Light. Philco Automatic Record Changer. Stroboscope Pitch and Tempo Control. Philco Tilt-Front Cabinet. Philco FM System. All of them exclusive, modern inventions that make Philco the *profit line* of the radio-phonograph industry!

**See Your Philco  
Distributor Now**

## PHILCO ALL YEAR 'ROUND

**The Most Valuable Franchise in the Appliance Field!**

# A RIOT IN RECORDS

## HOLIDAY BUSINESS PROMISES HEAVY RETURNS



Above, an early start on record gift promotion which this year includes national ads, radio, store displays, etc.

Below, one of Victor's five "Musicard" designs—the giant greeting card that holds any disc of buyer's choice.



While the dealer stood at the counter and unwrapped a new album with its holiday trim, a lot of things came flashing through his mind.

He could see that the holiday trimmings were early enough to be really valuable in terms of sales, and apparently they were the kind that would look just right when put to use in the store. The records seemed to be "gift merchandise" at its best.

He wondered if he should go all-out on record promotion this Christmas.

Just an hour before, he recalled, he had waited on a young matron who was a steady customer and who had surprised him by buying four 12-in. records at a clip. She had never done that before. But this time she had

the money, and had said brightly that "Hubby has a new job and I'm getting the records I want while I can."

True enough, reflected the dealer, the folks are making more money and spending more of it. He had a feeling that one of these days he would show that woman a new combination and make a deal of some size. She would be in again, after more records. She was a buyer, not a shopper, and so were a lot of other people, these days.

### BUYING MOOD

The dealer recalled also the incident of the young professional man who had recently come into the store and bought several semi-classical discs. He had made the remark that he was "determined to relax" with the help of his record player. Recorded music was something to keep his feet on the ground while a fighting world went haywire.

Wasn't this, the dealer asked himself, another element in record selling this Christmas? A lot of people were in a disc-buying mood because the war news was emotionally wearing them out. Wouldn't the Yuletide music fit appropriately into this situation?

Quickly the dealer thumbed through the new releases from Columbia, Decca and Victor. The Christmas theme was splashed throughout the lists. Holiday records of all types—vocal, instrumental, novelty, dramatic, juvenile, etc. Plenty of timely merchandise.

The question is, what *other* low-unit-price merchandise can a man get hold of, this Christmas, that will create as much traffic as records and will get me acquainted with as many folks as I can meet at the record counter? Volume-builders are badly needed because the supply of smaller radio units is doubtful.

And isn't it a fact that lately, customers have been bringing up the matter of national ads, on records? A lot of buyers have noticed advertisements in their favorite magazines, and no doubt the exceptional number of such promotions has served to build up a strong record interest for the Christmas season. A retailer may as well cash in on it.

### STRONG BUILD-UP

Speaking of new promotions by the record companies, it is certainly true that they are going great guns. Columbia, in announcing a \$200,000 promotion program on records as gifts, says that "nationwide surveys

indicate that between Thanksgiving and Dec. 25th, more than 35,000,000 discs will be sold."

And Victor has created a terrific stir with its current promotions. Such drives as the Catalog Concentration Campaign, the Dance Caravan, the Catalog Contest with 512 merchandise prizes, the "Weekly Song Hit" stunt in 15 Hearst newspapers, the Two-Records-for-One business, etc.

By this time the dealer thinks that the record business should pay off in a big way, this December.

But there's one more thing. Also on the record counter is a display of recording blanks. That reminds him of the three soldiers who came into the store yesterday. They had bought half a dozen blanks apiece, to use with the recorder in their recreation center at camp.

Why wouldn't they be sending their Christmas greetings on the blanks, next month? Especially if they could buy blanks specially designed for "Greetings." If that business ever really caught on, it would be important, because there are plenty of soldiers around town.

### UNUSUAL OUTLOOK

That's just one more thing that contributes to what looks like a swell business, for the weeks before Dec. 25th.

The dealer concludes, then, that with the extra buying power, the wartime need for recorded music, the appeal of the Christmas releases, the value of the store traffic, the new gift-promotion help offered by the manufacturers, the new spurge of national ads, and the Army business, that the record department deserves a lot of pre-holiday attention.

All out for Christmas records?

Well, as they are saying on one of the hit discs. "Yes Indeed!"

### BEST-SELLING RECORDS

Listed for RADIO TODAY in order of importance by Alex A. Gettlin, publisher of *Recordaid*.

PIANO CONCERTO—Enrich Madriguero on Victor 27614 and Freddie Martin on Bluebird 11211.

CHATTANOOGA CHOO CHOO—Jan Savitt on Victor 27573 and Glenn Miller on Bluebird 11220.

ELMER'S TUNE—Glenn Miller on Bluebird 11274.

IT HAPPENED IN SUN VALLEY—Glenn Miller on Bluebird 11263.

I'M THRILLED—Glenn Miller on Bluebird 11287.

I DON'T WANT TO SET THE WORLD ON FIRE—Dick Todd on Bluebird 11291 and Mitchell Ayres on Bluebird 11275.

WASN'T IT YOU?—Sammy Kaye on Victor 27567.

JIM—Art Jarrett on Victor 27580 and Dinah Shore on Bluebird 11204.

FIFTY MILLION SWEETHEARTS CAN'T BE WRONG—Tommy Dorsey on Victor 27617.

ADIOS—Xavier Cugat on Victor 26794.

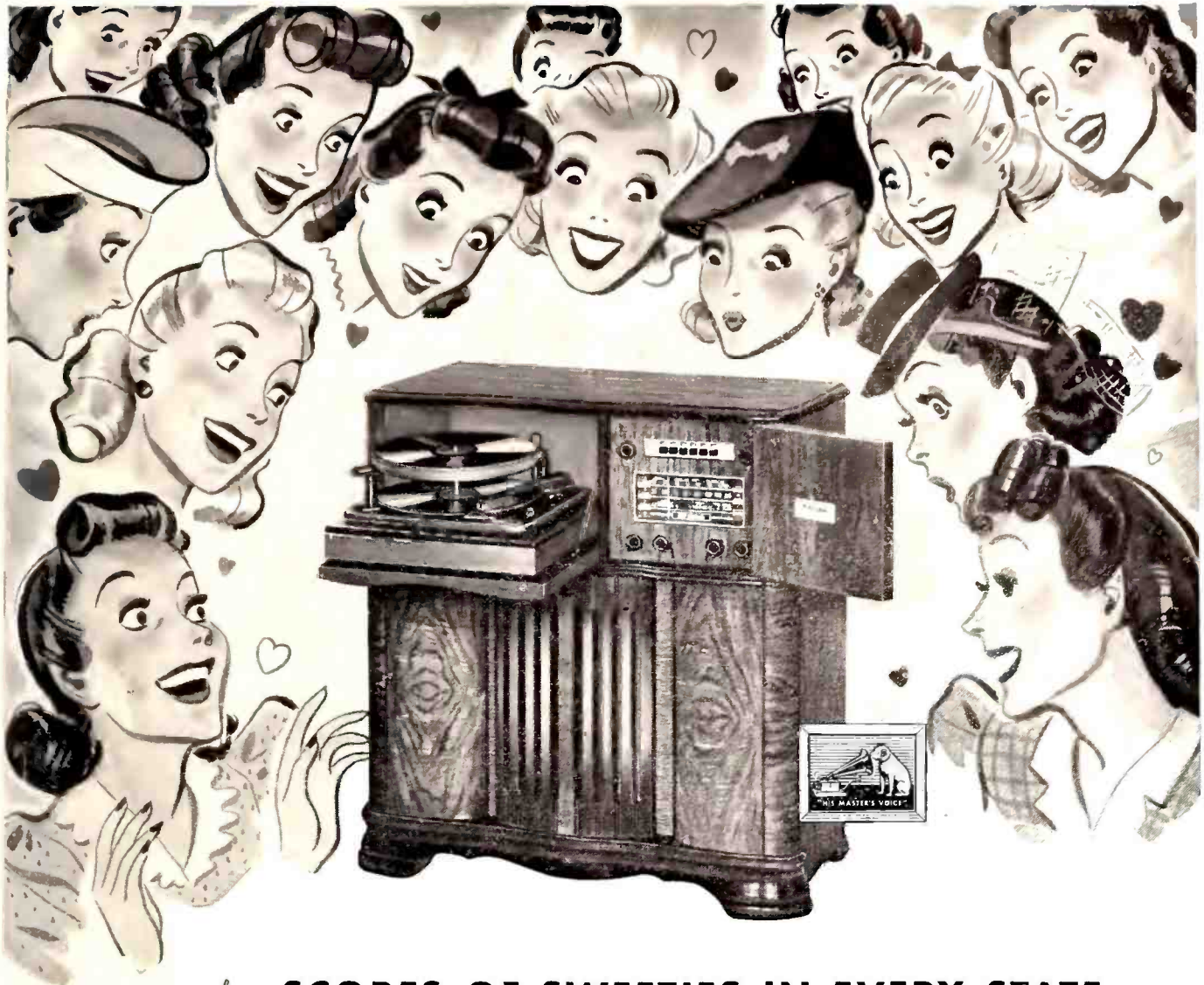

## SCORES OF SWEETIES IN EVERY STATE

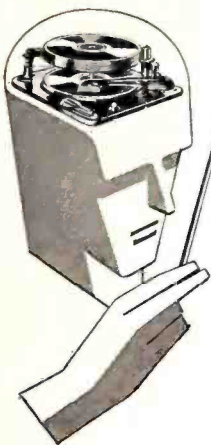

This new Magic Brain RCA Victrola has what it takes. Out on its own for only a couple of months, it's already the possessor of mash notes galore.

Why so popular? Well... we did a little analyzing and think this lineup gives the answer:

**1 NEW ROLL-OUT RECORD CHANGER!** It glides out automatically. Your customers load records at comfort level.

**2 REAL LIFE TO MUSIC... NO MORE OBJECTIONABLE MECHANICAL NOISES!** The New Jewel-Lite Scanner and lightweight Flexible Tone Bridge, important parts of the Magic Tone Cell, recreate records with brilliant tone fidelity and completely eliminate objectionable needle chatter.

**3 NO NEEDLES TO WORRY ABOUT!** Old-fashioned needles are entirely eliminated by the tiny sapphire point of the Jewel-Lite Scanner of the Magic Tone Cell.

**4 RECORDS LAST INDEFINITELY!** By exerting astoundingly light pressure

on records, the revolutionary Magic Tone Cell extends record life indefinitely.

**5 RECORDS PLAY, STOP, CHANGE—AUTOMATICALLY!** Just push a button and the Magic Brain does all the work—even turns motor off when records have been played.

**6 TELETUBE RADIO!** Standard, short-wave and foreign reception with powerful push-button set containing Teletube and new Audio System for finer amplification.

The instrument to push is the one with "oomph." RCA Victrola Model V-215 (illustrated) has it.

It means money to you!



# RCA Victrola

RCA Manufacturing Co., Inc., Camden, N. J.

A Service of the Radio Corporation of America

For Canadian models

write to RCA Victor Company, Ltd., Montreal

# VARIETY IN JOBBER PRIORITY SALES

What percentage of parts jobbers' volume goes into Defense sales and production, and so should have the advantage of advanced priority rating?

There is a wide difference of opinion on this subject.

RADIO TODAY's scouts have been scouring the field and conducting "cross-the-counter" interviews with jobbers and jobbers' men. And the answers they turn up range all the way up to 40 or 50 per cent—although they run across a number of parts distributors who think the average of Priority sales will not run 5 per cent.

In some Defense areas where a large amount of armament-plant work is being done, the estimates run above 50 per cent. Even 75 per cent has been proposed as a top figure, but these high Priority ratios are always reported for someone else, not the man who is doing the talking.

And where the Defense sales ratio is high in the case of a jobber who is specializing on such work, there is invariably a nearby competing jobber who in one way or another is taking advantage of the rush of defense materials, to point out that such industrial sales mean interference with ordinary sales for servicing home radio sets. So that while one distributor is busy going "all out" on Defense sales, his competition is ready to declare that regular business is suffering, and that the way is thus opened for others to do the regular radio-repair supplies business and to win a lot of new customers for future.

## "15% OR LOWER"—PRINCE

Kenneth Prince, legal counsel for the Priorities Committee of the Radio Parts and Associated Industries, with offices at 53 West Jackson Boulevard, Chicago, writes:

"I agree whole heartedly that the greater the publicity on priorities matters the better job the industry can do. Our experience indicates that some radio parts distributors have reported as high as one hundred per cent of their sales going into defense supplies; many have reported eighty-five per cent, a substantial number are in the fifty per cent class, but the majority run about fifteen per cent or lower. The general average should be in the neighborhood of twenty-five per cent.

"Gradually as the deliveries of radio materials slow down, jobbers will be more attentive to the task of getting priority certificates or customers certificates of defense require-

ments. The percentages will then be raised materially. In the mean time, if there is anything your paper can do to assist our committee's efforts by urging cooperation and reproducing the data contained in our committee bulletins, this aid will be appreciated by all branches of the industry."

## PRIORITY FOR ONE SET PER HOME—MOSS

Arthur Moss, executive secretary of the National Radio Parts Distributors Association, 65 Park Terrace East, New York, holds the opinion that actually, the percentage of priority sales by parts jobbers is something that has been and still is pure guesswork.

"I do not believe that many jobbers are doing anything like 50 per cent," writes Moss. "It is true there may be some, who due to their particular location, are receiving much more defense business than some jobbers not so fortunately located.

"We have been working with the priorities committee of the parts manufacturers and through NRPDA to get the jobbers to report a breakdown of their sales and if these figures are sent in as requested we will have a definite basis to figure on. My own opinion is that the majority of small jobbers may do between ten and fifteen per cent in the defense field, and some of the larger ones 25 per cent depending upon location.



Arthur Moss, executive secretary of the National Radio Parts Distributors Association.

"From our bulletins and sets of forms, which have been sent to all parts distributors, you will see that we are trying to get the proper statistical data.

"At the present moment, however, we are more concerned with obtaining a ruling from OPM on radio parts for the repair and maintenance of at least one receiver in every home."

## "NO DEFENSE BUSINESS!"

A few jobbers have written in to the Priorities Committee stating, "We sell only replacement parts for servicing radio sets. We have no defense business." To such as have written, and any others who hold the same opinion, Mr. Prince advises, "Investigate." A large number of jobbers have found, when they began to ask questions, that instead of having a fractional percentage of defense business, a substantial portion of their sales was finding its way into channels that are covered by the definition of Defense Supplies on the PD-25C and the PD-25D forms. If, after investigation, you find that you have no Defense business then, for your own protection, you better get out after some.

## "WHAT'S THE USE"

A few jobbers have written us in this defeatist vein after they looked over the data and saw that it involved some extra work. To such we say, "We can assign the best reason in the world for cooperating fully, namely, the desire to stay in business. The time is rapidly approaching when only those jobbers who do a substantial amount of defense or repair and maintenance business will be able to get deliveries.

The Defense Supplies Rating is a rating issued to individual manufacturers who qualify. The Priorities Committee is urging all suppliers to qualify and they, in turn, are designating this Committee to collect for them the percentage data from their jobbers. OPM, in Washington, has been advised of what we are doing, and this plan is the only means to save a tremendous amount of duplication of effort for the jobbers and the manufacturers.

## Radio Orders at Peak

A hearty prediction that "the future development of civilian radio transmission and reception will be greatly aided and stimulated by the present intensive development of radio devices needed for national defense" is made by Walter Evans, manager of the Westinghouse works at Baltimore, Md.

Mr. Evans made the statement in connection with a report that the backlog of radio equipment orders at his plant now exceeds \$35,000,000 and is nearly 35% ahead of the same period last year.

# Meissner

## PRECISION-BUILT PRODUCTS

*Presenting*

**THE MEN WHO *Create* THEM**

**AND THE**

# **JOBBER**

**WHO *Sell* THEM**

JAMES  
W.  
WATSON  
*President*



G. V.  
ROCKEY  
*Vice  
President*



BEN  
MILLER  
*Manager,  
Jobber  
Sales*



FOR almost twenty years the name Meissner has been your guarantee of the highest quality. Starting in 1922 as manufacturers of precision coil winding equipment, we gradually added headphones, transformer coils, RF-IF and similar coils, kits, etc., to complete the present-day Meissner line of precision-built products. Today, tomorrow, or in the years to follow, Meissner products will always be found foremost in the progress of radio.

**BUY WITH CONFIDENCE from MEISSNER JOBBER** →

MEISSNER MANUFACTURING CO.  
MT. CARMEL, ILLINOIS

**Meissner**  
PRODUCTS

*In*  
**CONNECTICUT**

- ▲ **HARTFORD**  
203 ANN STREET
- ▲ **NEW HAVEN**  
1172 CHAPEL ST.
- ▲ **BRIDGEPORT**  
177 CANNON ST.
- ▲ **WATERBURY**  
199 SOUTH MAIN ST.

▼  
**HATRY & YOUNG**  
CONNECTICUT

**New!**  
**MEISSNER**  
**"ANALYST"**



THE new Meissner Analyst is undoubtedly the most modern complete servicing instrument in the field today. The Analyst is completely wired, aligned and laboratory tested, furnished complete with 12 tubes all ready to be put into service.

**Meissner** MT. CARMEL ILLINOIS  
"PRECISION-BUILT PRODUCTS"

**TYDINGS**  
**COMPANY**

WHOLESALE RADIO  
SUPPLIES AND EQUIPMENT

*Distributing in*  
**WESTERN PENNSYLVANIA**  
from our Main Store  
937 LIBERTY AVE., PITTSBURGH  
**OHIO and WEST VIRGINIA**  
from our Branch Store  
230 N. 4th ST., STEUBENVILLE, O.

*Featuring*

**Meissner**  
"PRECISION-BUILT  
PRODUCTS"

**FM ADAPTERS**  
**KITS IF COILS**

*Fast Competent*  
*Service*

**WE FEATURE** *Meissner* **PRECISION-BUILT PRODUCTS**

**HEADQUARTERS FOR**

**Meissner**  
"PRECISION-BUILT  
PRODUCTS"

Our Specialty  
**REPLACEMENT COILS**

**IF - OSC - ANT - RF**

and other standard brands  
of radio merchandise

*Mail and Phone*  
*Orders Invited*

**RADIOTRICIAN**  
**TUBES & PARTS**  
**DISTRIBUTORS**

609 N. SHAMOKIN ST.  
SHAMOKIN, P.A.

**KING & IRWIN Inc.**  
WHOLESALE RADIO AND  
REFRIGERATION SUPPLIES

▼  
THE LARGEST AND  
MOST COMPLETE  
STOCK OF RADIO AND  
REFRIGERATION PARTS  
IN THE TRI-STATE  
AREA INCLUDING A  
COMPLETE LINE OF

**Meissner**  
**REPLACEMENT**  
**COILS**

*Mail Orders* ▼ *Solicited*

419 ELEVENTH ST.,  
**HUNTINGTON, W. VA.**

REPLACEMENT PARTS • TUBES  
• AMATEUR EQUIPMENT •  
• ACCESSORIES • SOUND AND  
LABORATORY EQUIPMENT

**H. JAPPE**  
**COMPANY**

OF NEW HAMPSHIRE, Incorporated

510 CENTRAL Ave.  
**DOVER, N. H.**

*Distributors*  
**RADIO PHOTOGRAPHY**

*Serving*  
MAINE  
NEW HAMPSHIRE  
VERMONT

*with*  
**Meissner**  
PRECISION - BUILT  
PRODUCTS

# 6

A National institution serving the trade with all Nationally Known brands of Parts, Servicing equipment, sound systems, etc.; from six convenient stores!

**NEW YORK** • 100 Sixth Ave.  
**CHICAGO** • 901 W. Jackson Blvd.  
**ATLANTA** • 265 Peachtree St.  
**BOSTON** • 110 Federal Street  
**NEWARK** • 24 Central Avenue  
**BRONX** • 542 E. Fordham Road

**CARRYING COMPLETE STOCKS OF**



—and specializing in service by mail

*Lafayette Radio*  
*Radio Wire Television Inc.*

*Time Proven*

## SIGNAL SHIFTER

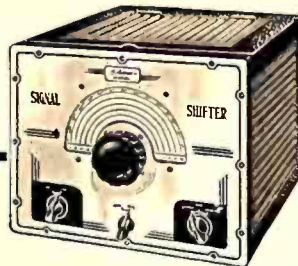

THE Meissner Signal Shifter is truly a time-proven instrument. The Signal Shifter permits instant frequency change in any given band—right from the operating position! It may be linked to any existing transmitter; “automatic standby,” “continuous operation” and “manual standby” are all available at the turn of a switch!



## Everything in RADIO—

- TUBES AND PARTS
- ELECTRONIC DEVICES
- INDUSTRIAL SUPPLIES
- SOUND SYSTEMS
- TEST EQUIPMENT
- PHONOGRAPHS
- RECORDERS
- TRANSMITTERS

*We invite inquiries from dealers, servicemen and manufacturers*

**VAN SICKLE**  
**RADIO SUPPLY CO.**  
 Indianapolis, Ind.

# WE FEATURE Meissner PRECISION-BUILT PRODUCTS

**LARGEST DISTRIBUTOR of RADIO PARTS in the State of NEW JERSEY**

REPRESENTING all the leading manufacturers in the radio industry CARRYING the complete line of



GIVE US A CALL



WE DELIVER

**Aaron Lippman and Co.**  
 246 CENTRAL AVE., NEWARK, N. J.  
 Telephone Mitchell 2-3065

N. Y.'s LEADING DISTRIBUTOR OF RADIO PARTS AND EQUIPMENT

ALL STANDARD MERCHANDISE IN STOCK!

PREVAILING TRADE DISCOUNTS

ALL MEISSNER PRODUCTS IN STOCK

INTELLIGENT EXPERIENCED STAFF

**TERMINAL RADIO CORP.**  
 68 West 45th St. • 80 Cortlandt St.  
 NEW YORK VAnDerbilt 6-5050

## SUN RADIO

offers IMMEDIATE DELIVERY from STOCK on all



There's No Waiting—No Delay at Sun — For Our Stock of Goods Is the Greatest Ever in Our History!

- F-M RECEPTORS and CHASSIS
- F-M/A-M RECEIVERS
- RECORDERS and TURNTABLES
- PRE-SELECTORS and SIGNAL SHIFTERS
- I.F. COILS, CHOKES and TRANSFORMERS
- SHORT WAVE KITS
- BEGINNERS KITS, etc.



**FREE!** NEW 1942 MEISSNER CATALOG from New York's Oldest Radio Organization **SEND FOR YOUR COPY TODAY**

SUN RADIO CO., Dept. RT-11  
 212 Fulton St., New York City

Please rush Meissner's free 1942 catalog.

Name .....

Address .....

City..... State.....

Dealer  Serviceman  Experimenter

Cut and Paste on Penny Postcard

# LUKKO

In addition to all popular lines of radio parts, test equipment, sound systems, etc., we handle the quality line in each manufacturing group. . . . For example —

*Meissner*

**FM ADAPTERS, AM & FM RECEIVERS  
9 and 12 TUBE KITS**

Send us your order, if we haven't got it, *We'll get it!*

LUKKO SALES CORP.  
5024 IRVING PARK BLVD.

## CHICAGO

*High Fidelity*



## MEISSNER PA TUNER

AVAILABLE either as a completely wired and tested unit, ready to operate, including tubes, or in a complete kit containing all parts required, with the exception of tubes. The Meissner High Fidelity Tuners are specially designed for highest quality reception providing a solution to the many problems encountered in producing good radio reproduction.



In the  
**MILWAUKEE  
TERRITORY**

It's

## MARSH RADIO SUPPLY CO.

Carrying all standard lines and many specialties, including

*Meissner*  
"PRECISION-BUILT PRODUCTS"

**FM ADAPTERS**

Special attention given to mail inquiries or orders

## MARSH RADIO SUPPLY CO.

526 W. State St., Milwaukee, Wis.

**WE FEATURE *Meissner* PRECISION-BUILT PRODUCTS**

DISTRIBUTORS OF . . .

*Everything in Radio*

LARGEST STOCKS OF RADIO AND ELECTRONIC EQUIPMENT IN ONE CENTRAL LOCATION in the WORLD

Fast Service  
Friendly Cooperation

Large Technical Staff to Serve Our Customers  
**COMPLETE STOCKS OF**

*Meissner*  
"PRECISION-BUILT PRODUCTS"

Write for Latest  
**ALLIED CATALOG**

**ALLIED RADIO  
CORPORATION**  
833 W. JACKSON BLVD.  
CHICAGO ILLINOIS

311  
So. WESTERN



CANAL  
2525

Chicago's Exclusive  
Distributor of

## THE *Brewster* FM ADAPTER

**GO W-J ALL THE WAY**

REPAIR PARTS      SETS  
TUBES                      RECORDS

**WALKER-JIMIESON INC.**  
311 So. Western Ave., Chicago, Ill.

*Everything  
IN RADIO  
At Lowest Prices!*

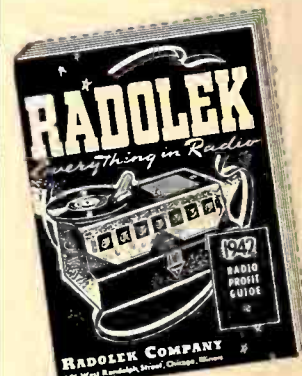

Get  
This  
Big  
**FREE  
Radio  
Profit  
Guide**



**Off the Press Soon**  
Features hundreds and hundreds of up-to-the-minute radio parts, sets, accessories, electric appliances and supplies. Indispensable to every dealer, serviceman and sound engineer. Send for the big **FREE 1942 RADOLEK PROFIT GUIDE NOW** . . . **SAVE MONEY AT RADOLEK!**

**RADOLEK COMPANY**  
601 W. RANDOLPH ST., Dept. RD-60  
Chicago, Illinois



**WISCONSIN  
HEADQUARTERS FOR**

RADIO AND ELECTRONIC  
PARTS, ACCESSORIES,  
SERVICING INSTRUMENTS  
AND SOUND EQUIPMENT

featuring

*Meissner*  
**TUNERS**

FM ADAPTERS, TUNING  
ASSEMBLIES AND ALL-  
WAVE TUNING UNITS



INQUIRIES INVITED  
FROM SERVICEMEN  
THROUGHOUT THE  
STATE OF WISCONSIN

**RADIO PARTS Co., INC.**  
538 W. STATE ST., MILWAUKEE, WIS.

**FM** *Converter* ★



by **MEISSNER**

FM RECEPTION with any ra-  
dio! A complete, self-powered, 8-tube  
converter designed to provide FM  
reception on any regular type radio  
receiver. Modern Cabinetry, easy in-  
stallation and simplicity of operation  
makes the Meissner F M Converter  
the ideal unit.



**PEMBLETON LABS**  
A SERVICE FOR  
THE SERVICEMEN

The house of complete satisfaction,  
handling radio parts of all kinds,  
including all popular lines used by  
the service profession.

LARGE STOCKS AND  
WIDE EXPERIENCE EN-  
ABLE US TO RENDER A  
SUPERIOR SERVICE . . .  
ESPECIALLY ON —



**PEMBLETON LABS**  
925 BROADWAY  
**FORT WAYNE, IND.**



**RADIO EQUIPMENT  
CORP.**

2822 FARNAM STREET

**OMAHA  
NEBRASKA**

Jobber of

NATIONALLY KNOWN REPLACE-  
MENT PARTS OF ALL KINDS

Specialists in  
TUBES

TESTING-EQUIPMENT  
PUBLIC ADDRESS SYSTEMS

and



Whatever You Need, See Us. Write  
or Phone Us. Prompt, Efficient Service

*If it's* **RADIO,**  
**B-A has it!**

Our immense stocks of sets, parts,  
supplies, PA systems, testers, kits  
and other electronic equipment cov-  
ers all the nationally known favorites  
—including the full line of



Like thousands of others, your en-  
tire needs can be met at one place,  
or on one order—at the lowest  
possible prices.

**You'll Like Our Prompt Service**  
(we usually ship same day)

Write for our new  
164-page catalog for

*Everything in Radio*

**BURSTEIN-APPLEBEE CO.**  
1012-14 McGee Street  
**KANSAS CITY, MISSOURI**



SERVING THE TWIN CITIES  
AND THE NORTHWEST . . .

*The*

**LEW BONN CO.**

. . . with two well-stocked stores  
where you will find Quality, Service  
and Price. Nationally known brands  
of radio supplies and equipment,  
with special stocks of



**THE ANALYST • THE SIGNAL  
SHIFTER • THE SIGNAL  
SPOTTER • REPLACEMENT  
COILS • HIGH FIDELITY PA  
TUNERS • RECORDERS.**

Prepare NOW for FM. Investigate  
Meissner FM Receivers, Adaptors,  
Chassis and Components.

**THE LEW BONN COMPANY**  
MINNEAPOLIS ST. PAUL  
1211 La Salle 506 Robert St.

CATERING TO

**M I A M I  
AND THE SOUTH  
FLORIDA  
TERRITORY**

Large and complete  
stock of all parts,  
and . . .



SERVICE OF THE  
KIND THAT YOU HAVE  
A RIGHT TO EXPECT  
—WHETHER AT THE  
STORE OR BY MAIL

**WALDER  
RADIO & APPLIANCE CO.**  
1809 N. E. 2nd AVE., MIAMI, FLA.

**COMMUNICATIONS  
RECEIVERS**

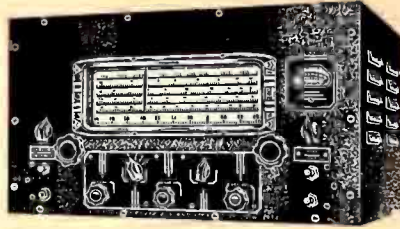

by **MEISSNER**

FROM the 9-tube "Traffic Scout"  
to the 14-tube "Traffic Master,"  
Meissner Communications Receivers  
incorporate every essential feature  
in amateur operation. These com-  
munications receivers are available,  
laboratory-built, or in complete  
kit form. They are precision engi-  
neered for top performance in keep-  
ing with the Meissner tradition of  
quality.



It pays to order  
your Radio Supplies  
from

**KINKADE  
in  
JACKSONVILLE**

featuring

- STORE DOOR DELIVERY
- ONE-DAY MAIL ORDER SERVICE TO SOUTH GEORGIA and NORTH FLORIDA

ALSO FEATURING A  
COMPREHENSIVE STOCK  
OF ALL WELL KNOWN LINES  
INCLUDING



**KINKADE RADIO SUPPLY**  
1412 Main Street  
JACKSONVILLE, FLORIDA



**SHULER  
NEW ORLEANS**

"We sell  
to sell again"

That's why we sell



AMPLE STOCKS FOR QUICK  
AND EXPERT SERVICE — IN  
EVERY BRANCH OF RADIO  
— THROUGHOUT THE CEN-  
TRAL SOUTH. LEADING  
LINES OF TUBES, PARTS  
TEST EQUIPMENT, P.A. AND  
OTHER ELECTRONIC  
APPARATUS

TRY US, PLEASE

...  
**SHULER SUPPLY CO.**  
902-04 POYDRAS ST.  
NEW ORLEANS, LA.

Offering —  
in the trading area of  
**SOUTHEAST  
MISSOURI**

— AN EXTENSIVE LINE OF  
NATIONALLY RECOGNIZED  
PARTS AND EQUIPMENT.  
EVERYTHING NEEDED BY THE  
SERVICE PROFESSION

- TUBES BATTERIES
- SOUND EQUIPMENT
- VOLUME CONTROLS
- REPLACEMENT COILS



**SUEDEKUM & SONS**  
620-22 GOODHOPE STREET  
CAPE GIRARDEAU, MISSOURI

**MEMPHIS'**  
Oldest Exclusive  
Radio Parts  
Wholesaler

Featuring



COMPREHENSIVE STOCKS  
OF ALL THE NATIONALLY  
KNOWN BRANDS

...  
**J. HARPER STODDARD**  
1155 Union Ave.  
MEMPHIS . . . TENN.

YOU CAN GET IT AT

# ZACK'S SAN FRANCISCO

LARGE STOCKS  
FOREMOST LINES  
FAST, EFFICIENT SERVICE  
PARTS AND TUBES, TEST  
INSTRUMENTS, SOUND  
SYSTEMS, ELECTRONIC  
EQUIPMENT

And of Course



TELEPHONE AND  
MAIL ORDERS GIVEN  
PROMPT ATTENTION

**ZACK**  
RADIO SUPPLY CO.  
1426 Market St., San Francisco, Cal.



by **MEISSNER**

RANGING from one to twelve tubes, the complete line of Meissner "Custom" Kits are all precision-built to give greater dollar for dollar value, performance and dependability. They are widely recognized by servicemen and custom set builders for their ease of construction, adaptability and excellent reproduction.



# RADIO SPECIALTIES CO.

Jobber of

Nationally advertised brands of parts, tubes, accessories, test instruments, P.A. systems, recorders and other electronic equipment.

Serving

**LOS ANGELES  
SOUTHERN CALIFORNIA  
AND SOUTHWEST**

from **THREE** stores:

**LOS ANGELES**  
1956 S. Figueroa Street

**HOLLYWOOD**  
6646 Santa Monica Boulevard

**PHOENIX, ARIZONA**  
401 West Jackson Street

In All Three, We Feature



**WE FEATURE Meissner PRECISION-BUILT PRODUCTS**

Buy from  
**RADIO  
TEL. SUPPLY  
CO.**  
*Los Angeles*

1701 So. Grand Avenue

**FOR TOP - QUALITY SERVICE**

**STOCKING** nationally known brands of all radio parts and equipment.

**FEATURING** the preferred lines of each product group.

**ASSURING** Promptness, Experience, Technical help if needed, and lowest prices.

Special attention to mail orders

**JOBBER FOR ALL**



## "HERE"

SAN DIEGO'S OLDEST  
WHOLESALE FIRM  
DEVOTED EXCLUSIVELY  
TO RADIO EQUIPMENT,  
ANSWERS THE

**ROLL CALL**

of

**JOBBERS**

featuring



Helpful service to the trade in San Diego County and the Imperial Valley area, has multiplied our floor space **SIX TIMES** since we started in 1932.

"You Won't Be Disappointed"

**WESTERN RADIO  
AND ELECTRIC COMPANY**  
1000 B St., San Diego, Calif.

# RADIO PRODUCTS SALES CO.

**DISTRIBUTOR OF**

Nationally recognized  
parts and equipment

**ALL THE BEST KNOWN LINES  
AND MANY SPECIALTIES**

Large stocks to meet every  
requirement of the  
service profession

Including



**RADIO PRODUCTS SALES CO.**  
238 W. 15th Street

# LOS ANGELES



Here we have the men and the merchandise at an aggressive distributing firm in North Carolina—the sales line-up at Freck Radio Co. in Asheville.

“Very busy selling Meissner products,” reports E. T. Kin-kade, Jacksonville, Fla.

# ON THE JOBBING FRONT

## PARTS DISTRIBUTORS ON AND OFF THE JOB



Above, the New Jersey jobber, Aaron Lippman. Below, F. W. Pembleton and son Jimmy, Ft. Wayne, Ind.

At lower left, “Bill” Shuler of Shuler Supply, New Orleans, a Meissner jobber as are the others on this page. Lower center photo shows the Pittsburgh, Pa., distributor, Emmet J. Tydings with his grandson. Lined up at the right is the staff of Marsh Radio Supply, Milwaukee, Wis.



Below, the Miami, Fla., distributor Alvin Walder is shown on vacation in the Colorado Rockies.



Scene at W. D. Brill Co., Oakland, Calif., shows (left to right) Mr. Brill; his associate Ralph Seitz, and George C. Connor, Hygrade Sylvania commercial engineer.

# RADIO PARTS IN DEFENSE

A powerful sound system has a loud voice in commissioning the U.S.S. Bristol at Brooklyn, N. Y. Atlas speakers (circled, upper right) were clearly heard by officers, crew, workers, etc.

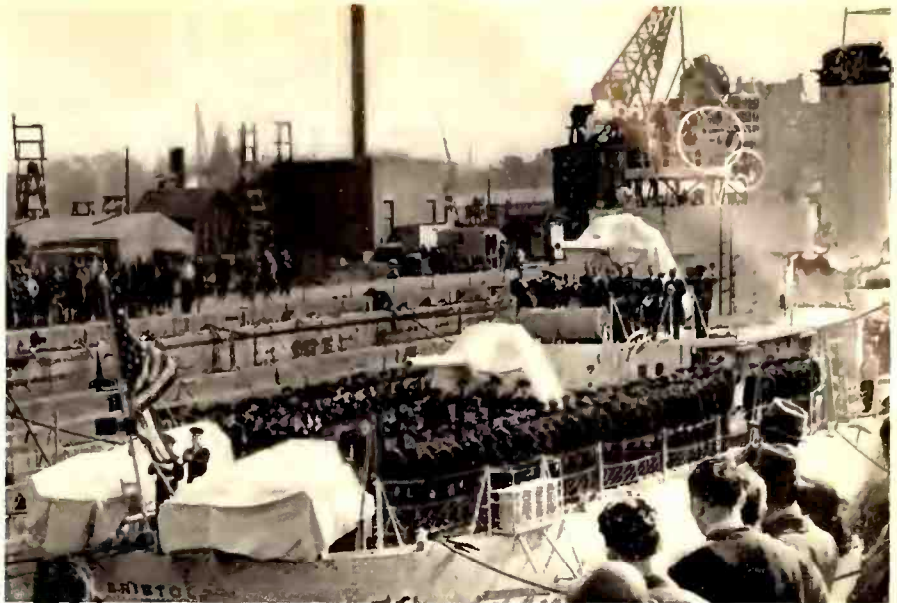

Speeding up of the National Defense Program has brought into use hundreds of applications of radio tubes and electronic devices. These are being multiplied under the whip of war preparation, on a scale never before achieved. And out of these applications are coming new developments which will eventually be used for future peace uses.

From time to time, these Defense applications of radio and radio tubes are reviewed during the weekly "Radio Magic" periods on the NBC Blue network, which are conducted by Editor Caldwell of RADIO TODAY. These programs originate in the studios of key station WJZ in Radio City, New York, at 7:15 EST (6:15 CST). Following are notes on Defense uses of radio tubes and photo-tubes, discussed during recent "Radio Magic" programs.

## PHOTO-TUBE MAKES STEEL

Take the manufacturer of steel, most vital of defense materials. The photo-tube or electric-eye—which never suffers from squint, strain or hangover—is now bringing back to the hard-pressed steel industry the famous Bessemer process, which was dropped at the turn of the century in favor of the



Jobber on guard! Arthur L. Dunn of Radio Equipment Corp., Meissner distributor at Omaha, whose picture arrived too late to join group opposite.

slower but more accurate open-hearth furnace.

The Government recently asked steel companies to consider construction of Bessemer converters as a means of speeding up the manufacture of steel and as a result several are now being built. The Bessemer process is the fastest way to make steel. Also, it is the most spectacular, for roaring flames rise 30 feet in the air as it turns a melt of iron into steel.

The Bessemer process was dropped years ago when the open-hearth method was found to give more accurate control.

For the Bessemer's difficulty was the fact that its successful operation depended solely upon the skill of its human operator. This expert with a trained color sense—called the "blower"—controlled the flaming, blasting converter by sight, judging what to do by the color and appearance of the flame.

But sometimes the "blower" would be suffering from a hangover, to the detriment of his eyesight and of the steel he was making. A little bleary, his eyes might not note a change of color at exactly the right moment—and away to the scrap heap would go a charge of steel.

## SPEEDS PRODUCTION, HARDENS STEEL

Now, however, a photoelectric cell, which never has hangovers and never sleeps, can take over the duty of watching the "blow" and deciding when to increase or decrease it. And so for Defense, there are now made available the Bessemer converter's advantages, for it can make steel faster, it can make it entirely from pigiron—thus conserving inadequate stocks of scrap—and it can be used in a speed-up process known as duplexing. For the Bessemer does its work in about half an hour, while the open hearth takes 12 to 18 hours to produce a heat.

Meanwhile, the new Radio Magic process of surface hardening steel by means of induced radio waves, has made it possible to use relatively cheap and plentiful steel for shells, instead of special steel costing five times as much. The hardening process has thus

expanded the available materials for shell production many fold.

## PE TUBE IN NIGHT SNAPSHOTS

Another use of the photo cell is in taking night airplane pictures of enemy territory. This American method of photographing cities, dockyards and other strategic positions by night has recently been used with brilliant success by the Royal Air Force. With engines cut off, the reconnoitering plane drops to an altitude of a mile and releases a flash bomb containing from twenty to forty pounds of magnesium powder, which enormous amount is touched off by a time fuse. The momentary blinding glare causes a photoelectric cell to trip the shutter of a camera in the airplane on high. As each bomb is thus exploded a terrain of about five square miles is photographed. Also, the film is automatically shifted to bring a new frame in line after each flash.

## VIBRATION TESTS

Radio tubes now also test basic raw materials such as steel. Every day in the testing laboratories of steel plants, turning out vast quantities of defense material, a continual fatigue-strength test of steel goes on. The Rayflex fatigue-testing machine meets industry's demand for the most scientific procedure to accurately conduct these tests.

The Rayflex machine vibrates a specimen bar of steel by the means of electro-magnets actuated from an oscillator-amplifier combination with frequencies varying from 6,000 to 18,000 cycles, condensing all the wear of years into a matter of minutes! The control apparatus, which must not fail under the exacting conditions of these essential tests, uses standard radio tubes.

The many instruments required on the control boards of modern airplanes, must be given severe vibration tests, to make sure they will stand up under the terrific vibration of planes in flight. Formerly the instruments were put on a motor-driven rattling table and given a good shaking. But this is

(Continued on page 58)

# NEW EQUIPMENT

PRODUCTS FOR SOUND AND SERVICE



## University speaker projector

★ New line of radial cone units designed for uniform projection. Model RBP uses "Infinite Baffle" principle. Flat top design suitable for ceiling or single suspension mounting. Waterproof for outdoor use. All steel construction with "floating rubber" speaker mounting and "non-resonant" rubber rims. Available for 12 and 8 in. cone speakers University Labs., 195 Chrystie St., New York, N. Y.—RADIO TODAY.



## Audiograph amplifier

★ Compact, 15-w. amplifier with or without phonotop is B-15C. Musical background may be mixed with speech. 4 and 8 ohm outputs allow single or dual speaker operation. Frequency response is flat from 50 to 8000 cps. John Meck Industries, 1313 W. Randolph St., Chicago, Ill.—RADIO TODAY.



## IRC resistor assortment

★ A convenient assortment of 1/2-, 1- and 10-watt resistors in the most frequently needed resistance values is supplied in metal cabinets. Regular price for the resistors is charged, the cabinets are included at no extra cost. International Resistance Co., 401 N. Broad St., Philadelphia, Pa.—RADIO TODAY.

## Hallicrafters model RSC-2

★ RSC-2 includes 3 units—an FM/AM tuner, a high fidelity 25-w. amplifier and a monitor speaker inclosed in a single rack. Amplifier provides for microphone and phono inputs. Frequency response of the amplifier alone is plus or minus 1 1/2 db. from 30 to 20,000. Hallicrafters, Inc., 2611 S. Indiana St., Chicago, Ill.—RADIO TODAY.



## Precision series 832-A

★ A 31-range, compact, AC-DC tester incorporates ranges to 1200 v., DC, 2400 AC, 5 megohms, 600 milliamperes and +62 db. A 3 in. square bakelite case houses the 800 microampere meter. 2% DC and 3% AC accuracy. Wire wound shunts and matched metallized multipliers of 1% accuracy. Precision Apparatus Co., 647 Kent Ave., Brooklyn, N. Y.—RADIO TODAY.

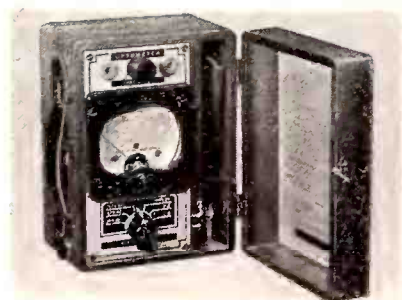

## Radio City tester

★ Designed for testing and servicing coin-operated amusement devices and such as phonographs, pin ball games, etc. Model 415 is only 6 in. x 3 in. x 2 3/8 in. AC & DC voltages; tests and measures resistance of relays, contacts, etc.; tests condensers. Jacks permit tests by headphones. Shop and portable types. Radio City Products Co., Inc., 88 Park Pl., New York, N. Y.—RADIO TODAY.

## Philco portable amplifier

★ Model 905-A, 15 watt sound amplifier is compact, and features a lapel microphone. Stand mike available. 110 v., 60 cycle. Philco Corp., Tioga & C Sts., Philadelphia, Pa.—RADIO TODAY.

## Knight communication system

★ Knight selective intercommunication system has 2 1/4 w. output enabling ten sub-stations to carry five simultaneous two-way conversations with absolute privacy. Up to 2,000 feet of cables may be used between each station. Walnut finished cabinets. 110-115 v. AC-DC operation. Allied Radio Corp., 833 W. Jackson Blvd., Chi., Ill.—RADIO TODAY.

## Clarostat rheostat

★ Armored type 25-watt rheostat mounted in a perforated metal housing. Uses an insulated metal core to support winding. Available in resistance values of 1 to 5000 ohms; other values on special order. Clarostat Mfg. Co., Inc., 285-7 N. 6th St., Brooklyn, N. Y.—RADIO TODAY.



## American mike

★ New dynamic microphone in which 2 units are used, has over-all range from 25 to 10,000 cps. Model D-220 has a selector switch permitting the use of either the high section or low section as desired. American Microphone Co., 1915 S. Western Ave., Los Angeles, Calif.—RADIO TODAY.



# Tuna Take Heavy Seas

## SO FISHERMEN TAKE THEM, TOO

**T**HE Captains of tuna boats go where the fish are and that means rough weather much of the time. Radio is vital because one captain radios others when he finds a school. Radios must work perfectly through shivers and shakes and terrific impact.

It is under conditions like these that the Sylvania Lock-In Tube is designed to perform its most vital service. Once in place it stays in, regardless of position, vibration or impact.

The Lock-In Tube is locked in place and performs under unbelievable punishment, so that is why it is a better tube for small boats and big boats—battleships, destroyers, dive bombers, fighting planes, tanks, jeeps, home radios, automobile radios, in fact everywhere where service requirements are tough. It is the big answer to consumer satisfaction no matter whether the consumer is the Army, Navy or you.

*Sylvania Radio Tube Division*

# HYGRADE SYLVANIA CORPORATION

EMPORIUM, PA.

500 FIFTH AVE., NEW YORK • SALEM, MASS. • ST. MARYS, PA. • IPSWICH, MASS. • TOWANDA, PA.

*Also makers of Hygrade Lamp Bulbs, Hygrade Fluorescent Lamps and Miralume Fluorescent Light Fixtures*

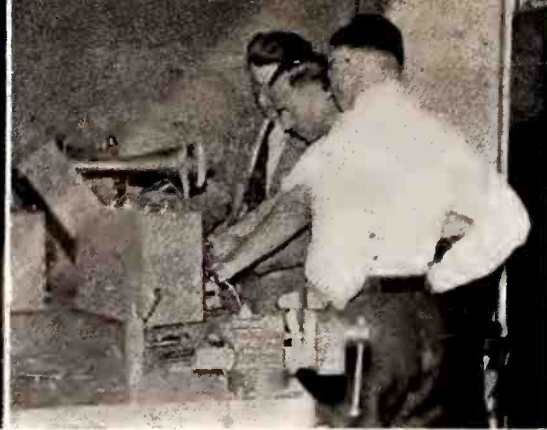

Tel-Tec, New York specialists in television, have made majority of metropolitan installations. Headed by George Duvall (far left), Tel-Tec has made the necessary changes, to get new standards, on more than 600 television sets since July. After changes and alignment, each receiver is "air checked" before it is returned.

New installations are constantly being made as set owners move from one location to another. Experience is big factor in sizing-up a location before doing a lot of "roof work."

# TELEVISION CHANGE-OVERS

SERVICE ORGANIZATION HANDLES BIG JOB IN N. Y.



Man on the roof changes position of antenna while comparing notes over two-way phone system with man at receiver. This method is fastest and gives best results.



After the location has been checked experimentally, the necessary mounting brackets are installed. The entire installation is quite sturdy and dependable since the antenna structure has little wind resistance.



Expansion bolts and metal bands anchor this mast to the chimney. Antennas and transmission lines have proven reliable after two years of exposure and no attention. Rust is worst enemy.



Final check is made before mast is clamped. This antenna is double dipole with double reflectors.



New owners are instructed in the use of the set and how to adjust the picture controls. New York is now served with about 30 hours of television programs each week from NBC and CBS.





MR. A. C. BURNS  
Tenth North Radio  
& Elec.  
2355 — 10th Ave.  
North  
Seattle, Washington

I have been selling N. U. tubes for over 10 years and find them most satisfactory. N. U. has been more than helpful in cooperating with the dealer with their equipment, sales promotion and advertising programs. I heartily recommend N. U. to any dealer or serviceman.

WHERE YOU FIND  
**NATIONAL UNION**  
YOU FIND BETTER  
**RADIO SERVICE**

**PREMIUM**  
*Quality*  
**TUBES**



**BATTERIES**



**CONDENSERS**

also Sound X/tra tubes, panel lamps, cathode ray tubes, exciter lamps, sound equipment, photo electric cells, sound accessories, dry batteries, flash light bulbs.

**NATIONAL UNION** invites . . .

All radio service dealers to enjoy the benefits of the N. U. Shop Equipment Plan. The latest in tube testers and test equipment are available to you . . . prompt delivery. More than 60,000 completed deals prove the success of this plan. Investigate now.

Ask Your N. U.  
Distributor or Write



**NATIONAL UNION**  
**RADIO Corp.**  
57 STATE ST. NEWARK, N. J.

## Radio Men in Big Charity Drive

Slated for Sunday night, Nov. 23, at the Waldorf-Astoria Hotel in New York City, is this year's \$100 dinner of the Radio, Music, Refrigeration and Allied Industries of the New York and Brooklyn Federations of Jewish Charities. Max Kassover of Vim Electric Co. and Jules M. Smith of Davega City Radio have announced the plans for the big philanthropic and social event. This radio division, for 14 years, has been first among the trade and industrial groups working for the Federations to complete its quota on behalf of the 116 medical and welfare institutions supported by the Jewish charities.

Honorary chairmen this year are Henry Benjamin, of Davega City Radio; Samuel Kassover, of Vim Electric Co.; and H. M. Stein, of Davega. The associate chairmen are: Benjamin Abrams, Emerson Radio and Phonograph Co.; Abe Bloom, General Instrument Co.; William Brand, William Brand & Co.; Samuel Salzman, Wholesale Radio Equipment Co., and Irving Sarnoff, Bruno-N. Y., Inc.

Working with the officers of the Division is a committee of manufacturers, distributors, dealers and parts, which includes the following leaders of the division:

Ed Berger, Octave Blake, Michael Cohen, Sam Cohen, Bernard D. Colen, Maurice Despres, Lou Dorfman, E. L. Frohlich, Isidor Goldberg.

Also Benjamin Gross, Sol W. Gross, Murray Gruhn, Henry Halperin, Jerome Harris, Al P. Hirsch, Benjamin Kosowitz, Phil Lauter, Samuel W. Lerer, Louis A. LeWinter, Jack Lieberman, Jack M. Marks, D. W. May, R. H. McMann, Victor H. Mayer, William Naumberg, Jr., Thomas O'Loughlin, Otto Paschkes, A. Pletman, S. J. Novick, O. W. Ray, L. K. Roth, Perry Saftler, Mortimer Salzman, O. C. Schreiber, George J. Seedman, Charles Sonfield, Louis Titsfsky, David Wald, Jack Walters, E. A. Wildermuth and M. W. Weintraub.

## Crosley Shows 1942 Units

Distributors for Crosley Corp. will get a look at the firm's 1942 line of refrigerators at a series of meetings which started Nov. 7 and will continue to Nov. 18 at the Netherland-Plaza Hotel in Cincinnati. Jobbers will be entertained in groups of 25, in 2-day sessions on new lines and merchandising plans, according to Robert I. Petrie, vice-president and general sales manager.

Mr. Petrie will preside at the meetings and other officials on the program include R. C. Cosgrove, J. F. Crossin, L. Martin Krautter, Ben Roe, and J. H. Rasmussen.

## Pair of Reps for Atlas

Sales Manager R. C. Reinhardt of the Atlas Sound Corp., Brooklyn, N. Y., has announced two new sales representatives to contact radio parts distributors for speakers, projectors, baffles, microphone stands, and microphone connectors.

The entire State of Indiana will be covered by Bruce L. MacPherson, with headquarters at 1919 Wells St., Fort Wayne. L. D. Lowery, 401 N. Broad St., Philadelphia, will sell Atlas Sound in Philadelphia, eastern Pennsylvania, southern New Jersey, Maryland, Washington, D. C.; Delaware, and Virginia.

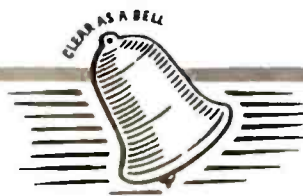

**DELIVERING**  
**THE GOODS**

● The times are helter-skelter. The writing of an order today is many times just a gesture. To get the goods on the shelf is another matter.

That's why it is worthy of note that SONORA is keeping faith with its Jobbers today. We are bending every effort to meet our obligations to our trade, filling our orders with energy, keeping dealers' shelves supplied with the merchandise they need for immediate sales.

If the goods can be delivered, SONORA will do it!



**Sonora**

**RADIO & TELEVISION CORP.**  
**CHICAGO**

# MERCHANDISING FACTS

## HOW MUCH A SALESMAN MUST SELL TO EARN HIS MONEY

At a Selling Cost of	4%	5%	6%	7%	8%	9%	10%	11%	12%	13%	14%	15%
<b>VOLUME OF SALES</b>												
Salary \$10.....	\$250	200	166	143	125	117	100	91	83	77	71	66
\$15.....	375	300	250	214	187	166	150	136	125	115	107	100
\$20.....	500	400	333	286	250	222	200	182	167	154	143	133
\$25.....	625	500	416	357	312	278	250	227	208	192	178	166
\$30.....	750	600	500	428	375	334	300	272	250	230	214	200
\$35.....	875	700	583	500	437	390	350	318	292	269	250	233
\$40.....	1000	800	666	572	500	445	400	364	334	308	286	266
\$45.....	1125	900	749	643	562	500	450	319	375	346	321	300
\$50.....	1250	1000	832	714	625	555	500	454	416	384	357	333
\$55.....	1375	1100	916	785	687	610	550	499	458	422	392	366
\$60.....	1500	1200	1000	856	750	666	600	549	500	460	428	400
\$65.....	1625	1300	1083	928	812	721	650	590	542	499	464	433
\$70.....	1750	1400	1166	1000	875	777	700	636	584	538	500	467
\$75.....	1875	1500	1248	1072	937	832	750	682	626	577	536	500

Examples of the use of this table follow:

Suppose a floor salesman has a salary of \$25; selling cost to average 6 per cent. Under 6 per cent and opposite \$25, read \$416, which is the amount of weekly sales this floor man must make.

Take the case of an outside salesman on a 9 per cent straight commission, with sales of \$390. Under 9 per cent, and opposite \$390, read \$35, the amount of the salesman's commission.

If your total selling cost, including your own drawing account, is to be held to 7 per cent, then total your floor salary, your own drawing account, and your outside salesman's drawing account. Say this amounts to \$100.

Under 7 per cent and opposite \$25,

read \$357; under 7 per cent and opposite \$75, read \$1,072. The sum of these is \$1,429, which is the amount of your sales necessary to cover a \$100 payroll at 7 per cent selling cost.

This table applies also to expense; in which case consider the salary column to be expense.

Outside selling costs range from 9 per cent on radio, to 15 per cent on refrigerators and 30 per cent on vacuum cleaners.

For store salesmen on salary or commission, selling costs range from 4 to 6 per cent. Total direct selling costs—salesmen inside and out, and sales supervision—should never exceed 15 per cent.

## What Every Man on the Floor Should Know

Selling consists of relating your product to a basic buying motive, and logically satisfying each of the buying decisions in terms of *your prospect*.

Here are the basic buying motives:

1. Comfort and Convenience—the desire for ease.
2. Safety, Health and Protection. Self preservation is a basic law of nature.
3. Economy, Gain and Price. This is the selfish desire for saving.
4. Satisfaction of Pride—"keeping up with the Joneses". Everybody likes to feel important.
5. Affection or Attention. This may be called the desire for romance.

When the five following conditions have been satisfied, a sale has been made:

1. The Need. The prospect must be satisfied that one or more of the basic buying motives *does* exist.
2. The Satisfaction of the Need. The prospect must be satisfied that the product being sold does fulfill the admitted need.
3. The Price and Terms. The prospect must be satisfied that she can pay for the product and that the price is fair and reasonable.
4. The Source of Supply. The prospect must be certain of your reputation and her satisfaction as the reason for buying from you.
5. The Time. The prospect must be confident that the proper time to buy is *now*.

## Automobile Battery Ground Chart

YEAR	1933	1934	1935	1936	1937	1938	1939	1940
Auburn.....	Pos.	Pos.	Pos.	Pos.	Pos.	Pos.	Pos.	Pos.
Boick.....	Neg.	Neg.	Neg.	Neg.	Neg.	Neg.	Neg.	Neg.
Cadillac.....	Pos.	Pos.	Pos.	Pos.	Pos.	Pos.	Pos.	Pos.
Chevrolet.....	Neg.	Neg.	Neg.	Neg.	Neg.	Neg.	Neg.	Neg.
Chrysler.....	Pos.	Pos.	Pos.	Pos.	Pos.	Pos.	Pos.	Pos.
Cord.....	Pos.	Pos.	Pos.	Pos.	Pos.	Pos.	Pos.	Pos.
DeSoto.....	Pos.	Pos.	Pos.	Pos.	Pos.	Pos.	Pos.	Pos.
Dodge.....	Pos.	Pos.	Pos.	Pos.	Pos.	Pos.	Pos.	Pos.
Duesenberg.....	Neg.	Neg.	Neg.	Neg.	Neg.	Neg.	Neg.	Neg.
Ford.....	Pos.	Pos.	Pos.	Pos.	Pos.	Pos.	Pos.	Pos.
Franklin.....	Pos.	Pos.	Pos.	Pos.	Pos.	Pos.	Pos.	Pos.
Graham.....	Pos.	Pos.	Pos.	Pos.	Pos.	Pos.	Pos.	Pos.
Hudson.....	Neg.	Neg.	Neg.	Neg.	Neg.	Neg.	Neg.	Neg.
Imperial.....	Pos.	Pos.	Pos.	Pos.	Pos.	Pos.	Pos.	Pos.
Lafayette.....	Pos.	Pos.	Pos.	Pos.	Pos.	Pos.	Pos.	Pos.
Lafayette.....	Pos.	Pos.	Pos.	Pos.	Pos.	Pos.	Pos.	Pos.
Lincoln.....	Neg.	Neg.	Neg.	Neg.	Neg.	Neg.	Neg.	Neg.
Lincoln Zephyr.....	Pos.	Pos.	Pos.	Pos.	Pos.	Pos.	Pos.	Pos.
Mercury.....	Pos.	Pos.	Pos.	Pos.	Pos.	Pos.	Pos.	Pos.
Nash.....	Neg.	Neg.	Neg.	Neg.	Neg.	Neg.	Neg.	Neg.
Oldsmobile.....	Pos.	Pos.	Pos.	Pos.	Pos.	Pos.	Pos.	Pos.
Packard.....	Pos.	Pos.	Pos.	Pos.	Pos.	Pos.	Pos.	Pos.
Pierce-Arrow.....	Pos.	Pos.	Pos.	Pos.	Pos.	Pos.	Pos.	Pos.
Plymouth.....	Neg.	Neg.	Neg.	Neg.	Neg.	Neg.	Neg.	Neg.
Pontiac.....	Pos.	Pos.	Pos.	Pos.	Pos.	Pos.	Pos.	Pos.
Studebaker.....	Pos.	Pos.	Pos.	Pos.	Pos.	Pos.	Pos.	Pos.
Terraplane.....	Pos.	Pos.	Pos.	Pos.	Pos.	Pos.	Pos.	Pos.
Willys.....	Neg.	Neg.	Neg.	Neg.	Neg.	Neg.	Neg.	Neg.

\*Some special custom-built models have negative grounded.

Auto-radio reference chart gives the terminal of battery connected to car frame. From P. R. Mallory Service Supplement, No. 3.

## The Service Job Cost and Income Figures

Yearly Income	Elements of income per job			Elements of Profit, including		
	Tubes	Parts	Services	Tubes	Parts	Over-owner's head salary
Under \$1,000	\$1.01	\$0.80	\$1.30	\$0.63	\$0.51	\$1.64
\$1,001 to \$1,500	1.00	.80	1.65	.65	.70	1.46
\$1,501 to \$2,000	1.13	.98	2.22	.61	.54	1.57
\$2,001 to \$3,000	1.01	.82	2.58	.48	.66	1.49
\$3,001 to \$3,500	1.70	1.64	3.28	.68	.98	1.18
\$3,501 to \$5,000	1.31	1.00	3.34	.62	.75	1.23
\$5,001 and over	1.98	1.48	3.55	.89	.78	1.68

## Display That Whirls



The metal rotating counter stand now offered to dealers by Duotone Co., Inc., 799 Broadway, NYC. Roomy racks have plenty of space for showing 4 styles of needles. This is part of sales program which includes ads in national publications.

## Record Catalog Re-Styled for Dealers

Columbia Recording Corp. has released to dealers the first annual revised edition of its Numerical Catalog containing complete listings of more than 15,000 records released on the Columbia Masterworks, Popular, Okeh Popular, Okeh Country Novelty, Educational and Foreign labels.

The new edition sells to dealers for \$4.50 and includes a monthly replacement service up to and including August, 1942, according to CRC advertising manager Patrick Dolan. New subscriptions will be accepted from dealers until the end of April, 1942, and the monthly replacement will come directly to dealers from Columbia's headquarters in Bridgeport. The revised catalog can be purchased from Columbia distributors.

Features of the new book include a special binder that takes new lists, convenient indexing, printing that is extra legible, etc.

## Victor Stages Big Record Contest

Among the record promotions now sponsored by RCA Victor is a big contest offering 512 merchandise prizes to consumers who write the best finish to the sentence, "I Like the Victor Record Catalog Because..." The contest starts Nov. 9th and runs three weeks; prizes to be awarded include combinations, albums and single records.

Entrants are encouraged to get entry blanks at Victor record dealers.

## Brengle for Turner

From The Turner Co., Cedar Rapids, Iowa, comes the news that the Ralph T. Brengle Sales Co., 605 W. Washington Blvd., Chicago, has been appointed the Turner representative in the Chicago area.

NOVEMBER, 1941

# RECORD BAR\* is "Going Over Big" There Must Be A Reason



\*Reg. & Copy. U.S. Pat. Off. 1940

## BITTER RECORD BOOTH B1

When booth demonstrations are needed, you can be sure of the complete customer comfort that helps sell more records—with this popular Bitter Record Booth. Standard Construction: Laminated veneer panel in frame; glazing in upper panel. Built in sections; easily erected by handy man. Standard finishes: Kiln dried birch finished in Walnut, Mahogany or painted.



NEW 1942 Catalog, Write NOW!

1. Saves Time
2. Saves Space
3. Sells More Records

The facts tell the story! It's a fact that every day more and more leading record dealers switch to RECORD BAR\* for bigger record volume, simplified record selling and highest quality reproduction. Take a tip from the leaders—install RECORD BAR\*—Today!



Bitter Album Rack #110

This new album sales stimulator holds about 250 album sets. Same dimensions as the famous Bitter Standard Record Rack (#100) — 2' 10 1/2" long, 7' 2" high, 15" deep; same design; same standard finish — walnut finished birch. May be used interchangeably or together to form attractive unit.



Bitter Record Rack #100

This attractive, compact unit holds 500 10", 500 12" records, 75 album sets. Specifications same as #110. No progressive record dealer can afford to do without the big time and space saving features of this famous record rack.

ASK ABOUT BITTER  
RECORD DEPARTMENT  
DESIGN SERVICE

## A. BITTER CONSTRUCTION CORP.

Brewster Building 27-01 Bridge Plaza North Long Island City, N. Y.

## The Nationally Advertised Phonograph Needle

Sell Fidelitone Floating Point Phonograph Needles for greater profit, faster turnover and complete customer satisfaction.

PERMO PRODUCTS CORP.  
6415 RAVENSWOOD AVE., CHICAGO, ILL.

Manufacturing  Metallurgists



# SELLING YOUR SERVICE

## HOW TO MAKE A PROFIT—AND KEEP THE CUSTOMER HAPPY

Selling service is an increasingly important factor in the radio business.

As our National Defense Program makes increasing demands on the basic raw materials and requires reductions in the production for consumer use, service may well become the dominant factor in preserving the radio business, as we know it.

Service specialists and dealer's service departments alike will be affected by the new importance of servicing, must face the new conditions and the new problems and solve them.

The operations of hundreds of servicemen and dealer's service departments have now been carefully studied, and thoroughly analyzed by RADIO TODAY.

From this data it is plainly evident that the successful operation of a service business requires as much *business* knowledge as it does technical radio skill.

It is almost invariable that when these conditions *are* present profitable operation results, and when they are *not*, the serviceman is lucky to draw an honest day's wage from his business.

A recent survey of our readers indicates that servicemen are generally well aware of the details of their problems, though a bit hazy as to the causes, the real underlying reasons behind their troubles.

### BUSINESS ANALYSIS

The most serious problems, according to our readers, fall into 5 major groups.

1. How to make a profit—and keep the customer happy.
2. How to handle the \$4 or \$5 repair bill on "compacts," when the customer refuses to pay.
3. How to sell the customer on the fairness of the service charge.
4. How to increase the "cash and carry" business.
5. How to establish the serviceman above the level of a day laborer.

If you look at these stated problems carefully, you will see that number 1 just about covers the entire range of business management and operation, and the others involve details or methods.

Let's see if we can break the first problem down to its underlying principles.

Broadly speaking "keeping the customer happy" means *selling* the customer the service he *needs*, when he needs it, at a price he is *willing* to pay.

"Selling the customer the service he needs" involves accurate knowledge of what is wrong with the set, and the ability to convince, or sell, the customer that he does need the service you recommend, and you are the one to do it.

Your recommendations must be honest, based upon your known facts.

You can't sell a job until you know what work is necessary, how you will

---

### TO HOLD CUSTOMERS

- Do an honest job and guarantee it.
  - Use good equipment to its full advantage.
  - Charge an honest price, and stick to it.
  - Advertise your business consistently.
  - Follow up your customers regularly.
  - Analyze all elements of your expense.
  - Follow up your customers regularly.
  - Be friendly, always.
- 

do it, and what parts will be required.

And you can't know these things unless you thoroughly inspect the set and correctly diagnose the trouble, before you start selling the customer.

Many servicemen think that if they do not quote a price they may do more work, make a bigger job, and a higher price. That may be, but it also has a reaction which is not good.

It is a fact that more customer goodwill is lost through unexpectedly large charges than for any other reason.

### PROFIT PROCEDURE

And so, most successful servicemen prefer to diagnose the trouble, sell the job, quote the price, before they do the work.

Some servicemen report that "sharpshooters" often try to find out exactly what is wrong with their set, and then either do the work themselves or have a "screw driver mechanic" do the work cheaply.

Most servicemen make a nominal fixed charge for set inspection, while others make no charge, though most

of them do *not* tell their customers enough details to enable another to do the work.

Those who do not make a service charge for diagnosis, charge the cost to advertising, to overhead, or to sales promotion.

The important fact is not what method is used to take care of the allocation of the cost, but that you do inspect sets and quote a price, *before* you do the work.

In giving estimates and bills to customers, practices among successful dealers vary. Some itemize parts and tubes, at list, and hours of labor, at \$1 to \$1.50 per hour.

Some quote a price for parts, tubes and labor without detail. Others quote a single price only, for the entire job. The method you follow is largely a matter of policy, and of your own opinion.

The less detail you show the harder it is to justify the charge. The more detail you show the more apt the customer is to demand an explanation.

### METHODS OF CONTACT

Let's look now at the next phrase in our broad statement, "when the customer needs it."

That involves you going to the customer, or having so completely sold your name, or your work, that the customer will come to you.

You can go to your customer by personal call, or by phone. You can bring your customer to you by letter, postcard, radio, newspaper, billboard, telephone directory, or other advertising.

Most successful servicemen, we find, make a frequent follow-up of their customers when they are in the neighborhood on other calls, or a regular

(Continued on page 47)

Know exactly everything that is wrong with every set before you fix it and give the customer alternatives in price for "making the set operate" and for "complete overhaul for 'like new' performance."

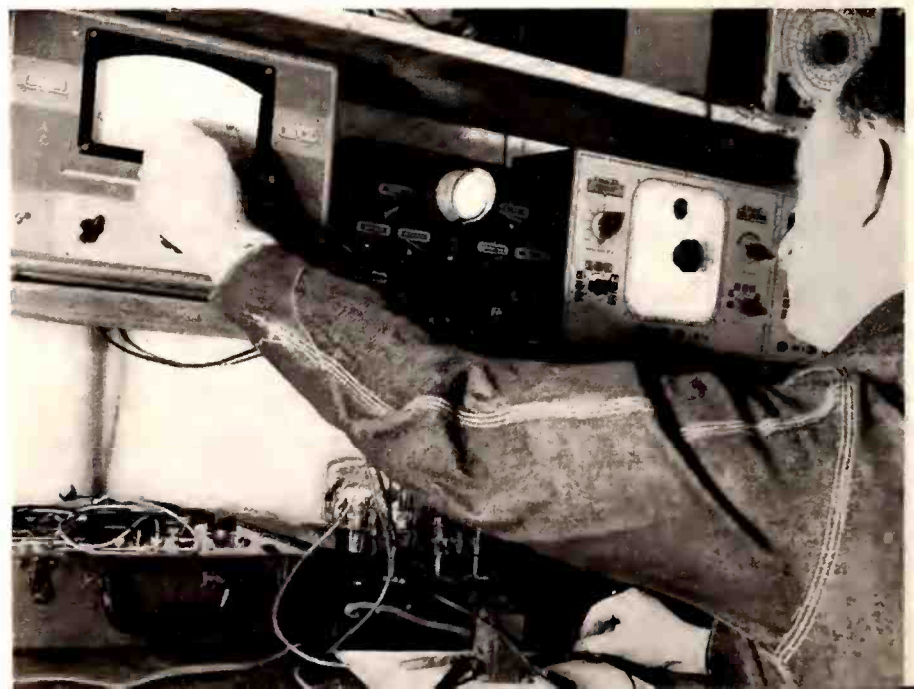

# Centralab

*The Quality Line*



### SELECTOR SWITCH

Available in an almost infinite variety of combinations . . . in bakelite or steatite . . . in single or multiple gang . . . from two to eleven positions on any one switch . . . also available for use in amateur transmitters.

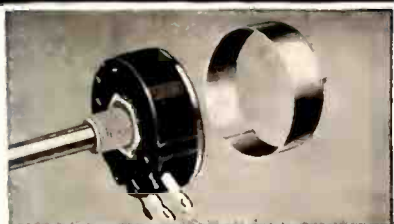

### STANDARD RADIOHM

Wall type resistor. Exclusive non-rubbing contact band.  $1\frac{3}{8}$ " diameter x  $9/16$ " deep. Available single, twin or triple, plain or tapped . . . with S.P.S.T., D.P.S.T. or S.P.D.T.

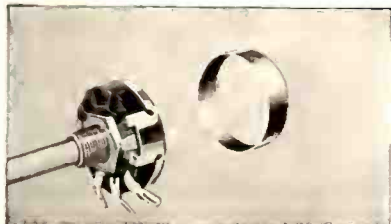

### MIDGET RADIOHM

Companion to "standard" . . . small size but large control efficiency. Available single, dual or triple . . . plain or one, two or three taps . . . with S.P.S.T., S.P.D.T., or D.P.S.T. Moulded bakelite case,  $1\frac{1}{8}$ " diameter,  $1/4$ " metal shaft  $3\frac{3}{8}$ " long.



### ELF RADIOHM

Smaller but also features the long, straight resistor strip. Available plain or tapped with S.P.S.T. switch . . . with or without dummy lug. Bakelite case  $57/64$ " diameter,  $17/32$ " deep (less switch)  $25/32$ " deep with switch.

Hams, Servicemen, Experimenters and Manufacturers appreciate the utter dependability of Centralab products. Since 1922 more than a hundred million radio parts bespeak the universal acceptance accorded Centralab products. Send for catalog if your jobber cannot supply you.

**CENTRALAB**  
Div. of Globe-Union Inc.  
MILWAUKEE

### WIRE WOUND RADIOHMS

In values from 2 to 10,000 ohms . . . insulated construction . . . 3 watts . . . universal shaft for all replacements . . . regular Radiohm switch covers may be attached . . . in linear curve only . . .

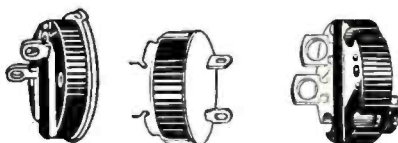

### ATTACHABLE SWITCH COVERS

For standard and wirewound resistors (Radiohms) as well as Midget and Elf Radiohms . . . S.P.S.T. . . . S.P.D.T. . . . D.P.S.T. . . . four point . . . S.P.D.T. (operates at clockwise position) and S.P.S.T. with Dummy Lug.

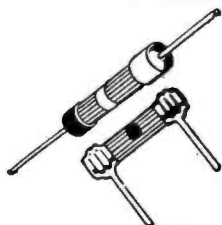

### LEVER ACTION SWITCH

Used singly or in groups . . . for broadcasting, receiving, public address, test instruments and industrial uses. Available in any one of ten different combinations including positive and spring return action.

### AXIAL LEAD RESISTORS

Body is insulated by inert ceramic jacket . . . proof against vibration and humidity . . . will withstand five times rated load without permanent change. In two sizes . . . RMA coded . . .  $1/2$  watt at  $1/8$ " x  $5/8$ " and 1 watt at  $1/4$ " x 1" . . . Also supplied in conventional RADIAL LEAD Style . . .  $1/2$  watt - 1 watt or 2 watt.



### CERAMIC TRIMMER CONDENSER

where greater stability than ordinary types is required. Supplied with neg. temp. coefficient of .006 MMF/MMF/C°. With or without mounting brackets.

### CERAMIC CAPACITOR

Small "special purpose" for h.f. circuits where temperature compensation, low power factor, or absolute permanence are important. 1000 V.D.C. leakage resistance more than 10,000 meg. Power factor less than 1%.

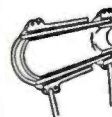

**SEND FOR CATALOG NO. 23**

# Centralab

# DIPOLE ANTENNAS

## FUNDAMENTALS FOR THE SERVICEMAN

The increased uses of high frequencies for broadcasting services are bringing new equipment and service methods to the serviceman.

One particularly important field for the serviceman is dipole antennas which are being used in frequency modulation, television, and short-wave reception. This efficient type of antenna is practical at the high frequencies used for these services, while it would be impractical at broadcast band frequencies.

Dipole antennas are balanced to ground electrically and depend upon the magnetic component of the radiation

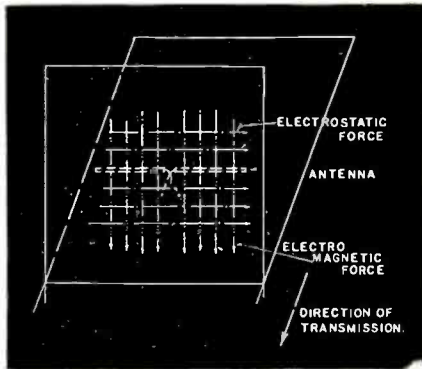

Fig. 1—Approximate space relation of dipole antenna and the electrostatic and electromagnetic forces. Actual wave front is a curved surface. Vertical lines are electromagnetic.

field for the voltage pick-up. The common single wire type of antenna, including the "hank" on the AC/DC sets, depends primarily on the electrostatic component of the radiation field for pick-up. That is, the single wire type of antenna acts as one plate of a capacitor, the other is the earth, and the electric charge stored in this capacitor by the electro-static radiation field, flows through the antenna input coil to introduce the signal into the receiver.

### RADIATION FIELDS

The dipole in a horizontal position has theoretically equal capacities between each arm and ground, therefore, very little difference in charge exists between the two halves of the antenna due to the electro-static component.

What are these electrostatic and electromagnetic components which have been mentioned? The current that is sent into the radiating antenna at the transmitter is alternating at the assigned frequency. The current may be amplitude modulated, or it may be constant in the case of frequency modulation. This current flowing in the antenna sets up an electromagnetic field in concentric circles with the antenna as an axis. This is similar to

the magnetic field set-up about any conductor carrying a current. At low frequencies, that is below approximately 10,000 cycles, the energy stored in the magnetic field about a conductor is returned to the circuit. At frequencies above this however, less and less of the energy is returned from the magnetic field, and this energy is said to be radiated. About 90 per cent of the energy supplied to a good high frequency antenna is radiated.

### STATIC COMPONENT

The electrostatic field about the antenna is representative of the electric force in the dielectric or air surrounding the antenna. This electrostatic force is similar to that which exists between two plates of a condenser which have a difference of potential between them. This electric field exists only in a dielectric or non-conductor and therefore can be made ineffective by shielding. This is done on some broadcast loops by surrounding the loop with a grounded copper screen. Only the magnetic component reaches the loop to produce a voltage.

Both the electromagnetic and the electrostatic field travel together at approximately the speed of light, 300,000,000 meters per second, or about 186,000 miles per second. The direction of travel of the wave front is perpendicular to the electrostatic and electromagnetic lines of force which are in turn perpendicular to each other. This can be seen in Fig. 1. Reversal of either the static or magnetic lines reverses the direction of transmission, reversal of both does not alter the direction of travel. The polarization of the wave is that of the electrostatic field which is parallel to the antenna. Thus, horizontal antennas send horizontally polarized static lines and the wave is said to be horizontally polarized. The reverse is of course true for vertical antennas.

### PLACING THE ANTENNA

Since the dipole antenna receives its voltage from the electromagnetic field, it must be placed so that its axis is perpendicular to this component in order that the advancing wave is "cut" by the receiving antenna. This process of "cutting" magnetic lines of force is similar to the action of a generator where the conductors are whirled through a magnetic field. Here, the magnetic lines move past the conductor, or antenna, with the same results.

Referring to Fig. 1, it will be seen that the receiving antenna must be parallel with the transmitting antenna in order to be cut by the magnetic lines of force. If the transmitting antenna is vertical, the magnetic lines are in a horizontal plane, and the receiving antenna must be vertical also. This is one of the polarization prob-

lems which must be solved by standardization of broadcasters to one method. The FM stations have chosen horizontal polarization as the standard. The stations which are now operating vertically polarized are to be changed to conform with the standard.

Polarization of the wave at the receiver is not determined solely by the position of the transmitting antenna with respect to the earth. It may change once or several times during its travel. Splitting and re-combining of a wave, reflection and refraction, all tend to change the polarization. The receiving dipole should in every case be adjusted to give the best possible signal from all stations in the receiving area.

### DIPOLE CHARACTERISTICS

The design of the dipole receiving antenna will in many cases be no problem to the serviceman. The receiving range of nearly every set can be increased, however, with the use of a more elaborate antenna. In many localities where FM stations cannot be heard with ordinary dipole antennas, good reception can be obtained if reflectors are added to the installations and attention is paid to impedance matching, elevation, and orientation. An example of how effective this can be, is shown in the success of S. Harold Bent, the Gardner, Mass. dealer whose story was given in October RADIO TODAY, page 34.

Dipole antennas are designed to resonate within the band of frequencies that are to be covered. That is, the antenna is cut to approximately one

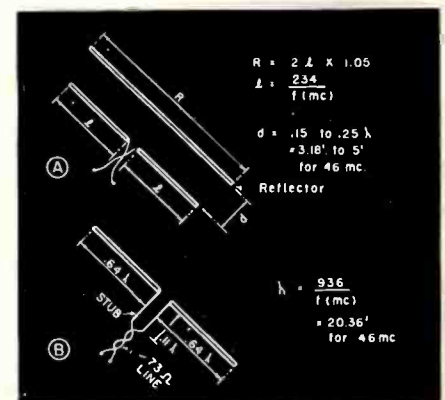

Fig. 2—Dimensions for FM antennas in 42-50 mc. band. A is plain dipole, and B is so-called extended zepp. B with a reflector is many times as efficient as A. Note matching stub.

half the wave length of the center of the band. The formula for figuring half wave antenna lengths is  $L = \frac{468}{f(\text{mc})}$ . For the center of the FM band, 46 mc., the length is 10.18 feet. Each quarter (Continued on page 49)

# Busy days are here...

## FOR SERVICEMEN

**Keep them profitable  
with dependable  
test equipment!**



**NOW AVAILABLE  
FOR FM AND TELEVISION**

**WESTON**  
Model 787  
UHF Oscillator



Fundamental frequency coverage from 22 to 150 megacycles. No harmonics . . . no band switching. Used with portable antenna or standard output leads. Reads 40 kc per division at 40 mc. Self contained battery operation: compact and extremely portable.

Today, as never before, the American public *wants radio* and can afford to pay for radio. Proof is that the demand for new sets has virtually doubled. But with long deliveries prevalent in so many fields, more old sets probably will be retubed and repaired than ever before. » » » A period like this is *made to order* for the servicemen with WESTON Test Equipment. For WESTONS help produce greater profit on every job. Measurements are simpler, surer . . . trouble can be spotted quicker . . . when these basic, direct-reading instruments are used.

But the *big profit* from WESTONS is shortly to come; for FM and television are rapidly getting into stride. *These same WESTON Test Instruments fully meet the new servicing problems involved. No new and expensive equipment will be needed for the job. Thus it pays . . . and continues to pay . . . to use dependable WESTONS for all servicing needs.* Weston Electrical Instrument Corporation, 597 Frelinghuysen Avenue, Newark, N. J.

# WESTON

## Test Instruments

# SERVICE NOTES

## Stromberg-Carlson Model 900 Circuit Notes

This AC/DC set features a tuned RF stage resistance coupled to the converter, negative feedback and degeneration in the audio stage.

Alignment instructions call for use of an output meter across the speaker voice coil and alignment with the smallest possible signal voltage. Be sure that the volume control is "full on" and that the metal plate is fastened in place on the bottom of the chassis.

The dial pointer should coincide with the 550 kc. mark with the plates fully meshed.

### ALIGNMENT

Tune the set to the high frequency end of the dial and introduce a 455 kc. modulated signal through 0.01 mfd. in series with the high side of the generator to the front or oscillator section of the tuning condenser. Note that the IF signal is not applied to the usual IF grid or converter grid. Start with the secondary of the output IF transformer and work back to the converter for maximum output. Keep the signal low.

To align the RF end, use a 200 mmfd. series capacitor in place of 0.01 mfd. and connect the signal to the antenna terminal. Set the dial and generator to 1400 kc. Adjust the oscillator and antenna aligning capacitors for maximum output. Turn set and generator to 600 kc. and check calibration. If it is too far off, repeat the 1400 kc. alignment.

To adjust the wave trap in the converter grid circuit, tune the set to 1000 kc. and the generator to 455 kc. While supplying a fairly strong modulated signal, adjust the trap trimmer for minimum output.

Normal operating voltages are indicated on the diagram.

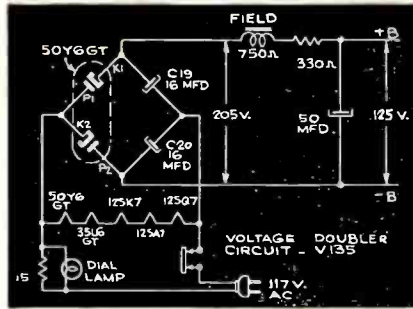

Voltage doubler circuit used in RCA V-135. No chassis connection to the power line with this circuit.

## Bridge Rectifier Used in AC/DC Set

A 50Y6GT is used in the RCA model V-135 as a voltage doubling bridge rectifier. An accompanying diagram shows the circuit. An advantage of this type of AC/DC circuit is that the B- and chassis have no direct connection to the power line.

In operation, C<sub>19</sub> and C<sub>20</sub> are charged, one on each half cycle, so that their charges add and produce approximately twice the line voltage across the output. The dial lamp is connected across a 15-ohm resistor which is in series with the filament string as well as the plate supply of the 50Y6.

## New N.U. 35Z5GT Has Improved Filament

The usual habit of connecting the pilot light across one section of the filament of 35Z5 rectifiers frequently causes that section of the heater to burn out if the pilot light should fail. From the circuit shown, it will be seen

that the plate current of the rectifier also flows through the parallel combination of the filament and light. Should the lamp fail, the total plate current flows through the heater section and frequently burns it out.

An improved design on National Union 35Z5GT tubes prevents failure from this source.

It is always good service practice to check the plate circuit for shorts when replacing a burned out rectifier.

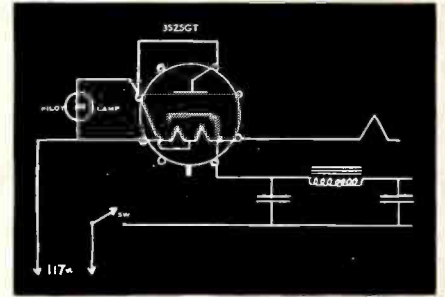

Pilot light failure causes extra current load on section of 35Z5 filament and possible burn-out.

## Wave Trap Connections

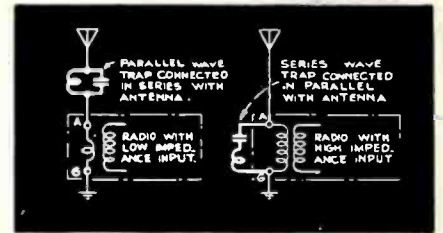

Low impedance primaries have few turns and usually have two terminals in addition to ground. AC/DC sets with "hank" antennas have high impedance primaries.

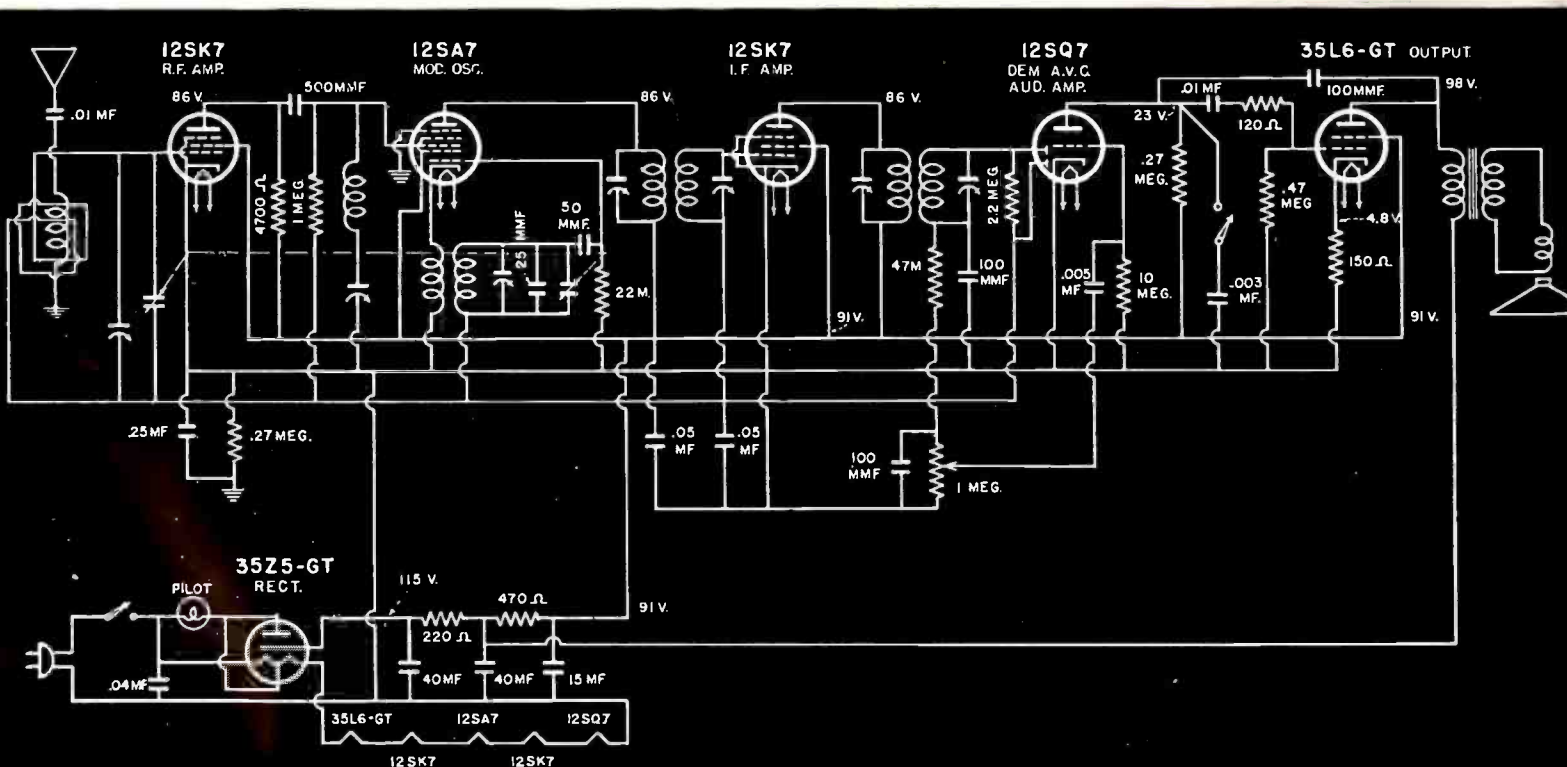



## SELLING YOUR SERVICE

(Continued from page 42)

periodic follow-up by phone.

By this means they are most apt to be "on the job" when the customer needs service.

New customers, they seek by some, or several, forms of advertising, with the preference shown for direct-mail and phone directory.

Handling the jobs, new or old, takes expert knowledge and high technical skill which lets out the "screw-driver" brigade.

But it also takes equipment—good equipment, skillfully used. Good equipment costs money. But the lack of it costs a good serviceman more.

Good equipment is the very basis of good work, as good work is the basis of customer satisfaction and successful business. It saves time in finding the trouble, makes the prices of competition profitable prices for you.

Good equipment makes your guarantee stick, by telling you when the job is properly done as well as what to do.

Displayed in your window, being skillfully used, the equipment is also an excellent means of attracting favorable attention, bringing more sales to you.

### WATCH EXPENSES

Throughout your operations, every element of your expense, and its relation to your sales must be known, and included in your prices as certainly as the material and time directly involved.

Behind the several basic factors we have mentioned, there are many principles and countless details far beyond the limitations of the scope of this article.

Business experience must be considered a vital ingredient of business success, but still does not reduce that business success to a precise formula. There is no such formula.

The fact remains that more business failures in this country are due to the lack of business experience than to any other single cause.

The service business is no exception. But careful thinking, and planning with every day's actions based upon the reactions of tomorrow will keep you going.

### National RCA Ads Aid Servicemen

The second of a series of full page color ads in Collier's for Nov. 15 by RCA also "goes to bat" for the servicemen. "Can you measure a millionth of a volt?" is the eye-catching question. The explanation in the copy describes the micro-measurements which are made by servicemen with their equipment in checking the performance of the customer's radio. Emphasis is put on the necessity of the public keeping their radios in good condition during the national emergency. The first of the series of ads, which ran in October 11 issue of Colliers, featured "What You Should Know About Radio Service During the National Emergency."

**SAVE! BUY NOW**  
**PRICES INCREASE**  
**ON ALL RIDER BOOKS\* AND RIDER MANUALS\***  
**DEC. 15th.**

★ There's only three weeks left in which to get these Rider Manuals and Rider Books at present low prices. Go over the list now, see the substantial savings you can make by acting today! Check the books you need and order immediately.

#### ALIGNING PHILCOS (2 Volumes)

Complete authorized data that makes alignment easier and quicker.

	After Dec. 14	Present Price	SAVE
Vol. I—1929 to 36	\$1.50	\$1.00	50c
Vol. II—1937 to 41	1.75	1.60	15c

#### FREQUENCY MODULATION

Explains F-M transmission as well as discussing the new F-M sets.

	After Dec. 14	Present Price	SAVE
136 Pages	\$1.50	\$1.00	50c
76 illus.			

#### OSCILLATOR AT WORK

Protect the investment in your present or future oscillator equipment. Read this book.

	After Dec. 14	Present Price	SAVE
243 Pages	\$2.00	\$1.50	50c
167 illus.			

#### VACUUM TUBE VOLTMETERS

Gives practical aspects and underlying principles of various types of v.t. voltmeters.

	After Dec. 14	Present Price	SAVE
180 Pages	\$2.00	\$1.50	50c
113 illus.			

#### METER AT WORK

Enables you to get the most from your meters and guides you in selecting new ones.

	After Dec. 14	Present Price	SAVE
152 Pages	\$1.50	\$1.25	25c
138 illus.			

#### SERVICING BY SIGNAL TRACING

An exposition of the theory of operation of all radio receivers. Explains the really fundamental method of servicing that is free from every limiting factor heretofore encountered.

	After Dec. 14	Present Price	SAVE
360 Pages	\$3.00	\$2.00	\$1.00
188 illus.			

(Also in Spanish Edition of 358 pages—price \$3.50)

JOHN F.

**RIDER**

PUBLISHER INC.

404 FOURTH AVE., NEW YORK CITY

Export Division: Rocke-International Elec. Corp.,  
100 Varick St., N.Y.C. Cable: ARLAB

#### CATHODE RAY TUBE AT WORK

This book explains the underlying theory and the circuits accompanying the Cathode Ray Tube. Present developments in the industry make this book a "must" for every serviceman.

	After Dec. 14	Present Price	SAVE
338 Pages	\$3.00	\$2.50	50c
460 illus.			

#### A. F. C. SYSTEMS

Complete explanation of all types of A.F.C.

	After Dec. 14	Present Price	SAVE
144 Pages	\$1.25	\$1.00	25c

#### AN HOUR-A-DAY WITH RIDER BOOKS

96 pages each, profusely illus.

on ALTERNATING CURRENTS IN RADIO RECEIVERS  
on D.C. VOLTAGE DISTRIBUTION  
on RESONANCE AND ALIGNMENT  
on AUTOMATIC VOLUME CONTROL

	After Dec. 14	Present Price	SAVE
Each book	90c	60c	30c to \$1.20

#### RIDER MANUALS

For complete, authorized, servicing data, all in one place, there never has been an equal to Rider Manuals. Get the volumes that are missing from your shelf at today's low prices.

	After Dec. 14	Present Price	SAVE
Vols. III to VI Covering 1932 to 35	\$ 8.25	\$ 7.50	75c ea.
Vols. VII to XII Covering 1935 to 41	11.00	10.00	\$1.00 ea.

**BUY NOW—Save!**

\*PRICES ON THESE  
2 NEW BOOKS BY RIDER  
WILL NOT BE RAISED AT THIS TIME

Abridged Rider Manual Vols. I to V  
Servicing data on sets widely distributed from 1930 and '35. 2,000 pages—\$12.50

Automatic Record Changers & Recorders  
Complete servicing information... Explanatory text and diagrams, etc. 700 pages—\$6.00

You bet. We're in step with progress — with better listening and therefore with quicker sales and more sales. Take us on, you wide-awake dealers.

KEN-RAD TUBE & LAMP CORPORATION  
OWENSBORO, KENTUCKY

DEPENDABLE  
*Radio Tubes*

**KEN-RAD**



# CIRCUIT NOTES

## Record Player Diagrams, Wireless and Complete

Record players of the wireless type have been very popular because of their ease of installation.

Generally, they are conventional converter tubes in oscillator circuits which use the plate of the tube. The voltage from the pick-up is usually connected to the grid nearest the cathode in order to get a good percentage of modulation.

The Fig. 1 shows the wireless oscillator used by Zenith in models S9001

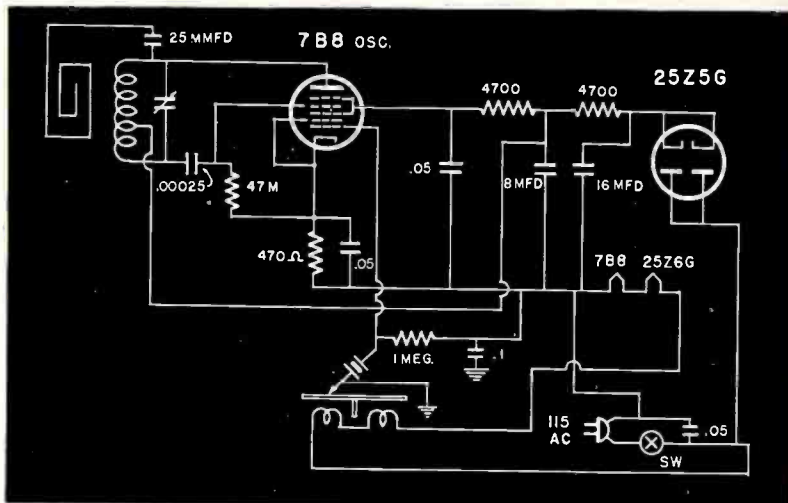

Fig. 1—Wireless phono oscillator circuit in Zenith model S9001. Crystal pick-up is connected to number 1 grid in the loctal converter tube. Note that the phono motor is in series with filaments.

and S9002. Note that the phonograph motor operates in series with the tube filaments.

Fig. 2 is the wireless player Silver-tone model 7061. Here, the phono pick-up voltage is used to modulate the screen grid of the 35L6GT. The screen voltage is blocked, with the 0.05 capacitor, from the crystal pickup. The radiating antenna is capacity coupled to the plate of the oscillator and is a third wire in the power line cord.

The complete record player in Fig. 3 is a Silver-tone model 5815. In this circuit, the pick-up voltage modulates the control grid of the 35L6GT. A shunt tone control is across the output transformer. The turntable motor is controlled by a separate switch.

that the filter sections are doing their job. If the hum still remains, try a

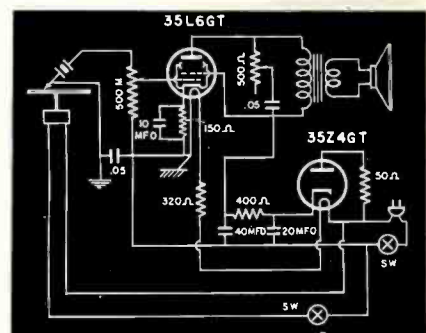

Fig. 3—A complete record player using beam power tube, control grid modulated.

### TRACING HUM

In tracing down hum on the wireless players, check to be sure that the lead from the pick-up to the modulator grid is well shielded and away from filament or rectifier circuits. Be sure

lower value of resistance from the modulator grid to ground. In the case of the screen grid modulated types, better filtering is the answer.

Fig. 2—This wireless player uses a beam power output tube and modulates the screen grid with the pick-up voltage. A third wire in the power line cord acts as the antenna.

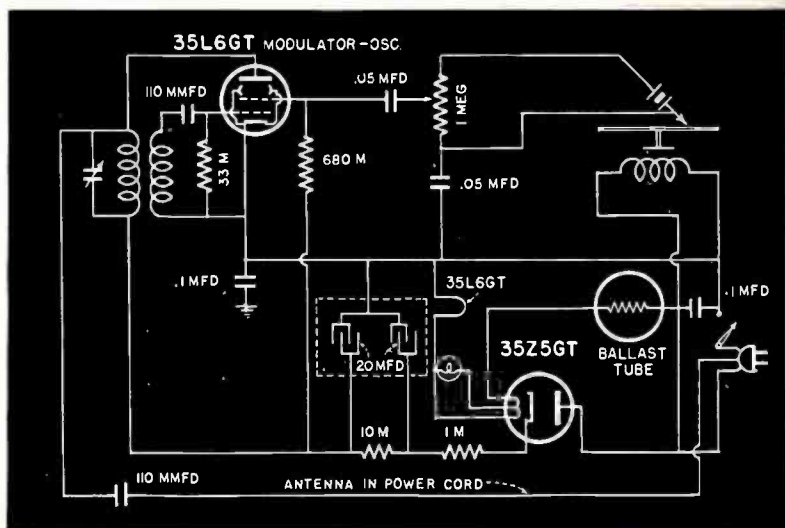

# DON'T JUNK YOUR OLD RADIO TUBES

• You can cash them in for valuable merchandise under General Electric's New Radio Tube Merchandise Award Program.

Get the facts! Talk with your nearest G-E Radio Tube distributor or write the General Electric Company, Radio and Television Dept., Bridgeport, Conn.

GENERAL ELECTRIC

## DIPOLE ANTENNAS

(Continued from page 44)

wave "arm" is half of this value, or 5.09 feet. These lengths are about 95% of the actual wave length in order to correct for the "end effect", which prevents all antennas from being theoretically correct.

A simple half-wave dipole has directional characteristics which are broadside to the antenna. As the length of the antenna is increased to  $3/2$  wave lengths, or a greater number of odd half waves, the directional pattern becomes such that it is more receptive to signals approaching at an angle to the axis of the antenna. For example, a three half-wave length antenna has six lobes of maximum reception. The two main lobes are broadside and the four minor lobes are located two on each side of the main lobes and about 30 degrees from the axis of the antenna.

### GREATER GAIN

With such a  $3/2$  wavelength antenna, stations which are about 60 degrees apart can be received without turning the antenna. Reception of both probably would not be possible with a simple half-wave dipole. If reception in opposite directions is not required, a reflector can be placed behind the antenna to increase the pick-up gain on the front side. The reflector should be about 5% longer than the antenna, and the exact length should be adjusted for maximum reception. The spacing between the reflector and the antenna determines the amount of gain over a plain dipole. The gain is maximum at about 0.15 wavelength or 3.18 feet and is slightly less at 0.25 wavelength or 5.09 feet. The reflector length should be adjusted for best performance if the distance between it and the antenna is changed.

Another important factor to consider is the height of the antenna above the ground. The ground reflection of a received wave combines in various phase conditions with the wave received at the antenna. Whether the reflected wave aids, or opposes the direct wave depends upon the height of the antenna, and the angle above the horizon at which the waves arrive. In general, the higher the antenna, the more improvement there is in reception of low-angle signals. Since FM waves travel either on a line of sight or at low angles to the horizon, this low angle reception is to be desired. The actual height of the antenna should be changed slightly during the testing period, since a difference of  $1/4$  wavelength, or 5 feet may mean that a weak distant signal will be received. It is best to have the antenna as high as possible, but a few feet up or down may greatly improve reception for certain stations.

### IMPEDANCE MATCH

The impedances of the transmission line and the antenna must be matched in every case for maximum results. With the simple half-wave dipole the low impedance line is connected to the center where the impedance is about 70 ohms. If longer antennas are used for better directional effects, matching stubs must be used to secure the proper match. These stubs are short paral-

lel conductors, usually  $1/8$  to  $1/4$  wave long which are connected between the antenna elements and the transmission line. The transmission line is moved along the matching stub until best performance is secured. Fig. 2 shows the dimensions of an extended dipole antenna with matching stub for connecting a low impedance transmission line.

As the high frequency broadcast services become more numerous, so will the need for service experts who can install correct antennas.

## N. U. Shop Cards Help Servicemen

Three new display cards for service

shops are offered by National Union Radio Corp., 57 State St., Newark, N. J., to help build customer confidence and insure an understanding of the shop's policies. One of the cards states "We reserve the right to make a nominal inspection charge," with the explanation that the location of radio troubles takes an unpredictable amount of time. The second card states that a charge of 5c is made for testing each tube, but that the test is free if defective tubes are replaced with one purchased from the service shop. The third card is in the form of a Certificate of Award which is good for a period of one year and states that "up-to-date radio test equipment" is used in the shop.

## To Simplify Resistor Replacements...

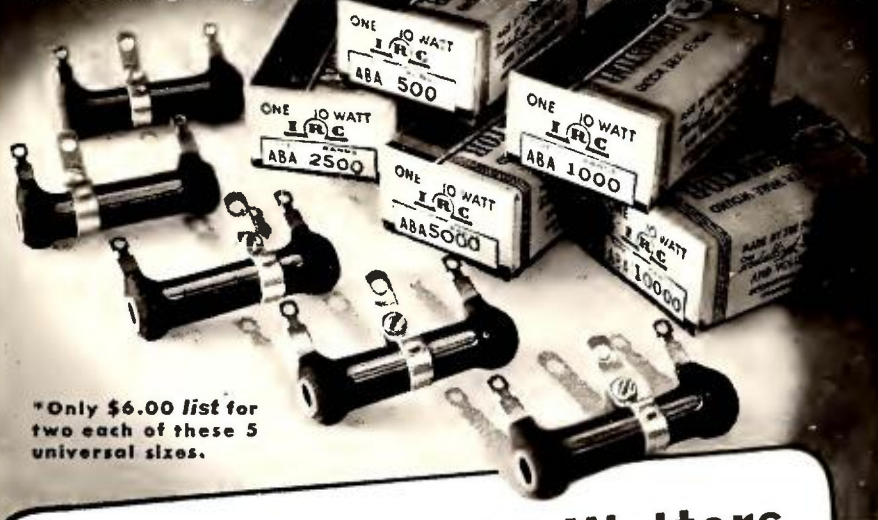

\*Only \$6.00 list for two each of these 5 universal sizes.

## Use Adjustable 10-Watt resistors for the Hard-to-Stock Sizes!



### CLIMATE-PROOFED

IRC Power Wire Wound Resistors are made in a complete range from 5 to 200 watts—all standard types having the famous IRC "Climate-Proofed" Cement Coating to guard against the most common cause of power resistor failure.

Sure you try to stock frequently used resistor values in half, one and two watt sizes, but it's difficult to have them all on hand at all times, and it's tough to hold up a job while you wait for the one you need.

Stock a couple each of the IRC type ABA adjustable ten watters, 500 - 1000 - 2500 - 5000 - 10,000 ohms,\* each of them adjustable by moving the slider for any resistance value up to the maximum.

These five units will handle any wattage requirements up to 10 watts and any resistance value from 50 ohms to 10,000 ohms. Use the low range units for high wattage-low resistance requirements because in all cases the wattage rating is based upon the full length of the resistor.

IRC Type ABA 10-watt Adjustable Resistors are made in all popular ranges from one ohm to ten thousand ohms and list at 60c each.



POWER WIRE WOUND

# RESISTORS

INTERNATIONAL RESISTANCE CO., 401 N. Broad St., Philadelphia, Pa.

## Permeability Tuner on BC and SW Spread Band

Permeability tuning is used on the battery operated Silvertone model 7110. This five-tube set uses a 1P5GT tuned RF stage and a 1A7GT converter. The set tunes four bands, 540 to 1700 kc., 9.45 to 9.75 mc., 11.62 to 11.95 mc., and 15.01 to 15.5 mc. These four bands are covered with a same moveable core tuner in the oscillator circuit. The diagram for the mixer stage is shown in the accompanying cut.

The permeability tuner coil has only a shunt trimmer on the broadcast band, but as the short-wave ranges are switched-in, a fixed tuned coil is connected across the main coil. This auxiliary coil is not inductively coupled to the main coil and serves only to reduce the total inductance to that required for the range. Additional trimmers are also switched in to allow adjustment. The tickler on the main coil is shorted out when the set is operating on the short-wave bands.

### NEUTRALIZING CAPACITY

Note the small capacity coupling from the oscillator grid to the injection grid. This small capacity is to neutralize the effect of space charge coupling on the short-wave bands. The electron space charge near the signal grid may cause a positive grid current to flow with loss of sensitivity if the neutral-

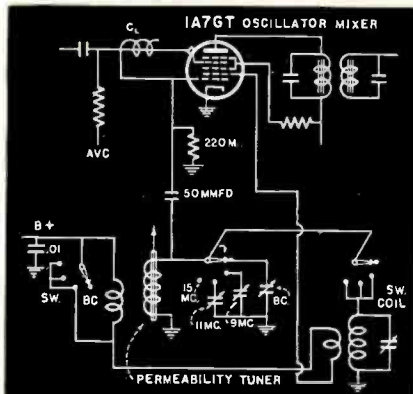

Permeability tuner is used on short-wave bands with additional shunt coil in oscillator.

ization is omitted. This small capacity is adjusted for maximum sensitivity on the highest frequency range.

The antenna circuit is fixed tuned on the short wave ranges, and the RF plate circuit uses a separate permeability tuner on SW.

### Clearing the Air

If the noise is "on the line" it can be filtered out, either at the source, or at the set. Not every filter, of course, will remove *all* noise, but *any* power line noise can be removed by

some filter. Get the right combination of chokes, and capacitance, and you "run the noise into the ground."

But very often it is a loose lamp bulb, or a defective socket, plug, cord, or connection that is causing the trouble. You will do your customer, and your own reputation, a greater service if you can locate the *source* of the noise, and correct it there, than by just slapping a filter across the line and forgetting the cause.

## BOOK REVIEWS

### Radio Servicing Course Book 5th Edition

N. N. Beitman  
Supreme Publications, 328 S.  
Jefferson St., Chicago

Radio servicing from fundamentals to business methods is included in twenty-two lessons in this enlarged fifth edition of a popular text. Designed primarily for the beginner, there are many chapters which will find use in nearly every shop. The lesson on radio servicing techniques includes a full treatment of signal tracing methods as well as other types. Alignment and cathode ray oscilloscopes are also fea-

Replace with the Best!

**ALLIANCE "EVEN-SPEED" PHONO-MOTORS**



**EASY TO INSTALL . . .  
Fit 95% of all makes**

**INDIVIDUALLY  
PACKAGED**

● The low cost and quick, easy installation of "Even-Speed" Motors make it more practical and profitable to replace the entire unit when trouble occurs. The "Even-Speed" line of only four phono-motors provides a unit for 95% of all replacement requirements. Carry a few in stock. Each motor and turntable comes in an attractive carton for your greater convenience.

Ask your jobber or write direct for complete information and low prices.

**ALLIANCE MFG. CO. • ALLIANCE, OHIO**

*Now Ready!*

## CHIME RECORDINGS for the HOLIDAY TRADE

For extra profits, sell these new high fidelity recordings of traditional Xmas music. Universally used to create the Holiday feeling. Our fourth series in this prime Christmas field.

Big waiting market among homes, churches, schools, stores, institutions and community celebrations. 10" Discs—2 selections each.

- 1006 HARK! THE HERALD ANGELS SING  
SILENT NIGHT, HOLY NIGHT
- 1007 ANGELS FROM THE REALMS OF GLORY  
IT CAME UPON THE MIDNIGHT CLEAR
- 1008 JOY TO THE WORLD  
O COME, ALL YE FAITHFUL
- 1009 O LITTLE TOWN OF BETHLEHEM  
WHILE SHEPHERDS WATCHED THEIR FLOCKS
- 1010 THE FIRST NOEL  
WE THREE KINGS OF ORIENT

Start now to make money in this new field of musical recordings. To play them is to sell them.

Wire or write at once

**LIST PRICE**  
\$2.00 each; the set for \$9.00

**RANGERTONE, INC.**  
73 WINTHROP ST., NEWARK, N. J.

ture lessons. Television, photo-electric, equipment, and communication equipment are among the new subjects offered to the progressive serviceman. Data charts, and test questions round out the text. The price of this book is \$2.50.

### Pioneering the Cathode Ray and Television Arts

Allen B. DuMont Labs., Inc.  
Passaic, N. J.

A historical report of the Allen B. DuMont Laboratories traces the development of this organization during its first decade. Cathode-ray oscilloscope development, specialized instruments such as the electronic switch, Resonoscope, etc., are described in words and pictures. DuMont television is described from "program to receiver." Photographs of the founder, Allen B. DuMont, and of key executives and engineers are included with those of the Laboratory and equipment.

### An Introduction to Television

C. J. Hylander &  
R. Harding, Jr.  
The Macmillan Co.  
New York

The progress of the art of television is told in a simple and interesting manner in this new book. Early historical facts are given as a background. The present method of electronic television is simply explained and well illustrated with drawings and pictures. More than 200 pages cover the subject from studio to receiver. A radio spectrum is printed in the front and back of this book.

### Radio Bounced by Bombs!

A well-known officer in Britain's Royal Navy has nothing but compliments for the ruggedness of American radios. He has sent a letter to Emerson Radio and Phonograph Corp., relating a memorable experience with an Emerson set, and congratulating the manufacturer.

The officer says that "an eight-inch shell burst six feet from my cabin and completely wrecked my wardrobe and splintered the cabin itself with shrapnel... my radio was thrown to the deck by the blast and I feared the worst... for actual fact, the only damage sustained was a fracture in the loud-speaker."

### New Wedemeyer Branch

George Wedemeyer of the Wedemeyer Radio Co., 221 E. Liberty St., Ann Arbor, Mich., wholesale distributors of radio parts and supplies, announces that a new branch store, at 329 N. Burdick St., Kalamazoo, is now open for business. Ed Lantz is in charge of the new shop.

### Servicemen Needed in Dixie!

The establishment of army posts throughout the South, the attendant influx of civilians to adjacent towns and cities, the magnet of huge defense industries and the sharp rise in cotton prices have created a boom in the radio-service business in Dixie. All conditions point to a continuance of this boom for several years at least, reports Herb Erickson, of Hendersonville, N. C.

The volume of radio repair work at many points is so great that existing facilities are heavily overtaxed and there is a crying demand for help.

"This is a genuine appeal to all connected with the radio industry in the east, the north, the west—if you are a good serviceman, if you are acquainted with or know of good servicemen seek-

ing work at top pay commensurate with reasonable living costs, nice country and climate, and congenial surroundings, willing to move to a good job, have them get in touch with Mr. Erickson, setting forth their qualifications, salary wanted and preference of location."

Mr. Erickson, who represents a number of prominent parts manufacturers, will act as clearing house between those needing good servicemen and good servicemen needing jobs, cheerfully and gratuitously, but without assuming any responsibility after connecting one with the other.

Positions are available in North and South Carolina, Tennessee, Alabama, Florida and Georgia. There is need too, for a number of jobber salesmen and countermen who know their business.

**JUST OUT!**  
NEW CATALOG 18

**OHMITE**  
RHEOSTATS \* RESISTORS \* TAP SWITCHES \* CHOKES \* ATTENUATORS

For Radio, Television, Sound, Electronic and Industrial Uses  
CATALOG NUMBER 18

**INDEX**

RHEOSTATS, Models H and J, Various Enamelled	1	PHANTOM DROPPING RESISTORS	Page
RHEOSTATS, Models A, L, N, R, and G, P, T, U,	2	CHOKES, TAPPED RESISTORS	11
10, 25, 50 and 75 Watt Ratings, Various Enamelled	3	TAP SWITCHES, Open-Type, All-Ceramic	11
"DIVISION" ADJUSTABLE RESISTORS	4	TAP SWITCHES, Power Type, All-Ceramic	11
"DIVISION" ADJUSTABLE RESISTORS	5	Models 312 and 312	11
100, 200 and 300 Watt Ratings, Various Enamelled	5	TAP SWITCHES, Power Type, All-Ceramic	12
100, 200 and 300 Watt Ratings, Various Enamelled	5	Models 312, 312 and 302	12
100 and 200 Watt Ratings	6	RAND CHANGE SWITCH DE-2	13
"BIRD'S NEST" RESISTORS, Various Enamelled	6	CHOKES, Radio Frequency Plate	13
100, 200 and 300 Watt Ratings	7	CHOKES, Power Line	13
"BIRD'S NEST" RESISTORS, Various Enamelled	7	ATENUATORS, Frequency Plate	14
100, 200 and 300 Watt Ratings	8	PAPER TUBE, High Voltage Tapped L-Plate	14
NON-INDUCTIVE DIVERTER ANTENNA RESISTORS	8	MELTING IRON CONTACT RHEOSTATS	14
Non-inductively Tapped to Center	8	"MELTING IRON" RESISTANCE BOXES	14
NON-INDUCTIVE CITY RESISTORS, Various Enamelled	9	DIALS AND KNOBS	14
Various Enamelled	9	GEN. CONTROL	14
"MULTIPLE" TAPPED RESISTORS	9	MOBILE TRAIN CONTROL RHEOSTATS	14
Various Enamelled	9	OHMITE OPEN LAR ELECTRIC	14
"PRECISION" RESISTORS	9		

OHMITE MANUFACTURING CO.  
4875 West Flournoy Street, Chicago, Illinois, U. S. A.  
All Telephones: AUSTIN 1076 - Cable Address: OHMITECO - Credit Code 926

**FREE** for the asking!

OHMITE MANUFACTURING COMPANY  
4875 Flournoy Street, Chicago, U. S. A.  
Send Free Catalog 18.

Name \_\_\_\_\_  
Address \_\_\_\_\_ State \_\_\_\_\_  
City \_\_\_\_\_

**Be Right with OHMITE**  
RHEOSTATS \* RESISTORS \* TAP SWITCHES

# They Said it Couldn't be Done!

Defense wanted the speakers moisture-proofed! In meeting this requirement, CINAUDAGRAPH successfully tested the MALLARD under water.

Whether it's for Defense, or just plain John Q. Public, CINAUDAGRAPH SPEAKERS represent superior workmanship, fine materials and intelligent engineering design. Write now for the new Fall Catalog listing all speakers. It's free!

## CINAUDAGRAPH SPEAKERS, Inc.

Dept. TY, 921 W. Van Buren Street  
CHICAGO ILLINOIS



## GE Names Five New Officers

The five new vice-presidents elected by the board of directors of the General Electric Co., and announced by the GE president, Charles E. Wilson, are W. R. G. Baker, Chester H. Lang, David C. Prince, Elmer D. Spicer and Harry A. Winne.

The new officials were named as a result of a major change in the GE organization setup, under which the firm has four major operating departments: Appliance and Merchandise, under vice-president Hardage L. Andrews; Radio and Television, under vice-president Baker; Lamp, under vice-president Joseph E. Kewley, and the Apparatus Department which, because of its volume and diversification, will have five vice-presidents. These are: Mr. Lang, in charge of defense activities and also continuing as Manager of Apparatus Sales; Mr. Prince, in charge of application engineering; Earl O. Shreve, in charge of commercial activities; Mr. Spicer, in charge of manufacturing, and Mr. Winne, in charge of design engineering.

## Now's the Season for Recorded Chime Music

One of the holiday profit-builders for radio and sound men lies in the sales of chime recordings to churches and other institutions. These organizations want Christmas music and chimes for their sound systems during the season.

A specialist in supplying these recordings is Rangertone, Inc., 73 Winthrop St., Newark, N. J. For the "Rangercords" the firm has developed a specially durable blank with thermo setting resin coating. Customers may pick favorite hymns from a wide range, and order them recorded on these 10", 12", or 16" discs. Rangertone has prepared a list of over 500 popular hymns and folk songs, in booklet form, and this will be sent to all those interested. It includes a large group of chime Christmas carols, of special interest just now. The 24-page booklet also includes complete directions for ordering.

## New Refrigerators by Stewart Warner

The new 1942 lines of refrigerators of the Stewart Warner Corp., Chicago, were presented to SW distributors at their 11th annual convention at the Edgewater Beach Hotel in Chicago, with a total of seven new units in the showing. The company introduced three conventional models and four Dual-Temps.

Joseph C. Elliff, assistant general sales manager for Stewart Warner, said that "we deplore the reduced number of units we can build, but we fully realize the gravity of the OPM priorities situation and are especially anxious to cooperate." Mr. Elliff pointed out, however, that the available Dual-Temps are "nationally important" because of the homemaker's effort to combat today's rising costs of living.

# The FINEST MICROPHONES

for P.A. and RECORDING!



**AMPERITE  
VELOCITY  
MICROPHONE  
WITH  
PATENTED  
ACOUSTIC  
COMPENSATOR**



**New P. G.  
DYNAMIC  
WITH NEW  
SUPERIOR  
ELIPSOID  
PICK UP  
PATTERN!**



**AMPERITE KONTAK MIKES  
IDEAL FOR AMPLIFYING  
STRINGED INSTRUMENTS  
USED WITH ANY AMPLIFIER  
AND WITH RADIO SETS.**



ASK YOUR JOBBER . . . WRITE FOR FOLDER

# AMPERITE

561 BROADWAY NEW YORK



## Radio Robot



Silo, the Radio Robot Man, travels in a special car among dealers and jobbers, to star in local radio demonstrations. He's the latest promotion by Zenith Radio Corp.

## New Plant to Triple Hytron Production

To handle the increasing demands for radio tubes in National Defense, the Hytron Corp., Salem, Mass., has purchased the "Sunshine Factory" in Newburyport, Mass., according to an announcement by Hytron general manager Bruce A. Coffin. This plant was formerly used by the W. G. Dodge Co., and gives Hytron an extra 100,000 sq. ft. of floor space.

With the Salem plants, the firm will now be able to more than triple its present output. Operations at the new site will start shortly after the first of the year, as the new plant is ideally suited to production of radio tubes and other electronic devices, soon to be placed in production. In this expansion, Hytron thus uses facilities already available, and gets more speed and

economy into the general defense effort.

Hytron officials point to this move as another major expansion for the firm which started in 1921 with but two employees. The new plant will add approximately 600 workers to the payroll, bringing total employment to over 1,200. The company is owned and controlled by Bruce Coffin, Lloyd H. Coffin, and E. M. Batchelder, all active in management of the organization.

## Emerson Holiday Drive Coming

A big promotion campaign on the Emerson personal radio Model 432, aimed at the Christmas market, has been announced by Phil Gillig, sales promotion manager of the company. It includes new displays for the set, newspaper ads, window streamers and complete promotional materials.

Emerson also revealed through its president, Ben Abrams, that the firm now has an all-time high in unfilled orders. Mr. Abrams says that the demand comes from foreign as well as domestic markets, and that it applies to Emerson's complete line of 50 models. He declared that every effort was being made to handle this unprecedented backlog of orders.

The Emerson head has also commented on the result of an exhaustive study of radio buying habits in the New York area, made by a metropolitan newspaper there. The survey showed that "of all home radios bought in the first 6 months of 1940, over 25% were Emerson... a substantial increase over 1938 and 1939 when Emerson also led the field with over 19% purchase preference for each of those years."

## More Expansion for IRC

To handle the new defense requirements with minimum interference to its regular production, the International Resistance Co. has added 30% more manufacturing space at 401 N. Broad St., Philadelphia. This is the third expansion for IRC in five years.



Hytron's head men are president Lloyd H. Coffin, left, and Bruce Coffin, founder and general manager. See story above.

# DETROLA

## AUTOMATIC RECORD CHANGER

### RADIO-PHONOGRAPHS



Designed by  
**DETROLA**  
Engineered by  
**DETROLA**  
Produced by  
**DETROLA**

THE WORLD'S  
*Easiest-  
to-Operate*

### AUTOMATIC RECORD CHANGER

They're simple, trouble-free... A child can operate them. You will marvel at this wondrous performance!

Every  
Model Has  
All Five  
EXCLUSIVE  
DETROLA  
FEATURES

1. The only  
Automatic  
Changer that  
plays home  
recordings

2. Gearless, noise-  
less operation.

3. Manual or  
automatic rec-  
ord selector.

4. New type cen-  
ter-post with  
amazing features  
for convenience  
in adding or re-  
moving records.

5. Free-floating  
tone-arm pre-  
vents record harm.

And That's  
Not All...

Each plays ten 12"  
or twelve 10"  
records—has feather-  
weight tone-arm,  
everlasting needle.  
Radio or phono-  
graph. YOU GET  
PERFECT TONE!

Also Complete  
Line of  
DETROLA  
3-way Personals  
And Portables  
TABLE MODEL  
RADIOS  
FARM SETS  
AND  
RECORDIOLAS



See Your Detrola Dealer

# DETROLA

DETROLA BLDG. DETROIT, MICH.



MODEL 412  
Automatic record changer  
with improved speaker



MODEL 417  
5-tube automatic radio-  
phonograph combination



MODEL 419  
6-tube automatic radio-  
phonograph combination



MODEL  
427

Console  
automatic  
radio-  
phono-  
graph

MODEL  
428  
Console-  
grand  
automatic  
radio-  
phonograph

# PACKED WITH POWER!

CONSERVATIVELY rated at 55 Watts Output, Thordarson Model T-30W55 amplifiers have an exceptional overload characteristic. This assures a peak reserve for quality reproduction at high sound levels.



Four microphone circuits are provided with independent gain controls for mixing. Optional low impedance input transformers are multiple shielded for absolute elimination of hum. Two phono input circuits operate into a fader gain control and may be mixed with one or all of the microphones. Bass or treble frequencies can be accentuated or attenuated independently of each other. Model T-30W55 is the ideal amplifier for installation in theatres, schools, institutions, dance halls, parks, flying fields, stadiums, race tracks, soundtrucks, etc. Ask your Thordarson Distributor for Amplifier Catalog 600F.

## AMPLIFIER DIVISION

# THORDARSON

500 WEST HURON STREET  
CHICAGO, ILLINOIS, U.S.A.

ELECTRIC MFG. CO.

TRANSFORMER SPECIALISTS SINCE 1895

## RADIO? COMMUNICATIONS? ELECTRIC POWER?

There is a PRECISION INDUSTRIAL CIRCUIT TESTER to meet your INDIVIDUAL SENSITIVITY REQUIREMENTS

Ranges to 6000 Volts—60 Amps—10, 20 or 60 Megs—70 DB  
1000, 5000 or 20,000 ohms per volt!

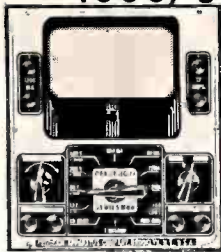

- ★ Series 844 (illustrated above)  
1000 ohms/volt AC and DC
- ★ Series 845 5000 ohms/volt DC  
Plus 1000 ohms/volt AC and DC.
- ★ Series 856 20,000 ohms/volt DC  
Plus 1000 ohms/volt AC and DC

★ SELECT THE AC-DC  
VOLT-OHM-DECIBEL-MILLIAMMETER  
BEST SUITED TO YOUR NEEDS

ADD THE SERIES J ★  
MULTI-RANGE A.C. AMMETER

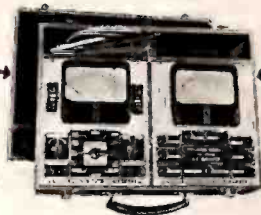

- ★ Series J (illustrated above). Eight  
AC ammeter ranges. 300 MA full scale  
to 60 AMPS. Available individually or  
as companion unit to Series 844, 845  
or 856.

★ Series 844-J Combination AC-DC Industrial Circuit Tester (center illustration). Complete with ohmmeter batteries and high voltage test leads. Furnished in walnut finished hardwood portable case, size 11 x 15 x 6" \$48.95

★ Series 845-J Combination AC-DC Industrial Circuit Tester. Complete as above \$52.95

★ Series 856-J Combination AC-DC Industrial Circuit Tester. Complete as above \$59.95

WRITE FOR NEW PRECISION INDUSTRIAL TEST INSTRUMENTS CATALOG No. 42-E

# PRECISION TEST EQUIPMENT

INDUSTRIAL • LABORATORY • RADIO • TELEVISION

PRECISION APPARATUS COMPANY • 647 KENT AVENUE • BROOKLYN, N. Y.  
Export Division: 458 Broadway, New York City, U. S. A. • Cable Address: Morhanex

## Newspapers Publish Hit Music

Now being printed in full in the "Puck Comic Weekly" Sunday section of 15 Hearst newspapers throughout the country, is a weekly song hit, complete with words and music. The hits are picked each week by a major band leader, and as most of the artists are Victor and Bluebird stars, Victor is helping its dealers cash in on the interest created.

An example of how this works is seen in New York, where the RCA jobber, Bruno-New York, Inc., is suggesting to dealers that they display the song hit page from the *Journal-American*, along with weekly promotional material and a list of each artist's complete recordings. The tune for Nov. 9th is Sammy Kaye's "Honey Bunch"; it is suggested that dealers proclaim the following week as "Sammy Kaye Week," and so on through the string of popular artists coming up.

## Jobber Is Not "Fair Weather" Friend

A special message in jumbo telegram form has been sent out by Simon Distributing Corp., Washington, D. C., giving the dealer and serviceman customers of the firm a novel and dramatic statement to the effect that Simon is not "priority snooty." The message describes the extraordinary seller's market that exists today and says that "distributors like ourselves can, without a great deal of effort, sell all of the merchandise allocated to us by various suppliers...but we have not forgotten that our best business asset is the loyalty of our customers...we appreciate your orders as much as ever."

The telegram adds that "we are looking zealously for new and available items to supplement those which have been curtailed," and conclude with "when the show is all over and victory has been attained, we hope that you will be able to say that there was no fluctuation in our loyalty to you...."

## Regottaz Becomes RCA Export Head

The new export manager of RCA Mfg. Co. is J. M. Regottaz, whose headquarters will be at Camden, N. J. He has been with RCA for 19 years and has traveled extensively in Latin America, Europe and the Far East. Mr. Regottaz will now direct and coordinate all export activities on all RCA products, according to the announcement by vice-president J. D. Cook.

## New Rep in Dallas

A new manufacturers representative in the southwest is the Merritt Co., 209 W. Suffolk St., Dallas, Tex., announced by J. C. Merritt, Jr. Mr. Merritt has been sales manager of the Dallas Electric Supply Co. and was formerly connected with the George E. Anderson Co., also of Dallas. D. L. Merritt will be in charge of the new office.



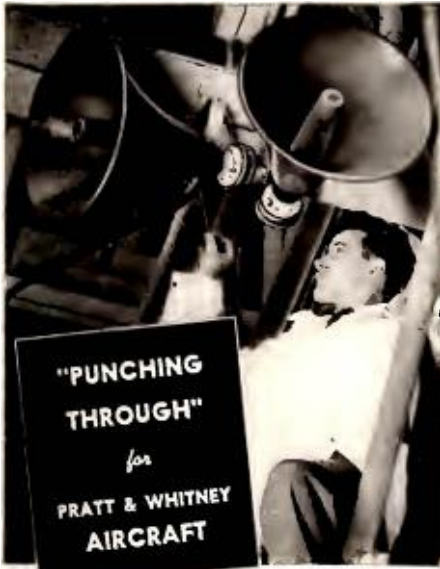

### ATLAS SOUND "DR" Speakers Help Defense Plant Production

THE ABILITY of the speakers to punch through all sorts of background machine noises is uncanny," reports Seeli Radio Co. of Hartford, Conn., who installed 23 "DYNAMIC REFLEX" Projectors and P. M. Driver Units in the new Pratt & Whitney Aircraft engine assembly plant. Many speakers were tested... but Seeli recommended Atlas Sound... which Pratt & Whitney selected. \* Use ATLAS SOUND on your next national defense installation... and you can guarantee "sound" coverage.



FREE: Sound Guide F-41!  
(Describes 101 p. a. products)

**ATLAS SOUND CORPORATION**  
1448 39th Street, Brooklyn, N. Y.

### Book Prices to Be Advanced

Although the Radio & Technical Publishing Co., 45 Astor Place, New York City, had done some advance planning and was able to hold off any boost in the prices of its books, the firm now announces that Jan. 1st, a price increase will be necessary because of rising costs of production. Prices on Ghirardi's "Modern Radio Servicing" and on his "Radio Physics Course" will be advanced one dollar each, but the old prices of \$4 each will stand for orders mailed up to and including Dec. 31. The \$3.50 tag on "Radio Troubleshooter's Handbook" will not be changed now.

### Sayre Named President of Bendix

The board of directors of Bendix Home Appliances, Inc., has elected Judson S. Sayre president of the corporation, following the resignation of D. O. Scott as head of the firm. Mr. Sayre is one of the country's best known appliance executives, and was at the time of his election the Bendix vice-president and director of sales. He has been active in the management of the firm since 1936, and under his guidance the company's sales have boomed; in the first 8 months of this year they were 142% greater than for the same period of 1940.

### NEW BOOKLETS

New 1942 Precision test equipment catalog is now available for general distribution and may be obtained either from local jobbers or by writing to Precision Apparatus Co., 647 Kent Ave., Brooklyn, N. Y.

A new bulletin issued by Cannon Elec. Development Co., 3209 Humboldt St., Los Angeles, Cal., supersedes all previous type "K" bulletins. The K & RK plugs and receptacles listed in this catalog are designed for aircraft applications.

Hallicrafters 1942 catalog of receiving, transmitting and radiophone equipment describes and illustrates models in different price ranges to meet varied requirements. Available from the Hallicrafters Co., 2611 Indiana Ave., Chicago, Ill.

One of America's most familiar cartoon techniques (Dr. Seuss) and less than 125 words of text are used to explain the Stromberg-Carlson "Acoustical Labyrinth" feature in a new booklet called "What Is a Wild Tone?" Stromberg-Carlson Tel. Mfg. Co., 100 Carlson Rd., Rochester, N. Y.

Walter L. Schott Co., 5266 W. Pico Blvd., Los Angeles, Cal., has just issued a new Walsco Unibelt Reference Chart which is available to distributors, dealers, and radio servicemen. Lists the most popular sets using dial belts and gives the required Unibelt number and length for each set.

## Step Ahead

with these  
**PLUG-IN ELECTROLYTICS**



### STANDARD PLUG-IN ELECTROLYTICS

Type AEP-450 — 450 v. D.C.W.

SINGLE SECTION:  
10, 20, 40 and 80 mfd. 1-5/32" dia.  
x 2 1/2" and 4 1/4" tall.

DOUBLE SECTION:  
10-10 and 20-20 mfd. 1-5/32" dia. x 2 1/2" and 3" tall.

TRIPLE SECTION:  
10-10-10 mfd. 1-5/32" dia. x 2 1/2" tall.  
Type AEP-45025

10 x 10 x 450 + 20 x 25. 1-5/32" dia. x 2 1/2" tall.

● Like to keep well ahead of the crowd? Well, here's a hot tip: Begin using these handy plug-in electrolytics for those radio, sound-system and electronic assemblies you're building or servicing regularly. They're the coming thing. They're smart — octal base fits standard octal socket; a cinch to test and replace; handle like another tube. Your customers will surely appreciate this up-to-the-minute touch.

### ● Ask Your Jobber . . .

He'll gladly show you these Aerovox Plug-in Electrolytics. Better still, try them in that assembly you're putting together. Ask for latest catalog . . . or write us direct.



**HUGELY EXPANDED NATIONAL ADVERTISING**  
*means hugely*

**EXPANDED PROFITS**

for ALL

**RECOTON**

DEALERS!  
RECOTON'S large scale national advertising campaign is now reaching millions of readers monthly . . . RECOTON has scheduled advertising in class and mass market magazines, simultaneously we introduced "CONCERTO," our new louder tone phonorecord and many new packages . . . all to send you more business.



A brilliant multi color display that no one can miss. This eye-catching silent salesman for home recording needles is a unique dispenser and sells on sight. Stocks RECOTON Steel Cutting, Stellite Cutting and Transcription Playback needles. The hardest pushing sales aid seen anywhere. Write for facts.

**RECOTON CORP.**

21-10 49th Ave.—L. I. C., N. Y.

## "Keep 'em Happy With Radio Gifts

(Continued from page 14)

standing training cantonments. A poster at the top of the window reads "Let Your Son Take A Radio With Him To Camp." Others point out the desirability of the radio as a companion during cold winter nights, and where no other form of amusement is provided. More than 15,000 people per day see this window. Finally, Mr. Murray has run a weekly newspaper ad, centered around a cartoon showing a young conscript in various phases

## BIGGER SETS, TOO

(From a letter written by Private Mendel H. Lieberman, Fort Ord, Monterey, California, to NBC)

"Some of the boys here enjoy listening to symphonic music in a place where they are undisturbed by conversations and games and competing radios to be found in the barracks . . . I have organized 'listening hours' in order to listen to your broadcasts of the NBC Symphony."

of army life—below this showing a typical small radio as sold by the shop. Copy invites the parents or friends of any conscript to check with the Delmar Radio Shop for prices as going-away gifts. Response from this ad, and window display, and the clever telephone campaign have added up into an all-time record radio sale for this aggressive St. Louis dealer.

## The Supply of GE Refrigerators

In a statement on the effect the OPM order which restricts the production of household refrigerators, A. M. Sweeney, the General Electric refrigerator section manager, says that his company anticipated the order and took steps to lighten its effect. He says that GE "wholeheartedly accepts the OPM order . . . in the interest of the national defense program . . . although it is a very serious curtailment as it reduces our refrigerator production to less than 45% of our going rate . . ."

By planning ahead, the firm now faces a cut that is far less severe than would have been necessary if it had continued its high rate of production in August and September. Mr. Sweeney declares that "our retail outlets should be able to meet their present demands for GE refrigerators for the next several months . . . and we will do everything in our power to continue production under the curtailment order up to the limit of our ability to get materials."

GE is making every effort to assign new work to its employees who have been released from the refrigerator production departments.

## Florida Jobber in Expansion

"Our record business is up 50% over last year," reports W. D. Rowlands, president of Major Appliances, Inc., Florida jobber with offices in Miami, Jacksonville, Tampa and Orlando. The occasion is the expansion of the Jacksonville quarters, which have been moved from 222 E. Bay St. to 474 Riverside Ave., with new showrooms and warehouse space for records and appliances.

Radio business for this distributor runs about 25% over last year, and is expected to increase more as the winter season gets under way. Like other jobbers, this firm faces "a delivery problem," but it continues with aggressive sales plans, anyway.

## Reps for Freed

Two new representatives have been appointed by Freed Transformer Co., 72 Spring St., New York City. Fred Groves, 3106 Edgewood Ave., Richmond, Va., will cover the states of Virginia, West Virginia, Tennessee, North and South Carolina. In the states of Georgia, Florida and Alabama, the new rep is Stanley K. Wallace, Lutz, Fla.

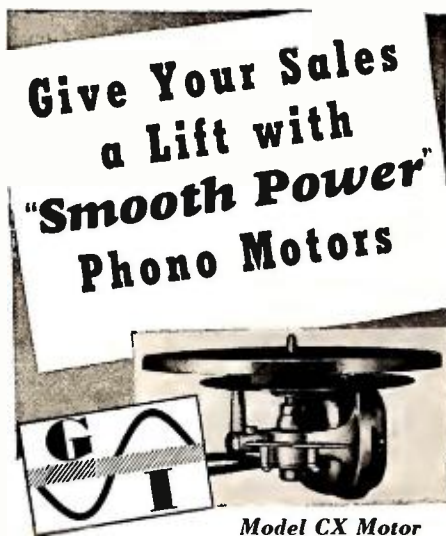

**M**AKE the "power plant" in your phonographs and combinations do a share of the selling. In sure steady, quiet turntable operation—get top-quality record playing, free from vibration or wow—by specifying General Industries "Smooth Power" Motors. Plenty of choice, in light, medium or heavy weights. Also supplied in all G. I. changers, recorders and recorder-changer units.

G. I. full-line service—the most complete line of phono power mechanisms obtainable from one manufacturer—gives you precision manufacturing, uniform high quality and specialized engineering design. Sellers in all new sets—sellers for rebuilding and replacements.

Send for Catalog and Prices

**The GENERAL INDUSTRIES CO.**

Dept. 15 ELYRIA, OHIO

Order your Cutting and Play-back Needles from our affiliate, Gener: l Phonograph Mfg. Co., Inc., Putnam, Conn.

**THIS NEW BOOK WILL HELP YOU**

**710 PAGES**  
more than 400 are brand new!

**NOW ONLY \$3.50 COMPLETE**

**MAKE MORE MONEY**  
in Radio Servicing!

**GHIRARDI'S REVISED & ENLARGED RADIO Troubleshooter's HANDBOOK**

IF NOT AVAILABLE AT YOUR LOCAL JOBBER USE COUPON IN ORDERING

From the Editor of SERVICE: ". . . definitely a 'best buy' even for those servicemen who have already the previous edition."

"As important to servicemen as test equipment," M. L. Muhlman, Ed., RADIO SERVICE DEALER. Now, when you haven't hours or hands enough to handle the business the emergency is creating, Ghirardi's revised, up-to-the-minute Radio Troubleshooter's Handbook is vitally important. It can save you time . . . increase efficiency—enable you to get a larger slice of the servicing boom.

Have at your fingertips for quick, easy reference trouble-and-remedy Case Histories for 4,607 models of over 196 makes of receivers and record changers . . . I.F. peaks and alignment data for 20,173 superhets . . . battery replacement data for 1,250 portable receivers . . . and lots more. **SPECIAL MONEY-SAVING COMBINATION OFFER!** Radio Troubleshooter's Handbook and Ghirardi's Modern Radio Servicing. (A complete course in modern servicing instruments and practical service work.) Both books at this special price, \$7.00.

**5-DAY MONEY BACK GUARANTEE!** Take five days to examine Ghirardi's revised and enlarged Radio Troubleshooter's Handbook, and Modern Radio Servicing. If you're not convinced these two volumes will pay for themselves, return the books and your money will be refunded. See your local distributor NOW. If he hasn't both books in stock, order direct. **DON'T FORGET . . . PRICES GOING UP JANUARY 1.**

**ORDER NOW AND SAVE TIME AND MONEY!** FREE! Color Code Chart—Get your copy of Ghirardi's latest Capacitor and Resistor color code wall chart. FREE—Simply check the coupon. **YOUR LOCAL DISTRIBUTOR** can supply you with the new Radio Troubleshooter's Handbook. If he hasn't ordered his stock of Ghirardi books, use this coupon to order direct.

**GOOD FOR BOTH BOOKS!**

Radio & Technical Publishing Co. (Dept. RT-121)  
45 Astor Place, New York

Please rush my copy of Ghirardi's Revised Handbook on 5-Day Money-Back trial. I enclose \$3.50 (\$4 foreign).

Me for that special Combination Offer! I enclose \$7.00 (\$8 foreign)

My jobber is . . . of . . .

Please send me a copy of your Resistor-Capacitor color code wall chart FREE.

Please send me additional info on the new Handbook.

Name . . . . .  
Address . . . . .  
City . . . . . State . . . . .

## Changers Are Tonic to Record Sales

The vital part played by the automatic record changer, in the tremendous sales up-surge in the record and phonograph industry, is described by Leonard Carduner, sales promotion manager of the Garrard Sales Corp., in a statement to *RADIO TODAY*.

"The changers," says Mr. Carduner, "have made it so easy, pleasant and thrilling to listen to records, that they have unquestionably boosted record sales...after consumers buy a changer they begin to realize how greatly it adds to their enjoyment of the music they want to hear...this is an incentive to buy more records and to continue to build record libraries." This executive compares the changers to the building of new highways—the roads are built because they are needed, but they are then responsible for increased traffic.

He declares too that dealers and jobbers should get thoroughly familiar with the various types of changers now available, for sale separately or in combinations. He recommends a detailed study of the works and the performance of the units, and suggests that each store should encourage one serviceman to specialize in the changers.

## Vote for Long-Life Phono Needles

The most popular long-life phonograph needle in the Chicago metropolitan area, according to the results of a survey made there last month and reported by Permo Products Corp., 6415 Ravenswood Ave., Chicago, is Permo's Fidelitone Floating Point needle. Permo regards this as a feat, since the needle has been on the market less than a year. The firm says that the needle design, which "filters record scratch" and is compounded of precious platinum metals, did the trick.

Permo also makes other Fidelitone points similarly tipped, including a De Luxe job, recording stylii, and Transcript-Tone Permo points.

## Extra Salesmen for Dealers

Now available through distributors of the Emerson Radio & Phonograph Corp. is a new miniature "silent salesman" in rich colors, suitable for window or counter. This display has room for three radios, and features rugged compactness.

Emerson jobbers are also offering a novel decalcomania for dealers' windows, with an eye-catching blend of 20 colors and a lively radio sales message.

## Clarostat's New Engineer

Jimmy Youngblood, who has been a special factory representative for Clarostat Mfg. Co., in the Marion, Ind., area, has been transferred to the Brooklyn, N. Y., headquarters of the company, to take a post as sales engineer.



# Do you use MICROPHONE CABLE?



8400—Single Conductor Cable



8402—Two Conductor, Crystal Microphone Cable



8422—Two Conductor Corban Microphone Cable



8423—Three Conductor Microphone Cable



8432—Shielded—for Temporary Installations

For Antenna Wire and Kits, Hook-up Wires, Transmission Cables, and all other specialized wires for radio and sound equipment—see Belden Catalog 841.



## Here Is Wire Insurance for Your Installations

Good wires mean good connections. That microphone you are installing will give longer, more satisfactory service with the right wire engineered for the particular type of job.

Belden microphone cables have been engineered for original equipment. They are furnished in a complete line for all types of applications. Belden-developed low capacity insulation, specially stranded conductors, and unique construction provide a cable that gives plus performance and longer life.

Ask your jobber.

# Belden WIRE

FOR GOOD CONNECTIONS

## AMERICAN RADIO TUBE CO.

Manufacturers of

### BALLAST TUBES

RADIO TUBES DIAL LIGHTS  
VOLUME CONTROLS  
CONDENSERS

Distributed by

### ART RADIO CORP.

115 LIBERTY ST.

NEW YORK

Quality at Lowest Prices . . .

Send for Price List . . .

ART RADIO CORP.,  
115 Liberty St., N. Y. C.  
Gentlemen: As per "ad" in *RADIO TODAY*  
please send Price List.

NAME .....

ADDRESS .....

CITY..... STATE.....

Please Indicate SERV. MAN DEALER  
Serv. Man or Dealer



## For Triplet Customers Only

Long before the state of emergency was proclaimed, the Triplet Company was getting ready to do its part in building our national security. We knew that we must meet important new responsibilities. At the same time, we felt keenly our continuing obligations to our customers—old friends with whom we have had happy business relations through many years.

We doubled—then tripled—our output to fill the needs of our old accounts. We added to our production facilities . . . hired many more men . . . are working extra shifts at time-and-a-half.

All this has not been enough. We have been called on to produce more and more for national defense. We are proud of the job we are doing to help meet the emergency, but it is difficult not to be able to serve our old friends equally as well. In the face of these conditions, the Triplet Company has adopted these policies "for the duration."

**FIRST:** We will continue to serve you by our service to our mutual responsibility—the national emergency.

**SECOND:** We will continue to do everything we can to fill orders from our regular customers, even though some deliveries may be temporarily delayed. No business from new accounts has been nor will be accepted until after our old friends have been served, except where priorities make it impossible to do so.

**THIRD:** Our engineering and research departments will continue to work on the development of superior equipment and improved methods to serve you still better when we can resume normal operations.

The present emergency is incidental and as we work towards the future, we will do our best to continue to merit your confidence and loyalty.

*C. L. Triplet*  
President

The Triplet Electrical Instrument Company  
Manufacturers of Precision Electrical Instruments

## RADIO PARTS IN DEFENSE

(Continued from page 35)

not enough, for it was found that vital delicate parts of instruments might fail because of vibrations of special frequencies present on the plane. So the new plan is to hook a powerful 50-watt loudspeaker to a shaking-table and then vibrate the instruments at every frequency in the audible and sub-audible range, fed from a radio-tube oscillator.

Going a step further, recordings have been made of plane vibrations in flight. These records can then be taken to the laboratory and played into the speaker-vibrator thus reproducing, on the laboratory shaking-tables, in both intensity and pitch, most of the vibrations of any type of actual plane in flight.

### CONTACT MIKES ON PLANES

Airplane pilots are now using contact microphones to listen in on each of their engines in succession, and to detect in advance any incipient engine trouble before it develops into serious proportions. With a contact mike applied to the engine, the pilot can hear its internal noises, without all the extraneous sounds due to wind rush around the plane. Such a mike enables the pilot to "apply his ear," figuratively, to any motor and to any vital part.

Such contact mikes have also proven valuable to pilots to detect the beginning of "wing flutter" during power dives. Such flutter, once begun, may reach dangerous proportions without giving the pilot any warning. But with his contact mikes perched way out on the extreme wing tips, he gets immediate notice of the beginning of the flutter, and can revise his flying position to stop the flutter before it has extended itself to hazardous amplitudes.

### SHIP-ENGINE NOISES

Contact mikes have also reduced the hazards of handling time-bombs and other deferred explosives. Instead of exposing the anti-bomb crew to the danger of being blown up, a microphone is placed in contact with the bomb using a long pole and then by wire from a safe distance the bomb experts can listen to the bomb clock work or firing mechanism, and determine the best way of handling that particular bomb.

Another way in which radio tubes aid in national defense, is the geographical location of new deposits of minerals and metals in which a shortage now exists in the supplies for American factory production. New radio-tube devices detect underground ores by a variety of methods using magnetic, electrical and radio principles.

### Radex Corp. Expands

The Radex Corp. of 1733 Milwaukee Ave. now occupies larger quarters at 1308-22 Elston Ave., Chicago. Radex reports increased business on commercial products, particularly the \$2 "Pocketracer" and the \$7.95 "Broadcast Signal Generator," as well as extra work on government contracts and sub-contracts.

## NEW BEST SELLER IN HOME RECORDERS!



Here's Talk-A-Phone's newest hit—a sensational 3-Speed Home Recorder! (1) Makes Records at 33 1/3 or 78 RPM; (2) Plays Records at either speed; (3) Works as PA System. 5 Tube Amplifier; 3 1/2 Watts Output; 6 1/2" Speaker; Electric Eye; with Crystal Microphone. Plays 10" and 12" records with lid closed. In handsome luggage-type portable case; 16" x 16" x 11". Quality-built—priced for volume sales! Write for details.



### A Complete PHONO LINE—20 Models! COMPLETE INTERCOM SYSTEM LINE!

Profit-Builders all Wired and Wireless Players, Player-Amplifiers, Changer Players, etc. Also fast-moving Intercommunication Systems priced to sell! Take on these profitable lines! Distributors—a few choice territories still open. Dealers—see nearest distributor or write to us direct. Prices, discounts, literature sent on request.

**Talk-A-Phone Mfg. Co.**  
1219L W. VAN BUREN ST., CHICAGO

## STERLING'S NEWEST POCKET METERS ARE REAL ASSETS TO DEALERS AND SERVICEMEN

A complete new line for testing "A" & "B" batteries of the various types of portable radio sets. Scientifically determined loads guarantee dependable results. Flexible terminals fit all socket holes.

Featured by all leading distributors



Model 42A tests all standard portable batteries. Red and Green graphic chart gives instant readings. Net price \$3.60. Write for catalog 519-0.

**THE STERLING MFG. CO.**  
9205 Detroit Ave. Cleveland, O.

# INDEX TO ADVERTISERS

	Page
AEROVOX CORP.	55
ALLIANCE MFG. CO.	50
ALLIED RADIO CORP.	30
AMPERITE CO.	52
ART RADIO CORP.	57
ATLAS SOUND CORP.	55
BELDEN MFG. CO.	57
BITTER CONSTRUCTION CORP., A.	41
BONN CO., LEW	31
BURSTEIN-APPLEBEE CO.	31
CENTRALAB	43
CINAUDAGRAPH SPEAKERS, INC.	52
CLAROSTAT MFG. CO., INC.	59
CONTINENTAL RADIO & TELEV. CORP.	Cover 4
DETROLA CORP.	53
EMERSON RADIO & PHONO. CORP.	1
FARNSWORTH TELEV. & RADIO CORP.	2
GENERAL ELECTRIC CO.	48
GENERAL INDUSTRIES CO.	56
HATRY & YOUNG	28
HYGRADE SYLVANIA CORP.	37
INTERNATIONAL RESISTANCE CO.	49
JAPPE COMPANY, H.	28
KEN-RAD TUBE & LAMP CORP., INC.	47
KINKADE RADIO SUPPLY	32
KING & IRWIN, INC.	28
LAFAYETTE RADIO	29
LIPPMAN & CO., AARON	29
LUKKO SALES CORP.	30
MALLORY & CO., INC., P. R.	Cover 2
MARSH RADIO SUPPLY CO.	30
MEISSNER MFG. CO., 27, 28, 29, 30, 31, 32, 33	4, 5
NATIONAL BROADCASTING CO.	39
NATIONAL UNION RADIO CORP.	39
OHMITE MFG. CO.	51
PEMBLETON LABS	31
PERMO PRODUCTS CORP.	41
PHILCO RADIO & TELEV. CORP.	23
PRECISION APPARATUS CO.	54
RADIO CORP. OF AMERICA	6
RADIO EQUIPMENT CORP.	31
RADIO PARTS CO.	31
RADIO PRODUCTS SALES CO.	33
RADIO SPECIALTIES CO.	33
RADIO & TECHNICAL PUBLISHING CO.	56
RADIO TEL. SUPPLY CO.	33
RADIOTRICIAN	28
RADOLEK CO.	30
RANGERTONE	7
RAYTHEON PRODUCTION CORP.	50
RCA MFG. CO., INC.	3, 25
RECOTON CORP.	55
RIDER, JOHN F.	47
RUCKER, LESLIE C.	60
SHULER SUPPLY CO.	32
SONORA RADIO & TELEV. CORP.	39
STERLING MFG. CO.	58
STODDARD, J. HARPER	32
STROMBERG-CARLSON TELE. MFG. CO.	12
SUEDEKUM SONS	32
SUN RADIO CO.	29
TALK-A-PHONE MFG. CO.	58
TERMINAL RADIO CORP.	29
THORDARSON ELEC. MFG. CO.	54
TRIPLETT ELEC. INSTRUMENT CO.	58
TYDINGS CO.	28
UNIVERSITY LABORATORIES	60
UTAH RADIO PRODUCTS CO.	Cover 3
VAN SICKLE RADIO SUPPLY CO.	29
WALDER RADIO & APPLIANCE CO.	32
WALKER JIMIESON	30
WESTERN RADIO & ELEC. CO.	33
WESTON ELECTRICAL INSTRUMENT CORP.	45
ZACK RADIO SUPPLY CO.	33
ZENITH RADIO CORP.	9

While every precaution is taken to insure accuracy, we cannot guarantee against the possibility of an occasional change or omission in the preparation of this index.

## Aveyard Joins Hays MacFarland

The Chicago advertising agency, Hays MacFarland & Co., now has a new partner and vice-president, A. E. Aveyard, and will change its name to MacFarland, Aveyard & Co. Mr. Aveyard is a nationally recognized advertising authority and had previously been a director and vice-president of two of the country's leading agencies. The Chicago firm is headed by Hays MacFarland, and associated with him are M. A. Jennings and A. B. Discens. These three principals, with Mr. Aveyard, will continue as before to direct the organization.

## Two New Reps for Talk-A-Phone

Talk-A-Phone Mfg. Co., 1219 W. Van Buren St., Chicago, now has two new sales representatives. Earl T. Harker, 326 Westmoreland Drive, Trenton, N. J., is assigned to New Jersey, metropolitan New York and Pennsylvania east of Harrisburg. S. W. Berk, 530 William Penn Way, Pittsburgh, Pa., will cover West Virginia, Pennsylvania west of Harrisburg and New York state with the exception of metropolitan New York.

### STATEMENT OF THE OWNERSHIP, MANAGEMENT, CIRCULATION, ETC., REQUIRED BY THE ACTS OF CONGRESS OF AUGUST 24, 1912, AND MARCH 3, 1933

OF RADIO & TELEVISION TODAY, published monthly at New York, N. Y., for Oct. 1, 1941. State of New York, N. Y., County of Westchester, N. Y. Before me, a Notary Public in and for the State and county aforesaid, personally appeared Orestes H. Caldwell, who, having been duly sworn according to law, deposes and says that he is the Editor of RADIO & TELEVISION TODAY and that the following is, to the best of his knowledge and belief, a true statement of the ownership, management (and if a daily paper, the circulation), etc., of the aforesaid publication for the date shown in the above caption, required by the Act of August 24, 1912, as amended by the Act of March 3, 1933, embodied in section 537, of the Postal Laws and Regulations, printed on the reverse of this form, to wit:

1. That the names and addresses of the publisher, editor, managing editor, and business managers are: Publisher, M. Clements, 277 Park Ave., New York, N. Y.; Editor, Orestes H. Caldwell, Catroek Road and Bible St., Cos Cob, Conn.; Managing Editor, Darrell Barteel, 309 E. 48th St., New York, N. Y.; Business Manager, M. H. Newton, 533 W. 215th St., New York, N. Y.

2. That the owner is (if owned by a corporation, its name and address must be stated and also immediately thereunder the names and addresses of stockholders owning or holding one per cent or more of total amount of stock. If not owned by a corporation, the names and addresses of the individual owners must be given. If owned by a firm, company, or other unincorporated concern, its name and address, as well as those of each individual member, must be given.) Caldwell-Clements, Inc., 480 Lexington Avenue, New York, N. Y.; Orestes H. Caldwell, Catroek Road and Bible St., Cos Cob, Conn.; M. Clements, 277 Park Ave., New York, N. Y.

3. That the known bondholders, mortgagees, and other security holders owning or holding 1 per cent or more of total amount of bonds, mortgages, or other securities are: (If there are none, so state.) None.

4. That the two paragraphs next above, giving the names of the owners, stockholders and security holders, if any, contain not only the list of stockholders and security holders as they appear upon the books of the company but also in cases where the stockholder or security holder appears upon the books of the company as trustee or in any other fiduciary relation, the name of the person or corporation for whom such trustee is acting, is given; also that the said two paragraphs contain statements embracing affiant's full knowledge and belief as to the circumstances and conditions under which stockholders and security holders who do not appear upon the books of the company as trustees, hold stock and securities in a capacity other than that of a bona fide owner; and this affiant has no reason to believe that any other person, association, or corporation has any interest direct or indirect in the said stock, bonds, or other securities than as so stated by him.

(Signed) Orestes H. Caldwell  
Sworn to and subscribed before me this 29th day of September, 1941.  
B. M. Phillips  
Notary Public Westchester County.  
Notary Public N. Y. County (Jer's No. 522.  
Notary Public N. Y. County Registers No. 2P327.  
(My commission expires March 30, 1942.)  
New York County Commission expires March 30, 1942.

## Power Rheostat

*as engineered by*  
**CLAROSTAT**



★ Tough! That best describes the Clarostat Power Rheostat. Used in today's fighting planes. Found in finest equipment. You too can enjoy the features of this sturdier power rheostat—insulated metal-core winding for uniform heat distribution and radiation; winding imbedded in cold-setting inorganic cement; heat-resistant ceramic body; unique tripod-type rotor; graphited-copper contact shoe riding on collector ring and winding; 25-watt rating even at one-third resistance setting. Other tough Clarostat items are:

### GREENOHMS . . .

Power resistors in fixed and adjustable types. 10 to 200 watts. Popular resistance values. Protected by unique Greenohm inorganic cement coating. Will withstand severe overloads without finching. Immune to wide temperature changes. Tougher than ever!

### GLASOHMS . . .

For tight places, these tiny flexible wire-wound resistors are just the thing. Fibre-glass cores and fibre-glass braided coverings. Can be operated at temperatures up to 1000° F. Frequently used as miniature heating elements. 1-watt and 2-watt per body inch ratings. Popular resistance values. Inexpensive. Practical. Tough.

### Ask York Jobber . . .

Order these items from him. Ask for latest descriptive literature and servicing data. Or write us direct.

**CLAROSTAT MFG. CO., Inc.**  
285-7 N. 6th St., Brooklyn, N. Y.



**Granddad didn't Need it—  
Neither did Dad  
(in the good ole days)**

**BUT YOU—Mr. Radio Man**

You know your circuits and you keep pace with modern inventions. But unless you are a good businessman, what good is it???

**"THE BUSINESS HELPER"**

by **Leslie C. Rucker**  
Past Pres. NRPDA

Based on 23 years of the study of the problems of the little man a 128 page, non technical, handbook, written in your own language for the modern man who operates a small business.

Among the problems discussed are Locations, Customer Relations, Buying, Selling, Contracts, Overhead Expenses, Banking, Bookkeeping, Collecting, Advertising, Employees, Insurance, New Business, Partnerships, Credit.

Endorsed by Sylvania — National Union — Radio Today — Parts

**Sells for \$2.00**

See your jobber or write to

**LESLIE C. RUCKER**

1312 14 St., N.W., Washington, D. C.

**Colorado Dealer  
Beats Shortages**

(Continued from page 22)

ment sales. Austin has realized a surprising number of sales to customers who pay cash, then ask the store to keep the set for them for several months.

Austin makes a point of high trade-in allowances, to buyers of higher-priced sets. Approximately twice standard allowance on trade-in sets is offered by radio salesmen if customers will buy above the \$79 average anywhere up to \$180.

**BIGGEST HEADACHE GONE**

Thus, slowing down on advertising promotion, equalization of sales over all price lines, and the allowance incentive have enabled this Denver dealer to keep up a stock of lower-priced radios for the customer who cannot afford to pay more—and there is little stock problem as a result.

**Don't Conceal Truth  
from Customer**

Editor RADIO TODAY:—

In a recent letter appearing in RADIO TODAY, radio service engineers were advised:

"Never to repair a set while the customer waits. They should never repair it in his presence. And they should never tell him exactly what was wrong."

This whole attitude, I feel, is basically wrong. But the last sentence is the worst. If it should be followed generally, it would only increase the public distrust indicated by the *Reader's Digest* article.

Aside from the moral issue, which is fully valid, the course of complete honesty pays good dividends.

The best way for the radio repair man to avoid cheating himself is to do good, thorough work, tell his customer the truth, and charge the full and reasonable amount for all services rendered.

With best wishes for your excellent magazine.

Arthur Bessey Smith  
Associated Electric Laboratories  
Chicago, Ill.



H. M. L. CAPRON,  
Merchandising Editor

**CAP SAYS:—**

**WHATEVER WAY THE CAT  
JUMPS!**

- Tomorrow is Another Day.
- Two years ago the French were a free and proud people.
- Today they are hungry and cold and reduced to virtual serfdom.
- A few years ago the radio business was characterized by cut-throat tactics—slim profits—and a mad search for new means of getting customers to buy radios.
- Today consumers are doing the hunting, and consumer buying is riding a new flood tide—setting new high marks.
- BUT TOMORROW IS ANOTHER DAY.
- Don't let the conditions of today blind you to the fact that this situation will not last forever.
- Some day, perhaps soon, entirely different conditions will prevail.
- The consumer buying tide will recede.
- Prices may spiral upward, or nose-dive downward.
- Radio production may be further drastically reduced—or *all restrictions may be off.*
- Many other changes, too, will occur.
- Now, more than ever, the future of your business depends upon your ability to *think clearly, act surely,* and
- "Be prepared to catch the cat no matter which way she jumps."

*University*

YESTERDAY your BEST sound customer was the NATIONAL DEFENSE PROGRAM.

TODAY it is your "MUST" customer.

REMEMBER: more sound equipment is necessary in connection with the

**Defense Program than All Other Channels**

**Combined**

NOTE: almost all DEFENSE REQUIREMENTS are handled by the LOCAL JOBBER, who has established a reputation for dependability in the various procurement divisions of the Defense Program.

Today the MAJOR PORTION OF UNIVERSITY REFLEX SPEAKER SALES are in connection with the Defense Program.

**UNIVERSITY LABS.**  
195 Chrystie St., N.Y.C.



## *In Defense of Your Business*

● So that the nation may continue to be informed—more than thirty-five million receivers in American homes and automobiles must be kept in first-class condition.

This is a responsibility of the trade—your responsibility and your contribution to the defense of the nation.

The replacement requirements which in the months to come will be more and more important to your business call for careful selection of parts in order to conserve resources and materials so important to defense and civilian needs. The requirements of Utah customers will be met as promptly and completely as possible.

Many Utah products are being used in National

Defense—for Army, Navy, Air Corps and important civilian communications. Utah engineers are continually at work, meeting the demands of the National Defense Program and its necessary restrictions on some materials. All the experience, knowledge and skill of the Utah production staff are required to comply with the ever-increasing demand for Utah Speakers, Transformers, Vibrators and Utah-Carter Parts.

UTAH RADIO PRODUCTS COMPANY, 814 Orleans Street, Chicago, Illinois. Canadian Office: 560 King Street, West, Toronto. In Argentina: Ucoa Radio Products Co., SRL Buenos Aires. Cable Address: Utaradio, Chicago.



# **S P E A K E R S**

**VIBRATORS • TRANSFORMERS • UTAH-CARTER PARTS**

NO LID TO LIFT!

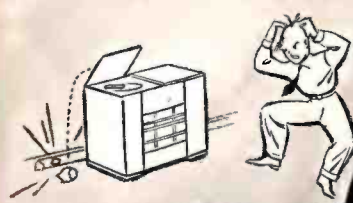

**NO SQUINTING!**  
Into an Unhandy Compartment



WITH AN

**Admiral**  
*Slide-A-Way*  
RADIO  
PHONOGRAPH



**Model 4207-A10**  
Note spacious record compartment. Five deluxe albums included at no extra charge.

Just open the doors . . . out slides Admiral's exclusive Slide-A-Way phonograph into full view. A world of glorious entertainment conveniently at your finger tips! Automatic Record Changer plays ten 12" or twelve 10" records. Changes them in 6½ seconds . . . safely, without chipping or scratching. Counterbalanced tone arm with Lifetime Needle floats like a feather over records. Reproduces with amazing tone purity. No annoying surface noise. No needles to change. Records last infinitely longer. Any wonder Admiral is the world's largest manufacturer of automatic record changers?

**GLORIOUS TONE, AMAZING SENSITIVITY ASSURED BY THESE ADMIRAL FEATURES**  
**Admiral 4207-A10 Radio-Phonograph**—An outstanding value in performance, tone and beauty. Super-powerful 10 tube superhet radio has three wave bands with special Magna-Band that s-p-r-e-a-d-s foreign stations for easy tuning. Triple-tuned RF converter circuit provides amazing sensitivity by eliminating "background" noises. Also feather-touch electric tuning . . . treble-bass compensation . . . super Aeroscope . . . auditorium dynamic speaker . . . exquisite hand-rubbed walnut cabinet.

**CONTINENTAL RADIO & TELEVISION CORP.**  
3800 CORTLAND STREET, CHICAGO, U. S. A.  
Originators of Slide-A-Way . . . Aeroscope . . . AC-DC-Battery Bantam . . . Tilt-Tuning . . . Touch-O-Matic.

*Pat*

**ARE these**  
**HARD HITTING**  
**Admiral ADS**  
**WORKING**  
**FOR YOU?**

Are you cashing-in on what is rapidly becoming the most popular and profitable name in radio? From Maine to California we get the same story from dealer after dealer: Admiral sales are breaking all records! With sensational values that challenge comparison in every price bracket . . . backed by the most aggressive national advertising campaign in Admiral history . . . is it any wonder that Admiral dealers everywhere are going to town?

**OVER**  
**36**  
**MILLION**  
**ADMIRAL**  
**MESSAGES**



Talk about aggressive advertising, listen to this! Over 36 Million Admiral Messages in less than 3 months! Full page . . . half page . . . and full columns . . . a steady parade of eye-catching, hard-hitting ads in Collier's, the Post, and Esquire. They're on the march right now . . . put them to work before they pass you by! Get in touch with your Admiral distributor today . . . let him show you why Admiral is the greatest value for the money in radio. Get set now with "America's Smart Set."

Originators of Slide-A-Way . . . Aeroscope . . . AC-DC-Battery Bantam . . . Tilt-Tuning . . . Touch-O-Matic . . . (Note—Admiral Radios are equipped with R.C.A. preferred type tubes)

Give the Gift  
that never stops giving

**Admiral**  
**BANTAM**



*THE first 3-WAY*  
**CAMERA RADIO**

**Model 29-G5 — AC-DC-Battery Bantam**  
Trim and compact as a pocket camera. Plays everywhere. Operates on battery when outside . . . plugs into AC or DC light socket when home (a battery-saving feature first introduced by Admiral). Powerful miniature speaker delivers clear room-filling tone. Aeroscope antenna. Smartly styled Tenite case with simulated leather trim. The perfect gift for the person who has "everything"

**CONTINENTAL RADIO & TELEVISION CORP.**  
3800 CORTLAND STREET, CHICAGO, U.S.A.  
Originators of Slide-A-Way . . . Aeroscope . . . AC-DC-Battery Bantam . . . Tilt-Tuning . . . Touch-O-Matic. Admiral Radios are priced from \$14.95 and up. See these sensational values at your nearest Admiral dealer.