

RADIO TODAY

via television



**GATEWAY TO
30,000,000
HOMES**



24,500,000 Homes with Radios
How the map would look if area of each state were proportional to its number of radio homes. (Outer shaded area shows total U. S. homes still without radios).

**JANUARY
1937**

STATISTICAL AND MARKETING NUMBER

TKGE40
.R25

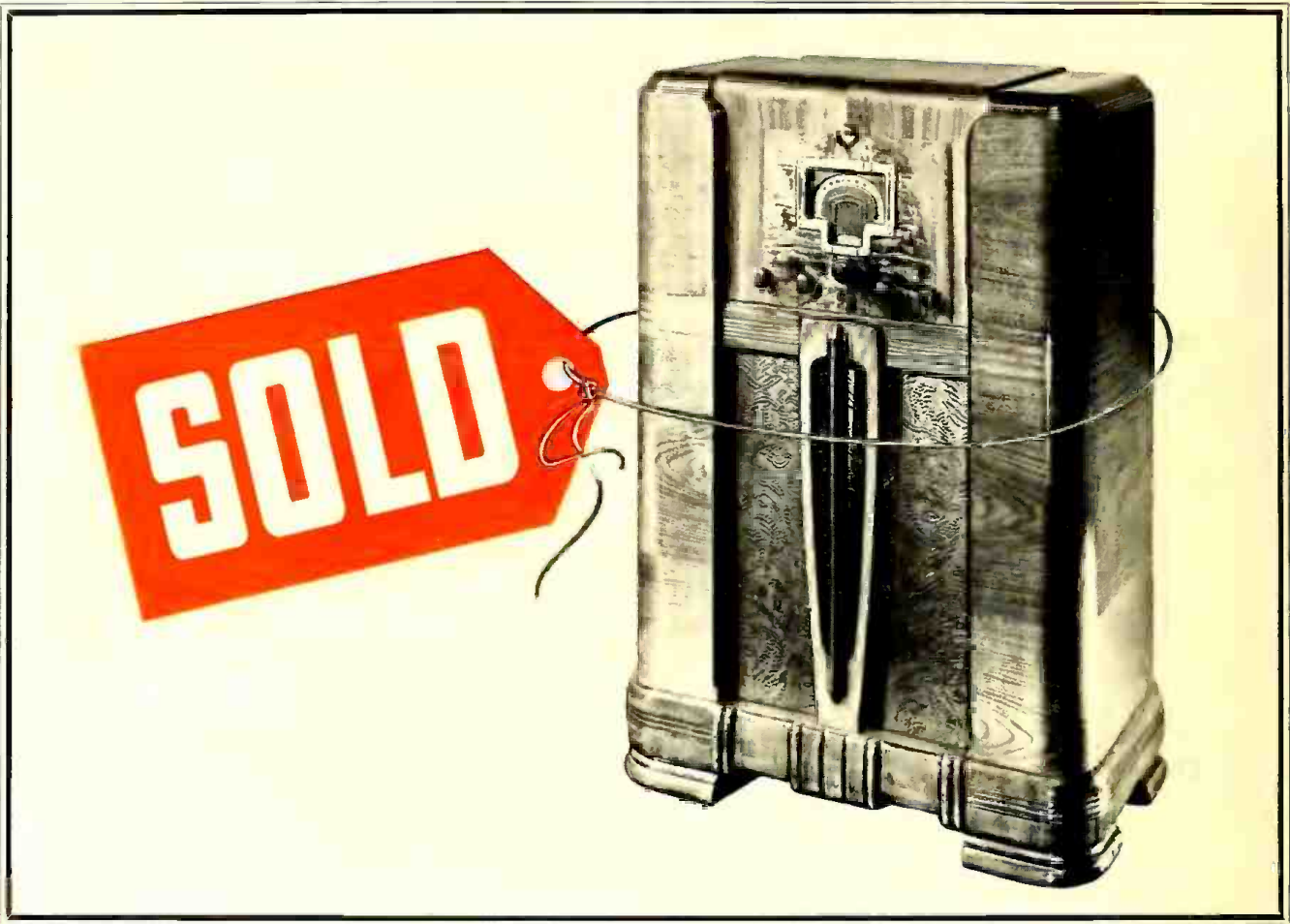

The Story Behind the Sale!

NBC Network Programs—more thrilling than ever before—are already increasing fine set sales for 1937!

THIS YEAR, we are delivering bigger and brighter NBC programs than at any other time in the history of broadcasting. And *you* know, as hundreds of alert dealers know, what this can mean in the sales of the better sets.

All-star Shows Mean All-star Sales
Our Blue and Red Network schedules, already in effect, are studded with Talent—the finest entertainment that money can buy. Tune them in on demonstrations... talk them up with prospects. They'll

put forth their most persuasive efforts in helping you sell the better sets. Remember this—

The interests of NBC are closely linked with you—the 15,000 dealers who contact and sell four to five million listeners a year. Use NBC Programs to demonstrate—they are the story behind many a fine set sale!

RCA presents the Metropolitan Opera every Saturday afternoon. And "Magic Key of RCA" every Sunday 2 to 3 P. M., E. S. T. Both on NBC Blue Network.

A Radio Corporation of America Service

NATIONAL BROADCASTING COMPANY

NEW YORK • WASHINGTON • CHICAGO • SAN FRANCISCO

J.K. 9/14/39

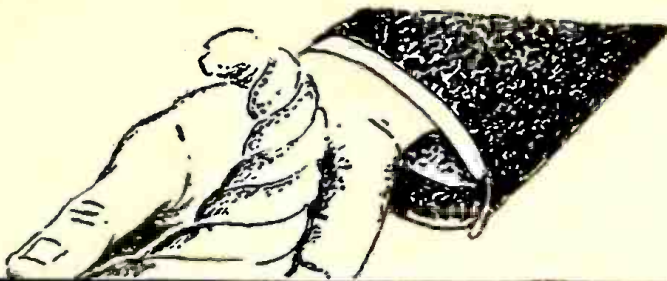

THE COMPLETE **SIMPLEX** LINE FOR 1937

Offers



... everything any jobber or dealer could want

Smashing values are represented not only in the 5 LEADERS illustrated below but in the complete 1937 SIMPLEX Line of the table models and consoles.

Every SIMPLEX receiver is a leader in its price class—sensational in performance, modern, beautifully styled from the one band T.R.F. model to the 11-tube, all-wave Superhet. 2, 6 or 32 volt models at proportionate prices. All models available for 2,000 meters—220 volt AC or AC-DC.

Under the NEW 1937 SIMPLEX JOBBER POLICY territories are absolutely protected because DISTRIBUTOR FRANCHISES are restricted to established Jobbers in large trade centers. Big profits, too, are assured through liberal Distributor Discounts.

Extensive programs of National Advertising & Radio Broadcasting will create tremendous demands for SIMPLEX Receivers. Are you ready to cash in on the BIG BUSINESS that's already started to pour in for SIMPLEX JOBBERS and DEALERS?

Write, wire or phone for details of territories available, prices and discounts.

THE SIMPLEX RADIO CO.

... FACTORY SANDUSKY, OHIO

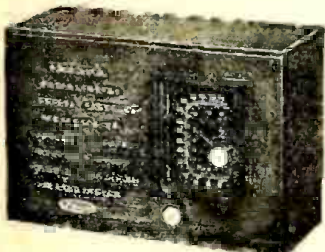

\$12.25
4 Tube T.R.F.;
1 Band



\$19.95
6 Tube Super;
2 Band



\$27.45
7 Tube Super;
2 Band



\$36.95
9 Tube Super;
3 Band



\$49.95
11 Tube Super;
3 Band

NOW! *Magic Voice* in RCA Victor 1937 Auto Radio Line!

● Cash in! Push these new sets with great sales features . . . Magic Voice, Finger-Tip Control, Escutcheon Plates for 1934, '35, '36 and '37 cars. A unique merchandising plan and aggressive, compelling promotional advertising will help you.

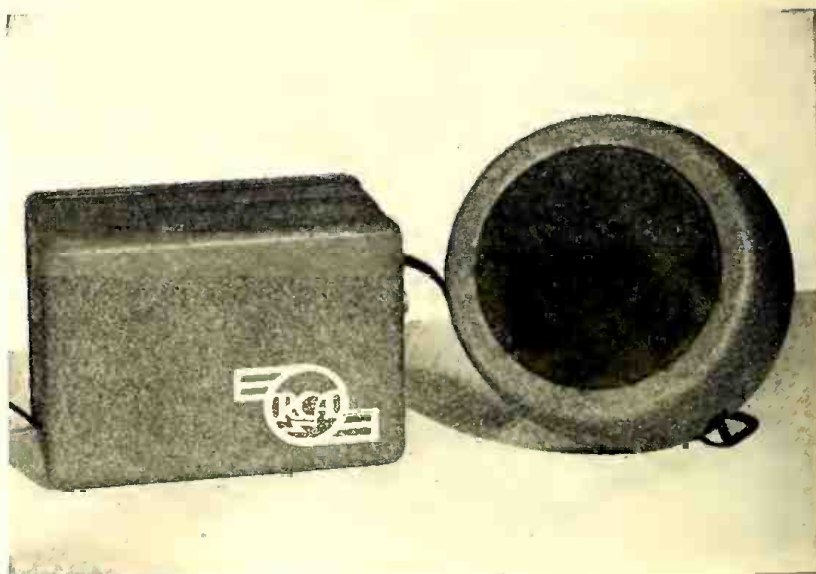

RCA Victor's 1937 automobile radios are made to order for easy and profitable selling by *you!* They bear radio's greatest name. They offer many features for finer performance. They are backed by a new, sales-inspiring merchandising plan!

Features? The famous RCA Victor Magic Voice makes its initial auto radio appearance—providing tone never before equalled in cars. Finger-tip control of *everything*. Escutcheon plates to match 1934, '35, '36, and '37 models. Two audio amplification stages. 9 watts output. And still others! For beauty, performance and tone—they're magnificent! And their low prices are an extra appeal that mean

● RCA Victor Magic Voice Model 67M-2 . . . 8-inch Magic Voice speaker, 6 tubes and Powertron, 9 watts output, 2 audio stages. Tone control and local-distant switch on control panel.

● RCA Victor Magic Voice Deluxe Model 67M-3 . . . 8-inch Magic Voice speaker, with auxiliary overhead speaker and three-way switch to select either or both speakers, 6 tubes and Powertron, 9 watts output, 2 audio stages.

. . .

extra sales! Order your stock now. Feature these superb new sets. Push them at every opportunity. Cash in on real auto radio value!

● (Below) RCA Victor Model 67M-1 . . . 6 tubes and Powertron. 2 audio stages, 9 watts output, built-in speaker, connections for extra (overhead) speaker if desired.



● (Above) RCA Victor Model 67M . . . 6 tubes, 3½ watts output. Outstanding performance at low price.



● 1937 RCA Victor Auto Radio escutcheon plates and controls to match instrument panel for cars, 1934 through 1937. Also available for steering post and under-dash mounting.

Tone and volume controls on left knob; tuning control and local-distant switch on right—for Magic Voice Models 67M-2 and 67M-3.



RCA presents the Metropolitan Opera every Saturday afternoon and "The Magic Key of RCA" every Sunday 2 to 3 P. M., E. S. T. Eoib via NBC Blue Network.

RCA Victor AUTO RADIO



RCA MANUFACTURING COMPANY, INC., CAMDEN, N. J.

A Service of the Radio Corporation of America

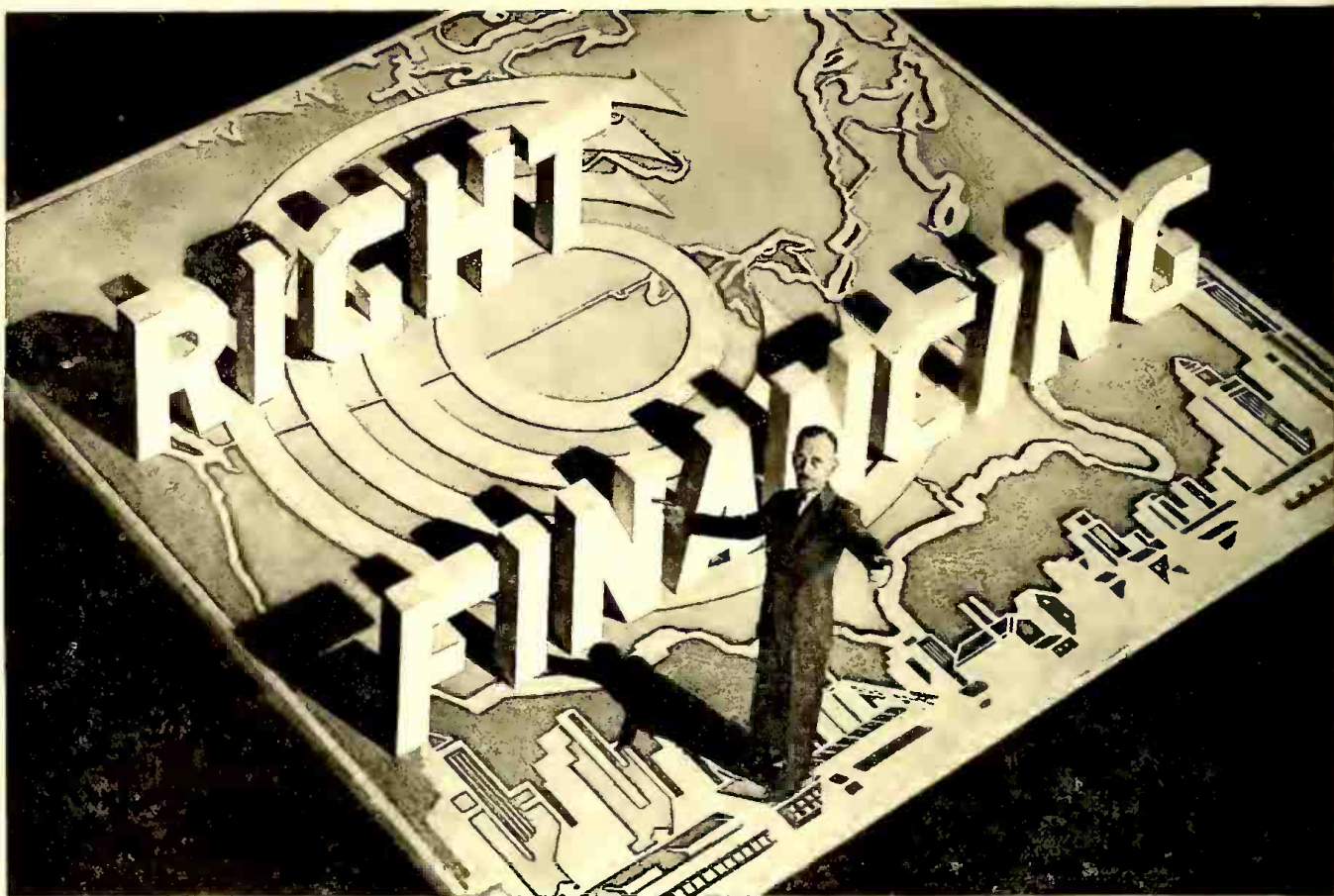

BRINGS BETTER PROFIT FROM RADIO SALES

EMPLOYMENT IS UP . . . wages are increased, bonuses are paid. Millions who have been sitting tight for several years now have the confidence and determination to gratify their needs and their desires.

This will be a big year for radio, bigger than the average year for the dealer who finances his time payment sales through Commercial Credit Company. Buyers appreciate the fair terms and low cost of Commercial Credit Company financing

and have confidence in the reliability of this nationally known institution.

Commercial Credit Company financing will not only make more sales, but will protect you against loss from bad sales. *Twenty-five years'* experience assures a smooth-working credit investigation and collection system, leaves you free to concentrate on sales.

Offices in 168 leading cities in the United States and Canada provide prompt, close and reliable co-operation in every case.

COMMERCIAL CREDIT COMPANY

COMMERCIAL BANKERS
CONSOLIDATED CAPITAL



HEADQUARTERS: BALTIMORE
AND SURPLUS \$60,000,000

FINANCING SERVICE FOR MANUFACTURERS, DISTRIBUTORS AND DEALERS THROUGH 178 OFFICES IN THE UNITED STATES AND CANADA

NEW

COLORADIO SERIES



SERIES 254 FOR AC CURRENT 5 TUBE SUPERHETERODYNE FEATURING METAL TUBES AND BEAM POWER TUBE

The Most Powerful Small Set Made

CHASSIS FEATURES: 7 tube performance; Illuminated airplane dial calibrated in KC; Frequency range 535 to 1750 KC; Beam power output tube; Automatic overload control; Built-in antenna; I. F. Frequency 456 KC; Acoustically fitted dynamic speaker, Operates on 115 volts, 60 cycles, AC.

254W: WALNUT BAKELITE CABINET	\$22.95
254D: BLACK BAKELITE WITH CHROMIUM	24.95
254V: PURE IVORY CABINET	24.95
254R: PURE CHINESE RED CABINET	24.95
254BG: BLACK BAKELITE AND GOLD	24.95
254G: IVORY AND GOLD	26.95
254RG: CHINESE RED WITH GOLD	26.95

Prices include full tube equipment

MODEL 254T IN WALNUT WOOD CABINET WITH IDENTICAL CHASSIS FEATURES . . . \$24.95



FADA BATTERY COLORADIO FOR THE FARM

SERIES 242 - 4 TUBE SUPERHETERODYNE OPERATES FROM 2 VOLT AIR CELL

CHASSIS FEATURES: 8 tube performance; 9 tuned circuits; Tunes American, Short Wave and Police Broadcasts; Frequency range 535-1750 KC and 2.26-9 MC; Illuminated airplane dial calibrated in KC and MC; Tone control; Phono-jack; Rubber mounted tuning condensers; 6 in. permanent magnet dynamic speaker; I. F. Frequency 456 KC; Automatic volume control, Air cell drain only .4 amps.

242W: WALNUT BAKELITE CABINET	\$31.50
242D: BLACK BAKELITE AND CHROMIUM	36.50
242V: PURE IVORY CABINET	36.50
242R: PURE CHINESE RED CABINET	36.50
242BG: BLACK BAKELITE AND GOLD	41.50
242RG: CHINESE RED AND GOLD	41.50
242G: IVORY AND GOLD	41.50

Prices include full tube equipment

SERIES 246 - 4 TUBE SUPERHETERODYNE OPERATES FROM 6 VOLT STORAGE BATTERY

CHASSIS FEATURES: Identical with Series 242 excepting special built-in "B" Eliminator and synchronous vibrator for power supply from 6 volt storage battery. Drain, only 1.45 amps.

246W: WALNUT BAKELITE CABINET	\$36.50
246D: BLACK BAKELITE CABINET	41.50
246V: PURE IVORY CABINET	41.50
246R: PURE CHINESE RED CABINET	41.50
246BG: BLACK BAKELITE AND GOLD	41.50
246RG: CHINESE RED AND GOLD	46.50
246G: IVORY AND GOLD	46.50

Prices include full tube equipment

Both Series obtainable in Walnut Wood Cabinets, Compact & Console Models.

FOR 12 PROFITABLE MONTHS IN 1937

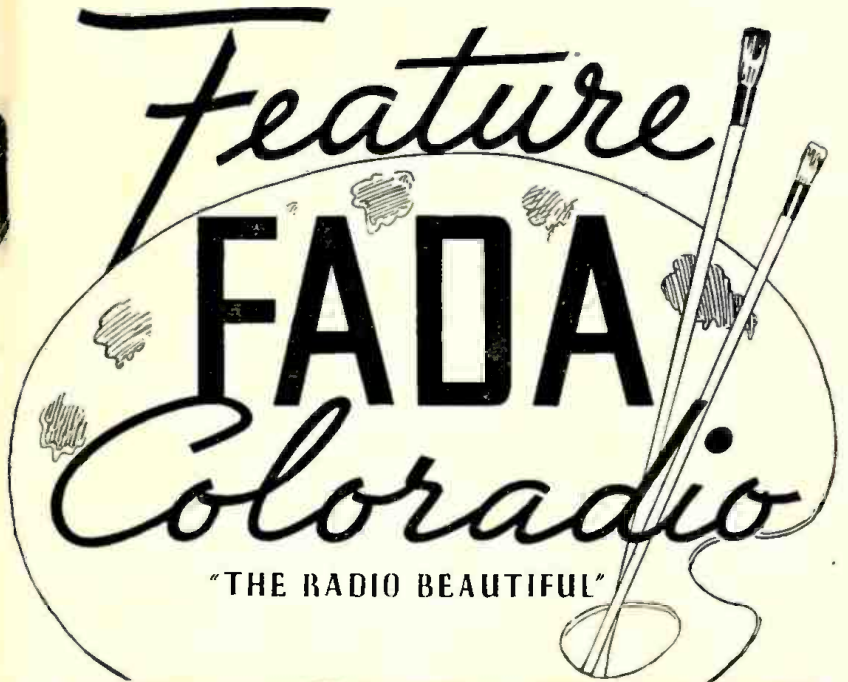

"THE RADIO BEAUTIFUL"

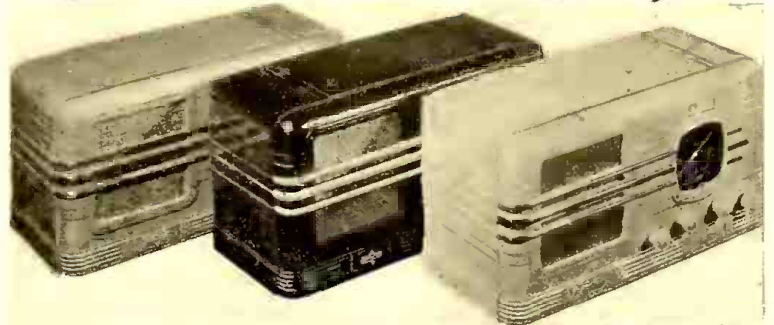

FEATURED IN 7 DISTINCTIVE SERIES IN 8 MAGNIFICENT COLOR COMBINATIONS

and priced as low as **\$19⁹⁹** complete

One of the oldest and surest devices used to command attention is the appeal of color. Color glorifies . . . Color is stimulating to the eye . . . Color creates the desire to buy. The appeal of color proves a strong selling ally because it is a "plus" feature. Color in radio is not new . . . but Coloradio by Fada is! Every Coloradio series possesses not only the appeal of color but also the new "Streamline" cabinet designs which blend with the majestic color combinations. No other small set line combines so many selling features to offer the consumer . . . Color . . . Streamline . . . Design . . . Performance . . . Value.

ATTRACTIVE COLORADIO DISPLAY NOW AVAILABLE

A new display designed for the new Fada Coloradio Series is available to all dealers.

SUEDE ZIPPER CARRYING CASES FOR ALL MODELS

Suede Zipper carrying bags for every Coloradio series are featured for as little as \$2.50

FADA RADIO & ELECTRIC COMPANY

LONG ISLAND CITY, N. Y.

PHILCO AUTOMATIC TUNING

FREE TO YOU!
This Big Illuminated
**ACTION
DISPLAY**
that sells
**PHILCO
AUTOMATIC
TUNING**



HERE'S a window or floor display . . . in full colors . . . that sells Automatic Tuning as never before! It gives a constant demonstration . . . it shows how Automatic Tuning works, by actual motion and illumination!

Down goes the girl's arm . . . the dial revolves to the Automatic Tuning position . . . and flash! the words, "Click . . . there's your station!" light up on the dial. And your own local call letters appear on the dial, always brightly illuminated! The cut-out words, "PHILCO AUTOMATIC TUN-

ING". at the top of the display, are also illuminated!

This life-size display has everything for quick-selling appeal . . . ACTION, COLOR and ILLUMINATION! And it comes to you FREE . . . ready to pull-in high-unit sales, week after week!

If you haven't yet received full details on how to get this free display, get in touch with your Philco distributor NOW! Be ready for the biggest radio business in history . . . cash-in with Philco Automatic Tuning in 1937!

PHILCO RADIO & TELEVISION CORPORATION

Staff—

DARRELL BARTEE
 RANDALL R. IRVIN
 M. H. NEWTON
 B. V. SPINETTA
 VINTON K. ULRICH

LEE ROBINSON
Sales Manager

RADIO TODAY

ORESTES H. CALDWELL
Editor

M. CLEMENTS
Publisher

Copyright 1937
 Caldwell-Clements, Inc.
 480 Lexington Ave.
 New York City
 Tel. PLaza 3-1340

Vol. III, No. 1

BOUNCING BILLINGS

★ With the Federal excise tax figures for 1936 showing an increase of 51 per cent over 1935, when radio-set sales numbered 6,000,000 sets, it becomes increasingly apparent that 1936 was at least an 8,000,000-set year, although basic license-bureau figures for the final quarter are not yet available.

At 8,000,000 sets, 1936 in unit production is thus 82 per cent ahead of America's business-peak year of 1929, when unit radio production was 4,400,000 sets. Measured in dollar volume, owing to the lower unit prices in 1936, 1936 radio volume is 25 per cent below the \$600,000,000 retail peak of 1929.

RADIO PARTS TRADE SHOW, CHICAGO, JUNE 10-13

★ Replacing the two Spring trade shows previously announced, the Radio Parts Manufacturers National Trade Show will be held at the Stevens Hotel, Chicago, June 10 to 13. A second Fall show will be held at New York, Oct. 1 to 3. Both will be sponsored by RMA and the Sales Managers Club, and Kenneth A. Hathaway will be managing director.

It is anticipated that the annual RMA convention will be held in Chicago immediately preceding the June Trade Show. Three other meetings are definitely set for the period of this show—those of the Sales Managers Club, the Institute of Radio Service men, and "The Representatives."

The board of directors of the non-profit Trade Show Corporation as now constituted, consists of A. A. Berard, Ward Leonard Electric Co.; Arthur Moss, Electrad, Inc., New York; S. N. Shure, Shure Brothers, Chicago, and Fred D. Williams, International Resistance Company, Philadelphia. Mr. Shure is president; Mr. Berard, vice-president, and Mr. Moss, secretary-treasurer.

PENNIES FROM HEAVEN

★ Web work in terms of broadcast billings for the span of 1936 exhibits some fine increases over 1935. Columbia's figure at the year-end is \$23,289,000, a 32 per cent jump over the total for 1935. NBC's Red Net got \$22,645,527 and for the Blue web the figure was \$11,878,423; total of \$34,523,950 represents an increase of 10.8 per cent over 1935 doings.

Mutual, the third national network who only recently annexed the coast-to-coast reach will probably hit about \$2,000,000 for the year.

WHERE THE EIGHT MILLION WENT

★ Chart on this page shows what happened to the estimated 8,000,000 radio receivers sold in 1936. Exports amounted to 650,000. Auto-radios 1,700,000, increasing the total of autos-with-radios to 4,500,000.

Of the remaining 5,650,000 home radios, 1,750,000 went to "new radio homes," families not previously possessing radios. The 3,900,000 sets sold to homes already having radios,

included at least a million sets purchased as "second" or "extra" sets, bringing the total of such "extra" sets in use up to 4,000,000. With total radio homes at 24,500,000, extra sets and auto sets bring the grand total of radio-broadcast "listening posts" in U. S. up to 33,000,000 as of January, 1937.

FAILURES DROP

★ According to Dun & Bradstreet, Inc., of the four concerns in the radio industry that filed applications for reorganization under Section 77-B of the New Bankruptcy Act during 1936, three were manufacturers and one a wholesaler. This was the same number of cases as recorded in 1935, for which year two were manufacturers and two wholesalers. Only one case was listed for 1934.

Since 1932, when the peak was set at 203, the annual reduction of failures in the radio industry has been uninterrupted. The number for 1936 was 52, as compared with the 1935 total of 55. The decline in the defaulted indebtedness, which reached an all-time high of \$9,067,804 in 1931, has been even more marked. Steady

RADIO'S 1936 SALES FEAT—WHAT BECAME OF ALL THE SETS

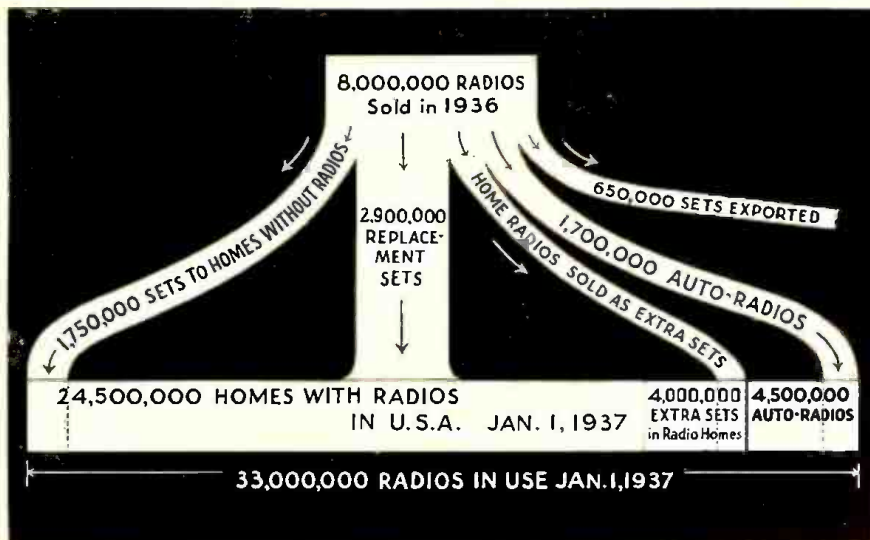



Time out from the Crosley convention. C. B. Savage, Shield Co., Ft. Worth, Tex., Lewis M. Crosley, vp & gm Crosley Radio Corp., Hymen Reader, Houston, Tex., and Lee Bird, Crosley field service.

yearly drops had lowered this total to \$602,920 in 1935, from which it rose to \$729,048 for the 1936 period.

The complete insolvency record for the radio industry since 1930, as compiled by Dun & Bradstreet, Inc., shows:

Manufacturers		
Year	Number	Liabilities
1930.....	40	\$3,522,400
1931.....	25	4,088,445
1932.....	38	2,035,630
1933.....	31	3,705,592
1934.....	12	1,242,868
1935.....	9	160,625
1936.....	5	185,359

Wholesalers and Retailers

Year	Number	Liabilities
1930.....	217	\$2,071,392
1931.....	160	4,979,359
1932.....	165	1,974,351
1933.....	109	1,813,980
1934.....	48	2,294,299
1935.....	46	442,295
1936.....	47	543,689

"17,000,000 EXISTING RADIOS OBSOLETE"—GEDDES

★ There are now about 6,700,000 radio receiving sets in the United States capable of picking up European and other overseas programs, according to Bond Geddes, executive vice-president of the Radio Manufacturers Association.

This means that about one-fourth of the radio families in the U. S., the number of which Mr. Geddes estimates to be 24,269,000, are now able to listen to foreign as well as domestic radio programs.

"Thus 17,500,000 radio families, or 70 per cent, have obsolete sets, without modern receivers for short-wave foreign broadcasting."

THEN LISTEN WE MUST

★ Sweet signals from NBC transmitters in 1936 have added up to something. Total program production for the year in terms of Red and Blue stations hours on the air amounted to 18,650, which is practically 10 per cent over 1935. Also in NBC affairs were notable increases in number of programs, mike appearances, number of stations signed.

Mongst the 10 types of broadcasts (music, women's programs, children's

features, talks, etc.) the accent runs to special events, reports and novelty. Special events were up almost 40 per cent because of such restless continentals as David Windsor. Reports include weather, agricultural and market broadcasts and all these got a heavy play among NBC Pacific stations.

Stomp business is on the wane; amount of dance music declined 3.3 per cent. Classical music rose 47.7 per cent and when you type all music as "serious" or "popular" you notice that the increase for serious melody was 21.4 per cent; for popular stuff, only 4.9 per cent.

RADIO STORK

★ Seems that policemen, if they are aided and encouraged by reliable radios, are in position to help women to have babies.

Recently at Greenburgh, N. Y., the police dept. was the only outfit available when a local housewife, Mrs. Eleanor Moller, suddenly found it necessary to multiply. Patrolman George Butler answered the call while the doctor was still miles away, being fetched by another officer.

Physician's car and Butler's car were linked by two-way radios. Latter was parked near Mrs. Moller's door with the controls turned up loud. Butler asked questions and followed directions, via radio, as he assisted the stricken woman through her crisis.

Reward for the resourceful cop is that the Moller child was named after him—unless Kate Smith decides that he's a hero and says so on the air.



Ernest H. Vogel, who succeeds the also promoted Ralph Cordiner as manager of GE Radio department.



S. N. Shure, of Shure Brothers, Chicago, president of Radio Parts Trade Show, Chicago, June 10-13.



J. M. Marks, Fada president, who has been eminently successful in using color to interest women in extra sets.

SPLASH OF COLOR

★ New radio models are afire with a modern treatment of bright colors. Just as a new car must look like a bullet in order to keep up with the streamline rage, radio must now bedeck itself in tints you never saw before.

Rainbow trend has several advantages: colored sets lend themselves nicely to display; they fill the need for sets in kitchens, nurseries, etc.; they attract persons who will buy anything that's novel; they shift attention away from the cabinet design itself.

TUBE PRICES UP 10-12%

★ Resale prices on a majority of radio-tube numbers were increased from 10 to 12 per cent this month, materializing a move long wanted by distributors, dealers and servicemen. The price increases were general throughout the tube field.

"These price modifications are the result of changes in type costs due to increased material and labor costs, variations in the proportional demands for the different types, and need for additional revenue in every branch of the tube business," explains E. S. Dietrich, manager of distributor sales for Raytheon.

Sample price increases are: Type 80 to 70 cents; type 26 to 70 cents; type 27 to 80 cents; type 45 to 80 cents; 77 and 78 to \$1.20; 6A8G to \$1.50; 6L7 to \$1.75; 6C6 and 6D6 to \$1.20.

NEW YEAR'S RESOLUTIONS

★ Some time ago there came to light in one of the old RCA files some suggestions written by David Sarnoff early in 1923. They are as follows:

- 1—Adapt yourself to circumstances, but don't lose character and purpose.
- 2—Be frank, but not blunt.
- 3—Be courageous, but not defiant.
- 4—Work hard, but consistently and not in spots.
- 5—Specialize and master some one thing, but don't narrow yourself and lose perspective.
- 6—Cultivate the power of expression in writing and speaking, but don't be verbose.
- 7—Separate the fundamentals from the details and summarize for action, but don't ignore the details.
- 8—Have faith in mankind and self-confidence, but do not be gullible or conceited.
- 9—Be democratic with your business and personal associates, but not to the point of breeding contempt or disrespect.
- 10—Visualize and plan ahead, but not so far ahead as to overlook the immediate future.
- 11—Strive to win by forty, but don't lose your health in doing it.

BUYERS WANT BETTER SETS; BATTERY MODELS UP

★ General prosperity across the land is held accountable for the increasing demand for console radios and for higher priced units. In the Middle West better farm conditions have resulted in a great increase in battery-set sales—expected to run between 800,000 and 850,000 for the year 1936.



Prince Bernhard, who married Holland's Crown Princess, visits Dr. Philips, Europe's radio king, at Eindhoven.

There is evidence that list prices are being better maintained; with the protection of certain state laws supported by the Supreme Court decision on fair-trade practice, radio dealers will have the protection of price legislation.

Threatened price increases have been a spur to some activity, although these increases have not generally materialized. Many new "interim models" have been introduced with the new calendar year. New features and gadgets continue to be in demand, particularly in the more sophisticated centers.



Boake Carter, with Mr. and Mrs. Sayre Ramsdell of Philco, on a hunting trip into the Pennsylvania mountains.

HOW TO MEET "CHAIN" COMPETITION

Radio dealer has many big guns on his side in present bitter war with chain-stores and mail-order retail outlets.

★ INDEPENDENT radio dealers in many communities are facing serious competition from chain stores and mail-order houses selling sets. Increasingly, such chain-store selling has been felt by merchants in other fields, and now its sinister influence is manifested in radio, particularly in the low-price lines.

Yet the independent radio dealer has many advantages over the chain-store operator, if he will put these advantages to work. Moreover, the independent merchant can take many a page out of the chain operator's notebook, and can apply to independent selling most of the methods which have made chain-store merchandising so effective.

That the lower brackets of radio-set sales have been chiefly affected by chain-store competition is evidenced by the effect on transactions in used sets and "trade-ins."

Low-priced market

In cities where chain stores flourish sales of used sets are off 50 per cent to 70 per cent! Surveys in typical midwestern communities show that present volume sales of low-priced, private-brand receivers are having the effect of decreasing the prospects for traded-in sets. The big chains refuse to accept trade-ins, but maintain volume with new merchandise at low prices.

In Niles, Mich., Starr Gephart, radio salesman in Henry R. Hill's

home-furnishing store, says, "We're located right across the street from the biggest chain department store in Southern Michigan and, if anything, it attracts business for us." A stock of four new sets and eleven used sets tells a different story. The used sets are priced right; yet they are not selling!

Across the street shoppers crowd in and out of Niles' largest department store, a mail-order chain operation. In a quiet corner of the second floor some thirty new receivers are attractively displayed. Each set bears a price-tag on which is printed the terms of time-payment sales. Answering our question, a clerk replied, "Used sets? I'm sorry; we haven't any on hand. But you can buy a modern seven-tube all-wave console we have here for only \$34.95. Four dollars down and four dollars a month."

On the wall back of the radios are the words, "The World's Largest Retailer of Radio." The chain-mail-order firm which operates this store sold over half a million new receivers in 1936. (\$302,577,265 in all lines for the first eleven months of 1936; a 21.9 per cent increase over the previous year!)

What this competition means to those independent dealers who feature used sets and trade-ins is evident in the ratio of eleven used sets to four new sets in Hill's store. Used sets cannot be sold at their current trade-in prices, in competition with new,

low-priced, private-brand sets. Furthermore, independent dealers handling such trade-ins make two sales to complete one, and perhaps lose the sale of a new small set in selling the used one.

"Trade-ins" on consignment

Mrs. Ruth Christensen, proprietor of the Niles Music Shop, and Niles' leading radio dealer, avoids direct competition with the chain store in the low-price class by featuring only high-priced radios. She evades the trade-in issue by taking used receivers on consignment only. If they sell, the money is applied on a new set. If not, the used set does not enter into the transaction for the new radio.

On the subject of chain-store selling, Mrs. Christensen says, "We don't run into much competition from chain stores because the class of trade we sell would not want to let their friends see a chain-store or mail-order radio in their homes. We can't afford to solicit low-priced business. It takes just as long to sell a \$35 radio as it takes to sell a \$95 set. We haven't had much luck with trade-ins so we take used sets only on consignment."

In spite of optimistic statements by Niles' dealers, chain stores are selling the bulk of the radios in the Niles territory. Records of radio service men, checked with the aid of veteran Bill Hansen, local parts dis-



WIDE PRICE DIFFERENCES between identical receivers. A well-known 11-tube set is featured in Niles, Mich., at \$48.75; in South Bend, Ind., under another name and slightly different cabinet, \$78.95; and in an auto-supplies chain \$95.

tributor, disclosed that nearly half the receivers in Niles and the adjoining rich Michigan fruit belt are familiar chain-store brands!

South Bend situation

Ten miles south of Niles, in South Bend, Ind., 19 independent dealers also suffer from chain-store competition. Four chain outlets (the largest being a branch department store of a big Chicago mail-order firm) feature radio sets at prices averaging 20 per cent to 40 per cent below price levels of national-brand sets. This department store employs four full-time servicemen to make installations and minor adjustments on new sets and to service sets for old customers. Contrary to trade belief, the chain sets are of good quality and give no more trouble than any other line of receivers.

INDEPENDENT DEALER

enjoys these advantages:

- Expert knowledge of radio sets
- Handles publicly-advertised brands
- Higher down - payments; shorter contracts
- Chains' widely different prices for same sets
- Chain brands orphaned by changing factories
- Public prejudice against chain-store brands

factory in country in which all our sets are made to the same standards as the leading brands. The reason we can offer better prices is because of our more economical system of distribution."

store managers are responsible for any losses.

Three of South Bend's chain radio outlets also sell auto parts. Auto radios are featured in each case, although midget sets and console models are also displayed. The smaller sets are low priced, but the console models average as high as equivalent national brand receivers.

\$48.75 to \$95 same set

Interesting price differences exist between identical receivers sold under various private brands. A well-known eleven-tube set, made in Chicago, is featured in Niles, Mich., at \$48.75; in South Bend, Ind., under another name and in a slightly different cabinet at \$78.95, and in a chain of auto service stations, under a third private brand, at \$95.00! This set is of excellent



MAIL-ORDER retail outlets depend largely on farmers and other drive-in customers.

SAME MODEL built in two different factories, discrediting clerk's claim of "our own make."

This store is credited with selling over 1,300 radio sets in 1936! Its business as a whole increased 27 per cent over the previous year. The entire business of this chain organization exceeded, in 1936, a million and a half dollars a day! This amazing volume of sales was accomplished despite a strict credit department. Quoting Martin Seus, a nearby dealer, "To get a demonstration of one of their sets in your home, you must make the down payment, sign away power of attorney and give ample credit references." Store managers are personally responsible for credit losses, and they exercise greater caution than store owners!

Loitering in the chain store, RADIO TODAY's representative heard a salesman explaining the RMA label on the back of a set. "That means one of the big three—RCA, Philco and us. We have the second largest radio

A trade-in is rarely accepted by a chain store unless taken in at such a ridiculously low figure that a profit is certain in its resale. Here again

quality with the most modern features. The only disparaging remark a dealer can make about these sets is that the customer never knows whether he is getting a real bargain or not.

CHAIN-STORE

policies worth copying:

- Handle "trade-ins" at a profit, or not at all
- Stock diversified goods, creating store traffic
- Enforce strict credit policy
- Develop good rural trade by direct-mail lists
- Use newspaper advertising extensively
- Employ trained store managers, usually college graduates

Yet chain stores have few real advantages over independent stores, while the home-owned stores have many advantages over their big rivals. Careful analysis of both systems of retailing discloses room for extensive improvement in radio merchandising. For instance, the diversified merchandise in a chain store assures greater store traffic. This suggests side lines for independent dealers, such as cameras, records, sheet music, novelties, etc., which will increase store traffic.

Well-paid salesmen in independent stores know their merchandise better and have better sales ability than the low-salaried clerks in the chain organizations. Here the chains are at-

tempting economy at the sacrifice of ability, though really paying the difference in salary in terms of lost prospects and sales. The chain stores handle the trade-in problem in the only way it can ever be handled satisfactorily—at a profit or not at all. Dealers have a real lesson to learn in this respect. Already shrewd independents refuse private-brand trade-ins at any price!

Store stocks; advertising

Chain stores usually display a larger stock of radio merchandise. This conveys an impression of large scale operations. Independents who concentrate on one line, instead of trying to pick a few leading models in several lines, can better match the impression created by the variety of models under one brand in the chain stores.

Dealers with national-brand receivers have the advantage of magazine and often radio advertising by the manufacturer. Of course, the chain stores point to the size and reliability of their own firm to counteract this form of advertising. Dealers defend themselves by explaining that under the competitive system of choosing manufacturers of a private brand, the sets may come from a different source each year, making previous models orphans. The independent in offering a recognized brand, protects his customer's investment against sudden depreciation, which is a well known feature of orphan radios.

Mail-order chain stores have a good rural trade which has been developed almost entirely through direct-mail

advertising. So far, independent dealers have felt that rural solicitation was unprofitable and they have ignored this market to a large extent. A good rural mailing list is the key to selling this market in the face of catalog competition.

Scrutinize credits

Strict credit investigation by chain stores reduces credit losses on long-time contracts. But the chains lose prospects to independent dealers, who, because of higher down payments and short-term contracts, have less concern about credit references. And in addition, they can offer the advantage of lower carrying charges where a larger down payment is secured.

Chain organizations use newspaper advertising more extensively than independent dealers, who rarely take full advantage of their local newspapers for fear of boosting their sets which are also handled by other stores. Manufacturers can do little in newspapers without dealer cooperation. On the other hand, independents have access to better circulars and sales helps. The catalogs handed out by chain stores are well written, but are usually printed in cheap style on poor quality paper. Prices are rarely included because of variations from time to time in different stores of the same chain. Here the independents have the advantage of nationally advertised prices.

Managers college men

An advantage held by chain stores is the care with which they select their managers, nearly all of whom are college-trained men who have

worked themselves up through their merchandising ability in various departments of the stores. They are guided in their efforts by the men who have preceded them. Some of the keenest merchants in the country are at the head of large chain selling organizations. Independent dealers, who are not too proud to learn from chain store methods, can pick up many sales ideas and display ideas which will prove profitable. Distributors can circulate these ideas to other dealers.

The coming year will witness even greater competition between chain outlets and independents than did 1936. Dealers can no longer afford to ignore the low-priced market which furnishes the chains with prospects who at times may be sold a higher-priced set. Trade-ins must be reduced or even eliminated. In the 1937 battle with the chains, the independents have the advantage, if they will use it.

PHONOGRAPH RECORDS

BEST SELLERS AS WE GO TO PRESS

BLUEBIRD

It's De-Lovely. Wintertime Dreams. Both with Shep Fields and his Rippling Rhythm—B6639.
In the Chapel in the Moonlight. You're Ev'rything Sweet. Both with Shep Fields and his Rippling Rhythm—B6640.
Easy to Love. I've Got You Under My Skin. Both with Shep Fields and his Rippling Rhythm—B6592.

BRUNSWICK

That's Life I Guess. Pennies From Heaven. Both with VC by Billie Holiday, both with Teddy Wilson and his orchestra—7789.
I Can't Give You Anything But Love. VC by Billie Holiday. Sallin's—stomp. Both with Teddy Wilson and his orchestra—7781.
So Do I. VC by Skinny Ennis. Pennies From Heaven. VC by Maxine Grey. Both with Hal Kemp and his orchestra—7749.

COLUMBIA

Mr. Ghost Goes To Town. Algiers Stomp.—stomp. Both by Mills Blue Rhythm Band under direction of Lucky Millinder—3158D.
Serenade in the Night.—tango. *Me and the Moon.* Both with vocal refrain, both with Mantovani and his Tipica orchestra—3159D.
I Heard a Song in a Taxi. Supposing. Both by the British Broadcasting Co. orchestra with vocal refrain—3160D.

DECCA

(By Titles)

In the Chapel in the Moonlight. Ruth Etting—1034. Mal Hallett and his orchestra—1033. Roy Smeck and his Serenaders—1038.
It's De-Lovely. Will Osborne and his orchestra—1058.
Pennies From Heaven. Bing Crosby—947. Jimmy Dorsey and his orchestra—951.

VICTOR

Whispering. *Tiger Rag.* Both with Benny Goodman Quartet—25481.
Pennies From Heaven. *So Do I.* Both with Eddy Duchin and his orchestra—25431.
It's De-Lovely. *You've Got Something.* Both with Eddy Duchin and his orchestra—25432.

TUBE STOCKS LAG BEHIND MARKET. BLAME TRADE SITUATION

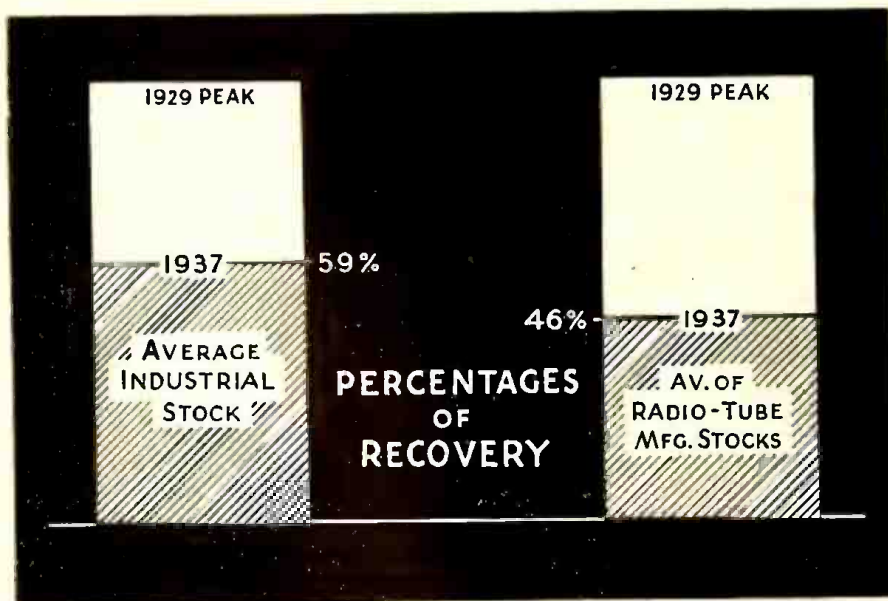



Realty Associates, Inc., Stewart Manor, Fairchild Photo

EACH KEY RADIO DEALER* MEANS A CONSUMER-MARKET OF 320 RADIO SETS

At \$55 per set, this is an average set business of \$17,600 per dealer.

This radio dealer also represents definite consumer markets for other radio products, too,—all within walking distance of his store. For example:

He sells annually 3,000 replacement radio tubes

He does annually \$4000 worth of servicing and repairs

He sells annually \$3000 worth of parts and supplies

He contacts continually 2000 homes. In these homes—

He is "radio advisor extraordinary" to a population of 8000

Of these 2000 homes, 500 homes still have no radio set; the other 1500 are "homes with radios" (200 of these radio-homes have two, three or more sets).

Of the regular sets now in use in these 1500 radio homes, 250 are sets 3 years old; 250 are 4 years old; 250 are 5 years old, and 500 are six years old or older.

Of these 2000 homes, 1000 have autos (250 with auto-radios, the rest without).

*There are 15,000 such radio dealers and 15,000 such radio "communities" in the United States. These 15,000 dealers do 85% of the radio business.

STATISTICS OF THE RADIO BUSINESS

THE FLOW OF DOLLARS THROUGH THE RADIO INDUSTRY—891 MILLIONS YEARLY

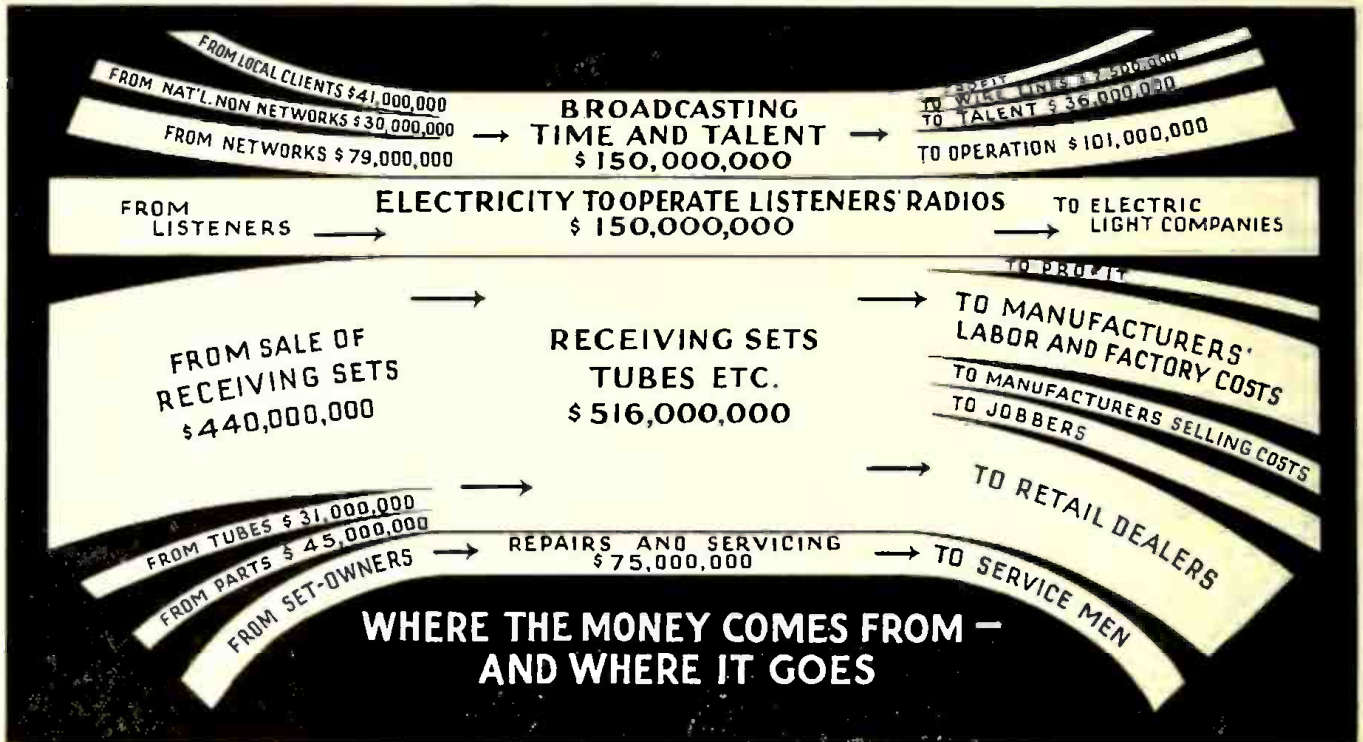

UNCLE SAM'S ANNUAL BILL FOR RADIO

Sale of time by broadcasters, 1936.....	\$114,000,000
Talent costs, 1936.....	36,000,000
Electricity, batteries, etc., to operate 33,000,000 receivers.....	150,000,000
8,000,000 radio sets sold in '36.....	440,000,000
46,000,000 replacement tubes.....	31,000,000
Radio parts, supplies, etc.....	45,000,000
Servicing radio sets.....	75,000,000
U.S. Public paid for radios in 1936.....	\$891,000,000

RADIO SETS IN USE

	Jan. 1, 1936	Jan. 1, 1937
U.S. homes with radios.....	22,869,000	24,500,000
Extra and "second" sets in above homes.....	3,000,000	4,000,000
Automobile radios in use..	3,000,000	4,500,000
Total radio sets in use, U.S..	28,869,000	33,000,000
Total homes with autos..	17,650,000	18,000,000
Total residence telephones..	11,000,000	11,500,000
Total homes with electricity	21,030,000	21,800,000
Total homes in U.S.....	31,000,000	31,471,000
Population U.S.....	128,000,000	128,853,000

RADIO-SET AND TUBE SALES

	Number	Retail Value
Total radio sets sold during 1936.....	8,000,000	\$440,000,000
Radio sets exported.....	650,000
Automobile radios.....	1,700,000	85,000,000
Home radios sold in U.S..	5,650,000	310,000,000
Home sets sold as replace- ments.....	3,900,000	215,000,000
Home sets sold to homes previously without radios	1,750,000	96,000,000
Home radios sold as extra sets.....	1,000,000	55,000,000
Battery sets.....	800,000	40,000,000
Tube replacements.....	46,000,000	31,000,000
Tubes, initial equipment..	50,000,000
Total tubes sold 1936.....	96,000,000	70,000,000
Parts, supplies, etc.....	45,000,000

ROLL-CALL OF RADIO INDUSTRY

Manufacturers of radio receivers.....	144
Manufacturers of radio tubes.....	13
Manufacturers of radio parts.....	620
Manufacturers of test equipment.....	55
Manufacturers of broadcast and amateur equip.	110
Manufacturers of sound equipment.....	95

"HOW TO MAKE MORE PROFITS

"Seller's market" points need of return to business fundamentals



Look up your lists of past customers. A lot of them are ready for new radio sets, better sets. Then reach for the telephone—or your hat!

★ Above all else, 1937 will be radio's great merchandising year. Radio manufacturers, jobbers and dealers will during the next twelve months need to go back to fundamental principles in distributing goods—to find and to apply the lessons which merchants in older lines have used with success over many years.

Already there is evidence that 1937 will be a "seller's market," with a definite trend away from the disastrous "buyer's market" that has dominated the dolorous 1930's. Advent of a "seller's market" should bring price stabilization, and closer trade relationships between manufacturer, distributor and dealer.

Commenting on this seller's market

in radio, E. T. Cunningham, president of RCA Manufacturing Company, observes that "the sale of higher-priced units is again larger and the trend is definitely up. With the cost of raw materials and labor steadily mounting, the necessity for marking-up radio-set prices becomes increasingly urgent and inevitable if radio is to be a profitable business for all.

Watch customers

"In the coming year, much can be done by the dealer, the wholesaler and the manufacturer in a cooperative effort to eliminate some of the destructive trade practices which have been carried over from the darkest days

out of which the radio industry seems now to have emerged. I am hopeful that much more will be accomplished in the new year."

Asked to counsel radio dealers about 1937 plans, Ralph J. Cordiner, General Electric Company, Bridgeport, Conn., advises:

"Radio, which has brought so much happiness to practically every home in the land, can also bring happiness and profit to radio retailers, if all retailers, as a body, resolve to conduct their businesses along those lines they know to be sound. As a step in that direction let us all keep our eyes focused more on our customers and less on our competitors."

Better business

Virtually every business indicator points to 1937 as a year of "enormous possibilities," says Sayre M. Ramsdell, vice-president of Philco Radio and Television Corporation. Continued business improvement generally and for the radio industry especially, is "definitely assured," he says.

"Many of the largest advertising budgets adopted for 1937 show sizable increases over the amounts spent last year. A greater volume of advertising means a larger volume of business; more business means less unemployment; and all this sums up into more money."

Mr. Ramsdell sees "unlimited possibilities" in the radio field, pointing out that surveys have shown that 25 per cent of radios now in use are more than six years old and lack short-wave range and automatic or magnetic tuning.

Higher prices and large volumes are seen by Powel Crosley, Jr., president of Crosley Radio Corporation.

Remind Your Customers

"If your radio is 1 year old"—
it lacks automatic frequency control & dial tuning

"If your radio is 2 years old"—
it lacks high fidelity

"If your radio is 3 years old"—
it lacks an airplane-type dial

"If your radio is 4 years old"—
it lacks all-wave reception

"If your radio is 5 years old"—
it lacks linear diode detection

"If your radio is 6 years old"—
it is not a superheterodyne

Postage
Will be Paid
by
Addressee

No
Postage Stamp
Necessary
If Mailed in the
United States

BUSINESS REPLY CARD
First Class Permit No. 22273 (Sec. 510 P. L. & R.) New York, N. Y.

RADIO TODAY

480 LEXINGTON AVENUE

NEW YORK, N. Y.



Send me RADIO TODAY for the period indicated below:

1 Year (12 issues) \$1.00

Send bill

3 Years (36 issues) \$2.00

Amount enclosed

Name _____ Title or Occupation _____

Company _____

Street _____

City _____ State _____

Our Main Line of Business is: _____

If RADIO TODAY is to be mailed to your home, fill in address here

No stamp needed on this card—it is ready for mailing.

OUT OF RADIO IN 1937"—I

Basic business policies essential to put dealer's house in order .

"The average price of sets sold has increased materially to about \$65 for consoles and \$42 for table models. It is estimated that the sales of auto radio sets for 1936 will reach 1,600,000 to 1,750,000 units, compared with 1,200,000 auto radios sold in 1935. The figure for 1937 unquestionably will be still greater. Radio, itself, has been one of the most important factors in business recovery. Being a \$400,000,000-a-year industry, it is itself a great factor in business advancement."

Accelerated vigor

Looking ahead, David Sarnoff, president, Radio Corporation of America, sees finer programs on the air and increased size and responsiveness of the national radio audience.

"The new art of television has moved out of the research laboratory into the field of engineering experiments under actual service conditions. There is every reason to believe that during the year 1937 the progress of radio, so significantly demonstrated during the twelve months just passed, will continue with accelerated vigor."

Retail check-up

With a new tempo thus introduced into the radio selling situation, the retail radio dealer needs to check over his own business plans.

To take advantage of the new opportunity, it will be necessary, in most cases, to overhaul his own merchandising set-up, all along the line.

Item by item, the functions of selling must be scrutinized, to see if, good as they were in the past, they measure up to the new conditions.

Store Location. Is this right to get the 1937 buying traffic? Is the store-front attractive and modern? Would a move be justified by better business?

Window Displays. Are these changed frequently and kept at a high standard of merchandising appeal? Are manufacturers' displays regularly used? Is advantage taken of motion displays? Special lighting effects?

Store Interior. Does this need overhauling? Have fixtures gotten shabby? Should floor layout be changed? What about demonstration rooms?

Salespeople. Does the sales personnel measure up to 1937 requirements? Can better salesmen be found? Would commission payments help? Can home demonstrations be handled better?

Advertising. Is enough attention given to this all-important builder of sales? Shall we use more newspaper space in 1937? More pictures? Direct-mail?

Installment Selling. People have confidence today, even if they haven't cash, and so are once more receptive to time-payment selling. Are dealer's selling policies tuned into this restored opportunity for time sales?

Bookkeeping. Does accounting system give a prompt and complete picture of operating costs and results? Does it give effective control? Is present system too expensive and bothersome?

Prospect Lists. Are former customers being followed up? Do new prospects get announcements of special interest? Is telephone selling being used?

Stock-control. Is right merchandise on hand? More lines or less? Right price brackets?

Tax Problems. Taxes loom larger than ever in the business picture—local taxes, state taxes, Federal taxes.

Is dealer's business arranged to meet this tax burden most economically? Is he watching all possible short-cuts to tax savings?

Profit Yardstick. How does dealer's showing compare with other similar businesses? Are yardsticks available for measuring "good operation" under present conditions? (RADIO TODAY will have more on this in February, just before you fill out your income-tax report, due March 15.)

Foregoing is a check-list which every radio dealer should apply to his own business during the opening months of 1937. It will pay every retailer to shake himself out of his rut and ask himself these questions.

In large measure each radio business man can answer these queries to his own immediate benefit. Merely turning his attention to these situations, one by one, will often suggest the best solution under the conditions.

But there are also problems on which the radio dealer needs outside help and counsel. To provide this expert assistance in "making more profits out of radio" RADIO TODAY will during 1937 present a series of articles, based on the practical experience of leading merchandising authorities in radio, taking up the main functions of profitable selling of radio for the retailer.



Mrs. Ruth Christensen, proprietor of the Music Shop, leading radio dealer of Niles, Mich., makes a specialty of upper-bracket radios. (P.S. She got the order.)

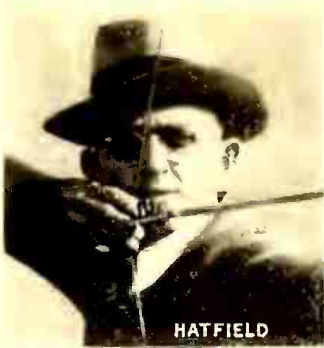

H. D. Hatfield & Son, Hollywood, Cal.



Weill's, Bakersfield, Cal.



Levitz Furniture Co., Lebanon, Pa.



Wurlitzer Co., New York City

PROMOTION CALENDAR FOR RADIO DEALERS

Eight experts crowd the days with seasonal tips from their experience

January 25-31

- 25—Investigate your phonograph-radio customers. Check on whether they're buying records and regard them as "extra set" prospects later on.
- 26—Pick an important sport event out of the headlines and plug it as a date before which listeners must certainly buy new radio tubes.
- 27—Feature the words, "Where Do You Spend Your Time?" in ads and window displays in an effort to remind prospects that they need good sets in their cars, bedrooms, kitchens, etc.
- 28—Plan now for Lincoln's and Washington's birthdays. Prepare their pictures for your window and say that their characters mean a lot to radio dealing.
- 29—Check up on the persons who buy records from you but have never bought a combination or a phonograph. Ask them, "Can it be that fine up-to-date recordings are being played on an old-fashioned spring operated "jolly" of pre-war vintage?"
- 30—Announce that your new sets "have a new engineering feature that you can understand." Display the backs of a receiver or two.
- 31—Sunday.

February 1-20

- 1—Feature a lively "Repeat New Year's Resolution."
- 2—Build your Valentine window. Get some comic Valentines, the more crude the better, and enlarge them for backgrounds. Accent the party atmosphere with hearts and cupids; plug broadcast dance music.
- 3—Get the phrase, "Let's Trade Radios," set up in unusual type and use it in newspaper copy and on window placards.
- 4—Sell the idea that each home should have a radio den. Use the details on how to create one and list all articles necessary along with list of advantages.
- 5—Connect with the art instructors in your local high schools and arrange to have the best student-drawn Valentines displayed in your window.
- 6—Talk up the broadcast this p.m. from the Metropolitan Opera in New York, just as you might have done last Saturday and may do next.
- 7—Sunday.
- 8—Publish a Valentine edition of "Radio Store News." Use free hand comic art work and conceal your advertising in the running comment.
- 9—Check your filing system for all

names and addresses of prospects picked up from different sources. Think of them in terms of the three holiday appeals that can be made at this time.

- 10—Collect the names of all persons in your area interested in voice culture. Arrange to demonstrate frequency control on new sets.
- 11—Mail Valentine postcards to your prospect list.
- 12—Lincoln's Birthday.
- 13—Display a huge batch of short wave lists and logs.
- 14—Sunday. St. Valentine's Day.
- 15—Start spot announcements on the air three times a week at 12 noon to 12:15. Besides replacement market, you can hit auto radio, second set and tube market.
- 16—Stir up interest in war news from Europe. Blow up lists of all news broadcasts.
- 17—Group all the display cards you got recently from manufacturers into a flashy background for new models.
- 18—Collect a group of "stills" from recent movies showing stars operating radios in action scenes.
- 19—Build a campaign on the dozens of new receivers that now are available in assorted colors. "Rainbow" theme to be used in window display.

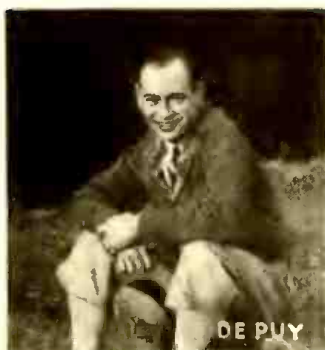

Spear's New York City

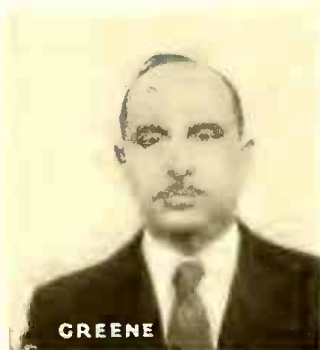

Greene's Radio Service, Lynn, Mass.



Albert's Dept. Store, Napa, Cal.

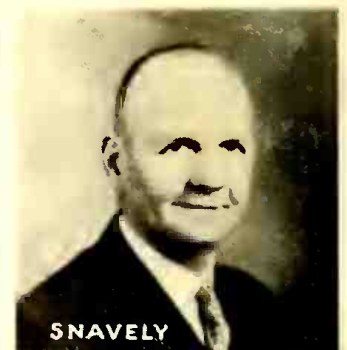

Snavely-Kelvinator, Lebanon, Pa.

1937 AUTOMOBILE RADIOS

- automatic frequency control for easy, accurate tuning
- acoustic compensation for better tone quality
- sales features give radio stores edge on car dealers

★ **PREVIEW** of the new auto sets indicates that radio dealers will have many new features with which to sell the new sets. And the set manufacturers will bring them to the attention of the motoring public. On the basis of circuit developments, descriptive phrases, and other sales advantages the radio dealer has been given greater opportunity than the auto dealer who must sell one type of set.

One of the outstanding developments has been the introduction of automatic frequency control for auto radios. So far only General Electric has announced AFC sets. With AFC the driver can tune in a station approximately and then the set does the rest, automatically tuning in the signal perfectly. This means that the driver need pay but little attention to tuning. G-E also uses class "B" audio amplification.

Lighting of dial

Again in 1937 Zenith is featuring "America's Safest Auto Radio." The safety lies in the big black no-glare dial which is easy to read and has a novel lighting arrangement which can be turned off after tuning has been completed. A single-figure beam is used which lights up only the figure to which the tuning indicator is pointing. On the steering-post model, the tone and volume controls take the form of knurled wheels at the left of the dial.

Arvin advertising stresses the "Phantom Filter" which brings in more stations and insures low noise level. This filter is a device which is inserted in the antenna lead and increases the efficiency of the transmission line. A "Geographical Compensator" or sensitivity control permits an adjustment of the sensitivity of the set to meet individual requirements.

RCA's Magic Voice has been incorporated in the deluxe auto sets. This acoustic equalizing gives a tone quality that is equivalent of home performance. Other RCA features are: synchronous vibrator-rectifier eliminating the need for a separate rectifier tube and 9-watt output in larger models.

A die-cast housing is utilized in Emerson's deluxe model. This development in structural sturdiness provides freedom from rattles and microphonism.

One of the DeWald Motortone receivers is of the self-contained type and mounts behind the instrument panel, the controls being below and flush with the panel. This type of construction results in a substantial saving in cost.

Simpler mounting

Single or two-hole mounting is found in new auto sets, a feature simplifying the installation problem. Custom controls for all car models permit the radio dealer to compete with car automotive dealers selling "specially designed" auto sets.

One big advantage the radio dealer enjoys is that his radios have numerous features that cannot be found in any of the sets merchandised by automotive manufacturers. Dual speakers can be purchased for almost any type set—dealer can install any kind of antenna that car owner wants and still be sure that set will work.

Filters

Various types of noise filters in the leading auto sets have done away with the need for ignition suppressors. At least one manufacturer (Zenith) is making use of the new permo-dynamic speakers in higher-priced models.

Iron-core I.F. transformers using inductance tuning are used by RCA. Pennatune permanently adjusted transformers are exclusive with Arvin. Tone controls are found in all the better sets, some of the continuously variable type; usually the control is mounted on the set itself.

"Factory installation" fallacy

In view of the fact that most people wrongly suppose that sets sold by auto dealers are installed at the factory, the radio dealer can correct that impression and use it to his advantage. Very few of the cars are ac-

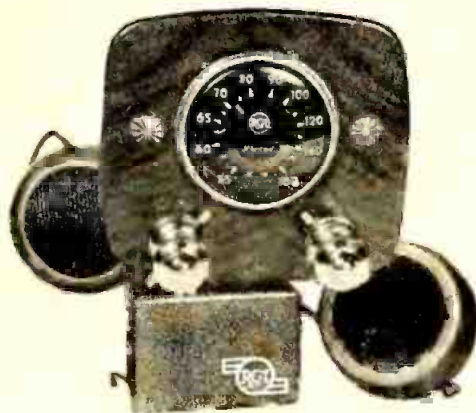

"Magic Voice" is featured by RCA.

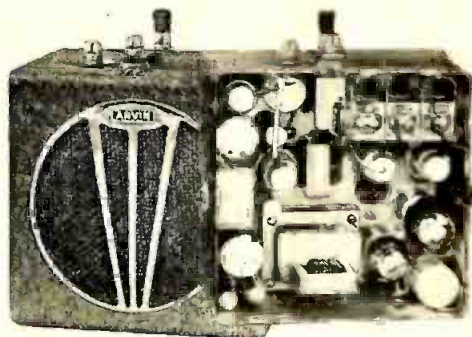

Arvin has "Phantom Filter."



Sturdy die-cast housing—Emerson.



G-E—automatic frequency control.

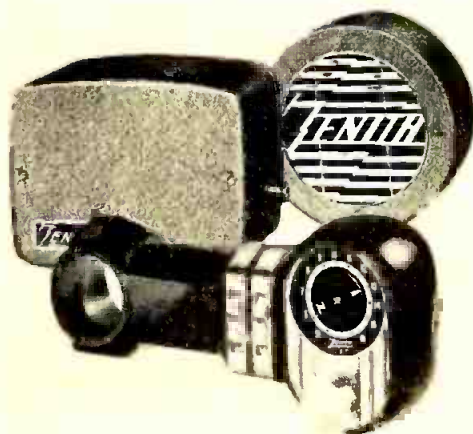

Zenith's safety no-glare dial.

tually factory-equipped except on explicit order—and in that case the buyer must usually wait a few weeks. Ordinary procedure is to equip the car not at the factory but locally—work being handled by either the distributor or dealer. Sometimes work is done by auto mechanics, or it may be done by a radio serviceman.

Radio dealer who has an expert serviceman can point out that his installation is at least as good as that done by a mechanic and may even

be better. So having the radio dealer sell and install his own brand of set is equal to or better than buying the radio with the car.

With an expected passenger-car production for 1937 in excess of $3\frac{1}{2}$ million, there is big opportunity for the radio dealer. Deducting from the total those cars sold with radios still leaves $2\frac{1}{2}$ to 3 million prospects for auto radio. And in addition, the owners of 1934, 1935, and 1936 cars should not be overlooked.

noise since the sets are not often used while under way.

There are also specially designed radios for use on boats—these are for 6-volt operation and consume as little as 1.8 amperes.

Farm-power plants

The small portable 6-volt and 110-volt AC gas engine farm-power plants also find their use among boating enthusiasts. For about 100 dollars it is possible to have 110 AC (300 watts) on board any boat. The generators are compact and easily operated. The convenience of AC on board should appeal to persons who are appliance minded—curling irons, fans, electric shavers, small pumps, and home radio sets are only a few of the devices that can be operated with “city power.”

Even the smallest of water craft are radio prospects. And for those not having electric power there are the portable dry battery receivers. These sets have the added advantage that they can be carried ashore and used on the beach or at the camp.

GAS STATION FRACAS

★ Dramatic pause is all that's noticed in New York City's outlet battle about what home sets shall be sold by gas stations. Sobol Bros., whose chain of 125 stations is primed to enter the business, were disturbed in their buying because local radio stores were inclined to rib their jobbers for selling to Sobol. These distributors were timid about burning bridges among established radio accounts.

George Solomon, director of Sobol's radio division, says that makes of home sets have not been selected, and that his firm awaits legal rulings. It is known, however, that Sobol's have played with the idea of private brands. In fact, a representative of the chain flew to Chicago, contacted leading private-brand manufacturers, secured a line of receivers built to the standards of leading Chicago mail order firms which operate retail stores. Early in February, report was, these sets would appear in 125 gas and oil stations in New York at price levels considerably below that of current nationally advertised brands. But now plans are still up in the air!

Short-sighted dealers may thus find themselves competing on a price basis rather than the equal basis of similar merchandise at list price. The gas-station organization has a good reputation for integrity and service. It is not likely that a private brand will reduce their volume, as they figure it.

RADIOS FOR YACHTS & BOATS

★ RADIO DEALERS in shore and lake regions have a rapidly growing radio-set market in owners of motorboats, cruisers, and yachts. Interest in boats is at a peak this year as evidenced by the attendance at the New York Motorboat Show this month. And radios are being demanded by the purchasers of these craft.

A few of the larger cabin cruisers seen at the Show were equipped with auto radios—suitably installed—as standard equipment. On others the Zenith boat models were in view.

Rich market

While the boat market is not large in numbers, it represents quite a rich market. People who buy motorboats and yachts are accustomed to paying three, five, and fifteen thousand dollars for their craft. Consequently a fifty to one hundred dollar

radio is a very small percentage of the total cost.

And the need for radio when on the water is great. After a boat leaves the dock it is out of communication with the world—there are no newspapers or theaters to go to. But with a radio the party can get the news reports and the wonderful programs. Weather reports are valuable to any skipper and purchases can be influenced on that basis alone.

Installing

Installation of the set aboard boat is simple and is easily done by any serviceman. Antennas may take the form of copper screening placed in roof or may consist of a wire stretched between two elevated points. Ordinary auto sets can be built into the boat and they will provide satisfactory reception. Usually no attempt is made to eliminate motor ignition



Owners of small craft form an elite list of radio prospects. There are many small boats on American lakes, rivers and coasts, most of which need a radio set.

EUROPE'S RADIO FLAIR

New designs that speak another language

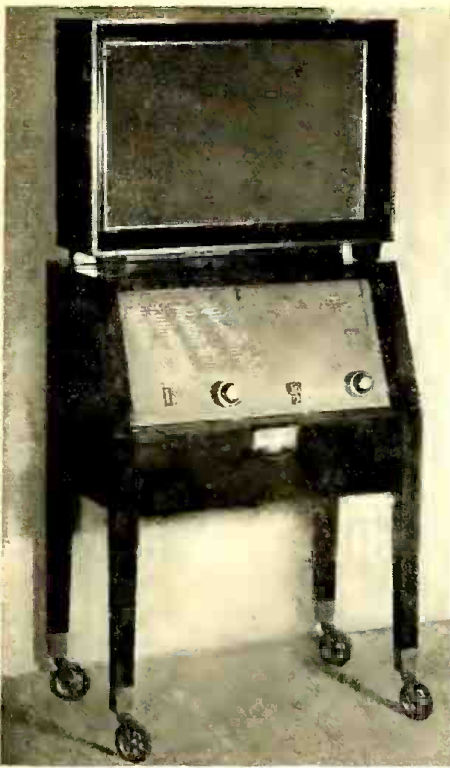

RADIO EAR—speaker atop this set comes off, can be dragged elsewhere in the room.

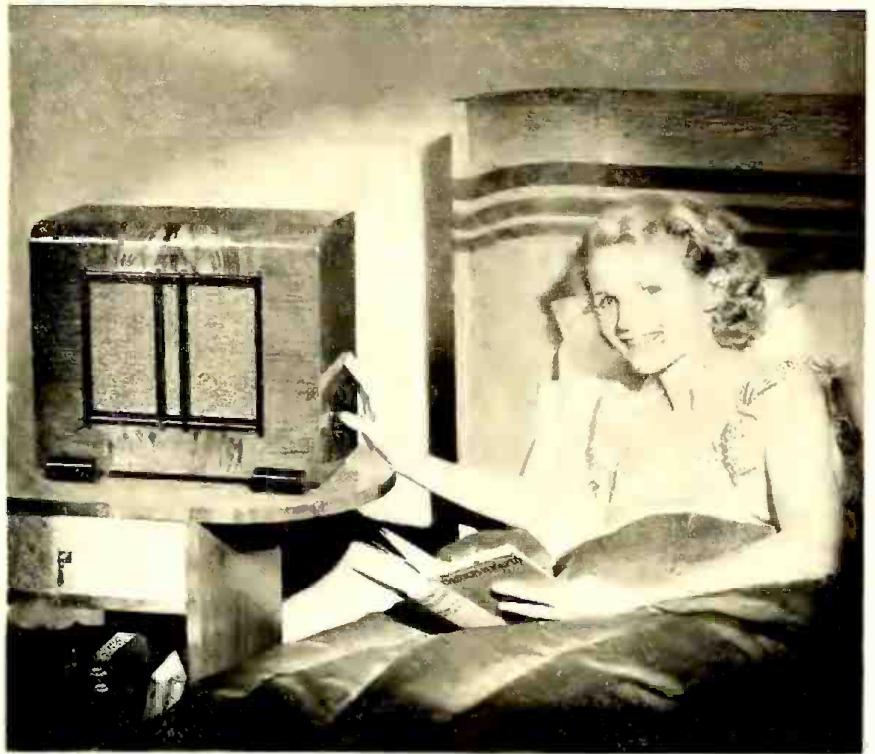

FUN IN BED except that listening in London is taxed "per valve." Hence fans use multiple (Stentorian) speakers with remote-control.

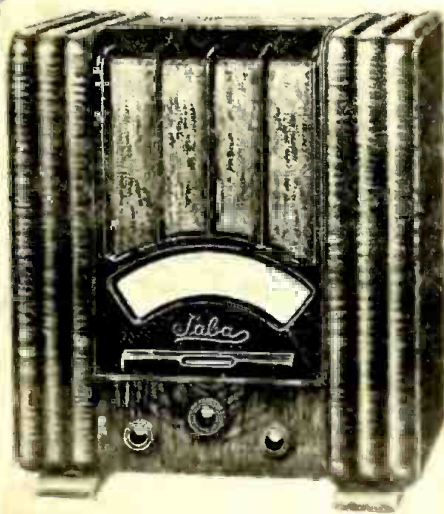

PERMANENT WAYER is the nickname for a German hit built of fancy woods plus bakelite.



FLATTEST EVER mechanism for record playing results in a new table "combination."

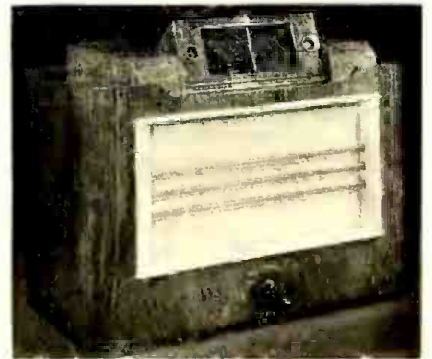

TEASER DIAL tilts to your convenience and has become a popular gadget on the continent.

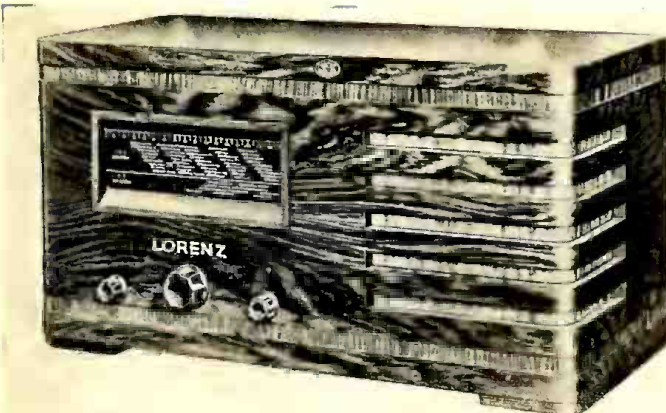

OBLONG STYLE kept the Europeans happy some three years before the Americans went to work on it.

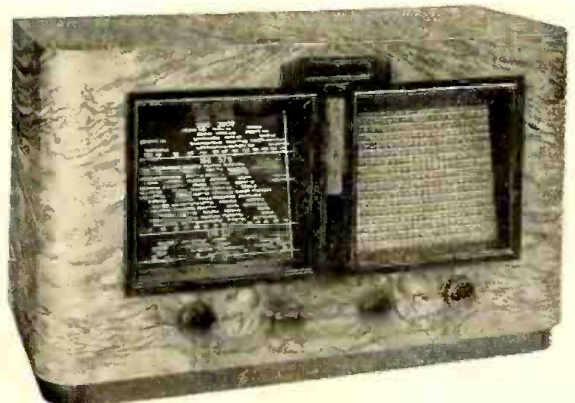

GEOGRAPHY LESSON on a "Radiobell" dial showing locations rather than kc.

NEW THINGS FROM THE MANUFACTURERS

Philco receivers

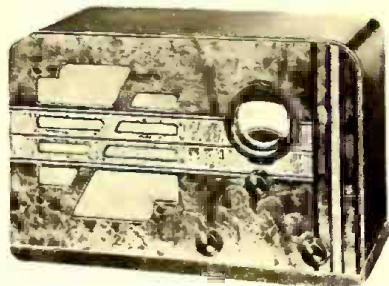

★ Six new sets added to Philco line. Model 62T (illustrated) is a 5-tube dual band superhet. Cabinet of walnut—size 10 x 15 $\frac{1}{4}$ x 8 $\frac{3}{8}$ inches. List \$29.95. Other table models:

61B 5 tube 2-band \$39.95
89B 6 tube 2-band 39.50
610B 5 tube 3-band 44.95

Console models:

61F 5 tube 2-band \$49.95
620K 6 tube 3-band 69.95

Philco Radio & Television Corp., Tioga & C Sts., Philadelphia, Pa.—RADIO TODAY—See also advt. p. 6

Westinghouse Serenader radio



★ Personal model 5 tube set. Available in colors—walnut with 3-stripe ivory inlay; Chinese red or antique ivory with harmonizing strips. Model WR-217—list \$24.85. Merchandising Headquarters, Westinghouse Radio, 150 Varick St., New York, N. Y.—RADIO TODAY

RCA-Victor receivers

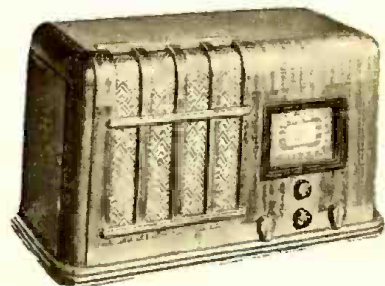

★ Twelve new models have been added to current RCA line. Model 5T-8 (illustrated)—5-tube dual-band superhet extending up to 6600 KC. 4 $\frac{1}{2}$ watt output—tone control—6-inch speaker. New type dial with 10-1 vernier. Antenna wavetrap—magnetite

core I.F. transformers. Other table models are:

5T-1 5-tube 2-band vertical
5T-6 5-tube 2-band horizontal
5T-7 5-tube 2-band horizontal
6T-5 6-tube 2-band vertical
7T-1 7-tube 3-band vertical

Console models:

6K-1 6-tube 2-band
6K-3 6-tube 3-band
7K-1 7-tube 3-band
8K-1 8-tube 3-band
9K-1 9-tube 3-band
9K-3 9-tube 3-band
10K-1 10-tube 5-band

RCA Mfg. Co., Front & Cooper Sts., Camden, N. J.—RADIO TODAY—See also advt. p. 2

Short-wave converters for autos

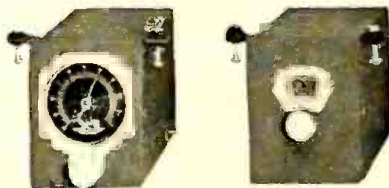

★ Converters to permit short-wave reception on any standard auto radio. Model 500 covers 1600 to 6000 KC—especially adapted for use by law enforcing agencies for reception of police calls. Model 600 covers 6000 to 18,000 KC. Regular broadcast reception not affected when converter is not used. Model 500 list \$21.95—model 600 \$24.95. ABC Radio Labs., 3334 N. New Jersey Ave., Indianapolis, Ind.—RADIO TODAY

Stromberg-Carlson receivers



★ Nine tube all-wave superhet with acoustical labyrinth (illustrated). High-fidelity—tri-focal tuning—selectorite dial. Adjustable sensitivity control on rear of chassis. Class A output of 5 watts. Model 140-M. Second model is the 145-SP ten-tube automatic phonograph radio combination. 130-J is an 8-tube all-wave horizontal table model. Stromberg-Carlson Telephone Mfg. Co., 100 Carlson Ave., Rochester, N. Y.—RADIO TODAY

Pilot AC-DC radio



★ 11-tube 4-band AC-DC superhet with 4 watts power output. Tunes 525-23,600 kc.—cathode ray tuning indicator—selective lighting of dial. Dual ratio dial—RF preselector on all bands. Tone control—10-inch speaker. Series 300. Pilot Radio Corp., 37-06 36th St., Long Island City, N. Y.—RADIO TODAY

Troy phonograph combination



★ 5-tube AC table type radio-phonograph—tunes broadcast band. Has AVC and tone control. RCA pick-up—Webster self-starting motor. Plays 12-inch records. Available in walnut, satinwood, and antique white finishes. Model 75PC—list \$44.50. Other Troy sets from \$14.95 to \$69.95. Troy Radio Mfg. Co., 1142 S. Olive St., Los Angeles, Calif.—RADIO TODAY

Waterproof "B" batteries

★ Burgess "B" batteries are now effectively protected from cell leakage and outside moisture. Each cell individually wrapped in 3 layers of moisture-resistant paper—cells separated by paraffined inner layer. Prevents stray current losses which cause noisy reception. Double wax seal on top and paraffined outside cartons. Burgess Battery Co., Freeport, Ill.—RADIO TODAY

Electric razor filterette

★ Noise filter to use with electric razors—effectively squelches interference produced by razors. Contained in
(Continued on page 26)

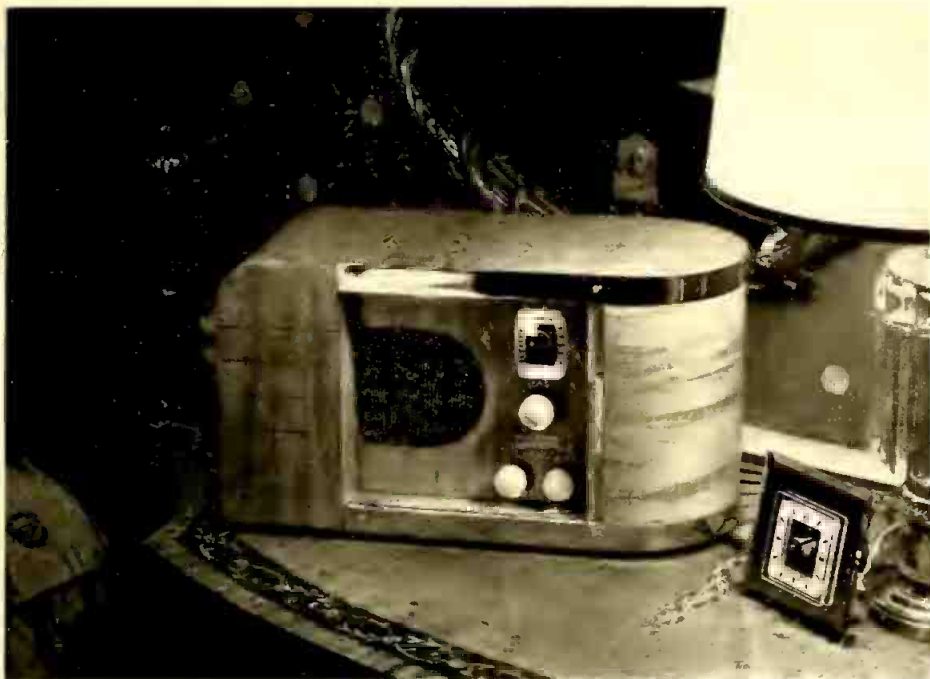

This is the
DICTOGRAPH

Silent!
RADIO

... an Outstanding Sales Opportunity!
WITH THE ACOUSTICON MYSTIC EAR

• When you feature the Dictograph Silent Radio, you start from scratch. *Everyone* is a prospect, radio-owners as well as non-owners—for this radio is absolutely non-competitive compared with all the conventional loudspeaking sets on the market. The Dictograph Silent Radio puts into your hands a brand new sales argument, growing out of its ability to make listening either a personal experience or a group experience at the turn of a switch. Dealers who have appreciated this fact are reaping a harvest of sales; you should be one of them.

Realize, please, that the Acousticon Mystic Ear is not an earphone or a miniature speaker. It is a newly patented device that employs the tonal fork principle in which 60% of all sound is heard through bone conduction. No other set can achieve the same result—because no other set can include the Mystic Ear.

Get the facts about this astonishing set that is revolutionizing the radio industry. Learn how it can build *your* income.

Return the coupon today.

DICTOGRAPH PRODUCTS COMPANY, INC.
Executive Offices: 580 Fifth Avenue, New York. N. Y.

Don't confuse the Acousticon Mystic Ear with an Earphone or a Miniature Loudspeaker.



The Tuning Fork.
... Strike it! Hold it in the ear! Little or no sound is emitted.



But press it against a table and the table is put into resonance—vibrates—gives forth a musical note.

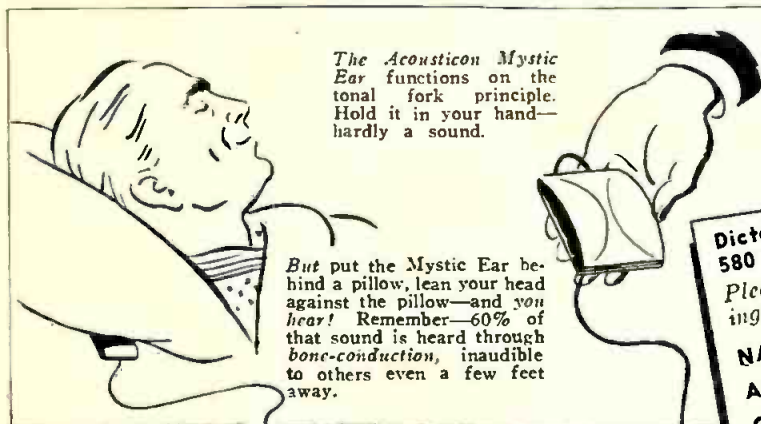

The Acousticon Mystic Ear functions on the tonal fork principle. Hold it in your hand—hardly a sound.

But put the Mystic Ear behind a pillow, lean your head against the pillow—and you hear! Remember—60% of that sound is heard through bone-conduction, inaudible to others even a few feet away.

Dictograph Products Co., Inc.,
580 Fifth Avenue, New York
Please send me further information concerning your Dictograph Silent Radio proposal.

NAME _____
ADDRESS _____
CITY _____ STATE _____
I am a retailer ; I am a wholesaler

PHENOMENAL
Sales
**OF THE NEW
LOW PRICED**

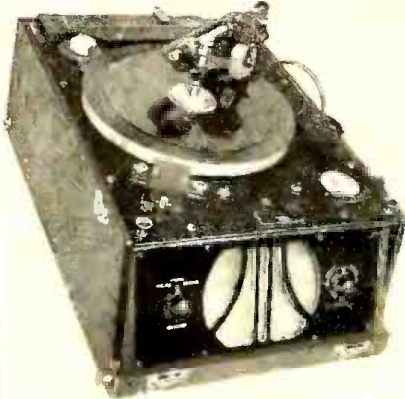

PRESTO RECORDER

... reveal widespread demand for a good low priced instrument.

Offered to dealers only three months ago ... the Presto Model D Recorder now rates center position in dealers' window and floor display ... the spot reserved exclusively for profitable, fast moving merchandise.

SALES RECORDS SHOW

... that every school, college, radio station, orchestra leader, church and civic organization is a live prospect for the recorder.

... that there is good money in making records for musicians, radio artists, public speakers, stores, hotels and industrial organizations.

Get the best of this business in your section!

WRITE NOW for dealer proposition and tested sales promotion data.

NOTE: The model shown makes phonograph records equal to any commercial record in brilliant, life-like reproduction of voice and music. It plays any record, up to 12", and also operates as a public address system.

WORLD'S LARGEST MANUFACTURERS OF INSTANTANEOUS RECORDING EQUIPMENT

PRESTO
RECORDING CORPORATION

137 West 19th Street, New York, N. Y.

FINER SOUND COVERAGE

- seasonal samples of p.a. profit
- additional installation tricks

SOUND FOR THE THIRTY MILLIONS

★ Education is the largest industry in the United States, and it offers correspondingly large markets for radio and allied products.

According to the Office of Education, Washington, D. C., the schools of the nation number as follows:

5,886	junior high schools
20,000	senior high schools
438	junior colleges
1,263	colleges and universities
236,236	elementary schools
9,992	private schools

273,820 total instructional units

Officials of the RCA educational division estimate the present total expenditure for education at two billion dollars annually. They place the number of school buildings in use at 180,000, housing 24,000,000 elementary and high-school students. Sound-reproducing equipment in use in American schools is estimated as:

1,200	public-address systems
60,000	phonographs
1,000	16-mm movie projectors with sound
500	35-mm movie projectors with sound
16,000	radio sets

Total student and instructor population of the educational institutions of all classes is placed at a grand total of 30,000,000.

SOUND PROSPECTS AFLOAT

★ Engineers at Wholesale Radio Service Co., Inc., New York, have stirred up considerable P.A. activity in the marine business. Technicians at the company have made a series of important shipboard installations recently and the sea-going adaptations of sound equipment seem on the upgrade.

Among recent jobs was the installation of a 20-watt de luxe portable system on a private yacht. This system is to be used for crew calls, re-broadcasting radio programs to all points on the ship, and paging. Included was a speaker horn designed for hailing passing vessels or for giving docking directions from the bridge.

NEW BULLETINS

★ Available to servicemen, sound men and engineers is a new "Microphone Applications and Specifications Chart" presented as an innovation in technical data by Shure Bros., 225 W. Huron St., Chicago. Request Form 227TK on letterhead or mention regular distributor's name.

★ Electrical Amplifier Corp., 135 West 25th St., New York City, has prepared a new catalog on its sound equipment.



This plug-in office communicating system by Webster Electric, Racine, Wis., provides for selecting any of a number of interconnected stations.

NOW "Step Up" Your Business with these New 1937 Models

Emerson

"RE-CREATES THE ARTIST



Radio

IN YOUR HOME"

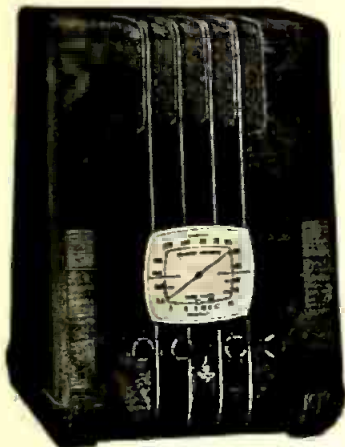

EMERSON Model Z-159
American—Foreign—Police
6-Tube AC Superheterodyne
Automatic Volume Control,
Tone Control, 3 Watts Output,
6½-inch Dynamic Speaker.
Hand-rubbed walnut cabinet
with slanting front panel. All
new features.

\$44.95

Slightly Higher in West and South

With this Dynamic Store and
Window "Silent Salesman"

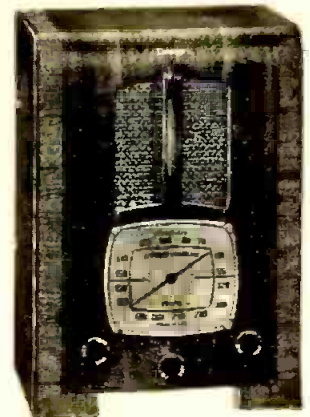

EMERSON Model R-156
"Miracle 5"
American Broadcast, All Police
Bands, Amateur and Aeroplane
Stations

5-Tube AC Superheterodyne
Automatic Volume Control,
Tone Control, 3 Watts Output,
6-inch Dynamic Speaker. Hand
rubbed walnut cabinet.

\$19.95

Slightly Higher in West and South

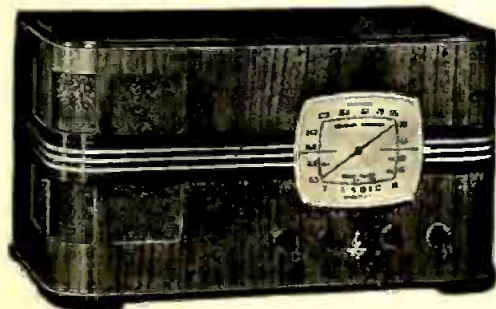

EMERSON Model Z-160
American—Foreign—Police
6-Tube AC Superheterodyne
Automatic Volume Control,
Tone Control, 3 Watts Output,
6½-inch Dynamic Speaker.
Hand rubbed walnut cabinet.

\$39.95

Slightly Higher in West and South

Virtually a "store within a
store" . . . handsome solid
wood construction in blue,
gold and red . . . 7 feet
high, 8 feet wide . . . an
irresistible background and
demonstration display for
the new EMERSON styles.
Ask for details of how you
can get this modern mer-
chandising unit.

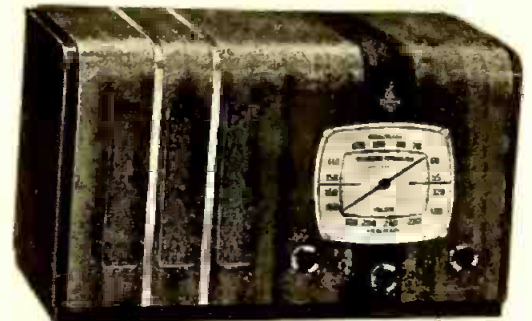

EMERSON Model R-158
American Broadcast, All Police
Bands, Amateur and Aeroplane
Stations.

5-Tube AC Superheterodyne
Automatic Volume Control,
Tone Control, 3 Watts Output,
6-inch Dynamic Speaker. Hand
rubbed walnut cabinet.

\$29.95

Slightly Higher in West and South



EMERSON MODEL
R-153

Same technical features
as Model R-158 (at
right). Hand rubbed
walnut cabinet.

\$26.95

Slightly Higher in West and South

EMERSON 1937 Plans
Ready for Dealers—
Get the Details Now.

Write or Wire Your
Nearest Distributor—or
Direct to Factory.

EMERSON RADIO AND PHONOGRAPH CORPORATION • NEW YORK, N. Y.
World's Largest Maker of Small Radios

NEW THINGS

(Continued from page 22)

a seamless aluminum housing $2\frac{3}{8}$ inches long—inserted between power outlet and appliance plug. For AC-DC lines up to 125 volts.

Featured in the Tobe line are other filterettes for all types of noise reduction. Model OB-110 is designed especially for oil burners. Contained in standard cut-out cabinet—conforms to wiring regulations. Tobe Deutschmann Corp., Canton, Mass.—**RADIO TODAY**

Operadio portable sound system



★ Portable 12-watt Class A sound system. Dual input channel for crystal mike and phonograph input. Separate tone controls for bass and treble. 12-inch speaker with cable and plug—crystal mike with 25-foot cord. Model 115—complete in leatherette covered carrying case. Operadio Mfg. Co., St. Charles, Ill.—**RADIO TODAY**—See also advt. p. 60

AC-DC colored table sets

★ New color addition to Emerson line is the model A-130—6-tube superhet. Available in white, red, green—with contrasting trim. List \$24.95. Emerson Radio & Phonograph Corp., 111 Eighth Ave., New York, N. Y.—**RADIO TODAY**—See also advt. p. 25

Portable sound system

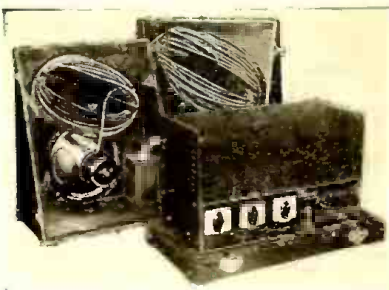

★ 25-watt high-fidelity sound system using beam power output stage. Sufficient gain to operate with all types of mikes. Mixer and tone controls. Model C55—list \$169 with mike, 2 12-inch speakers—housed in 2 black leatherette carrying cases. Transformer Corp. of America, 29 Wooster St., New York, N. Y.—**RADIO TODAY**

Refrigerator capacitors

★ Complete line of exact duplicate replacement units for refrigerators and other motor driven appliances. Catalog with specifications on request. Aerovox Corp., 70 Washington St., Brooklyn, N. Y.—**RADIO TODAY**—See also advt. p. 60

P.A. amplifier-phonograph



★ Combination 20-watt amplifier, phonograph turntable, 6-volt DC and 110 AC power supply contained in portable case. High-gain amplifier operates from all mikes. Dual channel input. Detachable remote control head for operating a distance from amplifier. Radolek Co., 601 W. Randolph St., Chicago, Ill.—**RADIO TODAY**—See also advt. p. 56

Amperex Class "B" tube



★ Hi-mu triode tube for amateur transmitters. Designed for Class "B" audio systems and for R.F. amplifiers. Zero bias operation up to 1250 volts—output 300 watts per pair. Plate dissipation of 75 watts. Requires exceptionally low driving power. Type ZB 120—price \$10. Amperex Electronic Products Corp., 79 Washington St., Brooklyn, N. Y.—**RADIO TODAY**

Recording amplifier

★ Eight-watt metal tube amplifier for recording. Gain of 120 DB. Uses phase inverter—has low and high pass filter arrangement operated by single control knob. Neon volume indicator. Small in size and portable—weight 12 pounds. Universal Microphone Co., Inglewood, Calif.—**RADIO TODAY**

Ballast resistor replacements

★ Line of metal tube ballast resistors for replacements. A representative stock kit of 12 different types takes care of most calls with minimum inventory investment. Clarostat Mfg. Co., Inc., 285 N. Sixth St., Brooklyn, N. Y.—**RADIO TODAY**—See also advt. p. 58

Miles sound equipment

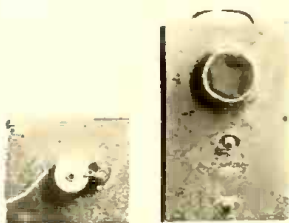

★ New line of Miles equipment includes pre-amplifiers, intercommunicating systems, P.A. systems, microphones and other sound items. Illustrated on

left is metal tube pre-amplifier for low level mikes. A "socket mike" is shown on right—this device will operate in conjunction with any radio set over the power lines within a building. Miles Reproducer Co., Inc., 114 W. 14th St., New York, N. Y.—**RADIO TODAY**

Fada colored sets

★ Complete line of colored sets—5, 6, 7-tube models—AC and AC-DC operation. Moulded cabinets in following colors—walnut, ivory, black, Chinese red. Gold or chromium trim on some sets. Model 250 in black with gold trim—list \$39.95—has 5-tube AC chassis. Fada Radio & Electric Co., 30-20 Thomson Ave., Long Island City, L. I., N. Y.—**RADIO TODAY**—See also advt. p. 5

Tru-Tan crystal pick-up



★ Quality crystal pick-up with off-set head which holds the needle when playing a 12-inch record practically true to tangent of the circle at all points—maximum error never exceeding $1\frac{1}{2}\%$. Gives better reproduction and longer record life. Double row ball bearing base swivel. Finished in black with chrome trimmings. Astatic Tru-Tan model B—list \$17.50. Astatic Microphone Laboratory, Inc., Youngstown, Ohio—**RADIO TODAY**

Magnavox auditorium speaker

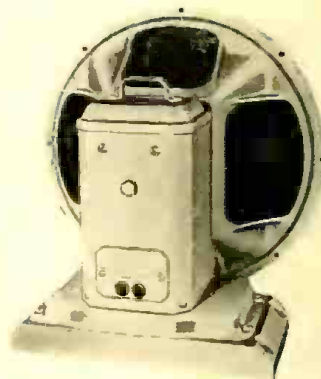

★ Heavy-duty 15-inch electro-dynamic speaker—handles 25 watts average power. Curvilinear cone with 2-inch voice coil. Field excitation from 10 to 25 watts. 3 models: standard—response up to 5000 cycles; high frequency covering up to 8000 cycles; low frequency covering 30 to 2500 cycles. Available with output transformer. Model 505 DC list \$42.50. AC excited—model 525 AC. Magnavox Co., Fort Wayne, Ind.—**RADIO TODAY**

Arcadia receivers

★ Eleven-tube AC console—3-band coverage from 528-18,300 kc. Phantom light dial using beams of light instead of pointers to indicate tuning and position of volume and tone controls. Metal tube—dual speed tuning—hi-fi switch. Model 30EL674. Other Arcadia models from 5 to 13 tubes. Wells-Gardner & Co., 2701 N. Kildare Ave., Chicago, Ill.—**RADIO TODAY**

THE dream of yesterday is the accomplished fact of today. Regular air service across the Pacific by Pan American Clipper ships has added an important link in the world's transportation facilities.

Back of this spectacular service, and making its success possible, is a complete system of radio beacons and communication. Technical excellence and reliability distinguish the radio equipment both in the air and on land. RF switch gear, bushings, tube sockets, inductances, condensers and other parts make use of ISOLANTITE insulation in all this radio equipment. ISOLANTITE in your equipment will assure best results.

ISOLANTITE, Inc.

233 Broadway, New York, N. Y.

Factory at Belleville, N. J.



SAN FRANCISCO

HAWAIIAN IS.

MIDWAY IS.

WAKE IS.

CANTON

PHILIPPINE IS.

GUAM IS.

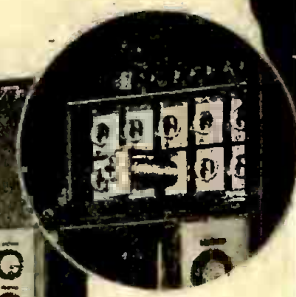

Western Electric 14-A Transmitter used at all of the land stations along the route of the Clipper ships. Note the liberal use of ISOLANTITE.

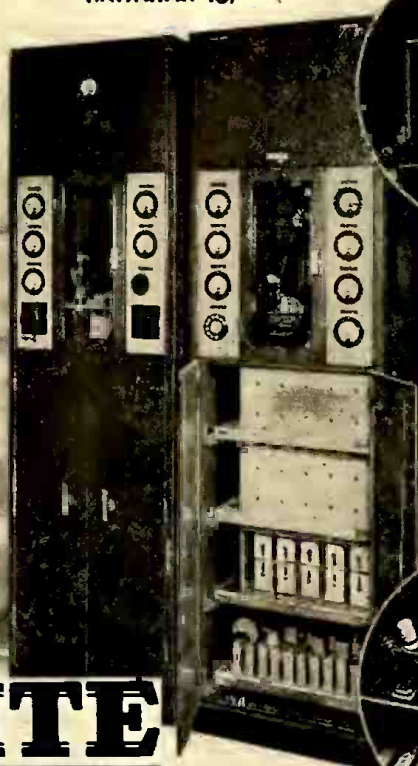

ISOLANTITE
INC.
CERAMIC INSULATORS

RADIO SERVICE SHOP

Using SUPREME Testing Instruments



WRITE FOR DETAILS

Designed by SUPREME INSTRUMENTS CORP. GREENWOOD MISSISSIPPI

CHECK LIST FOR
THE UP-TO-DATE

RADIO SERVICE SHOP

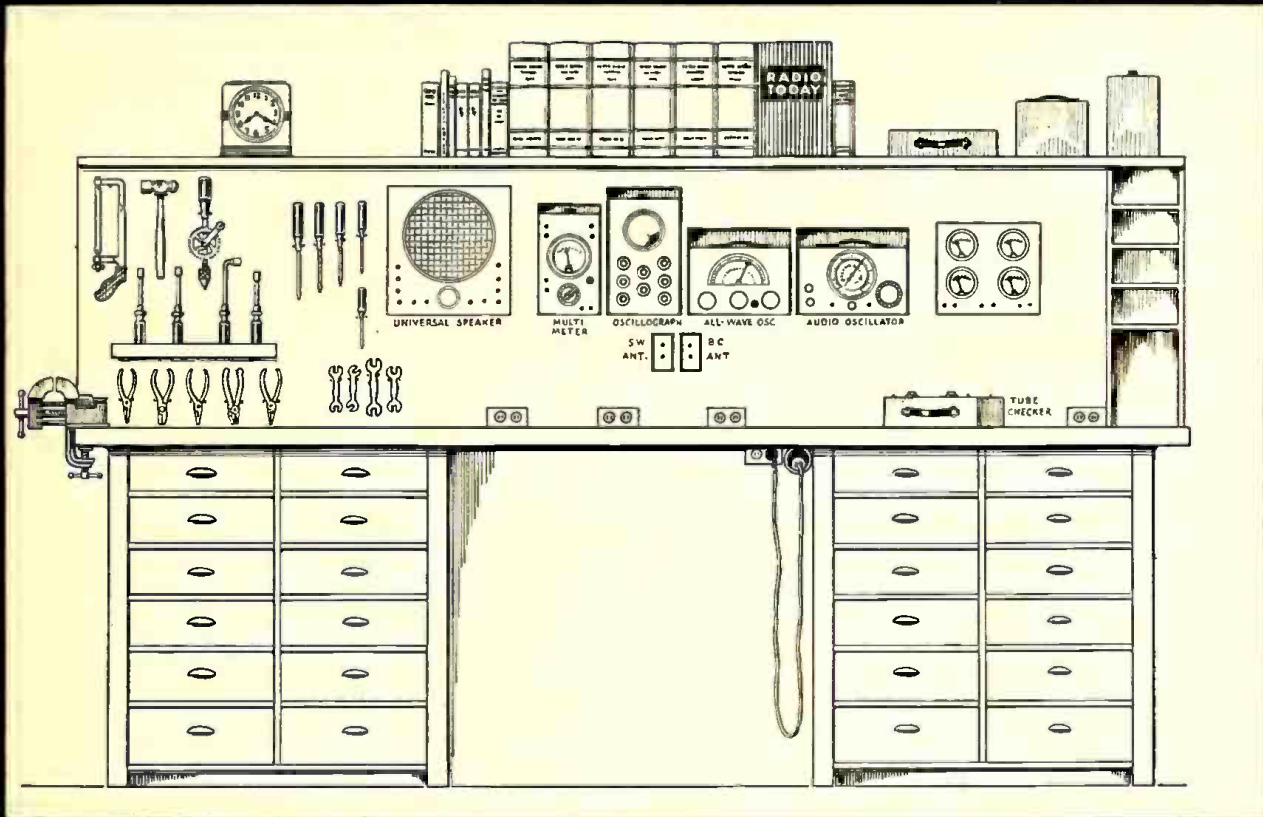

MUSTS

- All-wave antenna system & line filter
- Multi-range volt-ohm-mil meter AC-DC
- Calibrated all-wave R.F. signal generator
- Output meter or visual indicator
- Tube checker
- Vacuum tube voltmeter
- Cathode ray oscillograph with wobbler
- Assortment of meters
- Condenser tester
- Loudspeaker with universal trans. & field
- Service manuals or bulletins
- Subscription to RADIO TODAY

- Speaker shims
- Set neutralizing tools
- Tuning wand
- Polish kit
- Test leads & probers—clips
- Adapters
- 75 watt soldering iron with offset tips
- Flashlight
- Rubber mallet

- Long nose pliers
- Gas pipe pliers
- Diagonal cutting pliers
- End cutting nippers
- Set of flat wrenches 1/4 to 5/8
- Set of socket wrenches with offset
- Set of screw drivers
- Screw holding screw driver
- Offset screw drivers
- Assortment of drills and hand drill
- Bench vise
- Cold chisels
- Hammers
- Thin nose pliers
- Oblique pliers
- Wire stripper
- Hack saw
- File assortment

DESIRABLE

- Audio frequency oscillator
- Auto transformer for low voltage tests
- Shielded test room
- Impedance bridge (R, L, C tests)
- Spare power supply
- Spare audio system or P.A. amp.
- Turntable & pick-up
- Standard frequency records
- Condenser box
- Headphones
- Crystal calibrator (oscillator)
- Wattmeter
- Resistance indicator or decade
- Vibrator tester & storage battery
- Reference books

- Color coding outfit
- Auto cable repair unit
- Tube pullers
- Eyelet riveter & anvil
- 200 watt soldering iron
- Parts cabinets

- Tap wrench & taps 4 36, 6 32, 8 32, 10 32
- Drills for above taps
- Dies and holder—same sizes as above
- Circle cutter
- Electric drill
- Grinding wheel & motor
- Tin snips
- Wire gauge
- Box wrenches
- Extension cord and light for auto radio servicing

COPYRIGHT 1936

**RADIO
TODAY**

Ol' Man Centralab broadcasts-



THAT genial chap . . . the friend of servicemen and experimenters takes time out to remind you that every control problem can be met (better and easier) with **CENTRALAB CONTROLS**. Smoother — because of the long, non-rubbing contact, they give “profitable” service for a long time.

Change to Centralab

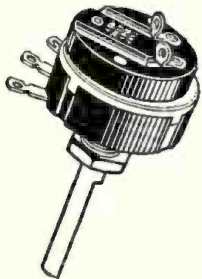

A mere handful
will service
practically any
set—old or new

Every Radio Service Man
should be a member of the
Institute of Radio Service Men

Centralab

Milwaukee, Wis.

BRITISH CENTRALAB, Ltd.
Canterbury Road, Kilburn
London, N.W. 6, England

FRENCH CENTRALAB CO.
118 Avenue Ledru-Rollin
Paris XI, France

FIXED RESISTORS
VOLUME CONTROLS
WAVE CHANGE SWITCHES
SOUND PROJECTION CONTROLS

UP-TO-DATE SERVICE BENCH

Suggestions for a well-equipped shop

★ Pictured on the preceding page is a suggested layout for a modern radio service bench designed first with the idea of having all instruments and tools in a handy location, and at the same time having as much equipment as possible on display in order to impress the customers. The second thought in the design is to have a minimum amount of instruments on the work bench and, yet, keeping all of them within easy reach. Hence oscillators, multi-meters and the like are fitted into recesses in the panel, while tools are mounted on the surface. Even when the job requires equipment of the portable type, this construction is very satisfactory for when the instruments are needed away from the service bench they can be easily lifted out.

Much drawer space has been provided in the design for tools that are used infrequently, spare parts, and other items that are not suited for mounting on the panel. A soldering iron holder constructed from a piece of iron pipe and wrapped in asbestos paper is mounted below the horizontal cross-piece. An ample supply of electric outlets is included in the design for both sets and test equipment. The power line connection for the set should pass through a line filter to remove electrical interference.

On the page also is a check-list for the serviceman — this list is separated into two columns, *musts* and *desirables*. After much research and interviews with many servicemen, a collection of *musts* was evolved. It is not our idea to state that a service shop should have every instrument listed — in many cases combinations or “service labs” are used which incorporate many of the items on the check-list.

Servicemen naturally have preferences as to types of equipment, and methods of working. While we show both the oscillograph and the vacuum tube voltmeter on our “*must*” list, it is obvious that both are not required. One man who favors visual study of wave form and alignment will regard the oscillograph as a “*must*,” whereas the vacuum tube voltmeter would be the “*must*” for another man — both preferences being based on the actual experience.

At the bottom of the page is a

compilation of tools that the serviceman should have. Particularly important is a set of flat and socket wrenches. A-1 service practice dictates that wrenches be used for all nuts instead of pliers — in addition the use of wrenches actually saves time. The use of pliers should be reserved for holding parts and cutting wires. Chisels are extremely handy for cutting off rivets, and their use is preferable to drilling out the rivets. And if you don't want to chew up the screw heads — there should be a screw driver to fit every size screw.

In the desirable column are listed a large number of test instruments that will save time and enable the serviceman to make tests that would otherwise be impossible. An audio oscillator or an electric phonograph outfit with frequency records will make it possible to test the audio frequency response of receivers and sound systems. The shielded test room (illustrated on page 36) when properly constructed will effectively keep out all static and electrical noise, thereby permitting checks on noise and sensitivity.

The crystal controlled oscillator is very helpful in accurately determining frequencies — it provides a means of checking the calibration on the signal generator. A wattmeter test on power transformers is of value in determining short circuits and other power supply troubles.

Reference books if read and studied are the backbone of the serviceman's knowledge. There are books written especially for the service trade and others used as text books in radio. Both are to be highly recommended.

MICROPHONICS, NOISE

★ Service note from Emerson points out that trimmer condenser screws should always be tight. “Never leave a trimmer with the outside plate so loose that there is no tension on the screw. Either bend up the plate or remove the screw. Loose screws are a source of noise, frequency drift and microphonism.”

★ Please turn to page 49 and register your vote on what items you feel should be included in manufacturers' service manuals. All you have to do is check the questions on a form and mail to RADIO TODAY.

AGAIN IN 1937-It's CROSLLEY!

THE COMPLETE RADIO LINE . . . THE PROFITABLE RADIO LINE



MODEL C-516-5 TUBES
AC-DC Superheterodyne Radio

Two Dual-Purpose Tubes . . . Airplane-Type Dial, calibrated in both meters and kilocycles . . . Tuning Range, 540-1725 Kc. . . 5" Dynamic Speaker . . . No Ground Required . . . Solid Mahogany Cabinet . . . Litz-wound antenna coils and other exclusive features. **\$1695**

The new 1937 Crosley Radio Line has *everything* . . . a complete group of models covering every price range . . . beautiful designs . . . superlative performance . . . new, advanced features that include the exclusive Crosley Auto-Expressionator, the Mystic Hand, and a dozen other equally sensational features . . . and greater dollar-for-dollar value. That explains the pronounced swing to Crosley by the radio-buying public . . . that's why experienced dealers everywhere are clamoring for the Crosley Franchise. Swing in behind the leader and sell Crosley, the radio that has everything. See your Crosley Distributor for complete details.

TUBE FOR TUBE... FEATURE FOR FEATURE... COMPARE THESE 1937 CROSLLEY VALUES WITH ANYTHING ON THE MARKET!



FIVER-5 TUBES

2 Bands . . . 540-4000 Kc. Continuous . . . 5" Speaker . . . **\$1999**
3 1/4 Watts Output.

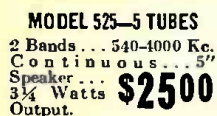

MODEL 525-5 TUBES

2 Bands . . . 540-4000 Kc. Continuous . . . 5" Speaker . . . **\$2500**
3 1/4 Watts Output.

MODEL 529-5 TUBES

2 Bands . . . 540-4000 Kc. Continuous . . . 5" Speaker . . . **\$2995**
3 1/4 Watts Output.



MODEL 629-6 TUBES

American-Foreign . . . 540-1710 Kc., 2350-7000 Kc. . . 6" Speaker . . . **\$3495**
4 Watts Output.

MODEL 634-6 TUBES

American-Foreign . . . 540-1710 Kc., 6000-18,000 Kc. . . 6" Speaker . . . **\$3995**
5 1/2 Watts Output.



MODEL 744-7 TUBES

Continuous Coverage . . . 540-18,000 Kc. . . 6" Speaker . . . **\$4995**
6 Watts Output.

Model 537 Console-5 Tubes
2 Bands . . . 540-4000 Kc. Continuous . . . 8" Speaker . . . **\$3995**
3 1/4 Watts Output.



Model 649 Console-6 Tubes
American-Foreign . . . 540-1710 Kc., 6000-18,000 Kc. . . 12" Speaker . . . **\$5995**
5 1/4 Watts Output.

Model 759 Console-7 Tubes
Continuous Coverage . . . 540-18,000 Kc. . . 12" Speaker . . . **\$6750**
6 Watts Output.

Model 769 Console-7 Tubes
Continuous Coverage . . . 540-18,000 Kc. . . 12" Speaker . . . **\$7995**
6 Watts Output.

Model 989 Console-9 Tubes
Continuous Coverage . . . 540-18,000 Kc. . . 12" Speaker . . . **\$9950**
12 Watts Output.



Model 1199 Console-11 Tubes
Continuous Coverage . . . 540-18,000 Kc. . . 12" Speaker . . . **\$10950**
20 Watts Output.

Model 1211 Console-12 Tubes
Continuous Coverage . . . 540-18,000 Kc. . . 12" Speaker . . . **\$12950**
25 Watts Output.

Model 1313 Console-13 Tubes
Continuous Coverage . . . 540-18,000 Kc. . . 15" Speaker . . . **\$14950**
25 Watts Output.

Model 1516 Console-15 Tubes
Continuous Coverage . . . 540-18,000 Kc. . . 15" Speaker . . . **\$17450**
25 Watts Output.

*** **WHATEVER HAPPENS YOU'RE THERE WITH A CROSLLEY**

CROSLLEY RADIO

THE CROSLLEY RADIO CORPORATION - - - CINCINNATI

POWEL CROSLLEY, Jr., President
Home of WLW—"the Nation's Station"—70 on your dial.
(Prices slightly higher in Florida, Texas, Rocky Mountain States and West.)



FOR RA



From the stage of the Metropolitan Opera House in New York come the operas RCA is sponsoring on the air. They are broadcast every Saturday afternoon over NBC's nationwide Blue network.

RADIO CORPORATION OF AMERICA

EVERYTHING IN RADIO FOR SERVICE IN COMMUNICATIONS

RADIO AT ITS BEST!

Radio Corporation of America sponsors matinee broadcasts of Metropolitan Opera every Saturday

IN the realm of music, opera is royalty. And king of music's royal family is the Metropolitan Opera Company. To sing on its stage in New York is the ambition of every operatic performer. To hear the musical masterpieces produced there is the desire of every music lover.

The Radio Corporation of America now makes it possible for all America to enjoy the Metropolitan Opera during the current season. Saturday matinee performances are broadcast direct from the Metropolitan Opera House stage, over NBC's nationwide Blue network. These broadcasts bring to every American family the world's most magnificent music.

RCA's service is universal

RCA, the only organization which actively participates in every branch of radio, contributes largely to the comfort and well-being of thousands the world over each day. It provides the most rapid means of communication. It links the sky and the sea and the land. Its broadcasting facilities bring entertainment, news and education.

These RCA services signify public confidence in the RCA name—the sort of confidence that creates good-will for every merchant handling RCA products. And this latest service—broadcast of the opera—is another good-will measure that will benefit all associated with the name of RCA.

RCA stands for radio—soundly engineered. Its past achievements prove this. And RCA sound engineering is some day going to bring radio *sight* to the world's millions!

RCA MANUFACTURING CO., Inc. • RCA COMMUNICATIONS, Inc.
NATIONAL BROADCASTING CO., Inc. • RCA INSTITUTES, Inc.
RADIOMARINE CORPORATION OF AMERICA

6 Ways the Metropolitan Broadcast can Increase Sales for You

1 It will send people into your store for their free copies of the "Story of the Opera."

2 There will be strong commercials on Magic Voice, Magic Brain, Magic Eye, Metal Tube radios, phonograph radios and Victor Records.

3 No other radio manufacturer has a coast-to-coast program—RCA has two for you...the Metropolitan Opera and the Magic Key.

4 The Opera broadcast maintains the traditional association between the Metropolitan Opera and RCA Victor—making you the musical leader of the community.

5 It stimulates interest in good music, good instruments and Red Seal Victor Records.

6 Finally, RCA has a splendid MERCHANDISING PLAN that will draw 500,000 listeners to radio and music shops. Get the details from your RCA Victor distributor.

Listen also to "The Magic Key of RCA" every Sunday, 2 to 3 P. M., E. S. T., on the NBC Blue Network.

ERICA • *Radio City* • NEW YORK
COMMUNICATIONS . . . BROADCASTING . . . RECEPTION





FOR RADIO AT ITS BEST!



From the stage of the Metropolitan Opera House in New York come the operas RCA is sponsoring on the air. They are broadcast every Saturday afternoon over NBC's nationwide Blue network.

Radio Corporation of America sponsors matinee broadcasts of Metropolitan Opera every Saturday

IN the realm of music, opera is royalty. And king of music's royal family is the Metropolitan Opera Company. To sing on its stage in New York is the ambition of every operatic performer. To hear the musical masterpieces produced there is the desire of every music lover.

The Radio Corporation of America now makes it possible for all America to enjoy the Metropolitan Opera during the current season. Saturday matinee performances are broadcast direct from the Metropolitan Opera House stage, over NBC's nationwide Blue network. These broadcasts bring to every American family the world's most magnificent music.

RCA's service is universal

RCA, the only organization which actively participates in every branch of radio, contributes largely to the comfort and well-being of thousands the world over each day. It provides the most rapid means of communication. It links the sky and the sea and the land. Its broadcasting facilities bring entertainment, news and education.

These RCA services signify public confidence in the RCA name—the sort of confidence that creates good-will for every merchant handling RCA products. And this latest service—broadcast of the opera—is another good-will measure that will benefit all associated with the name of RCA.

RCA stands for radio—soundly engineered. Its past achievements prove this. And RCA sound engineering is some day going to bring radio *sight* to the world's millions!

RCA MANUFACTURING CO., Inc. • RCA COMMUNICATIONS, Inc.
NATIONAL BROADCASTING CO., Inc. • RCA INSTITUTES, Inc.
RADIOMARINE CORPORATION OF AMERICA

6 Ways the Metropolitan Broadcast can Increase Sales for You

- 1 It will send people into your store for their free copies of the "Story of the Opera."
- 2 There will be strong commercials on Magic Voice, Magic Brain, Magic Eye, Metal Tube radios, phonograph radios and Victor Records.
- 3 No other radio manufacturer has a coast-to-coast program—RCA has two for you... the Metropolitan Opera and the Magic Key.
- 4 The Opera broadcast maintains the traditional association between the Metropolitan Opera and RCA Victor—making you the musical leader of the community.
- 5 It stimulates interest in good music, good instruments and Red Seal Victor Records.
- 6 Finally, RCA has a splendid MERCHANDISING PLAN that will draw 500,000 listeners to radio and music shops. Get the details from your RCA Victor distributor.

Liston also to "The Magic Key of RCA" every Sunday, 2 to 3 P. M., E. S. T., on the NBC Blue Network.

RADIO CORPORATION OF AMERICA • *Radio City* • NEW YORK

EVERYTHING IN RADIO FOR SERVICE IN COMMUNICATIONS... BROADCASTING... RECEPTION

UNDERSTANDING NEW RADIO CIRCUITS

Novel cathode ray tuning eye circuit—direct-coupled phase inverter

STROMBERG-CARLSON TRI-FOCAL TUNING EYE CIRCUIT

★ An improvement over the ordinary cathode ray tuning indicator circuit has been made by Stromberg-Carlson in their tri-focal tuning system. Eye is sensitive to weak signals, yet does not overlap on extremely strong stations. Circuit used is relatively simple and does not require use of extra amplifiers or controls.

Fig. 1 shows the wiring of the 6E5 circuit in skeleton form for simplicity. While a 6H6 tube is shown in the diagram, a 6Q7 is used in some of the sets with slight modification.

The cathode of the 6E5 is connected to the cathode terminal (Point D) of an uncontrolled I.F. amplifier tube. In this way the 6E5 always has its cathode at plus 7 volts. The grid of the tuning eye tube is connected to the cathode (Point A) of an AVC controlled tube.

When the set is off tune, the I.F. amplifier is working at full gain—the negative grid bias is minimum and the cathodes of the controlled amplifiers are at 7 volts. Note that the control grids of the tubes are returned to the cathode resistor at plus 4 volts (Point B) through the AVC circuit, giving an effective grid bias of -3 volts.

When a signal is tuned in, the AVC diode develops a negative bias which

is applied to the amplifier tubes. With the increased bias, the plate current of the controlled amplifier tubes decreases—consequently the voltage Point A falls; this creates a potential difference between A and D. As result, the eye closes as the voltage of A decreases—A goes negative with respect to D. The minimum to which A can fall is zero volts—the case where the AVC bias has caused complete cut-off of plate current. This means that the maximum negative grid potential that can be applied to the 6E5 is 7 volts which is just enough to close the eye.

The cathode of the AVC diode is connected to Point D so that a “delay” bias is provided for the AVC circuit.

In brief, we have the 6E5 tube connected across two points, D and A, the potential of which can vary from 0 at no signal to -7 at maximum signal. Point D is fixed while A is variable.

DIRECT COUPLED AMPLIFIER WITH PHASE INVERTER

★ New type of circuit is used in an amplifier developed by the Amplifier Co. of America. Amplifier is entirely direct coupled with the exception of the input and output transformers.

Illustrated is the phase inverter circuit which is direct-coupled, utilizing no coupling condensers. A 6C5 phase inverter tube is used—the load resistance being divided into two equal resistances, R_p and R_k . This inverter acts similar to any of the 6C5 inverters used in receivers (described on page 42 of August RADIO TODAY)—the unusual feature is the method of coupling, which is non-reactive.

Direct coupling is theoretically nothing more than cascading one amplifier stage after another without any blocking condensers. The grid of each successive stage goes to the plate of the preceding tube. Since there are no direct current blocking condensers or transformers to isolate the direct current voltages, the voltages used in each stage become higher and higher with respect to ground.

The voltages to ground on the various stages are not according to Hoyle; but if each tube is considered by it-

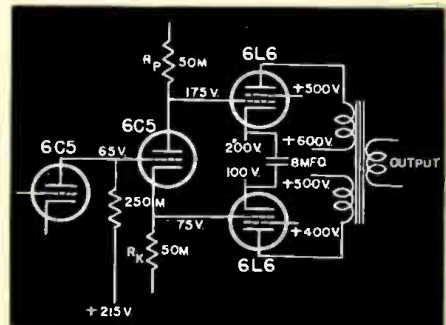

Non-reactive phase inverter for direct coupled amplifiers.

self, taking the cathode as the starting point, it will be seen that the grid, plate and screen voltages for each particular tube with reference to its cathode are correct.

Because of the fact that no condensers or transformers are used for coupling the layout design of a direct coupled amplifier becomes somewhat involved, particularly when phase inversion is necessary for push-pull operation. The voltage on any one element of a tube is dependent upon the voltages of all the other tube elements in the amplifier. The following is a brief explanation of the voltage relationships in the amplifier.

The grid of the 6C5 driver is at 65 volts while the cathode is at 75—thusly the grid is the required 10 volts negative. The grids of the 6L6 output tubes are connected to the cathode and plate of the 6C5. Since the plate of the 6C5 is 100 volts more positive than the cathode, the grid of the upper 6L6 is 100 volts more positive than the grid of the lower 6L6. In order to preserve the proper voltage relationships, then all the voltages on the upper 6L6 must be 100 volts higher than those of the other 6L6.

Note how an output transformer with two windings is used. This is done so that 600 volts can be put on one tube and 500 on the other. By making the cathodes 200 and 400 volts respectively, the operating plate voltage of each tube is only 400, which is the rated potential. And the 6L6 grids are each 25 volts less than the cathode—in this way the grids are operated at the 25 volt negative bias called for. An 8 mfd. condenser is connected between the 6L6 cathodes so that they will be at the same audio frequency potential.

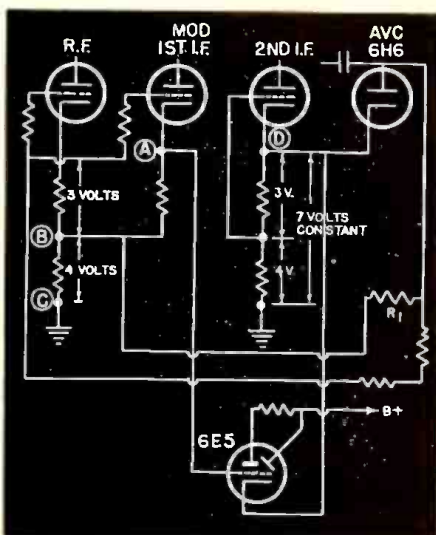

6E5 tuning eye circuit with a high sensitivity on small signals—non-overload on large signals.

FACTORY CAPACITY

Increased

RAYTHEON
TRADE MARK

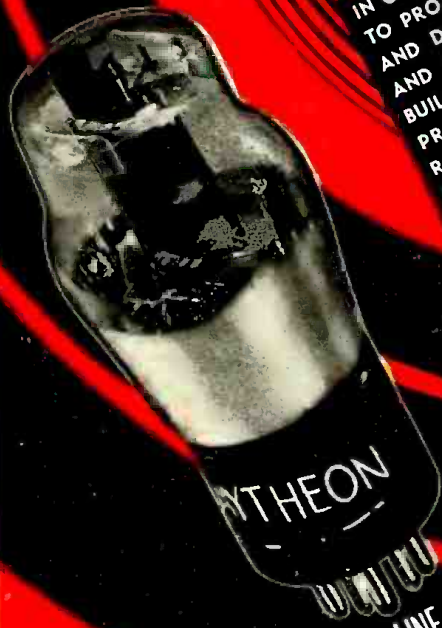

IN ORDER TO TAKE CARE OF THE CONSTANTLY INCREASING DEMAND AND TO PROTECT THE TREMENDOUSLY GROWING MANUFACTURERS' JOBBERS' AND DEALERS' REQUIREMENTS FOR RAYTHEON TUBES, NEW EQUIPMENT BUILDING, GIVING AN ADDITIONAL UNIT WHICH INCREASES RAYTHEON'S PRODUCTION CAPACITY BY 35%! WITH THESE INCREASED FACILITIES, EVEN DURING THE SEASON OF PEAK DEMAND! RAYTHEON'S GUARANTEES PROMPTNESS TO ALL ITS CUSTOMERS MEETING THE EXACTING REQUIREMENTS OF LEADING SET ENGINEERS WHO SPECIFY RAYTHEON TUBES. INCREASINGLY PROTECT JOBBERS AND DEALERS WHO HANDLE THE RAYTHEON LINE AND GUARANTEE THE QUALITY AND SALABILITY OF RAYTHEON'S PRODUCTS. LICENSED SET MANUFACTURERS EQUIP THEIR SETS WITH RAYTHEON TUBES BECAUSE THE NAME RAYTHEON INSURES TRADE AND CONSUMER QUALITY APPEAL, AND HIGHER COMPARATIVE SET UNIT PRICES WITH LESS SALES RESISTANCE. NO WONDER RAYTHEON TUBES ARE USED AND DEMANDED BY ALL LEADING RADIO PARTS DEALERS AND SERVICEMEN FOR GREATER TUBE PROFITS.

THE MOST COMPLETE LINE—ALL TYPES OF GLASS, OCTAL BASE, METAL AND AMATEUR TRANSMITTER TUBES
RAYTHEON PRODUCTION CORPORATION
420 Lexington Ave., New York, N.Y.
445 Lake Shore Drive, Chicago, Ill.
555 Howard St., San Francisco, Cal.
415 Peachtree St., N.E., Atlanta, Ga.
55 Chapel Street, Newton, Mass.

Remember...
**YOU PAY
 FOR THEM**



Even If You Don't Have Them!

If you're trying to service today's complicated radios without complete service information—if you're wasting time running to your jobber to use his manuals—you are paying a high price in time and money for "getting along" without a complete set of Rider Manuals. It's actually costing you money NOT to have them!

Be sure you have all necessary circuit information WHEN YOU NEED IT. Be sure your set of Rider Manuals is complete. Order any missing volumes from your jobber today.

VOLUME VII—JUST OUT
 1600 PAGES, \$10.00 - COVERING 1936-1937

Volume VI	— \$7.50	covering	1935-36
Volume V	— 7.50	"	1934-35
Volume IV	— 7.50	"	1933-34
Volume III	— 7.50	"	1932-33
Volume II	— 6.50	"	1931-32
Volume I	— 7.50	"	1920-31

... that goes for these Rider Books, too!

THE CATHODE-RAY TUBE AT WORK Complete, practical information on oscillographs, etc. 336 pps., 450 illus. \$2.50	SERVICING SUPERHETERODYNES Make repairs on constantly changing superhets at profitable speed. 288 pps. \$1.00
Hour a Day With Rider ON RESONANCE & ALIGNMENT You need this! 96 pps. 48 illus.; hard cover; only 60c	Hour a Day With Rider ON AUTOMATIC VOLUME CONTROL will speed up your AVC work. 96 pps., 65 illus.; hard cover 60c
Hour a Day With Rider ON OC DISTRIBUTION in Radio Receivers. How OC voltages are led to tube elements, etc. 96 pps. 69 illus.; hard cov. 60c	SERVICING RECEIVERS BY MEANS OF RESISTANCE MEASUREMENT Tells how to use Ohmmeter. 203 pps., 93 illus. \$1.00

Sold by all good radio jobbers

JOHN F. RIDER, Publisher
 1440 Broadway New York City

**RIDER
 MANUALS**
 NOW IN SEVEN VOLUMES

SERVICE NOTES

CORRECTING OVERLOADS

★ Many of the smaller sets not having AVC have a tendency to overload when operated in the vicinity of powerful broadcast stations. It is evidenced by blocking out of the signal as the volume control is advanced.

An automatic overload control can be incorporated in most of these sets by making the simple changes illustrated in the accompanying diagram. Originally the grid returns of the I.F. and 2nd detector tubes go direct to ground. These should be removed from ground, tied together and returned to ground through a 1 megohm resistor, which is shunted with a .01 mfd. or larger capacitor.

This information suggested by International Radio Corp. for their models 53 and 553 is applicable to other sets employing a similar circuit. In making this change on the Kadette receivers be sure that the cathode of the 6J7 tube is connected as shown and not left connected to the low end of the second I.F. transformer grid winding.

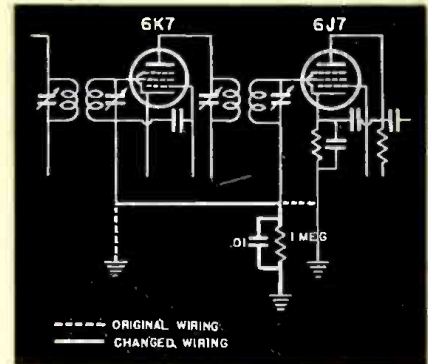

Suggested circuit changes for incorporating automatic overload control in small sets.

is a great need for properly shielded test rooms. These test booths effectively remove all outside electrical noises, prevent pick-up of strong local stations. When all external pick-up has been eliminated, it is obvious that any noise in the set is then caused by internal defects—only with a shielded room is it possible to effectively find and cure such difficulties.

The construction of a suitable shielded test room is a comparatively simple job for the serviceman who is the least bit handy with carpenters' tools. Pictured herewith is a room having a wooden frame.

In order to keep out external pick-up
 (To page 40)



The shielded test room is rapidly becoming one of the "must" items for the service shop. This one is easily constructed, using a wooden frame.

It's going to be a **LONG, COLD WINTER**



But not for the Dealers Who Sell Sylvania's!

• There'll be more radios played in the U.S. this winter than ever before. That means more sets to service... more tubes to sell!

You can build a better all-around year-round, steady business with the *right kind of tube*. It pays to sell Sylvania!

Here's why: No kick-backs. You're protected and your custom-

ers are kept satisfied because Sylvania stands in back of every tube it makes. They're guaranteed, and tested eighty separate times before they leave the factory!

Fair list prices, also for your protection. Sales and technical aids from topnotch engineering and promotional departments. And ask any

man who sells Sylvania...twelve months a year. They'll tell you that Sylvania is playing ball with the dealer!

Get to know Sylvania NOW! You can get FREE...full technical and sales information by writing to the Hygrade Sylvania Corporation, Emporium, Pa.

SYLVANIA

THE SET-TESTED RADIO TUBE

I. F. PEAKS and COLOR CODING

INSTALLMENT III—RADIO TODAY, JANUARY, 1937

Model Chassis	I. F. Peak	Model Chassis	I. F. Peak
BELMONT* Continued from December		CAPE HART* (Continued)	
RADIO TODAY			
746A	465-RC	404-CAW	465
750	175-RC	404-D	465
755	465-RC	404-E	465
770	465-RC	405-D	465
775	370-RC	405-E	465
777A	465-RC	406-D	465
777B	465-RC	406-E	465
777C	465-RC	407-E	465
778A	465-RC	500-E	465
786A	465-RC	B	180
787	465-RC	BAW	465
845	465-RC	C	465
856	465-RC	CAW	465
878	465-RC	CK	175
879	465-RC	D	465
880D	465-RC	E	465
880A	175-RC	E-1	465
880B	175-RC	Remote control sets have "R" added to model number.	
880C	465-RC	CAR-LECTRIC	
880D	465-RC	110 AC-6 volt	175
822	465-RC	CASE*	
1050	175-RC	16, 16A	262-RC
1070A	465-RC	17	262-RC
1070B	465-RC	19	262-RC
1077	465-RC	27, 27A	262-RC
1170	465-RC	110	262-RC
1172	465-RC	110A	262-RC
BOSCH See Amer. Bosch			
BROWNING-DRAKE			
40	175	610R	262-RC
80	175	710	262-RC
BRUNSWICK			
3 NC 8	180	710A	262-RC
3 NW 8	180	710AR	262-RC
5 NC 8	180	713	262-RC
11	175	713A	262-RC
12	175	713AR	262-RC
16	175	714	262-RC
17	175	714A	262-RC
24	175	715	262-RC
25	175	715A	262-RC
33, 33AC	175	715AR	262-RC
AVC-D	175	716	262-RC
BUICK See United Motors			
BULOVA			
600	175	716A	262-RC
601	175	718	262-RC
605	175	718A	262-RC
610	175	718AR	262-RC
C 751	175	719	262-RC
G 781	175	719A	262-RC
M 701	175	719AR	262-RC
CADILLAC* LA SALLE			
06-W	262	915	262-RC
55-X	175	916	262-RC
56-KB	175	917	262-RC
56-R	175	918	262-RC
56-Q	175	1015	262-RC
56-S2	175	1016	262-RC
56-T2	262.5	1017	262-RC
56-U2	262.5	1017R	262-RC
56-V1	262.5	1931C	262-RC
072	262	1941	262-RC
2029	175	1981	262-RC
2030	175	7113	262-RC
2772	262	7113R	262-RC
CANADIAN sets will be listed after completion of American.			
CAPE HART*			
50-E	465	71170	262-RC
51-E	465	71170A	262-RC
60-E	465	L19	262-RC
61-E	465	L27	262-RC
99	465	CENTRAL RADIO CORP.	
200	175	261	175
202	465	560	256
204-E	465	561	256
205-E	465	CHAMPION*	
300	175	52	456-R
301-C	465	52-DWG	456-R
301-CAW	465	500	456-R
302-D	465	501	456-R
304-E	465	523-G	465-R
305-E	465	557	175-R
400-B	180	558	175-R
400-BAW	465	600	175-R
400-C	465	601	175-R
400-CAW	465	633-G	465-R
402-B	180	811	465-R
402-BAW	465	1471-E	465-R
402-C	465	4169-H	465-R
402-CAW	465	6320	465-R
404-B	180	CHEVROLET*	
404-BAW	465	AC 80	175-RC
404-C	465	AC 81	175-RC
CLARION*			
25-85	175-RC	AC 82	175-RC
25-90	175-RC	AC 84	175-RC
25-91	175-RC	AC 85	175-RC
25-94	175-RC	AC 90	175-RC
25-100	175-RC	AC 91	175-RC
25-140	175-RC	AC 94	175-RC
25-160	175-RC	AC 100	175-RC
25-220	175-RC	AC 140	175-RC
25-240	175-RC	AC 160	175-RC
25-260	175-RC	AC 220	175-RC
25-280	175-RC	AC 240	175-RC
80	175-RC	AC 260	175-RC
81	175-RC	AC 280	175-RC
83	175-RC	TC 1	262-RC
84	175-RC	TC 2	262-RC
85	175-RC	90A	175-RC
91	175-RC	100AR	175-RC
92	175-RC	101	175-RC
94	175-RC	111	175-RC
95	175-RC	120	175-RC
96	175-RC	121	175-RC
100	175-RC	130	175-RC
100AR	175-RC	131	175-RC
101	175-RC	139	175-RC
110	175-RC	140	175-RC
111	175-RC	150	175-RC
112	175-RC	150B	175-RC
113	175-RC	151	175-RC
114	175-RC	152	175-RC
115	175-RC	153	175-RC
116	175-RC	154	175-RC
117	175-RC	155	175-RC
118	175-RC	156	175-RC
119	175-RC	157	175-RC
120	175-RC	158	175-RC
121	175-RC	159	175-RC
122	175-RC	160	175-RC
123	175-RC	161	175-RC
124	175-RC	162	175-RC
125	175-RC	163	175-RC
126	175-RC	164	175-RC
127	175-RC	164A	175-RC
128	175-RC	173	175-RC
129	175-RC	178	175-RC
130	175-RC	182	175-RC
131	175-RC	182B	175-RC
132	175-RC	222	445-R
133	175-RC	227	480-R
134	175-RC	231	480-R
135	175-RC	232	480-R
136	175-RC	235	480-R
137	175-RC	237	480-R
138	175-RC	238	480-R
139	175-RC	239	480-R
140	175-RC	240AC	490-R
141	175-RC	242	480-R
142	175-RC	250	175-R
143	175-RC	250AC	175-R
144	175-RC	250AC-DC	175-R
145	175-RC	252	480-R
146	175-RC	265	175-R
147	175-RC	279	175-R
148	175-RC	279AC	175-R
149	175-RC	300	175-R
150	175-RC	300AC	175-R
151	175-RC	300AC-DC	175-R
152	175-RC	301	175-R
153	175-RC	301AC	175-R
154	175-RC	301AC	175-R
155	175-RC	301AC	175-R
156	175-RC	301AC	175-R
157	175-RC	301AC	175-R
158	175-RC	301AC	175-R
159	175-RC	301AC	175-R
160	175-RC	301AC	175-R
161	175-RC	301AC	175-R
162	175-RC	301AC	175-R
163	175-RC	301AC	175-R
164	175-RC	301AC	175-R
165	175-RC	301AC	175-R
166	175-RC	301AC	175-R
167	175-RC	301AC	175-R
168	175-RC	301AC	175-R
169	175-RC	301AC	175-R
170	175-RC	301AC	175-R
171	175-RC	301AC	175-R
172	175-RC	301AC	175-R
173	175-RC	301AC	175-R
174	175-RC	301AC	175-R
175	175-RC	301AC	175-R
176	175-RC	301AC	175-R
177	175-RC	301AC	175-R
178	175-RC	301AC	175-R
179	175-RC	301AC	175-R
180	175-RC	301AC	175-R
181	175-RC	301AC	175-R
182	175-RC	301AC	175-R
183	175-RC	301AC	175-R
184	175-RC	301AC	175-R
185	175-RC	301AC	175-R
186	175-RC	301AC	175-R
187	175-RC	301AC	175-R
188	175-RC	301AC	175-R
189	175-RC	301AC	175-R
190	175-RC	301AC	175-R
191	175-RC	301AC	175-R
192	175-RC	301AC	175-R
193	175-RC	301AC	175-R
194	175-RC	301AC	175-R
195	175-RC	301AC	175-R
196	175-RC	301AC	175-R
197	175-RC	301AC	175-R
198	175-RC	301AC	175-R
199	175-RC	301AC	175-R
200	175-RC	301AC	175-R
201	175-RC	301AC	175-R
202	175-RC	301AC	175-R
203	175-RC	301AC	175-R
204	175-RC	301AC	175-R
205	175-RC	301AC	175-R
206	175-RC	301AC	175-R
207	175-RC	301AC	175-R
208	175-RC	301AC	175-R
209	175-RC	301AC	175-R
210	175-RC	301AC	175-R
211	175-RC	301AC	175-R
212	175-RC	301AC	175-R
213	175-RC	301AC	175-R
214	175-RC	301AC	175-R
215	175-RC	301AC	175-R
216	175-RC	301AC	175-R
217	175-RC	301AC	175-R
218	175-RC	301AC	175-R
219	175-RC	301AC	175-R
220	175-RC	301AC	175-R
221	175-RC	301AC	175-R
222	175-RC	301AC	175-R
223	175-RC	301AC	175-R
224	175-RC	301AC	175-R
225	175-RC	301AC	175-R
226	175-RC	301AC	175-R
227	175-RC	301AC	175-R
228	175-RC	301AC	175-R
229	175-RC	301AC	175-R
230	175-RC	301AC	175-R
231	175-RC	301AC	175-R
232	175-RC	301AC	175-R
233	175-RC	301AC	175-R
234	175-RC	301AC	175-R
235	175-RC	301AC	175-R
236	175-RC	301AC	175-R
237	175-RC	301AC	175-R
238	175-RC	301AC	175-R
239	175-RC	301AC	175-R
240	175-RC	301AC	175-R
241	175-RC	301AC	175-R
242	175-RC	301AC	175-R
243	175-RC	301AC	175-R
244	175-RC	301AC	175-R
245	175-RC	301AC	175-R
246	175-RC	301AC	175-R
247	175-RC	301AC	175-R
248	175-RC	301AC	175-R
249	175-RC	301AC	175-R
250	175-RC	301AC	175-R
251	175-RC	301AC	175-R
252	175-RC	301AC	175-R
253	175-RC	3	

RECTIFIED RF SIGNAL CURRENT
HIGH-MU TRIODE PLATE VOLTAGE

AFC (AUTOMATIC FREQUENCY CONTROL)
DIODE BALANCING CIRCUITS

OSCILLATOR AND POWER
TUBE GRID CURRENTS

POWER DETECTOR BIAS

AVC DIODE CURRENTS

PHOTO-CELL CURRENTS
AND PLATE VOLTAGES

*measure
them* **ALL**
WITH THE
**Super-Sensitive
WESTON**
Model 772
(20,000 OHMS PER VOLT
50 Microamperes Full Scale)

\$ **46**⁵⁰
NET

TO DEALERS
IN U. S. A.

and remember . . .

you can buy this famous 20,000 ohms per volt analyzer, and other WESTON radio instruments, through the convenient WESTON INVESTMENT PLAN.



No instrument yet offered the serviceman has met with such overwhelming response as Model 772. The reasons are obvious. With its sensitivity of 20,000 ohms per volt, Model 772 is not only ideal for all usual testing routine . . . but it also enables you to get into and thoroughly check circuits which cannot be tested with former servicing instruments. And being built to high WESTON

standards, servicemen know that Model 772 will serve dependably for years. Before you consider the purchase of test equipment be sure to get all the facts on Model 772 and other WESTON instruments for radio servicing. Ask your jobber for full particulars or return the coupon today . . . Weston Electrical Instrument Corporation, 597 Frelinghuysen Avenue, Newark, New Jersey.

WESTON
Radio Instruments

Weston Electrical Instrument Corporation
597 Frelinghuysen Avenue, Newark, N. J.
Send full data on Model 772 and other WESTON Instruments.

NAME _____
ADDRESS _____
CITY _____ STATE _____

**WHEN YOU
REPLACE
RADIO SHAFTS
USE ONLY**



**S.S. White FLEXIBLE SHAFTS
and CASINGS**



Specially designed for radio application they are **standard** original equipment on practically all makes of auto radios.

When properly applied, S.S. WHITE Shafts provide a quality of tuning that for ease of turning, smoothness and sensitiveness can scarcely be distinguished from a direct connection.

Be sure to ask your jobber for the **genuine** S.S. WHITE Shafts and Casings—and accept no others. They assure satisfied customers.

The S. S. WHITE

DENTAL MFG. CO.

INDUSTRIAL DIVISION

10 East 40th Street, Room 2310T

NEW YORK, N. Y.



MASTERTONE DE-LUXE

Portable Recording Unit

A precision-built portable reproduction of a professional studio installation—Everything complete—Recommended where studio quality results and portability are required—Write for Bulletin RT-1.

**RECORDING EQUIPMENT
MANUFACTURING COMPANY**
6611 Sunset Blvd., Hollywood, Calif.



SERVICE NOTES

(From page 36)

up the booth must be shielded on six sides, and all power connections coming into the room must be filtered. For this purpose special line filters can be purchased.

The cage is constructed of wooden strips bolted together, each side being made up of two separate sections for ease in handling. The screen can be either copper or galvanized iron. In

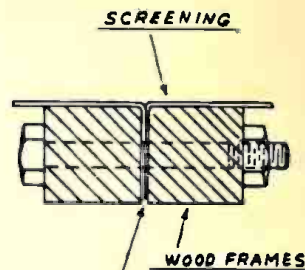

**THIS METHOD OF CONSTRUCTION
USED ON ALL JOINTS**

**WHEN EACH SECTION IS BOLTED
THE SCREENING MUST MAKE CONTACT
ON ALL SIDES OF EACH SECTION
ALSO ON THE DOOR**

order to provide good contact between the sections, the screen is overlapped $1\frac{3}{4}$ inches as shown by the sketch on this page, and no soldering is required.

Screening of top, sides and door is on the inside of the cage. Screening on the bottom is on the underneath side. The size of the booth should be sufficiently great to allow freedom of movements. If needed, specific drawings and dimensions can be obtained without charge from the Tobe Deutschmann Corp., Canton, Mass., manufacturers of power line filters and condensers.

**ANTENNA WIRING FOR
NEW BUILDINGS**

★ Specific recommendations for radio antenna installations are made in a new Interior Wiring Design Handbook that is being published for the architectural, building and electrical contracting trades.

Idea is that every home, apartment house and other buildings should have several radio outlets for each tenant. Recommendations urge the use of an outlet with connections for twisted pair from antenna and a ground connection. Twisted pairs from the various outlets are to be terminated in the attic in one set of connections.

This wiring should be of benefit to

QUIET PERMANENT RUGGED

"THE NAME TELLS YOU
IT'S A MASTERPIECE"



Metallized

VOLUME CONTROL

INTERNATIONAL RESISTANCE COMPANY

401 NORTH BROAD STREET, PHILADELPHIA, PA.

Factories or Licensees in Canada, England, France, Germany, Italy, Denmark and Australia

[MAKERS OF RESISTANCE UNITS OF MORE TYPES, IN MORE SHAPES, FOR
MORE APPLICATIONS THAN ANY OTHER MANUFACTURER IN THE WORLD]

New OHMITE POWER LINE CHOKES

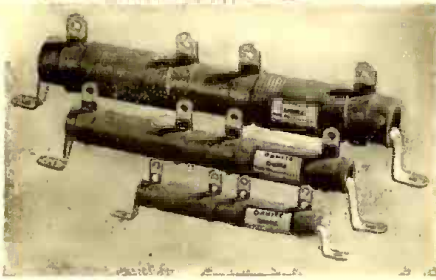

"Just the thing to cure R. F. interference," says Bill Fixit

"Many's the time I've wished for a unit like this to keep interference from a near-by transmitter out of a customer's receiver."

Z-20, 5 ampere chokes may be installed at the receiver with the usual by-pass condensers to serve as a filter for high frequency circuits. Z-21 and Z-22, 10 and 20 ampere chokes are suitable for installation at transmitters or other high frequency apparatus to prevent R. F. currents from going out over the power line. Ask your jobber or write for Bulletin 105.

another useful unit

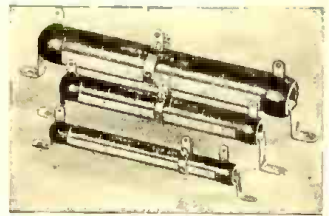

OHMITE DIVIDOHM

A semi-variable resistor, handy for replacing bleeders, voltage dividers or resistors of odd values. Patented percentage-of-resistance scale makes it easy to find approximate value wanted. Ask your jobber or write for Catalog 15 listing over 200 values in six sizes.

OHMITE
MANUFACTURING CO.
4847 Flournoy St., Chicago, Ill.
Manufacturers of
Resistors, Rheostats and Tapswitches

SERVICE NOTES

the owner and serviceman alike. Owner has benefit of concealed wiring—serviceman still has revenue from outside all-wave antenna installation, which is connected to terminal strip in the attic. Radio set can be moved around house—antenna and ground connections can be quickly made by utilizing outlets in the various rooms. The RMA is urging set manufacturers to become acquainted with the specifications so that their sets can be designed to operate satisfactorily with the recommended facilities.

A-K COLOR CODINGS

★ Color coding employed in the Atwater-Kent receivers previous to 1935 was their own system—and not the standard R.M.A. After 1934 most of the resistors employed in the A-K sets used R.M.A. coloring—but even in these later receivers a few resistors using their own private coding will be found. R.M.A. color coded mica condensers are used in the 1935 and 1936 receivers.

Fortunately most of the A-K color codings used only one or two colors and little difficulty will be had in distinguishing them from the R.M.A. coding. Below is Atwater-Kent's own color code for composition resistors.

- 150 — Brown & green
- 300 — Maroon & blue
- 425 — Blue, yellow, green
- 3,300 — Green & red
- 4,000 — Green & blue
- 5,000 — Blue & yellow
- 6,000 — Purple
- 7,500 — Yellow
- 10,000 — Maroon
- 12,500 — Purple & yellow
- 15,000 — Purple & red
- 20,000 — Red
- 30,000 — Gray & yellow
- 40,000 — Gray & green
- 50,000 — Black & red
- 65,000 — Gray
- 100,000 — White
- 250,000 — Black & yellow
- 500,000 — Black, yellow & red
- 800,000 — Black
- 1 MEG — Black & green
- 2 MEG — Blue
- Red & blue
- Red & yellow
- Black & purple
- Red & gray
- Blue & gray
- Green

ELIMINATING BC IMAGES

★ In certain locations image interference on the broadcast band may be experienced with the 2-gang super-het receivers. Trouble is that there isn't sufficient selectivity ahead of the I.F. amplifier.

Usually the difficulty is most pronounced at the high frequency end of the band. Interference is produced

(To page 47)

New! Auto-Top Aerial



U. S. Pat. 97447

THE common sense aerial for steel top automobiles. Puts the aerial OVER THE TOP where it belongs. Outstanding performance, plus keen streamlined appearance—highly polished aerial—semi-round—die formed like decorative body trim—MOUNTED ON TOP OF rubber vacuum posts—carries center trim line of hood, windshield, and rear window right over top of car. Extremely efficient—not damaged by weather—works in rain, ice and snow anywhere, anytime. Steel car top shields against interference from ignition and lighting. Easy to install—shipped straight, no kinks—no holes to drill in top—easy on car finish. Smart appearance—greater volume—more distance—and reduced noise.

\$385 LIST
SOLD BY LEADING JOBBERS

WEDGE MANUFACTURING CO.
2338 S. Michigan Avenue, Chicago

38 Amazing RADIOS



1937 Knight Radios offer you unbeatable profit-making opportunities! Sensational new features include giant 11-in. Magna-Span Oials and super-dynamic Vita-Tone Speakers. Unmatched performance, at amazingly low prices. 38 models, 5-19 tubes, as low as \$8.45!

10,000 Service Parts

You can fill every service need from the ALLIED Catalog—at lowest prices. Lists over 10,000 exact duplicate and replacement parts, complete test equipment, tools, books, etc. You save time, trouble and money on every purchase by ordering from ALLIED.

Send For CATALOG



This great 152-page Catalog also shows newest sound systems, amateur gear, kits, Ruripower units and Windchargers, etc. Whatever you need, you'll always find it in the ALLIED Catalog at the lowest prices.

ALLIED RADIO

ALLIED RADIO CORPORATION Dept. 15-A
833 W. Jackson Blvd., Chicago, Ill.
Send us your new 1937 Catalog (Free).

Name

Address

City

FULL SPEED AHEAD

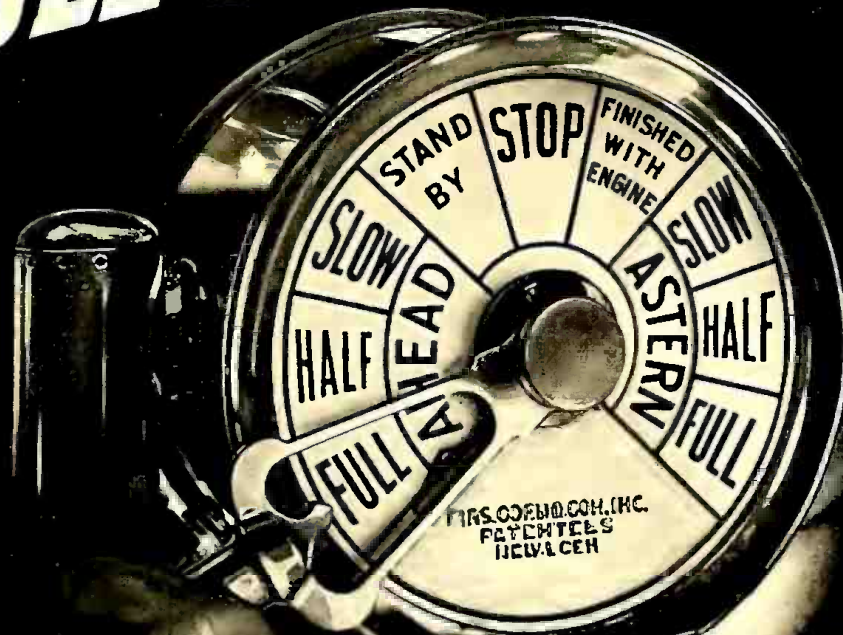

FRIGIDAIRE ADDS MORE POWER!

SETS A FASTER PACE FOR 1937

• It's full speed ahead as Frigidaire—already traveling faster than ever—greet the new year and the opportunities ahead with added power!

With a new selling strategy! With an enlarged schedule of packed-with-punch advertising—more dramatic and sales-compelling than ever! With a new product that incorporates many startling new features—including one that adds *so much* to the services of refrigeration that it will instantly capture the imagination of the buying public and start dealers talking from coast to coast!

Frigidaire Dealers in 1937 will have the most powerful program they have ever had. And be prepared for another record-breaking year!

Soon everyone will know the news. And Frigidaire men will be on their way to even greater success and profits!

FRIGIDAIRE DIVISION
General Motors Sales Corporation, Dayton, Ohio



YOU'LL DO STILL BETTER WITH FRIGIDAIRE IN '37!

DEALERS WILL SELECT APPLIANCES

New electrical lines register OK appeal on non-appliance stores

★ SILVER AND WHITE glisten of electric household appliances still is missing in a number of radio shops.

In a preliminary report on its most recent Census of Business, the United States Dept. of Commerce indicates that at least 4,309 radio stores in the country are not selling the merchandise.

To the radio dealer and to the radio-appliance merchant, this report will reveal the nature and extent of competition; to the appliance manufacturer it means that a flock of radio outlets have not been seduced by the extra profit involved in selling his products.

In the state of California, for instance, there are 457 known radio dealers of the non-appliance group, and the state of New York has a grand total of 604.

Curious distribution

Figures on these dealers, by states, refuse to follow any usual pattern of population, retail activity or sales importance. The states of California and Ohio are generally accepted as doing about the same volume of business in the industries concerned, and yet Ohio has 283 non-appliance radio stores as compared with California's 457.

On the other hand, the state of Iowa ranks about 14th on the 1935 Census preliminary report in general retail sales volume, while it is sixth from the top in the number of non-appliance radio stores. And Massachusetts has 155 of these stores, while ranking sixth in general retail importance.

It is to be remembered that these 4,309 radio outlets are exclusively those which do not come under the head of stores classed as musical, furniture, department, automotive, hardware, sporting goods, jewelry, etc., many of which are selling radio to the extent that the total number of radio outlets in the country is estimated at 50,300.

Considerable trade interest centers around the question of how many of the non-appliance radio men will be attracted by the new lines presented by the appliance manufacturers. The 1937 products are streamlined, lower in price, multi-featured, touted to the skies, vigorously encouraged by utilities and designed to attract fresh groups of prospects.

★ New distributor-dealer set-up for merchandising Copeland refrigerators has been announced by Dallas E. Winslow, president, Copeland Refrigeration Corp., Detroit. Sales for

the firm have formerly been handled by Truscon Steel Co. and many of the past outlets will be retained, but Copeland plans new accounts and has added a new factory staff to develop them. Directing the new sales organization are James D. McLeod, general sales manager, and W. G. von Meyer, vice-pres. and sales manager. Ad experts at Baldwin & Strachan, Inc., Buffalo, will direct Copeland's vigorous new promotional drive.

★ Completely re-designed refrigerator line of Sparton will be shown at Sparks-Withington's annual distributor convention at the Hayes Hotel, Jackson, Mich., Jan. 22 and 23. Jobbers from all parts of U. S. and Canada will be guests.

★ Howard E. Blood, outstanding national business exec who has been president of the Norge Division of the Borg-Warner Corp. since 1929, has been named executive president in charge of operations of all the various divisions of company. Firm has 16 plants in five states, and besides its Norge activities, is active in the automotive, marine, aviation and agricultural fields.

★ Capital City Distributing Corp., Albany, N. Y., jobbers for RCA, recently concluded a 3-day showing of Leonard refrigerators at Springfield, Mass. Max E. Hegleman, Capital City's sales manager, reports vigorous dealer-ordering.

CURRENT APPLIANCE SALES PROPOSITION CLICKS ALIKE WITH BOSS AND SALESMEN



TALE OF PROFIT about renewed work on electrical appliances comes from manufacturer's representative.



SAME STORY told to the dealer's sales force stirs up genuine enthusiasm for a snappy drive on new lines.

★ Thirty-six convention presentations in 33 of the major cities of the nation are currently giving the 20,000 members of the Frigidaire selling organization the new line of 1937 household appliances along with additional sales and merchandising plans. Ellsworth Gilbert is convention director and has arranged for three flying squadrons of a dozen men each to cover the 33 cities during February.

More than 600 members of Frigidaire's national sales executive staff met in Dayton, Ohio, Jan. 12 for a series of assemblies preliminary to the world-wide presentation of 1937 products. Prominent at the opening sessions were Carl A. Copp, general sales manager; V. A. Hetzel, installation and service manager, and E. G. Biechler, general manager.

★ Annual distributors' meeting of General Household Utilities Co., at the Hotel Stevens in Chicago, Jan. 5 and 6, gave some 300 jobbers the low-down on Grunow radio and refrigeration plans for 1937. New 1937 line of refrigerators was presented and included several surprise values; advertising, merchandising and sales plans were also explained. Grunow distributors also viewed several new attractive radio models.

Grunow officials important at the affair were Wm. C. Grunow, president; Walter L. Eckhardt, director of sales; Tod Reed, asst. sales manager; Dr. J. D. Jordan, development engineer; and M. W. Kenny, director of engineering.

★ New distributors for Crosley on Pacific Coast are the Associated Wholesale Electric Co., 1111 Santee St., Los Angeles, and the San Diego Auto Electric Co., 916 Union St., San Diego. Crosley district man in charge of the area is Paul W. Bialkowsky.

★ Indianapolis convention for Fairbanks, Morse & Co. distributors in December was a lively debut for the 1937 refrigerators. Annual affair was attended by 200 guests who ordered 103 per cent more boxes than at the previous convention. W. Paul Jones, general manager of the FM home appliance division, presented a list of new features; Parker H. Ericksen, radio sales manager, explained dealer-getting plans; John S. Garceau, new advertising manager, outlined national advertising; and Paul Eckstein, assistant ad manager, presented new promotional literature.

★ Time Appliance Co., New York City, were hosts Jan. 8 to 1500 dealers of the area at a Westinghouse refrigerator and range show at the Commodore Hotel. Complete 1937 line was paraded for the guests and officials explained the new advertising and promotion plans. Feature came when guests were given sledge hammers and invited to see whether the refrigerator cabinets would stand up under repeated blows. Hosts report that not a seam was broken.

★ Norge Division of the Borg-Warner Corp. reports that refrigerator sales for the year just closed were 41.3 per cent above totals for the previous year. General pick-up for all products of the firm was 56.5 per cent over last year and all previous records have been topped.

★ Kelley-How-Thompson Co., Duluth, Minn., is now an exclusive distributor for Stewart-Warner products. Acquisition of the line was followed by a sales conference with SW officials, at which the distributor's big sales organization heard about the new lines. Kelley-How-Thompson immediately scheduled a series of dealer meetings for Jan. 11 to 20 at Duluth, St. Paul, Minn., Fargo, Bismarck and Minot, N. Dak., Great Falls and Billings, Mont.



UPPED to position of ad manager for Stewart-Warner's radio and refrigeration division, C. C. DeWees.

★ At the studios of WLW, Crosley Radio Corp., Cincinnati, early this month approximately 150 distributors and their representatives assembled to view the new 1937 line of Crosley Shelvador refrigerators. Guests came from all parts of the U. S. to hear sales, merchandising and advertising plans outlined by Thomas W. Berger, Glenn H. Corbett and G. Earle Walker, respectively general sales manager, and manager and merchandising manager.

Feature announcements included a refrigerator equipped with a radio, and the first phonograph-radio combination to be marketed domestically by Crosley.

NAMES, ADDRESSES AND MOODS OF ALL HOUSEHOLDERS DESERVE AN INSTANT CHECK



FILED DYNAMITE in the form of other-dept. purchasers is dragged out for careful, seasonal sales effort.



"NO" WOMEN are apt to weaken when there's a new model, an appointment, a neat approach and a planned appeal.

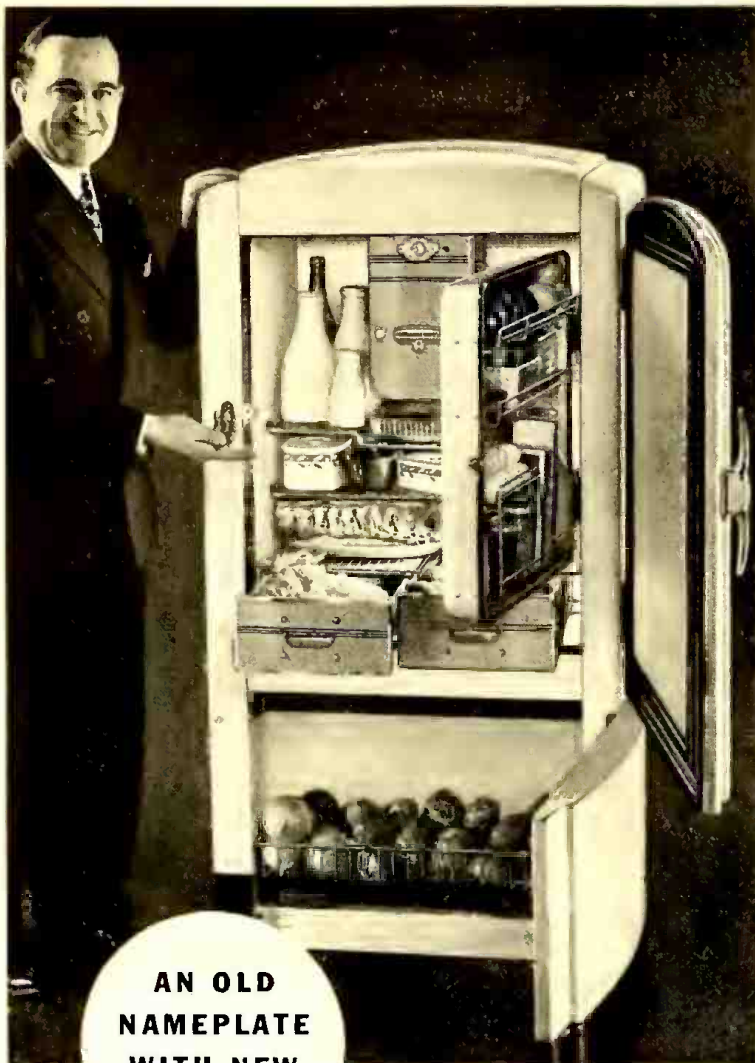

**AN OLD
NAMEPLATE
WITH NEW
MEANING**

NOWHERE!

but behind the
Fairbanks-Morse
nameplate

**CAN THEY FIND A
REFRIGERATOR
LIKE IT!**

Frankly, aren't refrigerator prospects a little jaded from the repetition of refrigerators with small differences?

Before deciding on your 1937 refrigerator sales activities, make your plans on the basis of whether or not you are going to sell refrigerators which, as far as prospects are concerned, look but little different from the one they will see down the street, across the street, and in thousands of stores everywhere.

Fairbanks-Morse dealers will have something different to make their plans more productive—a refrigerator line with a big, sales-compelling difference. A refrigerator that has every feature offered by all other refrigerators, *plus* a big, easily seen, easily understood feature—the **NEW CONSERVADOR**.

THINK OF THESE:

A refrigerator which out-economizes the most economical; which secures economy without sacrificing any ability to protect food during a heat wave. A refrigerator from which two-fifths of the food can be removed without opening the

main food compartment. A refrigerator with a twin-sealed door—the first modern door in the industry—simplified temperature control—automatic overload protector that resets itself—and a host of other features. A refrigerator whose low cost of operation you can prove, not in kilowatts, not by comparison, *but in pennies*—and do it right on your sales-room floor!

And think of the new Conservador! Only Fairbanks-Morse can give it to you to sell. Only behind the Fairbanks-Morse nameplate will you find the Conservador and such a host of worth-while features.

Only behind the Fairbanks-Morse nameplate can you find a refrigerator that gives you the final, big difference that puts over a sale when small differences fail.

Write, phone, or wire for name of your Fairbanks-Morse distributor. In justice to 1937 profits, do not close your line without first seeing Fairbanks-Morse Conservador Refrigerator. Fairbanks, Morse & Co., Home Appliance Division, 2060 Northwestern Avenue, Indianapolis, Indiana. Other Fairbanks-Morse Products: Washing Machines, Ironers, Radios, Automatic Coal Burners.

FAIRBANKS  **MORSE**
Conservador Refrigerator



"SPRAGUE SC'S
ARE THE BEST
I'VE FOUND
FOR
P. A. WORK!"

SPRAGUE
The Standard of Condenser Quality

Of all the thousands of Sprague inverted Aluminum Can Type Dry Electrolytics (Type SC's) sold last year, I'm convinced that MORE THAN HALF were used in Power Amplifier equipment where exceptionally good filtering and the ability to stand sudden surges are absolutely essential. Servicemen themselves will tell you they build up to 650 to 670 volts—and with extremely low leakages. We have done our best to give you the finest replacement condensers. We challenge competitors to equal their quality and electrical characteristics. Let me send the new Sprague Catalog today to help you on your next condenser order.

SPRAGUE PRODUCTS CO.
North Adams, Mass.

SERVICE NOTES

(From page 42)

by stations higher in frequency than the desired one by twice the I.F. peak. Very often local police transmitters will cause whistles and other noises—they can be easily identified because of their intermittent nature.

This kind of interference can often be remedied by altering the I.F. frequency of the set slightly so as to change the location of the image. For instance, if the desired signal is 1550 KC (WQXR in N.Y.C.) and image interference appears at 2450 KC (I.F. = 450 KC), by increasing the I.F. to 475 KC the new image appears at 1550 + 950 or 2500 KC. If this new frequency is clear there will no longer be interference when the set is tuned to 1550 KC.

Idea behind this change of I.F. frequency is to adjust the I.F. peak to such a value that when desired stations are tuned in, the image frequencies are not the same as those of powerful nearby transmitters.

When making such changes in the receiver intermediate frequency it will be necessary to readjust the oscillator series (low freq.) padding condensers and check the set tracking.

"Right you are, Buddy
and Sprague
small PTM's can't be
beat as

**INEXPENSIVE
SERVICE
REPLACEMENTS!"**



CONDENSERS
USE SPRAGUES... and Note the Difference

Fellows, you'll find these small Cardboard dry Electrolytic ETCHED FOIL Condensers (Sprague Type PTM) are built to take everything the rectifier will give them. They mean more pep for the set plus better tonal quality. Both you and your customers will quickly note the improvement. Conservatively rated at 525 volts, yet servicemen themselves say they'll take surges as high as 560 and even 580 volts! Won't break down because you can't reach the sparking point. FAMOUS SPRAGUE HUMIDITY-PROOF SEALING and other features at no additional cost.

Truthfully and sincerely,

Harry Kalkreuth
Sales Manager,

SPRAGUE PRODUCTS CO.
North Adams, Mass.



Portable Tester. Compartment for tools, tubes and repair parts. Overall size of case, 5" x 12" x 17". Counter Tester Models also available.

CONSTANTLY embodying new and improved features—yet always non-obsolete—RADIO-TECHNIC Tube Testers, among many other improvements, has the most advanced short test yet developed. It is the most sensitive of all short circuit tests, yet one which, through multiple readings, conforms to the most exacting requirements. All leakages cause the meter to read "bad." Intermittent shorts may be listened to by customers. Get complete details. Ask for Falder.

THE RADIOTECHNIC LABORATORY EVANSTON ILLINOIS

A Complete Line of
Tube Test Equipment

RADIOTECHNIC

TO DEALERS AND SERVICEMEN

**TRIAD RADIO TUBE
FREE!**

UP TO \$1.25 LIST

A DARING NEW PLAN

To convince you of the superior quality of Triad Radio Tubes—we are offering absolutely free any Triad Tube up to \$1.25 list with your purchase of Triad Tubes; plus free Engineering Data Chart. Mail coupon below—back will come your Free Tube Certificate. Present it to your jobber when you purchase Triad Tubes and get your Free Tube—save \$1.25.

MAIL TODAY!

TRIAD MANUFACTURING CO., Inc. THIS COUPON
Dept. A-11 Pawtucket, R. I. **WORTH \$1.25**

Sure I'll try Triads. Send me Free Tube Certificate... good for \$1.25. Also FREE Engineering Data Chart.

Name _____

Address _____

Town _____ State _____

Jobber's Name _____

"THE QUALITY NAME IN RADIO TUBES"

IF

you are a

SERVICEMAN

*You need radio's latest and largest
compilation of*

I. F. PEAKS *and* COLOR CODING DATA

APPEARING IN THIS ISSUE, PAGE 38,
CONTINUED IN SUCCEEDING ISSUES

AGAIN, RADIO TODAY adds to its record of "firsts"—
first in rendering much-needed services to the reader.
"I.F. Peaks & Color Coding Data" is not only first; it is
the most complete and accurate compilation ever made in
this field. It is so complete—so extensive—that it neces-
sarily appears in serial form and extends over a period of
many months.

You will need this compilation; this new material in con-
venient form. It will give you data on 8,000 sets, from
the first superhet up to and including the current models;
will give you the data on both private and standard brands.

Each instalment in the series will be uptodate—up to the
month when the instalment appears.

The intermediate frequency material is more accurate than
the manufacturers' own records! Yes, actually more accu-
rate. For this reason: In double-checking and cross-check-
ing the data from all available sources, many early errors
and omissions were found and corrected.

The color coding data, in conjunction with the I.F. data,
will be extremely useful to servicemen. It is obtainable at
no other source because no other compilation of this nature
has ever been made. Both classes of material will make
the service man's work quicker and more accurate.

Unless you are a subscriber or unless you send in your sub-
scription at once—you will miss out on this valuable com-
pilation. Each edition of RADIO TODAY is limited to the
usual print order; hence single copies will not be available.
Subscribe NOW!

SUBSCRIBE NOW!

Enter your subscription at the present low rate of \$1 for 1 year, or \$2 for 3 years. Use the post card here-
with. Mail it today. It will bring you information that is worth many times the cost of your subscription.

IF

you are a

DEALER

*You need these vital facts, figures
and methods:*

"HOW TO MAKE MORE PROFITS OUT OF RADIO"

BEGINNING IN JANUARY AND
CONTINUED IN SUCCEEDING ISSUES

FOR every man who sells radio at retail, RADIO TODAY
begins a series of feature articles that will be money-
makers—a series of the utmost importance, covering all of
the profit-phases of retail selling and retail sales promotion.

For example:

- How to reach more customers.
- How to "sell up" better sets.
- How to find prospects with cash.
- How to cut selling costs.
- How to pick go-getter salesmen.
- How to handle instalment sales.
- How to attract people to your store.
- How to select your radio stock.
- How to write radio ads that pull.
- How to control expenses against loss.
- How to insure profits.

—and, as a part of the series, a new statistical study of
selling costs entitled

"YARDSTICKS for PROFIT MAKING"

This eye-opening feature will be compiled with the coop-
eration of Dr. Norris A. Brisco, Dean of the New York
University School of Retailing.

With an entirely new and uptodate series of studies, this
feature will carry forward the systematic study of retail
selling costs conducted since 1926 by the present staff of
RADIO TODAY.

Make sure of getting this feature—all of it. Back orders
cannot be filled. Enter your subscription today.

Postage
Will be Paid
by
Addressee

No
Postage Stamp
Necessary
If Mailed in the
United States

BUSINESS REPLY CARD

First Class Permit No. 22273 (Sec. 510 P. L. & R.) New York, N. Y.

RADIO TODAY

480 LEXINGTON AVENUE

NEW YORK, N. Y.



Send me RADIO TODAY for the period indicated below:

1 Year (12 issues) \$1.00

Send bill

3 Years (36 issues) \$2.00

Amount enclosed

Name _____ Title or Occupation _____

Company _____

City _____ State _____

Street _____

Our Main Line of Business Is: _____

If RADIO TODAY is to be mailed to your home, fill in address here

No stamp needed on this card—it is ready for mailing.

SERVICE NOTES

MANUFACTURERS' SERVICE DATA

★ During visits with servicemen the subject of service bulletins invariably comes up—it seems that only a few manufacturers supply the data that the industry wants and uses.

Just what is needed in the way of service information varies from man to man—some want DC resistances of RF coils in spite of the fact that they have no devices to accurately measure these values. Others request data ranging from the impedance of voice coils to microvolt inputs for standard outputs. Another group must have current data for all tubes since they depend upon that type of analysis.

In order to please everyone, the manufacturers would have to publish 30 to 50 page bulletins for each model. Economically that is impossible.

Because of the wide differences in opinion **RADIO TODAY** is putting the subject up to servicemen everywhere. In this way it will perhaps be possible to find out what information is considered most valuable—and the data will be passed on to the set manufacturers.

Below is a short questionnaire listing a few items. If the data is *essential* place a number 1 next to these questions. If the data is *desirable* use number 2, and if seldom needed use number 3. Please paste the question on the back of a postcard and mail to us—and please use the extra space for any desired comments regarding service material.

SERVICE DATA QUESTIONNAIRE

See above article before answering.

Would you like all mfrs. to use a standardized type of schematic diagram? Yes.... No....

Values of parts, voltages, currents on (1) schematic and chassis layout (2) in table form—(cross out one).

- Microvolt inputs for sensitivity tests of sets on all bands.
- Cathode ray alignment data.
- Supplementary diagrams showing wiring details of coils, transformers, etc.
- Technical description of unusual circuit features.
- Detailed chassis layout showing location of parts, tubes, wires, etc.

Please mail to **RADIO TODAY**, 480 Lexington Ave., New York, N. Y.

Name

Street

City, State

January, 1937

GIVE ALL TUBES A COMPLETE TEST

on *P.O.E. Testers*
POWER OUTPUT-EMISSION

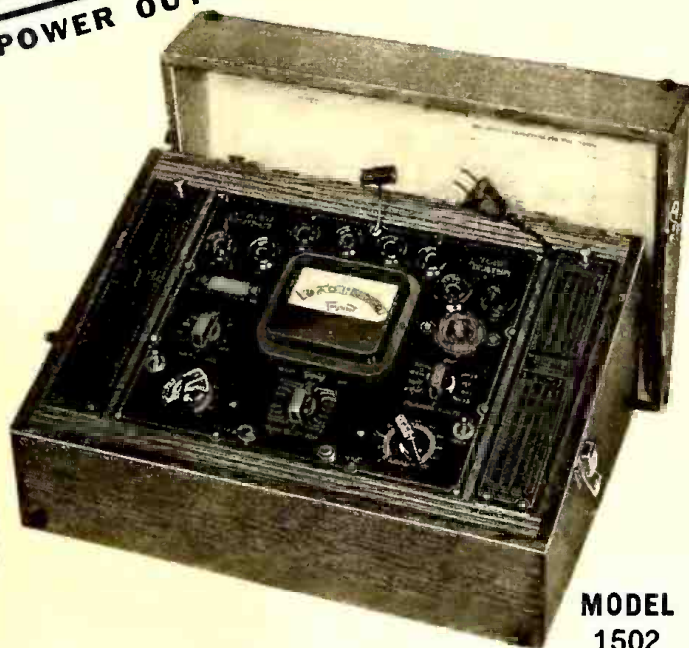

MODEL 1502

DEALER PRICE
\$36.67

- Radio Tubes have three different functions: to amplify, to deliver power, to rectify.
- For Amplifiers (75% or more of all tubes) the Power Output Test is absolutely the final word in determining the worth of the tube. The Power Output Test in Triplett P.O.E. Tester simulates actual operating conditions in the radio receiving set.
- For Power Tubes, the Power Output Test determines the amplification factor. The Emission Test determines the power handling ability. Both tests are necessary to properly analyze these tubes, available only in the P.O.E. Tester.
- The function of the Diode tube is to rectify. Here the Emission Test only is made to determine the condition of the tube. P.O.E. tests these under both voltage and current load. The proper high voltages used in the P.O.E. Tester will detect any flash overs.

Model 1502 has shadow graph line voltage indicator. Neon inter-element short test made while tube is hot. Complete in quartered oak case. DEALER PRICE—\$36.67

Model 1503 same as above but also combines separate Universal Volt-Ohm-Milliammeter, Condenser Tester and Decibel Meter. DEALER PRICE—\$46.67

Model 1504 same as 1503 but also combines Free Point Tester. DEALER PRICE—\$56.67



TRIPLETT ELECTRICAL INSTRUMENT CO.
191 Harmon Ave., Bluffton, Ohio

Please send me more information on Model 1502;
 Model 1503; Model 1504. I am also interested in

Name

Address

City and State

110 VOLTS AC ANYWHERE

KATOLIGHT, JR., AC PLANTS

Sells itself! 55 pounds. Self-cranking 300 watts, and rope-cranking 350 watts. Also 6, 12, 32 and 110 volts DC.

300 TO 10,000 WATT AC PLANTS

Specially designed for sound-truck, amplifier, P.A., radio and other work. Self-contained. Self-cranking by connecting to auto batteries.

DIESEL PLANTS

Full Diesel AC & DC plants. 2, 3, 5, 6 KW sizes.

AC, DC Generators, Rotary Converters; DC Plants; Windmill Lighting Plants.

Dealers, Jobbers, write for details and discounts

KATO ENGINEERING COMPANY

MANKATO, MINNESOTA, U. S. A.

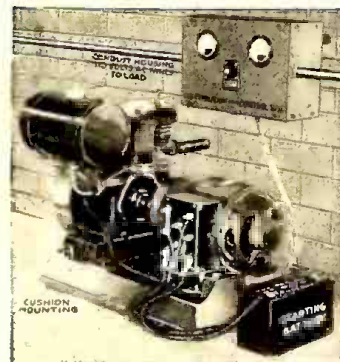

TO HELP YOU SELL MORE SOUND EQUIPMENT



Probably you have felt like lots of other Sound Dealers that you could do a bigger job in Sound Equipment if you could get a little bit of help and cooperation from the manufacturer. Webster-Chicago now offers you a well balanced program that will definitely work for you to get more business.

Shown above are:

1. Sound Engineering Book. 16 pages packed with Engineering and Sales Data. Copy available to you free of charge.
2. School Bulletin—A sales mailing piece for school principals, superintendents and architects—also series of letters.
3. Inter-Office Communicating System Folder. Gotten up definitely to open doors... well worth a trial in any locality.
4. Factory Call System. Mailing Piece. There is a big market for Call Systems. This mailing piece is unusual and will get attention.
5. Personal Dealer Signs. Here are signs with your name. Inquiry getters and business pullers for you, to put in your window, to place with all jobs you rent, to put in prominent places like hotel lobbies, or other spots available to aggressive dealers. Get more information.

Other helps are in process. In addition, Webster-Chicago maintains a steady advertising campaign to actual consumers resulting in hundreds of direct inquiries each month. Inquiries are forwarded to nearest Webster-Chicago dealer.

Remember also that with Webster-Chicago you will be handling a COMPLETE LINE of Sound Equipment and accessories of All Kinds.

WEBSTER - CHICAGO

Fully Licensed
Strict Dealer Policy
Time Payment Plan

WEBSTER-CHICAGO Section J-9 3625 W. Lake Street, Chicago, Illinois
Please send me without obligation Information on following Sales Help Free Manual on Sound Engineering
 Information on following Sales Help Free Manual on Sound Engineering
 Information on following Sound Equipment

Name _____
Address _____
City _____
State _____



ANOTHER MAJOR VIBRATOR IMPROVEMENT BY THE LEADER— No More Broken Leads

Utah has always been the leader in the design and manufacture of vibrators for radio purposes. This organization has pioneered in vibrator design, and is the recognized and leading source of the radio industry for this part.

Every Utah Vibrator embodies the same high qualities of workmanship and design found in other Utah products.

Speakers • Transformers
Chokes • Volume Controls
Tone Controls • Resistors
Plugs • Jacks • Push
Button Switches



Utah Vibrators are protected by one or more of the following patents:
1824082, 1935568,
1935569, 1944487,
1946563, 1951614,
1961053, 2009425.
Other patents pending.

Utah

VIBRATORS

UTAH RADIO PRODUCTS CO.
CHICAGO, U. S. A.

TORONTO
ONTARIO CANADA

BUENOS AIRES
(UCOA RADIO PRODUCTS CO.)

"15 YEARS OF LEADERSHIP"

SERVICE NOTES

CLEVELAND BANS "FIFTY CENT" SERVICE

★ Servicemen in Cleveland, Ohio, have been conducting a drive against the former evil of advertisements for "50-cent service calls."

As a result, reports Max J. Bauer, head of the radio and sound division of a local organization of servicemen, persistent "50-cent" advertisers in the local newspapers have stopped this practice, and signs quoting 50-cent and 75-cent service calls, have been replaced by \$1.50 minimums. This \$1.50 price, Mr. Bauer feels, is a fair charge to the public and covers the serviceman's gasoline, depreciation, etc.

SERVICE TIPS*

Zenith Model 750 Dead

★ If the grids of the I.F. tube become red hot look for a shorted I.F. transformer. This is caused very often by the leads of one winding touching those of the other winding.

Sparton Model 120 Oscillates When Warm

★ If the receiver functions correctly until it becomes hot increase the value of the by-pass condenser across the cathode resistor. Sometimes it is necessary to employ a condenser as large as 1 microfarad to obtain stability.

*Service tips are selected from the files of H. K. Bradford, President, Capitol Radio Research Labs., Washington, D. C.

Auto Rodio Distributor Interference

★ In some cases wear of the distributor shaft carrying the rotor will be responsible for considerable trouble in the way of interference. When this has been definitely established, the remedy, of course, is to replace the shaft. Undue wear of this shaft allows variation in the spark gap setting, thus causing trouble.

Brunswick Model S-14 Mushy, Whistle, Hum

★ Any of these troubles, either while the set is warming up or continuously, indicates unbalanced, gassy or otherwise defective power tubes.

RCA Victor R-11 Inoperative

★ If the .1 mfd. a-v-c filter condenser has a leakage resistance this will in effect over-bias the tubes which are a-v-c controlled making the set inoperative. If operation of the circuit is restored by removing the a-v-c tube, replace the .1 mfd. unit. A common trouble in this model may also be traced to an open in one of the windings of the second i-f transformer.

Mojestic Model 20 Sizzling and Frying

★ The tone control is usually responsible for this trouble. Open the chassis at the rear left side where the tone control is located and simply clip the condenser. If the customer wants to have a tone control, replace the condenser with a .03 mfd. 600 volt tubular type.

Philco Model 10 Noisy When Set Is Jorred

★ Check the coil shields for solid contact with the chassis. Also check the coil bracket supports for the same condition. As this trouble may correct itself if you invert the chassis, be sure to keep it right side up when doing this work.

Crosley Model 120 Inoperative

★ When the receiver is found to be dead over the lower end of the dial, it is quite possible that the dynatron

oscillator used in this receiver is not functioning. This may usually be traced to an over-oxidized flathead screw and stationary plate of the padding system used for the low frequency end of the tuning range. Such units must be carefully cleaned and replaced as before. Use sand-paper and alcohol in cleaning these units, and apply a thin coating of vaseline to each part when replacing to prevent further oxidation.

Here's the "Key" to
SUCCESSFUL
SERVICING

FOR MEN WHO WANT
TO GET AHEAD

Radio Service work is becoming more and more complicated. Technical training is a necessity if you expect to advance. Smart men are insuring their futures by training NOW. GOOD men always have GOOD jobs. Study at home and be ready to go ahead as a trained Service Technician.

COMPLETE HOME STUDY TRAINING
FOR PROFESSIONAL SERVICEMEN

A complete, up-to-date course in Advanced Radio Service and Public Address Work, with or without Television. Terms as low as \$5 monthly. Write for details now.

RIGHT NOW—WRITE NOW!



A request on a penny post card will bring you your own copy of this interesting, illustrated booklet. Explains courses, school, faculty, terms and your future in the Service field.

Free!

RADIO SERVICE INSTITUTE

SUBSIDIARY OF CREI

Dept. RT-1, 3308 14th St., N. W., Washington, D. C.

NEW — a low cost C-B Oscillograph MODEL 105 with Linear Sweep, Dual Amplifiers, etc.

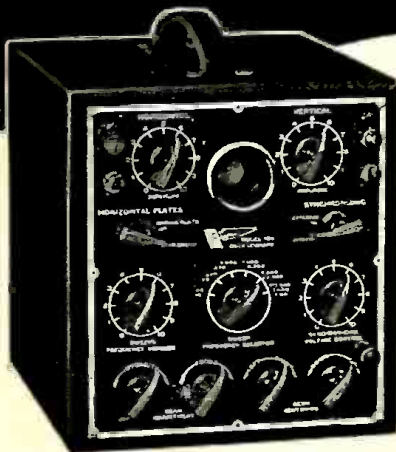

You Need Every One of These Exclusive Features

Uses the new Type 913 one-inch Cathode-ray tube and provides every feature of the most expensive oscillographs, such as: Linear Sweep with synchronizing circuit using the Type 885 Thyatron; separate High Gain Amplifiers for horizontal and vertical plates; Beam Centering Controls; and adjustable light shield for Cathode-ray tube screen.

Compact, easily portable — yet the most complete instrument ever offered using the Type 913 tube. Not one of these features can be omitted without so limiting the utility of the oscillograph that any saving is wasted by limited performance. Write for bulletin describing this instrument in detail.

Complete with five tubes, net cash **\$48⁹⁰**
Pay-As-You-Earn. \$5.50 down

Oscillators for Use with MODEL 105

This instrument now makes it possible for you to secure complete Cathode-ray Receiver Servicing equipment for only \$9.50 down (MODELS 81-A and 105). Designed for use with either the MODEL OM-A Frequency Modulated Oscillator or the MODEL 81-A Frequency Modulator, to produce calibrated selectivity curve images by single or double trace method.

The CLOUGH-BRENGLE CO.

2827 W. 19th St., Chicago, U.S.A.

Send at once full description of the new MODEL 105 Cathode-ray oscillograph and time payment order blank.

Name.....
Address.....

See Your Jobber Today — Or Use This Coupon

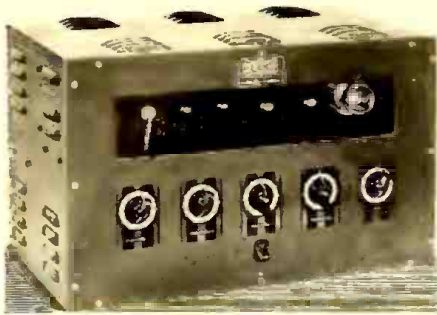

THE NEW STANDARD IN AMPLIFIERS

INTRODUCING a new type of amplifier—ultra modern in design and having the professional appearance so necessary for fine installations.

ELAMCO Series "B" amplifiers (illustrated) are built to the most exacting standards and developed around an original and unique type of construction, skillfully incorporated into moderately priced units.

Electrically, these amplifiers rank among the finest. Mechanically, they are vastly different, creating distinctive installations.

Descriptive bulletins are available, giving detailed information on these remarkable amplifiers. Series "C," chassis type amplifiers, will also prove mighty interesting to you. Send for your bulletins now.

STRICT DEALER POLICY



DOPE ON DISTRIBUTORS

★ Motorola's car radio line for 1937 was presented to a coast-to-coast gathering of distributors Jan. 14 in Chicago. Paul V. Galvin, president, Galvin Mfg. Co., directed the presentation, assisted by Joseph Galvin, vice-president of the firm, and Elmer Wavering, sales manager of Motorola auto set division. Extensive sales promotion plans were revealed, accenting cooperation with jobbers and dealers.

★ New service manager at the Fuller Specialty Co., Parkersburg, W. Va., is Keith Monroe. Fuller's manufacture and sell all types of sound equipment and maintain a laboratory in which to do wholesale service work for 10 dealers in Parkersburg and 30 in the area.

★ Bloch Bros., jobbers of Selma, Ala., have recently released to servicemen a new 1937 catalog, one of the most complete in the history of the house.

★ The Shield Co., Inc., Crosley distributor, Ft. Worth, Tex., has moved to a new home at 1010 Macon St. New outlay includes 18,000 sq. ft. of floor space, enlarged service and accessory departments, a big parking lot and a sound room specially built for demonstrating electric organs.



D. F. WELLS, new exec at the Hastings, Neb., jobber firm W. M. Dutton & Sons. Company recently annexed Emerson and Leonard.

★ Midwest - Timmermann Co., Davenport, Ia., one of the area's most important jobbers for Grunow radio and refrigerators, has opened a large radio parts dept. under the management of M. W. Berberet. Lines stocked are Tung-Sol, IRC, Cornell-Dubilier, Stancor, Webster-Chicago and Amphenol.

★ W. B. McCoy, formerly with an RCA-Victor distributor in New Orleans, has joined the staff of the Southern Equipment Co., San Antonio, Tex., jobber for RCA and Kelvinator. F. G. Atwater, official of the Southern firm, says that McCoy was "practically raised" promoting RCA and will now "ram rod" the line for the Texas company.

★ Supervised by Robert F. Weing, Zenith's recently appointed automotive radio head, meetings have been held in Chicago, New York, Atlanta, Kansas City, Los Angeles and San Francisco, at which jobbers saw the new 1937 line of car radio.

★ Jack Hennigh is the new branch manager of Spurrier's, Inc., Philco distributors of Wichita, Kan. Hennigh is a popular figure in Wichita's radio circles, and succeeds E. E. Brammer, who resigned as Spurrier's manager.

★ Home Modernizing Co., South Bend, Ind., have dolled up a trailer in green and ivory, the same colors as are featured at the firm's headquarters. J. F. Donahue, company president, reports that success in contacting Emerson dealers with the outfit has been unusual.

★ To the sales force of the Cooper-Louisville Co., Crosley jobbers of Louisville, Ky., has been added the live-wire appliance salesman, Charles F. Lister.

CANDOHMS
ZIPDHMS
SWITCHES
SPIRASHIELDS
BRIDGES
DECADE BOXES

MUTER FLASH

DEPENDABLE
QUALITY
AND
RELIABLE
SERVICE
ALWAYS

JACK SCANLAN
PETE DAILEY

LES MUTER

FLOYD CHURCHILL
FRED STEVENS

TWS - 11 - CHICAGO ILL 217 PM

JOBBER - DEALER - SERVICEMAN

NEW PUSH BUTTON SWITCHES WITH SPECIAL
FEATURES IMMEDIATE DELIVERY STOP COM-
PLETE CATALOG FREE STOP INSURE YOUR
PROFITS SELL MUTER PARTS STOP ASK ABOUT
ZIPDHMS AND SWITCHES

THE MUTER COMPANY

THE MUTER COMPANY 1255 S. MICHIGAN AVE., CHICAGO, ILL.

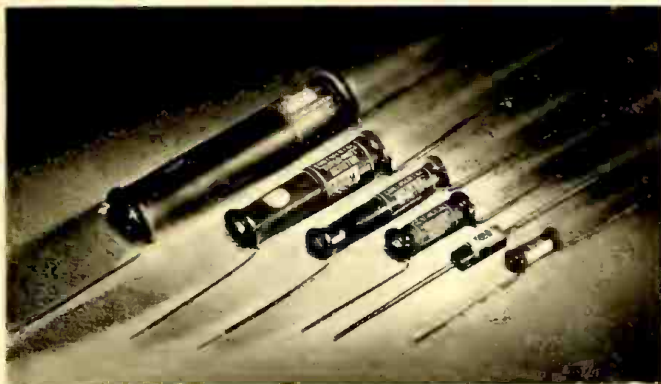

CONTINENTAL Insulated Resistors

insure circuit stability. These accurate and conservatively rated units are the choice of leading radio and instrument makers. Reading from left to right: H5, 5-watt, list, \$.50; E2, 3-watt, list \$.30; D2, 1-watt, list, \$.20; G4, 1/2-watt, list, \$.17; M5, 1/2-watt, list, \$.17; K7, 1/4-watt, list, \$.17. Ceramic insulation used on all except M5, which is insulated with molded bakelite. Specify CONTINENTAL Carbon insulated resistors on your next order.

Just out—Handy Pocket Data on Radio Interference, an informative up-to-date booklet which helps you sell radio interference elimination service, price, 10c postpaid.

CONTINENTAL CARBON Inc.

13910 Lorain Ave., Cleveland, Ohio • Toronto, Canada



for 1937

SELL TUBES ON

"Velvet"

In the Tung-Sol consignment plan there's no such thing as tied-up capital. A stock of Tung-Sol radio tubes on your shelves means "velvet" sales. You pay only for tubes sold. Orders — not cash investment — keep your stock replenished.

Desirable locations are still open for independent service organizations which can qualify. Write for the name of your nearest Tung-Sol tube wholesaler today.

TUNG-SOL

Tone-flow radio Tubes

TUNG-SOL LAMP WORKS, INC.
Radio Tube Division

Sales Offices: Atlanta, Boston, Charlotte, Chicago, Dallas, Detroit, Kansas City, Los Angeles, New York. General Office: Newark, N. J.

Announcing....

4 NEW AERIALS BY WARD

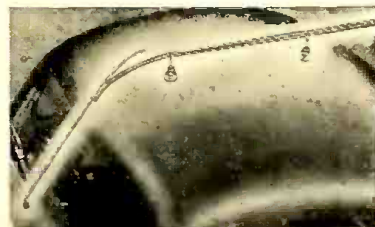

MODEL S.T.R.—The "Stratosphere"—List Price \$5.00 — Maximum efficiency. Enhances beauty of any car. Also MODEL T.A. "Tur-rette" for windshields that open.

MODEL A.L.T.—The "All-Range"—List Price \$4.25 — For cars with windshields that open — Also MODEL A.L. for windshields that do not open. No drilling in top necessary. Fits all cars.

MODEL F.L.—The "Flex-Rod"—List Price \$3.50 — Sensational Hinge Aerial — Fits all cars — Flexible — Efficient — No drilling.

IMPROVED MODEL H.P.R.—"Long-Range Twins"—List Price \$4.00—America's Finest Running Board Aerial—simple installation.

1937 CATALOG READY
SEND COUPON TODAY

USE THIS COUPON

WARD PRODUCTS CORP.
Ward Bldg. - Cleveland, O.

Send Ward's 1937 Aerial Catalog.

Name

Address

Check Dealer Jobber Service Man

The WARD PRODUCTS Corp.
WARD BUILDING CLEVELAND, OHIO
10 CANADA: STAS BROS. CORP. TORONTO, ONTARIO

NEW THINGS FROM THE MANUFACTURERS

Teletalk intercommunicating systems

★ Enlarged line of Webster teletalk systems include a master unit for use with several stations. Master station model has switch for selecting channel. Confidential models affording privacy in conversation are also available. Separate volume control at each station and exceptional tone fidelity. Webster Electric Co., Racine, Wis.—RADIO TODAY

Chassis cleaner



★ Premier electric blower for cleaning dusty radio and amplifier chassis. Quickly removes all dust from the set. Electric Vacuum Cleaner Co., Inc., 1734 Ivanhoe Rd., Cleveland, Ohio—RADIO TODAY

Skyscraper wind charger

★ DeLuxe Duncharger incorporating the Dunn governing principle of automatically shifting propeller angle during high wind velocities. Skyscraper model designed for 10-foot installation, giving increased power. Parris-Dunn Corp., Clarinda, Iowa—RADIO TODAY—See also advt. p. 56.

Ranger-Examiner multi-meter



★ AC-DC volt-ohm-milliammeter. Voltage range 0/10/50/250/1000 AC and DC at 1000 ohms per volt—0/1/10/50/250 mils. DC. Resistance scales 0/300/250,000 with 1½ volt battery. Housed in sturdy metal case with black enamel finish. Size 5¾ x 7¾ x 4¾

inches. Black and silver panel. Model 740—net \$18.60. Readrite Meter Works, Bluffton, Ohio—RADIO TODAY

Offset screw drivers



★ Chrome-molybdenum offset screw drivers for reaching screws in difficult places. Servicemen will find many uses for this type of screw driver. Available in 4½ inch (\$.40), 6 and 8 inch (\$.50) sizes. Kraeuter & Co., Inc., 569 Eighteenth Ave., Newark, N. J.—RADIO TODAY

Sonotone hearing-aid radio

★ AC-DC radio with special attachment to permit reception by persons who are hard of hearing. One model has outlet for those persons already using a hearing aid for conversational purposes. Second model equipped with "oscillator" or bone conduction reproducer. Switch permits loud speaker to be on or off. Sonotone Corp., 19 W. 44th St., New York, N. Y.—RADIO TODAY

Clough-Brengle test equipment

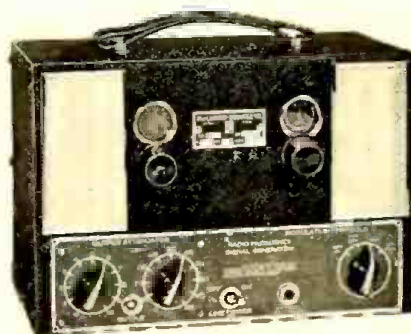

★ R.F. signal generator for receiver alignment and testing. Dial scale 25 inches per band—hand calibrated, accuracy ½ of 1 per cent. Modulated at 400 cycles—separate attenuators for both audio and R.F. voltages. Available for AC, AC-DC, battery operation. Model OC-A—list \$29.95.

Midget cathode ray oscillograph for visual alignment and receiver servicing. Uses new 913 cathode ray tube. Built-in sweep circuit, horizontal and vertical amplifiers. Housed in case 8¾ x 8¼ x 9¾ inches. Model 105. Clough-Brengle Co., 2815 W. 19th St., Chicago, Ill.—RADIO TODAY—See also advt. p. 51.

Crosley doublet antenna

★ All-wave doublet antenna which is practically equally efficient in reception of radio signals from all directions. Designed for maximum signal strength and at the same time minimizing static and noise. Crosley Radio Corp., 132 Arlington St., Cincinnati, Ohio—RADIO TODAY

Centralab switch kit

★ Assortment of wave-change switch parts which make it possible to assemble any required type of switch—more than 150,000 combinations possible. Shorting and non-shorting types—sections for test equipment also available. Centralab, 900 E. Keefe Ave., Milwaukee, Wis.—RADIO TODAY—See also advt. p. 30.

Paper cased electrolytics



★ New line of electrolytic condensers for service replacement and low power transmitters. Mounted in wax-sealed paper case with mounting flanges—constructed with Sprague moisture-proofing process. Available in 1 and 2 mfd. capacities—400, 600, 800, and 1,000-volt ratings. Sprague Products Co., North Adams, Mass.—RADIO TODAY—See also advt. p. 47.

Emerson antenna kit

★ All-wave high-fidelity antenna kit. Provides maximum sensitivity on short wave, noise elimination on all bands including broadcast, and automatic tuning of antenna to desired station. Model W-78—list \$5.00. Emerson Radio & Phonograph Corp., 111 Eighth Ave., New York City—RADIO TODAY

Fairbanks-Morse refrigerators

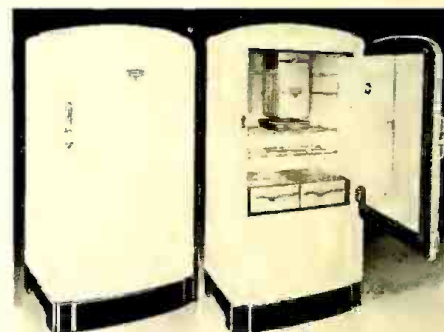

★ 1937 line of "boxes" includes 8 models, five in a D series with Conservador, and three in a DX series without Conservador. Capacity ranges from 4.68 to 7.50 cu. ft. gross. Features are selective simplified temperature control, self-sealing crisper, three coats

of Dulux, 2-way door opener, interior light, presto trays, motor protection and other items. Illustrated is the D7 Conservador—7.50 cu. ft., 14.50 sq. ft. shelf area. Fairbanks, Morse & Co., Home Appliance Division, Indianapolis, Ind.—**RADIO TODAY**—See also advt. p. 46

Sonora electric phonograph



★ Concert grand electric phonograph with amplifier using two 6L6 output tubes. Individual volume and tone controls. Piezo astatic crystal pick—AC operated turntable—13-inch hi-fidelity speaker. Cabinet of matched walnut veneers. List \$99.50. Table model list \$69.50. Sonora Electric Phonograph Co., Inc., 160 Varick St., New York City—**RADIO TODAY**

Moisture-proofed paper condensers

★ Paper condenser impregnated with a new compound which insures the condenser from absorbing moisture. Made in accordance with RMA specifications. Unique shape eliminates r.f. pick-up. Coated with layer of aluminum varnish. Dumont Electric Co., Inc., 514 Broadway, New York, N. Y.—**RADIO TODAY**

Grunow super-safe "boxes"

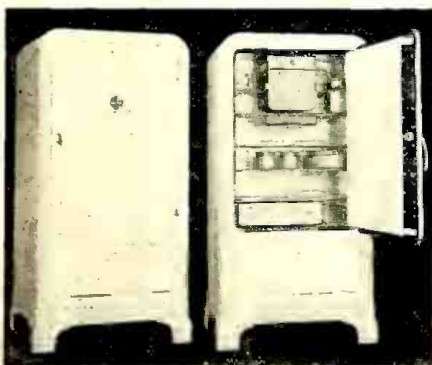

★ New line of Grunow refrigerators includes 6 models, two standard, two de luxe and two super de luxe. Capacity varies from 5.52 cu. ft. gross to 8.74. Special features include needle bar shelves, ice tray release, Carrene refrigerant, interior light, foot pedal door opener, rounded cabinet corners, deodorizer, water bottle (std. equip.), etc. Shown here is the 83WSD super de luxe—8.74 cu. ft., 16.9 sq. ft. shelf area. General Household Utilities Co., Chicago, Ill.—**RADIO TODAY**

Oil burner interference suppressor

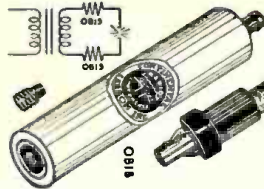

★ Ignition interference suppressor for use with oil burners. Resistance of 15,000 ohms—one inserted in each lead of the high tension circuit. Housed in Isolantite insulated tube. Has solderless cable terminal at one end and universal threaded stud at other—fits practically all standard transformers. Continental Carbon Co., 13900 Lorain Ave., Cleveland, Ohio—**RADIO TODAY**—See also advt. p. 53.

Audio oscillator

★ Variable fixed frequency oscillator for audio amplifier and speaker testing. Range 50 to 20,000 kc. in 10 steps. Harmonic content less than 6 per cent at 50 cycles and less at other frequencies. Output voltage of 5 volts across high impedance load—0.5 volts at 500 ohms. Battery power supply. Net \$23.95. Communication Instruments, Inc., 125 W. 40th St., New York City—**RADIO TODAY**

Ferranti hi-fi transformers



★ Two series of high-fidelity transformers for all audio circuits. Super models have frequency characteristic within 1 DB from 30-12,000 cycles. Ultra type within ½ DB from 30-16,000 cycles. Available in all types for high-quality amplifier circuits. Ferranti Electric Co., 30 Rockefeller Plaza, New York City—**RADIO TODAY**

New receiving tubes

★ Past few weeks have witnessed introduction of several new tubes. 1H4G 2-volt octal triode similar to 30; 5U4G F.W. rectifier similar to 5Z3; 6H5 tuning eye with current limiting grid similar to 6G5; Series of 150 mil octal 6 volt tubes—6D8G converter (6A8G), 6L5G triode (6C5G), 6S7G R.F. pentode (6D6), 6T7G duo-diode triode (6Q7G).

25A7 metal output pentode; 25A7 combined half wave rectifier (12Z3) and pentode (12A5). New beam power amplifiers: 6V6 and 6V6G similar to 6L6 but less power; 25B6G and 25L6 for AC-DC sets.

These tubes have been announced by following manufacturers:

Arcturus Radio Tube Co., 720 Frel-

inghuysen Ave., Newark, N. J.—1A4, 1B4, 1C7G, 1F5G, 1H4G, 1H6G, 1J6G, 5U4G, 5V4G, 5X4G, 5Y4G, 6B8G, 6E5, 6G5.

Hygrade Sylvania Corp., Emporium, Pa.—5U4G, 6D8G, 6L5G, 6S7G, 6T7G, 6V6, 6V6G, 25L6.—See also advt. p. 37.

Hytron Corp., 23 New Derby St., Salem, Mass.—25A7.

Ken-Rad Corp., Owensboro, Ky.—1H4G, 5U4G, 6D8G, 6S7G, 6T7G, 25A6.—See also advt. p. 63.

National Union Radio Corp., 570 Lexington Ave., New York, N. Y.—6H5.—See also advt. p. 59.

Raytheon Production Corp., 420 Lexington Ave., New York, N. Y.—6V6G, 25B6G, 25L6G.—See also advt. p. 35.

Triad Mfg. Co., Pawtucket, R. I.—25A7—**RADIO TODAY**—See also advt. p. 47.

Grunow receivers



★ 5-tube AC-DC table receiver with dial mounted in center of speaker grille. Set tunes 550-1700 kc. Horizontal type cabinet with rounded columns at either side. List \$29.95. Another model is a 6-tube vertical table set with speaker mounted below the dial—tuning range 550-1700, 2000-7000 kc.—list \$39.95. Third set a 7-tube console listing at \$59.95—tunes 550-1700, 2000-7000 kc. General Household Utilities Corp., 2638 N. Pulaski Rd., Chicago, Ill.—**RADIO TODAY**

Janette rotary converters

★ Complete line of rotary converters for changing DC to AC current—models for radio and sound apparatus. Radio models have filter effective from 10 to 547 meters. Standard frequency is 60 cycles—input voltage of 6, 12, 32, 115, 230 volts DC. Janette Mfg. Co., 556 W. Monroe St., Chicago, Ill.—**RADIO TODAY**

Elamco amplifier

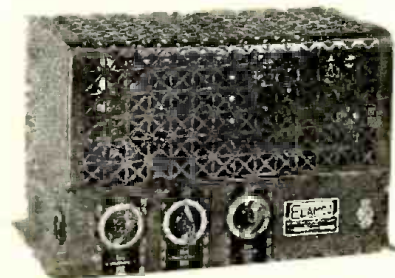

★ 14-watt power amplifier with high and low gain input channels. 117 DB overall gain—50-10,000-cycle response within 2 DB. Multiple output impedances. Provides field supply at 10,000 ohms, 16 watts. Field coils not necessary for operation. Model 8-C with tubes—list \$58.25. Electric Amplifier Corp., 135 W. 25th St., New York, N. Y.—**RADIO TODAY**—see also advt. p. 52

New! THE SKYSCRAPER DUNCHARGER



Incorporating the Famous and Exclusive DUNN Governing Principle!

The Higher the Tower, The Greater the Power!

Dealer Price
\$15.00
(Including Tower)

Far up above ordinary obstruction the sturdy SKYSCRAPER 10 FOOT Installation puts the Duncharger in the full unbroken wind stream where the slightest breeze can operate it with 100% efficiency.

DUNCHARGER ENGINEERING AGAIN IN THE LEAD!

First to build a successful governing device for a wind-charger, Parris-Dunn now leads the field again with a giant 10-foot unit, that will in practically every instance increase the power output by 25% or more, as compared to the old fashioned 6 foot unit.

The New Skyscraper Duncharger, at no increase in price, represents the greatest wind-charger value ever offered the radio dealer. It's the finest battery radio "sales clincher" you've ever had. Feature the Duncharger and watch your radio sales grow!

MAIL THIS COUPON

PARRIS-DUNN CORP.
CLARINDA IOWA, U. S. A.
20 Years of Successful Manufacturing Experience.

Please send me full particulars of Skyscraper Duncharger and sensational Parris-Dunn Merchandising Program.

Name

Address

City..... State.....

DOPE ON DISTRIBUTORS

★ Philco jobbers, O'Brien Hardware Co., Devils Lake, N. D., have named two additional dealers: A. H. Dahl, Jalna, and James Fahey, Warwick, N. D.

★ With the addition of the entire state of Maryland to its area, the Simon Distributing Corp., Washington, D. C., now covers three major territories: Maryland, District of Columbia and Virginia. Simon's handle Motorola and have a branch in Richmond, Va.; within the next few weeks another branch will be opened in Baltimore, Md.

★ I. H. Parks, official of the Auto Equipment Co., Denver, Colo., reports genuine success with a display booth at the recent Electrical Jubilee sponsored in Denver by the Electrical League of Colorado. Exhibit featured Emerson sets and Norge refrigerators.

★ At the Radio Maintenance Supply Co., the jobbers of Worcester, Mass., who handle Admiral sets and National Union tubes, Everett Merriam has been added to the sales staff.

★ From John H. Ewinger & Son, the Philco jobbers of Burlington, Ia., comes the news that two new dealers have been appointed: Hatch Motor Co., Burlington, and Fairfield Elec. Co., Fairfield, Ia.

★ RCA jobbers are currently distributing to dealers an elaborate "opera kit" plugging RCA's sponsorship of Saturday afternoon broadcasts from the Metropolitan Opera House in New York, via NBC-Blue Network. Kit includes stories of the opera, banners and posters. Latter are issued to dealers weekly with names of current operas and artists. Special record albums are also being merchandised as a tie-in with the broadcasts.

★ Showroom and warehouse space at Wholesale Radio Service Co., Inc., New York City, has been increased to handle a new rush. Report from the company is that many of its patron service men have started selling Lafayette radios as holiday specials.

★ W. M. Dutton & Sons Co., Hastings, Neb., have been appointed Emerson distributors. Dutton's big organization has been an important factor in the area for some 50 years. Company execs, H. A. Lainson and Don Wells, claim a record inventory in the Middle West during 7 years with Atwater Kent.

★ New sales manager at the Stanley Distributing Corp., Crosley jobbers of St. Louis, Mo., is William Gaston.



STEVE KUGLER, head man at OK Appliance Corp., Denver jobbers, looks after Admiral sets in the Rockies.

Does Your Radio Parts Supplier Fit you Like This?

DRESS UP!

... your profits with Radolek's Radio Supply Service! Radolek Service is "tailored" to exactly fit your every radio requirement... and purse. Radolek SPECIALIZES in giving the radio-man what he wants, when he wants it, and at the right prices. The 1937 Radolek Radio Profit Guide is just off the press. Completely new! Over 12,000 values! Hundreds of new items. Merchandise you've never seen before.



Repair Parts, Radio Sets, Amplifiers, Test Instruments, Tubes, Tools, Books, "everything in Radio and Public Address." You need this complete "guide" to greater profits. Send for yours today. FREE!

R A D O L E K
601 W. RANOLPM, CHICAGO, DEPT O3
Send me the Radolek Radio Profit Guide FREE.

Name

Address

City..... State.....

Service man? Dealer? Experimenter?

ON THE TRADE TICKER

★ Advance showings of 17 new RCA radio models have been staged in various parts of the country for the firms' jobbers. New-year sales plans were announced by Paul C. Richardson, RCA-Victor's radio and phonograph division manager, and Thomas F. Joyce, ad manager, has announced a vigorous ad and sales promotion campaign.

★ Sixty members of Chicago radio gentry went to a bachelor dinner given to E. G. May, ad manager for Sentinel Radio Corp., at Harry's New York Bar, Jan. 8. George Russell, Sentinel's sales manager, was toastmaster, seconded by E. A. Alschuler, the company's president. Mr. May was married on Jan. 16 to Miss Lilian Nape.

★ Radio and refrigeration division of the Stewart-Warner Corp., Chicago, has a new advertising manager in the person of C. C. DeWees. For many years DeWees worked in SW sales promotion, then became assistant ad manager, and now reaches the dept. top. F. R. Cross continues as general advertising manager for the parent company.

★ Harrison J. Cowan, advertising manager for Dictograph Products Co., Inc., is leaving that organization to establish his own advertising agency in New York. Associated with him will be Arnold Van Leer, well known motion picture publicist. New agency will be known as Cowan & Van Leer, Inc., with offices at 521 Fifth Ave., and will operate as a general advertising agency, emphasizing merchandising, sales promotion and special exploitation.

★ Further progress has been reported by the Galvin Mfg. Co. on the construction of its new two-story factory and office building at 4545 W. Augusta Blvd., Chicago. Handsome terra cotta plant will add 85,000 sq. ft. to space for making Motorola auto and home sets, will cost \$250,000 and will be finished by April 1, 1937. Firm's new line of car radios was announced this month, and its new line of home sets will be in production in early Spring.

★ Greatly increased volume in 1937 for Simplex Radio Co. is anticipated by Sidney H. Gatty, metropolitan sales and export manager, 132 Nassau St., New York. Mr. Gatty says 1936 was one of the most successful years in the history of the company. In addition to a complete line of sets, Simplex 1937 plans will emphasize a strict jobber policy and will include an extensive promotion program consisting of national space and radio time.

★ Belden Mfg. Co., Chicago, has found it necessary to increase its manufacturing facilities in both the Chicago and Richmond, Ind., plants. New building program will cost over \$120,000.



DISPLAY RADIOBAR WITH PHILCO



**in your Window . . . and
Watch the Buyers Come In!**

Radiobar has a tremendous pulling power, drawing people irresistibly into the store. The Radiobars that you sell to some of them, and the radios that you sell to the others, will quickly change your whole profit picture.

For extra profits—easy profits—sure profits, mail the coupon below for Radiobar's complete merchandising plan and dealer-helps. A great profit-opportunity, with powerful promotion and advertising back of it.



P. R. "TOD" REED, past year ad manager for Grunow, now assistant sales mgr. in charge of ads.

**RADIOBAR
CO. of AMERICA**
60 WARREN STREET
NEW YORK CITY, N. Y.
7100 MCKINLEY AVE.
LOS ANGELES, CAL.

Mail Today to Nearest Office—Dept. RT137

RADIOBAR CO. OF AMERICA
60 Warren Street, New York City or
7100 McKinley Ave., Los Angeles

Send your complete story to:

Name
Street
City & State

NOKOIL

The recognized Standard
of comparison for
Permanent Magnet Speakers



**RADIO
PUBLIC ADDRESS
INTERCOMMUNICATION SYSTEMS**

"A NOKOIL Speaker
for every purpose"

Send for prices and catalog describing the 10 different Nokoil models.

Ask for the name of our nearest distributor. Wright-DeCoster distributors are always anxious to cooperate.

WRIGHT-DeCOSTER, Inc.

2265 University Avenue, St. Paul, Minnesota
Export Dept.: M. Simons & Son Co., New York
Cable Address: "Simontrice"
Canadian Office:
Associated Sales Co., Guelph, Ont.

NA-ALD'S NEW ADAPTER



950 GEM



908CN KIT



"TF" SOCKETS



Tests Over 100
Octal-Based Tubes!

Simply use the adapter in ANY tube checker which can test a type 36 tube. Simple directions on base of adapter with chart for "good" readings. Toggle switch tests both plates.

950 GEM Octal Testing Adapter. List Price \$6.50

Here Is the Last Word
in an Analyzer Plug!

For those who want the latest, most compact plug. The insertion of the analyzer plug prongs into the socket contacts is made through special compact transfer units using very short moldings thus enabling any conceivable interconnection of circuits to allow testing any circuit whatsoever.

Generous molded insulation for each wire lead. No studs for ultra compactness. Smooth working, bulldog grip latch on plug releases instantly at touch on latch. Ten prong cable plug with socket to match. Special Na-Ald processed contacts as used in sockets making 2 million perfect contacts without failure.

908CN KIT supplied with 4, 5, 6, 7 sm., 7 lg., and octal adapters complete as illustrated. List Price.... \$11.50

Here Is Socket Perfection!

A socket designed especially for best quality instruments to give permanently dependable contacts. All types available.

Any Single Tube Type

List Price 40c ea.

Any Composite Type

List Price 50c ea.

Write for literature describing above and latest in plugs and connectors, adapters, etc., of all types

ALOEN PRODUCTS CO. Dept. RT1
715 Centre St., Brockton, Mass.

TRADE FLASHES

★ Institute of Radio Engineers, Emporium, Pa., section, held their most recent meeting Jan. 14 with H. H. Beverage as speaker. Beverage is chief research engineer for RCA Communications, Inc. Emporium is the Pennsylvania city famous as the home of Hygrade Sylvania Corp.

★ Webster Electric Co., Racine, Wis., has announced the appointment of the Kay Sales Co., Tulsa, Okla., as district sales representative for the states of Oklahoma, Arkansas and extreme western Tennessee. Plans are that J. P. Kay, manager of Kay Sales, will personally supervise the merchandising of Webster Electric sound equipment, pickups and Teletalk.

★ Radio Technicians Guild of Massachusetts has elected officers: S. S. Malo, president; G. L. Chapman, vice-pres.; G. W. Feldman, secretary; F. L. Kennes, treasurer, and W. F. Staples, librarian. Feldman's secretarial headquarters are at 546 Washington St., Boston.

★ Clarostat points to the selection of George D. Norris, Seattle, Wash., as sales representative for Washington, Oregon, Idaho, Montana, Northern Utah and Southern British Columbia. Norris will connect with jobbers of these areas, as well as the few manufacturers.

★ Motorola announces the appointment of Walter H. Stellner as assistant sales manager of its household division in full charge of advertising and sales promotion for home sets. Stellner was for the past 5 years advertising and promotion manager of RCA-Victor's radio and phonograph division; at an earlier date he was an ad exec at RCA's Chicago branch, and more recently he managed promotion for Radiola Distributing.

★ After a long airplane trip through Central and South America and Mexico, John F. Royal, NBC's vice-pres. in charge of programs, has returned to New York. Point of the trip was to arrange a regular exchange of programs between NBC and the Latin-American countries.

★ Part of Fada's increased sales activity has been to assign sales promotion manager George A. Lyons to work directly with dealers and distributors in the North Central states. Other Fada announcement is that after Jan. 1, Joseph Gerl, Midwest rep., will leave the company and shift his interest to refrigerators and associated lines.

★ Commander E. F. McDonald, Jr., president of Zenith Radio, is receiving congratulations as the father of a baby girl who arrived at Henry Hospital, Chicago, Jan. 2. Commander McDonald is a member of the hospital's board of directors and has been one of its chief benefactors for many years.

Replacement METAL-TUBE RESISTORS



The original and perfected unit. Use it for satisfactory, trouble-proof, profitable servicing.

A precisely matched unit for any set model using this form of line-dropping resistor.

Any total voltage drop and all pilot lamp combinations—ideal for series-connected heaters.

Coded and base-wired in accordance with R.M.A. standards for such devices.

FREE CHART: Lists all types of metal-tube type resistors and Clarostat equivalents. Most complete data yet issued on these important replacements. Write for your copy, as well as big 80-page volume-control replacement manual.

CLAROSTAT



MANUFACTURING CO.
Incorporated

285 North Sixth St.
Brooklyn, N. Y.

NEW! SENSATIONAL AUDITION EQUIPMENT

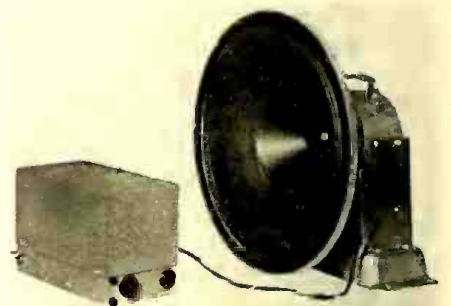

The 3-A is a 32-watt amplifier which with its 18-inch Super Giant Speaker has an acoustic sound output equal to a 214-watt system. It will drive one to four Super Giant Speakers to completely cover the largest indoor enclosure, and will comfortably and easily cover 50,000 to 100,000 people. An unequalled booster amplifier to raise the power of existing PA equipment, the 3-A provides flexibility never before available.

Send in the coupon today for complete details on this sensational NEW audition equipment.

McMURDO SILVER MASTERPIECE AMPLIFIERS

Full Details Free. Mail This Coupon.

McMURDO SILVER CORP.
2900-J So. Michigan Blvd.
Chicago, Ill., U.S.A.

Please rush me full details on new 3-A Masterpiece Audition Equipment.

Name

Address

★ **Electrical Appliance Dealers Ass'n of Brooklyn, N. Y.**, at its meeting of Jan. 6 elected officers for 1937: Russell A. Atkinson, president; James J. Schneer, first vice-president; Ralph Coviello, second vice-president; Albert H. Bernhard, secretary; A. H. Grafenstadt, treasurer, and Sam Klein, sergeant-at-arms.

★ **J. P. Kennedy**, formerly account executive for The Fensholt Co., was named sales and advertising manager of the Triumph Mfg. Co. of Chicago, Jan. 1st. Mr. Kennedy worked his way through the University of Notre Dame repairing and selling radios, finding time to be a member of the Fighting Irish boxing team and a radio instructor. Later he operated a radio sales and service store until becoming advertising and service manager of a wholesale radio parts firm in Chicago, from which he advanced to his position of account executive in the advertising agency. In this position he prepared the advertising for the All Star Junior campaign for eleven manufacturers and for Thordarson, Burgess, Belmont, Aladdin and Continental Carbon. Mr. Kennedy expects to develop the direct-to-dealer sales policy of the Triumph Mfg. Co. and to seek new markets for radio and electrical instruments.

★ **The Radelma Company**, 16 Hudson Street, New York, has been established by Harry Adelman to operate in the export field. Company will serve as American purchasing agents for foreign concerns and as exporting agents for American radio lines. Principals of Radelma have been intimately connected with the radio industry for 16 years.

★ **Electronic Laboratories, Inc.**, Indianapolis, Ind., has announced the appointment of Harry Gerber, Boston, Mass., as their representative in New England. Gerber is a vet in that area; four years ago he presented to jobbers there the first and original line of replacement condensers—those of the same company.



C. M. WILSON will now sales manage the radio section of GE appliances.

★ **Sparton Old Timers**, an inter-factory organization at the Sparks-Withington Co., Jackson, Mich., held their annual banquet early this month, with Capt. William Sparks on hand as usual. Club is active in welfare work and all members have been continuously employed by the company for at least five years. More than 1,000 employees now belong.

★ **J. D. Jordan**, formerly service manager of General Household Utilities Co., Chicago, has been transferred to the research and development department in charge of television experiments. Glenn A. Preston has been named service manager to fill Jordan's former post. Preston formerly was in charge of sales statistical data and franchise department.

★ **Ward Products Corp.**, makers of auto aerials and sound systems, have recently moved into their own new building on East 45th St., Cleveland, Ohio. Manufacturing space has been doubled and sales offices enlarged. Ward has a branch in Canada and an export office in New York City.

★ **Factory** formerly occupied by the Audiola radio plant of Fairbanks, Morse & Co., 430 S. Green St., Chicago, has been rented by the Arlab Mfg. Co., manufacturers of magnetic and dynamic speakers. Arlab recently acquired the Baritone Radio Corp. and will continue to manufacture all the firm's products under the supervision of Baritone's former chief engineer, Walter J. Paredes.

NATIONAL UNION A U T H O R I Z E D BY JOHN F. RIDER TO OFFER MANUALS FREE



Mr. John F. Rider, Noted Author of Service Books



● A necessity of modern service work is complete technical data on all makes of radio receivers. Mr. John F. Rider recognized this need years ago and compiled a great library of radio set circuits and information. National Union also knew how important service manuals would be. National Union decided that every service specialist in the country must have the chance to own the manuals compiled by Mr. Rider. National Union therefore makes it possible to get this library FREE. All seven volumes are given with the purchase of N. U. tubes . . . and N. U. is officially authorized by Mr. Rider to offer his great service library FREE. If you want any one or all of the Rider Service Manuals write now, ask how to get them or consult with your National Union distributor!

FREE SHOP EQUIPMENT, TOO!

No need for the alert and aggressive service expert to read about all the fine scientific instruments which service equipment manufacturers are making and wish that he might own them. Why? He can own them! How? By getting them Free with the purchase of National Union radio tubes.

National Union has given servicemen throughout the United States more than 50,000 pieces of fine equipment. If you're not taking advantage of National Union's service dealer plan, you're missing the greatest opportunity in the radio industry today.

All you do is contract to purchase a few tubes per week, place a small deposit, which refunded

to you after the tube purchase is completed and the instrument you have selected is yours "for keeps," without any strings attached. Meanwhile, remember that you have the use of the instrument all during the time tube purchases are being made.

ABOUT N. U. RADIO TUBES



National Union manufactures a complete line of radio tubes in glass, metal and G-type. National Union's high quality has made them the outstanding favorites in the radio service profession. All sales policies have been formulated with the idea of making National Union radio tubes the ideal replacement tube for the radio dealer. This has been backed up with a selling program that means real support and help to the wide-awake dealer. Dealers and jobbers handling National Union radio tubes are the leaders in repair parts and service.

NATIONAL UNION RADIO CORP.		RT137
570 Lexington Ave., New York City		
Tell me how to get Rider Service Manuals and other free equipment.		
Name	
Street	
City	State



Matched!

- ★ Exact-duplicate condenser replacements for any standard make of set.
- ★ Precisely matched electrically, mechanically, visually.
- ★ FIT right, LOOK right, WORK right—the only way to do a real servicing job.
- ★ Yet they cost no more than a makeshift collection of standard condensers, usually lots less for material and labor.

Send for CATALOG: Contains several pages of exact-duplicate condenser listings, as well as other condensers and resistors of AEROVOX line.



TRADE FLASHES

★ Radio Dealers' Association of New Orleans, one of the 12 organizations which make up the local Electrical Association, recently were entertainment hosts at a lively banquet at the swank Roosevelt Hotel. Affair was a record one in point of attendance; J. E. Muniot, Jr., president of the radio dealers' group, estimated that 450 persons were guests.

★ Following the announcement by Charles E. Wilson, vice-president in charge of the appliance and merchandise dept. of the General Electric Co., that Ralph J. Cordiner, formerly manager of the radio division, had been made assistant manager of the appliance and merchandise dept., Bridgeport, Conn., came the news that Ernest H. Vogel has been appointed manager of the radio sales division, with C. M. Wilson succeeding him as radio sales manager.

★ Glenn Browning, chief engineer, Tobe Deutschmann Corp., recently gave a talk and demonstration on the Audi-O-Graph for the Electronics Associates at the Harvard Institute of Geographical Explorations in Cambridge, Mass.

★ Samuel A. Gomez has been appointed South American representative for the Federal Sales Co., Chicago radio hardware center.



W. H. STELLNER, Motorola's assistant sales manager of Household Division.

★ Lee McCanne, secretary and radio sales manager of the Stromberg-Carlson Telephone Mfg. Co., spoke before a joint meeting of the Rochester Section, American Institute of Electrical Engineers and the Rochester Engineering Society, Jan. 5. Subject was "Voice Paging Systems."

★ Announcement has been made of the formation of the new Bendix Aviation Export Corp., through which will clear the world-wide trade of the Bendix Aviation Corp. and its affiliated companies. New corporation will have its main offices at 230 Park Ave., headed by Howard S. Welch, formerly president of the Studebaker Pierce-Arrow Export Corp. and since 1935 chief of the Automotive Aeronautics Division of the U.S. Dept. of Commerce.

★ Quam Nichol's chief engineer, "Ted" Trzyna, has returned to Chicago headquarters after a trip to the Pacific Coast. Trzyna was busy working along with the engineer groups of the Pacific's set makers and reported general success. Quam Nichol's has recently inaugurated a profit-sharing plan for its employees.

★ Henry L. Crowley & Co. have named LeRoy Schenck, 570 Lexington Ave., New York City, as manufacturers' representative for the metropolitan area and New Jersey. Schenck will handle manufacturers' and jobbers' sales on Crolite products, condensers, resistors, ceramics and Magicores.

★ Frederick B. Gleason, general commercial manager for the Western Electric Co., has retired from his position and is succeeded by Douglas F. G. Eliot, formerly personnel director for the firm.

★ Solar Mfg. Corp., 599 Broadway, N.Y.C., makers of radio and electric parts, has announced a 5 per cent wage increase to its 750 employees.

OPERADIO QUALITY MEANS DOLLARS TO YOU

The name OPERADIO has always meant good sound equipment . . . high-grade dependable merchandise, reasonably priced. That means dollars and cents to you . . . good profit, quick turnover and no costly calling back on the customer to fix equipment that has broken down. When you buy sound or P.A. equipment BUY

OPERADIO UNIT - MATCHED EQUIPMENT

All equipment is unit-matched" to insure a fine, well-rounded performance; and each piece is marked with the name "OPERADIO" . . . your guarantee of the best sound equipment that money can buy at a price no more than the ordinary.

The Operadio line is unequalled for completeness . . . including public address systems, speakers, amplifiers, paging systems, microphones, all component parts and accessories. Especially popular and profitable is the MODEL 111 AMPLIFIER PAGING SYSTEM (Illustrated).

Send in your name to receive catalogs and a free copy of THE SOUND ADVISOR. Address Dept. RT.

**OPERADIO
MANUFACTURING CO.**
ST. CHARLES, ILLINOIS

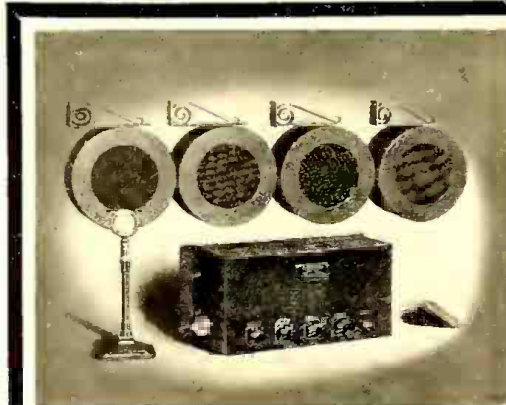

Model 111 Amplifier Paging System

A complete paging system for factories, hotels, public buildings, theatre dressing rooms and similar places. This system is equipped to use up to 12 speakers and comes complete with contact crystal microphone mounted on a beautiful stand, a special amplifier with its tubes which mounts on the wall at some convenient place near the microphone, a foot switch for use when talking, and a complement of 4 permanent magnet dynamic speakers in attractive steel wall cabinet.



"RADIO'S FAVORITE VOICE"

5-inch Standard Dynamic

A THOROUGHLY engineered and carefully designed Dynamic with excellent tonal qualities and the exclusive QUAM completely weatherproofed Armored Field Coils. A husky speaker with a conservative output rating of 3.5 watts, ideally built and priced for use in AC-DC sets and small table models.

Licensed under QUAM Patents

QUAM-NICHOLS CO.

Chicago New York, N. Y.
33rd Place & Cottage Grove Avenue 1674 Broadway



5 FEATURES

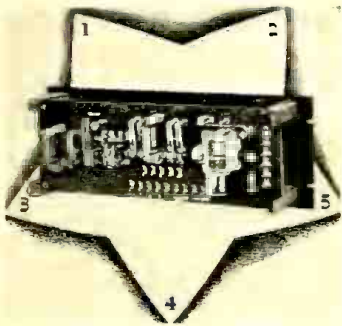

WARD LEONARD TRANSMITTER CONTROL PANEL

1. Provides a time delay to allow power tubes and rectifiers to attain proper operating temperatures. 2. Permits removing plate supply for transmitter adjustments without interrupting filament supply. 3. Protects plate supply from overloads. 4. May be operated from several remote points. 5. Standard relay rack mounting.

WARD LEONARD ELECTRIC COMPANY
MOUNT VERNON, NEW YORK

Please send me your new Bulletin 507C.

Name
Address
City State.....
Jobber's Name RT

★ R. G. Karet, director of sales, wholesale radio division, Utah Radio Products Co., Chicago, is currently contacting the trade in New York state, Pennsylvania and New England in connection with merchandising plans for 1937.

★ H. E. Capehart, vice-president and general manager of the Rudolph Wurlitzer Mfg. Co., North Tonawanda, N. Y., manufacturer of "Simplex" coin-operated phonographs, was host to more than one thousand members of the coin-operated phonograph industry at a banquet and show given Sunday night, December 6th, at the Waldorf-Astoria Hotel New York.

★ When E. G. Biechler, general manager, Frigidaire division, General Motors Sales Corp., recently congratulated his national sales organization on its 1936 sales record, he added: "Soon you will have new and more salable products, featuring a revolutionary improvement that will be the talk of the industry and instantly capture the imagination of the public."

★ Second expansion program undertaken by the Erie Resistor Corp. in the last 3 years has resulted in a recently completed addition to its main factory at Erie, Pa. New annex houses the plastic molding division and general offices of the company. Harold C. Sherk, vice-president and general manager of the firm, points out that to have the molding, finishing and engineering activities under one roof will greatly increase Erie's operating efficiency.

★ Harry J. Scheel, newly appointed export sales manager for the Majestic Radio and Television Corp., announces the opening of the Majestic export sales division with offices at 330 South Wells St., Chicago.

★ Impressive advertising stunt in use at the Paramount Radio Shop, Omaha, Neb., gives manufacturers a chance to take some elaborate displaying off the dealer's hands. Paramount has erected a giant neon sign, 74 ft. long, which has interchangeable letters. Makers of the lines which the store carries are given monthly turns at advertising their products. Store has finished a big expansion program; handles Stewart-Warner, Leonard, Crosley, Kelvinator, and Fairbanks-Morse.

★ Jack Silver, pioneer distributor of auto radio and president of the Jackson Distributing Co., Chicago, passed away Dec. 24 after an illness of 5 months. Mr. Silver was one of the first territorial jobbers for Motorola and had been connected with the Galvin Mfg. Corp. for 13 years.

★ William C. Stoner is the new head of a department recently organized by the Crosley Radio Corp. to assist jobbers to organize and to train their salesmen. Stoner has been district manager in Kansas, Missouri and Colorado; H. A. Armbright will now take that job.

★ New York dealers recently took on a new portable recorder, introduced by Presto Recording Corp. as a low-priced gadget to record parties and home entertainments, children's voices, favorite radio programs or sound for home movies. One dealer started to make records for customers; grossed \$64 the first day. Another had sold 2 of the instruments within 45 minutes after he got the machines.

★ Wesley M. Angle, president of Stromberg-Carlson Telephone Mfg. Co., picked up some lively news on a recent trip through Texas and Missouri. Business in those states runs at an unusually high level.

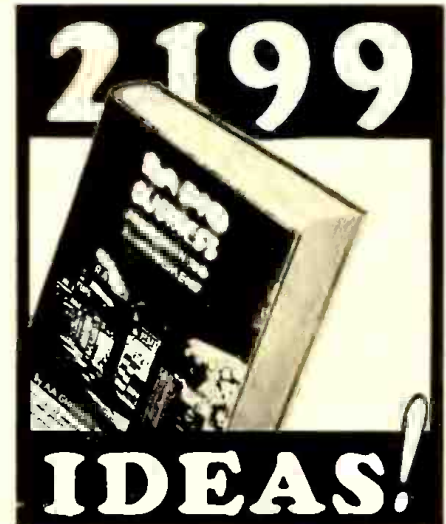

IDEAS!

RADIO BUSINESS Promotion and Management

By A. A. Ghirardi and T. S. Ruggles

YES—2,199 money-making ideas for building up your business. Ideas that have already been TESTED and PROVED SUCCESSFUL—100% sound and practical. Ideas you can put to work TODAY and turn into profit.

It's a WHALE OF A BOOK! It's got EVERYTHING you want to know about how to really run a radio business successfully—plans, methods, ideas for selling, advertising, merchandising, publicity, accounting, management, etc., etc. Applies to sale of sets, service, Auto Radio, P.A. work, home appliances.

The First and Only Book of Its Kind!

The man who uses this book is bound to make more money in 1937!

CLIP and MAIL Today

RADIO & TECHNICAL PUBL. CO.
45 Astor Pl., New York
Dept. RT0-17

★ OVER 400 PAGES
★ OVER 200 ILLUS.

Please send me free circular BB.

Name

Address

Free Circular

NEW

Non-Reactive Dynamic Beam-Power Amplifier and Streamlined Bullet Electro-Dynamic Microphone.

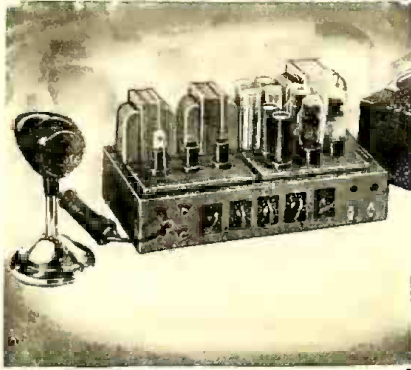

Available at an almost unbelievable Low Price!

Provides unrestricted frequency response, non-reactive signal division, two-phase bridge rectification, stabilized power supply, variable polar response, etc., etc.

Write for Circular No. 3713 for complete details and prices of this amazing sound system development by A. C. Shoney.

AMPLIFIER CO. OF AMERICA
43 West 20th St., New York, N. Y.

HOT BOOKLETS

★ Hammarlund Mfg. Co., 424 West 33rd St., N. Y. C., will send on request its new "37" catalog, a special type of booklet which includes stock sizes and graphic detail. Author and originator of the publication is Lewis Winner.

★ Pamphlet on the operation and installation of modern short-wave sets, prepared by the Radio Manufacturers' Association for the U.S. Dept. of Commerce, has been published by the U.S. Bureau of Foreign and Domestic Commerce. Latter bureau distributes it at 25 cents per copy; booklet presents complete details on all important aspects of short-wave listening.

★ Boonton Radio Corp., Boonton, N. J., will send on request a new bulletin titled "The Humidity Factor in Radio Work." Data includes graphs on the effect of moisture on wire insulation and on trimmer condensers.

★ New and complete description of over 20 instruments will be found in a new 1937 test equipment catalog issued by Clough-Brengle, 2815 West 19th St., Chicago, who send copies on request.

★ Universal Microphone Co., Inglewood, Cal., has issued two new and completely illustrated instruction sheets for its loose leaf catalog.

★ Hygrade Sylvania Corp., Emporium, Pa., is ready with its third and latest edition of its "Technical Manual," a 184-page booklet covering 193 current types of receiving tubes. Manual is marked 15 cents.

★ Just off the press is a new catalog titled "Resistors and Volume Controls" presented by International Resistance Co., 401 N. Broad St., Philadelphia.

★ New bulletin, illustrated with photos and diagrams, will be sent on request by Radio Receptor Co., Inc., 110 Seventh Ave., New York City; booklet features the "Series 7 dynamic mikes."

★ Furnished free of charge to jobbers, dealers and servicemen is a new revised characteristic chart offered by Champion Radio Works, Lynn, Mass. Complete line of Champion resistance tubes is covered in the chart.

★ As a supplement to its 80-page Volume Control Replacement Guide issued several months ago, Clarostat Mfg. Co., Inc., 285 North 6th St., Brooklyn, N. Y., now offers a handy reference list of exact duplicate volume control replacements arranged by type numbers.

★ Complimentary copies of a new "Manual A, Covering Tube and Radio Test Instrument Design," will be sent free to readers who request them. The 60-page illustrated booklet, marked 15 cents, is issued by Supreme Instruments Corp., Greenwood, Miss.

C-D ENGINEERS

Announce



**DYKANOL
IMPREGNATED
AND FILLED**



The type TL series of high voltage filter condensers were designed for power supplies, high power amplifiers, television circuits, transceivers, etc. Hermetically sealed in round aluminum containers, similar to those employed in the construction of electrolytic capacitors. One terminal is insulated, the other grounded. Can be conveniently mounted in either upright or inverted position.

LISTING

Cap. Mfd.	O.C. Working Voltage	Size	Cat. No.	List
2	600	2 7/8 x 1 1/2	TL-6020	\$2.25
3	600	4 1/2 x 1 1/2	TL-6030	2.75
4	600	4 1/2 x 1 1/2	TL-6040	3.00
1	1000	2 7/8 x 1 1/2	TL-10010	2.25
2	1000	4 1/2 x 1 1/2	TL-10020	2.75
.5	1500	2 7/8 x 1 1/2	TL-15005	3.00
1	1500	4 1/2 x 1 1/2	TL-15010	3.50

A post-card will bring you Catalog 135A or see your local jobber.

CORNELL-DUBILIER CORPORATION
1022 Hamilton Blvd., So. Plainfield, N. J.

CORNELL DUBILIER

DYNAMIC MICROPHONES

Are Increasing in Popularity



because they

- have greater sensitivity
- are free from inductive pickup
- have no background noise
- can work with long lines
- are sturdiest ever produced
- are weatherproof
- are small in size
- are reasonable in price

We solicit requests for special sound and amplifying equipment.

Send for our latest Bulletin 3013.

We are pleased to send this to you.

RADIO RECEPTOR CO., Inc.
110 SEVENTH AVENUE, NEW YORK, N. Y.

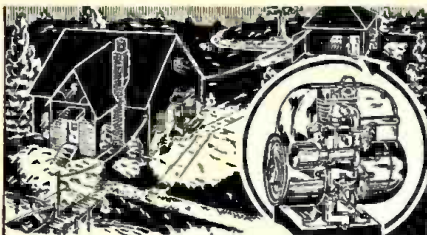

COMPLETE ELECTRIC PLANTS

ONAN ALTERNATING CURRENT GENERATING PLANTS furnish the same electricity as city power lines. Made in sizes 350 to 10,000 watts to meet the requirements of those who must provide their own electricity for Farms, Summer Camps, Cottages, Boats, Commercial Purposes.

OPERATE A. C. RADIO

These A. C. Plants operate RADIO, HOUSEHOLD APPLIANCES, WATER PUMP, MOTORS—anything that normally would operate from city lines. Will run Public Address Systems, Demonstrating Car Equipment, Talking Moving Pictures, X-Ray.

MODERN CONSTRUCTION

ONAN PLANT Engines are like the Motor Car, Truck or Tractor Engines. Operate on Gasoline, Gas or Distillate. Wiring and Installation is the same as for standard applications. Also 32 volt, Direct Current Models.

Write for details

D. W. ONAN & SONS

369 Royalston Ave. Minneapolis, Minn.



ONE CUSTOMER TELLS ANOTHER

The "good word" about Ken-Rad Tubes spreads, and you make more money. Take the first step to building better business by writing for our sales plan.



Manufacturers of a complete line of Standard Glass Types, G Series, and Genuine All-Metal Radio Tubes.

Ken-Rad Radio Tubes

KEN-RAD TUBE & LAMP CORPORATION, Inc., Owensboro, Ky.

(Also Manufacturers of Ken-Rad Electric Light Bulbs)

SALES PRIMERS

ILLUMINATED ACTION

★ Flashy display to feature automatic tuning has been built by Philco and already ordered by 3,500 dealers. The dramatic display has a girl with one arm in constant motion, amid brilliant colors, operating a huge dial which also moves. Lights behind the words, "Click . . . there's your station!" flash on and off, and lights for the call letters on the dial are another feature.

Philco also has a similar silent display in the form of a full-colored lithographed window item featuring automatic tuning. Company's current promotional schedule includes other dealer helps such as novel price tags, transcriptions, billboard posters, folders, wall charts, handbooks, rotogravure sheets, a puzzle, a Social Security Benefit Chart, talking movies, globes, postcards, movie slides, facsimile theatre tickets, door-handle cards and logs.

AUTO RADIO HELPS

★ Three display units have been built by RCA to assist dealers with effective merchandising of car receivers. First is designed for a single unit, with a musical background, casters and plug-in; second is an es-cuteon kit with a storage space included; third is a 3-unit affair with likely lettering and a 3-way switch.

TRIPLE APPEAL

★ Fada has announced a colorful display, No. 200, designed to handle three sets and to be used in the window, on the floor or as a demonstrator. About 50 inches high, it's tinted and lighted to set off the new colored receivers and is suggested for use outside the main radio dept. Company charges a nominal fee.

NEW DECALOMANIA

★ Neat decalcomania for the jobber's door or window has been issued by Clarostat Mfg. Co., 285 N. 6th St., Brooklyn, N. Y. Attractive 3-colored seal is available to all distributors carrying a representative Clarostat stock.

TUBE CARRYING CASE

★ Cardboard bag designed to make it easy for the serviceman's customers to carry complete sets of tubes to and from radio shops has been introduced by Arcturus Radio Tube Co., Newark, N. J. The case opens like a shopping bag, has protective compartments for 10 tubes, and has an OK appearance. Dealer's imprint can be added and Arcturus suggests use as a business card or mailing piece; the item is available at a small fee from the firm's jobbers.

INDEX TO ADVERTISEMENTS

Aerovox Corp.	60
Alden Products Co.	58
Allied Radio Corp.	42
Amplifier Co. of America	62
Centralab	30
Clarostat Mfg. Co., Inc.	58
Clough-Brengle Co.	51
Commercial Credit Co.	4
Continental Carbon, Inc.	53
Cornell-Dubilier Corp.	62
Crosley Radio Corp.	31
Dictograph Products Co., Inc.	23
Electric Amplifier Corp.	52
Emerson Radio & Phono. Corp.	25
Fada Radio & Electric Co.	5
Fairbanks, Morse & Co.	46
Frigidaire Div., General Motors	43
Galvin Mfg. Corp.	Cover IV
General Electric Co.	Cover III
General Industries Co.	64
Hygrade Sylvania Corp.	37
International Resistance Co.	41
Isolantite, Inc.	27
Kato Engineering Co.	49
Ken-Rad Tube & Lamp Corp., Inc.	63
Muter Co., The	52
National Broadcasting Co.	Cover II
National Union Radio Corp.	59
Ohmite Mfg. Co.	42
Onan & Sons, D. W.	53
Operadio Mfg. Co.	60
Parris-Dunn Corp.	56
Philco Radio & Television Corp.	6
Presto Recording Corp.	24
Quam-Nichols Co.	61
Radio & Technical Publishing Co.	61
Radiobar Co. of America	57
Radio Corp. of America	32, 33
Radio Receptor Co., Inc.	62
Radio Service Institute	51
Radiotechnic Laboratory, The	47
Radolek Co.	56
Raytheon Production Corp.	35
RCA Mfg. Co., RCA-Victor Div.	2
Recording Equipment Mfg. Co.	40
Rider, John F.	36
Silver Corp., McMurdo	58
Simplex Radio Co.	1
Solar Mfg. Corp.	64
Sprague Products Co.	47
Supreme Instruments Corp.	28
Triad Mfg. Co., Inc.	47
Triplett Elec. Instrument Co.	49
Tung-Sol Lamp Works, Inc.	53
Utah Radio Products Co.	50
Ward Leonard Elec. Co.	61
Ward Products Corp.	53
Webster-Chicago	50
Wedge Mfg. Co.	42
Weston Elec. Instrument Corp.	39
White Dental Mfg. S. S.	40
Wincharger Corp.	3
Wright-DeCoster, Inc.	58

While every precaution is taken to insure accuracy, we cannot guarantee against the possibility of an occasional change or omission in the preparation of this index.

RADIO & TELEVISION



AUTOMATIC CHANGERS Will Sell More of Your RADIO-PHONOGRAPHS

Moderate in cost, completely assembled units, easy and inexpensive to install. Silent, smooth-running, dependable two-speed motor with turntable; instantly adjustable for 33 1/3 or 78 r.p.m. Newest flat-type, flexible, balanced pickup. Simple, accurate and reliable changer mechanism. Precision-built throughout. Compact, efficient, and durable.

ORDER TEST SAMPLES

Model "L", shown above, plays and changes EIGHT 10-in. or SEVEN 12-in. records. Model "K" plays and changes SEVEN 10-in. records; plays 12-in. records changed by hand. Order samples TODAY . . . and be sure to specify whether AC or DC, also exact voltage and frequency of current you use.

The GENERAL INDUSTRIES CO.

3738 TAYLOR STREET, ELYRIA, OHIO

Sample of TRUETONE needles FREE

How television will be introduced to American homes, much in the way radio broadcasting is now brought to American listeners, was outlined by David Sarnoff, president RCA, in a recent address. He said:

The benefits which have resulted from the industrial sponsorship of sound broadcasting indicate that major television programs will come from the same source. It requires little imagination to see the advertising opportunities of television. Broadcasting an actual likeness of a product, the visual demonstration of its uses, the added effectiveness of sight to sound in carrying messages to the human mind—these are only a few of the obvious applications of television to merchandising. Commercial announcement can be expanded through television to include demonstration and informational services that will be of value to the public as well as to the advertiser.

Broadcasting has won its high place in the United States because—unlike European listeners—American set owners receive their broadcasting services free. Despite the greater cost of television programs I believe that owners of television receivers in the United States will not be required to pay a fee for television programs. That is an aspect of the television problem in which the

advertising fraternity will doubtless cooperate in finding the commercial solution.

Whoever the sponsor may be, or whatever his interests or purposes, he will be under the compulsion to provide programs that will bring pleasure, enlightenment and service to the American public. That compulsion operates today and must continue to operate if we are to retain the American system of radio broadcasting. The public through its inalienable right to shut off the receiver or to turn the dial to another program, will continue to make the rules. In television as in sound broadcasting the owner of a set will always be able to shut it off. In other words the ultimate censorship of television, as well as of sound broadcasting, will remain between the thumb and forefinger of the individual American.

I know of no other great public service which enjoys such a wide measure of public confidence, even public affection. The importance of that trusteeship is enlarged with every extension of radio facilities. Television, facsimile, the vast potentialities of short-wave transmission and ultra-high frequencies—in brief, the whole fascinating future of radio—will ultimately be yours to use. They will represent a new challenge and a new responsibility.



Capacitors



WET
DRY
PAPER
MICA
TRIMMER

Reliable . . .
in every climate
throughout
the world



WHEN IN NEED OF
GOOD CONDENSERS—
SPECIFY THE BEST

Literature on request

SOLAR MFG. CORP.
599-601 Broadway
New York City



In Germany, television research has been directed toward brighter and brighter cathode-ray images, capable of optical re-projection.

THE ONLY AUTO RADIO WITH AFC



For the first time in radio history, you can sell auto radio with *AUTOMATIC FREQUENCY CONTROL*. It's a sales-clinching feature. Your prospects will appreciate its safe-driving advantage — eyes concentrated on the road — while AFC permits instantaneous tuning for perfect Focused Tone reception. This new, sensational G-E Auto Radio offers the most *dramatic, demonstrable, sales-getting* combination of sales features ever incorporated in auto radio. Three proven profit leaders complete the G-E Auto Radio line.

Ask your G-E Radio Distributor how you can shift your sales and profits into "high" with a G-E Auto Radio **MERCHANDISING PACKAGE**.

DELIVERIES COMMENCE FEBRUARY

MODEL FA-60

6 G-E Metal Tubes, plus synchronous-type vibrator (8-tube performance).
6½-inch Speaker.
Antenna Circuit-matching System.
4 Watts Output.

MODEL FA-80

AFC Control.
8 G-E Metal Tubes, plus synchronous-type vibrator (12-tube performance).
6½-inch Speaker.
Compensating AVC.
Antenna Circuit-matching System.
3-point Tone Control.
7 Watts Output.
Class "B" Amplification.

MODEL FA-61

6 G-E Metal Tubes, plus synchronous-type vibrator (8-tube performance).
6½-inch Speaker.
Antenna Circuit-matching System.
Tone Control.
4 Watts Output.

GENERAL ELECTRIC

AUTO RADIO

**HOLD
EVERYTHING!**



The NEW 1937

Motorola

WILL BE RELEASED SOON

DON'T BUY

UNTIL YOU'VE SEEN *and* HEARD IT

FEATURES

FEATURES

FEATURES

GALVIN MANUFACTURING CORPORATION • CHICAGO