

RADIO TODAY

1 Yearly

Caldwell-Clements Inc., 480 Lexington Ave.

New York City

What It Costs to Sell Radio at Retail

- stores that made profits
- average "expense ratios"
- lessons from failures

Check-List For Merchants

- look your business over
- see what your store needs

Fights and Radio

- effects on receiver sales
- tube and service pick-up

Sell Sets as "Furniture"

- feminine appeal of woods
- cabinetry and finish
- knowing "period stuff"

Servicing the New Lines

Merchandising "Sound"

Robinson-Patman Quandary

What the Manufacturers Offer

Oscillator Specifications

—At right . . . Analysis of 81 profitable radio businesses, showing percentages of sales receipts applicable to various expenses and to profit. See page 14.

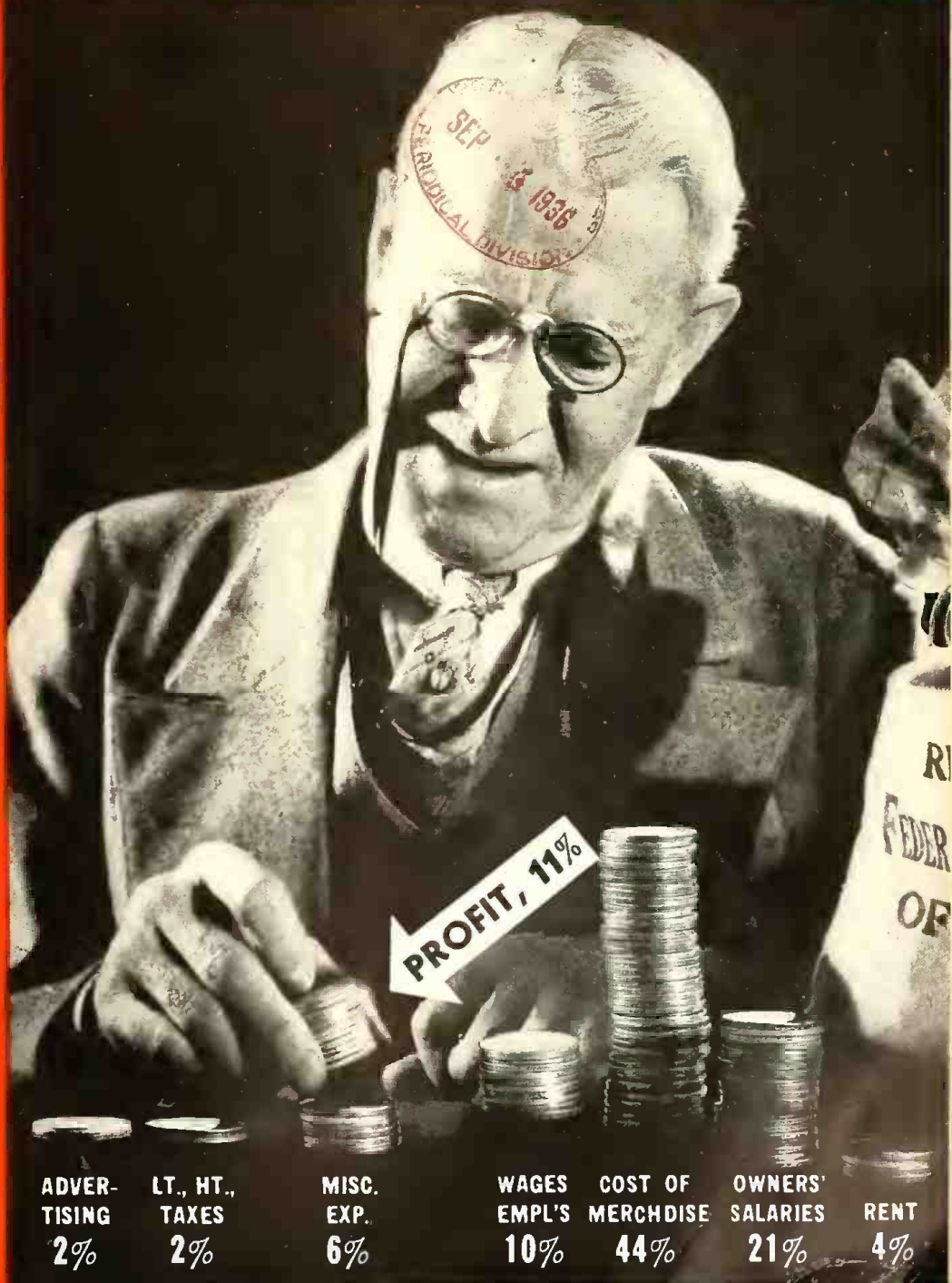

AUGUST
• 1936 •

ADVERTISING
2%

LT., HT., TAXES
2%

MISC. EXP.
6%

WAGES EMPL'S
10%

COST OF MERCHDISE
44%

OWNERS' SALARIES
21%

RENT
4%

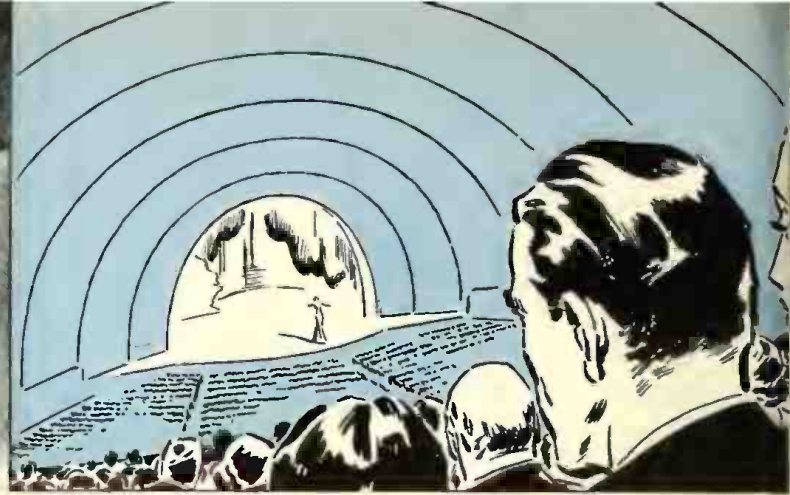

FIRST ROW ORCHESTRA

or last row balcony?

Ask your prospects where they'd rather sit to hear their favorite NBC network programs... it helps to sell the better sets!

The difference in reception between an average receiving set and a very good one is the same as the difference between a Row A orchestra seat, and one in the rear of the "peanut gallery." The gap is just that wide... the loss of pleasure as great.

Millions of listeners have a tremendous loyalty for certain all-star NBC network programs. Alert dealers have discovered this vital human interest... an interest which underlies all receiving set specifications, and colors the buying outlook.

That's why these dealers say, "Paul Whiteman, eh? Why, he gets my vote, too. But you ought to hear him on *this* model—there's no comparison. He's *twice* as good, if you can imagine such a thing!" Or it may be Jessica Dragonette... or Showboat... or Fred Allen.

NBC network programs are consistent winners of the nation's radio popularity polls, in all classifications. And this year's 10th Anniversary Program schedule far outstrips all others. Talk up these programs—make your prospects feel that such entertainment deserves the best possible sets they can afford. It pays off!

National Broadcasting Company, Inc.



A Radio Corporation of America Service

New York • Washington • Chicago • San Francisco

These Great Orchestra Leaders

PARADE ACROSS THE PAGES OF THE SATURDAY EVENING POST
TO SPEED YOUR "SUCCESS IN THE RADIO BUSINESS"



FRED WARING
CAB CALLOWAY



RUDY VALLEE
BEN BERNIE

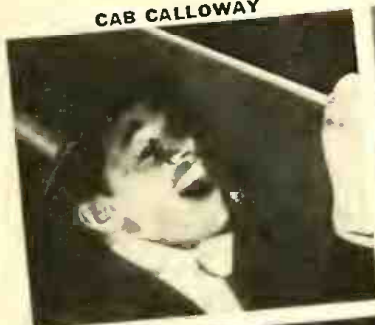

PAUL WHITEMAN
GUY LOMBARDO



ERNO RAPEE
FRANK BLACK



THE trade has already ordered over 4 times as many American-Bosch CentrO-matic Radio sets as a year ago. American-Bosch *must* have something worthy of your investigation.

It certainly has! . . . It has the "Automatic Maestro," latest and greatest radio engineering development. It has a market-measured line that embraces every price class. It has the exclusive band-stand baffle, over-size speakers, super-size black dials, woman-captivating cabinets, amazing prices—these and other selling advantages total 24 all-star features that are making American-Bosch CentrO-matic Radio the fastest moving line of the year.

And it has the year's outstanding promotions—both in point-of-sale and consumer advertising. National advertising stars great orchestra conductors, to emphasize the role of the "Automatic Maestro." Point-of-sale advertising features Paramount movie stars, living room backgrounds, challenging literature and the most beautiful, sales-compelling demonstration display stand in radio history.

American-Bosch is hitting a winning stride—in a big way. You can find greater success in the radio business with American-Bosch. Mail coupon below and learn why.

UNITED AMERICAN BOSCH CORP.
SPRINGFIELD, MASS. New York, Chicago, Detroit

American-Bosch Radio is licensed under patents and applications of R. C. A. and Hazeltine Corp.



UNITED AMERICAN BOSCH CORP.
SPRINGFIELD, MASS. Dept. RT-8

Please send copy of "Success in the Radio Business" containing complete information about the new American-Bosch line.

Name.....
Address.....

AMERICAN-BOSCH

'round

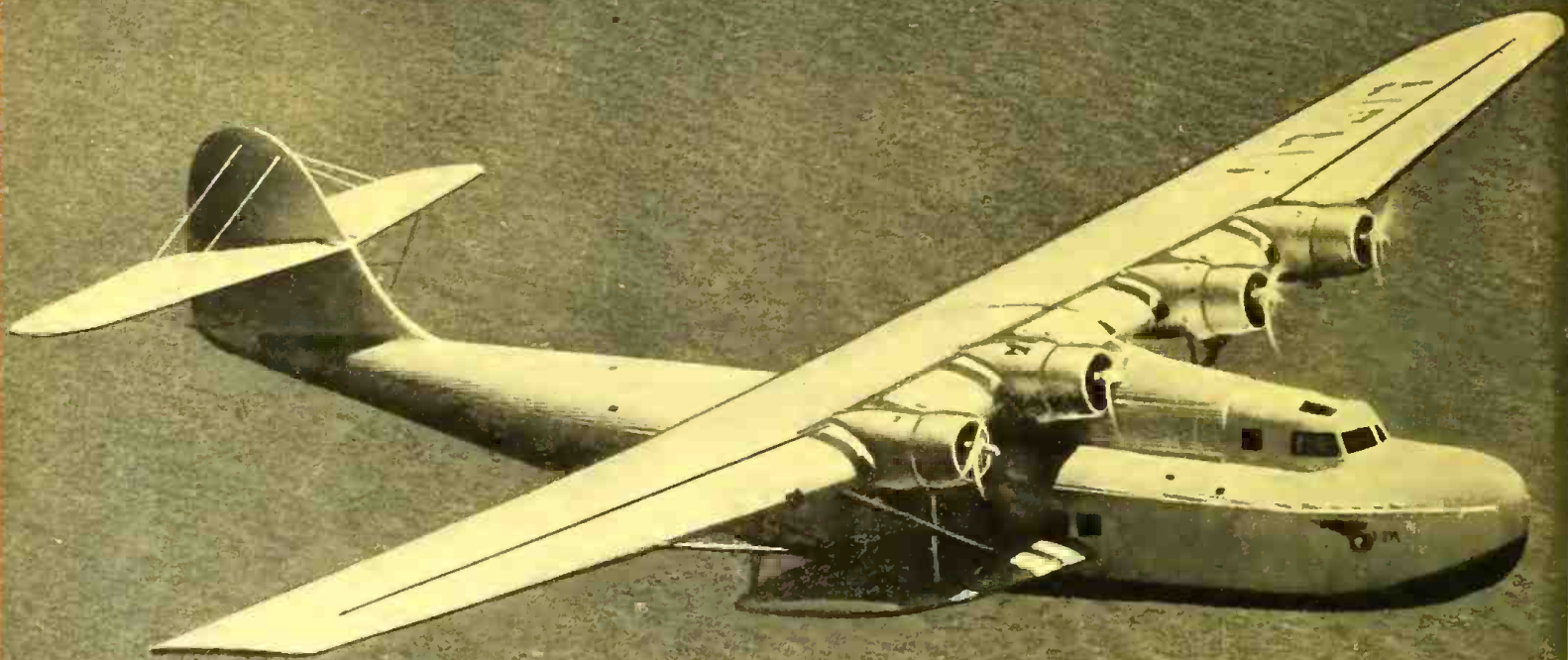

**SOUND
ENGINEERING**

Pan-American Airways...swift transportation system linking the United States with 33 foreign countries. Similarly, RCA Communications joins 32 large American cities and 47 nations with fast radiotelegraph service... Above is pictured the famous *China Clipper*, Pan-American Airway's mighty transpacific airliner, one of a fleet of new and super-powered sky giants.

RADIO CORPORATION OF A

EVERYTHING IN RADIO FOR SERVICE IN CO

the World by Radio

TWENTY-FOUR HOURS EACH DAY, the Radio Corporation of America, through RCA Communications, Inc., provides the world with dependable, efficient, economical domestic and international radiotelegraph service.

Messages sent "Via RCA" flash across nations with the speed of light, winging along invisibly over snow-capped mountain peaks, scorching deserts, mighty seas and sunken valleys, to swiftly bring together thousands separated by time, distance or raging elements.

The communications systems with which RCA achieves this far-flung service extend across thousands of miles, forming an invisible bridge between 32 important metropolitan centers in this country and 47 foreign lands. At Rocky Point, Long Island, RCA owns and operates Radio Central, world's largest and most powerful radio station. From this point and several others, domestic and transoceanic messages are shot into space. Next time *you* send a message *anywhere*—send it "Via RCA."

This, however, is but one of the RCA's radio services. This organization alone is engaged in *every* phase of radio. That's why the American public regards RCA as a house deserving of the utmost confidence. And because of this confidence, any product trademarked "RCA" sells well.

Hence, RCA dealers do a better business—enjoy finer profits. They are connected with Radio's Leader—the institution that has been *first* with radio's greatest *sound* achievements—the organization that some day will thrill the world with radio *sight*—RCA!

RCA MANUFACTURING CO., INC. • NATIONAL BROADCASTING CO., INC.
RCA COMMUNICATIONS, INC.
RADIOMARINE CORPORATION OF AMERICA • RCA INSTITUTES, INC.

Listen to "The Magic Key of RCA" on NBC Blue Network every Sunday, 2:00 to 3:00 P. M., E. D. S. T.

Covering the World "Via RCA"

RCA Communications, Inc., offers direct radiotelegraph service between:

32 AMERICAN CITIES

including

New York	New Orleans
Boston	Detroit
Philadelphia	Chicago
Camden	San Francisco
Baltimore	Los Angeles
Washington	Seattle

—plus efficient, fast transfer service to hundreds of communities

and

47 FOREIGN COUNTRIES

Argentina	Italy
Belgium	Japan
Brazil	Macao
Chile	("Via RCA" Manila)
China	Mexico
Colombia	Norway
Cuba	Panama
Curacao	Philippines
Czechoslovakia	Poland
Dominican Republic	Portugal
Dutch East Indies	Porto Rico
Dutch Guiana	Russia
Fiji Islands	Siam
("Via RCA" Honolulu)	("Via RCA" Manila)
France	Society Islands
French Indo-China	("Via RCA" Honolulu)
Germany	Syria
Great Britain	Sweden
Guatemala	Switzerland
Haiti	Spain
Hawaii	Turkey
Holland	Venezuela
Hong Kong ("Via RCA" Manila)	

—plus rapid transfer service to all other points in the world!

AMERICA • Radio City • NEW YORK
COMMUNICATIONS . . . BROADCASTING . . . RECEPTION



'round the World by Radio



**SOUND
ENGINEERING**

Pan-American Airways... swift transportation system linking the United States with 33 foreign countries. Similarly, RCA Communications joins 32 large American cities and 47 nations with fast radiotelegraph service... Above is pictured the famous *China Clipper*, Pan-American Airway's mighty transpacific airliner, one of a fleet of new and super-powered sky giants.

TWENTY-FOUR HOURS EACH DAY, the Radio Corporation of America, through RCA Communications, Inc., provides the world with dependable, efficient, economical domestic and international radiotelegraph service.

Messages sent "Via RCA" flash across nations with the speed of light, winging along invisibly over snow-capped mountain peaks, scorching deserts, mighty seas and sunken valleys, to swiftly bring together thousands separated by time, distance or raging elements.

The communications systems with which RCA achieves this far-flung service extend across thousands of miles, forming an invisible bridge between 32 important metropolitan centers in this country and 47 foreign lands. At Rocky Point, Long Island, RCA owns and operates Radio Central, world's largest and most powerful radio station. From this point and several others, domestic and transoceanic messages are shot into space. Next time you send a message *anywhere*—send it "Via RCA."

This, however, is but one of the RCA's radio services. This organization alone is engaged in *every* phase of radio. That's why the American public regards RCA as a house deserving of the utmost confidence. And because of this confidence, any product trademarked "RCA" sells well.

Hence, RCA dealers do a better business—enjoy finer profits. They are connected with Radio's Leader—the institution that has been *first* with radio's greatest *sound* achievements—the organization that some day will thrill the world with radio *sight*—RCA!

RCA MANUFACTURING CO., INC. • NATIONAL BROADCASTING CO., INC.
RCA COMMUNICATIONS, INC.
RADIOMARINE CORPORATION OF AMERICA • RCA INSTITUTES, INC.

Listen to "The Magic Key of RCA" on NBC Blue Network every Sunday, 2:00 to 3:00 P. M., E. D. S. T.

**Covering the World
"Via RCA"**

RCA Communications, Inc., offers direct radiotelegraph service between:

32 AMERICAN CITIES
including

New York	New Orleans
Boston	Detroit
Philadelphia	Chicago
Camden	San Francisco
Baltimore	Los Angeles
Washington	Seattle

—plus efficient, fast transfer service to hundreds of communities

and

47 FOREIGN COUNTRIES

Argentina	Italy
Belgium	Japan
Brazil	Macao
Chile	("Via RCA" Manila)
China	Mexico
Colombia	Norway
Cuba	Panama
Curaçao	Philippines
Czechoslovakia	Poland
Dominican Republic	Portugal
Dutch East Indies	Porto Rico
Dutch Guiana	Russia
Fiji Islands	Siam
("Via RCA" Honolulu)	("Via RCA" Manila)
France	Society Islands
French Indo-China	("Via RCA" Honolulu)
Germany	Syria
Great Britain	Sweden
Guatemala	Switzerland
Haiti	Spain
Hawaii	Turkey
Holland	Venezuela
Hong Kong ("Via RCA" Manila)	

—plus rapid transfer service to all other points in the world!

RADIO CORPORATION OF AMERICA • Radio City • NEW YORK
EVERYTHING IN RADIO FOR SERVICE IN COMMUNICATIONS... BROADCASTING... RECEPTION

HERE'S A PAIR TO THE BIGGEST SHOW

Grunow "TELEDIAL TWELVE"

All-Wave, All-World,
"Self-Tuning" 12-tube set
with Metal tubes and "Violin-Shape" Cabinet

\$99.95



THERE is no precedent in the radio industry for this announcement. No manufacturer of radio sets ever before has announced a policy of concentrated mass production.

Ford did it in the automobile business. Now Grunow does it in radio!

Every item in the 1937 line of Grunow radios will be a price and quality LEADER.

The Grunow dealer will be enabled thereby to concentrate on a few fast-selling, strongly advertised sets.

Starting immediately, Grunow advertising spotlights attention both on TELEDIAL, the No. 1 radio sensation of the year—the new self-tuning radio that brings in 15 stations in 15 seconds, perfectly tuned; and on the new, patented "VIOLIN-SHAPED" cabinets which remove the last trace of cabinet resonance. The last word in All-Wave, All-World radios, plus TELEDIAL and "VIOLIN-SHAPED" cabinets!

And that's not all the story. Look at the prices. Low price levels never before reached in radio. TELEDIAL sets priced way down under conventional sets without TELEDIAL. Mail-order-chain, private brand competition stopped cold by the own kind of prices on more attractive and higher-quality products.

Backed by powerful promotion, Grunow will write radio history in 1937. Let us send you full details of this advanced step in radio merchandising. Write today.

And SHIRLEY TEMPLE

Shirley is the Grunow Teledial girl! At the same time you read this, the first ads in a smashing national magazine drive will appear directed to over 12 million homes—featuring the lovely little 20th Century-Fox star whose newest release is "The Poor Little Rich Girl." By special arrangement with the studio, a local tie promotion which will net hundreds of prospective customers available to all Grunow dealers, from your distributor.

OF TICKETS IN RADIO!

Grunow "ELEVEN"

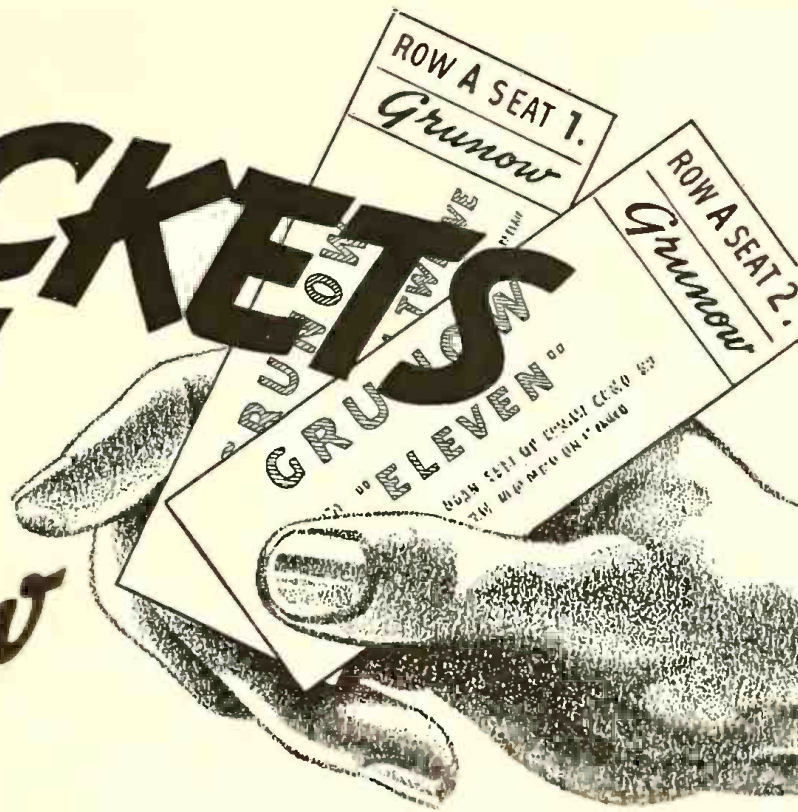

A quality, 11-tube set with
Metal tubes, "Violin-Shaped" Cabinet, and
11-Wave, All-World reception at the price of a "Six"

\$69⁹⁵

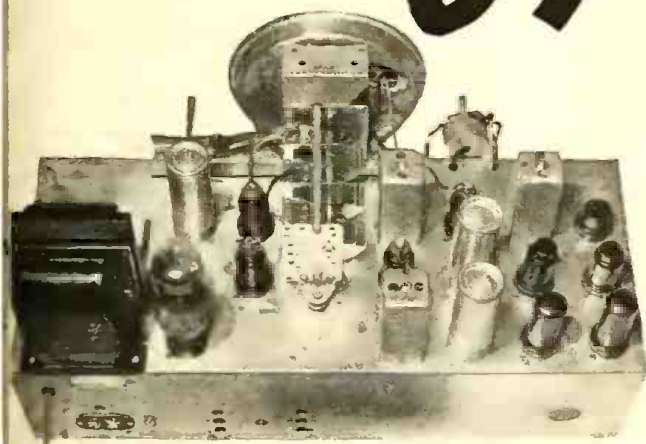

Look At This "GRUNOW ELEVEN" Chassis
This tells the quality story! The cleanest chassis
for service you've ever seen! Its size and metal
tubes are impressive selling features.



GENERAL HOUSEHOLD UTILITIES COMPANY
CHICAGO, ILLINOIS • MARION, INDIANA

Manufacturers of Grunow Super-Safe Carrene Refrigerator • Grunow Household Radios • Grunow Automobile Radios

HERE'S A PAIR TO THE BIGGEST SHOW

Grunow "TELEDIAL TWELVE"

All-Wave, All-World,
"Self-Tuning" 12-tube set
with Metal tubes and "Violin-Shape" Cabinet

\$99.95



THERE is no precedent in the radio industry for this announcement. No manufacturer of radio sets ever before has announced a policy of concentrated mass production.

Ford did it in the automobile business. Now Grunow does it in radio!

Every item in the 1937 line of Grunow radios will be a price and quality LEADER. The Grunow dealer will be enabled thereby to concentrate on a few fast-selling, strongly advertised sets.

Starting immediately, Grunow advertising spotlights attention both on TELEDIAL, the No. 1 radio sensation of the year—the new self-tuning radio that brings in 15 stations in 15 seconds, perfectly tuned; and on the new, patented "VIOLIN-SHAPED" cabinets which remove the last trace of cabinet resonance. The last word in All-Wave, All-World radios, plus TELEDIAL and "VIOLIN-SHAPED" cabinets!

And that's not all the story. Look at the prices. Low price levels never before reached in radio. TELEDIAL sets priced way down under conventional sets without TELEDIAL. Mail-order-chain, private-brand competition stopped cold by their own kind of prices on more attractive and higher-quality products.

Backed by powerful promotion, Grunow will write radio history in 1937. Let us send you full details of this advanced step in radio merchandising. Write today.

And SHIRLEY TEMPLE

Shirley is the Grunow Teledial girl! At the same time you read this, the first ads in a smashing national magazine drive will appear directed to over 12 million homes—featuring the lovely little 20th Century-Fox star whose newest release is "The Poor Little Rich Girl." By special arrangement with the studio, a local tie-up promotion which will net hundreds of prospects available to all Grunow dealers, from your distributor.

OF TICKETS IN RADIO!

Grunow "ELEVEN"

A quality, 11-tube set with Metal tubes, "Violin-Shaped" Cabinet, and All-Wave, All-World reception at the price of a "Six"

\$69.95



Look At This "GRUNOW ELEVEN" Chassis

This tells the quality story! The cleanest chassis for service you've ever seen! Its size and metal tubes are impressive selling features.

GENERAL HOUSEHOLD UTILITIES COMPANY
CHICAGO, ILLINOIS • MARION, INDIANA

Manufacturers of Grunow Super-Safe Carrene Refrigerator • Grunow Household Radios • Grunow Automobile Radios



THE SECOND "Big Parade" OF 1936 IS ON!

In Radio — As in Refrigeration — You'll Ride the Band-Wagon if You Ride with Stewart-Warner!

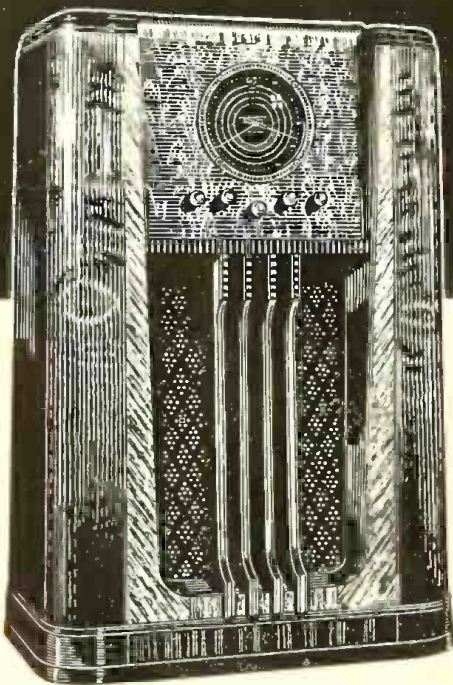

MASSIVE NEW COPPER PHOTO-TONE S P E A K E R

EVEN you hard-boiled radio dealers will cheer when you hear and see this great new Stewart-Warner line. What Stewart-Warner did in refrigeration—with the stand-out models of 1936 and a sales gain of 127% over the preceding season—Stewart-Warner has done again in both AC and farm radio. And smart dealers all over America have already told us they'll go to town with Stewart-Warner this fall.

That great new Copper PHOTO-TONE Speaker alone is enough to sell most prospects—because a brand new kind of construction sets a brand new standard of tone mellowness and perfection. But it's just one of the most impressive list of features we've ever wrapped up in one radio. These sets have everything!

And they—and you—are backed up with the most amazing finance plan the industry has ever seen—plus the most powerful merchandising in Stewart-Warner history. It includes everything from envelope stuffers to a national radio broadcast series featuring Horace Heidt and his popular Alemite Brigadiers. Get on the band wagon now! Your distributor has the whole story—and it's worth listening to.

Radio's Biggest Money's Worth! Here's "The Most of the Best" In Real Features — Real Enjoyment

- ★ TWIN Copper PHOTO-TONE Speakers
- ★ ELECTRON BEAM Power Amplifiers in Push-Pull with driver stage giving 20-watt undistorted output
- ★ SHADOW BEAM Tuner using new-type Cathode Ray Tube
- ★ 12-Tube Duo-Circuit FERRODYNE Chassis—19 tuned circuits
- ★ Huge 7-inch MAGIC DIAL with new Automatic Band Indicator
- ★ True ALL-WAVE, including Weather Band
- ★ New Trilinear AUTOMATIC VOLUME CONTROL
- ★ New 5-point TONE CONTROL giving both bass and treble control including true Hi-Fidelity
- ★ Independent SELECTIVITY CONTROL
- ★ Dual BASS COMPENSATION
- ★ Automatic Antenna Control
- ★ Antenna and Power Line Filters
- ★ Hand-rubbed CRAFT-BUILT Cabinets
- ★ And Many Other Improvements

STEWART-WARNER CORPORATION
CHICAGO, ILLINOIS



5-Metal-Tube Ferrodyne Receiver. Covers American Broadcasts and both Police Bands.

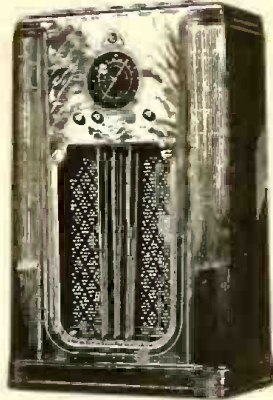

8-Tube All-Wave Ferrodyne Receiver with Shadow Beam Tuner and new PHOTO-TONE Speaker.

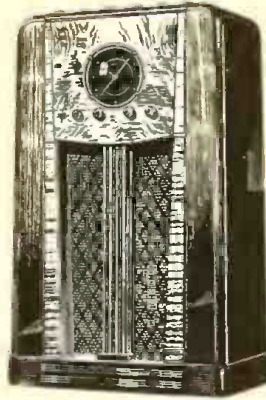

7-Metal-Tube All-Wave Ferrodyne Receiver with 12-inch Copper PHOTO-TONE Speaker.



6-Metal-Tube All-Wave Ferrodyne Receiver with new 6-inch Two-Ratio Magic Dial.



10-Tube All-Wave Ferrodyne. Electron Beam Amplifier. Shadow Beam Tuner. 12-inch Copper PHOTO-TONE Speaker.

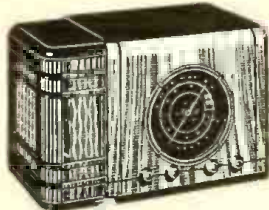

6-Tube Ferrodyne Receiver—with 3-band All-Wave Magic Dial and many other features

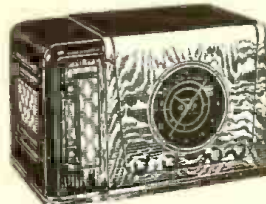

7-Tube All-Wave Ferrodyne Receiver, with all-metal tubes and big 6-inch Magic Dial.



● Massive new Copper PHOTO-TONE Speaker brings entirely new mellowness to radio tone.

NEW! AMAZING NON-RECOURSE FINANCE PLAN NOW READY!

You'll scoop competition plenty with Stewart-Warner's brand new finance plan! It's as far ahead of the field as Stewart-Warner's refrigerator finance plan was last spring! Non-recourse—100% advance—very low financing charge. Administered through all 144 C.I.T. offices. Ask nearest C.I.T. office or Stewart-Warner distributor for the complete details.

ON THE AIR for Stewart-Warner Radio!
Horace Heidt and his Alemite Brigadiers

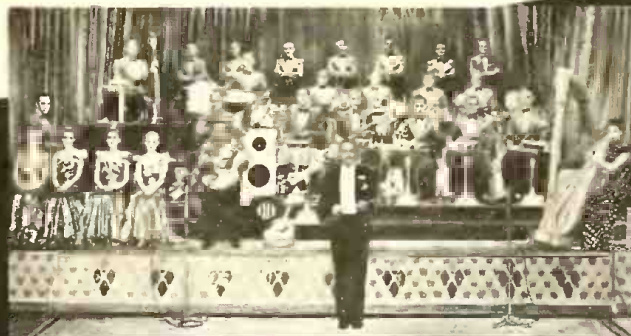

STEWART-WARNER

One
Million
Buyers

will "Look for
the Philco Dealer!"

Every Philco advertisement in the great national weekly and monthly magazines carries that message . . . "Look for the Philco Dealer!"

Millions read it . . . and heed it. And because they do . . . and will continue to do so with even greater interest this season . . . Philco is bending every effort to see that Philco dealers will have the million sets necessary to fill the orders of the million men and women who are

eagerly asking "How soon can you have my Philco installed?"

Remember . . . only Philco has the Spread-Band Dial with all important foreign stations named and located . . . plus *completely automatic tuning* of favorite American stations . . . plus the Philco *Foreign Tuning System!* That's why Philco is not talking in terms of "prospects." Philco is sending one million BUYERS to Philco dealers!

PHILCO RADIO & TELEVISION CORPORATION

Staff—

DARRELL BARTEE
RANDALL R. IRWIN
G. H. MAYORGA
M. H. NEWTON
B. V. SPINETTA
V. K. ULRICH

LEE ROBINSON
Sales Manager

RADIO TODAY

ORESTES H. CALDWELL
Editor

M. CLEMENTS
Publisher

480 Lexington Ave.
New York City
Tel. PLaza 3-1340

Vol. 11, No. 8

GENERAL MUSIC

★ Merry outlay of current business indexes indicates that general trade activity ranges boldly along high levels. Sunniest aspects of today's situation are (1) Building activity is running about 100 per cent above last year, (2) Second quarter net profits of over 200 companies were found to average 64 per cent above a year ago, (3) Employment and payroll reach new highs, (4) Stock market averages are the highest in over two years.

Less dazzling are the facts that the weather man has upset some crop outlooks; organized labor actions are pending. With these corrected, trade totals could sail to heaven.

UPSURGE IN BUYING POWER

★ After a statistical look-in on the affairs of 25 manufacturing industries, the National Industrial Conference Board reports cheerful gains in employment, hours worked, and money earnings during last June. Pipe the figures:

	Per Cent Gains Over a Year Ago
Hourly earnings	2.8
Average hours per week	8.9
Employment	7.4
Total man-hours	16.3
Payrolls	21.3

AND 90% HAVE RADIOS!

★ A large fact-finding organization recently completed a survey of 995,000 American homes, to study habits of living, ownership of homes and facilities, electrical devices in use, etc. Here are the figures from the final summary:

Own their own homes	47.0%
Own automobiles	49.6%
Have telephones	51.9%
Own vacuum cleaners	50.3%
Own electric washers	42.3%
Have savings accounts	41.3%
Have electric refrigerators	15.0%
Reached by newspapers	87.5%
Have radio sets	90.0%

BROADCASTERS' \$86,492,653 PAYROLL \$26,911,392

★ W. L. Austin, director of the U. S. Census, has just completed a survey of 1935 business done by the 561 commercial broadcasting stations and eight networks, showing total sales of \$86,492,653. Items are as follows:

Network advertisers	\$39,737,867
Spot advertisers	13,805,200
Local sponsors	26,074,476
Total sale of time	\$79,617,543
Sale of talent, etc.	6,875,110
	\$86,492,653

The total broadcasting payroll is reported as \$26,911,392, divided among 14,561 employees. Executives average \$96 per week; station artists \$41; technicians \$35; announcers \$29.

BUSINESS CYCLES, RADIO CYCLES

★ Old fans recall that in broadcasting's early years, 1921-22, cross-continent listening was easy. Later, about '27-'28, far-off stations were rarely heard. But in '32-'33 long-distance DX came in strong again. Now in 1936, the wall against DX is once more going up.

Curiously, this shift in listening conditions corresponds exactly with the solar cycle or change in the number of sunspots, as shown by accompanying curve.

When the "radio reflecting layer" 100 miles up is not disturbed by sunspot radiations or emanations, it forms a splendid mirror for distant signals. But then it also reflects transmitter sky-waves back down to nearby listeners (40 to 75 miles away), and these skywaves, coming in on top of the ground-waves cause distortion. So we have had "mushing" and fading, at those periods when DX is especially good.

Radio short-waves also show wide shifts in characteristics with the sunspot cycle. Weather, tree-growth, lake-levels, crops, animal life, all reveal similar cycles.

And the chart strikingly indicates that past business depressions ('29, '21, '07, '93, and '84) each followed within a year or so of a sunspot maximum. On the other hand minimums or bottoms on the sunspot curve have usually been harbingers of recovery or prosperity. See chart.

THE SUN, RADIO, AND BUSINESS

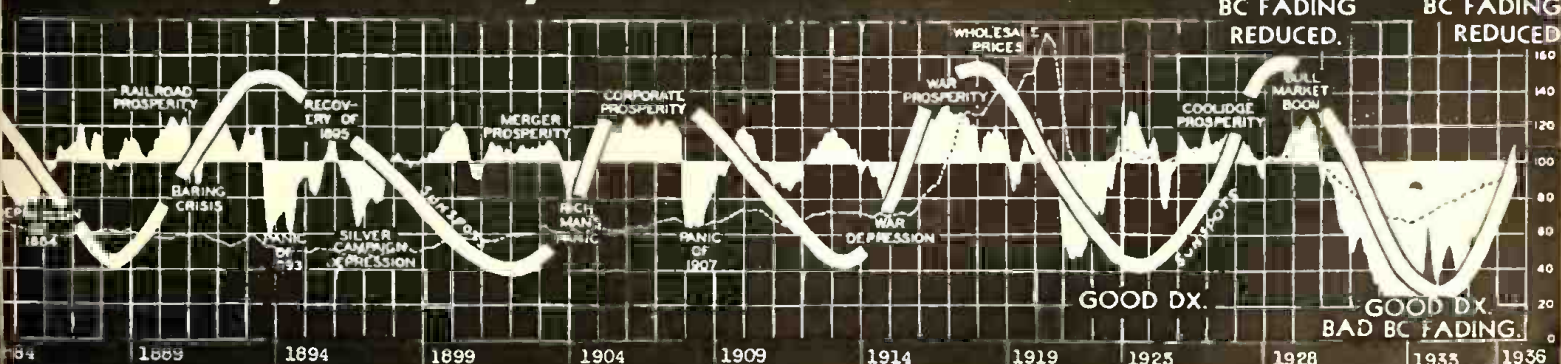



Commander E. F. McDonald, Zenith president, visits Carveth Wells, famous explorer and author, in the latter's auto trailer which, as you see, is radio-equipped. A "Hi-way Wincharger" takes power from the wind when the bus is rolling.

MUTER APPOINTS

★ President Muter of the Radio Manufacturers Association has confirmed a number of committee chairmanships, including some new names, for the coming year, as follows:

Credit Committee—Arthur Moss, New York.

Eastern—Ed Metzger, New York.
Western—P. C. Lenz, Chicago.

Engineering—W. R. G. Baker, Bridgeport.



A. D. Silva, for years Atwater Kent engineer, now joins Noblitt-Sparks on Arvin design.

Standards—Virgil Graham, Emporium, Pa.

Legislative—A. H. Gardner, Buffalo.

Membership—Paul V. Galvin, Chicago.

Eastern—N. P. Bloom, Louisville.

Western—Henry C. Forster, Chicago.

Traffic—J. C. Warner, Harrison, N. J.
Fair Trade Practice—E. F. McDonald, Jr., Chicago.

Television—J. M. Skinner, Philadelphia.

CONVENTION ON WHEELS

★ Something new in factory radio conventions was pulled by Art Haugh, Sparton sales manager, during his recent 30-day 7,000-mile dash through 21 states with the "Sparton Special," a Pullman equipped with his company's 1937 radios.

"We visited 29 cities," says Art. "Instead of trying to see an executive in his office, with his phone distracting his attention, we had him aboard the Pullman in comfort. He inspected the models at leisure, played each one, talked business, visited, and usually spent at least two hours aboard—instead of giving 15 or 20 interrupted minutes in his office. We also conducted school sessions to train local salesmen.

"I had a staff of nine. We took care of office routine, our own chef prepared lunches for our visitors, and we lived just about as we would at home and the office—except that we were traveling constantly, meeting new faces, learning new conditions in the field. We signed up some 1,500 new dealers, several distributors and took orders for nearly \$1,000,000 worth of new business."

DR. GOLDSMITH'S EARLY FLAT RECEIVER

★ The proposal of a "radio flat" on page 12 of April *RADIO TODAY*, attracted the interest of Dr. A. N. Goldsmith, well-known radio engineer, who tells us that in 1922 he applied for a patent on a flat receiver to be used as the lid of the phonograph in an early "combination." This patent, No. 1,721,151, was granted in July, 1929, and considerable quantities of these flat receivers were built by the Wireless Specialty Apparatus Company for RCA.

"It has been my belief for the last fifteen years that the flat receiver used in the lids of equipment, in doors, on walls, or in similar cases where area rather than thickness is available has a genuine place in the radio field," comments Dr. Goldsmith.

"I do not regard the flat receiver as a substitute for either the console or table models which, in many cases, can be at least as conveniently installed and used as could the flat receiver. There are, however, numerous instances where wall space or other unused areas are all that is available to the radio listener for the installation of his receiver. In these cases the flat receiver has a definite utility and should find a good public response."



Ira J. Owen, new president of Utah Radio Products, Chicago, and industrial counselor, who is author of the "Merchants Check List," page 19.

CONTINENTAL COUNT

★ The not-usually-so-busy International Broadcasting Office at Geneva, Switzerland, has gathered up the dope on the radio listening population of the world's several countries. Total world figure is 225,000,000 persons dialing 56,168,451 sets. Here's the radio set count for some chief countries (Denmark ranks eighth, but she has the greatest density of all—164.41 receivers per thousand Danes):

Great Britain	7,403,109
Germany	7,192,952
France	2,625,677
Holland	946,844
Sweden	834,143
Czechoslovakia	847,955
Belgium	746,395
Denmark	609,226
Austria	560,120
Italy	530,000
Poland	491,823
Switzerland	418,499
Hungary	352,907
Spain	303,983
Norway	191,378
Finland	144,721
Roumania	127,041
Yugoslavia	81,385
Latvia	82,175
Irish Free State	78,627
Algiers	41,344
Portugal	40,409
Danzig	29,000
Egypt	41,370
Lithuania	26,763
Morocco	23,079
Estonia	24,193
Luxembourg	15,000
Iceland	12,183
Bulgaria	17,213
Tunis	10,582
Turkey	6,175
Palestine	12,200
Greece	6,317
Syria	4,307

WHAT IN THE WORLD

★ Our fine-featured friends, the broadcasters, have made a costly pledge: to present to American radio listeners all of the unusual happenings abroad. NBC's schedule, for instance, calls for more than 500 foreign broadcasts during the current year, while last year this total was exactly 357. Major or minor mix-ups anywhere in the world are in store for American fans—sports, politics, special events—anything of genuine interest to the public, feature or fundamental.

Technique and skill involved in broadcasting the reports of the maiden voyage of the *Queen Mary*, not to mention the earlier airings from the Zeppelin *Hindenburg*, are stirring samples of how completely and expertly events are picked up for radio. Networks now have their representatives rushing all over the world in order not to miss anything that would intrigue the public. Due to the size and importance of the American radio audience, everybody cooperates with them, so that listeners may definitely count on a whole series of international thrills.



Furman Ferguson and Oliver Shaw of Charlotte, N. C., see happy days ahead as they chat with J. S. Knowlson, chairman of the Stewart-Warner board, and John Ditzell, radio sales manager.

RADIO SHOW BUZZ, NEW YORK, SEPT. 9-20

★ Exciting list of radio events is headed by the National Radio and Electrical Exposition at Grand Central Palace, New York City, Sept. 9 to 19. Giant group of exhibitors has been cooperating with the management in a special way, and Ralph Neumuller, key man of the Electrical Ass'n of N. Y., expects an event of unbeatable quality.

Exposition is scheduled "to tell the advance story of radio," and otherwise to feature lighting, refrigeration, heating, ranges, air conditioning, oil burners, laundry equipment, domestic and industrial appliances.

Plans for the 4th Annual Convention of the Institute of Radio Service Men at the Hotel Pennsylvania, New York City, Sept. 18-20, are advancing

with exceptional progress from headquarters at 510 N. Dearborn St., Chicago, presided over by Boss Hathaway.

RADIO REPORTER

★ Series of whiz gadgets recently installed at National Broadcasting Co. have given those studios a split-second method of handling news broadcasts. Onto the desk of the supervisor of announcers went some new mikes, an automatic volume control panel, various other instruments, so that he may "fade in" a hot news bulletin on the air any time.

Formerly, bulletins were dragged by messenger boys from the supervisor's office to the broadcast studio. Now, the chief announcer can broadcast the transcendent flashes within a few seconds after they are received.



Fred H. Wiebe, sales manager Brown Supply Co., St. Louis; Clyde E. Whitehill, director General Household Utilities Company; William C. Grunow, president of General Household, and W. C. Griffith, distributor, Indianapolis, Ind.

EASY-TO-SELL FEATURES

Squared off on this page, what we hear and are to hear among broadcast importants:

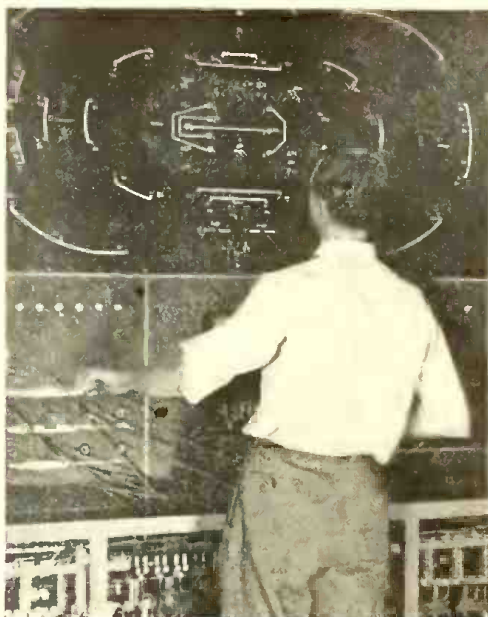

BERENICE ACKERMAN, directly above, a quality songstress on the Mutual network.

LOUISE MASSEY, upper left, gifted trouper with *The Westerners*, re-featured on NBC.

ELECTRIC MAP, middle left, whereby a German operator master-switched 100 field microphones, covering the Olympic Games, into 37 broadcast channels.

FRED ASTAIRE, bottom left, fleet-footed star to start a new series in September.

HOMER RODEHEAVER, directly below, leading a "community sing" broadcast on CBS; a likely trend in big-time programming.



PROFITS FROM FIGHTS

- radio sales, service follow the trail of the champs
- broadcast drag inspires more vigorous promotions

★ EXTRA crop of tough guys has battled its way into the champ class, and radio has learned to regard heavyweight boxing as a smash asset to all branches of the business.

Generally agreed it is that in point of tuned sets and listener interest, the prize fight shares honors only with major league baseball. National political events connected with the campaign mix-up draw millions of listeners, and the regular million-dollar broadcast features are a constant tonic, but for genuinely spectacular single draws, the ring's the thing.

Few types of broadcast features have received so much promotional attention from salesmen of tubes and sets, and from radio servicemen, as the leading boxing events of the past year. Rush of business, resulting from aired matches, has been so important that manufacturers, jobbers and dealers have begun to study its characteristics.

Out-and-out profit

Promotion plans can be based upon the assumption that as many as 40,000,000 listeners will tune in on a big fight. One fight sponsor (B. F. Goodrich Rubber Co. on NBC) counted on that many listeners two years ago, before popular interest in the champ situation zoomed to its present level.

Following the most recent big-time event, the researching Cooperative Analysis of Broadcasting issued the statement that "the radio audience reached record-breaking proportions . . . 57 per cent of the set owners interviewed reported hearing the fight." Same research revealed that 88 per cent of families who tuned in their sets at any time after 8 p.m. on the night of the match reported listening to the brawl.

Three weeks after this event, the sponsor had received more than 10,000 letters, cards and telegrams. Interesting angle, too, was that more than 10 per cent of these came from business execs and professional persons . . . the very type of listener who may be a good prospect for a new console.

Service and repair people have reported volume increases as high as

CASH IN — ON THE NEXT RING BATTLE

Use extra service calls to build prospect lists.

Dramatize the advantages of new models as fight bringers-in.

During post-fight service calls, pick up the names of non-radio-owners who had listened to your patrons' sets.

Plug the improved radio tube as a key to dependable reception of the match.

300 per cent during periods influenced by broadcasts of important matches. Merchandisers of new sets have reported boosts of 75 per cent and radio tube promoters declare that business is doubled during such periods.

Perhaps the most vital aspect of the whole matter is that since radio men contact millions of extra listeners during the hoopla of a broadcast from the ring, all of these contacts may be used as prospects for 1937 models. Amazing what the boxing business has done to build up the radio dealer's prospect lists.

Many smart merchants have seized this opportunity to put new sets out on trial; servicemen have deftly explained the reception advantages of modern receivers. Tube makers vir-

tually advertise their products as "tops item as a fight bringer-in."

Consistent characteristic of a radio fight audience is that several persons listen to one set. When fight sponsor, Buick Motor Car Co., looked over its "fan" response, it was discovered that 26 per cent of the communications were signed by more than one listener. The rest of Buick's report was: "Five or six signatures were not uncommon for a letter or card. One letter from Buffalo carried 100 signed names expressing appreciation for bringing the match to radio listeners."

Fact that people listen in groups certainly means one thing to the radio biz: the owner of the set is going to be darned sure that the receiver is in good condition. Reception failure at a dramatic moment could be intensely annoying to the owner-host surrounded by a group of guests. One unfortunate incident of this sort and several persons are likely to be prospects for a new set.

Coming events

At this point radio men may congratulate themselves that rarely has the heavyweight championship been such a disputed and widely discussed affair. Upsets are in order and unexpected batterings seem likely; Braddock will meet Schmeling in late September, but there is the popular feeling that there are fighters who can outstay either of them.

Neither Joe Louis nor Max Baer can be described as out of the running and Jack Sharkey has an important following. Meanwhile the radio dealer at last gets to the prospect who was never a good bet until this situation came along.

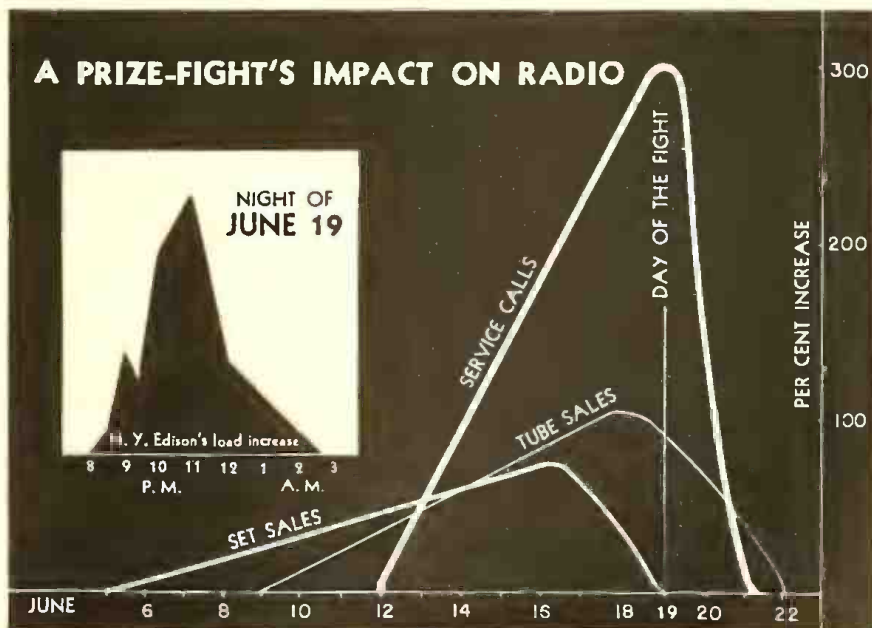

RADIO REPORTS THE "INSIDE"

Financial diaries of 131 representative U. S.

★ **TEMPERED** yardsticks, with which radio dealers may neatly determine the general nature of their chances for a profitable business, appear in important numbers in Dun & Bradstreet's 1936 Retail Survey.

An unbeatable analysis of the 1935 operations of 131 radio stores, with servicing or repairing, revealed that 81 of them were making a profit; these were scrutinized separately so

that differences in management and expense control could be accurately noted with a view of teaching a real lesson in store budgeting.

Aggregate net sales of all concerns involved added up to \$1,501,200, and the typical net sales figure among all radio dealers was found to be \$6,200. Interesting angle is that among those operating at a profit, the typical net sales figure was \$6,900.

What the radio seller needs to watch, if he wants to improve his prospects, shows up in the profit and loss statements listed in percentages of net sales for the year, under the dollar volume classification where his business happens to fall. To illustrate, if you are doing a yearly volume of under \$10,000, your total overhead expense should be around 46% of your net sales; if it is over that amount, the various expenses constituting your overhead costs will at least bear investigating. The whole story is in the table on this page.

HOW DO YOUR RATIOS STACK UP WITH THESE?

—All Concerns and Profitable Concerns—Typical Operating Ratios by Size of Concern—1935

FOR ANALYSIS OF STATEMENTS OF INDIVIDUAL CONCERNS

SIZE OF CONCERN (1935 Sales in Thousands of Dollars)	ALL CONCERNS				PROFITABLE CONCERNS			
	Under 10	10 to 20	20 to 30	30 & Over	Under 10	10 to 20	20 to 30	30 & Over
1 Number of Concerns Reporting	96	16	9	10	66	12	6	7

PROFIT AND LOSS STATEMENT (in Percentages of Net Sales):

2 Cost of Goods Sold	44.1	52.9	51.5	63.6	41.7	52.3	50.9	62.1
3 (a) Overhead Expense: Total	48.9	38.1	42.4	32.5	46.0	38.0	43.0	33.2
(b) Salaries of Owners and Officers	25.3	14.0	17.0	7.6	21.1	13.4	-	7.6
(c) Salaries and Wages of Employees	7.6	10.4	12.7	12.7	7.1	10.1	-	9.8
(d) Rent	4.8	3.5	4.4	2.1	4.6	3.6	-	1.7
(e) Advertising	1.7	1.4	1.9	2.0	1.8	1.4	-	1.8
(f) Light and Heat	1.8	1.1	0.8	0.6	1.8	0.8	-	0.5
(g) Taxes	0.5	0.4	0.6	0.4	0.6	0.3	-	0.4
(h) All Other Expense	7.2	7.3	5.0	7.2	9.1	8.6	-	11.4
4 Profit (or Loss)	7.0	9.0	5.1	4.0	12.3	9.7	6.1	4.7

MERCHANDISE RATIOS:

5 Gross Margin (Percent of Net Sales)	55.9	47.1	48.5	36.6	68.3	47.7	49.1	37.9
6 Realized Mark-up (Percent of Cost)	127.0	89.2	94.3	67.6	140.0	91.3	96.6	61.1
7 Inventory Turnover (Times per Year)	2.7	3.4	4.6	6.6	2.3	8.9	4.7	7.6
8 Ratio—Net Sales to Closing Inventory	6.3	9.7	7.6	10.3	6.0	9.7	7.6	12.0

OTHER INFORMATION:

9 Typical % Change in Sales 1934-35	+33.1	+9.2	+17.6	+20.3	+47.4	+8.6	+17.5	+26.7
-------------------------------------	-------	------	-------	-------	-------	------	-------	-------

Radio dealer's cue

Dun & Bradstreet's "typical" figures are medians, rather than averages, of the figures reported to them by the radio stores. Percentages from the various reports are arranged in order of their size and the one half way down the list is the median.

The dealer who reads the survey with a view of finding out how to budget a profitable business should, however, allow for conditions peculiar to his own business area. The research experts warn you: "A typical expense or merchandise ratio is a starting point for study, not a mold into which you should pour business."

Make allowances

Point is, if your rent is a larger-than-average percentage of net sales, it may mean that you're foolish on that score, or it may mean that what you are paying is justified by a selling location of extra advantages. In the latter case your costs may be considerably reduced in other ways, and you'd better stick.

In all tables presented on this and the following page. "All Other Expense" means such items as insurance, repairs, office supplies, etc. "Realized Mark-up" is the same as gross margin, but expressed in percentage of cost, rather than sales. "Inventory Turnover" means "Cost of Goods Sold" divided by the average of "Opening and Closing Inventories."

EXPENSES IN PERCENTAGES OF NET SALES

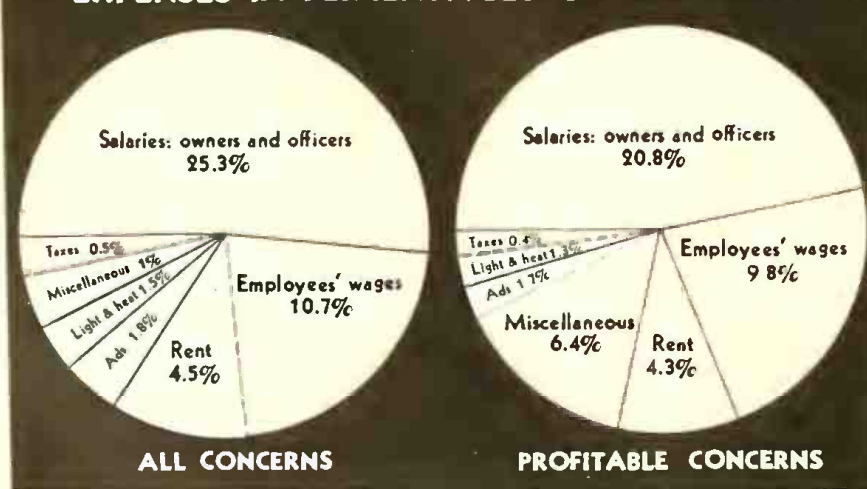

These are typical radio dealer experiences, charted from median figures.

ON RETAIL SELLING COSTS

radio dealers compiled by Dun & Bradstreet

Sharp reflections of radio trade conditions in various sections of the country are apparent in the "census area" table presented directly below. It will be noted that all regions are appropriately represented in the anal-

ysis of national trends. Regional figures on the operating ratios of the radio business must be considered in the light of geographic differences in wages and transportation costs. Some dealers of course operate in regions

far removed from radio production centers, or perhaps in areas where wage standards are influenced by local conditions of a peculiar nature. These will find their "Cost of Goods Sold" higher than the average.



HERE'S THE INFO ON RADIO SELLING, CUT BY ZONE LINES

		1 New England	2 Middle Atlantic	3 East North Central	4 West North Central	5 South Atlantic	6 East South Central	7 West South Central	8 Mountain	9 Pacific
1 All Concerns Reporting	(a) Number	11	22	30	20	11	(3)	(5) 9 *	(4)	(24) 28 *
	(b) Typical Net Sales	\$6,200	\$8,800	\$5,800	\$5,800	\$8,100		\$4,900		\$5,400

PROFIT AND LOSS STATEMENT (in Percentages of Net Sales):

2 Cost of Goods Sold	45.3	55.1	52.8	44.2	43.5	This Area	41.1	This Area	43.5
3 (a) Overhead Expense: Total	47.4	40.8	39.1	51.8	52.4	Combined	54.2	Combined	48.8
(b) Salaries of Owners and Officers	25.7	18.7	17.0	25.3	25.3	With	23.3	With	25.3
(c) Salaries and Wages of Employees	7.8	8.8	10.4	10.7	13.9	Column 7	11.7	Column 9	9.2
(d) Rent	4.6	5.0	4.5	4.4	3.2	West	4.1	Pacific	4.3
(e) Advertising	1.8	2.0	1.3	2.1	1.8	South	2.1	States	1.7
(f) Light and Heat	1.8	1.8	1.0	1.4	1.8	Central	2.5		1.7
(g) Taxes	0.5	0.3	0.5	0.4	0.9	States	0.5		0.7
(h) All Other Expense	5.8	8.2	4.4	7.5	5.5		9.9		3.9
4 Profit (or Loss)	6.3	3.3	6.3	4.0	4.0		4.7		9.7

MERCHANDISE RATIOS:

5 Gross Margin	53.7	43.9	47.4	55.8	55.4		58.9		55.5
7 Inventory Turnover (Times per Year)	2.0	4.2	3.5	3.0	3.5		4.9		3.8

OTHER INFORMATION:

9 Typical % Change in Sales 1934-35 (+ or -)	+3.6	+18.7	+28.8	+19.2	+20.3		+39.8		+26.7
11 Profitable Concerns, Percentage	(a) of Total Number	62	50	57	60	55		44	58
	(b) of Sales Volume	90	50	70	57	58		87	79

* This figure is the sum of the number of concerns in the combined areas. Number of concerns reporting from those several areas appear in parentheses in their proper columns.

Copyright, 1936, by Dun & Bradstreet, Inc.

—Summary of Typical Experience for 1935 FOR COMPARISON WITH OTHER TRADES

	All Concerns Reporting	Profitable Concerns
(a) Number of Concerns Reporting	28	11
(b) Aggregate Net Sales	\$ 1,007,200	\$ 350,800
(c) Typical Net Sales	\$ 15,600	\$ 15,500

MERCHANDISE RATIOS:

(a) Gross Margin (Percent of Net Sales)	35.4 %	42.2 %
Usual Range (b) Upper Limit	52.4 %	52.4 %
of Experience (c) Lower Limit	26.7 %	35.3 %
Realized Mark-up (Percent of Cost)	57.3 %	73.1 %
(a) Inventory Turnover (Times per Year)	4.0	3.7
Usual Range (b) Upper Limit	5.5	10.0
of Experience (c) Lower Limit	2.2	2.9
Ratio—Net Sales to Closing Inventory	7.2	10.3

OTHER INFORMATION:

Typical Percent Change:		
(a) in Sales 1934-1935 (+ or -)	+13.2 %	+13.2 %
(b) in Inventory during 1935 (+ or -)	+25.0 %	+45.0 %
Credit Policies:		
(a) Number of "Cash" Concerns (over 90% Cash)	1	0
(b) Number of Concerns Selling on Open Credit	20	9
(c) Their Typical Proportion of Credit Sales	25 %	40 %
(d) Number of Concerns Selling on Installment	21	7
(e) Their Typical Proportion of Installment Sales	45 %	50 %

And to complete the retail-costs picture, herewith Dun & Bradstreet's analysis of the 1935 operations of 28 refrigerator concerns. Less than half made a profit; see table at left.

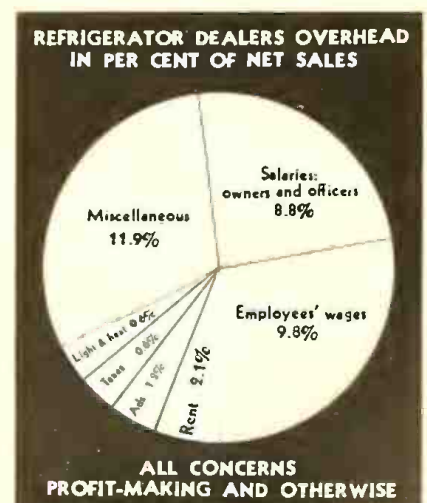

WHAT THE PUBLIC WANTS IN RECEIVERS

"Mind of the buyer" as revealed by answers to questionnaire

★ FOR several years leading automobile makers have carefully sounded out public tastes in car equipment, to learn what points particularly interest prospective buyers. Through questionnaires, the auto manufacturers have thus been able to get advance hints on effective sales arguments for themselves and for their dealers. Trends in public taste have been detected even before they fully crystallized.

The radio broadcasters have similarly watched public reaction to their programs, and have cooperated with women's clubs and women's committees in testing out individual family opinions as gathered by the women's organizations from all parts of the nation. Such samplings of listening tastes have resulted in important conclusions which have been applied in shaping program policies and in selecting talent.

Collect opinions

Why not apply the same kind of opinion-collecting machinery to get at what the public wants—or "thinks it wants"—in its radio receivers, asked Thomas R. Sterck, sales promotion manager, Westinghouse Radio, New York City.

So Mr. Sterck wrote out a set of questions. And with the cooperation of a national women's radio group representing women's organizations totalling 7,000,000 in membership, copies of this questionnaire were sent into 15,217 typical American homes.

Into 15,217 homes

A summary of the answers follows. From the replies it is apparent that the comments expressed represent the whole cross-section of American family life, and that the women who drew up the replies, consulted with husbands, sons and daughters in obtaining the answers to the questions asked.

One of the most important questions asked in the questionnaire was: "In your next radio, what type of cabinet would you prefer?" Various types of consoles, table models, furniture models and compacts were illustrated. The readers filled in their first, second and third choices.

While certain horizontal models of compacts drew a high vote, the console group polled 47% of the total vote of all types of cabinets.

Of the 12 radio-set models shown, 9 were voted on as follows:

- Highboy25%
- Armchair19%
- Large Conventional ...16%
- Horizontal16%
- Lowboy 6%
- End Table 6%
- Baby Grand 6%
- Secretary 3%
- Upright 3%

- Conventional SmallNo vote
- Modern Upright " "
- Modern Oval " "

Other questions follow, with summaries and the replies:

What type of wood finish do you prefer? Maple? Walnut? Mahogany? Other finish?

- Prefer Walnut60%
- " Mahogany22%
- " Maple16%
- " Other (Oak) ... 2%

100%

Would a radio cabinet designed as a definite piece of furniture appeal to you, if you could replace the radio mechanism in it from time to time as improvements were introduced?

70% Answered Yes.

Where would you locate an auxiliary set in your home?

- 74% Bedroom
- 13% Kitchen
- 9% Sun Porch
- 4% Outdoors

Should the tuning dial and control knobs be exposed or concealed?

60% prefer the dial and knobs exposed.

Would you prefer a radio with remote-control device?

77% prefer remote control.

In your next radio would the size of the speaker influence your purchase?

54% would not be influenced.

If so, what size speaker would you prefer?

- 30% prefer 10-inch speaker
- 26% " 14 " "
- 22% " 12 " "
- 13% " 6 " "
- 9% " 8 " "

Do you think more than one speaker is needed?

90% No

What tones do you prefer to have predominate? Bass notes? High notes?

MORNING STARS OF WESTERN FARM PROGRAM DEVELOP A DIAL DRAG



Stockyards at Kansas City can actually be filled, or emptied, by what market advice Phil Evans (left) and Tex Owens give on a.m. features.

50% Bass notes
50% High notes

How many radio tubes would you want in your next radio?

44% prefer 10 tubes
22% " 8 "
16% " 12 "
10% " 9 "
6% " 6 "
2% " 7 "

In your next radio set what additional features outside of regular broadcasting would you want to be able to listen to?

26% want Foreign broadcasts
24% " Complete around world
10% " Police
13% " Aircraft
5% " Amateur
9% " Weather
13% " Ship to Shore

In your next set which type of dial would you prefer? Airplane? Oval? Peep hole?

55% prefer Airplane Dial
32% " Peep hole Dial
13% " Oval Dial

In your next radio should the markings on the dial be large, medium or small?

58% prefer Medium Size Markings
42% " Large " "

In your next radio would you want a visual aid to tune in accurately?

88% Yes

In your next radio would an auxiliary pointer for more accurate tuning be desirable?

96% Yes

What do you think would be a fair price for the radio you have suggested?

Approximately 20% of those questioned indicated a preferred price.

These ranged from \$25 to \$200. However, the most popular prices were:

\$751st
\$1002nd
\$503rd

RADIO DATES AHEAD

National Radio and Electrical Exposition, New York... Sept. 9-19
IRSM Convention, New York, Sept. 18-20
Schmeling-Braddock Bout ...Sept. 24
President Roosevelt at World Power Conference, Washington, D. C., Sept. 11

WE PLAY AGAIN

★ Spectacular salesdrift in piano sales has been laid frankly and gratefully at radio's door. Sales are up 300 per cent during the past year over the figures for 1933, say the music trades execs in recent letters to National Broadcasting Co., and broadcasting is listed as "one of the major reasons."

More than once during the past decade the piano makers bit the dust; the debonair newcomer, radio, seemed to sweep the field. But the facts are that radio reached millions of new listeners, gave them a new interest in musical forms, moved them to participate. The piano is basic and its promoters gradually cashed in on the growth of musical culture, as did other instrument makers in their turn.

SOUND EFFECTS

★ Ray Kelley, who gets up artificial thunder and galloping horses and crackling fires for NBC, admits there are some sounds he cannot reproduce over the radio. . . . Such as (chuckles George Clark) the shake of a lamb's tail . . . or the clasp of a hand . . . or a girl powdering her nose. How about coming through the rye, Ray? . . . or three of a kind beating two pair . . . or ending up, quite appropriately, with holding one's tongue.

HURRY! FIREMAN!



In France, where the fire-laddies live in houses around town, short-wave radios spread the alarm. Radio set below tin-hat.

"VERITHIN" RECEIVER

★ Slender, circular, pin-up radio set has been designed by Nathan George Horwitt, long-time devotee to the "flat" style trend in radio design. Horwitt is Director of Plan at Design Engineers, Inc., New York City, and has applied for a patent on his "Verithin" innovation.

This discus-shaped model is dedicated to the contemporary tendency toward compact radios, to be suspended from walls, to be fitted into small corners, or to be built into walls. The trick design, as finally patented, will use 7 or more tubes, and will have a new dial screen upon which are projected station call letters; kilocycle markings are out.

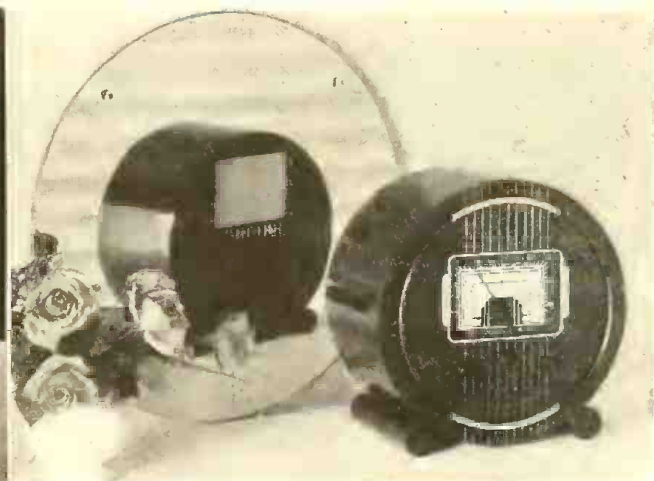
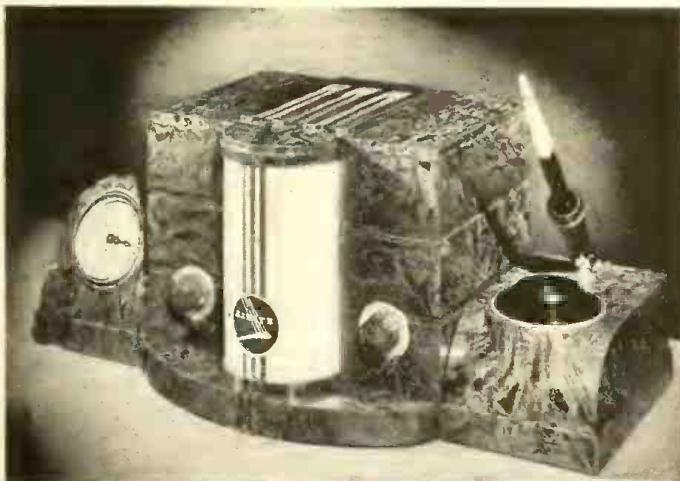

More novelties in radio-set design. Even the speakers find new positions—pointing upward or backward—in this (left) Airite Sengbusch combined desk radio-clock-inkstand and moulded of Bakelite, and (right) Wilcox-Gay boudoir receiver.

JOBBER'S JOB—TO TRAIN DEALER'S SALESMEN



Jobber-salesman peps up a dealer's crew (they listen at the left) with a fresh batch of sales ideas. Like these:

Salestip 1 (middle, left): Dealer learns the trick of dragging the whole prospect family in on the sale.

Salestip 2 (middle, right): Outside salesmen discover pleasant methods of using old patrons to find new.

Salestip 3 (bottom, left): Why customers walk out explained in terms of enlightened rules on interview control.

Salestip 4 (bottom, right): "Closing" methods worked out in detail to avoid last-minute failures to sell.



Photos from GE's talking slide-films produced by AudiVision, Inc.

RADIO MERCHANT'S CHECK-UP CHART

VERY GOOD—75-100
 GOOD.....60- 75
 RATING FAIR.....50- 60
 PCOR.....25- 50

FIRM NAME _____ CHECK MADE BY _____

ADDRESS _____ DATE _____

Item No.	ITEMS TO BE CHECKED Follow Instructions	Rating Per Cent	NOTES ON CHECK-UP Changes and Improvements To Be Made— Items to Be Watched	Date Finished	Item No.	ITEMS TO BE CHECKED Follow Instructions	Rating Per Cent	NOTES ON CHECK-UP Changes and Improvements To Be Made— Items to Be Watched	Date Finished
1	APPEARANCE Store Front Entrance Window Display Arrangement of Store Arrangement of Stock Fixtures				8	BUYING Purchased Last Month Purchased This Month			
2	CLEANLINESS Sidewalk Entrance Store				9	PRICE EFFICIENCY			
3	LIGHTING Store Front Windows Store				10	DELAYS In Ordering Goods In Filling Orders In Placing Goods on Display			
4	SIGNS Outside Inside				11	COMPLAINTS Quality of Goods Service Prices			
5	MERCHANDISE Quality Appearance Display Change in Displays				12	DELIVERY Cash and Carry Trucks Delays			
6	EMPLOYEES Appearance & Neatness Courtesy Interest and Loyalty Co-operation Salesmanship Attendance				13	ADVERTISING Local Papers Dodgers Window Store Signs			
7	INVENTORY Turnover Slow Moving Stock Sales Storage Dead Stock				14	TELEPHONE SERVICE			
					15	ACCOUNTING Accounts Receivable Accounts Payable Credits Collections This Month Collections Last Month Sales This Month Sales Last Month Overhead Expense Bills Mailed Out Mistakes			
						TOTAL			
						STORE RATING (Divide Total by 56)			

★ This chart can be used advantageously by any radio dealer who is willing to spend a little time now and then in checking up fundamental factors of his business. The success or failure of the chart is based solely upon the dealer's honesty with himself. If he will carefully check up each and every item in the fifteen divisions, without personal prejudice or bias, and investigate thoroughly the reasons for determining every percentage before he places it on the chart, he will have an accurate, vital analysis of his entire business.

However, the dealer should not be

satisfied with merely drawing up this chart for his own information and use; copies should also be given to the heads of the various departments whose activities include part of the check up. In turn these department heads should pass along the necessary information to the members of their departments pointing out wherever necessary how and why they have failed to measure up to the desired rating. If each and every individual member of the dealer's organization is kept in close touch with the percentages shown on the chart, there is no question but that this chart will

help to increase profits and materially stimulate personnel efficiency.

This chart was prepared by Ira J. Owen, for many years a well known administrative and industrial engineer, and now president of the Utah Radio Products Company, Chicago, Mr. Owen, over a period of years, made comprehensive merchandising and industrial surveys for some of the country's largest manufacturers, including Cutler-Hammer, Bissell Carpet Sweeper, Pepsodent, Federal Match Co., Western Electric and Universal Match Co.

RADIOS AS "FURNITURE"

— remember the feminine appeal of woods and cabinetry

— learn the selling lingo for standard period-art

★ "RADIO DEALER who is not using the 'furniture-interest' in his radio cabinets, to clinch sales, is overlooking a profitable sales-appeal," comments H. W. Frohne, famous merchandising authority in the furniture field. "Opportunity to use it is increasing, as women are becoming more and more important in the radio sales-picture."

A close analogy is to be found in the automobile industry, continues Mr. Frohne. The growing importance of the feminine style-appeal in motor cars was recognized a few years ago and ever since has been successfully used.

What women want to know

Experience shows that popular interest wanes, after a time, in products depending upon scientific invention. After the novelty of the invention has worn off and the products have reached a high state of mechanical perfection people show lessened interest in what makes the wheels go round. When that happens it becomes necessary to find a new sales-appeal.

This is the kind of questions women will ask about the furniture features of radios:

"Are your radios styled right and will they remain in style? Will they harmonize with my furniture? Are your radios sturdily built? Of what woods are they made? Is the finish lasting and easily kept in prime condition? Is the mechanism protected against dust?"

Talk cabinet woods

The dealer with the right answers to these and like questions pertaining to the style, materials and workmanship of radio cabinets is in a strong position to profit by popular interest in the furniture values residing in radio cabinets. By making intelligent use of the furniture-appeal, the dealer will clinch many a sale to women that might otherwise be lost.

The 1937 cabinets offer the informed dealer plenty of furniture selling-points. The manufacturers' printed announcements, unfortunately, have, so far, largely neglected the selling-value of the furniture-appeal in their cabinets. Most of them dismiss the subject with mere mention

of the finish-woods and the size of the cabinet. Instead, manufacturers could so effectively set the stage for the furniture-appeal by adding something like this to their printed announcements:

"These superb sound-reproducing instruments are fittingly encased in cabinets of correspondingly fine cabinetwork. Styled by the world's outstanding designers, these cabinets represent the same lasting qualities of style-rightness found only in the most worthy contemporary American furniture. Built by highly skilled craftsmen, of the finest cabinet woods and finished in rare, exotic figured veneers, these cabinets gracefully take their place beside other fine case-pieces in the home of discrimination."

"For the most part, the 1937 radio cabinets follow the most advanced ideas in modern styling. In line, form and finish, they have been conceived to harmonize with the formal European and American periods of furniture-art, as well as the contemporary modern mode. Most of them closely hug the floor, are streamlined, in graceful massing and delicate moulding, contrasting with richly figured plain surfaces. In their more pronounced modern form, they make chaste use of brilliant metal-inlaying, exotic marquetry and colorful enameling. Their richly-figured surfaces are transparently finished, in the current mode, to give the rare cabinet-woods full opportunity to display their ornamental richness.

Furniture styles

"Where models follow the more traditional styles, as in present-day furniture production, the later eighteenth century English Hepplewhite, Sheraton and Georgian design-types are adopted, occasionally the French Louis XVI, Regency and Napoleonic, and the American Duncan Phyffe."

To acquaint the radio dealer with some of the hidden constructional values of cabinets, so he may point these out to furniture-conscious prospects, simply drawn diagrams of jointing and veneering might be profitably incorporated in the radio manufacturer's printed trade and consumer announcements. Equipped with such practical supplemental information on cabinet-construction, the alert radio dealer should be able to formulate an effective sales-appeal along furniture lines, for use where the scientific merits of receiving-sets as sound-reproducing instruments, alone, may be insufficient to effect sales, or as clinchers to this and other sales-appeals now successfully used.



ZENITH
TRADE MARK REG.
LONG DISTANCE RADIO
TRADE MARK REG.

**America's
 Most
 Copied
 Radio**

-again a year ahead!

-with the biggest selling feature in years

THE ACOUSTIC ADAPTER

FITS THE RADIO TONE TO ANY ROOM SIZE

Going over big! That's the news we get from dealers and distributors everywhere on this remarkable new 1937 Zenith Super-Feature. By a simple adjustment that can be made either by dealer or customer, the instrument is balanced to provide the best tone quality for the particular room in which it is placed. So, through ACOUSTIC ADAPTATION, the same Zenith performs equally well whether it is in a spacious living room or a tiny bedroom—or anything in-between. Only Zenith has it, only Zenith dealers may sell it. It is one of the many ingenious new features found on the 1937 Zenith line. Investigate—see your Zenith distributor.



ZENITH MODEL 12-U-159

\$175.00

Prices slightly higher in West

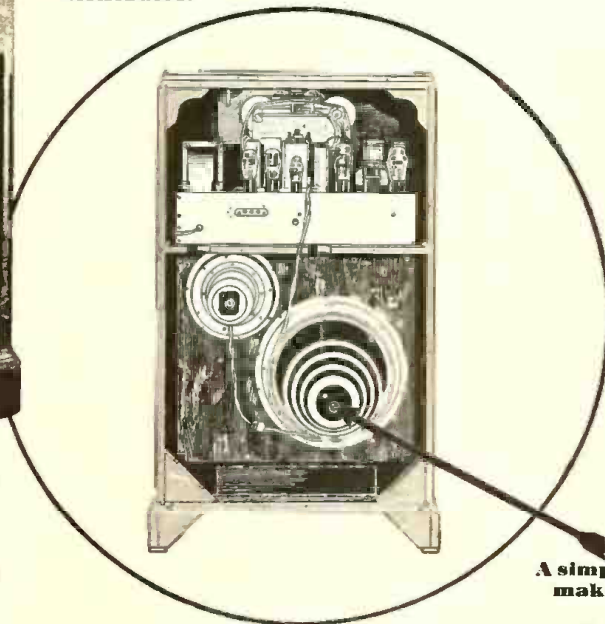

**A simple adjustment here
 makes Zenith superior**

**Exclusive features
 patented**

**ZENITH RADIO CORPORATION
 CHICAGO, ILLINOIS**

THRU THE LAB KEYHOLE

- television pictures shown in Philadelphia home
- Philco engineers transmit from 1-kw. station 7 miles
- experimental receivers deliver 345-line pictures

★ TELEVISION PICTURES of great clarity and brilliance—steady and absolutely unflecked by blemishes were transmitted to a Philadelphia home, 7 miles from the Philco television laboratories, August 11, for the inspection of a group of newspaper men.

In the studios different girls sang different types of songs in contrasting fashion, and the distant audience voted its choice. A boxing bout and a male quartet were also televised. Boake Carter addressed his fellow newspaper men on "The Freedom of the Air," and then, called by telephone, was interviewed by members of the audience, while the rest "looked on" on both sides of the conversation. A motion-picture film followed by television.

A 36-tube set

The experimental home television receivers used contain 36 tubes in all, and are of the cathode-ray type, with vertical cathode-tube viewed in a 45-deg. mirror. The three knobs for control of the 51-megacycle "picture" are grouped on one side of the console front; the three "sound" knobs on the other. The 51 mc. "picture"

and 54.25-mc. "sound" are tuned separately for flexibility, but single-knob control can easily be accomplished. So simple is the tuning, that inexperienced persons can quickly bring in good pictures. Once tuned and framed, the pictures were stable on the screen. In general, the new television receivers resemble ordinary large home consoles.

Sayre Ramsdell, Philco vice-president, presided at the tests, and with A. F. Murray, television engineer, issued detail specifications of the Philco television system, as follows:

Channel width	6 mc.
Spacing between television and sound carriers	3.25 mc. approx.
Polarity of transmission	Negative
Number of lines	345
Number of pictures per second	60 interlaced
Aspect ratio	4:3
Percentage of television signal devoted to synchronizing	20%
Synchronizing signal	Narrow vertical
Carrier frequency of picture transmitter	51 mc.
Carrier frequency of sound transmitter	54.25 mc.
Picture	7 in. by 9 1/4 in.
Color	Black & white

Larry Gubb, Philco president, commented that commercial television "will not come in 1936." Home receivers at the beginning may cost \$500, he estimated.



Sayre Ramsdell, Philco vice-president, who presided at Aug. 11 demonstration of television in the home.

J. M. Skinner, president Philadelphia Storage Battery Company and chairman of the RMA television committee, declared that to speed up commercial television, a patent pool should be set up something like that established in the automobile field. Under his plan each manufacturer would contribute his own patents to the pool, and would in turn get the use of the patents of others without cost, so that everyone would receive the benefit.

Television pool

Mr. Skinner commented on the need for television standardization, a continuous television band, and multiple television programs in the same area. In the proposed 42-90-megacycle band, most of the work so far has been done in the 42 mc. end, but very little at the 90 mc. end. If, however, the band assigned television by the FCC is not continuous, but is widely scattered, "you can kiss television goodbye for some time to come," in Mr. Skinner's words.

What the price of the initial television sets may be really doesn't matter, according to Mr. Skinner. Television will reach its own level of receiver costs and operating expense, and sets may range somewhere between \$250 to \$750, but the many factors of expense of programs, relay stations, coaxial cable links, etc., will all enter into the final problem of television costs.



Experimental home-television set by Philco, front and rear. Cathode-ray screen is viewed in 45-deg. mirror. Sound knobs on left, picture-control knobs on viewers' right. Pictures black-and-white, 345 lines, 6-mc channel.

3 to 1

**CONSUMER
PREFERENCE**
*for Fairbanks-Morse
Radio*

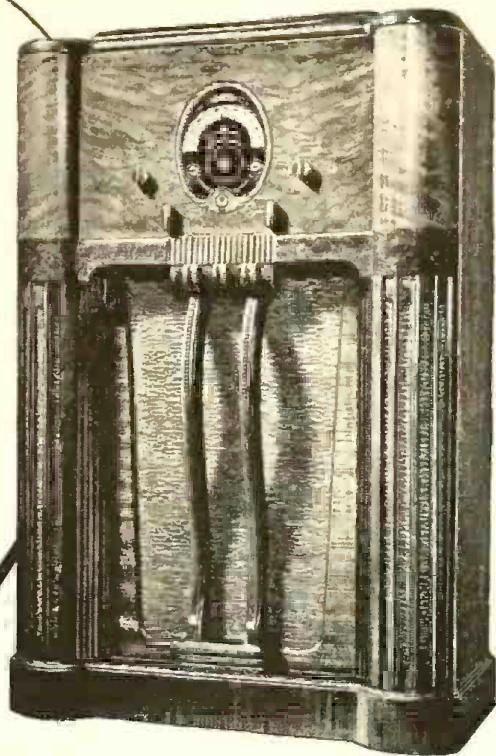

Masked demonstrations give F-M overwhelming majority over three other nationally known makes

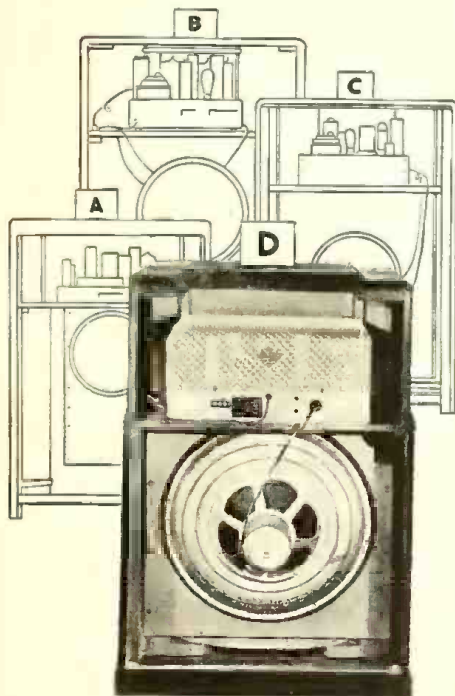

Recently 977 typical radio prospects were shown four radio sets. All were leading makes. All were covered with cloth, which left only the back of the cabinets exposed. All identification marks were removed. Only cards lettered "A," "B," "C," and "D" marked these four radios. Each one of the 977 persons, men and women, was asked:

If you were considering the purchase of a radio, which one of these radios would you investigate first?

Of the 977 persons interviewed, 658 or 67.35% expressed preference for Letter "D," the Fairbanks-Morse radio; 208 or 21.29% for make "A"; 56 or 5.73% for "B"; 55 or 5.63% for "C."

Why 3-to-1 preference for Fairbanks-Morse?

The answer is easy. The Fairbanks-Morse Turret Shield and Tone Projector are features which every person can see, feel, hear, and understand. Features that sell themselves.

Radio engineers conduct chassis per-

formance tests inside an ELECTRICALLY SHIELDED CAGE. The principle of the laboratory screen room is applied in the Fairbanks-Morse Turret Shielded Chassis, as the chassis also operates inside an electrically shielded cage. Noise and interference are screened out.

The Fairbanks-Morse Tone Projector is an enlarged cone, 22 inches in diameter, attached to the front of the speaker, making possible the largest baffle employed in any radio today. It projects and makes audible musical overtones ordinarily lost.

In addition to these two outstanding sales features and the exclusive Semaphore Dial, new Fairbanks-Morse radios contain 36 other features which add to salability.

What side of the 3-to-1 selling odds do you want to be on? Write for full information on the reasons for, and proof of, this 3-to-1 preference! Address your Fairbanks-Morse distributor or Fairbanks, Morse & Co., Home Appliance Division, 2060 Northwestern Ave., Indianapolis, Indiana.

FAIRBANKS MORSE
RADIOS 

RADIO'S PRICE PUZZLE

—mild cases of Robinson-Patman jitters
—experts speculate on practical effects

★ ONLY incidental squirming has been noted among price discriminators of the radio industry as a result of the enactment of the Robinson-Patman Anti-Price Discrimination Act, passed at the last session of Congress.

Radio execs divide their time between (1) muttering at their legal advisors, (2) eyeing the movements of the Federal Trade Commission, (3) waiting for a radio test in the courts, (4) wondering whether the next Congress will revise the law, and (5) speculating on what appropriation will be made by Congress for the enforcement of the law.

RADIO TODAY has actively interested itself in what the practical effect of the law will be within the next twelve months. Above some well-known names of the industry the editors have received spirited replies to that query, presented herewith.

Geddes speaks

From Bond Geddes, member of the Federal Bar, executive vice-president and general manager of the Radio Manufacturer's Association:

"You may quote me as stating that the new law presents some most complex merchandising problems, which will take months, if not years, to clarify. All RMA members were advised when the Robinson-Patman Bill was before Congress. They were sent copies of the new law and an analysis of the National Association of Manufacturers. Also our members have received a digest of the new law from the RMA counsel, Judge Van Allen of Buffalo. Executives of radio companies with their counsel are engaged in an exhaustive study of the new law.

"Today no company knows, without any doubt, whether it is operating in violation of the law or not. I am advised that the Federal Trade Commission will not issue any rules or regulations of general application but that it will administer it similarly to the original Clayton Act by rulings on cases as they arise under the Act. The Commission also will not give any informal opinions upon the legal status of matters presented on basis of hypothetical or ex parte statements of fact. In the months to come I believe that considerable changes in

radio merchandising and practices will result. I also venture the personal prediction that the Act will be revised by Congress and probably at the next session."

Neagle's views

From a statement prepared by F. E. Neagle, and approved by the Executive Committee of the National Electrical Manufacturer's Association, for distribution to all members of NEMA for their information and guidance:

"Business men must not believe that they can do nothing to bring their activities into line with the new law. That will, in time, certainly lead to trouble.

"It seems reasonable to conclude that each member of the industry should at once, if he has not done so already, present the facts of his business policies, in so far as they deal with questions arising under the Robinson-Patman Act, in as full detail as possible to his counsel so that he may obtain from him a definite and specific opinion on the facts as to the

application of the law to his business.

"The Federal Trade Commission cannot be looked to for advice on what the law means. Even were it the function of the Commission to give such advice it has been quoted as stating that it would not attempt to advise in specific cases as to the meaning of the law. Its interpretation will come only by way of cease and desist orders in specific cases and then its view is subject to the review of the courts.

"Views of lawyers as to the meaning of the Act differ. Unanimity of opinion as to the interpretation of the act does not exist. For that reason it is repeated that individual cases need individual advice based upon the specific state of facts that exists.

"There is no question that the enforcing agencies of the government are as much in the dark as business is. They are not supermen or gifted with clairvoyance. They must move slowly and cautiously and it is believed that they will. Business men should not rush headlong into new and untried ways of doing business. They too should move cautiously and carefully."

Neilson's angle

From Franz Neilson, prominent New York attorney, counsel to numerous electrical and other open-price trade associations:

"Notwithstanding the yearning of business men for advance advice and opinions from the Federal Trade Commission on operative policies of sellers and buyers under the act, that Commission, if it follows all past precedent, will *not* issue such advice and opinions. This for the very good reason that it could not undertake to examine in advance into the tens of thousands of situations all over the country. What it cannot do for all it cannot do for one. In the past it has said, in effect: "There is the law. Do not violate it. If complaints are filed with us against you for violation then and then only we appear in the picture. The only exception to our rule against taking any initiative being that under Sec. 2 (a) we may in due time and on our own prompting examine into the reasonableness of quantity differentials in given situations."

"Although organizations of wholesalers aided in getting the law across, they may well find themselves at a disadvantage, for there now appears no sound reason against big-scale retailers buying on the same discounts enjoyed by wholesalers buying in the same quantities."

MISCELLANEOUS MISCHIEF INSPIRED BY THE ROBINSON- PATMAN TUG-OF-LAW

1. Big concerns consider organizing branch houses, to bring their transactions within boundaries of a single state.
 2. Sellers try out methods of making contracts without naming quantities.
 3. Manufacturers consider new variety of private brands in order to offer buyers different specifications.
 4. Chain stores eye the possibilities of making their own products.
 5. Suppliers look into the question of making price agreements among themselves, within the provisions of anti-trust laws.
-

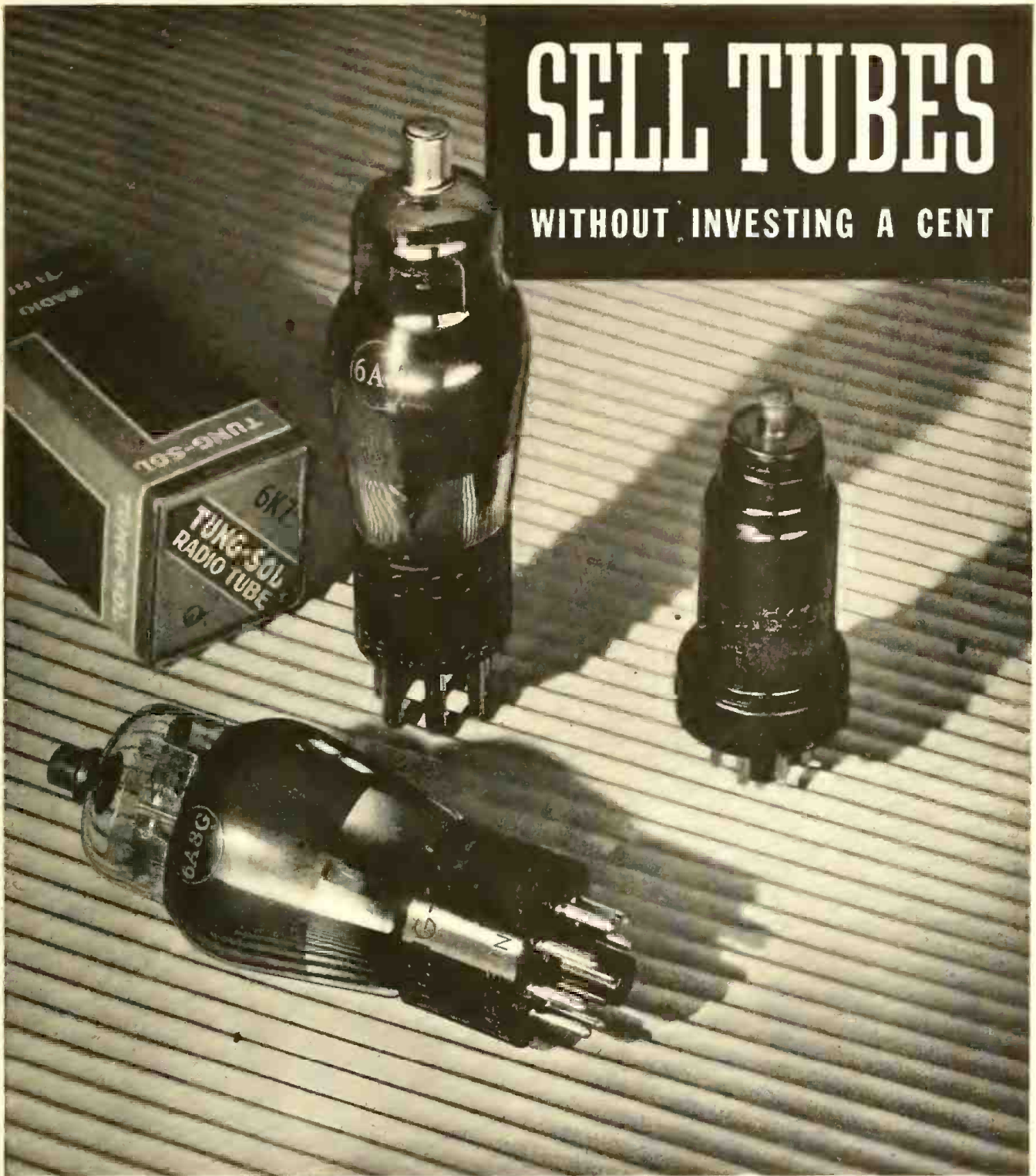

SELL TUBES

WITHOUT INVESTING A CENT

TUNG-SOL *Tone-flow radio Tubes*

TUNG-SOL LAMP WORKS, INC.
Radio Tube Division

SALES OFFICES: Atlanta, Boston, Charlotte, Chicago, Cleveland, Dallas, Detroit, Kansas City, Los Angeles, New York.
General Office: Newark, N. J.

Tubes must be made right in order to be sold successfully on such a basis. Tung-Sol tubes were the first and are today the only line sold nationally on consignment.

There are still desirable locations where independent service organizations who can meet requirements may be appointed as Tung-Sol agents. Ask your nearest Tung-Sol tube wholesaler who will supply details.

DEALERS SEIZE '37 SALES CHANCES

New lines inspire a smooth series of original selling devices

30% TO THE GOOD

★ Pictorial display of radio artists, both the entertainers and the announcers, has made a Philadelphia radio dealer's window a real magnet for radio prospects.

Dave Krantz, specializing in tubes and service, put his main appeal in the center of the window on a placard headed, "Don't Be Cheated Out of Your Favorite Radio Program." On one side was an attractive group of photos of radio stars, bunched around the sentiment, "On the Air Now—Your Favorite Radio Star." Other side showed a series of pictures of radio announcers, portraits of the best known ones.

Results are described by Mr. Krantz: "The first two weeks of this

display our business increase was approximately 30 per cent in sales of radio tubes and service. Our display has impressed people who we hope will be our future customers. I find that an average of eight out of ten people who pass our window stop and admire these photographs."

PATRONS BY THE HUNDRED

★ Jenson Bros., Terre Haute, Ind., are using a store-interest device which has results "that would surprise you." Plastered on a side wall is a long list of names of townspeople, conspicuous and easily readable. Just at present, the display is headed "Our First Hundred Norge Customers" and carries the names of 100 refrigerator buyers, but it may be changed

to other departments, and other hundreds of customers.

Other dealers have tried parading the names of their satisfied customers, but were faced with the problem of keeping the list up to date. Jenson's method of going at it by the hundred appears to be a solution.

GOOD-WILL METHOD

★ Radio dealers rarely put in display windows with no receivers in them, but Jack Talbot, Guthrie, Okla., does it under special circumstances and gets himself a nice reputation for being a town booster.

City of Guthrie celebrates annually a pioneer event for which the town is famous in the Southwest. Talbot cooperates with the city officials and works right in with their plans—puts in unusual windows, featuring the "early days" and does not include in the display a single electric appliance. "Welcome" sentiments are painted on the windows, and Guthrie folk get the idea that Jack Talbot's first thought is civic, rather than commercial.

Of course, the Talbot displays are faced with the usual house ads, and naturally the store's standing is boosted in the long run.

HERE THEY ARE!
ENOUGH MAJOR
LEAGUE BALL
GAMES TO ROCKET
RADIO SALES AND
SERVICE.

	CHI.	ST. L.	PHIL.	N. Y.	BOS.	DATE	DET.	CLEV.	WASH.	CINC.	PIT.	BRK.
AUGUST	Det.	Bos.	BRK.	PHI.	PHI.	AUG. 17			N. Y.	ST. L.	CHI.	
	Cle.	Det.	Bos.	BRK.	PHI.	18 19			N. Y.	ST. L.	CHI.	
	Cle.	Det.	Was.	BRK.	PHI.	20						
	CIN.	PIT.	Was.	Bos.	N. Y.	21 22 23	Chi.	St. L.				
	CIN.					24	Chi.					PHI.
	PHI.	Bos.	Chi.	St. L.	Det.	25 26 27			Cle.	N. Y.	BRK.	
	Bos.	PHI.	Cle.	Det.	St. L.	28 29			Chi.	BRK.	N. Y.	
	Bos.	BRK.	Det.	Chi.	Cle.	30 31			St. L.	PHI.	Bos.	
	N. Y.											
	SEPTEMBER	N. Y.	BRK.	Det.	Chi.	Cle.	SEPT. 1			St. L.	PHI.	Bos.
BRK.		N. Y.	St. L.	Cle.	Chi.	2 3			Det.	Bos.	PHI.	
Cle.						4			Phl.	ST. L.	CHI.	
Det2			BRK.	Bos.	PHI2	5 6	St. L.		Phl.	ST. L.	CHI.	
Bos.		PHI.	NY2	PHI2	BRK2	7		St. L2	Phl2	Bos2	STL2	
PHI.		CHI.	CIN.	CIN.	PIT.	9 10	Was.					PIT.
Was.		N. Y.	PIT.	ST. L.	CIN.	11 12	N. Y.					CHI.
N. Y.		Was.	ST. L.	CHI.		13 14	Bos.					CIN.
CHI.						15 16	Phl.					N. Y.
ST. L.		CHI.	Bos.	Was.	PHI.	17						CIN.
ST. L.	CHI.	Bos.	Was.	PHI.	18						CIN.	
ST. L.	CHI.	Bos.	Was.	PHI.	19 20	Cle.					N. Y.	
PIT.	CIN.	N. Y.	PHI.	BRK.	21			Chi.	Bos.		PHI.	
PIT.	CIN.	N. Y.	PHI.	N. Y.	22 23	St. L.					PHI.	
CIN.	CIN.	N. Y.	PHI.	N. Y.	24						PHI.	
St. L.	CHI.	Bos.	BRK.	PHI.	25						PHI.	
					26 27			Det.	N. Y.	PIT.		

Solid Type, National Light Type, American Large Dates, Sundays



Trigger broadcasts of baseball results suggest scores of dealer tie-ins.

DRAMATIC EXHIBIT

★ That the set salesmen will be greatly aided in his work on the sales floor if the receiver he is selling is "framed" by attractive decorative effects is the conclusion arrived at in the Kistler Electric Shop, Emporia, Kan.

Kistler uses lights, drapes, canopies, and the results are so encouraging that the fittings are being revamped for further use. Along the side of the shop are nine gilded canopies, each a separate unit, each containing a single console or two midgets. Belief is that in spite of the extra trouble, it actually pays to play three lights on each set. Bulbs are concealed so that the effect is theatrical, and rich drapes hang at the sides of each canopy. Whole series of arched units makes the store look impressive.

RCA VICTOR'S JULY SET SHIPMENTS

*More
Good
News!*

*3 times greater
than July last year*



Above—MAGIC VOICE Model 9K-2. Acoustically sealed tone chamber has been opened to show you the new tone control pipes reflected in mirror **\$129.95**

We told you that June shipments were greater than June, July and August last year. Now here's more good news

July shipments of RCA Victor 1937 radios were more than 3 times greater than those for the same month last year! In every American city, town and hamlet enthusiastic prospects are seeing—hearing—and BUYING these great radios!

And no wonder! For RCA Victor is offering sensational values—values that SELL! And prospects are turned into buyers through a widespread advertising campaign in four colors in the Saturday Evening Post and Collier's, as well as powerful advertising in many other national magazines. The Magic Key radio program . . . the vast array of sales helps supplied to dealers, all back this forceful campaign—and produce results!

Be sure *you* get your share of the business! Feature the MAGIC VOICE SERIES (from \$129.95 up) and the EXTRA VALUE SERIES of 28 sets under \$100. Push them for all they're worth—and they'll be worth plenty to you!

Right—New RCA Victor Table Model 5-X, 2-band AC or DC set. Domestic programs, short wave (49m), police, aviation, amateur calls. **\$32.95**
Also in porcelain white finish and in other handsome cabinets.



RCA Victor

RCA Manufacturing Co., Inc., Camden, N. J. • A service of the Radio Corporation of America

SELLING MORE DISCS

—record makers hike plugs 50%
—radio, movies offer more aid

★ WAX biz has developed itself some new grooves, in the midst of considerable chatter about "the record come-back."

News for dealers is that some of the leading recorders have come out with the statement that advertising appropriations for the current year will be 50 per cent over last season. This will add a wave of strength to the record dealer's merchandising efforts, a fine background for local campaigns to get the new recordings across to the public.

Another important development is the fact that popular music has taken on a great many new forms. Band leaders of the day have decided that they must have a distinct style of their own—they "ripple," they "swing" or get otherwise "hot" in some highly individualistic fashion.

Situation of this sort stimulates the collectors of records. Fans are likely to get interested in one of the instrumental styles and buy every record which comes under that head.

Hit parade

The broadcast features. "Your Hit Parade," have done a great deal to interest the public in success stories of current tunes. The stunt has interested thousands of persons in the popular ratings of hit songs; people



Benny Goodman, currently on Victor's No. 1 disc.

become favorite-conscious and sooner or later show up at the record shop to get the best sellers in wax.

Motion picture companies have been unconsciously plugging records in a big way. For their movie shorts, they feature record artists in one-reel pictures with a novelty slant—theatre fans get a sample of an artist's work and are not happy until they hear more of the favorite. They've learned to look for it on the record lists.

NEW GUIDE TO RECORDED MUSIC

★ An enormously interesting volume which is clearly a key book on "serious" recordings, has been published by The Gramophone Shop, 18 East 48th St., New York City, titled its "Encyclopedia of Recorded Music." Blue-bound volume has 547 pages, compiled by R. D. Darrell and with a forward by Lawrence Gilman, who refers to modern sound recorders as "miracle-workers."

Romantically readable for its smartly written notes on masters, this book is chiefly busy with a list of composers, presented with their available records. Aside from this exhaustive list, the volume includes sections on album sets, language study records, diction and literature recordings, national music and folk-songs.

More than 3 dozen foreign and domestic record brands and makes are found among the order numbers. A total of 681 composers are represented, all of them edited into the lists for other works than salon or "popular" compositions. Mild let-down comes, then, when the name of the white hot Negro jazzist, Duke Ellington, rates a column on such items as the "Birmingham Breakdown." Editorial explanations: "... the compiler would be stupid indeed arbitrarily to rule out a considerable number of works of this type . . . which reveal incomparable powers of rhapsodic melodic invention and an instinct for tonal nuances and orchestral ingenuities equal to the most brilliant flights of Rimsky-Korsakov's or Richard Strauss' imagination."

BEST SELLERS AS WE GO TO PRESS

BLUEBIRD

Do You or Don't You Love Me?—Fox trot. **On the Bench at Bali Bali**—Fox trot. Both with Shep Fields and his Rippling Rhythm—B6417.

You Started Me Dreaming—Fox trot. **Tormented**—Fox trot. Both with Wingy Mannone and his orchestra—B6359.

There's A Small Hotel—Fox trot. **On Your Toes**—Fox trot. Both with Bob Pope and his orchestra—B6453.

BRUNSWICK

There's a Small Hotel—Fox trot. VC by Maxine Grey. **It's Cotta Be Love**—Fox trot. VC by Skinny Ennis. Both from "On Your Toes," both with Hal Kemp and his orchestra—7634.

These Foolish Things Remind Me of You—Fox trot. VC by Marjory Logan. From the revue, "Spread It Abroad." **Take My Heart**—Fox trot. VC by Buddy Clark. Both with Nat Brandwynne and his Stork Club orchestra—7676.

Christopher Columbus—Fox trot. All My Life—Fox trot. VC by Ella Fitzgerald. From the Republic picture, "Laughing Irish Eyes." Both with Teddy Wilson and his orchestra—7640.

COLUMBIA

Red Rhythm—Fox trot. **St. Louis Wiggle Rhythm**—Fox trot. Both with Mills Blue Rhythm Band—3135D.

These Foolish Things Remind Me of You—Fox trot. Voc. Ref. with Carroll Gibbons and the Savoy Hotel Orpheans. **You Started Me Dreaming**—Fox trot. Voc. Ref. with Henry Hall and his orchestra—3136D.

Ride, Red, Ride—Fox trot. **Congo Caravan**—Fox trot. Both by Mills' Blue Rhythm Band, directed by Lucky Millinder—3087D.

DECCA

Christopher Columbus—Fox trot. **Froggy Bottom**—Fox trot. VC. Both with Andy Kirk and his 12 Clouds of Joy—729.

Until The Real Thing Comes Along—Fox trot. VC by Pha Terrell. **Waikiki and Swaglin'**—Fox trot. Both with Andy Kirk and his 12 Clouds of Joy—809.

On the Bench at Bali Bali—Fox trot. **I Met My Waterloo**—Fox trot. Both with Connie Boswell, both with Bob Crosby and his orchestra—829.

VICTOR

I've Found A New Baby—Fox trot. **Swingtime In The Rockies**—Fox trot. Both with Benny Goodman and his orchestra—25355.

When Did You Leave Heaven—Fox trot. **Sweet Misery of Love**—Fox trot. Both with Guy Lombardo and his Royal Canadians—25357.

It's a Sin to Tell a Lie—Fox trot. **Big Chief De Sotn**—Fox trot. Both with "Fats" Waller and his Rhythm—25342.

SMASH ALBUM

★ Arturo Toscanini, who is perhaps the most exquisitely careful conductor in the world, has recently consented to make recordings and the result is that Victor has a stunning Wagnerian album breaking all sales records for music dealers.

Toscanini has persistently declined to make records because he felt that his work was something less than perfect and therefore must not be perpetuated. Recently he was convinced, however, that his interpretations could be of great help to young musicians. So he made the already-famous Wagner album, which includes the *Siegfried Idyll*, Preludes to the first and third acts of *Lohengrin*, *Dawn and Siegfried's Rhine Journey* from *Gotterdammerung*.

Get in on the

Westinghouse landslide!

*the right models!
the right features!
the right prices!*



Sound business is like sound politics. You can't win without popular appeal.

A pre-season poll of thousands of prospective radio buyers has already given Westinghouse the popular vote. Based on a nation-wide survey, we *know* that this new line *has what the people want* . . . not just a single "appeal" . . . but all the worthwhile developments of radio science, built into a complete line of good-looking sets, priced at just the right level for profitable sales.

For complete information, call your nearest Westinghouse Radio Distributor or write Merchandising Headquarters, Westinghouse Radio, 150 Varick Street, New York.



CONSOLE, WR-314. Weather, Police, Foreign and Standard Bands, Precision Tuner, Precision Eye, Precision Hand, Spectrum Dial.



CONSOLE, WR-310. Standard and Police Bands.

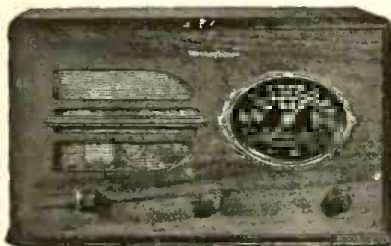

TABLE MODEL, WR-209. Standard and Police Bands, Spot-lite Tuning, Spectrum Dial.



TABLE MODEL, WR-102. AC-DC. Standard and Police Bands.



CONSOLE, WR-312. Standard, Foreign and Police Bands, Precision Tuner, Precision Eye and Spot-lite Tuning, Low Volume Bass Compensation.

FEATURE PLANKS in the WINNING Westinghouse PROFIT PLATFORM

- PRECISION TUNER
- PRECISION EYE
- PRECISION HAND
- ALL-METAL TUBES
- SPECTRUM DIAL
- SPOT-LITE TUNING
- STATION STABILIZER
- DUAL SELECTOR DRIVE
- AUDITORIUM SPEAKER
- PUSH-PULL OUTPUT
- LOW VOLUME
- BASS COMPENSATION
- THREE-POSITION
- BASS TONE CONTROL
- THREE-POSITION
- TREBLE TONE CONTROL
- HIGH FIDELITY CONTROL
- BEAM POWER AMPLIFIER

Westinghouse

Radio

MASSED EFFORT TO SELL RADIO

Set-makers come through with additional hundreds of flashy dealer-aids

★ **RESOURCEFUL** manufacturers, their books splashed with big advertising appropriations, their display artists working overtime, continue to tonic the industry with pointed promotional efforts.

Effect of this action reaches every unit of the trade, quickens the volume of dealer, distributor, serviceman alike. Details of the campaign, as undertaken by individual manufacturers, are at a premium because full knowledge of tie-in possibilities will, under current conditions, give the set retailer a powerful advantage.

Half a dozen big promotion campaigns from named manufacturers were outlined in **RADIO TODAY** for July; the vigorous drives of RCA, GE, American-Bosch, Zenith, Stromberg and Kadette made good news for dealers and distributors. Those campaigns were reported by the advertising specialists who framed them, and are followed herewith by similar news from other busy camps. General tone of all reports from big shot advertising managers continues with this issue to have a commanding quality from the standpoint of neatly merchandising 1937 receivers.

Fairbanks-Morse ready to aid dealers

Parker H. Ericksen is manager of radio sales for Fairbanks-Morse. Report from his direction:

"... a complete program of aggressive, helpful advertising and sales promotion has been launched. This program will include dominant magazine advertising in America's favorite popular magazines, backed by smashing direct-mail advertising, compelling display material, helpful sales manuals, distinctive newspaper advertising material, etc."

One of the featured FM window posters is a large three-color affair dramatically plugging the "Turret Shielded" radio. It shows a group of prospects admiring a model and invites passersby into the dealer's store for a demonstration. FM has also prepared a new envelope stuffer for dealer use.

Additional features of the FM campaign are listed by W. R. Ceperly,

company's advertising and sales promotion manager. FM has had 6 big mailings of broadsides to a group of 14,686 picked dealers; also among the dealer aids are a Jumbo Newspaper for consumer use, de luxe brochures, a console platform, neon signs in 3 sizes, special mailing pieces for battery lines.

FM also reports: "The first set of the window display service carries the headline 'Our Platform' and cashes in on the interest generated in connection with an election year. It carries the illustration of the donkey and the elephant, and the side card urges the prospect to look at the back of the set."

365 days picked for plugging

"No formula has yet been developed for determining when a radio prospect is ready to be transformed into an actual radio buyer. That's why Philco advertising is a year-round proposition, and that's why

Philco advertising uses all media at all times." In these words Ernest B. Loveman, advertising manager of the Philco Radio & Television Corporation, sums up Philco's advertising plans for the 1936-1937 season.

Following the policy which Philco has established over the years, the magazine schedule will continue on the twelve-months-a-year basis, without any reduction in what are ordinarily considered "slack seasons." Philco feels that there is no particular radio "season" and that it is just as important to keep its name and features before the prospective buyer in summer as in the pre-Christmas weeks. For this reason, Philco's national magazine schedule has no blank spots and Philco advertising continues without interruption every month in the year in the *Saturday Evening Post*, *Collier's*, *Liberty*, *Time*, *Cosmopolitan*, *American*, *Good Housekeeping*, *Red Book*, *True Story*, *News-Week* and *Etude*.

Philco's proud promotion

In broadcasting, a medium which has become increasingly important, as replacement sales have become by far radio's greatest market, Boake Carter will carry on for Philco five nights a week over key Columbia stations. At a time when politics and foreign affairs occupy so prominent a place in the public mind, Boake Carter enters his fourth consecutive year as Philco's editorialist of the air with a greater actual and a greater potential audience than he has ever before commanded.

While Philco magazine advertising would seem to provide more than adequate coverage in every city, town and hamlet, it will be supported by large-size weekly space in 200 newspapers throughout the country. In recent years, reports from impartial outside sources have shown that Philco newspaper advertising has totaled more than the rest of the industry combined, and Mr. Loveman feels this ratio will undoubtedly be maintained through 1937.

The farm market will also receive the same intensive cultivation Philco has given it in the past, with a co-

(Continued on page 32)



Movie star in cardboard is out to assist dealers with sales.

23 NEW MODELS



FROM A \$10 COMPACT TO THE FINEST CONSOLES



KADETTE 76—6 tube, AC-DC, TRF receiver at unusually low price. Standard broadcast and top police bands. 5" dynamic speaker, rich, full tones. Coils tropically impregnated. Selected American walnut veneer cabinet with unusual vertical grille. 9" high, 11 1/2" wide, 6" deep. Net weight 7 1/2 lbs. List.....\$14.95



KADETTE 86—A 6-tube AC-DC receiver. Standard broadcast. Amateur, airplane and all police bands. Illuminated and protected dial. Coils impregnated against moisture. Full 5" electro-dynamic speaker. Modern American walnut cabinet. Height 9 1/2", width 13", depth 6 3/4". Net weight 8 1/2 lbs. List.....\$22.50

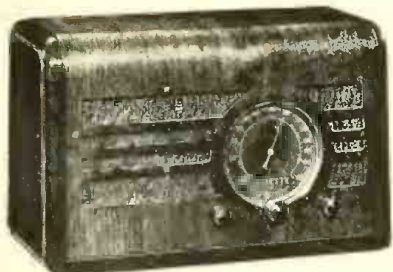

KADETTE 87—Powerful 7-tube World-Wide AC-DC Superheterodyne. Regular broadcast and American-Foreign short-wave bands. Automatic volume control. Coils tropically impregnated. 6" electro-dynamic speaker, powerful output, rich, glorious tone. Lay-down cabinet of American walnut. Height 10", width 16", depth 6 3/4". Net weight, 11 lbs. List.....\$29.95

A NEW \$10 LEADER



JEWEL Model 40—A new leader at a new low price—the original AC-DC compact greatly improved. By far the greatest radio value on the market. So small, so light (but 3 3/4 lbs.), yet giving wonderful performance with superb tone. List.....\$10.00

JEWEL Model 41—The same world famous original AC-DC compact in scratch-proof walnut Bakelite case. List.....\$11.50

JEWEL Model 43—Another of the improved line in ivory Plaskon case, with jewel-like grille. List.....\$12.50

JEWEL Model 44—Chinese red Plaskon case. Like all Jewel models it's but 5 1/2" high, 7 1/2" wide, and 3 1/4" deep.....\$12.50

KADETTE WILL AGAIN CHANGE THE RADIO TREND

This year we will place our entire merchandising efforts behind the "Kadette" name. Kadette will use both national magazines and large newspaper space this year. Individual mailing pieces, envelope stuffers, complete line folders, four color window displays, bright metal and enamel counter signs and display stands, etc., are now ready. Also effective dealer mailings, catalog pages, newspaper mats, selling portfolios, etc., for distributors.

There has been a constant strengthening of our distribution organization. Our organization has been active in eliminating unsound trade practices in the industry. These facts, coupled with a greater use of advertising during 1937, are Kadette's expression of confidence in the future of the radio business. Kadette invites aggressive merchants to join them in merchandising the best radio values of 1937 and pledges whole-hearted support in their endeavors.

If you want to be identified with the greatest radio values of 1937, if you believe in handling merchandise that is in advance of competition, if you want to sell radios that are styled for 1937 and carry a decided price advantage . . . you will write for full information immediately.



KADETTE 66X—6-tube AC-DC Superheterodyne. Standard broadcast, amateur, airplane and all police bands. 5" electro-dynamic speaker—full, glorious tone, high output. American walnut veneer cabinet. 9" high, 13 1/2" wide, 6" deep. Net weight 8 lbs. List.....\$19.95



KADETTE battery Model 400—Portable 4-tube Superheterodyne radio for farm homes, rural schools, boats, cottages, camps, house trailers and all unwired locations. Automatic volume control. Standard Broadcast and Short Wave. Uses 3 ordinary 1 1/2 volt No. 6 ignition cells (approximately 300 hours' service)—and 3 portable size "B" batteries. New Perm-O-Flux 6 3/4" dynamic speaker. Beautiful walnut cabinet. 16" long, 10 3/4" high, and 7" wide. Weight with batteries, 25 lbs. List.....\$29.95



BATTERY Model 500—five-tube 2 volt, battery-operated Superheterodyne. Comparable in sensitivity, volume and tone to higher priced electrically-operated sets. Standard broadcast and American-Foreign Short Wave. Automatic volume control. Coils tropically impregnated. 6 3/4" Perm-O-Flux permanent dynamic speaker. Space in cabinet for all batteries. American walnut veneer with butt walnut front panel. Height 11", width 24", depth 11 3/4". Net weight (less batteries), 15 1/2 lbs. List.....\$32.50

KADETTE

INTERNATIONAL RADIO CORPORATION, ANN ARBOR, MICH., U.S.A.

MILLIONS SPENT TO PROMOTE SALES

(Continued from page 30)

operative campaign in leading sectional and state farm papers stressing the features of Philco's extensive line of battery sets.

Backing up its dominating advertising campaigns, Philco has prepared and is supplying the most extensive and comprehensive variety of display material and dealer helps ever offered. Four thousand key dealers have already ordered the new permanent Philco floor display, one of the most elaborate and distinctive settings for the display of sets ever devised. Eight thousand dealers are buying the dealer kit service which provides new window display material monthly through the fall and winter. Strikingly effective outdoor and indoor neon signs are already brightening store-fronts and interiors, and are proving among the most popular display pieces ever offered radio dealers.

In addition to these more spectacular dealer helps, Philco will round out its advertising efforts with the advertising mat service to dealers which has proved so tremendously popular and effective. Orders for this service have already eclipsed all former years, and with the political campaign, sports events and special promotions planned for this fall, Philco dealer advertising seems destined to reach new heights in lineage and results.

One special promotion which is commanding special attention at this time is the new Election Edition of the Philco Political Radio Atlas, a book covering every angle of the Presidential campaign which is prov-

ing a great traffic-builder and sales-maker for Philco dealers.

Additional sales and advertising helps include 24-sheet outdoor posters, a variety of direct mail pieces and novelties, radio "logs," four-colored newspaper sections, rotogravure sections, consumer folders, radio guides, movie slides and many other effective sales aids.

Westinghouse says to win in a walk

After attracting considerable attention with some extensive pre-season poll-making on the matter of radio preferences, Westinghouse found its campaign stride and now the industry hears a lot of Tom Sterck, company's sales promotion manager.

Sterck's plans include "31,416,000 advertisements in leading national magazines," including *Time*, *The American*, *The Saturday Evening Post*, *Collier's*, and *The American Home*. A special series of newspaper ads has also been worked out.

Among the dealer helps offered by the company are "radio shorts" in the form of recordings, for use on the air as broadcast plugs; a de luxe batch of "sales literature" composed chiefly of folders and circulars; window streamers, specially-built window displays, talking slide films for store meetings, elaborate counter displays, and several illuminated exhibits for window and counter.

Fada has "streamline"

In a strong drive to make its new streamline radio a "buyword" with progressive dealers, Fada gets under



One-woman leg show designed to help dealers sell tubes.

way with J. M. Marks, general manager, spokesman:

"In our promotional and sales program we furnish dealers with large descriptive sales portfolios, authorized dealer signs in gold and black, large window cards in easel form, large and small window strips, handsome broadsides in colors, prepared advertising copy, mats of all sizes and description.

"In addition, we also are preparing special background displays for windows, counters and decorative use, and at different times of the season, special floor displays."

Mr. Marks further declares that Fada's advertising and promotional activities to the public will be given more accent as the company's sales volume continues to increase.

Sparton has special plans

From Sparks-Withington comes the assurance from advertising manager Guy C. Core that the company will have bigger and better plans as the year swings along; his statement continues, however:

"We shall have 32-page plastic-bound sales manuals 8½ x 11 for dealer use in the home. Also 16-page folders, a 12-page self-mailer, and a 28 x 42 broadside as well as illuminated world globes and many other premiums.

"A separate battery folder is likely and also another on our novelty models. We shall also have a series of from four to six window displays and two perhaps animated. Naturally radio set proof sheets as well as ad proof sheets, display cards, etc., will be available."



Catch-customer displays are ready for RCA dealers who need background pieces.

Up goes the Curve of
RAYTHEON
*profits to dealers and
service men!*



**THEY ARE REAPING
THE BENEFIT
OF RAYTHEON'S
LONG STANDING
PUBLIC ACCEPTANCE**

**The EASIEST TUBE to SELL
for REPLACEMENT**

Raytheon tube sales are climbing fast. No wonder! More radio manufacturers have equipped their sets with Raytheon Tubes than with any other. This makes it easy for dealers to make replacements with identical equipment.

More satisfied customers. More permanent profits!

Raytheon 4-pillar construction permits micro-accurate spacing of tube elements and holds them in permanent alignment. They are almost immune from rough handling.

Raytheon metal tubes are made with equally high standards of manufacturing and are easy to sell because Raytheon's acceptance is universal.

Write for franchise details and name of nearest distributor.

RAYTHEON PRODUCTION CORPORATION

All types of metal and glass tubes

420 Lexington Ave. . . . New York City 55 Chapel St. . . . Newton, Mass. 445 Lake Shore Drive . . . Chicago, Ill.
555 Howard St. . . . San Francisco, Col. 415 Peachtree St. N. E. . . . Atlanta, Ga.

"SOUND" TRENDS

- seasonal trix in sales and service
- development news in the P. A. field

THE "ELECTRIC BUTLER"

★ Novel feature of the Beaux Arts Ball held under auspices of Westchester Workshop, County Center, White Plains, N. Y., was an "electric butler" to announce the arrival of guests. This consists of a public-address system, so installed as to permit freedom of movement of the microphone through the foyer of the building. As guests arrived they were introduced over the "mike" which relayed the proceedings through powerful loudspeakers in the auditorium.

PAIN IN THE AVERAGE EAR

★ Merchandisers of sound equipment have found that owners and managers of any kind of race track are likely prospects for P. A. sales and service. It is often necessary to make announcements or to give instructions to the participants on any part of the track, and to make the amplification strong enough to be heard in the midst of a race.

Prize example of such installation is what Western Electric is doing with a job at the new Roosevelt Automobile Raceway at Mineola, Long Island, N. Y. Mounted on a steel tower will be 19 loudspeakers facing in all directions; estimates are that

WHERE TO SPOT PORTABLE OUTFITS IN VACATION TIME

Airports	Amusement Parks
Cabarets	Athletic Fields
Carnivals	Auction Rooms
Clubs	Basketball Courts
Conventions	Civic Centers
Exhibitions	Dance Halls
Factories	Department Stores
Fairs	Industrial Plants
Lodges	Outdoor Entertainments
Offices	Paging Systems
Auditoriums	Political Meetings
Chain Stores	Railroad Stations
Drug Stores	Steamship Piers
Gymnasiums	Swimming Pools
Restaurants	Tennis Courts
Ships	Weighing Stations
Stockyards	Window Demonstrations
	Retail Stores

the installation will produce a total sound of about 140 decibels. To listen to any sound over 130 decibels is actually painful to the average ear, and since the loudest man-made noise so far is in airplanes rated at 123 decibels (still only about one per cent of the new tower, in absolute power ratios) Western Electric will probably have the loudest device of any kind ever built by man.

IT SHAKES THE BONES IN THE HEAD!

★ Counts of the deafened, made by medical authorities, show that there are at least 5,000,000 persons completely lost to the talking-pictures because of inability to hear. Another 15,000,000 persons have impaired hearing.

To serve this great group, a number of leading sound-picture theatres are now installing outlets for "bone oscillators" which can be plugged in on the theatre sound circuits. The hard-of-hearing person applies to the box-office for a bone-oscillator, plugs in the contact at his seat, and then holds the lorgnette-like device against his skull just behind the ear. In this way the vibrations of speaker-diaphragm are impressed mechanically on the skull bones and transmitted directly to the inner ear. In a large percentage of the cases of deafness, the inner ear mechanism is not impaired, and vibrations brought in mechanically in this way, are heard as in normal hearing.

AUTO CO. PROSPECTS

★ Motor-car manufacturers have openly recognized the value of various types of sound equipment in several branches of vehicle manufacture.

Chevrolet equipped, at one time, over 300 new model sedans with special automatic sound system mobile units, through which to advertise the company's products. Several months later, Oldsmobile made a similar sweeping gesture. Nash has outlined for car dealers a special plan using sound in passenger cars.

Some auto makers have combined automatic record changers with car radios, in order to present sales talks on records. This stunt has the advantage of being heard by the prospect while he is inside the car.

REACHING THE MOB

★ Extraordinary method of covering "acres of spectators" was illustrated at the Olympic Stadium when German P. A. experts managed to reach all of 125,000 persons.

Dozens of "mushroom" speakers dotted the Stadium area. This huge sound system was fed by announcers operating anywhere on the grounds, using an ultra short wave transmitter of the knapsack type. Special master switchboard on the main system was necessary to plug in the short wave broadcasts from any section of the field.



"Sound" stunt of the year — moving short-wavers cover the Olympic Stadium in Berlin, their words picked up by a central receiver hooked to a huge network of "mushroom" amplifiers.

He's Your Prospect

- ... He is one of 6,000,000 Farmers who need radio—your greatest opportunity for sales and profit.
- ... He is one of the 5,158,000 Farmers reading about the sensational Sentinel 1937 Farm Radio in the leading farm papers.
- ... His neighbor owns one of the hundreds of thousands of Sentinel Farm Radios now in service.
- ... His family has heard the marvelous tone quality of Sentinel's new Dynamic Speaker—has admired the beauty of the superb Sentinel cabinets.
- ... His son wants to tune in European stations on the distinctive Sentinel Dial.
- ... He is thrifty and Sentinel's tremendous value and low prices appeal to him.
- ... He knows the Sentinel line is complete—that there is a Sentinel Radio to suit his requirements whatever they are.

He's "Sentinel Minded!"



SELL THIS MAN!
 He knows this Pioneer Farm Radio! He can't resist the amazing performance, the beauty of this sensational many-featured, low-priced but high quality 1937 Sentinel Line. It's the surest, soundest road to substantial dealer profits. Write today for full details of the new Sentinel Farm Radio and the Sentinel Sales Program for 1937.

- 2, 6 and 32 Volt Models
- Prices start as low as \$29.95 complete with batteries
- New Permanent Magnet Dynamic Speakers
- Tel-Eye Tuning
- New Consolette Cabinet
- Foreign Reception
- Attractive modern cabinets
- Distinctive New Oval Multi-colored Dial
- FarmPowr Gas Engine Generator and Wincharger Deal

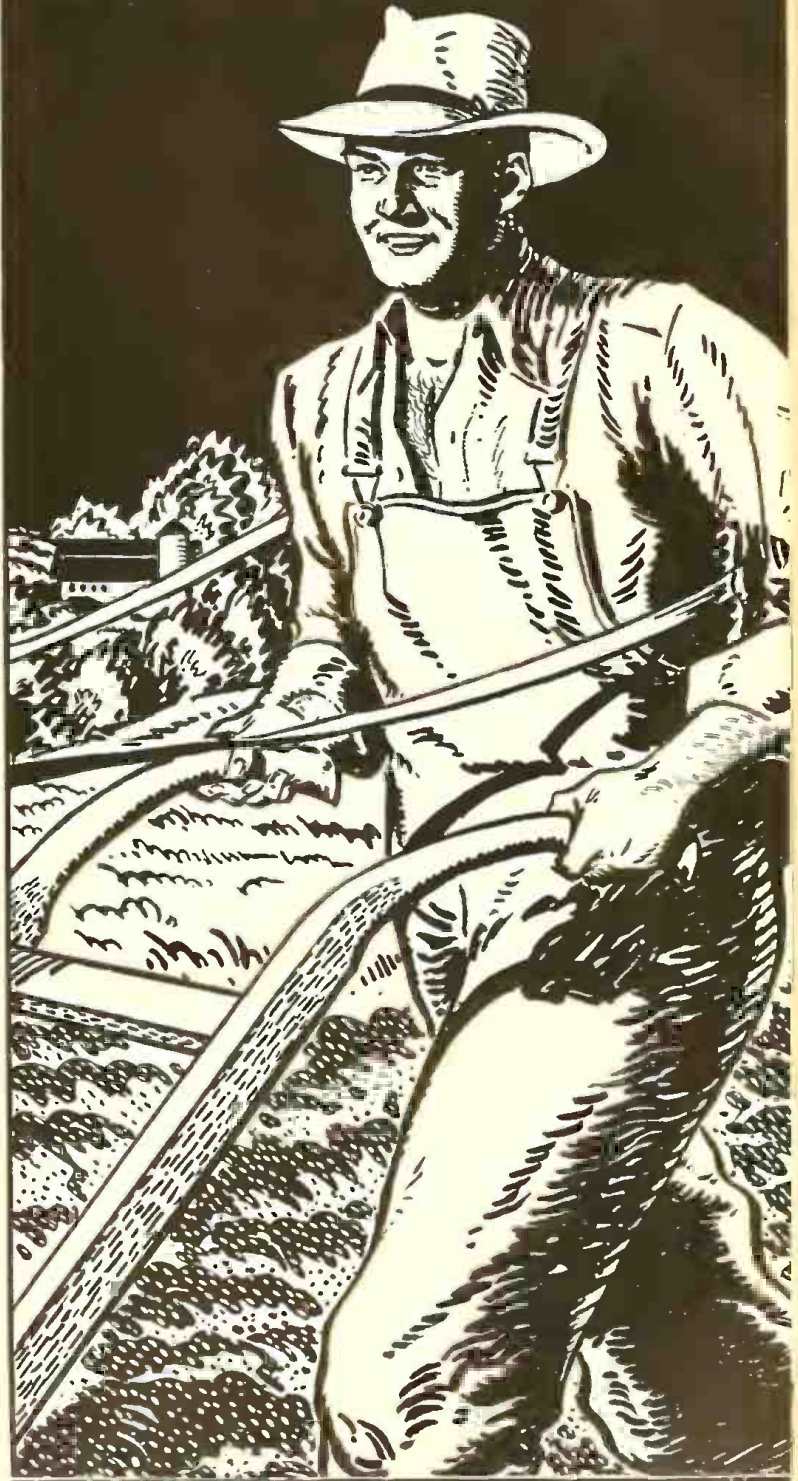

MAIL THIS COUPON TODAY

SENTINEL RADIO CORPORATION
 2222 DIVERSEY PKWY., DEPT. R.T.-A., CHICAGO

Gentlemen:
 Please rush me complete details of the 1937 Sentinel Farm Radio Line.
 Name

"THE PIONEER OF FARM RADIO"

Goodbye!

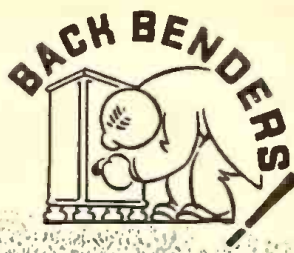

Admiral TILT-TUNER

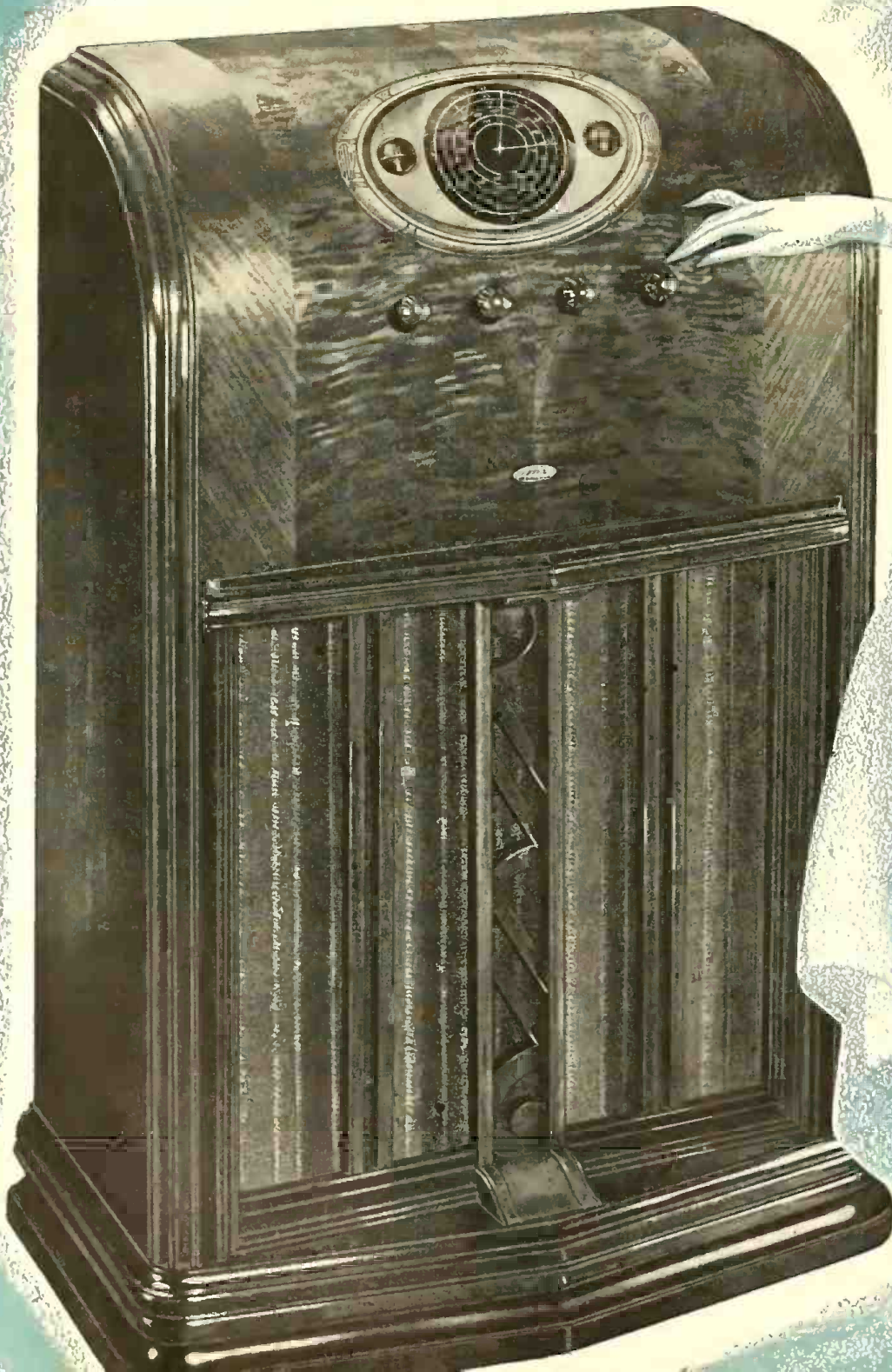

METAL TUNER

Model AM889, 17 tubes

A sensation from coast-to-coast... "goodbye to back-benders" . . . star-tune . . . especially with fly-wheel dial . . . "fly-wheel" set with double pointers for clock-tuner . . . visual wave-bar features, too . . . such as 50 watts undistorted push-pull amplification . . . automatic frequency bands (16.4 to 2000 meters) . . . 2 microvolt sensitivity.

Also 8 and 10 tube models
priced at \$149.50



ANOTHER
 " 1 " ST
 FOR
Admiral

4-TUBE, 6-VOLT "LAYDOWN" MODEL

AT THE UNHEARD OF LOW PRICE OF \$29.95 LIST

Now . . . an Admiral battery radio that "gets everything" at a price any farmer can pay! 43 to 550 meters . . . 6" permanent magnet dynamic speaker . . . illuminated 5½" airplane dial . . . automatic volume control . . . and the lowest battery drain on record! (Less than 1.2 amps). Uses only a 6 volt storage battery . . . no "B" or "C" batteries. Costs about ½¢ per hour to operate. Model B325, Admiral 4 tube, 6 volt "Laydown" . . . List price \$29.95.

Admiral Model B125—5 tube AC "Laydown". Same cabinet as above. A sensation at \$19.95 list.

Admiral Model B225—6 tube AC-DC "Laydown" . . . \$27.50 list.

Admiral offers a complete line for home, farm and auto . . . AC, AC-DC, Battery and Auto . . . 15 models . . . 4 to 17 tubes . . . 16.4 to 2000 meters . . . \$19.95 to \$175.00 . . . the biggest value in radio today!

CONTINENTAL RADIO & TELEVISION CORP.

325 W. HURON ST., CHICAGO, ILL.

THE EQUIPPED

AC "Tilt-Tuner", \$175.00

Everywhere folks are say-
 "give me a tilt-tuner!"
 or sitting it's the easy way to
 like these to help: 11" oval
 for high speed tuning . . .
 logging . . . visual station indi-
 cator, etc. Outstanding tone
 12" dynamic speakers . . . 30
 output . . . automatic bass com-
 e control, etc. 4 continuous
 . . . 17 RCA tubes . . . absolute
 price \$175.00.

Admiral "Tilt-Tuners"
 and \$99.50

MAIL THIS COUPON FOR FREE BOOK

Our new booklet gives detailed specifications covering all the new Admiral Models. Mail this coupon for your copy today. There is no obligation. Send to Continental Radio & Television Corp., 325 W. Huron St., Chicago.

Name _____

Address _____





Goodbye!

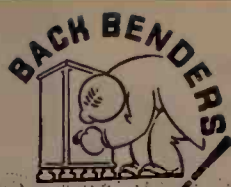

Admiral TILT-TUNER



ANOTHER
"1"
ST
FOR
Admiral

4-TUBE, 6-VOLT "LAYDOWN" MODEL

AT THE UNHEARD OF LOW PRICE OF

\$29⁹⁵
LIST

Now . . . an Admiral battery radio that "gets everything" at a price any farmer can pay! 43 to 550 meters . . . 6" permanent magnet dynamic speaker . . . illuminated 5 1/2" airplane dial . . . automatic volume control . . . and the lowest battery drain on record! (Less than 1.2 amps). Uses only a 6 volt storage battery . . . no "B" or "C" batteries. Costs about 1/2¢ per hour to operate. Model B325, Admiral 4 tube, 6 volt "Laydown" . . . List price \$29.95.

Admiral Model B125—5 tube AC "Laydown". Same cabinet as above. A sensation at \$19.95 list.

Admiral Model B225—6 tube AC-DC "Laydown" . . . \$27.50 list.

Admiral offers a complete line for home, farm and auto . . . AC, AC-DC, Battery and Auto . . . 15 models . . . 4 to 17 tubes . . . 16.4 to 2000 meters . . . \$19.95 to \$175.00 . . . the biggest value in radio today!

CONTINENTAL RADIO & TELEVISION CORP.

325 W. HURON ST., CHICAGO, ILL.

RCA

METAL TUBE EQUIPPED

Model AM889, 17 tube AC "Tilt-Tuner", \$175.00

A sensation from coast-to-coast. Everywhere folks are saying "goodbye to back-benders . . . give me a tilt-tuner!" And no wonder . . . standing or sitting it's the easy way to tune . . . especially with features like these to help: 11" oval dial . . . "fly-wheel" selector for high speed tuning . . . double pointers for clock-like logging . . . visual station indicator . . . visual wave band indicator, etc. Outstanding tone features, too . . . such as 12" dynamic speakers . . . 30 watts undistorted push-pull output . . . automatic bass compensation . . . automatic tone control, etc. 4 continuous bands (16.4 to 2000 meters) . . . 17 RCA tubes . . . absolute 2 microvolt sensitivity. List price \$175.00.

Also 8 and 10 tube Admiral "Tilt-Tuners" priced at \$79.50 and \$99.50

Dealers!
Jobbers!

MAIL THIS COUPON FOR FREE BOOK

Our new booklet gives detailed specifications covering all the new Admiral Models. Mail this coupon for your copy today. There is no obligation. Send to Continental Radio & Television Corp., 325 W. Huron St., Chicago.

Name _____

Address _____



UNDERSTANDING NEW RADIO CIRCUITS

Volume range expansion — new AVC circuit — phase inverter

SPARTON TONE EXPANSION

★ Some of the 1937 Spartou sets employ a volume range expander described as *tone expansion* in the sales literature. This is an electronic expander—a resistance type expander (Crosley expressionator) was described in RADIO TODAY for March on page 35.

In order to service these new circuits it is essential that the serviceman understand their operation. The basic circuit shown in Fig. 1 illustrates the principle used by Sparton.

There are two resistances in series R-1, 100,000 ohms and R-2 a variable resistance. The output from the first audio amplifier is fed through the coupling condenser C-1 to the series resistor combination. It is obvious from inspection that if R-2 were made zero ohms, no audio signal could reach grid of tube T-2. As R-2 is increased in value more and more signal voltage gets to the grid of T-2. If R-1 equals R-2, half of the voltage available from tube T-1 will go to T-2's grid. In other words it can be stated that the audio voltage on the grid of T-2 varies *inversely* with the value of R-2.

In the Sparton circuit R-2 is the

plate-cathode impedance of a 6K7G tube. Fig. 2 (heavy lines) shows the complete expander circuit as developed by Sparton.

The audio signal follows the path indicated by the arrowheads from the 6Q7G to the 6N6G.

The grid of the 6J7G tube is coupled to the plate of the 6Q7G through R33 and C35. The audio signal thus delivered to the grid of the 6J7G tube is amplified and passed on to a grid of the 6K7G expander tube.

Amplifier-detector

But the 6J7G is not used as an ordinary amplifier—it is biased to approximately plate current cut-off—in this way it amplifies only the positive audio peaks. In other words it is a rectifier-amplifier. The output of this amplifier-rectifier is direct coupled to the 3rd grid of the 6K7G tube. The 1 megohm resistor R16 and condenser C28 act as a filter to eliminate any audio frequency ripple—in this way the voltage impressed upon the grid is pure DC.

By varying the voltage impressed upon the grid of the 6K7G it is pos-

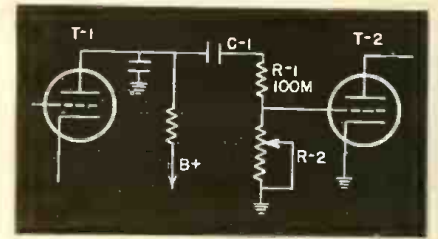

Fig. 1. Basic circuit of the Sparton automatic tone expansion.

sible to vary the plate to cathode impedance. As the grid voltage goes negative the impedance increases, or as the grid bias is decreased, the plate impedance decreases.

Changing the plate impedance is the same as varying resistor R-2 in Fig. 1. In this way we obtain an automatic variation of volume.

As a loud passage occurs a larger signal voltage is applied to the grid of the 6J7G tube. This causes the plate current in the tube to increase—therefore there is a greater voltage drop across resistance R22. Point A is negative with respect to point B. Therefore the voltage applied to the grid of the 6K7G is more negative than before the loud passage occurred.

With the grid more negative, the plate impedance increases. This increase reduces the voltage drop across R20 and a *greater* AF voltage is applied to the 6N6G tube. As a result the volume is greater.

When soft passages occur the reverse is true.

For normal volume there must be a signal loss in this circuit so that for loud passages more volume can be obtained by reducing the loss. In order to eliminate a great change in volume when the expander is removed from the circuit, a compensating switch shunts a 56,000 ohm resistor across a 100M ohm section of the R15 volume control. This reduces the gain in the grid of the 6Q7G circuit just enough to compensate for the removal of the expander—as a result there is no marked change in the volume level of the set when changing from automatic volume expansion to normal.

Note how the plate voltage of the 6K7G is supplied through R24 and R20. R17 and C34 serve as a resistance-capacitance filter to remove power supply ripple for both the 6Q7G and 6K7G tubes.

(To page 42)

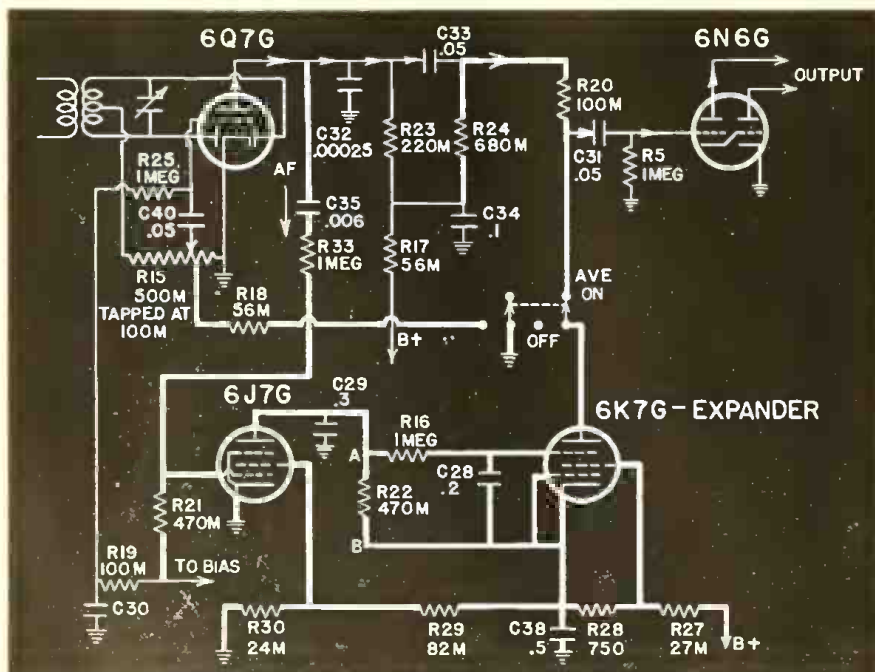

Fig. 2. Circuit as employed by Sparton for automatic volume range expansion. A 6J7G tube is used as an amplifier-detector while a 6K7G works as a variable impedance (controlled by 6J7G) to regulate the volume of the set.

THANK YOU, RCA!

for your open letter to resistor manufacturers, pointing out the superiority of

INSULATED RESISTORS*

- * Originally developed by International Resistance Company and now produced in millions.
- * One of many standard types of insulated resistors both Metalized and wire wound pioneered and popularized by IRC.
- * The features of design now being standardized by RCA are identical with the features of IRC insulated resistors.

Thus the experience of RCA in a great diversity of resistor applications, bears out the value and far-sightedness of IRC engineering.

Today, the same engineering talent and experience responsible for insulated resistors are available to all industrial and electrical users who have resistance problems.

REMEMBER—IRC makes resistance units of more different types—in more different shapes—for more different applications—than any other manufacturer in the world.



INITIATIVE — RESOURCEFULNESS — COOPERATION
to advance the interest of industry

INTERNATIONAL RESISTANCE COMPANY

401 North Broad Street
Philadelphia, Pa.

factories or licensees in
 CANADA ENGLAND FRANCE
 GERMANY ITALY DENMARK
 AUSTRALIA

RCA MANUFACTURING COMPANY, INC.
 A RADIO CORPORATION OF AMERICA SUBSIDIARY
 Camden, New Jersey

July 7, 1936

OPEN LETTER to RESISTOR MANUFACTURERS

Gentlemen: Subject: Insulated Resistors.

During the past eighteen months the trend in the industry has been toward the outright adoption and standardization of the insulated type of fixed carbon resistor.

The most satisfactory types based upon our investigations and tests are the units having the body insulated by a molded compound rather than those employing the use of a ceramic sleeve. These units are also more satisfactory in that they have the leads extending from the ends of the resistors in line with the axis of the body so as to provide point to point wiring. Our tests indicate that not only is the molded compound type mechanically stronger than the ceramic sleeve but in addition, will withstand a higher rating and does not require any moisture proofing treatment.

Several of the various makes of insulated units are so constructed as to provide a non-insulated unit by simply omitting the insulating operation.

We are interested in obtaining your comments on the following questions:

1. If you are not already producing an insulated unit, do you intend to do so?
2. What action have you taken toward standardizing the non and insulated types?
3. If you do not produce insulated units, do you, or could you rearrange your equipment to produce units with the leads extending from the ends of the body?

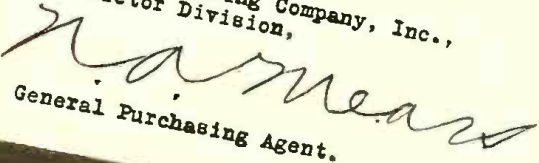
Very truly yours,
 RCA Manufacturing Company, Inc.,
 RCA Victor Division,

 General Purchasing Agent.

INSULATED RESISTORS PIONEERED by IRC

The INSULATED RESISTOR had its origin in the pioneer work of International Resistance Company

- The RECORD**
- 1931-33 Period of creative research and practical development.
 - 1934 Limited production started late in year. Entire capacity sold OVER 1,000,000 INSULATED UNITS.
 - 1935 Increased manufacturing capacity. Sales increased to more than 20,000,000 INSULATED UNITS.
 - 1936 New plant and equipment -- Sales first quarter compared with same period 1935 400% GREATER.
 - TODAY The IRC Insulated Resistor has created new design practice, now universally accepted.
- Reprinted from Radio Today, Apr. 1936*

20,000

THE NEW WESTON
MODEL 772
Super-sensitive analyzer..



PRICE
\$46⁵⁰
NET
TO DEALERS IN U. S. A.
(carrying case included)



Model 772 is furnished mounted in a durable, brown leatherette carrying case, with plenty of room for tools and accessories.

Remember... YOU CAN'T SERVICE TELEVISION

ohms per Volt!

with

SENSITIVITY OF 20,000 OHMS PER VOLT

PLUS RESISTANCE RANGES READABLE UP TO 30 MEGOHMS

PLUS CURRENT INDICATIONS AS LOW AS .5 MICROAMPERE

Unequaled for radio testing...essential when television comes!

Check all these features of Model 772

... then make your own comparison:

1. SENSITIVITY... 20,000 OHMS PER VOLT!

... for the first time, WESTON gives you the sensitivity you must have to best analyze any receiver circuit, old or new... especially those involving A.V.C., noise suppressor circuits, tone fidelity control, etc.

2. A BIG, ULTRA-SENSITIVE WESTON METER!

... a big, standard WESTON super-sensitive meter, with a large, easy-to-read scale with widely spaced markings. Big value alone in the meter!

3. TRUE VOLTAGE READINGS

... with this ultra-sensitive meter, plate voltages in resistance coupled circuits, grid bias and other DC voltage measurements can be made with certainty... for so little current is drawn by the meter that readings will not be greatly in error as is the case with less sensitive instruments.

4. THE ULTIMATE IN CURRENT MEASUREMENT!

... with Model 772, you can measure current far below present limitations. Currents of 10 or even 5 microamperes coming from the diodes can be accurately measured. Also cathode ray tube and photo-cell currents.

5. RESISTANCE MEASUREMENTS MADE EASY

... Model 772 provides a readable deflection as high as 30 megohms, with the high resistance values above 1 megohm sufficiently spaced out to permit an accurate check on all resistors in common use. The increased deflection at high resistance values gives a more critical check for condenser leakage.

6. DESIGNED FOR RAPID USE

... a convenient system of pin-jacks, along with a rotary switch, permits rapid changes of range and function for AC and DC measurements, and for use as a sensitive output meter. Separate jacks for the 1 M.A. and 100 microampere ranges protect the instruments from accidental damage. Can be used with WESTON Socket Selectors. Precision resistors used throughout. Built to WESTON'S unequalled standards of quality and workmanship.

7. WIDER RANGE OF USEFULNESS... INCLUDING TELEVISION

... with Model 772 you will also be equipped for servicing sound movies, amplifiers, photo-cell circuits and any circuit where current is small, even down to $\frac{1}{2}$ microampere—as well as for television. WESTON has already built the instruments for television broadcasting, so Model 772 was designed to include television servicing.

8. PRICE \$46.50 net... INCLUDING CARRYING CASE

... never before, has value of this kind been offered to the serviceman. WESTON provides it because of their large production on sensitive, quality instruments which are universally used by laboratories, and throughout industry. Investigate Model 772 today... before you buy any analyzer. See it at your jobber's... or, return coupon for complete data.

WESTON

Radio Instruments

WITHOUT 20,000 OHMS PER VOLT!

MAIL THIS COUPON TODAY

WESTON ELECTRICAL
INSTRUMENT CORP.,
597 Frelinghuysen Ave.
Newark, N. J.

Rush me complete data on the
new Model 772 Super Sensitive Analyzer.

NAME _____

ADDRESS _____

CITY _____ STATE _____

NEW RADIO CIRCUITS

(From page 38)

The time constant of the circuit is determined by R22, C38, C29. The delay is about 30 seconds.

The range of expansion is determined in part by the ratio of R33 to R21. The expander stops working at 200 milliwatts output—a surprisingly low value, which, however, gives good results.

FADA FLASH-O-GRAPH AVC

★ New AVC circuit is used in the Fada Phantom Flash-o-graph sets. Varying amounts of AVC voltage are applied to the tubes to prevent overloading and still allow for maximum sensitivity of tuning indicator.

Diagram of flash-o-graph control shows that full AVC is applied continuously to the 6K7 r-f. tube. A potentiometer is across the diode load resistor—the tap supplies varying amount of AVC voltage to the 6K7 i-f. tube.

When the potentiometer (phantom flash-o-graph control) is turned completely to the left, full AVC voltage is applied to the i-f. tube and the 6A8 converter. In this extreme position the grid return of the 1st detector is switched to the AVC circuit.

Thus for weak signals AVC is used only on the r-f. for medium signals a partial amount of AVC is applied

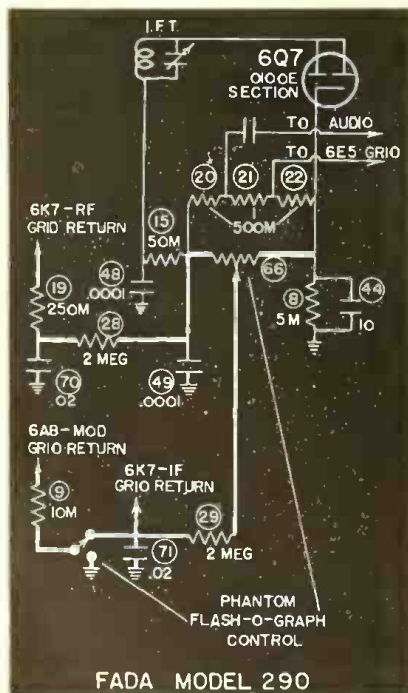

Fig. 3. Circuit for applying proper AVC voltages to various stages of set in accordance with local signal strength.

to the i-f., and for extremely strong signals AVC is used on three tubes.

In order to determine the proper adjustment of the flash-o-graph control, a 6E5 cathode ray indicator is tied into the circuit. The flash-o-graph shadow will just close when distortion begins due to overloading. Consequently the proper setting of the control is made by adjusting the control just short of the overload indication—this provides maximum sensitivity of the tuning flash-o-graph.

PHASE INVERTER

★ New circuit development is that of a high-gain single-tube phase inverter to drive a push-pull stage. Basic circuit is shown in Fig. 4. In the circuit point B is at ground potential with respect to audio frequency.

When the grid voltage is made less negative the plate current will increase. An increase of current in the series circuit will increase the voltage drop in the resistor. Point A is negative with respect to the B+ terminal. And point C is positive with respect to the B- terminal. Since the resistance from B to A is equal to that from B to C, the voltage drops across A-B and B-C will be equal in magnitude.

But A is negative with respect to B and C positive with respect to B. In other words there is a phase difference of 180 degrees—just what is needed for push-pull operation. The blocking condensers to the grids of the push-pull stage eliminate the effect of the B supply voltage permit only the changes in voltage to reach the grids.

Note that the grid of the 6C5 triode inverter is connected into the circuit—this provides a grid bias for the tube and at the same time cancels distortion due to the detector.

In Fig. 5 the circuit is shown as utilized in the Fada 290 receiver. Note that there is no cathode to ground by-pass condenser associated with the 6C5 inverter. To use a by-pass condenser here would render the circuit inoperative from a push-pull point of view. Referring to Fig. 4 again—a by-pass condenser from B to C would effectively short the circuit as far as a-f. is concerned, and the circuit would perform merely as a single-ended amplifier.

A more usual circuit would have a by-pass condenser connected across

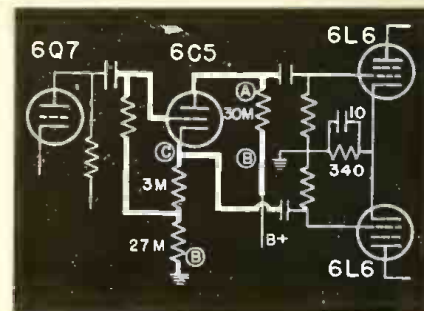
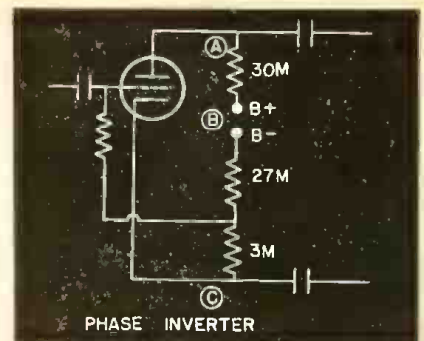

Fig. 4. (Above) Basic circuit for phase inverter. Fig. 5. Complete schematic of single-ended phase inverter.

the 3,000 ohm cathode resistor—but in this operation there would be no cancelling effect of detector distortion. If a by-pass condenser is employed across the cathode resistor, then the other two resistors must be equal in value.

Servicemen should familiarize themselves with this new inverter circuit as it will find much application in the new sets.

CLEAN UP THE SET

★ Cleaning up the chassis is an important part of every service call. The inside of the set is an effective dust collector, and the housewife, no matter how spick and span she keeps her home, will always neglect to clean the inside of the set for fear of breaking things or getting a shock.

Servicemen should utilize this angle in building up good-will. Clean the set even though you realize the set may not play any better. Call the customer's attention to the cleaning.

At the shop it is possible to use a blower to good advantage. The blower can be a vacuum cleaner with a small nozzle on the end of the hose. If you don't approve of blowing dust from one set into another, it's an easy matter to rig up a special cleaning bench with a hood and exhaust fan.

In the customer's home the serviceman will have to rely upon a small paint brush, dust cloth, and dust pan—latter can be borrowed from the housewife.

New 1937

ADDITIONS TO POPULAR



MASTER SERIES

FEATURES . . .

- **UNITS ARE INTERCHANGEABLE** in carrying case inasmuch as they are contained in metal cases of one size.
- **PORTABILITY.** Unit size is small, compact, hence light in weight and practical for the best results.
- **SOLID CONSTRUCTION.** The internal construction of all Master Units is designed so all parts are rigidly supported. Will stand up under hard usage and give service.
- **MAXIMUM PROTECTION AGAINST OBSOLESCENCE.** All designs carefully considered from a viewpoint of possible obsolescence. Being single purpose instruments in itself is great protection. Damage to one unit makes repairs single and does not tie up other instruments.
- **PRECISION BUILT.** Every test will show Master Units are outstanding in quality. Every effort made to maintain accuracy throughout. Represent the most up-to-date engineering practice in every detail.

Here are new units for owners of Triplet Master Unit Test Sets. The metal cases are the same size as used in previous models. Select your requirements now. Those and other future models will always keep your Master Units out in front—with a minimum outlay. You can always buy such additional units as your needs demand.

For those not owning Master Unit Test Sets, here is additional evidence of Master Unit advantages: A correlated line of equipment fulfilling the needs of the radio service dealer and insuring the greatest return per dollar invested. Ask others. Try one now and you will find yourself standardizing your Service Test Equipment with Triplet Master Unit models.

See them at your jobber's.

Mail coupon for more information.

THE TRIPLET ELECTRICAL INSTRUMENT CO.
199 Harmon Drive, Bluffton, Ohio

Please send complete Catalogue.

I am interested in more information on Model _____

Name _____

Address _____

City _____ State _____

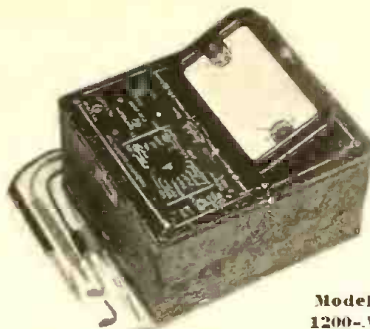

Model
1200-A

CONDENSER TESTER

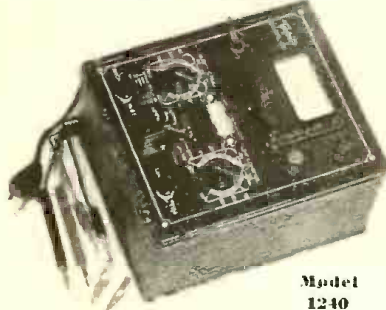

Model
1240

Checks all types condensers, Paper, Mica or Electrolytic, from .0001 to 10 microfarads. Detects internal shorts, opens or high resistance leakages. AC and DC voltages for breakdown tests available in steps to 1000 volts. Easily read meter scale.
Dealer Price\$24.83

AUDIO OSCILLATOR



Model
1260

Generates pure sound wave without distortion or harmonics. Laboratory accuracy. Wide frequency range. Signal strong and impedance matching is variable, permitting matching with low, medium or high impedance input of amplifier or P.A. systems. AC operated. Dealer Price\$28.34

TUBE TESTER



Model
1210-A

Tests all types of tubes, metal, glass, G-type, under R.M.A. load conditions. Direct reading colored GOOD-BAD scale. R.M.A. circuit used. Dealer Price...\$20.00

VOLT-OHM-MILLIAMMETER

Low ohm scale reading $\frac{1}{2}$ -500 ohms with 15 ohms center scale reading. Reads DC 10-50-250-500-1000 volts at 2000 ohms per volt. AC 10-50-250-500-1000 volts. 1-10-50-250 milliamperes; 1500 ohms; 1.5 and 3 megohms, back up low ohms scale $\frac{1}{2}$ -500.
Dealer Price\$21.67

Model 1200-B

Similar to Model 1200-A but with copper oxide AC.
Dealer Price\$26.67

VACUUM TUBE VOLTMETER

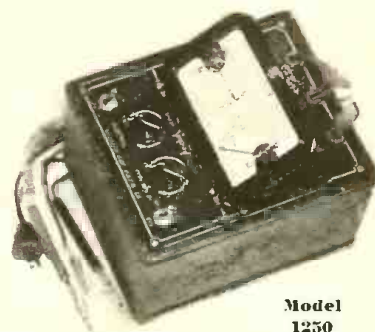

Model
1250

For the first time, accuracy independent of changing tube values. Self calibrated. Operation is extremely simple and fast. Reading all direct on a linear scale instrument. Dealer Price\$33.34

MODULATION MONITOR

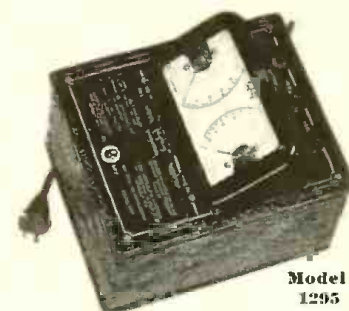

Model
1295

Indicates actual modulation percentage of radio transmitters on direct reading scale. Factory calibrated and no further calibration needed. Complete with all necessary accessories. Dealer Price.....\$24.83

OTHER MASTER MODELS

A.C. SIGNAL GENERATOR



Model
1232

Large 12" direct reading dial, 6 bands from 100 to 30,000 kc., fundamentals. Perfect attenuation. 400 Cycle Audio Note. Now with peaked calibrated coils. Broadcast and intermediate bands less than 1%, short wave bands 3% accuracy. Dealer Price \$25.00

Model 1232 D.C.
Similar to Model 1232 but self-contained battery operation.
Dealer Price.....\$23.33

FREE POINT TESTER

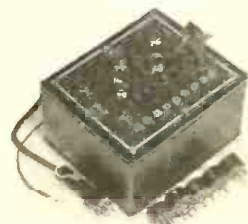

Model
1220-A

Used with volt-ohm-milliammeter for set testing. Makes all series and parallel instrument connections through five sockets with standard R.M.A. markings. Has plug and cord with all adapters.
Dealer Price\$10.00



ELECTRICAL INSTRUMENTS

SERVICE NOTES

SPARTON 726 & 776 RECEIVERS

★ Service data on opposite page shows schematic with values of all parts and chassis layout with trimmer condensers and alignment frequencies. Signal path through set is indicated by arrowheads—voltages for tube elements shown in white blocks.

These sets have 4 bands with trimmers for 3 only. Band 1 is broadcast (BC on chassis layout). Band 3 covers 3,600 to 7,200 (POL), band 4 extends to 15,000 kc. (SW). Position of switch for various bands indicated on antenna coil switch.

Broadcast band aligned first—oscillator parallel. RF, ANT at 1,350 kc. Oscillator series at 600 kc. Retune to 1,350 and check previous adjustments. Next align short-wave band at 15,000 kc.—oscillator parallel, RF, ANT; check sensitivity and calibration at 9,000 kc. Band 3 or POL is aligned at 7,200 kc.—RF, ANT, there is no oscillator trimmer; check sensitivity and calibration at 3,600 kc. Band 2 has no adjustments, but check operation at 3,000 and 1,700 kc.

Voltage readings may vary as much as 15 per cent from those given—they are given for a line voltage of 120.

STROMBERG-CARLSON MODEL 60

★ Stromberg-Carlson circuit with alignment and voltage data is on opposite page. Set is a 3-band super-het with variable selectivity.

Individual trimmers are used on each band—there are no interlocking trimmers. Alignment of the oscillator parallel condenser is first on any band followed by the RF and ANT trimmers. Finally the oscillator series padder should be adjusted—they will be found on the right-hand front corner of the chassis.

Wave-trap is found in rear of chassis. Note the 10,000 cycle filter in the plate circuit of the 6K7 audio amplifier—this is to eliminate carrier beats. Trimmer is on left hand side of chassis—ordinarily there is no need for adjustment.

Socket voltages are given in white blocks—line voltage of 120.

A separate 6J7 oscillator tube is used in this set coupled to the oscillator grid of a 6AS mixer tube.

SWAP WITH CUSTOMER

★ Up in Melrose, Mass., Trites Radio Service occasionally finds a customer who does not want to pay some six to ten dollars for repairs on his old set without knowing just how the set will sound after it is fixed.

To overcome this objection Mr. Trites demonstrates and offers the customer one of the turn-in sets in his shop. The terms are: customer's set plus \$10. The ten dollars will more than pay for the repairs in the customer's set—it can be repaired when business is slow and used over again in a similar transaction.

Swaps are limited to consoles of reliable make—and an unconditional guarantee is given with each set. Result is that customer knows just what he is getting before spending his money—and Trites' profit is increased.

PUSH-PULL TUBE REPLACEMENTS

★ If one of a pair of push-pull tubes needs replacement and the other one is relatively old, change both of the tubes. This will save a service call in the near future and give the customer better reception. Both the serviceman and customer profit by this procedure.

TAGGED RESISTORS FACILITATE SERVICING

★ New line of identified service resistors provides for the first time, according to Mr. Herr, head of Philco's Parts Division, a perfect method for quickly determining the value of a resistor so as to enable the serviceman to make the proper replacement in minimum time.

The new resistors are marked in two ways to eliminate all possibility of mistaking their values. Each is fitted with a rust-proof metal tag attached to one of the leads, plainly marked with the resistance value and, in addition, is color coded according to the R.M.A. code.

"This two-fold protection of resistor values solves all the previous problems of servicemen," Mr. Herr declares. "No more straining to puzzle out faded color combinations, fussing with trick charts, codes, wheels and gadgets and wasting valuable time by having to actually measure resistor values!"

(To page 48)

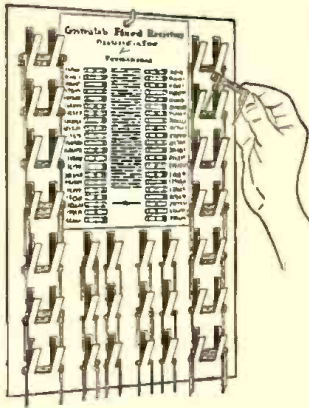

FREE Centralab Handy Fixed Resistor Rack

• YOU asked for it—so we repeat the offer. The Rack is yours absolutely FREE with a

SPECIAL DEAL

consisting of 20 1½ watt 316 type and 20 1½ watt 310 type CENTRALAB RESISTORS.

The Rack is of heavy sheet metal and will give years of service. The R.M.A. Color Chart is in full colors.

Hang this CENTRALAB RACK on your wall and know at a glance just where they are, and what resistance values you have on hand.

Write for descriptive information today.

Centralab

Milwaukee, Wis.

BRITISH CENTRALAB, Ltd.
Canterbury Road, Kilburn
London, N.W. 6, England

CENTRALAB
68-70 Rue Amelot
Paris, France

VOLUME CONTROLS
FIXED RESISTORS
SOUND PROJECTION CONTROLS
WAVE CHANGE SWITCHES

TIME PAYMENT FINANCING

THAT
Promotes
SALES



*Y*OUR potential customers are "finance-wise". They spend billions, annually, for automobiles, oil burners, radios, refrigerators, and other electric appliances of household utility. Where the unit prices are high enough to warrant, most of the purchases are made on a time payment plan. But not just *any* plan. They are demanding fair terms, fair treatment and fair understanding of their budget problems in the handling of collections.

This is the kind of service Commercial Credit Company offers through local offices in principal cities of the United States and Canada. It has been a valuable selling aid to a large number of leading manufacturers and their distributors. It has won the confidence and good will of millions of their customers.

For full details of Commercial Credit Company plans, write or phone headquarters or any branch office.

COMMERCIAL CREDIT COMPANY

COMMERCIAL BANKERS
CONSOLIDATED CAPITAL



HEADQUARTERS: BALTIMORE
AND SURPLUS \$49,000,000

FINANCING SERVICE FOR MANUFACTURERS, DISTRIBUTORS AND DEALERS
THROUGH 170 OFFICES IN THE UNITED STATES AND CANADA

I. F.-R. F. OSCILLATORS—Compiled by Radio Today

Model No.	Net Price	Fundamental range in Kc.	No. of bands	Calibration and accuracy	Length of scale inches	Modulation Frequency & percentage	Audio distortion	Attenuator Calibration	Max. volts	Min. volts	Freq. mod. jack	Power source	Dimensions in inches	Wt. in lbs.
BURTON-ROGERS CO., 755 Boylston St., Boston, Mass.														
11	\$30.45	100-35,000	6	{ Direct 1/2% IF. }	50	400 at 35%	NS	ARB	NS	NS	Yes	Batt	7x10 1/2 x 5	11
111	32.95	100-35,000	6	{ 1% BC 2% SW }	50	400 at 35%	NS	ARB	NS	NS	Yes	110 AC	7x10 1/2 x 5	11
CLOUGH-BREngle CO., 1134 W. Austin Ave., Chicago, Ill.														
OB	112.50	0-15,000 cycles	1	Direct 2%	24	2†	ARB	5	500 ohms	Batt.	7x17x8	20 1/2
OC	32.90	60-30,000	6	{ Direct 1/2% }	25*	30%	NS	ARB	3	1/2 uv.	Yes	110AC-DC	7 1/2 x 10 1/4 x 7 1/4	9 1/2
OM	57.75	100-30,000	5	{ Direct 1/2% }	25*	30%	NS	ARB	3	1/2 uv.	**	110AC	9x11 1/4 x 12 3/4	28
79	51.90	0-10,000 cycles	1	Direct 3%	7	5†	ARB	27	at 5000 ohms	110AC	9x13x10	19 1/2
81	34.25	Frequency modulator for use with any oscillator.										110AC	8 1/2 x 11 1/4 x 8	20
82	19.90	90-20,000	6	Direct 3%	8 1/2*	30%	NS	ARB	1/2	1/2 uv.	Yes	Batt.	7 3/4 x 10 x 6 1/4	11 3/4
*—Scale length per band. **—Has self-contained modulator. †Harmonic content.														
HICKOK ELECTRICAL INSTRUMENT CO., 10516 Dupont Ave., Cleveland, Ohio.														
O.S.7	\$48.00	{ 85-25,000 }	7	Direct	17	400 at 50%	4%	ARB	.1v.	1 uv.	Yes	110AC	6 1/2 x 11 1/2 x 9	NS
O-A-1 Wabblers	15.00	{ 0-10,000 cycles }	1	Direct								110AC	3 1/2 x 3 3/4 x 6 1/2	NS
Frequency modulator—capacity ranges of 15 & 30 micromicrofarads														
JACKSON ELECTRICAL INSTRUMENT CO., 430 Kiser St., Dayton, Ohio														
441 A	\$32.80	100-36,000	6	Direct 1/2%	72	400 at 30%	8%	ARB	.1 v.	.25 uv.	Yes	110AC	8 1/2 x 11 1/2 x 4 3/4	12
441 B	31.00	100-36,000	6	Direct 1/2%	72	400 at 30%	8%	ARB	.1 v.	.25 uv.	Yes	Batt.	8 1/2 x 11 1/2 x 4 3/4	12
J-M-P MFG. CO., (Acrocycle) 3048 N. 34th St., Milwaukee, Wis.														
B	\$12.50	{ 100-250 }	1	Direct 2%	12	{ 200 at 100% }	NS	None	NS	NS	No	110AC-DC	10 1/4 x 6 1/4 x 4 1/2	7
B	13.50	{ Harm. to 1500 }	1	Direct 2%	12	{ 60 at 100% }	NS	None	NS	NS	No	Batt.	10 1/4 x 6 1/4 x 4 1/2	8
PHILCO RADIO & TELEVISION CORP., Tioga & C Sts., Philadelphia, Pa.														
024		{ 105-250 }	2	Direct	NS	NS	None	NS	NS	No	Batt.	7 1/2 x 5 x 5	3 1/2
088		{ 220-500 }												
091		110-20,000	5	Direct	NS	400	NS	ARB	NS	NS	No	Batt.	7x10x6 1/4	13
		3600	...	Direct		Piezo electric oscillator						Batt.	6 1/2 x 9 x 5	7
RADIO CONSTRUCTION LABS., 136 Liberty St., New York City														
339	\$16.00	54-17,000	5	Direct 1%	NS	1000 at 40%	NS	ARB	100 uv.	12 uv.	None	110AC-DC	6x10x5 1/2	6
RADIO PRODUCTS CO., (Dayrad), 125 Sunrise Pl., Dayton, Ohio														
36	\$31.75	60-60,000	6	{ Direct 1/2% IF. }	36	400 at 5%	2%	ARB	NS	1/2 uv.	Yes	110AC	10x7x4 1/2	10
38	31.75	60-60,000	6	{ 1% BC 5% SW }	36	400 at 5%	2%	ARB	NS	1/2 uv.	Yes	Batt.	10x7x4 1/2	10
RCA MFG. CO., Front & Cooper Sts., Camden, N. J.														
9558	\$27.50	Frequency modulator—capacity ranges 15 & 30 micromicrofarads										110AC	8 1/2 x 9 3/4 x 4 1/2	5 1/2
9572	29.95	100 & 1000	...	Direct 0.05%		Piezo electric calibrator						110AC	5 1/2 x 4 x 2 3/4	1 1/2
9595	34.50	90-25,000	8	{ Direct 3% }	32	400 at 50%	10	ARB	.1 to .2	1-40 uv.	Yes	Batt.	8 1/2 x 9 3/4 x 4 1/2	5
				{ Chart 1/2%* }										
*—Available at extra charge of \$5.00.														
READRITE METER WORKS, 126 E. College Ave., Bluffton, Ohio														
554-A	\$14.40	100-20,000	5	Chart	6*	400 at 40%	1	None	1.5v.	Zero	No	Batt.	12x6 1/2 x 5 1/4	10
* Length per band.														
SUPREME INSTRUMENT CO., Howard St., Greenwood, Miss.														
189 Port.	\$36.95	{ 100-10,000 }	4	Direct 3%	26	400 at 30%	3	uv.	1/2 v.	1/2 uv.	No	115AC	5 1/2 x 11 3/4 x 8 1/2	15 1/2
189 Lab.	36.95	{ 10,000-30,000* }	2	Direct 3%	26	400 at 30%	3	uv.	1/2 v.	1/2 uv.	No	115AC	7 1/4 x 13 1/4 x 12 1/4	15 1/2
* Harmonics														
TRIPLETT ELECTRICAL INSTRUMENT CO., 122 Main St. Bluffton, Ohio														
1151	\$23.33	110-18,000	4	Chart	4*	400 at 40%	4	None	2v.	Zero	No	Batt.	11 1/2 x 7 1/2 x 4 1/2	10
1230	15.33	100-18,000	6	Chart	4*	400 at 40%	4	None	2v.	Zero	No	Batt.	8x6 1/4 x 4 3/4	12
1231	26.67	100-30,000	6	Direct	12*	400 at 40%	4	None	2v.	Zero	No	Batt.	8x6 1/4 x 4 3/4	14
1232	26.67	100-30,000	6	Direct	12*	400 at 40%	4	None	2v.	Zero	No	Batt.	8x6 1/4 x 4 3/4	14
* Length per band.														
TRIUMPH MFG. CO., 4017 W. Lake St., Chicago, Ill.														
110	\$29.94	100-10,000	4	Direct	NS	400 at 40%	NS	uv.	1/2 v.	NS	NS	110AC	11 1/2 x 10 x 9 1/2	NS
180	57.50	100-30,000	NS	Direct	NS	NS	NS	NS	NS	NS	Yes*	110AC	8x11 1/2 x 8 1/2	20
* Self-contained electronic frequency modulation.														
EARL WEBBER CO., 1217 W. Washington Blvd., Chicago, Ill.														
20	29.95	90-60,000	7	Direct 1/2%	49	400 at 35%	NS	ARB	1 v.	1/2 uv.	Yes	Batt.	11x7 3/4 x 6	10 1/2
40	24.95	90-60,000	5	Direct 1/2%	37	400 at 35%	NS	ARB	1 v.	1/2 uv.	Yes	Batt.	10 1/2 x 7 x 5 1/2	8
40A	19.50	90-60,000	5	Direct 3%	37	400 at 35%	NS	ARB	1 v.	1/2 uv.	Yes	Batt.	10 1/2 x 7 x 5 1/2	8
WESTON ELECTRICAL INSTRUMENT CORP., 614 Frelinghuysen Ave., Newark, N. J.														
692	45.00	100-22,000	6	Chart 2%	25 1/2	400 at 50%	NS	None	.2	1 uv.	Yes	Batt.	5 1/2 x 5 1/2 x 8 1/4	8 1/2

NS—Information not supplied. ARB—Arbitrary. uv.—Microvolts. Heading does not apply. The accompanying tabulations have been compiled from information furnished to the editors of RADIO TODAY by the manufacturers whose apparatus is described.

FREE...



New 1937 Edition Now Ready!

EVERY up-to-date service man needs this manual. New edition contains even more valuable information than any previous edition. Every replacement fact at your fingertips — up-to-the-minute in model listings, manufacturers, control requirements, etc. Would be worth paying a good price for — but you can get it free if you act promptly!

How to Get Your Copy Free

Simply send us ONE COMPLETE Electrad Volume Control Carton with your business card or letterhead and we'll send you the new Guide FREE. Supply limited, requests filled in order of receipt. Address Dept. R8.



Resistor Specialists

FEATURING:
Quiet Carbon Volume Controls
Vitreous Resistors
Truvolt Resistors
Power Rheostats

SERVICE NOTES

(From page 44)

A further feature of the new resistors is their special construction which provides extra high insulation value between resistor element and outer tubing—guaranteed 1,000 volts.

NOISY GROUNDS

★ Intermittent reception, high hum levels, and noisy reception may be caused by poor grounding of leads to the chassis. There are a number of sets in which the ground leads are soldered to lugs which in turn are riveted to the chassis. Also this same rivet may hold a socket or some other part of the set in place.

In due time the rivet loosens or at least oxidizes providing an intermittent or high-resistance ground. When grid and filament circuits are connected this way often there will be a definite increase in the hum level in addition to noise.

The remedy, of course, is to wire all the ground connections to each other, and ground that lead securely to the chassis.—GEORGE K. MEYERINK.

Stamford, Conn.

HIGH RESISTANCE VOLTMETERS

★ With the newer sets employing circuits extremely high resistances in the various circuits, such as AVC, AVE, and resistance coupled stages, the need for sensitive voltmeters is acute.

Low resistance meters—under 1,000 ohms per volt—give readings which do not indicate the true voltages delivered to the tubes through high resistance coupling or filter circuits.

The term *ohms per volt* means that the resistance of the voltmeter is equal to the scale reading in volts times the ohms-per-volt rating. A 100-volt meter with 1,000 ohms per volt rating has a resistance of 100,000 ohms. If 100 ohms per volt—the resistance for a 100 volt meter is only 10,000 ohms.

The effect of low resistance meters can be illustrated by taking some concrete examples from a typical radio. The screen voltage is fed from a 150 volt tap through a 50,000 ohm resistor. Normal voltage to screen is 100—normal voltage drop in resistor

(To page 50)

SOUND INPUT

MICROPHONE TYPE	SINGER AT 12" 10-BARS	SPEAKER AT 16" 3-BARS	CONVERSATION AT 16" 1/2-BAR
RCA MI6225 CARBON	-33 DB	-43 DB	-59 DB
RCA 50-A INDUCTOR	-61 DB	-71 DB	-87 DB
RCA 44-A VELOCITY	-67 DB	-77 DB	-93 DB

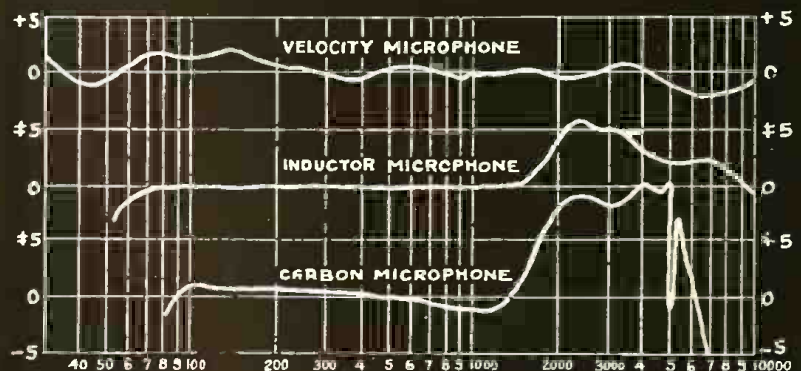

MICROPHONE OUTPUT AND CHARACTERISTICS

Frequency response curves and output levels of typical carbon, dynamic, and velocity microphones at various distances.

Choose WISELY



When Selling Gasoline Motor Powered Battery Chargers »

Choose wisely the battery charger that you sell to your radio customers beyond the power lines. Sell them the Briggs & Stratton Power-Charger—the compact, dependable, fully engineered battery charger that keeps 6-volt and 2-volt radio batteries fully charged all the time—power for continuous radio performance—provides electric light up to 200 watts and supplies gasoline motor power for driving small equipment.

Every Power-Charger sales will mean double profit to you. You will be assured a worthwhile profit on the Power-Charger, plus your regular trade profit on 6-volt radios and at the same time know that you have delivered a product that will render complete satisfaction — one that is backed by a company of world-wide reputation for building quality products.

Power-Charger Alone has all These Features

Briggs & Stratton 4-Cycle Gasoline Motor—Air cooled—nearly ¼ million in use — trouble-free, low cost operation. **Patented Built-In Flywheel Magneta** — Moisture proof. Supplies motor high tension ignition current. No battery needed except for electric starting. Motor easily started.

Electric Starting — Gasoline motor is electrically cranked by turning switch, 6-volt storage battery supplies current.

Generator — Special design, 6-volt, 200 watt, high efficiency unit with ample overload capacity. Armature full ball bearing. Fan cooled.

Multiple Control Switch — 4 settings — Start, Neutral, Low, High — "Low" delivers trickle charge for final charging stage, which conserves Battery Life.

Voltage Regulator Terminals — Provide for easy installation of voltage regulator which automatically controls generator output, and is available at small extra cost.

Ignition Shielding—Motor ignition is shielded. Power-Charger will not cause radio interference when running.

Power Take-Off and Emergency Starter Pulley — V-belt is provided to drive small equipment direct from motor. Pulley notched for easy emergency starting with rope.

Electric Control Box — Automatic cut-out, electrical instruments and all wiring fully enclosed and protected.

Fully Guarded — Drive belt and take-off pulley completely guarded. Safe.

Write, or mail the coupon for full information on the new field Briggs & Stratton Power-Charger opens up for you.

BRIGGS & STRATTON CORP., Milwaukee, Wis.

STANDARD EQUIPMENT

Multiple control switch — cut-out —ammeter—battery leads—voltage regulator terminals—ignition shielding—motor power take-off and starter pulley — air cleaner — muffler — stop button — choke knob — emergency starter rope—carrying handle — tools and complete instructions.

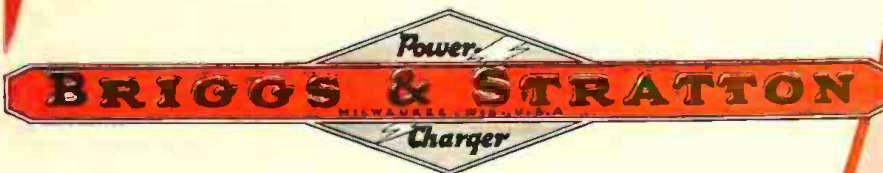

Briggs & Stratton Corp., Milwaukee, Wis.

Send complete information at once on the 6-volt, 200 watt Power-Charger.

Name of Radio Handled.....

Dealer Distributor

Firm

Street Address

City..... State.....

Signed..... RA-2

SERVICE NOTES

(From page 48)

50 volts. Using the 10,000 ohm low resistance meter mentioned above, a reading of about 25 volts will be obtained. Using a 1,000 ohm-per-volt meter with 100 volt scale the reading will be about 75 volts. A 10,000 ohm-per-volt meter with 100 volt scale will read about 95 volts—or approximately the correct value.

The need for high resistance meters in this case is readily apparent. If low or medium resistance meters are used the errors can be corrected by applying Ohm's law. The mistake most servicemen make is to forget that the value read on the meter is not the voltage present when the meter is removed.

The example just given was for a 50,000 ohm circuit—AVC circuits use resistances in the megohm class, thereby making errors in voltage measurement even greater.

The effect of voltmeter resistance can be further minimized by using a higher voltage range. A 250 volt range will have 2½ times as much resistance as a 100 volt range—but of course, the divisions on the scale

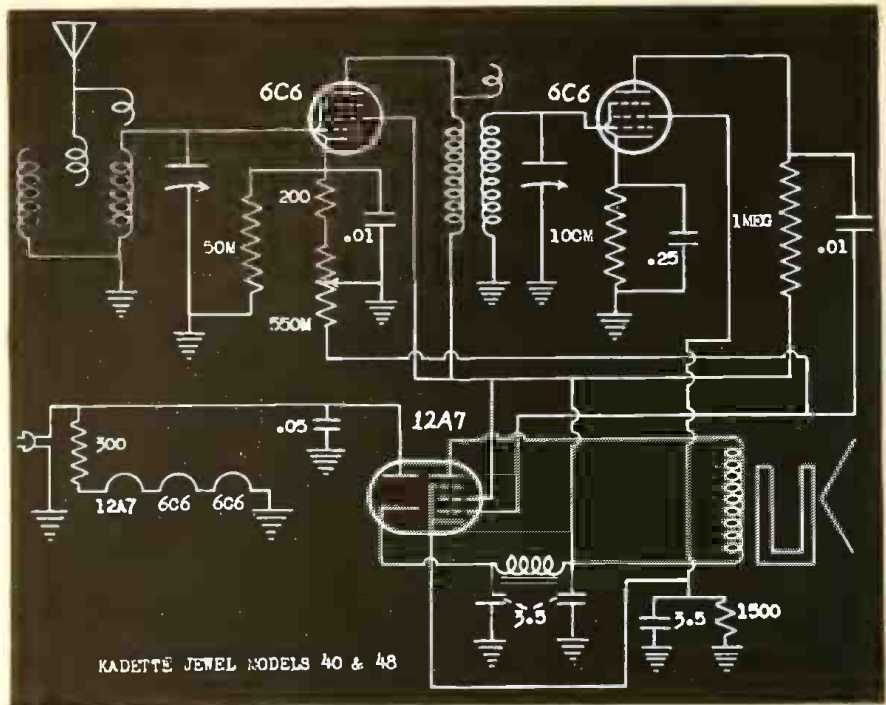

Schematic diagram of Kadette's Jewel model—note the 12A7 rectifier-output tube.

are closer together. Using a 250 volt 1,000 ohms-per-volt meter in the preceding illustration, the voltage read would be about 85. This example shows that often it is desirable

to use the higher voltage range even though the scale divisions are closer together.

In keeping with the need of high resistance voltmeters, Weston has introduced a new service instrument that provides a sensitivity of 20,000 ohms per volt—the highest now available to the serviceman. Other manufacturers have meters that are some 2,000 ohms per volt but the standard is 1,000. The Weston instrument will also measure currents as small as a few microamperes.

TRANSFORMER REPLACEMENT FILE

★ Recognizing the difficulty the service man has in finding the right transformer for his replacement jobs, especially when the radio receiver that he is servicing is obsolete, the Standard Transformer Corporation has made up a complete replacement guide that includes transformer data on practically every commercial receiver ever built.

The information given on index cards includes the model number of the receiver, the different styles or types of transformers, audios and chokes available, the type number and list price of same. It lists the complete line of Exact Duplicate Transformers and the other lines available.

This convenient, quick-reference file will save the serviceman hours and hours of time that he would otherwise spend hunting up data on his transformer replacement jobs. The card file is enclosed in an attractive box and is being offered free to ser-

(To page 53)

from now on
it's
UNIT-MATCHED
P.A. EQUIPMENT for me!

I've been doing P. A. installation work for a long time. I started buying parts . . . a microphone here, an amplifier there, a speaker from still another manufacturer.

Well, after the job was all set, it worked all right, but somehow or other I always had to keep running back to fix this and that . . . in short the equipment never seemed to work 100% right . . . and the calls were costing me money.

It wasn't until I started buying OPERADIO Unit-Matched P. A. Equipment, that I really could depend on installations working right and staying right.

I want to tell you that for real satisfaction, no complaints and a good sizable profit, you can't beat the OPERADIO line.

Ask About Our Convenient Time Payment Plan

Address Dept. RT for Catalog 10.



OPERADIO
MANUFACTURING COMPANY
Unit-Matched P. A. Equipment at its Finest
ST. CHARLES, ILLINOIS

A Custom-Built ROAMIO

for every car!

The passenger car registrations are about 22,640,000. Only about 10% of these cars have radios. Almost 90% of the automobile radio market is still wide open to the right radio receiver and the right kind of merchandising effort.

Crosley crashes this market with two brand-new Roamios and with custom-built controls for all modern cars. These Roamios represent the kind of performance that automobile drivers have been looking for—the kind of value that means quick sales, large volume.

Study the specifications, look over the new controls, compare the value . . . and you'll realize that here's your chance to get more than your share of the automobile radio business in your territory.

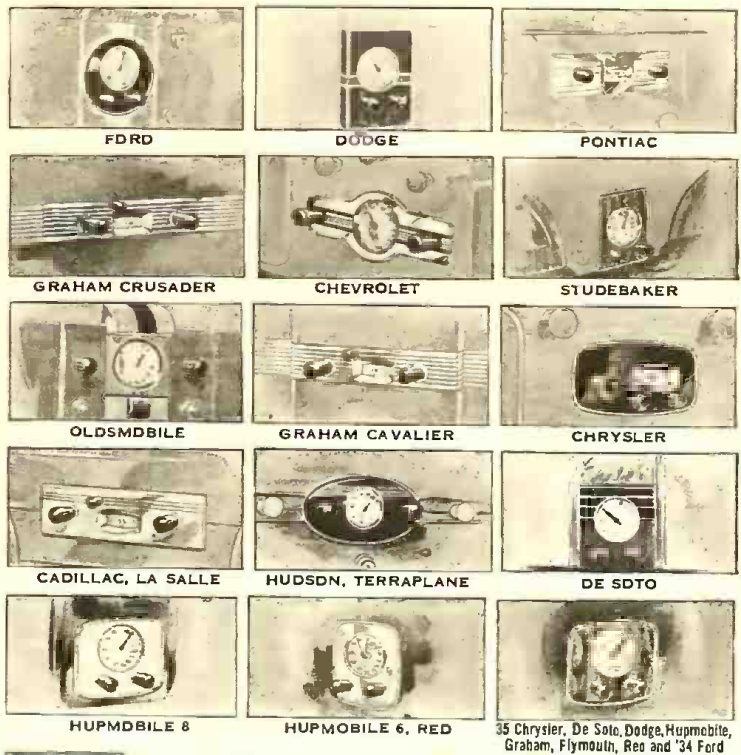

CROSLY ROAMIO A-266

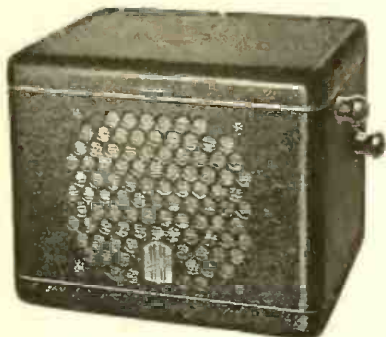

Six-tube superheterodyne automobile receiver with eight-tube effectiveness . . . no spark plug suppressors . . . balanced antenna tuning system . . . seven tuned circuits . . . full wave interruptor type vibrator . . . newly developed automatic volume control . . . automatic setting of dial logging . . . three gang tuning condenser . . . single housing . . . full floating moving coil electro-dynamic speaker . . . custom-built remote control with illuminated airplane type dial. Instrument panel controls that match the dash of any car are available. If preferred, however, steering column or under-dash controls are available.

\$39.95

(Prices slightly higher in Florida, Rocky Mountain States and west.)

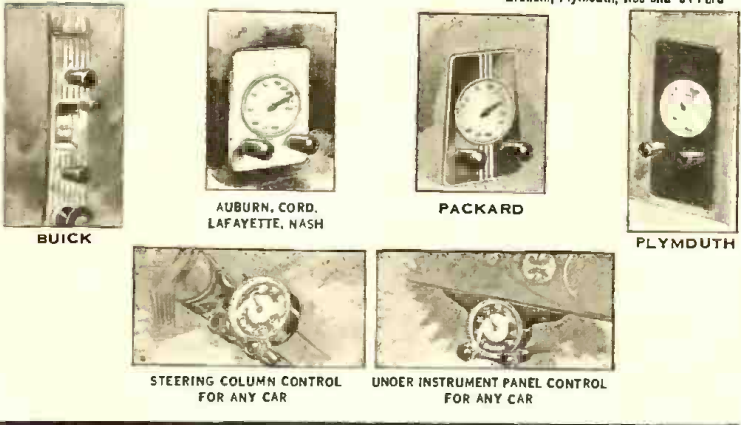

CROSLY ROAMIO A-366



Six-tube superheterodyne automobile receiver with nine-tube effectiveness . . . no spark plug suppressors . . . balanced antenna tuning system . . . seven tuned circuits . . . full wave synchronous type vibrator . . . newly developed noise reducing automatic volume control . . . bass compensation on volume control . . . automatic hess booster . . . push-pull amplification in output stage . . . full variable tone control . . . automatic setting of dial logging . . . three gang tuning condenser . . . full floating moving coil electro-dynamic speaker . . . adaptable to either header or under-dash speaker or combination of both . . . custom-built remote control with illuminated airplane type dial. Prices include choice of remote control.

\$54.95

With matched dual speakers . . . \$61.95

THE CROSLY RADIO CORPORATION, CINCINNATI POWEL CROSLY, Jr., President

C.I.T. Localized Finance Service Now Available for Radio Dealers

RADIO manufacturers, from A to Z, are now providing their dealers with the C. I. T. Budget Plan.

This makes available for radios the same quick, personalized service that has helped dealers build record sales for refrigerators and other major household appliances.

Furthermore, you can now offer your customers a combination C. I. T. Budget Plan sale of any two or more acceptable articles in one contract.

With the advantage of this new and better selling weapon the 1936-37 season should be one of the most profitable that radio dealers have ever known.

C. I. T. with Local Offices throughout the country is as near to you as your telephone. For quick credit service and the purchase of paper call the nearest C. I. T. office.

AS SALES GO UP - PRICES COME DOWN

Once a Luxury for the Few - Now a Pleasure to all
- with the aid of Instalment Buying

The earliest radios, whether hand-made or department store, didn't cost very much at work very well. Later models were more efficient but expensive—features obtainable only by those who could pay cash.

Then the industry followed the great lead of automobile builders—made the sale of customer selling. Responsible families with small incomes could pay part cash and the balance out of earnings.

Better Sets at Lower Prices

Sales crept up and prices dropped down. Spread out by instalment plans, requires improved radio standards. Today people in all walks of life enjoy superior entertainment in their own homes, whether they buy cash or on the C. I. T. Budget Plan.

Again and again, creative genius, mass production and distribution will be kept by placing essential features within the reach of the average pocketbook—increased profit, improved products and decreased prices.

C. I. T. has been privileged to take an active part in this advance. From a small beginning in 1920, C. I. T. has grown to be the largest independent sales financing institution in America. Today the C. I. T. Budget Plan is enabling thousands of Americans to enjoy radio while paying for them out of income. Similarly, millions of families are enjoying the full benefits of automobiles, refrigerators, washing machines and other modern household conveniences which promote health, comfort and happiness.

Send for this Free 16-Page Booklet

The C. I. T. Budget Plan is for those who need ready cash management. "Bring out of hibernation" why you're in no real way out of it as far as C. I. T. when working on the instalment plan. For a free booklet, C. I. T. Corporation, Park Ave., New York, New York.

C.I.T. COMMERCIAL INVESTMENT TRUST CORPORATION

WIDENS THE SCOPE OF BUSINESS

This advertisement is one of a series appearing in leading weekly magazines and newspapers throughout the country, having a total circulation of over 12,000,000.

Abilene - Akron - Albany - Altoona
Amarillo - Asheville - Atlanta - Augusta
Bakersfield - Baltimore - Bangor - Bay Shore
Beaumont - Beckley - Billings - Binghamton
Birmingham - Boise - Boston - Bridgeport
Bronx - Brooklyn - Buffalo - Butte - Camden
Cape Girardeau - Carbondale - Cedar
Rapids - Charleston - Charlotte - Chatanooga
Chicago - Cincinnati - Clarksburg - Cleveland
Columbia - Columbus - Cumberland - Dallas
Dayton - Denver - Des Moines - Detroit
El Paso - Erie - Evansville - Florence
Fort Wayne - Fort Worth - Fresno - Glens Falls
Greensboro - Greenville - Hagerstown

Harrisburg - Hartford - Hempstead - Hickory
Houston - Huntington, W. Va. - Indianapolis
Jacksonville - Jamaica - Jomestown
Jersey City - Johnson City - Kansas City
Knoxville - Lexington - Lincoln - Little Rock
Los Angeles - Louisville - McAllen - Manchester
Memphis - Miami - Milwaukee - Minneapolis
Mobile - Montgomery - Montpelier - Mt. Vernon
Nashville - Newark - Newburgh - New Haven
New Orleans - New York - Norfolk
Oklahoma City - Omaha - Orlando
Paducah - Paterson - Peoria - Perth Amboy
Phoenix - Philadelphia - Pittsburgh

Portland, Me. - Portland, Ore. - Portsmouth
Poughkeepsie - Providence - Raleigh
Reading - Reno - Richmond, Ind.
Richmond, Va. - Roanoke - Rochester
Rome, Ga. - Sacramento - St. Louis - Salisbury
Salt Lake City - San Antonio - San Diego
San Francisco - San Jose - Savannah - Scranton
Seattle - Sportonburg - Spokane - Springfield,
Mass. - Springfield, Ohio - Stockton - Syracuse
Tampa - Texarkana - Toledo - Tucson - Tulsa
Utica - Washington - Watertown - West
Palm Beach - Wheeling - White Plains
Wichita - Wilkes-Barre - Wilson - Worcester
Yakima - Youngstown - Zanesville

C.I.T.

C. I. T. CORPORATION • NEW YORK • CHICAGO • SAN FRANCISCO
A UNIT OF COMMERCIAL INVESTMENT TRUST CORPORATION
CAPITAL AND SURPLUS MORE THAN \$100,000,000



HELPING DEALERS TO WIDEN THE SCOPE OF THEIR BUSINESS

SERVICE NOTES

(From page 50)

vicemen sending in a Stancor Transformer box top, or, without the box top, at a price of 25 cents to cover mailing costs.

NOVEL BUSINESS GETTER

★ Good-will and confidence are promoted by "guarantee" tag used by Universal Radio Service, Albany, N. Y. Tag with string is attached to inside of radio and the customer's attention is called to this fact.

Tag has feature that it tells customer a story—it reminds customer of when set was last serviced, it shows who the serviceman was and gives his telephone number. Some contrast to the policies of the fly-by-night gyp artist!

Good but not so effective is the idea of tacking your business card to the inside of the cabinet.



Moral is to make it easy for customer to contact you in case set fails again. This creates confidence and brings in new and repeat business through your old customers.

SIMILARITIES OF RADIO TUBES

★ Accompanying tabulation (page 55) on tube types will familiarize the serviceman with the new tubes. Listing compiled by Hygrade-Sylvania Corp. shows what tubes give similar service or operation—it shows what new ones correspond to the old tubes with which the serviceman is already familiar.

The left hand, or reference, column is used for indexing purposes, while the second column gives the service or application of the tube. The three columns at the right list under the three headings, "Metal," "G," "Original glass," the types which give equivalent service (not replacement) in the circuit application of these three classes. (To page 54)

PLUS POWER



PLUS APPEARANCE

PLUS ECONOMY

60 WATT . . 4 POSITION AMPLIFIER

USING NEW 6L6-TUBE

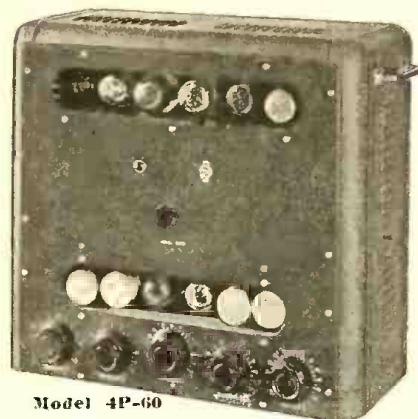

Model 4P-60

MODEL 4P-60

- 60 Watts Undistorted Output
- One to Four Position Input
- High Gain 143 db.
- Handles One to 10 Permanent Magnet Speakers
- Tapped Output Impedance
- Uses 4-6C6, 2-6A6, 1-76, 1-6E6, 2-6L6, 1-83, 1-5Z3 (furnished)

FULLY LICENSED
STRICTLY DEALER TIME PAYMENT
POLICY PLAN

WEBSTER-CHICAGO engineers have designed this extraordinarily powerful amplifier to fit in a compact, sturdy, attractive cabinet.

The 6L6 is an audio amplifying tube, using the newly discovered beam principle of controlling electronic emission. Properly handled, this tube develops a new order of amplification.

Think of a sound system having 60 watts undistorted output and yet the amplifier being no larger nor weighing any more than many amplifiers that heretofore developed but one-half or less power.

As you would expect, the economy is in proportion too. You will want to learn more about P.A. systems with this Webster-Chicago development. It opens up new possibilities for all sound dealers or engineers.

The development of this amplifier is again proof of Webster-Chicago leadership in this fast moving field. Sound dealers and engineers are urged to visit displays at Webster-Chicago jobbers.

See your jobber or write

WEBSTER - CHICAGO

manufactures a complete line of synchronized public address systems, sound equipment amplifiers and accessories of all kinds.

WEBSTER-CHICAGO
Section AU-9—3825 W. Lake St., Chicago, Ill.
Please send me more information on Model 4P-60—
I am also interested in sound systems for
—Rentals; —Portables; Fixed Systems, —Low Power, —High Power; Institutional Systems, —Hotels, —Schools.
Name
Address
City State.....

This ad pinned to your letterhead will bring you complete data on the great Baldwin line of Replacement Speakers.

CONSOLIDATED RADIO PRODUCTS CO. 361 W. SUPERIOR ST., CHICAGO
60 E. 42nd STREET, NEW YORK, N. Y.

A NEW DIRECT MAIL SERVICE IN RADIO

MANY advertisers have found difficulty in getting a really efficient mailing service. The demand has been for mailings to supplement or intensify trade paper campaigns, to run independently, to make special announcements or to send out literature giving greater detail than is usually given in space advertisements. Knowing of RADIO TODAY'S new technique in building lists for circulation purposes, these advertisers have wanted a corresponding efficiency in their direct mail work.

Now, through an affiliation with the W. P. Woodall Company, RADIO TODAY is able to offer a comprehensive radio mailing service. W. P. Woodall is a direct mail specialist. He organized and managed the McGraw-Hill direct mail department for 10 years and recently resigned to establish his own company to specialize in radio mailing service. In conjunction with that work, the Woodall company will manage and operate the direct mail division of RADIO TODAY.

In providing this additional approach to the radio market, the Woodall company will use strictly up-to-date lists of worth-while concerns, all classified so as to permit the selection of desired groups, and to omit all unwanted groups. The service is available to manufacturers, jobbers and others desiring to reach any division of the radio field with direct mail advertising. In selectivity and coverage, it will match precisely the sales effort of the advertiser, whether that effort is directed to vocational groups, or territorially, or both.

Full information on new lists and breakdowns, mailing rates, etc., may be obtained through this publication.

RADIO TODAY
480 Lexington Ave.
New York, N. Y.

SERVICE NOTES

(From page 53)

No implication is intended by the use of the term "equivalent" that the tubes so indicated are interchangeable. Where two or more types are listed together in any one of the group columns, it is indicated that, while there exists differences in characteristics, nevertheless the general function and classification of these two or more types are the same.

Note: The information contained in the tabulation is intended for the convenience of the serviceman in familiarizing himself with new tubes and should not be used in replacement work.

PROTECTING ANTENNA TRANSMISSION LINES

★ Service note from Philco suggests using a short section of braided loom at the top nail-it-knob insulator to keep the transmission line from

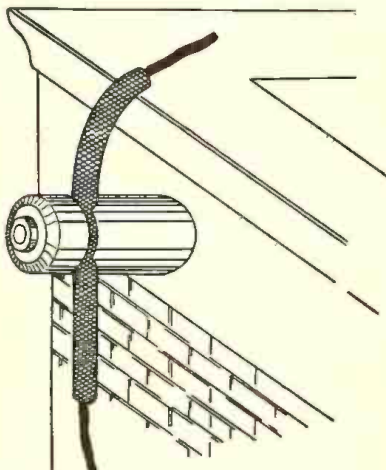

breaking due to swaying (see illustration). Loom prevents jerks from being applied at any single point and eliminates sharp angles in the transmission feeder. The braided loom can be purchased at any electrical supply house.

IMAGE FREQUENCIES—HOW TO USE THEM IN ALIGNING SETS

★ While alignment of the oscillator and r-f. circuits of all-wave superhets is practically the same for all bands, on the high frequencies care must be taken to align the oscillator at the correct frequency.

Theoretically the oscillator frequency can be either above or below the signal frequency of the 1st detector, but for proper operation it *must* be the frequency for which the manufac-

(To page 56)



CAPACITOR ANALYZER and RESISTANCE BRIDGE

CAPACITY, power factor, leakage, resistance, directly on the panel! The highly sensitive No. 6E5 Cathode Ray Tube is used for balancing. Dials are color-coded to match settings. A refined and extended Wien bridge, built into instantly useful form for laboratory, shop and field work.

Jobbers In All Leading Cities

SOLAR MFG. CORP.
599-601 Broadway, New York, N. Y.

PERFORMANCE PLUS This Practical "CHANGEABLE" FEATURE

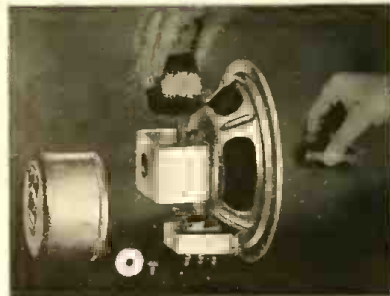

SPEAKERS by OXFORD

• Hear one of these new Oxford "Changeable Field" Dynamic Replacement Speakers! Then see how easily and economically you can change the field to suit your needs! Universal transformer matches any tube. Voice coil remains centered. Ideal for Service Men and Amateurs! Available in 6", 8" and 11" Models.

Ask your Jobber
— or write Now for Bulletin 361T

EXPORT DIVISION:
15 Laight Street, New York, N. Y.
Cable: "ARLAB"

"ACCEPTED BY SOUND JUDGMENT"

OXFORD-TARTAN
RADIO CORPORATION
915 W. VAN BUREN ST. • CHICAGO, U. S. A.

SIMILARITIES OF RADIO TUBES

Type	Function of Tube	Metal Octal base	"G" Octal base	Original Glass
TWO VOLT BATTERY TYPES				
1A4	Remote cut-off R-F amplifier	1D5G	1A4, 34
1A6	Pentagrid converter	1D7G	1A6
1B4	Sharp cut-off R-F amplifier	1E5G	1B4, 32
1B5/25S	Duodiode medium mu triode	1H6G	1B5/25S
1C6	Pentagrid converter	1C7G	1C6
1C7G	Pentagrid converter	1C7G	1C6
1D5G	Remote cut-off R-F amplifier	1D5G	1A4, 34
1D7G	Pentagrid converter	1D7G	1A6
1E5G	Sharp cut-off R-F amplifier	1E5G	1B4, 32
1E7G	Double output pentode	1E7G
1F4	Power output pentode	1F5G	1F4
1F5G	Power output pentode	1F5G	1F4
1F6	Duodiode pentode	1F7G	1F6
1F7G	Duodiode Pentode	1F7G	1F6
1H4G	Medium mu triode	1H4G	30
1H6G	Duodiode medium mu triode	1H6G	1B5/25S
1J6G	Double class B amplifier	1J6G	19
15	R-F pentode (Heater)	15
19	Double class B amplifier	1J6G	19
30	Medium mu triode	1H4G	30
31	Power output triode	31
32	Sharp cut-off R-F amplifier	1E5G	32, 1B4
33	Power output pentode	33
34	Remote cut-off R-F amplifier	1D5G	34, 1A4
49	Power output pentode	49

FIVE VOLT RECTIFIERS				
5V4G	Rectifier	5V4G	83V
5W4	Rectifier	5W4	80
5X4G	Rectifier	5X4G	5Z3
5Y3G	Rectifier	5Y3G	80
5Y4G	Rectifier	5Y4G	80
5Z3	Rectifier	5X4G	5Z3
5Z4	Rectifier	5Z4	80
80	Rectifier	5Y3G, 5Y4G	80
83V	Rectifier	5V4G	83V

SIX VOLT TYPES				
6A3	Power output triode	6B4G	6A3
6A4/LA	Power output pentode	6A4/LA	6A4/LA
6A6	Double class B amplifier	6N7	6N7G	6A6
6A7	Pentagrid converter	6A8	6A8G	6A7
6A8	Pentagrid converter	6A8	6A8G	6A7
6A8G	
6B4G	Power output triode	6B4G	6A3
6B5	Power output amplifier	6N6G	6B5
6B7	Duodiode pentode	6B7
6C5	Medium mu triode	6C5	6C5G, 6J5G	76
6C5G	
6C6	Sharp cut-off R-F pentode	6J7	6J7G	6C6, 77
6D6	Remote cut-off R-F pentode	6K7	6K7G	6D6, 78
6E5	Cathode-ray tuning indicator	6E5
6E6	Double triode power amplifier	6E6
6F5	High mu triode	6F5	6F5G, 6K5G
6F5G	
6F6	Power output pentode	6F6	6F6G	42
6F6G	
6F7	Triode pentode	6F7
6G5	Cathode-ray tuning indicator	6G5
6H6	Duodiode	6H6	6H6G
6H6G	
6J5G	Medium mu triode	6C5	6J5G, 6C5G	76
6J7	Sharp cut-off R-F pentode	6J7	6J7G	77, 6C6
6J7G	
6K5G	High mu triode	6F5	6K5G, 6F5G
6K6G	Power output pentode	6K6G	41
6K7	Remote cut-off R-F pentode	6K7	6K7G	78, 6D6
6K7G	
6L6	Power amplifier	6L6	6L6G
6L6G	
6L7	Pentagrid mixer	6L7	6L7G
6L7G	
6N6G	Power output amplifier	6N6G	6B5
6N7	Double class B amplifier	6N7	6N7G	6A6
6N7G	
6Q7	Duodiode high mu triode	6Q7	6Q7G	75
6Q7G	
6R7	Duodiode medium mu triode	6R7	6R7G	85
6R7G	
6X5	Rectifier	6X5	6X5G	84
6X5G	
36*	Sharp cut-off R-F amplifier	6J7	6J7G	36, 6C6, 77
37*	Medium mu triode	6C5	6C5G, 6J5G	37, 76
38*	Power output pentode	38
39/44*	Remote cut-off R-F pentode	6K7	6K7G	39, 44, 78, 6D6
41	Power output pentode	6K6G	41
42	Power output pentode	6F6	6F6G	42
75	Duodiode high mu triode	6Q7	6Q7G	75
76	Medium mu triode	6C5	6C5G, 6J5G	76
77	Sharp cut-off R-F pentode	6J7	6J7G	77, 6C6
78	Remote cut-off R-F pentode	6K7	6K7G	78, 6D6
79	Double class B amplifier	79
84	Rectifier	6X5	6X5G	84
85	Duodiode medium mu triode	6R7	6R7G	85
89	Triple grid output	89

* Indicating types little used for initial equipment at present but listed to indicate superseding types.

SPECIAL AC-DC TYPES				
25A6	Power output pentode	25A6	25A6G	43
25A6G	
25Z5	Rectifier	25Z6	25Z6G	25Z5
25Z6	
25Z6G	Rectifier	25Z6	25Z6G	25Z5
43		Power output pentode	25A6	25A6G

MORE THAN 3,000,000 RADIOS, NOW IN USE, HAVE UTAH PARTS AS ORIGINAL EQUIPMENT

FOR THE PAST FIFTEEN YEARS, UTAH HAS BUILT THE BEST SPEAKERS, VIBRATORS, TRANSFORMERS, CHOKES, VOLUME CONTROLS, TONE CONTROLS, RESISTORS, JACKS, JACK SWITCHES, PUSH BUTTON SWITCHES AND PLUGS. USE GENUINE UTAH PARTS! WITH ONLY TWENTY MODELS, UTAH CAN SUPPLY REPLACEMENT SPEAKERS FOR PRACTICALLY ANY MAKE OR MODEL OF RECEIVER! VISIT OUR EXHIBIT AT I. R. S. M. SHOW, BOOTH 35, HOTEL PENNSYLVANIA, SEPTEMBER 18, 19, 20.



PART OF THE HUGE PUNCH PRESS LINE IN THE UTAH FACTORY WHERE THE STURDY, RIGID SPEAKER FRAMES AND BASKETS ARE FABRICATED.



"15 YEARS OF LEADERSHIP"

SERVICE NOTES

(From page 54)

turer built his set. For this reason it is essential that the serviceman be sure that he is using the correct beat.

There are two simple ways to tell whether the set is aligned to the high or low beat. See accompanying diagram. If a signal is produced in the set when the dial reading is increased by an amount equal to twice the i-f. frequency, the oscillator in the act is working at a frequency lower (low

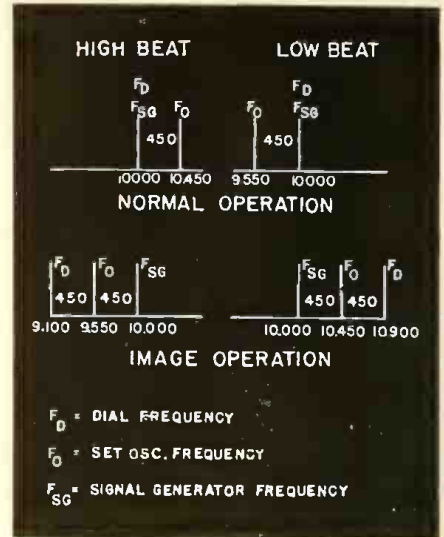

Chart showing frequency of dial, signal generator, and set oscillator for normal and image operation.

beat) than the detector. This is the usual mode of operation.

If the dial setting has to be decreased by an amount equal to twice the i-f. frequency to tune in the image, the oscillator is higher than the detector in frequency. (High beat).

During these tests it will probably be necessary to increase the output of the oscillator since the signal frequency circuits are out of tune.

A simple way to remember the frequency relationship is:
high image—low oscillator (usual)
low image—high oscillator (unusual)

when the set is retuned for the image—
not the test oscillator.

Two settings of oscillator trimmer

The second method of finding the beat is by adjustment of the oscillator parallel trimmer condenser. On the highest bands it will be found that there are two settings of the trimmer condenser which will give a peak. The setting with the greatest capacity—trimmer springs close together—is the low frequency peak, while the peak requiring less capacity is the high frequency one.

When aligning a set, a check should always be made to make sure that the proper beat is being employed—this means that the manufacturer's service data must be consulted. However, in about 95 per cent of the sets the oscillator works at the high beat-frequency higher than that of the detector and r-f. circuits.

If data is not available and in doubt as to whether or not the proper oscillator beat is being used, set the oscillator at various frequencies within the tuning range of that particular band and tune the set to reson-

(To page 60)

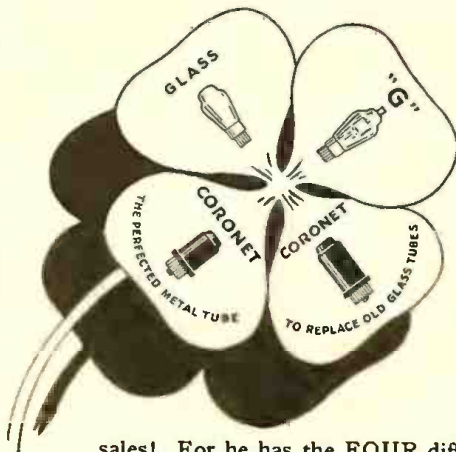

YOU'RE IN LUCK if you have ALL 4

THE DEALER or Serviceman who carries the ARCTURUS Line is lucky. He doesn't have to pass up

sales! For he has the FOUR different classes of tubes the public demands today:

1. GLASS. 2. "G". 3. CORONET—"the Perfected Metal Tube."
4. The NEW CORONET for modernizing old glass-tube sets

Only in ARCTURUS is this FOUR-WAY LINE available. Thousands of dealers and servicemen are cashing in on this FOUR-FOLD profit builder. 1936 is a good tube year. Make the most of it.

For full details of the 4-way Arcturus line write:

ARCTURUS RADIO TUBE CO., Newark, N. J.



ARCTURUS

GLASS—"G"

CORONET—THE PERFECTED METAL RADIO TUBES

Smash go PRICES!!

Triumph Condenser Bridge Analyzer

First Quality—latest design—9 built in Standards—50 mmfd. to 20 mfd. 50 ohms to 2 megohms. 50 microhenries to 20 millihenries. All direct readings. Visual leakage indicator tests leakages up to 1,000 megohms and just LOOK AT THE SMASHING OFFER!

Was \$20.00, NOW \$9⁹⁷



Triumph Preheater and Continuity Tester

For all filament voltages; directly calibrated; 14 sockets for all type of tubes. Tests pilot lights—Special Continuity Circuits with visual indicator. Saves over 75% of tube testing time and DRAS- TICALLY REDUCED.

Was \$14.95, NOW \$4⁹⁵



TRIUMPH MANUFACTURING COMPANY
4017 W. LAKE STREET CHICAGO, ILLINOIS

JOBBERB ON THE JUMP

replacement robot . . .

★ Steel cabinet of ingenious design is being offered to its jobbers by Aerovox Corp., 70 Washington St., Brooklyn, N. Y. Item has shelves and sliding doors, tells the serviceman what he needs for any given set, has a pocket for the latest replacement catalog, locates the necessary replacement unit, provides for automatic re-ordering of stock. Cabinet is available to jobbers stocking Aerovox exact duplicate condensers, at a nominal cost.

banquet for 150 . . .

★ Emerson's distributor in Albany, N. Y., Albany Distributing Corp. recently threw a country club banquet for 150 dealers of the area. Ben Abrams, Emerson president, addressed the group, and Nate Hast, eastern sales manager, also had a feature spot on the program. Dramatic announcements were made on the company's advertising tie-up with Lowell Thomas and Fannie Brice.

jubilee supplement . . .

★ F. B. Connelly Co., distributors of Seattle, Wash., have sent to their dealers a supplement catalog, issued as a follow-up to the Connelly Golden Jubilee book popular since last Fall.

new stocks . . .

★ As a result of the decision by Atwater Kent to promote radio lines less vigorously, 3 more jobbers have notified RADIO TODAY about what lines they will handle in place of AK: Rumsey Electric Co., Philadelphia, will stock Fada; C. M. McClung & Co., Knoxville, Tenn., will take on American-Bosch; Johnson Elec. Supply Co., Cincinnati, will handle Westinghouse.

fast manager . . .

★ Sentinel Radio Corp.'s go-getting sales manager, George W. Russell, recently made journeys to St. Louis and to Memphis, to return with a new list of Sentinel jobbers: Stratton-Warren Hdwe. Co., Memphis; Brown Supply Co., St. Louis; Shapleigh Hdwe. Co., St. Louis; and J. W. Davis.

drive in . . .

★ Walther Bros., Inc., Montgomery, Ala., jobbers who distribute Philco, were recently hosts to local dealers at an opening of new and improved quarters. Company now has twice its former floor space and has opened an up-to-the-minute drive-in auto radio service on an adjoining street.

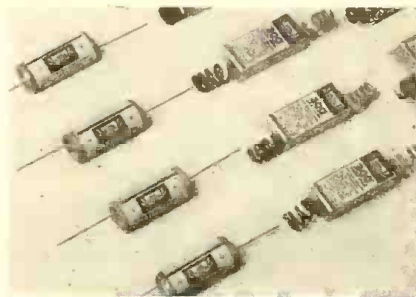

C-D PRODUCTION UP!

Competent observers predict that the production of radio receivers in 1936 will exceed SIX MILLION sets. And statistics show that the production of quality receivers predominates . . . it is no longer possible to compromise with quality and be successful.

Cornell-Dubilier's sales curve has shown a steady upward climb during the past year. . . . Cornell-Dubilier still maintains its dominant position in the industry. More condensers have been produced by us in 1936 than ever before in our history.

It has been no small task to obtain this recognition . . . we have had to be ever vigilant of our engineering progress . . . ever mindful of our obligation to the industry which we serve . . . "THE MAINTENANCE OF C-D QUALITY STANDARDS."

Available at all C-D distributors. Catalog No. 132A supplied on request.

WET & DRY ELECTROLYTIC • PAPER
DYKANOL • MICA

CORNELL-DUBILIER CORP.
4360 Bronx Blvd., New York, N. Y.



BIG SALES and GOOD PROFITS
with the NEW 1937

Freed-Eisemann
FAMOUS SINCE BROADCASTING BEGAN



One of
Our Many
Outstanding
Values—

LIST PRICE
\$17.95

STUDY THESE REMARKABLE FEATURES—

Model 50—Powerful 5 Tube Set • 5½", 4 color, illuminated Airplane Dial • Handsome Rubbed Walnut finish 2 tone Cabinet • Width 12", height 8", depth 7" • Natural Tone Dynamic Speaker • Works on either AC or DC current • Self-contained aerial; no ground needed • AN EXCEPTIONAL VALUE FOR QUICK, PROFITABLE SALES.

This model also available with extra band for shortwave, police and amateur calls—List Price \$18.95. Other FREED-EISEMANN models are priced from \$12.50 to \$49.95.

Prices on Export Models, for higher voltages and with long wave band on application.

DISTRIBUTORS AND DEALERS—Write for catalog and wholesale prices on complete line.

FREED MANUFACTURING CO., Inc.
44 WEST 18th STREET NEW YORK, N. Y.

FREE!

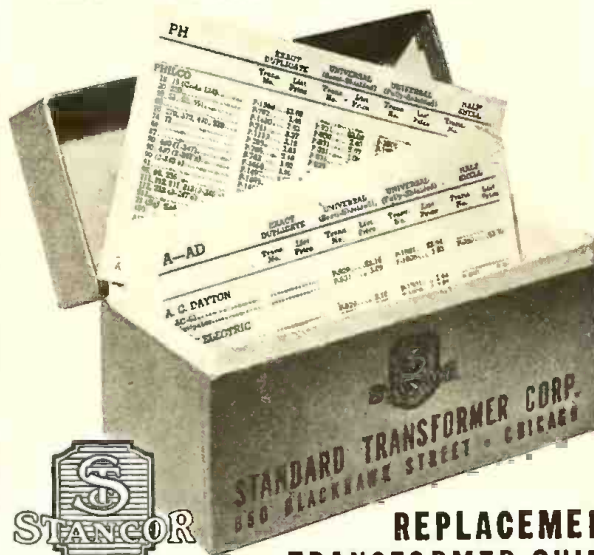

SEE OUR EXHIBITS—
Booth 2, IRSM Show, Sept. 18-20, Hotel Pennsylvania, New York. . . Booth 34, Amateur Radio Show, Sept. 5-7, Hotel Sherman, Chicago.

REPLACEMENT TRANSFORMER GUIDE

Don't hunt through page after page of catalogs for the right transformer for that replacement job—all the information is here, printed on cards in a handy card file—listing the right transformer for any receiver. It's FREE to users of Stancor Transformers.

MAIL THIS COUPON

STANDARD TRANSFORMER CORPORATION
856 Blackhawk Street, Chicago, Illinois
Please send me Stancor Replacement Guide.
I am enclosing Stancor Box Top.
I am enclosing 25 cents to cover mailing cost.

Name _____
Address _____

Your Guide to Profits!

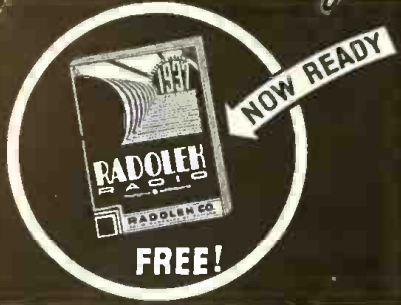

Everything In Radio

New Radio Profit Guide

Completely revised—right up to the minute—everything in radio—at the right price. Radolek makes money for you. Over 10,000 Repair Parts—a complete selection of Receivers, Amplifiers, Tubes, Tools, Books, Instruments—always in stock—ready for speedy shipment to you. You need this big Radio Parts Catalog. It's free! Send for it. Radolek endeavors to restrict distribution of The Profit Guide to those actively and commercially engaged in the Radio business. Please enclose your Business Card or Letterhead.

RADOLEK
621 W. RANDOLPH—CHICAGO

Send Me the Radolek Radio Profit Guide FREE.

Name

Address

Serviceman? Dealer? Experimenter?

JOBBERS

auspices . . .

★ One hundred and fifty dealers went to the Algonquin Club in Bridgeport, Conn., recently, to be guests of the D'Elia Elec. Co., at a lively Emerson show.

three to Bermuda . . .

★ Winners in the "On To Bermuda Contest," conducted by the Apollo Distributing Co., Crosley distributor, Newark, N. J., have been named by Sidney S. Muther of Apollo: J. H. Germond, E. A. Kirch Co., Newark; J. McKnight, Roth Seufferling Co., West New York; and J. E. Fitzgerald, J. E. Fitzgerald, Inc., Union City, N. J. Hundreds of other retail salesmen won merchandise awards.

show series . . .

★ Nassau Distributing Co., Inc., Newark, N. J., distributors of Grunow radios and refrigerators, are in the midst of a series of dealer shows in New Jersey. Company has attracted new dealers and will contact them with representatives Wooley Garvey, Henry Dresner, Jack Wheat, Morty Gutov, Harry Zinn, and Kelly Kaplan, all under the supervision of the corp. president, Louis Kaplan.

Representing the Nassau Co. in Southern New Jersey is Minna Saltzman, "probably the only wholesale saleswoman in the U. S."

classy conference . . .

★ At Wichita, Kan., and under the wing of local Philco distributor Spurrier's, Inc., more than 250 dealers and salesmen recently assembled for a big preview of 1937 sets and sales plans. They came from the Wichita, Dodge City, and Salina areas in Kansas, and from the Joplin area in Missouri. Supervisor of the event was Ray H. Turner, district rep for Philco; other company execs present were O. K. Spurrier, J. P. Stewart, E. E. Brammer, L. M. Kelly, and J. F. Leahy.

555 . . .

★ Frank Burke, of the Little Rock, Ark., distributing organization, 555, Inc., has reported that the company will handle a complete Delco line for the coming year.

here's a lift . . .

★ Harold W. Goldstein, chief of the Anchor Lite Appliance Co., Crosley distributors in Pittsburgh, Pa., has totaled up his radio sales for the month of June, 1936, and found that they were 500 per cent ahead of the same month last year.

200 years in Wheeling . . .

★ Ott-Heiskell Co., Crosley distributor of Wheeling, W. Va., is now celebrating its 100th birthday. City of Wheeling also has a centennial this year, and the radio wholesaler has worked out a tie-up in the anniversary events. Feature is Ott-Heiskell's special broadcasts on local Station WWVA.

ONLY Clarion OFFERS THIS
NEW
"year ahead"
P.A. LINE

If you are interested in a completely different line of Public Address amplifiers—if you believe that "year-ahead" features and unusual quality can bring you substantial PROFITS—then investigate the CLARION line. Ask your distributor for facts that prove themselves, or write direct to Dept.

**RATED OUTPUT
15 WATTS**

**2 ELECTRO
DYNAMIC
SPEAKERS**

**A SMART
LUGGAGE CASE**

**USES ANY
MODERN MIKE**

**PORTABLE
SOUND SYSTEM
Model C-17**

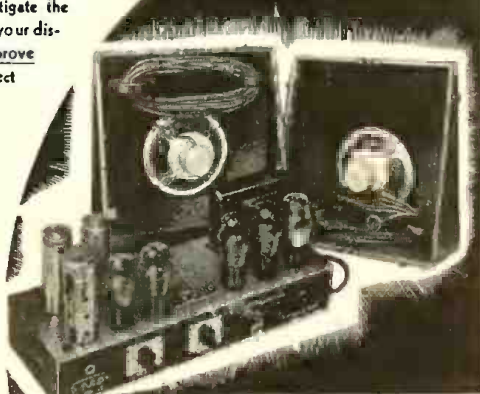

AMPLIFIERS BY

Clarion

**TRANSFORMER CORP. OF AMERICA
67 WOOSTER ST. . . NEW YORK . . N. Y.**



**JFD REMOTE-O-CABLE
REPLACER**
The ONE MACHINE that DOES IT ALL!



**\$3724
NET
To DEALERS**

Designed especially for auto radio work, the REPLACER easily and quickly removes old fittings—swedges cable to prevent unravelling—cuts cable to exact length—replaces old fittings on new cable.

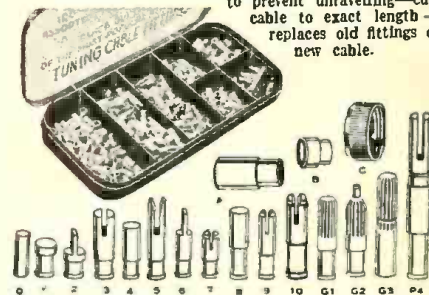

Auto radio control cable and bousing, same as originally used by leading set mfrs. 50, 100 and 200 ft. lengths. Plain and gear-type fittings and bousing-ends. Exact duplicates of size and quality. Equips you for 95% of all jobs. Write for 5-page catalog now ready.

J. F. DISTRIBUTING CO.

5024 Fort Hamilton Parkway
Brooklyn, N. Y.



J O B B E R S

no maddening crowd . . .

★ The Stromberg-Carlson representative in New York City, Gross Sales, Inc., has tried out a new type of dealer show to feature the company's 1937 line. Meetings are held in a series for dealers in small groups, three or four gentlemen at a time; Gross entertains four groups a day.

This series is the first big event to be staged in Gross' new show rooms at 570 Lexington Ave. Recent guests have been interested in the attractiveness of the new quarters, which were designed, laid out and constructed specially for more effective radio demonstrations and display.

Sunset Ridge . . .

★ Wood & Alexander, Stewart-Warner distributors of Hartford, Conn., invited their dealers to a friendly meeting recently at the local Sunset Ridge Country Club. Event had a golfing angle, but non-playing dealers found plenty to do. Whole thing was billed as "free from ballyhoo, high pressure and long tiresome sales talks." Fred R. Cross, Stewart-Warner ad manager, air-lined to the meeting.

turret shield . . .

★ New distributors for Fairbanks-Morse are the Capital Paper Co., Indianapolis, and the Keith-Simmons Hardware Co., Nashville, Tenn. Old FM refrigerator wholesaler, Bruno-New-York, Inc., New York City, has announced the appointment of Stern Bros., Manhattan, as a new dealer for the line.

from 28 counties . . .

★ Emerson jobber in Syracuse, N. Y., Graybar Elec. Co., was recently host to more than 200 dealers who came to the meeting from some 28 surrounding counties. Fred Carson, local Graybar exec, was chief host for the affair.

celebration dinner . . .

★ Because the Philco Radio & Television Corp. of Pennsylvania has held national leadership in sales since last May, the Atlantic Sales Division of Philco honored that wholesaler with a special dinner early this month. Peter Kain, manager, and Arthur C. Nodine, assistant manager, of the Atlantic Division, arranged for the event, and those of the Pennsylvania company who were complimented were John M. Otter (acting general manager), Clifford Malliet, Julian G. Pollock, J. P. Maguire, O. J. Tillett, M. J. Jaslow, Edward Neilson, A. J. Cronin, P. T. Tillett, and Eric Brehme.

New York to Dakotas . . .

★ Group of recently appointed distributors for Fairbanks-Morse are: Grant-Dadey Co., for North Dakota and Northwestern Minnesota; Northeastern Radio, Inc., Providence, R. I., for Rhode Island; York Automotive Distributing Co., New York City.

6 MILLION FARMS NEED ELECTRICITY!

Sell Them The PIONEER GAS-ELECTRIC POWER PLANT

for as little as **\$44.95**
LIST

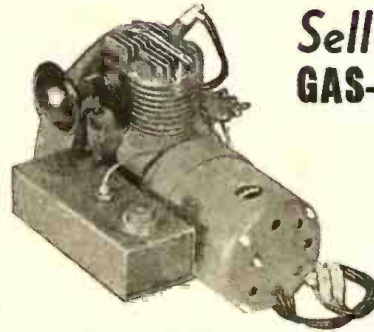

OTHER SMALL PLANTS

- ★ The PIONEER "Baby Jumbo" Gas-Electric Plant with magneto ignition: 6, 12 volts 150 watts DC; 6 volts 200 watts DC; 12, 32, 110 volts 250 watts DC. \$49.95 to \$59.95
- ★ The PIONEER "Blue Diamond" Gas-Electric Plant, 110 volts 300 watts AC. Supplies regular "city" current. Also has 50 watt DC winding for charging 6-volt batteries \$79.95

PUSH BUTTON STARTER! ENGINE AND GENERATOR DIRECT CONNECTED! Imagine the sales possibilities of this sturdy PIONEER Gas-Electric Power Plant! Conservatively rated at 200 watts, this 6 or 12-volt unit will keep the farmer's radio, auto and truck batteries charged, light his home, and provide $\frac{5}{8}$ hp. for driving any kind of small machinery mechanically! Powered by famous Lauson engine.

"GRAND CHAMPION"

This model is ideal for farm homes, camps, construction jobs, small garages, schools—wherever a large volume of Direct Current is needed. Equipped with PUSH-BUTTON STARTER! This heavy-duty, large capacity PIONEER Gas-Electric Power Plant is powered by a 4-cycle, single cylinder, air cooled Lauson engine. Built to stand up under 3 years of hard usage.

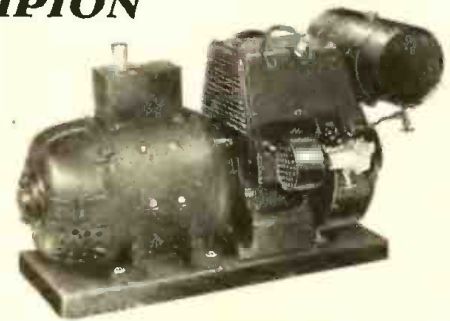

Capacity: 500 watts DC 32 or 110 volts; 1500 watts DC 110 volts.
Other large plants:
★ The PIONEER "Gold Crown" Gas-Electric Plants, 600, 1000 and 1500 watts 110 volts AC 60 cycles—1800 rpm.

Other Pioneer Products

"Silver Band" Dynamotors,
"Red Seal" Gen-E-Motors, Rotary Converters in various sizes and voltages. Mail coupon for full details.

MAIL THIS COUPON QUICK!

PIONEER GEN-E-MOTOR CORPORATION
464Y West Superior Street, Chicago, Ill.
(Cable Address "Simontrice" New York)

RUSH FULL DETAILS

Gas-Electric Power Plants Dynamotors
 Converters Gen-E-Motors

Name

Address

City..... State.....

GUTHMAN

Coils

● Guthman Coils are dependable! No matter what your requirements, there's a Guthman coil that will fit the job! Send us your specifications — we'll gladly submit samples and SPECIAL LOW PRICES!



EDWIN I. GUTHMAN and CO., Inc.
400 South Peoria Street, CHICAGO, ILLINOIS



Custom-Fitted!

For that fussy trade that insists on repairs that look as good as they work, you can bank on CLAROSTAT Exact Duplicate Controls because:

★ DATA

Most complete listing of exact duplicate controls covering requirements of all standard sets.

★ UNITS

Exact duplicate controls available, mechanically and electrically matching original equipment.

FREE GUIDE Send today for that big 80-page CLAROSTAT Volume Control Replacement Guide No. 2. Meanwhile, see your local jobber about those custom-fitted CLAROSTAT controls.

CLAROSTAT

MANUFACTURING CO.
Incorporated

285 North Sixth St.
Brooklyn, N. Y.





VENI VIDI VICI

UNKNOWN a year ago, MAGIC MAGNET SPEAKERS have brought to the radio industry a new concept of speaker performance. Manufacturers and Engineers were incredulous . . . unbelieving. It is greatly to the credit of the industry that foresighted manufacturers put them to every conceivable test and, when they had been proven—adopted them.

Amateurs, servicemen, public address technicians, quick to sense a revolutionary development, clamored for information and expressed their wholehearted approval with orders.

Thus, in an incredibly short space of time, CINAUDAGRAPH MAGIC MAGNET SPEAKERS came, saw and conquered.

Full technical data supplied on request.

●

CINAUDAGRAPH CORPORATION
Speaker Division, Dept. T. • Stamford, Conn

CINAUDAGRAPH

SERVICE NOTES

(From page 56)

ance. If the set will operate over the entire band with approximately the same sensitivity, it is reasonably certain that the proper beat is being used.

Another thing about checking images is that it eliminates errors in getting the right beat due to inaccurate calibration of the test oscillator. The set dial may be set for 15,000 kc. and the test oscillator may be generating a signal at 15,900 kc. instead of 15,000 kc. If the i-f. were 450 kc., then this signal would produce an output in the set because 15,900—15,450 equals 450 (assuming set uses high beat-set oscillator at 15,450 kc.)

IRSM CONVENTION

★ Event of the year for the radio serviceman is the New York City "1936 New York Radio Trade Show and 4th Annual Institute of Radio Service Men's N. Y. Convention," set for the Hotel Pennsylvania, Sept. 18 to 20, inclusive. Organization headquarters are at 510 N. Dearborn St., Chicago; secretary is Ken Hathaway.

READERS WRITE IN ABOUT "RADIO'S CANCER SPOT"

Mfrs. again

"Your efforts to expose 'Radio's Cancer Spot' are certainly appreciated here. Frankly I cannot see how you can do anything about it until the big manufacturers . . . can find a way to void present laws against regulating retail prices."

Barrow Radio,
Great Neck, N. Y.

Consumer angle

" . . . as difficult as trying to correct the evils of Wall Street! I have a plan whereby the public and the radio manufacturers are protected. The Better Business Bureau, Federal Trade Commission, RMA, and IRSM operate only in individual cases."

Kelley Radio Service,
Hempstead, N. Y.

Not so dizzy

"Here is one plan you may have missed—the 10 per cent discount plan." (This suggestion calls for legislation compelling dealers to sell to each other at a 10 per cent discount off the consumer price. Theory is that no dealer would price any item at less than he could afford to sell it for—Ed.)

A DIZZY DEALER.

Engine numbers

"A serial number on each radio could enable manufacturers to stop price-cutting. Provided, however, that the manufacturers were really anxious to prevent this and would be willing to fight for that purpose."

New St. Hardware Co.,
New York City.



MAKES POSSIBLE

noise-filtered radio . . .



The undoubted nuisance of "man-made" static from household appliances can at last be strained out on BOTH broadcast and shortwave bands. "NOISE-MASTER," the Amy, Aceves & King licensed antenna, improves radio reception in any and all locations. Made in several models to fit every requirement. Investigate!

Send for full particulars

CORNISH WIRE CO., Inc.
30 CHURCH ST., NEW YORK CITY

Ready ALLIED'S 1937 RADIO CATALOG

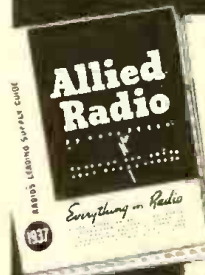

Every Service Department needs this up-to-the-minute Catalog! 152 pages packed with everything in radio, including the very latest developments.

Over 10,000 exact duplicate and replacement parts—newest service test equipment, tube testers, oscillographs, analyzers, meters—radio books, tools—38 new low-priced radio

receivers—All-Wave, Dual-Wave and Short-Wave, from 5 to 17 tubes—AC, battery, 32-volt, 6-volt and auto sets; latest Public Address systems—America's most reliable Win-charger and Ruripower units—tubes, batteries, accessories, etc. You can fill every service need from the ALLIED Catalog, at lowest prices. Just send coupon.

YOUR
SERVICE
DEPT.
NEEDS IT

SEND COUPON

ALLIED RADIO

833 W. JACKSON BLVD. Dept. 15-H
Chicago, Ill.

Send us your new 1937 Catalog (Free).

Name

Address

City..... State.....

TRADE NEWS

★ Earl S. Dietrich has been named manager of distributors' sales for the Raytheon Production Corp.; his headquarters will be at the company's New York City offices at 420 Lexington Ave. He will work under the general supervision of Raytheon's general sales manager, Edgar S. Riedel, whose headquarters continue at the company's Chicago offices, 445 Lake Shore Drive.

★ Philco has filed suit in New York Supreme Court charging that RCA has used agents to entertain women employees of Philco in order to secure inside information about the making of the latter's radio sets. RCA vice-president and general counsel Manton Davis replied that "there is no foundation whatsoever to the charge that RCA attempted . . . to obtain information as to the laboratory research, designs, distribution policies, or any other trade secrets of Philco."

★ Wallace Clarke, of the firm of H. W. Clarke, Ltd., prominent wholesalers of Wellington, New Zealand, was a recent visitor to the Ken-Rad plants at Owensboro, Ky.

★ Transformer Corp., N. Y. C., makers of Clarion P.A. equipment, have named sales representatives for 18 states: For Washington, Oregon, Idaho, Montana, Utah and British Columbia Province, Northwestern Agencies, 3rd and Vine Sts., Seattle, Wash.; for California, Arizona, Nevada and New Mexico, Conrad B. Strassner, 1425 S. Flower St., Los Angeles, Cal.; for Maine, Vermont, New Hampshire, Massachusetts, Rhode Island and Connecticut, H. Gerber, 94 Portland St., Boston, Mass.; for West Virginia and Western Pennsylvania, G. O. Tanner, 600 Grant St., Pittsburgh, Pa.

★ Stanley Manson, long-time direct factory representative for Stromberg-Carlson, has been awarded a larger territory in which to function. Besides western New York state, Manson will cover the cities of Buffalo and Syracuse, and adjacent areas where Stromberg has recently appointed new jobbers.

IN HEAVY PRODUCTION to meet a TREMENDOUS DEMAND

now!

PERM-O-FLUX

PERMANENT MAGNET

Dynamic Speaker



Your Set Manufacturer's
**Requirements are Assured by Our
 Unlimited Supply of a Rare New
 Magnetic Metal**



● The metal was developed in the Continental laboratories and is manufactured right in the Continental plant. Continental engineers have brought this metal to such a degree of perfection that it is unequalled for radio speaker reproduction. Prominent set manufacturers are finding that the superior tone qualities of Continental PERM-O-FLUX Dynamic Speaker have materially contributed to increased set sales.

BE SURE TO SEE
CONTINENTAL
 EXHIBIT AT THE
 National Electrical
 and Radio Exposition
GRAND CENTRAL PALACE,
 N. Y. Sept. 9 to 19th
 BOOTH NO. 3B

Among the PERM-O-FLUX features are: (1) a new type voice coil suspension that eliminates all possibility of rubbing; (2) a permanent flux density in the gap requiring no outside energy for field excitation, thereby reducing battery drain; (3) simplicity of installation; (4) no shielding required in automobile installation. The PERM-O-FLUX Speakers are available in many models and sizes. Complete literature on request.

Continental Motors Corporation

Radio Speaker Division
 12801 East Jefferson Ave. - Detroit, Michigan

Polyiron Parts Give You

GREATER GAIN

BETTER DX

INCREASED SELECTIVITY

LOWER NOISE LEVEL



Aladdin

TRADE MARK REG. U.S. PAT. OFF.

Write for Bulletin 536 filled with valuable technical data. . . Aladdin Radio Industries, Inc., 466T West Superior St., Chicago, Ill.

NEW Wright-DeCoster 12" NOKOIL Speaker



MODEL 982

The permanent magnet used in the Model 982 furnishes a field comparable to the electro dynamic units.

- Universal Transformer
- Para-Curve Diaphragm
- Impressive Appearance
- Draws No Current
- Electro Dynamic Performance

LIST PRICE **\$9.82**

The extreme sensitivity of this reproducer makes it adaptable to all types of battery sets. The demand for this unit has already been created and at the price it is destined to be one of the fastest selling items the radio industry has ever had.

Write for complete catalog and name of nearest distributor. Wright-DeCoster distributors are always anxious to cooperate.

WRIGHT-DECOSTER, INC.
2265 University Ave., St. Paul, Minn.
Export Dept.: M. Simons & Son Co., New York
Cable Address: "Simonrice"
Canadian office: Wright-DeCoster, Inc., Guelph, Ont.

The Complete RADIO SERVICE LABORATORY!



Merchandize Modernized Service. This Laboratory emphasizes as nothing else can, the thoroughness of your work. It is **ADVERTISING — SHOWMANSHIP — SALESMANSHIP** all in one. Webber's complete line of Portable Radio Testing Instruments are all engineered with the same skill and care as the Official Radio Service Laboratory. Write for catalog.

EARL WEBBER COMPANY, Mfrs.
1217 Washington Blvd. Chicago, Ill.



TRADE NEWS

★ Quam-Nichols Co., makers of Quam speakers, moved its factory a few weeks ago to 33rd Place and Cottage Grove Ave., Chicago. In its new home, Quam-Nichols has facilities to take care of the requirements of manufacturers and jobbers, and according to Jim Quam, president, and Miss Helen Staniland, his popular assistant, there is a welcome on the door at all times for visiting members of the industry.

★ E. R. Kuhn, who was identified with the radio industry from 1922 to 1935 in important sales capacities, died at St. Joseph, Mich., July 23rd after an illness of a few days. Burial services were held at the Rose Hill Cemetery, Chicago, on July 27th and were attended by a number of prominent radio men, including Ernest Alschuler, Jerome J. Kahn, David Lipsey, and others. At the time of his death, Mr. Kuhn was sales manager of the Cooper-Wells Co., St. Joseph, Mich., hosiery manufacturers. He is survived by a widow, two sons, a daughter and a brother, Paul Kuhn, head of the Burnett-Kuhn Co., Chicago, well known advertising agency.



First among 10,000 — W. S. Cobb, shown here with Mrs. Cobb, suggested that the United Transformer Corp. call its transmitter kit "Unitype," thereby cinching UTC's national contest.

★ RCA Parts Division has made the announcement that servicemen may now purchase its test equipment with a small down payment.

D. W. Onan of D. W. Onan & Sons, 43 Royalston Avenue, Minneapolis, Minn., calls attention to an error made by the photographer in hooking up the grindstone to the small generating plant shown on page 19 of our July issue. This picture was one of a series of farm scenes, taken especially for **RADIO TODAY**, and obviously the grindstone should have been shown driven through a speed-reduction shaft.

★ C. A. Verschoor, president of International Radio Corp., Ann Arbor, Mich., has announced a new angle on his company's merchandising efforts for the coming year. Dramatic accent will be given to the Kadette name throughout the campaign.



Maximum SIGNAL .. Minimum NOISE

- ★ TACO No. 200 System—product of years of specialized engineering... thousands of tests... present demand for the superlative.
- ★ All-wave—broadcast, police, amateur, short-wave. Self-selecting—no switching for bands. Noiseless.
- ★ Factory assembled, wired, soldered—ready to string up. No extras to buy.
- ★ Neatly packaged. Complete instructions. Ideal over-the-counter or service-call item. A "natural" at \$0.75 list.

Write for technical and sales data on this and other technical systems for any radio set, as well as master antenna system for modern home, apartment, hotel, etc.

TACO
TECHNICAL APPLIANCE CORP.
Pioneers in Noiseless Antenna Systems
17 East 16th St., New York City

COMPLETE ELECTRIC PLANTS



ONAN ALTERNATING CURRENT PLANTS OPERATE A.C. RADIO, PUBLIC ADDRESS SYSTEMS, SOUND CAR EQUIPMENT, MOTION PICTURES.

Can Be Used Anywhere

Supply Electricity for Camps, Cottages, Farms, Boats, Commercial Purposes and places where current is not available from power companies. Will Operate Water System, Refrigerator, Household Appliances.

Sizes to Suit Every Purpose

Built in sizes 350 to 50,000 watts, \$110 and up. Supply 110 or 220 volt, 60 cycle, single or three phase current. Operate on Gasoline, Gas or Distillate. Also 32 volt. D.C. Models. All Models furnished complete, ready to run.

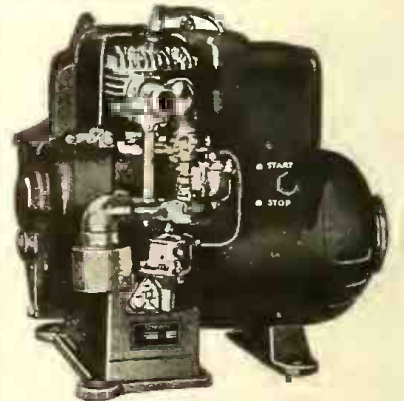

Write for details

D. W. ONAN & SONS
564 Royalston Ave. Minneapolis, Minn.

CONFIDENT that present markets are unusually receptive and offer more than ordinary sales opportunities, the country's leading electrical and radio manufacturers, distributors, and service organizations are cooperating in a mammoth presentation of their products and services to the vast Metropolitan New York Public in "An Exposition Created by the Industry, for the Industry, and the Public it Serves."

The Electrical Association of New York, Inc., sponsors, take pleasure in presenting the following list of exhibitors in the 1936 National Electrical & Radio Exposition.

RADIO

Ansley Radio Corp.
Continental Motors Corp. (Speaker Div.)
Crosley Radio Corp.
Emerson Radio & Phone Corp.
Fada Radio and Electric Co.
Fairbanks, Morse & Co.
General Electric Co.
Halson Radio Mfg. Corp.
International Radio Corp.
Majestic Radio & Television Co., Inc.
Midwest Radio Corp.
Pierce Airo Inc.
Pilot Radio Corp.
RCA Manufacturing Co., Inc.
Radiobar Company of America
Radio Lamp Co., Inc.
Sparks-Withington Co.
Stewart-Warner Corp.
Stromberg-Carlson Telephone Mfg. Co.
United American Bosch Corp.
Westinghouse Electric Sy. Co., Inc.
Zenith Radio Corp.

RANGES

Rex Cole Inc. (General Electric)
General Electric Co. (Hotpoint)
Kelvinator Corp.
Landers Frary & Clark
Lindemann & Hoverson Co., A.J.
Norge Corp.
Westinghouse Elec. & Mfg. Co.

REFRIGERATION

Apex Rotarex Corp.
Rex Cole Inc. (General Electric)
Crosley Radio Corp.
Fairbanks, Morse & Co.
Frigidaire Corp.
General Electric Co. (Hotpoint)
Kelvinator Corp.
Majestic Radio & Television Co., Inc.
Norge Corp.
Sears, Roebuck and Co.
Sparks-Withington Co.
Stewart-Warner Corp.
Westinghouse Elec. & Mfg. Co.

VACUUM CLEANERS

Apex Rotarex Corp.
Eureka Vacuum Cleaner Co., Inc.
General Electric Co.
The Hoover Company
Premier Division, Electric Vacuum Cleaner Co.
Singer Sewing Machine Co., Inc.
Westinghouse Elec. & Mfg. Co.

OIL HEATING AND AIR CONDITIONING

Continental Motors Corp.
Frigidaire Corp.
Kelvinator Corp.
Norge Corp.
Westinghouse Elec. & Mfg. Co.

MISCELLANEOUS

Bronx Gas and Electric Company
Brooklyn Edison Company, Inc.
Bruno-New York, Inc. (RCA Mfg. Co., Inc.) (Fairbanks, Morse & Co.)
Bushwick-McPhilben Corp. (Sparks-Withington Co.)
Caldwell-Clements, Inc.
Davega-City Radio, Inc.
Electrical Testing Laboratories
Horse Furnishing Review
Groller Society of London, Inc.
The International Nickel Co., Inc.
E. B. Lathan & Company (Hurley Machine Co.) (Landers, Frary & Clark) (International Radio Corp.)
McGraw Hill Publishing Co.
R. H. McMann, Inc. (United American Bosch Corp.)
The New York Edison Company, Inc.
New York and Queens Electric Light and Power Company
Radio Today
The Radio Weekly
Radio & Elec. Appliance Journal
Times Appliance Co., Inc. (Westinghouse Elec. & Mfg. Co.)
Warren-Norge Company, Inc. (Norge Corp.)
Westinghouse Lamp Co.

Wholesale Radio Equipment Co., Inc. (Stewart-Warner Corp.)
E. A. Wildermuth (Kelvinator) Corp.

LAUNDRY EQUIPMENT

Apex Rotarex Corp.
Crosley Radio Corp.
Fairbanks, Morse & Co.
General Electric Co.
Hurley Machine Co.
Norge Corp.
Westinghouse Elec. & Mfg. Co.

DOMESTIC APPLIANCES

Rex Cole Inc. (General Electric)
The Fay Company
General Electric Co.
General Electric Sy. Corp.
McGraw Electric Co., Waters-Genter Div.
National Enameling & Stamping Co.
Proctor & Schwartz Electric Co.
Silex Company, The
Singer Sewing Machine Co., Inc.
Wange Electric Co.
Warren Telechron Company
Westinghouse Elec. & Mfg. Co.
White Sewing Machine Company
Westinghouse Electric Supply Co., Inc.

NATIONAL ELECTRICAL & RADIO SHOW

Grand Central
Palace New York

SEPT.
9-19

Daily incl. Sunday
11 a.m. to 11 p.m.

TRADE ON A GALLOP

- Westinghouse names head for new sales promotion dept.
- Majestic picks "vet" for director of sales

★ Westinghouse Elec. and Mfg. Co. has named J. M. McKibbin as manager of its newly organized sales promotion department, to direct the activities of all district office sales promotion managers and to coordinate all apparatus sales promotion operations except those of the merchandising dept. McKibbin has been with Westinghouse for 16 years, has

been sales promotion manager for Cleveland, Detroit, and Pittsburgh offices, moves to his new post from former managership of industrial distribution.

★ Commercial Trading Corp., Crosley dealer of Portsmouth, Va., has moved to new and modernized quarters at 702-704 High St.

★ L. J. (Lou) Stutz, one of the "veterans" of the radio industry, has been appointed sales manager of the Majestic Radio & Television Corp., Chicago, manufacturers of Majestic radio receivers. Lou Stutz entered the radio industry in its early days and for many years was a sales executive in the Fada organization, attaining outstanding success in Middle West territory. He has also been identified with prominent jobbing organizations and therefore is familiar with the merchandising of radio products on both sides of the picture.

★ Ralph B. Austrian and M. F. Burns, widely known radio executives, have been elected assistant vice-presidents of the RCA Mfg. Co. Austrian, whose headquarters are at the company's 411 Fifth Ave. studios, in New York, will maintain close contact with motion picture producers and theatre circuit operators in the East, in connection with RCA Photophone's sound recording and reproducing equipment sales activities. Mr. Burns will establish similar contacts with the producers and large exhibitors on the West Coast, and will make his headquarters at RCA's Hollywood studios.

★ Irving Sarlin, the dynamic radio merchandiser who was mentioned in July "Radio Today" as having been appointed radio buyer for the "Ludwig-Bauman chain," has more accurately received that appointment from the C. Ludwig Bauman Co., Brooklyn, N. Y.

GOVERNED POWER!

The Wind Successfully Harnessed At Last With the GYROMATIC 6-VOLT WINDCHARGER

The success and life of any wind-charger depends upon the efficiency of its governing device. The GYROMATIC patented principle of control efficiently, actually and visibly governs propeller speed under all conditions.

SIMPLE, STURDY CONSTRUCTION MADE POSSIBLE BY THIS PRINCIPLE REQUIRES LESS THAN HALF THE PARTS USED BY OTHERS

New Delco Remy Generator especially developed for windcharger work. The successful result of years of research and experiment. Sealed bearings that require no further lubrication.

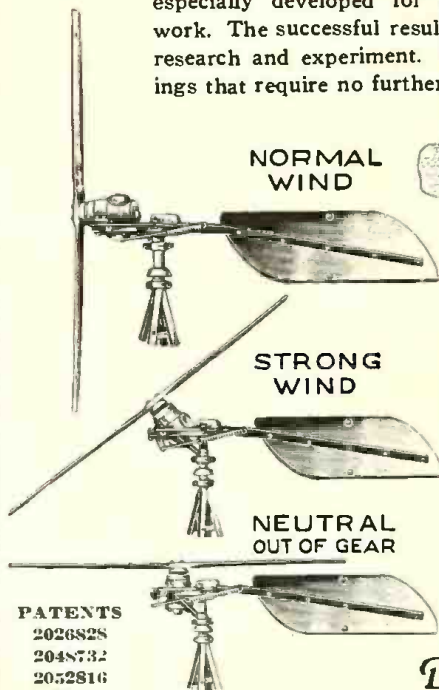

PATENTS
2026828
2048732
2052816

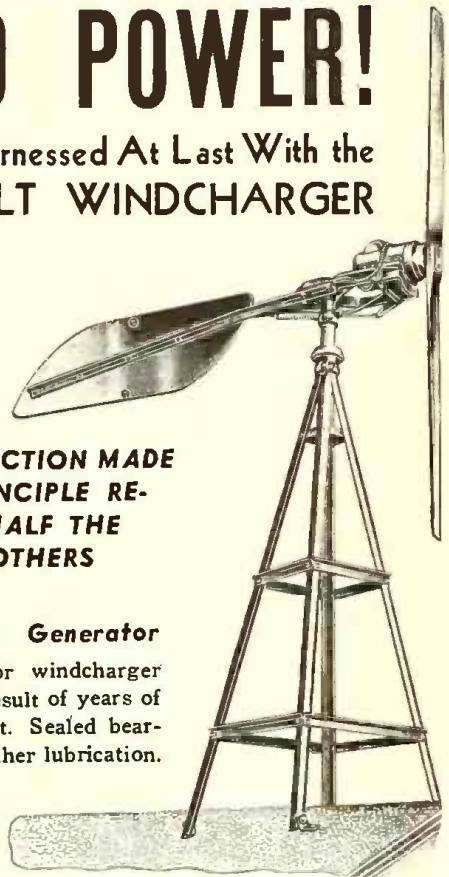

Radio Manufacturers

write for details of NEW COUPON PLAN. There is an established demand for GYROMATIC WIND-CHARGERS. Why not coupon the best?

Exporters

write for details of our special export deal.

Retail Dealers

Ask how to get Highway Demonstrator that makes farm sales easy.

Dunn Manufacturing Co.
Clarinda, Iowa, U.S.A.

STEWART-WARNER PRESENTS NEW FINANCE PLAN

★ Stewart-Warner Corp. is extending to its radio dealers a new nationwide non-recourse and limited recourse finance plan, according to announcement made at their national distributors' convention in Chicago last month. Under the new arrangement, dealers are relieved of total contingent liability with 100 per cent advance, or relieved of 3 months contingent liability with 100 per cent advance.

"Stewart-Warner thus becomes the first manufacturer to extend such cooperation to radio dealers," states F. A. Hiter, vice-president and general sales manager of the company. "This is in line with the plans introduced to our refrigerator dealers last March well in advance of any other manufacturer."

"When F. H. A. withdrew from the picture, the activities of First Banc-credit were curtailed, and it was up to us to find some other way of helping our dealers with their financing. We have long realized the importance of some sound plan of credit selling in helping our retailers move merchandise. So we inaugurated a new plan."

"Working through the C. I. T. Corporation, Stewart-Warner now offers a retail radio finance plan along the same lines which have proved so helpful in selling refrigerators. Like the refrigerator plan, this will be administered on a sound and practical basis through the 144 branches of C. I. T."

3 Profitable Years

for RCA Radio Tube Dealers



Soon the RCA Radio
Check-Up will start
on its third year

Check-Up activities will be more vigorous and resultful than ever during the new season starting in the fall.

Spot announcements on stations that blanket the country.

Interesting, convincing advertisements in *Saturday Evening Post* and *Collier's*.

Local newspaper advertising with which you can tie-in.

Direct-mail material and lots of it.

Window and store displays.

RCA Radio Tubes are the only ones promoted in such an aggressive manner, the only ones backed by a continuous promotion program that brings great benefits to you and your customers. It pays to stock, sell and push RCA Radio Tubes.

RCA MANUFACTURING CO., Inc.
Camden, New Jersey

A Service of Radio Corporation of America



Radiotrons

NEW THINGS FROM THE MANUFACTURERS

Fixed resistor rack

★ Sheet metal rack for holding pig tail resistors. Resistor inventory shown at a glance—easy to find any particular value. Free with purchase of 40 Centralab resistors. Centralab, Milwaukee, Wis.—**RADIO TODAY**—See also advt. p. 44.

1937 Sentinel sets

★ New Sentinel line is comprised of 24 receivers—both battery and AC types.



Model 66BCE illustrated above. 8 tube 6-volt battery superhet—tuning range 530-1,720, 1,600-5,800, 5,700-20,500 kc. 6E5 cathode-ray tuning indicator. Power output 1½ watts.—battery drain 2.8 amps. Ten-inch dynamic speaker. List \$89.95. 66BT table type—list \$69.95.

Other Sentinel receivers:

Model	Table Console
46AE 8T 3-band AC	
47A 11T 4-band AC	
52AE 6T 3-band AC	
57AE 9T 3-band AC	
63B 4T 1-band 6V	\$29.95 \$34.95
65B 6T 2-band 2V	39.95 59.95
67L 6T 2-band 32V	39.95 59.95
68B 6T 3-band 6V	44.95 59.95
69U 5T 2-band AC-DC	
70A 5T 2-band AC	
71U 5T 2-band AC-DC	



Two-volt 5-tube table superheterodyne—540-1,720 kc. range. Self-contained batteries. Large airplane dial—per m o-dynamic speaker—AVC. Cabinet 12½ x 20½ x 12½. Model 60BT—list \$29.95. Console model list, \$34.95.

Sentinel Radio Corp., 2222 Diversey Ave., Chicago, Ill.—**RADIO TODAY**—See also advt. p. 35.

Tymit switch

★ Clock operated switch for turning radio (or electrical appliance) on and off at any desired time over 24-hour period. Capacity of 660 watts. List \$9.75 Tork Clock Co., Mt. Vernon, N. Y.—**RADIO TODAY**

Simplex sound system



★ Five watt portable sound system—gain of 58 DB. Heavy duty 6½-inch speaker. Two button carbon mike with 25-foot cable. All items contained in case for carrying—size, 9¼ x 11½ x 4½. 110 AC operation. Model OP—list \$37.95 complete. Simplex Radio Co., Sandusky, Ohio—**RADIO TODAY**

Self-selecting antenna



★ Deluxe antenna automatic circuit arrangement that permits maximum efficiency on broadcast or short-waves. Special armored wire with high-tension core around which copper conductors are grouped. No-loss cross bar insulator at top of antenna transformer. Complete and assembled—list \$6.75. Technical Appliance Corp., 17 E. 16th St., New York City—**RADIO TODAY**

Directional baffle projector

★ Efficient short baffle for use with 8 or 12-inch standard dynamic speakers. High frequency equalizer for smooth overall response. 90° horizontal angle—50° vertical. Baked gray wrinkled finish—size, 27 x 27¼ x 17¼ inches. Type MI-4428. RCA Mfg. Co., Camden, N. J.—**RADIO TODAY**

Philco de luxe aerial

★ High-efficiency aerial with phosphor bronze wire. 60 foot flat top and 50 feet additional for supporting antenna supplied. Four Pyrex 8-inch insulators supplied and 4 8-inch stand-

offs. Special transmission line 100 feet long. Flat-top, aerial transformer, and line factory assembled. Complete with ground wire, clamp and lightning arrester. List \$32.50. Philco Radio & Television Corp., Philadelphia, Pa.—**RADIO TODAY**

Inter-communicator by Holtzer-Cabot

★ Two-way intercommunication system has been developed for hospital use—allows patient to call and talk directly with nurse, can be switched to reproduce radio programs, etc. Holtzer-Cabot Electric Co., 125 Armory St., Boston, Mass.—**RADIO TODAY**

Tobe auto antenna



★ Fish-pole type antenna for auto use. Consists of telescopic steel pole mounted on a bracket. Pole insulated from bracket by live rubber. Bracket fits on rear bumper of car. Furnished with lead-in wire. Pole is flexible enough to permit bending when car goes into garage. For use near broadcasting station antenna does not need to be extended. List \$3. Tobe Deutschmann Corp., Canton, Mass.—**RADIO TODAY**

Sectionalized sound system

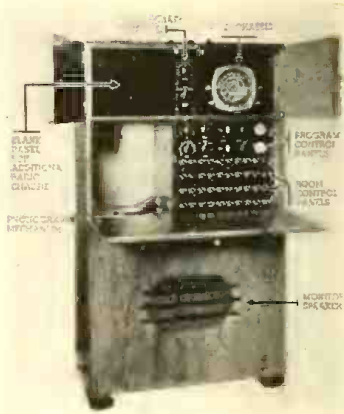

★ Sound systems for schools, hotels, stores, and institutions. Designed on section basis—each one taking care of 10 rooms. System has: radio

(To page 68)

Leadership is Always on the Lookout
for
New and Better Products

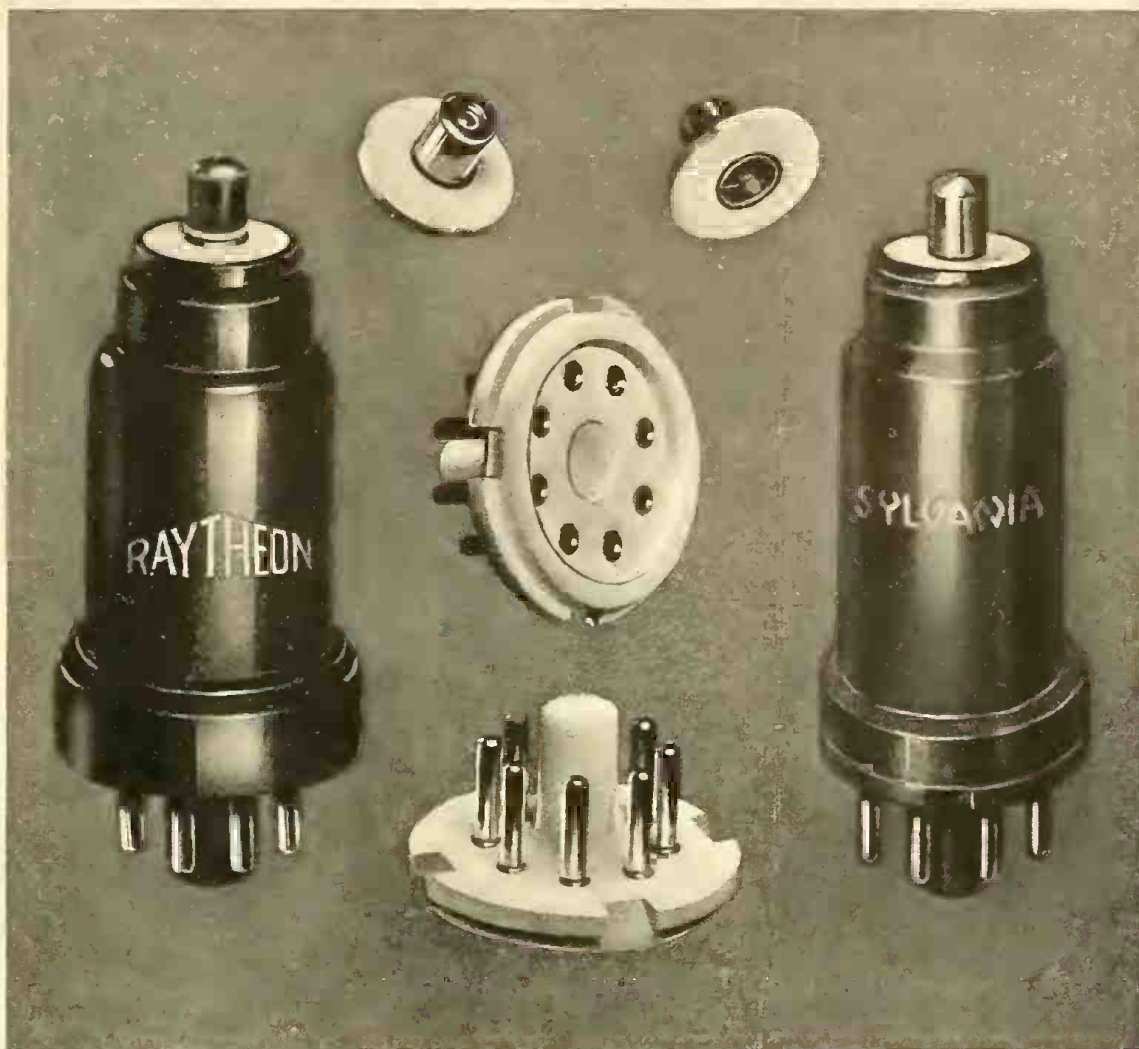

Recognizing the need for better insulation for the grid cap on all metal tubes, ISOLANTITE, INC., has produced an assembly to meet this need. These manufacturers have already found that ISOLANTITE grid cap assemblies improve their tubes.

ISOLANTITE bases for special tubes where low losses are of paramount importance will be available soon.

ISOLANTITE for both ends of the metal type tubes will assure the best possible performance.

ISOLANTITE, INC., 233 BROADWAY, N. Y. C.
FACTORY AT BELLEVILLE, N. J.

Isolantite
CERAMIC INSULATORS

NEW THINGS

(From page 66)

set, microphone, phonograph inputs — distribution of same. Two-way communications from central point to each point — emergency cut-in switch to all points. Webster-Chicago, 3825 W. La'ne St. Chicago, Ill. — RADIO TODAY — See also advt. p. 53.

Iron-core i-f. transformers

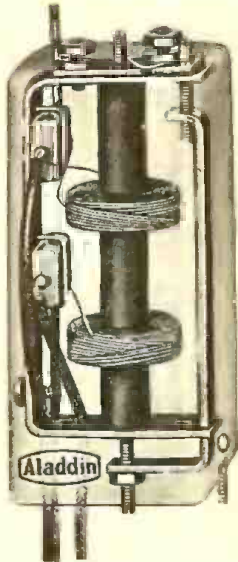

★ I-f. transformers with iron cores and permeability tuning (movable cores) to provide stability. Primary and secondary tuned from top of can. Standard 1 $\frac{3}{8}$ inch aluminum shield. Withstand extreme conditions of temperature, humidity, vibration, and shock. Series L. Aladdin Radio Industries, Inc., 466 W. Superior St., Chicago, Ill. — RADIO TODAY — See also advt. page 61.

Emerson radio-phonograph



★ Table type combination—5-tube AC. Dual-wave superhet circuit—microselector dial—AVC. Tone control—6 $\frac{1}{2}$ -inch dynamic speaker—output 3 watts. High-impedance magnetic pick-up. 78 rpm. turntable—plays 10 and 12-inch records. Hand rubbed cabinet of figured walnut—size, 16 x 17 x 14 $\frac{1}{2}$ inches. Model L-143—list \$59.95.

Emerson Radio & Phonograph Corp., 111 Eighth Ave., New York City — RADIO TODAY

Gyromatic windcharger

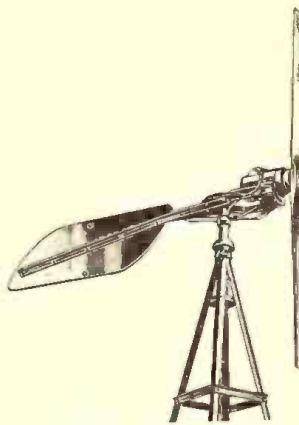

★ Wind driven charger for 6-volt batteries. Wooden propellor drives Delco-Remy generator—16 amp. capacity. Unit automatically adjusts itself to various wind velocities. Supplied with cut-out and ammeter. Rain hood keeps water from entering front bearing. List without tower \$37. Towers \$2.50 to \$22.50. Dunn Mfg. Co., Clarinda, Iowa — RADIO TODAY — See also advt. p. 64.

West-o-therm thermometer

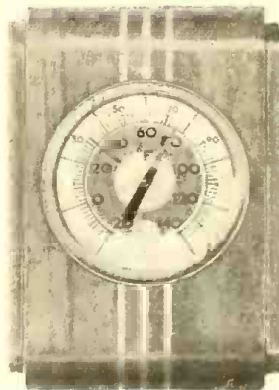

★ New type thermometer for household and office use. Model illustrated is wall type—solid walnut with temperature unit finished in old gold. Model 4H-1—list \$2.50. Other indoor and outdoor models from \$1.50 up. Weston Electrical Instrument Corp., Newark, N. J. — RADIO TODAY

Variac auto transformers

★ New style variable auto transformer that provides small voltage variations. By various connections of windings numerous voltage and current ratings obtainable. Model 70—list \$10, model 80—list \$15. General Radio Co., 30 State St., Cambridge A., Mass. — RADIO TODAY

4-way utility mikes

★ Convenient mikes designed for use as desk, banquet stand, hand, and ring mountings. Special handle fits base making a desk stand. Easily removable for floor stand or suspension. Available with crystal (general purpose or communications) and carbon units. Gen. purpose crystal—model 70HK—list \$27.50. Shure Bros., 215 W. Huron St., Chicago, Ill. — RADIO TODAY

Acousti-reflex speaker cabinet

★ Cabinet for increasing speaker efficiency and minimizing feed-back difficulties. Constructed for 12-inch speakers. Has exponential chamber that takes sound from rear of speaker and projects it to augment sound from front of speaker. Made of seasoned plywood. Acousti-reflex cabinet. Operadio Mfg. Co., St. Charles, Ill. — RADIO TODAY — See also advt. p. 50.

Nokoil permo-dynamic speaker



★ Twelve-inch permanent magnet dynamic speaker with field strength comparable to electro-dynamic speaker. Ideal for battery sets. Universal transformer covered by field pot. Para curve cone for higher fidelity reproduction. Overall depth 6 $\frac{1}{2}$ inches. Model 982—list \$9.82. Wright-DeCoster, Inc., 2265 University Ave., St. Paul, Minn. — RADIO TODAY — See also advt. p. 62.

Bullet dynamic microphone



★ Microphone housed in molded bakelite case. Electro-dynamic microphone with output equal to that of carbon mike—minus 35-40 DB. Response below 200 cycles attenuated to reduce boominess. Broadly directional characteristics in front region—non-directional with mouth pointed to ceiling. Impedance 10 ohms. Transducer Corp., 30 Rockefeller Plaza, New York City — RADIO TODAY

Velotron microphone

★ Velocity microphone employing a static rather than magnetic field. Extremely high output of —50 DB. Maintains high fidelity characteristics even with close talking. High impedance but can be used with cable lengths up to 500 feet. Angle of pick-up somewhat greater than usual velocity mike. List \$20. Bruno Labs., Inc., 20 W. 22nd St., New York City — RADIO TODAY

LATEST OFFERINGS OF RADIO LITERATURE

INFORMATION on any of the products listed below may be obtained promptly by using the post card herewith. Put a circle around the numbers of the items that interest you, fill out the card and mail. No postage needed.

This is an advertisers' service, free to anyone engaged in the radio business, and we ask you to confine your requests to those items in which you have a specific interest. All of these requests are forwarded to the respective manufacturers and are not filled by RADIO TODAY direct.

USE THIS POSTCARD TO GET FREE INFORMATION
NO POSTAGE REQUIRED

119 Weston. Complete data on a new super-sensitive set analyzer having a sensitivity of 20,000 ohms per volt; resistance readings up to 30 megohms; current as low as .5 microampere.

120 Tung-Sol. Characteristic chart of metal "G," and glass tubes giving unusually complete data on all tube-types and diagrams of base connections using RMA numbering system.

121 C. I. T. Details of a dealer financing plan applicable to set sales or a combination of two or more acceptable articles in one contract.

122 Clough-Brengle. Bulletin on sales aids to be used by service men in conjunction with Clough-Brengle Cathode Ray Service Laboratory.

123 Hygrade Sylvania. 1936-1937 edition of company's manual of auto radio installation and servicing. New service tips. Section on motor interference.

124 Transducer. Folder on the "Bullet" electro-dynamic microphone having extraordinary sensitivity in speech pickup.

125 Jefferson. Bulletin giving circuit and list of parts for 20-watt push-pull amplifier using 6B5 tubes. For PA and station amplifier work up to four dynamics.

126 Pioneer Gen-E-Motor. Literature on gas-electric power plants, 200 to 1,500 watts, for lighting, charging and driving light farm machinery.

127 Sentinel. Details of 1937 farm radio sets and Sentinel 1937 Sales Program.

128 Taco. Technical and sales data on antenna systems for individual sets and master antenna systems for homes, apartments, hotels, etc.

129 Solar. Capacitor analyzer and resistance bridge, giving direct panel readings. Has 6E5 cathode ray tube for balancing.

130 Stancor. Description of replacement transformer guide (card file in box). How obtainable, etc.

131 Maddin. Bulletin 536 giving technical data on polyiron parts, notably IF transformers.

132 Dunn. Literature on gyromatic wind-chargers using gyromatic principle of control. Propeller speed governed visibly.

133 Electrolab. Leaflet on cathode ray oscillograph, electronic switch, direct-coupled amplifier and AC amplifier, for service and laboratory use.

134 Continental Motors. Six-page color folder presenting data on various types of Permi-O-Flux permanent magnet speakers.

135 Western Electric. Leaflet listing bulletins recently issued on numerous types of radio and sound equipment; police, marine, airport systems, etc. For broadcast station operators and sound engineers only.

136 Admiral. Literature on 1937 receivers featuring console models with "tilt tuning" and curved, inclined panels; also battery sets and auto radio.

137 RCA. Description of \$3 handbook of radio service business methods; 220 pages on administration and record-keeping. How to get book free.

138 Triumph. Details of special price offer on condenser bridge analyzers; preheaters and continuity testers.

139 Aerovox. Industrial condenser replacement bulletin No. 665, a guide to replacement condensers for condenser-start motors as used in refrigerators, oil burners and other fractional horsepower drives.

140 Trav-ler. Circulars covering 1937 line of receivers including table and console types and two models of auto radio.

141 Ken-Rad. Sales plan to assist dealers and service men in developing better tube business.

142 Magnavox. Announcement of new 15-in. heavy duty dynamic speaker handling output of 6L6 tubes. Designed to eliminate need of dual speakers. Adaptable to PA.

FOR FREE SALES HELPS FILL OUT
AND MAIL THIS CARD

Put circle around numbers upon which you
desire information

To simplify your writing for dealer helps, merchandise booklets, etc., this service is offered without charge. Just fill out this card and mail promptly.

Please do not ask for literature in which you have no interest.

119 120 121 122 123 124 125 126
127 128 129 130 131 132 133 134
135 136 137 138 139 140 141 142

Your Name

Title

Name of Co.

Address



BUSINESS REPLY CARD
First Class Permit No. 22275 (Sec. 510 P. L. & R.) New York, N. Y.

RADIO TODAY

480 LEXINGTON AVENUE

NEW YORK, N. Y.



RADIO TODAY

480 LEXINGTON AVENUE, NEW YORK.

Enter my subscription to RADIO TODAY for one year (12 months) and send me a copy of FINGER-TIP FACTS ON RADIO.

- Herewith is \$1.00 in full payment.
 Bill me \$1.00 after mailing.

Name _____

Company _____

Address _____

Title _____

If RADIO TODAY and FINGER-TIP FACTS ON RADIO are to be mailed to your home please furnish home address here: _____

What is Your Main Line of Business? Please Check:

- Radio Dealer
 Radio Service
 Electrical Dealer
 Radio Distributor
 Broadcast Station Mgr.
 Automotive Dealer
 Furniture Dealer
 Musical Instrument
 Radio Manufacturer
 Engineer
 Miscellaneous
 (Please write in what business)

Postage
Will be Paid
by
Addressee

No
Postage Stamp
Necessary
If Mailed in the
United States

BUSINESS REPLY CARD

First Class Permit No. 22273 (Sec. 510 P. L. & R.) New York, N. Y.

RADIO TODAY

480 LEXINGTON AVENUE

NEW YORK, N. Y.

RADIO'S *only* TRADE DIRECTORY & HANDBOOK

FREE

with one year's
subscription to
RADIO TODAY

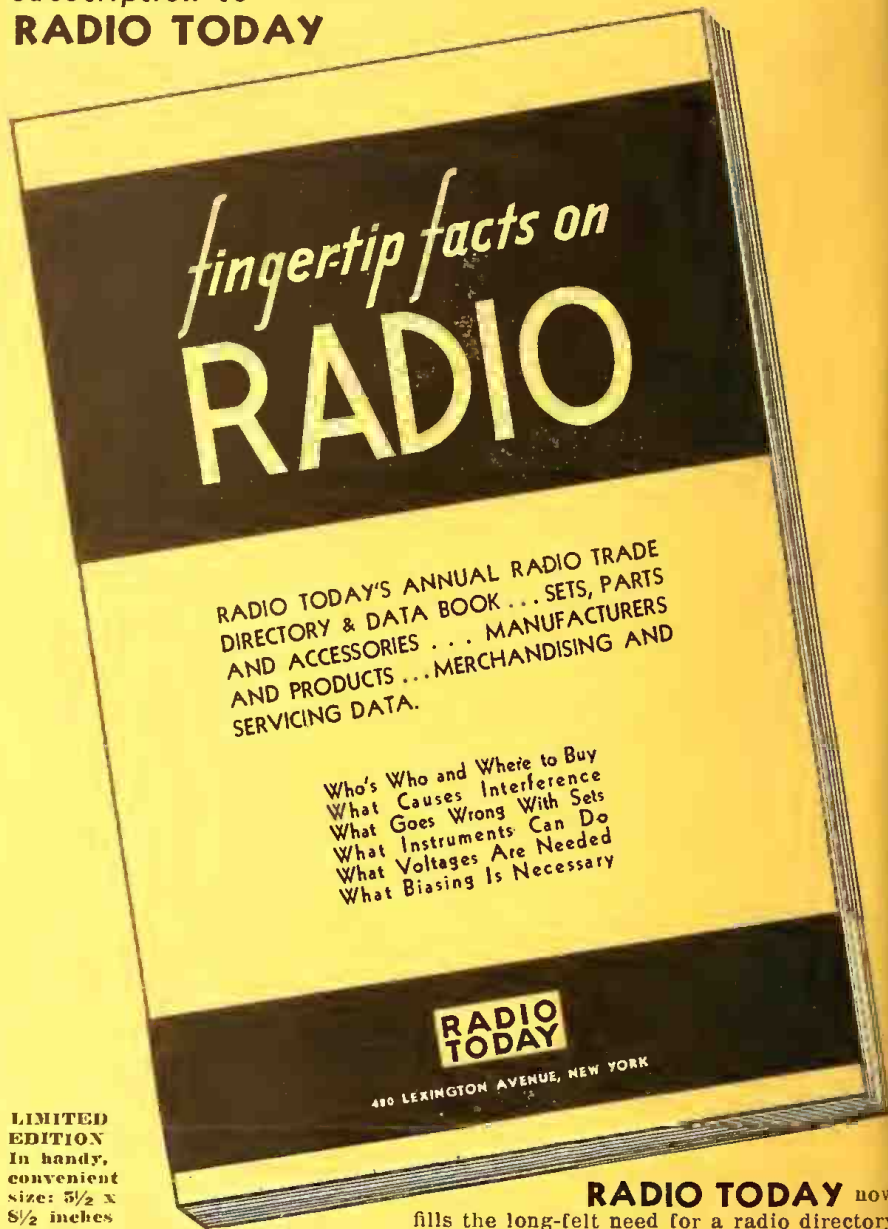

LIMITED EDITION
In handy, convenient size: 5 1/2 x 8 1/2 inches

Who's Who and Where to Buy
What Causes Interference
What Goes Wrong With Sets
What Instruments Can Do
What Voltages Are Needed
What Biasing Is Necessary

RADIO TODAY now

fills the long-felt need for a radio directory that is complete, authoritative, up-to-the-minute! Charts

and tables have been included to fill the demand for this type of information in handy, permanent form. Every progressive distributor, dealer and service man will find innumerable ways to put this directory and handbook to work.

CONTENTS: Names and Addresses of Manufacturers of Receiving Sets, coded to guide you in selecting amateur, commercial, farm and battery, home, radio-phonograph combinations and auto sets.

Names and Addresses of Manufacturers of Parts, Equipment and Instruments, segregated by lines to cover antennas, batteries, coils, condensers, generators, converters, line filters,

microphones, public address equipment, resistors, speakers, etc.

Service and Merchandising—CHARTS! TABLES!—just the kind of information every dealer and service man needs daily. It tells you what goes wrong with radio sets—and why; it gives you data on radio set analyzers; sources of radio noise—helps you look for interference—aids you in eliminating the trouble; it gives you tube ratings and bias resistor tables.

← FILL IT IN—TEAR IT OFF—MAIL IT TODAY →

Wilcox-Gay 1937 sets

★ New line totals eight models—both AC and AC-DC operation. Unusual is the styling found in some of cabinets.

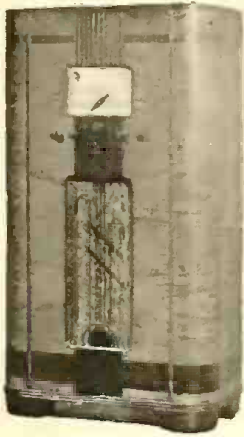

Six-tube 3-band AC superhet—3-gang tuning condenser. Full-vision 6-inch vernier dial—metal tubes. Tone control—AVC 12-inch speaker—6G5 tuning indicator. 37-inch console. Model A-19—list \$49.95.

Other consoles:

A-20 8T 3-band AC	\$69.95
A-21 11T 3-band AC	99.95

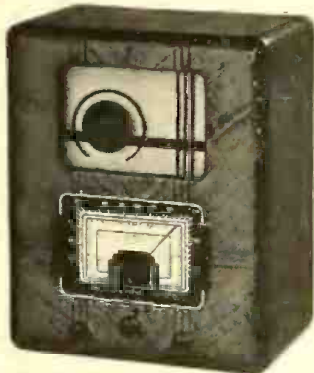

AC-DC 6-tube table receiver—3 wavebands—3-gang condenser. Full-vision vernier dial—AVC. Ballast tube—6½-inch speaker. Cabinet 14½ x 12 x 8. Model A-15—list \$27.95.

Other table receivers:

A-11 5T 2-band AC	\$19.95
A-16 5T 2-band AC	22.50
A-17 6T 3-band AC-DC	36.95
A-18 6T 3-band AC	39.95

Wilcox-Gay Corp., Charlotte, Mich.—
RADIO TODAY

Flex-mount condenser mounting

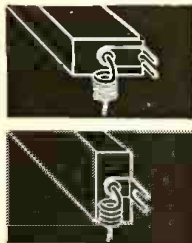

★ Adjustable mounting bracket now supplied with Solar "little giant" electrolytic. Flex-mount is a movable tab which permits mounting condenser on flat side or edge. Solar Mfg. Corp., 599 Broadway, New York City—
RADIO TODAY—See also advt. p. 54.

RCA beat oscillator

★ Variable frequency audio oscillator for set, P.A., and speaker testing. Range 30-15,000 cycles—output impedances of 250, 500, 5,000 ohms. Vernier calibrated dial. Complete with all tubes—AC operation—list \$64.50. RCA Mfg. Co., Camden, N. J.—
RADIO TODAY

Globe Trotter radio



★ 4-tube AC-DC TRF receiver housed in a globe. By turning globe receiver is tuned. Covers broadcast band only—dynamic speaker. Ten-inch globe in 6 colors. Metal chrome frame. List \$24.95. Globe Trotter Radio Co., 549 W. Randolph St., Chicago—
RADIO TODAY

Admiral battery set



★ 7-tube 6-volt battery receiver—only 1.7 amp battery drain. 4 tuning bands including weather—3-gang condenser. Class B audio output. 8-inch permo-dynamic speaker. Full-vision all-in-one dial. Model M551—list \$59.50.

Other 6-volt battery models:

AZ593 6T 3-band cons.	\$69.50
B325 4T 2-band table	29.95
M5878 7T 4-band cons.	79.50
2544 6T 3-band table	49.50

Continental Radio & Television Corp., 325 W. Huron St., Chicago, Ill.—
RADIO TODAY—See also advt. p. 36.

Speaker tester

★ AC operated signal generator which delivers a variable audio signal to set. Covers audio range from 40-8,000 kc. suitable for testing all radio speakers including high fidelity. Model 055 speaker tester supplied in kit form for serviceman. Philco Radio & Television Corp., Philadelphia, Pa.—
RADIO TODAY

Weston super-sensitive analyzer

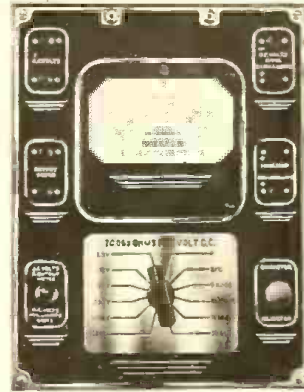

★ Multi-range meter with sensitivity of 20,000 ohms per volt. 50 microampere movement with 5-inch scale. Ranges available—voltage AC and DC, 2.5/10/50/250/1,000; current, 100 microamperes, 1/10/50/250 mls. resistance, 0/3,000/30,000/3 megs/30 megohms. Model 772—net \$46.50 with carrying case. Weston Electrical Instrument Corp., Newark, N. J.—
RADIO TODAY—See also advt. p. 40.

Line noise filter

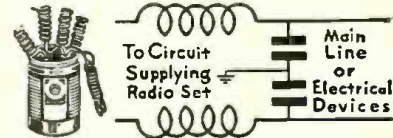

★ Heavy-duty inductive-capacitive line filter for use at source of noise. Rated at 10 amperes, 110-220 volts. Size 4¾ x 3 inches diameter. Filter-con model F1005DH—list \$5. Continental Carbon Co., 13900 Lorain Ave., Cleveland, Ohio—
RADIO TODAY

Velvet action mike stands

★ New type microphone stand with friction clutch. Adjustment on clutch is adjusted to weight of mike—and mike can be lowered or raised without further adjustment. Rubber cushion mounting on base absorbs vibration. List—\$7.50 to \$12.50. Atlas Sound Corp., 1451 39th St., Brooklyn, N. Y.—
RADIO TODAY

Sportsman receiver



★ Four tube portable superhet. Tunes 540-1,750 kc. Illuminated full-vision dial—AVC. Five-inch speaker. Powered by two flashlight cells and 3 midget B batts. Cabinet finished in weatherproof material. Size 9½ x 8½ x 4½. Model AA—list \$26.50 less batts. Simplex Radio Co., Sandusky, Ohio—
RADIO TODAY

FOR RADIO-REFRIGERATOR DEALERS

★ COOL and crisp, there comes from the Consumers' Market Section of the Department of Commerce a report on what 38,637 families are doing about refrigeration in their homes. Flat fact is that 31,685 of them are not doing anything about it—that number are without "boxes."

This series of reports is based upon conditions in 9 different cities: Austin, Tex.; Fargo, N. D.; Portland, Me.; Columbia, S. C.; Salt Lake City, Utah; Trenton, N. J.; San Diego, Cal.; Racine, Wis., and Birmingham, Ala. Washington began the survey in 1934 and will include 64 cities in the series before it is finished.

Market chances

When these investigators tabulated results, in which refrigerators were listed as only one of many items, families were divided into 9 different income groups, ranging from "no income" to "\$7,000 and over." There were, in the combined cities, more families listed as having an income of "\$1 to \$499" than in any other one group. In fact, in Columbia 38.1% of the families reporting came within that classification.

Sales possibilities are revealed in the report where it can be seen that

in some cities certain income groups are practically saturated with refrigerators, while in other localities the same income group has a small percentage of ownership.

For instance, in Salt Lake City and in Austin there are more families classified as receiving incomes of \$500 to \$999 than in any other one group. Yet in the Utah city about 26% own refrigerators, while in Austin only about 16% own them. Climate angle on this comparison is also interesting.

WHAT THE TRADE IS DOING

★ Fairbanks-Morse has announced a series of new radio-refrigerator distributors: C. Kurtzmann & Co. for Buffalo and surrounding New York and Pennsylvania territory; The Olmsted Co., Syracuse, N. Y., for central New York; R. B. Wall Co. for Wilkes-Barre, Pa. and area. To handle the FM Conservador refrigerator line throughout the state of Maine, Farrar-Brown Co., Portland, has been named.

★ Stern & Co., Inc., Grurow distributors of Hartford, Conn., have announced themselves as forthcoming hosts to refrigerator dealers on two trips: one over Labor Day on the S.S. "Evangeline" to Nova Scotia, the other after Jan. 1, 1937 by train to Chicago.

★ Crosley Corp. has announced a huge contest for refrigerator salesmen, prizes in which are 17 Chevrolets, 68 Shelvadors, 102 consoles, 153 wrist watches, and any number of Crosley "Fiver's." Contest opened July 10 and will end Aug. 31; affair was organized by Thomas W. Berger and is called "Hot Summer For Crosley Cold Refrigeration" prize contest.

★ Among the few blessings of prolonged hot weather is the effect it has on refrigerator sales, which GE's specialty appliance sales manager A. M. Sweeney has checked up on. Carload orders from dealers and distributors have come in at an unusual rate; sales are rapidly rising among lower income groups especially.

★ F. B. Connelly Co., household appliance wholesaler for the Northwest with branches at Seattle and Spokane, Wash., Billings and Great Falls, Mont., and Portland, Ore., is celebrating its 50th birthday. Recent appointments in the organization are: C. A. Tubbs as manager of Spokane operations; Lowell Grant Jackson as sales representative in Idaho and Montana; R. D. Lord as sales representative in the Yakima and Wenatchee Valley.

★ Electric refrigerator dealers of Sheboygan, Wis., launched a co-operative advertising and selling campaign for electric refrigerators when some 40 members of the Sheboygan Electric Refrigeration Bureau and their salesmen held a recent meeting at a local park.

Group was addressed by Gustav Marx, president, Gustav Marx Advertising Agency of Milwaukee, advertising counsel for the Milwaukee Electric Refrigeration Bureau. Officers of the Sheboygan bureau are L. L. Perry, manager; Eitel Meyer, treasurer, with F. W. Greusel, G. W. Fedler and L. L. Perry members of the board of directors. Campaign consists of a series of newspaper advertisements, direct advertising, printed sales helps and bill boards. Prizes are offered as additional stimulation to dealers and salesmen to push the sales of electric refrigerators.

★ W. Paul Jones, general manager for the home appliance division of Fairbanks-Morse & Co., has reported that shipments of FM Conservadors for the month of June past, were 207 per cent greater than for June of last year.

★ Crosley Corp. has released a detailed description of a new product made by the company, a machine to grow hair, called the Xervac. Device is electrically operated, based upon the practice of using alternate periods of vacuum and pressure to restore blood circulation. Developed by Dr. Andre A. Cueto, Cincinnati physician, the machine is presented to the appliance trade as an attraction to all persons who wish to combat baldness.

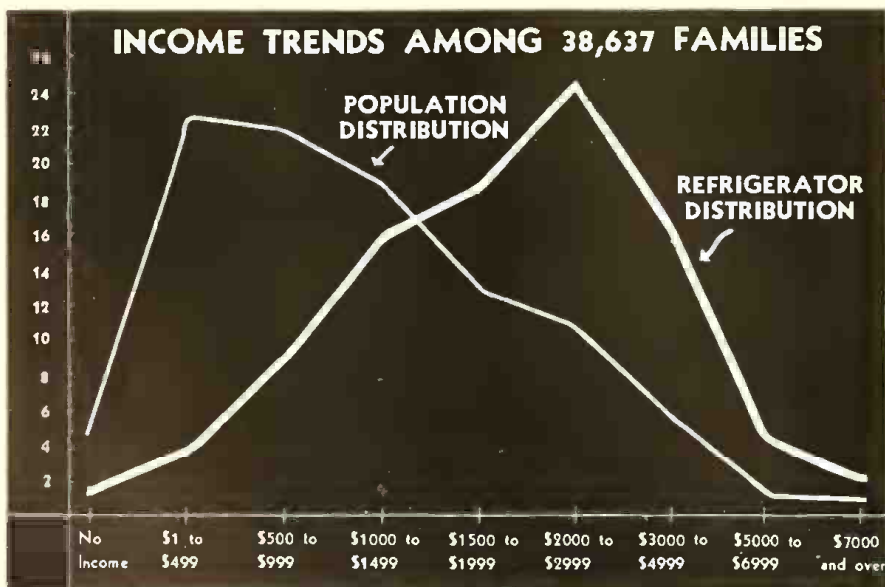

A Tale of Nine Cities — Atop are charted the distribution percentages of families and "boxes" by income groups, averaged from a study of 9 towns made by the Consumer's Market Section of the Dept. of Commerce.

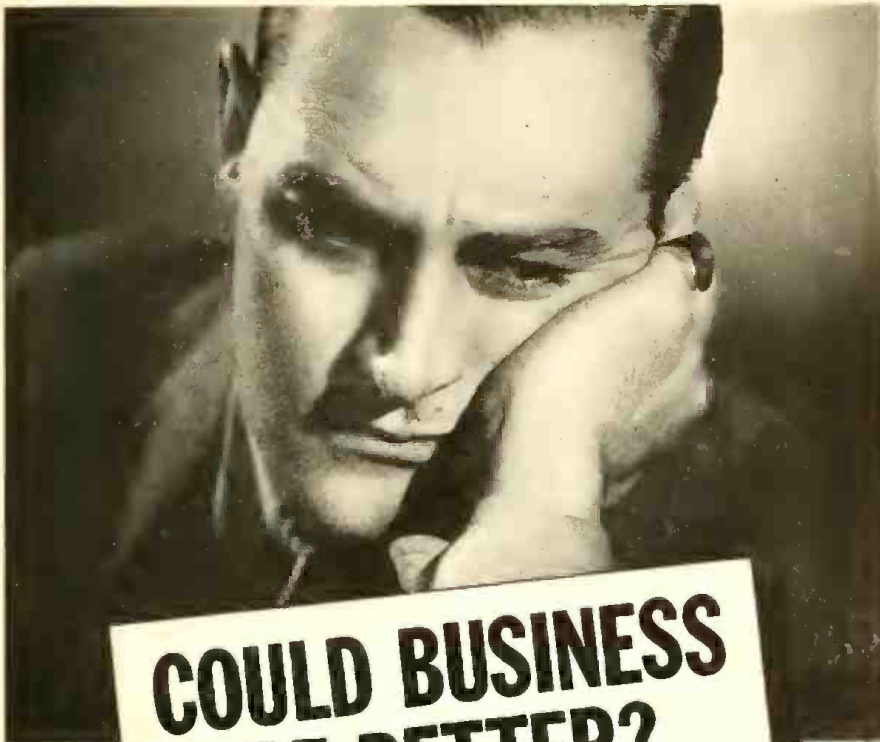

**COULD BUSINESS
BE BETTER?**

**YOU CAN MAKE YOUR
BUSINESS BETTER BY SELLING SYLVANIA TUBES!**

● One inferior tube can lose you a customer forever! Why take a chance? Sell Sylvania and be sure your customers will be pleased every time! Remember . . . Sylvania quality never changes! Before a Sylvania tube ever reaches your shop . . . eighty separate tests have been made for your protection! Here's what the Sylvania policy means to you: Fair list prices . . . a six-months guarantee on every tube . . . and valuable technical and sales helps. Sylvania stands ready to make your tube business pay!

Put your tube business on a safer, more profitable basis now! For complete sales and technical information address the Hygrade Sylvania Corporation, Emporium, Pa.

SYLVANIA

THE SET-TESTED RADIO TUBE

This AUGUST ISSUE of RADIO TODAY
CARRIES MORE PAGES OF
ADVERTISING THAN ANY
OTHER RADIO TRADE PAPER
And RADIO TODAY is just one year old!

**INDEX
TO ADVERTISEMENTS**

Aladdin Radio Industries, Inc.	61
Allied Radio Corp.	60
Arcturus Radio Tube Co.	56
Briggs & Stratton Corp.	49
Centralab	44
Cinaudagraph Corp.	60
Clarostat Mfg. Co., Inc.	60
Commercial Credit Corp.	46
Commercial Invest. Trust, Inc.	52
Consolidated Radio Products Co.	53
Continental Motors Corp.	61
Continental Radio & Television Corp.	36, 37
Cornell-Dubilier Corp.	57
Cornish Wire Co.	60
Crosley Radio Corp.	51
Dunn Mfg. Co.	64
Electrad, Inc.	48
Fairbanks-Morse Home Appliance Co., Inc.	23
Freed Mfg. Co.	57
General Electric Co.	74, Cover III
General Household Utilities Co.	4, 5
E. I. Guthman & Co., Inc.	59
Hygrade Sylvania Corp.	73
International Radio Corp.	31
International Resistance Co.	39
Isolantite, Inc.	67
J. F. Distributing Co.	58
National Broadcasting Co.	Cover II
National Radio Exposition	63
D. W. Onan & Sons	62
Operadio Mfg. Co.	50
Oxford Tartak Radio Corp.	54
Philco Radio & Television Corp.	8
Pioneer Gen-E-Motor Corp.	59
Radio Corporation of America	2, 3
Radolek Co.	58
Raytheon Production Corp.	33
RCA Mfg. Co., Inc., Radiotron Division	65
RCA Mfg. Co., Inc., RCA-Victor Division	27
Sentinel Radio Corp.	35
Solar Mfg. Corp.	54
Standard Transformer Corp.	57
Stewart-Warner Corp.	6, 7
Stromberg - Carlson Telephone Mfg. Co.	Cover IV
Technical Appliance Corp.	62
Transformer Corp. of America	58
Triplett Elec. Instrument Co.	43
Triumph Mfg. Co.	56
Tungsol Radio Tubes, Inc.	25
United American Bosch Corp.	1
Utah Radio Products Co.	55
Earl Webber Co.	62
Webster-Chicago	53
Westinghouse Elec. Supply Co.	29
Weston Elec. Instr. Corp.	40, 41
Wright-deCoster, Inc.	62
Zenith Radio Corp.	21

While every precaution is taken to insure accuracy, we cannot guarantee against the possibility of an occasional change or omission in the preparation of this index.

TRADE ON A GALLOP

— William C. Grunow heads group of newly elected execs

— RCA announces changes, appointments on sales staff

★ **General Household Utilities Co.**, Chicago, makers of Grunow products, early this month completed its reorganization plans and held a distributor meeting in the Windy City. Elected officers of the reorganized company were William C. Grunow, president; Allen G. Messick, vice-president; Ralph R. Trimarco, treasurer; Sidney L. Arneson, secretary.

Grunow jobbers at the convention heard about 3 additions to the radio line, the company's national advertising blanket and its tie-up with Shirley Temple. Featured execs in the 2-day meeting were Walter Eckhardt, director of sales; Howard J. Shartle, general sales manager; Tod Reed, advertising manager; J. J. Davin, sales promotion manager.

★ More strengthening of the distribution set-up of the **Stromberg-Carlson Telephone Mfg. Co.** is seen in company. Nine distributing organizations have recently been added to the Stromberg sales organization: Parks and Hull of Baltimore, Md., serving the Baltimore area; American Sales Co. of Columbus, Ohio, covering 50 adjacent counties in Ohio; Hefty Sales of Madison, Wis.; Farrar-Brown of Portland, Me., serving the entire state of Maine; Graybar Electric Co. of De-



W. A. Wolff of Western Electric and Herbert Metz of the Graybar Co., sniff the ocean breezes at Atlantic City.

troit for the Eastern half of the state of Michigan; Graybar Electric Co. of Pittsburgh for southwestern Pennsylvania and northern West Virginia; Graybar Electric Co. of Syracuse, N. Y. for the Syracuse area and the Graybar Electric Co. of Buffalo, N. Y.

★ **G. K. Throckmorton**, executive vice-president of the RCA Mfg. Co., announces changes and appointments in the RCA Victor executive sales organization: **Paul C. Richardson** has been appointed manager of field activities, with headquarters at Camden, N. J. **Henry C. Bonfig**, formerly manager of the western division, has been transferred to Camden headquarters to take up new duties in the sales department. **Vance Woodcox**, formerly in the sales department, has been appointed manager of a newly created central division, with headquarters at Chicago.

Prior to his association with RCA Victor, Richardson had been engaged in special merchandising activities for the Curtis Publishing Co. and the *Saturday Evening Post*. He brings to his new duties several years of experience in the radio field where he served as general sales manager of the Pierce-Phelps, Inc., radio distributing company of Philadelphia. He was also advertising manager of the American Installation Corp.

★ **Seutinel Radio Corp.**, Chicago, has made extensive alterations in its present factory and has branched into another new plant; increased facilities amount to almost doubling the company's capacity.

★ **Parker H. Ericksen**, radio sales manager for the home appliance division of Fairbanks-Morse, has reported that over 1,500 radio dealers have written to the FM offices for information about the company's new radio line.

Woodall leaves McGraw-Hill to head own direct mail business

★ **W. P. Woodall**, who organized and managed the direct-mail division of McGraw-Hill for over 10 years, resigned, effective August 1st, to start in business for himself. He has organized the **W. P. Woodall Company**, which will specialize in advertising and selling by mail. Offices of the new company have been established in the Printing Crafts Bldg., 461 Eighth Ave., New York City. Mr. Woodall's company will handle industrial, radio trade and mail-order lists and will operate as consultants to manufacturers and advertising agencies in planning and conducting mail campaigns to complement publication advertising and direct selling campaigns. His radio lists will be operated in cooperation with **RADIO TODAY**.



SALES PROMOTION MATERIAL

SELLS RADIO!

You get faster turnover with G-E Radios, because they are backed by a complete Sales Promotion Service that:

★ **Attracts prospects to your store**

- Direct mail
- Movie trailers
- Radio broadcasts
- Newspaper mats
- Banners
- Listener's Guide
- Political Reporter
- Novelties

★ **Gives your window "buy" appeal**

- Deluxe window displays
- Four-in-one window displays
- Bubbling sign
- Mounted Ad reprints
- Streamers

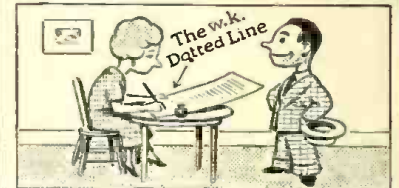

★ **Puts across a sales message inside your store**

- Spot display
- Feature panels
- Pennant display
- Domestic, foreign, full-line spots
- Tone Tester
- Folders
- Broadcast demonstration schedule
- Feature price tags

★ **Trains your salesmen to make more sales**

- Sales training films
- Sales training manuals
- Photographic portfolio
- Trade-up pencil
- Certificate of Salesmanship
- Bandmaster Club

★ **Helps you plan your own promotions**

- The Bandwagon
- Window display manual

With this complete point-of-sale service to support the hard-hitting, national G-E Radio magazine advertising that thousands of your local prospects read, you are bound to make more sales and more PROFIT!

For further details write your local G-E Radio Distributor, or General Electric Co., Radio Division, Bridgeport, Connecticut.

WATCH G-E RADIO IN 1936!



Focused Tone

IS "THE SALESMAN'S LINE"

Step-up Values That Make It Easier For Salesmen To Step Up In Price

There are EXTRA and BIGGER PROFITS in store for you when you go after the "sell up" business with General Electric Focused Tone Radio. Every step up in price is fully justified by a step up in demonstrable values. Features that the buying public can understand and appreciate. Features that are really "hot" with reason-why selling arguments. Features that fit every price bracket and meet the standard of performance demanded by every type of customer. Features your salesmen CAN show and demonstrate. It's a matter of simple salesmanship to break sales records and cash in on this "trade-up", profit-making opportunity.

See Your G-E Radio Distributor For Complete Information On
General Electric's "STEP UP" Selling Plan.

FEATURES THAT HELP YOU "SELL UP" FOR PROFITS

- G-E Colorama Dial—automatically flashes from red to green when the receiver is in perfect tune.
- G-E Automatic Frequency Control—instantly and automatically lines up the receiver on peak of resonance with the incoming signal.
- G-E Local Station Personalizer—a "custom-made" scale that flashes the station's call letters as you tune in.
- G-E Silent Tuning—eliminates all noise while tuning between stations.
- G-E Metal Tubes — for stabilized performance.
- G-E Sentry Box — directs and controls reception.
- G-E Sliding-rule Tuning Scale—lists all stations in a straight line, using a separate scale for each band. It's "as easy to read as a ruler."



GENERAL  **ELECTRIC**

Focused Tone Radio

APPLIANCE AND MERCHANDISE DEPT., GENERAL ELECTRIC COMPANY, BRIDGEPORT, CONN.



**UNFILLED ORDERS GREATEST
IN COMPANY'S HISTORY!**

*Stampede to New Line
puts business at
Record Peak*

**YOU HAD BETTER
SIGN THE COUPON, TOO**

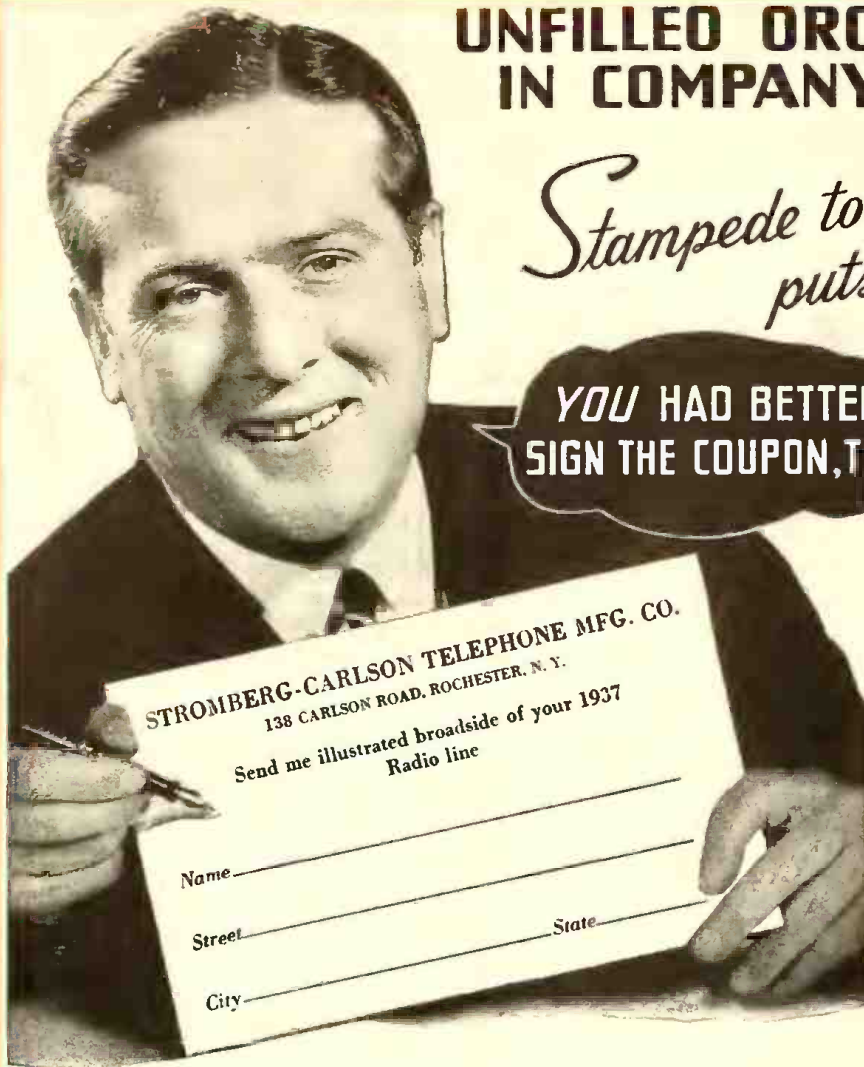

STROMBERG-CARLSON TELEPHONE MFG. CO.
138 CARLSON ROAD, ROCHESTER, N. Y.

Send me illustrated broadside of your 1937
Radio line

Name _____

Street _____

State _____

City _____

6 TABLE
MODELS
FROM **\$49⁹⁵**

21 CONSOLES
FROM **\$78⁵⁰**

5 RADIO-
PHONOGRAPHS
FROM **\$199⁵⁰**

THIS RUSH of orders from dealers and distributors shows their appraisal of the new 1937 Stromberg-Carlson—truly radio's magnificent line—offering not only more exclusive features, but a broader range of choice.

MORE CONSOLES, in number and variety—12 having the season's most talked-of radio feature, the Acoustical Labyrinth.

MORE TABLE MODELS—3 of them with *rosewood* cabinets.

MORE RADIO-PHONOGRAPHS, starting at a remarkably low price for instruments of Stromberg-Carlson quality.

WIDER PRICE RANGE—\$49.95 to \$985.00.

And attractive features, nearly all exclusive, such as Tri-Focal Tuning, Carpinchoe Leather Speakers, Indexed Knobs, Automatic Sensitivity Control, and Free-floating Phonograph Pickup. *There is Nothing Finer Than a Stromberg-Carlson.*

Only Stromberg-Carlson has the Acoustical Labyrinth

This exclusive Stromberg-Carlson feature takes the unnatural boom out of radio voices and music, and provides deep bass notes with a new fidelity.

The long, winding passageway of the Labyrinth, lined with a special acoustical material, takes the place of the usual box-like cavity in the cabinet which is the

source of the exaggerated boom in the low tones.

The air passage of the Labyrinth is so tuned and proportioned that it not only removes this exaggeration, but greatly extends the range of bass notes that are effectively reproduced. The Labyrinth also increases the volume capacity and accuracy of the loud speaker.

CUT OUT AND MAIL THE COUPON TODAY

Stromberg-Carlson

12 LABYRINTH
MODELS
FROM **\$149⁵⁰**

