

# RADIO and Television TODAY

51 Yearly

Caldwell-Clements, Inc., 480 Lexington Ave.

New York City

## General Business

- recovery holds at 97%
- prospects good thruout 1936
- retail buying up, all lines
- January activity strong

## Radio Trade

- receiver sales reach all-time record of 5,700,000 for '35
- tubes 73,000,000 for year
- many new January lines appear

## Broadcasting

- air-time \$86,000,000;  
\$25,000,000 for talent
- political broadcasts under way

## Automobile Radio

- 1935 closes with 1,200,000 sold
- automotive industry rush carrying car-radio to new highs in '36
- rumored Ford will make radio standard car equipment

## Trade-ins

- dealers report 80-90% of sales involve handling old sets
- trade-in problem more acute
- *Radio Today* launching campaign to give old sets to shut-ins

## Public-Address

- local political meetings open new sales opportunities
- moderate-priced equipment now available

## Phonograph "Combinations"

- 31 makers now offer units
- finance plans available to trade
- dealers hold women's club recitals

## RADIO WILL ELECT THE NEXT PRESIDENT!

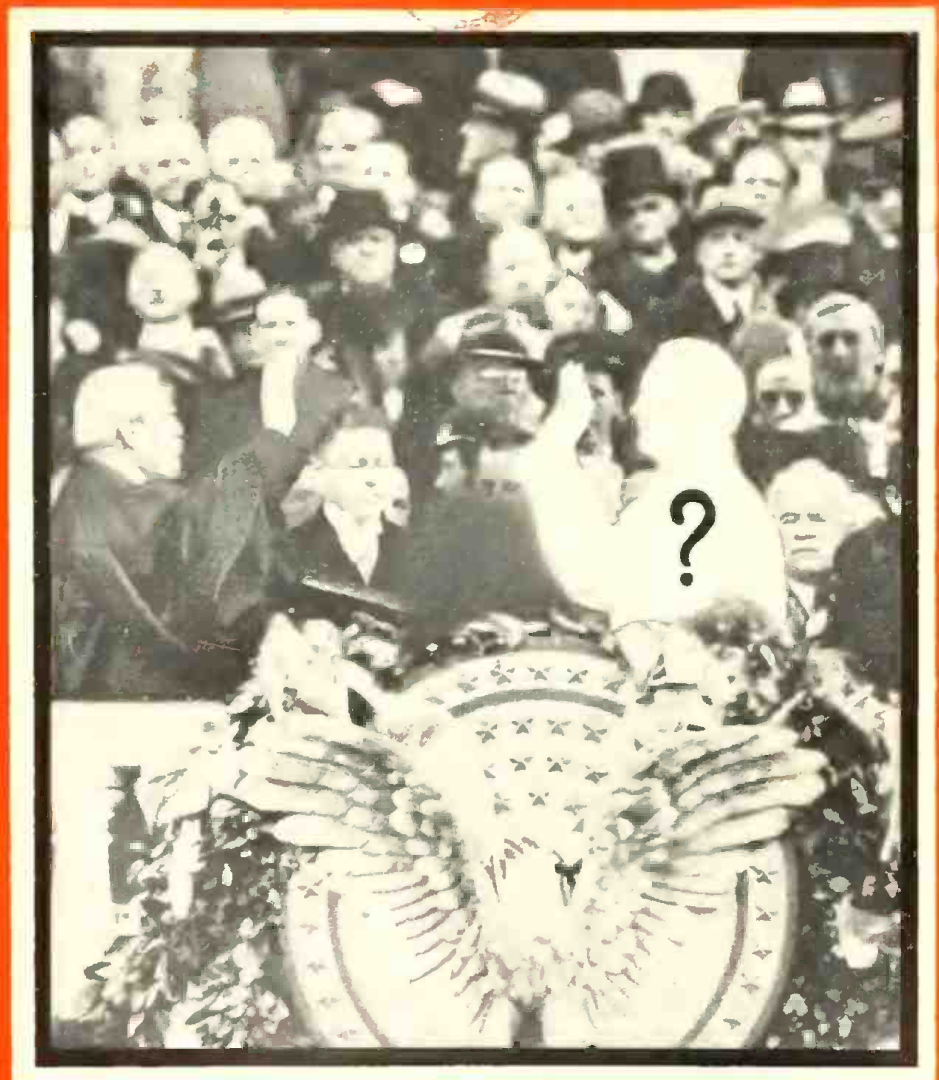

Tense popular interest in the coming election will hike demand for radio sets all through 1936. For—Radio will elect the next President!

MAGIC KEY BUILDS  
PROGRAM WITH TALENT  
DRAWN FROM ALL  
AROUND THE WORLD



There's been a lot of talk about a man on a horse. Well, he seems to have arrived, and bless us, if it isn't Paul Whiteman. No, he didn't wear his horse to the NBC studio for his Magic Key appearance—but you should see him at Jumbo.



From feeble little station ETA of Addis Ababa, RCA Communications picked up Ed Beattie, put his talk on the RCA Magic Key program.



HOW HIGH IS A MOUSE WHEN IT SPINS? Right smart high in world popularity when it can keep up the dizzy pace of Mickey Mouse. Walt Disney, Mickey and a gang of their pals turned up on an RCA Magic Key broadcast. Went over big.

*Cash in on greatest  
air shows ever heard*

## **Magic Key of RCA takes place among NBC programs that are building demand for new, up-to-the-minute sets**

**T**HE better the entertainment offered on the air, the bigger the interest in new radio sets. And this year NBC programs are at a new high in all 'round interest. Every day and every evening the NBC Networks present show after show that holds the interest of millions.

The Magic Key of RCA is one of the more recent comers. Starting last October this show has attained nation-wide following. And it has attained it on Sunday afternoon, when the whole family listens.

This Magic Key program put right up to NBC the job of organizing a program to sell the goods and services of all its associated companies. Because of RCA's position the program had to have dignity. But it also had to sell. So the dignity was achieved on the basis of doing everything well. Thus RCA proved itself no cobbler with barefoot children. It wrought well at its own trade, and for its own offspring.

Sell today's great National Broadcasting Company shows to your prospects, and you will sell more radio sets.

# **NATIONAL BROADCASTING COMPANY, INC.**

A SUBSIDIARY OF RADIO CORPORATION OF AMERICA • NEW YORK • CHICAGO • WASHINGTON • SAN FRANCISCO

"Bullseye" 1936 Sales Now with these 3 "Hot Shots!"

*Justice*  
**Emerson**

"RE-CREATES THE ARTIST



**Radio**

IN YOUR HOME"



**EMERSON . Model 116**

*With Tone Control and Aeroplane Dial*

NEW — 5-tube AC Superheterodyne with Tone Control — Aeroplane Dial — Two Bands: 95 to 200 Meters and 196 to 555 Meters — Standard American Broadcast and American Short Wave including both Police Bands, Amateur and Aeroplane Stations — 3 Watts Output — Emerson "Micro-Selector" and other features — in a handsome Walnut Cabinet, 14 1/4 in. high — with RCA tubes. List Price,

**\$24.95**

Get Emerson's 1936  
Proposition NOW

Write or wire your nearest Emerson distributor — or send direct for details of discounts, promotion, etc., during Emerson's biggest year ever!

Freshen up your stock — lead off with these winners — three of the liveliest, easiest-to-merchandise sets on the market — priced to sell in all territories — with appearance and performance which make them in all ways sensational.

All other Emerson models — up to \$129.95 — are scheduled for the biggest records in history during 1936!



**EMERSON  
Model 108**

5-tube AC-DC Superheterodyne — Aeroplane Dial — Automatic Volume Control — Dustproof Dynamic Speaker — Two Bands: 75 to 200 Meters and 193 to 565 Meters — Standard American Broadcast and American Short Wave, including both Police Bands, Amateur and Aeroplane Stations — Bakelite Cabinet, 11 in. high — RCA tubes. List price,

**\$24.95**

**EMERSON Model 109**

4-tube AC-DC Superheterodyne — Covering American Broadcasts, Police and Amateur Stations — Illuminated Aeroplane Dial — Dustproof Dynamic Speaker — Bakelite Cabinet — 9 1/4 in. wide — RCA tubes. List Price,

**\$17.95**



EMERSON RADIO & PHONOGRAPH CORPORATION, 111 Eighth Avenue, New York, N. Y.  
The EMERSON Line Also Comprises Models for Every Foreign Market. Cable Address: EMPHONOCO, N. Y.

**YEAR AFTER  
YEAR . . .**

1931  
1932  
1933  
1934  
1935

and again in

**1936**

★ ★ ★ *It's*

**PHILCO**

**1935** was a big year for Philco dealers . . . a year in which they made great strides forward . . . built up prestige . . . made more profit than ever before.

And now for another year . . . a year that promises even more to Philco dealers than the one that has just closed! Philco has kept a watchful eye on sales opportunities . . . has figured out just what you need to boost 1936 sales to still greater heights . . . and NOW Philco announces many new additions to the 1936 line! These additions will give you the same jump on competition in 1936 that Philco has always given you in the past.

The new models are ready now! And in every American and Foreign Philco, you have the greatest sales weapon of the day . . . the exclusive

*built-in*

## **AERIAL-TUNING SYSTEM**

From all sides . . . from dealers everywhere . . . letters pour in telling of the tremendous success of this great Philco invention as a sales-builder! Here is a "feature" that only Philco dealers can offer . . . a feature that registers with the public for it doubles the number of foreign stations you can get and enjoy. It's a feature that means SALES for YOU!

You can make January a record month. January is the time to pile up those points for the great Philco Havana Cruise . . . points that will make you one of the 2481 guests on the luxurious "Monarch of Bermuda," with all expenses paid!

Get full details of the new additions to the Philco line . . . and of the Philco Cruise to Havana . . . from your distributor!

**PHILCO RADIO & TELEVISION CORPORATION**

# RADIO TODAY

Staff—

DARRELL BARTEE  
FRANKLIN S. IRBY  
RANDALL R. IRWIN  
G. H. MAYORGA  
M. H. NEWTON  
JOHN F. RIDER  
B. V. SPINETTA  
VINTON K. ULRICH

LEE ROBINSON  
Sales Manager

ORESTES H. CALDWELL  
Editor

M. CLEMENTS  
Publisher

480 Lexington Ave.  
New York City  
Tel. PLaza 3-1340

Vol. II, No. 1

## BRIGHT 1936

★ Signs for general business in 1936 seem good. As year opens the business index stands at between 96 and 97 per cent—compared with 83 per cent a year ago.

General business activity will undoubtedly continue at least at present levels throughout the year, and may even go higher, although the prospects of a Presidential election usually have the effect of slowing down business.

Experienced observers, however, declare they see no signs of business let-up in 1936. On the contrary intense small-house building is expected, with benefits all along the line.

## DURING 1936, RADIO WILL ELECT NEXT PRESIDENT

★ With 1936 an election year, and the political pot already bubbling, radio has had handed to it the greatest drawing card on earth—a full-blast Presidential campaign.

For radio—not the newspapers—will elect the next President. Popular interest, high and low, city and country, will be centered upon the present contest. The sessions of Congress, the party conventions, the campaigns, and finally the election itself, will provide a continuing spectacle for radio listeners, and one which should sell sets.

So radio sales should hold their own during 1936. And despite the enormous production totals of the year just closed, radio sets will be in more demand than ever.

So while radio production for 1936 may not run far ahead of 1935, it will be substantially based and sound, and should repeat the glowing record of 5,700,000 sets.

## BROADCAST BILLINGS

★ Networks have added up their revenues for 1935 and are still beaming over the totals. From NBC: "Ours is \$31,148,931, which is 11.9 per cent over 1934, not including talent expenditures." From CBS: "Ours is \$17,637,804, which is 19 per cent over 1934, and the largest in our history."

For the year, 1935, Columbia's totals and the estimates of NBC revenue, by networks, line up as follows:

NBC Red .....	\$18,722,715
CBS .....	17,637,804
NBC Blue .....	11,659,499

Figure issued by the Mutual Broadcasting System was for the last 6 months of 1935, a total of \$697,821.

Total time sales on all stations in the U. S for 1935 adds up to about \$86,000,000, compared with \$72,887,000 in 1934. Where this upthrust will bring the totals in 1936 to a figure which is likely to mark radio as a financial miracle, since the presi-

dential campaign and the sponsor's preference for celebrities will drive the expenditures sharply upward.

## 5,700,000 SETS SOLD IN 1935

★ Reports compiled by RADIO TODAY indicate that radio-set production for the fourth quarter of 1935, although slowed up by retail set-backs, nevertheless exceeded third-quarter production. Particular features were the big output of October and the end-of-year rise of automobile-radio production.

Estimating fourth-quarter production at 1,700,000 sets, and combining this with the license totals for other quarters and with unlicensed sets, the figures are given below, dollar volumes being retail values of sets with tubes.

1935	Units	Retail Value
1st quarter .....	1,155,438	\$69,000,000
2nd quarter .....	1,074,909	64,000,000
3rd quarter .....	1,521,684	91,000,000
4th quarter (est.) .....	1,700,000	101,000,000
Total licensed .....	5,450,000	\$325,000,000
Unlicensed .....	250,000	11,000,000
Total sets .....	5,700,000	\$336,000,000

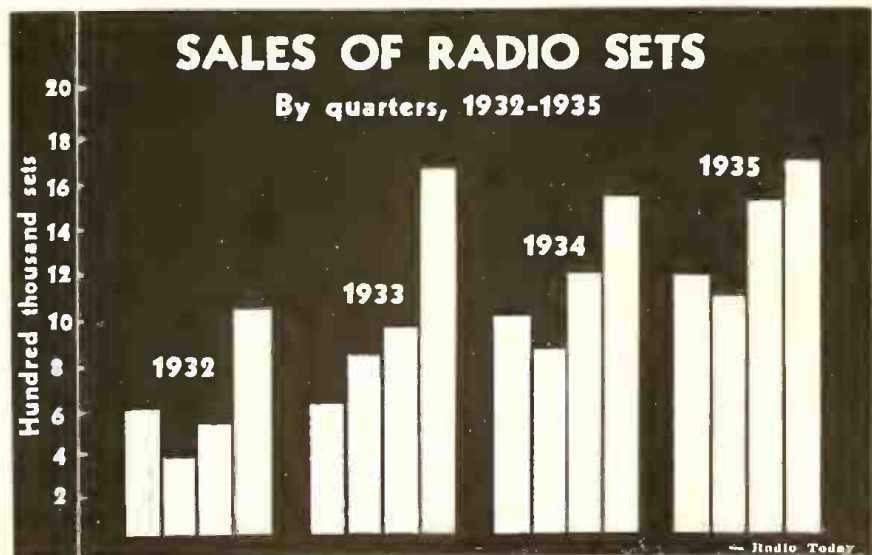



David Sarnoff, president RCA, shows Major Lohr, new prexy NBC, how to operate the controls of a big network.

## RE-ALLOCATION OFF TILL AFTER ELECTION

★ For the past two or three months radio circles in Washington have been agog with reports of plans for a complete re-allocation of broadcast facilities, station power, clear channels, and new applications. Broadcasters have been lying awake nights worrying over their future assignments if the mysterious re-allocation plan, concocted in FCC engineering offices, went through without notice.

But now all these headaches are postponed for the time being, and it is certain that there will be no station shift between now and November.

The White House was courteously reminded that broadcasting is in 1936 the most powerful electioneering medium, far out-distancing the press, that "Radio will elect the next President." So there will be no mussing up of the ether channels between now and Nov. 4. But after election, look out for a big shake-up.

## DOZEN STATIONS FLIRTING WITH 500 KW

★ Success of 500 kw. transmitter power on WLW, Cincinnati, has aroused the interest of other leading broadcasters, and many are eager to follow Crosley into the super-power realm.

Recent check-up showed that there are at least ten or a dozen stations

which are now considering applications for 500 kw. or thereabouts and have discussed possibilities with manufacturers.

Meanwhile it is rumored that if other broadcasters barge into the 500 kw. class, Powel Crosley will apply for still greater power, perhaps 1,000 kw. — "a million watts." At any rate it is a matter of record that the Crosley station has long led the power procession, back from the days when it pioneered 50 watts and 500 watts, then considered gigantic by other broadcasters.



Walter Holland, who retires as Philco vice-president, to ranch in Arizona.

## NEW NBC PREXY

★ Honored newcomer to the prexy's office at NBC is Lenox R. Lohr, succeeding Merlin H. Aylesworth, who asked to be relieved of the chief's duties because he has enough to do with the chairmanship of RKO.

Among other things, Major Lohr has emerged from Cornell and Cambridge Universities, the World War, and the general-managership of Chicago's Century of Progress. Seven years he was a member of the board of directors, executive secretary and editor of the Journal of the Society of American Military Engineers.

Smart journalist, distinguished engineer, seasoned showman, Major Lohr has already had first hand-shake with FCC moguls at Washington.

## DISPLAY ON WHEELS

★ From Chicago, Fairbanks-Morse has forwarded to RADIO TODAY a novel account of how several distributors get results with the use of trucks and trailers in contacting dealers and dealer prospects with merchandise models for sales demonstration work.

These traveling displays roll up to the dealer's front door with a working supply of radios, refrigerators, washers, and ironers, and create a mild sensation with a well-planned show-off of the models. It dramatizes the efforts of the salesmen and cuts the contact costs for the distributors.

Fairbanks-Morse distributors now using the device are Appliances, Inc., Cincinnati; True and Blanchard Co., Newport, Vt.; Charles E. Turnock Co., Milwaukee, and Fairbanks-Morse & Co., St. Louis.

## BIG RETAIL BUSINESSES

★ Signify what it may, the dizzy amounts spent by consumers in 1935, considered by groups, ranged from one billion to seven, with radio's figure set at \$400,500,000. Total retail biz in the United States for the year is estimated at \$32,000,000,000; last year the figure was \$28,548,000,000.

Estimated line-up for 1935 is: Food group, \$7,560,000,000; automotive group (includes gas and oil), \$6,800,000,000; apparel group, \$2,405,000,000; furniture and household group, \$1,472,000,000; drug group, \$1,267,000,000.

## "RADIO WILL ELECT THE NEXT PRESIDENT"

★ An observer who is making a tour throughout the nation studying economic and political conditions, makes the following significant report to his principals:

"If one does any great amount of talking with 'dirt-farmers' and the public generally, about the political outlook, he will soon find that the influence of the newspapers and their editorials is a very much over-rated factor in the present-day world.

"The fact is that *radio has run away with the show* in influencing the politics of the public — and from the writer's travels he finds it *five-to-one in effectiveness*. And the group he finds still least conscious of this change, is the newspaper publishers themselves. They are still living in the world of yesterday."

## TELEVISION-CABLE ROW

★ After the American Telephone and Telegraph Company had been granted authority by the Federal Communications Commission to lay the much-discussed coaxial cable between New York City and Philadelphia, the company asked for a rehearing because the grant stipulated that the cable must be made available to others for experimental purposes in television.

A. T. & T. moved to have testimony of commercial uses of the cable ruled out of the affair, but the FCC said thumbs down, and is hearing evidence on that very angle.

## CARLOADS FOR RADIO

★ Radio is now big business and has gotten to the point where its raw materials come in thousand-carload lots.

During 1935 the entire radio industry is estimated to have consumed a million miles of wire — enough to reach four times to the moon. Some 1,500 carloads of steel were consumed for receiver chassis and parts. And 3,500 carloads of lumber went into cabinets.

The radio-set industry collected roundly \$367,000,000 from the American public for receivers and tubes — exclusive of set operating costs, servicing repairs, and broadcasting. Thus the set-and-tube business alone supported some 350,000 people, both direct employees and those occupied in the supply of constituents and raw materials.



Howard Briggs of Howard Radio, with Burton Browne, of FB & M, Chicago, — old timers.

## EXCISE TAX SHOWS 1935 RADIO 25% AHEAD

★ The official government report of Federal excise taxes collected on sales of radio sets for the first eleven months of 1935 indicates that 1935 sales of the radio industry will be about 25 per cent ahead of 1934.

During November, the U. S. Revenue Bureau reports, the 5 per cent

radio and phonograph excise tax collections were \$571,479.61, an increase of 23.5 per cent over the collections of \$462,638.47 during November 1934. This does not include excise taxes on automobile radio which are not separately reported but are included among automobile accessories taxable at 2 per cent.

The radio excise tax collections for eleven months ending November 1935, totaled \$3,706,420.65, an increase of 25.5 per cent over the similar excise tax collections of \$2,952,737.48 for the similar eleven months period of 1934.

## SERVICE EXPENSE, 46%

★ Statistics indicate that radio service men operating recognized servicing establishments or stores all over the United States operate at an expense as high as 46 per cent of total income.

Recognizing that the salary of the owner, which is a part of this expense, is on the average less than \$1,000 a year, the low prevailing service charges and the definitely limited prices which may be charged for replacement parts when sold, these expense figures are extremely high. They are very much higher than the ratio found in profitably operated maintenance sale organizations. Since a man can work only a definite number of hours each day, that is, if he is to live like a human being, the only means of rectifying the situation is to raise service charges.

Proper financial planning and operation calls for an expense not greater than about 30 per cent of the total income, assuming at least \$1,500 a year salary for the operator.

## WHAT WAS SPENT FOR RADIO IN 1935

5,700,000 radio sets, with tubes	\$336,000,000
39,000,000 tube replacements	31,000,000
Electricity and batteries to operate 25,500,000 home sets	154,000,000
Repairs and servicing of sets (minus replacement-tube sales)	68,000,000
Broadcasting time sold	86,000,000
Broadcast talent costs	25,000,000
<b>1935 Total</b>	<b>\$700,000,000</b>

Compiled by Radio Today



Scramble among amateur photographers for camera angles of the principals in NBC's *Eno Crime Clues* program. In the unusual contest, Miss Paula Morse of New York City was named winner last month.

## DEEPER BLUE

★ Major move by NBC to give Pacific Coast listeners a finer program service was the opening of a second coast-to-coast net, an expensive 1936 gesture which will carry to the west coast the same programs heard on the Basic Blue Network headed by Station WJZ. Extension of the Blue Web thus offers coast fans the whole works on both NBC chains.

Five stations in the West joined NBC to complete the hook-up, and along with KFSD these are to be

known as the Pacific Coast Blue Network. Newcomer stations, which are KGO, KECA, KEX, KJR, and KGA, hook up with the rest of the Blue stations at Omaha.

NBC thus belts the northern section of the nation with two trans-continental webs; the term "coast-to-coast" has a new meaning for sponsors who want a national reception for their artists.

## TELEVISION TESTS USE MOVIE FILM

★ Motion pictures will come to the aid of television at the outset, for the proposal now is that recent-run feature films will be put on the air, for the enjoyment of television "lookers-in." These part features can be supplemented with trailer "pre-views" of current movie offerings, and also news reels. In this way, television instead of sapping movie-attendance, will be made to supplement it.

Programs offer another difficulty, for when the actors are to be both seen and heard, production problems are enormously complicated.

These are but a few of the problems which television faces before the present laboratory developments, advanced as they are, can be put to commercial application.

As radio dealers, jobbers and service men read and hear about the coming experiments in television transmission at New York, they should be prepared to explain to their customers that these are only local experiments which will have no significance for many months so far as

television service for the country is concerned.

Radio receiver sales can therefore be carried on undisturbed, despite the local New York experiments.

## OLD RADIOS GIVEN TO INVALIDS; SOLUTION FOR TRADE-INS

★ With old radio sets presenting increasing obstacles to the sale of modern sets into millions of homes well able to afford quality radio reception, *RADIO TODAY* is launching a nation-wide campaign to get such old sets *given away* by their owners to local deserving shut-ins and unfortunates who would not be able to buy radios for themselves.

The undertaking will be carried out through local welfare groups entirely outside of the radio trade. Volunteer and professional charity workers will be asked to find deserving recipients — invalid, blind, aged — to whom a radio set would mean so much.

Each such transfer of an old radio will bring happiness to an individual otherwise shut off from radio, besides impressing on the well-to-do donor a new appreciation of radio-broadcast quality with modern sets.

Each such gift will also create a vacuum into which a new high-quality set can be immediately sold, so that radio dealers will want to work closely with local agencies engaged in this inspiring effort.

## GRUNOW REORGANIZED, GOES AHEAD

★ General Household Utilities Company, Chicago, Ill., manufacturer of Grunow radio and refrigeration products, has completed plans during the past thirty days which will enable the company to go ahead on a definite, sound basis, with ample working capital.

On Dec. 31 W. C. Grunow sent a telegram to Grunow distributors that briefly summarized the company's financial and manufacturing status:

"Federal Court appointed C. A. Albers and me permanent trustees. . . . This morning court authorized purchase of materials to put wonderful 1936 line of refrigerators into immediate production. . . . I believe reorganization will be completed in near future. You may pass this news on to your dealers. Radio production now running in excess of a thousand sets per day."

In a letter mailed the same day to



"Doug" Smith, recently named as Echophone's vice-president in charge of sales, located at Chicago.



Grunow dealers everywhere, Mr. Grunow added:

"General Household Utilities did thirty-two million dollars' worth of business in thirty-four months, with insufficient capital. That's the situation in a nutshell. And it tells convincingly of the very overwhelming value we have built into Grunow radios and refrigerators. But lack of adequate working capital, for the volume we have been doing, made it nec-



New Grunow exec — Howard J. Shartle, sales head of General Household Utilities Co.

essary for us to reorganize under 77B. (77B is in no sense a receivership.)

"On Dec. 24 a plan of reorganization was filed. This plan is so fair to creditors and to stockholders that the assurance of more than 80 per cent of the debt and the consent of an overwhelming majority of the stock was instantly given (the law calls for an assent by only two-thirds of the debt and 51 per cent of the stock)."

Grunow distributors and dealers were further gratified to learn of the appointment of Howard J. Shartle as general sales manager of the company. Mr. Shartle brings to this important position a background of a quarter century in executive, sales and merchandising positions in the radio-music industry. For several years he was an important executive in the Victor Talking Machine Com-

pany and over a long period was head of the Cleveland Talking Machine Company, Cleveland, Ohio, one of the most successful distributing organizations in the country. Mr. Shartle is, therefore, familiar with the marketing of specialty products from every conceivable angle. He knows the problems of jobber and dealer thoroughly and adequately, and is admirably qualified to work in close cooperation with every factor of the Grunow organization.

During the past few weeks, Mr. Shartle has surrounded himself with a corps of thoroughly experienced and capable merchandisers, including Otto Bowman, Jimmy Rasmussen, Herbert E. Young, James J. Davin and H. D. MacRae.

Every member of this staff has been identified with the merchandising of Grunow products for many years. Mr. Bowman is assistant sales manager; Mr. Rasmussen is advertising manager; Mr. Young is Eastern manager, with Mr. MacRae as his assistant. Mr. Davin is functioning as a division manager in Western territory.



John Shephard III, president of New England's progressive chain, the Yankee Network.

sion of the company, plugged every Thursday night on CBS by Horace Heidt and his popular entertainers.

## RADIO HELPS SAFER DRIVING

★ Simply because it seems ghastly and fantastic that motorists and pedestrians should be steadily mangled at an astonishing rate on the highways of the country, Stewart-Warner has moved to give the matter of safe driving the benefit of a big-time radio program. Altruistic gesture is similar to Squibb's backing the cause of world peace, except that Stewart-Warner carries a banner of more immediate concern.

Activity in the national campaign will center around the Alemite divi-

## JAPANESE MENACE

★ A new and widespread source of radio interference on the short waves is reported coming from incandescent electric lamps. Particular lamps, exhibiting no visible fault, are found to set up Barkhausen oscillations at 30 to 60 megacycles.

Such oscillations are found especially prevalent in Japanese lamps. The oscillations are set up in the lamp filament itself, and have nothing to do with loose sockets or poor connections, which are other sources of radio interference.

## MORE RADIO HOMES THAN AUTOS

Homes with radio sets, Jan. 1, 1936	22,500,000
Sets in homes with two or more radios	3,000,000
Automobile radios in use, Jan. 1, 1936	3,000,000
Total radio sets in use, Jan. 1, 1936	28,500,000
Total passenger car registrations, Jan. 1936	22,450,000
Total homes with automobiles, Jan. 1936	17,650,000
Total residence telephones, Jan. 1936	11,000,000
Total homes with electricity, Jan. 1936	21,030,000
Total homes in United States, Jan. 1936	31,000,000

Compiled by Radio Today

# THERE'S NO SUBSTITUTE FOR SELLING

— large percentage of replacement sales in 1936  
— quality sets best demonstrated in home

— present users as prospect list for calls  
— "service inspections" as door-openers

★ "OUTSIDE selling" by radio dealers has met with distinct objection on the part of many successful radio merchandisers, until recent months. But surveys conducted by RADIO TODAY throughout the country, show that this method of "going after the business" into the customer's home is now being utilized by an increasing number of retail radio organizations.

More and more, as radio becomes a replacement business, is it found necessary to get into the homes of existing radio listeners, and show them the great improvements in the new receivers, to replace their now-obsolete equipment.

## Rule of seven

In any community, divide the homes with radios into seven groups. Then the first of these groups will be found to have radio sets sold during 1935; the second, sets dated 1934; the third, 1933; the fourth, 1932; the fifth, 1931; and the sixth and seventh will contain outmoded products of 1930, 1929 and before.

Thus half of the homes in your town—any town—have radios four years old or more—radio sets badly in need of replacement. These are sets with cabinets that have become eye-sores, and with reproduction tone that is far substandard compared with the splendid broadcasting of today.

## Tinny awfulness

The loyalty with which a radio owner will insist that the tone of his old set is the equal of anything on the market, has long been the despair of musically-discriminating friends as well as the bane of the interested radio dealer. It is only by getting a new radio set into such a home, connecting it up, and letting the prospect hear it for himself, alongside his own radio, that the tinny awfulness of the old reproducer becomes evident to the dotting owner.

Demonstration and contrast will tell the story. Demonstration will "show up" the old set with its lack of the low notes which deepen and enrich the reproduction, and its failure to deliver the sparkling high frequencies which add life and character to music and voice. "Demonstration is believing."

## Home demonstrations

And such demonstration has to be done in the home itself. In few stores during daylight hours are radio reception conditions such as permit any adequate demonstration of the full reproduction possibilities of the new sets. Field-strengths are usually weak in business sections, among steel buildings, and here also electrical interference is at its maximum.

The place to demonstrate and sell the 1936 radio set is right in the home where the set is to be used.

## Go after present users

Homes to which radio sets have been sold in the past, often make the best possible prospect lists, say radio dealers who are cold to ordinary canvassing. The retailer who sold the same householder a set several years before, has an excuse to go himself or send a man to check-up on the set's performance.

If the receiver has become obsolete in performance or appearance, it is logical to suggest that a modern set be sent up to "try out." Here the selling psychology is the same as that of the automobile salesman who always tries to get the prospect seated behind the steering wheel, and then encourages him to "take a little drive."

Experience shows that once the new radio set is in the family's hands and the dials are twirled for a night or two, sales follow in most cases.

## Digging up prospects

Newspaper advertising and direct-mail campaigns through letters, post-cards and booklets, afford another way to dig up interested prospects and save the salesman the time taken to complete cold-turkey calls.

Telephone calls provide other "openers." Often a woman's voice is best for making such canvasses. After the appointment has been made, the salesman can "get through" the home portals more easily if he is "expected."

Some dealers require their outside salesmen to keep several radio sets always in customers' homes on demonstration. Point here is to maintain such demonstration sets continually in circulation, and make the demonstration periods relatively short and definite. Successful dealers recommend setting a time for the demonstrator unit to be moved away—or a decision to buy reached. Of course on request the demonstration period is usually extended, but again to a definite date, which should be rigidly observed.

In every town and every neighborhood there are hundreds of radio sets that need replacement. The owners

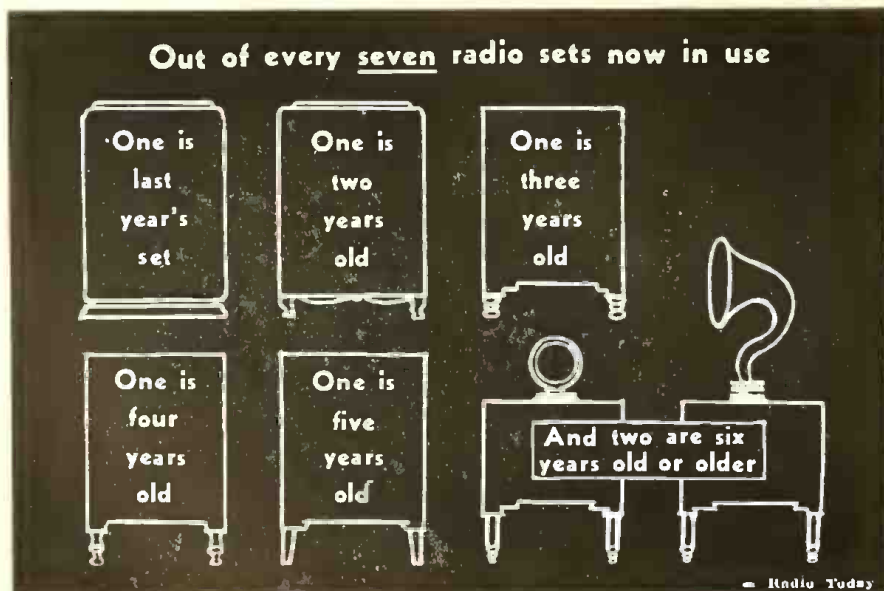



How the map would look if area of each state were proportional to its number of radio homes

# THE "RADIO STATES OF AMERICA"

## HOMES WITH AND WITHOUT RADIOS

Listening audience and receiver markets by states, as of January 1, 1936 Compiled by Radio Today

STATE	HOMES WITH RADIOS	PERCENTAGE OF HOMES WITH RADIOS	HOMES WITHOUT RADIOS	STATE	HOMES WITH RADIOS	PERCENTAGE OF HOMES WITH RADIOS	HOMES WITHOUT RADIOS
Alabama	227,500	37.7	374,700	Nevada	17,170	63.8	9,730
Arizona	56,100	50.3	55,400	New Hampshire	98,600	81.8	21,900
Arkansas	128,800	28.8	317,900	New Jersey	939,000	90.7	93,000
California	1,474,000	83.8	285,400	New Mexico	45,400	44.6	56,200
Colorado	195,600	72.3	75,200	New York	3,035,000	92.7	229,700
Connecticut	356,000	88.4	47,700	No. Carolina	280,000	41.6	393,700
Delaware	48,000	79.4	12,500	No. Dakota	88,000	60.0	58,400
Dist. of Col.	121,800	95.6	5,600	Ohio	1,405,000	80.0	347,800
Florida	216,500	53.6	187,300	Oklahoma	305,300	51.8	284,000
Georgia	272,200	41.2	389,400	Oregon	221,100	80.4	53,900
Idaho	77,800	71.0	31,500	Pennsylvania	2,009,700	88.1	275,400
Illinois	1,728,000	85.6	291,500	Rhode Island	156,000	90.7	15,900
Indiana	625,000	71.8	244,500	So. Carolina	149,500	40.2	222,800
Iowa	482,000	75.5	155,200	So. Dakota	108,300	66.0	55,700
Kansas	334,500	68.5	154,000	Tennessee	327,800	52.6	294,500
Kentucky	323,800	52.3	294,100	Texas	768,000	53.1	677,900
Louisiana	271,000	53.8	232,700	Utah	88,000	74.4	30,200
Maine	143,200	71.3	57,800	Vermont	64,200	71.2	26,100
Maryland	333,400	83.8	64,500	Virginia	315,900	59.4	215,800
Massachusetts	945,000	89.5	112,300	Washington	349,100	80.4	85,500
Michigan	964,000	77.5	278,200	West Virginia	250,500	65.6	137,800
Minnesota	463,000	74.7	156,500	Wisconsin	512,000	70.0	220,900
Mississippi	119,500	25.0	358,900	Wyoming	35,100	59.0	24,400
Missouri	679,500	72.0	263,800				
Montana	90,800	65.9	47,100		22,501,670		8,416,630
Nebraska	256,000	73.3	92,700				

Of the 31 million American families, 72.6% have radios.

of most of these will not come into the store of their own volition. The new set merchandise must be taken to the customer's home and the contrast between new and old radios demonstrated to all the family.

The radio dealer can't wait in his store for this business to come in. He must go out. Within walking distance of his store are thousands of dollars of prospective sales waiting for his calls.

can be done, and what it will mean to the household.

Dealers agree that so far as selling value is concerned the big talking point is the all-wave feature of the new models. Therewith it may be pointed out that although the all-wave feature is highly desirable for the main receiver in the home, the foreign angle is not important for a receiver in the kitchen or nursery.

One prominent dealer said flatly that he did not take in the old sets; he has an elaborate scheme for inspiring charity on the part of the owner, and has a good supply of suggested places where the old receiver would be greatly appreciated as a gift. Hospitals, orphanages, club rooms, social enterprises, and recreational centers are on the list.

Dealers must remember, however, that such old receivers are usually a large-size console with a good supply of old-fashioned legs, and in suggesting spots where they may remain in use, specific help must be given as to how to place the old set to the best advantage.

### Second hand biz

Some dealers have made a fair profit by reconditioning the old sets and pushing them among people who cannot afford a better set. Difficulty here is that the prospect was attracted in the first place by publicity given the 1936 receiver features, and may not be sidetracked to a set which has only the features of yesterday.

It might be kept in mind, though, that among people of the lower income brackets, who do not own a set and have never had any experience with the 1936 models, an old set, properly reconditioned and plugged as a good value, may have sufficient appeal.

Experience has proved that it is not wise to sell old sets on time, which is the procedure in many cases, unless it is completely and carefully reconditioned. Service responsibility for the dealer following such sales is likely to remove all chance of profit.

### Air plugging

Generally agreed, it is, that whatever trade-in policy is adopted by the dealer may best be plugged on the air in local broadcasts. Allowance offers which have already gone on the air are the ones which stuck in the minds of prospects, according to dealer reports. Everyone who hears the offer on the air already has a set, of course, and the medium seems to dramatize the trade-in biz particularly well.

# "TRADE-INS" TODAY

- manufacturers present more models to lift trade-in burden
- dealers develop specific uses for old sets kept in homes
- owners also encouraged to make gifts of outmoded sets

★ SO long as we live and do business, some part of the 13,000,000 allowance-conscious owners of outmoded radios will be continually dragging them in to trade for new models.

Facts are that the old sets average between five and seven years in age, and dealers report that as high as 90 per cent of their sales involve some allowance made for them. Problem becomes freshly important as the public becomes aware of the finer reception features of 1936 models and begins to wonder what part of the \$2,000,000 weekly programs is missed when heard through an antiquated set.

### Aid from headquarters

At least two leading makers of sets have offered specially priced models to help the dealer meet the trade-in problem. In these cases the advertised list price indicates an exceptionally wide margin, so that the dealer may offer attractive allowances and still expect his normal profit. Differences in these models as compared with the others are usually found in the cabinet, rather than in the chassis.

These policies moved some dealers to remark: "How we handle trade-ins depends almost entirely upon which set we are selling. Allowances vary with the attitude of individual manufacturers."

### Your solution here?

Picked up from scores of thoughtful dealers, some of them plenty grey over the problem, are assorted solutions and possible answers to the question, "What is to become of the old sets?"

Even in the midst of price cutting, some dealers insist that dignified reluctance to offer high allowances can be used to induce patrons to keep the old set. Convinced that the shop offers a complete and first class brand of service of both the old and the new, customers will often forget the allowance angle.

Some dealers have offered to recondition the old set, if the patron will buy a new one and find another spot in his home for the old one. The trick here is for the salesman to get the prospect involved in a discussion as to how the reconditioning

## WHERE 1935'S RADIO-SET OUTPUT WENT

Sets exported	600,000
Battery sets to farms	550,000
Automobile radios	1,200,000
Sets to new listeners in wired homes	1,000,000
Replacement sets and additional sets in homes previously having radio	2,350,000
<b>Total 1935 set production</b>	<b>5,700,000</b>

Compiled by Radio Today

# AUTOMOBILE RADIOS

- dealers eye trends in auto sales as best guide today
- hook-ups with car dealers and dept. stores prove smart
- auto radio promoters win argument on safety in driving

★ AUTO horns, several loud ones, are honking at the dealer's door.

Drivers come from auto dealers, department stores, export concerns, or just off the street, and they want installation and service of a sort which they had not learned to expect before the advent of 1936.

Automotive manufacturers, who pretty well out-promoted everybody else in 1935 and emerged with the best sales volume since 1929, could scarcely have chalked up such rosy gains without creating a stir among those who sell car radio receivers.

Dull conclusions to the effect that car dealers sell the sets along with the cars and that's the end of it, are something less than valid at this point. There are plenty of car dealers and department stores who maintain neither the equipment nor the servicemen to do the work required for car radios.

## New slants

Change in the date of the auto shows inspired a shift in the sales curve for autos, and left a promotion spot for merchandisers of car radio, since the 1936 car receiver models were not ready at the time of the show.

Custom-built controls, deftly designed to match all car models, are now receiving their widest publicity, although they are not brand new as a mechanical feature. Since the up-rush in auto sales runs definitely toward the higher-priced models, many dealers are cashing in on the stronger demand for rear-seat installations.

## Specialization

By this time, the public has had enough experience with the operation of auto receivers to know its relation to the car's ignition system. Dealers have discovered a nifty talking point in accenting the fact that it requires a highly specialized type of service to assure "clear reception with maximum motor power."

M. B. McCullough, who heads the MacAdams Equipment Co., Inc., 507 W. 56th St., New York City, is one exec who specializes very seriously and will soon open new and improved

shops. MacAdams' activity is dedicated directly to the theory that servicing 1936 car radios requires attention that is special and peculiar.

## Beautiful hook-ups

Emil Krauss, of Krauss Bros., 210 W. 65th St., New York City, has some profitable hook-ups with car dealers and department stores; contracts for installation and service which have boosted his business to 1929 levels. Mr. Krauss has the advantage of being a pioneer who knows his way around in the automotive business.

Local applications of this get-together policy, among car dealers and radio experts, is quite possible in cities of all sizes, since in many cases the car manufacturers do not stipulate to their dealers where or by whom the radio installations may be made.

## An argument settled

Safety cranks who have persisted in the claim that car listening is a menace to safe driving have been shouted down and outnumbered. Drivers testify that listening in tends to cut their speed; a lively broadcast is refreshing and lessens the fatigue of driving; what driver will go to sleep in the midst of an interesting program?

Reports have it that the proposed ordinance prohibiting auto radios in St. Louis has died a well deserved death in one of the city's committees.

## Driver programs

It has been found that among business men who drive to and from work, the appeal of news reports and market reviews has an enormous appeal. Considerable merchandising success awaits those who would regard this class of drivers as important enough to merit extra attention; perhaps the day will come when special broadcasts will be arranged for this, or other professional types of drivers whose road habits are known.

N. Cooper, of the York Automotive Dist. Co., 17 W. 60th St., New York City, remarks that drivers who have tried listening to news broadcasts in their cars are likely to regard it as a necessity rather than a luxury. With the nearby perfect reception now available to the driver, via the 1936 sets, Mr. Cooper's point is that a new receiver is actually a necessary investment.

## BRAVO, IN A WAY

★ A Wisconsin motorist has discovered that it's unthinkable, his not having a radio in his car. The man, Mr. Bibby, was driving un-musically along on the way home from Madison, when he was hailed by a debonaire hitch-hiker, who inquired elegantly, "Have you a radio in your car?"

Mr. Bibby, feeling himself unexpectedly identified with the Middle Ages, admitted that he hadn't a radio. The hitch-hiker coolly thanked him and said he'd wait for another car.

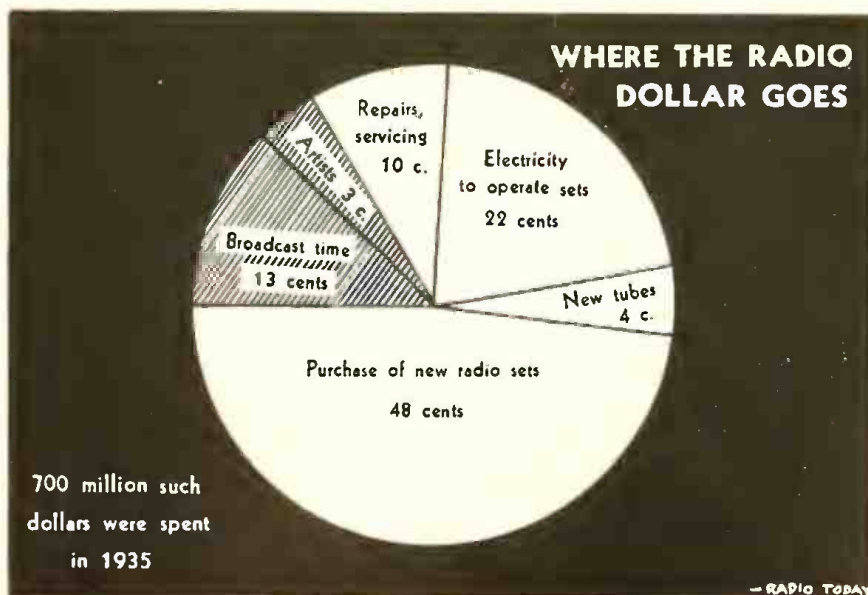

# ACCENT MODERN

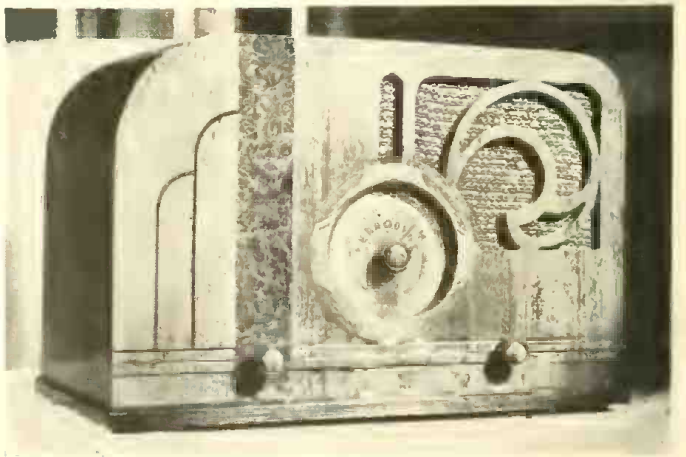
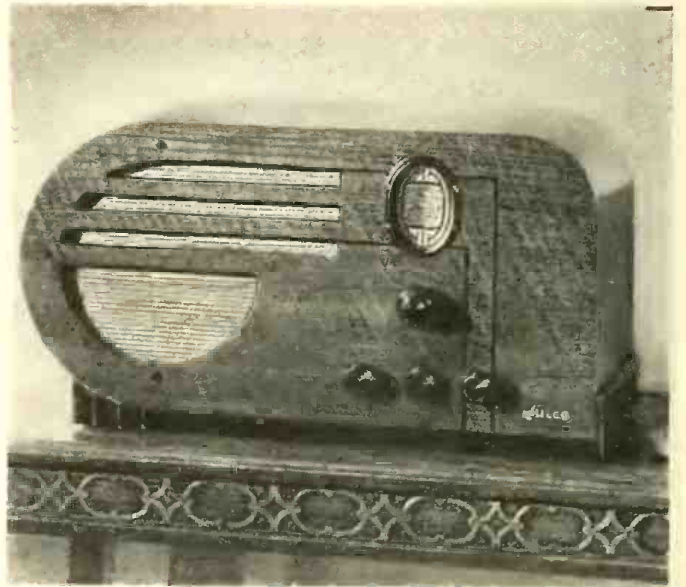

Speed patterns of the 20th century—above is Zenith's strikingly styled distributing headquarters at Chicago. Below are passengers dialing RCA receiver aboard the Union Pacific's radio-equipped streamlined train.

Above, Hollywood favorites try out the neat and novel Royale "Radiobowl," in which the speaker points vertically. Center is a new and fast-looking bookshelf model by Philco, and below is recent and intriguing design from Stewart-Warner.

# SELLING MORE TUBES

- condition of tubes now in use reveals surprising situation
- technical education of dealers and servicemen important now
- record tube output in 1935; 39,000,000 in replacement biz

## ★ TUBES wear out with use.

The majority of the listening public doesn't yet seem aware of this simple fact of life, if one can judge from the number of radio tubes sold at retail for replacement.

For if the dealer will consider any group of radio sets in use in his community, he will find an astounding situation with respect to the hours and years the tubes have been in use.

Out of every four tubes, one was replaced last year; another tube has been in use two years; the third has been running three years, and the fourth tube is four years old or older.

It is time therefore to put pressure on getting the old tubes out of the sockets, and new tubes in.

## Manufacturers help

Sensitive promoters of the tube-replacement business have betaken themselves to the serious education, in one way or another, of dealers and servicemen. These days, a smart dealer will get plenty from the manufacturers in the way of info; lists of sales ideas, formulae for feature promotions, the technical low-down, equipment data, display features, tip files, "deals," and assorted sales stimulators.

## Test equipment

"Tune-ups," it turns out, are best adapted to promotion in smaller towns where types of service can readily be personally publicized. In many cases they have been successfully staged before special broadcasts of universal interest. Trend is toward plugging these offers on the air, although newspaper and handbill ads are popular among dealers.

"Deals" offered by the tube makers formerly ran to casual shop equipment, such as coats, displays, and files, but at this point there are many which include the highest priced testing equipment. Signal generators, tube checkers, testers, trouble shooters, oscilloscopes, combinations, meters, analyzers, voltmeters, etc., come from the leading instrument makers and are offered through the

tube promoters. Price of the instruments is often credited when tubes are ordered from the makers.

## More stunts

Dressing up a handsome blonde as a "human radio tube" sold 5,000 tubes in little over a week at Russell's Radio Co., Indianapolis, Ind. The girl wore a costume featuring the colors on the containers of the tubes handled at the store, and she stayed at the place all day long to test old tubes brought in as a result of a special ad. Tube tester was put in the center of the floor, and a special window display helped to attract traffic.

Up-to-the-mark technique in tube selling asks not only that dealers improve their technical education by an intelligent perusal of new reference manuals and data charts, but they should advertise the fact that they are up to the minute, for the benefit of the patrons. Neat and spectacular testing equipment is operated in prominent spots in the shop, surrounded by flashy tube displays.

Servicemen are encouraged to know and sell allied electrical merchandise, along with sets and tubes, so that they may start with one and end up with the other.

## 73,000,000 tubes in year

First-of-year estimates indicate that 73,261,000 radio tubes were made and sold during the last twelve months. Probably 39,000,000 of these went into replacements through retailers and servicemen. Here are the figures by quarters for tube sales by tube licensees during last year and the year before, together with estimated total sales:

	1935	Tubes	Value
Jan.-Mar.	.....	15,247,456	\$ 5,266,500
Apr.-June	.....	14,454,219	4,563,800
Jul.-Sep.	.....	20,559,634	7,365,897
Oct.-Dec. (est.)	.....	21,000,000	7,500,000
Licensed (est.)	..	71,261,000	\$24,700,000
Unlicensed (est.)	..	2,000,000	570,000
All tubes	.....	73,261,000	\$25,270,000
1934			
Jan.-Mar.	.....	13,664,063	\$ 5,369,678
Apr.-June	.....	11,400,000	3,900,000
Jul.-Sep.	.....	12,200,577	4,472,389
Oct.-Dec.	.....	20,000,000	7,300,000
Total licensed	..	57,264,640	\$21,042,067
Unlicensed (est.)	..	2,000,000	540,000
Total, 1934	.....	59,264,640	\$21,582,067

## DRAMATIZING BROADCAST PROGRESS

★ Lively and convincing demonstration of what improvement has been made in the quality of broadcasting since 1922 was staged at WOR, Newark, N. J., a recent broadcast of the popular Alfred Wallenstein's Sinfouietta program.

By using line-filters to cut out the high and low-register notes, WOR engineers were able to show what the broadcast would have been like in 1922, in 1925, and in 1929, using the various types of old-style mikes. When they turned on the 1936 arrangement, using the new non-directional mike, the improvement in tone quality was obvious and amazing.

**Out of every four radio tubes now in use, one was replaced**

in 1935      One in 1934      One in 1933      And No. 4 has been used since 1932 or longer

— Radio Today

# RADIOS FOR FARMERS

- farm groups tense with interest in 1936 political battle
- uprush in income this year makes farmers likely buyers
- home demonstrations will sell farm families quickly

★ THIS 1936 promises to be a banner year for radio on the farm. For the American farmer loves nothing better than his politics. And whereas in former Presidential years he had to hitch up and drive to town to sit-in on mere small-town oratory, now his radio set gives (or can give) him a reserved seat to listen to the nation's topflight political debaters, including the Presidential candidates themselves.

So 1936 is going to see a good many thousands of new radio receivers move promptly into farm territory; thousands of new farm listeners will be added to the political audiences, and the farm voters will go to the polls in November as well informed as any city cousins.

For as a purchaser of radio sets and other new merchandise, the farmer is now equipped with real money in his overalls pocket—cash dollars which have flowed in to him along with the rise in the prices of farm products.

What the farmer has gone through, during the depression, and how far he has already come-back, on the way to a state of rural prosperity, is best

pictured by the total figures on farm incomes for the United States.

Prior to 1929, the farm income of this country ran between 13 and 16 billion dollars a year. By 1932 however, the farm total had dropped to only four billions, imposing on the farm population hardships even worse than those visited on industrial communities.

But in 1933 farm income turned upward, and the total reached five and a half billions. In 1934, it had passed seven billions; in 1935 it was eight billions.

And for 1936, the outlook is for 9 to 10 billions of farm money in circulation, indicating that a healthy share of the 1929 totals have already been regained.

Of the United States' total 130,000,000 population, 35,000,000 live on farms; another 25,000,000 live in small rural communities and rightly can be classed with the farm group.

There are 6,500,000 farms; hardly 10 per cent of these farms are yet served with electricity, leaving a vast number of farm homes which are prospects for battery sets of one kind

or another, if they are to enjoy any radio reception at all.

It is not surprising then that the sale of battery sets for farm use reached during 1935 the all-time top total of 550,000. Special-battery sets for use with "air-cell" batteries, made up a part of this. Also during the year just closed, the wind-mill generator was introduced, enabling the farm listener to employ an ordinary storage battery and to keep it charged by wind-power, without further attention or trips to the village for replenishment.

## 4,000,000 farms without radio

And yet today, as the Presidential campaign of 1936 opens with its first scattering shots, there are at least 4,000,000 farm homes which are *without radio sets*, although well able to purchase them.

For the farmer is a generous if thrifty buyer. Look around his tool yard or shed and see his \$150 feed-grinder, his \$300 binder, his \$650-\$1,000 tractor; his \$700 team of horses; his \$1,000 car. Then do not question his ability to buy and pay for a good radio set, if it is once brought out and set up in his home, so he can work the dials for himself.

The radio set on the farm is far more than an entertainment device. It is a newspaper, a cultural channel, and an economic necessity to the farm producer who must depend upon distant markets to sell his wares at best prices.

## Farm home features

Also, farm interests have been the subject of some extra program-building on the part of the broadcasters, so that broadcast schedules now include special features that farmers will not want to miss.

Rural listeners have learned to count on the National Farm and Home Hour for valuable tips on agricultural news, events, research and farm trends. Sponsored jointly by the U. S. Dept. of Agriculture and NBC, the popular broadcast is heard daily except Sunday through 60 station outlets.

To sell radio sets to these 4,000,000 farm homes is the radio industry's next big job. And it will have to be done by taking the sets to the farms, connecting them up, and letting the farm family discover for itself the miraculous country back of those magic dials.

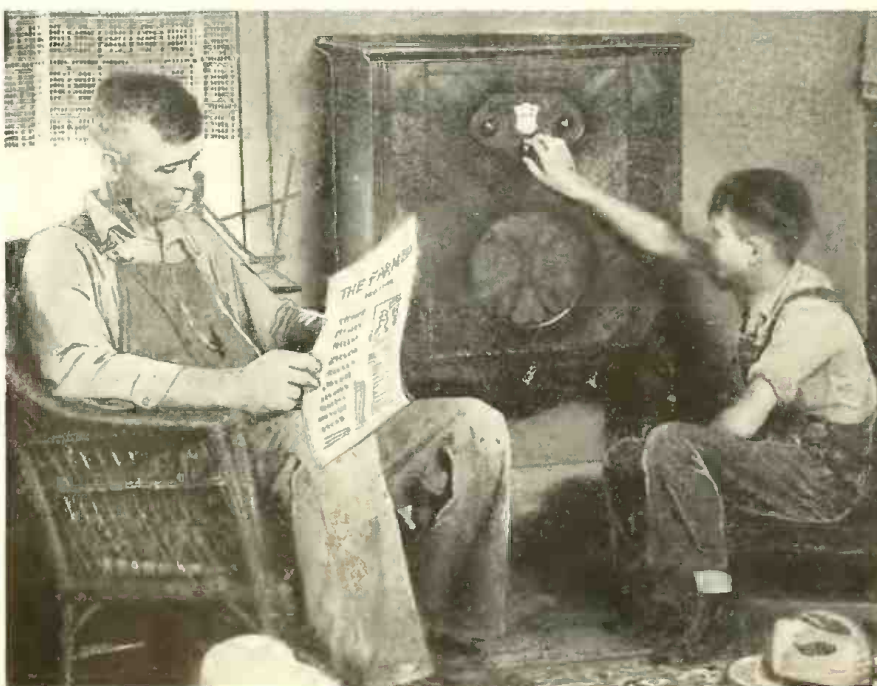



# PUBLIC ADDRESS FOR 1936

- local political campaigns create demand for P.A. rentals
- large profit in furnishing amplifier systems
- manufacturers supplying specialized equipment

★ **STORMY** opening of the presidential campaign and its allied by-play will furnish an additional income to wide-awake radio dealers and servicemen who are "public address" conscious.

The possibilities of renting-out amplifier systems are practically unlimited; there will be hundreds of political meetings in every community between now and Election Day—each rally should have its public address system so that the speaker can be heard clearly in the far corners of the auditorium without raising his voice.

Sound cars, too, are virtually a necessity if the candidates are to reach the general public—most of whom are too busy or lazy to attend scheduled pow-wows. By parking the car at a busy spot in the town and first playing a phonograph record, the politician can soon attract a large audience. He then can address the group, irrespective of size, via the amplifier with complete ease; the power of his voice can be used for oratory rather than mere coverage of the crowd.

## Getting started

Many servicemen have gone into public address work with an investment on the order of \$100 or less. The capital required depends entirely upon quality of reproduction desired—fortunately, for speech amplification it is not necessary to have high-fidelity microphones and amplifiers.

For the dealer who wants to be equipped for mobile work and inside installations, a single system which will work on both 110 AC and 6 volts DC is most economical. Ordinarily such amplifiers have a power output of 15-20 watts, which is capable of covering almost any gathering, inside or outdoors. Most PA men use their delivery car, usually a passenger model, for the mobile installation. By mounting one or two loudspeakers on the roof on swivels, the reproducers can be pointed in any desired direction for optimum coverage.

For use indoors the system is operated from the AC line. Most of the portable-mobile equipment is compact and not too heavy for one person to move, and it can be set up in

a short time. It represents an ideal solution for the individual who wants to do both types of work with the least investment.

A turntable and pick-up for record reproduction are necessary for the success of any PA set-up. The records are valuable in providing musical interludes, attracting attention, and giving both the speaker and audience a relief.

## Mike attraction

A word should be said about microphones—if possible several different types should be on hand. In certain installations one particular type may give better results. Spare microphones are desirable, because mikes have a great attraction—and they are very likely to disappear if not watched very closely. For this reason expensive microphones, if used, should be carefully guarded.

The PA man should use the microphone attraction in his selling. Since the mike is the symbol of broadcasting, it is well to bring a shiny one along on all sales calls and let the prospect handle it—the results are strikingly effective.

Making contacts is the most important thing in selling PA services to political campaigns. Knowing a friend who has a friend in politics is one way. Advertising over the local broadcasting station is very effective—particularly in smaller communities. And get acquainted with the engineer and operators of your local stations—they receive many requests concerning public address installations.

Your own store is also an effective place to advertise your services. On service calls and sales of sets make mention of the fact that you can supply amplifiers—hand out your calling cards, on which there should be reference to public address and a picture of a microphone. When you rent your services—have a sign in the auditorium or on your sound car telling who you are and that you are supplying the PA system. You should always contact the owner of the hall and try to sell him on the idea of having a permanent installation—there is much profit in such sales.

## What to charge

Prices for rental are always difficult to determine. The policy of charging what the traffic will bear is about the only advice that can be given. This charge depends upon the competition, the state of finances of the organization, who you know, and your own reputation. Always get a deposit in advance—if possible get the full amount. Too many persons have found out that it is practically

(To page 33)



# "MILLION - DOLLAR PROGRAMS

★ ORGANIZED rush, sustained and expensive, for renowned artists who will face the mike for the benefit of listeners in 1936, starts off a new year of thrilling air features. Star performances will crowd the air waves to such an extent that radio dealers have only to mention the details, in order to convince his prospects that he is selling a singularly spectacular type of merchandise.

Intense interest has already been stirred up in radio's part in the next presidential election. Colorful political skirmishes are the order of the day, and many extraordinarily dramatic broadcasts lie ahead.

## ... as never before

H. V. Kaltenborn, veteran news analyst at CBS has observed: "The loud speaker has brought the political leaders and their ideas into every American home . . . as a result this national campaign is sure to arouse the country as never before."

Unprecedented position of radio at the recent opening of Congress resulting in specific publicity for the stands to be taken by both the national chains, set the pace for listener interest in coming political intrigue. Never before have party leaders waited at the door of the studios with such eager requests for time.

Political gentry have realized the terrific meaning of radio's power and the fact that they will influence greatly what goes on the air during the year does not mean that listeners will be bored with dull political fanfare. It means that they will be able to tune in on the news that interests them more than anything else at the moment.

## More millions ready

Trends in programs building for 1936 are likely to accent big names, as regular features and as guest stars. Interesting adaptations of the amateur shows are expected, although the sponsors appear to shy from rank novelties. Tip-top comedians appearing with dance orchestras seem to be encouraging the popular yen for brisk farce and swing tunes of the instant.

It appears too that new emphasis will fall on world-wide broadcasts, 24 hour studio schedules, sport events,

and radio versions of newspaper features, cartoons, and columns.

Listeners will never be bored with misguided innovations cluttering the air waves in 1936, because the pattern is pretty well fixed and sponsors know what types of shows have brought national acceptance for products already plugged in broadcasting.

Who is to gather, who is to sponsor, and who is to broadcast news reports will perhaps be settled in 1936, but meanwhile listeners hear complete summaries anyway. Commentators have worked up huge followings and public interest in the news as interpreted by the human voice is definitely on the upgrade.

## These will sell sets

Promising item on new CBS bills for 1936 is "Musical Reveries" featuring the tenor, Stuart Churchill, four times a week. More artists on the Ford Hour at the same studios include Lucrezia Bori, Gregor Piatigorsky, Enzo Pinza, Richard Bonelli, Efrem Zimbalist, and Nelson Eddy.

Full glory of the Metropolitan Opera's joyous Saturday matinees are not to be missed on NBC; main season continues until Mar. 21. Peculiar punch of the Metropolitan's auditions for new singers is also available now to radio fans, since it has been dragged from behind Manager Johnson's locked doors and launched on WÉAF, sponsored and all.

There's a new Fred Waring set-up on NBC and a new Palmolive Beauty Box lay-out on CBS as dial spots of fresh value. Paul Whiteman, well

paid and thinner, has his pretentious "Musical Varieties" well under way. Expert rhythmist Harry Reser and his Cliquot Club Eskimos are also back on the air.

New at WOR is a "Short Story Seminar" with a deal of literary lions scheduled for it; the station has also launched a Viennese affair, titled "Alt Wien," which is very welcome indeed because of its Strauss music. WOR also goes in for some racy adventure on the high seas, with a new feature billed as "The Holisters."

Fresh batch of "Melody Matinees" has had a brisk opening on WÉAF. Bing Crosby has taken over the Kraft show, Thursday nights, and his sensational new comedian, Bob Burns, gets more encouragement.

## BOAKE CARTER STARTS 4TH YEAR

★ Valiant and bold-spoken Boake Carter, newscaster on the Columbia Broadcasting System under the sponsorship of Philco, has just begun his fourth year on the air. Airing five nights a week, at 15 minutes a clip, the feature costs Philco, in round figures, \$12,500 weekly, for time alone, and the bill for 1935 will be around \$560,000.

Mr. Carter believes in "discussion" and has not been reluctant to inspire it. His interpretation of the news is crisply independent; he's the sort that comes right out with views that are pointed and honest. He has waded into many a political mix-up and preferred to follow only the civilized impulse. And on his 23-station hook-up he has gathered a following which applauds heartily.

## THE BLACK LIST OF RADIO'S ENEMIES

1. *Publicity-seeking politicians who condemn broadcasting to get newspaper headlines*
2. *Disgruntled reformers (getting nowhere fast with prohibition) who want more free time for themselves*
3. *Newspaper publishers who print distorted facts*
4. *Radio men who knock programs*

## NEW HIGH FOR AIR ADS

★ Powerful drag of broadcast advertising got further proof when the Sinclair Minstrels, an NBC show ethered on the Blue net of 46 stations, made an offer of a free Dinosaur Stamp Album to every child who would go to a Sinclair service station accompanied by an adult.

Actually, within 48 hours after the offer was aired, over 1,000,000 children rushed out after an album. At least the Sinclair people found the supply exhausted after the first excitement, and the next week hiked the supply to 2,000,000.

# GO WITH EVERY SET WE SELL"



Directly above is Miss Mary Pickford, who will begin broadcasts from her Hollywood home, Feb. 11.



Important on the dial — top (left) Haile Selassie, Ethiopian Emperor who is radio-conscious; center (left) Sigmund Romberg, composer of 68 romantic operettas.

Shown in the bottom row are Deane Janis (left), California caroler; Lucrezia Bori (center); and Nelson Eddy (right). Latter two artists are favorite guests.

# PHONOGRAP COMBINATIONS

- musical appreciation sharpened by studies now on the air
- new glamour of opera stars has hit the public fancy
- family circles are now curious about fine points
- 1936 features of radio-phonographs make them practical

★ THIRTY-ONE MILLION homes in the United States would like to be credited, if you please, with some cultural ambitions!

Oddly enough, exactly 31 of the leading radio manufacturers in the country are now making radio-phonograph combinations. Prices range from \$50 to \$1,400 but the data is destined to change swiftly as new models are offered to meet the renewed interest in this "instrument of distinction."

## Inspired by radio

Not all prospects for combinations need to have high-brow tastes, but whatever musical instincts have slumbered in us have been considerably stirred by samples of classics heard and explained in radio programs. Much of this interest had its origin in the 65,000 radio equipped schools of the country, and now there must be provision made for follow-ups at home.

Walter Damrosch's Music Appreciation Hour on NBC is "required listening" for 10,000,000 school children; the program on CBS titled "Understanding Opera" goes over a network of 36 stations. Both of these, and others, have been found to be of sure-fire interest to adults also.



Tommy Dorsey, leading Victor sales

Upshot is that the trend these days is toward "the fine points of musical composition and performance" as the Radio Institute of Audible Arts puts it. Musical study and experimentation in homes can best be carried on with the use of a good radio-phonograph combination.

## Selling angles

Here is the chance for dealers to suggest that all of this fascinating home study and experimentation may be carried on at small additional cost by investing in an instrument which can play the musical favorites when needed. Appetites for model selections have been sharpened, and it is up to the dealer to see that something is done about it in the American home.

Right now, the dealer will find that manufacturers are busy creating new departments, new franchises for coming merchandising campaigns in combinations. Additional models are being offered which will meet the demands in any dealer's locality, and doubtless it will mean a fine source of more profits for him.

## Demand for stars

Recently, the stage of the Metropolitan Opera has been emptied by singers who found it profitable to journey to Hollywood. Lily Pons, Lawrence Tibbett, Gladys Swarthout, Nelson Eddy, Nino Martini, and Grace Moore are among those who have worked up popular followings which were denied to even the top-flight dramatic stars.

Elaborate ballyhoo of these artists, which Hollywood has by no means neglected, has created a situation in which their names actually mean something to the patrons who come into a radio dealer's shop. Since their masterpieces have all been recorded, it appears that a record-player should be easy to sell.

Dealers may now tell their prospects that the controls and record-changing devices used on the new combinations are simple and prac-

tical. New model being offered by General Electric is an example; record reproduction is handled through audio system, using 9 ten-inch or 8 twelve-inch records, changed in 4½ seconds. This instrument does not use remote controls.

Hostesses in fashionable homes often require musical programs which do not permit commercial announcements that are likely to accompany regular broadcasts. Private social gatherings held in the daytime must turn to the combination for a musical menu which is exactly proper.

Localized popularity of certain opera stars fits into the merchandising of combinations; Norwegian communities are likely to welcome the chance to hear Kirsten Flagstad's songs when and as often as they feel the urge.

Sample of doings in the field is RCA's recent announcement that Commercial Investment Trust Co., One Park Ave., New York City, will finance purchases of the Victor Library of Recorded Music, working with dealers under much the same terms as apply to radio-phonograph combinations.

This is the first time that financing plans have been available to dealers on any phonograph record merchandise, and the step opens the way for renewed sales promotion.

## Best sellers as we go to press

### BRUNSWICK

Love Will Live On—Fox trot. Then I Shan't Love You Any More—Fox trot. Both by Hal Kemp and his Orchestra—7578.

Begin the Beguine—Fox trot. Can't We Dream a Midsummer Night's Dream—Fox trot. Both by Leo Reisman and his Orchestra—7575.

I Got Plenty o' Nuttin'—Fox trot. It Ain't Necessarily So—Fox trot. Both by Leo Reisman and his Orchestra—7562.

### DECCA

The Music Goes 'Round and Around—Fox trot. VC by Mike Reilly. Looking For Love—Fox trot. Reilly-Farley and the Onyx Club Boys—578.

No Other One—Fox trot. A Little Bit Independent (But Easy on the Eyes). Both with VC by Bob Crosby and both played by his Orchestra—629.

Red Sails in the Sunset—Fox trot. Madonna Mia—Fox trot. Vocal by Carmen Lombardo, with Guy Lombardo and his Orchestra—585.

### VICTOR

The Music Goes 'Round and Around—Fox trot. (If I Had) Rhythm In My Nursery Rhymes—Fox trot. Both by Tommy Dorsey and his Clam Bake Seven—25201.

It Ain't Necessarily So—Fox trot. I Got Plenty o' Nuttin'—Fox trot. (Both from "Porgy and Bess".) Both by Guy Lombardo and his Royal Canadian Orchestra—25204.

Quicker Than You Can Say Jack Robinson—Fox trot. When A Great Love Comes Along—Fox trot. Both by Guy Lombardo and his Royal Canadian Orchestra—25205.

# VICTOR RECORDS ROLLING UP NEW TRIUMPHS!

*Definitely, this is the time to push your record business*

Here's a significant fact:— during the first two weeks of January, Victor Record sales were bigger than the same period in December. That's most unusual. Record sales usually drop in January. January 6th brought Victor Records more orders than any other single day in the past 8 years! That was in spite of the fact that December 30 and 31 were the biggest two consecutive days during the previous 5 years! No matter how you look

at them, those figures prove just one thing: Victor Records are going big. The sales curve is shooting up. It's been rising for nearly three years now. Dealers who saw the boom coming have been making plenty of money with Victor. There's still no sign of a slackening pace. This is the time to give your record department an extra boost for extra profits. If you haven't a record department, get one, in a hurry. We'll tell you how to get going.



These figures show how sales of Victor Records continue to increase.



The mighty little R-93 Record Player—see how it's selling. Every sale means a new record prospect.

**Dollars go Round and Round**

Victor always has the hits. "The Music Goes Round and Round" by Tommy Dorsey and his Clam Bake Seven (Victor Record 25201) is breaking all sales figures, rolling up bigger profits to dealers.

# VICTOR RECORDS

RCA MANUFACTURING COMPANY, INC., Camden, N. J., an RCA Service

# SALES IDEAS THAT WORKED

Tested sales stunts that may give you a lively start this year

## Logs pull the biz

★ Hollywood radio dealer drags in the customers by distributing annually to 6,000 prospects a complete radio log, which the recipients have learned to depend on. H. D. Hatfield & Son regard this as the best possible direct mail appeal to Hollywood residents, and many a new customer comes in to say that "I've been using your log as a guide for years—thought it was about time to drop in and get acquainted."

Hatfield's also gets results from a manufacturer-printed short-wave log to which is attached a personal note in reproduced handwriting.

## Country campaign

★ Brothers and England, Wellington, Ohio, announcing a departure from previous emphasis on sound equipment and service, have carefully planned a new local campaign for this season.

The line-up: "An extensive sales and service campaign in rural areas within a 25-mile radius, to cover radio and home electrical appliances. Only one radio line will be carried. Calls at every rural home served by commercial electrical lines are planned. We will depend upon actual home contact almost exclusively."

Brothers and England, backed by what wisdom they picked up in the

business since 1931, go on to say: "The plan might not work in metropolitan areas, but we tried it in a small way last year in our territory and did not lose a single sale due to a trade-name. What sells them is performance, trade-in allowance, ability of the set to stand up, and the service we give them if and when they need it. Any dealer equipped by experience, and capable of rendering real service when needed, can do likewise."

## Offers 3-month trial

★ Radio men at Broome Furniture Co., Santa Fe, New Mexico, do not regard three or four days as a good test of a receiver, and suggest to prospects that they keep the set for two or three months, and make a small deposit. Plan eliminates those who merely want to use a machine free of charge, and the others usually keep the set. Broome's reports that "very few come back."

## Hikes traffic 500%

★ Allan Jones, an operatic favorite in St. Louis, made a personal appearance for dealers Union-May-Stern at their radio store in that city and jammed the sales rooms to capacity. Stunt was pulled amid great ballyhoo for the world premiere of the singer's latest movie; the

dealer upped his store traffic 500 per cent and made ten more sales than any day of the past year.

A full hour program, distribution of autographed photos, and vigorous newspaper ads were part of the event.

## Appeal via roto ads

★ Maloney Sport Shop, Bayonne, N. J., stirs fan interest in New Jersey with regular issue of Philco's lively roto circular, 10,000 strong. Prospects in Maloney territory seem intrigued by the tricky lay-out titled *News—Views* which presents timely shots of important persons and places in radio, and the Sport Shop enjoys quickened sales tempo.

## Sells in cycles

★ At the Rockefeller Center Radio Shop, the "only radio shop in Radio City," the practice of selling in "gift cycles" is in favor, particularly for holiday merchandising. Sales managers at the shop consistently display a handsome representation of all sets which are adapted to use by all members of the family cycle, appropriate receivers for housewives, husbands, sons and daughters of all ages.

Floor displays at the swank shop are elegantly arranged from the "every-purpose" angle. Window exhibits feature placards with such captions as "Remember the child in your home" and "Just the thing for the bedroom or den."

## Let who will be clever

★ Malvin H. Marshall, of the Anchorlite Appliance Co., Pittsburgh, has this advice for younger salesmen: "Make a natural and pleasant approach—don't overdo yourself trying to attract your prospect's attention; get the prospect seated if possible and intelligently discuss your merchandise; ask for an order."

Marshall theory is that salesmen should be human and sensible and yet quite positive in personal demeanor. He sees no point in putting on any sort of an act, and he has had exceptional success with the simple technique.



Jobbers True & Blanchard, Newport, Vt., cover territory with this conspicuous trailer, equipped for brisk demonstrations of battery or power line sets.

## Glass houses for dealer

★ Grunbaum Bros. Furniture Co., Seattle, Wash., pioneer radio dealers with a special sized radio department on the first floor, have completely revamped the receiver display rooms to handle year-round activity. Layout includes 6 booths, each scientifically sound-proof and equipped with short-wave aeri-als.

Five of the booths are used for the five major lines featured by the department, the sixth is used for a collection of table and midget models of mixed makes. Side walls of each booth are glass panels, so that sales references can be made without disturbing the patron.

Grunbaum has successfully used the device of selling sets in a window also, so that street traffic may observe the whole performance given by the Grunbaum salesman.

## Dealer "lends" new sets

★ "After getting the feel of a new set," insists J. A. Mayes, radio manager at the Allen & Jemison Hardware Co., Tuscaloosa, Ala., "many are unable to go back to the antiquated product."

Mayes' service men, on their calls, are likely to leave a new set at the home of the patron while the old one is being repaired, unless minor adjustments can be made at the time. A salesman then calls on the prospect and states the cost of repair and the allowance that can be made on the new set. With the new one already installed, Mayes reports that about 25 per cent will say "all right."

## Dealer "traps" prospects

★ Under the word "Free," the Charles E. Wells Music Co., Denver, staged an elaborate radio show in an upstairs room, hostesses and all, and then fixed it so that the guests could not get back down to the street without passing through the store. Elevators went up, but never down.

Event attracted 1,000 visitors daily for three days, and 90 per cent of them turned out to be prospects. Organ concerts were the only musical features.

## Beauty shops need sets

★ Resourceful dealers will discover that operators of beauty shops are likely prospects for good receivers. Radio programs are the favorite entertainment for patrons



Pleasant, new, sound-proof demonstration booths, a row of six, are the boon of floor salesmen at Grunbaum Bros., Seattle, Wash. Glass panels between them allow salesmen to make inter-booth sales references.

who might be in for some dull moments while the body is being groomed. Other forms of pastimes have been tried, but none is as satisfactory as a lively radio program, particularly since the patron can listen without having to move about while the beauty operator is in action.

## Follow-up wrinkle

★ At the Robinson Radio and Refrigeration Co., Houston, Texas, salesmen of refrigerators and gas ranges are instructed to follow up every major sale within 30 to 60 days to try for a radio sale.

"This plan for re-contacting customers works very fine for us," say Robinson managers. "Eighty per cent of our radio sales are to people who have purchased some appliance from us before, or have bought a radio here. And, incidentally, our radio sales average better than \$75 each."

## Valentine eye-catcher

★ Neat and effective radio window for Valentine time, built around a large red paper heart through which a radio set has been pushed, has been used successfully by several dealers. The pierced paper heart is displayed at the rear center, and the dealer may fill up the remaining space with other trimmings of his own choice.

Electric Shop, Cincinnati, used the device supplemented by the use of a yellow spot-light, and larger models at the sides. Smaller appliances were

exhibited amid a profusion of white tissue, heart and dart stickers, pleated pink drapes and black velvet. United Music Store, Toledo, got a good effect with an exceptionally large paper heart with the radio breaking through at the center.

Miller's Electric Shop, Pasadena, used the idea along with a carnival effect—streamers hung from the ceiling—and three bridge lamps at rear sides and center. In all cases the theme of the display plays up appropriate sentiment and romance.

## Out-of-town service

★ Acme Radio and Refrigeration Service, Topeka, Kansas, announced recently a special out-of-town service charge for nearby radio families around the Kansas capital. The newest deal is "Out-of-town service at 10c per mile—no extra mileage charge for additional stops."

## "Ensemble" stunt

★ Main floor booth at the May Company, Denver, Colo., displays the necessary articles "To Make the Home More Livable" chosen from various departments of the store. Firm assumes that a prospect for living room accessories is also a prospect for at least a mantel radio, if the radio is shown as an important part of the properly appointed living room.

Radio department at May's is on the second floor and many shoppers would miss it if the booth did not accent the receiver as a necessary item for the living room.

# STANDARDIZING SERVICING TECHNIQUE

John Rider points out that systematic methods of servicing will produce greater profits

By JOHN F. RIDER

Service Editor, RADIO TODAY

★ **DESPITE** the fight which rugged individualism has waged in connection with Federal affairs—we still feel that interest can well be aroused in the standardization of servicing technique. We write these lines with the full knowledge that it is a controversial subject and that there will be those people who will claim that they have their own and individual methods of testing, and that there can be no standardization of technique. Also there are those who feel that the merits of individuality are preferred to mass production systems. On the other hand, we feel that too much time is consumed in the servicing of a radio receiver. Speaking about time consumed, we greet the man who will immediately speak about the intermittent contact and the uncertainty of locating the sources of trouble within a specified time. We grant that this is true. However, intermittent types of troubles do not represent the greater majority of defects in radio receivers. Without qualification, we say that all

other types are subject to a routine form of test, rather than the hit or miss and trial and error methods, which are typical of rugged individualism.

We have no quarrel with hit or miss and trial and error methods where they constitute a part of a logical test procedure, but where the operation is in reality a matter of groping in the dark—that certainly is not consistent with modern times.

## Scientific servicing

What is a scientific method?—you may ask. Several can be advanced and each may find its proponents. At this time we are not so much concerned with the selection of any one system, as we are with the inculcation of the idea to proceed through the receiver in a logical manner—wherein the normal process of advancement is well-established in the mind of the operator. It is quite natural that some sort of breakdown or division of the sections in a radio receiver or amplifier be advanced as being a logical sequence. The exact nature of this breakdown may be dif-

ferent in a case of a receiver which is “dead” and a receiver which is operative but not producing the required results. Whether the actual tests in each of the divisions in the receiver is a voltage test or a resistance test is a matter of choice—although we favor the resistance method of analysis. As we stated, the important thing is a logical pre-established approach.

Hopping from one part of the receiver to the other—guessing as to the operation of any one component network in the receiver—wondering about this and that—does not belong in modern servicing routine.

## Not stereotyped

It is barely possible that by this time you may have cultivated the impression that we advocate a stereotyped “hand-book” method of attack in servicing problems. This, too, is far from the truth. There are sufficient variations of servicing problems to preclude the actual servicing from ever becoming a dull, colorless affair. There are enough variations present in the arrangement of the receivers, which come into the modern service shop, to arouse interest in each and every instance and to make each receiver a separate problem and one which taxes the ability of the operator. Nevertheless, there is still something universal in all of these receiver problems, and that is the use of a common method of attack. Perhaps this may mean the acquisition of new equipment—or additional equipment and the abolition of improvised testing systems. If such is the case, it must be done and there is no alternative.

## Eliminate guesswork

There is no denying the fact that receivers have become quite complicated and that if the problems presented by modern design are to be solved, guesswork must be eliminated. What with the interlocked circuits, no method other than a routine procedure will enable the discovery of the defect in the shortest possible time. Such mode of operation is required for the protection of the customer and for the self-preservation



In the home the set analyzer often provides an effective means of determining the general source of trouble. Business-like equipment will foster the idea among radio owners that the serviceman really knows his radios.





CONSOLE LISTS AT  
**\$39.95**  
 \$42.90 IN FLORIDA  
 AND WEST COAST

TABLE MODEL LISTS AT  
**\$25.95**  
 \$28.50 IN FLORIDA  
 AND WEST COAST

**NEW!**

**TWO METAL-TUBE FERRODYNES THAT ARE  
 PRICED TOO LOW!**

*Latest Stewart-Warner creations offer beauty and performance far beyond their cost. Read the opportunity they offer you*

**E**VERY tradition of radio value in the lower price bracket is swept aside by this announcement!

Just think of a real, full-size *Craft-Built* console, beautifully and strongly built in overlaid curly maple, pencil-striped walnut and matched stump walnut, and hand-rubbed to a fine satin finish—a genuine *Ferrodyne* chassis with *seven tuned circuits* engi-

neered throughout especially for the **NEW METAL TUBES**—a full 8-inch speaker of the most improved design—all drawing buyers into *your* store with this amazing price!

And a twin in table size, equally well housed, identical in performance and just as surprisingly priced!

Here's just the tonic radio sales need for the late winter season when *value*

is the key to profit. Both have *5 metal tubes*. Both have illuminated dial, tone control, built-in line filter and other quality features, and cover both police bands. Both offer you—and your prospects—more than radio has ever offered before. If your distributor hasn't contacted you, phone or wire him now. STEWART-WARNER CORPORATION, Chicago, Illinois.

**STEWART-WARNER**  
*Ferrodyne* **RADIO**

and profitable operation of the service station. The common good of the industry demands that the customer be protected against penalties in the form of excessive charges, imposed because of non-systematic procedure in the service shop and the resultant unnecessary loss of time. The financial welfare of the servicing industry also demands systematic procedure in order that the prices which are charged be in line with common sense and reason—yet be profitable.

## PROFIT ON PARTS

★ HOW do you sell your parts? We know that you buy at a discount—a 40 per cent discount off list. Do you charge for your parts at list and figure that you are earning 40 per cent on the sales price? Do you figure this 40 per cent on list as being a part of your profit and allow it to influence your charge for the time and labor involved in the service shop?

You may be interested in the following facts: While it is true that the discount you receive is 40 per cent off list, it has been found that between 10 per cent and 20 per cent of this 40 per cent is absorbed in various expenses relating to the handling of these parts, with 15 per cent representing a very fair and commonplace average. It is, therefore, evident that at best the usual net profit is seldom more than 25 per cent on the sale price—that is, if you are selling or charging for these parts at list. Oftentimes the sale of the part at list represents a loss, and for that matter—if the list price of the part were twice as great, it would still represent a loss. We are referring to low-priced replacement items; as, for example, small resistors and condensers, units, which, while of high quality, list at prices ranging from 15¢ to perhaps 35¢ or 40¢.

### *High handling expenses*

The discount on a 20¢ resistor is 8¢. As a general rule, the handling expenses relating to such a unit, that is, in connection with its purchase and sale, invariably cost more than the aforementioned 8¢. In view of the fact that the greatest number of replacement parts, which are handled by a service organization during a year, are the low-priced items, it is essential that service men earn their full profit on sales as represented by the discount off list. Expressed in another manner, it is the wisest

move to charge for replacement parts at list.

Of course, there are exceptions to this statement, as for example, the case of a unit which sells for \$6.00, \$8.00 or \$10.00, and where a charge to the customer at list price would make the entire service charge so high as to result in the loss of the job. In such instances, it is quite proper to sacrifice some portion of the profit upon the parts, providing that there is no loss entailed in the handling of the part and that the proper amount of profit is made upon the sale of the service, time, or labor.

## MAILING PIECES

★ MAYBE we're too curious, but upon numerous occasions we have spoken to friends of ours who receive literature from service organizations. In each and every case, the same comment was heard—namely that there was no reader appeal in the literature which was received from the service organization. We, of course, realize that the amount of money available for such material is not as great as is available to other organizations which attempt direct mail sales. At the same time, we also realize that a post card can be made attractive. If those organizations, which supply mailing pieces of one kind or another for use by servicemen, would give some thought to the contents and appearance of such material, the interest of the recipient—that is,

the set owner—would be aroused to a greater extent.

### *Educational data*

Take, as one concrete example of what text could be printed upon a post card—the subject of receiver tuning. We doubt very seriously if 20 per cent of all the radio receiver owners, operating receivers equipped with tuning indicators, appreciate the indication upon the tuning meter as it relates to the tone quality of the reproduced signal. This fact was brought to our attention during several conversations. . . . The men and women of the household did not read the instruction booklets. A catchy head and a short description contained upon such a mailing piece would attract the attention of these people. At least such is our reaction, based upon questions asked.

Of course, we know that all of the people who would receive such a mailing piece from a local organization, would not be in possession of receivers equipped with tuning meters, so that some of the material will be wasted. Such waste, however, would not be in excess of the normal loss with the present type of mailing piece. A subsequent mailing could cover some other phase of tuning, which would, perhaps, be more generally applicable.

At any rate, we feel that some change is necessary in order that the direct mail efforts of the servicing industry be more lucrative.



Many servicemen prefer to do their repairs at the shop after having made a rough estimate for the job. In the shop it is usually easier to repair the trouble, and the customer feels that he is getting more for his money.

Greatest tube merchandising idea in years!

# RCA Check-up continued in 1936

**Who wouldn't pay 1/2 cent to hear PAUL WHITEMAN perfectly?**

**Second Radio Service Week!**

**Complete RADIO CHECK-UP .50**

**Special radio service offer... Good for one week only! COMPLETE CHECK-UP YOUR RADIO Only \$1.50**

**RADIO week... noisy? CALL IN THE RADIO "DOCTOR"**

**FINAL PRE-HOLIDAY OFFER 10 RADIO CHECK-UPS**

**Less than 3c per day per year for radio's wonderful programs**

**RCA RADIO TUBES**

**RCA**

AS A RESULT of its amazing success, the RCA Radio Tube Check-Up Promotion is being continued on an even larger scale in 1936. This great plan, tried and proven in 1935, has brought undreamed-of results in the form of new business to dealers in every part of the country. It has sold not only tubes, but repair jobs, new receivers, and other appliances.

The secret of its success is that it helps everybody. We sell tubes; you sell tubes and more; the customer gets new enjoyment out of radio.

In 1936 the Check-Up campaign to improve radio reception (statistics show there are 5,850,000 sets in need of repair) will be waged in all direc-

tions: (1) Weekly in over 100 newspapers; (2) Three to six spot announcements a week on a nation-wide network of more than 30 broadcast stations; (3) National advertising in the Saturday Evening Post, Collier's and other leading periodicals; (4) Special new and result-producing direct mail pieces. Consult your jobber as to how you can tie in with the 1936 Check-Up for greater profits. Then, what dealers say about the Check-Up will be only what you know from your own experience.

**FOR PROFIT-MAKING IDEAS, ATTEND RCA SERVICE MEETINGS**

# RCA RADIO TUBES

RCA Radiotron Division, RCA MANUFACTURING CO., INC., Camden, N. J., A Radio Corporation of America Subsidiary

# CUSTOM-MADE CABINETS

- strong interest in modern design justifies special plugging
- console prospects can be headed toward newly styled jobs
- “freaks” have been given dignity of legitimate novelties
- cabinet lines complete enough this year to attract interest

★ QUEEN ANNE is slipping.

Praise as you will the graceful tapers of period designs, the modern trend in radio cabinet design is still substantial and steady. Fact that people have definite ideas on this subject, along with their increasing interest in higher-priced receiver models, shows that 1936 is a good spot for promotion of custom-built cabinets.

Additional profits for the coming year are certainly in store for the dealer who will suggest to his prospects that he is in position to respect their tastes in furniture. Respect them and satisfy them with a cabinet that is a thing of beauty and is appropriate to whatever specific interior decorative scheme is being used in smart homes.

## Tricky jobs

Recently, specialists in cabinet making have taken the ideas which were formerly regarded as unsuccessful “freaks” and added a note of luxury. This is meeting the demand for people of legitimate tastes who

want something else than just an ordinary radio cabinet.

Lamps, fireplaces, bars, French commodes, clocks, and book cases, under this treatment, can be presented with good effect to fashionable prospects. However, straight cabinets are more profitable for the ordinary dealer, since they can be promoted as a piece of distinctive furniture, specially designed, which will utilize any radio receiver chassis on the market at no additional cost.

## Decorative aspect

Dealers have reported that the best way to start selling one of these jobs is to remark that “we’ve placed this console in thousands of homes, but if you want something that many others do not have, at no greater cost. . . .” In any case if dealers are interested, they should begin, where it seems timely, at the furniture end of the appeal.

One talking point which can be used in 1936 for the first time, actually, is that the cabinet makers have, in stock and ready to go, the

complete range of new patterns in wood.

Superior Cabinet Corp., for instance, has nearly 20 different cabinet designs in stock at present; half a dozen are designed for radio-phonograph combinations. Sliding doors, hand-rubbed finishes, Oriental striping, hand-carved decorative touches, and rubbed-effect lacquers are among the features.

## Speaker lamps

Interesting development in wide-range reproduction is being made by the Radio Lamp Corp., 744 Madison Ave., New York City. Company is headed by William J. Cox, and is soon to market loudspeaker lamps, floor and table.

Air-column amplification, similar to that involved in wind instruments and organ pipes, will be used in the new speaker lamps. Depending upon the capacity of the air tube which forms the stem of the lamp, frequency ranges are established which add to the volume of the treble notes in the slender stem of one lamp, and increase the richness of low notes heard through the larger stem of another.

Inventor W. D. Smith has proven that for better reproduction, amplification should be done at several points in a single room; hence the selection of the lamp from among other furniture pieces. New designs in floor and table models are being designed by Warren E. Cox.

Remote control feature is provided through a control box called the “Radiorgan,” which plugs in under the power tube of any set and regulates the volume of any lamp.

## NOVELS KILLED BY RADIO —TARKINGTON

★ That the novelists would ever be moved to complain seriously about the advent of radio had not seemed likely until Booth Tarkington told the Associated Press recently that after radio’s inroads, television would about finish the popularity of the novel as a pastime in American homes. Now, radio is linked with the talkies in a trend which is described as an important distraction from popular interest in novels.

Other novelists have amiably greeted radio audiences in person. James Hilton and his radio version of “Lost Horizon” is an example; John Erskine, Fannie Hurst, Rupert Hughes, and J. B. Priestly are also among those who have cashed in on broadcast features.

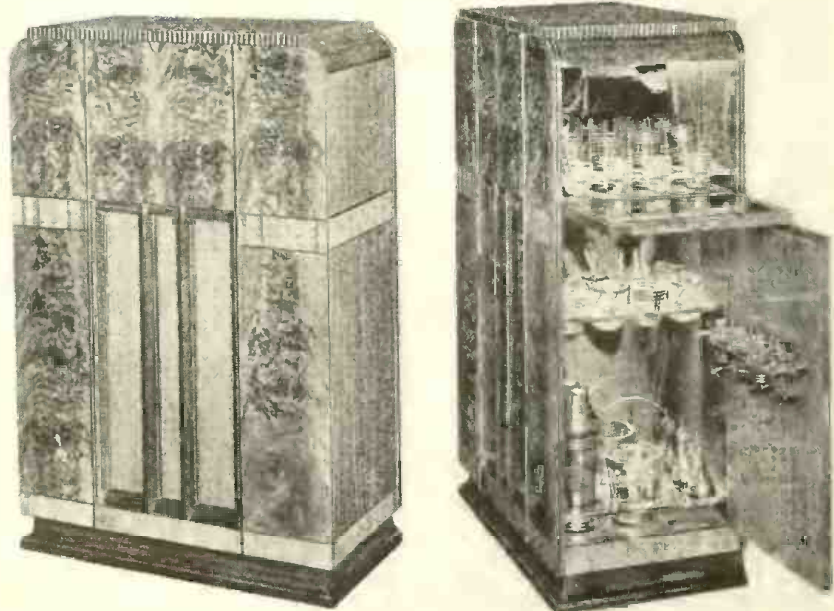

With a carved top frame and a liquor proof bar, this cabinet has room for any make receiver; an example of recent artistic efforts on the part of well-stocked specialists in cabinet building.



*I am convinced...*  
*...says A. Atwater Kent*

**Y**OU have helped to make 1935 a good Atwater Kent year. Your business and ours should and can be even better in 1936. My energies are directed toward achieving that end.

"I am working with our engineers to produce the most practical, salable sets that can be made.

"In 1936, we believe that our new dramatic advertising and merchandising will be more effective than ever before. Our advertising will look entirely different, fresh and exciting. It will work hard for you and will bring more people into your stores.

"I am convinced that 1936 will be a profitable radio year, especially for Atwater Kent dealers."

*A. Atwater Kent*

# ATWATER KENT RADIO

*with Control-Room Reception*

**TRY THIS TESTER AT YOUR**

**JOBBERS**



Model 710-A

**DEALERS  
NET PRICE**

**Only \$16<sup>50</sup>**

**• CHECKS ALL  
PARTS OF RADIO  
CIRCUITS USING  
GLASS OR METAL  
TUBES.**

This popular three meter set tester checks all parts of radio tube circuits by plugging directly into the receiving set sockets.

D.C. Voltmeter Scale 20-60-300-600

D.C. Milliammeter Scale 15-150

A.C. Voltmeter Scale 10-140-700

Model 710-A—In Black Leatherette Case complete with all necessary connections.

Dealer Net Price .... **\$16.50**

Model 712-A—Same as 710-A but having Triplet moving coil Model 223 2" D.C. Voltmeter (1,000 ohms per volt).

Dealer Net Price .... **\$22.20**

**OTHER**

**READRITE PRODUCTS**

Readrite also manufactures all types of testers used for servicing radio sets, including: Set Testers, Oscillators, Resistance, Continuity and Capacity Testers, Point-to-Point Testers and inexpensive Indicating Meters.

*Readrite*

**TESTERS AND METERS**

**MAIL THIS COUPON**

READRITE METER WORKS  
119 College St., Bluffton, Ohio  
Please send me more information on  
.....Model 710-A .....Model 712-A  
.....New Catalogue.

Name .....  
Address .....  
City..... State.....

# SERVICING—INTERFERENCE

## I-F. wave traps

★ Quite a number of receivers manufactured today incorporate wave traps in the antenna system, which are resonated by the distributed capacity or by definitely inserted condensers to the intermediate frequency, as a precaution against interference from various types of beacon stations. The positions of these traps, with respect to the antenna transformer, are shown below and classified from A to D. In view of the resonant frequency of these trap circuits, with respect to the normal frequency range of the receiver, it is very possible that incorrect alignment, or state of resonance, may exist without in any way influencing the response of the receiver on the regular bands. Consequently, it is necessary to make a separate test, by feeding an i-f. signal into the antenna system in order to establish the efficiency of the circuit.

Whereas the normal trimmer adjustment calls for maximum output signal, correct adjustment of such trap circuits requires that the output at the intermediate frequency be minimum, to indicate that the trap circuit is functioning properly. It may be well to remember, when checking these trap circuits, that no adjustment is required or should be made upon the regular i-f. amplifier. It is, of course, assumed that the i-f. amplifier trimmers are correctly set in accordance with the normal i-f. alignment practice. When checking such wave trap circuits, the strongest possible signal should be fed into the receiver.

Incidentally, wave traps for nor-

mal broadcast station signal interference elimination are still in vogue, despite the improved design of radio receivers. Accordingly, these simple diagrams can be used to indicate the possible positions of wave traps incorporated for the purpose of eliminating such local station interference. In view of the possibility of signal reduction on adjacent channels, it might be a good idea, when using such local station signal traps, to shunt the trap circuit with a variable resistor of from 1,000 to 50,000 ohms. This procedure makes the trap circuit most effective on the undesired signal and, at the same time, makes it broad enough so that it will not interfere with adjacent channel signals and will not require constant readjustment.

Referring again to the interference from a beacon signal, it may be necessary to readjust the trap to correspond with the frequency of the interfering signal. If, in the event that there is interference from some local broadcasting station, then it may be possible to utilize the trap for the elimination of that signal by re-tuning. In the event that the value of capacity used across the trap coil is too great, it can be removed and a smaller value of capacity, in the form of a trimmer, can be used.

## More oscillator sales

★ Do not touch the alignment unless it is absolutely necessary—and that is the usual comment made concerning radio receivers which are brought in for service. . . . Strange as it may sound, there has been a great deal of talk concern-

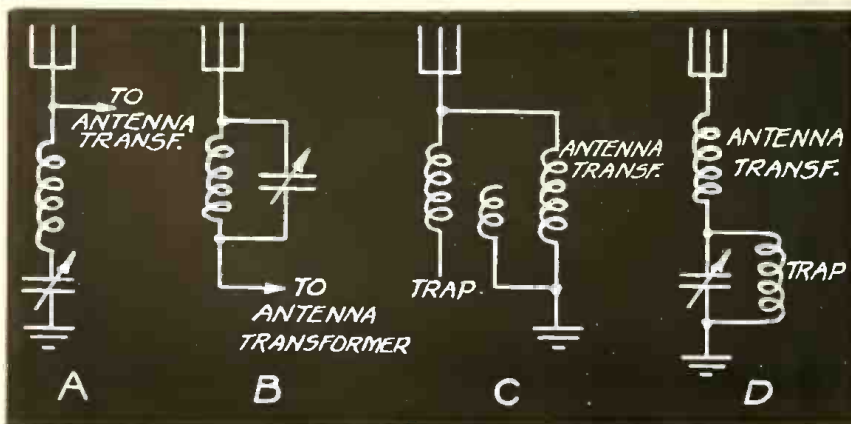

Wave traps tuned to the intermediate frequency are used in many of the modern superhets. The traps are adjusted after alignment is completed.

# NEW LINE SUPREME INSTRUMENTS APPROVED FOR F. H. A. LOANS

Let Uncle Sam equip YOUR shop NOW with the New Supreme Laboratory models you need, at no more cost than your telephone.

No Down Payment. As long as 18 months to pay. Present FHA act expires in April. See your jobber NOW.

## SUPREME LABORATORY MODELS APPROVED FOR FHA LOANS

Supreme 385 Automatic Laboratory Model .....	\$77.95
Supreme 89 DeLuxe Tube Tester Laboratory Model...	\$45.95
Supreme 339 DeLuxe Analyzer Laboratory Model .....	\$39.95
Supreme 189 Signal Generator Laboratory Model .....	\$36.95

**SUPREME INSTRUMENTS CORP.**  
Supreme Bldg. Greenwood, Miss., U. S. A.

## PROBLEM



To find a reliable source for all your radio supplies which will bring you the highest grade of merchandise at the lowest prices—which will offer you a vast selection to fill every Radio Service need—which will give you quick "streamlined" service and smart handling on each order—and which, besides, will work with you on your problems, right at your shoulder, in a friendly, helpful way.

## APPLY -



ALLIED's 1936 Catalog—the leading Radio Supply Guide. A real index to radio progress—brimming over with fine standard merchandise lines at lowest prices—sparkling with new test equipment developments, new P.A. systems, new metal tube radios—rich with fine selections of tools and thousands of high grade parts—everything to save you money and help you succeed.

## RESULTS:

Save time—save money—get any part, any brand, any time you want it—at the lowest prices—and enjoy ALLIED's speedy, helpful personal service besides. Keep an ALLIED Catalog by your side—it pays.

SEND FOR YOUR FREE COPY



## ALLIED RADIO

833 W. JACKSON BLVD., CHICAGO, ILL. DEPT. TR.  
Send me your FREE 1936 Catalog—the most complete Radio Supply Guide ever published.

**FREE**

Name .....

Address .....

City..... State.....

ing the necessity for immediate alignment of some of the new all-wave receivers. More and more of the receivers, although perhaps a month old, have made necessary re-alignment of the r-f. and i-f. stages. As a matter of fact, on several occasions it was found definitely advantageous to align the receiver upon the delivery to the customer. The increase in operating efficiency, after such alignment was made, was surprisingly great. Add to this the greatly increased number of all-wave receivers as against the single-band receivers produced during 1935 and you have a very good reason for a very definite upturn in the sale of test oscillators.

Oscillator sales to servicemen have never reached their proper proportions. Just why this is so, is hard to explain, unless it is due to the fact that so many servicemen depend upon the broadcasting stations as their source of test signal. It is true that the accuracy of the broadcast signal is far greater than is available with the average service test oscillator, but such type of testing is anything but modern. Perhaps the very nature of the device has contributed to its reduction in sales. We are referring to its simplicity. . . . Simple as it may be, the fact still remains, an oscillator—perhaps even two test oscillators—is a paramount piece of equipment in a radio service station.

## Regenerative superhets

★ There are on the market today a number of four and five-tube superheterodyne receivers, wherein a regenerative demodulator, or second detector, tube is used in order to provide sufficient gain and selectivity to compensate for the use of but one i-f. amplifier stage, or the absence of an i-f. amplifier tube. With the exception of the regenerative de-

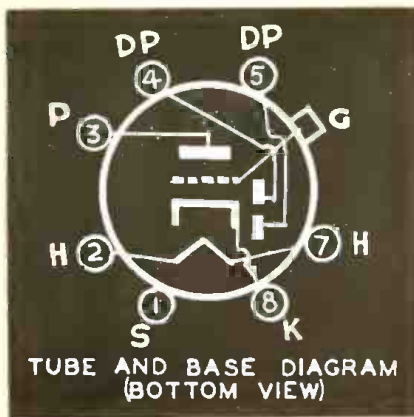

Socket wiring diagram of the metal type 6Q7 tube.

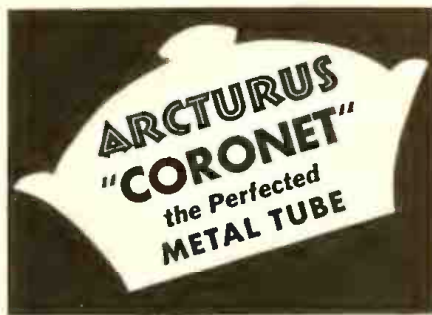

The advantages of the Arcturus "Coronet" are:

1. Superior in capacitances;
2. Dependable vacuum;
3. Free from gas troubles;
4. Eliminating possibility of shorts to ground;
5. Rugged structure;
6. Quiet operation; no metallic sleighbells;
7. Long life.

From everywhere manufacturers, distributors, dealers, servicemen, engineers have acclaimed the Arcturus "Coronet" as the *perfected* metal tube.

You who use and sell tubes cannot be satisfied with less than the best. Today, the Arcturus "Coronet" is *the* metal tube that assures you the kind of service you should expect. *Get the details of this remarkable new improvement today.*

ARCTURUS  
RADIO TUBE CO.  
Newark, N. J., U. S. A.



DATA BULLETIN on Arcturus "Coronet" Tubes sent free on request. Use coupon below.

ARCTURUS RADIO TUBE CO.  
NEWARK, N. J.

Please send me your bulletin on Arcturus "Coronet" Tubes.

My Name.....

Address.....

City.....

My Jobber..... RT1

# SERVICE NOTES

**JUST OFF the PRESS! COMPLETELY REVISED!**

**THE** New Radolek 1936 Profit Guide is the most complete Radio Parts Catalog ever published. Completely revised — right up to the minute, bringing you everything in Radio — at the right prices. Packed with valuable money-saving "radio-buying" information — every page brings you extra profits! Contains over 10,000 individual Repair Parts — hundreds of new items — a complete new selection of Receivers and Amplifiers. Radolek offers you one complete source for all your Radio requirements. . . Everything you need — always in stock . . . ready for prompt delivery to you. This Book is your handy index to Radolek's huge storehouse of Radio materials . . . you need it — it's FREE. Send for it!

RADOLEK restricts distribution of the PROFIT GUIDE to those actively and commercially engaged in the Radio Business. Please enclose your Business Card or Letter Head.



**RADOLEK**

575 W. RANDOLPH STREET  
CHICAGO, ILLINOIS

Name: .....  
Address: .....  
Serviceman?  Dealer?  Exper.?



tor, the circuit of which is shown herein, the balance of the receiver is of conventional nature. The alignment of this receiver, while not necessarily tricky, deserves a few words of comment. When first aligning the system, the regeneration control, which is the trimmer in the second detector plate circuit, is adjusted for minimum regeneration and the i-f. trimmers are adjusted for maximum signal output. The i-f. signal is fed into the control grid of the mixer tube. After the i-f. adjustments for the maximum output are finished, the generation control is advanced until a howl or squeal is heard. Then this control is backed off until the howl ceases, consistent with maximum output.

With the increase in regeneration, it may be necessary to readjust slightly the i-f. trimmers. After this adjustment is finished, the test signal should be advanced to 1,000 or 1,100 kc. and fed into the antenna transformer, just as if it were a regular broadcast signal. If excessive regeneration is evident, the regeneration control should be backed down slightly more.

When making adjustments on this type of a receiver, it is essential that all shields used be in place and that the level of the signal be not greater than that required for proper indication.

For visual alignment with an oscillograph, it will be found that the i-f. resonance curve is somewhat asymmetrical, when adjustments are set to maximum output. Consequently, when working with a double-image pattern, it will not be possible to cause the two patterns to coincide throughout their entirety.

## 105 to 130 volts

★ Time and again, a receiver is serviced in the shop and when delivered to the customer, does not perform as well as it did on the bench. Under certain conditions, superheterodynes actually cease operating when delivered to the home. Investigation discloses that there is a need for what would be a test in the shop over line voltages ranging from 105 to 130, and the adjustment of the receiver so that it performs equally well over this range of power supply voltages.

The problem is not so bad when the line voltage in the home is greater

than that in the shop, but every so often the reverse is the case, and if it so happens that the oscillator in the receiver is critically adjusted, it is possible that, with reduced line voltage in the home, it becomes inoperative, or at least erratic in operation. This consideration is particularly important in receivers which have been in use for several years and where the receivers are subjected to varying climatic conditions — particularly high humidity.

The type of trouble we have mentioned occurs very frequently when receivers are tested in a large community with fairly normal line voltage, and when the receiver is returned to a home in the outskirts or suburbs of a town, where the line voltage is apt to vary all over the scale and usually is much lower than in the town.

## Use specified line voltage

In connection with line voltage, it might also be a good thing if some device were available to the industry, for use in the service shop, whereby it would be possible to arrange a line voltage which conforms with that specified in conjunction with the test voltage tables supplied as part of the service information covering the radio receiver. For example, if the operating voltage table specifies a line voltage of 120 volts, it would be a good thing if this voltage regulator could be so adjusted that the line voltage being supplied to the receiver during its test on the bench, would be exactly 120 volts. In our opinion, this would eliminate the possibility of a defect passing unnoted because of the normal tolerance allowed in such voltage tables. Where it is possible that a tolerance of 10 per cent may

**if**

**YOU WANT YOUR OBSOLETE SET ANALYZER OR TUBE CHECKER**

*Modernized*

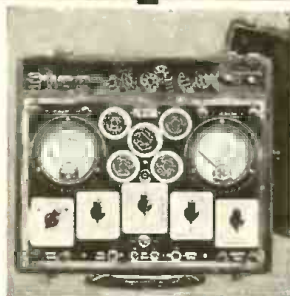

**WRITE FOR OUR PLAN**

MENTION MODEL NUMBER OF YOUR OLD INSTRUMENT

MODERNIZATION DIVISION DEPT. "T"

**PRECISION**

APPARATUS CORPORATION  
821 EAST NEW YORK AV., BROOKLYN, N. Y.

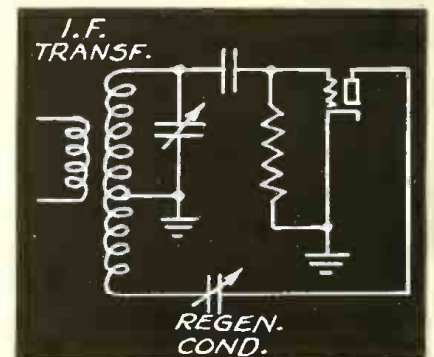

Alignment of superhets using a regenerative second detector is somewhat more involved than usual.



Yes the IMPOSSIBLE is a REALITY- the Amazing WRIGHT-DECOSTER NOKOIL Dynamic Reproducer



"All that the Name Implies"  
NO FIELD COIL OR CURRENT

- Performs like an electro-dynamic reproducer
- Requires less space than an electro-dynamic speaker
- Priced to compete with electro-dynamic reproducers
- The answer to the demand for a compact permanent magnet dynamic speaker
- Available in 6" and 8" models

OPENS NEW AND PROFITABLE FIELDS FOR EVERY RADIO SERVICE MAN.

Write for complete catalog, prices and name of nearest distributor. Wright-DeCoster distributors are always anxious to cooperate.

WRIGHT-DeCOSTER, Inc.  
2265 UNIVERSITY AVE., ST. PAUL, MINN.  
Export Dept. M. Simons & Sons Co., New York  
Cable Address: "Simontrice"  
Canadian Office, A. M. Flechtheim & Co., Guelph, Ontario



A satisfied customer is the service man's greatest asset. . . and satisfied customers are the result of good work and the use of dependable replacement parts. Ward Leonard resistors, relays and rheostats are dependable and are profit makers. Send for Bulletin 507A today. It shows the Ward Leonard Line and gives prices. Be welcome when you call again.

## WARD LEONARD

WARD LEONARD ELECTRIC CO.  
South Street, Mount Vernon, N. Y.

Please send me Service Man's Bulletin No. 507A.

Name \_\_\_\_\_

Street \_\_\_\_\_

City \_\_\_\_\_ State \_\_\_\_\_

Jobber \_\_\_\_\_

RT

be satisfactory when the receiver is tested at a specified line voltage, a reduction in line voltage of from 10 to 15 volts introduces additional variations, which interfere with the application of the normal tolerance limits.

### Audio oscillators

★ If you look through magazines you will find that more and more manufacturers are announcing audio-frequency oscillators — the majority of which are of the beat-frequency type. . . . And more and more service stations are equipping themselves with such equipment. We believe the time is not far distant when distortion in radio receivers is going to be eliminated by the service-man.

At the present time distortion due to some trouble in an audio system goes unnoticed in altogether too many cases. Consistent with such checking is the necessity for greater information in the radio press concerning audio amplifier operation — particularly as it relates to those factors which introduce distortion. In this connection, we believe that the time has come for more extensive discussion of distortion as introduced by elements contained in audio-frequency amplifiers, exclusive of the amplifying tubes. This is so despite the fact that the most flagrant violator is the amplifying tube itself.

### Sine waves

★ It is significant to note that in contrast to the r-f, i-f. test oscillators produced years ago, the modern oscillator of similar type is being designed in such manner that the signal, when demodulated in a properly operating receiver, is of sine-wave character and is suitable for oscillographic types of audio tests.

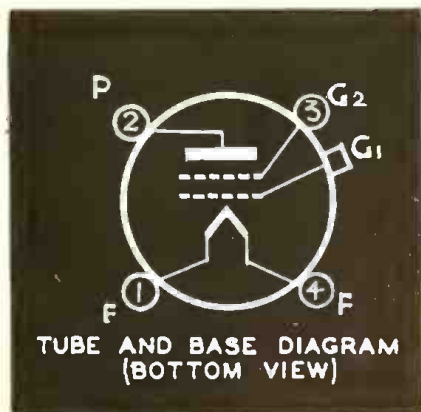

Socket wiring diagram of the types 1A4 and 1B4 2-volt tubes.

THE LAST STEP in TUBE TESTER DESIGN

POWER OUTPUT

DYNAMIC MU CONDUCTANCE

COMPOUND CIRCUITS

by

MUTUAL CONDUCTANCE

TRIPLETT

EMISSION TESTERS

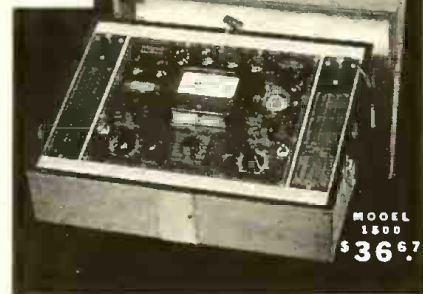

MODEL 1500 \$36.67

The power output circuit by Triplet is the last step in Tube Tester Design. This circuit checks all types of tubes under load, approximating actual conditions in a radio set. Visit your nearest Triplet jobber and see for yourself how this checker catches those defective tubes you had so much difficulty in locating.

Model 1500 tests all types of radio tubes; glass, metal, or glass-metal on the power output circuit. Housed in attractive modernistic case with removable cover, suitable for portable or counter use.

Dealer Net Price . . . . . \$36.67

Model 1501, the new Triplet Multi-Purpose Tube Tester, combines 10 instruments in one. Housed in same case as 1500.

Dealer Net Price . . . . . \$46.67

### TRIPLET MANUFACTURES

a complete line of electrical measuring instruments for radio, electrical and general industrial purposes both standard and custom built. See them at your jobbers. If you have an electrical instrument problem, write to TRIPLET.



### MAIL THIS COUPON

Triplet Electrical Instrument Co.  
192 Harmon Drive, Bluffton, Ohio  
Please send me more information Model 1500—1501—  
Please send me new 1936 catalog.

Name \_\_\_\_\_

Address \_\_\_\_\_

City \_\_\_\_\_ State \_\_\_\_\_

# IF IT'S SOUND WEBSTER-CHICAGO MAKES IT

Now! A COMPLETE P. A.  
SYSTEM WITH A FULL  
8 WATT OUTPUT

Crystal Microphone Single or Dual  
Speakers Mixes Microphone & Phonograph



MODEL P.A. 308

MODEL P.A. 308 has full 8 Watt undistorted output. It is equipped with 8-in. dynamic speakers, has fifty feet of extension cord, and is housed in a strong leatherette covered case. Fully portable, net weight with single speaker 27 lbs.

MODEL P.A. 308 is also available for fixed installation. System is complete, speaker furnished with baffle.

Price is surprisingly low. Write for details.

WEBSTER COMPANY

Section J9

3825 W. Lake St., Chicago, Ill.

## WEBSTER-CHICAGO

manufactures a complete line of public address systems, sound equipment amplifiers and accessories of all kinds.

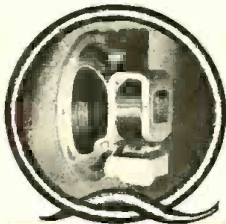

The only Speaker with  
Armored Field Coils.

Licensed under  
Quam Patents.

# QUAM SPEAKERS

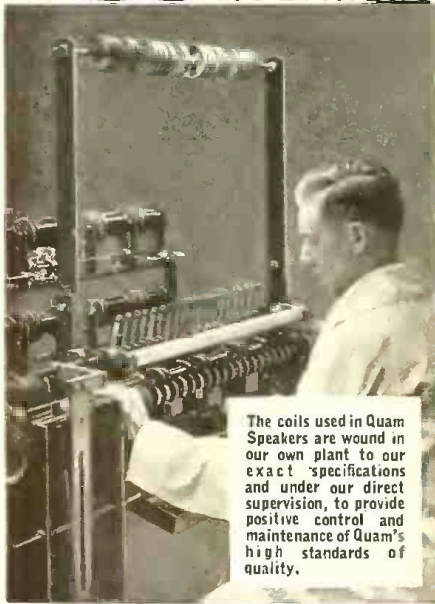

The coils used in Quam Speakers are wound in our own plant to our exact specifications and under our direct supervision, to provide positive control and maintenance of Quam's high standards of quality.

### QUAM-NICHOLS CO.

1693 W. 74th Street, Chicago

1674 Broadway  
New York

30 9th Street  
SAN FRANCISCO

303 E. Pike Street  
Seattle

209 W. 17th Street  
Los Angeles

3037 Knox Avenue, S.  
Minneapolis

"AMERICA'S LARGEST SPEAKER MANUFACTURERS"

# SALES STIMULATORS

Leading manufacturers present  
valuable promotion material

## DISPLAY FOR METAL TUBES

★ Quiet but effective window or shop display for metal tubes has been issued by Ken-Rad Corp., Owensboro, Ky. Neatly colored cardboard exhibit has holes for insertion of five of the tubes, seen against a silver background.

## TUBE TALK SUPPLEMENT

★ Second supplement for Raytheon's popular loose-leaf book, "Tube Talks" will soon be published to bring tube data up to the minute. Owners of the smart volume were furnished tube complement data on sets from 25 of the leading manufacturers when they bought the book; they got a first supplement some time ago in the form of a tube chart, and now the new second supplement will offer tube complements from additional set makers.

Dealers get "Tube Talks" and an endless string of supplements for 50 cents from Raytheon offices at 30 East 42nd St., New York City.

## NEW SERVICE BOOSTER

★ RCA jobbers are interesting their dealers in a new 3-point service and sales builder. System consists of three units: a 48-page book containing "101 Sales Service Ideas," a tip file with steel cabinet, and a book titled "Radio Service Business Methods."

Cost of this neat lay-out to the serviceman is \$1.50; a \$5 purchase and \$1.50 deposit are necessary to obtain the items. As purchases continue, the jobbers offer additional "tip packets" for the file, and deposit is refunded when the total of parts purchases is \$60.

## 1936 CHART

★ Four-page folder carrying a good description of the new Coronet "metal tube" has just been issued by Arcturus Radio Tube Co., Newark, N. J. Bulletin contains a complete chart of characteristics and a table giving pin connections and physical specifications.

# TRADE NOTES

★ Case Electric Corp., manufacturer of Case radio sets, has closed its Chicago office, and the company's sales and executive headquarters will be located at the factory in Marion, Ind. Export sales activities will continue to be under the direction of Harry J. Scheel, 330 South Wells St., Chicago, Ill.

★ Henry C. Forster, well known throughout the loud-speaker industry, has just acquired the license covering important patents and new developments in the manufacture of permanent-magnet dynamic speakers. Mr. Forster, who is making his headquarters at 1307 South Michigan Ave., Chicago, states that these new patents will permit the production of permanent dynamic speakers for battery and auto radio sets on a basis "comparing very favorably with magnetic speaker manufacturing."

★ Midwinter convention staged by the Philco Radio & Television Corp. of New York is set for Jan. 19 at the New York Hippodrome. Dealers from metropolitan areas in New York and New Jersey are expected to be on hand for an elaborate show and an address by L. E. Gubb, Philco prexy.

★ Second annual convention for Fairbanks-Morse distributors was held in Chicago early this month, with the Conservador refrigerator getting a break in presentation programs. Paul Jones, new head of the company's appliance sales division, was important at the sessions.

★ Modern two-story plant formerly used by the Haynes Auto Co. in Kokomo, Ind., has been taken over by the Crosley Radio Corp., Cincinnati, as part of increased production schedules.

(To page 34)



## WE GIVE YOU THE NEW CORNELL-DUBILIER CATALOG NUMBER 127

• Replete with technical information regarding the construction and uses of all types of industrial capacitors.

• Six pages devoted exclusively to mica transmitting condensers. Capacitors utilizing Dykanol, the non-flammable, non-explosive impregnating medium fully detailed. Motor starting electrolytic capacitors described, illustrated and listed.

• Twenty-four complete pages of pertinent facts worth knowing for economical transmitter and industrial design and construction.

• Your copy is waiting for you! Let us have your name and address and the following morning you will have it.

**CORNELL-DUBILIER**  
CORPORATION

4360 BRONX BOULEVARD  
NEW YORK

# "WHAT'S IN A NAME"—WHOLESALEERS?

## Some puzzling misnomers in radio jobbing field

★ MISLEADING firm names attached to many radio jobbing firms must result in heavy sales losses each year, in the opinion of Charles Golenpaul, aggressive and mau-about-town sales executive for the Aerovox Corporation.

Perhaps radio men, among their many other accomplishments, are expected to be mind-readers as well. At least they are called upon to recognize businesses handling radio no matter what the camouflage or disguise or misnomer may be. Thus a concern may be a chair company or jeweler or sash-and-door manufacturer to the public at large; but to the radio service man it is supposed to mean radio. Still another correct guess decides whether it's wholesale or retail, merchandising or servicing, sets or parts.

But let Charlie tell his own story:

"From my choice collection of camouflages and disguises unintentionally worn by radio jobbers, I present for first prize a mattress and spring company. That's what this jobber calls himself. But he wins only by a nose; for I present a chair company, a jeweler, lumber and paint company, sash-and-door, bicycle, liquor, wagon wheels, wholesale drug and tobacco, and sporting goods firm names as runners-up. Who could ever guess that these firms, many of them splendid and outstanding jobbers in their respective territories, are really handling a huge volume of radio parts business? In many instances radio today is their main line even though they have held on to a firm name indicating an earlier activity. The tail may now be wagging the dog; but the dog has kept its fair name.

### Everything but radio

"Then there are hardware, auto accessories, electric supply, phonograph, piano, musical equipment, ignition-starter-battery, and tire applications which, even by the widest stretch of the imaginative radio mind, can hardly be linked with radio-wholesale. Or even if this be radio, how can radio studios, sound systems and other radio-sounding firm styles be linked with the selling of sets and parts for resale?

"I am particularly concerned with

firm names definitely indicating a radio activity in direct competition with the very trade sought. Thus there are jobbers who cling to 'laboratory' or 'service' or 'servicing' or 'repair.' Fatal words, those. For the service man is always suspicious of the jobber who may be dabbling with servicing on the side. Even if there is no foundation to such a suspicion, why permit it to be reared in the first place by an obsolete or poorly chosen firm name?

"Jobbers should try to use the good old term 'radio.' And to qualify their radio activity, there is the choice of 'wholesale,' 'supply,' 'supplies,' 'parts,' 'components,' and so on.

"A good name is better than precious ointment," says the Old Testament. Which means, in modern radio language, that a descriptive firm name saves a lot of sales effort when selling radio service men and radio retailers."

### PUBLIC ADDRESS

(From page 15)

impossible to collect after the campaign is over.

In purchasing the equipment it is well to buy the best possible, taking into account one's own financial status and the competitive conditions. PA manufacturers will help you pick the equipment best suited to your particular problems. (See RADIO TODAY'S Trade Directory in December issue for list of manufacturers.)

"Cheap equipment may prove your

downfall," advises an old timer in this public-address game, "it takes but one failure in your equipment to give you a black eye.

"An item often overlooked is that of blanket public liability insurance. It is inexpensive and should be obtained to avoid trouble from law suits arising from people tripping over wires, etc."

Depeudable service and fair prices will make PA profitable for the radio man in the coming year. He should get into it at once and build a name for himself.



## Ken-Rad Radio Tubes

DEPENDABLE LONG LIFE



Our complete dealer sales plan opens the way to better business. Write for it today.

Glass or Metal  
Radio Tubes

THE  
KEN-RAD  
CORPORATION, INC.

Division of The  
Ken-Rad Tube  
and Lamp Corporation

OWENSBORO  
KY.

Also Mfrs. of Ken-Rad  
Incandescent Elec. Lamps

**NATHANIEL  
BALDWIN  
CONTROLLED RESONANCE  
SPEAKERS**

This ad pinned to your letterhead will bring you complete data on the great Baldwin line of Replacement Speakers.

CONSOLIDATED RADIO PRODUCTS CO., 361 W. SUPERIOR ST., CHICAGO  
200 BROADWAY, NEW YORK, N. Y.

# TRADE NEWS

(From page 32)

★ New laboratory models in testing equipment made by the **Supreme Instruments Corp.**, Greenwood, Miss., have been accepted by the Federal Housing Administration for monthly payment plans. Supreme jobbers are handling the loans and making immediate deliveries without a down payment, but dealers can also make direct connections with Supreme headquarters at Greenwood.

★ January 23 is going to be a red-letter day for one of the veterans of the radio industry—**George W. Russell**, sales manager of the **Sentinel Radio Corp.**—for on this particular day Mr. and Mrs. Russell will celebrate their twenty-fifth wedding anniversary, with their five children joining in the felicitations.

## MANUFACTURERS! Important for 1936!

Probably the most economical and certainly the simplest to use speaker connector is our #203F Series in which the plug is rigidly attached to the speaker with a single sheet metal screw and the connector has individual leads to suit chassis circuit requirements. Used on 1935 RCA and G.E. sets.

Each contact and lead is individually insulated with molded insulation. The molded baffle on the plug meets Underwriters requirements. No need for clamps, brackets, screws, etc. Write today for complete information.

### HAVE YOU SEEN OUR NEW "MAGIC EYE" CONNECTOR?

Write for details on our #206FE "6ES" Tube Connector



**ARE YOU MAKING EQUIPMENT USING DRY BATTERIES?**  
Get the story on our complete line of molded connector plugs for battery cables.

Whatever your requirements may be we have a complete line of regular and special plugs, connectors, sockets, etc., to suit every purpose and requirement.

Consult us on your new and special requirements for quick service and low cost.

### DEALERS and JOBBERS

Write today for our new catalog of metal tube adapters, sockets, plugs, connectors, analyzer plugs, etc.

#950GEM adapter shown at right tests all metal tubes in the 36 socket of any tube tester.

Single, compact, self-contained unit. Rugged and dependable.

List Price .....\$6.50

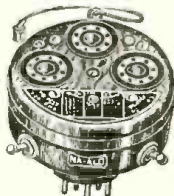

**ALOEN PRODUCTS CO.**  
Dept. RT1 715 Centre St.  
Brockton, Mass.

★ **E. H. Vogel**, formerly of the radio-phonograph sales division of **RCA Victor**, now belongs to the radio division, merchandising dept., of **General Electric Co.**, Bridgeport, Conn.

★ A new advertising agency has just been formed in Cincinnati, Ohio, by **Douglas Allen** and **Lehnd Davis, Inc.**, both of whom have been identified with the advertising and radio fraternities for many years. The new agency has opened headquarters in the **Enquirer Building** and among its important accounts are the advertising activities of the **Crosley Radio Corp.**, Cincinnati, and the **Ken-Rad Corp.**, Owensboro, Ky.

★ **Zenith dealers** from Montana and Washington were guests of **Zenith Radio Corp.** Monday, Jan. 6th. Breakfast, luncheon and dinner were served at the **Medinah Club**, Chicago, with informal discussions on sales and merchandising plans. The **Midland Implement Company**, Billings, Mont., and the **Brown Johnston Company**, Spokane, Wash., Zenith jobbers, sponsored the party. Zenith hosts were **C. T. McKelvey**, assistant sales manager, and **Parker H. Erickson**, sales promotion manager.

★ **H. H. Kunkler**, for many years prominent in radio and formerly connected with **U. S. Radio and Television Corp.** and **General Household Utilities Co.**, has joined the **Stewart-Warner Corp.** as assistant to **Frank A. Hiter**, general sales manager of the company. Mr. Kunkler, who is well known to distributors and dealers from coast to coast, will concentrate his activities on the **Stewart-Warner radio and refrigeration divisions**.

★ **Fada Radio & Electric Co.**, Long Island City, N. Y., has issued the news of the appointment of two new sales representatives: **Herman A. Smith**, to cover Eastern Michigan, Southern Indiana, Ohio, West Virginia and Kentucky; **Ben Stevens** to cover Baltimore and Washington areas, New York State and Pennsylvania.

★ **Charles Mahoney**, who heads the metallurgical department of **Ken-Rad Corp.**, tube makers of Owensboro, Ky., went to Chicago late last month and made a pointed address on "Radio Tubes and Metallurgical Problems" for the **Chicago Radio Engineers Club**. Leading radio and tube engineers in the Chicago area thus got a pertinent Mahoney version of research and development work on metal tubes.

★ **A. G. Lindsay**, manager of the foreign division of the **Crosley Radio Corp.**, sailed on Jan. 10 from New York on the S.S. "Reliance" for South Africa, to visit **Crosley distributors** there. From Africa, Mr. Lindsay will continue to Brazil, Uruguay, the Argentine, across the Andes to Chile, Peru, and Colombian ports; Panama, Canal Zone and Trinidad will be included on the way back.

★ **Plutag Co.**, Bucharest, Rumania (Address: Piata Academiei 1, Scara B), have sent to "Radio Today" a report of a thriving business in the importa-

tion of "wireless sets and miscellaneous radio products." Report included a statement of renewed interest in American radio products, along with a request for catalogues and price lists from the American companies.

★ **W. R. G. Baker**, for the past few years connected with the **RCA-Victor Co.**, has been appointed managing engineer of **General Electric's** entire radio receiver section. Mr. Baker was an important figure in early radio development at GE, and now returns as chief of its engineering and production activity.

★ **F. J. Wessner**, National Union Radio Corp.'s general sales manager, has announced that **Lloyd Marsh** is the new regional manager for the company in Washington, Oregon, Montana, and Idaho. Marsh is a vet district manager for National Union.

★ **Harry Boyd Brown**, Philco's merchandise manager, is in the midst of an extended tour of the Pacific Coast.

★ **Garod Radio Corp.** has just moved into new and larger quarters at 115 Fourth Ave., New York City. New lay-out will double production facilities, and output will be hiked 40 per cent; considerable emphasis has also been placed on an ultra-modern showroom at the new address.

★ New district manager for the National Union Radio Corp. is **Ross Turner**, named to head sales activity in Texas and Louisiana. Turner headquarters will be at 612 Medical Arts Building, Fort Worth, Texas.

★ Substantial demonstration of faith in the radio biz is the announcement by **Hygrade Sylvania Corp.** that an additional factory building will be erected immediately, at Salem, Mass. Occupancy of the huge new plant is set for early summer.

★ **Station WMEX** will soon occupy new studios now under construction at 70 Brookline Ave., Boston.

★ Revamping of field forces has been announced by **RCA Mfg. Co.** New administration divides the country into two major divisions; **John W. Griffin** will manage the eastern one, and **Henry C. Bonfig** the western. Activity at Camden for the new set-up is headed by **M. F. Burns**.

★ **J. A. Stobbe**, field engineer for the **Arcturus Radio Tube Co.**, recently has been guest speaker at servicemen meetings both in Chicago and Milwaukee.

★ **Maurice L. Gaffney**, formerly managing editor of "Advertising and Selling," is the new head of the Trade News Division at **CBS**.

★ Lively meeting of some 700 RCA dealers of the East was staged in Atlantic City early this month, with **RCA Victor** and several RCA jobbers of the territory as hosts. Get-together centered on merchandising plans for new under-\$100 RCA items.

★ **William Fraser**, **Stromberg-Carlson's** field engineer, has recently appeared at meetings of the Institute of Radio Service Men both in New York City and Philadelphia.

★ **T. A. Kennally**, general sales manager for **Philco**, has returned home from a visit to Kansas City, Mo.

★ The following listings should be added to the trade directory published in last month's "Radio Today":

#### Public Address and Amplifiers

**S. H. COUCH CO., INC.**, N. Quincy, Mass., "Couch," "Samson," "Pam"—AMP, PRE, PA  
**FEDERATED PURCHASERS, INC.**, 25 Park Place, New York City, "Acra-tone"—AMP, PRE, PA

**Tubes, Transmitting and Special Purpose**  
**NATIONAL UNION RADIO CORP.**, 570 Lexington Ave., New York City, "National Union"—CRT, PC, SP

**UTAH VIBRATORS**

Tear out this ad and pin to your letter-head for FREE copy of the NEW UTAH General Catalog of vitalized radio parts

**UTAH RADIO PRODUCTS CO., Orleans St., Chicago**

# WHOLESALEERS

★ **Ken-Rad Corp.**, Owensboro, Ky., was host recently to some 100 dealers and servicemen at a "Explore First Your Own Backyard" meeting. Guests came from southern Indiana and Kentucky.

★ Meeting of the board of directors of the **Radio Manufacturers Association** has been set by Pres. **Leslie F. Muter** for Jan. 29 at the Hotel Stevens in Chicago.

★ Following the **Fairbanks-Morse** distributors meeting Jan. 10 at the Stevens Hotel, Chicago, **Mr. Coen**, who heads the firm of **Menard-Coen, Inc.**, Chicago distributors for the company, took off for a trip to Florida. Mr. Coen's version of current radio business: "Very satisfactory in 1935 and every indication that 1936 will be excellent."

★ **Allied Radio Corp.**, Chicago distributors, last month opened new sales rooms with a three-day celebration which some 11,000 dealers, servicemen, amateurs, and sound men attended. Visitors were allowed to operate the equipment personally; more than a dozen manufacturers had products there.

★ **W. C. Perkins**, vice-president of **Case Electric Corp.**, Chicago, Ill., and **Marion, Ind.**, was a recent visitor to the New York trade, making the rounds with **Roy Knibb**, well-known radio sales executive, who recently joined the Case organization as New York representative.

★ Interesting bid to dealers was sent by **Ontario Electric Corp.**, Buffalo, N. Y., **Crosley** distributors, for a meeting Jan. 9 and 10. Announcement of the gathering was made first by cartoons, but the final invitation was in the form of a summons to the "Crosley Court of Appeal."

★ **Crosley Radio Corp.** has reported changes and additions to its list of distributors. **Jobbers** now lined up are **Maurer-Greusel Co.**, Milwaukee; **Motor Power Equipment Co.**, St. Paul, Minn.; **Morris Distributing Co.**, Binghamton N. Y.; and **Moore-Bird Co.**, Denver, Colo.

★ **Schuster Electric Co.**, RCA Victor jobber in Cincinnati, has attracted wide attention with its sponsorship, along with **Station WCPO** and the Cincinnati Post, of a campaign to get radio-phonographs into local schools. Students earn the instruments by collecting old Victor records.

★ **Pilleo** distributor meetings were held late last month in 6 scattered cities on the same date. Sectional rallies were in Atlanta, Kansas City, Philadelphia, Cleveland, Chicago, and San Francisco.

★ **York Automotive Distributing Co., Inc.**, has opened at new branch distributor at 177 Central Ave., Newark, N. J. **York Co.**, headed by **N. Cooper**, distributes Motorola.

★ **Fred Goldberg**, general manager, and **Dave Slobodien**, president of the **Apollo Distributing Co.**, Newark, N. J., are on a factory-visiting jaunt over the eastern end of the country; they will go to Cincinnati, Chicago, Peoria, and Dowagiac, Mich. **Apollo Co.** distributes **Crosley** radios, refrigerators, washers, ironers and vacuum cleaners.

★ New and finer facilities of the **MacAdams Equipment Co., Inc.**, are being opened at 507 W. 56th St., New York City; former address was 601 W. 57th St. The company, specialists in auto radio, is headed by **M. B. McCullough**.

★ **Arthur Puddin**, exec of the **Material Disposition Corp.**, New York City, has returned from a European trip on which he made official visits to offices there.

## "WHERE TO BUY IT" SERVICE

You can now get those hard to find items through **RADIO TODAY's** exclusive service. **RADIO TODAY** will put you in contact with the manufacturer of any radio item you may need.

**RADIO TODAY's** files include the makers of all radio items — no longer need you search and search to find a manufacturer of that special part or equipment.

From rivets and washers to receivers and broadcast stations — **RADIO TODAY** serves you. From radio schools to broadcasting networks — **RADIO TODAY** will serve you.

Your request should include the following information:

1. Product or service desired.
2. Use to which the product will be put.
3. Your position in radio.
4. Your name and address.

**RADIO TODAY** will immediately put you in touch with manufacturers that will be pleased to serve you. Our suggestions will *not* be restricted to manufacturers who advertise in **RADIO TODAY**.

This service is *free* to all **RADIO TODAY's** readers — subscribers and non-subscribers — advertisers and non-advertisers.

Address: "WHERE TO BUY IT" SERVICE

**RADIO TODAY**  
480 Lexington Ave.  
New York City

## RADIO TODAY'S

### ★ BOOK SHOP ★

The services of this department are offered for your convenience. Just send us your order, with remittance at the list price, for any Radio Book you desire and we will forward it to you without delay. Here are a few suggestions. Order your Radio Books from

BOOK SHOP, RADIO TODAY

480 LEXINGTON AVE. NEW YORK, N. Y.

**Radio Physics Course**, by **Alfred A. Ghirardi**, 2nd Revised Edition. Basic electrical theory pertaining to the latest applications. Used the world over as a valuable reference and text book. Nearly 1,000 pages. 500 diagrams and illustrations. \$4.00

**Principles of Radio**, by **Keith Henney**. Intended primarily for radio students, experimenters, and technicians — this book covers a wide range of subjects from the fundamentals of electricity to the modern concepts of modulation and detection. Well illustrated. Practical. 491 pages. Cloth. \$3.50

**The Outlook for Television**, by **Orrin E. Dunlap, Jr.** In this volume a leading student of broadcasting and television gives you the latest information on the subject and offers, in addition, the ideas of eight foremost authorities on the value of television in their individual fields. \$4.00

**The Advertising Agency Looks at Radio**, edited by **Neville O'Neill**. Get the first detailed and comprehensive statement of the Advertising Agencies' point of view on Radio from 18 experts. 248 pages. \$3.00

**Elements of Radio Communication**, by **John H. Morecroft**. Contains simple laws of circuits, particularly useful in radio communication. General idea of radio communication. The vacuum tube and its uses. Radio telegraphy. Radio telephony. Receiving sets. 286 pages. Cloth. \$3.00

**Elements of Loud Speaker Practice**, by **N. W. McLachlan**. A small, practical manual. Covers the entire field of practice excepting some theoretical and advanced aspects. Illustrated with simple diagrams. \$1.75

STANDARD EQUIPMENT WITH ALL LEADING SET MANUFACTURERS

# Candohms

## ARMOURD WIRE WOUND RESISTORS



OVER ELEVEN MILLION IN USE

MAY WE SAMPLE AND QUOTE?

**MUTER**

**THE MUTER COMPANY**

1255 SO. MICHIGAN AVENUE  
CHICAGO

STANDARD EQUIPMENT WITH ALL LEADING SET MANUFACTURERS

# NEW THINGS FROM THE MANUFACTURERS

## HIGH-GAIN AC AMPLIFIER

★ Three-stage resistance coupled amplifier with gain of 73 db. from 500 ohm input. Response flat within ¼ db. from 25 to 9,000 cycles. Power supply from power amplifier—2.5 or 6.3 volt tubes—4 mils. plate current—no motorboating or hum. Output drives power amplifier—20,000 ohms or greater. Absence of transformers allows close mounting to power supply. Model SH3—net \$20. Bruno Labs, 20 W. 22nd St., New York City—**RADIO TODAY**

## POWER LEVEL INDICATOR

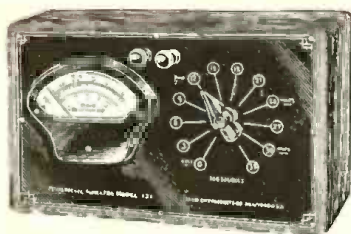

★ AC voltmeter and power level indicator for amplifier and public address servicing. Range—minus 12 to plus 43 decibels and 0-5-20-80-160 volts. Rectifier type meter—10,000 ohm L-type non-inductive attenuator—db calibration for 500 ohm line. Can be used for frequencies from 20 to 20,000 cycles—frequency correction up to 15,000 cycles less than one db. Net—\$25.85. Radio City Products Co., 88 Park Place, New York City—**RADIO TODAY**

## ADDITIONS TO 1936 LINE

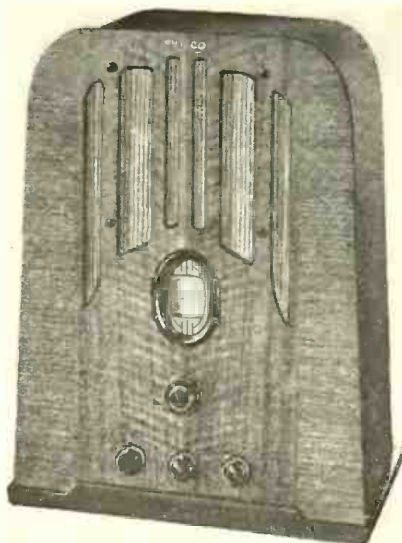

★ Among recent additions to Philco line is 3-band 6-tube battery superheterodyne. Plate and grid potentials supplied by vibrator power unit. Power-driven audio system—permanent-magnet dynamic speaker—tone control. Precision dial with 2-speed drive—built-in aerial tuning

system. Model 624B (illustrated) list \$74.95 with 6-volt battery, 624F cons. \$89.95. 624K cons., \$100. Other additions are:

602C 5-T. compact, \$29.95; 610T 5-T. a-w. (all-wave) compact, \$49.95; 625 6-T. a-w. Baby Grand, \$57.50; 625J 6-T. a-w. cons., \$74.95; 625S 6-T. a-w. cons., \$64.95; 635X 6-T. a-w. cons., \$85; 645K 7-T. a-w. cons., \$95; 651X 8-T. AC-DC a-w. cons., \$105; 655B 8-T. a-w. Baby Grand, \$85; 665X 10-T. a-w. cons., \$155. The following have new cabinets:

60B 5-T. table, \$32.50; 84B 4-T. table, \$20; 89B 6-T. table, \$39.95; 116B 11-T. a-w. Baby Grand, \$104.50; 680X 15-T. hi-fi a-w. cons., \$280. New auto receivers are:

816 6-T. single unit, \$39.95; 817 6-T. single unit, \$49.95; 818 same as 817—2 speakers, \$59.95; 818K 6-T. 2-unit, \$59.95; 819 7-T. 2-unit, \$69.95; 819H same as 819—2 speakers, \$77.60.

Philco Radio & Television Corp., Philadelphia, Pa.—**RADIO TODAY**

## MODERNISTIC TABLE RADIO



★ AC-DC skip band receiver with walnut cabinet finished front and rear for that table in center of room. 6 tubes including ballast and 2 metal. Superhet circuit—range, 535 to 1670, 5500 to 17600 kc. Duo-colored calibrated full-vision dial—dynamic speaker. De Wald model 615—list \$37.50. Pierce-Airo, Inc., 510 Sixth Ave., New York City.—**RADIO TODAY.**

## CONSTANT IMPEDANCE LOGARITHMIC ATTENUATOR

★ Logarithmic attenuator with new design principle which makes it possible to have a substantially constant impedance. Attenuation linear in db. and continuously variable over entire range of 5 to 60 db. Available in impedances of 15 to 10000 ohms. List \$3.00. Electrad, Inc., 175 Varick St., New York City.—**RADIO TODAY.**

## WAVE-CHANGE SWITCHES

★ Centralab of Milwaukee, Wis., announce the addition of a line of wave-changing switches and other radio products acquired through the purchase of Perfex Controls Co. of Milwaukee. The Perfex line will be marketed under the Centralab banner.—**RADIO TODAY**

## METAL-TUBE HI-FI CONSOLE

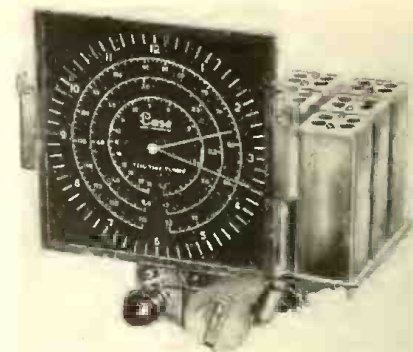

★ Ten-tube all-wave superheterodyne—540 to 21,000 kc. in four bands. Variable selectivity control—tone control with bass compensator. Power output of 10 watts—3 speakers. Dual-speed vernier dial tunes like a clock—360° band length. Chassis illustrated shows details of tuning system—8-inch diameter dial. Walnut console 42 in. high. Model 1017. Case Electric Corp., 1307 S. Michigan Ave., Chicago, Ill.—**RADIO TODAY**

## GAS ENGINE GENERATORS

★ Gas engine generators for use in isolated and mobile installations—AC models available in 300, 600, 1,000 volt-amperes—DC generators in 600 and 1,000 watt ratings. Powered by single-cylinder, four-cycle, air-cooled engine operating at 1,800 rpm. Manual starting and automatic speed control—self-excited field. Eacor 300 VA generator with filter—list \$107.50 Pioneer Gen-e-motor Corp., 466 W. Superior St., Chicago, Ill.—**RADIO TODAY**

## AC-DC TABLE SUPERHETS



★ Long-wave and skip-band 6-tube superheterodyne for AC-DC. Range 147 to 340, 515 to 1,530, 5,750 to 15,800 kc. Ten tuned circuits. Cabinet of figured walnut. Model 168, list \$49.95. Model 167—same as 168 but without low-frequency band, list \$44.95. Fada Radio & Electric Co., 30-20 Thompson Ave., Long Island City, N. Y.—**RADIO TODAY**

## RADIO CLOCK-SWITCH



★ Set the hands of this portable clock switch, and the radio set is automatically turned on for desired program, and off again when broadcast is over. Permitting any interval up to 12 hours, switch may be used to let radio set play at bedtime, allowing listener to sleep, or to wake him next morning. Switch can be disconnected and used to time clothes-washer, turn off reading lamp when user falls asleep, defrost refrigerator, time sun-lamp exposure, and for many other applications. Mark-Time switches are made by M. H. Rhodes, Inc., 1270 Sixth Avenue, New York City—RADIO TODAY

## COMPACT ELECTROLYTIC CONDENSERS

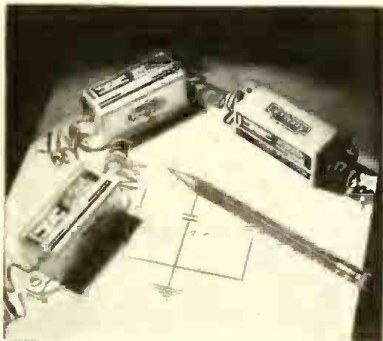

★ Unusually small dry electrolytic condensers with working voltage of 450. Require half the space taken by standard condensers of equal capacity. Ideal for replacement in all sets. Fully described in 1936 catalog. Tiny-Mike type TM. Sprague Products Co., North Adams, Mass.—RADIO TODAY.

## GAS ENGINE CHARGER

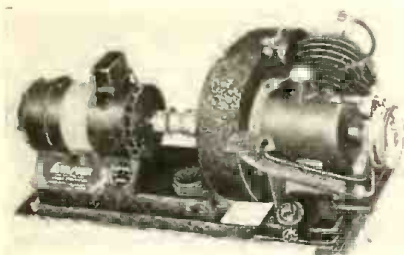

★ Portable 6-volt generator for farm radios powered by 4-cycle air-cooled gas engine. Heavy-duty generator has charging rate of 18 to 20

amperes. Equipped with automatic circuit breaker and ammeter—ball bearing construction. Rubber mounted to prevent vibration. "Farm Power"—list \$49.95—special combination price with Sentinel farm radios. Sentinel Radio Corp., 2,222 Diversey Pky., Chicago, Ill.—RADIO TODAY

## 6-TUBE CONSOLES



★ All-wave 6-tube superheterodyne with metal tubes. Range—540 to 1,540, 1,540 to 4,200, 5,900 to 18,200 kc. Black full-vision dial with colored tuning scales. Model 565K (illustrated) 40 inch console, figured walnut front, striped walnut top and sides, list \$69.95. Model 565W same chassis—console of center-matched walnut, list \$49.95. United American Bosch Corp., Springfield, Mass.—RADIO TODAY

## MIRROR-GLASS COMPACT

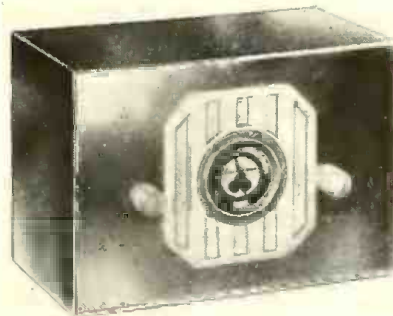

★ Table type superheterodyne in cabinet of mirrored plate glass—silver, blue, pink, or green. Five tubes—AC-DC. Two bands—545 to 1,500, 1,500 to 4,000 kc. Dynamic speaker and airplane type dial. Freed-Eisemann model BG-357-P. Freed Mfg. Co., 44 W. 18th St., New York City—RADIO TODAY

## ELECTRIC PHONOGRAPH

★ Electric record player with three-tube amplifier and 8-inch dynamic speaker. High-impedance pick-up and constant speed turntable. Plays 10 and 12-inch records. Housed in modernistic walnut veneered cabinet. Designed for home use—ample volume for average sized room. Operates on AC only. RCA Victor Electrola model R-95—list \$49.95. RCA Mfg. Co., Camden, N. J.—RADIO TODAY.

## P.A. AND RADIO ANALYZER



★ Test instrument developed primarily for public address and radio servicing. Multi-range AC-DC meter (including 6 db. ranges). Point-to-point resistance and selective analysis (socket) testing methods—rotary switches. Model 491—net \$89.95. Supreme Instruments Corporation, Greenwood, Miss.—RADIO TODAY.

## MODULATION MONITOR

★ Modulation monitor with (1) DC meter for setting average rectified carrier, (2) peak indicating light flashes on all peaks exceeding predetermined value, (3) meter continuously indicates percentage modulation. Dual speed meter—fast-up, slow-return—easy to read. Meets requirements of amended Rule 139 of FCC. List \$195. General Radio Co., Cambridge, Mass.—RADIO TODAY.

## CERAMIC-CONDENSERS

★ Capacitors using ceramic-dielectric—practically immune from leakage and voltage breakdown—dielectric constants from 50 to more than 170. Provides extreme compactness—material can be fabricated in thin sheets and tubes. H. L. Crowley & Co., W. Orange, N. J.—RADIO TODAY

## PORTABLE RADIO-PHONO



★ All-wave 7-tube superhet receiver—AC-DC operation for set and turntable. Electromagnetic pick-up—tone and volume controls. Radio covers 535 to 4000, 5800 to 18000 kc.—employs a ballast and metal tubes. Compact case of fine-grained leatherette of brown—metal fittings in oxidized finish. Model PC31—list \$100. Garod Radio Corp., 34 East 12th St., New York City.—RADIO TODAY.

(To page 38)

# NEW THINGS

(From page 37)

## LIGHT-WEIGHT AC POWER PLANTS

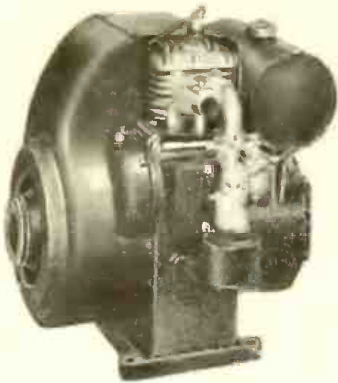

★ Light-weight AC generators (110 volt, 60 cycle) for home, sound-car, and public address systems. Fully enclosed machines powered by 4-cycle gasoline engine operating at 1800 rpm. Engine has magneto ignition, float-feed carburetor, governor, pressure lubrication. Capacities up to 3000 watts. Model 3L (350 watts) illustrated—list \$110 complete. D. W. Onan & Sons, 43 Royalston Ave., Minneapolis, Minn.—RADIO TODAY.

## VELOCITY MIKE WITH PRE-AMP

★ High output (—40 db.) from velocity microphone employing pre-amplifier housed in bottom of microphone. Absence of input transformer eliminates noise and hum. Gradual rising characteristic (7000 to 11000 CPS) gives brilliant reproduction of highs. 6J7 metal tube operates from self-contained batteries or AC. Exceptionally high signal to noise level. Model SR80P—list \$100. Amperite Corporation, 561 Broadway, New York City.—RADIO TODAY.

## MULTI-SECTION MIDGET ELECTROLYTICS



★ Dual and triple section electrolytic condensers of extreme compactness—mounted in cardboard container with mounting flanges—individual positive and negative leads. Dual sections in 250 and 525 volt peak ratings—4 to 8-16 mfd. Triple 8 mfd. section offered. Exact duplicate paper and electrolytic condensers now available for several hundred of the more popular receivers. Aerovex Corp., 70 Washington St., Brooklyn, N. Y.—RADIO TODAY

## NEW TUBES

★ Following tube types announced in past month: 6Q7—metal duo-diode triode similar to 75; 6X5—metal full-wave rectifier for automotive use similar to 84; 25A6—metal pentode similar to 43; 25Z6—metal full-wave rectifier similar to 25Z5; 950—glass 2-volt power output pentode.

Announced by Arcturus Radio Tube Co., Newark, N. J.—types 6Q7, 6X5.

By Hygrade Sylvania Corp., 500 Fifth Ave., New York City—6Q7, 6X5, 25A6, 25Z6.

By Ken-Rad Corp., Owensboro, Ky., —6Q7, 6X5, 25A6, 25Z6.

By National Union Corp., 570 Lexington Ave., New York City—6Q7, 6-Q7MG, 25A6, 25Z6.

By Raytheon Production Corp., 30 E. 42nd St., New York City—6Q7, 6X5, 25A6, 25Z6, 950—RADIO TODAY

## 5-TUBE CONSOLE AND TABLE COMPACT

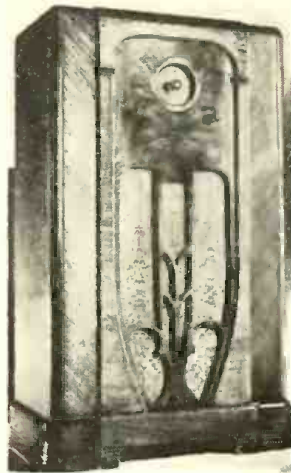

★ Low-cost 5-tube superheterodyne receivers—7 tuned circuits—metal tubes. Receives up to 2,500 kc. Power line filter and 456 kc. code filter. Tone and automatic volume controls. Table model 10 in. high x 15¼ in. wide x 7¼ in. deep—5¼ in. dynamic speaker—type 1421 list \$25.95. Console of walnut, curly maple, red gum—8 in. speaker—model 1425 list \$39.95. Stewart-Warner Corp., Chicago, Ill.—RADIO TODAY

## CATHODE-RAY OSCILLOGRAPH



★ Oscillograph with “top deck” controls—special viewing angle on tube—easy to see and operate.

Linear sweep circuit—20 to 50,000 cycles—positive locking circuit. Horizontal and vertical amplifiers—gain of 37. Three-inch 906 tube. Input impedance ½ megohm with amplifier—1 megohm direct to plates. Removable calibrated scale. 12½ in. high x 18½ in. deep x 8¾ in. wide—weight 21½ lbs. Model 800—net \$79.50. Triumph Mfg. Co., 4,017 W. Lake St., Chicago, Ill.—RADIO TODAY

## ELECTRIC EYE TUNING



★ Line of home and farm receivers from five tubes to ten-tube all-wave superhet utilizing cathode-ray tuning and metal tubes. Model illustrated covers 145 to 345 and 540 to 18,000 kc.—dual ratio tuning vernier—calibrated airplane dial—electric eye. Metal tubes in i-f. and r-f. stages—A prime 45 output stage. Clarion TC43—net \$52. Transformer Corporation of America, 100 Sixth Ave., New York City—RADIO TODAY

## DUAL-BAND 5-TUBE SUPER



★ Table type superheterodyne with 3 watts output—5 glass tubes—two bands, 540 to 1,530, 1,500 to 3,200 kc. Audio overload control—tone control—dynamic speaker. Antenna i-f. wave trap—line filter—power transformer with electrostatic shield. Walnut cabinet—14¼ in. high x 10½ in. wide x 8 in. deep. Model 116, list \$24.95. Emerson Radio & Phonograph Corp., 111 Eighth Ave., New York City—RADIO TODAY



## MODERNISTIC RIBBON MIKE

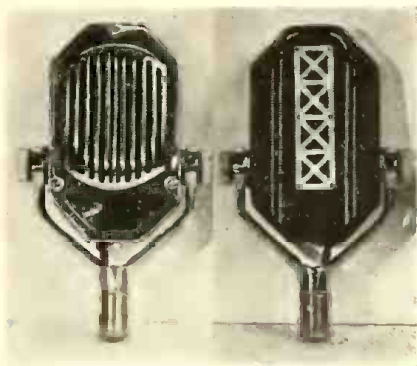

★ Velocity type microphone for all 'round use—broadcast, public address, remote pick-up. New-style, futuristic jet-black enamel and chrome polished casing of small size— $2\frac{3}{4}$ " x  $4\frac{3}{4}$ " x 1" thick. Swivel mounting. Also new is an adjustable stand that can be folded up or adjusted to fit awkward-sized space. Microphone—list \$22.50. Universal Microphone Co., Inglewood, Cal.—RADIO TODAY

## MEDIUM-PRICED RADIO LINE

★ Among 9 additions to 1936 line is 8-tube table superheterodyne with magic eye—magic brain construction—metal tubes. Range—540 to 18,000 kc. Dual-ratio vernier colorband dial. Output of 5 watts—8 in. dynamic speaker. Wave trap for reduction of i.f. interference.  $21\frac{1}{4}$ " high x  $15\frac{3}{4}$ " wide x  $9\frac{1}{8}$ ". Model T8-18—list \$69.95.

Other models: C6-8 6T. a-w. (all wave), AC-DC cons., \$69.95; C6-12 6T. 2-band cons., \$49.95; C8-19 8T. a-w. cons., \$89.95; C8-20 8T. a-w. cons., \$89.95; C11-3 11 T. a-w. cons., \$150; T6-7 6T. a-w. AC-DC table, \$49.95; T6-11 6 T. 2-band table, \$39.95; T9-10 9T. a-w. table, \$79.95. RCA Mfg. Co., Camden, N. J.—RADIO TODAY

## GRUNOW 1936 SPECIFICATIONS

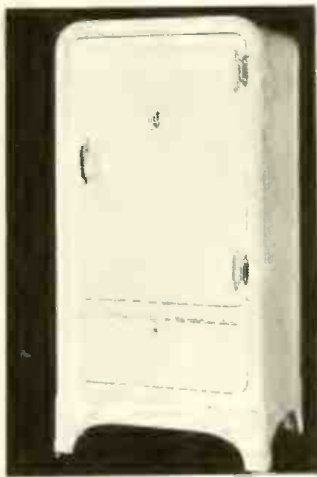

★ Deluxe and super deluxe line of seven refrigerators. Porcelain food compartment with stainless bottom. Rotary compressor utilizing Carrene—adjustable temperature control. Model 82R (illustrated)—

8.2 cu. ft., 12.4 sq. ft. shelf area. Makes 156 ice cubes—12.5 lbs.  $62\frac{1}{4}$ " high x  $31\frac{3}{4}$ " wide x  $26\frac{13}{16}$ ".

Other models: 50M, 5.03 cu. ft.,  $53\frac{1}{16}$ " x  $24\frac{1}{2}$ " x  $24\frac{3}{4}$ "; 51M, 5.03 cu. ft.,  $53\frac{1}{16}$ " x  $24\frac{1}{2}$ " x  $24\frac{3}{4}$ "; 58M, 5.6 cu. ft.,  $56\frac{5}{8}$ " x  $25\frac{1}{2}$ " x  $26\frac{5}{8}$ "; 61M, 6.02 cu. ft.,  $56\frac{1}{2}$ " x  $24\frac{1}{2}$ " x  $25\frac{1}{2}$ "; 67M, 6.7 cu. ft.,  $58\frac{3}{8}$ " x  $29\frac{13}{16}$ " x  $26\frac{13}{16}$ "; 70R, 6.7 cu. ft.,  $58\frac{3}{8}$ " x  $29\frac{13}{16}$ " x  $26\frac{13}{16}$ ". General Household Utilities Corp., 2638 N. Crawford Ave., Chicago, Ill.—RADIO TODAY

## METAL TUBE PRE-AMPLIFIER

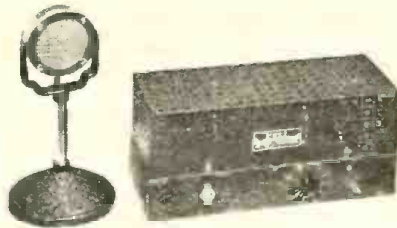

★ Two-stage resistance-coupled pre-amplifier utilizing metal tubes. Input impedance suitable for crystal and high-impedance ribbon mikes—output of 200 and 500 ohms. Designed for public address work—gain control and power switch. Operates from AC.  $11\frac{1}{2}$ " wide x  $4\frac{1}{2}$ " deep x  $5\frac{1}{8}$ " high. Model L5. Bell Sound Systems, 61 E. Goodale St., Columbus, Ohio—RADIO TODAY

## STEWART-WARNER REFRIGERATORS



★ Ten models for Stewart-Warner 1936 line. Deluxe models feature illuminated temperature control—porcelain interior and exterior. Slo-cycle twin-cylinder compressor—sulphur dioxide refrigerant. Models 766 and 766-P (illustrated)—7.4 cu. ft., 16.5 sq. ft. shelf space. Makes 141 ice cubes—12 lbs.  $61\frac{1}{2}$ " high x  $31\frac{1}{4}$ " wide x  $24\frac{13}{16}$ ".

Other deluxe models: 866 and 866-P, 8.1 cu. ft.,  $64\frac{3}{8}$ " x  $31\frac{1}{4}$ " x  $24\frac{13}{16}$ "; 666 and 666-P, 6.3 cu. ft.,  $57\frac{3}{4}$ " x  $28\frac{3}{4}$ " x  $23\frac{13}{16}$ "; 566, 5.5 cu. ft.,  $54\frac{1}{2}$ " x  $28\frac{3}{4}$ " x  $23\frac{13}{16}$ ". Master models: 656, 6.3 cu. ft.,  $57\frac{3}{4}$ " x  $28\frac{3}{4}$ " x  $23\frac{1}{2}$ "; 556, 5.5 cu. ft.,  $54\frac{1}{2}$ " x  $28\frac{3}{4}$ " x  $23\frac{1}{2}$ "; 456, 4.5 cu. ft.,  $51\frac{7}{16}$ " x  $23\frac{7}{8}$ " x  $21\frac{1}{8}$ ". Stewart-Warner Corp., 1826 Diversey Pky., Chicago, Ill.—RADIO TODAY

## 1936 GIBSON LINE



★ Six models in 1936 line. DeLuxe types feature "Magic freez'r shelf"—scientific distribution of space. Flexible gum base lacquer or lifetime porcelain finish. Hermetic monounit— $\frac{1}{5}$  hp. motor. Model CB-796 (illustrated)—7 cu. ft., 15.8 sq. ft. shelf area. Makes 105 ice cubes—10.25 lbs.  $30\frac{1}{2}$ " wide x  $27\frac{3}{4}$ " deep x  $60\frac{1}{2}$ ".

Other deluxe types: CB-696, 6 cu. ft.,  $30\frac{1}{2}$ " x  $26\frac{1}{4}$ " x  $57\frac{1}{2}$ ". Standard line: S-46, 4 cu. ft.,  $24\frac{1}{2}$ " x  $21\frac{13}{16}$ " x  $50\frac{1}{8}$ "; S-66, 6 cu. ft.,  $29\frac{3}{8}$ " x  $26\frac{1}{2}$ " x  $55\frac{1}{2}$ "; SD-646, same as S-66, with magic freez'r shelf; S-86, 8 cu. ft.,  $33\frac{3}{8}$ " x  $26\frac{3}{4}$ " x  $60\frac{1}{2}$ ". Gibson Electric Refrigerator Corp., Greenville, Mich.—RADIO TODAY

## G-E REFRIGERATORS

★ 1936 line consisting of six models. Hermetically sealed units—stainless steel cooling units. All-steel cabinets finished in white Glyptal-baked enamel—porcelain interiors. Adjustable temperature control. Model V-7 (illustrated)—7 cu. ft., 13 sq. ft. shelf area. Makes 84 ice cubes—11 lbs.  $30\frac{1}{2}$ " wide x  $56\frac{13}{16}$ " high x  $26\frac{3}{4}$ ".

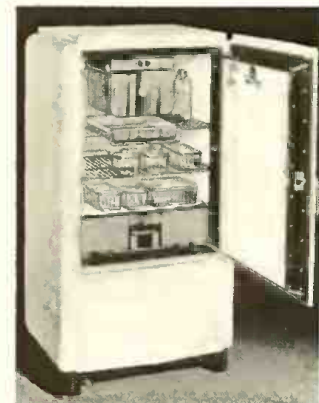

Other models: V-4, 4.3 cu. ft.,  $23\frac{1}{2}$ " x  $52\frac{13}{16}$ " x  $24\frac{3}{8}$ "; V-5, 5.2 cu. ft.,  $27\frac{3}{4}$ " x  $52\frac{13}{16}$ " x  $24\frac{3}{8}$ ". Monitor top models: M-5, 5.1 cu. ft.,  $24\frac{1}{2}$ " x  $64\frac{1}{2}$ " x  $21\frac{1}{2}$ "; M-6, 6.4 cu. ft.,  $28\frac{13}{16}$ " x  $63\frac{3}{8}$ " x  $22\frac{3}{4}$ "; M-7, 7.2 cu. ft.,  $28\frac{13}{16}$ " x  $66\frac{1}{2}$ " x  $22\frac{3}{4}$ ". General Electric Co., Nela Park, Cleveland, Ohio—RADIO TODAY

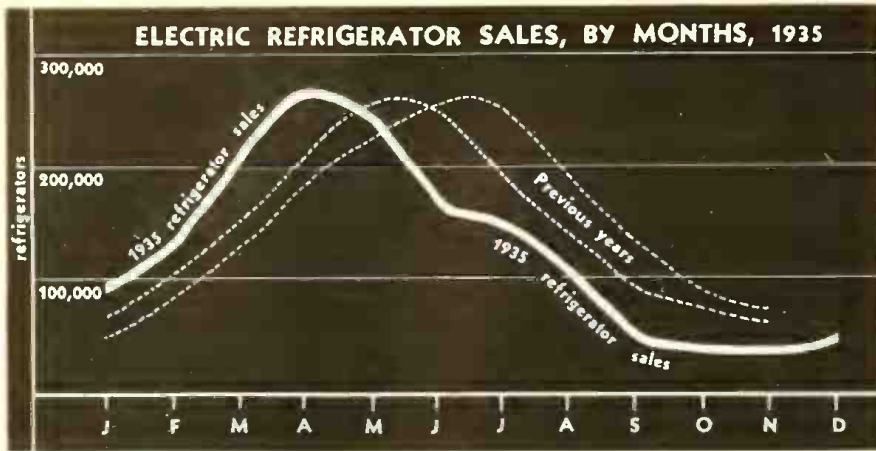

Heavy line, refrigerator sales in 1935, reveals a new break for radio dealers. Peak sales are coming earlier each year.

# FOR RADIO-REFRIGERATOR DEALERS

★ IT'S just a bump in a sales curve, but it's something for radio dealers to keep an eye on.

Rarely has refrigeration news had such special meaning for radio men. As the chart above shows, sales peak for "boxes" was definitely advanced a month or two forward in 1935, as compared with curves of other years, and the conclusion is that good refrigeration business early in the year makes the boxes ideal merchandise to push during any seasonal lull in radio receivers.

New refrigerator models, besides having the seasonal appeal which radio men are looking for, will sell under a merchandising technique similar to the retailing of radios. Dollar value of refrigerators per unit is not far from that of radio sets, prospect lists are interchangeable and selling methods are often interchangeable.

## Service similarities now

Delivery problems for radio consoles are almost identical with those of refrigerators. New types of trucks are easily adaptable to both branches, and delivery facilities, generally speaking, in point of loading gadgets and installation equipment, may be readily used for both.

Expert servicing of 1936 radio sets is, of course, a separate science and specifically has little in common with

servicing boxes, but authentic instruction in both often proceeds from the same source and much of the technical background is similar.

## Major boosters

Radio dealers who feel the urge at this point to get in on the new situation in refrigerator sales will find at least two important groups who are ready and eager to help in sales campaigns and promotional activity, the electric-power companies and the manufacturers. Both are eternally sponsoring national ad campaigns and both are spending millions to clinch the argument that electric "ice-boxes" are money-savers for American families today.

These interests are encouraged by the general uptrend in national retail sales in home appliances of higher priced brackets; the trend is conspicuous in any current business index. There is the feeling, too, that when the Soldiers' Bonus is paid, which may be very soon, millions will be invested in household equipment.

For the coming year, the dealer may expect the rural electrification developments, the FIAA and rising food prices to stimulate sales in boxes. The latter is a general condition and only adds to the popular strength of business, but either of the other elements will continue to have off-shots in specialty selling of a sort peculiar to 1936.

★ National field representatives of Frigidaire Corp., Dayton, Ohio, went to that city Jan. 14 for a four-day national convention. Program featured previews of 1936 models, outlines of plans for the selling campaign to be launched in March, and factory visits. Interesting angle is that the Dayton display will be taken on the road by Frigidaire execs for presentation to 20,000 dealers in 40 cities.

★ Westinghouse bulletins report that radio-refrigerator dealers in New Jersey intend making new sales plans to follow up a recently passed food law in that state. State Dept. of Health now requires the bakers to refrigerate pastries at 50 degrees.

★ National convention of Kelvinator distributors was held in Detroit, Mich., Jan. 8-10. Hundreds of guests, many of them also radio wholesalers, went into the Kelvinator plans for 1936, watched previews, and listened to addresses by George W. Mason, president; H. W. Burritt, vice-president; and Sam C. Mitchell, sales promotion manager.

★ Harry C. Mealey, Hotpoint refrigerator division manager for General Electric Co., has announced plans for a dramatic 1936 sales campaign. Set-up includes national, newspaper, outdoor and trade paper ads, along with a heavy supply of promotional literature for dealers.

★ Exceptionally well-attended House Furnishings and Appliance Show was staged early this month in Chicago with radio and refrigerator men active. Refrigerator displays at the Merchandise Mart included Crosley, Frigidaire, and Westinghouse; other exhibits at the Hotel Stevens were by Gibson and Universal Cooler.

★ Annual distributors' convention of the Norge Corp., Detroit, Mich., opened Dec. 10 in that city with most of the States represented in the gathering. Convention schedule was built around the 1936 Norge Rollator; company execs on the program included Howard E. Blood, president, and John H. Knapp, vice-president in charge of sales.



P. B. Zimmerman ("Zim" to admiring friends), GE's wizard of refrigerator selling, now heads all GE merchandise sales, including radio.

# BIG THINGS AHEAD!

## FOR **Hotpoint** REFRIGERATOR DEALERS!

MANUFACTURED BY GENERAL ELECTRIC

- ★ NEW DELUXE LINE
- ★ NEW STYLING
- ★ NEW FEATURES
- ★ NEW MERCHANDISING PLANS
- ★ NEW LOWER PRICES ON STANDARD LINE!

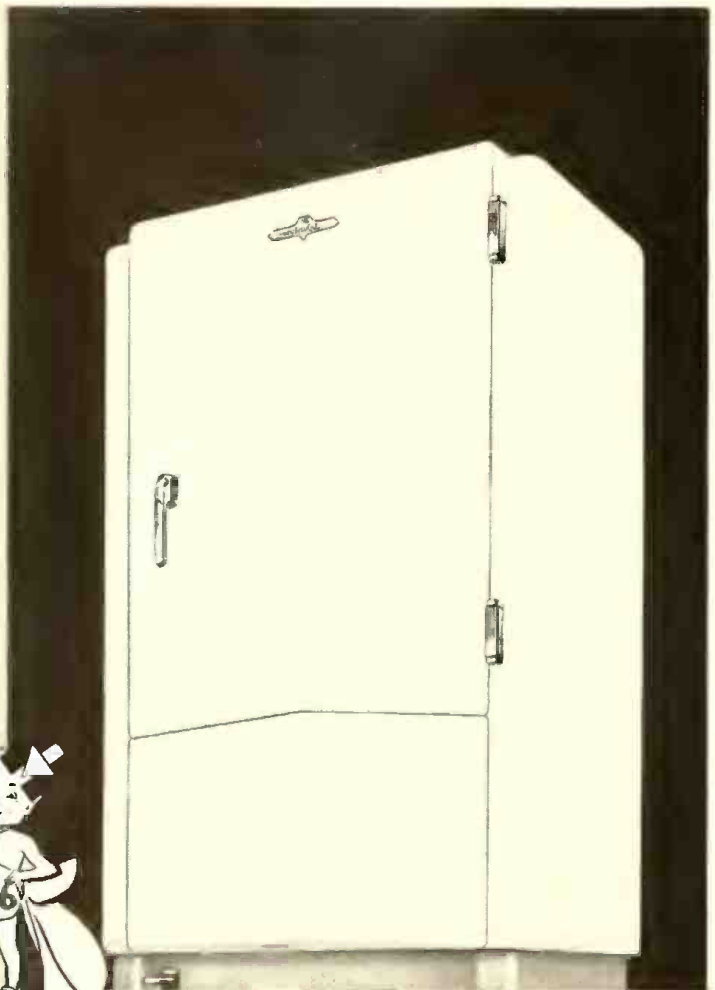
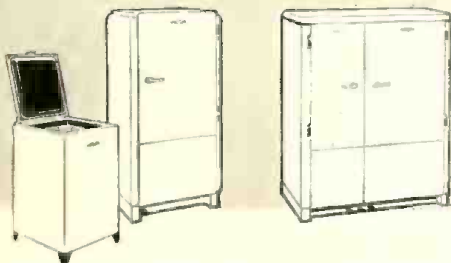

**H**OTPOINT electric refrigerator dealers are going places in 1936! With a new and expanded line, effective national advertising and a forceful merchandising program, Hotpoint invites progressive dealers to share in increased sales.

Here is what Hotpoint offers:

A complete line of 12 models. • New deluxe refrigerators with distinctive styling . . . striking beauty . . . new convenience features. A line with eye appeal and sales appeal. • Standard household models at lower prices. Equipped with the famous Hotpoint Super-Service mechanism . . .

built for years of continuous, economical service. • Larger refrigerators for use in food stores, restaurants, etc. • Small Thriftype refrigerators at astonishingly low prices for families of modest income.

• National advertising program with full pages in *The Saturday Evening Post*. • Expanded co-operative local advertising for your newspapers and for radio and outdoor. • Window displays. • New merchandising plans to help you sell more with less effort and less cost.

Yes, Hotpoint dealers are going places. Come along! Hotpoint's easy time pay-

ment extension plan gives you adequate display for little investment. Overnight warehouse deliveries. For complete details, clip the coupon and mail it today!

HOTPOINT Refrigerator Div., Appliance and Merchandising Department, Section RT 1, Nela Park, Cleveland, Ohio.  
Please rush details of the Hotpoint Refrigerator franchise, without obligation.

Name

Address

City  State

# IN 103 DIFFERENT COUNTRIES DISTRIBUTORS SPECIFY SYLVANIAS!



SYLVANIA CONTINUES TO EXPAND! NOW IN 103 COUNTRIES, DEALERS AND DISTRIBUTORS DEPEND ON SYLVANIA RADIO TUBES FOR PERFECT RECEPTION

• Sylvania glass tubes and Sylvania metal tubes are known and sold around the world! That means that whether they are bought for replacement or for original equipment, *Sylvanias satisfy.*

For three years Sylvania has been the largest supplier of glass tubes for original equipment, and the same high quality you have always expected and received from Sylvania glass tubes is present in the new metal tubes.

Whether you buy Sylvania glass tubes or Sylvania metal tubes, you can be sure they are good tubes. That's because tone fidelity and long life are *built into Sylvania tubes.*

Write for complete sales and technical details on Sylvania Radio Tubes. Communicate with foreign sales division, Hygrade Sylvania Corporation, 500 Fifth Avenue, New York, N. Y. Cable: Hysylvania, New York. Domestic correspondence should be addressed to Emporium, Pa.

## SYLVANIA

THE SET-TESTED RADIO TUBE